

# SCIENTIFIC AMERICAN

[Entered at the Post Office of New York, N. Y., as Second Class matter. Copyright, 1896, by Munn & Co.]

A WEEKLY JOURNAL OF PRACTICAL INFORMATION, ART, SCIENCE, MECHANICS, CHEMISTRY, AND MANUFACTURES.

Vol. LXXIV.—No. 24.  
ESTABLISHED 1845.

NEW YORK, JUNE 13, 1896

[\$3.00 A YEAR  
WEEKLY.]

## CONSTRUCTION OF THE YARROW WATER TUBE BOILER.

We have been favored by Mr. Yarrow, of torpedo boat fame, with photographs and a description, showing his new system of expanding boiler tubes by steam, and other improvements in the boilers themselves. The tube expander which is here shown in operation in the shops at Poplar, London, was designed to replace the old apparatus, which was worked by hand. The introduction of the steam-driven tool has resulted in a great saving of time and cost over the old system. The expander, which is small and compact, is suspended at the desired height, and is driven either by a motor or, as shown in our engraving, by a cord from the overhead shafting, operating through a length of flexible shafting. The taper mandrel within the body of the expander is revolved by the action of the rollers, the body being driven by the miter gear, which can be seen in the cut. By giving the rollers a slight inclination they are made self-feeding, and over-expanding is guarded against by providing a stop. In the accompanying illustration three of the Yarrow boilers are shown turned up on end for the purpose of expanding the tubes where they enter the water pocket.

Mr. Yarrow states that the impression that it is a difficult matter to retube his style of boiler, on account of the tubes being straight, is erroneous, as may be seen from the accompanying cut, which shows a section through one of the boilers. If it is desired to insert a tube, say in the center of the tube plate, it is only necessary to pass it far enough through the upper or lower

plate to clear the opposite plate, passing the tube from the hole in one plate to the next hole in other plate and repeating the movement until the desired position is reached. Thus the upper end of the tube is first passed through hole, A, in the drum; it is then slid down until the lower end enters hole, B, in the water pocket and the upper end is clear of A. This end is then passed up into C, and the lower end drawn out of B and placed in D. By continuing this movement the tube can be carried through a line of holes to its place. The same method is adopted in remov-

ing a faulty tube, though, of course, all the tubes in its way have to be also removed. The lower tube end is expanded, in the case of repairs, by sending a boy into the water pocket for the purpose. When this cannot be done, a long mandrel is passed through the tube and operated from above.

The accompanying section of the upper drum of a Yarrow boiler shows the new system of automatic feed. All makers and users of water tube boilers are aware of the value of any system that will automatically regulate the feed. These boilers contain very little water at any one time and the fierce ebullition causes great and rapid fluctuations of water level.

Yarrow & Company are endeavoring to overcome the difficulties of constant feed by providing an automatic device within the drum of the boiler, and by providing each boiler with its own independent donkey pump. It is claimed that only in this way can the obstruction of a breakdown in any one boiler be localized. In any group of boilers which have a common source of feed supply the bursting of a tube in one of the boilers will call for an extra supply of water that will be greater in all probability than the capacity of the pump. As a consequence the water level will be lowered, not merely in that particular boiler, but in the whole set. This would be a dangerous predicament and might easily result in serious injury to the complete plant.

These considerations are especially strong when applied to the water tube boiler, where the internal pressure in the tube would cause a specially large escape of

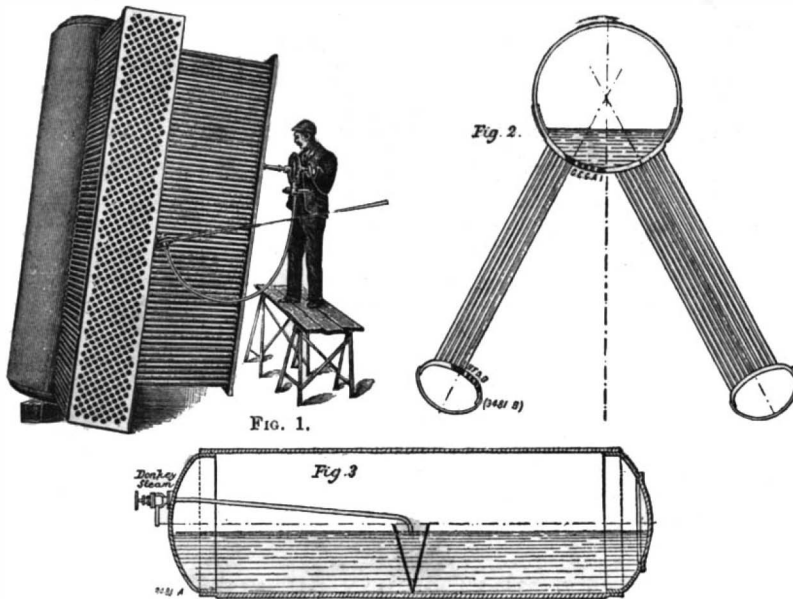

DIAGRAMS SHOWING METHOD OF RETUBING AND AUTOMATIC FEED OF THE YARROW BOILER.

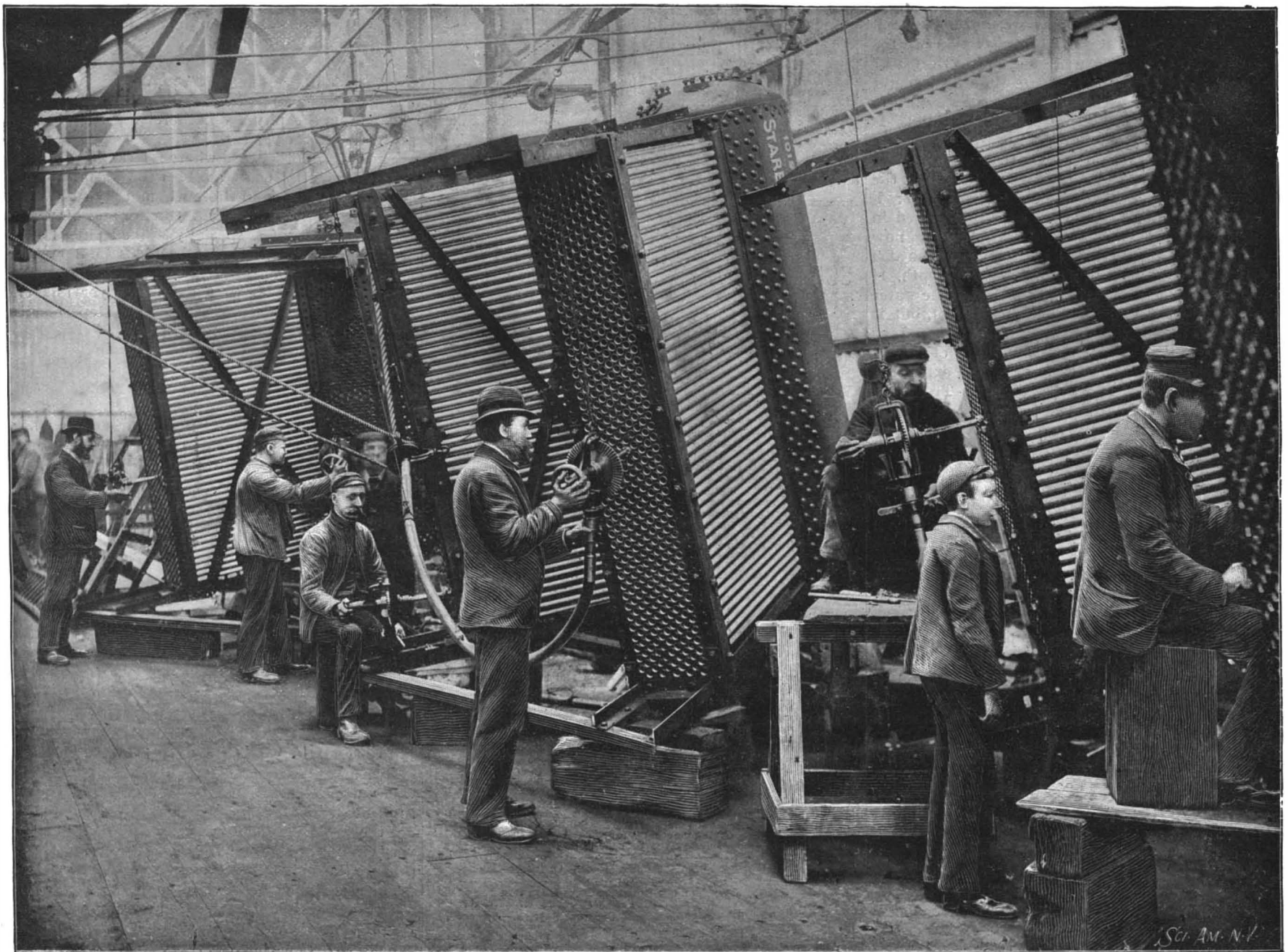

EXPANDING BOILER TUBES IN THE YARROW & COMPANY'S MACHINE SHOPS.

water in the event of its rupture, as compared with the tubes in the common form of boiler, where the pressure is external.

Another advantage to be secured by using separate feed is that it favors the use of a very simple and reliable device for securing automatic feed. It is self evident that any so-called automatic feed must be absolutely reliable, for the reason that the knowledge that such a feed has been fitted to a boiler will cause the stokers to pay less attention to the water level.

The device shown in the cut has proved very successful on a boat fitted with engines of 300 horse power; though it remains to be seen how it would work on a large scale. About the center of the steam drum is arranged an inverted funnel, which is perforated so as to insure that the water level within it shall be the same as the general level in the drum. The funnel serves to prevent any violent ebullition of the water within it and maintains it at a steady level. Above the water in the funnel and near its surface is fixed the steam supply pipe for the donkey pump. So long as the water is below the pipe the donkey will supply the boiler; but when it reaches the pipe, water, in place of steam, will pass to the pump and actuate the steam piston. Now, since the steam piston is larger than the pump piston, it follows that, as long as water flows through the steam pipe, the boiler will be relieved of water, and this will go on until the level falls again. It is thus evident that a double advantage is secured by this system—the boiler is pumped up if the water is too low and it is relieved if it be too high, both actions being automatic.

The Pool of Siloam.

The excavations which are being made in Jerusalem have disclosed much that was hitherto unknown about the pool of Siloam. The identification of the site of this pool is important, because of its bearing on the situation of the city walls. It has hitherto been considered that the pool of Siloam, shown to every visitor of Jerusalem, was one of the few undisputed localities in the topography of the sacred city. Now, however, as investigation progresses, doubts have been raised on this point. Among archæologists a contest has arisen as complicated as that concerning the site of Calvary, the sepulcher, and other sacred places in Jerusalem. The pool of Siloam is in size the least of all the Jerusalem pools, which from the most ancient times have been relied upon by the inhabitants to store up water from the springs. It had, however, the singular characteristic of suddenly increasing in depth as the water poured in from some unknown source.

The pool of Siloam, although small in size, played an important part in the sacred history of Jerusalem. It was to Siloam that the Levite was sent with the golden pitcher on the "last and great day of the feast" of tabernacles; it was from Siloam that he brought the water which was then poured over the sacrifice in memory of the water from the rock of Rephidim. It was to this Siloam water that the Lord pointed when he stood in the temple and cried, "If any man thirst, let him come unto me and drink." The Lord sent the blind man to wash at the pool of Siloam, the sacredness and efficacy of whose waters are still believed in at Jerusalem. The pool of Siloam, which has now been almost wholly uncovered and which is the one formerly shown to visitors, is 18½ feet in depth, 14 feet wide at one end and 17 at the other. The water in it is maintained at a depth of 3 to 4 feet, but is likely to rise a foot or more at any moment. It is faced with a wall of stone, now greatly out of repair. Several columns stand out of the side walls extending from the top downward into the cistern. The water passes out of the pool through a channel cut in the rock, which is covered for a short distance. This subsequently opens and discloses a lively, copious stream which empties into a garden planted with fig trees. Jerome, who lived only six miles from the pool of Siloam, refers to the intermittent character of its waters, which has led some historians to identify it with Bethesda. Josephus speaks of its waters as having been very abundant, but recent investigations do not bear this out.

There are a large number of somewhat similar pools in Jerusalem, which has thirty or forty natural springs within a radius of eight miles. If it could be shown that one of these was in reality the pool of Siloam, whose location has not hitherto been questioned, it would add a still further confusing element to the discussion of the historical sites in Jerusalem. Many of the most important places depend for their identification upon their nearness to or remoteness from the pool of Siloam. The mysterious ebb and flow of the waters of the present pool has been largely relied upon as sufficiently proving its identity with that referred to in the Scriptures. It has now, however, been found that a similar phenomenon takes place in the Fountain of the Virgin, which is close by. There the water rose a foot in five minutes, and within five minutes more it sank to its former level. It is believed that the excavations which are being made in Jerusalem may explain this apparent mystery, which nobody has yet been able to account for.—Public Opinion.

Scientific American.

ESTABLISHED 1845,

MUNN & CO., Editors and Proprietors.

PUBLISHED WEEKLY AT

No. 361 BROADWAY, NEW YORK.

TERMS FOR THE SCIENTIFIC AMERICAN.

(Established 1845.) One copy, one year, for the U. S., Canada or Mexico... \$3 00 One copy, six months, for the U. S., Canada or Mexico... 1 50 One copy, one year, to any foreign country belonging to Postal Union 4 00 Remit by postal or express money order, or by bank draft or check.

The Scientific American Supplement

(Established 1876) is a distinct paper from the SCIENTIFIC AMERICAN. THE SUPPLEMENT is issued weekly. Every number contains 16 octavo pages, uniform in size with SCIENTIFIC AMERICAN. Terms of subscription for SUPPLEMENT, \$5.00 a year, for the U. S., Canada or Mexico. \$6.00 a year to foreign countries belonging to the Postal Union. Single copies 10 cents. Sold by all newdealers throughout the country. See prospectus, last page. (Combined Rates.—The SCIENTIFIC AMERICAN and SUPPLEMENT will be sent for one year, to one address in U. S., Canada or Mexico, on receipt of seven dollars. To foreign countries within Postal Union eight dollars and fifty cents a year.

Building Edition of Scientific American.

(Established 1885.) THE BUILDING EDITION OF THE SCIENTIFIC AMERICAN is a large and splendidly illustrated periodical, issued monthly, containing floor plans and perspective views pertaining to modern architecture. Each number is illustrated with beautiful plates, showing desirable dwellings, public buildings and architectural work in great variety. To architects, builders and all who contemplate building this work is invaluable. Single copies 25 cents. By mail, to any part of the United States, Canada or Mexico, \$2.50 a year. To foreign Postal Union countries, \$3.00 a year. Combined rate for BUILDING EDITION with SCIENTIFIC AMERICAN, to one address, \$5.00 a year. To foreign Postal Union countries, \$6.50 a year. Combined rate for BUILDING EDITION, SCIENTIFIC AMERICAN and SUPPLEMENT, \$9.00 a year. To foreign Postal Union countries, \$11.00 a year.

Export Edition of the Scientific American

(Established 1878) with which is incorporated "LA AMERICA (CIENFIFICA E INDUSTRIAL," or Spanish edition of the SCIENTIFIC AMERICAN published monthly, uniform in size and typography with the SCIENTIFIC AMERICAN. Every number contains about 50 pages, profusely illustrated. It is the finest scientific, industrial export paper published. It circulates throughout Cuba, the West Indies, Mexico, Central and South America, Spain and Spanish possessions—wherever the Spanish language is spoken. THE SCIENTIFIC AMERICAN EXPORT EDITION has a large guaranteed circulation in all commercial places throughout the world. \$3.00 a year, post paid to any part of the world. Single copies, 25 cents.

MUNN & CO., Publishers, 361 Broadway, New York. The safest way to remit is by postal order, express money order, draft or bank check. Make all remittances payable to order of MUNN & CO. Readers are specially requested to notify the publishers in case of any failure, delay, or irregularity in receipt of papers.

NEW YORK, SATURDAY, JUNE 13, 1896.

Contents.

(Illustrated articles are marked with an asterisk.) Ang-Kor Wat, ruins of... 376 Archimedeon screw\*... 376 Avalanche, study of a Swiss... 375 Boiler explosion... 379 Boiler, water-tube\*... 369 Camera stand\*... 372 Carriage race, horseless\*... 377 Coast defenses... 371 Copper-mining\*... 373 Diphtheria investigation... 374 Eclipse, the coming... 379 Electric light, Edison's new\*... 378 Elevated railroads, extension of... 374 Essay competition... 370 Films, employment of... 379 Furnace\*... 374 Gas engine\*... 372 Gesture in disease, significance... 378 Insect remover and destroyer\*... 374 Lathe, copying\*... 372 Light, Edison's new\*... 378 Meat and milk from sewage farms... 376 Patent solicitors... 370 Pavement, a cushion\*... 373 Peary's plans... 374 Rapid transit... 374 River and Harbor Bill... 371 Roentgen photography... 374 Science notes... 374 Siloam, the pool of... 370 Skin, utility of colored... 376 SUPPLEMENT, the... 371 St. Paul, record of... 375 Steam, superheated... 371 Sun spots\*... 379 Tree jacket, orange\*... 376 Water, device for raising\*... 376

TABLE OF CONTENTS OF SCIENTIFIC AMERICAN SUPPLEMENT No. 1067.

For the Week Ending June 13, 1896.

Price 10 cents. For sale by all newdealers.

I. AERONAUTICS.—The North Pole Balloon.—A detailed account of Herr Andree's Polar balloon, with which he hopes to reach the North Pole.—1 illustration... 17057 II. ARCHÆOLOGY.—Babylonia and Elam Four Thousand Years Ago.—By HERBERT G. FISCHER.—This paper gives reproductions of the obverse and reverse of a Babylonian tablet.—2 illustrations... 17060 III. CHEMISTRY.—Water Analysis by Pharmacists.—Simple directions for a sanitary examination of water by pharmacists... 17061 IV. CIVIL ENGINEERING.—Coast and Lighthouse Illuminating in France.—By C. S. DU RICHIE PRELLER.—The first installment of a comprehensive paper.—16 illustrations... 17069 Light Railways in Belgium.—An account of a typical light railway, very interesting in view of the present agitation in favor of light railways.—4 illustrations... 17064 A Novel Tow Boat.—1 illustration... 17066 V. EDUCATION.—The Making of a Great University for London.—By SYLVANUS P. THOMPSON.—This interesting article contains the table which gives statistics of the leading universities of the world... 17048 VI. MEDICINE.—The Senses.—Their Use and Cultivation... 17061 The Special Influence of Altitude Upon Health, Disease and Sanitation.—By R. E. SOLLY, M.D... 17060 VII. MISCELLANEOUS.—The Coronation of the Czar of Russia.—An interesting account of the coronation and the method of illuminating the tower of a church by electricity.—2 illustrations... 17047 A Novel... 17061 Engineering Notes... 17063 Electrical Notes... 17063 Miscellaneous Notes... 17063 To Prevent Frosting of Windows... 17062 VIII. ORDNANCE.—Automatic Firing Guns.—By HIRAM STEVENS MAXIM.—The Peabody-Martini Rifle.—The conclusion of this important paper on the subject of automatic firing guns.—5 illustrations... 17056 IX. PHOTOGRAPHY.—Carbon or Autotype Printing.—By T. O. MAWSON.—Relative Photographic Values of Midday Sunlight... 17057 A Kinetoscope Giving Several Views.—A description of the Doley kinetoscope, which gives four views at the same time.—4 illustrations... 17058 X. PHYSICAL GEOGRAPHY.—Puffing Holes.—An interesting account of this remarkable phenomenon... 17060 XI. PHYSICS.—The Action of the Roentgen Rays Upon Double and Triple Electric Strata.—By M. N. PILTSCHIKOFF... 17062 XII. PSYCHOLOGY.—The Nineteenth Century Seeress.—An account of Mlle. Henriette Couédon, a modern Parisian seeress who has been attracting so much attention among French medical men.—1 illustration... 17049 XIII. TYPOGRAPHY.—An Old Press Room.—An interesting view of a press room at the middle of the last century.—1 illustration... 17065

OUR SEMI-CENTENNIAL ESSAY COMPETITION.

We would draw the attention of competitors for the \$250 premium, offered for the best essay on the "Progress of Invention During the Past Fifty Years," to the fact that the date limit set for the reception of manuscript is drawing very near. There is a danger of the essayist underestimating the time which will be necessary for him to do justice to so comprehensive a subject. Although the paper will be comparatively short, covering about two and a half columns of the SCIENTIFIC AMERICAN, it is liable to involve an amount of previous reading and general reference which will cover more time than the intending writer may estimate. For this reason, and in order that the judges may have ample time to examine manuscript which will be submitted to them, we trust that intending competitors will not defer the transmission of their essays until the last allowable date.

We also direct attention to the card which is appearing in our current issues, by means of which we are endeavoring to obtain an expression of opinion on the part of our readers as to what invention introduced during the last fifty years has conferred the greatest benefit upon mankind. The answers that have already come in indicate that opinion will be far from unanimous; and the value and interest of the vote will depend largely upon the number who favor us with a reply. We hope that the majority of our readers will find the matter of sufficient interest to send a card expressing their views.

PATENT SOLICITORS AND THE PROPOSED PATENT BAR.

Such relations as those of lawyer to client or of physician to patient have always been recognized as sacred. In the professions also so much depends upon the competency as well as honor of the practitioners that the law very properly takes cognizance thereof, and requires proof of standing and of competency before any person is allowed to practice in the professional role. In the lawyer's care are placed the rights of his client to property, to freedom or to life itself. He very justly is subject to rigid investigation before being admitted to the bar and is required to serve a clerk's apprenticeship before practicing independently. A similar condition obtains in the case of the physician. He must possess definite and statutory qualifications before he is allowed to practice his profession and take upon himself the dispensing of remedies against the ills of mankind. His adjunct the apothecary is subject to similar requirements. Exhaustive examinations, practical and theoretical, have to be passed before the pharmacist can legally put up a single prescription. He is obliged to understand the qualities of all drugs; to watch every prescription for the detection of possible error in it. If an error has crept in involving danger to the patient, he is to note it, and guard against it, and must act as a constant check upon the physician, thereby giving additional protection to the patient.

There is another case where relations just as sacred and confidential exist as between members of the above professions and those whom they serve. We refer to the relations of patent solicitor and his client.

The services of a specially trained patent solicitor are essential, and the inventor has to enter into intimate and confidential relations with him—relations precisely comparable to those of lawyer and client. His secret work is all disclosed. The steps of his invention are discussed; he tells what led to it, what was his first conception, in order to enable the fundamental idea to permeate specification and claims. It would be hard to find a more confidential relationship than that of inventor and his patent attorney. Honor is the first essential in the practitioner's character. The papers are prepared, the solicitor, under his power of attorney, is given carte blanche to prose cute, and fees are paid. Competency is now required to properly conduct the work.

Within the past two or three years the country has been flooded with pamphlets, tracts and circulars from patent solicitors whose irregular practices are widely known in the profession. To warn the widely scattered class of inventors against such offenders is a slow, unsatisfactory, and impracticable process. The inventor is left to be enlightened only at the hands of that hard master bitter experience.

These irregulars are often possessed of capital and by extensive advertising are able to lure the unsuspecting into their clutches, and in some cases these "gentlemen" have a quite extensive practice before the Patent Office. Their business methods are widely known and are thoroughly understood in the Patent Office, whose officials would gladly embrace any opportunity to disbar such attorneys from practice, were not the provisions of the law for attaining this end so very circumscribed that it is practically impossible to procure the evidence necessary to convict.

The remedy for these evils is suggested in the annual report of the United States Commissioner of Patents. He proposes the establishment of a patent bar analogous to the bar of courts of regular procedure, but a bar whose members should be solicitors of patents. There

is no thought of restricting the membership to lawyers, but the idea is to insure proper representation of the rights of applicants for patents. The essentials for practice before the office having been determined on, and the conditions for the issuance of a license or diploma being fixed, none save those holding such license or diploma should be eligible to appear as attorneys in the prosecution of patent cases before the office. Such an association could take cognizance of practices over which the Patent Office would have no jurisdiction and could punish offenders against common professional morality. Such a course of common self-defense has been found necessary in England, and resulted in the establishment some few years ago of the Chartered Institute of Patent Agents.

The necessity for such an association arises from the very limited powers of the Commissioner of Patents in disqualifying those who are known in the profession to be disreputable and dishonest. Stories constantly reach us of inventors who have lost their fees or who have had their interests jeopardized or their patents lost at the hands of irregular attorneys; but the Patent Office, although perfectly aware of the practices of such attorneys, is not able to protect such victims or punish such offenders, as the latter are sufficiently clever not to commit an act of "indiscretion" after the Patent Office has jurisdiction over the case. The Commissioner has pointed out in his report the only solution for these abuses, and the establishment of a patent bar would elevate permanently the standard of the profession, and would redound alike to the advantage of the profession and to the great mass of inventors, who number many thousands, and who deserve to receive every protection from harm and imposition.

#### THE RIVER AND HARBOR BILL.

The River and Harbor Bill has been passed over the President's veto in the House by a vote of 220 to 60, and on the following day it was similarly passed in the Senate by a vote of 56 to 5, the vote in the House being taken without any debate, that of the Senate being preceded by a debate of four hours. There is one important feature of the bill that has now become law which will commend itself to all engineers who have had any practical experience in river and harbor improvement: we refer to the provision which it makes for the letting of the whole of a contemplated scheme of improvement by contract, and the authorization of the expenditure of the whole sum necessary to carry it out.

It is safe to say that there is no department of public works in which the old system of executing work by piecemeal has proved more extravagant and wasteful than in this. In river and harbor improvement the exigencies of the case generally demand that the work shall be pushed through with dispatch. To place a certain sum of money at the engineer's disposal, and tell him to go ahead and do as much as he can with it, is in some cases to invite disaster. This has been proved time and again in the construction of jetties, training walls, revetments, etc., where the construction of the trestle, mattress, or other preliminary and more or less unstable structure has necessarily to precede and keep well ahead of the stone rip-rap and ballasting which is subsequently added to give it stability. It has been a common thing for the harbor jetty, which has been built in the summer, and left without rock ballast because the year's appropriation had run out, to be swept away by the winter's gales. Moreover, the intermittent system of work involves the idleness and depreciation of a vast amount of valuable plant, which under the present arrangement will be kept continuously at work.

It is unfortunate that the annual report of the engineers in charge of this branch of work, or at least a brief digest of it, is not more widely read by the public at large. The mere recital of the vast improvements which have been made in both harbor and river navigation would make the large sums annually asked for this work appear more reasonable and less extravagant than they are popularly supposed to be. A few feet more depth of water on an ocean bar, or as many inches gained on the gravel bar of an inland river, will mean many thousands of tons increased capacity for the channel or river in question, and an enormous advance in the trade of the districts which are served thereby.

#### COAST DEFENSE.

The nation has received another emphatic reminder of the necessity for improved coast defenses in the shape of a statement by a member of the Senate Committee which recently inspected the fortifications of the port of New York. At the close of the inspection Senator Squire stated that the committee was instructed "to visit and examine the harbor defenses of the city of New York, it being known that the port of New York was better protected than any other of the twenty-seven ports from Portland, Maine, down." At Sandy Hook they found "just two of the direct fire guns in readiness for firing." There were "sixteen mortars ready for placing, but without

conning towers or rangers." At Fort Wadsworth there were "five 8 inch guns, not yet emplaced, and it will be some time before they are ready. At Fort Hamilton" the committee "found a 10 inch gun not yet mounted." The senator drew attention to the fact that "few people stop to think an enemy can come in through Long Island Sound and Hell Gate." On the Sound they "found at Willets Point two 10 inch guns not yet emplaced," and three or four 8 inch guns. "Here is the seat of the great torpedo school, having the only complete casement in the United States." The torpedo arrangements are very complete; and "they undoubtedly form a most deadly defense, if properly protected with guns; but they are not protected."

As compared with the above mentioned guns already on the ground, "the committee in its report will say what is absolutely needed for the defense of New York. First of all, ninety-three direct fire 8, 10, and 12 inch long range, high power guns. In addition to these, one hundred and seventy-six 12 inch steel rifle mortars and twenty-five rapid fire guns."

Such is the present condition of the New York defenses, and New York is the best defended of the twenty-seven ports. It must, moreover, be remembered that the building of high power guns and the preparation of emplacements is the work of years. "If all the manufacturing facilities now available were put into use, it would be impossible properly to fortify New York alone in less than three years." Of all the contemplated national expenditures none is more urgent than this, for there is no other point at which an enemy could deliver a blow with such immediate and lasting effect. The spirit which prompts military preparations of this kind is not aggressive, but, as its name indicates, strictly defensive, and therefore pacific.

In view of the statements of Senator Squire, it is gratifying to note that the agreement just reached by Congress on the Fortifications Bill gives the country by far the most liberal appropriation for coast defense ever made. The bill now carries \$11,572,964, of which \$7,377,888 is an outright appropriation and \$4,195,076 an authorization of contracts. We note, moreover, with pleasure, that the House and Senate conferees have provided for the manufacture of a 16 inch gun, being prompted thereto by the consideration that improved methods of manufacture will enable us to turn out a reliable gun of this caliber, and that its superior smashing effect upon hard-faced armor renders it a desirable weapon for coast defense. The arguments in favor of these large guns will be found in detail in our issue of May 30.

#### Superheated Steam.\*

The practical difficulties in the way of realizing the promised economical gains resulting from the use of superheated steam have thus far more than balanced the advantage derivable by its application in all ordinary and usual cases. It was at one time the most attractive and common field of invention.

Of the four principal and recognized methods of reducing that waste which comes of initial, or cylinder, condensation—compression, jacketing, compounding, and superheating—the last named, could all mechanical difficulties be overcome, would be by far the best and most effective. The two kinds of difficulty to be overcome are those attending the construction of a superheater incapable of injury by the process of superheating and the introduction of the required and variable amount of superheat at the engine without injury to cylinder, piston, valves, or packing.

The boiler, as well as the cylinder, is the gainer by superheating, for the reduced expenditure at the cylinder means less demand upon the boiler, and the added heating surface at the superheater gives a still further gain.

The economical effect of a small amount of superheat is seen in the securing of dry steam at the engine and in the reduction of cylinder condensation, and, if the superheating be carried far enough, the engine is transformed into a superheated steam engine. The effect of superheating, so far as employed in the steam engine, ordinarily, is the checking of heat waste by initial condensation. The real limit of gain at the engine is found when the gain by reduction of initial condensation reaches its economical maximum. A more serious difficulty is found in constructing superheating apparatus that shall be safe, adjustable to the varying demands of the engine, and costing little for maintenance.

The economy of superheating comes of the fact that it is possible to reduce the waste of condensation by the expenditure of but a fraction of the amount of heat in superheating the charge that would otherwise be expended through such condensation. The application of one thermal unit in superheating invariably saves several units of heat which, with saturated steam, would be stored temporarily in the metal of the cylinder, to be later discharged without performing its share of the work. "The limit in superheating is, today, considered to be practically somewhere inside of 500° F. or within a range of not much above 100° F.

\* Abstract of a paper by Prof. R. H. Thurston before the St. Louis meeting of the American Society of Mechanical Engineers.

above the usual maximum temperature of saturation." The results of some fifty authentic and well conducted experiments show that the gain in fuel ranges from ten to fifty per cent of the fuel used with wet steam; that about 100° F. gives complete extinction of initial condensation; that even fifteen or twenty degrees will make an important gain in reduction of internal wastes; that every discreetly applied use of this system returns from two to ten times its cost in heat expended; and that the indications are, judging from past and present practice, that good engineering in this direction pays well. The average of fifty-two cases observed by the writer gives a gain of twenty-six per cent with a superheat of 105° F.

Taking an average case in which the quantity of heat brought over from the boiler is 1,100 B. T. U., and twenty-five per cent condensation occurs at entrance into the cylinder, the heat wasted per pound is 275 B. T. U. To supply this amount of heat by superheating the steam would demand an increase of temperature of 570° F. The economy is measured by the difference between this equivalent of the waste and the quantity of heat expended—wasted in a certain sense—in its reduction.

The conclusions of practical importance are:

1. Superheated steam, as hitherto employed in the steam engine, has absolutely no thermo-dynamic value. The value of the maximum measure of ideal efficiency,  $(T_1 - T_2) T$ , is in no manner altered by its introduction into the system.

2. Superheating has for its sole purpose and result in the steam engine to-day the reduction of the internal thermal wastes of the engine, consequent upon the phenomenon known as initial or "cylinder condensation." Here it is extraordinarily effective, and a small quantity of heat expended in superheating the entering steam effects a comparatively large reduction in the expenditure of steam in the engine.

3. Superheating is superior to any other known means of reduction of internal waste, such as jacketing; while the multiple cylinder engine has also its limitations.

4. The introduction of metallic packings and of high test lubricants has enormously reduced the difficulties resulting from destruction of packing and decomposition of lubricants under the action of superheated steam.

5. The low temperature of gases in the uptake of modern boilers, while it lessens the difficulty of destruction of superheaters by heat, necessitates a correspondingly large area of superheating surface. One of the most serious and attractive problems for the engineer to-day is the production of a superheater which will withstand gases of high temperature, transfer their heat to steam, and have a reasonably long life.

6. Small engines will gain by superheating more than large, slow engines more than fast, and simple engines more than multiple cylinder systems.

7. The larger the waste to be checked in the engine, the farther should the superheating be carried.

8. The extent of superheating should be adjustable—not only to the particular size and type of engine in view, but also in the same engine—to the extent to which expansion is carried.

9. The average simple engine consumes an annual amount of fuel about equal in value to its own first cost. Five dollars being returned in saving to each dollar paid for superheating, it will pay annually to expend the full equivalent of the interest on the price of the engine in maintaining a good superheating system. When, however, as has hitherto usually happened, this account includes such large interest and wear and tear accounts as cause the total annual expense to exceed this financial limit, the engineer will wisely decline to thus invest capital.

10. Given an efficient superheater, and the engineer can adjust his temperature and pressures of working fluid to the character of material in boiler and engine, and secure the best adjustment of the thermal to the dynamic limit.

11. This is to-day the greatest problem presented to the designing and constructing engineer, unless it be that of rendering the interior of the cylinder non-conducting, so as entirely to prevent initial condensation, thus making the steam engine a purely thermo-dynamic machine.

#### The Scientific American Supplement.

The readers of the SCIENTIFIC AMERICAN, who have not seen late numbers of the SCIENTIFIC AMERICAN SUPPLEMENT, are urged to send for a copy, in order that they may see the new features of it. An entire page is devoted to Engineering, Electrical, and Miscellaneous Notes. These notes are excerpts, abstracts and translations from the scientific and technical press of the world. A column of Selected Formulæ is also given each week. The object of this collection is to give the latest formulæ and to form an appendix to the "Scientific American Cyclopaedia of Receipts, Notes and Queries." Various other interesting features have been added which will make the SUPPLEMENT more popular among a larger class of readers. Subscription price, \$5 per annum; single copies, 10 cents each.

**A HANDY CAMERA STAND.**

The ingenious camera stand shown in the accompanying illustration has been patented by Mr. Lafayette Noble, of No. 40 Washington Street, Haverhill, Mass. It consists of a ferrule, which is adapted to be fitted on the top of a stick which has been driven into the ground for the purpose. It is secured in place by a thumbscrew, and its upper end is reduced to carry a cylinder, which is slipped on over the same, and also held in place by a thumbscrew. The upper end of this cylinder is provided with notches, which receive the hooked ends of four arms, which, when in place, extend at right angles to each other in a horizontal

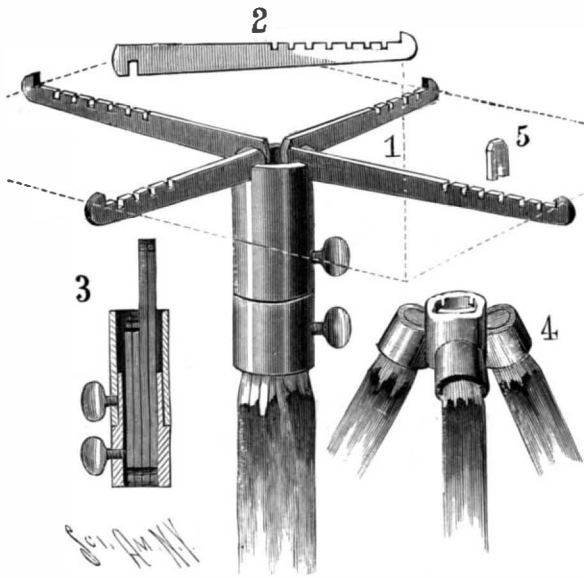
**NOBLE'S CAMERA STAND.**

plane, and form a base for the camera to rest on. The outer ends of these arms are provided with upwardly projecting lugs, which engage the ends and sides of the camera. The upper edges of the arms are notched to receive the lower forked end of a block, Fig. 5, which extends above the arm and engages a recess in the bottom of the camera. By this arrangement lateral and longitudinal movement of the camera are entirely prevented. It will be seen that, by loosening the upper thumbscrew, the cylinder, arms, and camera may be swung round into the desired position. If so desired, the lower ferrule may be formed to receive three supports, as shown in Fig. 4. It will be seen that when not in use the arms can be unhooked and slipped into the ferrule, as shown in Fig. 3, the whole apparatus occupying so little space that it can easily be carried in the pocket. On account of its handiness, it should specially meet the needs of the amateur photographer.

LORD RAYLEIGH has been appointed a foreign member of the Copenhagen Academy of Science.

**IMPROVED GAS ENGINE.**

Mr. Harry L. Parker, of Princeton, Illinois, has patented an improved gas engine, the details of which are shown in the accompanying illustration. The invention consists of an auxiliary cylinder, having a valved connection with the main cylinder, and provided with a valved piston moving in unison with, and traveling in the same direction as, the main piston. The main piston is connected at its front face by a pitman with the main driving shaft, and on the rear face it has a hollow piston stem which passes into an auxiliary cylinder, where it carries a piston. The two cylinders are connected by suitable ports and by a conical plug valve operated from the main shaft, whereby the explosive mixture may be admitted from the auxiliary to the main cylinder. The main cylinder is also provided with an exhaust port, which leads through said valve to the final exhaust as shown. In the engraving the engine is on the forward stroke, and the cylinders are connected through the valve; on the return stroke the valve will be thrown over, opening the exhaust from main cylinder and closing the ports between the two cylinders. The inner end of the main cylinder is provided with a diaphragm to prevent the mixture from burning faster than it enters the cylinder. The ignition is done by suitable electrodes set in the head of the cylinder. The auxiliary cylinder is provided with a chest at its outer end, connected with the gas and air supply, which contains a port operated by an outer valve and controlled by an inner self-closing valve as shown. A similar valve and port are provided in the auxiliary piston, said port being controlled by a self-closing valve. In operation, when the two pistons are on the forward stroke, the explosive mixture is drawn into the auxiliary cylinder, the amount being regulated by the outer valve in the chest. On the return stroke the mixture passes through the port in the auxiliary piston into the annular space between the hollow piston stem and the cylinder, where it is compressed to four or more atmospheres, according to the relative diameters of the cylinder and piston stem. The plug valve is now in the position shown in the engraving, and the mixture will pass into the main cylinder, and, becoming ignited, will propel the main piston. During this operation another charge will be drawn in for the following stroke. The construction is such that a 50 horse power engine could be started by means of a hand air pump and a small reservoir, carrying 20 or 30 pounds pressure.

**PATENT AUTOMATIC COPYING LATHE WITH AUTOMATIC SCREW FEED.**

This machine has been designed for turning from patterns all kinds of irregular shapes, such as spokes,

neck yokes, singletrees, hammer, hatchet, railroad, mining pick and ax handles, shoe lasts, gun stocks, and other similar wooden articles. It has been constructed from entirely new designs and embraces improved labor saving features, which increase the quality of the work and enable a facsimile of any pattern placed in the machine to be produced. It is massive and heavy, built from iron and steel throughout, and designed for the hardest service.

The cutter head is fitted to a heavy steel spindle, running in large bearings attached to a vibrating frame, which is traversed upon planed ways across the path of the material to be turned by means of a heavy screw. The hand lever projecting up over the carriage is used for bringing the cutter head up to the work, or locking it back out of the way when not in use. The feed can be instantly changed from right to left or from left to right, which effects a saving of time, as the machine is prepared to commence the cut at either end of the stick. It will be observed that the knives cut on the under side of the material, discharging the chips downward and overcoming any liability of injuring the operator.

The feed is very powerful, with three changes of speed, and automatic in its action, stopping instantly when the end of cut is reached, or arrested at any point desired. The tail stock is fitted on top of the frame, which is planed true, and is always in perfect

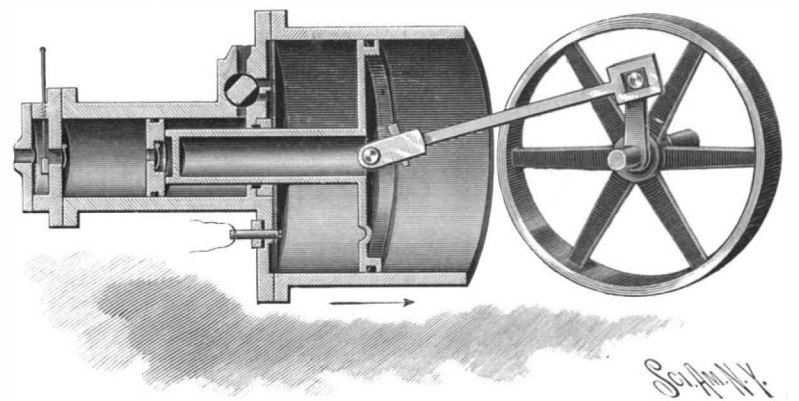
**PARKER'S IMPROVED GAS ENGINE.**

alignment with the head center, and it can be quickly adjusted horizontally to or from the head center for short or long turning, taking 48 inches at the longest or anything shorter, and turning work from the smallest sizes up to 8 inches in diameter.

The pattern which guides the path of the cutter head and governs the shape of turning is placed upon centers at the rear portion of the machine, and it should be of an exact duplicate of the shape desired to turn, but the size of the article turned may be varied, either larger or smaller, from the same pattern.

This machine, which is manufactured by the Defiance Machine Works, Defiance, Ohio, works per-

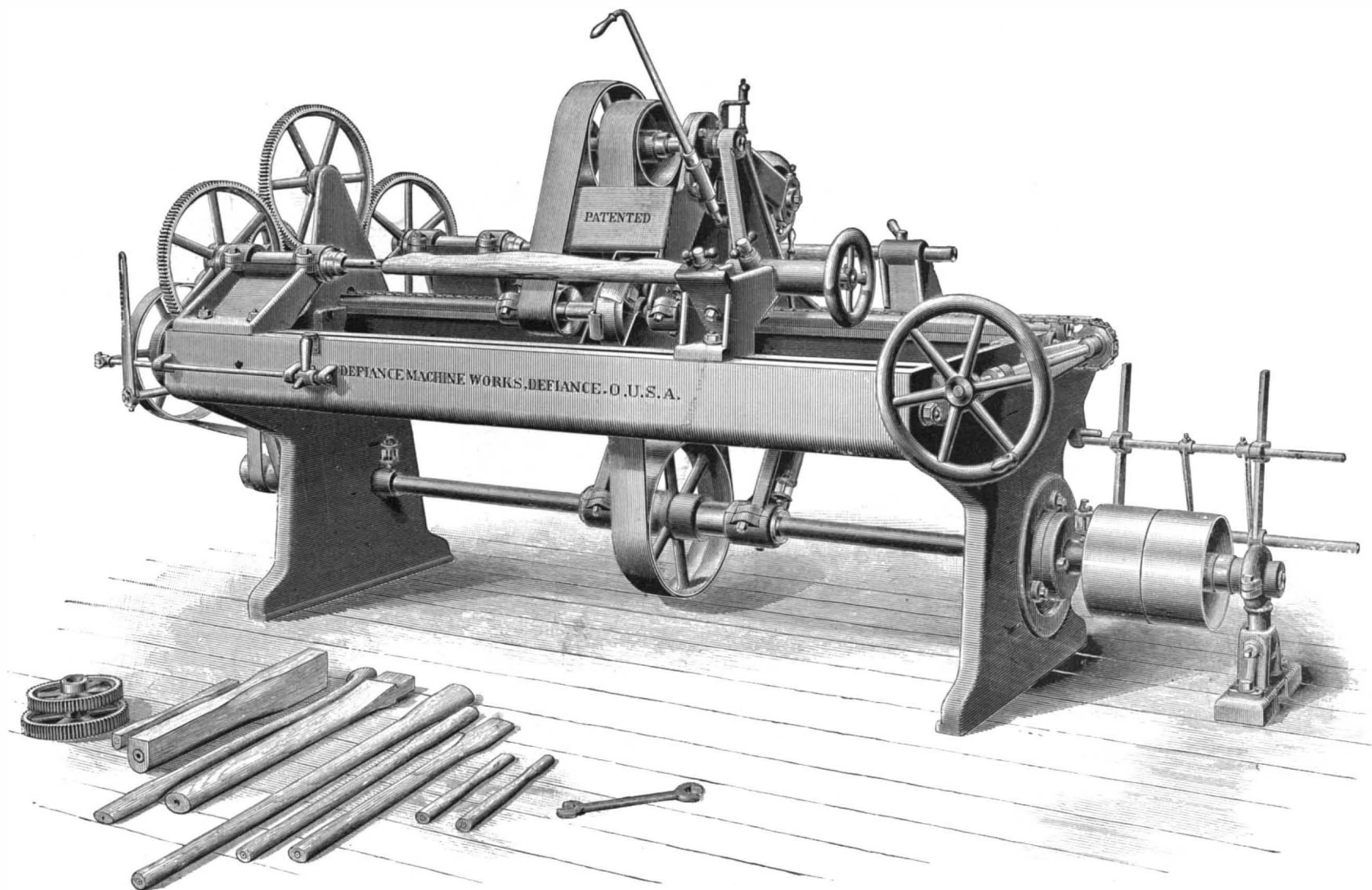
**PATENT AUTOMATIC COPYING LATHE WITH AUTOMATIC SCREW FEED.**

fectly in the hardest seasoned timber, turning the work smooth and producing perfectly square corners without tearing, and it is extremely simple to operate.

The tight and loose pulleys are 10 inches diameter, 5 inches face, and should run 430 rotations per minute; the floor space occupied by this machine is 4½ feet by 8 feet.

**A CUSHION PAVEMENT.**

The improved street pavement herewith illustrated has been designed and patented by Mr. Daniel W. Campbell, of North Creek, Warren County, New York. The blocks are all made in one shape and size, being formed with plane faces on the top, bottom, and sides, but having offsets or ledges formed at each end, the front ledge being at the top and the rear ledge at the bottom of the block, as shown in the illustration.

The depth of the said ledges is such that when the blocks are laid together there will be a square void between them whose depth will be approximately one third the height of the blocks. In paving a street the brick or stone blocks are laid in rows transversely to the street, with their flush sides in contact, and the offsets forming a continuous ledge or step across the street as shown in the engraving. Upon this ledge is laid a strip of wood or other flexible material, and another row of blocks is then laid in place, its upper ledges overlapping and resting upon the upper face of the strip as shown. Such a form of construction presents a flexible pavement, which will be comparatively silent under a passing vehicle; and the longitudinal strips will assist in preventing the formation of ruts and hollows in the surface of the street. It will be seen that by completely overlapping the wooden strips the blocks exercise upon them merely a compressive strain, and do not tend to shear them off, as is the case when such strips are engaged by grooves formed in the adjoining faces of the blocks.

**COPPERSMITHING.**

The present illustrations represent the manufacture of the copper vacuum pans used principally by sugar manufacturers, distillers, etc. In the manufacture of sugar the sirup is run into these pans, where it is evaporated by means of steam to the point of crystallization. The pans range in size from about 3 feet to 15 feet in diameter and from 8 to 25 feet in height. The pans when completed consist of a dome, belt and bottom. The dome and bottom being beaten to the proper form by hand and the belt plates rolled into shape and brazed, the different sections then being placed in position and bolted together. Connected to the sides on the interior of the bottom sec-

tions are coils of copper pipe which are heated with steam for boiling the sirup.

The number of feet of pipe for each apparatus depends on the size of the pan and the amount of evaporation required. In the largest of these pans as many as 3,000 square feet is used. The pipes range, according to the size of the pan, from 2 to 6 inches in diameter. The copper comes from the mills to the coppersmith in sheet form cut into the proper shape.

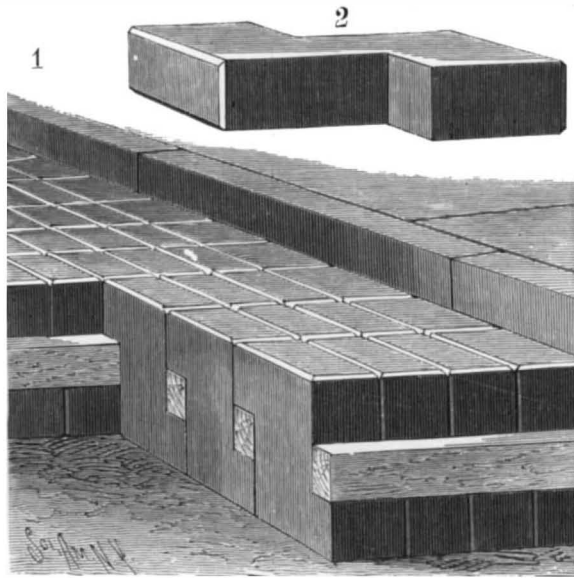

**CAMPBELL'S CUSHION PAVEMENT.**

The belt plates range from about 28 inches to 24 feet in length, from 14 inches to 12 feet in width, and from ¼ to ⅝ of an inch in thickness. The belts are made in from two to eight pieces, according to the height and diameter of the pan. The copper plates for the dome and bottom come circular in shape and flat. They are first suspended over a forge containing a hot coke fire until they become red hot and then beaten into shape with wooden mauls. The furnace or forge is about 10 feet in length, about 4 feet in width and about 2½ feet in height. The copper sheet is suspended to within 4 inches of the fire until it becomes red hot, which takes about twenty minutes. Two operators then beat the heated metal with the mauls, beginning about half way from the center, the heavy blow causing the material to bend and form itself into the proper shape. During the beating process the metal is turned and held in position by an attendant with a pair of tongs. The mauls are about 12

inches in length, about 5 inches in diameter, and weigh 15 lb. each. It requires about two days to beat out a dome 8 feet in diameter and 30 inches in depth. The object of beating the metal while hot is to keep it a uniform thickness. After the beating process the dome or bottom is suspended on what is called a head. This head is about 8 inches square and made of steel, the top of which is slightly curved and smooth. The head rests in an iron brace which is fastened securely to the end of a heavy wooden beam about 5 feet from the floor. The under side of the dome or bottom rests on top of the head, the two operators who stand on a raised platform then hammering the metal smooth, hard and bright. The planishing hammers used weigh about 6 lb. each, and are very highly polished and made of steel. An attendant also turns the material during the hammering process, which takes about one and one-half days. The ends of the belt are then scarfed and rolled and the parts brazed. The ends of the belt to be brazed are placed over the forge fire, which is blown up to a temperature of about 1,800° Fah. A brazing spelter composed of about 60 per cent of copper and 40 per cent of zinc is then placed along the joint, which melts and unites the two parts solidly together. Bolt holes are then bored in the 5 inch flanges on the belt, bottom and dome and the sections then put together.

The copper pipe is placed in the bottom section in rows one above the other, between braces made of gun metal, the coils of pipe being placed about 10 inches apart. As the sections are put together a coating of putty, consisting of red and white lead and oakum, is put between the flanges, making it airtight when bolted. After the putty has been applied, two iron rings, one being placed on top of the flanges and the other on the bottom, are bolted securely together with ¾ inch iron bolts, about 3½ inches apart. The large copper vacuum pans, that measure 15 feet in diameter and containing about 3,000 feet of pipe, will weigh about 80,000 lb. To build one of these large pans it will require about four months with the labor of from twelve to fifteen men. The cost of these pans ranges from \$500 up to about \$15,000, according to the size and quantity of material used. The copper costs from 16 to 22 cents per pound, according to the size of sheet, the length and the width and thickness. The sketches were made at the North River Copper Works, New York.

It is said that the habit of turning around three or four times before lying down has survived in the domestic dog from his savage ancestry. It then served to break down the grass and make a bed.

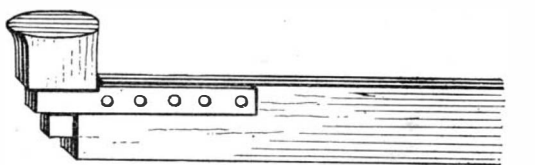

STEEL HEAD FOR SMOOTHING DOME.

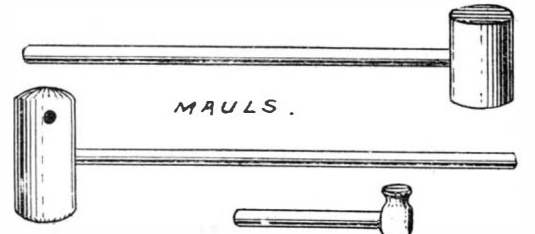

MAULS.



PLANISHING HAMMER

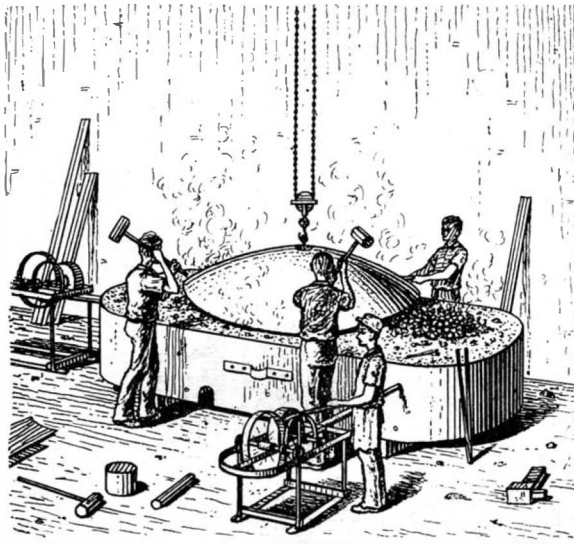

BEATING HEATED COPPER INTO SHAPE.

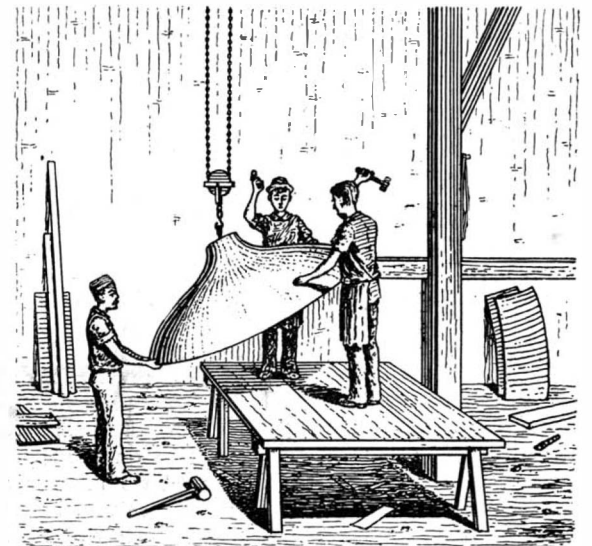

SMOOTHING.

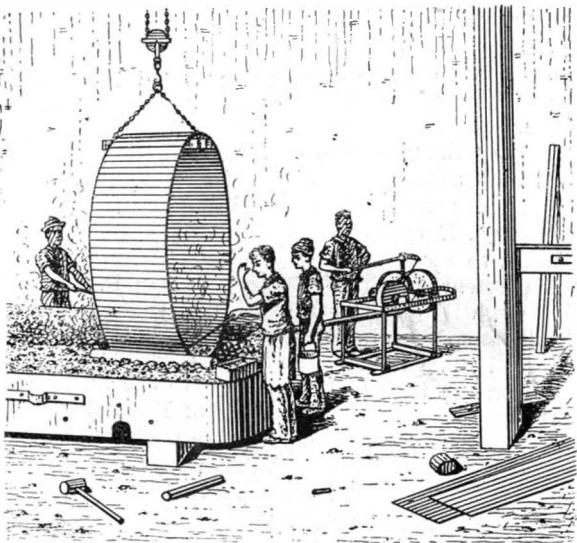

BRAZING.

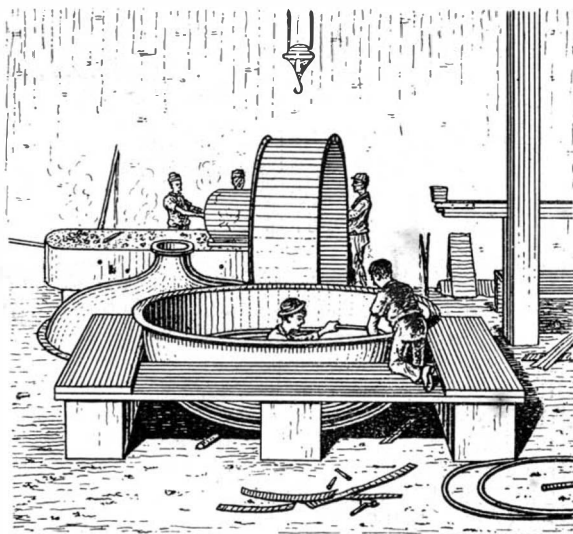

PUTTING PIPE IN PAN BOTTOM

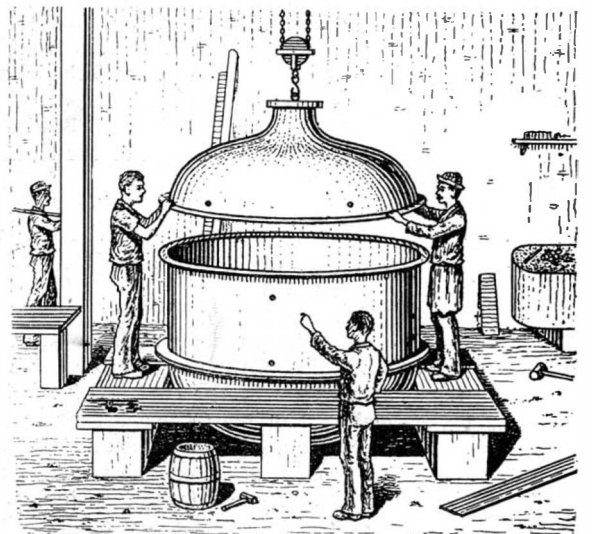

SETTING UP.

**THE MANUFACTURE OF COPPER VACUUM PANS.**

## Science Notes.

It is stated that Huxley's library is now offered for sale.

Dr. Adalbert Kruger, Director of Kiel Observatory, died recently. He was an astronomer of world-wide reputation and was editor of the *Astronomische Nachrichten*.

Rev. W. C. Ley, a meteorologist of considerable reputation, died on April 22. His researches were principally on the clouds and the movements of the upper air currents.

The University of Pesth has conferred honorary degrees upon Lord Kelvin, professor in the Glasgow University; Herbert Spencer, the English philosopher; Max Muller, the orientalist; Prof. James Bryce, M. P., the eminent English geologist and scientific author, and Dr. John Shaw Billings, of Philadelphia.

It is said that dew is a great respecter of colors. To prove this take pieces of glass or board and paint them red, yellow, green, and black. Expose them at night, and you will find that the yellow will be covered with moisture, and the green will be damp, but that the red and the black will be left perfectly dry.

Negroes are black owing "to the stimulating action of solar heat, combined with moisture and an excess of vegetable food, yielding more carbon than can be assimilated, the character being then fixed by heredity." This extraordinary theory appears in a recent geographical school book bearing the name of Cambridge University.

The Paruchowitz bore hole, near Rybnick, in Silesia, which attained a depth of 2004.34 m. (nearly 1,096 fathoms) when the rod broke, has passed through eighty-three carboniferous strata, the total expense having amounted to \$18,700, says the *Practical Engineer*. The 384 thermometrical observations that were made showed a very irregular increase of temperature with depth, the average being 1° C. (1.8° F.) for every 35.14 m. (18½ fathoms).

The question as to the fusibility of platinum in a carbon heated furnace seems at last to have been definitely settled by Victor Meyer, says *Science*. A sheet of platinum completely inclosed in a mass of fire clay was fused to a globule in a blast furnace heated with gas carbon. In this case action of carbon or of furnace gases on the platinum was absolutely excluded. Under similar conditions an alloy of platinum with 25 per cent iridium was unchanged.

Filehne has studied the action of copper when combined with albuminous substances, and finds that a cupratin compound, analogous to Schmeideberg's ferratin, can be administered to dogs and cats in doses of 26 grammes within twenty days without injurious effects. He infers that compounds of copper with albumen would not be injurious in human food, and that from 0.01 to 0.02 gramme of copper daily in this form would not cause any sensible disturbance. The case is very different with copper stearate, which causes serious degeneration of the liver and kidneys when administered for some long time, though it was not possible in this way to produce acute poisoning.—*Deutsch. Med. Wochensh.*, 1896.

In the *Contemporary Review* for May, Dr. Alfred R. Wallace describes M. Elisee Reclus' proposed gigantic model of the earth, and argues that the construction of such a globe would be feasible and desirable. But he thinks that the scale proposed by M. Reclus, 1/1000000, should be reduced by one-half. This would give an internal diameter of 167 feet and a scale of almost exactly a quarter of an inch to a mile. The chief point made by Dr. Wallace is, however, that the model should be placed on the inner surface of the sphere.

There has been a volcanic eruption on the island of Socorro, off the Mexican coast. Two months ago, which is the latest date of news received, lava was running down the mountain sides, overflowing the lowlands, and moving toward the sea. The news came in a letter to the Hydrographic Office from the schooner Zampa, bound for Tacoma, whose captain spoke the Danish bark Schwalde, of Guaymas, which passed Socorro on March 20. The sky and sea were filled with ashes miles away from the island, and the blazing mountain was first made out at night. It was a magnificent sight, the Danish captain said, but he did not dare venture too near, on account of the troubled condition of the ocean.

An extremely interesting series of experiments on the action of a powerful magnetic field on the cathodic rays in Crookes' or Hittorf's tubes is described by Herr Kr. Birkeland in the *Elektroteknisk Tidsskrift* (Christiania). These experiments prove, says *Nature*, that in such a field the cathode rays are strongly deflected in the direction of the lines of force, and can even be concentrated on to the surface of the tube until the glass melts. Moreover, the evidence suggests that the rays which emanate from one and the same cathode fall into groups, of which the physical constants are connected by some definite law, just as are the frequencies of the different tones emitted by a vibrating rod. The investigation has an important bearing on the theory of the aurora borealis. The Danish meteorologist, Herr A. Paulsen, is of opinion that the aurora owes its origin to phosphorescence of

the air produced by cathodic rays in the upper strata of the atmosphere, and Herr Birkeland suggests that the earth's magnetism may be the cause of this phosphorescence becoming intensified in the neighborhood of the terrestrial poles.

## INSECT REMOVER AND DESTROYER.

A new and improved machine for the removal of potato bugs and like insects from vines has been patented by Mr. Washington Reeder, of Lake City, Michigan. The invention consists of a machine with

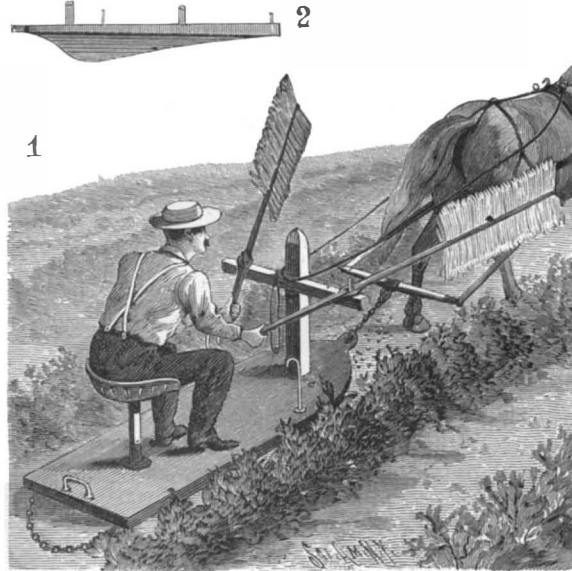

REEDER'S INSECT REMOVER AND DESTROYER.

a body shaped substantially like the hull of a boat, having a pointed front and a rounded keel as shown in the illustration. An upright mast is provided in front of the driver, upon which is fitted a cross bar, at the ends of which are pivoted two oar-like arms, which project on each side of the machine and terminate in brooms or brushes. The inner ends of these oars have suitable handles which can be grasped by the driver, and he is thereby enabled to beat and brush the bug-infested rows of potatoes on each side as he drives the machine through between them. At the front central portion of the body of the machine a clevis is provided, to which the machine may be attached. As the device is driven through a potato field the bugs are brushed into the space between the rows and crushed by the passage of the body of the machine over them.

## IMPROVED BOILER FURNACE.

The improved furnace shown in the accompanying illustration has been patented by Mr. Henry Theodore Dieck, corner of Alvar and Dauphine Streets, New Orleans, La. The furnace may be constructed with only one shell, as shown in the illustration, or with two or more shells if desired. At the front end of the shell is a firebox with grate and ash pit of the usual construction. The bridge wall slants upwardly and



DIECK'S IMPROVED BOILER FURNACE.

rearwardly, and terminates in a flame bed, which is segmental in cross section, and has its upper surface eccentric to the exterior surface of the shell, the greater distance between the flame bed and shell being at the upper portion of the former. The flame bed falls slightly toward the rear, where it curves up and over, finishing against the end of the shell just above the shell flues, into which it guides the furnace gases. The flame bed extends upwardly on both sides to or above the shell flues and provides a large heating surface; and as the area of the cross section of the flame bed increases in a rearward direction, ample provision is made for the proper combustion and flow of the smoke and gases, and a superior draught is secured.

## The Proposed Extensions of the Manhattan Elevated Railroads.

A committee of the Manhattan Elevated Railroad directors has submitted to the Rapid Transit Commission a comprehensive plan for the extension of their system. Briefly stated the proposed extensions and additions are as follows:

1. A new two track structure to commence at the Battery Place station on the west side and run along West Street to Little West Twelfth Street; then by Tenth Avenue to Twenty-third Street, where a spur would be run from the Pennsylvania and Erie ferry houses to Ninth Avenue. Another spur would run from Christopher Street ferry to the Eighth Street station of the Sixth Avenue line.

2. A cross town line from the City Hall station at the entrance to the Brooklyn Bridge, running up Centre Street to Canal Street, and westward along the same to a junction with the proposed West Street line.

3. To provide increased accommodation and speed on the up and down lines, it is proposed to provide four tracks on the Third Avenue line from Chatham Square to Sixth Street, and three tracks from Sixth Street to the Harlem.

On Second Avenue it is proposed to lay a third track from Grand Street to the Harlem River.

The Ninth Avenue line is to have a third track from the Battery to the curve at One Hundred and Eighth Street, whence a new line is proposed which shall run via Tenth Avenue or the Western Boulevard to Fort George.

Mr. Gould stated that the company stood ready to build these proposed lines at once; and he submitted two other routes which the company were prepared to cover as soon as the growth of the neighborhood called for it. The first of these was a line from the Fort George extension at One Hundred and Sixty-second Street and Tenth Avenue, to run out along the Kingsbridge Road to the city line. The other future extension was to take place from the One Hundred and Seventy-seventh Street terminus of the present line toward the city line to the north. To provide for a pressing need Mr. Gould said that his company was prepared to build at once a branch line from the One Hundred and Forty-ninth Street station on the east side line, running along the Westchester Road to the Bronx River. It is reported that the representatives of the Manhattan roads stated that they were prepared to build the extensions with their own capital and that they made no stipulations as to the payment of damages.

It must be admitted that this proposal is framed on comprehensive lines, and that it appears to meet the pressing necessities of the hour most admirably. The directors of the elevated roads have a rare opportunity just now to establish themselves in the confidence of the public, by pursuing the liberal and far-sighted policy which is outlined in their present proposals.

## Explorer Peary's Plans.

Civil Engineer R. E. Peary's plans for his Arctic expedition this summer are now substantially complete. Instead of St. John's, N. F., as in former years, Sydney (Cape Breton) will be the point of departure, from which port the expedition will leave about July 15 in a steam whaler from the Newfoundland fleet. From Cape Breton the course northward will be laid along the Labrador coast, as the conditions of ice will permit; then, crossing Davis Straits to the Greenland coast, stops will be made, if practicable, at Godthaab and Godhavn, and possibly at Upernavik. Lieut. Peary will push forward with all practicable speed to accomplish the main object, the obtaining of the great meteorite, the largest in the world, which he discovered and located not far from Cape York last year. With the meteorite secured, the southern course will be laid across Melville Bay to Godhavn, where a call will be made on the return for the purpose of embarking any of the party who may have awaited the ship at that point. Coming south, an attempt will be made to penetrate Hudson Straits and, if possible, examine some valuable mining prospects which have been reported in an uninhabited and inaccessible place on the north coast of its waters. Calls may also be made at the Labrador ports, if circumstances favor, and it is possible that while the ship is absent Peary may go, if conditions are favorable, north of Cape York, to his former headquarters at Inglefield Gulf. The scientific party from Cornell University, headed by Prof. Ralph S. Tarr, of the department of geology, will embark on the steamer, leaving her at some point agreed upon in Greenland, for scientific field work, during the time of her absence to the north. Prof. Burton, of the Boston Institute of Technology, is also contemplating a similar scientific field excursion, and one or two other passengers may be added to the party. North of Godhavn, however, Mr. Peary will be without associates, excepting the captain and crew of the steamer, whose aid will be ample for the work which he will have in hand. If the expedition accomplishes its designed work and obtains the meteorite, it will return directly to New York.

**Notice.**

A premium of \$250 is offered by the SCIENTIFIC AMERICAN for the best essay on THE PROGRESS OF INVENTION DURING THE PAST FIFTY YEARS.

This paper should not exceed in length 2,500 words. The above-mentioned prize of \$250 will be awarded for the best essay, and the prize paper will be published in the Special 50th Anniversary Number of the SCIENTIFIC AMERICAN of July 25. A selection of the five next best papers will be published in subsequent issues of the SCIENTIFIC AMERICAN SUPPLEMENT at our regular rates of compensation.

The papers will be submitted for adjudication to a select jury of three, consisting of—

- Prof. R. H. Thurston, Cornell University.
- Judge A. P. Greeley, Washington, D. C.
- Prof. R. S. Woodward, Columbia University.

Rejected MSS. will be returned when accompanied by a stamped and addressed envelope.

Each paper should be signed by a fictitious name, and a card bearing the true name and the fictitious name of the author should accompany each paper, but in a separate sealed envelope.

All papers should be received at this office on or before June 20, 1896, addressed to

Editor of the SCIENTIFIC AMERICAN,  
361 Broadway, New York.

**Correspondence.**

**X Ray Experiments.**

To the Editor of the SCIENTIFIC AMERICAN:

I have in my possession a Crookes tube, exactly identical in construction with the one described on page 342, SCIENTIFIC AMERICAN of May 30, excepting the glass bulb, which is pear-shaped.

Considering the fact that I am using this tube with an ordinary Winshurst induction machine of my own construction, with 20 inch hard rubber plates, its work is simply marvelous.

For the benefit of your readers who desire to use this kind of apparatus, I would say that the condensers should be small, not over 16 or 18 square inches of foil surface on each side, and the outside coatings should be connected with each other; the anode of the Crookes tube should be connected to the positive pole of the machine and cathode to the negative pole, with a spark gap of not less than one-half inch. Gap should be made between ball terminals, as a good, clean spark is absolutely necessary; if air is so damp as to break it into a brush discharge, no effect will be obtained in the tube.

The light is, of course, intermittent, but if the machine is in good order and runs fast enough, the sparks follow each other in such rapid succession as to be practically continuous in lighting effect on a fluoroscope, which this tube illuminates brilliantly, bringing out the bones in the hand very distinctly. The tungstate calcium used in fluoroscope is sold by dealers as high as \$5 per ounce; but an ounce of it—enough for two or three fluoroscopes—can be made for 30 or 40 cents, as follows: Mix about 1 ounce each of common salt, tungstate soda, and chloride calcium; last two articles should be bought at retail for about 2 cents per ounce. Put the mixture in a common crucible, also obtainable for about 10 cents, fit a tin cover to it and bury to the lid in a good coal fire—the kitchen stove will do—so as to bring it to a full red heat; leave it for two or three hours, or until contents are fused to a clear liquid, then set it out to cool and crystallize. The resulting hard, glass-like mass should be broken out with an old chisel or by breaking the crucible—broken up and thrown into a jar of water, which will gradually dissolve the chloride of sodium formed, and the fine crystals of tungstate calcium will settle to bottom. Wash by decantation till all taste of salt is gone, and pour out on filter or blotting paper and dry.

Make your screen of thin wood or cardboard, coat with common prepared glue, and sift on the tungstate, shaking off all that does not stick when dry. Fasten to bottom of ordinary box of the fluoroscope form, and you will have as good a fluoroscope for a few cents as can be bought for a few dollars.

I think I have demonstrated, and with rather poor apparatus, that the X ray will produce a visible image on the sensitive plate in less than 1-1000 of a second.

When I run my static machine very slow, the sparks can be made to jump the gap arranged as described at about the rate of one or less per second. The fluoroscope then shows a distinct instantaneous flash of light as each spark passes, seeming to indicate that the X ray is produced only at or during the instant of the passage of the spark, which, according to Wheatstone, occupies about 1-24000 of a second of time.

Desiring to test the effect of one spark and upward on a plate, I placed a common pocket comb in a metal edged case on a 4 x 5 plate holder, containing plate covering about three-quarters of an inch of holder, with a block of steel one inch thick, and machine

slowly run till one spark passed the gap, then plate of steel was moved up three-eighths of an inch, and one more spark passed, thus giving two sparks exposure to remainder of plate; the steel block was then pushed up another three-eighths of an inch, and two more sparks passed, giving four to remainder of plate, and so on up through 8, 16, 32, 64, etc., to 512 on last three-eighths inch of plate. Plate was developed immediately, the print from same plainly showing the metal rim of comb case down to the seventh space from top, corresponding to eight sparks, equal to about 1-3000 of a second's exposure.

My machine works in the open air, which is very damp most of the time at this time of year, but with a properly cased powerful machine and a spark gap of one inch or more, I think it could be shown that one spark would produce a visible image on the plate.

Middletown, N. Y.

[We have received from Mr. Ogden some specimens of his X ray photographs, which are very fine; also the photograph mentioned, which shows the images produced by exposures of different lengths.—Eds.]

**The Utility of Colored Skin.**

Man, no matter what country he inhabits and what are the exterior conditions that he undergoes, has an internal temperature that varies within very narrow limits. If the exterior temperature is very cold, the circulation becomes more active and the chemical changes that generate heat are more intense, while physical conditions, such as friction and perspiration, contribute also a large part toward maintaining this balance of temperature by modifying at the proper time the formation or emission of heat. Races and climate produce in these vital actions certain curious modifications which have hitherto received little attention. It would be, for instance, interesting to know whether the human temperature is the same in all latitudes and for every race. Davy was one of the first to take up this question in two voyages to Barbados and Ceylon. He concluded that the temperature varies with the race by several tenths of a degree as we approach the tropics. The observations of Jousset accord with those of Davy. While other authors have held a different opinion, M. C. Richet, who has summed up the work on this problem, concludes that "the temperature of men of different races, under the same conditions of environment, is sensibly the same." This racial influence is then no greater than that which some have attributed to sex; that is, it is practically null.

Dr. Eijkmann, director of the Pathological Institute of Weltevreden, Batavia, Java, has attacked this question anew. He has especially tried to find how a Malay and a European react under the influence of exterior temperature, and what, in particular, is the role played by the color of the skin in the physical regulation of temperature. He has performed, for the solution of this problem, the following experiments. . . . One means of regulating temperature is by the loss of heat by conduction and radiation. If we place a thermometer near the skin of the arm or the chest and surround it with a sort of guard, the thermometer will rise the faster as the heat given out by the body is greater. M. Eijkmann has made this experiment in both Europeans and Malays. The results differ slightly according to season. During the warm and dry season the advantage is with the natives; the temperature of the thermometer placed near the arm is 33.55° C. [92.39° F.] with Europeans and 34.05° [93.29° F.] with natives. On the contrary, during the cool, wet season, Europeans give 32.75° [90.95° F.], while natives give 32.55° [90.50° F.] The latter have thus radiated off less heat. Observations made at different hours of the day prove that, in general, the loss of heat by radiation is a little less with natives than with Europeans, and this difference is about 0.4° [0.7° F.]

What causes this difference? We must in the first place eliminate the color of the skin. To test this, the author used two exactly similar metal cylinders, covered with skin carefully removed from the shoulders of persons who had recently died. The one was from a European, the other from a Malay. On one cylinder the European's skin was placed outside the Malay's; on the other, the Malay's was outside the European's. This arrangement was to prevent all possible error due to a difference in the conductivity of the two skins. The two receptacles were then filled with water in such manner that the thermometers plunged in each marked at the outset the same temperature. The results of the experiments made under these conditions show that there is no appreciable difference in radiating power between the brown and the white skin. The bulbs of two similar thermometers were covered with a double layer of skin [as before]. . . . Thus disposed they were exposed in a damp chamber to the sun's rays. At the end of a certain time the temperatures were as follows: White skin on outside, 47.5° [117.5° F.]; brown skin on outside, 50.1° [122.18° F.] But we return to the radiation. The color of the skin has no influence, and cannot explain the fact that the loss of heat is a little less in Europeans than in Malays.

Other experiments give us the true reasons, which relate to the evaporation that takes place at the surface of the skin, which is greater in Europeans because they drink more.—Paris Cosmos.

**Study of a Swiss Avalanche.**

Natural Science gives a summary of the report made by Profs. Heim, Forell and Chodat on the great Gemmi Pass avalanche of September 11, 1895. The detailed description of the results of the catastrophe made by men of good standing in the scientific world is of great value. The avalanche was caused primarily by the splitting away of the lower parts of the Altels glacier.

The Abstract says: "On reaching the foot of the Altels, the avalanche, which up to this point must have consisted of one vast moving block of ice, measuring one and a quarter millions of cubic meters [4,000,000 cubic feet], was reduced to fragments, at the same time that the heat generated by the shock converted these into a semi-fluid condition. Among the debris were to be seen some blocks of considerable size, but only a few exceeded two meters [6½ feet] in diameter. With the velocity acquired in its descent, this river of ice rushed across the pasturage and up the western slope of the valley to a height of 1,300 feet along the rocky wall of the Weissfluhgrat. Not being completely able to surmount this barrier, the main mass came surging back—like a vast sea wave recoiling from the cliffs—with such force that some of it returned to a height of one hundred feet up the eastern side. Isolated blocks, however, were hurled clear over the ridge into the adjoining valley, the Uschinenthal.

"The avalanche was preceded by a terrific blast of wind which swept away chalets, trees, men, and cattle as though they had been feathers. This is proved by the fact that, far above the limit reached by the avalanche, hundreds of trees have been uprooted, and lie in regular rows, indicating with mathematical exactitude the direction of the aerial current. These trees are for the most part of great size, several indeed having trunks one meter in diameter. Such as were protected by a large rock or a reverse dip on the hillside have been spared. Others, standing with only half their height above such hollows, have had the exposed part blown off, while the subsequent oncoming of the avalanche has not succeeded in tearing up what was left of them, even when it has enveloped their base. This wind produced a veritable bombardment of ice dust mixed with stones, which has stripped the roots and branches of the trees laid low by the wind itself, and which must have killed man and beast before ever the real avalanche overwhelmed them. Further away the trees have only been denuded of their upper portion, the branches composing which were transported to a great distance, and now form a compact line of debris among the far-off scattered trees, like the bank of sea wreck left on open coasts after a fierce storm. Ice bombs, too, round like cannon balls, but with an average diameter of one foot, which lay all about in the neighborhood of the fallen mass, bore eloquent testimony to the extreme violence of the wind. On the way from the Hotel Schwarzenbach, before coming to the Bernese frontier, the green pasture was strewn with these balls like a battle field in old muzzle-loading times.

"The true avalanche, in its recoil from the rock wall, has formed an immense rampart, separated from the rock by a deep trench. On the sides, under the stress of the enormous power of the wind, which, like the avalanche itself, was deflected by the Weissfluhgrat, blocks of considerable size were driven around as in a whirlpool, so as, at least on the northern edge, to have been forced back up the slopes of the Altels toward the entrance of the gorge leading to Kandersteg. These different atmospheric motions were well marked, owing to the disposition of the materials which came under their influence. Near the Winteregg, the trees, shrubs, and grasses were all bent toward the north, forming an exterior zone, which was more and more thickly covered with the dust, etc., raised by the catastrophe as the central mass was approached. A second zone, within the first, was found to consist of the loose rocks, etc., thrust aside by the head of the ice mass as it dashed up the west slope; the inner edge of this zone was itself covered by a layer of ice and snow, representing the matter that kept pouring off from the sides of the central body in its upward progress, and also the results of the reflux which took place when its further advance was barred. Some of the ice and stones hurled against the Weissfluhgrat had adhered to it, being plastered, as it were, into the fissures and gullies. These masses were being constantly detached from their precarious position, and kept descending in roaring avalanches."

DR. ROENTGEN has published some new facts about his rays. He finds that all solid bodies can generate them; the only difference being in the intensity, the greatest intensity being produced by platinum. He finds that the insertion of a Tesla coil between the Ruhmkorff coil and the ray-producing apparatus is very advantageous, and that the X rays and the air traversed by them can discharge electric bodies.

**Meat and Milk from Sewage Farms.**

If a cow is fed on turnips, within twenty-four hours her milk will taste of turnips, and if butter be churned from the cream, the butter will taste too. The intensity of the turnip flavor is the measure of the quantity of turnips taken. In like manner, if pigs be fed on horseflesh, as they often are, their bacon will taste of the horseflesh; if they be fed on fish, the bacon has a fishy taste. The same is true of hens and their eggs. Feed hens on decaying animal matter, which they will eat greedily, and both their eggs and flesh will be most unpleasant and unwholesome eating. In the case of ducks the facts are much more striking. Ducks are very unclean feeders. Give them abundance of garbage, and they will refuse corn and similar food. Their flesh is then most pungent to the taste, and in many people is so potently poisoning as to produce diarrhœa. Animals fed on sewage farms under certain conditions are liable to have their flesh and secretions changed in character by the sewage-produced herbs and grasses upon which they feed. If the sewage on a given farm be so managed that no more of it be put into the soil than any given crop can adequately deal with, then the crop will be sweet and natural, and the cattle or other animals fed on it will be sweet and natural too. But if the soil be gorged to repletion with sewage, then the crops will be surcharged with sewage elements, and unfit for food, and the meat and milk of animals fed on such crops will be like the crops, and very unpleasant to the taste as well as dangerous to the health. It is in the last resort all a question of the intelligence and conscience of the managers of sewage farms.—Hospital.

**ARCHIMEDEAN SCREW USED FOR DRAWING WATER.**

The principal contrivance in this machine consists of a sort of covered screw (or Archimedean screw) placed diagonally upon its axis, the lower end of which enters the water of the reservoir, A, and the upper one of which ends in the reservoir, B, which is the one to which it is desired to raise the water.

Around the long piece of wood, C, that we call an axle, it is necessary to wind tubes of lead or other metal (marked D and E in the figure), the mouth of which will be in the reservoir, A, and their outlet a little above the reservoir, B.

When this Archimedean screw revolves in the proper direction, the parts of the pipes that enter the reservoir, A, will become filled with water through the mouths of the tubes, and, through the revolution of the tubes, the liquid will be gradually carried from the lower to the upper part of the screw, where it will empty into the reservoir, B.

This screw is revolved through the intermedium of the large wheel, F, which is at the upper end of the axle, C, and which is actuated by manual power in

pulling the rope, G, just as one pulls a bell rope. Our engraving is from an old print.

**ORANGE TREE JACKET.**

A jacket for protecting orange trees against the action of frost has been patented by Mr. Philip F. Brown, of Blue Ridge Springs, Va. By reference to the illustration it will be seen to consist of a tubular, longitudinally split waterproof jacket, which is formed of an inner layer of woolen goods or other suitable non-conducting material, and an outer coating of rubber. Arranged between the two layers are several coil springs, whose ends are held in the longitudinal edges of the

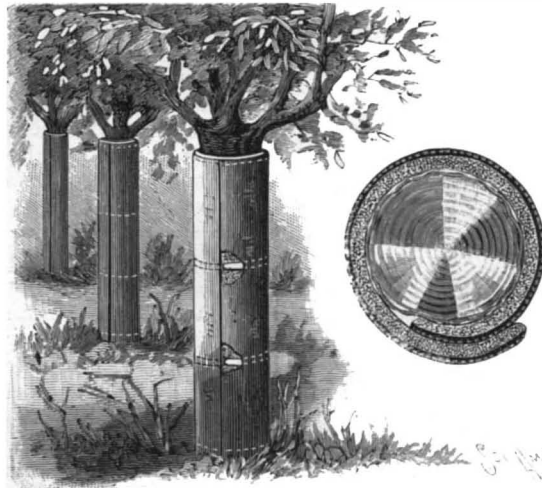

**BROWN'S ORANGE TREE JACKET.**

jackets, so that under their action said edges will be caused to overlap and the jacket given the form of a roll or coil.

To place the jacket in position, the edges are sprung apart and it is then drawn around the trunk, the springs causing it to close upon the tree and snugly embrace it. By keeping a stock of various sizes of these jackets on hand the orange grower can jacket his grove at very short notice and thus prevent the great loss due to freezing. The use of this device makes it possible to grow the semitropical trees in the parks of the North.

**The Ruins of Ang-Kor Wat.\***

Around the ruin, and some three or four hundred yards away from it, there is a wall twelve or fifteen feet high, and in an excellent state of preservation. It is impossible to follow this wall all throughout, on ac-

\*These, the most inaccessible and most interesting ruins in Further Asia—sometimes known as Nakkon-Wat—are admirably and fully described in Surgeon-Major MacGregor's book, "Through the Buffer State."

count of the dense jungle growing about it here and there. But I followed the outside of it as well as I could from the southwest corner to the south gate, and counted seven hundred and fifty-three steps, representing half the length of the wall in a west-east direction. Making due allowance for the more or less tortuous way that I was compelled to take, this rough measurement would make the wall in this direction something like three-quarters of a mile long. Our Kumer guide said that the walls, as well as the buildings, were square, with equal length of sides; but whether he was right or wrong about the walls, which we were not able to measure thoroughly, we found that he was quite wrong about the buildings themselves; for I measured them afterward, and found that, with the exception of the central platform, they were really oblong in figure, with the longer sides directed east and west and the shorter ones north and south. Inside the parklike wall is another wall, only a few feet high; and inside this again, only a short distance from it, is the magnificent ruin itself. I happened to have a measuring tape with me, twelve yards long, but by attaching a piece of twine to it we were enabled to get a length of twenty-seven yards. With this combination we measured the building, and the measurements may be relied on as correct enough for all practical purposes. . . .

The bass reliefs are raised three or four feet above the ground, and are about four or four and a half feet wide. Speaking roughly, they look to the naked eye about half as wide again as the frieze of the Greek Parthenon, to be seen in the Elgin rooms of the British Museum. The sculptures are somewhat less "relieved" from the general surface than the bass reliefs just mentioned, but they are apparently quite as finely chiseled, and in a much better state of preservation. It was on this inner wall that the measurements of 705 feet by 588 feet were taken, extending from the outer door post on the one side of the building to that on the opposite side. Bass reliefs abound on the walls almost everywhere throughout the ruin; but it is on the outside of this inner wall of the corridor that they are particularly abundant and extensive. Taking the sum of the four sides, there is nearly half a mile of almost continual sculpture on these four walls alone, and representing various scenes, most of which are of a warlike character, while one side in particular is occupied by what appears to be a tug of war on a large and ancient scale. Scores of men on one side are doing their utmost to pull over exactly the same number of men on the other side, while the umpire, or whoever he may be, represented by a larger figure than the rest, is seen in the middle between the two contending parties, and sitting on the back of a turtle, whatever allegorical meaning that fact may contain.—Public Opinion.

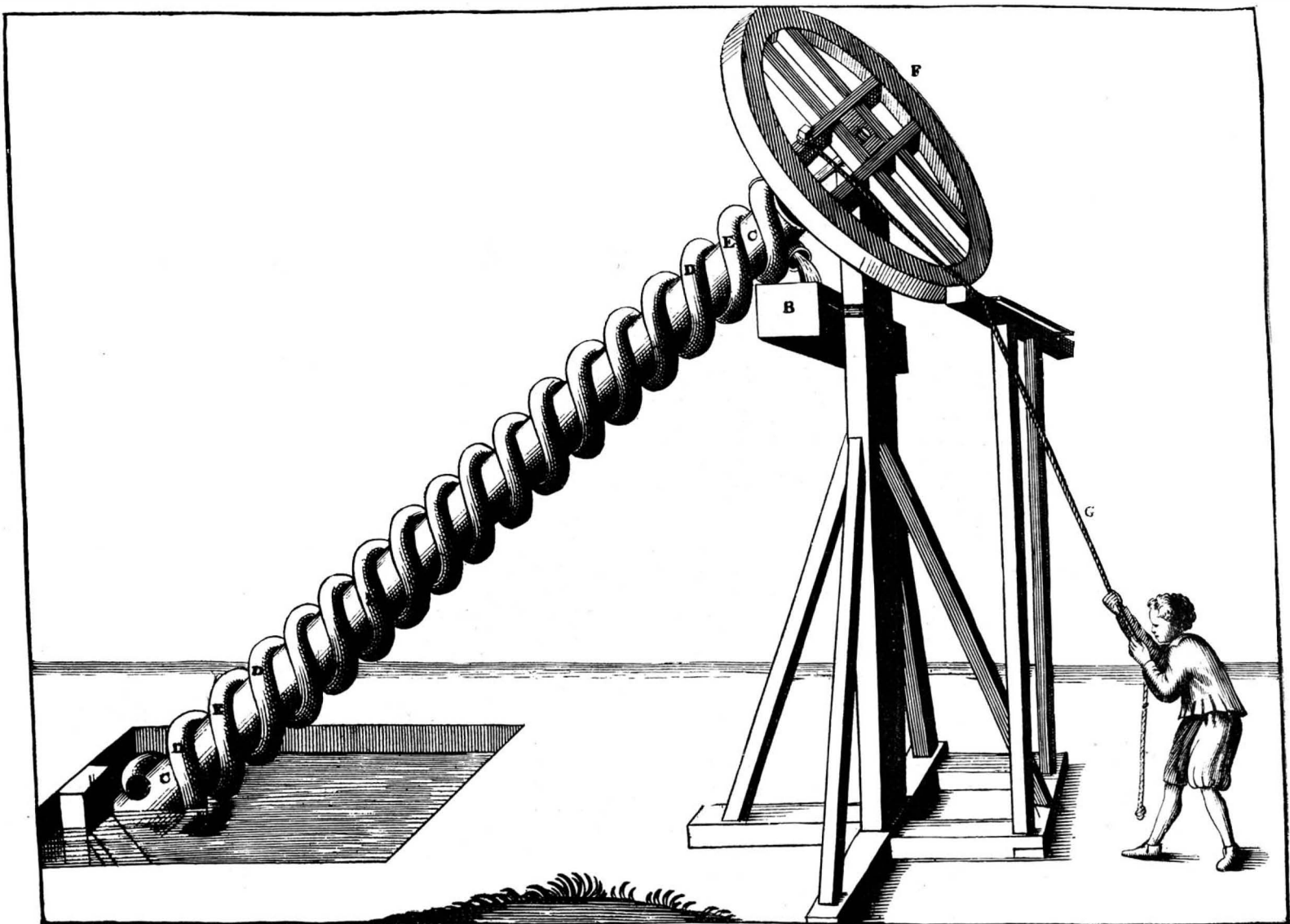

**ARCHIMEDEAN SCREW USED FOR DRAINING A MARSH.**



**THE HORSELESS CARRIAGE RACE ON DECORATION DAY.**  
 The Cosmopolitan Horseless Carriage Race from City Hall, New York, to Irvington and return, for \$3,000, was run on May 30, the winner being Charles

Booth-Crouch carriage and the third was the Roger carriage, a French invention. The carriages began to arrive about half past nine in Printing House Square and they afterward moved up into Mail Street at the

two hours in Mail Street before the start was made. A number of wheelmen were on hand to follow the carriages over the course. Among them was a representative of the SCIENTIFIC AMERICAN. The start was



THE COSMOPOLITAN HORSELESS CARRIAGE RACE—THE ROGER CARRIAGE.



THE COSMOPOLITAN HORSELESS CARRIAGE RACE—THE BOOTH-CROUCH CARRIAGE.

E. Duryea, of Springfield, Mass. There were nearly thirty vehicles entered for the race, but on the morning of Decoration Day only six appeared to compete for the prize. Four of these belong to the Duryea Motor Company, Springfield, Mass., one was the

back of the Post Office. The large number of people who assembled to see the start showed that the race had attracted considerable attention. The crowd at last became so great that the police reserves were called out to maintain order. The carriages remained for

made at five minutes to twelve; the route was up Broadway to Fifty-ninth Street, to the Boulevard, and then along Eleventh Avenue to Kingsbridge, where the judges were to meet the carriages. The route from Kingsbridge was through Broadway,

Yonkers, Hastings and Dobbs Ferry to the Ardsley Country Club, the return being made over the same road. The ride through the city was very exciting. The carriages dodged back and forth in front of and around cable cars and wagons, and demonstrated beyond argument that the horseless carriage is much more capable of control than the ordinary horse and carriage. They passed through the most crowded portions of the city, which was in holiday attire in honor of the day. The crowd at Madison Square was particularly dense, but the carriages had no difficulty in making their way through the crowd without accident. When the Boulevard was reached, speed was increased and the wheelmen had difficulty in keeping up with some of the carriages. The only serious accident of the day occurred on the Boulevard, where a wheelman was run into and seriously hurt by one of the horseless carriages. The operator was arrested.

From the Boulevard to Kingsbridge there are a number of hills, and in places the road is very bad. The carriages had no difficulty whatever in climbing these hills at a good pace, and demonstrated that they were all excellent in coasting down a hill. The noise made by the carriages was not particularly noticeable, and they did not appear to scare horses along the route. Occasionally they stopped to make minor repairs. Kingsbridge was reached at 1:10 P. M. Here the water tanks were filled, and the carriages awaited the arrival of the judges, who came on a special train. The judges were Gen. Nelson A. Miles, U. S. A.; Gen. William G. Craighill, Mr. John Jacob Astor, and Mr. Chauncey M. Depew.

The judges examined the carriages, and then took the train to Irvington. The speed race really began at this point. Four of the carriages made the turn at the Cosmopolitan building, at Irvington, and passed the judges' stand at the new Ardsley Casino, where a stop was made to get water. Carriage No. 1, in charge of Frank Duryea, arrived at the Casino at 3:15 P. M., the time from Kingsbridge, a distance of 13 miles, being made in one hour, five minutes, forty-two and two-fifths seconds. Carriage No. 2, a Duryea vehicle, arrived at 3:30 P. M., and No. 5, the Roger carriage, in charge of T. W. Brander, arrived at the Casino porch at 3:44 P. M. The judges stood on the Casino veranda and gave the official time as each carriage arrived. The award was based upon the following points, the maximum being 100: speed, 35; simplicity of construction and durability, 30; ease in operating and safety, 25; cost, 10. Several exhibition tests were given on the Ardsley Park ground. The first of the horseless carriages returned to the Post Office, New York City, at 7:13 P. M. It was one of the Duryea wagons, managed by Mr. F. Duryea. There was a large crowd in waiting as the vehicle came down Broadway and turned into Mail Street, north of the Post Office. The greatest speed was attempted between Kingsbridge and the Ardsley Country Club. In Yonkers arose an obstacle which filled the racers with gloom. Peabody Hill reared its lofty head above them and resisted every effort of the motor. So the driver and umpire descended and pushed it over the crest of the hill. Several of the carriages met with misfortune.

The trial proved beyond question that the American horseless carriage of the day is a success and is well adapted for use in our city, as it appears that it can be turned and stopped more easily than ordinary vehicles. We present illustrations of two of the carriages taken by the special photographer of the SCIENTIFIC AMERICAN just at the start. We have already illustrated the victorious Duryea carriage in the SCIENTIFIC AMERICAN for November 9, 1895.

The Roger vehicle was made in Paris and weighs 1,730 pounds; the guiding is done with the wheels, which turn inside of a narrow space, the inside wheels turning more than the outer. It is guided with extreme ease, and was stopped and started on the day of the race in good time. The five horse power Benz motor is actuated by gasoline. The ignition is produced by an electric spark; the cylinder is cooled by a water jacket; the power is transmitted to the rear wheels by means of belts, sprockets and chains. Two belt shifters permit different speeds, and differential gear allows the back wheels to turn with ease. The wheels are provided with solid rubber tires. The race demonstrated that the pneumatic tires were better adapted for the motor carriages than the solid tires. The other carriage, which we illustrate, is the Booth-Crouch carriage, made at Youngstown, Ohio. The motor was made by W. Lee Crouch, of New Brighton, Pa. The fuel used is gasoline. The carriage was driven by Dr. Booth, of Youngstown, Ohio, and it would undoubtedly have made a very successful showing if it had not met with the misfortune of the breaking down of the spark apparatus.

The first woman who has received the permission of the minister of public instruction to attend lectures in the University of Munich, Bavaria, is Miss Ethel Gertrude Skeat, daughter of the well known editor of Chaucer's works.

EDISON'S NEW ELECTRIC LIGHT.

A notable example of the stimulation of invention by new discoveries is found in the latest work of Edison, which follows the discovery of Roentgen and the fluorescence of his own invention. This latest invention is a fluorescing lamp in which is found the promise of the artificial light of the future. The lamp appears to have all the qualities requisite for perfect illumination; the light is mild but effective; it is diffusive like daylight. It gives off no perceptible heat, which latter quality goes to show that its economy has no parallel in other kinds of artificial illumination.

One form of the lamp consists of a highly exhausted oblong glass bulb having wires sealed in the ends, each wire being provided with a small plate inside the bulb, one of these plates being inclined to cause a distribution of the rays over the side of the lamp. The inner surface of the lamp is covered with a granular mineral substance which is fused on the glass and is highly fluorescent. When the lamp is excited by connection with an induction coil, the fluorescent material becomes luminous.

Originally Edison used calcium tungstate for his fluorescing material; but by trial he found that the vacuum soon deteriorated, and after a long series of experiments has discovered a fluorescing material which does not affect the vacuum, while it has a higher efficiency than the calcium tungstate.

Mr. Edison thinks that the fluorescing material converts all of the X rays into light. He has a theory as to the manner in which the light is produced. The crystals are composed of light and heavy particles and the impact of the waves produces a stress in the crystals which causes the emission of light. Mr. Edison describes these waves as sound waves, because they differ in their mode of vibration from ether waves. Their motion is infinitely more rapid than that of

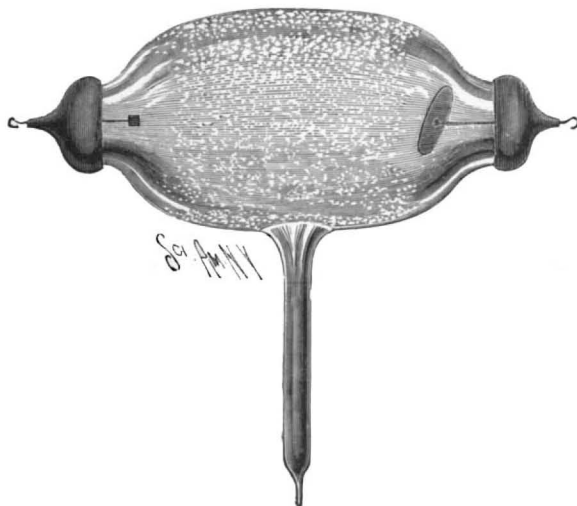

EDISON'S FLUORESCING VACUUM LAMP.

sound waves with which we are familiar; they are comparable as regards velocity with electric or light waves. As to efficiency, the fluorescing lamp produces light at the rate of 0.3 of a watt per candle power. When this is compared with 3 watts per candle power for incandescent lamps, and 1/2 watt per candle power for arc lamps, it will be seen that there must be great economy in the fluorescing lamp.

The Record-breaking Trip of the St. Paul.

Friday, June 5, 1896, will be a red letter day in the annals of the American transatlantic marine. The passengers which the St. Paul landed at the North River dock, New York, at twenty minutes past four in the afternoon of Friday, had only left Southampton at noon on the previous Saturday, so that the time of the whole trip of 3113.7 knots was only 6 days 5 hours and 32 minutes. The excellence of the performance will be better understood when it is remembered that she traveled over the long route, thereby adding fully three hours to the time she would have taken had she followed the record course of the New York, which was 3,047 knots long, and was covered in 6 days 7 hours and 14 minutes. The average speed for the whole trip was 20.82 knots. The highest hourly average speed for a whole day was made on Monday and Tuesday, when she covered 521.9 and 521.7 knots, and slightly exceeded 21 knots per hour.

The story of the St. Paul's trip, her tenth to the westward, is thus told by her log:

	Distance.	Lat.	Long.
May 30, left Southampton, 12 noon.			
May 31.....	487.8	49-48	14-01
June 1.....	521.9	48-33	27-11
June 2.....	521.7	45-51	39-17
June 3.....	513.0	42-38	50-13
June 4.....	508.6	41-46	61-36
June 5.....	518.9	40-36	72-56
	41.8	To Sandy Hook.	
	8,113.7		

This performance places the St. Paul well up in the

front rank for speed, being exceeded only by the Campania and Lucania, one of which has averaged slightly over 22 knots for the whole trip and about 23 knots for a single day's run. It must be remembered however that the horse power of these ships is 30,000 against the 10,000 horse power of the American ships.

The engines and boilers were being driven at full pressure for the whole distance, and the chief engineer states that there was not a single case of heated journals or leaking tubes. This is an admirable performance when it is remembered that the boilers carry 200 pounds of steam, and the revolutions are about 90 per minute. The coal consumption is given out as 310 tons per day against a reputed consumption of over 500 tons for the Lucania and Campania.

Notice to Our Readers.

In order to obtain the opinion of the readers of the SCIENTIFIC AMERICAN as to what invention introduced within the last fifty years has conferred the greatest benefit upon mankind, we publish the accompanying card, which please cut out and return to the editor. Those who preserve the paper for binding and do not desire to deface their files, or who read this notice at a library, will please answer by postal card. It is desired to get as full a vote as possible. The result of the vote will be published in the Special 50th Anniversary Number of the SCIENTIFIC AMERICAN on July 25.

\*\*\*\*\*  
 \* Editor of the SCIENTIFIC AMERICAN. \*  
 \* Dear Sir: \*  
 \* I consider that..... \*  
 \* ..... \*  
 \* invented by..... \*  
 \* has conferred the greatest benefit upon man- \*  
 \* kind. \*  
 \* Name..... \*  
 \* Address ..... \*  
 \*\*\*\*\*

The Significance of Gesture in Disease.

When you ask a patient to locate his pain, he does so by a movement of one or both his hands. The gesture, however, not only indicates its seat, but describes its character and distribution. This is an all important point. If the pain is widely distributed over the whole chest, the patient locates it with a circular rubbing motion of the palm of the hand, indicating the diffused soreness.

The pain of a serous inflammation, on the other hand, is described by first drawing the hand away from the body and then, with the fingers close together or with the index finger extended and the others flexed, cautiously approaching the seat of the inflammation.

In appendicitis the patient does not touch the skin at all when asked to locate the pain. He simply holds the palm of his hand over the diseased area.

With very violent abdominal pains which are not inflammatory, the patient slaps himself vigorously across the abdomen on being asked to indicate the location of his trouble.

If a child refers a persistent pain to the stomach, and there is no tenderness or pressure, disease of the spine is indicated.

In hip joint disease, the pain will be referred to a point inside the knee.

With terrific diffused pain in the leg, not due to an inflammation, the patient grasps the leg firmly. If it is a darting or lancinating pain, he will indicate it with one finger.

In the pain caused by the descent of renal calculi and gall stones, he follows their course with the top of the thumb or index finger.

The pain of hepatic neuralgia or "shingles" is indicated with the thumb or finger.

In joint pains the patient approaches the seat of trouble very cautiously with the hand spread flat.

The degenerative pain of locomotor ataxia is described by grasping the affected area firmly, indicating a band-like pain. Or, if the pain is sharp and lightning-like in the leg, the pain gesture is perfectly descriptive, an energetic downward motion, at the same time twisting the hand as though manipulating a corkscrew.

A patient will indicate the seat of a severe syphilitic headache by hammering with the tips of his fingers.

A patient complained of a severe headache. "In what part of the head is it?" he was asked. "The vertex," he replied. On being asked to indicate the exact spot, he placed his finger on the parietal eminence. This he did three times in succession, though claiming to feel the pain exactly on the top. Upon examining the mouth a defective tooth was found. As soon as it was removed the pain disappeared.—

Nat. Board of Health Mag.

**SUN SPOTS OBSERVED MAY 31, 1896.**

To the Editor of the SCIENTIFIC AMERICAN:

Prevailing severe storms have induced me to make two drawings of a large group of sun spots visible to the protected naked eye on May 31, 1896, as a dark spot near the lower limb of the sun, as shown in Fig. 1, and of which Fig. 2 is a telescopic enlargement. To those who recognize the direct influence of solar eruption on our earth's electrical state, with its consequent atmospheric disturbance, the appearance of such a large group at this time of storm would seem to afford some proof.

L. H. HORNER.

Springfield, Mass., June 1, 1896.

**Employment of Fogged Films.**

At the London Camera Club conference Capt. W. De W. Abney suggested the following method of using fogged films: It sometimes happens that a celluloid film coated with a sensitive gelatino-bromide emulsion is accidentally exposed to light (light fogged), or has been exposed in the camera; but for some reason or other it is not thought desirable to proceed with development, etc. These "spoiled" films may be used in the following way: They are placed in a bath of potassium bichromate and sensitized just as though they were pieces of ordinary carbon tissue. When dry they are printed in the usual way, but with this important difference, viz., that the celluloid is put next the negative image, i. e., the printing is through the celluloid, and so first reaches the back of the film. Thus no transfer is needed, so that when the faint image of silver subsalts is visible, the development of the bichromated gelatine in hot water may take place just as though ordinary carbon tissue were being manipulated. Experience shows that it is found best to pour the hot water over and over the surface, so as to thoroughly wash out the soluble gelatine. We have now an image in gelatine containing a developable silver salt. Development may now take place in the ordinary way. Furthermore, where local treatment is required, brush development and brush fixation may be applied. This opens up a field for local treatment.

**A DESTRUCTIVE BOILER EXPLOSION.**

BY FRANK WOODMANCY.

The W. P. Orr Linseed Oil Company's mill, at Piqua, Ohio, was wrecked by the explosion of one of the boilers Sunday night, April 5. Three men were in the building at the time, but none were seriously hurt. Had the explosion occurred an hour later, a number of employes would have been at work, as they were to go on duty at midnight. The capacity of the boiler was one hundred horse power and the explosion shook the entire city. A four story wing of the building, fifty-five by seventy-five feet, was completely razed and the main structure badly wrecked, besides doing considerable damage to other property.

A practical engineer of several years' experience gives his theory as to the cause of the explosion in the following:

"There is but one plausible theory, and that is what is known in our terms as 'foaming.' The cause most liable to produce this effect is the use of deleterious compounds, of which many are now manufactured ostensibly for the purification of boilers by removing exotic substances, such as scales of magnesia, lime or sulphur, but which in reality, from the fact that they are composed largely of sodium compounds, assist in creating extraneous matter. When this condition is produced, gases are almost certain to collect under the water and elevate it sufficiently to create a deceptive condition in the gage, on which most engineers depend for guidance.

"The result of this is that the heating surface of the boiler is exposed to a fierce heat, with nothing to cool it, on account of the elevation of the water. The consequence is obvious, especially where an engineer is

unable to detect this chemical change. During such a state of affairs steam may be rapidly created without the knowledge of the engineer, whose only resource for discovering this condition is in the engine, which always gives warning in a peculiar manner. Thus it is very clear that as much as one hundred and fifty pounds of steam might have generated, for this

who with a six inch photographic lens of forty feet focal length, specially constructed by Brashear for the occasion, will attempt to repeat and improve upon the remarkable results he obtained during the Chilean eclipse of 1893. On his plates the image of the moon will be nearly four and a half inches in diameter, and the corona will be more than a foot across.

Mr. Burckhalter, with a lens of twenty feet focus, will make photographs of just half the size, using an ingenious contrivance of his own, which, by means of a star shaped screen revolving swiftly in front of the photographic plate, gives to the outer regions of the corona an exposure many times longer than that allowed to the lower and brighter portion. It is hoped in this way to bring out satisfactorily on the same plate the whole extent of the corona in a single picture—a thing never yet accomplished. On negatives that show the outer portions well the inner portions have hitherto been entirely overexposed, and their interesting details quite obliterated.

From England Mr. Christie, the Astronomer Royal, takes

out a large party equipped to occupy at least two stations. A party also goes from France in charge of Deslandres, of the Paris National Observatory; but we have no information as to its composition and outfit, except that their work is to be mainly spectroscopic; nor do we yet know whether Germany will have a party in Japan.

In Siberia a number of stations will be occupied by the Russian astronomers, and some of them will be very thoroughly supplied with photographic apparatus. The most of them will make only visual observations.

In Norway and Finland the observers will be numerous, though for the most part amateurs. There will, however, be at least one English party provided with instruments precisely like those taken by Mr. Christie to Japan, so as to give strictly comparable results; and America will be fairly represented by several observers. But the sun will be rather low, and the duration of totality so short (less than two minutes) that the results are likely to be much less satisfactory than those obtained in Siberia and Japan.

The special aim of the observations will be, of course, to get information about the corona—its structure, the variations, if any, which occur during the two and a half hours while the shadow is traveling from Norway to Japan, and the peculiarities of the coronal spectrum. The identification of terrestrial helium a year ago has naturally much intensified the interest in the thus far mysterious element, provisionally called coronium,

which produces the most conspicuous line in the coronal spectrum, and has hitherto been found nowhere else, unless, perhaps, in one or two of the so-called "new stars." It is earnestly hoped that on this occasion we may get some new light on the subject.

But while the corona will be the principal object of observation, other matters will be looked after also. The spectrum of the "reversing layer"—the lowest region of the chromosphere—will be carefully studied, as well as that of any prominences that may be visible; and an attempt will be made to determine the precise region where the great "H" and "K" bands of the solar spectrum have their origin—bands at present ascribed to calcium, but in many ways very peculiar in their behavior if they are really due to that metal.

If the weather is fine, we may fairly expect real and important additions to our knowledge; but the "Prince of the Power of the Air" is a very malignant and intractable demon.—The Independent.

GOVERNOR MORTON has signed the bill relating to the use of the reservoir site on Fifth Avenue, New York City, for the erection of the new New York Public Library, Astor, Lenox and Tilden foundations,

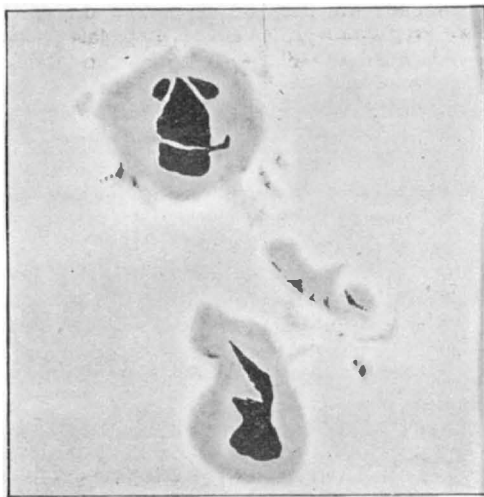
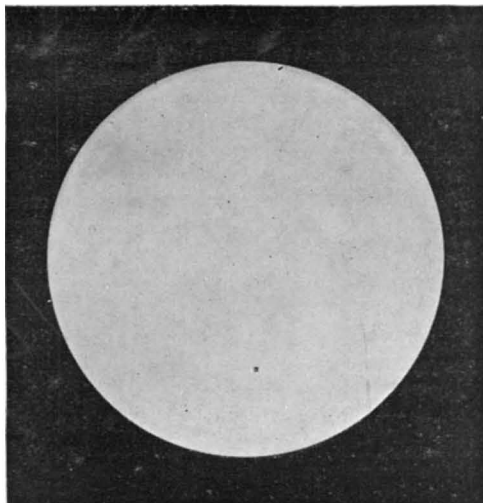

Fig. 1. SUN SPOTS OBSERVED MAY 31, 1896. Fig. 2.

amount, in my opinion, would have been necessary to produce the effect attained by this explosion."

**The Coming Eclipse.**

The astronomers are beginning to put themselves in motion for the observation of the eclipse on August 9. As noted in these columns some time ago, it begins in the morning off the coast of Norway, and the track of the shadow passes over Finland, Northern Russia, Siberia and Yezo, the northern island of Japan, where it arrives in the afternoon.

In Norway and Finland the sun will be very near the horizon, and the duration of the obscuration will be less than two minutes. In Siberia, where the eclipse takes place at noon, the astronomical conditions will be the best; but considering the ease of access and the probable conditions of the weather, the Japanese stations have the advantage, and offer the best chances of success. The most important expeditions will go there.

From this country two parties have gone or are going. The largest, of nine persons, is under the charge of Prof. D. P. Todd, of Amherst College, and sailed from San Francisco about the twentieth of April on Mr. A. C. James' yacht Coronet. The heavy and elaborate equipment of apparatus was sent around the Horn last winter upon the yacht, and is sufficient to fit out three stations, provided, as is likely, that enough amateurs can be found on the ground to assist in the use of the instruments. The apparatus is so

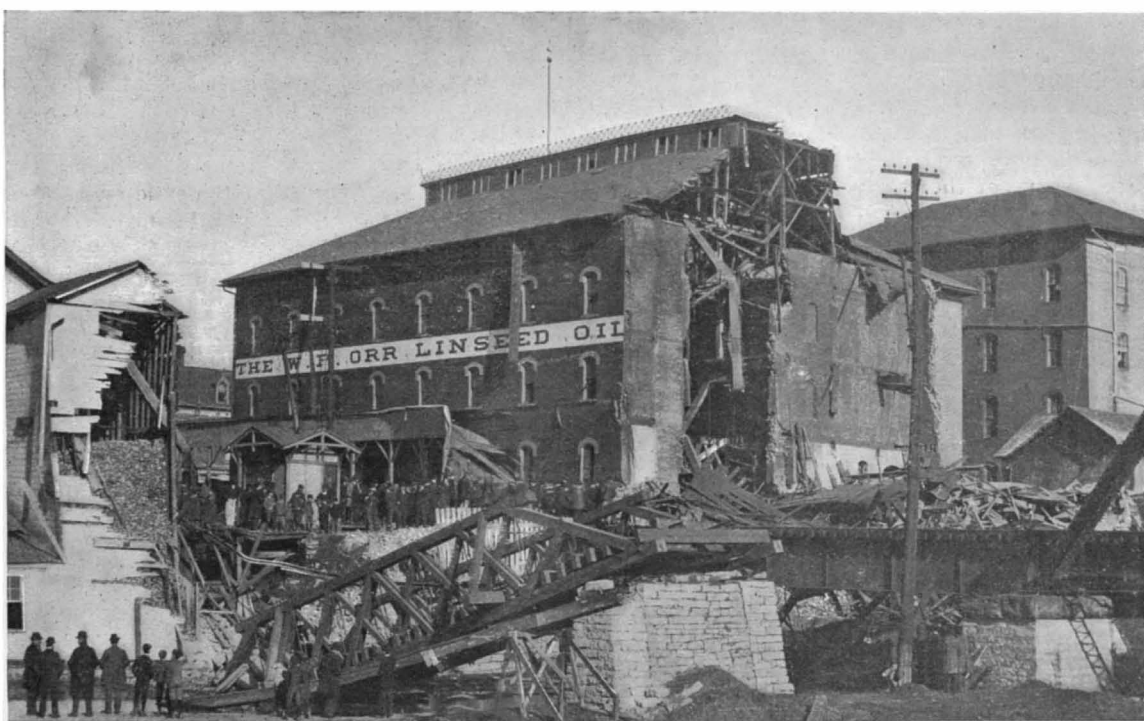

A DESTRUCTIVE BOILER EXPLOSION AT PIQUA, OHIO.

largely automatic that no great amount of special astronomical experience is needed for many of the proposed operations, which are for the most part photographic. The visual spectroscopic observations are also provided for, as well as polariscopic and photometric. Mr. and Mrs. James accompany the party, and Mrs. Todd goes with her husband.

The liberality of Col. Crocker and other friends in San Francisco enables the Lick Observatory to send out a second party, headed by Prof. Schaeberle,

## RECENTLY PATENTED INVENTIONS.

## Railway Appliances.

**RAILROAD TIE PLATE.**—Alexander B. B. Harris, Bristol, Tenn. This tie plate is made so as to form a spiked socket with straight cylindrical outer edges, without any toe or flange at their lower edges, but making the two opposite tongues which lie in the line of the grain of the wood thicker at their lower ends than they are above, while the other tongues are of the same size below that they are above, so that when the spike is driven it expands the lower edges of the two thickened tongues outwardly in the line of the grain of the wood, but does not expand the others, which would produce a strain transversely to the tie and split the latter. The form of spike is changed from an elongated nail to a short and thick plug, which, while having a spiked head, does not penetrate the wood of the tie, but simply serves to expand the pendent tongues of the tie plate in the bored hole of the tie, thus furnishing a very strong body of metal to resist the lateral thrust of the rail and the cutting of the heads of the spikes whenever the car wheels jump the track.

**ELECTRIC BLOCK SIGNAL AND TRAIN LIGHTING SYSTEM.**—John Calhoun West, Atlanta, Ga. The object of this invention is to provide a railway system so arranged that it is impossible for trains to collide with each other or to be accidentally switched; mechanism is provided for cutting off the steam and applying the brakes of oppositely moving locomotives when they enter the same block, also for applying the brakes when a locomotive enters a block in which there is a train at a standstill or where there is an open switch. The means for obtaining these ends consist, broadly stated, in two main conductors forming parts of an open circuit charged by any suitable source of electricity and extended parallel with each other and along the track of a broken conductor, the brakes of which are one at each block and with which brakes are associated a series of bridge conductors, and in mechanism carried by the locomotives of the trains, and comprising means for electrically controlling the throttle and brake valves and suitable conducting devices for co-operation with the conductors of the track. The invention also comprises improved mechanism for lighting trains and head lights.

**CAR COUPLING.**—Charles H. Smith, Birmingham, Ala. This invention relates to improvements in car couplings of the Janney type. In brief, it consists of a knuckle having an edge wall of the tail piece longitudinally recessed, this recess having a pocket at its end nearest the knuckle pivot, and a keeper bar across the recess and of a curved plate spring having a toe that is interlocked with the pocket and keeper guard, and normally projects the free end of the spring away from the tail piece of the knuckle. It also consists of an upward extension of the drawhead chamber and a curved lifting bar, adapted to work in a slot at the top of the extension, and adapted to engage a gravity block which may be operated from the exterior of the drawhead and controls the swinging movement of the knuckle.

**CAR FENDER.**—William T. Donohue, New York City. The object of this invention is to provide a fender which will normally be carried in an upright position in front of the dashboard of the car, yet be close enough to the ground at its lower end to strike an object falling in the path of the car, and to devise a means whereby the fender, as it strikes an object, will be immediately placed in operative connection with the axle of the car or other driving shaft and be instantly turned downward to an inclined position or to a position to convert it virtually into a cradle to receive the person. Means are also provided by which, when the fender is lowered sufficiently, the driving connection between the driving shaft and the fender will be severed, the driving mechanism being also automatically set in action by inward pressure on the fender, thus relieving the motorman or gripman of all responsibility of the manipulation of the fender and enabling him to devote all his time and attention to the brakes and driving mechanism of the car.

**DRAWBAR FOR RAILROAD CARS.**—John Shaw, Woodburn, Ore. The object of this device is to relieve the cars in a train of the pulling and pushing and strains and jerks, thereby freeing the car body of the weight of the train. It consists principally of a frame extending longitudinally on the under side of the car from one end to the other. The said frame is mounted to slide and springs interposed between the frame and the body of the car take up the strain.

**CAR COUPLING.**—James A. Ward, Delta, Idaho. This device relates to car couplings of the side latching or Janney type. The device is adapted for reliable operation and dispenses with the loose pintle bolt between the knuckle and drawhead, so as to afford a cheap and durable hinged joint between these parts; furthermore, to adapt a car coupling for ready release when in a coupled condition with a similar coupling. The drawhead has a pintle formed on one of its side walls and a reduced or web portion between said wall and the pintle, and of a knuckle having a channel to engage the pintle. This channel has an outward opening of less width than the diameter of the pintle, the inner wall of said outward opening being adapted to engage the inner surface of said reduced or web portion, and define the opening of the knuckle.

## Mechanical.

**VAPOR ENGINE.**—Albert F. Rober, Ilwaco, Washington. This improvement is designed for vapor engines, whereby the air and vapor are mixed in proper quantity and positively fed into the explosion cylinder to insure a positive impulse to the piston at each revolution of the main shaft. It consists principally of a valve casing having a chamber connected at one end with the working cylinder and at the other end with a compressed air reservoir, a valve for controlling the oil passing to the said chamber, and a valve in said chamber and controlled from the main driving shaft to admit the mixture to the cylinder at the proper time.

**STREAM BLOWER.**—George R. Jarman, Durham, N. C. The object of the invention is to provide a new and improved generator which is simple and durable in construction and more especially designed for

use on stationary engines or locomotive boilers to produce a forced draught in a very simple and economical manner, to insure perfect combustion and increase the capacity of the boiler. The invention consists principally of a tube in the steam chamber connected with a steam supply and provided with angular ports leading forwardly into the said tube, to cause the steam passing through the said ports into the tube to travel forwardly and draw the air into the tube.

**TAP AND DIE HOLDER.**—James M. Carpenter, Pawtucket, R. I. This invention relates to a tap and die holder, and is arranged to permit the tap and die to accommodate or adjust itself relative to the work and to compensate for any defect in the die itself and defects in the alignment of the spindle of the machine with the tap or die holders, so as to insure a perfect cutting of the thread. It consists of a hollow head and a hollow die seat having universal movement therein and provided in its bore with an outwardly flaring surface adapted to engage the inner end of the die, and an annular cap removably secured to the seat to move in unison therewith relatively to the head, and provided at its opening with an inwardly flaring surface adapted to engage the outer end of the die.

**DEVICE FOR LOWERING BOATS.**—John Albert Gamble, Ashville, Ala. This invention provides a simple and durable device by the means of which a boat can be expeditiously lowered and whereby, simultaneously with the lowering of the boat, ladders or steps will be carried down, enabling a person to readily descend from the deck to the boat. Another object of the invention is to hold the boat away from the side of the vessel in a rough sea, thereby preventing the boat from becoming swamped or crushed. The mechanism is so arranged as to allow the boat to freely rise and fall with the motion of the water.

**REFRIGERATING APPARATUS.**—Hu Maxwell and Robert R. Maxwell, Fresno, Cal. The primary object of this invention is to provide an improved apparatus for refrigerating by evaporation, especially adapted for domestic use. In brief, it consists of two troughs supported one above the other and having an absorbent cloth extending from one trough to the other and forming an inclosure, of which the refrigerator is formed. The cloth is held in the upper trough by a removable top which rests thereon and carries a tank for supplying water to the troughs and cloth. The top also supports the shelves within the refrigerator.

**HAND TRUCK.**—Harry York and George E. Slaughter, Colton, Cal. This invention provides for an improved method for chocking or braking a hand truck for the purpose of preventing its forward or backward movement while being loaded. It consists of an ordinary hand truck, of a transverse swinging brake bar having parallel arms secured to the frame of the truck, the arms being jointed and attached to the brake bar, a helical spring being employed to maintain the brake bar either in operative or inoperative position. When the truck is lowered to position to be moved the brake is automatically released.

**THILL COUPLING.**—Charles T. Redfield, Glen Haven, N. Y. This improvement provides a simple and novel construction by which to efficiently secure the thill iron to the clip, to secure the bolt so that it will not turn, to hold the securing nut from turning on the said bolt and to accomplish that result through the aid of a spring, so arranged that it not only co-operates in securing the locking of the nut, but also efficiently serves the purpose of an anti-rattling device. The invention consists in certain novel features and combinations and arrangements of parts in which this object is obtained.

**FIRE ESCAPE AND EXTINGUISHER.**—Joseph Clabron, Lexington, Ky. The main object of this invention is to provide a combined fire escape and hose holding and manipulating apparatus, and one by which persons may ascend and descend a building and which will be capable of holding a hose in position to throw a stream of water upon the building. The invention consists, broadly stated, in a ladder held to the side of a building and having a peculiarly constructed hoisting apparatus, whereby persons and things may be raised or lowered, and having also a peculiarly constructed hose holding and hoisting device.

**RADIATOR.**—Augustus Eichhorn, Orange, N. J. This improvement provides a superior steam heater and combines therewith an improved air heating mechanism. These results are obtained, first, by constructing the radiator with two divisions of different radiating capacity, each section being thrown in and out of operation by valves controlling the exit of cold air, and, therefore, the inlet of cold steam; and, second, by a series of plates which inclose the base of the radiator and form a hot air space fed by an air conduit which passes through the floor and into the air space, and which is controlled by register mechanism operative from the exterior of the radiator. Supplementary to the broad idea of this invention, it includes various novel features of construction attending the register mechanism and the plates for forming the air space.

## Electrical.

**SAFETY APPLIANCE FOR ELEVATORS.**—John H. Tennyson, New York City. The object of this invention is to provide a means whereby, upon touching a button in the elevator cage or car or at any predetermined point within one or more electrical circuits, the brake drum of the elevator engine will be instantly applied together with the brake controlling the guiding shaft, and also the supply of steam is cut off from the elevator engine, and the safety clutches or clutches of the elevator car will be immediately brought into action through the medium of the same button or in the customary manner. The above result is accomplished through the medium of simple, durable and economic mechanism, which is applicable to any form of engines or to any type of hoisting or manipulating machinery or elevators.

## Miscellaneous.

**DAMPING DEVICE FOR MUSIC BOXES.**—Henry Langfelder, Jersey City, N. J. The object of this invention is to provide a new and improved damping

device arranged to positively bend the tongue of the comb previously to its being sounded by the pin of the cylinder and the tooth of the star wheel. It comprises a resilient damper for the tongue and a resilient bar engaging the damper extending into the path of travel of projections moving with the tongue sounding mechanism.

**TWO COMPARTMENT BOTTLE.**—Hugh Gallagher, New York City, assignor to Lillie Deechan, of Brooklyn, N. Y. The object of this invention is to provide a new and improved two compartment bottle, which is simple and durable in construction and is specially designed for containing separately two kinds of tablets, pills, or other articles. It consists principally of a bottle body formed with a neck at each end to receive a closing device, and so formed at or near its middle with inwardly extending projections integral with the body to form two compartments therein.

**PNEUMATIC TIRE.**—Harry C. Dean, Long Island City, N. Y. This invention relates to tires for bicycles or other vehicles, the object being to make a light, simple and punctureproof tire, either of the single or double tube variety; the tread is provided with an annular shield formed of a series of plates of hard material, these plates being each provided with elongated or slotted openings and rivets, the rivets of one plate working in the slots of adjacent plates. The shield is arranged inside the outer sheathing or shoe of the tire so that it will be protected from wear, while in turn it protects the inner portion of the tire from being punctured.

**PAPER TOY.**—Edward Tinkham Gibson, Minneapolis, Minn. The invention consists first of a continuous blank of paper from which the front, lateral sides, stage platform and background to the stage of a toy theater may be produced by freeing certain portions of these said parts from the blank of paper by die cuts, bending certain of these said parts on scored or creased lines, and locking the parts together in position; second, of paper "scene shifts," or "scenery," which are used in combination with the theater; and, third, of paper figures representing actors, each of which is provided with a long strip extension projecting at a right angle to the erected figure, and which figures may be caused to move about upon the stage platform by manipulating the said strip extensions from the side of the theater, when the surface of the said strip extension is on the same plane as that of the figure, and manipulating them from the back of the theater when the surface of the said strip extension is bent at its junction with the figure to form a right angle with the surface of the figure.

**DESIGN FOR A MIRROR FRAME.**—Albert Wanner, Jr., Hoboken, N. J. This design consists of panels having scroll ornaments at certain of the corners, and a leading feature of the design, and one marking a departure in such frames, consists in placing ornaments on the frame outside the panel or panels at the corners.

NOTE.—Copies of any of the above patents will be furnished by Munn & Co., for 25 cents each. Please send name of the patentee, title of invention, and date of this paper.

## NEW BOOKS AND PUBLICATIONS.

**JAMES CLERK MAXWELL AND MODERN PHYSICS.** By R. T. Glazebrook, F.R.S. London, Paris, and Melbourne: Cassell & Company, Limited. 1896. Pp. 224. Price \$1.25. (Already reviewed.)

**COLUMBIAN KNOWLEDGE SERIES.** Edited by Prof. Todd. Number III. Handbook of Arctic Discoveries. By A. W. Greely. Boston: Roberts Brothers. 1896. Pp. x, 257. Price \$1.

General Greely presents, in this little work, a most acceptable account of work done by Arctic explorers. No subject at the present time is attracting more attention than Arctic and Antarctic exploration, and this abstract of everything that has been done up to date will, we are convinced, be highly acceptable. We are so inclined to forget what has passed and give undue credit to the present that, if for no other purpose, the book will be useful in showing how successful old time explorers were in reaching high latitudes and how very little has been gained in Arctic exploration. Numerous maps have been given to elucidate the text.

**THE PROCESS YEAR BOOK. 1896.** Penrose & Company, London, England. E. & H. T. Anthony & Company, New York. Pp. 160. Price \$1.

The book is an annual comprehensive epitome of the progress that has been made during the past year in half tone process work and tri-color printing, explaining besides numerous other processes. It is copiously illustrated, some examples showing the remarkable progress that has been made as regards the use of screens and of dry plates. There are several interesting articles on practical subjects by experienced workers and a fund of useful information. That the delicacy and accuracy of the half tone process blocks is fast superseding the steel engraving of former days is very evident from the illustrations found in this book. There is a full exposition on the subject of tri-color printing, a process rapidly growing in favor, and one of interest to printers desirous of extending their business. The book is handsomely printed, and is an excellent example of a substantial English publication.

**ANDERSON'S PHOTO-MECHANICAL PROCESSES AND GUIDE TO COLOR WORK.** By MacFarlane Anderson. 1896. New York: E. & H. T. Anthony & Company. Pp. 182. Price \$5.

A compact, well printed handbook containing explicit directions for the working of several different processes, including photo color printing work, with illustrations of apparatus, screens and specimens of different styles of half tone engravings, by a writer of experience and ability. It is a book that will be appreciated by all process workers and others desirous of acquiring a knowledge of the practical operations necessary in the manufacture of half tone process blocks.

## Business and Personal.

The charge for insertion under this head is One Dollar a line for each insertion; about eight words to a line. Advertisements must be received at publication office as early as Thursday morning to appear in the following week's issue.

Marine Iron Works. Chicago. Catalogue free.

"C. S." metal polish. Indianapolis. Samples free.

Mariner & Hoskins, Assayers, 81 Clark St., Chicago.

W. Hoskins & Co., Assay Furnaces, 81 Clark St., Chicago.

Presses & Dies. Ferracute Mach. Co., Bridgeton, N. J.

Screw machines, milling machines, and drill presses The Garvin Mach. Co., Light and Canal Sts., New York.

The celebrated "Hornsby-Akroyd" Patent Safety Oil Engine is built by the De La Vergne Refrigerating Machine Company. Foot of East 138th Street, New York.

The best book for electricians and beginners in electricity is "Experimental Science," by Geo. M. Hopkins. By mail, \$4, Munn & Co., publishers, 361 Broadway, N. Y.

Stay with your job, and with your wages pay installments for a profitable olive orchard. Booklet free. Whiting's Olive Colony, Byrne Building, Los Angeles, Cal.

Concrete Contractors—Make more money by extending your business. Investigate Ransome's Concrete Construction. Liberal terms for exclusive rights. Ransome & Smith Co., 75E Monadnock Block, Chicago.

Cripple Creek—Its History to Date, Illustrated. Just out, with correct map and costly full page views natural as life. This great book will be sent free prepaid with our big 56-col. family paper 3 months on trial for 25c. (stamps or silver) club of 5, \$1. Latest mining news. Mention the SCIENTIFIC AMERICAN and address Illustrated Weekly, Denver, Colo.

Send for new and complete catalogue of Scientific and other Books for sale by Munn & Co., 361 Broadway, New York. Free on application.

## Notes &amp; Queries

## HINTS TO CORRESPONDENTS.

Names and Address must accompany all letters or no attention will be paid thereto. This is for our information and not for publication.

References to former articles or answers should give date of paper and page or number of question. Inquiries not answered in reasonable time should be repeated; correspondents will bear in mind that some answers require not a little research, and, though we endeavor to reply to all either by letter or in this department, each must take his turn.

Buyers wishing to purchase any article not advertised in our columns will be furnished with addresses of houses manufacturing or carrying the same.

Special Written Information on matters of personal rather than general interest cannot be expected without remuneration.

Scientific American Supplements referred to may be had at the office. Price 10 cents each.

Books referred to promptly supplied on receipt of price.

Minerals sent for examination should be distinctly marked or labeled.

(6874) R. W. S. says: Can you send me paper describing method of obtaining the enamel or glazed effect obtained on photo. work? A. Apply the prints face down while wet to the smooth varnished side of a ferrotype plate, squeeze it by rolling a rubber roller over the back, having blotting paper between the print and paper. When dry it will have a high polish and drop off the sheet. The polish is called glace finish. To mount such prints without losing the gloss, make the following mounting solution: Soak 1 ounce refined gelatine in cold water for an hour, then drain off and squeeze out the water as much as possible; put the gelatine in a jelly pot and place the latter in a pan of hot water on the fire; when the gelatine has melted stir in slowly  $2\frac{1}{2}$  ounces pure alcohol, and bottle for use. This glue will keep indefinitely, and can be melted for use in a few minutes by standing the bottle in a basin of hot water. As it contains a very small percentage of water, it hardly affects the gloss of the prints and dries almost immediately.

(6875) G. L. writes: Will you please answer through your valuable paper or otherwise the following questions: 1. What is the essential difference in quality between magnet and annunciator wire? A. It is a difference in the insulation, the annunciator wire having paraffin in the insulation, while magnet wire has a thin insulation of cotton alone. 2. Will magnet wire wound on fields of dynamo be improved if paraffined? A. It is good practice to do so—shellacking is perhaps preferable. 3. What formula for electroplating fluid do you give, so as to give a Grenet battery 2 volts and  $2\frac{1}{2}$  amperes? A. One gallon sulphuric acid and three gallons of water are mixed. In a separate vessel six pounds potassium bichromate are dissolved in two gallons boiling water. Mix, and use only after cooling. There are many variations on the above. 4. If I increase the plates of a Grenet cell, what advantage would I get? A. It tends to increase amperage and to lower resistance. 5. What would be the effect if I run too high an amperage through a wire? A. It would melt the wire, often explosively. 6. What is the safe carrying capacity of No. 18 wire? Of No. 5 wire? A. 25 amperes and 82 amperes respectively. If exposed to the air, they will carry more than this. 7. Where can I get resin oil, or how can I make it? A. Apply to a dealer in chemicals. Try Queen & Company, Philadelphia. 8. Can you give address of some electrical college? A. Columbia University, New York. 9. Could a voltmeter be made by passing the current through a platinum wire, and would it expand in proportion to the current? A. A voltmeter can be so made. The Cardew voltmeter is an example. Your problems are incorrectly solved. The metal seems to be zinc—analysis would be needed to determine it.

(6876) F. G. D. says: Through your valuable column would you give me a practical method to manufacture brass signs with the acid process. Also a good filling for the same. A. Paint the sign with asphalt varnish, leaving the parts to be etched unvarnished, raise a border around the outside, made of soft beeswax



Advertisements.

ORDINARY RATES.

Inside Page, each insertion - - 75 cents a line  
Back Page, each insertion - - - \$1.00 a line

For some classes of Advertisements, Special and Higher rates are required.

The above are charges per square line—about eight words per line. This notice shows the width of the line, and is set in agate type. Engravings may head advertisements at the same rate per square line, by measurement, as the letter press. Advertisements must be received at Publication Office as early as Thursday morning to appear in the following week's issue.

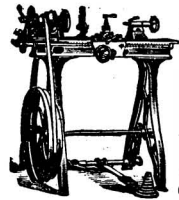

Star Lathes  
Foot Power  
Screw cutting  
Automatic  
Cross Feed  
9 and 12 inch Swing.

New Designs. Novel Features.  
Send for Catalogue B.  
SENECA FALLS MFG. COMPANY,  
695 Water St., Seneca Falls, N. Y.

AMERICAN PATENTS.—AN INTERESTING and valuable table showing the number of patents granted for the various subjects upon which petitions have been filed from the beginning down to December 31, 1894. Contained in SCIENTIFIC AMERICAN SUPPLEMENT, No. 1002. Price 10 cents. To be had at this office and from all newsdealers

POWER & FOOT LATHES. SHAPERS, PLANERS, DRILLS, MACHINE SHOP OUTFITS, TOOLS AND SUPPLIES. SEBASTIAN LATHE CO., 120 CULBERT ST., CINCINNATI, O.



THE CURTIS  
Steam & Grease SEPARATOR

IT WILL separate water from steam, and so deflect the water that it cannot get back into the current.

IT WILL separate grease and sediment from exhaust steam. The grease may be drawn off at intervals, and the sediment removed. Send for Circular S. E.

D'ESTE & SELLEY CO.,  
29-33 Haverhill Street, Boston.



GATES ROCK AND ORE BREAKERS  
LEAD ALL OTHERS IN  
ECONOMY DURABILITY CAPACITY

ESTIMATES furnished for COMPLETE CRUSHING PLANTS We manufacture MINING MACHINERY of every description. Gates Iron Works, Dept. C, 650 Elston Av., Chicago, Ill



VANDUZEN STEAM PUMP  
THE BEST IN THE WORLD.

Pumps Any Kind of Liquid. Always in Order, never Clogs nor freezes. Every Pump Guaranteed.

10 SIZES  
200 to 12000 Gallons per Hour.

Cost \$7 to \$75 each. Address THE E. W. VANDUZEN CO., 102 to 108 E. Second St., Cincinnati, O.

THE ORNAMENTAL IRON INDUSTRY.—Description of the method of manufacturing wrought iron into ornamental and artistic forms. With 9 illustrations. Contained in SCIENTIFIC AMERICAN SUPPLEMENT, No. 1020. Price 10 cents. To be had at this office and from all newsdealers.



"Fuel Saving." "Close Regulation."  
THE MASON HYDRAULIC  
DAMPER  
REGULATOR

Will work on 1/2 lb. variation. High or Low Pressure. Send for Catalogue Free.

THE MASON REGULATOR CO., 7 Oliver St., Boston, Mass.



20" X 8'  
Engine Lathe

Powerful. Strong. Heavy. Well Made.  
Weights 3,100 lbs. Made by F. E. REED CO., Box 817, Worcester, Mass., U.S.A.



ARMSTRONG'S PIPE THREADING  
—AND—  
CUTTING-OFF MACHINES

Both Hand and Power. Sizes 1 to 6 inches. Water, Gas, and Steam Fitters' Tools. Hinged Pipe Vises, Pipe Cutters. Stocks and Dies universally acknowledged to be THE BEST. Send for catalog.

THE ARMSTRONG MFG. CO., Bridgeport, Conn.



NEW IMPROVED  
TAPPING MACHINE

25,000 holes tapped per day. Description mailed. Machinery and Tools. Brass Machine Screws.

HARVEY HUBBELL,  
875 State Street, Bridgeport, Conn.

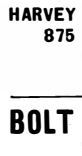

BOLT CUTTERS AND NUT TAPPERS  
IN GREAT VARIETY.

Cutting all sizes up to two inches.

WELLS BROS & CO.,  
Greenfield, Mass.  
P. O. Box B.



STEVENS ARMS & TOOL CO.  
THE NEW STEVENS SCRIBER

STEVENS #80 SCRIBER  
7/8 INCH. PRICE 40 CENTS

Easy to hold. Nicely tempered. In beauty and usefulness an ornament to every mechanic's kit. Send for Book. J. STEVENS TOOL CO., P. O. Box 280, Chicopee Falls, Mass.

NO DIRT. NO SMOKE. NO NOISE. NO LICENSE. ABSOLUTELY SAFE.

PENNSYLVANIA IRON WORKS COMPANY,

BUILDERS OF THE  
"GLOBE" GAS

AND  
GASOLINE ENGINES  
for Stationary and  
Marine Service.



Launch with 9-I. H. P. "Globe" Engine, property of F. F. Milne, Island Heights, N. J.

Catalogues and Prices on application.

Address, 50th Street and Lancaster Avenue, PHILADELPHIA, U. S. A.

LATHES and General Line of Machine Shop Tools.

Hill, Clarke & Co.,  
160 Oliver Street,  
BOSTON.  
16 So. Canal Street,  
CHICAGO.

FOR EVERY CYCLIST.



Three tools you are always needing: Screw-driver, Awl, Wrench. All in one light, compact combination. Finely finished, nickeled. Weighs only 2 oz. Length closed 3 in. If your hardware dealer hasn't it we will send it on receipt of 45 cents. Stamps taken.

THE L. S. STARRETT CO., Box 33, Athol, Mass.

SYCAMORE CASE of 1, 2, 3, 4, 6, 9, 12 Inch Tempered Rules

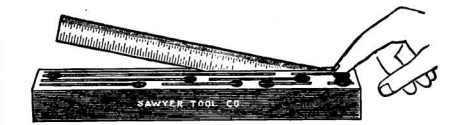

Also 4 inch Narrow and Center Gage. P. P. until Sept. 1st for \$4.00. Sawyer Tool Co., Athol, Mass.

TURBINE WATER WHEELS. SEND FOR PAMPHLET. JAMES LEFFEL & CO., Springfield, Ohio, U. S. A.

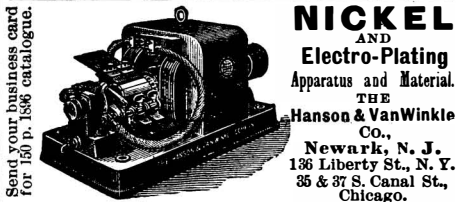

NICKEL AND Electro-Plating Apparatus and Material. THE Hanson & VanWinkle Co., Newark, N. J., 136 Liberty St., N. Y., 35 & 37 S. Canal St., Chicago.

A Book of Tools

Facts about Factory Trucks and Micrometer Calipers, in "A BOOK OF TOOLS."

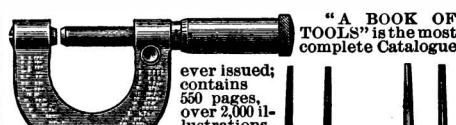

"A BOOK OF TOOLS" is the most complete Catalogue ever issued; contains 550 pages, over 2,000 illustrations, prices are given.

A copy of this book sent, postpaid, to any address upon receipt of 25 cents in stamps.

CHAS. A. STREILINGER & CO.,  
Address Box 124, Adv. Dept. DETROIT, MICH.

NICHOLSON FILES LEAD. High Priced, but most Economical. NICHOLSON FILE CO., Providence, R. I., U. S. A. Box 894. FREE! BOOK ON FILES 450 STYLES

FOR BICYCLE MANUFACTURERS  
QUINT'S  
TURRET DRILLS

Arranged for Tapping with from two to twelve spindles.  
A. D. QUINT,  
4 Clinton St., Hartford, Conn., U. S. A.

How to Build a Home

Those intending to build will find the very best practical suggestions and examples of Modern Architecture in the handsomest Architectural Magazine ever published . . .

"The Scientific American Building Edition."

Each number is illustrated with a Colored plate and numerous handsome engravings made direct from photographs of buildings, together with interior views, floor plans, description, cost, location, owners' and architects' names and addresses. The illustrations include seashore, southern, colonial and city residences, churches, schools, public buildings, stables, carriage houses, etc.

All who contemplate building, or improving homes or structures of any kind, have in this handsome work an almost endless series of the latest and best examples from which to make selections, thus saving time and money.

PUBLISHED MONTHLY. SUBSCRIPTIONS \$2.50 A YEAR. SINGLE COPIES 25 CENTS.  
For sale at all news stands, or address MUNN & CO., Publishers, 361 Broadway, New York

Architecture  
Architectural and Mechanical Drawing; Electricity; Mechanics; Plumbing; Mining; Civil Engineering in all Branches; Steam Engineering (Loco., Stat'y and Marine).  
The International Correspondence Schools



To Carpenters,  
Machinists, Electrical Workers, Plumbers, Steam Fitters, Pattern Makers, Steam Engineers, Draftsmen, Miners, Civil Engineers, etc. Everywhere. Free Circular. State Subject you wish to Study.  
B 949 Scranton, Pa.

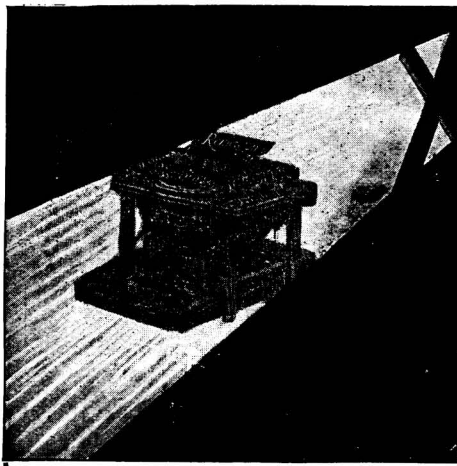

The more searching the test, the more satisfactory the qualities revealed by the

NUMBER SIX MODEL  
REMINGTON STANDARD  
TYPEWRITER

WYCKOFF, SEAMANS & BENEDICT  
377 Broadway, New York

THE FADING OF PIGMENTS.—A Paper by Capt. W. DeW. Abney, discussing the action of the various rays of the spectrum upon colors. Contained in SCIENTIFIC AMERICAN SUPPLEMENT, No. 1016. Price 10 cents. To be had at this office and from all newsdealers.

WE DON'T HAVE TO BLOW

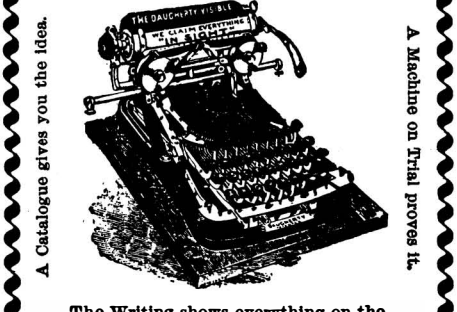

The Writing shows everything on the

"DAUGHERTY VISIBLE"  
TYPEWRITER  
Send address and guarantee express charges to  
The Daugherty Typewriter Co.  
PITTSBURG, PA.  
P. O. Box 1200 "C." Factory at Kittanning, Pa.

NEW PATENT  
Raw-Hide Bound Mallets

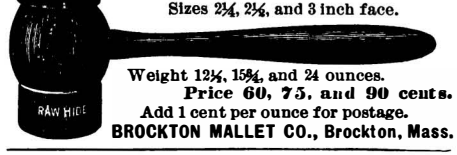

Sizes 2 1/4, 2 3/4, and 3 inch face.  
Weight 12 1/2, 15 1/2, and 24 ounces.  
Price 60, 75, and 90 cents.  
Add 1 cent per ounce for postage.  
BROCKTON MALLET CO., Brockton, Mass.

EDGE TOOLS  
are often nearly ruined by using a grindstone not adapted to the work. Our quarries produce a large variety of grits suitable for grinding any tool.

May we send you our Catalogue, which will give you some information?  
GRAFTON STONE COMPANY,  
No. 80 River Street, GRAFTON, OHIO.

DYNAMOS & ELECTRIC MOTORS  
Our 10 to 75 light Dynamos are pronounced a success by all who have them in use. High grade, compound wound, self-oiling, self-aligning bearings, high efficiency and great durability guaranteed. Lowest prices. Do your own lighting, no experience required. Send for catalogue and prices. Complete plants furnished.  
ROTH BROS. & CO., Mfrs.,  
30-34 Market Street,  
Chicago, Ill., U. S. A.

ACETYLENE APPARATUS.—ACETYLENE number of the SCIENTIFIC AMERICAN SUPPLEMENT, describing, with full illustrations, the most recent, simple, or home made and commercial apparatus for generating acetylene on the large and small scale. The gas as made for and used by the microscopist and student; its use in the magic lantern. The new French table lamp making its own acetylene. Contained in SCIENTIFIC AMERICAN SUPPLEMENT, No. 1057. Price 10 cents. To be had at office.



HYPNOTISM  
Sixty methods, \$6; my process \$2. 100 page book, 10c. Key to Power, 30c. Prof. Anderson, S. A. 6, Masonic Temple, Chicago.

BOOKS ON ELECTRICITY AND MAGNETISM JUST READY.

A Catalogue of Books on Electricity, Magnetism, Electrical Engineering, Electric Lighting, Electric Railways, Telephone, Electro-Deposition of Metals, Electrotyping, Electro-Metallurgy, and Cognate Subjects, 32 pages, sent free to any one in any part of the world who will furnish his address.

HENRY CAREY BAIRD & CO. INDUSTRIAL PUBLISHERS, BOOKSELLERS & IMPORTERS 810 Walnut St., Philadelphia, Pa., U. S. A.

This SCREW CUTTING LATHE (cuts Right and Left threads) 6 inch 4-jaw Chuck—jaws reversible, 6 Lathe Tools, Set Twist Drills, \$69.85. FRED FRASSE CO. 21 Warren Street, New York

The Edison Phonographic News tells where and how you can procure cheaply A PHONOGRAPH or A KINETOSCOPE the great money-earning wonders. Sample copy 10c. THE OHIO PHONOGRAPH CO., CINCINNATI, O.

The Bartley Direct Running Saw Mill Most complete, compact, and substantial Portable Saw Mill now on the market. Can be set up anywhere. Cuts all kinds of lumber. Entirely self-contained. No lost power. Hundreds in use. Write for Illustrated Catalogue. WM. BARTLEY & SONS, Mrs., Bartley Station, N. J.

THE COBURN PATENT TROLLEY TRACK HOUSE DOOR HANGERS The first made with adjustable track. The track can be put up in 30 minutes. Send for Book. The Coburn Trolley Track Mfg. Co., Holyoke, Mass.

Physical and School Apparatus GALVANOMETERS STANDARD, SINE, TANGENT, REFLECTING and WIEDEMANN GALVANOMETERS. Catalogue free. E. S. Ritchie & Sons, Brookline, Mass.

BUY TELEPHONES That Are Good—Not "Cheap Things." The difference in cost is little. We guarantee our apparatus and guarantee our customers against loss by patent suits. Our guarantees and instruments are both good. Western Telephone Construction Co. 250 So. Clinton Street, CHICAGO Largest Manufacturers of Telephones in the United States

TELEPHONES for Long or Short Distance Use. Also Interior or Warehouse Telephones. Sent on trial to responsible parties. Sold thousands during the last two years, every one a success. Send for Circular and Testimonials. Julius Andrae & Sons Co. MILWAUKEE, WIS.

MODELS & GEARS EXPERIMENTAL WORK CATALOGUE FREE UNION MODELWORKS CHICAGO

Seventeenth Edition of Experimental Science

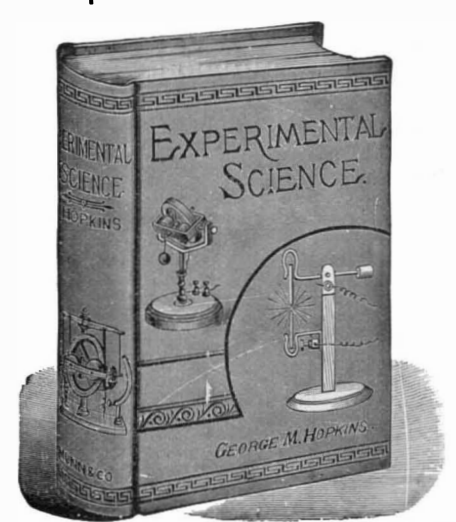

REVISED AND ENLARGED. 120 Pages and 110 Superb Cuts added.

Just the thing for a holiday present for any man, woman, student, teacher, or anyone interested in science. In the new matter contained in the last edition will be found the Scientific Use of the Phonograph, the curious optical illusion known as the Anorthoscope, together with other new and interesting Optical Illusions, the Optical Projection of Opaque Objects, new experiments in Projection, Iridescent Glass, some points in Photography, including Hand Cameras, Camera Obscura, etc.; Systems of Electrical Distribution, Electrical Ore Finder, Electrical Rocker, Electric Chimes, How to Color Lantern Slides, Study of the Stars, and a great deal of other new matter which will prove of interest to scientific readers.

MUNN & CO., Publishers, Office of the SCIENTIFIC AMERICAN, 361 BROADWAY, NEW YORK.



VELOX PAPER A Revolution in Photographic Printing. When exposed to the same light, prints 500 times quicker than albumen. . . . GLOSSY or MATT. No dull or rainy weather to interfere with your work. No dark rooms nor complicated manipulation. . . . Nepera Chemical Co., Sole Manufacturers, NEPERA PARK, N. Y.

THE FISHER Patent Steam Pump Governors For Steam Pumps Working under Pressure and the FISHER PATENT GRAVITY GOVERNORS For Steam Pumps filling elevated open tanks, are the most positive and durable devices made for the purpose. . . . 201 S. 1st Avenue. - - - Marshalltown, Iowa.

The Practical Trousers Hanger and Press keeps trousers "Smooth as if Ironed." Money refunded if not satisfactory. Illustrated booklet with testimonials and facsimile letters of duplicate orders, free on request. . . . 425 Walnut St., Phil., Pa. Agents wanted

ALCO VAPOR LAUNCH. Engine and helm controlled from bow. Latest improved and only 12 to 1 motor now ready for the market. . . . Marine Vapor Engine Co., Jersey City, N. J.

MONITOR MARINE GAS ENGINES AND LAUNCHES MONITOR VAPOR ENGINE & POWER COMPANY GRAND RAPIDS, MICHIGAN.

SMALL GASOLINE LAUNCHES 17 ft. by 31 in. 3/4 h p. motor. For 1 or 2 persons. Speed, 8 to 9 miles per hour. . . . J. H. RUSHTON, CANTON, N. Y.

FOR INVENTORS AND PROMOTERS. WANTED: Some easy selling electrical or mechanical specialty by well equipped Machine Works. . . . Address "SPECIALTY," care this paper.

MESSRS. MUNN & Co., Solicitors of Patents, have had nearly fifty years' continuous experience. . . . PATENTS taken through Munn & Co. receive special notice in the Scientific American. . . . New York, 361 Broadway.

RUST ABSOLUTELY PREVENTED ON MACHINERY, TOOLS AND METALS, BY MANNOCITIN. OPINIONS OF LEADING AM. MFRS. OTTO GOETZE, U.S. AGT. 114 BROAD ST. N.Y. Sample Can. 25c. by mail.

DIXON'S 691 CYCLE CHAIN GRAPHITE saves wear of chain, prevents rust and increases ease, speed and comfort. . . . JOS. DIXON CRUCIBLE CO., JERSEY CITY, N. J.

Howard Chainless Bicycle. The first man in any town who buys one will be allowed an agent's discount and offered an agency, whereby he gets comfortable and makes a specialty of selecting stones for all special purposes. . . . HOWARD, 171 Summer Av., Newark, N.J.

DO YOU USE GRINDSTONES? If so, we can supply you. All sizes mounted and unmounted, always kept in stock. . . . The CLEVELAND STONE CO. 2d Floor, Wilshire, Cleveland, O.

QUEEN'S NEW AUTOMATIC LAMP. Its Six Points of Superiority: 1. It keeps in focus constantly. 2. Regulates and runs silently. 3. No attention required to help it regulate. . . . Queen & Co., Inc., Philadelphia

WIRE Machinery for making any articles from WIRE Automatic wire forming machine department is in charge of R. C. Manville. . . . THE WATERBURY MACHINE CO., WATERBURY, CONN., U. S. A.

LINEN REVERSIBLE COLLARS AND CUFFS. MADE OF FINE CLOTH IN ALL POPULAR STYLES. Equal in Fit and Wear to finest linen. . . . REVERSIBLE COLLAR CO. Boston, 77 Franklin St., New York

AUTOMOBILE CARRIAGES: THE Paris-Bordeaux-Paris Race of.—Brief account of the performance of the vehicles that obtained the prizes in the competition instituted by the Petit Journal. . . . SUPPLEMENT, No. 1023. Price 10 cents. To be had at this office and from all newsdealers.

KLINE'S PATENT IMPROVED Boss Jar Holder and Top Wrench Entirely new—Fits any jar. No more burned hands in canning fruit.—No more broken jars while filling.—No trouble to carry hot jars.—No more bad temper trying to open jars.—No more trouble to close them.—Made of best steel wire and rubber.—Will last a lifetime. Price 50c per set. . . . KLINE & CO., Mfrs., 4 River Street, Florin, Pa.

EXPERT MODEL MAKING ESTABLISHED 1867 J. C. SEYLER WORKS 179 E. MADISON ST. CHICAGO MODEL CHICAGO, ILL. CATALOGUE FREE

SMALL MOTORS for All Purposes. The best manufactured. Specially adapted for all kinds of light work, sewing machine outfits, toys, dental drills, jewelers' lathes, models, etc. . . . MOTOR CO., Manufacturers of Electric Motors and Electrical Specialties, 122 Mitchell St., PROVIDENCE, R. I.

CROOKES TUBES AND ROENTGEN'S Photography.—The new photography as performed by the use of Crookes tubes as a source of excitation. . . . SCIENTIFIC AMERICAN SUPPLEMENT, Nos. 181, 189, 238, 243, 244, 292, 295, 405, 450, 105, 105, 104, 105, 105, also SCIENTIFIC AMERICAN, Nos. 7, 8, 10 and 14, Vol. 74. . . . L. R. HITCHCOCK, Watertown, Conn.

Eclipse Cream Separators are Closest Skimmers. Most Durable, Easiest Running and far the Simplest Hand or Power Separator on the market. . . . C. L. CHAPMAN SEPARATOR WORKS, LITTLE FALLS, N. Y.

DEAFNESS and HEAD NOISES relieved by using Wilson's Common Sense Ear Drums. New scientific invention, entirely different in construction from all other devices. . . . WILSON EAR DRUM MANUFACTURING CO., Louisville Trust Co. Building, Louisville, Ky. . . . 1122 Broadway, New York

Durable—Easily Applied. This roofing is manufactured from natural Trinidad asphalt materials, and will not dry up and become brittle under exposure to the weather as coal-tar roofings do. . . . WARREN CHEMICAL & MFG. CO., 85 Fulton Street, New York, U. S. A.

ICE HOUSE AND COLD ROOM.—BY R. G. Hatfield. With directions for construction. Four engravings. Contained in SCIENTIFIC AMERICAN SUPPLEMENT, No. 399. Price 10 cents. To be had at this office and from all newsdealers

SEND \$100 FOR 6 MONTHS TRIAL OF THE WESTERN ELECTRICIAN ILLUSTRATED

ATTENTION! INVESTORS FOR SALE! Foreign Patents—Canada, Mexico, England, Germany, Austria, Belgium, France, Italy, one of the most novel and useful inventions of the age. . . . RYERSON D. GATES, 106 La Salle St., CHICAGO, ILL., U. S. A.

SCROLL SAWS Foot Power Machinery, Tools, Forges, Drills, etc. Send for catalogue. Wilkinson Co., 85 Randolph St., Chicago

UNCLE SAM is looking for Bright Young Men to take the Civil Service Examinations now being held throughout the United States. \$1,200 to \$2,500 per annum, paid examiners in Patent Office. . . . Natl. Correspondence Institute, C. S. Dept. Washington, D. C.

A WALL STREET BROKER would furnish office or desk room. Could act as secretary of company and procure capital. Veritas, P. O. Box 773, New York.

SCIENCE OF MECHANICS. DESCRIPTIVE CIRCULAR FREE. OPEN COURT PUB. CO. CHICAGO

LIGHT and fine machinery a specialty. Model and experimental work strictly confidential. Drawings made and inventions perfected. How, 19 Gull St., Buffalo.

ICE MACHINES. Corliss Engines. Brewers' and Bottlers' Machinery. THE VILTER MFG. CO., 859 Clinton Street, Milwaukee, Wis.

Shorthand by Mail Thoroughly taught by reporters. Catalogue and first lesson free. Potts Shorthand College, Williamsport, Pa.

IDEAS DEVELOPED. Absolute secrecy. Send for particulars. Advice and suggestions free. Correspondence and sample orders solicited. 25 years in business. Gardam & Son, 96 John St., New York.

WELL DRILLING MACHINERY of highest grade. Warranted the best in use. All sizes and depths. LOOMIS CO. TIFFIN, OHIO.

TYPE WHEELS, MODELS & EXPERIMENTAL WORK, SMALL MACHINERY NOVELTIES & ETC. NEW YORK STEEL WORKS 100 NASSAU ST. N.Y.

DEAFNESS & HEAD NOISES CURED by my Invisible Tubular Ear Cushions, Whispers heard. . . . F. Hiscox only, 853 Broadway, N. Y. Send for book of proofs FREE

Pattern Maker's Gouges, Woodworkers' Chisels, Gouges, Turning Tools. Send for Price List. BUCK BROS., Millbury, Mass.

WOODEN TANKS. For Railroads, Mills and Manufactories. Builders of Steel Towers and Tanks. La. Red Cypress Wood Tanks a specialty. W. E. CALDWELL CO., 217 E. Main Street, Louisville, Ky.

WANTED Wire and metal specialties to manufacture in quantities. Send samples for prices on work or tools. L. R. HITCHCOCK, Watertown, Conn.

INVENTORS OF SPORTING SPECIALTIES WILL FIND IT OF ADVANTAGE TO CORRESPOND WITH AN INDIVIDUAL WHO SUBMIT THEIR ARTICLES TO N. P. O. BOX 2308 NEW YORK

VOLNEY W. MASON & CO. FRICTION PULLEYS, CLUTCHES, and ELEVATORS PROVIDENCE, R. I.

Hawkins' "Aids" to Engineers EXAMINATION TIPS, with Questions and Answers, 3 1/2 x 7 1/2, leather, gilt edge, \$2.25, postpaid. Send for FREE Descriptive Catalogue of this and other Engineers' Books. THEO. AUDEL & CO., 91 Liberty Street, New York, N. Y.

COPY LETTERS fifteen a minute, all legible, use my improved automatic copying machine. . . . JOHN H. ANDERSON, 910 Monmouth, CHICAGO.

CARBORUNDUM HARDEST ABRASIVE KNOWN. EMERY AND DIAMOND POWDER SUBSTITUTE. IN FLOUR, POWDER, CRYSTAL, WHEEL, SLAB & HONE FORM. CARBORUNDUM CO. MONONGAHELA CITY, PA., U. S. A.

MANUFACTURE OF STARCH FROM Maize.—By J. Krieger. Full details of the process. With one illustration. Contained in SCIENTIFIC AMERICAN SUPPLEMENT, No. 1012. Price 10 cents. To be had at this office and from all newsdealers.

C. F. SPLITDORF, MANUFACTURER OF INDUCTION COILS, MAGNETS, SPECIAL WIRE WINDING, ETC. 17-27 Vandewater St., New York.

THE NEW are the standard of excellence. DEPARTURE BELLS over. Made in 16 different styles and prices. Send postal for booklet to THE NEW DEPARTURE BELL CO., 210 North Main Street, Bristol, Conn., U. S. A.

X RAYS in Politics. The money question solved. The great campaign puzzle. 10c. post paid U. S. and Canada. Agents wanted. Adams & Morrison, 836 W. Folk St., Chicago, Ill.

Advertisements.

ORDINARY RATES.

Inside Page, each insertion. - 75 cents a line  
Back Page, each insertion. - \$1.00 a line  
For some classes of Advertisements, Special and Higher rates are required.

The above are charges per agate line—about eight words per line. This notice shows the width of the line, and is set in agate type. Engravings may be advertised at the same rate per agate line, by measurement, as the letter press. Advertisements must be received at Publication Office as early as Thursday morning to appear in the following week's issue.

"All is not  
**Columbia**  
that Glitters."

Your pleasure and safety depend on knowing what is under enamel and nickel before you buy a bicycle.



No question about Columbias. If you are able to pay \$100 for a bicycle why buy any but a Columbia?

See the Catalogue. Free if you call on the agent. By mail for two 2-cent stamps

**POPE MFG. CO.**  
HARTFORD, CONN.

Branch Houses and Agencies are almost everywhere. If Columbias are not properly represented in your vicinity, let us know.

All Columbia Bicycles are fitted with **HARTFORD SINGLE-TUBE TIRES** UNLESS DUNLOP TIRES ARE ASKED FOR. WE KNOW NO TIRES SO GOOD AS HARTFORDS.

MANUFACTURE OF BICYCLES.—A very comprehensive article giving the details of construction of every part of these vehicles. With 15 engravings. Contained in SCIENTIFIC AMERICAN SUPPLEMENT, No. 908. Price 10 cents. To be had at this office and from all newsdealers.

**Typewriter Patent**

This company owns Letters Patent No. 558,428, issued April 14, 1896, covering broadly all machines in which the cylinder turns up to expose the line of print, or in which a duplex or cross ribbon feed is used. The patent also covers many other features of modern typewriter construction. Infringers will be vigorously prosecuted.

Wyckoff, Seamans & Benedict.  
327 Broadway, New York.

**The American Bell Telephone Company,**

125 Milk Street,  
Boston, Mass.

This Company owns Letters Patent No. 463,569, granted to Emile Berliner November 17, 1891, for a combined Telegraph and Telephone, covering all forms of Microphone Transmitters or contact Telephones.

A WATCH movement is a machine whose value depends upon the perfection of each of its parts and the mechanical skill with which those parts are put together. We not only make every part of a WALTHAM movement, but we make the machinery by which those parts are made. There is the least possible chance for inaccuracy. The "RIVERSIDE" and "ROYAL" movements are as accurate time-keepers as human ingenuity has yet made possible.

For sale by all retail jewelers.

AMERICAN WALTHAM WATCH COMPANY.



AGENTS WANTED FOR FINE TOOLS IN EVERY SHOP. WRITE FOR CATALOGUE AND AGENCY. **C. H. BESLY & CO.** CHICAGO, ILL., U.S.A.

**POCKET PRESTO CAMERA**



A Photographic Wonder. A Midget in size, a Giant in capacity. 50 film exposures, or 4 glass plate exposures without re-loading. Makes big pictures—good ones too. Size 1 1/4 x 1 1/4. A REAL POCKET CAMERA. Rounded corners.

So Simple a Child Can Operate it. Snap Shot or Time Exposures. Price, complete, with film and glass plate magazines, loaded for 25 exposures, \$2.50. Illustrated booklet on receipt of stamp. Sample mounted photo free if you mention "Scientific American."  
**E. B. KOOPMAN,**  
Agents Wanted. 33 Union Square, New York.

ONLY PRACTICAL MAGAZINE CAMERA.

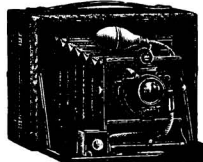

**SUNART'S "VENI, VIDI, VICI,"**  
SUNART MAGAZINE,  
SUNART FOLDINGS.  
Send for Illustrated Catalogue—2 cent stamp.  
**SUNART PHOTO CO., ROCHESTER, N. Y.**

**CRITERION**  
Stereopticons, Magic Lanterns and Accessories.  
Triple Stereopticon for Projecting Views in Natural Colors. Slides for Projection in Natural Colors.  
**X RAY LANTERN SLIDES**  
and other novelties. Self-Centering Arc Electric Focusing Lamps for Theatres, Photo-Engravers, etc.  
**J. H. COLE & CO.**  
115-117 New York  
and 50 Fifth St., New York  
Send for Catalogue.  
AGENCIES:  
189 La Salle St., Chicago, Ill.  
181 Post St., San Francisco, Cal.  
50 Bromfield St., Boston, Mass.  
38-39 So. Tenth St., Phila., Pa.  
415 N. Broadway, St. Louis, Mo.  
126 Erie Co. Bank Bldg., Buffalo, N. Y.  
234 Marietta St., Atlanta, Ga.



Three New Model  
**Smith Premier Typewriters**

Nos. 2, 3 AND 4

HAVE YOU EXAMINED THEM?

Many Improvements Heretofore Overlooked by Other Manufacturers.

Address **THE SMITH PREMIER TYPEWRITER COMPANY, Syracuse, N. Y., U. S. A.**

BRANCH OFFICES IN TWENTY-NINE PRINCIPAL CITIES IN THE UNITED STATES.

Gas and Gasoline Stationary Engines

GASOLINE TRACTION ENGINES  
COMBINED ENGINES & PUMPS  
GASOLINE PORTABLE ENGINES  
**USED** Any Place By Any One For Any Purpose  
CHARTER GAS ENGINE CO., P. O. Box 148, Sterling, Ill.

At 1/4 Price Bicycles, Watches, Guns, Buggies, Harness, Sewing Machines, Organs, Pianos, Saws, Tools, Scales of all varieties and 1000 other articles. Lists free. Chicago Scale Co., Chicago, Ill.

The **\$5.00** POCKET KODAK

EASTMAN KODAK CO., ROCHESTER, N. Y.  
Sample photo and booklet for two 2-cent stamps.

The ... **Premo Camera**

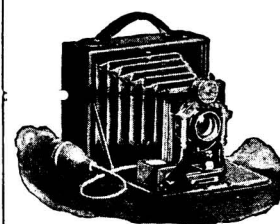

\* Styles for 1896 now ready \*

ROCHESTER OPTICAL CO., Rochester, N. Y.

**Scientific Book Catalogue**

RECENTLY PUBLISHED. Our New Catalogue containing over 100 pages, including works on more than fifty different subjects. Will be mailed free to any address on application.  
**MUNN & CO., Publishers SCIENTIFIC AMERICAN,**  
361 Broadway, New York

1896 High Grade Bicycles

Shipped anywhere C. O. D., at lowest wholesale prices.  
\$100 "Oakwood" for \$125.00  
\$85 "Arlington" " \$100.00  
\$65 " " " \$75.00  
\$20 Bicycle " \$10.75  
Latest models, fully guaranteed; pneumatic tires; weight 17 1/2 to 30 lbs.; all styles and prices. Large illustrated catalogue free.  
Cash Buyers' Union, 162 W. Van Buren St., B 13 Chicago

**A Boiler Feeder For High Pressures**

WORKS AT 150 TO 250 LBS. STEAM as easily as OUR STOCK INJECTOR AT 25 TO 150 LBS.  
May we tell you about it?  
**PENBERTHY INJECTOR CO.,**  
116 Seventh Street, DETROIT, MICH.

High grade wheels at popular prices, \$45, \$65, \$75. Also, our superb Elypha at \$100, forming an absolutely complete line. Agts wanted. Exclusive territory. Estab. 1864. Cata. Always free. House, Hazard & Co., Mrs. 16 G St Peoria, Ill. Reliable  
**VERLAND CYCLES**

ENGINES, Boilers and Machine Tools. New and Second-hand. Send stamp for paper "Machinery & Supplies." W. P. Davis, Rochester, N. Y.

THE DELIGHT OF BICYCLING DEPENDS ON PROPER TIRES.  
**RIDE Hartford SINGLE TUBE TIRES**  
"MADE BY THE HARTFORD RUBBER WORKS CO. IS A GOOD GUARANTEE."  
Their popularity has forced everybody into making single tubes  
THE PROPER SINGLE TUBES ARE HARTFORDS  
INSIST ON HAVING THE ORIGINAL COST MOST - WORTH MOST  
THE HARTFORD RUBBER WORKS CO. HARTFORD, CONN.  
NEW YORK. CHICAGO.

HALF A CENTURY OF CYCLES.—An interesting history of the cycle from its origin up to the present time. The first crank-driven bicycle. The "bone-shaker" and its successors. The tricycle. The modern wheel. Cycle building a science. Points of improvement. The pneumatic tire. A hand and foot cycle. With 9 illustrations. Contained in SCIENTIFIC AMERICAN SUPPLEMENT, No. 1012. Price 10 cents. To be had at this office and from all newsdealers.

"KRIM" Cyclists' Storm Suit.

Cape and Leggings. Weight 24 oz. Takes up little room when not in use. Put on in a minute. Hand loops keep Cape over handle bar. Ask your dealer, or we will mail them post-paid on receipt of price, **\$3.50.**  
Sold separately: Cape, - - - \$2.00  
Pair Leggings, 2.00  
Send for circular "K." Agents Wanted.  
**CLEVE & KRIM,**  
49 Summer St., Boston  
Makers of Fine Mackintoshes. Patent applied for.

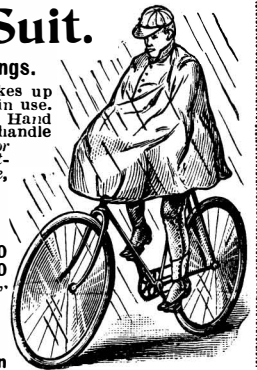

THE BICYCLE: ITS INFLUENCE IN Health and Disease.—By G. M. Hammond, M.D. A valuable and interesting paper in which the subject is exhaustively treated from the following standpoints: 1. The use of the cycle by persons in health. 2. The use of the cycle by persons diseased. Contained in SCIENTIFIC AMERICAN SUPPLEMENT, No. 1002. Price 10 cents. To be had at this office and from all newsdealers.

THE **Duguid** CYCLE SADDLE



for Ladies' use. Broad and comfortable, and guaranteed to hold its shape. Most sensible and serviceable Saddle in the market. Twenty years' experience in working leather enables us to make good this claim.  
ALL STYLES GENTLEMEN'S SADDLES also. Ask for the **Duguid**. If your dealer will not supply you, we will send, prepaid, on receipt of price: Ladies', \$4.00; Gentlemen's, \$3.50. Furnished with clip for T or L seat post.  
**THE DUGUID SADDLERY CO., Syracuse, N. Y.**

**The Dodge Bicycle.**  
A STRICTLY HIGH GRADE WHEEL.  
SUPERIOR MECHANISM  
FIRST CLASS WORKMANSHIP  
**THE DODGE CYCLE CO.**  
MANUFACTURERS.  
50 WEST ST. SYRACUSE N. Y. MODEL "A" WEIGHT 22 Lbs.

The Name "HUNTER" . . . never was put on anything that wasn't first-class. That name has stood for simple, plain, unvarnished integrity, and hence it is put on the . . .  
**HUNTER CYCLES**  
Send for Catalogue.  
**HUNTER ARMS CO., FULTON, N. Y.**

If Inventors and Manufacturers Having new articles of merit to place on the market will forward samples or description of their goods, they will receive careful attention and consideration by The Elastic Tip Co., 46 Market St., San Francisco, Cal.

**JESSOP'S STEEL** THE VERY BEST FOR TOOLS, SAWS ETC.  
WM JESSOP & SONS L<sup>o</sup> 91 JOHN ST. NEW YORK

**PRINTING INKS**  
The SCIENTIFIC AMERICAN is printed with CHAS. ENEU JOHNSON & CO.'S INK, Tenth and Lombard Sts., Philadelphia, and 47 Rose St., opp. Duane, New York