

SCIENTIFIC AMERICAN

[Entered at the Post Office of New York, N. Y., as Second Class Matter. Copyright, 1898, by Munn & Co.]

A WEEKLY JOURNAL OF PRACTICAL INFORMATION, ART, SCIENCE, MECHANICS, CHEMISTRY, AND MANUFACTURES.

Vol. LXXVIII.—No. 11.
ESTABLISHED 1845.

NEW YORK, MARCH 12, 1898.

[\$3.00 A YEAR.
WEEKLY.]

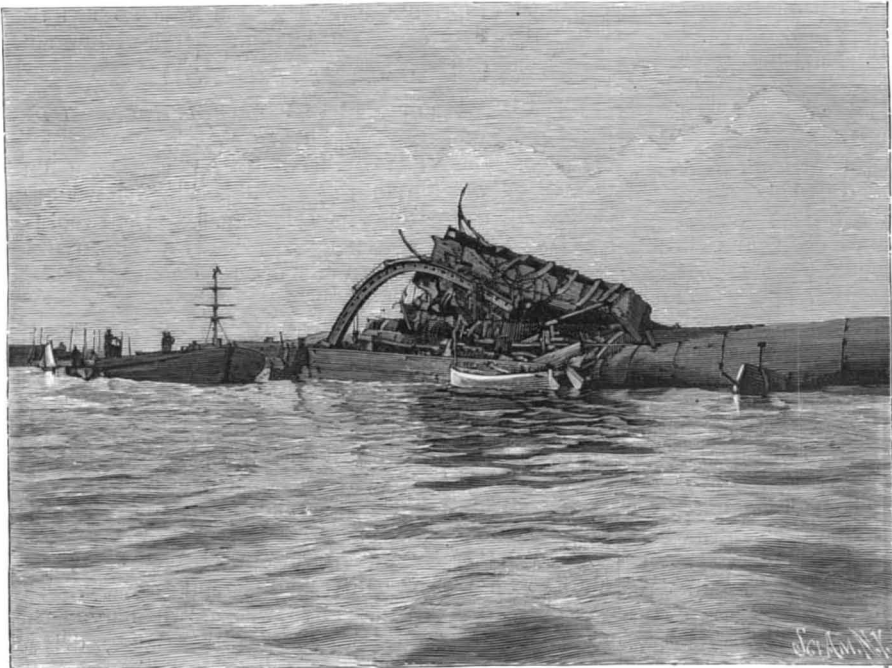

1.—PORT SIDE OF WRECK, SHOWING SUPERSTRUCTURE, DECK RUINS AND OVERTURNED SMOKESTACK.

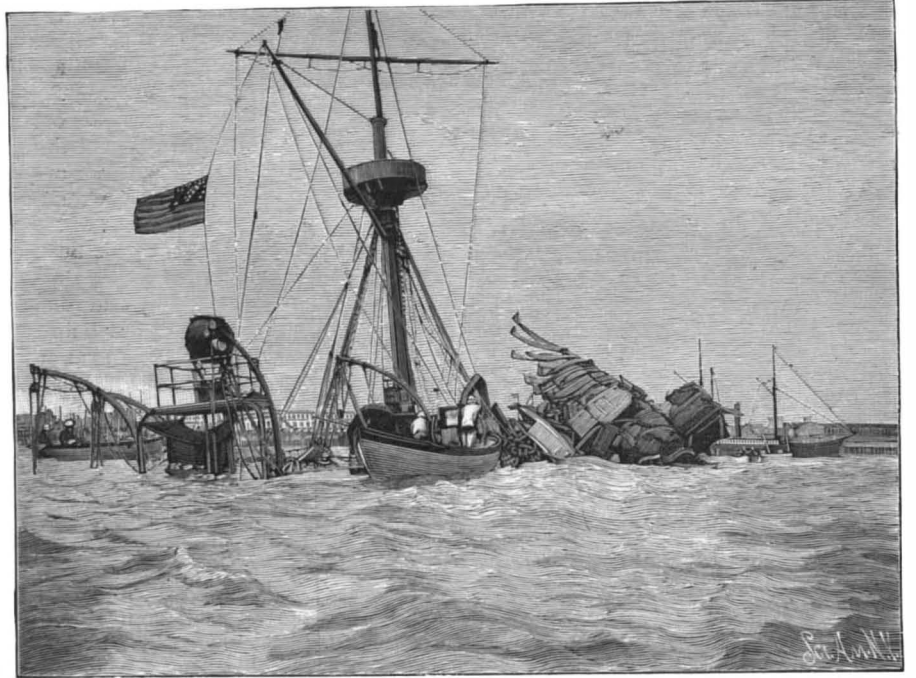

2.—VIEW FROM STARBOARD QUARTER, LOOKING FORWARD—SHOWS DECK, CONNING TOWER AND BRIDGE THROWN TO STARBOARD.

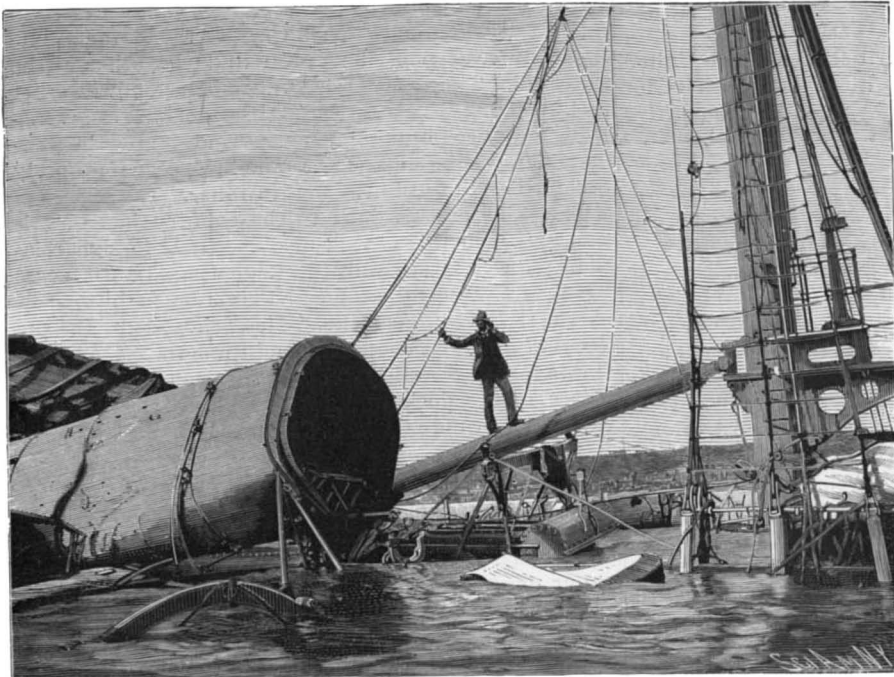

3.—VIEW OF MAINMAST AND TOP OF AFTER SMOKESTACK.

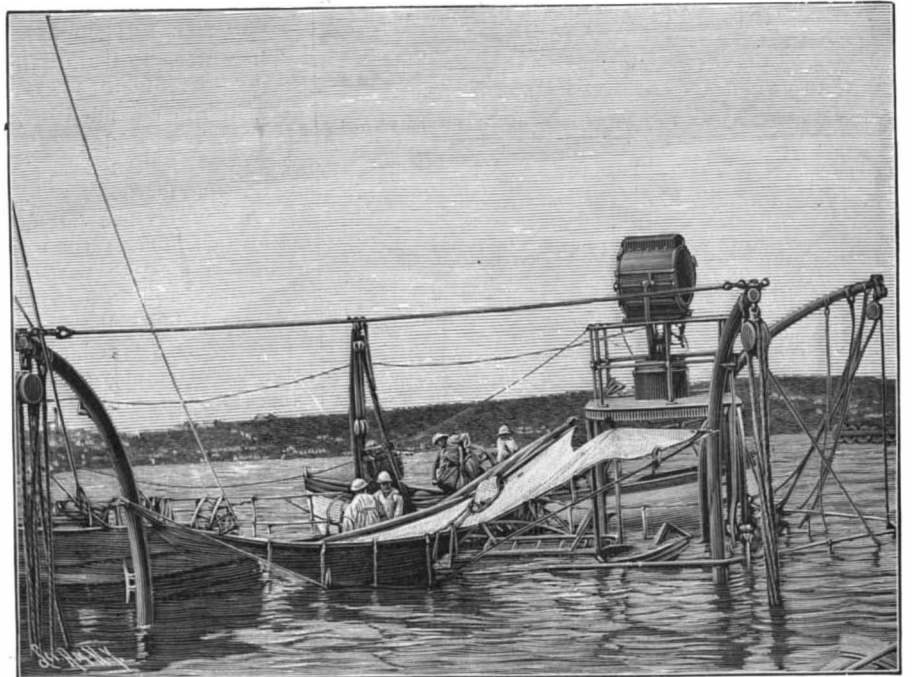

4.—THE AFTER SEARCH LIGHT—DIVERS AT WORK ABOVE QUARTER-DECK.

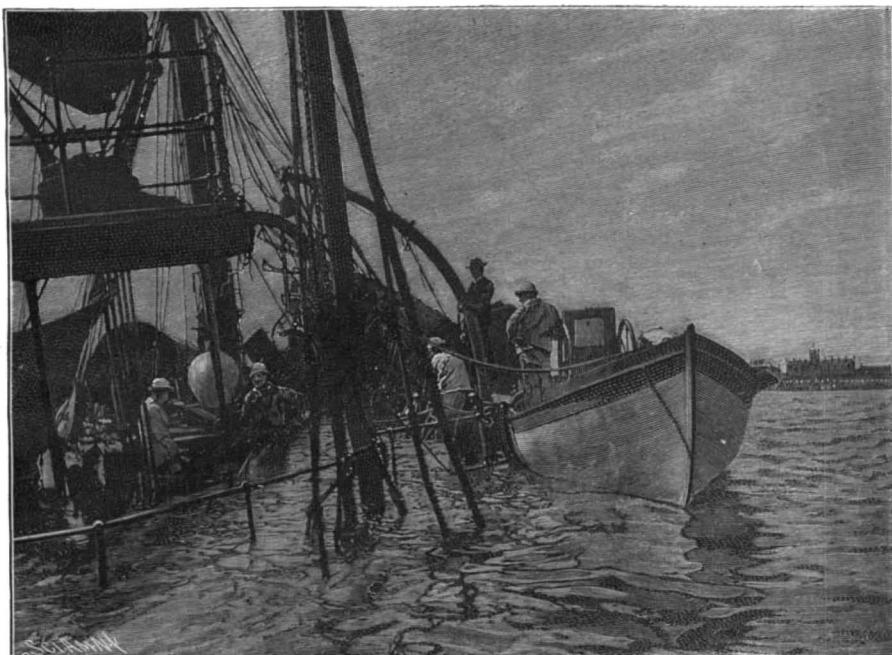

5.—STERN VIEW—RAIL OF SUBMERGED QUARTER-DECK IN FOREGROUND.

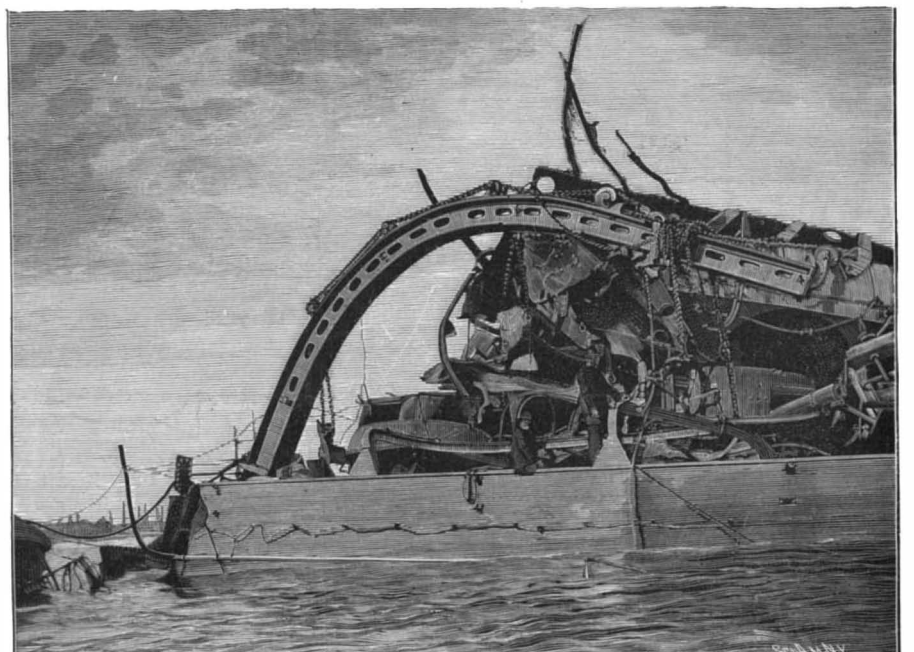

6.—THE FORWARD HALF OF SUPERSTRUCTURE—DECK BLOWN OVER AND BACK UPON REAR HALF.

THE "MAINE" DISASTER.—[See page 167.]

Scientific American.

ESTABLISHED 1845

MUNN & CO., - - - EDITORS AND PROPRIETORS.

PUBLISHED WEEKLY AT

No. 361 BROADWAY, - - NEW YORK.

TERMS FOR THE SCIENTIFIC AMERICAN.

One copy, one year, for the U. S., Canada or Mexico... \$3.00
One copy, six months, for the U. S., Canada or Mexico... 1.50
One copy, one year, to any foreign country, postage prepaid, £0 15s. 6d. 4.00

The Scientific American Supplement

is a distinct paper from the SCIENTIFIC AMERICAN. THE SUPPLEMENT is issued weekly. Every number contains 16 octavo pages, uniform in size with SCIENTIFIC AMERICAN.

Building Edition of Scientific American.

THE BUILDING EDITION OF THE SCIENTIFIC AMERICAN is a large and splendidly illustrated periodical, issued monthly, containing floor plans and perspective views pertaining to modern architecture.

Export Edition of the Scientific American

with which is incorporated "LA AMERICA CIENTIFICA E INDUSTRIAL," or Spanish edition of the SCIENTIFIC AMERICAN, published monthly, uniform in size and typography with the SCIENTIFIC AMERICAN.

NEW YORK, SATURDAY, MARCH 12, 1898.

Contents.

(Illustrated articles are marked with an asterisk.)

Acetylene and acetone (7375)... 173
Acetylene notes... 170
"Apennino" statue, Florence*... 171
Appraisers' stores, New York... 171
Arctic climate... 172
Book output in England... 171
Books, new... 173
Boys, good advice to... 168
Burners, acetylene (7375)... 173
Burning fields of ice... 162
Celestine... 168
Cheese as a food... 164
Civil service, the... 167
Death rate of soldiers in Cuba... 165
Divers working on "Maine" wreck*... 161
Dry dock, the Brooklyn... 162
Electric working of Ynuiden locks... 170
Europe, our trade with... 162
Explosions caused by paint... 167
Fighting forces of the world... 166
Gage, safety, Froehlich's*... 164
Gas, natural, in Kansas... 162
Gun, Hummer's noiseless... 164
Havana, "Maine" wreck at*... 161
Health resorts, ocean and high altitude... 170
Heat motor, Diesel's*... 165
Ink spots, to remove... 167
Inventions recently patented... 172
Kissing, the ethnology of... 168
Klondike and California gold finds... 162
Klondike relief expedition, the*... 169
Lands, public, of the U. S... 163
Laps, bound for the Klondike*... 169
Laundrymen's wax (7372)... 173
"Maine," wreck views of the*... 161
Monuments, Roman circular... 169
Naval cadets, practice ship for*... 168
Notes and queries... 173
Paints, priming coat for... 167
Patents granted, weekly record of... 173
Photographs, coloring... 167
Plants, pitchers in... 171
Railroad, London underground... 163
Reindeer, shipping*... 169
Rust, an old preventive of... 163
Science notes... 166
Shoe polishing device, Bur-well's*... 166
Signaling through pipe systems... 172
Spanish army, the, in Cuba... 166
Sun spots, some recent*... 171
Thawing apparatus, Harris'*... 164
Train robbers' punishment... 167
Wood, heating capacity of... 167
Wood, life of, under water... 167

TABLE OF CONTENTS OF Scientific American Supplement

No. 1158.

For the Week Ending March 12, 1898.

Price 10 cents. For sale by all newsdealers.

I. ARCHAEOLOGY.—A Representation of the Crucifixion.—An illustration of the new graffito which has just been discovered in the Palace of Trajan at the Palatine Hill, Rome.—It is believed to be a true representation of the Crucifixion scratched on the wall by a Roman soldier.—2 illustrations... 18514
II. CIVIL ENGINEERING.—A Spiral Railway Tower for Niagara Falls... 18506
III. CYCLES AND CYCLING.—The Growth of Invention in Cycles.—1 illustration... 18504
IV. ELECTRICITY.—An Electric Curve Tracer for Delineating the Forms and Phases of Periodic Electric Quantities; viz., Electric Currents, Electromotive Forces, Electric Power and Magnetic Induction, also for Tracing Hysteresis Curves.—By Prof. EDWARD B. ROSA.—A full account of a very interesting and ingenious piece of apparatus.—9 illustrations... 18513
V. FINE ARTS.—The Gobelins Manufactory at the Exposition of 1900.—2 illustrations... 18508
VI. MARINE ARCHITECTURE.—How a Ship is Built.—An interesting account of how a ship is built, from the time the drawings are made until the vessel is ready to make the trip.—A very full article, profusely illustrated.—10 engravings... 18501
VII. MECHANICAL ENGINEERING.—Machine Tools.—A description of a milling cutter and twist drill grinding machine and a port cutting and slot drilling machine.—2 illustrations... 18504
VIII. MEDICINE AND HYGIENE.—Report on the Bubonic Plague in Bombay... 18513
IX. METEOROLOGY.—Nocturnal Photographs of the Eiffel Tower.—A view of a bolt of lightning striking the Eiffel Tower.—2 illustrations... 18509
X. MISCELLANEOUS.—Engineering Notes... 18507
XI. NATURAL HISTORY.—An Interesting Monster.—By CHARLES STEWART.—An illustrated description of a case of polymelian canine monstrosity... 18516
XII. PHOTOGRAPHY.—Black Print Processes.—By ALBERT E. GUY.—A full account of a useful process of copying drawings... 18508
XIII. STEAM ENGINEERING.—Reversing Steam Turbines.—A description of the method by which Mr. Parsons has succeeded in solving the problem of reversing turbines.—An important article.—6 illustrations... 18506
XIV. TEXTILES.—The Gobelins Manufactory at the Exposition of 1900.—2 illustrations... 18508

KLONDIKE AND CALIFORNIA COMPARED.

The expected rush to the Klondike is already well under way, and judging from the present indications, it is probable that the army of fortune-hunters which will enter this inhospitable region during the coming season will far exceed in numbers the emigration to California in the days of forty-nine.

According to this authority, one claim in Calaveras County produced \$250,000 from an area 100 feet long by 40 feet wide, and ninety pounds of gold were taken out in twenty-four hours.

THE UNITED STATES CIVIL SERVICE.

There were, in 1897, in the civil service of the United States government, 178,717 positions, of which 87,107 were in the classified list, to be filled by competitive examinations, and 91,610 unclassified, two-thirds of whom were fourth-class postmasters, the others ranging down to mere laborers.

From a recent revision of the manual of examinations for the classified civil service we note a few of the leading particulars. The examinations are arranged for according to the following divisions of the service:

1, departmental; 2, custom house; 3, post office; 4, government printing; 5, internal revenue. In all, except the first of these divisions, the designation indicates, perhaps, sufficiently the nature of the positions to be filled, but it may be remarked that the departmental service covers the railway mail and Indian attaches, the pension agencies, steamboat inspection and light-houses and life-saving, the mints and assay offices and sub-treasuries, and the engineer and ordnance departments at large, as well as civil, steam and electrical engineers, draughtsmen, etc.

The general examinations are held twice a year, in March and April and in September and October, at designated places in all the States, and applications must be received by the commissioners at least ten days prior to the date of examination, such applications being made on special forms prepared therefor.

vacancies occur. John R. Procter, Washington, D. C., is at present the president of the Civil Service Commission.

The civil service law has met with not a little opposition from the politicians of both parties, many of whom have desired to dispose of official positions as the rewards of effective work at the polls, irrespective of the fitness of employes for their places; but it is safe to say that the great majority of the people of all parties are strongly in favor of the law, and would prefer to see it extended in its operations, to include a still larger number of those who work for the public.

THE COMPLETION OF THE BROOKLYN NAVAL DRY DOCK.

In our issue of December 25, 1897, we gave an illustrated description of the methods which have been adopted in repairing Dry Dock No. 3, at the Brooklyn Navy Yard. It was expected at the time that repairs would be completed in a very few weeks, and this sorely needed work placed at the disposal of the navy.

The greatest possible force was crowded upon the work, the new lines of sheet piling being driven with all possible speed and the flooring laid on so as to enable the dock entrance to be partially flooded, with a view to reducing the flow of the springs and stopping the disastrous undermining. This has now been done, and two lines of 12 x 12 sheet piling driven as deep as it will go now extend across the entrance, one at the outer edge of the apron and the other at the outer sill.

The value of this dock to the country just now is simply inestimable in view of our critical foreign relations; for it is our only dock on the Atlantic coast which will safely admit our first-class battleships, such as the "Iowa" and the "Massachusetts."

OUR TRADE WITH EUROPE.

A study of the statistics of our foreign trade for the past year shows that while the United Kingdom is our largest customer it does not take so large a proportion of our exports as formerly. Ten years ago the total value of our exports to the United Kingdom was \$359,734,531, or over 50 per cent of our total exports; whereas in 1897 the proportion had fallen to about 44 per cent.

The large increase in our exports, amounting to \$94,000,000 over the previous year, was, of course, chiefly due to the increased demand for our wheat and corn, the increased export of all cereals amounting in value to some \$70,000,000. The increase in exports of iron and steel was \$14,000,000; in bicycles it was \$3,000,000; in copper, \$3,000,000; and in lumber and manufactured articles in wood, \$5,500,000.

BURNING FIELDS OF ICE.

BY E. B. KNERR.

It seems a somewhat surprising statement to make that on the ice-covered surface of a Kansas lake it is possible to build bonfires by simply breaking through the ice and applying a match to the surface of the water. The flames will shoot up as high as a man and

will burn brightly for a minute or two. This is what has been possible for several winters on Doniphan Lake, Kansas, and on one of its tributary streams.

The fuel for these fires is natural gas, which bubbles up through the water the year round, but it is only during the very cold winter nights that it is thus temporarily stored under the ice in immense bubbles or pockets, sometimes ten to twenty square yards in extent. Puncture these bubbles with a chisel, apply a lighted match, and one has a roaring flame before which the skater may warm his benumbed fingers. The experimenter must be careful to stand between the wind and the jet of gas as he lights it, or he will have his clothing singed before he can get out of the way of his impromptu torch.

There are places where the gas supply is so abundant as to prevent the ice from forming, except on the very coldest nights. When such places are frozen over they remain covered only a few days, for the gas, coming from a considerable depth in the earth, is so warm that it soon melts a passageway through the ice and escapes. The present winter formed ice of fifteen inches thickness on the lake, and yet some of the areas of gas supply were not frozen over. Near the entrance of one of the creeks into the lake the water is quite shallow and the bottom may be readily seen. Here the gas has formed regular channels up through the mud, and out of these large bubbles of gas are discharged every few seconds.

Doniphan Lake is located about four miles north of Atchison, Kansas, and is a river lake; that is, it was formed from a bend of the Missouri River by the water taking a short cut across the narrow neck of the bend, thus leaving the old bed to be occupied by a beautiful horseshoe lake about five miles in length. This happened during the high waters of the spring and early summer of 1891.

Because the lake is thus comparatively recent in formation, some observers have contended that the gas which collects under the ice is only marsh gas. But the supply is too great to be accounted for in that manner. Were it marsh gas, it would rise more equally all over the lake, for the bottom is everywhere about the same. On the contrary, the gas is supplied only in certain localities, and the eastern arm of the lake is without gas. Besides, the places of discharge are the same the year round. On the Missouri side of the river are three other lakes of like formation: Mud, Sugar and Bean Lakes. These do not show gas except in occasional very small bubbles.

It is not surprising that natural gas should be found in eastern Kansas. A boring at Kansas City, about fifty-five miles south of Doniphan, gave a small supply of gas a few years ago. Ninety miles southwest of Kansas City, at Iola, Kansas, a gas well, in recent years, furnished seven million cubic feet of gas per day.

There is no doubt that the Doniphan gas is true natural gas, and comes from the interior rocks of the earth. The question of quantity can only be determined by prospecting. Should a "gusher" be struck here, it would be a great find, for St. Joseph, Mo., is only sixteen miles to the north, Atchison is practically on the field and Kansas City is less than sixty miles to the south.

THE PUBLIC LANDS OF THE UNITED STATES.*

Nearly one-third of the whole United States, exclusive of Alaska, is still in the hands of the general government, the greater part of this being open to entry and settlement under the Homestead act. The great bulk of these vacant public lands lies within and west of the Rocky Mountain region, considerable areas, however, remaining in Florida, Alabama, Mississippi and the States west of the Mississippi River. The lands within the western half of the United States are, for the most part, within an arid climate, and although the soil when watered is very fertile, yet the scarcity of water supply renders it difficult, if not impossible, for the settler, unaided, to make a home.

During the past twenty or thirty years the development of agriculture by irrigation has proceeded rapidly, until at the present time nearly all of the easily available sources of water supply have been utilized. There remain, however, many large rivers whose flow has not been diminished by the diversion of water for irrigation, and also many opportunities for the construction of great reservoirs in which floods can be held until the season when water is required.

The construction of the great irrigation systems by which thousands of acres can be rendered susceptible of irrigation requires enormous capital. A number of large enterprises of this character have been built by corporations, but, as a rule, these have not been profitable. Nearly all of them are now bankrupt, owing to the difficulty of selling lands or water rights to persons who can successfully till the soil and pay the annual charges for maintenance.

Irrigation is an art which requires many years of

practice, and the average farmer, coming from humid lands, meets with so many disappointments and failures that he is apt to become discouraged, and, with small means, is barely able to obtain subsistence, much less to make the payments required by his contract.

The canal systems have, as a rule, cost considerably more than anticipated, owing to unforeseen difficulties or accidents. The interest charges and cost of maintenance have eaten up the resources of the companies, so that the history of most enterprises of this character has been a series of financial disasters, although the systems, as a whole, from an engineering standpoint, have been good. The great question for the American people is how to utilize the vast area of vacant fertile land so that it shall be used for homes for future millions. With forethought and wise laws, it will be practicable for a population as large as that east of the Mississippi River to find homes in the West, but, with the haphazard methods prevailing and lack of systematic control, it is doubtful whether a small proportion of these can be accommodated.

The laws governing the public land were made to suit the conditions of the Ohio and Mississippi valleys, and the attempt to apply them in the arid West has been disastrous to the interests of the people as a whole, allowing favored individuals to grasp the scanty water supply and thus hold in tribute thousands of acres, preventing others from sharing in what should be the common property.

Only a small proportion of the vacant public lands can be irrigated, on account of the lack of sufficient water; but even this small amount, being widely scattered, will render possible a large population. The remaining land is, for the most part, valuable as grazing, although there are vast tracts originally covered with forests upon which trees will grow, if not wantonly destroyed. The public forests, however, have been recklessly pillaged and fires, set by accident or design, have destroyed timber and woodland of inestimable value in the future development of the country.

The land laws are confessedly poor and their enforcement necessarily weak. Everyone is apparently interested in obtaining what may be of momentary advantage or pleasure to himself, with utter disregard for the future. With the reckless destruction of the forests, it is believed by many that diminution of the water supply has followed.

The public lands being open to everyone and grazing permitted everywhere, it results that herds and flocks wander at will, pasturage being governed largely by questions of the supply of water for drinking. Most, if not all, of the springs have been seized upon by cattle companies, who, from this point of vantage, exclude others from the vicinity. Where water is comparatively abundant, there has been a tendency for the stock to increase to the limit of the food supply, and, as a result, the vegetation has been eaten so close that many of the more nutritious forage plants are said to have been exterminated from certain areas. Thus, from all sides the public lands are being plundered and their value reduced, while the man who would make a home is at continually greater and greater disadvantage, owing to the fact that, apparently, no one is charged with the duty of looking to the future and protecting the grazing, woods and water from injury.

Since the time of the revolution, the public lands have served as the outlet for the energies of the people. During the prevalence of hard times, men out of employment could go West, take up a homestead, and, by their own labor, secure a competence for their children. The public lands are still of enormous extent, and this condition might continue to prevail for many decades, but now has almost ceased, owing to lack of forethought in ascertaining the water supply and in protecting it so that all men might have opportunities of utilizing it to the fullest extent. The mischief in many localities is now past remedy, but in others it may be possible for the general government of the States to construct the necessary works by which the fertile arid lands can become the homes of many prosperous people.

The easily available sources of water supply have been taken by individuals or corporations. These have built ditches and canals by which several millions of acres have been brought under irrigation. The smaller enterprises have, as a rule, been successful, and, as in the case with the Mormons in Utah, the farmers dependent upon irrigation have been more prosperous than those of any other part of the United States. The large corporate enterprises have, as a rule, been financial failures, owing to the difficulty of selling their lands or water rights to farmers. There remain opportunities for the construction of many great irrigation systems requiring enormous capital; but since it is doubtful whether these can be made to pay a fair rate of interest, it is improbable that investors will risk their money.

The construction of these great canals and storage reservoirs is a matter of prime importance to the State and nation, as in the case of harbors, lighthouses and other works pertaining to navigation. Although these do not pay directly, yet their indirect benefit is such as

to justify large annual expenditures. In the case of irrigation works there is no doubt but that the cost of reclamation will ultimately be returned, and possibly a small interest on the first investment, so that the government will, in the long run, be reimbursed.

Before the work of reclamation on a considerable scale can be undertaken, it is necessary to be fully informed of all the conditions, and to ascertain as nearly as possible what will be the probable water supply. Investigations of this character are being undertaken by the United States Geological Survey, maps prepared and systematic measurements of various streams being made. Not only is surface supply being ascertained, but a careful study is carried on of underground structure, in order to bring together data concerning the possibilities of obtaining water by pumping or through artesian flow. The results of these investigations are published from time to time in the annual reports of the Geological Survey and in special bulletins dealing with various phases of the subject, and known as the water supply and irrigation papers.

When all the water supply has been utilized that may be obtainable, it is probable that nine-tenths of the public land will still remain unirrigated. Much of this is valuable for grazing, and, if proper laws are enacted, such that farmers and cattle companies can be secured in their enjoyment of certain definite tracts, it will be possible to enormously increase the pastoral industries. A system of leasing must be adopted in the near future giving preference to the small farmer or settler, so that he may be induced to make a permanent home.

The public forests, so necessary for the growth and development of the country by furnishing timber and firewood and in protecting the water supply, should be held by the government and guarded from fire. The experience of other countries has shown that this can be done at relatively small expense and the timber used, the young growth being protected so that the supply is continually renewed. It is practicable to inaugurate a system of supervision which will be amply supported from the sale of timber. The forests, instead of being rapidly destroyed, will tend to increase in value. Before this can be done it is necessary that the people of the United States awake to the present conditions and give the matter of their heritage a proper and businesslike consideration.

LONDON'S UNDERGROUND ROAD.

The American companies obtained the entire contract to equip the London Underground Railway, including the electric locomotives, under the following guarantee: Efficiency of steam engine at full load, condensing, 92 per cent; efficiency of three-phase generators, without counting the current for exciting the field magnets, 95 per cent; average efficiency of transmission of current from the power house to the locomotives, including the loss in transforming the current from a high voltage to a low voltage under a full load, 90 per cent; efficiency of the locomotives under full load, 90 per cent.

The entire length of the new line is 5½ miles, and there will be ten stations between the two terminals. At each station there will be large electric elevators to carry the passengers to and from the street. The train service will be carried on by 32 trains of 7 cars each, the seating capacity of each train being 336 passengers. The average speed of the trains is to be 14 miles an hour, including 20-second stops at each station. The maximum speed between stations will be 30 miles an hour. The trains will be run at first on a 2½ minute headway. In order to obtain these speeds with the smallest expenditure of cost, an interesting expedient has been resorted to in the construction of the tunnels. Instead of building it on a level or with constant grades from station to station, the separate tunnels which carry the tracks are run in a series of dips. The train upon leaving a station will immediately start down an incline, so that gravity shall add to the acceleration of its speed. When it approaches a station it will run up-grade, which will stop it with little use of the brakes. Each train without the locomotive will weigh 105 long tons and with the locomotive 147 long tons, but with the dipping tracks only 100 horse power will be needed for each train.

A METAL RUST PREVENTIVE OF 1402.

In an entertaining but little known book, entitled "Sir John Hawkwood," by John Temple-Leader and Giuseppe Marcotti, we find the following receipt for a metal polish and anti-rust: "Cut off all the legs of a goat from the knee downward, let them stay in the smoke for a day, then keep them fifteen or twenty-five days. When you require them, break the legs and take out the marrow from the bones and grease the arms (armor) with it, and they will always keep bright, even when wet."

Those of us who are fortunate enough to possess any armor find that vaseline is equally effective. It is not very generally known that one of the most famous captains of mercenary troops in Italy, in the fourteenth century, was an Englishman, Sir John Hawkwood.

* Abstract of two lectures delivered before the Franklin Institute, Philadelphia, by F. H. Newell, Hydrographer to the United States Geological Survey.

A SAFETY WATER GAGE FOR BOILERS.

The illustration represents a gage for marine or other boilers, so arranged that the gage will immediately close on the breaking of the glass, preventing the escape of steam and water from the boiler. It is designed to be of especial value for ships' boilers inclosed within narrow limits, and in general for high pressure

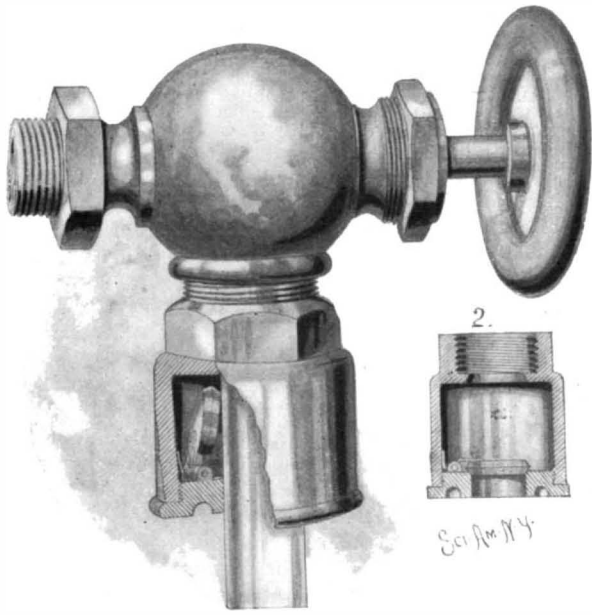

FROEHLICH'S WATER GAGE FOR BOILERS.

boilers. It has been patented by Henry Froehlich, of Honolulu, Hawaii. Fig. 1 represents in perspective the upper part of the gage, with a portion of its valve section broken out, showing a sectional view with the valve open, it being understood that there is a similar valve at the top and bottom of the gage, communicating with the steam and water spaces respectively, the bottom valve being inverted. Fig. 2 is a sectional view, the glass being removed and the valve seated. The gage is secured to the boiler by the usual heads, connected by the gage glass, and on opposite faces of the heads are the safety devices, taking the place of the usual packing nuts, and through which extend the upper and lower ends of the glass. In the open end of each casing screws a cover having a central valve seat for the passage of the end of the glass and the reception of a pivoted valve, which normally rests against the side of the glass, as shown in Fig. 1. A spring presses on the valve, and, in case of the breaking of the glass, contributes, together with the pressure of the water or steam, to insure its instant closing. The valve has a beveled edge, and its surface is concave, so that the steam or water may most efficiently act to force it instantly to closed position as soon as its normal support, the glass, is removed, and thus prevent the escape of steam or hot water from the boiler, the upper valve swinging downward to its seat and the lower valve swinging upward.

HUMBERT'S NOISELESS GUN.

The suppression of smoke in firearms is considered an advantage, but how would it be if we should succeed also in suppressing the noise and the flash that accompany every discharge of a cannon or musket? We should succeed in carrying on a battle in silence, and somewhat, too, after the manner of blind people, as there would no longer be anything to reveal the position of a battery of artillery, even at night. But we cannot very well conceive of a silent battle, and one

without cannon or musketry. In days of old, when only side arms were known, a hand to hand conflict was inevitable, and the air was filled with the shouts of the combatants. With long range weapons it would be entirely different, and we should all at once see a regiment arrested in its march, decimated by a shower of balls, without any indication to guide the return fire.

The thing appears possible, at least in part, according to the recent experiments of Colonel Humbert, who proposes to close the extremity of the gun, as soon as the projectile has made its exit, so that there shall be no flash, and that the air shall be prevented from abruptly entering the piece—such entrance being one of the causes of the detonation. By the same fact, the recoil is very greatly reduced, if not completely annihilated.

The system devised by Colonel Humbert for attaining such a result consists of a block, B (Fig. 1, Nos. 1 and 2), which is screwed to the extremity, A, of the muzzle, which has been previously threaded to this effect. This block has an aperture of the same diameter as that of the bore of the gun, and toward its center there is a chamber, H, in which there is a shutter, F, that pivots at one of its extremities. This, in its normal position, is horizontal (No. 1), and lies in a recess prepared for its reception. Beneath there is an empty space, b b. When the powder is ignited, the projectile takes on, as usual, its full velocity; but, at the moment at which it is about to make its exit through the extremity, G, of the block, a portion of the gas, still at a very high pressure, flows under the shutter, F, and forces it to rise and assume a vertical position (No. 2). It thus prevents the exit of the flame as well as of the gas, which escapes with a relatively feeble velocity through a number of small apertures, D (Nos. 1 and 2), formed in the rear end of the block. The air cannot enter until the pressure is almost null, and it then produces neither noise nor recoil. In order that the escape of the gas in the rear may not discommode the gunner, there is arranged at a short distance from the block a screen, I, against which the velocity of the gas is checked.

For a musket the apparatus is the same, with the exception that for the shutter there is substituted a ball, S (No. 4), which performs the same role.

When the inventor submitted his idea to the ministers of war and navy, it was not thought that there was any reason for taking it seriously, and he was permitted to patent it and make whatever he thought proper out of it. Left thus to his own initiative, he was obliged to seek in some private manufactory the means of making a practical experiment. The Hotchkiss establishment put itself at his disposal, and experiments were made with a gun of 37 mm. caliber. The experiment gave, in the main, the results that had been anticipated: the flash was scarcely visible and the noise was greatly reduced. The recoil, however, still existed in a large measure; but the value of such a system cannot be judged from a few hasty tests.

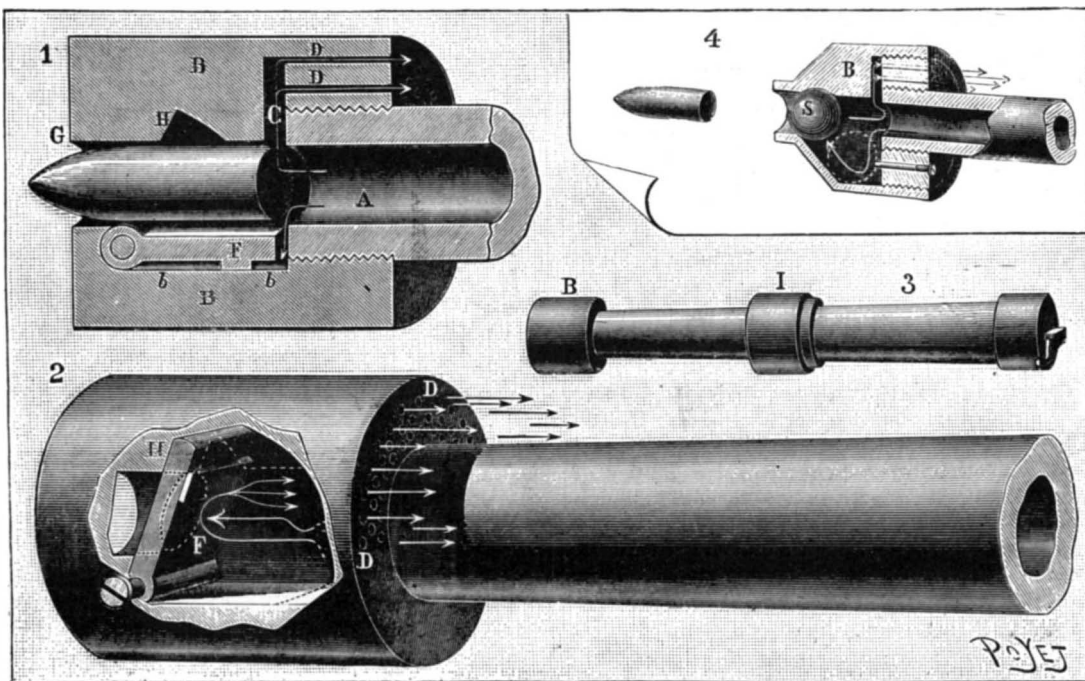

THE HUMBERT NOISELESS GUN.

1 and 2. Block, B, screwed to the muzzle, A, of a gun; G, projectile; F, shutter; D D, apertures for the escape of the gas. 3. The entire barrel: B, the block; I, the screen. 4. The device applied to a musket: B, the block; S, ball valve.

The inventor, guided by the remarks made at the experiments, has worked further upon the problem, and expects to reach a complete solution of it. The artillery committee has, on its side, recognized the fact that there is reason for not remaining indifferent, and it is with its aid that some new experiments are to be made.

One great advantage of this invention is that it does not essentially modify the present material. It will suffice to add thereto the block that we have described, and the expense of this will be slight as compared with that which any important modification of our armament usually involves.—La Nature.

AN APPARATUS FOR THAWING FROZEN GROUND.

To thaw frozen ground and facilitate the working of shafts and tunnels therein, an apparatus to direct and retain the heat of a furnace upon the face of an excavation, while also rendering access practicable to such face, is shown in the accompanying illustration, and has been patented by William E. Harris, of No. 207 Twenty-eighth Street, Chicago, Ill. The cone-shaped firebox of the furnace is formed by a coil of pipe

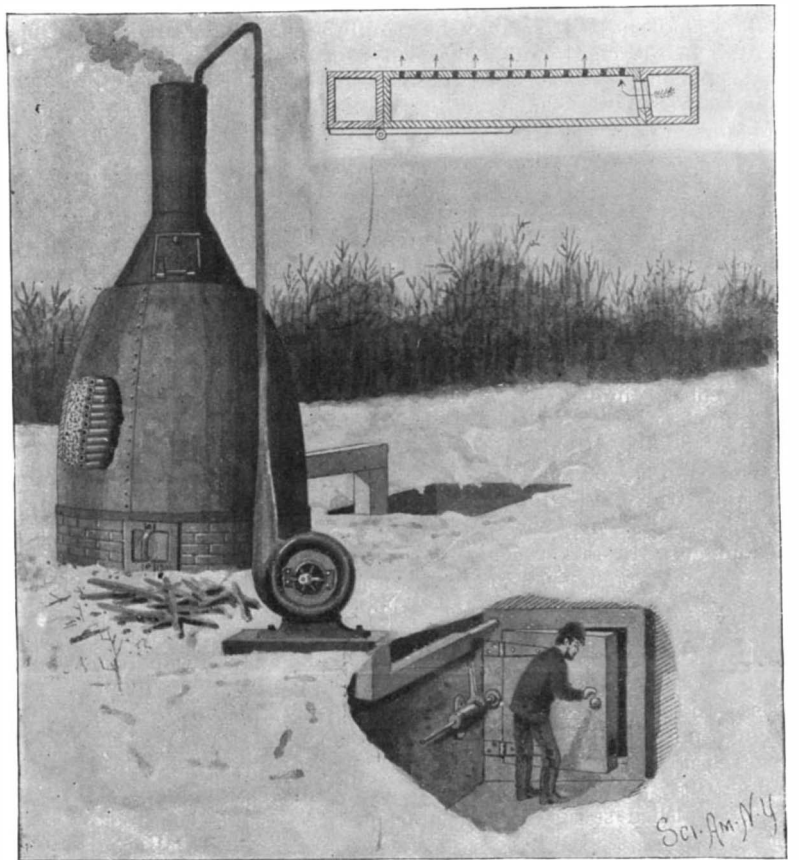

HARRIS' THAWING APPARATUS.

covered by a layer of clay inside the shell, there being a suitable outlet at the top for the escape of the smoke and gases, and through which the upper end of the coil extends, to connect with a blower, by which air is forced through the pipe to be heated by the burning fuel. The lower end of the coil is extended through a box or conduit, where it is surrounded by sand or other non-conducting material, to the ground to be thawed, where it connects with a sleeve held on a shield set against the ground at the end of the tunnel. The shield consists of a hollow frame with central hollow door, there being apertures in the walls of the frame and door, allowing the heated air to pass directly in contact with the frozen ground against which the shield is placed. A jack holds the shield in position as the thawing proceeds, the door being opened from time to time to remove the ground, and the shield being moved forward accordingly, the pipe connecting with the coil being lengthened as the work progresses.

Cheese as a Food.

The London Family Doctor says: "Cheese is a very rich and valuable food, likely to form a very large constituent in the future, and, especially for the working-man, to be very extensively used. There is a difference in stomachs in their ability to digest this article. The writer is able to make an entire meal of cheese with very little bread, and digest it more easily than rice or oatmeal; but in most stomachs it is less digestible, in some, extremely so. Each person must learn for himself. It is a convenient form of animal food, and, when good, particularly agreeable.

"There is a great difference in the composition of cheese both in its water, fat and nitrogenous matter. In general, however, it may be remarked that every variety contains a large amount of nitrogenous matter, and it is for this that it is especially useful as a food. Skim milk cheese is especially rich in this constituent, but less rich in fat. Those who abstain from flesh food will find in cheese abundance of nitrogenous matter to take the place of that found in flesh."

DIESEL'S HEAT MOTOR.

It is a well known fact that the steam engine, in spite of the splendid service which it has rendered since Watt first made it practicable, and the great advance which has been made in its construction, especially of

is a further loss by condensation and re-evaporation in the engine cylinders, and a general loss at all points of boiler, engine and steam pipe connections by condensation and radiation.

An important step in the direction of economy was

ventor, began in 1882, and the conditions which govern the machine were fully formulated in 1893. In the ordinary forms of gas or oil engine the charge is ignited by a jet, hot tube or electric spark, and as we have stated, the combustion is so rapid as to be practically

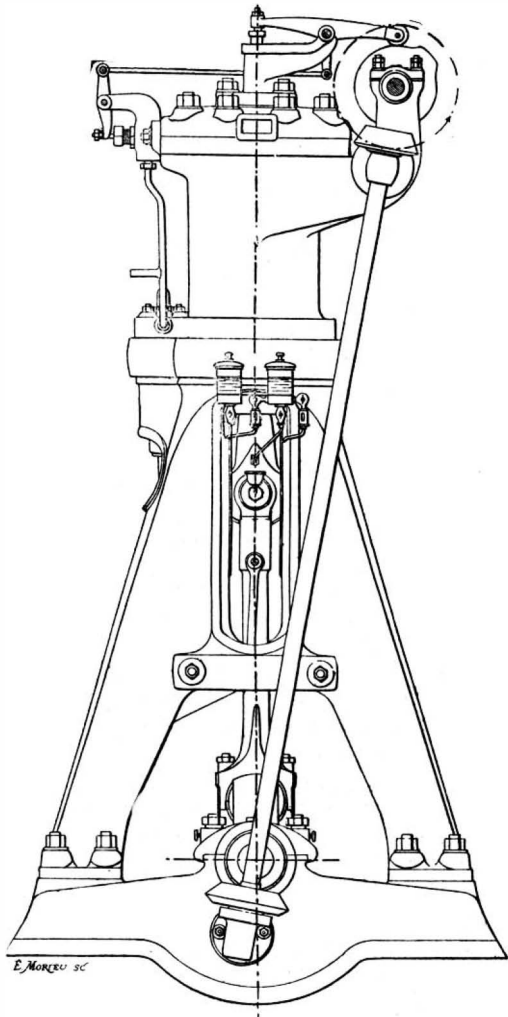

Fig. 1.—SIDE ELEVATION AND PLAN OF DIESEL'S 20 H. P. THERMIC MOTOR.

late years, is a most extravagant machine. In the process of burning fuel in a boiler furnace to produce steam, and expanding the steam in a cylinder to secure useful work, only a small percentage of the energy stored in the coal is available as power on the shaft.

Both theoretically and by actual test it can be shown that a high pressure steam engine of the common type and the smaller sizes utilizes only from 4 to 6 per cent of the energy contained in the coal. If we test an up-to-date Corliss engine, we shall find only 8 or 9 per cent of the energy accounted for; and if we take one of the largest multiple expansion engines with the best modern improvements in condensers, cut-off, etc., the best return will be from 12 to 14 per cent of the energy contained in the coal.

The causes of this enormous loss are well known. There is a loss in the furnace through imperfect combustion, resulting in the emission of smoke from the smokestack. There is a further loss due to the impossibility of absorbing all the heat from the gases before they pass to the uptake, where in some marine boilers their temperature has been sufficient to render the base of the smokestacks red hot. There is an enormous loss due to the latent heat of evaporation—heat absorbed in the effort to turn water at 212° F. into steam at the same temperature. This heat is never, in the simple high pressure engine, returnable as work on the engine shaft. There

is realized when the internal combustion motors were introduced. These, whether using gas or oil, abolish the steam boiler altogether and develop the energy of the fuel within the cylinder itself. The fuel is first introduced into the cylinder, then compressed by the return stroke and ignited. The combustion is so rapid as to amount to an explosion, and the initial pressure is much higher than that in a steam cylinder. With these motors an efficiency of about 20 per cent is realized under favorable conditions.

A further improvement, marking an advance as important in its way as that of the internal combustion motors over those using external combustion, has been made by Mr. Rudolph Diesel, of Munich. The experiments which led to the construction of the present successful machine, which is known by the name of the in-

explosive. In the Diesel motor the igniting spark or jet is dispensed with altogether, and the temperature of ignition is secured by the compression of pure air. After the air has reached the temperature of ignition of the mixture through compression, the fuel is introduced gradually into the cylinder and is burnt steadily during the stroke of the piston. The result is that the combustion is effected at a practically constant temperature.

We present four views (Figs. 1 to 3) of a 20 horse power Diesel motor which was tested early in 1897, by Prof. Schröter, of the Polytechnic School of Munich, when an efficiency of 34.7 per cent was realized.

The motor consists essentially of an air pump, a compressed air reservoir, an expansion cylinder, a fuel injector actuated by a small pump, and valves for control-

ling the pump, reservoir and the expansion cylinder. The pump compresses air into the reservoir, L, at a pressure of between 500 and 600 pounds to the square inch. This pressure is transmitted through the pipe, S, to the injection chamber, D. The fuel, kerosene, is injected into the same chamber by means of a small pump. The injection of the fuel is controlled by an injection needle valve, which rises under the action of a cam during the period of combustion. The duration of the admission, the beginning of the injection, and the pressure in the cylinder, L, may be modified according to the power to be produced. The injection needle, the admission valve and the expansion cylinder are controlled by a set of cams mounted upon a shaft near the top of the cylinder, which is driven by bevel wheels on the main shaft and has an angular velocity equal to half that of the driving shaft—a condition required by the four cycle operation of the expansion cylinder. There are five of these cams in all; two of them set the motor in operation through the compressed air contained in the reservoir and three others operate during the running of the motor. The movement of a lever shown in

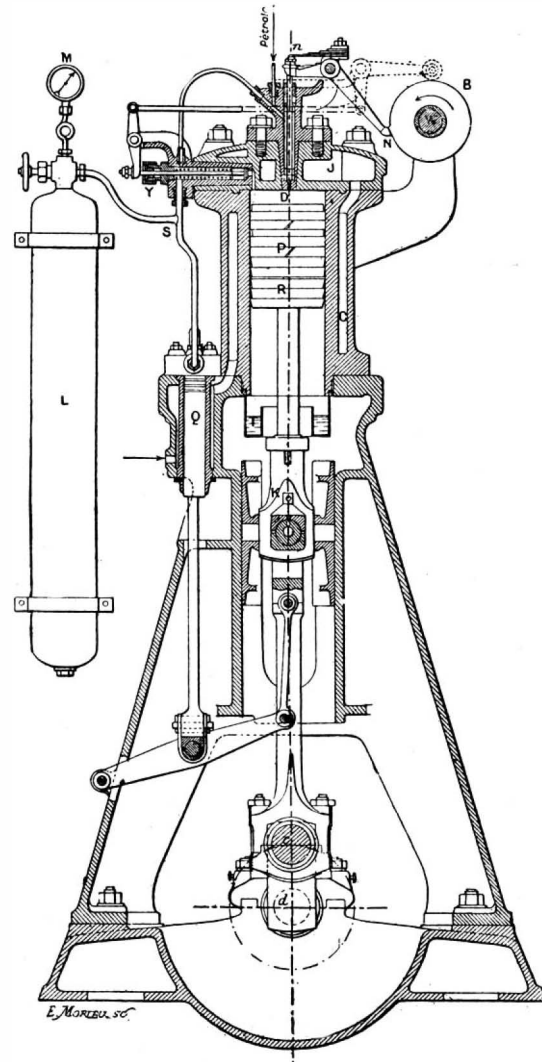

Fig. 2.—TRANSVERSE SECTION.

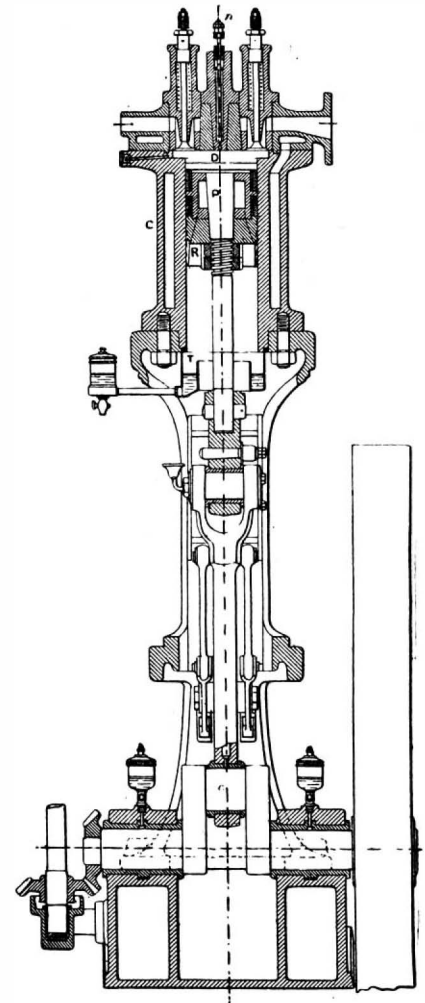
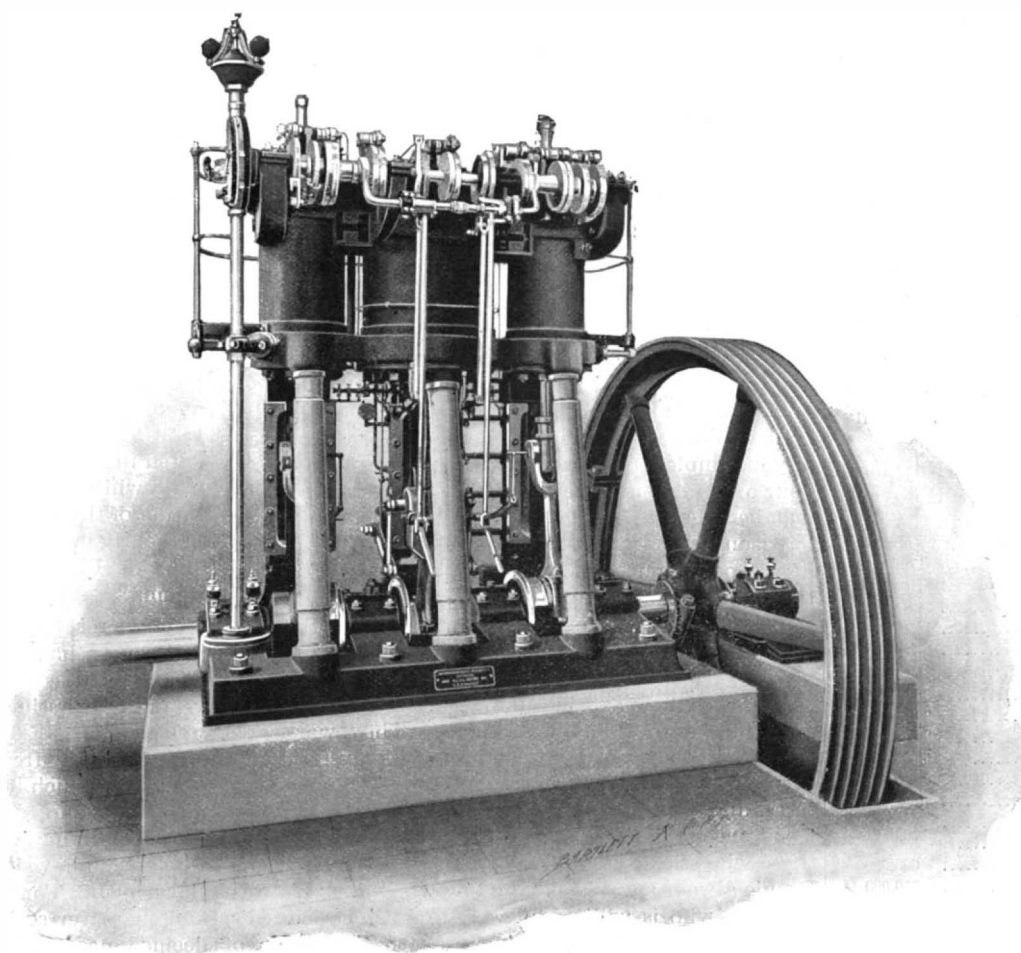

Fig. 3.—LONGITUDINAL SECTION.



THREE-CYLINDER COMPOUND DIESEL MOTOR—150 HORSE POWER.

the plan of the motor causes the cams to slide upon the shaft and places them in gear for starting or operating. In starting, the two cams above mentioned put the cylinder in communication alternately with the valve, V_1 , which admits the air under pressure, and with the exhaust valve, V_2 . When the pistons acquire sufficient velocity the controlling lever is thrown over, causing the cams to slide along on their shaft and assume a position corresponding to the four cycle operation. The starting cams are now out of service; of the other three, the first admits air coming from the pump through the pipe, S, the second operates the fuel injection valve at D, and the third the exhaust valve, V_2 . The cylinder is cooled by means of a water jacket and it is lubricated by means of an annular reservoir, T, filled with oil, into which the lower half of the piston dips at the bottom of its stroke. From this brief description it will be seen that in the Diesel motor there is no vaporization and no special ignition of the combustible mixture. The compression of the air to about forty atmospheres raises its temperature sufficiently to cause it to ignite the kerosene which comes into contact with it gradually during the stroke of the piston. The explosion is prolonged, the expansion is isothermic and the combustion, on account of the excess of air contained in the cylinder and its high temperature, is perfect. In addition to its high economy, the Diesel motor has the advantage that the power is easily regulated by acting upon the fuel injector, and the running at a variable charge is done without any break, since the compression always raises the air to the temperature of ignition of the mixture. The motor is always ready to be started, and, as the combustion is perfect, there is no fouling of the interior of the cylinder and the odor of the exhaust gas is practically imperceptible.

We also show a perspective view of a later and much more powerful motor, with three cylinders, which is rated at 150 horse power. It works with compound compression and compound expansion and is now running in the works of the Augsburg Machine Company, Augsburg, Bavaria.

Fighting Forces of the World.

The latest addition to the military census of the world presents some queer figures. At the present time Europe has 3,500,000 men under arms. The following are the figures of the different armies on a peace footing, says The New York Sun:

	Men.
Denmark	10,000
Servia	20,000
Holland	22,000
Greece	25,000
Portugal	36,000
Roumania	47,000
Belgium	52,000
Sweden and Norway	57,000
Spain	80,000
Switzerland	125,000
Turkey	180,000
Great Britain	200,000
Italy	240,000
Austria	360,000
France	570,000
Germany	580,000
Russia	896,000

The above armies employ 550,000 horses in time of peace.

In Asia there are about 800,000 men under arms, divided as follows: Persia, 25,000; Japan, 100,000; India, 200,000; China, 270,000; and the remainder in the other Asiatic countries.

North and South America are set down as the least protected, considering the extent of territory. They foot up, on a peace footing, of course, only 160,000 regular soldiers, scattered as follows: Mexico, 40,000; the United States, 30,000; and 90,000 in Brazil, the Argentine Republic, Chile, Paraguay, Peru, Venezuela, and Colombia.

In Africa and the archipelagoes of Oceanica there are about 150,000 regulars.

The standing armies of all civilized nations amount to 4,610,000 soldiers, with 700,000 horses. The cost of keeping this military population amounts to about five billion dollars a year.

So much for the armies in time of peace. Now let us take a look at the figures in war paint. Here they are:

	Men.
Turkey	700,000
Spain	190,000
Servia	210,000
Sweden and Norway	430,000
Roumania	160,000
Denmark	60,000
Belgium	167,000
Austria (including all reserve forces)	2,000,000
Italy	3,000,000
Russia	5,000,000
Germany	4,500,000
France	4,380,000
England	660,000
Japan	500,000
South American republics	600,000
China	850,000
United States	200,000

No doubt the statistician, while wading through the above flood of figures, forgot some of the National

Guard of the United States, but one can easily afford to forgive him. His discoveries are interesting all the same.

Death Rate of the Spanish Army in Cuba.

Inspector-General Losada, of the Spanish forces in Cuba, recently issued his official report, says The Medical News, in which are indicated losses almost without precedent in modern times. His report shows that out of the 200,000 soldiers sent by Spain to put down the insurrection in the island from the beginning of February, 1895, to the beginning of December of the year just terminated, not more than 53,000 (a little over one-fourth) are at this moment fit for active service. The 147,000 are either dead or sent back to the motherland ill or wounded. The causes of this unprecedented death rate and sick list are (besides casualties in action) mainly three: (1) the inappropriateness of the clothing furnished to the European troops; (2) fatigue; and (3) lack of food. The report, which does not apparently err on the score of reticence, paints a lurid picture of military service in the chief Spanish colony. Under successive generals the three years' campaign, in spite of numberless royalist "victories," leaves Cuba as precarious a Spanish possession as ever; while a whole generation must intervene before island and motherland alike can recover from the loss of blood, property and treasures.

A SHOE POLISHING DEVICE.

To facilitate putting a high polish on boots and shoes, the outfit shown in the engraving has been invented and patented by Robert F. Burwell, No. 902 Chapel Street, New Haven, Conn. It comprises a box or stand having in its lower portion a drawer for brushes, dauber, etc., while in its open top is a foot rest, on opposite sides of which are rollers, one end of

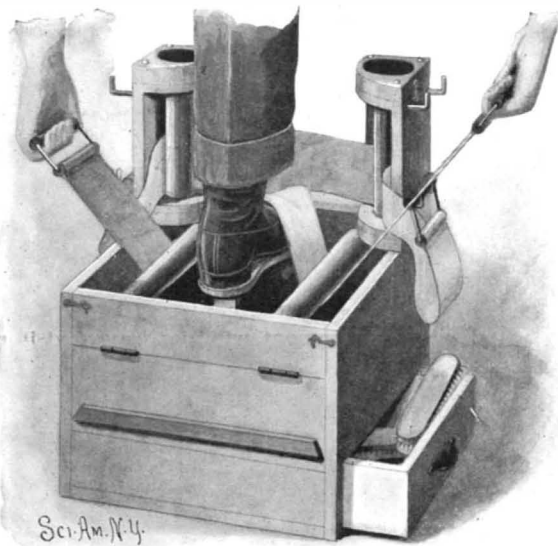

BURWELL'S POLISHING APPARATUS.

the box having a hinged portion to allow of conveniently removing the rollers. Under the rollers and over the rest on which one's boot or shoe is placed extends a polishing band having handles at each end, by means of which the band may be passed rapidly back and forth over the front of the shoe. A second set of rollers is journaled in vertical posts on one end of the box, the tops of the posts being recessed to contain blacking boxes, and a band passed around these rollers and around the rear of the shoe is similarly operated to polish the heel portion.

Good Advice to Boys.

You are learning a trade. That is a good thing to have. It is better than gold. Brings always a premium. But to bring a premium, the trade must be perfect--no silver plated affair. When you go to learn a trade, do so with determination to win. Make up your mind what you will be, and be it. Determine in your own mind to be a good workman.

Have pluck and patience. Look out for the interests of your employer--thus you will learn to look out for your own. Do not wait to be told everything. Remember. Act as though you wish to learn. If you have an errand to do, start off like a boy with some life. Look about you. See how the best workman in the shop does, and copy after him. Learn to do things well. Whatever is worth doing at all is worth doing well. Never slight your work. Every job you do is a sign. If you have done one in ten minutes, see if you cannot do the next in nine. Too many boys spoil a lifetime by not having patience. They work at a trade until they see about one-half of its mysteries and then strike for higher wages. Act as if your own interest and the interest of your employer were the same. Good mechanics are the props of society. They are those who stick to their trades until they learn them. People always speak well of a boy who minds his own business, who is willing to work and who seems disposed to be somebody in time. Learn the whole of your trade.--Ex.

Science Notes.

Vaticana is the name given to one of the latest asteroids discovered, No. 416, in honor of Father Boccardi, of the Vatican Observatory, who has computed its course.

Roentgen rays have proved of great assistance to the surgeons of the British army in dealing with gunshot wounds among the troops engaged in the luckless expedition on the Indian frontier.

Oxford University has been obliged to lock up the books in the Radcliffe camera, where the reference books of the library are kept, owing to so many volumes being stolen. The worst offenders are said to be undergraduates preparing for examination, and the greatest sufferer the department of history.

The immense balloon hall in the barrack yard of the Berlin aeronautical department, where the steerable aluminum airship invented by Engineer Schwarz had been stored with the sanction of the department up to two months ago, is now being torn down, as it has been decided not to resume the experiments with the Schwarz balloon.--Staats Zeitung.

High prices are paid for butterflies, and some private collections, such as that of the Hon. W. Rothschild at Tring, Herts, are said to be worth £100,000 more or less. Some New Guinea butterflies have fetched £50 apiece. One of the Rothschilds is said to have paid £200 for a Papilio, now quite common. The demand for rare specimens has led to dishonesty. The insects are dyed or else wings from one species are fastened to the bodies of other species.

The map of James Cook, 1778, was the first to bear the name "Alaska," which was a corruption of the India Alak shack or "Endless land." The United States began to treat with Russia for the acquisition of Alaska under Presidents Polk (1845 to 1849) and Buchanan (1857 to 1861), and the matter was opened again in 1866 by Seward, who was then Secretary of State, and closed the transaction on March 31, 1867, Russia ceding all claim to Alaska for the consideration of \$7,200,000.

M. Martel, the well known French cave hunter, has explored an "aven" or natural pit, in the limestone of the Lozère, France, with remarkable results. After descending a vertical shaft for about 200 feet, he found an immense hall, sloping downward, and at the lower end a "virgin forest" of stalagmites, resembling pine and palm trees. Many of them are very beautiful, and one, over 90 feet in height, reaches nearly to the vault of the cavern. Nothing like this forest of stone has been observed in any other known cave or pit.

While almost all the civilized countries of the earth have made it a point to assist the important work of the international survey of the earth, by joining the new association for this purpose, the Argentine Republic has refused, according to the Nat. Ztg., to become a member. The fact that so rich and large a country as the Argentine Republic, with a territory of almost 3,000,000 square kilometers and a population of more than 4,000,000 people, does not want to spend a few hundred dollars annually for such an important problem has caused great surprise in scientific circles.

Agostini, the author of the beautiful monograph on the Orta Lake, has been occupied since last spring with the exploration of the volcanic lakes in the old Latium, regarding the depth of which nothing definite was known. The result of about 3,000 soundings which Agostini has taken in the Bolsena Lake, whose area is 114 square kilometers, was a maximum depth of 146 meters; the lake of Mezzano, which is situated west thereof, has a depth of 31 meters. The temperature on the bottom of the Bolsena Lake was constantly 7.1 degrees (C. ?) The investigations are being continued on the lake of Bracciano, etc.

Kutscher has succeeded in cultivating the mycelium of a fungus from decaying wood, which is strongly phosphorescent, thus proving that the luminosity of that substance is due to an organized body and not to purely chemical causes, as Hartey and De Bary have assumed. The mycelium obtained from pine trees exhibiting the phosphorescent phenomenon was cultivated in decoctions of beech bark and agar-agar, forming a white brilliantly luminous growth. The fructification of the fungus has not yet been obtained; consequently its botanical characters cannot be decided.--Jour. de Pharm. (6), vi, 504, after Zeitsch. für phys. Chem.

We regret to state that the publication of Garden and Forest has ceased with the last issue for the year 1897, which completes the tenth volume. For ten years the experiment has been tried of publishing a weekly journal devoted to horticulture and forestry and absolutely free from all trade influences. This experiment, which has cost a large amount of time and money, has shown conclusively that there are not persons enough in the United States interested in the subjects which have been presented in the columns of The Garden and Forest to make a journal of this class and character self-supporting; therefore, it was wisely deemed necessary to suspend the publication, very much to the regret of its many friends.

THE "MAINE" DISASTER.

As we go to press the mystery which envelops the "Maine" disaster is as great as ever and the country is still anxiously awaiting the verdict of the Court of Inquiry. So faithful have the members of the board, the survivors of the "Maine," and the divers who are at work on the wreck been to the policy of silence which has been enjoined by the administration, that practically nothing of an authoritative or expert character regarding either the cause of the wreck or its present condition has been made public.

Meanwhile, both the administration and Congress have been taking all necessary steps to place the country in a state of full preparedness for such complications as might follow upon the publication of the Court of Inquiry's report, if it should prove that the "Maine" was blown up by design. Directly and opportunely in line with these preparations is the bill for the addition of two sorely needed artillery regiments to the existing force, which is likely to become law at an early date. The Assistant Secretary of the Navy has recommended the addition of 1,500 men to the navy, and the purchase of 100,000 tons of coal and its storage at convenient coaling stations, and great activity prevails in the arsenals and among the various private companies that manufacture war material for the government.

These preparations, however, are in no sense to be regarded as "war measures;" they simply indicate a determination on the part of the government to bring the defenses of the country up to the state of efficiency which should distinguish them, even in times of profound peace. Congress, while lavish in its appropriations for some purposes, has ever been slow to grant money for the defenses of the nation, and it was only just before the "Maine" disaster that the House cut down the Fortifications Bill by more than one-half. The frightful calamity in Havana Harbor and the still more frightful horrors which it may possibly precipitate are stirring up the government to an appreciation of the time-worn truism that in time of peace we should prepare for war.

Every effort should be made to raise the "Maine" and bring what remains of it to a home port. To this end Congress has appropriated \$200,000 and a contract has been made with the Merritt and Chapman wrecking companies of this city and the Boston Tow-boat Company, by which they are to receive \$871 per day for the use of their plant and \$500 extra for each day's work of the powerful floating derrick "Monarch." The "Monarch" can lift a dead weight of 260 tons, and is credited with being the largest of its kind afloat. It is capable of lifting, unaided, each of the "Maine's" turrets with its two inclosed 10-inch guns. The combined weight of the two guns is about 54 tons and the weight of each turret and guns combined will be over 150 tons. The after turret will probably be recovered intact, and the forward turret, which was immediately above the explosion, on account of its enormous strength, is not likely to be wrecked beyond repair.

The terrific force of the explosion can be realized from a study of the engravings on our first page, which have been prepared from a set of photographs furnished by our correspondent in Havana. From the disposition of the wreckage it is possible to approximately determine the location of the explosion and the direction in which a part of its disruptive force was exerted. By comparing the two illustrations which we published Feb. 26 with these of the wreck the reader can identify the particular parts of the ship shown in each view. Perhaps the most striking are those shown in Figs. 1, 2 and 6, which represent the same mass of wreckage viewed from different standpoints. In the general view of the "Maine" of Feb. 26 he will notice the two large boat cranes which stood up amidships, one on each side of the superstructure deck at about the middle of its length. The long stretch of plating seen in Fig. 6 is that portion of the side bulwarks of the superstructure deck which extends from the boat crane aft on the port side, or the opposite side to that shown in our illustration of Feb. 26. The bead, or moulding, which will be noticed near the water line marks the level of the superstructure deck. It will be seen that just forward (i. e., to the left in Fig. 6) of the boat crane the plating and the deck line break off abruptly, and the forward half of this deck, including the pilot house, the conning tower and the captain's bridge, is missing. To find it we must look above the half of the deck that remains, where it lies bottom up with the pilot house, bridge, etc., buried beneath it. The deck beams, torn from the side framing of the ship but still riveted to the deck, can be plainly seen in the various views. From this it is evident that whatever may have happened in the hold of the ship, the blast was sufficient to tear loose the forward half of this deck and fold it back upon itself.

From the fact that the floor was rolled back toward the starboard side of the ship (see Fig. 2) it is probable that the explosion occurred on the port bow, or at any rate that the rush of gas came chiefly from that quarter. On the other hand, it may be that the dead weight of the forward turret, which was located to starboard, mitigated the force of the blast on that side.

A further evidence of the force of the explosion is shown by Fig. 2, where what appears to be the cylindrical walls and framing which carried the conning tower may be seen still attached to the forward (now the rear) end of the overturned deck. If this is the case, the massive conning tower with its thick steel plating, the captain's bridge and the pilot house must have described a great half circle through the air as they were lifted up and rolled back to their present position. Conspicuous among the mass of wreckage in Fig. 6 is a 6-inch gun with its gun-shield. This gun, which is now lying upside down, must have been blown over with the deck from its original position, abreast the pilot house and 80 feet distant from its present position. The top of the forward smokestack is shown in Fig. 3, and it is seen at full length in Fig. 1. The forward mast was carried away, and the only visible indication of the existence of the forward half of the ship is a few disconnected and twisted plates which show above water above where the bow of the ship should be. The after half of the vessel below water is said to be intact. The views taken at the stern show the mainmast with the United States flag flying in memory of the martyred sailors, many of whose bodies are supposed to be still entombed beneath it. The elevated structure at the extreme after end of the wreck is a searchlight platform. There was a similar platform in the bow, but this has disappeared.

The work of the divers has been impeded by the great amount of wreckage with which the ship is encumbered and by the muddy condition of the water. The latter is so filthy as to render the electric hand lamps with which the divers are provided practically useless, and they have to be guided largely by the sense of touch. The wreck itself is said to be steadily sinking into the soft mud of the harbor bottom, and, taking everything into consideration, it looks as though any critical examination of the ship's bottom, supposing it still exists, would be impossible.

It has been suggested that a cofferdam should be built entirely around the wreck and the water then pumped out, thereby enabling the hull to be patched up sufficiently to float it. It will be time enough to talk of patching the hull when it is clearly ascertained if there is sufficient forward hull left to admit of patching. Even if there is, it is very doubtful if a line of sheet piling could be driven in the surrounding mud, which must be strewn with a vast amount of wrecked bars and plating. If it should prove that the wreck cannot be floated, it is to be hoped that whatever the cost may be, the government will not leave a visible remnant of our ill-fated ship in the waters of Havana Harbor.

The Punishment of Train Robbers.

Mr. J. W. Shrague, of The Express Gazette, has issued an appeal to Congress in behalf of a national law to suppress train robbing and train wrecking. The following record of the last eight years forms the basis of his argument:

RECORD OF TRAIN ROBBERIES IN THE UNITED STATES.

Year.	Number of "hold-ups."
1890.....	12
1891.....	16
1892.....	16
1893.....	33
1894.....	34
1895.....	49
1896.....	28
1897.....	30
Total number of trains "held up" in eight years.....	218
Total number of people killed.....	78
Total number of people injured (shot).....	67

THE RECORD FOR 1897.

Number of railroad "hold ups".....	30
Number of robbers killed.....	4
Number of robbers injured (shot).....	3
Number of passengers and trainmen killed.....	4
Number of passengers and trainmen injured (shot).....	8

We are all aware that a terrifying total can be made up by summarizing statistics on almost any subject, and such statistics are dangerous things to play with. Here, however, is a record of seventy-eight persons killed (which we presume to be correct) as a result of a proceeding which is in itself criminal to the last degree. Lives may be lost unavoidably (as in the legitimate operation of railways), and, beyond doing our best to limit the number, we can only deplore them as a necessary incident of a necessary service. But there is no palliating or redeeming feature about the mortality caused by train robbers. There have been various bills introduced in Congress on the subject, of which the Hubbell bill is perhaps the most succinct, comprehensive and satisfactory. It provides, on conviction of any person "who shall be by any means or in any manner concerned or connected in the offense" (already fully defined in the bill), a penalty of "death or imprisonment in the penitentiary at hard labor for a term of not less than ten years." It would be better if it was not necessary to provide the alternative of imprisonment and if there could be but one penalty, and that penalty death. But, either by the passage of the Hubbell bill or of some measure even more stringent, Congress should act and as speedily as possible.—*Railway Age.*

Miscellaneous Notes and Receipts.

To Remove Ink Spots from Paper.—Shake 20 grammes of lime chloride with 30 grammes of distilled water until dissolved, let stand for some time, pour off the clear liquid into a dark (blue) flask and add 5 grammes of acetic acid to this liquid. In order to remove writing, etc., paint it with the fluid, using a fine hair pencil, press with blotting paper and dry. By this method erasures are avoided on the paper, which is important with documents and other valuable manuscripts.—*Das Gewerbe.*

Explosions Caused by Paint mixed with petroleum ether are said to have occurred frequently of late in England. The admixture of petroleum ether is made to hasten the drying of the paint. Aside from the recent accidents with such paints in the interior of vessels, attention is called to the fire in former years on the man-of-war "Doterel," where 151 persons lost their lives. Hence great caution is recommended in employing such paints; in closed rooms their use should be entirely prohibited.—*Centralbl. d. Bauverwaltg.*

The Heating Capacity of Wood.—Heretofore it was generally believed that the heating capacity of hard wood was greater than that of soft wood, but this is not so. The greatest heating power is possessed by one of the softest woods, viz., the linden. Taking its heating capacity for the unit, the second best heater is also a soft wood—fir with 0.99 heating power; next follow the elm and the pine with 0.98; willow, chestnut, larch, with 0.97; maple and spruce fir with 0.96; black poplar with 0.95; alder and white birch with 0.94 only; then comes the hard oak with 0.92; the locust and the white beech with 0.91, and the red beech with 0.90. Hence hard wood heats the least.—*Staats Zeitung.*

Priming Coat for Large Oil Paintings which are to be Rolled Up.—Take common canvas and prime with a mass consisting of 4 parts chalk, 2 parts glue and 1½ parts alum. The last two substances are dissolved hot, and first the glue is stirred in the chalk steeped in water, then the alum. After this priming, coat once with best white lead, caoutchouc oil, a little turpentine and litharge, and, when dry, paint on this. The ground will neither crack nor peel off if carefully treated. A priming coat for oil paintings on paper is produced by coating the paper first with glue water, and, when dry, once with this and a little white lead. No oil painting should be rolled up until it is thoroughly dry. If this has to be done, however, and the painting is still a little tacky, moisten clean white paper with water and lay it on the painting. But oil paintings can never remain entirely clean if rolled up before thoroughly dry.

By the addition of alum the glue is transformed into a tough jelly, upon which the basic coat is built. This priming would also be suitable for jute decoration.

Another Process.—The canvas is saturated with strong glue water after having been firmly stretched upon the wall or the floor. Before this is dry the first priming coat is put on, using a rather thick oil paint. Naturally the canvas, whose pores are saturated with glue water, will not absorb the oil. The glue water dries toward the back, and can thus not act injuriously upon the oil paint coat. Owing to the immediate application of the oil paint upon the fresh glue, a combination is created which, in its turn, prevents the canvas from hardening on account of the glue.—*Maler Zeitung.*

Coloring Photographs.—The method described below enables even persons who have received no technical education in drawing or painting to produce nicely decorated photographs. The photograph to be colored must not be mounted on cardboard. It is held against the window pane, so that the albumen layer touches the glass. This transparent photograph is then hatched on the back with a lead pencil, sketching the plainly visible outlines of the different parts which are to be painted with different colors. Then lay the albumen side of the photograph upon a blotter and simply apply the desired colors on the back of the picture into the sketched contours, which will hardly require much skill. After that, prepare a mixture of 10 parts benzine and 1 part vaseline, which pour over the photograph, rubbing it thoroughly into the paper with the finger. After first the back and then the face of the picture have been treated in this manner, it has become transparent and may be dried with a cloth after one to two hours and mounted on cardboard. The colors appear distinctly and are well visible.—*Technische Mittheilungen für Malerei.*

Long Life of Wood Under Water.—A valuable find was brought to light by the dredging engine which is at work for deepening the bed of the river Maine, near Karlburg. It consisted of six oak trunks, of which the largest measured twelve, the others nine, six, etc., cubic meters. They were lifted and taken to Langengrozzetten, where they were dragged ashore in the presence of a large crowd of lookers-on. The wood of the trunks is black, like ebony, and, according to the opinion of a woods and forests assessor, they may have been lying in the water from 1,000 to 1,500 years. The find represents a considerable value, and will furnish excellent wood for inlaying purposes.

NEW PRACTICE SHIP FOR THE UNITED STATES NAVAL CADETS.

It is a matter of common observation that the coming of steam into the navy has tended to eliminate the old-time sailor as he is recorded in the tales of Captain Marryat and other popular writers of sea stories. We are all of us familiar with the pictures of the old ships-of-line and frigates as represented by the Constitution, with their towering masts and their vast spread of snowy canvas. They were picturesque to the last degree, and in the work of keeping them in first-class order there was at all times abundance of skill and plenty of hard work required of the man-of-war's man. When the first armored battleships made their appearance, they were provided with a full spread of sail, and except for its greater length and its single row of ports there was little to distinguish the side-armed ship of twenty years ago from the wooden frigates of an earlier day. With the increasing speed and the increased destructive power of the lighter guns, naval constructors began to feel the necessity of reducing the amount of topmaste carried by the ships, and in course of time the three masts gave place to two. Even these were in time stripped of their yards and running gear, until now the only representative of the yards and sticks of an earlier day is a couple

Hiehorn, of the United States navy, and, as will be seen from the illustration, she is a beautifully modeled ship, with fine lines and a considerable sheer both forward and aft. She has a high freeboard, and should render a good account of herself in stormy weather. She will have a total sail spread of about 20,000 square feet, and with her easy lines she will undoubtedly prove to be a speedy craft. The vessel is to be constructed of steel, and the bottom will be sheathed with yellow pine and copper. The captain will have special accommodation in the after part of the vessel, and there will be accommodation for ten wardroom officers, two warrant officers, one hundred and eighty cadets and a crew of ninety men.

It is proposed to make the lower masts and lower yards of steel, the balance of yellow pine or spruce. The proposed arrangement of battery consists six 4-inch rapid fire guns on the gun deck, four 6-pounders and two 1-pounders on the spar deck. The boats carried will be: One 30-foot steam cutter; one 30-foot launch; two 28-foot cutters; one 28-foot whale boat; one 28-foot gig whale boat; one 20-foot dingy. Two small boilers are to be supplied to furnish steam for the steam windlass, steam pumps, heating and for the dynamos, the vessel being wired for electric lighting; steam is also to be furnished to the distilling apparatus

that which prevails with us. In it the lips do not touch the surface of the person kissed. The nose is brought into light contact with the cheek, forehead or hand; the breath is drawn slowly through the nostrils, and the act ends with a slight smack of the lips. The Chinese consider our mode of kissing full of coarse suggestiveness, and our writers regard their method with equal disdain.

Darwin and other naturalists have attempted to trace back the kiss to the act of the lower animals who seize their prey with their teeth, etc. An interesting recent study of the subject is by M. Paul d'Enjoy in the Bulletin of the Paris Anthropological Society, vol. viii, No. 2.—Dr. Daniel G. Brinton in Science.

Celestine.

There was a production of 40 tons of celestine in the United States in 1897, this having come from Put-in-Bay, Ohio, where there is said to be a vein of the mineral 6 feet in width, says The Engineering and Mining Journal. The existence of this mineral at numerous localities in the United States has been known for a long time. Dana describes its occurrence in the limestones about Lake Huron; at Drummond Island, Strontian Island and Put-in-Bay, Lake Erie; at Chau

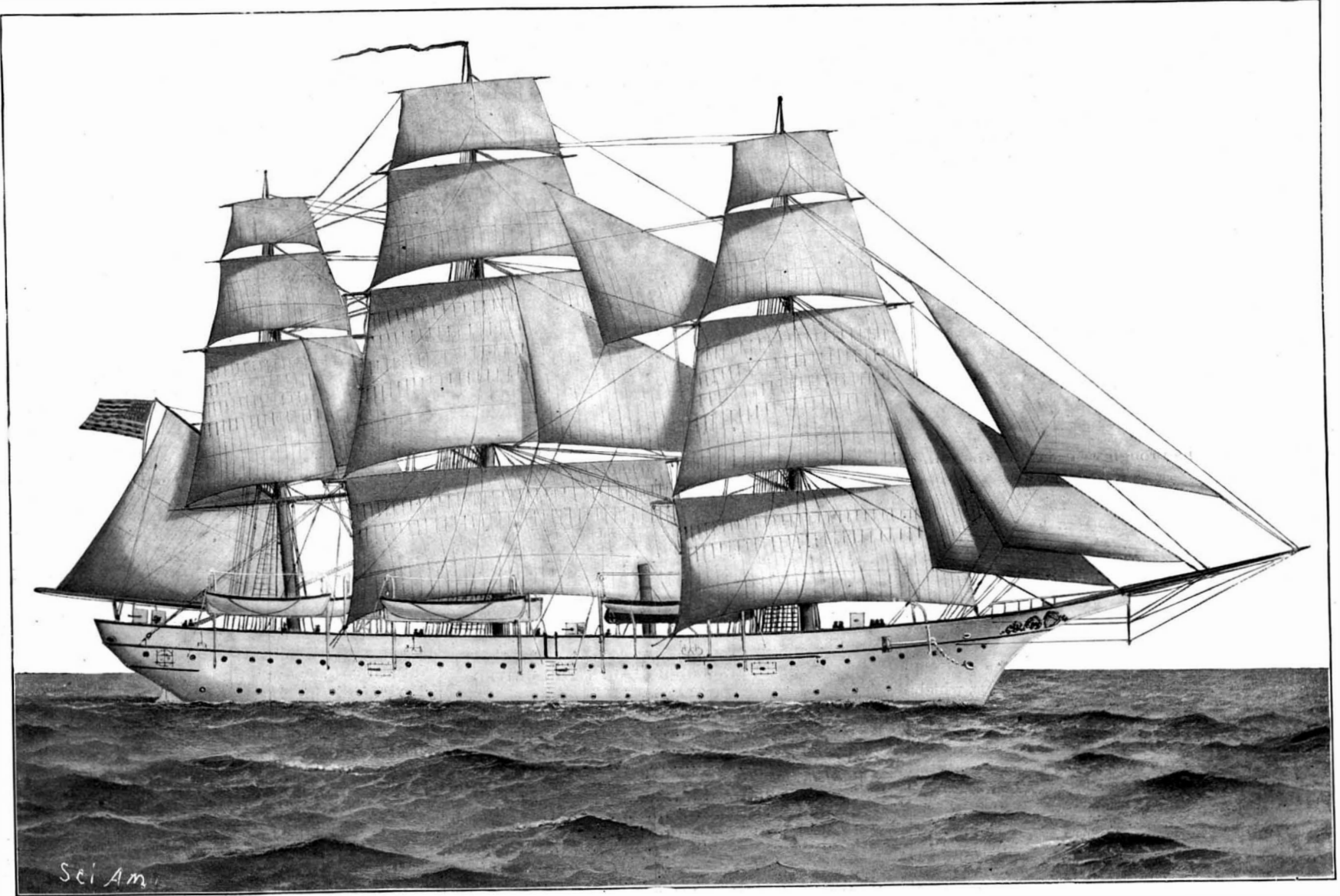

NEW PRACTICE SHIP FOR UNITED STATES NAVAL CADETS—DISPLACEMENT 1,195 TONS, SAILSPREAD, 20,000 SQUARE FEET.

of straight steel towers to which the name of mast is still given, perhaps by way of courtesy. As a consequence of these changes, there has been a deterioration in the seamanship of the average Jack Tar as compared with his predecessor in the days of the sailing frigate and the three-decker.

It is realized that in order to give our officers the fullest possible training for their duties, it will be of great advantage to the navy to possess a training ship which will be fully equipped with sail power. In his last annual report Captain P. H. Cooper, superintendent of the Naval Academy, says: "It is entirely useless to argue that sufficiently good seamen can be made on board the steamers or auxiliary steamers, for there is an education of the nerves and brain and the habit of command which can only be inculcated in the same school which has reared the greatest naval commanders the world has seen, and that school has been the sailing ship. I cannot urge too strongly my former recommendation that Congress be urged to authorize the building of two moderate sized composite sailing vessels, which should be supplemented by two small brigs for stationary work."

We present in this issue a view of the practice sailing ship which, in response to the foregoing recommendation, is being constructed for the use of the cadets at the United States Naval Academy, Annapolis, Md. The ship was designed by Chief Constructor

tus and refrigerating plant. General dimensions: Length on water line, 175 feet; breadth at water line, 37 feet; draught, forward, 15 feet 6 inches; draught, aft, 17 feet 6 inches; draught, mean, 16 feet 6 inches; and displacement about 1,195 tons. The vessel is to cost about \$141,000.

Those of our readers who are familiar with the rig of a modern ship will notice that the practice ship carries single topsails in place of the customary double yards. This is done with a view to giving her crew of cadets as much exercise as possible, for, of course, the heavy single topsail with three reefs will give the youngsters more work to do than would the lighter double topsails with only one reef, especially when the winds blow high.

The Ethnology of Kissing.

The kiss was unknown, I think, among the aboriginal tribes of America and of Central Africa. From the most ancient times, however, it has been familiar to the Asiatic and European races. The Latins divided it into three forms—the osculum, the basium and the suavius; the first being the kiss of friendship and respect, the second of ceremony and the third of love. The Semites always knew the kiss, and Job speaks of it as part of the sacred rites, as it is to-day in the Roman Church.

The Mongolian kiss, however, is not the same as

mont Bay, Lake Ontario; and at Schoharie and Lockport, N. Y. A blue fibrous celestite is found at Bell's Mills, Blair County, Pa. In fact, the localities where specimens of this mineral may be found would make a long list. There are deposits in the vicinity of Burnet, Texas, which are said to be sufficiently large to be workable. The slight value of the crude mineral, however, would prevent its exploitation in a remote locality. The large vein in Put-in-Bay, Ohio, mentioned above, was discovered in 1893 by a German geologist, who found the mineral in crevices around the shores, and subsequently sank a shaft near the center of the island, directly opposite the Perry Cave. It is said that the 40 tons of mineral referred to were shipped to Germany. Pure celestine, or celestite, is sulphate of strontium, containing 56.4 per cent strontia and 43.6 per cent sulphuric anhydride, but it is usually associated with calcium (calciocelstite) or with barium (barytocelstite). It is analogous to barytes, and, like the latter, has a high specific gravity, this ranging from 3.95 to 3.97. It is used for the preparation of nitrate of strontium (red fire), as a pigment like barytes, and in beet sugar refining, the most of the mineral being consumed probably in the last direction. The market value of celestine is very low, probably not in excess of \$2.50 per long ton, ex ship at Liverpool or Antwerp. There is a production exceeding 8,000 tons of celestine per annum in England.

THE KLONDIKE RELIEF EXPEDITION.

The "Manitoban," of the Allan line, from Boscop, Arctic Lapland, arrived at New York on Sunday, February 27, the trip occupying twenty-four days. The steamer brought the Lapland Reindeer Yukon Relief Expedition, which is in charge of Dr. Sheldon Jackson, who introduced the first domestic reindeer into Alaska and who, under the auspices of the federal government, is about to place the first colony of Lapp settlers in Alaska. The expedition was planned by the War Department for the relief of the miners in the Klondike country, but since the arrival of the expedition it has been decided to abandon the intended relief, owing to the fact that the conditions on the Yukon have changed so as to render the expedition unnecessary. The result is that the reindeer brought by the steamer will be sold, and it is expected that the amount received will be sufficient to reimburse the department. The decision of the officials does not affect in any way the sending of the northern immigrants to Alaska.

The "Manitoban" brought a unique cargo, the first of its kind ever imported into the United States. It consisted of 113 immigrants, 537 reindeer, 418 reindeer sleds, 511 sets of reindeer harness and between 3,000 and 4,000 bags of moss for feeding the reindeer en route. The immigrants consist of 42 Lapp, 10 Finn and 15 Norwegian herders and drivers and their families, making a party of 68 men, 19 women and 26 children. Each of the three nationalities has a celebrity. Samuel Johannesan Balto is a Lapp who crossed Greenland with Nansen and wears a silver medal conferred on him by King Oscar II., Olaf Paulsen is a Norwegian who boasts of three prizes received from King Oscar for skill in rifle shooting, and Johan Petter Stalogargo is a Finn who has the distinction of having been the northernmost mail carrier in the world, having for eight years carried the mail on his back to North Cape, Norway.

The "Manitoban" had rough weather, but the reindeer stood it well and did not appear to be inconvenienced by the rolling of the ship. They were carried in pens built on the upper and first decks between the amidships superstructure and the poop. Many of the reindeer were in a pitiable plight when they reached New York, owing to the fact that they were dehorned at sea, so that they would not injure each other, themselves or their driver. Some of their heads were still bleeding when they were put in the cattle cars to carry them to their Western home.

The reindeer sleds are built of light, thin wood and are much the form of the forward half of a canoe, only decked over for about two-thirds of their total length of about seven feet; from 300 to 400 pounds make a sled load and ten sleds make a team, nine being loaded with goods and one being occupied by the driver. Each sled is drawn by one reindeer, whose harness consists of a rawhide thong about the neck with a single trace running between the foreleg, so that the animal pulls a bit sidewise and does not step into its tracks twice, as it would if it pulled straight ahead. The driver, who rides in the first sled in a reindeer caravan, drives with reins tied to the steed's horns. The other animals are tethered each to the rear of a sled and in front of another. The reindeer are very useful in countries where summer thaws leave a muddy trail, as their hoofs are large and flat and spread out when the foot is planted, so they scarcely sink in the lightest snow or the softest ooze. The large supply of Arctic moss brought with the reindeer will be more than sufficient to feed them during the entire trip to Dyea, and there is found a day's journey inland from that place a moss which the reindeer can eat. In the SCIENTIFIC AMERICAN for September 4, 1897, is an interesting article entitled "The Alaskan Reindeer—The Camel of the North," to which our readers are referred for interesting particulars regarding this hardy and useful animal.

The emigrants stood the trip far

worse than the reindeer and suffered a good deal from seasickness. Notwithstanding the condition of their lives and their nomadic habits, the reindeer herders and drivers are not stupid and are remarkably domestic. They insist upon taking their families with them when they make a permanent move, and generally, when any number move together, they insist upon taking the minister with

caps, but the popular headdress seemed to be a four cornered cap made of bright colored cloth, with a tassel attached to each corner. These caps were filled with moss. A few of the men were dressed in dark blue cloth clothes cut after the style of the fur blouse, and kilts trimmed with red braid. The women were dressed so nearly like the men that it needed a careful glance to distinguish them. A particular feature of their dress seemed to be the kilt, but some of the men also wore kilts which confused the spectator. The women wore heavy brass and silver finger rings with bangles. The men were generally undersized according to the American standard, the Lapps being larger than the Norwegians and smaller than the Russian Finns, but they were all wiry, close knit fellows, and seemed to be capable of standing a great deal of hardship. The women did not show their age; the blue eyed women fifty years of age do not look more than thirty years old, and there was an absence of wrinkles and gray hair.

Our engravings show the reindeer on their way from the pens at the Pennsylvania Railroad stockyards in Jersey City to the train and a group of Laplanders on the steps of the car just prior to their departure for the West on March 1. The party was shipped by a special train made up of thirty stock cars of approved design, the train moving in two sections. Two tourist cars, a cooking car, three baggage cars, complete the trains. It is the intention of the drivers to stop at Dyea, Alaska, until two

or three round trips are made into the Klondike country. It is believed that the reindeer can be sold to good advantage in Alaska and that the drivers can obtain very remunerative wages.

Roman Circular Monuments.

The circular form was a favorite one with the Romans for their sepulchral structures of a more pretending class than ordinary. It will be sufficient here merely to mention those in honor of Augustus and Hadrian. The Tomb of Cæcilia Metella is a low cylinder, the height being only 62 feet, while the diameter is 90, and it may be considered as nearly solid, the chamber or cella being no more than 19 feet in diameter. This cylindrical mass is raised upon a square substructure, which combination of the two forms is productive of agreeable contrast, and it was accordingly frequently resorted to. The Tomb of Plautius Sylvanus, near Tivoli, consists also of a short cylindrical substructure on a square basement, but is otherwise of peculiar design, one side of that stereobate being carried up so as to form a sort of low screen or frontispiece, decorated with six half-columns and five upright tablets with inscriptions between them. The Tomb of Munatius Plancus, at Gaeta, is a simple, circular structure of low proportions, the height not exceeding the diameter, and therefore hardly to be called a tower, notwithstanding that it is now popularly called Roland's or Orlando's Tower. Of quite different character and design from any of the preceding ones is the ancient Roman sepulchral monument at St. Remi, which consists of three stages—the first a square stereobate raised on gradini and entirely covered on each side with sculptures in relief; the next is also square, with an attached fluted Corinthian angle and an open arch on each side, and the uppermost is a Corinthian rotunda, forming an open or monopteral temple (i. e., without any cella), the center of which is occupied by two statues. As instances of other combinations we may briefly refer to what is called the Tomb of Virgil, near Naples, consisting of a square substructure surmounted by a conical one; to the Roman monument at Constantine, in Africa, conjectured to have been a cenotaph in honor of Constantine, the lower portion of which is a cylindrical structure surrounded by a peristyle of twenty four Doric columns and carried up as a lofty cone in receding courses or gradini, leaving at its summit a platform for an equestrian statue.—The Architect.



TAKING REINDEER TO THE CARS.

them, but in this instance they did not do so. They nearly all read and write and as a rule are good Lutherans. Some of the Laplanders dress partly in European dress; these were easily distinguished from the crew and helpers by their heavy leather moccasins and the long ugly looking sheath knives that hung from their belts, no less than by their facial characteristics. The majority were fully dressed in their gay native costume, the outer garment being a great fur coat heavily trimmed about the cuffs and collars with bright red, blue and yellow flannel and fringed about the skirt with the same material. They wore tightly fitting fur trousers and decorated leather moccasins topped with bright wool or flannel bands. Their hats were of various shapes, materials and colors; some wore fur caps with elongated ear laps that hung over their shoulders. Others wore knitted wool or cloth



GROUP OF LAPPS BOUND FOR THE KLONDIKE.

Acetylene Notes.

The Progressive Age of recent date had an interesting collection of notes on acetylene which we reprint.

Interesting tests, says The Gas Engineer's Magazine, Nov. 10, 1897, concerning the combustion of acetylene and air mixtures, have been made by Le Chatelier, of Paris. He has found that a mixture containing less than 7.7 per cent of acetylene burned with a yellow flame, the brightness increasing with increasing acetylene contents. The combustion was perfect. A mixture containing above 7.7 per cent and up to 17.3 per cent of acetylene burned with a blue flame, the product of combustion being, besides water and carbonic acid, carbonic oxide and hydrogen. With contents of 17.3 per cent a part of the mixture already remains uncombusted, and carbon is separated, the separation at 25 per cent taking place in the form of a dense, black vapor. With acetylene contents up to 57 per cent the mixtures remain explosible. Explosibility commences with 2.7 per cent, while a coal-gas and air mixture requires at least a gas content of 8.1 per cent in order to be explosible. Acetylene ignites much easier than other gases, even oxygen, its igniting temperature being about 500° C. The theoretical heat development for acetylene, burning in air, is 2,400° C., that of coal gas 1,900°. The separation of carbon is avoided by combustion under pressure out of small openings, or better by mixing the gas with its own or the double volume of air, without injury to its illuminating effect. The use of from 10 to 20 per cent of oxygen is for this purpose preferable to the admixture of air.

In passing pure cold acetylene saturated with CCl_4 vapors into a flask cooled to 0° C., Messrs. Forcrand and Sully Thomas (Comptes Rendus, vol. 125, p. 109) found among the fragments of ice in the flask which was under a low pressure some crystalline white flakes such as are produced by H_2S under the same conditions. Above 5° Cent. these bodies decompose and give off acetylene freely. The flakes referred to are a mixed hydrate of acetylene and CCl_4 . We can obtain the same hydrates by replacing CCl_4 by CHCl_3 , $\text{C}_2\text{H}_4\text{Cl}_2$, CH_3I , CHBr_3 , etc. By replacing C_2H_2 by C_2H_4 , CO_2 or SO_2 we obtain similar crystals which are stable above 0° C. These also decompose with effervescence and give off the gas which produced them; they are more stable than simply hydrates of these gases.

Moissan and Etard found (Annales de Chimie et de Physique, November, 1897) that when pure thorium oxide was heated with carbon in an electric furnace, a carbide of thorium was easily produced having a formula C_2Th . This compound in presence of cold water produced a mixture of gaseous carbides containing acetylene, methane, ethylene and hydrogen. Liquid and solid carbides were also produced. Five different samples gave the following percentage results:

	1	2	3	4	5
Acetylene.....	14.49	14.90	15.23	47.05	48.44
Ethylene, etc.....	3.81	5.70	6.01	5.88	5.64
Methane.....	38.47	34.20	30.32	31.06	27.69
Hydrogen.....	43.34	45.20	48.44	16.01	18.23

The first three samples were from a melted mass of carbide, while the two last were from pure crystallized thorium carbide.

Calcium Carbide Works at Geneva.—The authorities at Geneva, Switzerland, who control the electric light plant situated at Vernier, have decided to utilize the idle hours of their plant for the manufacture of calcium carbide. The dynamos are driven by turbines operated by abundant water power. In order to reduce manual labor charges as much as possible the pulverizing of the coke, mixing the lime and carbon and other operations are performed mechanically. From the time the crude material is received until it comes from the furnace but one man's labor is required, most of the operations being automatic. They pay special attention to the use of good material and to the attaining of a good product which will be sought after for the production of acetylene for car lighting where a pure quality is especially required. The coke used contains but 5 per cent of ash. The lime is very pure, containing 99 to 99.5 per cent of calcium oxide. Each furnace will take 500 horse power (6,000 amperes at 57 volts). They are probably the largest used for the manufacture of calcium carbide. The furnace is a large cylindrical crucible 59 inches in diameter and 32 inches high. The electrode is made of compressed carbon in six pieces, each 60 inches long, 5.2 by 9.2 inches in section. The weight of the six carbons is over 858 pounds, and the total section is 287 square inches. The crucible is fed from above by iron chutes. The daily production will be six tons, but this can easily be increased. The works seem to have been established under the most favorable conditions as regards power and installation, and propose to turn out a first-class product only.

Two Vienna chemists, Dr. Fuchs and Dr. Schiff, find that when acetylene gas is passed over water covered with a layer of olive oil there is at first absorption of the gas by the oil to the extent of 48 per cent by volume, and that the saturated oil then, standing on fresh water, only allows absorption by the water to the extent of from 1.5 to 2 per cent by volume in three

hours. They say that for analytical purposes the carbide should not be powdered; the weight goes wrong on account of the absorption of moisture from the air, and for the same reason there is a loss of gas. But when compact lumps are used, the lime formed tends to shelter some of the carbide from the water if the lumps be immersed; whereas, when the water is slowly dropped on the lumps, each drop is partly blown off in steam and cracks the carbide, which thus becomes so porous that the decomposition is complete.

The American Druggist and Pharmaceutical Record, under the head of "Tariff Problems Considered," says the Treasury Department will send out a special agent to make an investigation of the value and market price of calcium carbide. This article is used in the manufacture of acetylene gas, a product which is now being extensively exploited by a large syndicate, which controls the patents under which it is manufactured. The tariff law levies an ad valorem duty on this product, and as it has been brought in at several ports, collectors have varied more than 200 per cent in their valuations; but in all cases have materially exceeded the invoice valuation. The company controlling the patents have an important interest in keeping the apparent cost of the article as low as possible, as they are disposing of royalties in nearly all the States and the economy of production necessarily depends upon the cost of the raw material. In view of the limited supply and circumscribed market, the department sees no way of ascertaining the value of the article without a special investigation.

Some experiments on the use of acetylene in signaling lamps have recently been made by Mr. A. E. Munby. Such good results have been obtained with the primitive apparatus employed that it seems well worth considering whether acetylene could not take the place of the lime light where portability is an object. The apparatus consists of a 5-ounce bottle carrying a two-hole rubber cork. Water drips on the carbide from a wide glass tube holding about 2½ ounces, and furnished with a connection of rubber tube and a screw clamp to act as regulator. The gas escapes from a straight tube to the lamp, being trapped on the way by a wider piece of tube, into which the smaller tubes are corked at each end. The gas tube enters the lamp through the base, and the gas burns from an ordinary 0000 Bray. The generator weighs when charged one pound, and after two minutes will give a steady light for thirty or forty minutes. Of course, for permanent work, the generator would have to be arranged in metal. Even then it would probably be the lightest gas-supplying arrangement for the illumination yet produced.

The Current Supplement.

The current SUPPLEMENT, No. 1158, contains a number of articles of more than usual interest. Perhaps the most remarkable is the one relating to the Crucifixion, which has just been discovered by Prof. Marucchi on the walls of the Palace of Tiberius, on the Palatine Hill, Rome. A fac-simile reproduction is given of the "graffito" which is believed to have been scratched on the wall by a Roman soldier who was present at the Crucifixion.

"How a Ship is Built" is the subject of a long article describing the process of building ships in Germany and is illustrated by eight engravings. Those of our readers who are interested in rotary engines will find two important articles, "Hult's Rotary Engine" and "Reversing Steam Turbines;" the latter describes the latest improvements in the Parsons turbine. They are both fully illustrated with sectional views.

"Black Print Processes" describes in great detail the method of making black print copies of drawings. "Instinct and Intelligence in Animals" is another paper of great interest. "An Electric Curve Tracer," by Prof. Edward B. Rosa, Ph. D., describes an ingenious apparatus for delineating the forms and phases of periodic electric quantities. It is very fully illustrated. For a complete table of contents of this number of the SUPPLEMENT, the reader is referred to page 162.

Electric Working of the Ymuiden Locks.

Ymuiden is the North Sea entrance of the ship canal which joins Amsterdam in a straight line to the sea. The installation was completed this March, 1897, says The Trade Journals Review. A gate, turning in 39 feet of water, can be opened against a wind exercising a pressure of 20 kilogrammes per square meter (4 pounds per square foot) by a motor of 45 horse power. The cables for the electric motors, lamps and signal wires are placed in three conduits made in the bottom of the lock chambers. Each groove contains 15 cables of Felten and Guillaume, all insulated with okonite and rubber, two lead sheaths and a fourfold iron armor. The locks have three heads, each head being fitted with four gates, four sluices and four capstans. Each of these gates, sluices, etc., is worked by its own electric motor, but the motors are grouped together.

The gates are moved by hydraulic rams guided on rollers, and four chains carried over sheaves and a drum; the latter is actuated by means of a worm from

the electric motor. The lifting of a sluice against a difference in level of 6.5 feet requires about eight tons; it is done within one minute. The capstans claim more power still. The dimensions of the actual central power station allow of the simultaneous motion of two parts, for instance, two gates or two sluices. The height to which the latter have been raised is indicated on the switch board. The electric motors and switchboard come from the Elektrizitäts Gesellschaft, late Schuckert & Company, of Nurnberg. The illumination is effected by means of 12 arc lights and 300 incandescence lamps; groups of the latter are used for flash effects. The primary power is supplied by a temporary plant, comprising two steam engines of 25 and 90 horse power and three dynamos. The permanent plant will be provided with a large battery of accumulators, which will act as a powerful reserve.

Ocean and High Altitude Health Resorts.*

Recent knowledge of microbic life, as related to the purity of the atmosphere, justifies the inference that the benefit to consumptives derived from sea voyages or from resort to high altitudes is independent alike of the extreme density and moisture of the ocean atmosphere in the one case and of the rarefaction and dryness of the air in the other. In both cases the air is inimical to tubercle bacilli, as it is also inimical to other bacilli—indeed, to all microbic life. And, barring the preventable conditions of a foul bilge and inadequate ventilation of staterooms and other sleeping quarters on board ship; close bedrooms, defective house drainage, unhealthful surroundings and dust—barring these conditions respectively, ocean atmosphere and high altitude are alike propitious and commendable to persons afflicted with or predisposed to pulmonary consumption.

Ocean air, however, it should be understood, is not the air of the seacoast, but of the open sea, sufficiently distant from the land to be free from all contamination. It is more equable and, in corresponding latitudes, excepting the tropics, warmer than over the land; and within the tropics, though warm, is never sultry, as it is at the same degree of temperature on the land, nor is the temperature so high. In the tropics the range of the thermometer at sea is from 72° to 84° F., and rarely as high as 86° F. at midday. The mean relative humidity is about 73.5 per cent (100 representing complete saturation). The humidity is usually a little greater in the night than during the day, but commonly is less at all times than that of the air of seacoast places.

Besides the excess of moisture, as compared with that of the land distant from the seacoast, the ocean air always contains some sea salt, although, excepting in the trade winds or in gales, in infinitesimal quantity; never in such excess, even in the trade winds or gales, as to be otherwise than a healthful stimulus to respiration.

It also possesses properties beneficial to certain specific diseases.

The special advantages of an ocean atmosphere are:

1. Its entire freedom from the dust common to domestic conditions—particles of tissue wastes of all sorts, hair, straw, feathers, cobwebs, insects, dried sputa, etc.; from traffic dust—the wear of travel and friction; from all insoluble and irritating grit wafted from paved streets, houses, walls, dusty roads or sandy plains. It is air, in short, that contains a maximum of the elements essential to life and health and a minimum only or none at all of the deleterious substances always floating, in greater or lesser degree, in the lower stratum of the atmosphere over the land.

2. Complete change of scene and rest; relief from all sources of excitement and worry—newspapers, telegrams, messenger boys, letters, expectations, and all sorts of indescribable turmoil. And the passing breeze is not from just over the marsh or stagnant pond, nor is it from the malodorous tenement house district; it bears no foul emanations and no disease germs. Every breath of it is brand new, and when exhaled it never hovers round to taint the next inspiration, but is wafted away and speedily transformed into the purer elements of the atmosphere.

Thus inhaled throughout the day, the pure, soft air soothes the nerves, invigorates the functions, promotes sleepiness and welcomes repose. Sound slumber supervenes, and with no business appointments to be met, abundant time is taken for breakfast, dinner and supper—with an invigorated appetite and improved digestion.

The invalids to whom an ocean atmosphere is most commendable are pointed out by that which is just above stated—consumptives in the incipient stage and persons predisposed to consumption; persons of scrofulous diathesis; persons afflicted with nervous complaints—not organic nervous diseases, but the easily recognized conditions of overwork, though often undefinable, the result of physical or mental nervous strain, anxiety, worry, irritability, debility, nervous breakdown, insomnia; and persons afflicted with chronic nephritis.—The Sanitarian.

* Abstract from "Winter Health Resorts."—Medical Record, November 27, 1897.

SOME RECENTLY OBSERVED SUN SPOTS.

To the Editor of the SCIENTIFIC AMERICAN :

I inclose a sketch of a large group of sun spots as seen on February 13, 1898, 12 M. The group was visible to the naked eye as a black dot near the center of the disk. A severe storm obscured the sun until Friday, February 18, when the group was found to have changed. The largest spot, that on the right in the sketch, had split into four. The appearance of such a large group at this time of solar inactivity is interesting, in view of the severe storms now raging throughout the Northern States.

L. H. HORNER.
University of Maine, Orono, Me.

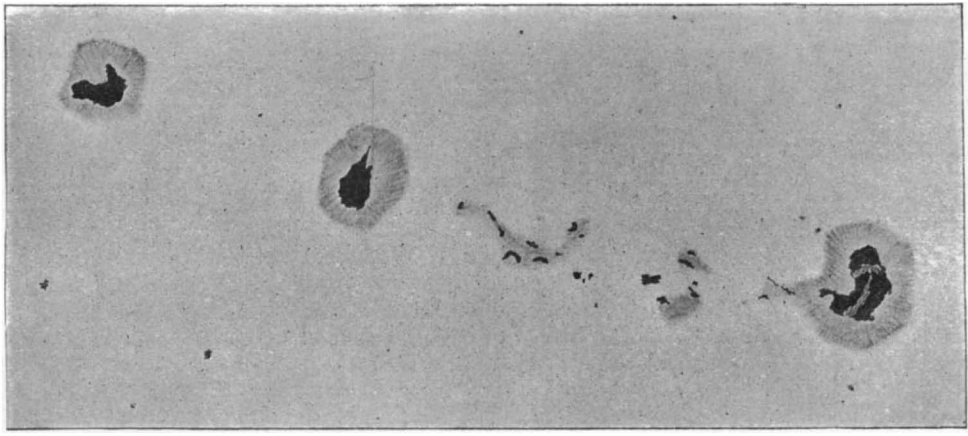

SOME RECENTLY OBSERVED SUN SPOTS.

England's Book Output.

The Publishers' Circular says that the output of books during the past year was larger by some 1,400 tomes than in 1896. In theology there is a rise of about 100 books, and in education 160, while politics and commerce show the notable augmentation of 300 books. While the demand for light reading also grows, the total increase in fiction is not so great as was expected. Travels and poetry are much the same as last year. The total number of books and new editions published in the past twelve months is 6,573. The smallest number is on law, 140, and the largest is novels, 2,677. There is revived interest in theology, while the arts and sciences show a falling off.

THE "APENNINO" OF GIOVANNI BOLOGNA.

About nine miles from the Porta San Gallo, of Florence, on the road to Bologna, are the remains of the Villa of Pratolino, built in 1569, by Francesco de' Medici, son of Duke Cosimo I., from the designs of Bernardo Buontalenti, for the reception of Bianca Capello the Venetian. It was her favorite place of residence, and here she devoted herself to magic and the composition of philters. After her death a room was shown where it was said she used to distill a cosmetic from the bodies of newly born infants; of course this is improbable, but an old Italian villa would lack interest in the eyes of the country folk if it did not have some legend attributing horrible crimes to the former occupants. As the home of Bianca Capello, Pratolino was extolled even by the poet Tasso. The villa has long been in ruins and the park is now a great picnic resort of the Florentines who are out for a holiday, and about the only relic of former splendor is the colossal crouching figure of stucco, 62 feet high, representing the "Genius of the Apennines" and very generally attributed to Giovanni Bologna.

During the golden age of the Italian Renaissance, there were already many signs of decadence. Painters and sculptors made abstract and incoherent works. They were constantly striving after the colossal and the effects of *trompe d'oeil*, until at last they became improvisators, and the excessive facility of the cinquecentists reacted unfavorably as regards, not the quantity, but the quality of their work. Collaboration was abused, leading the really great men to become merely what in music would be called an "impresario," and, finally, nothing was left but a great army of mediocrities, who only assisted in the downfall of public taste. This straining after the unnatural and the grotesque really dates from the time of Raphael and Michelangelo. The latter even considered the idea of shaping

a peak in the mountains of Carrara into the semblance of a giant; fortunately, the scheme was not carried out.

St. Christopher, the colossus par excellence of the middle ages, soon became degraded to the proportions of a local saint, patrons insisted on the artists affecting the colossal, and the Polyphemes of the Villa Madama of Giulio Romano and his giants of the palace of Té at Mantua, and last, but not least, Giovanni Bologna's

giant, are examples of the result of this longing for the immense.

Giovanni Bologna was not an Italian, but was born at Douai, in 1530. This city was then a part of the Low Countries and therefore he is sometimes known as "Il Fiammingo." He early went to Rome to study sculpture and afterward stopped in Florence, where, enjoying the friendship of Bernardo Vecchiotti, the goldsmith and bronze caster, and the patronage of Francesco de' Medici, he made rapid strides in his art and soon he was known as the creator of masterpieces. He died in 1608 and is buried in the church of the Annunziato at Florence.

We need only concern ourselves with the "Apennino," or "Jupiter Pluvius" as it is often called. The statue is unfortunately in a ruinous condition; it is placed at the end of the terrace and faces the villa. If the giant were suddenly to be endowed with life, when he rose, like Rip Van Winkle, from his long sleep of four hundred years, he would be 104 feet tall. The god crouches, grasping the rock with one hand, while

execution of the colossus for the petty sovereign and his favorite he demonstrated his ability to grasp the large and monumental as well as the small work of the goldsmith's shop.

Pitchers in Plants.

Prof. S. H. Vines gives a useful résumé of the present state of our knowledge of the structure and function of pitchers in plants. The known examples belong to the orders Sarraceniaceæ, Nepenthaceæ, Asclepiadaceæ, Saxifragaceæ and Lentibulariaceæ, with which may also be associated the underground scales of *Lathræa* (Scrophulariaceæ). In the great majority of cases these structures are traps for insects; while others have apparently no such function. Among insect traps, the greater number (Sarraceniaceæ, *Genlisia*, *Utricularia*) appear to be incapable of digesting the insects which they capture, absorbing only the products of the decomposition caused by micro-organisms; these therefore are not correctly termed carnivorous plants. The pitcher of the various species of *Nepenthes*, and possibly also that of *Cephalotus* (Saxifragaceæ), undoubtedly secretes a digestive enzyme. When pitchers are not insect traps, they have some function in connection with the supply of water to the plant; either relieving it of an excess of water which it may have absorbed, or storing it up for future use.—*Journ. R. Hort. Soc.*, 1897.

The New Appraisers' Stores at New York.

The Appraisers' Stores at Washington and Laight Streets, New York City, which have cost about \$3,000,000, will be ready for occupancy on April 23. The work was begun on the Stores in 1890 and the immense building is now practically complete. It is the most convenient building in this country and occupies an entire block. It is ten stories high and is equipped with every known device for easy and speedy handling of goods. In the center of the structure are ten freight elevators, with a lifting capacity of 84,000 pounds. These elevators are reached by a driveway with an entrance and exit, so that the trucks can load, unload and leave the building without turning around and without getting in each other's way. All goods will be received on the ground floor, which is equipped with trolleys, cranes, hoisting blocks, etc. The building, having light on every side, gives the best possible opportunity for examining goods and determining the quality. There are over a hundred telephones in the building and pneumatic tubes facilitate the delivery of messages to every part of the building. There are over three miles of corridors in the great structure. Splendid vaults are provided for the storage of valuable goods such as jewels. The building has many special features, such as a cold storage room of 3,000 square feet for tobacco seized or held for an adjustment of



GIOVANNI BOLOGNA'S COLOSSAL STATUE CALLED THE 'APENNINO' AT PRATOLINO

with the other he presses a point of rock above the head of a marine monster, which is still readily distinguishable notwithstanding its dilapidated condition. The hair and the beard of the colossus descend like stalactites on his shoulders and breast. It is necessary to be architect as well as sculptor to execute a work of this kind, and Giovanni Bologna shows that he was a great artisan and artist in constructing so solidly and in such just proportion this prodigious work. In the

duty. The laboratory occupies two sides of the top floor and in it all the chemical tests will be made. It is believed to be the largest commercial laboratory in the country and possibly in the world. The new building will enable the appraiser and his assistants to carry on their work with the greatest dispatch and with a minimum of expense, and the importers will probably not now have any just complaint of delay or improper handling and storage of their goods.

Arctic Climate.

BY PROF. RALPH S. TARR.

* The summer of 1896 was an unusual one in respect to the amount of ice that was floating in the Arctic seas, and hence, from this, one might gain a somewhat exaggerated idea of the amount of floe ice that is generally moving southward along the American side. Yet this very exaggeration is important, since it brings out clearly the striking differences between the water conditions on the two sides of Davis Strait. The ship upon which I made my voyage encountered pieces of floe ice in the middle of July, just north of Newfoundland on the Labrador coast; and from that point until we left the American side, in latitude 65°, we were not out of sight of the sea ice that had formed during the winter in the more northern regions, and was now floating southward in the cold Arctic current which bathes this coast. Sometimes, and especially near the northern part of Labrador, and the southern portion of Baffin Land, the floe ice was so heavy that the ship was obliged to reduce her speed to half the normal amount, and then slowly push her way through the heavy cakes of ice. Sometimes it seemed as if further progress would be impossible, and so indeed it would have been had we not been supplied with a well-built whaling vessel and with steam to propel her. While off the Labrador coast we saw an excellent illustration of the importance of steam in this kind of navigation, when we passed at full speed a sailing vessel which was lying in the ice, and, being dependent entirely upon the wind, was unable to push her way through.

About the first of August an attempt was made to enter Cumberland Sound (latitude 65°) in southern Baffin Land; but the mouth of this great bay was completely shut in by the floe ice, so that even our steamer could not push her way in. After an unsuccessful attempt to enter Cumberland Sound through the heavy floe ice, the ship sailed northeastward toward Disco Island, on the Greenland coast; and from the time that we lost sight of the American land until we again returned to this very place no floe ice was seen, although we went nearly 600 miles further north. Again and again we were in the midst of great masses of icebergs which had been broken off from the front of the immense glaciers that end in the sea; but the sea or floe ice, which was so abundant on the American side, had by this time entirely disappeared from the Greenland coast. On our return to Baffin Land, early in September, another attempt was made to enter Cumberland Sound, and this was successful only after three days of effort to penetrate the barrier of ice, including a halt of about sixty hours, when we

were held firmly in one place, being unable to move either way.

Therefore, along this part of the coast, during the year 1896, there was ice throughout the entire summer; and by way of contrast practically no floe ice was seen on the Greenland coast. This difference explains the differences in climate that were mentioned. There is a constant presence of floe ice in the south-moving current of water, whose temperature is therefore kept at about the freezing point, and this current, going southward past Newfoundland, bathes the shores of Nova Scotia and of New England, north of Cape Cod, with water that has been chilled in the Arctic and that has borne ice southward, until the warm conditions of the temperate latitudes caused it to disappear.

What has been described for the Atlantic applies almost equally to other parts of the world, although no ocean shows such marked differences as the North Atlantic. In the Pacific, for instance, there is no cold Arctic current, because the opening between the Pacific and Arctic is too small to permit a large body of water to move southward; and in the southern oceans the movement of the cold Antarctic waters is not impeded by the land, and hence passes mainly eastward, driving around the earth to the southward of the southernmost parts of the continents. Nevertheless, even here there is some northward movement of the cold water of the frigid zone, so that the southernmost lands are cooled by it.

It may be stated as a law that the eastern coasts of continents have lower temperatures than the western, for the reasons mentioned above. The reason why the warm currents bathe the western coasts, while the cold waters flow along the eastern shores of the land, is that the earth in its rotation deflects all moving currents, whether of air or water, to the right in the Northern Hemisphere and to the left in the Southern. Therefore, the current starting in the Arctic and moving southward, being turned toward the right, if land does not prevent, moves toward the west; but if land does interfere, as finally happens, it passes along the coasts and keeps close to them. A current starting in the tropical belt and moving northward, as in the case of the warm equatorial current which eventually forms the Gulf Stream, is caused to turn toward the east, and hence away from our coast. This is the reason why the Gulf Stream, after passing between Florida and Cuba, and starting up the American coast, gradually turns off across the Atlantic, leaving our country to come under the influence of the cold Labrador current, and, passing across the Atlantic to the European coast,

produces the result at first mentioned, that the zone of habitation and civilization of Europe extends much further north than that of the American side.—The Independent.

Signaling through Pipe Systems.

Considering that, in cases of mishaps and accidents, it is always desirable to have more than one means of communication, Schale has been conducting experiments on the distance through which pipes, such as are used in mines, may be relied upon for conveying signals. From the report in the Zeitschrift für Berg-, Hütten- und Salinenwesen in Preussen, it would appear that straight pipe systems will carry the sound a long way, but that side branches are less reliable. Schale made experiments in Westphalian coal mines, using the sprinkler pipes put up to lay the dust. These were mostly galvanized wrought iron pipes, from one to two inches in diameter, suspended by wires or hooks, or placed in conduits, and connected by flanges with rubber packing, or fitted into one another with hemp packing. The branches generally join under right angles. He first used a funnel-shaped mouth-piece, but found that his hands were a better help. Slowly spoken words could be understood at the extremities of straight pipes 1,600 feet long, especially when the pipes were firmly fixed. Whistle signals were much less distinct; tapping the pipes answered best, of course. Every side branch decreases the efficiency. Yet communication was fairly good, for instance, with a pipe 160 feet long, divided into two side branches, and the main pipe being further continued through a connection containing a valve to two other side branches, each of the four branches having a length of 700 feet. Signals from the starting point were received at all four lateral ends, but communication between the sides was difficult. For spoken words, the diameter of the pipe ought to increase with its length; but wide pipes require a more powerful voice. It is noteworthy that words will not pass well from a wide pipe into a narrower one.

To strengthen mucilage, an addition of chrome alum is recommended. It would be advisable first to make a trial with the addition of 1 per cent of a 5 per cent chrome alum solution to the gum arabic, then the suitable proportion can be easily found out. The following mixture has also been found to be effective: Six parts joiner's glue, soaked in cold water a day previously, are dissolved with 2 parts sugar and 3 parts gum arabic in 24 parts hot water, and boiled till the mass is thinly liquid.

RECENTLY PATENTED INVENTIONS.

Engineering.

STEAM BOILER.—Enos Hook, New York City. This boiler has an outer and an inner shell, with water tubes depending from the top of the inner shell to receive heat from a fire chamber therein, while water tubes are secured by their ends within header boxes affixed to the inner shell of the boiler and in open communication with the water space. The tubes hung from the crown sheet of the water chamber receive heat from the fire chamber and the hot air passage at its rear, the boiler being designed to have increased efficiency by the provision of greater heat-receiving area than in boilers of this class as heretofore constructed.

REVERBERATORY FURNACE.—Henry L. Charles, Butte, Mont. In furnaces for smelting and refining copper and other ores, this invention provides improvements whereby the gases are carried off in a simple manner and the cost of fuel and working reduced to a minimum, the working of the furnace being completely under the control of the operator. A flue is curved downward from one end of the hearth and a bridge located between the flue and the hearth, while an arch built over the bridge runs transversely with reference to the hearth, the arch having vertical perforations opening at the top of the furnace to regulate the draught passing over the bridge.

WATER RAISING DEVICE.—William S. Lempert, Marfa, Tex. To raise water by means of a compressed fluid, such as air, affording a continuous flow of water, according to this invention, a box completely submerged, and made with two compartments, has two water inlet valves adapted to swing inward and open when the pressure outside is greater than that within, the water thus filling each compartment successively, the top of each of which is in communication with an air supply pipe from an air compressor, the valves being set by an automatic device or turned by an operator to connect with either compartment, according to the time required for filling and emptying the compartments. The air pressure in a filled compartment forces the water to be raised and discharged through the outlet pipe.

Railway Appliances.

CAR COUPLING.—Lewis L. Bigelow, Delta, Col. This is a coupling of the hook and catch type, adapted to automatically couple with a similar coupling or to receive the end of a link projected from a common car coupling. The coupling bar has at one end an elongated link and at its other end a catch block with a locking face, a tripping lever pivoted in the drawhead having interlocked connection through a dog with the catch block, while a coupling pin on each drawhead is adapted to engage a link of the coupling of a meeting car.

RAILROAD RAIL FASTENER.—Giles D. Mims, Edgefield, S. C., and Samuel K. Dunkle, Finleyville, Pa. To connect together the ends of railroad rails

and secure them to the ties, this device comprises two splice plates having bolts for fastening them to the web of the rail, and each provided with integral tongues extending beneath the rail base to the opposite side from the one on which the plate lies, and there provided with spike holes. There is a slight spring to the plates when they are clamped against the rails, and the fastening is designed to afford a very firm and strong joint, effectively preventing the spreading of the rails under the lateral thrust of the car wheels.

SWITCH OPERATING MECHANISM.—Charles W. Yerbury, Newark, N. J. This invention relates to electrical mechanism for operating switches on electric railways, providing therefor a comparatively simple and inexpensive system which will be completely under the control of the motorman. The switch carries an armature, on each side of which is an electromagnet, there being a number of circuit closing devices forward and rearward of the switch, and means carried by the car for operating the circuit closing devices to close a circuit through the electromagnets from the trolley line wire.

Mechanical.

BALL BEARING.—Heinrich Meltzer, Ratibor, Germany. This bearing comprises a box through which a shaft extends, and on the inner wall of the box is a series of spring rings, arranged in pairs and bent slightly toward each other, a series of balls being held between each pair of rings, by which the balls are kept normally in line, while yet a slight lateral deviation is permitted when side strains occur. The rings are of such form as to fit with their peripheries close against the inner surface of the cylindrical bearing box, while their inner edges extend slightly beyond the diameters of the balls.

BOX FOLDING MACHINE.—William Lederer, New Haven, Conn. In machines for handling pasteboard blanks and making pasteboard boxes, this invention provides improvements whereby the machine is adapted to take the blanks as they come from the scoring machine and fold them into their proper shape, pasting one edge and securing the edges together, the scoring machine being attached to one end of the machine. The machine may be adjusted for boxes of any size, and to make several boxes at once or one large box, the machine simply folding and pasting the body of the box, the boxes being discharged in the form of flattened tubes, to be finished by hand.

WINDOW GLASS CUTTER.—Charles J. Meissner and Francois Koenig, Boston, Mass. To facilitate the accurate cutting of a pane of glass without danger of breaking it, as is frequently the case when an ordinary yard stick is laid on the glass and a cutter run along one edge, this invention provides a device consisting of a fixed guide on which a graduated stick is movably held, a holder being adjustable and adapted to be secured on the stick. The device is simple and inexpensive, and readily adjustable for its work.

REGISTERING MECHANISM.—George A. Smith, New York City, and Samuel P. Freir, Hasbrouck Heights, N. J. This mechanism is especially adapted for convenient attachment to a typewriter or other machine for counting periodic movements, as for registering and indicating the periodic depressions of a word-spacing bar, and thus registering the number of words written. Provision is made for the return of the registering mechanism to zero at any point of its movement, and the register is also adapted for use to indicate the paging of a book, the rotation of bicycle wheels, and other purposes.

Agricultural.

CHURN.—Henry H. Coppock and Frank W. Miller, Pleasant Hill, O. This churn has a four-sided body or cream receptacle in which is rotated a horizontal dasher shaft, carrying radial arms to which are attached dasher blocks having a diagonally beveled front portion and a concave rear face. The blocks are arranged out of line on the shaft, and the beveled portion of each block throws the cream laterally against the following block, causing a thorough agitation of the cream, while the concave rear faces of the blocks cause a vacuum behind each block to draw in and further facilitate the thorough agitation of the cream.

MILK STRAINER.—John Littlejohn, Aurora, Ill. This device has an upper funnel, forming a hopper, and a lower funnel which has a cuplike receiver forming a sediment chamber for a lower strainer depending from the upper funnel, there being an upper strainer in the shape of an inverted truncated cone at the lower end of the upper funnel. The strainers are inverted or inclined above sediment chambers, and the improvement permits the use of finer meshed straining cloth than is ordinarily employed.

MILK COOLER.—Simeon Snider, Palatine, Ill. This is a device for use in connection with a flowing supply of water, which is passed through a pipe journaled to swing back and forth in the tank in which the milk to be cooled is placed. The pipe has angular end bearings in the end walls of the tank, and at its discharge end is connected with a counterweight arm, the discharge of water being made alternately into one of two buckets which have vertical movement, and the filling of each bucket causing its downward movement and a swinging of the cooling pipe from one side to the other in the tank, thus facilitating the rapid cooling of its contents.

FARM GATE.—Stephen E. Auker, Rushville, Neb. This invention provides a swinging gate adapted to be raised at its outer end to avoid snow, etc., and to counteract sagging. It has two end uprights, one or more intermediate vertical pickets, a diagonal brace to which the uprights and pickets are pivotally connected, and a series of horizontally strung wires permanently secured at one end of the inner of the uprights and stapled or otherwise connected with the pickets, while their outer ends are attached to adjusting keys in the outer one of the uprights.

Miscellaneous.

MUSICAL INSTRUMENT.—Silvester Hadley, Gosport, Ind. As an instrument designed as a substitute for a pipe or piccolo, and one permitting the performer to readily imitate the whistle of birds, the device provided by this invention comprises a piston fitted to slide in the barrel of a whistle, keys being connected with the piston for moving it in the barrel, and the keys being of different lengths to move the piston to different positions, there being a tuning attachment, and the whole being carried by a suitable frame consisting of a standard with brackets.

WIRE STRETCHER.—Daniel H. Jones, Lenoir City, Tenn. This is a machine especially adapted for the stretching of fence wires, and comprises a number of winding drums mounted on a suitable supporting frame, wire clamps being connected to the drums and two cam levers arranged end to end on the base, one of them being rigid and the other pivoted, while an angular guard extends along the upper edge of the stationary lever to hold the wire thereon, the wire jamming between the peripheries of the levers. The drums connected to the clamps are rotated by a crank handle to tighten the wires, the machine being also applicable for stretching telegraph, telephone and electric light wires.

WASHING MACHINE.—Richard N. Brent, Wellington, Kansas. The body of this machine is a circular, tublike vessel in the bottom of which freely turns a ribbed disk, while an upper disk, ribbed on its lower side, slides and turns on a perpendicular shaft, a handle being connected to the shaft, so that by swinging or oscillating the handle, both disks are oscillated in opposite directions. The clothes are submerged in the wash water between the disks, the upper disk being pressed down upon them by a spring on the upper end of the shaft, whereby the clothes may be effectively rubbed without being torn or injured.

Designs.

CHECKER BOARD.—Henry A. Rackleff, Woodford's, Me. This board is an equal-sided triangle, and on it is a series of similar small triangles, the various rows or series being arranged in pyramidal form.

CASE.—Adelbert E. Foutch, New York City. This design is for cases adapted to contain stereoscopic goods, such as glass and pictures, the case being divided interiorly into several properly proportioned compartments and exteriorly representing two or three books placed one on the other.

LAMP BODY.—Charles J. Seiter, New York City. This design represents a flower, some of the leaves of which are brought together, forming a hollow upper globe, while others are dropped to constitute a lower draping section.

NOTE.—Copies of any of the above patents will be furnished by Munn & Co. for 10 cents each. Please send name of the patentee, title of invention, and date of this paper.

Advertisements.

ORDINARY RATES.

Inside Page, each insertion, - 75 cents a line
Back Page, each insertion, - \$1.00 a line

For some classes of Advertisements, Special and
Other rates are required.

The above are charges per agate line—about eight
words per line. This notice shows the width of the line,
and is set in agate type. Engravings may bear adver-
tisements at the same rate per agate line, by measure-
ment, as the letter press. Advertisements must be
received at Publication Office as early as Thursday
morning to appear in the following week's issue.

WOOD OF METAL WORKERS
without steam power can save
time and money by using our
Foot and Hand Power Machinery
SEND FOR CATALOGUES—
A—Wood-working Machinery.
B—Lathes, etc.
SENECA FALLS MFG. COMPANY,
695 Water St., Seneca Falls, N. Y.

POWER & FOOT SHAPERS, PLANERS, DRILLS,
LATHES, MACHINE SHOP OUTFITS, TOOLS
SEBASTIAN LATHE CO. 120 CULBERT ST. CINCINNATI, O.

A College Education for 7 Cents a Day
Improve your condition.
Thorough courses, by mail, in
Mechanical, Steam, Electrical, Civil,
and Sanitary Engineering, Mech-
anical Drawing and Machine
Design easily learned by our meth-
ods. Small tuition fees—cash or
monthly installments to suit your
convenience. Courses in the Home
Schools of Art, Architecture and
Trades. Write for Free S. A. Circular,
containing sample instruction
and question pages, list and prices
of courses, sample of mechanical
drawing plate, etc. State subjects
interested in. Special inducements
to those enrolling now.

THE UNITED CORRESPONDENCE SCHOOLS,
F. W. EWALD, Gen. Mgr. 154, 156, 158 5th Ave., New York

PIPEFITTERS!
Your kit is not complete unless
it includes the famous
STILLSON WRENCH
which is particularly adapted for turning out the best
work without crushing the pipe in the least. All parts
are drop-forged. Once tried, it is always used. It has
many imitations but no equals. See explanatory cuts.
Price list on application to
WALWORTH MFG. CO., 20 Oliver Street, Boston, Mass.

A TELEGRAPH OPERATOR'S
WORK IS PLEASANT
pays good wages, and leads to the
highest positions. We teach it
quickly and start our graduates
in telegraph service. Expenses
low. Established 26 years. Write
for Catalogue.
VALENTINE'S SCHOOL OF TELEGRAPHY,
No. 6 Mill St., Jessesville, Wis.

WOODWORKING MACHINERY.
For Planing Mills, Carpenters,
Builders, Furniture, Chair, Vehicle,
Wheel and Spoke Makers, etc.
Correspondence Solicited.
Illustrated 312-page Catalogue free
to manufacturers and foremen.
THE EGAN CO.
327 to 347 West Front Street,
CINCINNATI, OHIO.

TRANSITS AND LEVELING INSTRUMENTS.
NICKEL PLATED ELECTRIC LEVELS
C. F. RICHARDSON ATHOL, MASS.
SIZES, 2 and 3 inches. Prices, 25 and 30 cents.
For Book on C. F. RICHARDSON & SON,
the Level. P. O. Box 977, Athol, Mass., U. S. A.

THE OBER LATHES
For Turning Axe, Adze, Pick,
Sledge, Hatchet, Hammer, Aug-
er, File, Knife and Chisel Han-
dles, Whistlestrees, Yokes, Spokes,
Porch Spindles, Stair Balusters,
Table and Chair Legs and other
irregular work.
Patented. Send for Circular A.
The Ober Lathe Co., Chagrin Falls, O., U. S. A.

BARNES'
UPRIGHT DRILLS
Complete line, ranging from Light Friction
Disk Drill to 42" Back Geared Self-
Feed. Send for New Catalogue.
W. F. & JOHN BARNES CO.
1999 Ruby Street, ROCKFORD, ILL.

ARMSTRONG'S No. 0 THREADING MACHINE
Can be attached to bench or post.
Designed for threading the
smaller sizes of pipe, iron or
brass, also bolts. Has two speeds,
one for pipe 1/2 to 1 inch; the
other for pipe 1/4 to 2 inches,
inclusive. Uses the regular
Armstrong adjustable dies. Other
attractive features. Send for
particulars. The Armstrong
Mfg. Co., 139 Centre Street,
New York. Bridgeport, Conn.

ELECTRO MOTOR, SIMPLE, HOW TO
make.—By G. M. Hopkins. Description of a small electro-
motor devised and constructed with a view to assist-
ing amateurs to make a motor which might be driven
with advantage by a current derived from a battery, and
which would have sufficient power to operate a foot
lathe or any machine requiring not over one man power.
With 11 figures. Contained in SCIENTIFIC AMER-
ICAN SUPPLEMENT, No. 641. Price 10 cents. To be
had at this office and from all newsdealers.

GOERZ'S DOUBLE ANASTIGMAT.
THE BEST LENS ON THE MARKET
FOR SALE BY ALL DEALERS.
OPTICAL C. P. GOERZ BERLIN-SCHÖNEBERG
WORKS
NEW YORK OFFICE 52 E. UNION SQUARE
SEND FOR CATALOGUE WITH DETAILS & PRICES.

Table listing various mechanical parts and their prices, including Heat regulator, Heater, Hitching strap clamp, Hoisting machinery, Holdback fastener, Hook, Hook and eye, Horseshoe, Horseshoe pad, Horseshoe toe calks, etc.

Buy Telephones
THAT ARE GOOD—NOT "CHEAP THINGS."
The difference in cost is little. We guarantee
our apparatus and guarantee our customers
against loss by patent suits. Our guaran-
tee and instruments are both good.
WESTERN TELEPHONE CONSTRUCTION CO.
250-254 South Clinton St., Chicago.
Largest Manufacturers of Telephones
exclusively in the United States.

"QUEEN" ARCHITECT LEVEL \$50
Improved Transits & Levels
Graduated entirely on our
large dividing engines. Special
award at the World's
Fair. All kinds of Engineer-
ing, Surveying and Drafting
Instruments and Materials.
220 p. illustrated catalogue
mailed free only if this ad.
is mentioned.
QUEEN & CO., Inc.,
1011 Chestnut St.,
Philadelphia.

Eyelet Machines.
We can furnish the Latest Improved Eyelet Machines
for making shoe eyelets and special eyelets of all
descriptions. We are also builders and designers
of Special Wireworking Machinery.
Send for Circular.
BLAKE & JOHNSON,
P. O. Box 7, WATERBURY, CONN., U. S. A.

WELL DRILLING MACHINERY.
MANUFACTURED BY
WILLIAMS BROTHERS,
ITHACA, N. Y.
MOUNTED OR ON SILLS, FOR
DEEP OR SHALLOW WELLS, WITH
STEAM OR HORSE POWER
SEND FOR CATALOGUE
ADDRESS WILLIAMS BROS. ITHACA, N. Y.

This beats Wind, Steam, or Horse
Power. We offer the
WEBSTER 2 1/2 actual horse power
GAS ENGINE
for \$150, less 10% discount for cash.
Built on interchangeable plan. Built
of best material. Made in lots of 100
therefore we can make the price. Boxed
for shipment, weight 300 pounds.
Made for Gas or Gasoline.
Write for Special Catalogue.
WEBSTER M'F'G CO.,
1074 West 15th Street, CHICAGO

Manufacturers' Models
of every description made to order with prompt-
ness, precision and economy. Models of Typeset-
ters, Typewriting Machines, Cash Registers, Cyclo-
meters, Revolution Counters, etc.; in fact, any kind
of model made from designs. Also special tools and
machinery for any and every purpose. Correspond-
ence invited from those intending to equip a plant.
Illustrated Circular free.

Che Pratt & Whitney Co., Hartford, Conn.
MIETZ & WEISS KEROSENE
ENGINE
the most economical power
known. Absolutely safe and
reliable. Runs with common
kerosene. Perfectly auto-
matic. Patented 1897 U. S.
and European countries.
128-132 Mott St., New York

NO FIRE, SMOKE, OR HEAT. ABSOLUTELY SAFE
Truscott Boat Mfg. Co., Drawer 9, St. Joseph, Mich.
\$200 and up. Send 5 stamps for Catalogue.

BICYCLE TIRE REPAIRING.—THE
Mending of Single Tube Tires.—A practical article illus-
trating the method of inserting patches and plugs with
pliers and pluggers, together with rubber band plugging
and the use of puncture bands. 311 illustrations. Con-
tained in SUPPLEMENT 1102. Price 10 cents. For
sale by Munn & Co. and all newsdealers.

This \$3000 Launch for \$2000, guaranteed or money
refunded. Send stamps for Catalogue.
RACINE BOAT MFG. CO., CHICAGO
On Receipt of Ten Cents in Stamps (practically
25% of retail price) we will send you one of our
I-2 INCH AUGER BITS

A fine cutting tool, perfect clearance, especially good in
hard wood and for end boring. Send for Cir. S. A., free.
THE FORD BIT CO., HOLYOKE, MASS.

ACETYLENE APPARATUS
Acetylene number of the SCIENTIFIC AMERICAN SUP-
PLEMENT, describing, with full illustrations, the most
recent, simple or home made and commercial apparatus
for generating acetylene on the large and small scale.
The gas as made for and used by the microscopist and
student; its use in the magic lantern. The new French
table lamp making its own acetylene. Contained in
SCIENTIFIC AMERICAN SUPPLEMENT, No. 1057.
Price 10 cents prepaid by mail. For other numerous
valuable articles on this subject we refer you to page 21
of our new 1897 Supplement Catalogue, sent free to any
address. MUNN & CO., 361 Broadway, New York.

TOOLS OF ALL KINDS
Send 10 cents for
126-page illustrat-
ed Catalogue.
GOODNOW & NIGHTMAN BOSTON

Shaving—Easy—Safe—Luxurious.
WITH
WILLIAMS'
SHAVING
SOAPS
THE ONLY REAL
SHAVING SOAPS
SOLD EVERYWHERE.
Williams' Shaving Stick, 25 cts.
Genuine Yankee Shaving Soap, 10 cts.
Luxury Shaving Tablet, 25 cts.
Swiss Violet Shaving Cream, 50 cts.
Jersey Cream (Toilet) Soap, 15 cts.
Williams' Shaving Soap (Barbers'), 6 Round Cakes,
1 lb., 40c. Exquisite also for toilet. Trial cake forsc. stamp.
THE J. B. WILLIAMS CO.,
GLASTONBURY, CONN.
LONDON, 64 GREAT RUSSELL ST. W.C. STONEY, 161 CLARENCE ST.

ARTESIAN WELLS
Any depth from 10 to 2,000 feet. Wells for the Improved
Air Lift Pump a specialty. Old dug wells made deeper.
Test Boring for Water. Soundings made for Foundations.
Send for references and particulars.
I. H. FORD & CO., 104 Fulton St., New York

Weber Gasoline Mine and Mill Pumps
ALL SIZES.
FOR ALL DUTIES
Economy and Efficiency
Guaranteed.
Address, stating condi-
tions,
WEBER GAS AND
GASOLINE ENGINE CO.
402 S. W. Boulevard, Kansas City, Mo.

"WOLVERINE" GAS AND GASOLINE
ENGINES, STATIONARY
AND MARINE.
The "Wolverine" is the only re-
versible Marine Gas Engine on
the market. It is the lightest en-
gine for its power. Requires no
licensed engineer. Abso-
lutely safe. Manufact'd by
WOLVERINE MOTOR WORKS,
12 Huron Street,
GRAND RAPIDS, MICH.

ENGINEERING NOTES, ELECTRICAL
Notes, Miscellaneous Notes and selected Formulas, are
published each week in the SCIENTIFIC AMERICAN
SUPPLEMENT, forming an excellent review of the
shorter matter which appears in the American and
foreign press. The back numbers, containing valuable
formulas, may all be obtained. Price 10 cents each. For
sale by Munn & Co. and all newsdealers.

GAS AND GASOLINE ENGINES
WATER MOTORS
BACKUS WATER MOTOR CO. NEWARK, N. J. U. S. A.

VAPOR LAUNCH COMPLETE FOR \$150
AND UPWARDS
Row,
Sail
or
Steam
Boats.
Send five cents for catalogue. Racine Yacht and
Boat Works, Racine Junction, Wis., Box A.

YANKEE DATER, 15 cts.
Date your Letters, Bills, etc., and
save time, money and mistakes;
instantly adjusted to any date for
10 years in advance; also has extra
words Paid, Received, etc. Sent
postpaid, with catalogue of 2,000
bargains for 15c., 2 for 25c., \$1 25 doz.
CONSECUTIVE NUMBERER
Numbers up to 100,000 same price.
ROBT. H. INGERSOLL & BRO.
Dept. No. 147, 67 Courtland St. N. Y.

A COMPLETE
ELECTRICAL LIBRARY
BY PROF. T. O'CONNOR SLOANE.

AN INEXPENSIVE LIBRARY OF THE BEST BOOKS
ON ELECTRICITY.

For the Student, the Amateur, the Workshop, the Electri-
cal Engineer, Schools and Colleges.
Comprising five books, as follows:
Arithmetic of Electricity, 138 pages, - - \$1.00
Electric Toy Making, 140 pages, - - - 1.00
How to Become a Successful Electrician, 189 pp. 1.00
Standard Electrical Dictionary, 682 pages, - 3.00
Electricity Simplified, 158 pages, - - - 1.00

5 Volumes
for \$5.00
The above five
books by Prof. Sloane
may be purchased sin-
gly at the published
prices, or the set com-
plete, put up in a neat
folding box, will be fur-
nished to readers of
THE SCIENTIFIC
AMERICAN at the
special reduced price
of Five Dollars.
You save \$2 by order-
ing the complete set.
Five volumes, 1,-
300 pages, and
over 450 illus-
trations. Send for
full table of contents
of each of the above
books, also for our
complete book catalogue of 116 pages, containing refer-
ences to works of a scientific and technical character,
free to any address.
MUNN & CO., Publishers, 361 Broadway, N. Y.