

SCIENTIFIC AMERICAN

[Entered at the Post Office of New York, N. Y., as Second Class Matter. Copyright, 1899, by Munn & Co.]

A WEEKLY JOURNAL OF PRACTICAL INFORMATION, ART, SCIENCE, MECHANICS, CHEMISTRY, AND MANUFACTURES.

Vol. LXXXI.—No. 17.
ESTABLISHED 1845.

NEW YORK, OCTOBER 21, 1899.

[\$3.00 A YEAR.
WEEKLY.]

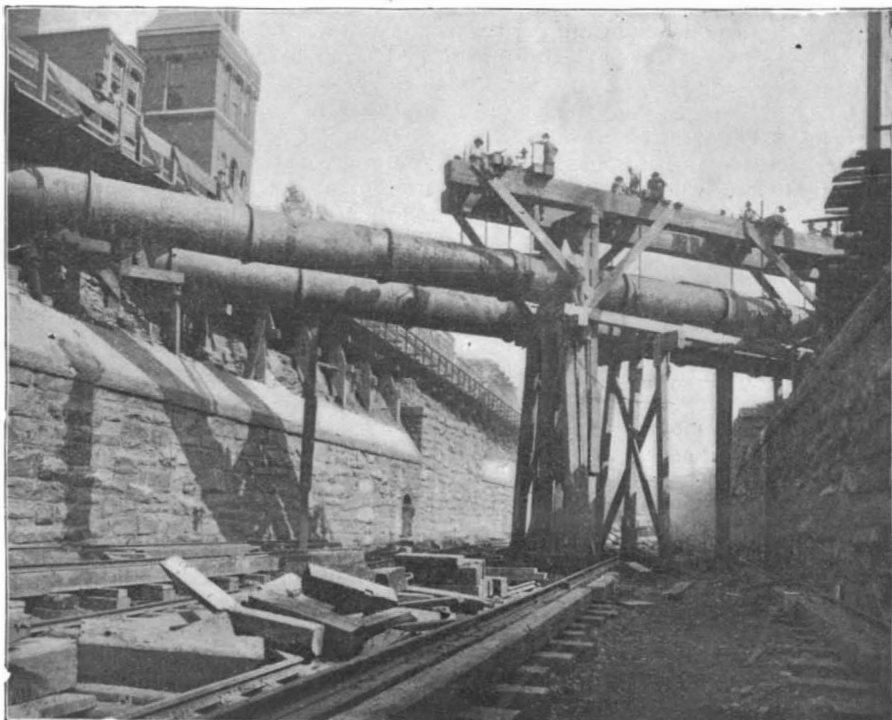

48-inch Water Pipes at Twenty-fourth Street being Raised.

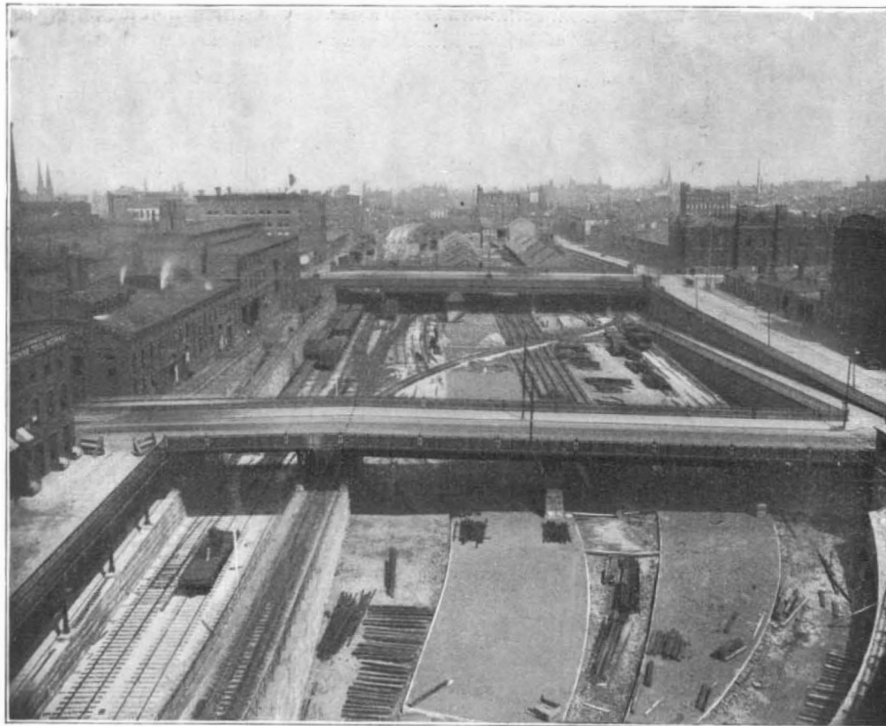

Bird's-eye View of Open Subway and Yard, Looking East from Sixteenth Street.

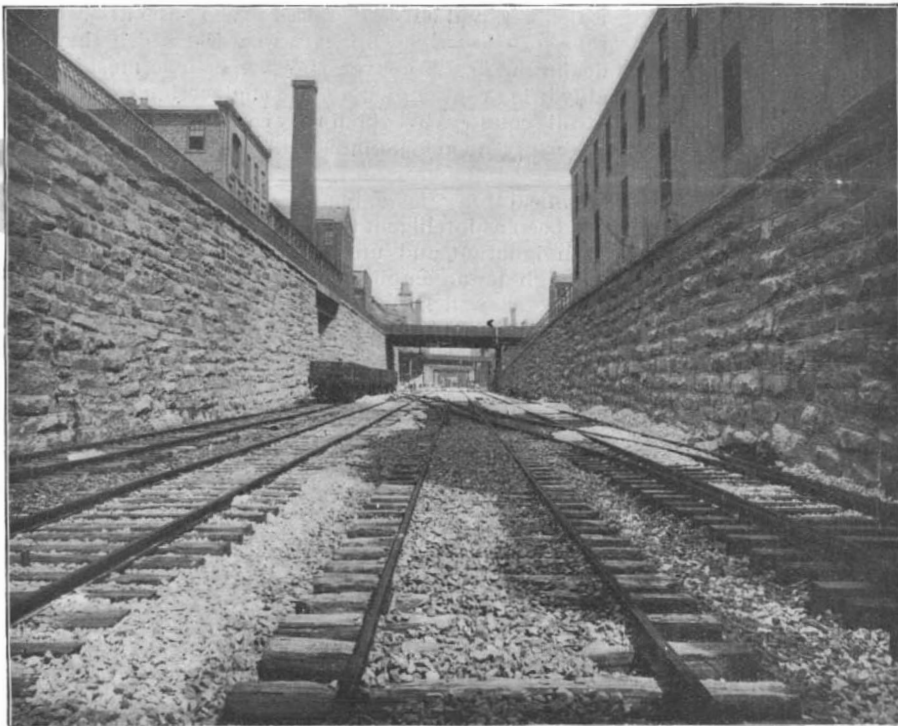

Open Subway, Looking East from Twentieth Street.

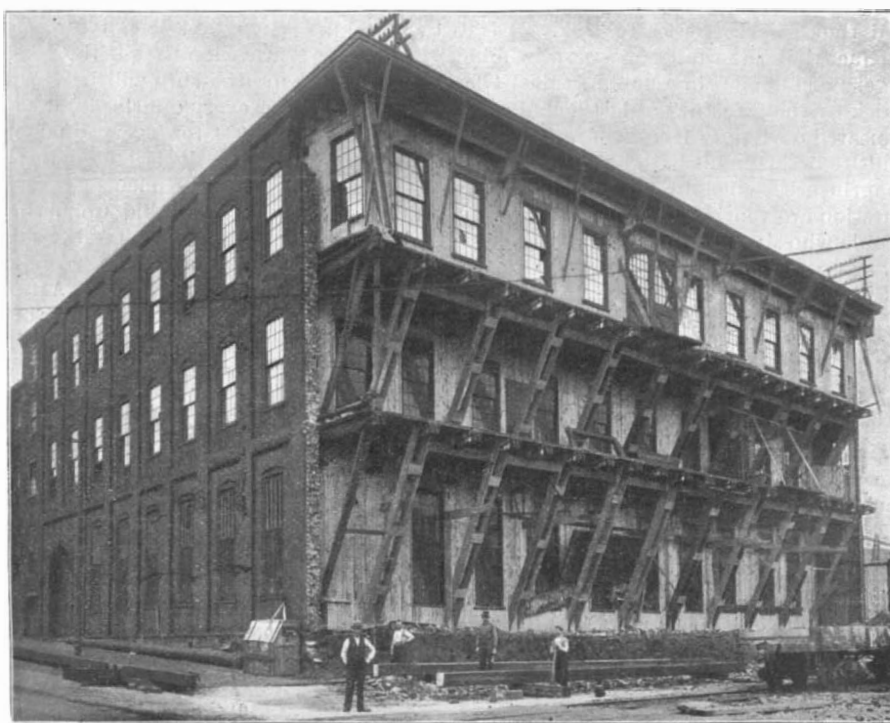

Reconstruction of Part of the Baldwin Locomotive Shops, Necessitated by the Building of a Retaining Wall.

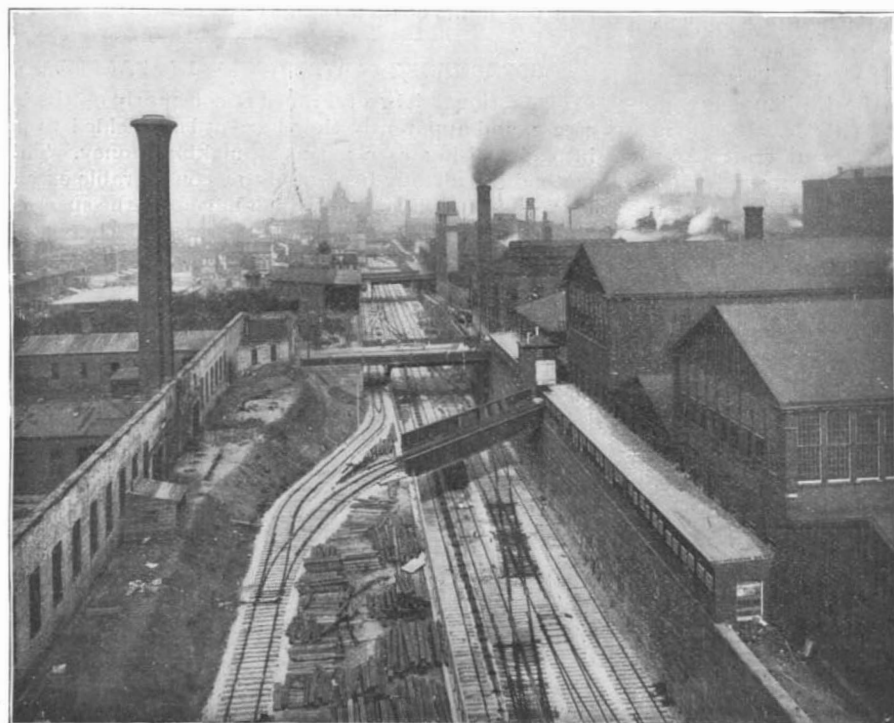

Bird's-eye View of the Open Subway, Looking West from Sixteenth Street.

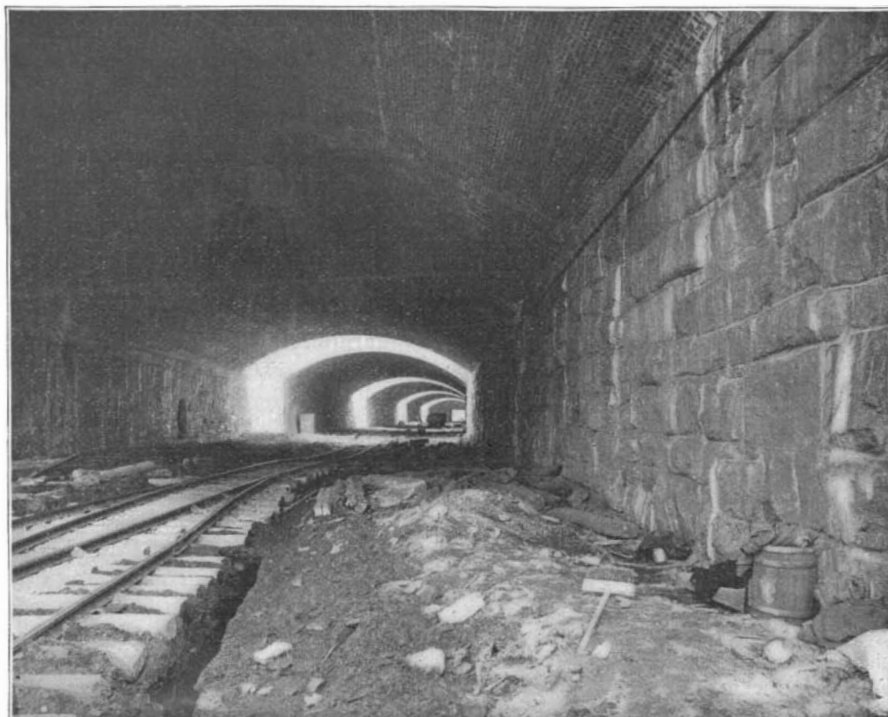

View in Tunnel During Construction, Looking East.

THE NEW PHILADELPHIA SUBWAY AND TUNNEL.—[See page 261.]

Scientific American.

ESTABLISHED 1845

MUNN & CO., - - - EDITORS AND PROPRIETORS.

PUBLISHED WEEKLY AT

No. 361 BROADWAY, - - NEW YORK.

TERMS TO SUBSCRIBERS

One copy, one year, for the United States, Canada, or Mexico \$3.00
One copy, one year, to any foreign country, postage prepaid. £0 16s. 5d. 4.00

THE SCIENTIFIC AMERICAN PUBLICATIONS.

Scientific American (Established 1845).....\$3.00 a year.
Scientific American Supplement (Established 1876)..... 3.00
Scientific American Building Edition (Established 1885)..... 2.50
Scientific American Export Edition (Established 1873)..... 3.00

The combined subscription rates and rates to foreign countries will be furnished upon application.
Remit by postal or express money order, or by bank draft or check.

MUNN & CO., 361 Broadway, corner Franklin Street, New York.

NEW YORK, SATURDAY, OCTOBER 21, 1899.

HYSTERIA AND YACHT RACING.

We regret to say that the sensational press is just now doing its very best to warrant the statement recently made in a foreign journal that we are a people much given to a form of popular hysteria.

We refer to the unwarranted—we had almost said cowardly—attack which has been made upon the managing owner of the American yacht "Columbia"; a gentleman who for the third time in the history of the cup has voluntarily undertaken the onerous labors and untold anxieties incident to the management of a cup defender.

Time and again has this distinguished yachtsman brought the American boat across the line, an easy victor over the challenging vessel; and the very journals that are now indulging in cheap sneers at his expense, were then the loudest in their praises of his untiring zeal, his executive ability, and his unquestioned skill as a yachtsman. Yet to-day we are told that his zeal is mere self-exploitation, his executive ability mere meddlesomeness, and that as a yachtsman he is crudely amateurish.

Now there is a cause for this sudden change of front, and the cause is not far to seek. It is to be found in the fact that the vanity of a certain minority (happily a very small one) in our midst has been cut to the quick by the fear that at last a challenging yacht has appeared off Sandy Hook that seems to their timorous souls to be just a bit better than our own; and in the chagrin occasioned by this discovery, the journals in question are venting their mortification upon the very people who should command at this crisis their warmest sympathy and support.

Such a spirit is pitiful to contemplate even in the abstract; but when it is so shameless as to flaunt itself in printer's ink upon column after column of a metropolitan paper, it may well bring a blush of shame to the cheek of every citizen and sportsman who has the fair name of his country at heart.

Mr. Iselin and the gentlemen associated with him in the management of "Columbia," are every bit as good yachtsmen when sailing a defeated "Columbia" as a victorious "Defender" or "Vigilant." In the name of good sportsmanship and common decency, then, let us have done with a show of petulance and bad temper, which befits more the kindergarten or the nursery than the public discussion of the greatest sporting event of the nineteenth century.

LIQUID AIR PROMOTING.

Somebody once made a statement to the effect that where the carcass is there will the vultures be gathered together. Though the speaker had in his mind a far different event from the liquid air craze of the year 1899, and the liquid air fallacy that was to be killed as soon as it was hatched, the interpreter of the prophecy might be excused for thinking that in the sudden swoop that has been made by the company-promoting vulture upon the liquid air carcass, he beheld a veritable fulfilment of the prediction.

For the protection of the public, we wish to enter an earnest protest against the commercial exploitation of comparatively untried inventions of which so much is going on in various parts of the country. The most flagrant examples of this sort of thing just now are to be found in the starting of companies and the selling of stock for the promotion of liquid air schemes of more or less, and generally more than less, preposterous pretensions. We do not say that any of these are deliberate attempts to obtain money falsely, but we do say that the crude nature of the liquid air apparatus, whether it be in the form of motor, refrigerator, explosive or whatnot, the absence of any demonstrated facts to establish its value, and the utter fallacy of the theories upon which the successful operation of many of these devices depend—render it our duty to warn the readers of the SCIENTIFIC AMERICAN against investing their money in enterprises which exist only in the imagination of their promoters.

We were recently consulted by correspondents with regard to the wisdom of investing in one of the most audacious of these enterprises, which has its headquar-

ters in the city of Boston and boasts of a modest capitalization of \$5,000,000. We made it our business, accordingly, to ascertain by correspondence and personal inspection just what kind of liquid air motors and plant for the manipulation of the same, the company possessed; but after the exchange of several letters and a visit by a representative of the SCIENTIFIC AMERICAN to the headquarters of the company we have failed to find either a motor, or a plant for the manufacture of the same, which would justify the Liquid Air, Power and Automobile Company in asking the public to put a single penny in its coffers.

We have at hand the explanatory pamphlet which was furnished us, at our request, by the company. We give a few quotations from this surpassing document, the opening sentence of which is a gem that needs no setting of the editorial pen: "Steam and electricity, giants both as they are, have had their day." Rivaling it in brilliance is the statement that "their fields were and are limited when compared with the transcendent possibilities of liquid air, whose power is not only on the earth but above it and beneath the sea as well." Of course the L. A. P. and A. Company has patents, and the fact is suggested as follows: "But now, with the inventions of George Code, Hans Knudson, and Milton Chase to control and apply it (liquid air) as a motive power, its possibilities of usefulness and profit admit no bounds less than those of the firmament above!"

The description of the glories of the new motor culminates in a burst of triumph with the statement, "the power transmitter enables us to secure five horse power from two." In the endeavor to warn the public against investment in a scheme of such grotesquely absurd pretensions, we cannot do better than allow the last quotation to stand without comment.

THE "DENVER" CLASS OF CRUISERS.

According to a report from Washington, a test has been made in the experimental towing basin which gives reason to believe that the new 3,500-ton semi-protected cruisers, if built, would attain a speed of 17 knots with 4,500 horse power. The specifications of these vessels call for a speed of 16½ knots, with the provision that if the speed on trial falls below this figure the ship will be accepted at a reduction of \$25,000 for every quarter knot to 16 knots, and a reduction of \$50,000 for every quarter knot between 16 and 15½ knots. It is stated in the report that these towing-tank experiments prove that shipbuilders who are intending to bid upon the plans for these vessels need have no fear that the ships will not fulfil the requirements as to speed.

The SCIENTIFIC AMERICAN has already criticized these cruisers as being of a type that is altogether out of date, and for most of the purposes of modern warfare practically useless. For the work that they are supposed to do they will be at least 3 knots too slow, even if they should reach, as the towing-tank experiments suggest, a speed of 17 knots an hour. We are free to confess that this discussion as to whether our new cruisers are to make 16½ or 17 knots is a waste of time and words in this late day in the development of the fighting ship. It would have been timely in the late seventies and early eighties, when we were considering the plans of the old 16-knot "Atlanta" and "Boston"; but the fact that in this age of 19-knot battleships and 22-knot armored cruisers, the first use to which our new towing tank is put is the testing of 15½ to 16½-knot half-protected cruisers, is positively humiliating.

Not merely in respect of speed, but as regards their armor and armament, these ships, by the time they are launched, will be at least eighteen years behind the times. We speak advisedly and "by the book," as a comparison with the first ship that was constructed of the protected cruiser type will show. This was the "Esmeralda," built in 1883 for the Chilean navy, purchased from that country in 1895 by Japan, and now known as the "Idzumi." This famous craft was the prototype of the modern, high-speed, protected cruiser, and as such she forms an admirable foil to set off the advance which has been made in the intervening years since she was launched. In view of the fact that the new cruisers, if they are ever built, will not be launched before the year 1901, the interval between the "Denver" and her prototype will amount to eighteen years. Let us see, then, from the following table, what advance has been made in that period, as judged by the proposed cruisers.

	"Esmeralda." 1883.	"Denver." 1901.
Displacement.....	2,950 tons	3,500 tons
Speed.....	18.3 knots	16.5 knots
Horse power.....	6,080	4,500
Coal supply.....	600 tons	700 tons
Officers and men ..	300	290
Main battery.....	Two 10-inch B. L. rifles, } Six 6 inch B. L. rifles }	Ten 5-inch rapid-fire guns
Protective deck.....	1-inch complete	*None
Torpedo tubes.....	3	None

*Strip of 2-inch armor for one-third of the length amidships.

The comparison is, to say the least, profoundly discouraging. Here we have a vessel 550 tons larger than her eighteen year old prototype, that has 2 knots less speed, over 1,500 less horse power, is less completely protected, mounts a less powerful battery and fewer men to fight it, and that carries not a single torpedo tube as against three in the smaller ship!

Nor can those who are responsible for foisting a whole fleet of inferior ships upon the country evade the force of this comparison by claiming that the "Esmeralda" was a "show-window vessel," built for the trade, and unable to stand the hard knocks of actual service; for after a dozen years in the Chilean navy, during which she went creditably through the Chili-Peru war, she was considered sufficiently valuable by Japan to be purchased and placed on the active list of their navy.

We are correct in stating that nine-tenths of the naval constructors are opposed to the proposed cruisers, just as they were opposed to the construction of the six composite gunboats of the "Annapolis" and "Princeton" class which, but for the accident of the Spanish and Philippine wars, would have been useless for the duties of the American navy. The public is asking why these six obsolete vessels were ever proposed, much less authorized. Perhaps the Congressional Committees on Naval Affairs, who are responsible for the fiasco, can explain.

A TIMELY REBUKE.

We note that in a recent issue The Practical Engineer, of London, administers a stinging and richly deserved rebuke to that section of the English press which has been giving vent to its mortification over the American invasion of British trade by a tirade of abuse and misrepresentation which would do credit to the columns of the ripest yellow journalism. Referring to the suggestions of inferior workmanship which have been made regarding the Atbara bridge, in the Soudan, our contemporary says: "It is deeply regrettable to notice the tone assumed by some of the London journals, whose observations upon the subject are not only in extremely bad taste, but are, furthermore, in many cases ridiculous, and only calculated to show the utter ignorance of the writers upon the subject which they are dealing with. Moreover, they are such as must inevitably bring contempt upon the engineering community of this country, by whom they cannot be too promptly or too strenuously repudiated."

The distinction between the technical and the non-technical press is well made, for the tone of the one has been as intelligent and just as that of the other has been ignorant and unfair. "Engineering," speaking through its accomplished editor, who, by the way, is almost as well known on this as on the other side of the Atlantic, has ever been marked by a generous appreciation of the rapid advance made by the United States in the engineering industries during the past two decades, and even "The Engineer" has, of late years, abandoned its ungenerous attitude and has warned its readers that Englishmen were being beaten by America in some of their most important lines of work.

The London daily press, with a few notable exceptions, has always been the nursery of all that is ultra jingoistic and pseudo-patriotic in Great Britain, and there is a danger lest its late hysterical outburst over the Egyptian bridge and the Midland locomotives should be mistaken by the American people for a true expression of the attitude of the mass of the English people or the journals that provide them with technical literature. As a matter of fact, the latter have proved to be thoroughly awake to the serious nature of American competition, and have shown a full appreciation both of the superiority of American methods and the faults of their own.

GOVERNMENT ADVERTISING IN FRANCE.

The national debt of France is constantly on the increase, and apparently they have at last decided to go into advertising as a means of making money. This method has already been used to a considerable extent by various municipalities which have sold the space on certain public buildings to advertisers as the panels of city railway cars are disposed of in the United States. Now, however, the railway stations, police stations, custom houses, barracks, and other public buildings which are entirely under the control of the government are to be used to some extent for advertising purposes. The value of this space for advertising purposes is greatly enhanced by legal restrictions on the owners of private property which prevents the sale of space for similar purposes. The government has also introduced another advertising enterprise, which is the "lettre annonces" or advertising postpaid letter sheet. Half a sheet of ordinary letter size paper of rather poor quality is devoted to advertising except a space reserved for the address and a 15 centimes postal frank is printed upon it. The letter is written on the other half of the sheet, which is ingeniously folded and held by a gummed flap. The whole affair is sold for 10 centimes, that is, two-thirds of the price of single letter postage or exactly the same as a postal card. The

purchasers therefore, saves one-third of the postage, and gets his paper-envelope and the privacy of his correspondence for nothing. The scheme is worked by a corporation which is practically a government enterprise. While the sale of the postal cards and postage stamps will probably be decreased by this means, the receipts from advertising will enable the government to make a substantial profit out of the project.

THE DEFECTIVE EYESIGHT OF SCHOOL CHILDREN.*

BY ARCHELAUS G. FIELD, M.D.

Defective eyesight among school children has been and still is a subject of much concern.

The abnormal condition largely in excess of all others as shown by statistical reports in general is myopia or short sightedness.

In his report of investigations of the subject more than thirty years ago, Cohn shows after examining the eyes of ten thousand school children that there were in the elementary departments about two per cent with defective vision from this cause; in the intermediate departments about eight per cent; in the high school fifteen per cent; and in the gymnasium twenty-six per cent. It will be noticed that these figures indicate an approximation to a regular ratio of increase from the lower to the higher grades. More recent statistics show an increase since that time of from twenty-five to fifty per cent in the higher German schools. While Germany leads the world in the intensity and persistence of school life, she also leads it in the percentage of myopics. Statistics show that the same conditions prevail in every other educational country in very near proportion to the devotion to school work. The causes assigned are first, "bad" light; second, bad air; third, inheritance; fourth, unnatural position; fifth, using the eyes during partial congestion of the blood vessels of the brain; sixth, general debility; seventh, using the eyes upon fine print or in too near proximity. These causes are all more or less amenable to remedies, and it is fair to assume that the suggestions have been adopted in the sanitary management of schools. If so, we are confronted at this stage of the inquiry by two propositions, first, that the importance of the subject has been fully appreciated, and second, that the prevalence of the defect has not decreased. Cohn placed as first in the list of causes "bad," meaning dim light, and the same prominence has been given to this cause by most writers and teachers down to the present time. He recommended the construction of school houses with one square foot of glass area to every two feet of floor space. Modern school houses are constructed with a view to flooding them with light. Such provisions should all be utilized on dark days. But the flood of light on bright days is responsible, associated as it is with near vision for the prevalence and increase of myopia. With the better provisions for lighting modern school houses the care and responsibility of properly regulating the light increases.

While collecting material for this paper the writer visited, and from measurements, estimated the proportion of glass area to floor space of more than forty school rooms. The variation in view of the fact that they were all constructed for the same purpose was very striking running all the way from 1 to 4, or 1 to 20. While the light in the latter is none too strong to be used by scholars in their ordinary work on dark days, and can be sufficiently shaded for bright days, the light of the former cannot be made sufficient for any but the brightest days.

It is doubtful if any human eye can be habitually employed in near vision on ordinary print in such strong light as is afforded by 1 to 4 or 1 to 6, without producing permanent and irreparable myopia. All of the rooms visited were provided with some sort of window shades or shutters, and there was some pretence at using them, but in the absence of any guide other than the sensations of the teacher the benefits were spasmodic and insufficient. This brings us to the single object of this paper, viz., the necessity for the most systematic and efficient regulation of light, and constructive provisions for lighting. Most rooms are lighted from windows on one side, or on one side and one end. No such room can be approximated to uniformity in lighting. The seats nearest the windows may have light equal to 1 to 2, while the distant seats may have light equal only to 1 to 15 or 1 to 20, and the respective scholars are placed at corresponding disadvantage. While much has been done to improve the architecture and convenience of modern school houses in some respects it is doubtful if many of them surpass in evenness of light, the old log school house of former times with two or three windows upon each of two opposite sides. The accommodative apparatus of the normal eye adapts its optical parts to a wide range of external conditions, but too long continued or overworked it becomes disabled. This is precisely what happens to produce most visual defects in the school room. Every one knows that when a double convex lens such as is the crystalline lens is focused upon a near

object, the back focus recedes. In other words, the change of one of the conjugate foci changes the other. On the same principle in near vision the image falls too far back for the posterior wall of the retina, and to secure sharp vision the distance between the lens and posterior wall of the retina must be increased. This is accomplished by the accommodative apparatus.

The contraction of the ciliary muscle increases the convexity of the lens to shorten its focal distance and at the same time moves it slightly forward, while the probability is that the two oblique muscles, grasping the eyeball upon either side and acting against each other, compress the eyeball laterally, thus elongating its antero-posterior diameter and increasing the distance between the lens and posterior wall of the retina. Whatever may be thought of this explanation, it cannot be denied that elongations of the eyeball is the pathological condition in uncomplicated myopia, and that such elongation must, of necessity, have resulted from the action of the accommodative apparatus.

Again, the stimulus of bright light contracts the iris, reducing the pupil, and shutting off the peripheral rays. The central rays, which are brought to a focus further away, become the visual rays, and again the image is formed too far back for the posterior wall of the retina. The action of the accommodative apparatus in securing sharp vision is precisely what it was in the case of near vision, and again the result is temporary myopia. This may also be demonstrated by the use of a large and then a small stop before the same double convex lens, the image falling further back as the size of the stop is reduced.

In school life we have these two causes acting singly and also conjointly to produce the myopic condition, and being continued too long, overcomes the natural elasticity and recuperative energy of the accommodative apparatus, resulting in chronic, permanent and incurable myopia.

The remedies are obvious:

1. Provision for uniformity of light and impartial seating of pupils, by placing windows on two opposite sides at least of the school room.

2. Every window, more especially those exposed to direct sunlight, should be provided with two shades of different density, both lowering or opening from the top of the window.

3. The maintenance, approximately, of a uniform standard of light, presumably that represented by one square foot of glass to twelve or fifteen of floor space on bright days.

Some attention would be required, but if the great army of myopics constantly emerging from the schools and colleges can be thereby reduced the trouble will be well rewarded.

THE BOERS AND THE GIRAFFE.

The Boers are credited with being great hunters, and chief of them in his younger days was President Kruger, whose daring in attacking a lion single-handed, with a hunting knife, as has many times been told. When the Boers migrated from Cape Colony to the Transvaal they were forced to clear the way by killing 6,000 lions, many of which were killed by Kruger. For years the South African Boers have been hunters, and their skill with the rifle is due to this daily practice in the fields and woods. But with them the killing of game has been either a matter of dollars and cents or self-protection.

Their creditable work of freeing South Africa of the dreaded lions, which roamed in such numbers that life was rendered unsafe anywhere in the country, is offset by their ruthless destruction of the giraffe from Cape Colony to the Botletli River. If they killed 6,000 lions in the Transvaal before existence was made safe, they may have killed 60,000 of the innocent, graceful giraffes. In the early days of South African history the giraffe was the most abundant game in the Transvaal, Matabeland, and Orange Free State, but the creature has been killed off like our American buffalo, and the few remaining representatives of a noble race gradually driven north. For years past the giraffe has been a profitable quarry for the Boer hunters, and the animal was valued by them only because the hides were articles of commercial use. They were pot-hunted, shot down in droves, and destroyed in the greatest number possible in every direction. The extinction of the animal in South Africa is now threatened, and its preservation by legislation comes when it is almost too late. In this respect, too, the brief history of the creature will resemble the story of our buffalo.

A good giraffe skin is worth from \$10 to \$20 in South Africa to-day, and much more in Europe. On their hunting trips ten and fifteen years ago it was a common matter for one hunter to kill forty and fifty of these graceful animals in one day. The reason for this is that the giraffe is the most innocent of animals, and easily hunted. They are absolutely defenceless, and there is hardly a case on record where a wounded giraffe turned upon the hunter. It is true they have great powers of speed, and they can dodge rapidly from tree to tree in the woods, but they offer such a fair mark that these tactics hardly ever save them. Not

until unusually frightened does the giraffe make its best speed, and then it is often too late, for the hunter is upon it. There is really no element of danger connected with this sport, and that makes it less exciting and attractive to a true sportsman. Under certain circumstances it is possible to be injured with the powerful legs of the giraffe, which are capable of kicking a blow that would kill a lion. This latter beast for this reason takes good care to attack the giraffe at unexpected moments.

It takes a good horse to run down a giraffe, and if the least advantage is permitted the wild creature the race is lost. Its peculiar gait is very ungraceful and deceptive, but it covers the ground with remarkable facility. In the open veldt the hunters always have the best of the race, but the giraffe when surprised makes instantly for the forest where tough vines and intermingling branches make travels difficult for the hunter. The bushes and thorns tear and lacerate the skin of the horses, but the tough skin of the giraffe is barely scratched. The creature will tear a path through the toughest and thickest jungle, and never suffer in the least.

This skin or hide of the animal is its chief article of value. No wonder that the bullets often fail to penetrate this skin, for it is from three-quarters to an inch thick, and as tough as it is thick. This skin when cured and tanned makes excellent leather for certain purposes. The Boers make riding whips and sandals out of the skins they do not send to Europe. The bones of the giraffe have also a commercial value. The leg bones are solid instead of hollow, and in Europe they are in great demand for manufacturing buttons and other bone articles. The tendons of the giraffe are so strong that they will sustain an enormous dead weight, which gives to them pecuniary value.

The extinction of the giraffe in South Africa is to be deplored, because the animal is peculiarly adapted to the wilderness of forest and veldt, where it feeds on the giraffe acacia that nature seems to have raised specially for it.

G. E. W.

VITRIFIED CLAYPIPE INSTEAD OF IRON FOR GAS MAINS.

The idea of using vitrified claypipe instead of iron was proposed to Irvin Butterworth by Henry L. Doherty, President of the Madison (Wisconsin) Gas and Electric Company. The former read a paper upon it at the Western Gas Association meeting at Milwaukee. The suitability of vitrified claypipe for gas mains is due to their cheapness, durability, strength, non-susceptibility to electrolytical action, slight susceptibility to changes of temperature, non-porosity, adaptability to the making of service connections by the use of special or small auxiliary distributing pipes of wrought iron. Vitrified claypipe should, of course, be selected and laid with the same care which is given to the laying of cast iron mains. The possibilities for the reduction of the construction accounts of gas companies by the use of vitrified claypipes instead of iron for gas mains seems too great and promising to be despised.

AMERICAN STEEL FOR A PRINCE'S PALACE.

The Imperial architect of the Japanese government has placed orders with the Chicago Steel Company for several thousand tons of structural iron and steel to be used in the construction of a palace for the Crown Prince of Japan at Tokio. The palace is to be 400x300 feet and three stories high, to be constructed specially with a view of withstanding earthquake shocks. The general plans includes, says The Railway Review, a system of bracing connecting all of the columns below the basement floor, the whole system to be imbedded in concrete. Under the roof on the line of the bottom chord there is to be another system of heavy bracing connecting all of the columns. The object of this unique structural design is to get a framework which will move as a whole in case it is disturbed by the force of an upheaval. There will be an open colonnade in front with heavy columns and a broad staircase up to the entrance. The exterior is to be built of Japanese granite.

A LONG PHOTOGRAPHIC TELESCOPE.

Last spring a plan was proposed at the Harvard College Observatory for the construction of a telescope of unusual length for photographing the stars and planets. Anonymous donors have now furnished the means by which this experiment may be tried. The plan will, therefore, take definite shape, and it is expected that a telescope having an aperture of 12 inches and a length of 100 feet or more will be ready for trial at Cambridge in a few weeks.

EDWARD C. PICKERING.

THE method of making sheet lead for tea packing in Formosa is most interesting. The lead is brought from Australia in pigs and after being melted is poured between two large tiles, the required degree of thickness for the sheet being obtained by pressure by the feet. The sheet is afterward trimmed to suitable sizes and shapes for soldering.

*Read at the Columbus meeting, 1899, of the American Association for the Advancement of Science.

AN IMPROVEMENT IN FRICTION CLUTCH-PULLEYS.

Our illustration represents an improved friction clutch pulley for belting, the invention of Thomas J. O'Brien, of Cairo, Ill., which has an equal friction pressure on both sides, and in which the strain of the belt is directly in the center. The pulley comprises two side pieces or webs loosely mounted on the shaft. To both webs a pulley-rim is rigidly secured. Between the webs and within the pulley-rim is a friction disk fastened rigidly on the shaft and formed with projections, V-shaped in cross-section as shown, which are adapted to engage similarly-formed recesses in two bearing-rings attached to the inner sides of the webs. The one bearing-ring is movable and is provided with projecting stems to which angle-levers are pivoted. These angle-levers are also pivotally connected with the webs through which the stems extend. Loosely

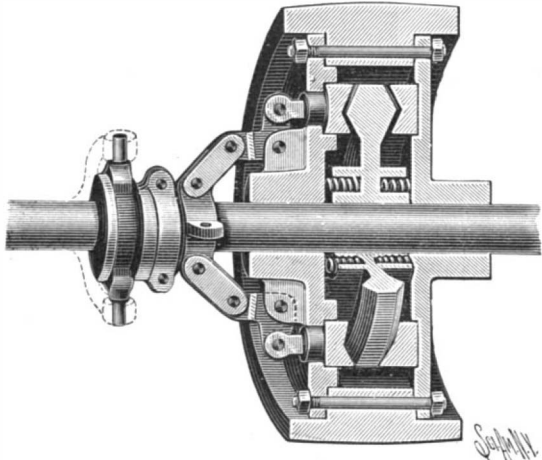

O'BRIEN'S FRICTION CLUTCH-PULLEY.

mounted on the shaft is a long sleeve, made in two sections for convenience, which sleeve is connected by links with the angle-levers. In a channel on the sleeve a shifting-ring is seated with which the ordinary shifting-lever is designed to engage.

When the parts are in the position shown in our illustration the centrally located friction disk will rotate with the shaft, while the pulley and sleeve, together with their connections, will remain stationary. In order to set the pulley in motion the shifting-lever is operated to move the sleeve toward the pulley, thereby rocking the angle-levers and forcing the bearing ring, to which the angle-levers are secured, into engagement with the friction disk. A slightly further movement of the sleeve will cause the pulley to be shifted so as to force the friction disk into engagement with the fixed bearing ring.

When the sleeve is moved in the opposite direction coiled springs seated in recesses formed in the hub of the friction disk will press the parts to their loose or stationary position.

A COMPACT HIGH SPEED ENGINE.

A simple form of engine which would occupy but little space and which, nevertheless, would develop considerable power, has long been sought by manufacturers of automobiles and launches; for the motors at present in use are not only very bulky and heavy, but are often too complex in construction to be readily controlled. We have recently had the opportunity of inspecting a small high speed engine, invented by a mechanical engineer, Mr. Gabriel P. B. Hoyt, of Jamaica, Borough of Queens, New York city, which will

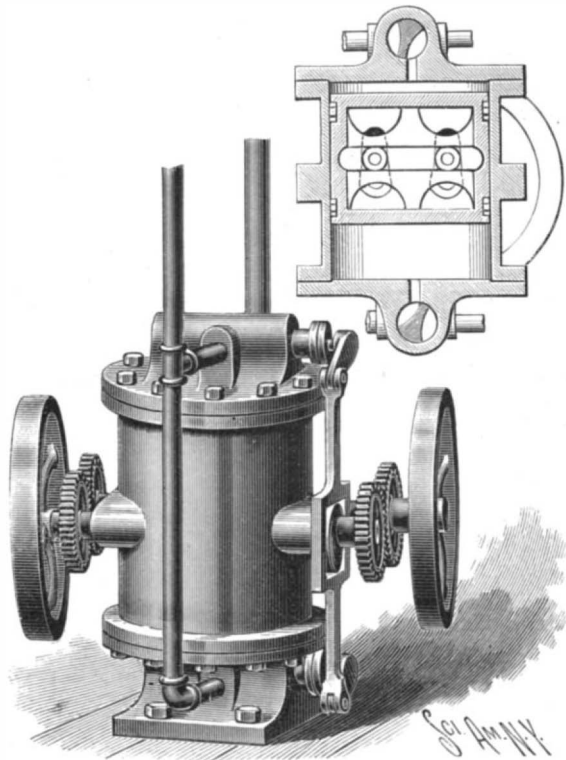

HOYT'S HIGH SPEED ENGINE.

probably find its broadest field of usefulness in automobiles and launches in which, as we have already remarked, high power engines of small size are of the utmost importance.

The engine in question comprises essentially a cylinder in which a reciprocating piston is mounted, provided with a slot into which the wrist pins of two crank-arms extend. The crank arms are carried by shafts, which at their extremities, are provided with gear wheels meshing with each other. When steam or any other motive agent is admitted to the ends of the cylinder a continuous rotary motion is given to the shafts by the action of the slotted piston on the crank-arms and wrist-pins. The two shafts being geared together, a uniform rotary motion is obtained without vibration, especially when the piston starts on the return stroke, as the two shafts rotate in opposite directions by reason of the connecting gearing. The piston is always perfectly balanced; for the oppositely turning wrist-pins are at all positions of the stroke at equal distances from the center of the piston. Any suitable valve-gear can be employed.

We have seen a double engine of this type, which although it occupied less than a cubic foot of space, developed 6 horse power at 600 revolutions. The engine was only a rough model, mounted on an old soap box and held in place merely by the steam pipe; nevertheless, despite the unstable foundation, the vibration was hardly perceptible either to the eye or touch.

By changing the construction of the valves the engine can be converted into a gas engine, in which form it will probably be especially serviceable in launches. The lack of vibration, the large power which is condensed within a small space, and the simplicity of construction in which the usual crossheads and guides have been dispensed with, are the chief points of interest in this new engine.

A BOILER WITH A REMOVABLE FIRE BOX.

The relining of the fire box of a boiler is a task which, besides necessitating the expenditure of much time and labor, is often accompanied by difficulties due to the construction of the furnace. It was with the object of facilitating the relining of fire boxes that the boiler-furnace we illustrate herewith, was invented by Mr. Charles W. Baird, of 495 Broadway, New York city—an object which has been attained by the employment of a removable skeleton frame with which the furnace parts are connected.

The skeleton frame in question slides on trucks in the sides of the fire box and is provided on each side with water-legs furnished with blow-offs and cross-connected in the rear by a pipe projecting up into the bottom of the boiler, far enough to prevent the passing of sediment or scale into the legs and to maintain the proper quantity of water in the legs. The water-legs add to the power of the boiler, since they also generate steam. Moreover, they take the place of the usual firebrick lining, which, in the ordinary construction of boilers, hard fired, is usually very short-lived.

Between the sides of the skeleton-frame, cross bars extend which, in conjunction with a dead-plate at the front of the frame serves to support the grate-bars. The door-front is carried by the arch and dead-plates. The arch-plate supports its own bricks but not those of the smokebox above and is completely protected by its firebrick lining so that it cannot readily burn out. A new plate can be substituted whenever necessary without disturbing the construction of the fixed parts of the furnace. When the supporting firebricks are burned the arch-plate is still held in position by metallic blocks mounted on the end portions of the dead-plate. The arch-plate is protected from the fire by a special form of brick which locks into the arch-plate and which can be renewed when burned out in a very short time. By reason of this protection the arch-plate is preserved so that it will at all times sustain the brickwork above it comprising the smokebox, etc.

The skeleton-frame with its water legs, when slid into position on its tracks, is jacked up firmly against the heading course of the upper brick lining and is held in place by wedges forced under the frame. When it is desired to reline the furnace the skeleton frame is raised at each end by jack screws; and the wedges are removed to allow the frame to sink on rollers placed on the tracks. The skeleton frame can then be pulled out, thus leaving the interior unobstructed for any necessary repairs.

The water-legs are protected at the hottest part by a lining of retort cement, which by experience has been found to be far superior to firebrick.

It is most difficult to obtain satisfactory and adequate translations of catalogues and price lists. There are many firms who profess to make technical translations, but their charges for the work are usually high and the manufacturer has no security that his work will be properly carried out and he has no means of gaging the literary style of the translations. The English press has recently agitated this subject and the last number of Feilden's Magazine has an editorial devoted to it.

A COMBINED WALKING AND SULKY PLOW.

A patent has been granted to James E. Phillips, of Dayton, Mich., for a plow which is designed to be used either as a walking or sulky plow, it being possible to employ as many horses as the hardness of the soil and the width of the furrow to be turned may require.

When used as a sulky, the plow is fitted with a skeleton axle having two series of apertures and adjustable spindles for the wheels. The pole enters the space between the top and bottom plates of the axle and is held in place by a pivot-pin passed through one of the apertures of the series. The pin is shifted from one aperture to another, to permit the working of two, three, or four horses. An equalizing bar is pivotally secured to the outer end of the pole at one end, its other end being slotted to receive a bolt passing through one of the second series of apertures in the

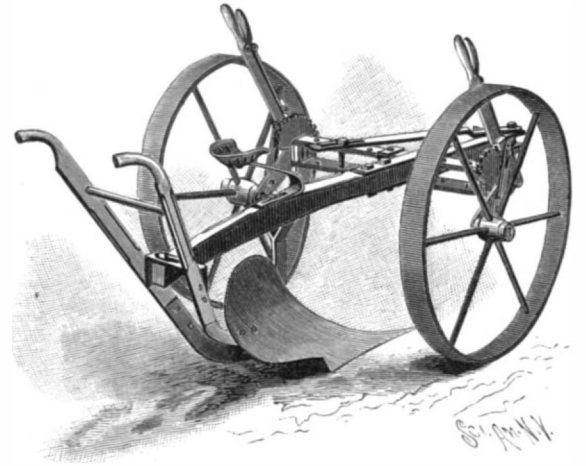

PHILLIPS' WALKING AND SULKY PLOW.

axle. The bolt can likewise be shifted to permit the employment of two or three horses. The axle can be raised or lowered by levers which can be adjusted to suit the driver without changing the depth of the furrow. The plow standard is vertically adjustable and carries a seat which can be shifted to balance the weight of the double-trees, so that the plow will not run too much on its point. The handles for the share are provided with a long, curved slot, with a set-screw passing through the heel of the plow beam and the curved slot. When working two horses the beam is carried to the left hand end of the slot and secured. When three horses are used, the beam is shifted to the center of the slot, and when four horses are employed, to the right hand end of the slot. When the sulky plow is to be converted into a walking plow the share and handles are removed. A longer beam is then attached to the plow standard, and handles and a suitable clevis provided.

The swing of the beam being limited by stops in turning corners, the plow can not turn over, for one wheel will roll back and the other forward.

The novel features of the invention are to be found in the ingenious means devised for equalizing the draft, rendering it possible to employ several horses.

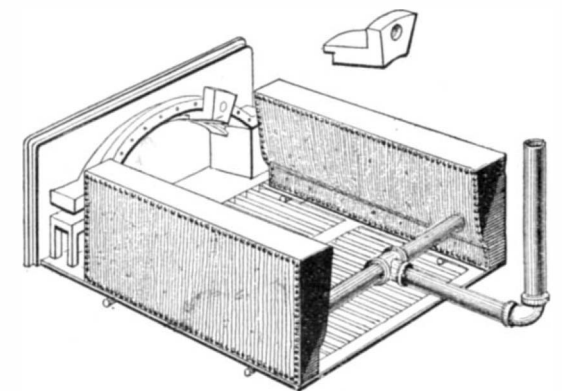

THE SKELETON-FRAME.

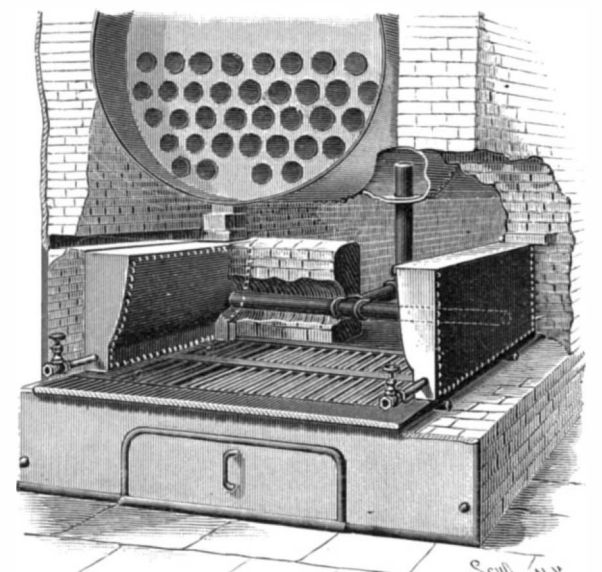

A BOILER WITH A REMOVABLE FIRE BOX.

THE PHILADELPHIA SUBWAY AND TUNNEL.

The engineering problems which have been met and solved in Philadelphia in the new Pennsylvania Avenue Subway and Tunnel are of peculiar interest at the present time, when the subject of rapid transit in New York and other cities is, awakening such widespread attention. These problems are also similar to those which will face the engineers of the East River and other tunnel projects which are contemplated.

The Philadelphia Subway and Tunnel which has been completed, abolishes seventeen dangerous grade crossings of the Philadelphia and Reading Railroad on the line of Pennsylvania Avenue in the heart of the city of Philadelphia and involves an expenditure of approximately \$6,000,000.

On December 26, 1890, the city of Philadelphia authorized the construction of the Philadelphia and Reading Terminal Railroad to Twelfth and Market Streets upon condition that at the points where its allied companies' tracks crossed Broad Street at Pennsylvania Avenue and near Lehigh Avenue, Broad Street should be raised about 21 feet so as to carry it by bridges over the tracks of the railroads. After the construction of the bridge and its approaches near Lehigh Avenue in the northern part of the city, it was clearly demonstrated that a similar raising of the grade of Broad Street at Pennsylvania Avenue, which is almost in the heart of the city, would not only seriously damage valuable property, but would

also ruin the city's finest avenue which is one of the notable streets of the world and which is used for all military and civic displays and there would still be left sixteen dangerous grade crossings unprovided for, so that other means of obviating the difficulty were sought for. The question of elevating the railroad tracks from Thirteenth Street to Thirtieth Street was considered. But as such construction would have entailed the crossing of the intersecting street by bridges which would probably have to be of the plate-girder type, and as many of the streets crossed were important highways, it was seriously objected to by the citizens of the southern part of the city. The bridge over Broad Street itself was vigorously opposed to in view of the fact that not only the tracks leading to the terminal, but also the connection to the Willow Street branch and the sidings to the freight house on the east side of Broad Street would have to be provided for. This would have resulted in a bridge 265 feet long, which would be objectionable. The engineers of the city of Philadelphia and of the Railroad Company, assisted by the late John A. Wilson as consulting engineer, had consultations which resulted in the preparation of plans and estimates for the depressing of the tracks by an open subway crossed by bridges and by a tunnel under Pennsylvania Avenue, thus abolishing at one stroke all grade crossings and at the same time providing adequate facilities for both freight and passenger traffic. The subway does not disfigure any of the streets which it crosses and the grades have been so arranged that the superstructure of the bridges are beneath the level of the streets so that they present an unbroken appearance. The tunnel itself is destined to work a great reformation in an entire section of the city which will result in an increased value to private property, and Pennsylvania Avenue itself will soon be a splendid driveway furnishing an appropriate entrance to Fairmount Park.

It is believed that the new system will result in a partial financial return to the city in increased taxes, on account of the increased valuation of the property. A reference to the map will give some idea of the enormous amount of work which was required. From Callowhill Street, between Eleventh and Twelfth Streets to Thirteenth and Noble Streets, extends an elevated structure 959 feet in length. The subway from Thirteenth Street to a point east of Twenty-second Street, is 4,180 feet in length. The tunnel has a length of 2,711 feet from the east side of Twenty-second Street to a point west of Twenty-sixth Street, where the tunnel ends. An open subway extends to the westward and is 2,150 feet long, terminating at Thirtieth Street. The total length of the work is, therefore, about two miles. Accompanying this depression and alteration of tracks, there was also an enormous amount of work in the alteration, construction and reconstruction of all the yard tracks, freight houses, engine depots and signal buildings and other structures, so as to pro-

vide as much accommodation and as full and convenient a method for operation and conducting business as then existed, adequate track connections to the various industrial establishments along the line of the Philadelphia and Reading Railroad had also to be provided, for the new subway passes by the Baldwin Locomotive Works and other great establishments which help make Philadelphia one of the greatest manufacturing cities in the world. The entire reconstruction of the sewage system between Twelfth and Thirtieth street traffic was reduced to a minimum. Fifty-five shafts were sunk at various points and tunnel headings were driven from them. Hoistings engines with derricks, generally driven by compressed air, were placed over each shaft to lift the excavated material. The tunnel headings were worked with rock-drills driven by compressed air. After the tunnel was begun it was found that Philadelphia had a considerably larger number of mains for water and gas, conduits for electricity and sewers than was known to exist at the different bureaus. They were all in active operation, and on many occasions offered serious menace and several times damage to the building of the new sewers. The work of constructing the outlets into the Schuylkill River at Powelton Avenue, as shown by the dotted line on our map, was most tedious, owing to the fact that the sewer had to be built on piles and platform through an old wharf, with the top of the platform below mean low water, requiring the use of a diver and making it necessary to work for a time at low tide only.

On Pennsylvania Avenue, between Green Street and Fairmount Avenue, the tunnel excavation was carried on beneath dwellings, of which a large number were occupied. Driving tunnels and constructing sewers beneath the streets in the heart of a great city, maintaining the flow in existing sewers and other municipal structures, requiring blasting, and the close proximity to industrial establishments containing delicate machinery, meeting with treacherous quicksands, fighting the tides—all these were circumstances which required the greatest diligence on the part of engineers of known ability in order to attain the desired end. One of our engravings shows one of the difficulties with which

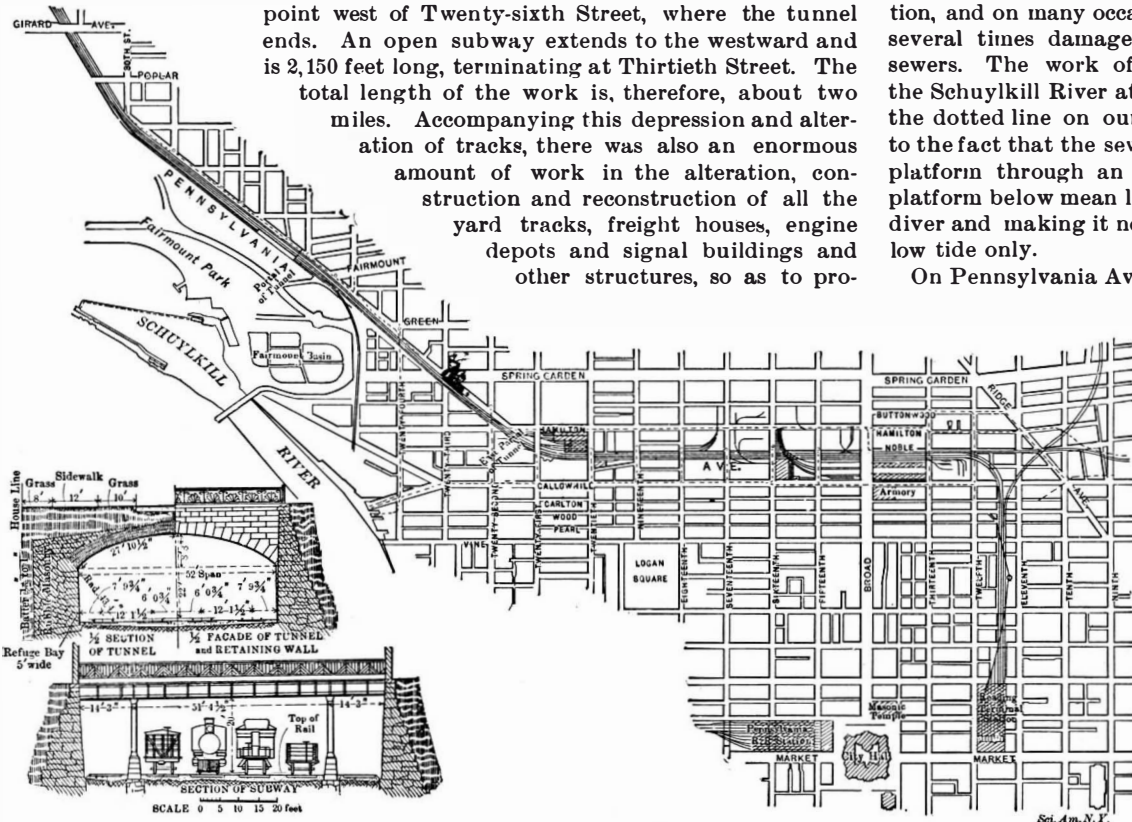

MAP OF THE PHILADELPHIA SUBWAY AND TUNNEL, WITH SECTIONS.

the engineers had to contend. This was the raising of a 48-inch water main which crossed Pennsylvania Avenue on the line of Fairmount Avenue, Green Street, and Twenty-fourth Street, and at such an elevation as to interfere with the arch of the tunnel. It was, therefore, necessary to reduce the diameters of the mains to allow them to cross. This was accomplished by dividing the 48-inch main into two 36-inch mains at Fairmount Avenue, while at Twenty-fourth Street and Green Street the diameter was reduced by means of a reducer-cone on either side of the throat, using the principle upon which the Venturimeter is based.

Another of our engravings shows the method used in building a temporary front for one of the Baldwin shops at Eighteenth Street. The old front was removed and after the retaining wall of the subway was built the new front was constructed with the wall for a foundation. At various other points similar work was carried on.

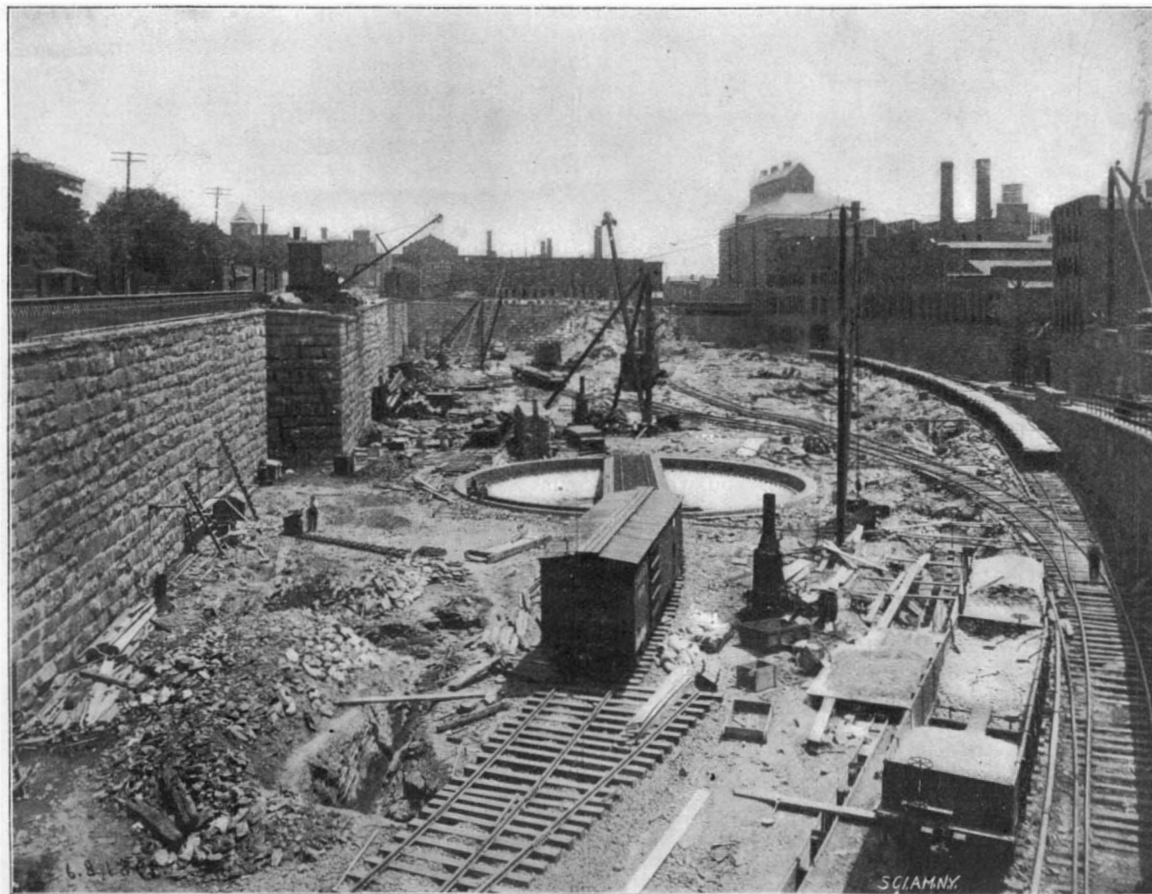

RAILROAD YARD AT TWENTIETH STREET DURING CONSTRUCTION.

We will now proceed to describe the subway and tunnel in detail. Our bird's-eye view of the subway and yard looking east from Sixteenth Street shows at the extreme right the tracks of the Philadelphia and Reading Railroad Company, which descend by a grade of 2½ feet per hundred into the depressed yard. The tracks cross Thirteenth Street at about the present grade, necessitating the lowering of that street so as to pass under the railroad. Between this street

and a point near Sixteenth Street, the entire space between the northern side of Callowhill Street and the north side of Pennsylvania Avenue has been excavated, forming an immense depressed yard. Broad Street and Fifteenth Street are carried over this yard on bridges, as shown in our engraving, Broad Street being the first bridge shown. The streets are carried over the subway on plate girder-decked bridges from Sixteenth to Twenty-second Streets, the tracks running on a comparatively flat grade to a subway whose width

Streets was necessary, and considerable alterations in the gas and water mains, and electric conduits were also required. Three independent systems of sewers having a total length of 3½ miles were necessary to drain the territory with its new conditions, so that entirely new sewers were constructed, as the then existing system was not deep enough for use. On account of the new sewers being in the heart of the great city, they were constructed in tunnel, so that the interference from

and a point near Sixteenth Street, the entire space between the northern side of Callowhill Street and the north side of Pennsylvania Avenue has been excavated, forming an immense depressed yard. Broad Street and Fifteenth Street are carried over this yard on bridges, as shown in our engraving, Broad Street being the first bridge shown. The streets are carried over the subway on plate girder-decked bridges from Sixteenth to Twenty-second Streets, the tracks running on a comparatively flat grade to a subway whose width

is about 80 feet, and having 20 feet clearance between the top of the rail and the bottom of the girders at the street crossing, as shown in our sectional plan of the subway. The side walls of the tunnel are vertical and are built of rubble masonry in the best manner. At Twentieth Street the subway opens out into a large yard which is triangular in shape, and is one of the most impressive pieces of work in the whole subway. It will contain the new engine house, freight houses, and repair shop. None of these are built at present. From a point east of Twenty-second Street a tunnel extends to a point near the entrance of the B. & O. R. R. tunnel west of Twenty-sixth Street. From this latter point to Thirtieth Street the tracks ascend with a 1.3 per cent grade to the original grade at Thirtieth Street. In order to carry on the work along the line of the Pennsylvania Avenue it was necessary to lay temporary tracks on Hamilton Street from a connection at Tenth Street with the Willow Street branch to the main line at Twenty-second Street, and from this point westward to shift the old tracks on Pennsylvania Avenue to the south side so as to admit of the construction of the northern wall of the tunnel, after which the temporary track was shifted to the extreme north side of the avenue and supported in part by the newly constructed wall. This, of course, allowed the south wall of the tunnel and the arches to be built. Railway facilities were maintained with business establishments by means of temporary tracks during the construction. After the completion of the temporary tracks, buildings on both sides of Pennsylvania Avenue were underpinned, and where the tracks ran down into the subway at Thirteenth Street it was necessary to lower this street about 13 feet in order to avoid the grade crossing. The work on the south side of Pennsylvania Avenue west of Fifteenth Street included heavy retaining walls. At one or two places along the line of the subway, sharp inclines will permit cars to ascend to the level of the street, and at one place, at least, there is an opening made from the subway into the present ground floor of buildings by means of a hydraulic lift.

It is a most interesting walk to descend to the subway by one of the inclines and walk through it. The workmanship has been of the best, and the subway and tunnel solve the problem of rapid communication through a city as far as Philadelphia is concerned. The tunnel itself consists of a segmental arch with 52 feet span and 8 feet 8 inches rise; the crown is 22 feet above the top of the rail and the arch radius is 43 feet 4 inches and it is designed for four tracks. The arch roof is of brick 3 feet thick at the crown and 4 feet thick at the springing line. Over the top of the tunnel and in the center of Pennsylvania Avenue are thirteen openings for ventilation. These are constructed of steel protected by a terra cotta covering. The visible openings in the street are 10 feet wide by 47 feet 10 inches long for twelve of the openings and 10 feet by 78 feet for one. These openings are surrounded by a rustic masonry wall 3 feet 8 inches in height, around which vines will be planted, and around this wall is a grass plat 6 feet wide, in which shrubs will be planted. An ornamental iron fence, protected by an 8-inch graphite curb, will surround the whole. In appearance Pennsylvania Avenue will soon resemble Park Avenue in New York, although it does not do so at present. There is no doubt that the tunnel will cause a vast improvement in the section of the city through which it runs, for the avenue itself is now 120 feet wide and the sidewalks 20 feet in width; the six feet nearest the curb are sodded and planted with selected trees. Between the main curbs, 80 feet apart, the street will be of asphalt, the distance between the main curb and the ventilating openings being 27 feet on each side of the street. At the western end Pennsylvania Avenue widens out into a plaza where the Washington monument is located. When the tracks are finally removed and the streets properly repaired, it will be a most advantageous means of access to Fairmount Park. There is an open subway east of the tunnel. When the original plans of the tunnel were prepared, an artificial system for ventilating was devised, but owing to the expense it was not carried out, and the tunnel is so admirably ventilated that it would hardly seem necessary to install such a system. The total weight of the bridges is 7,529,783 pounds and of the vent openings 1,710,000 pounds, making a total of 9,239,783 pounds, or about 4,600 tons. The work of constructing the subway and tunnel has been carried out under the direction of the Bureau of Surveys of the Department of Public Works, of which Mr. George S. Webster, M. Am. Soc. C.E., is chief engineer, and we are indebted to him for courtesies in the preparation of the present article.

A DOUBLE-TRACK drawbridge over the Chicago River was recently shifted bodily a distance of 83 feet. The method employed was to jack it up 26 inches from its central pier, thus allowing a cradle to be built underneath it. This cradle ran on ways which were lubricated with tallow and the weight of the bridge having been transferred to it the whole was hauled bodily to its new position. The weight was over 600 tons.

Correspondence.

The Eruptions of Mauna Loa and the Sunspot Period.

To the Editor of the SCIENTIFIC AMERICAN:

In your number of September 2 you furnish some very interesting details concerning the recent eruption of this celebrated volcano and give the dates of the known eruptions. Having lately read a paper (not yet published) before the Royal Irish Academy on the relations observable between the dates of volcanic eruptions and the sunspot period, and with reference to five volcanoes of Europe, I was greatly interested by learning the dates of the Mauna Loa eruptions as communicated in your article, and beg leave to submit the following details as representing the connection observable between the dates of the eruptions mentioned and the years of Maxima and Minima sunspot periods as known, the Maxima being marked + and the Minima-

Years of Eruption as mentioned.	Intervals in years.	Corresponding sunspot period years.	Differences.
1789		+1789	
1823	34	-1823.2	0.2
1824			
1825			
1840	17	-1837.2	2.8
1852	12		
1855	3	-1856.2	1.2
1859	4	+1860.2	1.2
1868	9	-1867.2	0.8
1881	13	-1879	2.0
1887	6	-1889.6	2.6
1890		(-1901 ?)	

It may be observed that the sunspot year's herein presented are for the most part years of Minima (there being in fact, but two years of Maxima). This would be quite in accordance with Kluge's theory as to the correspondence of years of marked volcanic activity with Minima sunspot years. It would be very interesting to treat in the same way the data ascertainable as regards the other American volcanoes and I have the certainty that the results would prove very interesting and help to the elucidation of the causes of volcanic activity in general.

J. P. O'REILLY,

Ex-professor Mining and Mineralogy, Royal College of Science, Dublin.
September 12, 1899.

The Twentieth Century Problem.

To the Editor of the SCIENTIFIC AMERICAN:

I have just noticed an article in your excellent paper under the caption of "Some Calendrical Facts About the Twentieth Century." In this article you make the statement that, "of course, the first century began with the year 1 and closed with the year 100." This seems a trite statement, and yet even in this there is room for cavil. Some of those who have been discussing the question on this coast are prone to get mixed up on just what they mean. A child is not one year old until it has passed the last day of the twelve month since its birth, and yet it was in its first year during the whole of the time up until it can be said to be a year old. The fact of its being one year old, or being in its first year, are two entirely different things. But the mistake of confounding these two ideas is what makes the difficulty in the minds of many in the application of the same principle to the counting time when we have to deal with centuries. A century is not one year, old, if you will allow that expression, until the first year is passed; so likewise the hundredth year is not so denominated until it has also passed. When we write dates we write the time that has passed, counting from the supposed birth of Christ up to and including the day which is then in progress. For instance, when we write the present date we say that 1899 years have passed away, and that we are in the 9th month and the 26th day of that month, which month and day belong to the 1900th year. Or, in other words, we are now in the 1900th year; and the 1900th year will close on December 31, 1899. We do not begin to write our date (which refers to time passed) as 1900 until after the real year is passed.

As soon as we have passed into the 1901st year, we begin to write our date as 1900, and so many months and days. But the month and days belong to the new year. Hence, we can but conclude that we are now in the 1900th year, and that the year closes the century. If this be true then the 20th century will begin on January 1, 1900.

Will you please let me know whether I have your idea or not, and, if not whether my reasoning is correct? I would like to have this subject set clearly before your readers, for, although it is of minor importance, yet it is a question which puzzles many of them.

E. H. VAN PATTEN.

Dayton, Washington, September 26, 1899.

[The first century began on Jan. 1 of the year one.

January 1st of the year 100 was still of the first century, otherwise that century would only have continued ninety-nine years. The second century began on January 1st of the year 101.

The same custom holds true with reference to numbering years that is in vogue with reference to naming months and numbering the days of a month. We name a month or number a month as soon as we enter upon it, and it retains that name or number during its entire term, so the moment we enter upon a new year, the year is identified with its own number in the series of years, which number it retains to the close of the year. Hence the date referred to is not the 26th day of the 9th month of the 1900th year, but the 26th day of the 9th month of the 1899th year. Putting it otherwise, we may say that the length of time from the beginning of the Christian era to the close of September 26, 1899, was 1898 years 8 months 26 days. It is evident, therefore, that the length of time from the beginning of the Christian era to the close of December 31, 1900, is just 1900 years, which completes the 19th century, this century having been so called ever since the first moment of January 1, 1801. The moment we enter upon January 1, 1901, we begin the 1901st year, which is the first year of the 20th century. That we really begin to write the number of a year as soon as that year has begun, and not after it has passed, as our correspondent maintains, is a matter not to be settled by logic, of course. It is a simple matter of fact, universally recognized by historians and astronomers, such having been the custom from the beginning of the Christian epoch, and even in earlier times in other epochs. Whether we write "September, 26, 1899," or "9-26, 1899," we have simply an abbreviated form of writing in full "the 26th day of September in the year of our Lord 1899."—Ed.]

Automobile News.

In Germany trials are being made with ambulance carriages provided with 5 horse power petroleum engine, with sufficient fuel to run for fifteen hours. The engine drives a dynamo, and a powerful projector is also furnished.

An automobile party to make a journey to the Mammoth Cave, of Kentucky, is being organized. The party will be made up of eight persons, traveling in two automobiles, while a third will carry the baggage of the party. The start will be made about October 15.

One great reason for the popularity of the automobile is that it can be more readily managed by women than horse-drawn vehicles. Many women object to driving horses on account of their liability to shy or bolt. The automobile offers marked advantages in this respect, but no lady should try running an automobile until she thoroughly understands the mechanism.

The Mechanical Science Section of the British Association is in favor of an amendment of the laws regulating the use of motor wagons on the highways. At present all motor cars in England are limited to three tons weight unloaded. It is now found that the economical load is from 8 to 10 tons, and to carry this it is considered desirable to be allowed a heavier weight when unloaded than 3 tons. Of course some light metal can be used in the construction of motor carriages, but it is not considered desirable in heavy wagons. It is believed that the whole matter will be brought up before Parliament during the next session.

Dr. Lehweß proposes to undertake an automobile trip from Pekin to London, or a distance of 8,000 miles, the greater portion of which is through a practically unknown country. A special carriage, built to order for the extraordinarily severe work, is being made by a Paris firm. The car has a carrying capacity of fuel and water sufficient to propel the car 300 to 400 miles. The start will be made about the end of February or March. The car will be run through Brindisi and from there it will be taken by water to the East. The doctor's companions will be two mechanics. There is no question that this is a serious attempt which is being made. The automobile industry has always suffered from races, excursions, etc., which are not properly planned or which are beyond the limits of present construction. We are afraid that the present instance will be no exception to the general rule.

German Amber Production Acquired by the State.

By virtue of the law of May 1, A. C., the entire amber production of East Prussia has passed into the hands of the government. Paragraph 1 of the law reads: "The Imperial government is empowered to apply the sum of M. 9,750,000 (\$2,450,000) to the purchase of the real estate situated in the districts of Fischhausen and Memel and in the city of Königsberg i. p., belonging to the firm of Stantien & Becker or Privy Councilor Becker of Königsberg i. p., as well as the entire business and establishment carried on under the said firm in Germany for the production and working up of amber and trade in raw amber, ambroid, melted amber (colophony) and by-products.—*Farben Zeitung.*

Science Notes.

The chalk plate process is being used with satisfaction in the various monthly reports of the Climate and Crop Service.

On October 6, a statue of John Ericsson was unveiled in the presence of an enormous crowd at Gothenburg, Sweden. Nearly 40,000 school children with banners marched by the statue which was modeled by the Swedish sculptor Fahlstadt.

Work has begun on the renovation of the façade of the Cathedral of Milan. An attempt will be made to remove some of the inconsistencies of style due to the fact that four centuries were taken in the completion of the cathedral. The plan adopted is that of Guiseppe Brentano, who won the prize over 120 competitors.

The American Horological Society held its second annual watch and clock trade exhibit in Chicago. The exhibit opened on October 2, and closed October 14. The exhibit include watches and clocks, tools, and novelties of all kinds. The process of diamond-cutting, lens grinding, electro-plating, engraving, etc., was shown.

Nine columns of the hypostyle hall of the Temple of El-Karnak, at Thebes have fallen. The Temple of El-Karnak is one of the most magnificent temples of ancient architecture in the world. The hall measures 170 x 329 feet. The stone roof was originally supported by 134 columns, the tallest of which were nearly 70 feet high and 12 feet in diameter. It was built by Setee I. of the nineteenth Egyptian dynasty.

Prof. R. T. Hill, of Washington, accompanied by a party of five men, has started on a perilous voyage down the Grand Canyon of the Rio Grande. They left Presidio October 7. They will not be able to get out of the canyon until Del Rio, about 200 miles below their starting point, is reached. The Mexican guide who is with the party made a trip through the canyon a few years ago, and he is the only person known to have made the dangerous voyage. Recently there have been severe rains in this region which has caused a large flow of water in the river so that it is thought there will be little difficulty in making the trip in boats.

The Society for Checking Abuses of Public Advertising, or "Scapa" as it is usually called in England, is having considerable success. The Building Act Committee of London County Council have recommended the prohibition of offensive signs, and in many places the Society has obtained the concessions it desired. The Northeastern Railway Company has commenced to remove some advertisements which were considered unsatisfactory. The Society has awakened considerable interest in foreign countries. Notwithstanding the value of the work the Society is doing its work with an expenditure of less than \$500 per annum.

The Export Exposition at Philadelphia is gradually getting in shape. The cool days and the 50-cent rate of admission make the esplanade and exhibition aisles look dreary until 6 o'clock. A large proportion of the exhibitors are not found at their spaces until the evening. Many of the exhibitors of moving machinery defer their exhibitions until the evening. It is said that the management is considering the feasibility of continuing the exposition until November 30. Work has begun on a covered passageway to connect the main building with the Agricultural Building. Only a few exhibitors are still behind with their exhibits.

The Treasury Department will shortly put into operation a new plan for refining at the mints, which will save the government \$60,000 or \$70,000 a year. It is always necessary to mix a certain amount of silver with gold in refining it, and the mints have been in the habit of using their own silver over and over again, gaining nothing by it either in profit nor in the quality of the work done. The government is authorized by law to do refining for individual customers as well as for its own coinage, provided that the charges do not exceed the actual cost of the work. The present scale of charges for refining silver is probably twenty years old, and the Treasury now intends to lower its charges so as to attract silver held by private parties and thus get what it needs for its gold refining with compensation thrown in.

It may not be generally known that the by products of fruit stones are of considerable value. The pits of peaches, apricots, nectarines, plums and prunes which have heretofore been thrown away or used for fuel have a market value. This is specially true of the peach and apricot pits. There is now a strong demand for them at \$8 to \$10 a ton, delivered in San Francisco. The kernel is of course what is sought. From the kernel of the apricot Turkish "nut candy" is made which has almost displaced the almond. The same substance is used for the adulteration of cinnamon, allspice and nutmeg. Prussic acid, and essence and oil of almonds are made from the peach and prune pits and these flavors are used in many ways. The pits are cracked in San Francisco and the kernels are then sent East.

Engineering Notes.

A bicycle geared to 240 will be sent to the Paris Exposition. The front sprocket contains 60 teeth and the rear sprocket 17 teeth.

At the southern entrance to the Suez Canal, at Port Tewfik, there is an oil installation. The oil is stored in vast quantities in tanks for use either by ships or in houses. The tanks each have a capacity of 4,000 tons of liquid fuel for such steamers as may be fitted to burn it. Special trucks are provided for sending oil by rail and the wants of the neighborhood are supplied by small oil tanks.

The new air power cars in use on the Twenty-eighth and Twenty-ninth Street lines, New York City, are doing excellent service and the noise of the exhaust air is not disagreeable, but it leaves a filthy trail of mingled grease, graphite and moisture on the roadway close to the tracks, which is unpleasant in appearance and in odor. It ought to be a comparatively simple matter to remedy this by putting in proper drip pans.

The St. Lawrence canals will attract a great deal of trade when they are completed. The capacity of the canals now nearing completion will at first be about 3,000,000 tons a year in one direction, but by degrees as ships are built more to the requirements of the trade, the capacity may be doubled and when the power of the Falls for lighting purposes is fully used and the canal system comes under government control 12,000,000 tons each way may be handled.

A shaft which has just been completed by the Bethlehem Steel Company for the Boston Elevated Railway, is 27 feet 10 inches long, and the diameter of the fly-wheel fit is 37 inches; the diameter of journals, 34 inches; the diameter of the crank disk fit 32 inches. The shaft is hollow, the axis hole being 17½ inches in diameter. The weight is 65,410 pounds. The shaft is of fluid compressed nickel steel hydraulically-forged on a mandrel, oil tempered and annealed.

A natural soap mine and a paint mine were two of the latest curiosities which have been discovered in British Columbia. Several soda lakes have been found in the foothills near Ashcroft, British Columbia. According to Feilden's Magazine their bottoms and shores are encrusted with a natural washing compound containing borax and soda. It is quite equal to the washing powders in common use for cleansing purposes. About 275 tons of the compound have been cut and taken out of one lake. It is handled exactly the same as ice. One lake alone contains 20,000 tons.

The manager of the Chicago Electric Traction Company has devised a new transfer ticket which is believed to be quite original and which is illustrated in the "Street Railway Review." The ticket in many respects does not differ from those already in use. The date of the month and the hour of the day is indicated by punching out the proper figures in the top or margin in the usual manner. For indicating the destination a diagrammatic sketch of the company's lines is placed in the lower part of the ticket, and it is only necessary for the conductor to punch the proper point on this miniature map.

At St. Johns, New Brunswick, the use of lead for making joints in a 24-inch water main has been superseded by wood. This practice was decided on in view of the satisfaction given by wooden joints in a 12-inch main laid in 1851 and a 24-inch main laid in 1857. The plugs are made from pine staves free from knots and gum. The staves are driven home and tightly wedged. The joints are tested by filling the pipe with water before covering it. Where for some reason the pipe had to be covered before it could be tested or the joints were too open or too close to permit the use of wooden plugs, lead joints have been substituted.

Secretary of War Elihu Root has issued an order calling the attention to a formal order dated August 24, 1897, which prohibits persons from visiting the fortifications of the United States. The Secretary declares that the formal order has frequently been disregarded and he directs a rigid enforcement of its provisions hereafter. The immediate cause of the order is said to be that a military attaché of one of the foreign governments recently visited the military posts at the mouth of the Columbia River. No one can question the justice of the order as in no country can foreigners inspect modern fortifications, and in most countries they are entirely closed to all.

The Holland submarine torpedo boat made another excellent run on October 6, in Little Peconic Bay, in a heavy snow storm with head winds and against the tide. It caused the sea to run so high that it was impossible at times to see the vessel from the deck of the steam yacht "Josephine" from which guests witnessed the run. A German naval constructor who is visiting the United States to inspect shipbuilding plants, and to investigate the naval methods in vogue in this country, was on board the submarine boat. He was favorably impressed with the mechanism of the vessel and was pleased with her performance. He was of the opinion that in the hands of competent men the boat would prove a formidable weapon.

Electrical Notes.

A long distance telephone line has been opened between Chicago and Dallas, Texas. The tests have been very satisfactory.

In the harbor at Honolulu, telephone service between vessels and the shore may be obtained by connecting with the permanent telephone cable in the harbor.

In the Tesla interrupter, the interruptions are obtained by a stream of mercury impinging upon a rotating disk having projecting teeth. The interruptions take place in a gas under pressure, thus permitting a much higher frequency than would otherwise be possible.

Work on the Northwestern Elevated Railroad in Chicago is progressing favorably. Nearly six of the seven miles of road is now completed. The traveling crane used in hoisting the structure into place has been worked to its full capacity, erecting on an average of eight spans or about 250 linear feet per day.

Notwithstanding the recent destruction by fire of all the buildings of the exposition at Como, Italy, the ceremonies to commemorate the centenary of the discovery of the voltaic pile were held at Como, September 18 to 23. Remarkable energy was exhibited in the rebuilding of the burned structure and the gathering of new exhibits.

Twenty-three miles of aluminum cable will be used to transmit 2,000 horse power at a pressure of 10,000 volts from Tariffville to Hartford, Conn. The cable is three-fourths of an inch in diameter and consists of seven strands, each made of seven wires of No. 11 Brown & Sharp gage. At the present price of copper, the saving to be made by using aluminum will amount to \$3,500.

The Batignolles Railway tunnel near Paris is to be lighted by lines of 10 candle power incandescent lamps. They are placed a meter apart and they are the same height as the carriage windows so that if any train is stopped in the tunnel it will be lighted from the outside. Another interesting feature is that the lamps are automatically lighted and extinguished by the passage of a train, which operates switches automatically by means of the rims of the wheels.

Three electric fountains have been started at the Crystal Palace, near London, and they are drawing large crowds. Electric fountains have been known for many years in both France and the United States, but we believe that this is the first time they have been shown in London. The fountains were designed and erected by F. E. Darlington, of Philadelphia, who has had considerable experience in building such fountains. The power is supplied by two vertical triplex power pumps built by the Goulds Manufacturing Company.

The New York and New Jersey Telephone Company during the recent visit of the "Olympia" installed a set of long distance telephone apparatus on that vessel. Two copper sheathed cables were laid between the war vessel and the main land at Tompkinsville, S. I. The cable was laid after dark with the aid of the search lights of the fleet. It is thought that this is the first time in America at least, that a warship has been connected by cable with the shore in this way. A good deal of business was transacted over the telephone while the vessel remained at anchor off Tompkinsville.

The Eastern Railway Company, of France, is using what might be called a central station on wheels for repairing the Torcenay tunnel. It is mounted on a railway truck and includes a petroleum engine which serves to drive a dynamo which furnishes current for propelling the truck by means of a motor and for lighting the works in the tunnel. The dynamo furnishes sufficient current for propelling the truck by means of a motor and for lighting the works in the tunnel. The dynamo furnishes sufficient current to drive 4 to 6 arc lamps or 30 or 40 incandescent lights. It has also been found of great service for night work and for use on other tunnels.

The Paris Exposition administration has taken all the measures possible to offer security to exhibitors and visitors against fire. The rules which are laid down in great detail are admirable, and they deal with stairways, doors, emergency doors, etc. An emergency light system for night use will consist of electric lamps of one candle power bearing a distinctive red color. All wood of the framework in the building will be covered with an insulating coat of non-inflammable material, and all stairways will be fireproof. Great attention is to be paid to the floors of all the exhibition buildings, cafés, etc., and before being accepted will be tested at the expense of the directors. All decorated canvas, awnings, and canvas coverings must be fireproof. All motive power other than electricity will be admitted only under rigid conditions. The regulations for heating and lighting provide that it can only be done by gas or electricity. The use of any form of hydrocarbons, acetylene, or other gases, than coal gas, is positively forbidden. All theaters, concert halls, etc., must have iron or asbestos curtains, and the lighting of such places will be exclusively by electricity.

PRELIMINARY SKIRMISHING BETWEEN "SHAMROCK" AND "COLUMBIA."

In the late eighties there sailed from Fairlie, Scotland, bound for America, a saucy little deep-keel cutter, yclept the "Minerva," which was designed to afford more genuine yachting excitement and right royal sport than any craft of her type and nationality before or since. She was a cutter pure and simple, with certain individualities, somewhat novel then, but familiar the world over now, which entitled her to be known as "a Fife boat." American yachtsmen of that day were having no end of fun with sloops of the 40-foot class, and a whole fleet of these vessels, most of them centerboards and all of them "fliers," was on hand to try their paces against the newcomer. "Minerva," under the skillful handling of Charlie Barr, the present skipper of "Columbia," set out to show the way around the course in her very first race, and she repeated the performance consistently throughout two whole yachting seasons; boat after boat was built for the avowed purpose of "downing" the doughty little champion, and it was only after her two seasons of sweeping victories that Burgess, of "Puritan" and "Volunteer" fame, succeeded in the effort.

"Minerva" established the fame of William Fife, Jr., with American yachtsmen; and when it was learned that the new champion for the "America" cup was to come from the board of this talented designer, the knowing ones thought upon "Minerva," and predicted that matters would be decidedly interesting off Sandy Hook in the early days of October, 1899.

They are. In the three incompleting races that have been sailed, "Shamrock" has so far fulfilled the predictions of Mr. Iselin that she would be dangerous in light weather, as to lead a high authority who was intimately concerned in the construction of "Columbia," to say that any race that was sailed in over four hours' time was likely to be won by "Shamrock." The same person is authority for the statement that in a wind of sufficient strength to enable the course to be covered in less than four hours, "Columbia" would win.

So we were all wrong it seems; not even excluding the owners, managers, and skippers of the "Shamrock," and our own "yachting sharps," who noted the easy way in which "Defender" held the 1899 champion when there was any weight in the wind. It was to be "Columbia" in light weather and "Shamrock" in a blow. Now it seems we have to turn our ideas quite upside down and petition for those blustering winds that were to have wafted the green boat to victory.

For our own part we have to confess that after watching the three attempted races with the closest attention we fail to see that the contest is settled be-

fore it is begun. The only point of sailing on which "Shamrock" has established a decided superiority is in going to windward. On this point of sailing she is certainly superb, at least in the light winds that have prevailed. In running she is no faster than "Columbia"; and whenever the two boats have been on a reach in the same weight of wind, "Columbia" has more than held her own. Of course, we are aware that on a windward and leeward course it is the windward work that wins the race. But five times out of six, the extraordinarily fickle winds off Sandy Hook have a way of shifting so as to make the course a reach both ways. On a triangular course "Columbia's" fine reaching qualities should bring her home with a slight margin to spare.

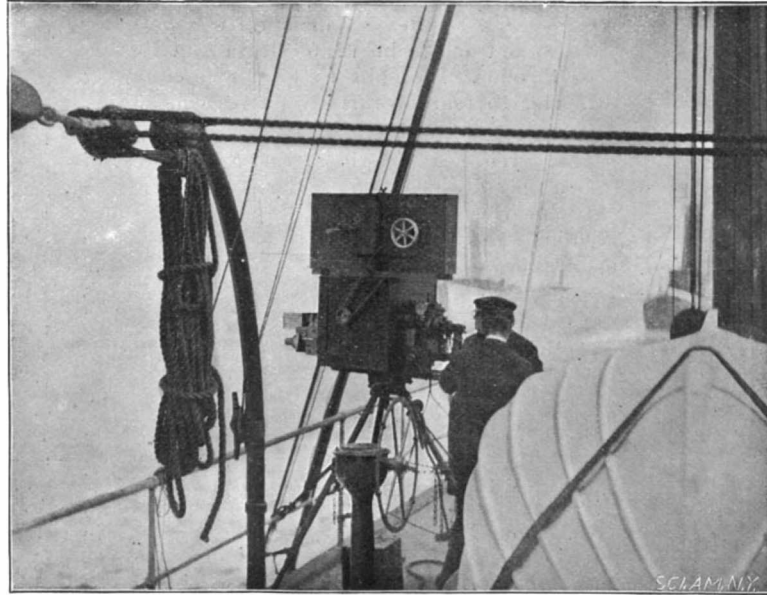

THE BIOGRAPH CAMERA SET UP ON THE COMMITTEE BOAT "LUCKENBACH."

With all due deference to the popular impression that "Shamrock" is most dangerous in light weather, we feel bound to record our conviction, formed after a study of both boats in the dry dock, and of their recorded performances in tuning-up trials, that "Shamrock" will prove to be most dangerous in good, whole-sail breezes. She has logged 30 miles in a 16-knot wind, at the rate of 13 knots an hour; 15 miles out being sailed on a broad reach and the return journey on a close reach. She has also worked dead to windward at the rate of $7\frac{1}{4}$ knots an hour, to do which she must have been making over $11\frac{1}{2}$ knots close hauled. These timings were made and carefully checked by yachting experts on the press tugboat in the preliminary trials. "Columbia" may have made similar or even better speeds than these; but if so, they have never been recorded or made public.

The accompanying illustrations, representing the third

attempted race, were taken by the American Mutoscope and Biograph Company on board the committee boat "Luckenbach" of the New York Yacht Club. In view of the possibility of a foul when the yachts approach each other in their manœuvres, the committee determined to be prepared to take moving pictures which would accurately portray the relative positions of the yachts for periods of times extending to as much as twenty minutes. The records so made were to be considered as absolutely official, and put in as evidence, should any dispute arise. Accordingly a biograph camera was set up on the deck of the "Luckenbach," as shown in the accompanying illustration. In the first three pictures the imaginary starting line is drawn from the committee boat on which the photographs were taken to the Sandy Hook lightship. The yachts are sailing away from the committee boat and parallel with the line. At the gun "Columbia" squares away, setting her balloon jib-topsail, while "Shamrock" luffs up to get to windward. About half way to the outer mark, fifteen miles away, "Shamrock" forged ahead, gaining a lead of about a third of a mile; but shortly before reaching the mark "Columbia" drew up and was lapping the stern of "Shamrock" as they rounded the stake.

Our thanks are due to the American Mutoscope and Biograph Company for the opportunity to present these interesting and unique photographs to our readers.

The Reproduction of Pompeii.

The amusement side of the Paris Exposition will certainly not be neglected, and the scheme of Chevalier Pesce to reproduce the life of Pompeii is rapidly coming into concrete form. The project has been under consideration for some time, and in a few months the visitor to Paris will behold once more the vanished city, which the excavation, of recent times have brought to life.

The life of the Forum, the camp, the gladiators, the Temple of Isis, the theater bordering on the Forum, the numerous shops and public baths, and all those houses, squares and open spaces in which were formerly concentrated the life, activity, the pleasures and the celebrations of public spectacles which made this watering place by the Mediterranean one of the most attractive spots in the Italian peninsula will be rendered very real. Numerous actors in costumes archæologically accurate will give to the city its former animation.

BRIGADIER-GENERAL A. W. GREELY who is Honorary Vice-President of the International Geographical Congress, by special permission of the Emperor was allowed to ascend in a military kite balloon at Potsdam. This balloon was the invention of Percival Siegfeld. General Greely has purchased a similar balloon for the use of the United States government.

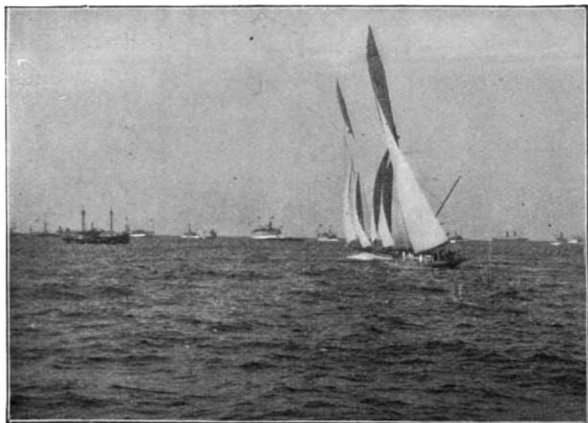

1.—Manœuvring for the start from the Sandy Hook lightship.

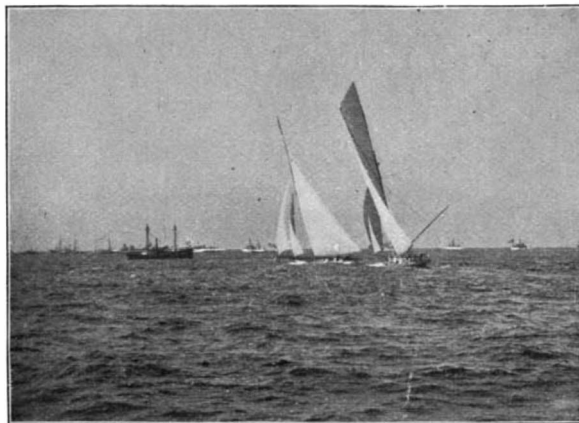

2.—Nearing the line; "Columbia" ahead, "Shamrock" lowering her spinnaker pole to starboard.

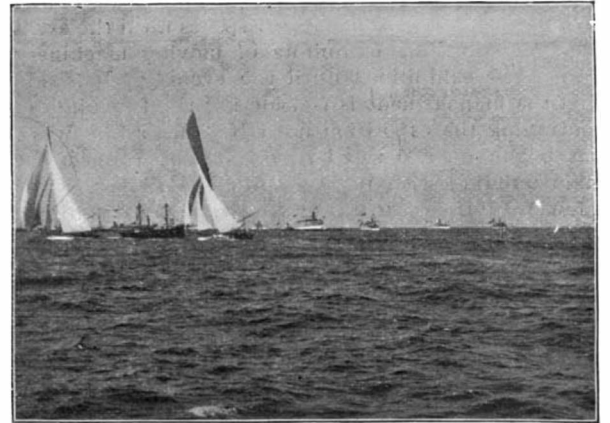

3.—Crossing the line; "Columbia" 17 seconds in the lead sets balloon jib-topsail, and "Shamrock" luffs up into the weather position.

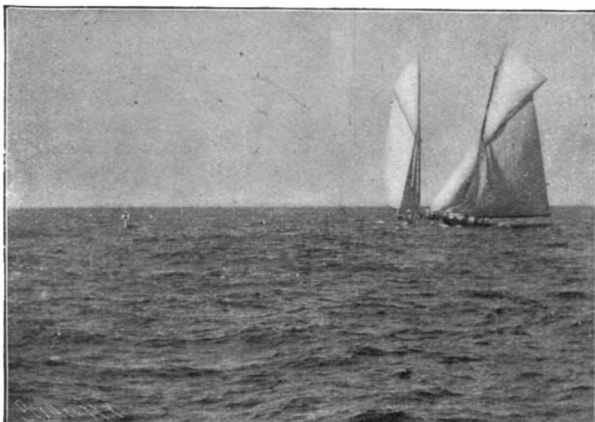

4.—Nearing the outer mark; "Shamrock" in the lead with boom to port, "Columbia" overhauling her, with boom to starboard.

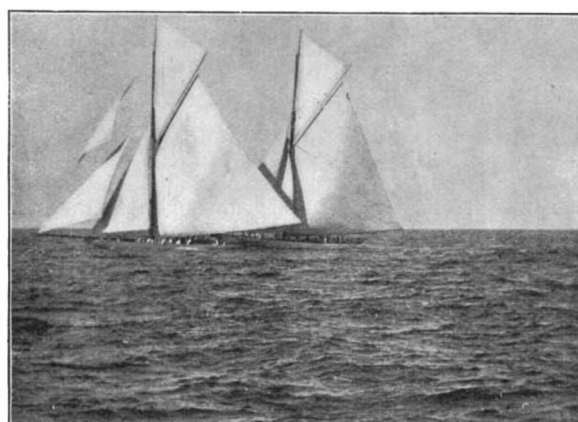

5.—Rounding the mark, "Shamrock" 9 seconds in the lead. "Columbia" establishes an overlap and rounds between "Shamrock" and the stake.

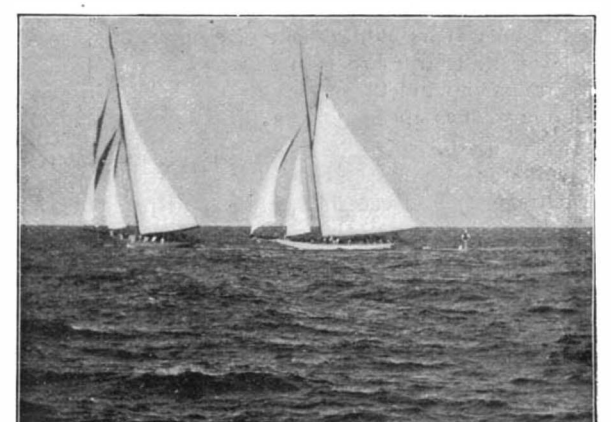

6.—The stake rounded and the yachts close-hauled on the starboard tack.

OFFICIAL BIOGRAPH PICTURES OF THE YACHT RACE, TAKEN FROM THE COMMITTEE BOAT.

BOATS AND SAILS.

BY WALTER BURNHAM.
SAILS.

Supposing four playing cards be stood vertically in a row, with their edges touching, and the area thus made be regarded as a sail, as represented in Fig. 1. The wind which would pass through a line equivalent to the right hand edge of the fourth card and the left hand edge of the first card (that is the after-leech of a sail and the mast) may be regarded as a column of wind divided into four parts, *A, B, C, D*, moving in the direction shown by the arrow.

In Fig. 2, *A* is the column of air which strikes on the first card and is turned or deflected by the first card and passes aft over the three remaining cards. This

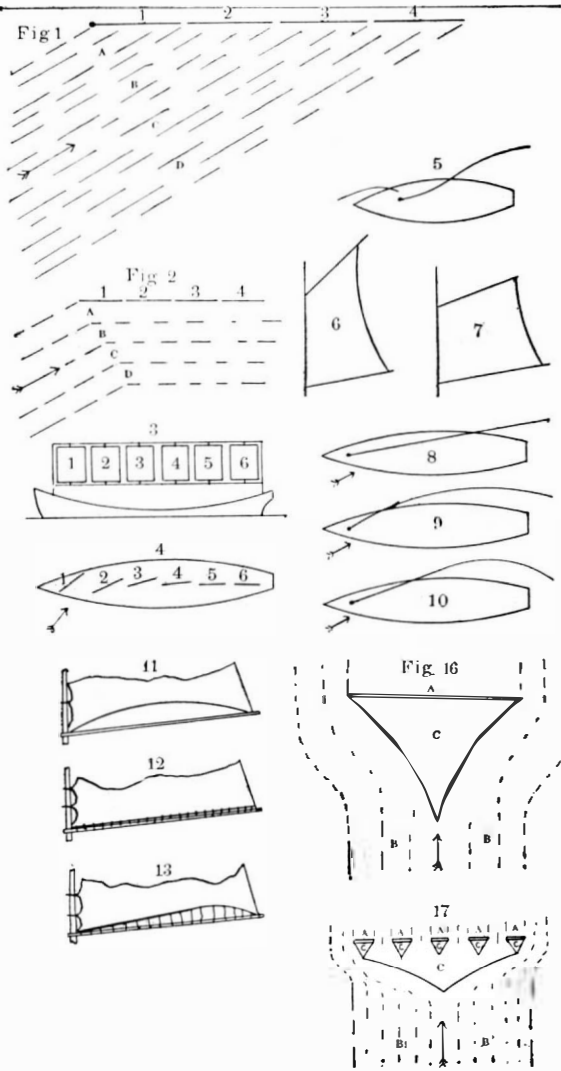

ACTION OF WIND ON SAILS.

column of wind does not lose its dimensions very much. A little is "spilled" over the top and bottom of the card but it turns in bulk. If it does not turn in bulk, that is to say, if the bulk of wind is materially affected, then its pressure must be materially increased or diminished, which is seen at once not to be the case, or the wind must be backed up.

For many years I was under the impression and conducted my experiments under the belief that the wind did materially lessen in its bulk, but of late years I have become positive in the opinion that the deflection of wind which would have struck on the first card, or the section of the sail nearest the mast, remained about the same in size, density and velocity and passed aft over the sail. This is why I speak so positively.

Column of wind, *B*, is that column which would

strike on card 2, but which never reaches the card because the deflected wind, *A*, from the first card is interposed between it and the sail. Similarly so in *C* and *D*. It will then be seen that on the first part of the sail a mixture between a dead-ahead wind and a favorable wind; on the third part of the sail two dead-ahead currents; on the fourth part, three.

In investigating this further, the following experiment was tried, shown by Figs. 3 and 4. On a boat a framework was put up that carried six smaller frames, covered with muslin, thus constituting sails. Each of these six sails was pivoted in the center so that they might take any angle. The first plate or sail was set at the angle shown by No. 1, Fig. 4, the course of the wind being shown by the arrow. No. 1 was fastened in this position. Then No. 2 was slowly moved until it was found to be set at the angle which received some wind, that is, "set so it would draw" and fastened. Nos. 3, 4, 5, and 6 were similarly and subsequently so set. When it was found that No. 5 was set almost fore and aft, the leech or after part of sail No. 6 was really to windward of the keel. This may seem, when so stated, astonishing, but it will readily be conceded when it is remembered how the jib will "back" the mainsail as shown in Fig. 5, or how much more in-board the boom of a mainsail must be drawn than that of the foresail, and numbers of other similar experiences.

Attention is also called to the fact that if some cotton be thoroughly saturated with tar and lighted, the smoke from it cannot be made to touch the sail unless held forward of the mast and quite in line with the wind. As you go to windward of the mast the distance the smoke will remain from the sail increases, going to show that the bulk of the wind as it is turned by the sail does not materially diminish.

For these reasons, attention is called to Figs. 6 and 7. Fig. 6 representing a tall and narrow sail, which is undoubtedly the speediest; Fig. 7 being a low and broad sail, which is undoubtedly the slowest.

The course of the deflected wind and its unaltered bulk, is without doubt the explanation of why a catboat can outpoint a sloop, and a sloop outpoint a schooner, and a schooner outpoint a ship.

Fig. 2 and the facts that are gathered from it, are also an explanation of why a perfectly flat sail, as shown in Fig. 8, is not good. It also shows why a bellied sail is better than a quite flat sail, as shown in Fig. 9, and it would also point to the proper curve in a sail being that shown in Fig. 10. In old times they used to fasten the sail free on the boom, as shown in Fig. 11, which represents a too much bellied sail for beating. The custom now is to lace the sail on the boom, as shown in Fig. 12, and I think that with the lacing of the sail it is very easy to secure a too flat sail, as shown in Fig. 8.

I have almost always been able to speed a boat up and increase her windward work materially by relacing it on the boom, as shown in Fig. 13.

Figs. 3 and 4 suggest an experiment in sails which I have very thoroughly tried, and of which illustrations are given later, but before I leave the sketches I wish to explain what I have found to be the case in a sail running before the wind, as illustrated by sketches 16 and 17.

In Fig. 16, *A* is the sail and *BB* is the wind, and *C* is the cone of dead air that rests upon the sail. Allow me to liken the sail and the wind and this cone of dead air to one's putting his hand into sand and moving it. It would be found that a cone of sand remains on the hand. Any one who has gone out on the boom of a sail "running" has found himself in a place of comparative calm, the smoke from his cigar remaining with him. If the sides of the cone are at a correct

angle, the wind will be "split" and pass the sail without exerting its greatest effect on the sail, whereas if the sail have openings in it they allow the base of the cone to constantly pass through, bringing the apex nearer the base and increasing the angle of the cone. In a sail of 100 square feet area, I have found that 65 per cent of the area being covered by cloth and 35 per cent of the area being open, their speed was equal. What I have said of Figs. 16 and 17 must be thought of when looking at the following photographs.

PHOTOGRAPHS OF SAILS.

The accompanying photographs are a few of many experiments that have been tried—the general results may be stated as follows:

In running before the wind, all sails set at right an-

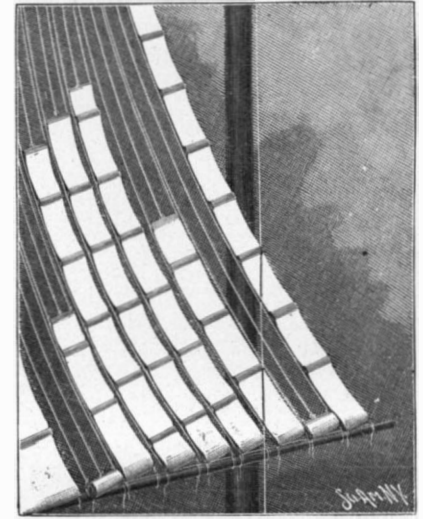

Fig. 5.



Fig. 6.

gles to the wind are materially benefited by having holes in them through which the wind may escape and thereby lessen the height of the cone of dead air that rests on the sail. In beating, the sails are subject to a very much greater windage than they would be if there were no openings in them. Each section may be considered a little sail on the hoist of which the windage is felt. When a large sail is composed of a number of small sails, the "windage" of the large sail is very materially increased, as has been explained above, and this "windage" or direct contact of a substantially dead-ahead wind is so material that unless the advantage gained by getting rid of the "spilled" wind is very great the "windage" is materially felt, the result being that while any one of the forms that I have tried causes the boat to move at least one-half

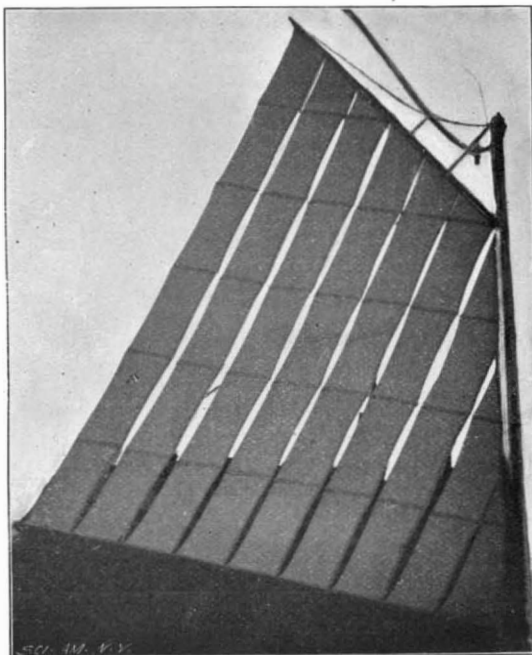

Fig. 1.

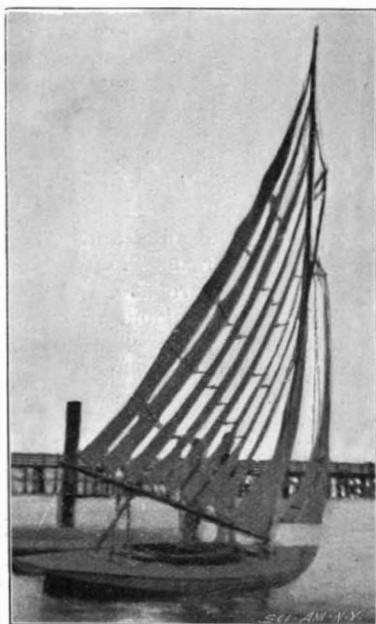

Fig. 2.

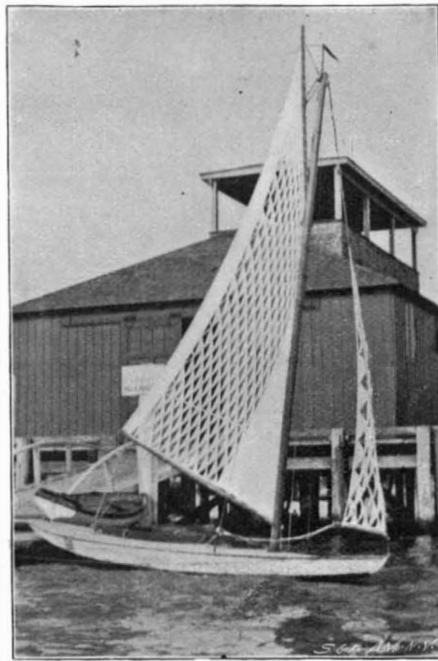

Fig. 3.

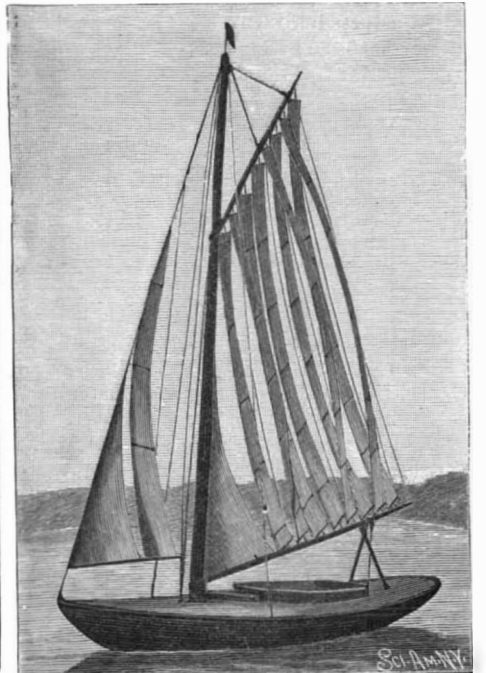

Fig. 4.

faster on a certain wind (that is on wind particularly adapted to the slant of the members and their "spill") on any but that certain wind it is a trifle slower than an ordinary sail.

Taking the whole field and sails as they are used, the old form of sail, that is, the sail having no openings in it, is best.

I present the accompanying photographs, as they may be of interest as photographs of odd forms of sails, and further in the belief that some of the phenomena shown in them may be of material benefit in setting sails and also in cutting them.

The accompanying photographs are not arranged in order, but being numbered, attention can be called to each one.

Fig. 1. This is a sail composed of strips running perpendicularly. Each strip is kept flat and stretched apart by strips of wood inserted in pockets, that is, "stretchers" are used, or "battens," the last or stern cloth is the sail having five battens in it. These strips were connected together by being tied at the points where the battens came, the front edge being held taut, the rear edge of the one in front of it strung out to leeward the distance which the uniting string allowed. By tying them close in or far out I could learn the thickness of the "spill." These experiments soon proved that the "spill" was about as thick as the current of direct air which struck on each strip. Fig. 2 is a view from the rear, which shows the opening between the strips through which the "spill" passed. (It is assumed that the wind deflected by one member passes off of that member to leeward, and on in front of the next member behind it.) Fig. 3 is a different form. In this, each member is in the form of a triangle, its apex forward.

Fig. 4 is that photograph of those shown from which the greatest information may be derived. It is made of individual perpendicular strips which one raised and lowered by an individual halyard and downhaul. In this way I could set the first three and leave unfurled the next two, and set the next one-half way up, the next one three-quarters, and the next one-quarter, but in that way getting exact balance. The members being individual and all set, when I gave it a good full of wind, "laid down" in their proper order. As I gradually let out the boom, one member after another would spring to windward and belly out just as much to windward as the other members did to leeward. As I caught this snap shot, it will be seen that while members 1, 4, 5, 7, and 9 remain bellied out to leeward as they should be, that members, 3, 6 and 8 are similarly bellied out, but to windward. I account for this by the thickness of the current of deflected wind. No. 7 shows the same sail full of wind.

Fig. 5 is a view of the same sail shown as in Nos. 1 and 2, in which strips Nos. 2 and 8 are furled and Nos. 3 and 7 are half hoisted.

Fig. 6 represents two boats with substantially the same kind of sails, the difference being that the sail on the forward boat is composed of five members, whereas the rear sail is composed of six.

For a long time I have been convinced that the more individual members in a sail, the speedier it was. (I have asserted above that these sails are very much more speedy when sailed as they are adapted to be sailed, that is, on a certain wind and course only.) These two sails then are exactly of the same dimensions, placed on boats of the same model and sailed the same course, all things being alike but the sub-divisions of the sail, in one case into five members, in the other case into six. I always started the sail with five members ahead of the sail with six members, and invariably the sail with six members out-sailed that with five. (I have often wondered in view of the above experiments on the hull and sails, if the fastest boat under certain conditions would not be a boat of immense beam and shallow draught, that had a number of sails set on masts, that ran across the boat instead of fore and aft.)

I feel that the hull of boats is better understood and carried out than is the set and draw of the sails. I suggest that when, as has often been the case, two boats of seemingly the same model of hulls raced, the different results were more attributable to the sails than to the hulls.

Naval Estimates for the Year.

The estimates for the naval establishment for the fiscal year ending June 30, 1901, have just been approved by Secretary Long. The estimates amount to \$73,045,183.15, an increase of \$24,537,187.57. The in-

crease includes \$12,268,474.32 for public works at various navy yards and stations, the current appropriation for the same purpose being \$5,840,786.50. For the new Naval Academy \$2,021,000 will be required as compared with the current appropriation of \$720,000. For the increase of the navy, including construction, machinery, armor and armament, \$22,983,101 will be required, while the current appropriation is only \$10,392,402. The Bureau of Construction and Repairs requires \$3,000,000, additional. The Bureau of Steam Engineering \$1,000,000, and for pay of the navy about \$700,000. The Bureau of Ordnance on the other hand requires about \$700,000 less.

XIPHOPAGES, OR HUMAN DOUBLES.

The first living double monster that we know much about was described by Isidore Geoffroy Saint-Hilaire, and consisted of the twin sisters Helene and Judith, who were born in Hungary in 1701 and died in 1723. The Siamese twins, Chang and Eng, attracted much attention in their time and were exhibited in Europe and America. They were born in 1717, were married and had children, and died at an advanced age. These two brothers were connected by means of a ligamentous band passing from the epigastrium of one to that of the other. Later on, the two sisters, Millie and Christine, who were born in Columbia County, South Carolina, in 1851, were exhibited in Europe. These twins were connected by the back. Recently, there have been presented to the Academy of Medicine of Rio Janeiro, Brazil, two sisters connected with each other in front and thus belonging to the category of what are now called Xiphopages.* By this term are de-



Fig. 1.—THE SISTERS RODICA AND DOODICA.

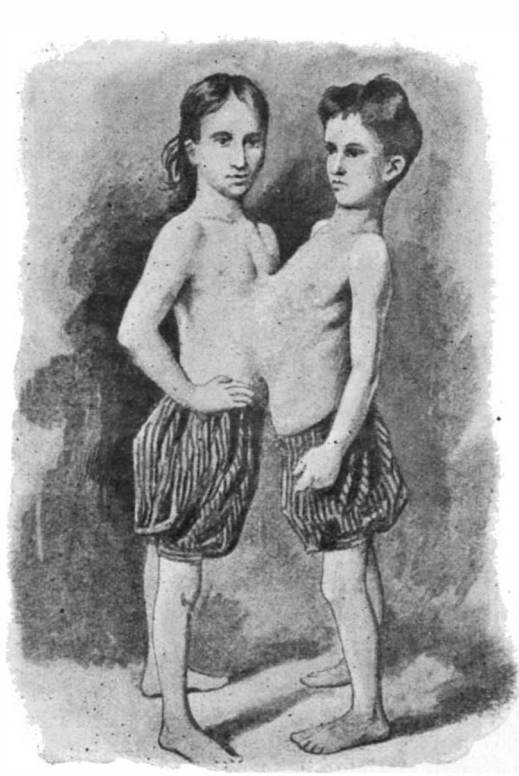

Fig. 2.—THE SISTERS ROSALINA AND MARIA.

signed two well-developed individuals with one umbilicus in common and connected from the lower extremity of the sternum to the navel. Such double monsters are curious. There are some that are provided with a thoracic cavity proper to each individual. These are genuine Xiphopages. In others, the independence of the thorax is limited to the upper part of the thoracic cavity. M. Marcel Baudoin, who has made a special study of such monsters, designates these latter by the name of Thoracopages.

The true Xiphopages are rare in science. In fact, the number of those born living and that have been observed does not appear to exceed seven or eight, and several of these have not lived longer than a few days, or even a few hours.

In 1892 there were exhibited in Europe the two sisters, Rodica and Doodica (Fig. 1), who were born in the English Indies in 1889. They were three years and some months old when they were exhibited in Brussels.

In Fig. 2 are shown the two sisters, Rosalina and Maria, who have just been discovered in Brazil. These two girls are ten years of age and were born at Cachaeiro de Itapemerim. The parents were anxious to know whether or not they could be separated. That all depends upon the nature of the junction. Three Xiphopages have already been operated upon, two of them with success, and all were of the female sex.

With radiography, it will be easy to ascertain whether the two bodies are absolutely consolidated or whether they are independent. If the latter is the case, a surgical operation might be performed with a considerable chance of success.

For the above particulars and the illustrations, we are indebted to La Nature.

* From ξιφος, a sword, used in the anatomical sense of ensiform cartilage, and πηγυσι, "to fix."

The Fuel Value of Cereals.*

At the present time, when the consumption of stored fuels is so enormous, it seems to be interesting to obtain some data as to the annual production of fuel materials by ordinary growth. The fact that in some parts of the country coal is very expensive whereas corn and other cereals are very cheap, makes it interesting to know whether it might not be more economical to burn the corn than to export corn and import coal. That has been done in some states at certain times when corn was very plentiful; but comparatively little data exists on the subject. At the meeting in Toronto of the British Association for the Advancement of Science, Lord Kelvin read a very interesting paper on the annual product of fuels and gave some speculations with regard to the way in which the oxygen of the atmosphere has been supplied by the constant production of stored fuel, bringing out the approximate result that if the stored fuel were all burnt again we would be left with an atmosphere free from oxygen. Some of those points created quite a little interest at the time; and last year Dr. Mees gave a short account of Lord Kelvin's paper before the Science Club at Terre Haute which, in some way, got into the newspapers. The whole subject has in consequence been again brought prominently before the public through some of the information bureaus sending out abstracts of that paper, with photographs of Lord Kelvin and others, all over the country.

It occurred to us, while talking that matter over, that it might be profitable for some of our students to take up the matter and make some determinations of the actual fuel value of some of these cereals; it would

be good practice and would furnish some information which might be valuable. Following out that idea one of our senior students took up the subject last spring and the results which he obtained are those which I have embodied in the table accompanying this paper. You will find a rather interesting result, for instance, in the case of corn (see yellow corn in the table), the fact that whether you take the stalk, the corn, or the cob, you get very nearly the same fuel value per gramme or per pound. We have it here in the gramme unit; heating value in British Thermal Units per pound is got by multiplying by 9/5. The percentage of water does not differ very much in the three cases. The dry corn would be a little, but comparatively little, higher than the others. You will find also the rather curious result that all these cereals come very nearly alike with the exception of the few that are known to contain considerable quantities of oil. Those run up high; but the ordinary cereals such as corn, oats, wheat, rye, barley, millet, rice, etc., are very nearly alike

in their values; they run from about 3,800 to a little over 4,000; oats being the highest with 4,200, millet coming next, 4,137. Cottonseed, which we would expect to be high, is a little low in water (but that would not bring down the number very seriously) giving us 5,160, sunflower seed 4,900, and the castor bean the highest of all, 5,400.

I may say that the work was done in the chemical laboratory at the Rose Polytechnic Institute under the supervision of Prof. Noyes, with whose permission I have presented the results to this section.

Substance.	Heating value in therms per gramme.	Percentage of water.
Yellow corn.....	4,093	12.1
Yellow cornstalk ..	4,030	10.8
Yellow corncob	4,015	10.1
White corn.....	3,850	13.0
White corncob.....	4,065
Cornhusk	3,939
Mixed oats	4,203	11.0
Wheat.....	4,096	12.8
Rye.....	3,852	12.5
Barley.....	3,807	11.7
Millet	4,137	10.8
Rice	3,755	13.2
Navy beans	3,860	13.8
Wheat straw	4,043
Timothy hay.....	4,137
Cottonseed.....	5,152	7.7
Cotton	4,157
Sunflower seed.....	4,932	8.8
Castor bean.....	5,405	6.2

THE Egyptian Railway Administration has accepted the tender of a Belgium firm for the supply of twenty locomotives.

* A paper by Prof. Thomas Gray, of Rose Polytechnic Institute, Terre Haute, Ind. Read August 23, 1899, at the Ohio State University, Columbus, O., before the Section on Mechanical Science and Engineering of the American Association for the Advancement of Science. Reported especially for the SCIENTIFIC AMERICAN.

TOTAL ECLIPSES OF THE SUN.

WITH SOME REFERENCE TO THE NEXT ECLIPSE VISIBLE IN THE SOUTHERN STATES, MAY 28, 1900.

BY G. E. LUMSDEN, F.R.A.S.

Were it possible for us to see shadows against the sky, and to take up out in space a suitable position for the purpose, we should perceive that both the earth and the moon ever cast behind them vast black cones pointed away from the sun, the common source of illumination. Could we measure these cones, we should find that the shadow of the earth is 850,000 miles, and that the shadow of the moon is 238,000 miles in average length. The moon's path is far from being exactly circular. It is elliptical, or egg-shaped, so that while the distance which separates the earth and moon from each other averages 240,000 miles, there are days when she is only 222,000 miles away, and other days when she is as far off as 252,000 miles, a difference of 30,000 miles. And this is the reason that, to the naked eye, our satellite at times appears to be larger, or smaller, than at other times. Any one who follows her through a sufficient number of lunations will detect not only these but other interesting differences, and will notice that she never "fulls" twice in precisely the same part of the sky, because she is constantly changing her position by rising or falling from night to night, thus passing, as it were, every month, through many degrees of north and south declination. And it will be further observed that, in obedience to some law, the moon in our summers becomes full at or near her lowest point as she hangs over the southern horizon, and in our winters at her highest point over our heads, thus provisionally affording light to that pole, for the time being, most in need of it. An eclipse of the sun visible to us can occur only when the moon is new, that is when she passes exactly between us and the sun, just as one might pass his clenched hand from right to left between his face and a lighted lamp. Now, if an eclipse happen when she is at her least distance, 222,000 miles, from us, and, therefore apparently greatest in diameter, the apex or point of her shadow-cone will come into contact with the surface of the earth and be broken off to the extent of some thousands of miles. If, however, one happen when the moon is at her greatest distance, 252,000 miles, from us, and, therefore, apparently least in diameter, the apex of the shadow will pass over our heads at a distance of many thousands of miles, and somewhat after the fashion of a balloon floating by at a considerable height. In the first instance, the eclipse will be total along the path more or less curved, over which the broken shadow travels, because the moon will be large enough to hide the sun. In the second, the eclipse will be annular, because the moon will have been, by her distance, apparently diminished to that degree that at no instant while she is crossing the solar disk can she completely obscure it, for around her coal-black body will blaze a ring of the white-hot sun.

Of the stupendous scale of total solar eclipses, moon-cast shadow-apparitions are impressive and awful to the last degree; they are phenomena never forgotten by those who see them. Than Prof. Langley there is no better authority, he having observed three. No wonder he declares that repetition does not dull the interest, and that a total eclipse of the sun is worth a journey round the world to behold.

For the purpose of observing these phenomena, scientific men and women do not hesitate, literally, to go to the ends of the earth. Especially promising eclipses have found enthusiastic observers on the steppes of Russia, the wastes of Asia, the inhospitable shores of Africa, the peaks of the Andes, and lonely rocks in mid-Pacific. The total phase is the only portion of a solar eclipse of the slightest value to astronomers or solar physicists, or, indeed, of real interest to the mere sight-seer, and this phase, under the best possible conditions, cannot at any one place last so long as eight minutes; commonly, the duration does not exceed three minutes. Notwithstanding this, and the chance of complete failure, owing to the presence of clouds, costly expeditions are from year to year fitted out by governments, observatories, societies, and private munificence, and the arduous duties devolving upon them are ungrudgingly assumed by men eager to glean from the sky every vestige of information obtainable by telescope, spectroscope, and camera during the few precious moments that the obscuration of the sun is sufficiently complete to allow critical examination to be made of the solar appendages, visible to man only when daylight has been thus temporarily turned into night. Readers of the SCIENTIFIC AMERICAN will, therefore, readily appreciate the keen interest with which scientific men and women on this continent are looking forward to the next total eclipse, which, most fortunately for them, will, on the 28th of May, 1900, be visible in Mississippi, Alabama, Georgia, South Carolina, North Carolina, and Virginia, or, in other words, throughout a broad belt, extending from New Orleans to Cape Henry.

The shadow-path of the approaching solar eclipse will cross the American continent, and, within the United States, will cover a belt fifteen hundred miles long by about forty miles wide at New Orleans, and sixty miles wide at Cape Henry. Observers should, if possible, take up positions on the central line of the path, as the shadow will there be densest, and the phenomena best seen. Along this central line, and within the north and south limits of the path, there will be thousands of excellent stations. From every city, town, village, hamlet, and farm throughout the belt observations may be made to great advantage. The best positions will be found in the moon's path

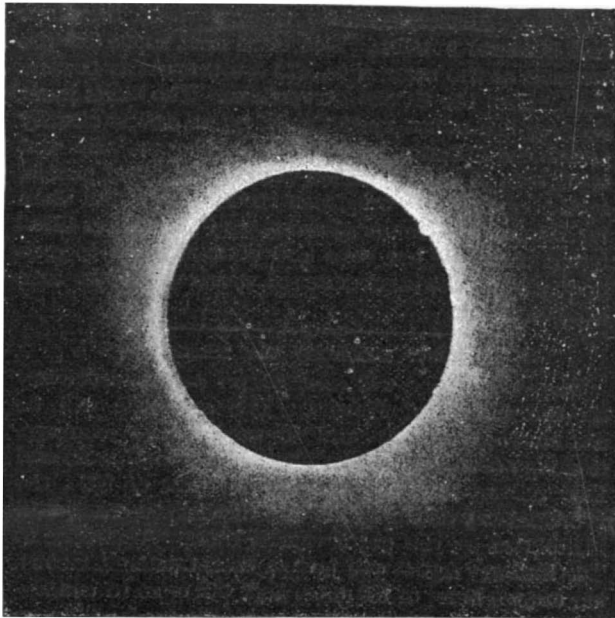

THE SUN'S CORONA, TOTAL ECLIPSE, JANUARY 22, 1898.

from the Appalachian highlands on to the Atlantic coast. Some of these have already been selected by professional astronomers, who have chosen localities likely to be most free from cloud. These ladies and gentlemen will take care to be on the ground several days in advance, so as to arrange their instruments and drill their staffs to the last degree of thoroughness and precision. No doubt the unprofessional men and women who will be present on eclipse day will number many thousands. Well equipped parties will go south and east from all parts of the continent, not excepting Canada. At least one official party will come out from England, while other parties from that and other countries will go to places in Europe and Africa. The eclipse will be total along a path extending from a point near the southern end of Lower California, across Mexico, the United States, the Atlantic, twice cutting the path of ocean travel, Portugal, Spain, Algiers, and Egypt. Outside of this path the eclipse will, some time

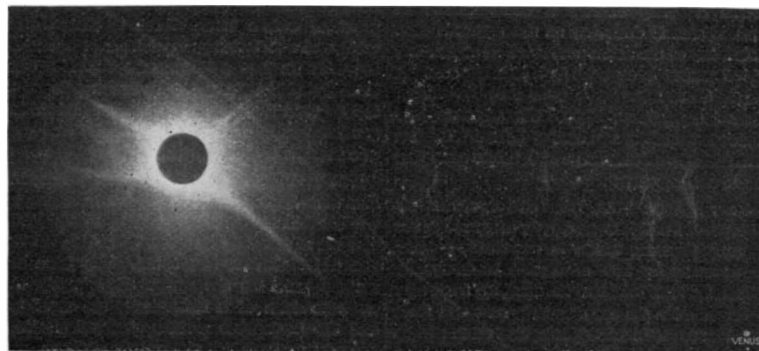
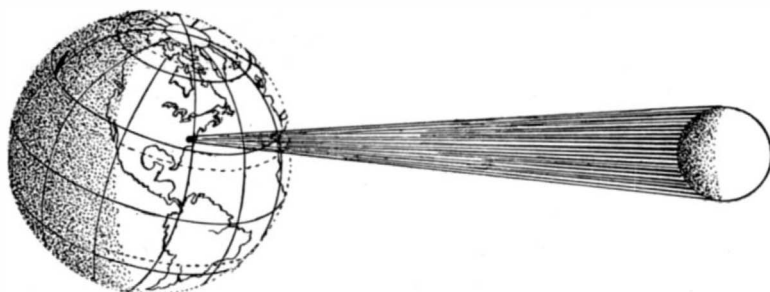

PHOTO OF SOLAR CORONA,

Taken with a small camera by Mrs. E. W. Maunder, January 22, 1898. Venus in the lower right hand corner.



ECLIPSE SHADOW, MAY 28, 1900, OVER CAPE HENRY.

during the day, be more or less partial to observers from the North Pole to the river Amazon and from the central Pacific Ocean to the Red Sea.

On the 28th of May next, sometime after local sunrise, the round black shadow of the moon, like a great arm, will sweep in out of space, coming into contact with the earth near the Revilla Gigedo Islands in the Pacific Ocean, about five hundred miles south and west of California. With the tremendous initial velocity of about one hundred miles a minute, the shadow-cone will rush toward the mainland and enter Mexico near

Cape Corrientes. In eight minutes it shall have crossed the Rocky Mountains, where, flying from peak to peak and from valley to valley, the spectacle must be sublime, though lasting but thirty seconds. By 7:30 Central Standard time (or 8:30 Eastern Standard time) it shall have crossed the Gulf near the mouth of the Rio Grande and plunged New Orleans into sepulchral gloom.

For the purposes of anticipation and study, let us imagine ourselves to be members of a group of enthusiastic men, women, and youths, not necessarily scientific or practiced observers, only anxious to see everything possible. We should be posted upon the highest possible eminence, so as not to miss the tremendous impressions due to the sudden rushing upon us of the stupendous shadow. We ought to be in the center of the ground over which the shadow will pass. If this position be near New Orleans, we shall have totality for seventy-seven seconds. If we are at Union Point, Greene County, Georgia, the center of the path in the United States, we shall have darkness for ninety-two seconds. If we are near the Atlantic coast, not far south of the city of Norfolk, we shall have one hundred and five seconds for observation. Let us assume that we have brought with us opera and field glasses, telescopes, spectroscopes, barometers, thermometers, and well regulated timepieces set to Washington, Greenwich, and local times. Of course, we have notebooks, pads of drawing paper, cardboard, white and blackened, upon which have been laid down black disks, around which our artistic members, by rapid sketching with colored chalks, may draw the phenomena we shall see. We have candles and lanterns, the latter for use if wind arise. Of course, we have cameras and plates of various speeds and densities of coating. We have seen the beautiful photographs taken on the 22d of January, 1898, in India, by Mrs. E. W. Maunder, with a small camera having a one and a half inch lens, nine inches in focus, photographs due entirely to her own conception of what might be accomplished with such a camera, and which have proved to be of scientific value. The images were small, but from them excellent drawings have been made. We have everything in readiness. Instruments are mounted or suspended. Cameras have been focused, the most distant objects being used for the purpose. Thermometers have been placed so that we shall be able to take the temperature of the air and soil; we have been told off by our director, who has given each of us some special duty to perform, and who ought to have knowledge sufficient to tell us what to look for and to explain the various phenomena as they come under our notice. Timepieces and thermometers must be read; information as to exposing plates must be given; the moments of contact announced, and the seconds during totality called off in a loud voice. And though we are all assisting, we shall be able to see everything. Professional astronomers will not be so fortunate. They must be in constant attendance upon their instruments, and will probably work behind screens shutting them off from the world, so that their attention shall not be distracted.

From our calculations, we know when the various contacts will occur. The sun is about three hours high, and the sky clear. We are told that the edge of the lunar disk is all but touching the edge of the sun, but we cannot detect the presence of our satellite. It has been explained to us that the moon is really moving toward the east and at the rate of about half a mile per second, that the surface of the earth is carrying us toward the east at the speed of about twelve miles a minute, and that the shadow is approaching us from the west at the velocity of nearly one mile a second. During the hour and twelve minutes which must elapse between the first detected cutting by the moon into the sun's limb and totality, we shall have ample opportunity to observe and draw sun-spots and faculae, if any, to note down our impressions, to estimate the effect the gradual extinction of the direct solar rays is having upon objects around us, and the falling of the mercury in the thermometers. As totality approaches, we should be on the alert for the shadow bands which are usually present in bewildering variety a few moments before the fact of the sun is hidden, pulsating, it is said, in a manner to suggest the throes of nature in dissolution, and as if conscious of impending disaster. Nor should we forget to notice the effects of increasing twilight upon animals, birds, insects, and flowers. On such occasions, domestic fowls go to roost, birds return to their nests, butterflies act "as if drunk," deer run about in alarm, and flowers, such as crocus, tulips, anemones, gentians, hepatica, pimpernels, wood sorrel, and wild geranium close, and a peculiar hush falls upon everything. At this moment attention must be given to the sun, or what is left of it, for we must see the splendid phenomena known as Bailey's Beads, visible for an instant or two as the moon's advancing edge closes in upon the eastern edge of the sun, but visible

again when the western edge of the moon moves forward just enough to allow the solar rays to glint round at us through the valleys among the lunar mountains.

But when warned by our director, every eye must be turned to the west, for whatever else we succeed in doing, we must not fail to see the lunar shadow as it approaches. We may not live long enough to witness another eclipse under such auspices. Let us make the most of this. Forbes, who observed at Turin, the total eclipse of 1842, said that he was so confounded by the awful velocity of the shadow, which swept toward him from the Alps, that he felt as if the great building on which he was standing swayed beneath him and began to fall over in the direction of the coming gloom. The rapidity of its motion and its black intensity produced the sensation that something material was flying over the earth at a speed "perfectly frightful," and he involuntarily listened for the rushing noise of a mighty wind. Airy describes as "very awful" a shadow retreating away among the hills of Northern Spain. Other writers are no less dramatic in their accounts of these phenomena, and the tremendous impression they create. But when the shadow has come, and after we have recovered to some degree from the effects of shock, and of the sudden darkness into which we have been plunged, we must rivet our attention upon the sun, or rather upon the moon, around whose black disk by this time will have appeared the splendid phenomena associated with a total solar eclipse, seen in all its majesty. Striking indeed is the almost instantaneous substitution, as in a dissolving lantern, of one picture for another, the one showing the sky with the blackened sun like a blot upon it, the other showing the sky suddenly draped in the mantle of night, upon whose sable bosom glow planet, star, and coronal halo, and also rostrate jets of incandescent gaseous matter leaping upward from and falling back upon the sun.

Now we photograph, sketch and color most assiduously, not losing a single second. We lay down the positions of planets, comets, if any, and of bright stars. The eclipse is taking place in the constellation of Taurus, between the fine red star Aldebaran and the Pleiades. We look to see whether Aldebaran is able to make its presence known by shining through

the gauzy structure of the corona, and how many of the bright stars in Orion and other constellations can be detected. We glance about the horizon and note the rich color-tones, ranging from black, in the zenith, through browns, purples, crimsons, and reds, to yellow lying along the rough sky-line thirty miles away, where the sun is still shining, though with a partially hidden disk. We notice the ashy tints around us, reflected in our own faces. But a sudden glow along the western edge of the moon warns us that totality has gone like a flash, and that we have time only for a quickly exposed photographic plate or two, and for watching another lovely dissolving view, the fading out of night before the returning glow of all-conquering day. Almost instantly the landscape brightens and becomes familiar. Not until now, as we feel the warmth of the solar rays, did we suspect a passing chill. New life throbs everywhere. The black lunar shadow has swept majestically by us and is already out on the Atlantic, rushing toward Europe. Its vast track behind us is sprinkled with thousands of people, spell-bound by the wondrous vision vouchsafed them by Nature, who, for a moment, as it were, has lifted but a corner of her robe and allowed them to gaze upon glories, the impressions of which will never fade from memory.

A New Railway for Hawaii.

The construction will soon begun on a new railway on the island of Hawaii. The contracts will be awarded in a few days and the road will be in operation very soon. It will be known as the Kohala and Hilo railway and will connect the port of Hilo, the principal city on the island and the eastern coast, with Mahukona on the northwestern coast. According to The Railway Age it will have a total trackage, including branch lines, of 130 miles and will open to cultivation a large fertile territory originally inaccessible on account of lack of transportation facilities. The road will be operated by electricity, which will be generated by water power. Three power plants will be built each of sufficient size to furnish sufficient power to run the entire road should necessity call for it. One will be located near Hilo, another at Hakalau, which

is near the center of the road and a third at Kuhiaele, which is at the northern end of the island. The track will be off standard gage with 60 pound rails. The company will start with one hundred 20-ton cars and 6 electrical locomotives, 2 for passenger service and 4 for freight. Three hundred employes will operate the road and the cost of construction will be about \$2,500,000. It is believed that the wood will be of incalculable advantage to the planters of the island. With the new road the time from Honolulu to Hilo will be only 13, instead of 36 to 39 hours.

The Current Supplement.

The current SUPPLEMENT, No. 1242, has a number of important papers. "The Evolution of Technical Education in Economics, Politics and Statecraft" is an address by Dr. R. H. Thurston delivered on the occasion of the anniversary meeting of the Franklin Institute at the National Export Exposition. "The Uganda Railway" is accompanied by a map. "Boats and Sails," by Walter Burnham, is one of the most interesting articles which we have ever published relating to shipping. It is an amplification of the article which is published in this issue of the SCIENTIFIC AMERICAN, and is accompanied by eleven illustrations. "Electric Auxiliary Machinery in the United States Navy" is by Alton D. Adams. "The Observatory at Pulkowa" is an interesting illustrated article. "Proper Forms for Cross Sections of Moving Bodies" is an article by M. F. Mithoff. "The Progress of Science and Its Results" is the Presidential address of the British Association.

Contents.

Amber production, German.....	262	Mauna Loa and the sun spot	262
Automobile news.....	262	period.....	262
Boats and sails.....	265	plow, walking and sulky.....	260
Boers and the giraffe.....	259	Pompeii, reproduction of.....	264
Boiler with a removable fire	260	Paulley, friction touch.....	260
box.....	260	Rebuke, timely.....	258
Books, new.....	260	Science notes.....	263
Cereals, food value of.....	266	Steel, American, for prince's	259
Claypipe for gas mains.....	259	palace.....	259
Cruisers, "Denver," class of.....	258	Subway and tunnel, Philadel-	261
Electrical notes.....	263	phia.....	257, 261
Engineering notes.....	263	Sun, total eclipse of.....	267
Eyesight of school children de-	259	Supplement, current.....	268
fective.....	259	Telescope, long photographic.....	259
Hawaii, new railway for.....	268	Twentieth century problem.....	262
High speed engine.....	260	Xiphophorus, or human doubles.....	256
Inventions, index of.....	269	Yacht racing, hysteria and.....	258
Inventions recently patented.....	268	Yacht racing, preliminary skir-	264
Liquid air promoting.....	258	mishing.....	264

RECENTLY PATENTED INVENTIONS.

Agricultural Implements.

SHEEP-HOOK.—PHILIP I. MOULE, Bercail, Mont. The hook is so constructed that the leg of a sheep may be readily caught thereby and held as long as desirable, it being practically impossible for the animal to free itself. The leg of the sheep is automatically locked without injury by a peculiar form of spring loop, so that the operator can release the animal when necessary.

VINE-CUTTING ATTACHMENT FOR PLOWS.—GEORGE H. NUNGEZER, Pooler, Ga. The purpose of this invention is to provide an attachment for plows especially adapted for cutting sweet-potato vines in advance of the plow in order that the vines may be readily cut and plowed under, and that the beds may be simultaneously sided or hilled and made ready for digging or plowing out. The attachment consists of a support, by the ends of which knives are carried, the support being adapted for attachment to a plow-beam.

Engineering Improvements.

METHOD OF AND APPARATUS FOR GENERATING POWER.—GUSTAF M. WESTMAN, 1144 Broadway, Manhattan, New York city. The operation of the motor involves the free expansion of the motive fluid. Free expansion is the condition of the fluid in which it can expand to the surrounding pressure without doing any work or putting other bodies in motion. In such condition the velocity of the fluid is increased; but when putting other bodies in motion, the fluid necessarily loses velocity proportionate to that acquired by the body set in motion; consequently, the fluid loses power or ability to expand; and its temperature can not sink as low as it would have done if no body had been put in motion. This may be regarded as the application of a new physical principle to engineering.

AUTOMATIC WATER-FEEDER FOR STEAM-BOILERS.—CLAUDE B. HANTHORN and ALVADORE WELCH, Astoria, Ore. This invention relates to a type of water-feeding devices employed to supply water to steam-boilers, while they are in service and also capable of use in connection with oil, gas, or fluid boilers. An efficient device of this character is provided, which is readily connected with any steam-generator and which automatically feeds water from a source of supply into the boiler by force of gravity, the apparatus being adapted for adjustment to maintain the water in the boiler at a desired height.

BOILER-FURNACE.—SAMUEL W. BUTTERFIELD, Three Rivers, Canada. The furnace is designed to burn mill refuse and coal and is arranged to insure a complete combustion of the fuel and quick generation of steam in the boiler. The boiler is provided with a fire-box under its front end and with a second fire-box located in front of the first box and having communication with the inner box over a bridge-wall. The grate of the inner box is above that of the outer box. By having two fire-boxes located one in front of the other, a complete combustion is obtained, so that the heat-units are all utilized in the generation of steam.

Mechanical Devices.

COMBINED DOOR LATCH AND LOCK.—EDWARD E. NELSON, Fillmore, Ill. The latch and lock are devoid of springs and provide means for the locking of both the latch-bolt and lock-bolt at the same time, thus affording double security. The working parts comprise a slide-bolt, a slidable locking-bolt, and a shackle-bar having

two lateral projections and slidably disposed between and parallel with the bolts. The shackle-bar is adapted by adjustment to engage the lateral projections with the latch-bolt and locking-bolt, thereby securing them against retraction.

WRAPPING-MACHINE.—GEORGE L. GAY, Spokane, Wash. This invention provides a wrapping-machine for newspapers, pamphlets, circulars or the like, which is arranged to deliver the material for forming the wrappers from an endless roll, then to place the wrapper securely and firmly around the newspaper, circular or other paper to be wrapped, and at the same time to fold both the wrapper and paper, finally to cut the wrapper from the endless roll and to seal the end and deliver the paper completely wrapped ready for mailing.

Railway Appliances.

CAR-COUPLING.—ALFRED R. HEATH, Covington, Ind. The coupling is of the hook-and-catch type, and comprises a body having a hook-member at one end and a slotted draw-bar at the opposite end. At the forward end of the slot a rock-shaft is supported, the rear side of which is engaged by a fulcrum-box. A buffer-spring in the slot has its ends respectively pressing upon the draw-bar and fulcrum-box. The great range of rocking adjustment enables two cars of different heights to be coupled together so that there will be no cramping strain on either car-coupling.

SEAT.—JOHN JAMES, Polo, Ill. This inventor has devised a simple seat which is especially adapted for the use of locomotive-fremen, which is removably applied to the locomotive-tender, and which can be compactly folded. When the seat is not to be used, its back may be thrown down over the seat, and the seat and back and connected parts so folded together that there will be but little space occupied.

MAIL-CRANE.—FRANCIS M. EDWARDS, Greigsville, N. Y. Most mail-cranes in use must be mounted at or beyond a switch or upon the outer sides of double tracks. This necessity often involves the location of the mail-crane at a considerable distance from the station. The present device can be placed upon either side of a track, between double tracks and near a station, so that it may be watched. The crane has a receiving-arm pivoted upon a horizontal pivot and provided with a locking extension at its inner end and with a bag catching and holding device at its outer end. A spring-held catch engages the locking extension of the arm, and a pivoted bag-delivering arm is adapted to be engaged by the delivering-arm in its drop. Connections to the catch are provided for releasing the receiving-arm.

CAR-REPLACER.—ISAAC H. WISE, Huntsville, Ala. The car-replacer is a device for replacing cars and wheeled vehicles upon a track. The car-replacer has a toothed rib or track and a toothed segment-disk has flanges at each side of the teeth, engaging the rack. A notch at one edge of the segment-disk is adapted to receive the car-axle. A similarly-curved segment-disk secured to the toothed segment is adapted to bear upon the base. The car-axle will be lifted as the segments roll upon the base. The angular position of the device will determine the amount of side movement given to the car. Hence the car can be raised and transferred sidewise as many times as necessary.

Miscellaneous Inventions.

FASTENER FOR BUTTONS.—ARTHUR H. LOHSE, Manhattan, New York city. Connected with a button having eyes is a plate through which and through the

eyes a rivet passes. A pin extends through another eye of the button and through the plate. The pin and rivet serve to hold the button and plate together. A tongue on the plate is adapted to be turned against the pin. A button once fastened cannot very readily be loosened or torn off.

SURVEYOR'S COMPASS.—RUDOLPH J. GOEPFINGER, St. Francis, Ark. The compass comprises a casing having a graduation over which a needle plays. A retaining device or stop projects into the path of the needle and is movably mounted on the casing, so that it may be brought into registry with different points of the graduation. The vibrations and oscillations of the needle are hence confined, and the needle comes to rest in a comparatively short time, thereby enabling the surveyor to run lines quickly.

IRONING-BOARD.—WILLIAM HARGROVE and JAMES J. WYLD, Montreal, Canada. This invention provides a simple and ingenious ironing-board which can be readily attached to a table and which can be folded into a small space when not in use. The board is provided with a head, which is placed on top of the table, and with bearings in which a leg is fulcrumed, resting with its free end upon the floor. A clamping extension on the leg engages the under side of the table-top to hold the board. The board is held in extended position by a brace on the leg, which brace engages one of a number of teeth on the under surface of the board.

BUTTONHOLE-MOISTENER.—DANIEL F. BAGLEY, Brooklyn, New York city. This device for moistening the buttonholes of collars, cuffs, shirts, and the like, consists of pivotally connected handles, to one end of each of which a jaw is pivoted. The jaws contain absorbent pads for the water. By applying the jaws to opposite sides of a buttonhole, the starch is extracted and the buttonhole portion rendered pliable, while the adjacent portions still retain their stiffness.

PROCESS OF MAKING SOLUBLE ALKALINE SILICATES.—FRITZ HENKEL, Düsseldorf, Germany. The inventor has discovered that, by intimately mixing solid silicic alkalies or alkaline silicates with a little water, in the proportion of six to one, and strongly heating the mixture, or by mixing the solid silicic alkali or alkaline silicate with a hot, concentrated solution of the silicate, a substance is obtained which cakes to form a solid mass which can be pulverized and is easily soluble in cold water.

PROCESS OF DECOLORIZING VEGETABLE JUICES.—JOHANNES C. BOOT, Klatten, Java. The object of the invention is to render the iron salts of decolorized sirups and juices innocuous, so that a permanent decolorization is obtained. To this end the inventor heats the juices (concentrated below 50° Brix) to about 50° C.; and, under constant stirring, sulphurous acid alone or zinc and sulphurous acid are added. So far the process is that usually employed. The liquid is then heated to 80° C. and a soluble ferrocyanid is added until the iron (or iron and zinc) is precipitated. The liquor is then filtered or decanted.

HOSE-CLAMPING DEVICE.—ALBERT M. BURGHER, Clay City, Ky. This device for attaching clamps to hose consists of opposing jaws arranged to receive the clamp and provided with handles. A device is provided for adjusting the jaws; and a fulcrum is furnished for the handles. A bearing-block is carried by the movable fulcrum and is arranged for engagement with the clamp to be secured. The device is adjustable to hose-clamps of different diameters.

PNEUMATICAL APPARATUS FOR APPLYING TOOLS TO SURFACES OF ANY SOLID BODIES.—LOUIS J. MOISSENET, Cherbourg, France. The appar-

atus applies or affixes tools to the surface of any solid body and employs a vacuum created by one or more suckers of proper size placed on the surface and in the interior of which a more or less complete vacuum is produced, so as to establish on the surface of the body fastening-points which permit any machine-tool to be fixed in place, such as a drill, mortising machine, and the like. The suckers serve firmly to fix a brush or stay on the surface to be operated upon; and the tool is fitted to the bench, which serves as its fixed point of support during the work.

PRESS.—GEORGE F. CROSS, San Antonio, Tex. This improved press for holding down sauerkraut, pickles, and the like, in barrels or tubs, comprises a presser or follower-plate on which a guideway is vertically mounted. A presser-foot slides in the guideway; and on the presser-foot arms are mounted on horizontal axes. The arms extend over and engage the follower or presser plate to rock thereon, and serve to hold the follower or presser plate in position.

CALCINING-FURNACE.—CHARLES M. ALLEN, Basin, Mont. The furnace has a number of hearths located one above the other, the uppermost hearth being shorter than the hearth beneath it, leaving one end of the roof of the lower hearth exposed to form a drying-floor leading to the entrance of the upper hearth. The drying-floor is capable of freely taking up the high heat the lower hearth and of imparting that heat to the material discharged upon the drying-floor to expel the moisture from the material during its travel over the floor and before its entrance into the upper hearth. Inlets are provided for the products of combustion to the hearths at the extreme ends; and an outlet for the products of combustion at the discharge end of the lowermost hearth. Very little sulphuric acid being generated, it follows that the life of the hearth is greatly lengthened.

SACK-HOLDER.—FRANK H. GILBERT, Ridgefield, Wash. The sack-holder comprises a hopper with straps secured to the outer sides of its rear wall and terminating in hooks at the upper end. A bracket is attached to the rear wall, and a locking and releasing bar is mounted to rock in a channel formed in the rear wall and is held in place by the straps. Holding-bars are mounted to rock on the opposite side walls of the hopper. Lugs extend inward from the holding-bars and are adapted to be engaged by the locking and releasing bar. A spring moves the locking and releasing bar to its normal position. The sack-holder can be easily attached to a bin or other support.

METHOD OF PRESERVING AND TAWING SKINS.—URY DE GÜNZBURG, Boulevard Lamouroux 52, Vitry-sur-Seine, (Seine), France. In the method to which the present invention relates, the cohesion of the fibers of the hide or skin is destroyed, and putrefaction is prevented without the help or the formation during the operation of any crystallizable salt, which would have the effect of diminishing the strength of the skin. Consequently, skins thus treated contain no crystallizable salts, remain perfectly flexible, and lose none of the strength they possessed before being treated. Water, be it cold or hot, has no effect whatever on a skin thus prepared.

PIPE-COUPLING.—WILLIAM J. HENNING, Key West, Fla. The coupling comprises two sleeves respectively adapted to embrace pipe-sections. The first of these sleeves has interior threads to engage one of the pipe-sections. A collar embraces both sleeves and serves to draw them together. A gland-like collar threaded on the second sleeve is adapted to carry a packing whereby the second sleeve is hermetically connected with the adjacent pipe-section. The pipes can

thus be hermetically coupled, even though they be of different diameters.

PACKAGE FOR PERCOLATING COFFEE.—HENRY M. HUMPHREY, Plainfield, N. J. This invention provides an improvement upon the Humphrey percolator-package which has been described in our columns. The improvements embody a metallic seal for the mouth of the coffee-containing bag, which seal can be partially bent over so as to open the mouth and provide a hook for suspending the bag from the edge of the coffee-pot. Hot water is then poured into the bag and permitted to percolate through the coffee and into the pot.

GATE.—OLAUS B. JACOBS, Roland, Iowa. The invention provides a barrier for gateways in stock-fences or other inclosures that will permit the larger stock to pass through, but will effectually retain hogs, sheep, and other short-legged animals. The gate or barrier comprises a frame and palings in series in the frame, the frame having passage-ways between them and spaced and arranged to permit the passage of animals having long legs and to constitute a barrier for animals having short legs.

MEDICAMENT-CARRIER.—CHARLES M. JONES and ALEXANDER LE ROY HARVEY, Baxter Springs, Kan. This surgical appliance consists of a flexible band between the ends of which a connecting elastic strip extends. Cover-straps are secured over the outer faces of the ends of the band and over the flexible strip to secure the flexible strip to the band.

CHURN.—WILLIAM F. FRIBLEY, Bourbon, Ind. The cover portion of the churn is provided with a funnel portion having a top comprising two segmental frames pivotally connected at one side to swing relatively to each other. Each of the sections has a strainer; and through openings formed in the sections a dasher-rod is movable, having connection with a mechanism, the operation of which requires but little muscular power.

CHURN-DASHER.—WILLIAM H. SWAN, Kankakee, Ill. The churn-handle is provided with a set of rotary dashers so constructed that in churning, the dashers will rotate in opposite directions and their motion will be automatically reversed by the up-and-down movement of the handle. The churn can be filled nearly to the top since the dasher does not splash the cream.

SKIRT AND BELT SUPPORTER.—ALICE M. TULLY, Manhattan, New York city. The supporter consists of a safety-pin adapted for engagement with a waist and provided with a hook, and a second safety-pin adapted for engagement with a skirt-band and having an eye arranged for insertion over the hook whereby to hold the waist and skirt detachably connected. The point of the hook is adapted to enter the inside of a belt whereby the belt is held in place and the eye is prevented from coming off the hook so long as the belt is in place.

SHOE-DISPLAYING DEVICE.—DONALD S. BERTONE, Indianapolis, Ind. The device is particularly adapted for the use of traveling salesmen and is inclosed in a trunk for shipment. The invention consists of a wheel having shelves to which shoes may be fastened and which may be secured to the wheel either in tangential or radial positions, according as it is desired to display the shoes or prepare the device for shipment.

BUNG.—JACOB CONRAD, Chicago, Ill. This improved barrel-bung can be readily applied and used with or without a bushing, and is designed to prevent the opening of the barrel during transit. The bung has a cylindrical casing loosely fitting in the hole and having internal threads receiving a hollow screw with inwardly-extended ribs running longitudinally therewith and adapted to be engaged by a key. Beyond the casing the inner end of a screw projects, which end loosely receives a rivet carrying a presser-plate. A yielding gasket loosely surrounds the inner portion of the screw and casing and is engaged by the presser-plate, so that as the screw is drawn into the casing the gasket is expanded to close the bung-hole. The bung-hole can be opened only by the key.

WATER-HEATER.—MICHAEL E. HERBERT, Jr., 240 to 252 Root Street, Chicago, Ill. The device is a water-heater for baths and domestic purposes. It employs a water-jacketed feeding-magazine and comprises a boiler made in two main parts, the upper of which has a pendent annular water-chamber and the lower of which incloses or forms the fire-box. These two parts are connected by a series of vertical pipes.

WAGON-BODY LIFTER.—HON. ORLO H. DRINKWATER, Cottonwood Falls, Kan. The wagon-body lifter comprises sills and a toggle-arm having its side bars pivoted at their upper ends to the pivoted toggle-arm. Rollers operate on the sills. Great power can be exerted to lift the body from the running gear, the running-gear itself being caused to transmit the power. The lifter is adapted for bodies of different sizes.

CALCULATOR.—WILLIAM D. CONKLIN, Rutherford, N. J. The calculator is designed to reckon wages, the wage per hour, day, or week, and the number of hours of service given. The calculator comprises a base-plate provided with sets of guideways arranged one above the other and at right angles to each other. Imperforate plates slide in the lower set of the guideways; and each bears numbers representing the amounts of pay due for a certain number of hours and indexed to indicate the hours served. Perforated plates slide in the upper set of guideways, each indicating the amount of wages for a given time. A perforated face-plate is placed above the sliding plates.

Designs.

BOX.—LEOPOLD AUERBACH, Manhattan, New York city. The box is designed to contain candy, is cylindrical in shape, and is covered by a medallion on which the head of Columbus is produced.

HINGE FOR DOOR-HANGERS.—JOHN C. GABEL, Jr., Onarga, Ill. The hinge is of novel construction and provides a means for suspending the carriages of sliding-doors, especially freight car doors. The hanger is designed to be used in connection with a sliding-door devised by the same inventor.

NOTE.—Copies of any of these patents will be furnished by Munn & Co. for ten cents each. Please state the name of the patentee, title of the invention, and date of this paper.

Business and Personal.

The charge for insertion under this head is One Dollar a line for each insertion; about eight words to a line. Advertisements must be received at publication office as early as Thursday morning to appear in the following week's issue.

Marine Iron Works. Chicago. Catalogue free. For logging engines. J. S. Mundy, Newark, N. J. "U. S." Metal Polish. Indianapolis. Samples free. Gasoline Brazing Forge, Turner Brass Works, Chicago. Yankee Notions. Waterbury Button Co., Waterbury, Ct. Handle & Spoke Mch. Ober Mfg. Co., Chagrin Falls, O. Gear Cutting of every description accurately done. The Garvin Machine Co., Spring and Varick Sts., N. Y. Wanted—Capitalist to invest in Patent Pliers. A. Hesterhagen, 226 Communipaw Ave., Jersey City, N. J. Ferracite Machine Co., Bridgeton, N. J., U. S. A. Full line of Presses, Dies, and other Sheet Metal Machinery.

Machinery for R.R. contractors, mines, and quarries, for hoisting, pumping, crushing, excavating, etc., new or 2d-hand. Write for list. Willis Shaw, Chicago.

The celebrated "Hornsby-Akroyd" Patent Safety Oil Engine is built by the De La Vergne Refrigerating Machine Company. Foot of East 138th Street, New York.

The best book for electricians and beginners in electricity is "Experimental Science," by Geo. M. Hopkins. By mail, \$4. Munn & Co., publishers, 361 Broadway, N. Y.

Send for new and complete catalogue of Scientific and other Books for sale by Munn & Co., 361 Broadway, New York. Free on application.



HINTS TO CORRESPONDENTS.

Names and Address must accompany all letters, or no attention will be paid thereto. This is for our information and not for publication. References to former articles or answers should give date of paper and page or number of question. Inquiries not answered in reasonable time should be repeated; correspondents will bear in mind that some answers require not a little research, and though we endeavor to reply to all either by letter or in this department, each must take his turn. Buyers wishing to purchase any article not advertised in our columns will be furnished with addresses of houses manufacturing or carrying the same. Special Written Information on matters of personal rather than general interest cannot be expected without remuneration. Scientific American Supplements referred to may be had at the office. Price 10 cents each. Books referred to promptly supplied on receipt of price. Minerals sent for examination should be distinctly marked or labeled.

(7734) H. E. B. asks for a list of the twenty-four inventions and discoveries of highest rank made during this century, alluded to in Horace C. Hovey's article on the American Association for the Advancement of Science, in our issue of September 2. A. The list, as enumerated by Prof. Edward Orton, in his address before the association, is stated to be as follows:

- | | |
|----------------------------|------------------------------------|
| 1.—Railroads, | 15.—Molecular Theory of Gases, |
| 2.—Steamships, | 16.— |
| 3.—The Telegraph, | 17.— |
| 4.—The Telephone, | 18.—The Periodic Law in Chemistry, |
| 5.— | 19.— |
| 6.— | 20.—The Glacial Epoch, |
| 7.— | 21.—The Antiquity of Man, |
| 8.— | 22.—Organic Evolution, |
| 9.—The Phonograph, | 23.—Cell Theory and Embryology, |
| 10.—The Roentgen Rays, | 24.—Germ Theory of Disease, |
| 11.—The Spectroscope, | |
| 12.—Anesthetics, | |
| 13.—Antiseptic Surgery, | |
| 14.—Conservation of Force, | |

He remarked that he had quoted from Alfred R. Wallace's classification. Wallace's numbers 5, 6, 7 and 8 are thus filled:

5.—Lucifer Matches,	7.—Electric Lighting,
6.—Gas Illumination,	8.—Photography.

Prof. Orton added Lord Kelvin's "Vortex Theory of Matter" and the "Nebular Theory." The latter, as in the same range with Wallace's No. 19, "The Meteoritic Theory." His No. 16 is "The Velocity of Light Directly Measured," and his No. 17 is "The Uses of Dust." He called attention to the obvious fact that the personal equation of the author of such a list would appear in the selection of the great advances.

(7735) J. K. L. asks: If a person wishes to become an electrician and knows nothing of the subject, what book should he start with? A. If a person knows nothing of electricity, the best book to study first is probably Thompson's "Elementary Lessons in Electricity and Magnetism," price \$1.40 by mail. This book employs no mathematics beyond algebra. We are inclined to think that the best course for one who wishes to gain a working knowledge of electricity in order to be an electrician is to take the course in one of the best correspondence schools. He will there be taught practically rather than theoretically. This is almost the only course open to one living remote from colleges, or one so situated that he cannot stop working and earning while he is learning his new subject.

(7736) J. S. writes: I wish to get a chemical in powder or liquid form, that will absorb heat quickly, and when heated, to retain a high temperature for say twenty-four hours or so when confined. Will you kindly send me the best formula? A. We do not know any substance which will heat quickly and also retain heat for a very long time. The two requirements are antagonistic to each other. Sodium nitrate fused will give off a great deal of heat in cooling, but it will corrode the vessel in which it is contained. Air slaked lime may be raised to a very high temperature.

(7737) H. B. asks: Which is the best iron to use on transformers and alternating current motors? A. Any good soft wrought iron is suitable for the core of a transformer.

NEW BOOKS, ETC.

CHRISTIAN SCIENCE AND OTHER SUPERSTITIONS. Being selected from "Faith-Healing, Christian Science, and Kindred Phenomena." By J. M. Buckley, LL.D. New York: The Century Company. 1899. Pp. 128.

METRIC TABLES. By Sir Guilford L. Molesworth, London and New York: Spon & Chamberlain. 1899. 24mo. Pp. 86. Price 80 cents.

This is the third edition of a handy little book on metric tables. The equivalents are arranged so that they can be readily handled by those who have to convert measures.

THE TEACHING BOTANIST. A Manual of Information upon Botanical Instruction. By William F. Ganong, Ph.D. New York: The Macmillan Company. 1899. 12mo. Pp. 270. Price \$1.10.

As its title implies this work is addressed to the teaching botanist and serves as a manual of information upon botanical instruction and deals with its elementary presentation as a science. The work will certainly prove of great value to all teachers of botany, giving as it does clear instruction as to scientific drawing and description, laboratories and their equipment, botanical collections, botanical books and their use and many other interesting things which it would be difficult for the teacher to find in convenient form.

PHYSICAL NATURE OF CHILDREN AND HOW TO STUDY IT. By Stuart H. Rowe, Ph.D. New York: The Macmillan Company. 1899. 12mo. Pp. 206. Price \$1.

The tests which the author outlines may be made in a comparatively short time and will be a great help in solving some of the individual problems which present themselves to every teacher. The book deals with sight, hearing, manner, ability, enunciation, nervousness, fatigue, diseases, habits of posture, movement, etc. When we examine a modern book on pedagogy like the present volume, it is a revelation of modern methods of instruction, and we can but feel that the older methods must have had a great deal of cruelty connected with them, because the teachers themselves were unfamiliar with the physical nature of children. The book is a most admirable contribution to the literature of teaching.

TO INVENTORS.

An experience of fifty years, and the preparation of more than one hundred thousand applications for patents at home and abroad, enable us to understand the laws and practice on both continents, and to possess unequalled facilities for procuring patents everywhere. A synopsis of the patent laws of the United States and all foreign countries may be had on application, and persons contemplating the securing of patents, either at home or abroad, are invited to write to this office for prices, which are low, in accordance with the times and our extensive facilities for conducting the business. Address MUNN & CO., office SCIENTIFIC AMERICAN, 361 Broadway, New York.

INDEX OF INVENTIONS

For which Letters Patent of the United States were Issued for the Week Ending

OCTOBER 10, 1899.

AND EACH BEARING THAT DATE.

[See note at end of list about copies of these patents.]

- Accumulator plates, tool for making, W. Majert. 634,469
 Air brake, C. N. Dutton. 634,723
 Alarm. See Burglar alarm.
 Animal trap, Bowen & Twitchell. 634,844
 Animal trap, E. H. Walker. 634,489
 Ash can, T. F. Burke. 634,551
 Asphalt from petroleum residue, manufacturing, W. F. W. 634,818
 Awning, M. Ryan. 634,475
 Axle and bearing, E. E. Stuver. 634,774
 Axle lubricator, wiper, and dust guard, J. S. Paten. 634,475
 Back pedaling brake, W. H. Penseyres. 634,780
 Barrel cover, M. Holms. 634,723
 Basket, E. A. Polsley. 634,703
 Bathing appliance, W. Vanderman. 634,484
 Bayonet, sliding, W. C. Laird. 634,496
 Bearing, J. A. Jamieson. 634,822
 Bearing, crank shaft, W. A. Hance. 634,825
 Bed bottom tightening device, spring, A. C. Lottman. 634,531
 Bell, alarm, F. Hein. 634,727
 Bench. See Wash bench.
 Berry picking machine, Lane & Comeau. 634,773
 Bicycle, R. P. Ambler. 634,738
 Bicycle, etc., L. Sturges. 634,707
 Bicycle frame, L. R. Johnson. 634,822
 Bicycle guard, W. J. Chapman. 634,820
 Bicycle pedal attachment, H. R. Sieverkrupp. 634,591
 Bicycle stand lock, Capen & Cheney. 634,441
 Bicycle support, A. Brown. 634,439
 Bicycle wheel, P. L. Smith. 634,857
 Binder, loose leaf, F. R. Welsh. 634,510
 Binder, temporary, F. J. Schleede. 634,630
 Bit, W. E. Sell. 634,739
 Black signal system, electric, S. H. Hall. 634,816
 Blotter holding device, J. M. Rix. 634,785
 Bobbin latch, H. C. Fowler. 634,662
 Boiler cleaner, M. M. Cram. 634,521
 Boiler burner heater, T. Kruse. 634,734
 Boiler furnace, steam, J. O. Morris. 634,829
 Bolt. See Pedestal brace bolt.
 Book leaf, or music holder, P. A. Veilex. 634,781
 Book, manufacturing sales, J. A. Graham. 634,438
 Books, reference or page marker for, S. J. Sawyer. 634,768
 Boot or shoe, E. Roche. 634,588
 Bottle filling apparatus, W. Bachner. 634,731
 Bottle stopper attachment, F. Morrison. 634,697
 Bottles, etc., means for closing, P. Kirschen. 634,622
 Bouquet holder, N. M. Worley. 634,517
 Box, F. Knobeloch. 634,645
 Bracket. See Lamp bracket. Seat post bracket. 634,647
 Brake. See Air brake. Back pedaling brake.
 Brake appliance, W. T. Shryock. 634,704
 Brick, F. Pagnon. 634,562
 Bridge gate, H. Chesman. 634,717
 Broom handle, A. S. Allen. 634,637
 Brush, C. H. Hansen. 634,817
 Brush, C. H. Hansen. 634,827
 Brush, C. E. Thompson. 634,547
 Brush, liquid blacking, W. H. Beeching. 634,608
 Brush, scrubbing, J. L. Gans. 634,813
 Burglar alarm, J. W. Wigner. 634,635
 Burner. See Gas burner. Hydrocarbon burner. 634,651
 Cab, hansom, Paradis & Desrosiers. 634,651
 Cabinet for lace, etc., J. E. Russell. 634,589
 Cabinet for sales accounts, store, Yorger & West. 634,713
 Cam or pulley fastening, W. C. Davis. 634,660
 Can. See Ash can. Garbage can.

- Car coupling, M. I. Welch. 634,783
 Car, dumping, M. G. Bunnell. 634,682 to 634,684
 Car dust guard railway, J. S. McKenzie. 634,473
 Car fender, street, Smyth & Dienerich. 634,508
 Car life guard, street, R. F. Preusser. 634,834
 Car, railway, J. W. Dunn. 634,749
 Car step, supplemental, A. Heiprin. 634,618
 Car window dust guard, H. B. Shutts. 634,770
 Cars, electric lighting apparatus for railway, W. F. Richards. 634,542
 Carpet, J. Birney. 634,797
 Carpet stretcher, E. R. Moser. 634,471
 Cartridge for multiple cannon, L. Masini. 634,826
 Case. See Show case.
 Case or box for matches, etc., B. Rosenband. 634,543
 Cash register, G. H. Gledhill. 634,726
 Caster, adjustable, J. H. Chase. 634,805
 Cheese curd aerator, C. J. Moore. 634,761
 Churn, J. E. Clark. 634,847
 Churn, F. V. Koulik. 634,553
 Churn and butter worker, combined, E. F. Moenke. 634,534
 Churn gate valve, T. J. Howe et al. 634,730
 Cigar ash receptor, P. L. Cole. 634,746
 Cigar rolling machine cutting device, C. B. Schultz. 634,481
 Clamp. See Pole or column clamp. Tooth clamp.
 Cleaner. See Engine cleaner.
 Cloth shearing machine cloth rest, Amback & Hollingworth. 634,002
 Cloth shearing machine rest, Amback & Hollingworth. 634,003
 Clothes line and clothes pin holder, combined, S. Burkman. 634,519
 Coaster, gravity, H. O. & A. W. Moritz. 634,669
 Cock, blow off, L. E. Butler. 634,440
 Coin assorting and counting apparatus, F. S. D. Scott. 634,506
 Comb. See Currycomb.
 Compressor brush holder, W. Cooper et al. 634,804
 Confectionery coating machine, W. H. Weeks. 634,633
 Cooling beer, etc., apparatus for, W. Bachner. 634,792
 Corset clasp, A. Ferr. 634,576
 Cot, knockdown, D. Holge. 634,665
 Cotton press filling box, Thorsen & Shutt. 634,839
 Coupling. See Car coupling. Pipe coupling. Thill coupling.
 Crate, folding, G. A. Jones. 634,733
 Cross tie, metallic, J. D. Wilson. 634,656
 Culinary vessel, C. Halstead. 634,557
 Cultivator, J. Mallon. 634,823
 Cultivating spring trip, R. Harless. 634,558
 Cupric sulfate solutions, refining, O. Hofmann. 634,751
 Currycomb, O. S. Hopkins et al. 634,458
 Cutter. See Vegetable cutter.
 Cycle, M. Pedersen. 634,865
 Cyclometer, G. T. Brown. 634,610
 Decorations, apparatus for making free hand relief, W. A. Willower. 634,786
 Dental instrument fastener, J. W. Ivory. 634,832
 Dental mirror attachment, W. I. Brigham. 634,638
 Detonator composition, G. P. Bickford-Smith. 634,716
 Developing tray rocker, J. H. Clarke. 634,639
 Disinfectant, sprayer, water closets, cisterns, etc., apparatus for automatically feeding, A. C. Monfort. 634,499
 Disinfecting apparatus, R. S. West. 634,640
 Disinfecter for automatically delivering disinfectant to charges of flush water, J. L. Wade. 634,515
 Display and lighting appliance, D. E. Henning. 634,472
 Display cabinet for window shades, H. McGinnis. 634,472
 Display rack, revolving, M. F. Xander. 634,636
 Door attachment, G. J. Winter. 634,491
 Door check, G. W. Warner. 634,596
 Dock, dry, W. H. Gartz. 634,554
 Draining apartment, mechanical, G. K. Rich. 634,836
 Drawing outfit, mechanical, G. K. Rich. 634,778
 Drawer pull, D. W. Towner. 634,738
 Drier, Bishop & Jerguson. 634,798
 Drill. See Ratchet drill.
 Drill, M. M. Moore. 634,920
 Driving mechanism, S. P. Pierson. 634,833
 Dumping apparatus, G. M. Kenned. 634,643
 Dyeing wool fast black, Julius & Jaublin. 634,824
 Egg holder, B. Keys. 634,500
 Electric brake, G. H. B. Hooper. 634,666
 Electric meter, P. Eibig. 634,811
 Electrical bell post, W. Roche. 634,786
 Electrical conductors, crossing for underground conduits for, V. Koch. 634,759
 Electrical indicator, M. Waddell. 634,487
 Electrical indicator, Waddell & LeGrand. 634,488
 Electrical influence machine, K. S. Lemstrom. 634,467
 Electromagnetic cylinder engine, G. H. B. Hooper. 634,667
 Elevator. See Revolving elevator.
 Elevator, H. R. Tracy. 634,513
 End gate, wagon, W. F. Gatewood. 634,555
 Engine. See Electromagnetic cylinder engine.
 Gas engine. Gasoline engine. Rotary engine.
 Engines, electric starting device for gas, J. W. Raymond. 634,541
 Entrenching tool, J. C. Michie. 634,696
 Evaporator, T. Kuzel. 634,465
 Eyeglass guard, F. Chapp. R. Kabus. 634,686
 Eyelet, E. L. Sibley. 634,564
 Fence post base, W. Perry. 634,672
 Fender. See Car fender.
 Figure, jointed, C. B. Morrow. 634,503
 File, letter, Stable & Mills. 634,545
 Film, apparatus for developing roll, Smithers & Kelly. 634,631
 Filter, N. Lanser. 634,691
 Filter, water, Armstrong & Mulconroy. 634,714
 Filter, water, W. F. Toussy. 634,512
 Filtering device, portable, A. Marks. 634,470
 Fire extinguisher, automatic, O. Hoffmann. 634,442
 Fire resisting construction, interior, A. T. Stearns. 634,737
 Fish globe or tank, A. J. Park. 634,624
 Flask top, F. De Gordy. 634,641
 Flax breaking and reducing machine, J. T. Smith. 634,675
 Flood gate, W. Clough. 634,688
 Floor setting tool, L. A. Manwarink. 634,561
 Foot rest, adjustable, J. A. Moore. 634,579
 Fortune telling device, Long & Capron. 634,582
 Fountain, E. D. Brainard. 634,669
 Fuel preparing and feeding apparatus, A. A. Day. 634,569
 Furnace. See Gas furnace.
 Furnaces, charging device for heating, J. Hundley. 634,499
 Garbage can, C. J. Vaughn. 634,677
 Gas apparatus, acetylene, G. Harden. 634,817
 Gas burner, acetylene, H. E. Shaffer. 634,588
 Gas engine, F. Good. 634,529
 Gas engine, A. Lee. 634,529
 Gas engine, T. J. Sturtevant. 634,609
 Gas engine, G. A. Whitcomb. 634,654
 Gas fixture safety connection, McDermott & Bennett. 634,537
 Gas generator, acetylene, G. F. Dillon. 634,732
 Gas leak indicator, P. Hartenfels. 634,687
 Gas lighting or extinguishing mechanism, time, A. B. Shaw. 634,856
 Gas machine, acetylene, J. E. Landrum et al. 634,690
 Gas machine pump, gasoline, E. J. Crawford. 634,612
 Gasoline engine, automatic, O. W. White. 634,679
 Gate. See Bridge gate. End gate. Flood gate.
 Gate, N. Early, Jr. 634,810
 Gelatin tubes, apparatus for forming, P. J. Foulon. 634,449
 Gelatinous substances, apparatus for manufacturing, C. D. Hyatt. 634,685
 Gem setting, Ballou & Burdett. 634,567
 Generator. See Gas generator. Steam pressure generator.
 Gin driving mechanism, C. W. Brown. 634,800
 Glass articles, machine for grinding, E. F. Genet. 634,452
 Glove, J. Comrie. 634,443
 Governor, engine, C. D. Palmer. 634,650
 Grain shovels, brush attachment for power, F. Kaucher. 634,578
 Grate, G. A. Long. 634,694
 Grate, C. Blackader. 634,505
 Hay loader, J. Wilson. 634,599
 Hay press, E. J. Shirley. 634,544
 Heater. See Vehicle heater.
 Heating apparatus and device for controlling action thereof, steam, C. E. Van Auken. 634,547
 Heel, C. Blackader. 634,544
 Hinge, spring, W. F. McKee. 634,554
 Hoisting machine, A. P. Peterson. 634,586
 Hook. See Winch hook.
 Hoop. See Metal hoop.
 Hydraulic knocking press, H. M. Crowell. 634,719
 Hydrocarbon burner, H. Howard. 634,642
 Hydrocarbon oil burning apparatus, W. J. Jackman. 634,463
 Indicator. See Electrical indicator. Gas leak indicator. Office indicator.
 Indicator, T. A. Tribble. 634,485
 Ink well case, W. H. Harten. 634,795
 Insulating support for electric wires, C. N. Beal. 634,568
 Ironing board, D. B. Wallace. 634,741
 Jack. See Lifting jack.
 Jar, W. S. Bayless. 634,742
 Joint. See Mechanical joint. Universal joint.
 Journal, roller, frictionator, automatic, J. G. Smith. 634,860
 Kiln, W. Davis-Douglas. 634,721
 Knife, S. H. Jones. 634,621
 Knitting machine, H. A. Betney. 634,843

(Continued on page 270.)

Advertisements.

ORDINARY RATES.

Inside Page, each insertion, - 75 cents a line Back Page, each insertion, - \$1.00 a line

For some classes of Advertisements, Special and Higher rates are required. The above are charges per agate line—about eight words per line.

Star Screw... cutting Lathes Automatic Cross feed 9 and 11-inch Swing. New and Original Features Send for Catalogue B. Seneca Falls Mfg. Company, 695 Water St., Seneca Falls, N.Y.

POWER & FOOT LATHES SHAPERS, PLANERS, DRILLS, MACHINE SHOP OUTFITS, TOOLS AND SUPPLIES. SEBASTIAN LATHES CO. 120 CULVERT ST. CINCINNATI, O.

Foot Power and TURRET LATHES, Planers, Shapers, and Drill Presses. SHEPARD LATHES CO., 133 W. 2d St., Cincinnati, O.

Queen's Patent "Triple Plate" Toepler-Holtz Electrical Machine. Can be used at all times of year and in all kinds of weather.

Queen's Patent "Triple Plate" Toepler-Holtz Electrical Machine. Can be used at all times of year and in all kinds of weather. QUEEN & CO., Inc. 1010 Chestnut St. Philadelphia, Pa.

HAVE THE LATEST IMPROVEMENTS. No machine shop can be thoroughly up-to-date unless it has the most modern perfected tools.

ASHLEY PATENT NIPPLE HOLDERS hold nipples for cutting either right or left hand threads. They hold the sleeve from turning and take the strain off both the sleeve and shank thread.

HIGH GRADE WOOD WORKING MACHINERY Single Machines or Complete Equipments for Any Class of Work.

J. A. FAY & CO. 10-30 John St., CINCINNATI, OHIO

MACHINES FOR ROLLING SCREW THREADS. Any size up to 1" diameter, 3" long. Four sizes of machines.

BLAKE & JOHNSON, P. O. Box 7, Waterbury, Conn.

THE ELECTRIC HEATER.—A VALUABLE paper, with working drawings of various forms of the electrical heaters, including electric soldering iron, electric pad for the sick, etc.

LATHES FOR GUNSMITHS, TOOL MAKERS, EXPERIMENTAL AND REPAIR WORK, ETC. W. F. & Jno. Barnes Co. 1999 Ruby Street, ROCKFORD, ILL.

ROUND OR SQUARE BASE SKINNER Improved PLANER CHUCKS. Heavy, strong accurately made. Greater capacity than any other chuck.

"Universal" Kneading and Mixing Machines Over 600 in use. Over 300 varieties in 155 different industries. Patented in all countries. WERNER & PFLEIDERER Saginaw, Mich. Builders of all kinds of Chemical Machinery, also at Cannstatt, London, Vienna, Berlin, Paris and Moscow.

The Yankee DRILL GRINDER for grinding both Twist and Flat Drills. Grinds all sized drills from 1/8 to 3/4 in. Can be set for any size in a few seconds.

You spend thousands on coal bills—but how much to save the steam? Want to know more about it?—Ask for our booklet "H" on the HEINTZ STEAM TRAP. WILLIAM S. HAINES CO., 136 South Fourth St., Philadelphia, Pa.

Table listing various mechanical parts and their prices, including Knitting machine striper attachment, Labeling machine, Ladder, Lamp, etc.

TWO VALUABLE PATENTS FOR SALE. AN IMPROVED FLYNET AND CHECKEASE FOR HORSES.

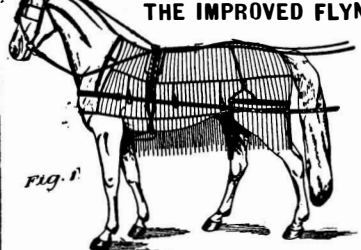

By means of certain ELASTIC PORTIONS, this Flynet is always kept in position and will fit large or small horses. It is adapted to extend to the collar or hames of the harness and will cover the horse to a greater extent than the ordinary nets while not interfering with the comfort or movements of the horse.

THE IMPROVED CHECKEASE is made of ELASTIC MATERIAL or cord fitted with suitable checking devices and applied in such a manner that a horse may use the muscles of the neck by dropping or turning the head from side to side but will quickly return to the desired raised position.

E. READ GOODRIDGE, Decker Building, 33 Union Square, NEW YORK.

SAVE 1/2 Your FUEL wasted up chimney. BY USING THE ROCHESTER RADIIATOR. COST \$2.00 AND UP. Money refunded if not satisfactory. ROCHESTER RADIIATOR CO., 60 Furnace Street, Rochester, N. Y.

Foreign Trade Marks FOR American Merchants. It is not generally understood amongst merchants that in many foreign countries the first registrant of a Trade Mark becomes the legal owner of said Mark.

GREAT POWER—SMALL COST! The maximum of strength, durability and safety, with the minimum of cost that describes our HOISTING ENGINES for operation on Gasoline, Distillate or Crude Oil.

MIETZ & WEISS KEROSENE and GAS Engine The most economical power known. Absolutely safe and reliable. Burns with common kerosene. Perfectly automatic.

WITTE GASOLINE "HOISTS" Guaranteed to work at any altitude if you get it with the electric igniter. You can not afford to assume any risk and with a "Witte Hoist" you don't do it. Write your own Guarantee. Ask for catalog S.A. Witte Iron Wks. Co. 120 Walnut St., KANSAS CITY, Mo.

Gas Engine IGNITER Complete with spark coil, \$1.50. The Best Thing on the Market. Send for catalogue. The Carlisle & Finch Co., Sixth St., Cincinnati, O.

The "Wolverine" Three Cylinder Gasoline Marine Engine. The only reversing and self starting gas engine on the market. Lightest engine for the power built. Practically no vibration. Absolutely safe.

SMALL POWER MOTORS. This cut represents our small 110 volt Direct Current Motor with clamp attachment. We make these in three sizes 1-10, 1-8 and 1-6 h. p. Can also furnish them on flat base or with speed regulating rheostat in base.

PERFECT - PUMP - POWER. is attained only in the TABER ROTARY PUMPS. They are mechanical simple and durable. Will pump hot or cold fluid, thin or thick. Requires no skilled mechanic.

Planning the New Home Anyone contemplating the building of a new home will find the Building Edition of the Scientific American of peculiar and absorbing interest.

MUNN & CO. PATENT SOLICITORS, 361 BROADWAY, NEW YORK. For full information concerning Foreign Trade Mark Registration, address

LUCKE'S ROLLS Made of a stock for 50 years controlled by Spanish export trade in Porto Rico. Secured by us for American consumption at 1-6th cost of Cuban leaf. A most pleasing astonishment to any lover of a rich, tropical-flavored tobacco.

The Pipe of the Century ...THE... "MALLINGKROTT" PATENT NICOTINE ABSORBENT AND VENTILATED SMOKING PIPE, IS THE ONLY PIPE FIT FOR A GENTLEMAN TO SMOKE.

DON'T BE HARD UP \$2,000 A YEAR EASY Plating. Gold, Silver, Nickel and Metal for traveling, taking orders, using and selling Prof. Gray's Plating. Plates, Watches, Jewelry, Tableware, Bicycles, and all metal goods.

Planning the New Home Building Edition of the Scientific American of peculiar and absorbing interest. This beautiful publication is issued monthly, and contains practical articles and suggestions on modern house building.

(Continued on page 271)

From the Shop

to the office; from a small salary to a good one, is but a step if you go the right way about it. Our system makes it easy for you to

CHANGE YOUR WORK

without loss of present salary. We guarantee to give you an education by mail in Steam, Electrical, Mechanical or Civil Engineering; Mechanical and Architectural Drawing; Bookkeeping; Shorthand, and English Branches. 37,000 students and graduates.

The International Correspondence Schools, Box 942, Scranton, Pa.

To the Office

"American-Hunnings" TELEPHONES.

Transmitters, Magnet Bells and Telephone Switchboards. Over 200,000 of our telephones in successful operation. Used by War and Navy Departments.

Buy Telephones THAT ARE GOOD--NOT "CHEAP THINGS." The difference in cost is little. We guarantee our apparatus and guarantee our customers against loss by patent suits.

WESTERN TELEPHONE CONSTRUCTION CO 250-254 South Clinton St., Chicago. Largest Manufacturers of Telephones exclusively in the United States.

NICKEL AND Electro-Plating

Apparatus and Material. THE Hanson & Van Winkle Co., Newark, N. J.

The Ideal Hunting Shoe

The concentrated product of fifty years of shoemaking skill. Ten inches high, Bellows tongue, uppers gray color, soft as a glove, tough as steel, cannot harden.

M. A. SMITH & SON, Manufacturers, 29 and 31 N. 13th St., Philadelphia, Pa.

BABBITT METALS.—SIX IMPORTANT formulas. SCIENTIFIC AMERICAN SUPPLEMENT 1123.

DEWEY SEARCH-LIGHT. The neatest, most attractive and timely novelty yet gotten up in connection with celebration to the Great Admiral.

RAILWAY APPLIANCES Introduced and Manufactured Abroad.

Persons controlling patents for railway appliances of recognized merit for track signalling or rolling stock, desiring to have them manufactured and introduced in Great Britain or British possessions in South Africa, India, and Australia, or in Egypt, can make favorable arrangements with a long established British manufacturer of such appliances, well known to railway managers in those countries.

Snake Watch Chain

Latest Vienna novelty. Made of highly polished GUN STEEL. Not a link is visible, but so flexible it can be wound round the finger. Smooth as satin but very strong. Your jeweler never saw anything like it.

PATENT PROTECTION

Cuba, Porto Rico, AND THE Philippines. Owners of United States Patents, Trade Marks, Prints and Labels may procure protection in the Colonial possessions of the United States by effecting registration in these countries.

MUNN & CO. PATENT SOLICITORS, 361 BROADWAY, NEW YORK. 625 F STREET, WASHINGTON, D. C.

THE HARRINGTON & KING PERFORATING CO. PERFORATED METALS OF EVERY DESCRIPTION FOR ALL USES. CHICAGO SCREENS OF ALL KINDS.

- Tire valve, bicycle, R. Honold, 634.752
Tobacco granulating machine, A. Picken, 634.476
Tobacco pipe, J. T. Davey, 634.806

50 YEARS' EXPERIENCE PATENTS

Anyone sending a sketch and description may quickly ascertain our opinion free whether an invention is probably patentable. Communications strictly confidential.

Scientific American. A handsomely illustrated weekly. Largest circulation of any scientific journal. Terms, \$3 a year, four months, \$1.

MUNN & Co. 361 Broadway, New York

We want to buy some patents, inventions, ideas. Write to BUCKLAND & SON, San Francisco, Cal.

TURBINES

MACHINES, Corliss Engines, Brewers' and Bottlers' Machinery. THE MILLER MFG. CO., 329 Clinton Street, Milwaukee, Wis.

ICE MACHINES

apparatus, scientific novelties, etc. Illustrated catalogue of parlor tricks free. Complete catalogue with 600 engravings, 20c.

FOR STEREOPTICONS AND SLIDES

Inventions Practically Developed. Fine Machinery, Pattern and Model Making. D'Amour & Littledale Machine Co., 130 Worth St., N. Y.

GAS AND GASOLINE ENGINES

FOR SALE--Van Norman Lathes, 29 in., Waltham Watch Tool Co.'s make, with full attachments, nearly new.

SO SIMPLE A CHILD CAN USE THEM. SUNART CAMERAS



N. Y. CAMERA EXCHANGE. 50% Saved on all makes of Cameras

THE ONLY CAMERA FOR ALL PURPOSES IS THE PREMO ROCHESTER OPTICAL CO. 30 SOUTH ST. ROCHESTER, N.Y.

ELECTRIC POCKET SEARCH LIGHT

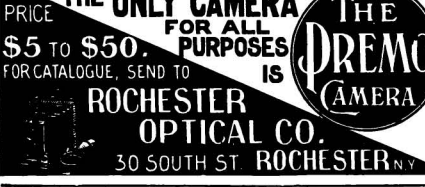

FINE GREY IRON CASTINGS. Art Castings in Iron, Stove Plate, Light and Medium Weight Machinery Castings, Cold Work Patterns

LIFE PRODUCERS

JUST OUT.—Send for List No. 9.—150 Illustrations of CHISELS, GOUGES, CARVING TOOLS, RAZORS, PLANE IRONS, PLATE IRONS, TRIMMING TOOLS.

THE WIZARD'S TABLET

AMERICAN PATENTS.—AN INTERESTING and valuable table showing the number of patents granted for the various subjects upon which petitions have been filed from the beginning down to December 31, 1894.

\$3 a Day Sure

Models and Experimental Work. Inventions Developed. Special Machinery. E. V. BAILLARD, 106 Liberty Street, New York.

Brass Band

Burst Water Pipes a Thing of the Past. You can now make all water pipes as secure from bursting in winter as in summer.

THE PNEUMATIC DOME MANUFACTURING COMPANY, 501 E Street, Northwest, Washington, D. C.

DESIGNS.

- Axle dust guard, C. L. McCallister, 31.641
Badge, E. & H. De Mulin, 31.618
Badge, G. Greenburg, 31.617

TRADE MARKS.

- Bitters, Luytjes Brothers, 33.545
Boots, shoes, and slippers, Packard & Field, 33.538
Brooms, O. K. Kilmann, 33.537

LABELS.

- "Alt-Bayerisch," for bottled beer, Joseph Fallert Brewing Company, 7.165
"Consomme," for soups, American Food Company, 7.166
"Dodge's Sore Throat Cure," for a medicine, B. E. Matthews & Company, 7.167

THOROUGH INSPECTIONS
 AND INSURANCE AGAINST LOSS OR DAMAGE TO PROPERTY AND LOSS OF LIFE AND INJURY TO PERSONS CAUSED BY
STEAM-BOILER EXPLOSIONS
 HARTFORD STEAM BOILER INSPECTION AND INSURANCE CO.
 HARTFORD, CONN.
 J. M. ALLEN, PRESIDENT; W. B. FRANKLIN, VICE PRESIDENT; J. D. PIERCE, SECRETARY; F. B. ALLEN, 2ND VICE PRESIDENT; L. BRAINERD, ASST. TREAS.; L. F. MIDDLEBROOK, ASST. SECY.

JESSOP'S STEEL THE VERY BEST FOR TOOLS, SAWS, ETC.
 Wm. JESSOP & SONS, 121 JOHN ST., NEW YORK

The Passing of the Pacers.

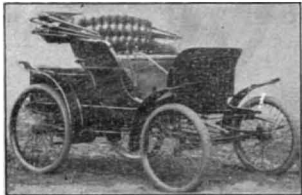

Thoroughbreds are going out of fashion. Automobiles are coming in. In fact, they are in **THE WINTON MOTOR PHAETON**

sets the style in the new conveyances. It is the acme of elegance, utility and safety. Easily operated, even by a novice. Hydro-carbon system. Write for catalogue.
THE WINTON MOTOR CARRIAGE CO., Cleveland, Ohio.

THE POINT IS BE VALUETY WRITER
SMITH PREMIER
 TYPEWRITER
 Claims this Distinction and POINTS with pride to its Superior CONSTRUCTION, SIMPLICITY, AND DURABILITY.
 Send for Art Catalogue, Free
THE SMITH PREMIER TYPEWRITER CO
 Syracuse, N.Y. U.S.A.

T. AUSTEN, Ph.D., President. F. J. MAYWALD, Vice-Pres. L. S. MOTT, Sec. and Treas.

The Austen Chemical Research Co.

Experimental Investigation of Technical Problems. Research Work for Manufacturers. Improvement and Invention of Processes and Products. Utilization of Wastes and Unapplied Substances. Reduction of Manufacturing Costs. Testing, Perfecting, Introducing and Disposing of Processes and Products. Manufacturing Formulas. Explanatory Circular on Application.
 52 BEAVER STREET, NEW YORK.

GARDNER'S STOCK
 C. H. BISHOP & CO. 10-12 N. CANAL ST. CHICAGO ILL. U.S.A.

You Owe It

to your Family and Friends to have a

Gram-o-phone

in your home.

ADMIRAL SCHLEY writes:

"Nothing in the sound reproductions of to-day so marvelous as this wonderful discovery."

TRIAL OFFER.

Subscribers to **The Scientific American**

On receipt of \$5.00, simply as evidence of good faith, we will ship to any subscriber to the **SCIENTIFIC AMERICAN** our new \$18.00 Gram-o-phone, and six (6) signed, indestructible 50-cent records (total \$21.00), your own or our selection, with the privilege of 24 hours' examination, when the balance may be paid your express company, or goods returned and your money refunded. By paying \$1.00 extra, payments may be made in installments. Send for printed matter giving particulars.

FOR SALE EVERYWHERE.
National Gram-o-phone Corporation,
 Broadway & 18th Street, New York.

THE MODERATE PRICE of Waltham Watches has placed within the reach of every one accurate time-keepers that will last a lifetime. A watch movement particularly recommended is the "**RIVERSIDE**." For sale by all retail jewelers in any quality of case desired.

The "Perfected American Watch," an illustrated book of interesting information about watches, will be sent upon request.
 American Waltham Watch Company, Waltham, Mass.



WELL, THAT'S FINE!

WELL THAT'S FINE!
 So Everyone Says Who Uses the
"GEM" SAFETY RAZOR

IMPOSSIBLE TO CUT THE FACE.
 It's the BEST and SIMPLEST Safety ever devised. No experience required.
WE GUARANTEE AND KEEP THEM SHARP FOR ONE YEAR.
PRICE \$2.00, POSTPAID.
 Your money back if you cannot shave yourself with the "Gem" Safety Razor.
 Send for Illustrated Price List.
THE GEM CUTLERY CO., 673 Hudson St., NEW YORK.

The Remington
 Typewriter goes into
 Every Corner of the Earth
 and does
Good Service
 Everywhere
 WYCKOFF, SEAMANS & BENEDICT, NEW YORK

For Correct Styles in AUTOMOBILES
WOODS MOTOR VEHICLES

are the **Standard of the World**, for the Woods Motor Vehicle Company, under the Woods designs, sets the style in every known form of Automobile from the light Top Buggy illustrated here to the finest Broughams, Victorias and Cabs. The simplicity of their mechanical and electrical construction makes these vehicles **standard** to-day and ten years from to-day; and the point considered in the development of these vehicles — of which over thirty different styles are catalogued — is that they are carriages in every sense of the word and not mere conveyances that go without a horse, as the many enthusiastic owners of Woods Motor Vehicle Company Carriages bear testimony.

Latest Style, Lightest Weight, Weight 1000 lbs.
Lowest Priced Electric Speed per hour 14 miles.
Vehicle in the World. Mileage capacity, one charge 25 miles.

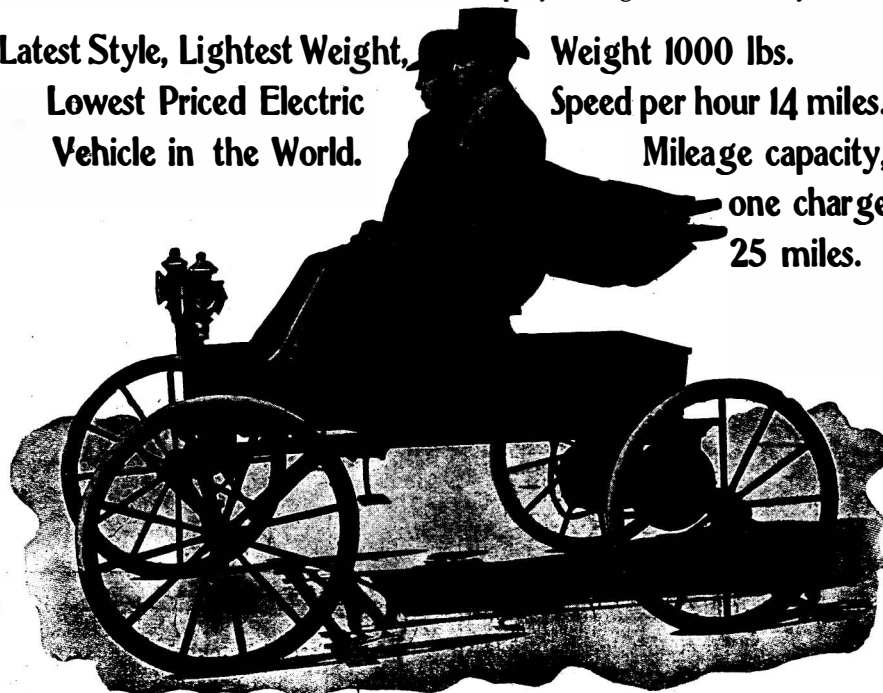

Price \$1000.00 net. ROAD WAGON WITH TOP. Price without Top \$925.00.

The tremendous demand for the splendid conveyance illustrated above, being as it is a light side bar top carriage, with all the life, character and lightness of such a vehicle, is taxing the Company's manufacturing facilities as fast as it can increase them, and to insure prompt delivery in the Spring it advises placing orders early this Fall and Winter. It can, however, make prompt delivery at present on this particular style of vehicle in from thirty to forty days.

Send for book of magnificent illustrations of latest styles in Automobiles.

WOODS MOTOR VEHICLE COMPANY,

547-551 Wabash Ave., CHICAGO. Vanderbilt Ave. and 44th St., NEW YORK CITY. 14 King St., TORONTO, CANADA.

HIGH GRADE FOOT POWER LATHES

W. P. DAVIS, ROCHESTER, N. Y.

ASBESTOS FIRE-FELT COVERINGS
 PURE ASBESTOS, ABSOLUTELY FIRE PROOF.
 REPLETE WITH AIR CELLS. PERFECT NON-CONDUCTORS.
 STRONG, LIGHT, FLEXIBLE, EASILY APPLIED.
 MADE IN SECTIONS THREE FEET LONG
 FIT STANDARD PIPE 1/2 INCH TO 16 INCHES.
H. W. JOHNS MFG CO.
 NEW YORK, CHICAGO, PHILADELPHIA, BOSTON
 ASBESTOS MATERIALS, LIQUID PAINTS & STAINS
 ROOFING MATERIALS, ELECTRICAL MATERIALS.

"PEGAMOID" ALUMINUM PAINT.

Latest application of Aluminum. Looks like Frosted Silver. Washable, Untarnishable, Water, Oil and Weatherproof. Durable. Easily Applied. Bicycles, Yachts, Radiators, Pipes, Metal Work, Machinery, Dynamometers, Apparatus, Arc Lamps, Sockets, Brackets, Cars, Stations, General Decoration, etc. Sample bottle, by mail, for 25 cents.
THE AMERICAN PEGAMOID CO., 339 B'way, New York.

WILLIAMS' SHAVING STICK
 MAKES A SMILING FACE
 WILLIAMS' SOAPS SOLD EVERYWHERE, BUT SENT BY MAIL IF YOUR DEALER DOES NOT SUPPLY YOU.
 Williams' Shaving Stick, . . . 25 cents.
 Genuine Yankee Shaving Soap, 10 cents.
 Luxury Shaving Tablet, . . . 25 cents.
 Williams' Shaving Soap (Barbers'), Six Round Cakes, 1 lb., . . . 40 cents.
 Exquisite also for toilet. Trial cake for 2c. stamp.
The J. B. WILLIAMS CO., Glastonbury, Conn.
 LONDON: 54 GREAT RUSSELL ST., W.C. SYDNEY: 181 CLARENCE ST.

PRATT'S PATENT POSITIVE DRIVE DRILL CHUCKS.

Impossible for Drills to slip when held by them. Send 2 cent stamp for Illustrated Catalogue.
THE PRATT CHUCK CO., Frankfort, N. Y., U. S. A.

The Typewriter Exchange

1 1/2 Barclay St., NEW YORK
 124 La Salle St., CHICAGO
 38 Bromfield St., BOSTON
 817 Wyandotte St., KANSAS CITY, MO.
 209 North 9th St., ST. LOUIS, MO.
 432 Diamond St., PITTSBURGH, PA.
 We will save you from 10 to 50% on Typewriters of all makes.
 Send for Catalogue.

ADVANTAGES OF Our Patent Gold Process of Galvanizing Cut and Wire Nails.

Very low cost, smooth surface, coating will not crack off heads or elsewhere, no sticking together. Orders received. Estimates and information furnished to manufacturers upon application for plants to galvanize nails or other articles under license on royalty basis. Inspection of process in operation at our plants is invited. See article in **SCIENTIFIC AMERICAN**, April 22, 1899.
U. S. Electro Galvanizing Co., 346 Broadway, New York

COMPTON
 Mistakes in Addition, Office Headache, and mistakes in carrying forward don't occur where the Comptometer is used. It saves half the time in doing the work and all time looking for errors. Solves with great rapidity and absolute accuracy all arithmetical problems. Why don't you get one?
 Write for Pamphlet.
FELT & TARRANT MFG CO.
 52-56 ILLINOIS ST., CHICAGO.

Scales All varieties at lowest prices. Best Railroad Track and Wagon or Stock Scales made. Also 1000 useful articles, including Safes, Sewing Machines, Bicycles, Tools, etc. Save Money. Lists Free. **CHICAGO SCALE CO., Chicago, Ill.**

PAYS to write for our 256-page free book. Tells how men with small capital can make money with a **Magic Lantern** or Stereopticon.
McALLISTER, Mfg. Optician, 49 Nassau St., N. Y.

A USE OF POWER can hardly be named (unless it be for driving an airship) that the **CHARTER**

is not being applied to it uses Gasoline; was the first in the U. S. to use Gasoline; is pre-eminent to-day. Proof from all over the Western Hemisphere, by addressing **CHARTER GAS ENGINE CO., Box 148, STERLING, ILL.**

PIERCE WELL ENGINEERING CO. 186 Liberty Street, New York. Manufacturers of Machinery for **WATER, OIL and GAS WELLS,** Mineral Prospecting, Test Borings, 10 to 5000 feet deep. Largest experience, best line, highest grade in America. Send for catalog, 200 engravings. State what is wanted.

PRINTING INKS
 The **SCIENTIFIC AMERICAN** is printed with **CHAS. ENEU JOHNSON & CO.'S INK,** Tenth and Lombard Sts., Philadelphia, and 47 Rose St., opp. Duane, New York