

SCIENTIFIC AMERICAN

[Entered at the Post Office of New York, N. Y., as Second Class Matter. Copyright, 1902, by Munn & Co.]

Vol. LXXXVI.—No. 11.
ESTABLISHED 1845.

NEW YORK, MARCH 15, 1902.

[\$3.00 A YEAR.
8 CENTS A COPY.]



Trainload of Copper Bars.

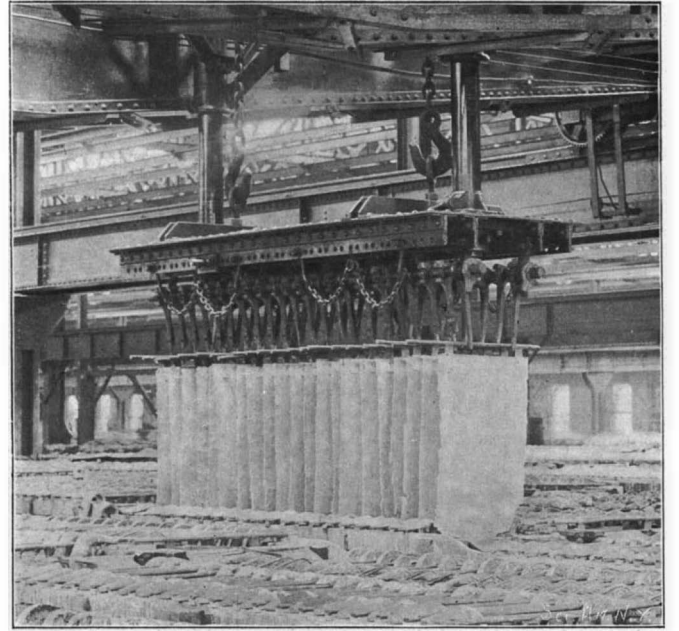

Traveling Crane Placing Set of Cathode Plates in a Tank.



The Tank House. Measures 200 by 600 Feet. Contains 1,600 Tanks.

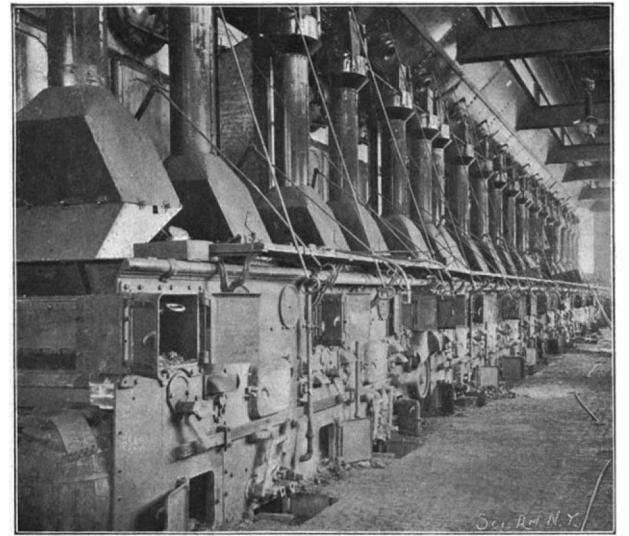

Boiler Room.

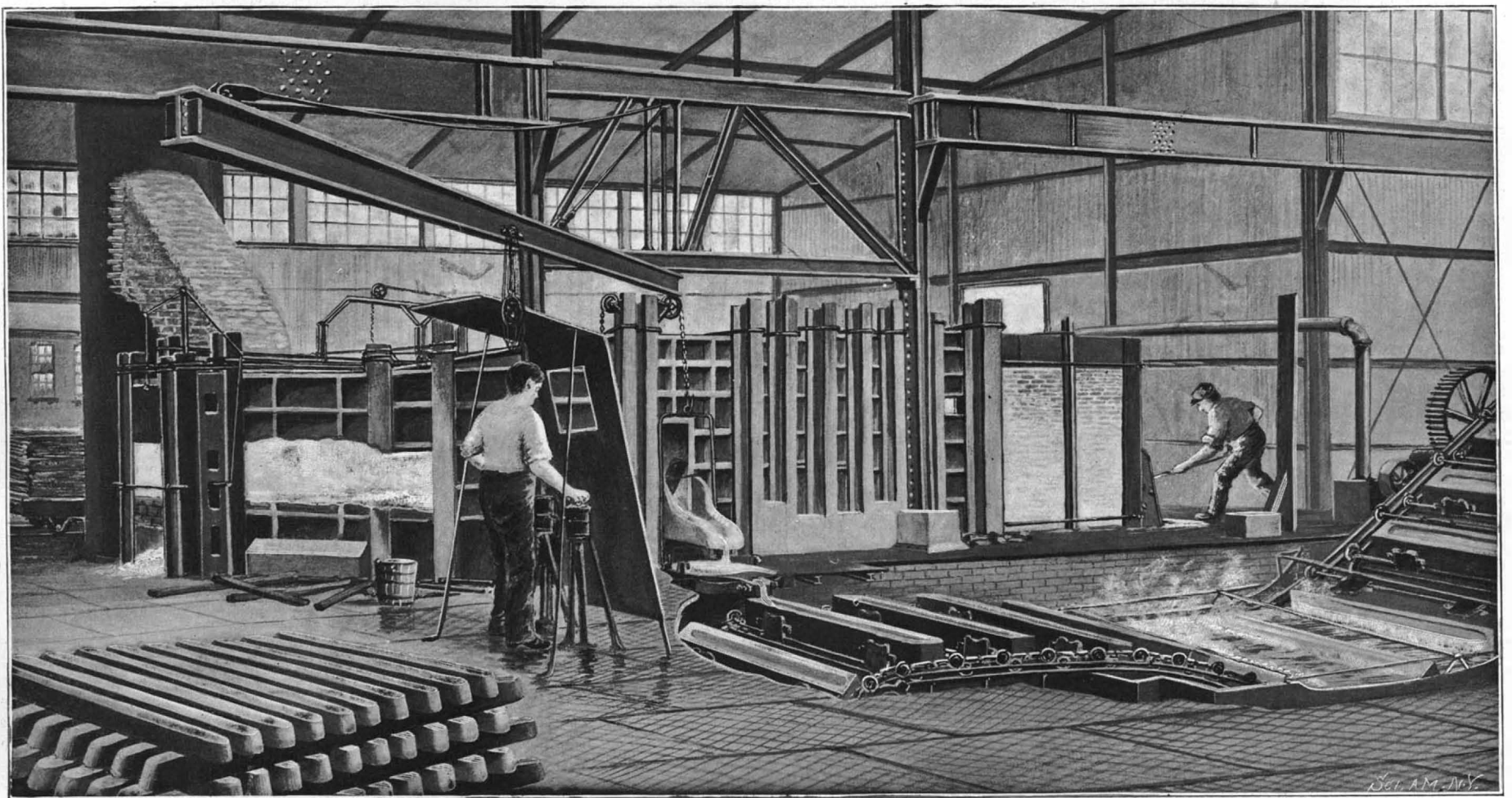

The Furnace House—Casting and Cooling Refined Copper Bars.
THE ELECTROLYTIC REFINING OF COPPER.—[See page 187.]

SCIENTIFIC AMERICAN

ESTABLISHED 1845

MUNN & CO., - - Editors and Proprietors

Published Weekly at

No. 361 Broadway, New York

TERMS TO SUBSCRIBERS

One copy, one year for the United States, Canada, or Mexico \$3.00
 One copy, one year, to any foreign country, postage prepaid. £0 16s. 5d. 4.00

THE SCIENTIFIC AMERICAN PUBLICATIONS.

Scientific American (Established 1845) \$3.00 a year
 Scientific American Supplement (Established 1876) 5.00
 Scientific American Building Monthly (Established 1885) 2.50
 Scientific American Export Edition (Established 1873) 3.00
 The combined subscription rates and rates to foreign countries will be furnished upon application.

Remit by postal or express money order, or by bank draft or check.
 MUNN & CO., 361 Broadway, New York.

NEW YORK, SATURDAY, MARCH 15, 1902.

The Editor is always glad to receive for examination illustrated articles on subjects of timely interest. If the photographs are sharp, the articles short, and the facts authentic, the contributions will receive special attention. Accepted articles will be paid for at regular space rates.

THE NEW CUNARD LINERS.

If there is one company more than another that is identified with the history of the transatlantic passage it is the Cunard Company, and its historical interest is enhanced by the fact that through all its long service it can boast of having never lost a passenger. At the present writing, however, one of its most famous vessels, the "Etruria," is being towed into port, suffering from that most common of all steamship ailments, a broken propeller shaft. This mishap, by the way, serves merely to emphasize the wonderfully successful record of this ship and her sister ship the "Umbria." Although they were put in service as long ago as 1888, they are now good for over 19 knots an hour. They are the largest single-screw vessels in the world, and represented, at the date of their launch, the most advanced ideas in marine engine construction. The "Etruria" was the first ship to make the transatlantic passage at an average speed of 20 knots an hour.

Equally famous as record-breakers were the next pair of Cunarders, the "Campania" and "Lucania," the latter of which was the first liner to pass the 22-knot mark for the whole passage. These two vessels, it may be truly said, were the progenitors of the high-speed twin-screw vessels of the last decade of the nineteenth century. With their great length of over 600 feet, their large engine power of over 30,000 horse power, and their use of tandem, multi-cylinder engines, they introduced the latest era in the growth of the high-speed liner, of which such vessels as the "Deutschland," "Oceanic," and "Kronprinz" are the latest developments. The Cunard Company have seemed content to rest on the laurels gained for them by these vessels, and for nearly a decade they have seen the German companies forge to the front in the production of ocean "fliers." For the past two years, however, they have been considering the question of putting two new high-speed vessels on the Queenstown route, and we are able to state authoritatively that it has now been determined to give these ships such speed-lines and engine power that they will be considerably faster than any ocean liner building or planned at the present time. The probabilities are that the contract speed will not be less than 25 knots an hour, and in view of the fact that to secure this speed in ships of the size would require not less than 47,000 horse power, it is natural that the company should seriously consider the adoption of the steam turbine, with the object of reducing the weight and bulk of the necessary installation of boilers and engines. Although the use of the turbine has not been definitely determined upon, there is a strong movement among the directors in favor of its adoption.

We commented last week upon the fact that in the equipment of one of the underground London railways, the central power station was to be equipped with steam turbines, each of 10,000 maximum indicated horse power. There is every reason to believe that the performance of these turbines will be eminently satisfactory. It is certain that the variations of load to which turbines of the same size would be subjected on board an Atlantic liner would not be more severe than those experienced in the operation of an electric road, for the turbine is peculiarly susceptible to its governor, and with the great depth of submersion of the propellers of ships of this size the liability to racing in heavy weather, with its resulting variations of load and stress, would be largely avoided. An equipment of four 12,000 horse power turbines on four shafts would give the required horse power for the speed, and we venture to say that the perfect absence of engine vibration—propeller vibration will always be present—would render these ships, should they be so equipped, the most popular high-speed liners in the world.

THE PARK AVENUE HOTEL FIRE.

The Park Avenue Hotel fire, in which a score of persons lost their lives, does not prove, as the daily press would have us believe, that fireproofing is a failure. On the contrary, there is every reason to

believe that it was the fireproof construction of the hotel, limited though it was in degree, that prevented a positive holocaust, in comparison with which the present loss of life would be insignificant. Strictly speaking, the building should be called semi-fireproof. It was built over twenty years ago, and probably included all the latest ideas on fireproof construction. The main walls, which are of brick, are substantial, and have a cast iron sheathing on the outside. The floors consist of I-beams with brick arches turned in between. There are the usual partition walls, and, of course, there is an abundance of inflammable wood-work throughout the building.

The evidence thus far come to light tends to show that the fire started at the bottom of an elevator shaft and spread from thence to the corridors on the various floors; and it is to the existence of a considerable amount of woodwork in the elevator shaft, in the windows opening from the shaft to the courtyard, and in the doors leading to the corridors, that the exceedingly rapid spread of the fire is due. Had this wood-work been fireproofed, or, better yet, had the window sashes and doors and all fittings throughout the shaft been constructed of metal, it is probable the fire would have been confined to the shaft, and that not a single life would have been lost. At the same time, the evidence of the Chief of the Fire Department shows that the hotel was sadly deficient in fire-fighting apparatus. The firemen complained of being unable to find stand-pipes or fire hose, and there appears to have been but very inadequate provision of fire alarms for meeting such an emergency as occurred on the night of the disaster.

Undoubtedly the loss of life was largely due to the ignorance on the part of the transient guests of the fact that there were rear staircases by which they could have escaped from the hotel. As it was, they rushed for the central staircase adjoining the elevator, and in doing so ran into the fire itself; a fact which emphasizes the necessity for providing more conspicuous signs than those that are ordinarily found in hotels to-day, directing guests to fire escapes or to alternate stairways and elevators. We venture to say that in scores of hotels, where there are two or more separate staircases or elevators, the majority of the guests are aware simply of the existence of the one elevator which is most adjacent to their own rooms. In this connection we would most earnestly impress the fact that in large hotels and office buildings it would conduce greatly to the safety of the guests if, instead of concentrating the elevators in one locality, they were placed at two or more widely separated positions in the building.

WIRELESS TELEGRAPHY IN NAVAL WARFARE.

The feat accomplished by Marconi on his recent trip to this country, when he received distinct tape-written messages from Poldhu, Cornwall, until he was over 1,500 miles from that point, must have served to silence all doubts as to the commercial practicability of wireless telegraphy. Nowhere is the success of this system being watched more keenly than by the navies of the world, for it is well understood that, in proportion as the range of wireless telegraphy is extended, will the operations of future naval campaigns be greatly modified. Already it is possible to communicate across 1,500 miles of water, and although it is true that the sending station of Poldhu is equipped with a specially powerful plant, we presume there are no mechanical or structural difficulties in the way of equipping naval scouting vessels with sending apparatus of equal power. We notice that the British government has authorized the construction of four new vessels of the naval scout type which are to have a speed of 25 knots an hour and are to be equipped with very lofty masts for wireless telegraphy purposes. It is probable that this type of ship, which was originated by Russia with the ships of the "Novik" class, is destined to enjoy a popularity similar to that of the torpedo boat and the destroyer. With fleets of these craft patrolling the sailing lines between the most important strategic points, a nation will be able to keep in close touch with all important movements of the enemy, and naval warfare will be played very much less in the dark than it has been. If, for instance, during our late war, wireless communication over 1,500 miles of water had been possible, the naval operations would have been greatly simplified and much confusion and anxiety avoided. It will be remembered that in our blind groping to get in touch with Cervera's fleet, and in the attempt to conduct the war by the triangular Washington-Sampson-Schley method of communication, the transmission of news was ultimately dependent upon the speed and good luck, in finding either commander, of the various converted yachts and cruisers of comparatively low sea speed that were used to carry dispatches. It is certain that many of the risks of the war that were run and much of the confusion and controversy that resulted were due to the difficulty of obtaining quick communication from shore to ship and between the ships themselves.

With a 1,500-mile-radius Marconi system installed, however, how completely the story of the war might have been changed. Let us suppose that stations similar to that at Poldhu had been erected at Key West and at Washington, and that all the important vessels engaged in the campaign had carried sending and receiving apparatus to match it. Let the reader take a map and strike, with a 1,500-mile radius, circles from Key West and Washington, and he will find that from both stations it would have been possible to communicate directly or indirectly with every vessel engaged in the Santiago campaign throughout the whole of the operations of the war. Instead of our fast ocean scouts "Yale," "Harvard," "St. Paul" and "St. Louis" having to remain within reasonably close touch of a telegraphic station, these vessels, had they been so minded, could have cruised far across the Atlantic Ocean; or they could have formed complete chains of communication with Washington by stationing one at the Canary Islands and another at Cadiz to give notice of the start of the Spanish fleet or fleets, and stationing the other two in mid-ocean to pick up the news and transmit it to Admiral Sampson, or direct to the Key West or Washington station. The "Oregon" would have been in touch with Key West nearly a week before she completed her voyage around Cape Horn, while, in the Philippines, Dewey, by leaving one of his smaller non-fighting craft at Hong Kong, could have cut the cable, as he did, and yet have communicated hourly with Hong Kong and so with the Navy Department at Washington.

Returning to the Santiago campaign, we can see that all the miserable imbroglia known as the Sampson-Schley controversy never have occurred, for Schley would have been relieved of all doubt as to the proper course to take in the matter of blockading the Spanish ports, or of making retrograde movements, for he would have been in touch both with Sampson and the Navy Department at Washington, either directly, or through the intermediary of some United States vessel, carrying the Marconi equipment.

In view of the far-reaching effects which the demonstrated success of wireless telegraphy is bound to have on naval warfare we are glad to notice that Rear-Admiral Bradford, Chief of the Bureau of Equipment, is said to have ordered wireless telegraphy equipments of various types, in which are included the Marconi and the Slaby-Arco, which are to be thoroughly tested before it is decided what system will be adopted by the United States navy.

A PLEDGE TO IMPROVE THE PARK AVENUE TUNNEL.

The investigation by the Grand Jury of the recent accident in the Park Avenue tunnel of the New York Central Railroad Company, in which seventeen people lost their lives, has resulted in the indictment of the engineer of the New York Central train for manslaughter, and the dismissal of the complaint against the railroad company. The complaint stated that it was the duty of the company to use all reasonable means to prevent trains from running under such close headway as to be in danger of collision, and to equip their line with an adequate system of signals, but that the company omitted to perform its duty as thus outlined. The testimony before the Grand Jury occupied three days and a half in presentation, and a day and a half was spent in discussing the same. District Attorney Jerome has stated that the law in the case was carefully examined by himself and his assistants, and that the Grand Jury, which he describes as being "exceptionally intelligent," fully understood everything connected with the case. Furthermore, Mr. Jerome, who certainly cannot be accused of partiality to the railroad company's side of the case, was of the opinion that further proceedings against the railroad company would be inexpedient and futile.

Unquestionably, the feature in the evidence which was considered to absolve the railroad company from the charge of culpable negligence was the practically unanimous testimony of the experts that the signaling system employed in the tunnel was the very best in existence. Speaking in a general way, and considering this system of signals in respect of its efficiency when used under normal conditions, we quite agree with the experts that it is the best in existence. But inasmuch as the system depends for its efficiency upon the visibility of the signals, and the evidence clearly proved that, under conditions which are perpetually occurring in the tunnel, the signals are not visible, we are inclined to think this "best system in the world" for use in the open and under normal conditions, ceases to be so under the exceedingly abnormal conditions that exist in the Park Avenue Tunnel. We venture to say that there is no stretch of track in all the 400,000 miles of railroad in the world where the conditions are similar to, or even approach, those in this tunnel. "What is one man's meat is another man's poison." The best signals in the world for the stretch of viaduct, for instance, by which the New York Central tracks approach the tunnel, from the north, may become, as the event has surely proved, an exceedingly unreliable and treacherous system if it is extended

into the darkness and smoke and steam-obscured atmosphere of the tunnel itself. In saying this we are still in perfect agreement with the findings of the Grand Jury, who had to deal simply with the legal technicalities of the case and the expert evidence as presented. What we claim is that where a signal system that depends on visibility ceases to be visible, it is time to apply some automatic, contact system, which shall be independent of atmospheric conditions, and shall stop a train with the certainty with which any other well-designed automatic appliance performs its functions.

Having said this much, however, we hasten to state our gratification with the very prompt and unmistakably sincere pledge which the Directors of the New York Central Railroad Company have recently given to the Mayor of New York city, that just as soon as they can obtain the proper legislative sanction they will proceed with the electrifying of the local suburban service and the construction of the tunnel-loop terminals beneath the present Grand Central Depot. This pledge has been given in the form of a letter signed by Messrs. Vanderbilt, Depew and Morgan and a half dozen other prominent Directors. The letter opens by stating that the writers have been informed that the Mayor has given his support to a bill pending in the Assembly, the object of which is to name a fixed date on and after which the use of steam in the Park Avenue tunnel shall be forbidden; that the Directors are advised that, while it is practicable to operate the suburban service electrically by using the side tracks and an underground loop at the terminal, in the present stage of the art it is not practicable to operate electrically the heavy through trains which carry distant as distinguished from local traffic; and that the company is ready to undertake this work of construction as soon as the requisite consents from State and municipal authorities are obtained. At present there is a law existing which forbids the use of any power except steam in the tunnel.

The letter, deprecating the fixing of a strict time limit, proceeds as follows: "In lieu of such legislative action, the company herewith pledges to the city its good faith to proceed with the substitution of electricity for steam upon the side tracks immediately upon the grant to the company of the necessary authority to do so, and to carry the work forward as rapidly as possible. In addition the company also pledges itself to substitute electricity for steam in the operation of the central tracks, as soon as and whenever a practical plan can be prepared which gives reasonable promise of producing satisfactory results. This pledge on the part of the company is intended to carry with it the good faith of the individual Directors who compose its Board."

On receipt of the letter, Mayor Low communicated with the Chairman of the Assembly Committee on Railroads in Albany as follows: "In any private relation of life the personal assurance of these gentlemen (the signers of the letter) would be considered as being in every respect as good as their bond. The letter, therefore, seems to me to lay a good foundation for the waiving of a fixed date to be named in the bill for the prohibition of the use of steam in the tunnel, provided that in other respects the railroad company meet the views of those most interested." We do not doubt that the great majority of the public will agree with the Mayor in accepting the pledge of the New York Central Directors as being given in perfect good faith. There is every commercial reason why the company should desire to ameliorate tunnel conditions, to say nothing of the humanitarian side of the question. Unquestionably the interests of the company in the past have suffered enormous injury because of the "tunnel nuisance," as it is very aptly termed, and the recent accident is bound to have a most serious deterrent effect upon home-seekers who, but for the tunnel, would be disposed to locate in the many charming suburbs along the Sound and in Westchester County. The ordinance prohibiting the use of any other power than steam in the tunnel should be repealed at once. As to the question of fixing a time limit, we think that as a mere question of business policy it should be done. Tunnel building and the electrical equipment of suburban lines are not new and untried arts; and it would not be difficult to name a date for the completion of the New York Central changes which would cover all possible contingencies. The anxiety of the company to have the time limit clause waived, is easily explained. The problem of electrical equipment of large systems is passing through a critical stage, and there are some questions that a delay of a few years would see satisfactorily solved, such, for instance, as the relative value of the steam turbine and the reciprocating engine for central power plants, or the superiority of the direct-current (American) or alternating current (Ganz) systems of motors. The immediate adoption of one or the other system might ultimately prove to be a costly move to the company. This, however, is a risk that the company must be prepared to take; for it is out of the question to ask the public to wait for an indefinite period, while the question of the best

system of electrification of steam roads is being solved. There is a good system available for suburban railroad traffic now. Let the company use it; and let the Legislature by all means fix a reasonable time limit for the completion of the work.

THE BRITISH NAVAL PROGRAM FOR 1903— REORGANIZING THE FLEET.

BY OUR ENGLISH CORRESPONDENT.

According to the naval program of the British government for 1902 many important changes are advocated in the construction and armament of future battleships. This decision is the result of the recent progressive developments in explosives and projectiles. The vote for the navy for the present year aggregates \$156,275,000, which is an increase of \$897,500 over the estimates for the year 1901. Of this total sum \$45,290,000 is to be expended upon the construction of 27 new warships of all types, comprising: 2 battleships, 2 armored cruisers, 2 third-class cruisers, 4 "scouts," 9 destroyers, 4 torpedo boats, 4 submarines.

Although the sum voted for new vessels is smaller than was anticipated, the Admiralty, following the example of France and certain other European powers, intend to devote a large sum of money to extensive rearmament and overhauling of the largest and comparatively recent vessels of the present navy. This scheme of modernization affects 25 vessels in all. The plan of reconstruction is as follows:

Eight battleships of the "Royal Sovereign" class to have secondary batteries on upper deck (comprising six 6-inch quick-firers each) placed in armored casemates.

Battleships "Barfleur" and "Centurion," each to have her ten 4.7-inch guns firing a 50-pound shell replaced by 6-inch quick-firers firing a 100-pound shell.

Cruisers "Powerful" and "Terrible," each to have four more 6-inch quick-firers in casemates added, increasing the total number of these weapons to 16.

Thirteen cruisers of the "Arrogant" and "Talbot" classes, each to have six 6-inch quick-firers in place of 4.7-inch weapons.

During 1902 the construction of 60 new vessels will be completed and 27 new vessels commenced, and by March 31, 1903, the navy will be augmented by the following strength: Battleships, 13; cruisers, armored, 22; cruisers, second-class, 2; cruisers, third-class, 2; sloops, 4; auxiliary vessels, 2; destroyers, 10; torpedo boats, 5; battleships authorized in 1902 program, 27; total, 85 vessels of all types.

The decision of the Inquiry Committee into the recent mysterious loss of the torpedo-boat destroyer "Cobra" in the North Sea, due to frailty in construction, and also the numerous accidents, such as buckling and starting of plates, that have befallen other destroyers when encountering heavy weather, has not proved unavailing with the Naval Department. The designs for this type of vessel and the work it is to accomplish have been considerably modified. When destroyers were first designed it was not contemplated that they would be frequently used otherwise than as working from a fixed base. Experience, however, has shown that vessels with greater sea-keeping power are required for service with the fleets, and, accordingly, the Admiralty has decided both materially to strengthen the type of future destroyers and also to create a new class altogether, to which the name "scout" has been given. The Admiralty do not propose that the naval designer should initiate a design for this new class of vessel, but invite the private ship-builders of the country to give the navy the benefit of their creative ingenuity by submitting designs to fulfill certain stated conditions.

Moreover, a special committee has also been appointed to advise the Admiralty in respect of the strengthening of some of the existing vessels. The Naval Department has often been urged to build large numbers of destroyers at a time; but this is not considered an advisable policy. In the first place, the destroyer is a type of warship which is still in process of rapid evolution; in the second place, it must by its nature be a short-lived type; and to build large numbers in the same year would inevitably result in large numbers becoming obsolete at the same time.

A new departure is also to be made in connection with the disposition of the armor, in the armor-clads, as an offset to the vast improvements that have recently been made in high power explosives and shells. This arrangement of the armor is to be made upon the three new first-class battleships, which will be named, respectively, "King Edward VII.," "Commonwealth" and "Dominion." When completed these vessels will be far ahead of any of the battleships in the British navy, so far as the armor protection and its scheme of disposition is concerned. Indeed, the only vessel to compare with them is the Japanese battleship "Mikasa," built by the Vickers-Maxim Company, whose design is stated to be the result of this innovation in the British practice of armor protection. As in the "Mikasa," the main broadside armor of the new British ships is to be carried to the upper deck, so that all broadside guns on the main deck will

be completely protected by the armor of the citadel. The new British ships will excel the Japanese "Mikasa" in the thickness of plating, owing to their larger total displacement, for while the "Mikasa" is 15,200 tons, these new vessels are to be of 16,350 tons. This main belt will, as in the "Mikasa," be between 21 feet and 22 feet deep, extending 5 feet below the water line, so that in the event of the ship's rolling there will be no chance of the unarmored bottom being exposed, even momentarily, to hostile fire. Over 70 per cent of the total length of the new ships will be protected by belts, whereas in the "Majestic" class the proportion of the length armored is 55 per cent, in the "Admiral" class 43 per cent, and in the "Inflexible" 34 per cent. The water line belts in the new ships will be 9 inches thick in the citadel, reduced by stages to 4 inches at the ends. For the length of the citadel the thickness will be 8 inches from the main belt up to the level of the main deck, and from the main deck to the upper deck 7 inches. The division bulkheads between the 6-inch guns on the main deck and the longitudinal armor wall behind the guns will be of hardened steel.

The new armored cruisers are to be of a modified "County" type. They will be 450 feet in length, 67 feet beam, and 10,200 tons displacement, whereas the "County" class measure 440 feet in length by 66 feet beam with a displacement of 9,800 tons. The new vessels, however, will have the same draught of 24 feet 6 inches. The slight increase in length is to enable a different type of boiler to be used, and also to allow of 7.5-inch guns to be used in each turret at the forward and after end of the vessels, instead of twin 6-inch guns as in some of the preceding ships.

Another new departure is to be the inauguration of coal depot vessels for torpedo-boat destroyers, of two distinct characters, to be utilized accordingly as the destroyers are, or are not acting from a fixed base. One class of depot ship is being prepared for the flotillas at the home ports, and the "Leander" is being prepared as a depot ship for the destroyers in the Mediterranean. From this experience the Naval Department hope to learn more clearly what is exactly required in this direction; but if the new "scout" class should prove a success, these depot ships would not be wanted for them to the same extent. In the case of distilling ships, one has been bought and fitted which should be in service within the year, and experiments have been made with others. But in this connection it is suggested that far more satisfaction would be attained if by improvements in the boilers ships were to distill their own water, and to be rendered independent of auxiliary distilling vessels.

In connection with fuel, the Admiralty are continuing their experiments with the Temperley-Miller apparatus for coaling battleships while in motion, and are also studying the possibility of utilizing oil fuel. An engineer has been specially detailed to superintend the latter experiments, so that the trials may be conducted thoroughly, and exhaustive information obtained as to the feasibility of employing liquid fuel upon a sufficiently extensive scale. Reserve stocks of patent fuel have been deposited at the several naval depots abroad also.

Although the unfortunate disasters to the "Viper" and "Cobra" prevented the Admiralty from obtaining sufficient data regarding the possibilities of utilizing the Parsons turbine for the propulsion of war vessels, the Naval Department intend to experiment further with these turbines. For this purpose two torpedo-boat destroyers and one third-class cruiser are to be engined with the Parsons turbine. The fitting of the turbine in the latter vessel will afford a splendid opportunity for effectively testing its qualities as compared with reciprocating engines, for in this case, in view of the high speed to be developed, the weight available for the machinery has to be minimized. The speed for 3,000 tons displacement on a draught of 14 feet 6 inches is to be 21¾ knots, and yet only 548 tons is allowed for machinery; so that even with water-tube boilers of the express type only 2.65 square feet of heating surface is allowed per horse power, and the boilers are required to develop 20 horse power per square foot of heating surface.

An important alteration has also been made with regard to the letting out of contracts and the supervision of naval construction in private yards. Hitherto this duty has been performed by the Department of Naval Construction. It is now considered, however, owing to the magnitude of the fleet, that this department is sufficiently occupied with the duty of designing. This responsibility of supervising private naval work is to be vested in a new department, the chief of which is to be officially known as the Controller of the Navy. The qualifications of this official are a thorough knowledge of Admiralty practice and an exhaustive technical knowledge of ship construction. It is anticipated that naval construction in private yards will, as a result of this change in the Admiralty administration, considerably facilitate and expedite the execution of Admiralty contracts, which will result in a greater efficiency and economy.

THE SEARCH LIGHT IN PHOTOGRAPHIC WORK.

BY FRANK C. PERKINS, BUFFALO, N. Y.

In photography, art printing, and many other similar kinds of work, it is necessary to work with surfaces illuminated as evenly and as brightly as possible. Such work is now being largely done abroad by means of projectors of the same general construction as the ordinary searchlight as to form, electric current used, and type of feeding mechanism employed, but the projectors are fitted with transverse dispersers, as indicated in the accompanying illustrations. Fig. 1 shows the method of using a projector for photographic purposes and the transverse disperser projector is noted in Fig. 2. This type of focusing arc light apparatus is constructed by the Elektrizitäts-Aktien Gesellschaft, formerly known as Schuckert & Co., of Nurnberg, Germany, the celebrated searchlight electrical manufacturers.

The rays from the parabolic glass mirror, which are almost parallel, are first spread horizontally by means of an ordinary disperser of about 20 deg., with a cylindrical lens running vertically. Each lens distributes in an angle of 20 deg. the whole of the light falling upon it, causing a superposition of the images of all the lenses and effecting an equalization of the unevenness of the projector rays. In front of this a second lens is attached which distributes the light vertically on the same principle.

When adjusted at a maximum intensity and uniformity, the illuminated square has a width and height of 85 centimeters, with the disperser a distance of 2½ meters from the illuminated surface, the current being about 35 amperes at the focusing arc lamp. If the current is increased to 50 amperes and a somewhat larger disperser is used having a mirror of 600 millimeters in diameter instead of 450 millimeters as in the former case, the area of the illuminated square will be 88 by 88 centimeters. As the disperser is increased in distance from the illuminated surface to 3, 4 and 5 meters, the illuminated square is increased in size from 100 centimeters square to 158 centimeters square, with currents of from 35 to 50 amperes. The weight of these special projectors is from 175 kilogrammes to 290 kilogrammes, the former weight representing a disperser having a mirror 450 millimeters in diameter and the latter a disperser with a mirror 600 millimeters in diameter. Excellent results are obtained with this new apparatus, although the cost is somewhat higher than photo-engraving lamps, this class of apparatus being generally used in this country.

THE ATBARA RIVER BRIDGE.

The world-wide attention attracted by the construction and erection of the Atbara Bridge in the Soudan was due to other causes than the magnitude of the work itself. The chief of these were, first, that the bridge was urgently required in connection with the British campaign in the Soudan; second, that the work was awarded to an American firm because of its promise of shorter delivery and lower price than could be obtained from English firms; third, because, although the contract time was very short, the work was completed well within the time.

The events which led up to the awarding of this contract to an American firm are to be found in the conditions and necessities of the campaign against the Dervishes by Kitchener, whose success was due mainly to the fact that he opened a line of railway communication as he went, and was able to concentrate his forces with full supplies, etc., right in the heart of the far-distant Soudan country. In order to continue his campaign against the Dervishes, the General found it necessary to complete a railway line as far south as Khartoum, and this involved bridging the Atbara River. The place selected for the bridge is 1,100 feet wide. During part of the year the river at the site is entirely dry, but during the summer months, beginning with the latter part of June, it is a raging torrent. The army engineers

having constructed a railway some distance south of the Atbara, found it beyond their power to bridge the river itself; and the British Egyptian government, on making inquiries in England early in October, found that two years were required for the construction of the bridge, the reason given being that the shops were overcrowded with work. Second tenders were then asked of two American and five British firms, speedy delivery being laid down as the chief consideration. The lowest bid was that of the Maryland Steel Com-

pany, which offered to deliver the bridge material at Liverpool at the price of 2.55 cents per pound, within four months, the next offer being that of an English firm, Horsley, which offered to deliver the material at 2.89 cents in three and a quarter months. When the tenders reached Egypt in the latter part of December,

1898, it was found that since the bidders expected to use falsework in erecting the bridge, the work could not be prosecuted until after the summer floods, which would involve the loss of a year's time. Accordingly new bids were asked, based upon the condition that no falsework should be used, and the bridge should be built by overhang, from pier to pier. The Patent Shaft and Axle Company, the only British firm which responded to the final call, offered to do the work at 3.37 cents per pound, delivering the first span in Liverpool in sixty days and the rest in three weeks, while the best American bid, that of the Pencoyd Iron Works, offered to do the work at 2.5 cents per pound, the whole of the bridge to be delivered in New York in forty-two days. The bid of the last-named company, was, of course, accepted.

The Atbara structure is a single-track, narrow-gage railway bridge, composed of seven pin-connected through-spans, each 147 feet in length between centers of end pins. The width, center to center, of the trusses is 16 feet 2 inches, and the depth between chord centers is 21 feet 6 inches. The trusses, as will be seen from our illustrations, are of the ordinary Pratt type, with inclined end-posts and stiff, riveted bottom chords instead of eye-bars which latter, for many years, were the prevailing practice in American bridges. The Pencoyd Iron Works, allowing two weeks for shipment to Liverpool, promised the delivery of

the work in a third of the time required by the British firm, and at the same time asked a much lower price per pound for the steel. The bridge is carried upon steel cylinder piers, 8 feet 3 inches in diameter, covered by cast-iron pier-caps. The substructure was built by a Cairo firm, while the Pencoyd Iron Works designed and furnished the entire superstructure under a lump-sum contract, while they also furnished the pier-caps and the erection plant and tools under a special pound-price contract. The same company provided the extra erection force, a superintendent, two foremen and five riveters, riggers, etc. The bridge was designed to carry two engines, each weighing 181,000 pounds, followed by a uniform load of 2,240 pounds per foot. The material specified was open-hearth steel, ranging from 60,000 to 70,000 pounds ultimate strength. The plans, method of erection, etc., were worked out under the supervision of Messrs. C. C. Schneider, the Chief, and P. L. Wolfe, the Assistant Chief Engineer.

The method of erection was as follows: One span was erected temporarily on shore to serve as a holdback anchorage for the first span over the river. The inshore end of this temporary span was loaded with 60,000 pounds of steel rails; a steel traveling derrick was erected on the top chords, and a temporary connection made between the two spans to take the tension in the top chords and the compression in the bottom chords. After the connection over the pier had been made the erection proceeded continuously across the river, while the overhang method, which is customary in the erection of cantilever bridges, was used. As soon as the span had been carried far enough out to enable the booms of the traveler to reach the next pier, the cast-iron pier-caps were set, and the span was completed and thus rendered self-sustaining.

The weight of the bridge is as follows: Superstructure, 1,258,300 pounds; temporary steel work and traveler, 121,000 pounds; cast-iron pier-caps, 129,600 pounds; duplicates and extras, 4,000, making a total of 1,512,900 pounds. The account of the construction of this bridge, given after its completion by Richard Khuen, in an article before the Engineers' Club of Philadelphia, gives a categorical statement showing the extreme rapidity with which this contract was carried through. The first inquiry was received January 7; on January 13 cantilever erection was specified; three days later the statement of the maximum loading of the bridge

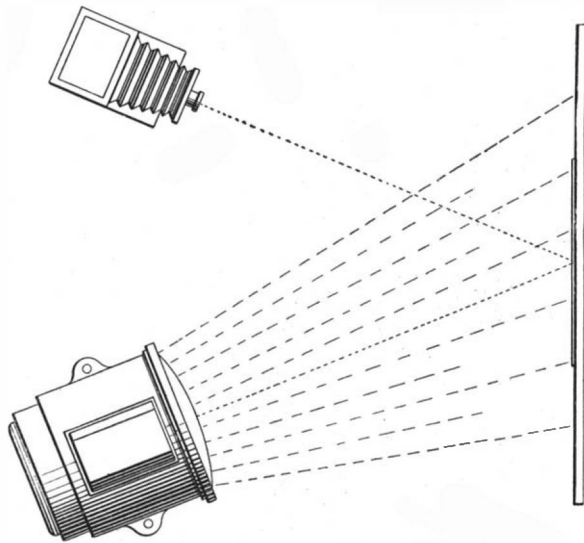

Fig. 1.—PLAN VIEW OF THE PROJECTOR IN OPERATION.

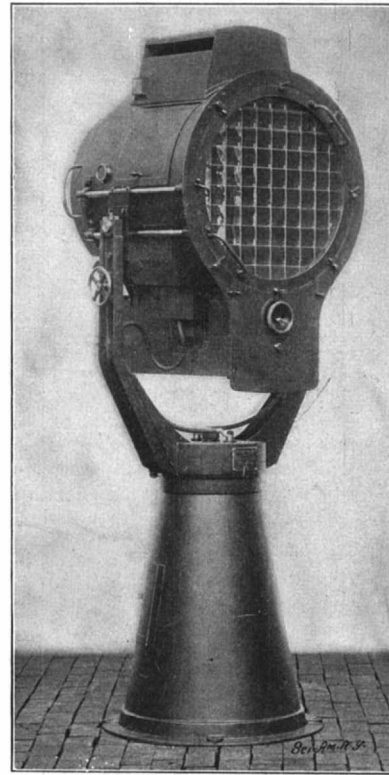

Fig. 2.—A TRANSVERSE DISPERSER PROJECTOR.

pany, which offered to deliver the bridge material at Liverpool at the price of 2.55 cents per pound, within four months, the next offer being that of an English firm, Horsley, which offered to deliver the material at 2.89 cents in three and a quarter months. When the tenders reached Egypt in the latter part of December,



PORTAL VIEW OF THE COMPLETED BRIDGE.



Seven 147-foot spans; total weight of superstructure, 620 tons. Order received January 20; structure shipped March 7; erection completed August 19.

ATBARA BRIDGE IN THE SOUDAN, IN COURSE OF ERECTION.

was received, and on January 20 a quotation was sent to England. Four days later the company received the order for the bridge and the specifications. Two days later a change of the span length was ordered, and on the following day, January 27, the stress sheet was completed. In ten days the shop drawings were finished and all material ordered, and on February 6 work was started in the template and bridge shops. March 7, just a month later, the entire structure was shipped from the Pencoyd Works, in spite of the fact that seven days were lost on account of the closing of the shops during a blizzard. The entire time from receipt of final data to date of shipment was forty days, or two days within the contract time. Excluding the seven days lost on account of the blizzard, and four Sundays, we find that only twenty-nine actual working days were consumed in working out the design and details and building the structure ready for erection.

Although the designing and manufacturing of the bridge was a very rapid piece of work, it is not so difficult a feat as it was considered to be in England. The capacity of the Pencoyd Bridge shop ranges from 5,000 to 6,000 net tons per month. On the basis of 5,000 tons per month, the 750 tons comprising the whole contract represent only about four days' work for the entire shop. The erection crew left New York April 22, and reached Atbara June 16. A little over two months later, August 19, the bridge was finished; that is to say, within seven months of the date of the placing of the contract. The shortest time occupied in erecting any one span was four days. The merit of this work, considered as an engineering performance, was acknowledged by General, now Lord Kitchener, in his address at the formal opening of the bridge. He said: "The opening of this bridge is due to their [i. e., American] energy and ability and the power they possess in so marked a degree of turning out work of

this magnitude in less time than it can be done by any one else. I congratulate the American foremen and workmen on the excellent success which has crowned their efforts in the erection of this bridge in the heart of Africa, far from their homes, during the hottest months of the year, and dependent solely on the labor of men speaking a foreign tongue. They

THE MERGENTHALER-HORTON BASKET-MAKING MACHINERY.

It has been one of the peculiarities of the fruit industry of the United States that the makers of baskets have found it difficult to cope with the overwhelming orders of the fruit-growers. This unfortunate peculiarity has been due primarily to the fact that all fruit-

baskets used in America have been produced by hand.

In 1894 a machine was patented by Mr. Emmet Horton, which was the first practical apparatus for the mechanical making of baskets. Horton did not stop with the invention of a solitary labor-saving device. Continuing his work, he devised improvements, simplified complex constructions, increased the operative efficiency, and at last produced a machine that could turn out more baskets in an hour than could twelve skilled basket-makers under the old system. When it is considered that the machine can be operated at a cost less than the wages of a single workman, that the baskets are produced as rapidly as they can be counted, and that they are better and stronger than those made by hand, the industrial possibilities of such a machine are evident.

In later years, Mr. Horton was associated with Ottmar Mergenthaler, whose name will ever be linked with the famous linotype machine. These two invent-

ors produced the machines shown in our illustrations, now made by the Mergenthaler-Horton Basket Machine Company of 287 Broadway, New York city. The present article will be devoted to a general description of three types of machines now in use, two of which serve for the making of grape baskets, and the other for the making of berry baskets.

The berry-basket machine is to a very large extent the product of Mr. Horton's genius. It is a mechanical

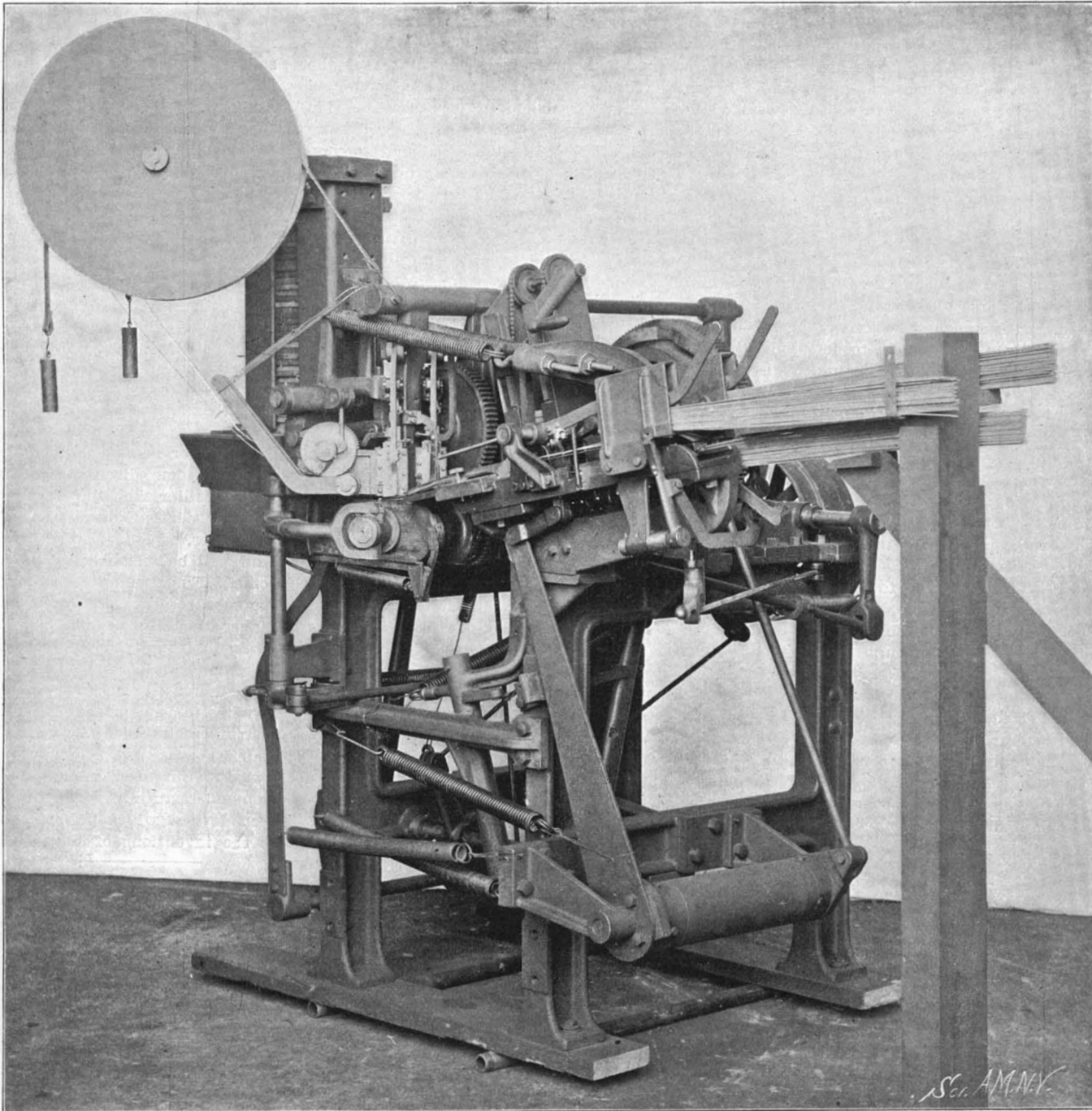

MERGENTHALER GRAPE BASKET MACHINE.

have shown by their work the real grit they are made of."

Consul Bergh, of Gothenburg, writes: The Göteborgs Mekaniska Werkstads Aktiebolag, of this city, intends to build a drydock for vessels 490 feet long and of 25 feet draft, or from 6,800 to 8,000 tons displacement, and has applied to the government for subsidies. If this dock is built it may to an extent promote the establishment of direct transatlantic steamship communication. The present drydock is not large enough for ocean steamers of largest size.

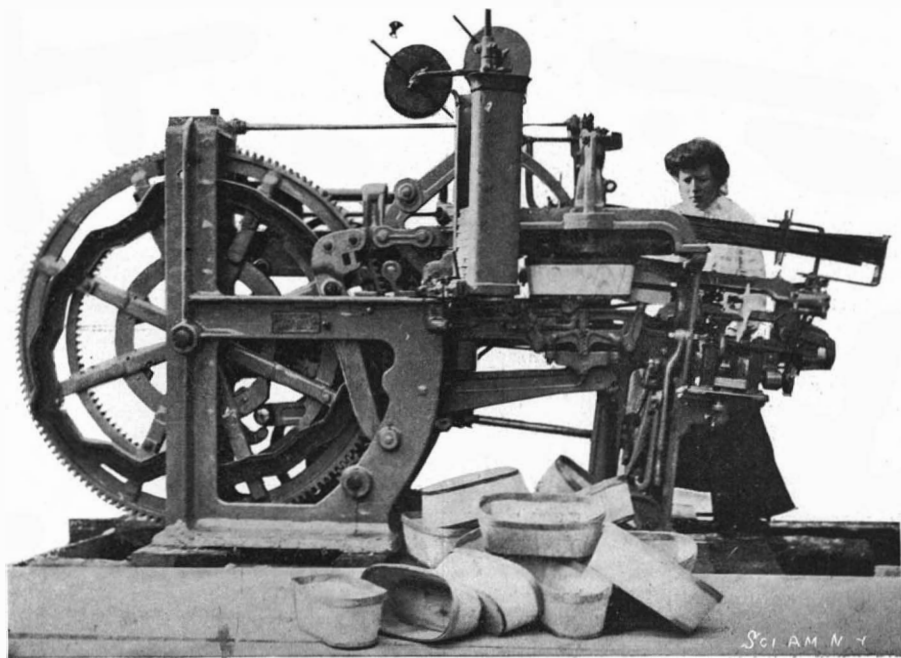

HORTON GRAPE-BASKET MACHINE,

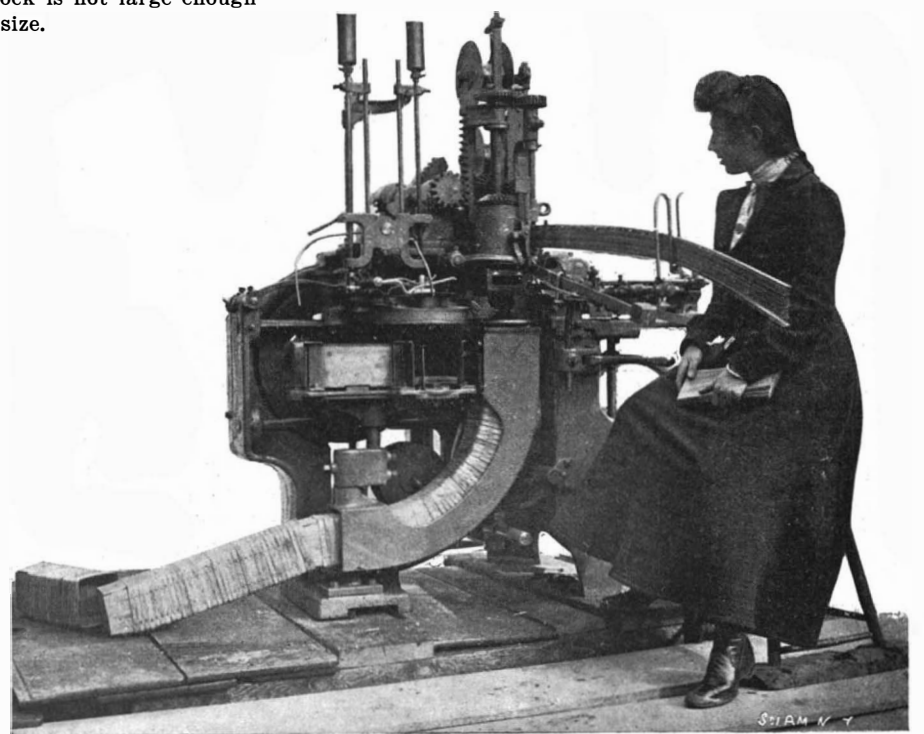

HORTON BERRY-BASKET MACHINE.

substitute for human fingers, but almost immeasurably more efficient. The sides and bottom of the berry-baskets are formed of crossed veneers or sheets of suitable wood of appropriate shape, which veneers or sheets are bent into shape by forming mechanism and secured at their edges by a wrapped band lying inside and outside the edges, properly nailed or stapled. The novel features of this particular machine are to be found in the mode of operation and in the bringing together of the blanks and forming mechanism in order to produce a completed basket. The blanks are bent by means of a form and a die. The form is axially movable, and intermittently rotative; the die is rotative and laterally movable. In order to receive the blank, the die is moved laterally away from the form. While the die is so removed, the form is rotated through three-fourths of a revolution to wrap a band, which has been applied to one side, around the remaining three sides of the form. Thereupon the die is returned opposite the form, the form is caused to move axially into the die to fold the blanks upon it, and is thereafter successively partially rotated, while the band is wrapped and nailed, and further moved axially after the die has moved laterally away from it, to deposit the basket in a receiver. All that now remains to be done is to staple the basket, which is done by a bottom nailer and a side nailer. The bottom nailer is laterally movable, and co-acts with the laterally-movable basket-receiver, in which the completed basket is deposited by the form. As the receiver is moved from opposite the form, the nailer is moved opposite the form, a nail is driven into the bottom of the basket, the nailer is moved away, and the receiver is again brought into position in order to receive the completed basket. During the three-fourths revolution to which the form is subjected in order to wrap the band, a nail is driven into the band at one side of the basket. The basket is then successively rotated through one-fourth of a revolution at each step, the side of the basket being nailed after each fourth of a revolution. The completed baskets are received in a curved basket-receiving chute in which they are deposited by the form, and which delivers them nested to the base of the machine. This brief outline of the mode of operation, brief because of the limited amount of space at our disposal, will give a general idea of the ingenuity of the construction.

One of our illustrations pictures a grape-basket making machine, the parts of which are also automatically secured together by staples, which are automatically formed and driven as the operation of assembling the parts progresses.

The blanks for forming the sides of the basket are taken one at a time from a magazine by a "picker," which delivers them to a "holder." From the holder the blanks are taken by a "gripper" and carried to a form, about which they are assembled and secured to other parts of the basket. The "gripper" consists of two jaws which are automatically opened and closed at the proper time and which are moved back and forth between the sides-holder and the form. Provision is made for opening the jaws either automatically or at the will of the attendant. The bottom pieces are fed from a bottom-supply receptacle or magazine which is made adjustable for different sizes of bottoms, and which is so supported that it will move out of the way should it be subjected to excessive pressure by an improper operation of the crane. The picker is so operated that it moves quickly and positively when in the act of picking up a side piece, but more slowly when moving with a blank from the sides receptacle or magazine to the grippers, so there is sure to be no liability of moving more than one side piece at a time, and danger of dropping the side is avoided. Guides are provided to direct the sides so that they are evenly bent around the form. The band-feeding mechanism is of simple and novel construction. The inner ends of the bands are arranged in gangs or bunches on supports, disposed at an angle with reference to the axis of the form. Where the form is arranged on a vertical axis, the supports for the inner ends of the bands are made horizontal, and on them the bands are arranged to lie edgewise vertically. Feed-screws are mounted on a horizontal axis in such a manner that they enter between the bands, separate them and deliver them, one at a time from each bunch to a chute, through which they pass to the form adjacent to the stapling mechanism. The stapling mechanism feeds the wire, cuts it into proper lengths, bends it to form staples, and drives the staples into the basket.

Mr. Mergenthaler's grape-basket machine differs somewhat in principle from the basket-making machines invented by Mr. Horton. Instead of storing the bottoms in a pile from which the gripping-jaws of the crane carry them to the form, and swing them to the form, Mr. Mergenthaler achieves the same results by disposing the bottoms in a magazine, across the lower end of which reciprocates a slide that delivers the bottoms, one at a time to a narrow chamber. This narrow chamber holds the bottoms vertically in line with the end of the form, which is mounted on a horizontal axis. The upper end of a

feed-lever provided with clamping devices reciprocates through the narrow chamber and moves each basket into position in front of the form, where it is taken by another lever moving at right angles to the feed-lever and pressed against the end of the form, to be held there during the making of the baskets. The sides are fed from their magazine by a slide to a pocket in line with another slide, by which they are moved upon a table, from which they pass to the form. The slide, whereby the sides are fed to the form, also feeds the bands. Sometimes it is desirable that the sides be made slightly to overlap in the completed basket; and devices are employed to cause the side pieces to overlap while they are being secured together. The bands are held in stacks in separate compartments of a magazine from which they are delivered laterally to a slide, which transfers them to guides from which they are taken by another slide. Reciprocating toward and from the form, this latter slide feeds the bands to the form. As the bands are fed forward, a side-piece is taken up by the slide, which delivers it with the bands to the form. Enough side pieces are fed to the form by the slide for completing a basket without feeding the bands by the slide, for the bands are drawn forward without being actuated by the slide, after the first side piece has been secured to the bands. As in the Horton machine, the staples are made from a continuous length of wire and driven into the stock, immediately after being formed. Since the stapling mechanism moves with the form during the operation of driving a staple, considerable speed is gained in constructing the basket. So far as the driving mechanism is concerned, attention should be called to the fact that no mutilated gears are used. For the most part, the working elements are driven by the cams of a single cam-shaft, which actuates levers connected by rods with the parts to be operated. Some few parts, however, are driven by spur-gears or by ratchets, the whole being so constructed as to operate smoothly and without material interruption.

A single grape-basket machine of the best type produced by the Mergenthaler-Horton system is capable of making 4,000 complete grape-baskets in a day. A single berry-basket machine can produce 12,000 complete quart berry baskets in a day, or in other words, 20 baskets a minute. When it is considered that 2,000,000,000 baskets are annually required to hold the grapes, berries and peaches of American farmers and fruit growers, the importance of the saving of labor in the manufacture of baskets is manifest.

Marconi's Latest Feat.

Following hard upon the transmission of the letter "s" from Cornwall to Newfoundland by wireless telegraphy comes the news of the transmission of entire messages for a distance of 1,551 miles.

On board the steamship "Philadelphia," bound westward, Marconi made a series of experiments, the purpose of which was to determine at exactly to what distance it was possible for his station at Poldhu, Cornwall, to transmit an intelligible message. He asserts that at a distance of some 1,551 miles he received distinct communications, and that simple signals were perceptible at 2,100 miles. Those who were skeptical when the news was first spread last December of transoceanic signaling will have but little to criticize in the latest performance of Marconi. The officers of the "Philadelphia" and the tape of the recording instrument fully corroborate the statements of the inventor. In Newfoundland Marconi had received the sound of the signal "s" through a telephone receiver, so faint was the ticking of the instrument; but now he can exhibit ribbons of paper bearing the messages sent from Cornwall up to a distance of 1,551 miles, and after that the signal letter "s" to a distance of 2,099 miles.

The "Philadelphia" sailed from Cherbourg on Saturday, February 1, at 6 P. M. Two hundred and fifty miles west of Poldhu the first experimental message was received, which read, "Stiff southwest breeze. Fairly heavy swell." That same night, when the "Philadelphia" was 500 miles off Cornwall, a second message was received, reading, "All in order. Sign. Do you understand?" Both of these messages the chief officers of the ship signed. On the 4th, when the "Philadelphia" had passed the 1,000-mile mark of her voyage, the captain and first officer of the vessel received a message, "Fine here. Thanks for telegram." The following morning saw the receipt of a fourth message, when the "Philadelphia" was 1,163 miles west of Poldhu. It read, "May every blessing attend you and your party." The fifth message, which was the last that came in words, was received on the same day, and its import was somewhat similar to that of the second. After the receipt of the fifth message the letter "s" was telegraphed by the operator at Cornwall merely to inform those on board the vessel that the station was still at work. Finally, when the liner had passed the 2,099th mile, the tests were stopped. The messages mentioned were only a few of those actually received. Communication was

kept up almost constantly; but it was deemed unnecessary to submit to the public more than half a dozen signed tapes.

Marconi, it is said, hopes to succeed in transmitting messages commercially across the Atlantic during the coming three months. The European station will probably be continued at Poldhu; on the American side two stations will be used, one at Cape Breton and the other at Cape Cod. In order to send and receive messages it will be necessary to build towers of sufficiently substantial construction to withstand the fierce gales that ravage the eastern coast of North America. The instruments are to be of the latest type and of the highest power yet used.

The receiver of the "Philadelphia" was not constructed for long-distance work. For that reason it was capable merely of receiving, not of sending messages. The success obtained may be fittingly termed a triumph for Marconi and for his system.

At the present time wireless telegraphy has been of service chiefly in placing steamships, in communication with one another. Both in the merchant marine and in the navies of the world we may soon expect to see a rapid development and a more general introduction of the Marconi system and as well as of its European rivals. That wireless telegraphy will sooner or later become a formidable competitor of the submarine cable seems fairly certain; but whether it will ever supersede land telegraphy is a question open to some discussion. Wireless apparatus is so much costlier than the simple Morse instruments commonly used that, despite the necessity of using wires and poles, it is doubtful whether communication on land will be seriously modified for many a decade to come. Furthermore, it must be remembered that the speed of transmission by the Morse system is far higher than that which has so far been obtained by ethereal telegraphy. The quadruplex systems of telegraphy which have been introduced in late years have increased the speed of transmission by means of wires to an enormous extent. Many sets of Marconi instruments would be required to send the messages which are carried by a single wire in a quadruplex system. But after all is said and done it cannot be disputed that a new method of communication has been devised which promises to be fully as important as the inventions of Bell and Morse.

The English Cruiser "Spartiate."

An unprecedented event in the annals of the English navy has been the delay in the construction of the new cruiser "Spartiate." This vessel has occupied no less than four and a half years in building. She is one of the first-class cruisers authorized in March, 1896. She was laid down at Pembroke Dockyard just before the great engineering dispute which paralyzed the shipbuilding industry, and her completion was delayed after this disorganization had come to an end. She was eventually launched on October 27, 1898, but even after she was afloat she was so neglected that it was not until November, 1900, that she was ready to leave Pembroke and proceed to Portsmouth for her trials. After some further procrastination she was taken to sea for her tests. Her second run in the Channel proved disastrous, and had to be abandoned, and she returned to port to have one of her crankshafts replaced. Since this time she has been continuously in the hands of the dockyard workmen. Recently she was taken to Spithead to resume her thirty hours' steam trial, but leaky condensers necessitated her return to Portsmouth for further overhauling. When this was completed she was taken out again, but once more broke down owing to leaky tubes. She is of the improved "Powerful" type, with a displacement of 11,000 tons, and is calculated to steam at 20 $\frac{3}{4}$ knots. All the British cruisers now being constructed are to steam at 23 knots, and are more heavily armed, besides having vertical armor in addition to one or more heavily protected decks. The "Spartiate" has no side armor. She will probably not be ready for commissioning until next spring, six years since she was authorized by Parliament, and nearly five years since her construction was begun.

Melting Snow by Steam.

The recent heavy snowstorms, which for several days have partially blocked the enormous traffic of New York city, brought to light three curious machines employed by the Street Cleaning Department for the removal of snow. In general appearance these snow melters resemble a road roller without rollers. In place of the forward rollers is a large iron box, into which a dozen men shovel snow. Behind the box and extending to the rear end of the machine is a boiler, from which two funnel-shaped pipes about a foot in diameter extend into the box. Steam is forced from these pipes through jets into the box, and the snow melts as fast as it is dumped into the box. The water runs down into a sewer. In eleven hours one machine removed 750 yards of snow. Nine teams were able to do the work for which seventy-five were formerly required.

ELECTROLYTIC REFINING OF COPPER.

On the banks of the Raritan River and on the outskirts of the thriving town of Perth Amboy, N. J., there is located the largest copper-refining works in the world. Here, in the course of every month, some 10,000,000 to 12,000,000 pounds of refined copper are deposited in the Tank House; while the monthly output from the refining furnaces varies from 15,000,000 to 18,000,000 pounds. The Raritan Copper Works are devoted exclusively to the electrolytic refining of the product of the great smelters of the West.

THE FURNACE HOUSE.—The raw product comes to the works in the shape of copper pigs, which measure about 5 inches by 8 inches by 16 inches in length, and whose quality ranges from 95 to 99 per cent pure copper. It receives its first treatment in the Furnace House, which consists of three buildings, the first of which measures 80 x 600 feet and contains four 50-ton anode furnaces and five refining furnaces of the same capacity. The second building measures 80 x 200 feet and contains four 25-ton furnaces; and there is also a blast-furnace building. The anode furnaces, as the name implies, are used for melting down pig copper in order that it may be cast into the large flat plates which form the anodes in the depositing tanks. The copper pigs are charged into large reverberatory furnaces, each charge weighing about 100,000 pounds. After about six or seven hours in the furnace the charge is melted, and then for thirteen or fourteen hours more it is thoroughly worked by methods similar to those used by the puddlers in some systems of iron-making. The effect of the furnace treatment is to work off some of the impurities, the copper being advanced from 98½ per cent of purity to about 99½ per cent. The slags formed in the furnace treatment by the oxidation of the copper and the impurities combined with the silicious materials forming the sides and bottoms of the furnaces float as scum on the surface of the molten metal. It is skimmed off and sent to the blast furnace to recover the 55 per cent of copper which it contains. After eighteen hours' treatment in the anode furnace, the copper is drawn off into a casting machine, which consists of an endless chain of molds, each mold being pivotally carried in and forming part of a conveyor. The taphole of the furnace discharges into a ladle, from which the metal is poured into the mold. This ladle has a transverse tipping motion and is of large enough capacity to hold a charge for one mold, and as much more metal as may run into the ladle while that charge is being poured. The anodes are one inch in thickness, 24 inches in width and 36 inches in depth. Each is provided on its upper edge with two projecting lugs, which extend over the edge of the depositing tank and serve to support the plate in the electrolyte. We present an illustration showing a similar casting machine in operation before a refining furnace, from which wire bars are being cast for the wire mills. The anodes are now loaded upon cars and drawn into the Tank Building. Here they are loaded into frames, each of which holds twenty-two anodes, which is the total number necessary for each tank.

THE TANK HOUSE.—The Tank House contains the whole of the electrolytic plant. It consists of one large building measuring 200 feet in width by 600 feet in length. The main floor space is given up to 1,600 depositing tanks, which are arranged in four groups of 400 each; while in small additions at the end of the main building there are 32 liberating tanks. Four powerful electric cranes for handling the electrodes run the length of the building, each crane serving 400 tanks. The tanks are operated on the regulation multiple system, the tanks arranged electrically in series and the electrodes in each tank are parallel. The latter are about 2 feet wide by 8 feet long, and 3 feet deep, and each contains 22 anode and 23 cathode plates arranged in multiple. They are filled with dilute sulphuric acid and sulphate of copper electrolyte, and with a view to securing a constant circulation of the electrolyte the tanks are arranged in sets, with a solution well and a pump to each set. The liquor is drawn from the bottom of one tank and flows over to the next tank below it, the electrolyte being thus brought in thorough contact with the whole surface of the plates in the series of tanks.

The thin cathode sheets which are used in the depositing tanks are formed in what are known as "stripping" tanks, of which there are one hundred and eighty. The cathodes in the stripping tanks consist of rolled plates of pure copper, smeared with grease or plumbago, with their edges protected against the formation of copper by grooved wooden strips. After the cathodes have been in the stripping tanks for thirty-six hours, they are removed, and the thin sheet of copper is peeled from the plates, the grease serving to prevent any close adhesion of the surfaces. The thin cathode sheets are then flattened out by beating with wooden paddles, and are hung by means of two thin copper loops, riveted to the plates, from copper rods, the ends of which rest upon the edges of the depositing tank. The anodes as they are brought

to the Tank House from the casting furnace, are hung on special iron frames, on which they are so positioned that they will have the proper spacing in the depositing tanks. The traveling crane picks up the frame with its complete set of anodes (twenty-two) and places them in position in the tanks, the total weight of the complete set being between four and five tons, while the twenty-three cathodes together weigh 160 pounds. The action of the current is to transfer pure or practically pure copper from the heavy anode plates and deposit it upon the thin cathode sheets. The latter increase in weight from 6 to 8 pounds to 75 to 80 pounds during the seven days that they are in the tank. At the end of seven days they are withdrawn, loaded onto cars, and taken to the refining furnaces. Fresh cathodes are supplied, until the anodes, at the end of forty-two or forty-three days, have been so reduced as to have to be themselves replaced with fresh anodes.

REFINING FURNACES.—The product of the tanks, in the shape of heavy deposited cathodes, is taken to the 50-ton refining furnaces, where it is melted down and brought to "pitch," that is, to a purity of 99.88 per cent. In the process of melting the copper takes up a certain amount of oxygen, and this is removed by introducing into the bath of molten metal a pole of green wood, the carbon of which combines with the oxygen, and passes off as carbon dioxide. From the refining furnaces the copper is cast into the various forms required by the mills to which the copper is to be shipped. One of our illustrations shows the mechanical conveyor of one of the "wire-bar" furnaces, that is to say, a furnace which is occupied in casting bars of copper for shipment to the wire works. The molten metal flows from the taphole into a ladle and from the ladle is poured directly into the molds, as they are brought successfully beneath it. The molds are pivoted at their ends to the links of a conveyor. After each mold is filled with metal, it is drawn through a bath of water, and then tipped over to discharge its contents. The conveyor is operated by a ten horse power electric motor, and the ladle is operated by a hydraulic plunger which is under the control of the ladler.

TREATMENT OF THE SLIMES.—The first process in the treatment of the slimes is to extract the copper, and this is done by boiling the slimes in concentrated sulphuric acid and blowing air through the liquid during the process. The slimes are then washed, dried and smelted on the hearth of a cupel furnace, and a bullion of gold and silver is recovered. The silver and gold bullion is boiled in large kettles filled with sulphuric acid, where the silver is dissolved and forms sulphate of silver, while the insoluble gold collects on the bottom of the kettle. The sulphate of silver solution is siphoned off into tanks, the bottom and sides of which are lined with copper plates. Here the sulphate is reduced, the silver being precipitated on the copper plates as "sponge silver," which is collected, washed, dried, melted in crucibles, refined, and cast. The gold is collected from the bottom of the kettles and is also washed and refined and cast, the pure silver and gold, thus obtained, being shipped to the Mint.

The power house for the supply of the large amount of current necessary for the depositing of 12,000,000 pounds of copper a month is, as may well be imagined, a large one. The boiler room contains eight 400 horse power and two 200 horse power Babcock & Wilcox water-tube boilers, equipped with the Murphy automatic stoker. The fuel is brought to the boilers and the refuse, ashes, etc., removed by mechanical conveyers. The engine room contains five vertical cross-compound condensing engines, each direct-connected to a General Electric generator, the largest of which delivers 4,500 amperes at an efficiency of 93.5 per cent.

The Current Supplement.

The current SUPPLEMENT, No. 1367, opens with an illustrated description of the "Kronprinz Wilhelm," one of the latest fast ocean steamers. Mr. R. Spoerr describes in an illustrated article "Nurseries for Grapevine Grafts." "Silk and Its Producers" is the title of an instructive article by Mr. R. Lydekker. Prof. David Starr Jordan, president of the Leland Stanford University, who is one of the foremost American zoologists, has an able article upon the "Fish-Fauna of Japan." How armor plate is made is told in a brief article accompanied by engravings. Major P. Cardew continues his popular description of the three-phase electric railway. Diagrams accompany his explanation. The study of the phenomena occurring in the four-cycle gas engine, by means of the manograph, is made the subject of another article. A biography of Mathias Baldwin, the founder of the locomotive industry of the United States, will prove of special interest at a time when the Baldwin Works are celebrating their seventieth anniversary. The usual Consular and Trade Notes will be found in their customary places.

Automobile News.

Bucolic opponents of the automobile have some very queer ideas concerning the operation of motor carriages. An Ohio genius proposes that, in order to prevent the frightening of horses the life-size figure of an equine be attached to the front of every motor vehicle.

Dr. Schatzel, an official connected with the Bavarian Post Office, has recently made an extensive report of the subject of automobiles in the postal service. He is very much in favor of the self-propelled wagons, and predicts a far-reaching revolution to take place upon the general introduction of the motor car in the government postal service.

A Westfield, Mass., firm has recently shipped a gasoline carriage to Cape Town. The names of the persons ordering the machine were not announced, and it is hinted that it was designed for use for scouting purposes by English officers. The order was given, however, after a test in which a number of vehicles of different types were entered.

The Fairbanks Company have within the last few months equipped, throughout, a number of automobile companies, selling them their entire equipment of power, plant, machinery and tools, and taking charge of the erection, the transmission and the complete installation of the same. Their success in this line has led them to form a distinct department for the consideration of this work.

An automobile tire of the single-tube pneumatic type recently placed on the market has a core inserted. This core is molded and vulcanized in halves, each half being a complete ring semicircular in cross section; it is constructed on the truss principle. Even the largest puncture cannot put this tire out of commission, the resiliency of the core keeping the tire in shape after the air has been entirely exhausted. All the wear comes on the outer surface of the tire, which can be made light or heavy, according to the demands made upon it.

A peculiar speed-measuring device for automobiles has recently been patented. The instrument is inclosed in a metal case with a glass front, the whole being as nearly dust and air proof as possible. In the inner case are two fans, the larger one receiving its impulse from the vehicle tire and the smaller one deflected by the air currents set up by the larger fan. The arbor on which the small fan is mounted carries a pointer and is encircled by a hair-spring providing the counter-force. When the speed of the vehicle is to be measured, the roller at the end of the shaft is brought into direct contact with the tire of one of the road wheels.

The minimum of lightness is claimed to have been attained in the 3 horse power runabout now being built by R. H. Metcalfe, of Patchogue, L. I. Its weight will closely approximate 250 pounds, and it will possess a maximum speed of eight miles an hour. A new feature will be the cooling of the motor by means of a funnel underneath the body designed to catch the wind and direct it to the engine. In this connection it may be stated that French designers and builders have become convinced that lightness in a motor vehicle is attained only at the expense of strength, and that all the latest patterns of light pleasure machines are being constructed on heavier lines than heretofore.

The question of the storage of his fuel is one of the most serious questions which confronts the owner of a gasoline automobile. The fuel must be stored around in more or less generous quantities, and when kept within a building there is always risk as well as increased insurance charges. In order to meet these emergencies a cabinet has been devised and manufactured by S. F. Bowser & Company, of Fort Wayne, Ind. It consists of a construction of galvanized metal standing about seven feet high. The lower half contains the gasoline, while the upper part contains the pump, access to the latter being secured through a drop door. The pump is supplied with a measuring device, by which it is possible accurately to gauge the amount of gasoline, thus preventing overflow and waste.

The new electric stages running on Fifth Avenue present a very striking contrast to the ancient horse-drawn vehicles which have been such a familiar sight along the avenue for so many years. The new vehicles are of the Riker build, and are known as the Wilkesbarre type. They carry 48 cells of a capacity of 250 ampere hours or a little more. The weight of the batteries is 3,800, and that of the complete carriage 10,350 pounds. They have a traveling radius of about 50 miles and a speed of about fifteen miles an hour, and the Fifth Avenue trip is made with a saving of one-third the time as compared with the horses. Each vehicle has two 5 horse power motors. It is the intention of the company to place in service two larger omnibuses carrying thirty-two passengers. Those now in use carry eighteen.

THE NEW YORK ASSAY OFFICE—MELTING AND REFINING.

In a previous article in the SCIENTIFIC AMERICAN for February 15, 1902, the process of assaying gold and silver bullion was described, and in the present issue the question of refining the bullion will be taken up. After the Assayer has stamped his bars, the owner can either take away these bars, which have now been officially certified as to their purity, or the government will purchase them according to its need. The work of refining and melting is carried on in the rear building and is under the charge of Mr. B. T. Martin, who became Melter and Refiner in 1883, having been connected with the Mint service since 1850. The bars now purchased by the government are classified, as far as possible, into groups which represent approximately the same degree of fineness. They are first melted in crucibles and furnaces heated by gas or coal. Then they are poured into molds which are so arranged as to permit a large surface being exposed to the acid. The bullion is mixed in such proportion that the gold or silver which is mixed, or has been added to assist in the process, shall not exceed one-third or one-twelfth, respectively, of its entire weight. About 200 pounds of these granulations are placed in each of the large kettles on the upper floor, shown in our engraving, with 150 pounds of sulphuric acid. This is termed the "separating room," for here the silver is separated from the gold. About 200 pounds of sulphuric acid are added gradually during approximately three hours' boiling. The silver is also dissolved and the resulting solution is siphoned off into reducing vats on the floor below. Another charge of 150 pounds is added and heated for one and one-half hours, when it is also run off. The fire having been withdrawn a third charge of acid is added, and

the gold is taken out with a perforated iron ladle and put in small kettles. Here it is heated in three successive charges of acid for about six hours. The gold is emptied into the washing tub, where it is treated with one charge of cold and two of warm water. These

solutions are poured into the washing jar, from which, on settling, the solution is run into large tanks on the floor below. The gold is emptied into one of the filters, then roughly washed with warm water and drained. This process is repeated and the gold is pressed into a cake or cheese with the aid of a hydraulic press. These cheeses are then dried in an oven and melted and cast into bars of from 997½ to 998½ thousandths fine.

The silver was entirely dissolved by the acid, and the next process is to recover it from its liquid state. In the silver reducing vats, ingots or bars of copper are placed on end around the sides next the heating coils and subjected to ten or twelve hours' boiling. The resulting copper solution is run off through a filter into a concentrating vat. The silver remaining on the copper bars is scraped off and the whole of it is taken out and put in a filter, copper hoes and shovels being used. After washing it is pressed into cakes, dried and melted with sodium nitrate as a flux. It is then cast into bars of a fineness of 999 to 1,000 fine. The whole process depends upon the fact that sulphuric acid has more of an affinity for copper than for silver. The solution of copper sulphate which has been formed is strengthened by boiling about ten hours. It is then run off into the crystallizing vats. In from two to three days the mother liquor is run off into the large tank on the floor below; from whence it is run off into the carboys or tanks of its purchasers. The crystals of copper sulphate (blue vitriol) are taken from the sides and bottom of the vats, drained and subsequently redissolved in water and run off into the crystallizing vats again. The crystals form on lead strips and are very handsome. The proceeds of the blue vitriol and mother liquor nearly cover the entire cost of the acid and copper. The

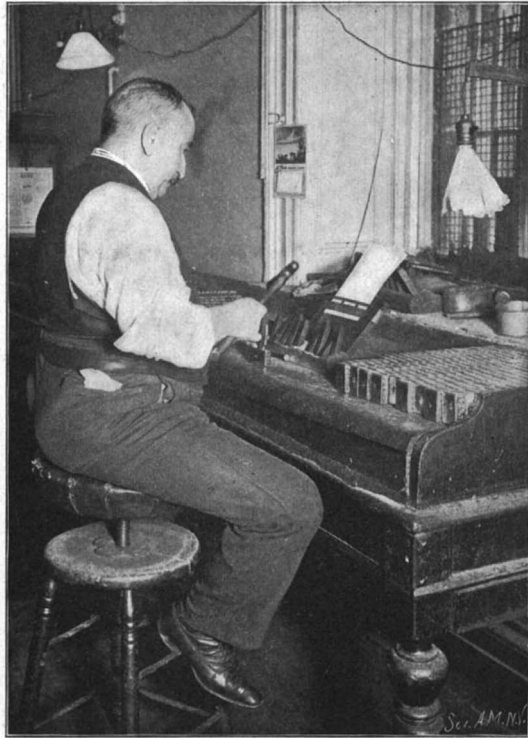

Stamping \$8,000 Gold Bars with Fineness, Weight and Value.



Concentrating the Silver Solution and Precipitating the Silver.



Separating the Gold from the Silver by Boiling with Sulphuric Acid.



Stamping Value, Weight and Fineness on Silver Bars.

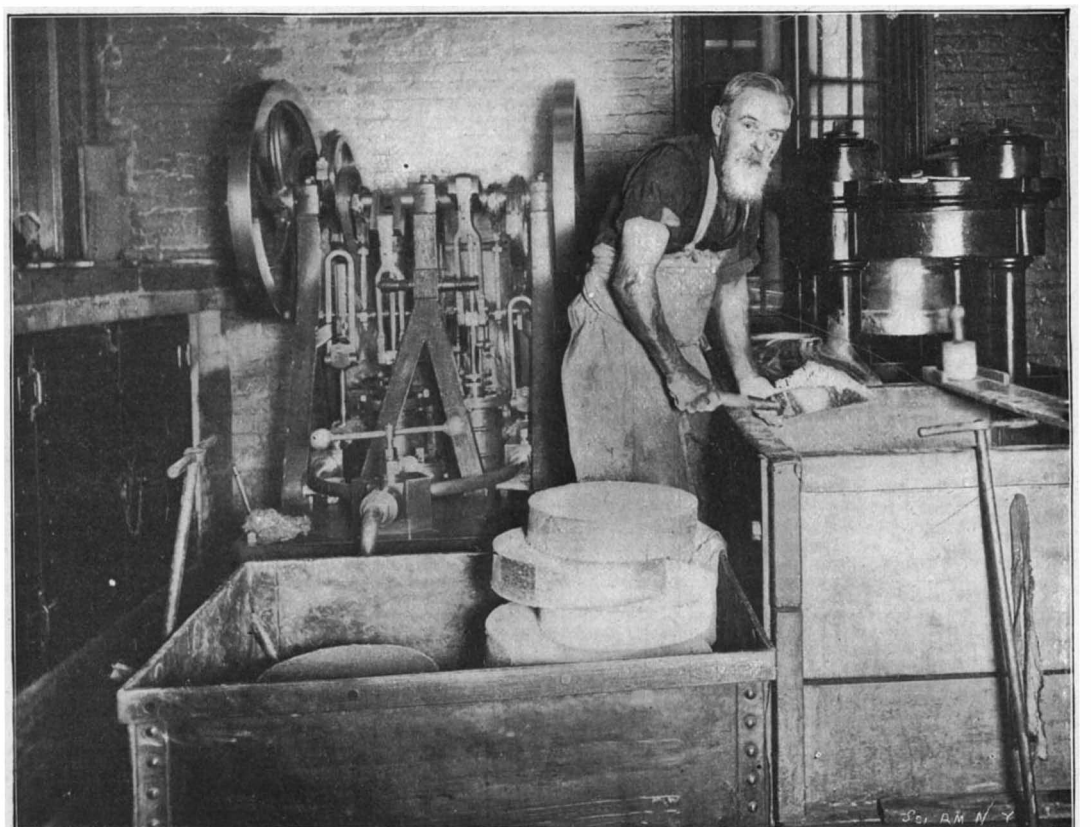

Pressing Precipitated Silver into "Cheeses."

acid is conveyed by gravity about the building. Each bar is stamped with its fineness and weight, and these marks are accepted all over the world. Bars are of various sizes, those of a value of \$8,000 being preferred. Bars are made all sizes to accommodate even the small manufacturer, small bars of \$100 worth being made. Last year about \$14,000,000 were taken out for use in the arts. The deposits for the fiscal year ending June 30, 1900, had a value of \$56,296,096.15 for the gold and \$7,516,742.58 for the silver. The number of gold deposits melted was 8,581; of silver, 3,223, making a total of 11,804. The number of fine mint and standard bars made and delivered to the Superintendent was, of gold 40,616, and of silver 42,562.

One of our engravings represents bars of various sizes with the value stamped upon them. The smallest bar at the left is worth about \$105. Then the bars run up in size to \$8,000. Two silver bars are shown at the back. A "gold brick" has come into our language as the very epitome of fraud, and that they are a grim reality is shown by the four samples which were placed upon the truck. They are of all sizes and shapes to meet the varying fancy of their victims and are rarely of the shape of the Mint bars. Two of them would have been worth \$18,000 had they been actually of gold instead of base metal. Those who are in need of gold bricks should be willing to purchase them at the regular rates, and all sizes may be had at the Mint office. It might be said in closing that the Assay Office is open to visitors.

A NEW EQUATORIAL TELESCOPE FOR OXFORD.

BY OUR ENGLISH CORRESPONDENT.

At the Radcliffe Observatory, Oxford, England, a new 24-inch equatorial telescope is being erected. Although by no means the largest in the world, this instrument is replete with several new features and appliances, the result of recent experiments and investigations, so that it is one of the most modern combinations of the refinement of inventive skill and mechanical arrangements extant.

The telescope has been constructed entirely by the famous optical instrument manufacturer, Sir Howard Grubb, F. R. S., at the Rathmines Astronomical Works, Dublin, Ireland. Curious to relate, the designing and construction of large telescopes is now practically an Irish monopoly, since Sir Howard Grubb, who is now the greatest authority on this work, has built all the large telescopes worthy of mention in all parts of the world. It will be remembered that the Lick Observatory and telescope was erected mainly from his designs and it was the first observatory to be equipped with the mechanical rising floor, which has proved so successful that it was adopted in all the subsequent observatories.

The glass for the lens of the Oxford instrument was cast at the celebrated Mantois works in Paris, thence transported to Dublin in the rough, and there cut and ground to the requisite shape.

All the lenses for these huge telescopes are cast in Paris. The process employed by the Mantois firm in the manufacture of the glass as a jealously preserved secret. It was originally discovered by a Swiss mechanic, who divulged his secret to Mantois. The secret was afterward secured by an English lens-making firm, Messrs. Chance Brothers, of Birmingham. The latter firm, however, has never entered into competition with the Parisian manufacturers in the casting of telescopic lenses. Their work is entirely restricted to the manufacture of the prisms and lenses utilized in lighthouses, and they are the sole manufacturers of this specialty for the Trinity House Brethren, who control the lighthouses and light ships round the coasts of Great Britain. The Mantois firm cast the huge 40-inch object glass for the Yerkes instrument, and also those for the telescope at the last Paris Exhibition, which proved such a dismal failure.

The Radcliffe Observatory at Oxford, for which the new telescope has been designed, is one of the oldest in existence. It was founded about the year 1772 by the Radcliffe Trustees, after whom it is named, in response to a request by Dr. Hornsby, the Savilian Professor of Astronomy of that day. At that time it was probably the finest observatory in Europe, and was equipped with instruments by the famous maker, John Bird. About 1840 an important addition was made to the instrumental equipment in the great 7½-inch heliometer, which was

for many years the finest and largest instrument of its class in the world.

For some time past the necessity of a modern equatorial telescope has been experienced, and the new instrument has been installed, through the efforts of the Observer, Dr. Arthur Rambaut, F. R. S., formerly Astronomer Royal for Ireland.

The instrument consists of two telescopes combined—one for photographic observations of the heavens, and the other for direct visual work.

The photographic telescope contains a lens of 24

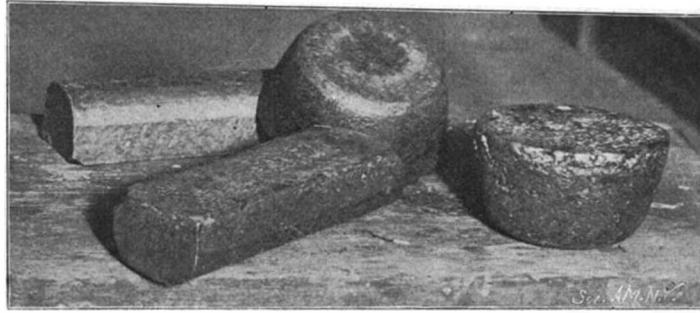

"Gold Bricks"—Spurious Imitations Sold to the Unwary.

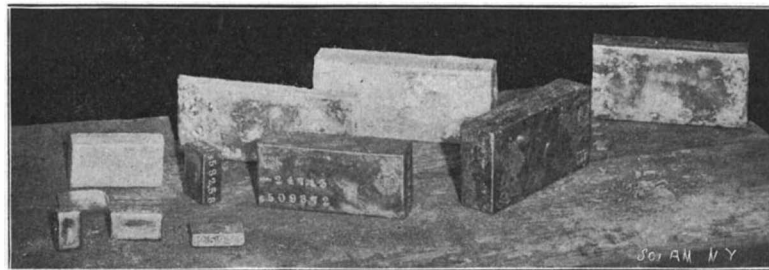

Gold Bars—Value \$100 to \$8,000 Each.
THE NEW YORK ASSAY OFFICE.

inches diameter, and is 22 feet 6 inches in focal length. The direct visual telescope is of 18 inches aperture, and is of the same length as the 24-inch telescope. The necessity for two telescopes arises from two causes. In the first place, owing to the fact that light of different varieties is unequally refracted by the glass of which the lenses are composed, it follows that an object glass which is constructed to give the best possible image when viewed directly by the eye, will not bring those rays, which are chiefly active in forming the photographic image, to a perfect focus, and it is found necessary to use an object glass made especially with a view to receive these rays. In the second place, in order to obtain photographic pictures of the fainter objects, some of which, from the astronomer's standpoint, are just as important as the more conspicuous ones, it is necessary to submit the photographic plate to their feeble rays for a prolonged

period of several hours. In certain instances even the whole length of the winter's night is not sufficient to obtain a useful picture, and it is necessary to expose the plate for several nights in succession upon the same object. All the time that the star is being photographed it is moving across the sky, and consequently to obtain a sharp image it is of fundamental importance that the telescope should be kept pointing exactly at the particular star during the whole of the exposure. This is accomplished to a high degree of precision by means of very accurate clockwork. But no mechanism with uniform motion made by human hands, can be made to move regularly with the accuracy which some branches of astronomy demand. The precision which has been attained in Sir Howard Grubb's newest form of electrically-controlled clock may be comprehended from the fact that exposures of half an hour's duration are sometimes taken, which, even under the microscope, will show no distortion of the star's image, although an error in the motion of not more than the twentieth part of one second would leave its mark upon the plate. What actual quantity this twentieth part of a second of motion represents may be gleaned from the fact that the telescope takes 24 hours to complete a revolution, so that the space passed over in this time would be little more than 1-2,000,000th part of a revolution. When the exposure is prolonged for hours and hours, a slight correction is necessary, due to the effect of refraction of the earth's atmosphere. Owing to this refraction, the apparent motion of the stars is not absolutely regular, and, therefore, it becomes necessary for the observer to keep an occasional watch upon the star during exposure through a second telescope placed beside the photographic instrument, and to introduce any slight corrections rendered necessary from this cause. The clockwork

which drives the Oxford instrument is of the same construction as that designed by Sir Howard Grubb for the telescopes installed by him with such conspicuous success at Greenwich, Cape Town, Melbourne, Mexico, Perth (West Australia), Madrid, Cork, etc. Some new features of special interest are worthy of note, the most important of which is that in connection with the circles. In the Oxford instrument all the silver divided circles can be read by one microscope fixed to the eye-piece of the telescope, so that the observer has no occasion to leave his seat to see that his circles are properly set. By turning a small lever fixed in close proximity to this telescope, one or other circle can be brought into the field of view, while the same motion causes a little electric lamp attached to each circle to be lighted up automatically, so as to illuminate the particular circle required. New slow motions have been designed, and in some cases, little electric motors are utilized to do this work, the motor itself being started and controlled by an electric switch of peculiar construction, available to the observer in any part of the room.

The latter is driven by delicate clockwork and controlled by a touch of the observer's finger.

The observatory for the accommodation of this instrument at Oxford is 60 feet from the ground level to the crown of the dome. It is equipped with the Grubb elevating floor, having a rise and fall of 9 feet; when the floor is at its lowest elevation the telescope may be pointed vertically, and when raised 9 feet the instrument is practically horizontal. The controlling gear of this floor is within convenient reach of the observer's chair, so that it may be manipulated in the dark, with perfect safety and without necessitating the observer's moving from his seat. As a rule, however, a telescope for useful work does not have to be brought lower than 20 degrees to the horizontal axis, as the earth's atmosphere at a more lateral elevation prevents accurate observations being made.

The floor is operated by a hydraulic ram, exerting a pressure of 50 pounds per square inch. As a matter of fact, however, this ram is not actually required for raising and lowering the floor, as the latter is so delicately counterbalanced by weights that a ram is only utilized to lift any extra weight, such as that of the observer, that may be standing on the floor. In the earlier types of elevating floor, there was a decided seesaw movement, as the observer moved from one side of the apartment to the other; but in this case, all such possibility of any tilting, no matter how great the weight placed at one side may be, is obviated. This is accomplished as follows: The ropes upon which the counterbalancing weights move up and

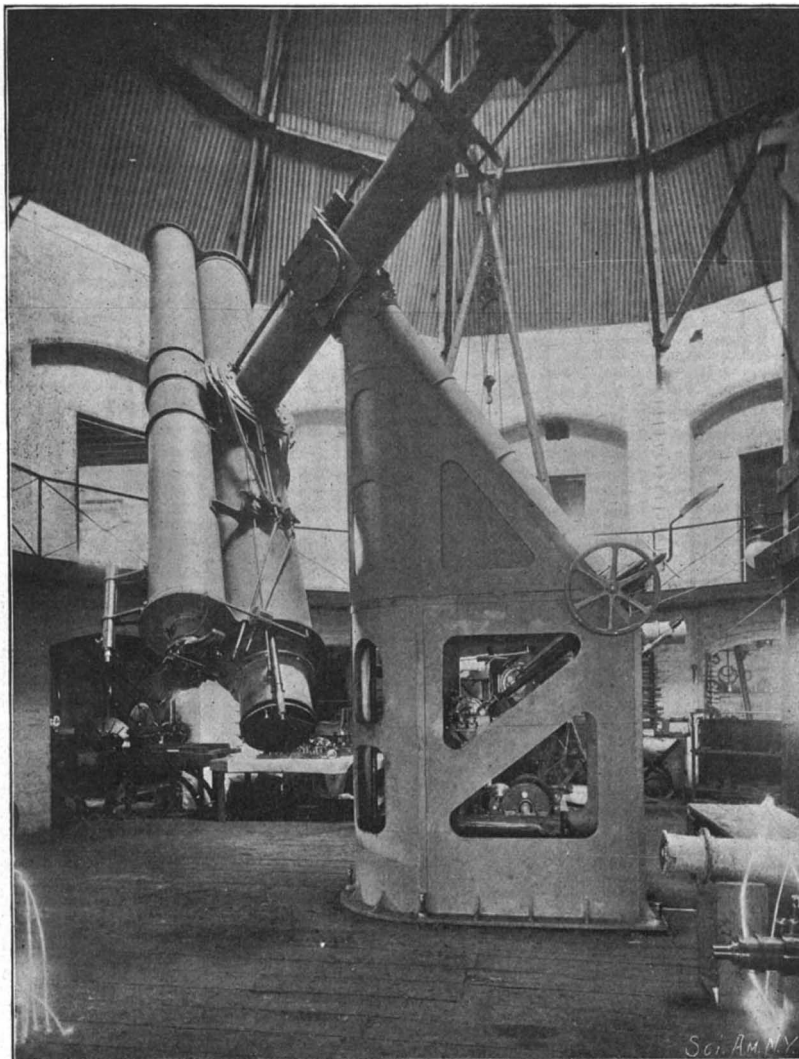

NEW EQUATORIAL TELESCOPE AT RADCLIFFE OBSERVATORY, OXFORD, ENG.

down are connected with the ram. When an excess of weight is thrown upon one portion of the floor, the downward strain tightens the ropes upon the opposite side, thus setting the hydraulic ram in motion automatically, and sufficient pressure is thus exerted by the ram to resist the excess weight of that particular spot. By this means the floor maintains its equilibrium and is absolutely rigid.

Further Experiments with the "Belleisle."

The British Admiralty has been carrying out some further gunnery experiments with the old coast defense ship "Belleisle," this time for the purpose of gaining information as to the resisting qualities of the steel armor which has been ordered for some time past for the latest cruisers. The "Belleisle" had been carefully prepared at Portsmouth Dockyard for the experiments. Into the forepart of the vessel had been built a replica of a 20-foot section of one of the latest armored cruisers, bunkers, water-tight compartments, and armored deck being all complete. On the starboard side of the ship, representing a cruiser of the "Monmouth" class, the target section was faced with four Cammell-Krupped 6-inch armor plates. On the "Belleisle's" port side, representing a cruiser of the "County" class, the target was faced with four Cammell-Krupped non-cemented armor plates approximately 4 inches thick. Some of the plates were backed with bunkers filled with coal. For the guidance of the gunners on the two attacking gunboats the position of these, and the place where the armored deck joined the ship's side were indicated by special marks. The "Belleisle" was moored about one mile off Bembridge, off the east end of the Isle of Wight. Between her and the shore two gunboats were stationed. The starboard side was first attacked from a range of 400 yards, four rounds being fired at it, two from a 6-inch gun and two from a 9.2-inch gun. Between the two rounds the Lords of the Admiralty and the gunnery officers, who were superintending the experiments, went on board the "Belleisle" and made a close examination of the effect of the lyddite and other projectiles used, and some photographs were also taken of the plates which had been struck. The "Belleisle" was then turned round, and the 4-inch armor on her port side fired into by the 9.2 and 6-inch guns, with the result that the plates were perforated and a plate either cracked or started below the waterline. The "Belleisle" took in water rather rapidly, and a tug was placed alongside to pump her out. It was deemed advisable to bring the trials to a close, and the vessel, with the plates which had been struck covered, so as to hide the results from view, was towed back into Portsmouth Harbor. The "Belleisle" will be docked to undergo careful inspection, in order that the effect of the experiments may be fully reported upon. The result of the trial, however, proved that cruisers of the "Drake" class are able to resist a heavy gun fire, but the 4-inch armor on the ships of the "County" class can be penetrated with the 9.2-inch gun. The special lyddite shell used in the experiments did not give the results anticipated, and practically its effect showed that lyddite-filled shell, or common shell, are of little use against armor. But the lyddite scattered its fragments over a huge area; in one case it hurled debris 1,200 yards. Some considerable space around where the shell burst was swept with fragments of shattered shell. Had a shell burst inside a battery, it would have completely destroyed it. In this direction plentiful evidence was given of its destructive qualities.

Paterson's Flood.

After having been almost wiped out by one of the fiercest fires which has ever raged in the eastern part of the United States, the unfortunate city of Paterson has now been swept by a deluge which has wrought fearful havoc. How great the loss will prove to be can only be guessed at now. It is estimated the loss to the county in bridges alone will amount to \$300,000. About four hundred small shops are said to have been flooded. The loss to their owners is inestimable; for it will be a considerable time before the stores can be opened again for business. At a conference held between the mayors of Wallington and Passaic it was calculated that the damage would probably amount to \$1,000,000. The Passaic mills will lose about \$600,000; while about \$200,000 damage has been suffered by owners of personal property. In Wallington the loss is about \$200,000.

The Franklin Institute has issued its report upon granite as an insulator. Granite chips were reduced to powder and calcined feldspar and kaolin added with water to make a plastic mixture. After the molded objects had been heated to 3,000 deg. F. they were glazed. The product crushed at 7,000 pounds pressure per square inch, and showed a tensile strength of 900 pounds per square inch. The sample tested showed an insulation resistance of eight megohms, but the size of the sample is not stated.

Legal Notes.

ENGLISH NEWSPAPER TITLE COPYRIGHT.—In the Chancery Division, Mr. Justice Swinfen-Eady recently gave judgment in the case of Willox vs. Pearson. It appeared during the proceedings that the plaintiff was the proprietor of the Evening Express, an old-established newspaper, with which was associated the Liverpool Courier. The paper was known throughout Liverpool and Lancashire as the Express. On December 2, 1901, the defendant, Mr. Arthur Pearson, published in Liverpool a paper called the North Express. Since that time the plaintiff claimed that the defendant's paper was called out in the streets of Liverpool as the Express, and that it was so folded and exposed that only the title Express could be read, and that consequently the one paper was mistaken for the other.

The fact of the plaintiff's paper being known as the Express did not give him any exclusive right to that title. Sir John Willox admitted that the appearance of his paper and of the defendant's was entirely different, and that there had been no attempt on the part of the defendant to pass his paper off as the Evening Express. The evidence of the plaintiff came to this—that street vendors of the defendant's paper had sometimes called out Express, and that people intending to purchase the plaintiff's paper received the defendant's paper instead. But people who purchased newspapers are supposed to be able to read. If they do so, the court held, they will immediately discover their mistake. Moreover, the defendant's was a morning paper, and the sale of it was practically over before the plaintiff's paper was on the street. Hence the two newspapers could not be said to come into serious conflict. The court therefore found that the plaintiff had failed to make out a case.

SOLID TIRE DECISION.—In the patent infringement case, the Rubber Tire Wheel Company vs. The Goodyear Tire & Rubber Company, Judge Wing, in the United States Court, for the Northern District of Ohio, at Toledo, decided in favor of the plaintiffs. Judge Wing based his decision largely upon the opinion of Judge Thomas in the case of the Rubber Tire Wheel Company vs. The Columbia Pneumatic Wagon Wheel Company, in which the validity of the Grant patent, owned by the Rubber Tire Wheel Company, was sustained. Judge Wing came to the conclusion that "while the elements of the complainants' combination are, each of them, old and well known, this particular combination of shape of rubber and of flange, and the position of the retaining wires, has not been shown in any previous patents or other publications." A permanent injunction was ordered to issue against any further infringement of the Goodyear Tire and Rubber Company, who thereupon presented an application for an appeal to the United States Circuit Court of Appeals. The appeal was allowed, and the Goodyear Company signed a bond under which they are permitted to manufacture tires as before, while the case is pending in the Court of Appeals. The bond covers all damages that may be suffered by the complainants if the final decision should be in their favor.

The Rubber Tire Wheel Company also won a suit in France, the case being that of Boudin vs. Rouy. The suit was one for damages for alleged infringement of the Grant patent on solid rubber vehicle tires which was issued in France, April 10, 1896. In America the tire is known as the "Kelly-Springfield Tire." Although certain claims of the patent were declared invalid on account of publication in the United States in 1894, the Court held the patent valid and to have been infringed. As a result the defendant was compelled to pay a preliminary sum of 1,000 francs damages in addition to a sum to be fixed by a board of experts, together with costs.

RIGHTS OF A PATENT ASSIGNEE.—In the Court of Appeals of the District of Columbia an opinion has been handed down in the case of Whitson vs. The Columbia Phonograph Company, which opinion clearly defines the rights of an assignee who has contracted to sell or lease patented phonographs with a company since become insolvent. The Columbia Phonograph Company, the complainant in the suit and the appellee, had received certain privileges from the North American Phonograph Company, which company, after the contract had been signed, became insolvent. The National Phonograph Company, claiming to be the successor of the North American Phonograph Company, sold its goods to Whitson Bros., dealers in phonographs in the District of Columbia. The Columbia Phonograph Company brings action to restrain the Whitsons; and the question involved in the case is: What are the rights of the Columbia Phonograph Company? The Court found that since the complainant acquired from the owners of the patents the exclusive right to deal

in phonographs in the District of Columbia, an injunction pending proceedings was properly granted by the court below to restrain the defendants from dealing in phonograph supplies. The fact that the company originally owning the patents is now insolvent and has gone out of business does not affect or limit the exclusive right given to the complainant. After rights under a patent have been granted, any person who obtains control of the patent with knowledge or notice must be assumed to have taken subject to such rights and is disqualified from infringing those rights.

THE REGISTRATION OF TRADE MARKS IN THE UNITED STATES BY RESIDENTS OF THE PHILIPPINES.—In the many arguments and decisions in the courts and their review in the literature of the day, the lawyer as well as the layman has been confused with the uncertainty of the status of the new island possessions of the United States and the residents thereof. The question comes up afresh in a recent case where a resident of Manila and a former subject of the King of Spain has been refused registration for his trade marks by the United States Patent Office.

Under the United States statutes a person "domiciled in the United States or located in any foreign country or tribes which by treaty, convention, or laws, affords similar privileges to citizens of the United States, may obtain registration" for his trade marks. In construing this law, the Attorney-General does not find anything which would authorize the registration of a trade mark in the United States in the name of a resident of the Philippines. It is held that the Philippines are not a part of the United States, neither are they a foreign county, nor are the tribes in the Philippines recognized as having power to make a treaty or pass a law for the protection of trade marks. The Attorney-General rests here, but if we investigate the matter a little further we will find that the statutes have in mind the protection of trade marks which are the property of persons residing in countries where provision has been made for the registration of the trade marks of citizens of the United States. Although the Philippines have no power to pass laws for the protection of trade marks, the United States Congress has such power, and through the War Department it has made provision for the protection of trade marks in the Philippines, which are the property of citizens of the United States. Leaving out of the discussion all questions as to the status of a country which is neither foreign nor domestic, and persons who are neither foreigners, subjects, nor citizens, it would seem in the spirit of the law, the residents of the Philippines are entitled to register their trade marks in the United States, for the bar to the registration has only in view the states, countries and tribes which will not permit the registration of trade marks, the property of citizens of this country.

SOMETIMES an invention, although it is apparently an improvement on an old device, which any skilled mechanic could have conceived in the regular course of his trade, is given the full protection of our patent laws, merely because it supplied the proverbial long-felt want. An example is found in the appeal taken by the Brunswick-Balke Collender Company against Thum et al., in the matter of which appeal Judge Lacombe handed down a decision in favor of the appellee. The patent in question was granted for improvements in bowling apparatus, which improvement consist in a runway or trough for the return of the balls, so constructed that the balls are made to roll rapidly down an incline until near the players' end of the alley, and then up an ascending incline. The momentum is thereby so far checked that the force of the impact is broken, so that no injury can be sustained by a player who is engaged in picking out a ball. The improvement is extremely simple, and it would seem, a perfectly obvious application of the law of gravitation. Judge Lacombe stated that if there were nothing in the record but the bare statement of facts set forth, the charge of infringement which was sustained in the Court below against the company would not have been approved, but the evidence showed conclusively that this very demand for an arrester of the return ball had troubled skilled mechanics for many years and that no one before the patentee had hit upon the device which now seems so obvious. Indeed, the old-style runway has existed for some forty years, during which time there was a constant demand for an improvement which would remedy the difficulty. Suspended shot bags of various shapes, weighted sections of hose pipe, whisk brooms set to retard the traveling ball, pieces of stiff leather arranged shutter-like across the trough, levers having a piston entering a dashpot—in a word everything but the ascending incline had been tried for the purpose of arresting the momentum of the swiftly moving ball. In view of these many devices, the Court held that the patentee's improvements were certainly entitled to the protection of a patent. Thum's charge of infringement was therefore sustained.

"BATACLAN"—THE FRENCH ARMY HIGH-JUMPING HORSE.

Capt. Giraud, of the French colonial artillery, is the proud owner of a horse that has made a record for himself in France as a high jumper. "Bataclan," as the animal is called, is now about twelve years old. He was bought when he was but four years old, in Normandy, for only 1,100 francs (\$220).

"Bataclan" has a record of having cleared a hurdle 6 feet 7 inches without a rider. This is of course far below the American record, but is an interesting performance. The accompanying illustrations, reproduced from photographs lent by Armée et Marine, show how clever and tractable a performer "Bataclan" is. Last year he carried off the palm at Vichy, Clermont, and Nimes. Unfortunately, the exigencies of the service have prevented Capt. Giraud from entering "Bataclan" in many contests. It is likely, however, that the horse will take part in some of the coming contests in France.

An apparatus which is intended to occupy the place of the atmosphere, so far as concerns the necessary breathing to sustain life, has been invented by M. G. F. Joubert, late Professor of Chemistry at the Paris Ecole Polytechnique. The apparatus is specially intended for the use of divers, or for those whose occupation requires them to enter places where there are noxious gases. The invention consists principally in the manufacture of a substance which the Professor calls "Oxylithe." This chemical, which emits oxygen, has the general appearance of a stone, and resembles the well-known calcium carbide. By means of this discovery, in addition to a process of absorption of carbonic acid gas, M. Joubert claims to be able to produce a complete "breathing cycle," which sustains life without the aid of the atmosphere, and without any inconvenience to the subject of the experiment. The person whom Professor Joubert submitted to several tests had an apparatus fixed over his mouth and nose. He inhaled the artificial air by a tube connected to one end, and breathed out the vitiated air into a second tube connected with the other end of the apparatus. Mr. Joubert also conceived the idea of applying his invention to an explosion engine, and to substantiate his claim, he obtained a 1 1/4 H. P. petrol motor for the propulsion of motor cars, to demonstrate how it might be utilized for this purpose. The first experiment was perfectly successful, and the motor worked in a closed cycle without any assistance from the outside air, either as regards the supply of oxygen or the exhaust of the waste gases. Other larger engines were then experimented with, with the result that it was found that for a given power, the consumption of gas, petrol, or alcohol was reduced by 30 per cent, by means of the new process. The most important application of this invention will be in connection with submarine boats. It has hitherto been difficult to make use of any motive power in submarines, except that derived from electrical storage batteries.

Improvement Needed in the Alcohol Motor.

Despite the many attempts to popularize alcohol as a motive power, and the many strong points that have been recorded in its favor, little success has attended the movement. Every automobilist would welcome a fluid cheaper, safer, and as effective as petroleum. All these claims have been advanced for alcohol. What is needed is apparently a new form of motor—one somewhat more substantial than the gasoline engine and one having a considerably longer stroke, in order to utilize the greater expansive force of alcohol. A growing industry like automobilism should not be wholly dependent upon a few motive agents. A new and cheap fuel with all the qualities of petroleum would do much to increase the popularity of the automobile.

Brief Notes Concerning Patents.

Charles Eastwood, who died at Manayunk, Philadelphia, was the inventor of the stop motion on weaving looms, and was one of the first to introduce the power loom into the heavy woolen district of Yorkshire, England. He came to this country about twenty years ago and leaves a large family of children.

John L. Mason, the inventor of the Mason preserving jar, died on February 28 at his home, No. 577 Franklin Street, Brooklyn. The jar devised by him is used everywhere and has carried his name all over the world. He was born in Philadelphia and patented the jar when he was thirty years of age. It brought him a great deal of money.

A dispatch from Bucyrus, Ohio, says that the American Clay-Working Company of that place has given an order for machinery to manufacture an artificial fuel from clay which has undergone a chemical treatment. The invention was discovered by an old railroad engineer of Omaha, Neb., named Hofman. It is said that the heat given out by the fuel is greater than coal, and there is almost no ash remaining.

Celluloid for Phonograph Records.

When softened by the admixture of a solvent, celluloid expands considerably. Frank L. Capps of Newark, N. J., has availed himself of this property in making phonograph records. Within a cylinder matrix containing upon its inner face a cast in reverse of the original sound record, a celluloid cylinder is inserted. The two cylinders are then immersed in alcohol or the commercial "celluloid thinner," but preferably amyl acetate. Thus they are held for a short time until the surface of the celluloid has become softened. They are then removed from the bath and allowed to dry, care being taken that there is no slip between the two cylinders. When the celluloid cylinder is softened by the solvent, it expands and resumes its normal condition by the evaporation of the solvent alone; but the solvent can evaporate only from the interior surface of the celluloid cylinder and not from its outer surface, which is now tightly clamped against the surrounding matrix surface. Consequently the whole interior surface shrinks back from the center toward the matrix, drawing back and contracting the whole thickness of the cylinder wall. As each particle of the solvent from the outer surface of the celluloid cylinder and each particle throughout the mass of the same passes out, its place must be taken by an equivalent particle of celluloid. Hence the celluloid material is packed closely against the matrix surface, so that when the celluloid has resumed its normal condition the cylinder is of slightly larger diameter both externally and internally than originally. When the celluloid is thoroughly dried, it is separated from the matrix, and will be found to contain on its outer surface a faithful copy of the original sound record.

Electrical Process for Preserving Wood.

The Praktischer Maschinen-constructeur describes a method of preserving woods by electricity, which is applicable not only to railway ties, telegraph posts, and the like, but also to fine woods used in making furniture. The apparatus employed comprises essentially a wooden trough, on the bottom of which a lead plate is carried, connected with the positive pole of a source of electricity. The wood to be treated is placed upon this plate and covered with a second plate connected with the negative pole. The trough is filled with a solution of borax, resin, and sodium carbonate. Under the influence of the current the sap of the wood exudes and rises to the surface of the bath, its place being taken by the preserving solution. After five or eight hours of this treatment, the wood is removed and dried, either in the open air or in a drying oven. The current used has a tension of 110 volts. The consumption of energy is about 1 kilowatt hour per cubic meter of wood. For wood freshly cut and very moist, the current expenditure is still less. The temperature of the leaching bath varies from 40 to 45 deg. C.

A Chicago inventor has applied the Wheatstone bridge to the very novel purpose of detecting the presence of metals in the earth. The terminals of the bridge are inserted in the earth at a definite distance apart, and the reading of the resistance boxes taken, thereby showing the resistance included in the space between the two terminals. If ores or minerals be present, then the resistance of the earth at the particular point where the measurement is taken will be less than if no ore or mineral were present, by reason of the well-known fact that a current will seek the path of least resistance. The inventor therefore claims that by comparing the measurements taken in different places of the same region, the location as well as the presence of the ore can be detected. When the location is once determined, the depth below the surface is to be ascertained by varying the distance between the terminals and comparing the corresponding readings of the rheostat.



"BATACLAN" CLEARING A 6-FOOT 7-INCH HURDLE.



"BATACLAN" CLEARING A DINNER TABLE.

O. H. Hampton, of Fountain City, Ind., has made some interesting experiments in photographing by means of acetylene light. Negatives were made fully equal in intensity to those which were taken in broad daylight. Mr. Hampton has invented a special machine, whereby photographs can be taken by means of acetylene light. Photographers who find it difficult to employ electric light will probably soon have recourse to acetylene.

The British government has removed the library in connection with the Patent Office to more commodious premises in Chancery Lane, London. The new building is 139 feet in length, by 59 feet in width, and about 74 feet high. The floor of the library, which contains over 120,000 bound volumes, is devoted to English patent specifications, indexes, etc., scientific text-books, and the current as well as the unbound numbers of English and foreign periodicals. On the lower gallery can be consulted the foreign patent specifications, as far as they are in the library, and the bound volumes of periodicals and magazines. The top gallery is reserved for books that are rarely required.

RECENTLY PATENTED INVENTIONS.**Agricultural Implements.**

MACHINE FOR HARVESTING ONION SETS OR SIMILAR CROPS.—J. W. JEFFERSON, 101 Main Street, Louisville, Ky. The onion sets are removed from the earth by means of series of scoops mounted on endless vertical chains. These diggers raise the crop to the top of the machine, and deliver it through converging chutes into an inclined rotary screen, which separates the vegetables from the soil, and discharges them at the rear of the machine. The endless chains travel on sprockets, which can be adjusted to regulate the depth of soil taken up, and are driven by the rotatable rear axle, which is connected by clutches to the hubs of the rear wheels.

BELT GEARING FOR THRESHING MACHINES.—WILLIAM NEWMAN, Alexandria, S. D. It frequently happens that the long driving belt, which connects the threshing machine to the traction engine, is blown off its pulleys by the wind. Mr. Newman dispenses with this belt and substitutes a wire cable in its stead. In order that the cable may not be bent too short in rounding the pulleys, large band wheels are employed, on the grooved peripheries of which the cable travels. To insure the proper friction a strip of rubber is placed along the base of the groove, and in addition, a series of grips are employed whose jaws clamp the cable where it presses the base of the groove.

Apparatus for Special Purposes.

APPARATUS FOR CLEANING THE BOTTOMS OF SHIPS.—ROBERT S. CULPEPPER, Houston, Tex. The docking of a vessel in order to remove barnacles from her bottom entails considerable expense. Often enough it happens that the vessel is far from a drydock. The present invention provides a practicable and portable apparatus that can be compactly stored on shipboard and can be brought into use quickly. The device will effectually remove foul adhesions from the bottom and sides of the ship.

Electrical Apparatus.

ELECTRIC COIL.—WILLIAM SPENCER, JR., Schenectady, N. Y. The inventor has endeavored to provide an improvement in coils for electricity, such as generators. The invention is a compound coil, the inner coil having air spaces to prevent it from becoming heated. Air spaces are also provided between the inner and outer coils for a similar purpose.

FORMER FOR FILAMENTS FOR INCANDESCENT ELECTRIC LAMPS.—G. C. WEBSTER, Warren, Ohio. The invention consists of a former upon which double spiral filaments for incandescent electric lamps are wound and secured before being subjected to the baking process. The former consists of a cylindrical carbon body having ears at the top, and two spiral grooves leading downward therefrom on opposite sides, and terminating in straight portions parallel to the central axis. A bundle of carbon filaments are laid with their central portions between the ears, and are wound along the spiral grooves, to which they are held by threads wrapped spirally around the former.

Engineering Improvements.

SPARK ARRESTER.—W. P. ALLEN and J. E. H. BROWNE, Albuquerque, N. M. The spark arrester may be placed in a locomotive at comparatively small cost, and consists of a casing placed in the smoke-box over the ends of the boiler flues. The product of combustion passing through the flues, forces the sparks through a sieve and a hood of wire netting at the nozzle of the casing. The sparks are thus extinguished, and the cinders are forced out of the smoke-stack by the exhaust of the engine. The side and bottom walls of the casing slant, respectively, inward and upward, and act as deflectors to force the sparks and cinders toward the outlet sieve. The top of the casing is hinged so that it may be readily swung open when it is found necessary to clean the arrester or the boiler flues.

ROTARY ENGINE.—T. J. MASTERS, Cardiff, England. The improved engine consists essentially of a revolving piston divided internally into a number of chambers, each presenting a radially-disposed face to the pressure of the steam, and each provided with a steam-admission port opening through the periphery of the piston. The admission ports of adjacent chambers are alternately in different transverse planes. The piston revolves steam tight in a cylinder provided with circumferential steam-passages and ports opening therefrom through the inner wall of the cylinder, in such positions that the admission-ports of the piston will coincide therewith at certain points during the revolution of the piston. Each chamber has also an exhaust port opening through the end of the piston, and these ports coincide, at certain points in the revolution, with corresponding exhaust ports in the end or side cover of the cylinder. The number and disposition of the admission and exhaust ports is such that steam will be admitted to more than half the number of chambers at one time, during which time it is being exhausted from the remaining chambers.

Gas Apparatus.

ACETYLENE GENERATOR.—ELMER F. MACKUSICK, Manhattan, New York city. The generator is arranged automatically to feed and charge the generator with calcium carbide in a very simple and effective manner, without danger of losing the gas-saturated water. The device can be used without the aid of skilled labor, the generation of gas automatically stopping upon cessation of consumption of gas.

GAS-HOLDER.—ELMER F. MACKUSICK, Manhattan, New York city. The gas-holder is intended to be used in connection with acetylene-gas generators, and is arranged to cool the gas to insure a rapid condensation of the moisture in the gas, so that it will pass to the bell in a dry state. Means are also provided for the escape of the gas in case of excessive pressure in the gas-chamber in the upper part of the water-tank of the holder.

Hardware and Tools.

BUTTER-CUTTER.—IRA B. WALKER Etna, Cal. The device is intended to cut butter into squares of equal size and weight, and is of particular service in creameries or the like. By its means slabs of butter, representing, for instance, a day's output, can be quickly and evenly cut to the designed sizes.

GAGE.—CLARENCE M. SEARS, Botsford, Conn. The gage is useful for all purposes to which such instruments can be applied. It is particularly serviceable when working with machine tools. By its means measurements can be accurately gaged, a tool located with respect to the part to be operated upon, and any variation in one direction or the other detected.

DOOR SECURER.—EDWIN P. RAETHER, San Diego, Cal. It has been the inventor's purpose to provide a simple appliance that can be readily introduced between the lower end of a door and a door-sill to hold the door closed. The device is of such small size that it can be carried in the pocket, ready for use at any time.

LOCK.—OSCAR KATZENBERGER, 702 South Alamo Street, San Antonio, Tex. It is the purpose of the invention to improve upon the principles and parts of a lock previously patented by the inventor so as to permit their application to every kind of lock made. The improvements consist of such an arrangement of the parts as to permit the application of the tumblers to the bolt direct, instead of to the auxiliary bolt, as heretofore; and such changing of the parts as to permit the use of a concavo-convex spring to produce the necessary friction on the tumblers instead of the spiral spring. The use of a dog and ratchet wheel, the latter having a smooth place for the beginning is thus permitted. The combination is communicated by sound or touch.

Heaters.

STOVE.—WILLIAM HEUERMAN, Sedalia, Mo. The invention provides a means by which to enforce a circulation of heated air and products of combustion in such a manner as to increase the heating capacity of the stove, save fuel, and regulate the combustion.

MAGAZINE HEATING STOVE.—JONATHAN W. NOXON, Valley City, N. Dak. Mr. Noxon has devised novel details of construction for a heating stove of the self-feeding type, permitting an exact control of fuel combustion, adapting the stove for complete burning of valuable waste, gaseous products, and utilizing the combustion of fuel for heat generation to a degree greatly in excess of that afforded by ordinary stoves.

ATTACHMENT FOR STOVES.—JOHN H. SOEHREN and CHARLES J. ROHLF, Everly, Iowa. The invention relates to improvements for attachments for cooking stoves, ranges, or heaters. A simple device is provided which is designed to be placed above a stove to catch any steam, heat, or smoke that may rise, and direct the steam or the like into the smoke-pipe or into a pipe leading into an upper room for the purpose of heating that room.

STOVE.—EDWARD E. WALTERS, Leighton, Pa. The stove has a firebox around which a water-jacket is arranged. In the water-jacket is a continuous passage surrounding the firebox. Connections extend between the ends of this passage and a water boiler, to provide for the circulation of water. The boiler in question comprises a shell through which fire-tubes pass; an inclosing casing having an outlet for the products of combustion; and passages carrying the draft from the firebox into the end of the casing and through the water-tubes or into the side of a casing past the boiler. The stove is useful for cooking and general house-heating.

Machine Tools.

MULTIPLE SPINDLE LATHE.—FRANK HIRSCH, Stockholm, Sweden. The headstock of this lathe is provided with a horizontal drum carrying a number of chuck-spindles, and the lengthwise-moving slide-rest is provided with a corresponding number of tool-spindles in opposition to the chuck-spindles, while besides the slide-rest a number of tools adjustable in a direction at right angles thereto are employed. The chuck-spindles are driven by a gear-wheel having internal teeth and surrounding said spindles. The revolving drum may be stopped independently of the chuck-spindles, and the device is so arranged that any individual chuck-spindle may be stopped for tak-

ing off a finished piece of work without interrupting the rotation of the others. In screw cutting the tool revolves at a uniform speed in the same direction as the chuck-spindles, but at a less speed while screw cutting, and at a greater speed during its withdrawal. The lengthwise motion of the slide rest is transmitted through levers to one or several tool slide-rests arranged to move in a direction at right angles to the drum axis. The tool slide-rests may be automatically moved in several directions.

Mechanical Devices.

SAVINGS BANK.—ARTHUR C. REICHEL, Union Hill, N. J. This registering savings bank is provided with a mechanism that will cause the sum total of the money deposited in the bank to be accurately indicated at an opening in the casing. Two coins cannot be introduced into the bank in quick succession; nor can a second coin be introduced before the first enters at the receiving slot of the bank, has passed through the mechanism and has been registered. After a certain sum has been deposited the door of the bank can be opened.

SHOE-CLEANING MACHINE.—WILLIAM RICHARDSON, Colfax, Wash. The machine consists of a frame provided with two standards between which a brush is mounted to turn. A cleaner engages the surface of the brush; a locking device secured to one of the standards holds the cleaner in place. By turning the brush through the medium of a crank handle and shaft the shoe can be quickly cleaned.

SHINGLE PACKER.—FRANK CAMPBELL, Haynesville, Me. The invention is a machine for packing shingles in bundles. The shingle packer consists of a frame, in the upper portion of which are inclined bed rails; a head-board; and a removable foot-board. Side-guides are mounted to swing on the bed-rails. In order to force the shingles closely together, upper and lower presser-bars simultaneously movable in opposite directions, are employed. By means of this device shingles can be rapidly packed before they are tied.

LIQUID WEIGHING MACHINE.—WILLIAM W. GEORGE, Winchester, Ky. Mr. George has devised a very ingenious contrivance for weighing liquid as it is discharged from a keg or other vessel. A device is attached to the keg whereby the faucet is turned off when the desired amount of liquid has been weighed. The operation is automatic.

MERRY-GO-ROUND.—WILLIAM F. MANGELS, Coney Island, Brooklyn, New York city. The improved construction devised enables a movement to be given to the seats without the use of a pit, or without unduly raising the platform and seats above the ground. Easy running of the machine is secured by giving a smooth uniform movement to the several parts of the driving-gear for the crank-shafts to avoid undesirable jerks and strain on the revoluble frame and seats.

AMALGAMATOR.—J. R. SAWYER, Arroyoseco, N. M. The amalgamator consists of a number of conical drums, one above the other, and horizontally mounted to rotate in suitable bearings. The drums are connected by a chain and sprockets, and have series of cups along their inner surfaces. While the drums are rotating, the material containing the precious metal is fed into the base end of the uppermost drum and is treated by the mercury contained in the cups. Owing to its nature, the mercury readily takes up the precious metal as it flows out of the cups at the top and through the material back into the cups at the bottom of the rotating drum. This operation is continued while the material, under pressure of the new material continually added, gradually works along the uppermost drum and through a pipe into the second drum. There it is similarly treated and discharged into the next drum, and so on through the entire machine. The mercury owing to its specific gravity and fluid form is retained and will not travel up to the apex of the drums.

GOLD SEPARATOR.—A. L. DANA, Colorado Springs, Col. The mineral is first passed over a spreader-plate into a trap. Water flows into this trap underneath the spreader-plate, causing an undercurrent which will lift the dross, while the gold, by its specific gravity, settles to the bottom. If any gold escapes from the first trap it is carried to a second trap where the same operation takes place. The overflow and tailings pass out through a spout, and any values that may be carried along in the pan are stopped by a riffle. The traps and pan are oscillated in order to assist in separating out the gold.

CAN STRAIGHTENER.—C. W. NICKLAUS, Elgin, Ia. The invention is a simple device for taking kinks and dents out of the cylindrical sides of tin cans. The can is placed onto a concave seat or straightening bed, and a former arm, operated by foot power, is forcibly brought down against the inner wall of the can, thereby pressing out the dents. In order to adapt the device to different cans, detachable can-seats of different sizes are employed.

GEOGRAPHICAL CLOCK.—A. J. DAY, Semaphore Road, Exeter, South Australia. The object of this invention is, by one instrument and with one dial, to indicate standard time at all parts of the world, also to indicate the point on the equator at which the sun is at its meridian, and to enable the mean time to be calculated. It is to be used in

connection with an ordinary map or globe, and the zone system by which the earth is divided into twenty-four zones, each equal to one hour of time. Twenty-four pointers indicate the time in each and all of the twenty-four time zones. A circle is attached to the underside of the pointers, having the degrees of a circle marked thereon, and an index shows on the dial, at any moment, the actual meridian and its longitude, from which the mean time at any place can be calculated.

CASH REGISTER.—N. COLLINS, Monument Square Chambers, London. The invention relates to machines for registering cash receipts. Printed records are furnished of each individual amount received, and of the aggregate of that and the several amounts previously recorded, as well as a record of the time at which each transaction is registered. The apparatus is especially designed to prevent the falsification of the record through omission to complete the registration, by printing a record of a transaction in respect of which a key may have been depressed. A separate time-record is also printed in order to show the times of opening and closing the machine for purposes of business. The entire mechanism may be locked to prevent unauthorized use of the machine outside business hours.

Railway Contrivances.

HOSE-BRIDGE.—DE CALVUS SMITH, Colebrook, Ohio. The invention is an improvement in hose-bridges for use on railroads, where it is desired to pass a hose across a track in case of fire. The bridge can be readily applied to the rail and secured thereto from lateral or longitudinal displacement; is supported or steadied in position by lateral arms and adjustable supporting devices; is braced by an arch-bar; and efficiently serves the purpose for which it is intended.

RAIL JOINT.—WILLIAM H. SHIPE and JOSEPH P. GLEESON, Scottsdale, Pa. The invention is in the nature of a combined chair and rail joint, in which the chair-like base will stand a space between two adjacent ties, so that it will be supported on both ties. A joint can be produced between the ties. Devices are employed for securely fastening the rail in the joint section. The invention obviates the use of bolts and nuts.

STREET-CAR TRANSFER-TICKET.—MORGAN WASHBURN, 280 Broadway, Manhattan, New York city. The system in vogue in our large cities, by which it is possible for a street-car passenger to travel long distances for a single fare, is only too often abused. Frequently passengers resort to the cheap, but dishonest, practice of using transfer-tickets in such a manner that they pay but a single fare, where they ought to pay several. Mr. Washburn has devised a means which will frustrate any such scheme. By means of a ticket divided into sections, containing each the name of a railway line, and into indices arranged along the side of each section and repeated in the several non-separable sections, he succeeds in preventing a passenger from traveling in a circle or returning to a starting-point with but the payment of a single fare.

SEAT.—LOUIS JANSON, Brooklyn, N. Y. The seat is reversible, and is adapted particularly for use in railway-cars. The back of the seat is fastened to the upper ends of two levers which are pivoted to the seat-base. The seat proper has an arc-shaped slide at each end, bearing on socket pieces in the base, and is connected by levers to the seat-back. To lock the seat two arms are pivoted to the center of the base, and so connected with the seat-back, that the latter must be lifted up before moving sidewise to reverse the seat.

RAILROAD CONSTRUCTION.—W. M. HICKOK, Parisburg, Ohio. Cup-shaped anchor-plates are employed at intervals along the track. Extensions from these plates have recesses at their tops adapted to receive the base portions of rails. Tie-rods pass through openings in these extensions and lugs on the ends of the rails, connecting one to the other. Opposite rails are connected by cross-ties.

TROLLEY.—J. S. VAN LEER, St. Louis, Mo. This invention aims to prevent a trolley from leaving the wire, and also to facilitate in finding the wire. Arranged on opposite sides of the trolley are guard-plates having an elliptical form, their upper portions extending above the plane of the trolley. At their lower ends these plates are connected together and weighted, which causes them to maintain an upright position at all times. By giving them an elliptical shape, should they engage a cross-wire, they will be swung downward and clear the same.

RAILWAY TIE.—C. DE CEW, Brooklyn, N. Y. The invention relates to metallic railways. The chairs, bearing on the ties against the rail at opposite sides thereof, are formed with slots disposed transversely to the rail, and have pairs of diagonally-disposed or V-shaped beveled surfaces. Spring keys with correspondingly beveled surfaces engage the surfaces of the chairs, and are connected by bolts to the ties.

Vehicles and Their Accessories.

AUTOMOBILE LOCK.—JOHN F. WILSON, Jetmore, Kans. The invention is a device for locking the controlling-lever of an automobile-motor. A lock of simple construction is provided, which can be operated only by the person to whom the combination at which it is set is known. Thus the starting of the ve-

hicle is prevented. Should an attempt be made to open the lock without releasing the proper latches, an alarm will be sounded.

SPEED-RECORDER AND REGISTER FOR VEHICLES.—CARL FRANCKE and HEINRICH SCHWABACHER, Dessauerstrasse 6, Berlin, Germany. The apparatus will indicate the time at which a tram car left a station, the speed at which the car covered its journey, the time at which it completed the journey, and the various stopping places. The apparatus can also be made to indicate the total of the various separate journeys made within a certain given period.

BRAKE.—GASTON H. DE BERLY and EUGÈNE G. RASSINIER Rue Darnémont 4, Paris, France. The invention is chiefly characterized by the combination of a sleeve carried and fixed to the hub of spokes of a motor vehicle wheel, which sleeve is acted upon with braking effect by two rollers carried upon a lever. The lever is pivoted to the axle; and by its operation a progressive grip is obtained upon the inside or outside of the sleeve or upon both sides.

PAWL AND RATCHET BRAKE.—E. CANAPLE and F. THIÉBAUX, Germigny-l'Évêque, Seine et Marne, France. With this invention the driver of a vehicle may use both hands, if desired, to operate the brake lever, as the pawl and ratchet act automatically. By the shifting of a weight on the pawl the latter may be made either to engage the ratchet teeth or to swing free from them.

VEHICLE BRAKE.—J. W. PACKARD and W. A. HATCHER, Warren Ohio. The brake comprises a shoe mounted on a lever hung from the vehicle spring and actuated by a connecting-rod and foot lever. The shoe coats with the inner periphery of an annular brakering rim fastened directly to the inner periphery of a wheel at one side of the spokes.

ELASTIC TIRE.—W. F. WILLIAMS, 17 and 18 Great Putney Street, Golden Square, London. The invention consists in embedding into the rubber an open-meshed fabric, of the nature of a fishing-net, formed of cords knotted together at their points of intersection. The meshes are large and open so that the rubber will fill and completely envelop them. The knots insure that the cords will mutually support each other, and they so strengthen the rubber as to prevent tearing.

Miscellaneous Inventions.

ARCH.—LOUIS LANE, Toledo, Ohio. Mr. Lane has devised an improved construction of small arched bridges, culverts, and the like. Arch plates spring from abutments, which plates are corrugated in the direction of their curve. A key-bar is arranged between the upper ends of the plates. To the bar plates are secured engaging the upper and under surfaces of the arched plates. By properly proportioning and employing metal arch-plates, the trouble and expense of temporary centering which has rendered the use of such arches impracticable in many places, owing to the great diversity of sizes, are saved.

CURRYCOMB.—JOSEPH E. GILBERT, Danville, Mich. The scraper-blades are held together in pairs. Through slots in some of the scraper-blades, guide-bars loosely pass, which are held at their ends in the outer toothed bars. The scraper-blades can be moved endwise. Hence, it is possible to remove the adhering scurf from the comb, simply by moving the scraper-blades, and not by striking the currycomb against the floor or wall to its great injury.

CURTAIN-FIXTURE.—WILLIAM E. MATHEWS, Ferndale, Cal. The curtain-fixture is easily applied and readily adjusted. The same screw or clamp will operate to secure the curtain-bracket in any desired adjustment, and will, at the same time, bind the bars that form the bracket in clamping engagement with the window casing.

PAPER-FASTENER.—ROBERT MCMAHON, Manhattan, New York city. The paper-faster consists of two members, of which one is provided with pins to be passed through the papers and to engage the other member. Registering apertures in the members permit the passage of a seal-ribbon. Flaps on the second member conceal and lock the pins without covering the registering aperture. The device fastens any desired number of superposed sheets securely together.

SHIPPING-BOX.—ASA E. PIPER, Buffalo, N. Y. The box is intended to hold and ship produce, such as butter, the construction being such that the box can be knocked down, so that several boxes can be made to occupy a very small space. The cost of manufacture is small.

CHATELAINE-BAG HOOK.—MARCUS T. GOLDSMITH, Manhattan, New York city. The inventor has devised a hook that is arranged to be held securely in position on the waist-belt, so that it cannot be accidentally detached. Only the wearer can remove the hook.

WINDOW BOX FOR PROTECTING FOOD.—ALEXANDER BOLLER, Manhattan, New York city. This folding box for windows can be closed up flat, so as to occupy a minimum amount of room in storage. Self-adjusting fastening devices permit the attachment of the box to a window-frame of almost any size. The upper lid can be raised or lowered to permit cleaning of the window-panes. The lower member can be adjusted to enable the window-

sill and the bottom of the box to be thoroughly cleaned. The sides can be adjusted without disturbing the bottom. However slanting the sill may be, the bottom can always be maintained level.

BOTTLE CLOSURE.—JOHN SCHIES, Anderson, Ind. The neck of the bottle is grooved to receive a sealing strip, so formed as to be engaged by the threaded cap. The seal swells in the groove, while the cap is held to the seal by the screw-threads. The threading of the cap into the ring, as well as the moisture of the contents of the bottle, will operate to aid the natural resilience of the seal in forcing the seal into the groove of the bottle-neck.

SLIDE LOOP-CLIP.—ISAAC GOURES, 403 East Seventy-seventh Street, Manhattan, New York city. The invention is an improved device for holding a supporting strap or loop as adjusted on a belt of elastic webbing or the like. Mr. Goures' device is of simple construction, and, when in position, prevents the loop or strap from sliding along the web. The clip is so arranged that it will neither cut into nor soil the web during its movement.

PROJECTILE AND FUSE.—LEOPOLD JULIG, 348 Seventh Street, San Francisco, Cal. The invention is a new projectile and fuse, whereby greater effectiveness is obtained. It is an improvement upon that form of projectile in which the fuse or primer is ignited by the primary combustion of potassium, which, when brought into contact with water ignites and burns spontaneously.

CALCULATOR.—ARMAND T. BEAUREGARD, Stamford, Conn. This improved calculator is more especially designed for use in testing the accuracy of electric recording watt meters and finding by mere inspection the percentage error whether the meter be fast or slow.

CHATELAINE HOOK.—LOUIS B. PRAHAR, Brooklyn, New York city. Mr. Prahar has devised a simple, light and durable form of chatelaine hook, so constructed that it can be quickly applied to a belt or band, and as readily removed. The chatelaine hook is held to a support in such a manner that it can work no injury.

BAR MIXING-GLASS.—HENRY MORGAN, Cripple Creek, Colo. The invention provides a mixing-vessel having an internal hinge, and a strainer loosely pivoted on the hinge. The liquid passes through the strainer and into a serving-glass. The device is readily detachable.

CARBID CARTRIDGE FOR ACETYLENE GAS GENERATORS.—BLAIR F. MACKUSICK, Manhattan, New York city. The inventor has devised a new and improved charge for acetylene gas generators, which is arranged hermetically to inclose the calcium carbide and to prevent its disintegration by moisture while not in use. An intermittent generation of gas is caused and the charge is submerged in water, thus insuring a cool generation of gas.

NOZZLE.—CHARLES A. SNIDER, Jersey City, N. J. A carrier provided with a number of different articles is movably mounted upon a support in such a manner that by moving it any one of the articles can be brought into an operative position. The invention is particularly applicable to nozzles for fire-hose or fire-hydrants. The construction is simple and compact; and its parts easily accessible.

VALVE.—ANTON WAGNER, Manville, R. I. The purpose of this invention is to enable one having charge of a valve to tell exactly to what extent the valve has been moved, and thus accurately regulate the amount of fluid that may pass through it. This end is attained by providing a peculiarly constructed scale used with the valve, so that all movements are recorded on the scale.

BOX.—AUGUST FLASKAMP, Crefeld, Germany. The box is intended to contain and display scarfs, neckties, and similar articles, and to hold the things displayed either directly on posts or supporters or between partitions. The individual supports for the articles or the supports for the partitions are simply constructed and securely fastened in position in the bottom of the box.

Designs.

HOOF PAD.—JOHN CAMPBELL, Manhattan, New York city. The body of the pad has at its side edges forward of the heel at the quarter two shoe recesses, the inner walls of which are formed by the outer surfaces of the projection. In the body at the underside there is a depression or pneumatic chamber which narrows toward the front of the pad and from which a channel leads through the heel to the back edge.

NECKTIE.—ABRAHAM W. COWEN, Manhattan, New York city. The design provides a combined four-in-hand and bow tie.

SUSPENDER YOKE.—BENJAMIN STEIN, Manhattan, New York city. The leading features consist of two connected side-wing sections curving upward and outward in opposite directions; and a downward-extending tab member, forming a portion of the central section of the yoke and continuous with the side-wing sections.

PURSE TOP.—SIDNEY A. KELLER, Manhattan, New York city. The leading feature of this design is an arch surmounted on the faces and other margin by a complete floral pediment.

NOTE.—Copies of any of these patents will be furnished by Munn & Co. for ten cents each. Please state the name of the patentee, title of the invention, and date of this paper.

Business and Personal Wants.

READ THIS COLUMN CAREFULLY.—You will find inquiries for certain classes of articles numbered in consecutive order. If you manufacture these goods write us at once and we will send you the name and address of the party desiring the information. **In every case it is necessary to give the number of the inquiry.** MUNN & CO.

Marine Iron Works. Chicago. Catalogue free. **Inquiry No. 2202.**—For complete address of Mr. J. Wilson, of Perth Amboy, N. J., holder of patent No. 690,215.

Motor Vehicles. Duryea Power Co., Reading, Pa. **Inquiry No. 2203.**—For manufacturers of water-wheels. **"U. S." Metal Polish.** Indianapolis. Samples free.

Inquiry No. 2204.—For manufacturers of compressed brick machinery. **WATER WHEELS.** Alcott & Co., Mt. Holly, N. J. **Inquiry No. 2205.**—For novelties and patent labor-saving devices.

Stencil Machines.—A. J. Bradley, 101 Beekman St. N. Y. **Inquiry No. 2206.**—For dealers in very fine wash and flour of emery.

Metal substitute. Crane Bros., Mfrs., Westfield, Mass. **Inquiry No. 2207.**—For dealers in photo-engraving supplies. **Handle & Spoke Mch.** Ober Mfg. Co., 10 Bell St., Chagrin Falls, O.

Inquiry No. 2208.—For manufacturers of compressed air apparatus for cleaning carpets, furniture, etc. **Sawmill machinery and outfits manufactured by the Lane Mfg. Co.** Box 13, Montpelier, Vt.

Inquiry No. 2209.—For makers of machines for making clay knobs, bushing cleats, etc. **Rigs that Run.** Hyarocarbon system. Write St. Louis Motor Carriage Co., St. Louis, Mo.

Inquiry No. 2210.—For manufacturers of the Tesla electrical system for carrying ore and bags of grain. **For sheet metal stampings and novelties try Standard Stamping Co.**, Seventh and Hudson, Buffalo, N. Y.

Inquiry No. 2211.—For manufacturers of steel tracks for wagon roads. **Are you looking for anything in bent woodwork?** Write Tucker Bicycle Woodwork Co., Urbana, Ohio.

Inquiry No. 2212.—For wholesale dealers in amber, horn and celluloid mouth pieces for pipes. **We make anything in sheet metal, any shape.** Estimates free. Metal Stamping Co., Niagara Falls, N. Y.

Inquiry No. 2213.—For makers of electric or steam motor and wheel combined, so as to be attachable to vehicles to be run as an automobile.

I will represent you in Europe. Hardware or novelty trades. Best references. "Europe" Box 773, New York. **Inquiry No. 2214.**—For makers of glazed, brown, stone backing bottles for liquid backing.

We develop inventions through their several stages, manufacturing for the market. Amstutz Osborn Co., Cleveland, O.

Inquiry No. 2215.—For makers of non-absorbent round paper boxes of 2 1/2 x 3 and 3 1/2 inches deep, plain outside. **Special and Automatic Machines built to drawings on contract.** The Garvin Machine Co., 149 Varick, cor. Spring Streets., N. Y.

Inquiry No. 2216.—For makers of cheap 1 oz. ink bottles. **Manufacturers of patent articles, dies, stamping tools, light machinery.** Quadriga Manufacturing Company, 18 South Canal Street, Chicago.

Inquiry No. 2217.—Wanted to buy compressed air carpet-cleaning machines.

Patents developed and manufactured, dies, special tools, metal stamping and screw machine work. Metal Novelty Works Co., 43-47 S. Canal St., Chicago. **Inquiry No. 2218.**—For dealers in powdered lead prepared by blowing a jet of steam through the molten metal.

The celebrated "Hornsby-Akroyd" Patent Safety Oil Engine is built by the De La Vergne Refrigerating Machine Company. Foot of East 138th Street, New York.

Inquiry No. 2219.—For manufacturers of portable houses and buildings. **The best book for electricians and beginners in electricity is "Experimental Science," by Geo. M. Hopkins.** By mail, \$4. Munn & Co., publishers, 361 Broadway, N. Y.

Inquiry No. 2220.—For dealers in apparatus, cans, etc., for the condensed milk business.

WANTED.—Foundry chemist who can also superintend cupolas and produce iron at lowest cost. Young man preferred. Stover Manufacturing Company, Freeport, Md.

Inquiry No. 2221.—For flat steel 5-16 x 3-32.

Wanted.—Revolutionary Documents, Autograph Letters, Journals, Prints, Washington Portraits, Early American Illustrated Magazines. Correspondence Solicited. Address C. A. M. Box 773, New York.

Inquiry No. 2222.—For cuts of Serrel or other automatic silk reeling machinery; best loom for weaving organzine silk; best loom for weaving floss, for illustrating bulletin of a State Department of Agriculture.

WANTED.—Draftsman of first-class skill wanted in manufacture of highest grade fine instruments. Unusually attractive position for right man, satisfactory compensation and association with experts. Address, stating age, experience and desired salary, Electrical, Massachusetts. Box 773, New York City.

Inquiry No. 2223.—For a simple and inexpensive steel basket.

WANTED.—A first-class machinist to take charge of a water power plant, seven miles out from the city of Lancaster, Pa. Must be a sober, married man who has had some experience with turbine wheels; man who has had some experience with the Lombard water-wheel governor preferred.

Salary, \$720, with house rent free. Residence is a large mansion house, located in a small village within 500 yards of the water power, large garden and stable for horse and cow. Address Lancaster Electric Light, Heat and Power Company, Lancaster, Pa.

Inquiry No. 2224.—For a light and powerful motor suitable for an airship. **Send for new and complete catalogue of Scientific and other Books for sale by Munn & Co., 361 Broadway, New York. Free on application.**

Inquiry No. 2225.—For dealers in Richard B. Locke's "Gyro Evaporators."

Inquiry No. 2226.—For manufacturers of rubber supporter buttons for hose supporters.

Inquiry No. 2227.—For parties in New York making small horseshoe magnets.

Inquiry No. 2228.—For dealers in the slicer, blocker and taper machines for manufacturing corks.

Inquiry No. 2229.—For dealers in machine shop outfits.

Inquiry No. 2230.—For makers of rock-drilling machinery and outfits.

Inquiry No. 2231.—For dealers in model air cylinders and valves.

Inquiry No. 2232.—For makers of camel's hair cloth for hydraulic press work.

Inquiry No. 2233.—For manufacturers of pipes.

Inquiry No. 2234.—For manufacturers of baskets or cans for removing debris of villages and city streets.

Inquiry No. 2235.—For manufacturers of parts for suspenders.

Inquiry No. 2236.—For makers of fire escapes.

Inquiry No. 2237.—For manufacturers of spring guns.

Inquiry No. 2238.—For manufacturers of cotton gins.

Inquiry No. 2239.—For dealers in yarn for blankets or robes.

Inquiry No. 2240.—For dealers in rims for cheese boxes.

Inquiry No. 2241.—For dealers in diamond dyes, fast colors.

Inquiry No. 2242.—For a machine for mixing sand and other ingredients for making glass.

Inquiry No. 2243.—For parties to make novelties of white metal, aluminum, etc., to order.

Inquiry No. 2244.—For machinery for making wooden dishes for butter and lard.

Inquiry No. 2245.—For parties to manufacture small articles from pressed steel.

Inquiry No. 2246.—For manufacturers of seed and coffee triers.

Inquiry No. 2247.—For makers of peanut-vending slot machines, which will deliver in sacks, with lump for heating.

Inquiry No. 2248.—For makers of a slot machine, showing lady in a case delivering packages of gum when machine is operated.

INDEX OF INVENTIONS

For which Letters Patent of the United States were Issued for the Week Ending

March 4, 1902,

AND EACH BEARING THAT DATE.

[See note at end of list about copies of these patents.]

Table listing inventions and their corresponding patent numbers, such as Adhesive material to paper, machine for applying, C. W. Hobbs 694,749; Adjustable screen, W. N. Rumely 694,496; Adjustable stand or support, G. L. Marsolais 694,401; Aging apparatus, J. C. Hebden 694,640; Air and gas mixing and supplying apparatus, G. H. Burrows 694,611; Air blast apparatus, J. M. Tyler 694,588; Air brake system, A. Bruggemann 694,525; Air compressor, D. O'Connell 694,885; Air ship propeller blade, F. W. Dufwa 694,356; Alarm, See Burglar alarm 694,447; Amusement or illusion apparatus, T. Van Kannel 694,701; Animal trap, E. D. & O. V. Vantyle 694,738; Ant trap, furniture, M. Goldberg 694,666; Atomizer pump, J. Robertson 694,631; Axle skew, E. Good 694,849; Badge or button, J. Frame 694,644; Ball ears on sheet metal vessels, forming, Hornung & Wolf 694,745; Baking pan, F. Hall 694,448; Bale band applying and tightening device, A. A. Vardell 694,543; Ballot box, C. D. Green 694,782; Barley and malt, testing, W. H. Prinz 694,608; Bearing, antifricition, W. J. Brewer 694,505; Bearing, roller side, J. C. Wands 694,549; Bearing, roller side, C. F. Huntoun 694,506; Bearing, side, J. C. Wands 694,361; Bedstead, R. Fleck 694,585; Beer, apparatus for converting wort into, Selg & Guntrum 694,584; Beer, converting wort into, Selg & Guntrum 694,511; Bell mounting, electric, C. Wolttequand 694,390; Belt, B. Kronthal 694,388; Bicycle attachment, R. Kaucher 694,875; Bicycle saddle, G. A. Meighan 694,539; Bicycle seat post, England & Hutchinson 694,423; Billiard cue, W. C. Kood 694,643; Boat, submarine, J. P. Holland 694,604; Bobbin holder, spindle, Bass & Chase 694,413; Boilers, assembling frame for steam, E. J. Pennington 694,829; Bolt cutter and trimmer, J. Candlish 694,593; Bookbinding, R. P. Winckler 694,841; Book cover fastener, supplemental, F. R. Derrick 694,490; Book holder, E. W. Murphy 694,534; Boring holes in rock, etc., apparatus for, F. H. Davis 694,535; Boring machine, double spindle, drawer pull, S. F. Wise 694,510; Bottle cleaning machine, A. Goetz 694,372; Bottle washer and rinser, W. M. Phelan 694,416; Bottling table, W. M. Phelan 694,415; Box fastener, C. M. Johnson 694,520; Box for containing eggs, etc., R. Baker 694,663; Box staying machine, R. Partzsch 694,536; Braiding carrier, A. B. Diss 694,785; Brake wheel, M. Z. Sims 694,394; Brick machine, Lee & Glessner 694,744; Bridge, bascule, C. F. Hall 694,889; Broiler, revolving, P. Pooley 694,379; Buckle, J. H. Hart 694,727; Buckle, back band, D. T. Bryan 694,380; Burglar alarm and door check, combined, C. H. Hawkinson 694,456; Burner. See Gas burner 694,769; Bushing, bung hole, N. H. Medbery 694,636; Button, J. Gump 694,677; Cable hanging book, Seyler & Auxer 694,897; Calculating machine, J. W. Sloss 694,881; Calendar, H. W. McAll 694,792; Call, electric, J. Salmon 694,570; Cam mechanism, variable, T. M. North 694,920; Camera, D. H. Houston 694,925; Camera, folding panorama, D. H. Houston 694,925; Camera, folding roll holding, D. H. Houston 694,928; Camera, folding roll holding photographic, D. H. Houston 694,862; Camera, folding support, D. H. Houston 694,516; Camera, panoramic, Akers & Richards 694,823; Camera, panoramic photographic, D. H. Houston 694,923; Camera, photographic, Prieur & Dubois 694,573; Camera, roll holding, D. H. Houston 694,919; Camera, roll holding photographic, D. H. Houston 694,922; Cane loader, J. Hornor 694,458; Capping machine, electromagnetic, L. J. Borle 694,385; Car bolster, railway, Ingoldby & Bowling 694,462; Car door and locking device therefor, grain, S. A. Crone 694,494; Car, express, J. E. Porter 694,883; Car fender, McGarity & Hopf 694,715; Car, metal, A. B. Bellows 694,909; Car roller bearing, J. B. Christopher 694,436; Car side bearing, railway, F. R. Cornwall 694,504; Car side bearing, railway, J. C. Wands 694,470; Carriage motor, C. Gouchon 694,713; Cartridge, C. A. Bailey 694,713

(Continued on page 194)

Cartridge, gun, R. W. Scott..... 694,675

Cash box, J. J. Peetz..... 694,896

Cash register, W. J. Carroll..... 694,887

Cash register, J. P. Cleal..... 694,872

Cash register, G. H. Guest..... 694,853

Casting mold, S. Michailoff..... 694,418

Casting mold, S. Michailoff..... 694,566

Casting of alloys containing copper and zinc, improving, E. S. Sperry..... 694,688

Cement, manufacture of, J. Steiger..... 694,802

Chain, conveyor, G. W. Cross..... 694,533

Chain, drive, C. W. Levalley..... 694,870

Chair, O. L. Beardsley..... 694,457

Chair foot rest attachment, W. A. Eddy..... 694,538

Chairs, cradles, etc., attachment for, L. M. Sartain..... 694,426

Cheese box, W. A. Simister..... 694,798

Cigar bunching machine, M. M. Gardner..... 694,625

Cigar mold, G. M. Williams..... 694,507

Cigar tip cutter, E. Walker..... 694,591

Clarifier, L. Littly..... 694,871

Clay pan emptying device, J. P. Wynn..... 694,903

Clock, self-winding electric, Hoelt & Schultz..... 694,546

Clothes horse, S. G. MacMillan..... 694,766

Clothes line apparatus, H. Perdreux..... 694,414

Clothes line ratener, F. Raub..... 694,455

Clutch, H. Illingworth..... 694,550

Clutch, friction, J. Harrington..... 694,472

Coach, equalizing suspender, W. N. Best..... 694,346

Cock, stop and waste, E. Munger..... 694,880

Coin controlled apparatus, H. G. Sweeney..... 694,693

Collar blanks, etc., machine for folding, W. W. & W. L. Dixon..... 694,844

Collar blocking machine, horse, R. Dodson..... 694,733

Collar fastening device, plow, C. C. Chappel..... 694,351

Commode stand and seat, folding, J. H. Prentice..... 694,890

Compound engine and valve therefor, S. M. Vauchain..... 694,702

Concrete construction, E. L. Ransome..... 694,580

Concrete construction, reinforced, E. L. Ransome..... 694,577

Concrete, coupling metal bars in reinforced, E. L. Ransome..... 694,576

Concrete mixer, E. L. Ransome..... 694,578

Condensing coil, A. Siebert..... 694,597

Connecting device, J. R. Carter..... 694,459

Conveyer apparatus, G. S. Baker..... 694,519

Conveying apparatus, Delaney & Miller..... 694,355

Cooking boiler, W. H. Taylor..... 694,805

Cork holder, F. S. Towle..... 694,446

Cork extractor, G. C. Ferguson..... 694,466

Corn popper, T. G. Melish..... 694,657

Corn sheller feed drag, W. C. Rowe..... 694,667

Corns, protector pad for, S. A. Level..... 694,762

Cot and stretcher, convertible, E. B. Clifton..... 694,353

Cotton chopper, A. L. Hockett..... 694,474

Cotton chopper, J. T. James..... 694,479

Cotton chopper scraper attachment, A. L. Hockett..... 694,475

Coupling, See Pipe coupling.

Crate, A. von Schluembach..... 694,794

Crate, banana, C. A. Doud..... 694,845

Cuff holder, M. S. Goldman..... 694,739

Cultivator, R. H. Avery..... 694,819

Cultivator cover, H. M. Phillips..... 694,797

Culvert, sectional, F. A. Sicklesteel..... 694,796

Curtain pole, D. L. Altman..... 694,710

Cutting irregular surfaces, machine for, A. Johnson..... 694,386

Damper regulator, stove, B. J. Casterline..... 694,460

Dandy roll, F. H. Bills..... 694,717

Decoy, J. Coudon..... 694,732

Dental chair back rest, G. Sibley..... 694,683

Dental chair, chest blowing attachment, W. W. Bregg..... 694,526

Designator or enumerator, Collamer & Mahony..... 694,730

Disinfecting cabinet for barbers' use, etc., W. E. Sewell..... 694,676

Display device, portable, T. E. Stark..... 694,690

Display stand for foot gear, G. C. Sweet..... 694,694

Distilling oil, J. A. Dubs..... 694,621

Door mat, C. Kuhn..... 694,554

Door sealer, C. F. Williams..... 694,812

Drafting table and T-square attachment, A. Kutsche..... 694,889

Drill, R. Binnie..... 694,822

Drill rods, etc., screw joint fastener for, F. Wulf..... 694,514

Drilling machine, automatic, D. Ramsay..... 694,784

Drilling, milling, and tapping machine, turret, A. D. Quint..... 694,783

Dye and making same, blue sulfur, J. Abel, reissue..... 11,973

Economizer, H. Vernon..... 694,590

Egg preserving apparatus, P. H. Treadway..... 694,501

Egg preserving compound, J. M. Stukes..... 694,899

Electric light support, adjustable, E. E. Walters..... 694,810

Electric meter, C. T. Claypool..... 694,832

Electric motor, T. B. Hatch..... 694,639

Electric or other motors, means for controlling, E. R. Gill..... 694,369

Electric protective device, W. P. Hardy..... 694,855

Electrical conductive, outlet member for, R. M. Thibault..... 694,806

Electrode for purifying liquids by electrolysis, W. R. Chipman..... 694,933

Electrolytic process, J. Meurant..... 694,658

Electromagnet apparatus, D. Perret..... 694,778

Elevating and controlling mechanism, J. F. Hardy..... 694,637

Elevator and carrier, J. M. Applegate..... 694,818

Engine brake, E. Y. Moore..... 694,403

Engine stop mechanism, T. Milles..... 694,877

Engine vaporizer, explosion, C. O. White..... 694,708

Engines, electric igniting apparatus for explosive, S. F. Neill..... 694,409

Envelop opener, T. Anderson..... 694,817

Evaporating pans, transfer and hinge for, G. A. King..... 694,874

Evener for gang plows, four horse, Brown & Elick..... 694,610

Expansion bolt, D. W. Bennett..... 694,345

Extension table, E. J. Spink..... 694,439

Fare register, R. H. Recorder, W. M. Kelch..... 694,483

Fed water purifier, J. W. Pearce..... 694,571

Fence for chicken closures, portable, G. C. Lathrop..... 694,761

Fence machine, wire, H. Martin..... 694,768

Filter, oil, H. Sims..... 694,434

Finger ring, C. T. Wittstein..... 694,595

Firearm sighting device, W. Youlten..... 694,904

Fire escape, Kaschewitz & Barthel..... 694,866

Fire escape and convertible scaffolding, telescopic, W. E. Monroe..... 694,771

Fire resisting partition, wall, etc., W. Seefeldt..... 694,583

Fireproof construction, P. F. Brandstedt..... 694,720

Fireproof flooring, J. B. Hinchman..... 694,381

Flier, F. A. Meller..... 694,876

Flier, J. J. McOsker..... 694,884

Flushing apparatus, P. F. Glackin..... 694,629

Flushing tank, automatic, P. F. Glackin..... 694,627

Forging machine, S. Vanstone..... 694,808

Framing or other purposes, ornamental stock for, J. H. Killon..... 694,755

Fuse cut out plural, C. J. Dorsey..... 694,912

Game, See Micrometer gage.

Gage, G. W. Winckfield..... 694,509

Game apparatus, D. Smith..... 694,799

Game table cushion, R. F. Downey..... 694,463

Gas burner, Bunsen, B. M. Hanna..... 694,746

Gas burner, incandescent, C. A. Bluhm..... 694,824

Gas engine, H. Junkers..... 694,552

Gas engine, Freeman & Throop..... 694,735

Gas generator, acetylene, L. T. Stephenson..... 694,587

Gas generator, acetylene, J. Harris..... 694,918

Gas igniter, T. B. Wilcox..... 694,902

Gas retort stand pipes, apparatus for cleaning, J. H. Taussig..... 694,443

Gear, speed changing, G. E. McElroy..... 694,407

Gearing, A. T. Brown..... 694,724

Glass articles, manufacture of hollow, P. T. Sievert..... 694,685

Glass flattening and annealing apparatus, Anderson & Hollingsworth..... 694,711

Gold from refractory ores, recovering, H. R. Cassel..... 694,349

Grading machine, T. R. McKnight..... 694,661

Grain cleaner, A. D. & G. L. Francoeur..... 694,540

Grain drill, A. Armitage..... 694,598

Grain drill, A. Smith..... 694,499

Grain shocking machine, Woolley & Fox..... 694,512

Grain tube cup, W. C. Renaker..... 694,419

Grate bar, J. Barker..... 694,601

Grinder, mowing machine knife, F. G. Green..... 694,376

Grinding machine, cutlery, A. Johnston..... 694,387

Gun barrel, W. F. Cole..... 694,833

Gun, breech loading, G. S. Lewis..... 694,654

Gun, rapid fire, G. J. Boehm..... 694,606

Guns, firing multishot, R. W. Scott..... 694,674

Gymnastics, combination apparatus for heavy, H. Sude..... 694,442

Hair clasp, J. Machado..... 694,534

Halter, G. P. Cooley..... 694,531

Hammer, automatic, A. Stromdahl..... 694,898

Harrow and cultivator, reversible rotary, M. Schichtl..... 694,429

Harrow, riding, B. Alsup..... 694,451

Harvesting machine grain divider, J. F. Steward..... 694,441

Hat pressing machine, Klinger & Reynolds..... 694,756

Hay press, automatic, F. S. Buchanan..... 694,827

Hay rake, W. S. Livengood..... 694,558

Hay rake, horse, W. A. Cavett..... 694,831

Hay rake, side delivery, C. W. Baird..... 694,344

Hay rake, sulky, A. R. Black..... 694,719

Heel nailing machine, B. F. Mayo..... 694,656

Heel nailing machine, F. E. Raymond, 2d..... 694,605

Hinge, detachable spring, G. H. Schiek..... 694,670

Hinge for supporting and operating doors, W. L. Selleck..... 694,432

Hinge, water close seat, P. F. Glackin..... 694,628

Hitching device, J. W. Evans..... 694,465

Hitching device, horse, D. T. Granberry..... 694,375

Hoist, self-dumping, E. L. Ransome..... 694,579

Hoisting and conveying apparatus, H. H. Guffin..... 694,378

Hoisting and dumping apparatus, tramway for, G. D. Johnstone..... 694,551

Hook and eye, A. McNicol..... 694,777

Horseshoe, J. R. Holland..... 694,917

Horseshoe calk, B. McKenzie..... 694,776

Horses from vehicles, device for clearing, L. L. & W. S. Livengood..... 694,363

Hose nozzle, J. E. Garrison..... 694,365

Incandescent mantel support, J. F. Bredow..... 694,347

Ingot, compound, S. A. Cosgrave..... 694,618

Ingot or billet heating furnace, J. B. Nau..... 694,569

Ingots and mold therefor, manufacture of compound, S. A. Cosgrave..... 694,731

Insect destroyer, R. A. McCrone..... 694,882

Insect guard, O. H. Watkins..... 694,901

Iron. See Smoothing iron.

Ironing board support, A. J. Pochner..... 694,779

Ironing machine, C. W. Anderson..... 694,906

Ironing table, E. Fisk..... 694,360

Ironing table, D. A. Sox..... 694,800

Jar holder, fruit, E. Himmelmann..... 694,747

Jar top wrench, fruit, E. Himmelmann..... 694,748

Jewelry, setting for finger rings or other articles of, C. T. Wittstein..... 694,594

Journal bearing, antifricition, W. J. Brewer..... 694,607

Kitchen box, R. C. Enyart..... 694,358

Kitchen implement, combination, H. C. Needham..... 694,491

Kitchen rack, A. M. Schiele..... 694,793

Knife, A. Zwickler..... 694,814

Knitting machine, circular, H. A. Houseman..... 694,382

Knitting machine yarn changing mechanism, circular, W. P. Young..... 694,515

Label holder for bottles, etc., O. H. C. Voigt..... 694,809

Labeling machine, Gilman, McKaig..... 694,815

Lace roller, J. W. Leslie..... 694,475

Lace rack, M. M. Savlan..... 694,428

Lamp, W. J. Smart..... 694,435

Lamp burner attachment, H. L. Hills..... 694,858

Lamp, electric arc, M. S. Okun..... 694,410

Lamp, incandescent gas, W. Tice..... 694,695

Last, E. S. Morton..... 694,659

Last, darning, A. E. Macdonald..... 694,562

Leather articles, machine for buffing, J. R. Scott..... 694,431

Living material, C. S. Bird..... 694,522

Lino type justifying device, J. R. Rogers..... 694,788

Lino type machine matrix, J. R. Rogers..... 694,789

Liquid dispensing apparatus, W. & W. Hucks, Jr..... 694,646

Liquid separators, liner for centrifugal, N. W. Gales..... 694,736

Lithographic process, C. H. Prinke..... 694,574

Locomotive boiler, S. S. Riegel..... 694,786

Loom picker stick connection, E. Cheverette..... 694,352

Loom stop motion, N. & G. Fortier..... 694,362

Lubricant holder, non-fluid, G. W. Brown..... 694,609

Lubricator, McCanna & Delaney..... 694,406

Magnesia, compound, E. Reuff..... 694,424

Mail bag catching and delivering device, C. R. Bennett..... 694,908

Mail catcher and deliverer, Mills & Fremd..... 694,878

Mail marking machine, J. French..... 694,850

Mail liquors, manufacture of, J. Schneible..... 694,671

Manhole cover, R. Becker..... 694,455

Match box, K. Halfacre..... 694,471

Mattress, spring wire, C. H. Closterman..... 694,614

Measurer, lumber, B. G. Moss..... 694,405

Meat cutter, H. G. Voigt..... 694,704

Metal treating apparatus, G. C. Carson..... 694,348

Metals, refining composite, T. Ulke..... 694,699

Metallic tie and rail clamp, combined, W. M. Gilpin..... 694,737

Metallic tie and rail fastener, M. Berringer..... 694,716

Micrometer gage, Stromberg..... 694,804

Mill power, automatic cut off for, B. Strittmatter..... 694,803

Mines, electric apparatus for exploding, S. Evershed..... 694,914

Mop head, H. S. Brewington..... 694,826

Mop wringer, W. Geddes..... 694,469

Mop wringer, A. H. Allison..... 694,517

Motive power apparatus, J. Hofmann..... 694,642

Music leaf turner, C. H. Dascomb..... 694,839

Music rack, J. H. Stanfield..... 694,500

Music roll, automatic musical instruments, P. Welin..... 694,560

Musical instrument, W. Van Netten..... 694,589

Nailing device, H. von Kalinowski..... 694,649

Nebulizer, H. Goltermann..... 694,630

Nest, poultry, G. C. Lathrop..... 694,759

Numbering machine, J. F. McNutt..... 694,408

Numbering machine, S. R. Shoup..... 694,682

Oil and air regulator, automatic, F. W. Paritt..... 694,886

Oil can, spring, F. D. Bocorselski..... 694,444

Ore concentrator, W. Thurmond..... 694,734

Ore sampler, Foster & Colledge..... 694,734

Oven door, F. H. Van Houten..... 694,700

Packing for piston rods, metallic, Longstreth & King..... 694,764

Padlock, H. G. Voight..... 694,703

Padlock, J. J. Cotter..... 694,837

Pants or overalls, H. S. Lanier..... 694,556

Paper box blank feeder and folding mechanism, G. M. Griswold..... 694,635

Paper box corner stay, H. B. Smith..... 694,436

Paper box stacker and drier, G. M. Griswold..... 694,634

Paper making machine, T. H. Savory..... 694,427

Paper making machine, Moore & White..... 694,772

Paper making machine wire or felt guide, W. M. Gilbert et al..... 694,368

Paper or strawboard boxes, machine for cutting blanks for, W. B. Browning..... 694,725

Paper pulp screen, S. H. Tibbets..... 694,690

Paper pulp screen, apparatus, D. Sharrp..... 694,678

Paper size, resin sizer for, H. F. Chappell..... 694,728

Pedometer, E. Kuhn..... 694,652

Pencil, B. T. Mulligan..... 694,879

Phonographs, etc., automatic releasing mechanism for, J. Wall..... 694,705

Photographic roll holder, D. H. Houston..... 694,930

Photographic roll holder, daylight loading, D. H. Houston..... 694,921, 694,922

Photography, shutter for color, J. M. Frachebourg..... 694,364

Pipe collar, E. J. Mallen..... 694,873

Pipe coupling, A. Y. Robertson..... 694,422

Pipe cutting machine, rotary, H. E. Boyd..... 694,523, 694,524

Pipe Jack, G. J. Maas..... 694,399

Pipette, H. Comer..... 694,530

Planter, M. B. Gooing..... 694,852

Pliers and tongs, Smith's, G. F. Budach..... 694,828

Plow, G. A. Kelly..... 694,553

Plow, A. Schulz..... 694,672

Plow, M. Stagnin..... 694,689

Plow, G. A. Kelly..... 694,931

Pneumatic drill, T. Barrow..... 694,714

Pocket clasp, J. A. Skaer..... 694,498

Poultry, drip, grit, and feed device for, G. C. Lathrop..... 694,700

Power regulators, automatic actuator for, E. R. Gill..... 694,370

Power transmitting mechanism, H. W. Sumner..... 694,692

Precious metals from ores, cyanid process of extracting, B. W. Beeger..... 694,521

WOOD or METAL Workers

Without Steam Power should use our Foot and Hand Power Machinery. Send for Catalogues.

A-Wood-working Machinery, B-Lathes, etc.

SENECA FALLS MFG. CO.
695 Water St., Seneca Falls, N. Y.



MACHINE SHOP OUTFITS.

ENGINE & FOOT LATHES. TOOLS AND SUPPLIES.

SEBASTIAN LATHE CO., 120 CULBERT ST., CINCINNATI, O.

Foot and Power and Turret Lathes, Planers, Shapers, and Drill Presses.

SHEPARD LATHE CO., 133 W. 2d St., Cincinnati, O.

WALWORTH PIPE VISES

are the Heaviest and Strongest vises made.

RENEWABLE STEEL JAWS.

WALWORTH MFG. CO.,
128 TO 136 FEDERAL STREET, BOSTON, MASS.

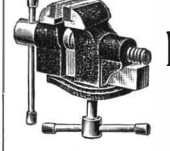

If You Want the Best Lathe and Drill

CHUCKS

WESTCOTT'S Strongest Grip, Greatest Capacity and Durability, Cheap and Accurate.

Westcott Chuck Co., Oneida, N. Y., U. S. A.

Ask for catalogue in English, French, Spanish or German. FIRST PRIZE AT COLUMBIAN EXPOSITION, 1893.



B. F. BARNES ELEVEN-INCH SCREW CUTTING LATHE

For foot or power as wanted. Has power cross feed and compound rest. A strictly high grade, modern tool. Ask us for printed matter.

B. F. BARNES COMPANY, Rockford, Ill.



"OLDS"

GASOLINE ENGINES are remarkable for SIMPLICITY and ECONOMY Write for Prices.

Olds Motor Works, 1325 Jeff. Ave., Detroit, - - Mich.



Asbestos-Metallic Packings

OLYMPIA

SHEETING, GASKETS, TAPE and PISTON PACKINGS. Will stand the highest pressure for either steam or hydraulic work. Write for samples and price list.

C. W. TRAINER MFG. CO., (Est. 1874), 88 Pearl St., Boston, U. S. A.



MAXIMUM POWER-MINIMUM COST.

If you use a pump for beer, lard, acids, starch, petroleum, brewer's mash, tanner's liquor, cottonseed oil or fluids, hot or cold, thick or thin you want to get the **TABER ROTARY PUMP** which does the most work at the least expense. Simply constructed. Can be run at any desired speed. Perfectly durable. All parts are interchangeable. Needs no skilled workman. Defects guaranteed. Catalogue free.

TABER PUMP CO., 32 Wells St., Buffalo, N. Y., U. S. A.



THE EUREKA CLIP

The most useful article ever invented for the purpose. Indispensable to Lawyers, Editors, Students, Bankers, Insurance Companies and business men generally. Book marker and paper clip. Does not mutilate the paper. Can be used repeatedly. In boxes of 100 for 25c. To be had of all booksellers, stationers and notion dealers, or by mail on receipt of price. Sample card, by mail, free. Manufactured by Consolidated Safety Pin Co., Box 121, Bloomfield, N. J.

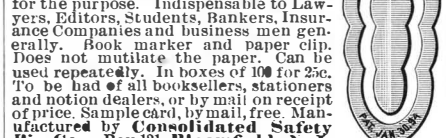

TRUSCOTT MARINE MOTORS.

The simplest, most powerful, and highest speed marine engines of their class upon the market.

Made single, double, and triple cylinder, both two and four cycle, ranging from 1 to 40 H. P.

Catalogue for the asking.

Truscott Boat Mfg. Co., ST. JOSEPH, MICH.

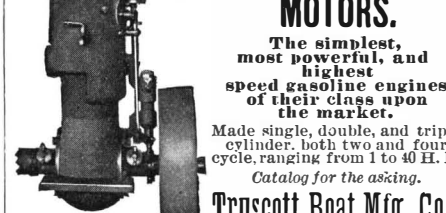

CROSS TEST LEVEL.

Leveling is indicated every way without moving the tool. Weighs 3 ounces. Size 2 in. x 3 in. x 1/2 in. Price \$1.50.

Catalogue of Fine Tools free.

THE L. S. STARRETT CO.,
Box 13, ATHOL, MASS., U. S. A.



BICYCLE TRICYCLE RUNABOUT AUTOMOBILE & LAUNCH WORLD'S RECORD. MOTORS \$500 UP.

UNQUESTIONABLY THE LARGEST AMERICAN MANUFACTURERS.

E. R. THOMAS MOTOR CO., 100 BROADWAY, BUFFALO, N. Y.



Precious metals from refractory ores, apparatus for recovering, H. R. Cassel..... 694,350

Printing, imitating beige or vigoreux by, L. Hirsch..... 694,860

Printing machine, H. A. W. Wood..... 694,597

Printing press, A. E. Dowell..... 694,767

Pulley rims, roll for curving sheet metal, C. Cascadan..... 694,846

Pulley, sash, J. J. Jost..... 694,910

Pulp screen circulating box, L. Whalley..... 694,482

Pump for fluid tanks, F. W. Howard..... 694,645

Pumping apparatus, C. C. Worthington..... 694,513

Racking apparatus, liquid, R. H. Salmons..... 694,668

Rail fastener, J. M. Spaulding..... 694,687

Rail fastener, E. W. Hogan..... 694,750

Rail joint, J. W. Kennedy..... 694,754

Railway gate, W. W. & J. W. Allen..... 694,815

Railway joint, J. L. Mayes..... 694,655

Railway tie securing device, A. B. Allen..... 694,911

Railway tie securing device, W. E. Covan..... 694,833

Railway signaling device, G. G. Ritchie..... 694,898

Railway structures, device for reducing the noise in elevated, H. G. Farr..... 694,559

Railway switch, H. K. J. Manger..... 694,629

Railway switch, G. G. Guenther..... 694,742

Railway switches, electrical operation and control of, Duconso & Rodary..... 694,847

Railway system, electric, J. Ryan..... 694,425

Railway tie, metallic, A. P. Ramberger..... 694,600

Railway track, G. S. Kendall..... 694,343

Railway track laying machine, H. Mann..... 694,564

Rattan dividing machine, H. W. Larsson..... 694,757

Rattan strip trimming machine, H. W. Larsson..... 694,868

Rattan strips, machine for longitudinally dividing, H. W. Larsson..... 694,869

Razor, safety, F. R., & O. Kampfe..... 694,650

Refrigerator, door fastening device, B. A. Stevens..... 694,691

Registers. See Cash registers.

Revolving screen, V. W. Mason, Jr..... 694,565

Rim opener, N. Axlund..... 694,518

Rivet making machine, F. W. Wood..... 694,596

Rod swab, J. O. Dauphin..... 694,340

Rolling channel irons, apparatus for, H. S. Smith..... 694,437

Rolling metal forms, machine for, C. F. Brooker..... 694,722

Rotary engine, R. W. Barton..... 694,603

Rotary engine, Liebhogener & Klemm..... 694,757

Rotary explosive engine, C. F. Lembke..... 694,468

Rudder attachment, C. E. Gaillac..... 694,428

Saddle, harness, C. F. Brooks..... 694,723

Sash fastener, W. Carrick..... 694,112

Sash fastener, A. C. Hendricks..... 694,856

Sash lock, G. W. Anderson..... 694,816

Saucepan, R. E. Vanderburg..... 694,507

Saw clamp, A. W. C. Binkert..... 694,738

Saw handle, detachable, E. L. Laberty..... 694,555

Sawmill lumber conveyer, E. E. Thomas..... 694,690

Saw mills, guide operating means for band, E. E. Thomas..... 694,697

Scale, automatic computing, W. F. Hummer..... 694,647

Scale for maltsters, test, W. H. Prinz..... 694,781

Scraper, wheeled, W. S. Livengood..... 694,560

Screw driver, T. A. Farrell..... 694,848

Screw press, L. M. Hosca..... 694,861

Separator for ore, coal, etc., J. N. Rice..... 694,427

Sewing machine gage, G. Goulson..... 694,932

Shaft construction, G. J. Maas..... 694,397

Sheet metal drawing die, J. N. Reynolds..... 694,892

Shelf for desks, etc., swinging, E. J. Timmons..... 694,445

Ship windlasses and capstans, mechanism for operating, F. N. Connet..... 694,616

Ships, means for guiding and propelling steam, L. Sher..... 694,433

Shirt and collar, W. C. Gay..... 694,532

Shocking attachment, wagon, M. Brun..... 694,726

Shoe or boot, B. E. Lockett..... 694,872

Silo, G. H. Greenfield..... 694,377

Singletree attachment, J. Hafer, Sr..... 694,544

Sled runner, G. Johnson..... 694,753

Smoothing iron, vapor heated, W. Mitchell..... 694,770

Sole laying machine pressing form, G. H. Gifford..... 694,367

Speaking tube for trains, S. S. Boyd..... 694,825

Speed recording apparatus, R. W. Eaton..... 694,913

Spinning machine yarn or thread guide, J. W. McCarthy..... 694,568

Spring lid box, A. M. English..... 694,357

Spring wirework, H. R. Kuersten..... 694,391

Sprocket wheels, casting, C. W. Levalley..... 694,395

Spur, riding, J. G. Riddings..... 694,421

Square, center, K. O. Muehlberg..... 694,774

Squeezer, J. C. Cumber..... 694,617

Stand, W. C. Krack..... 694,867

Steam drying apparatus, R. Baldwin..... 694,454

Steam dress, A. A. Dieter..... 694,430

Steam boiler, E. J. Pennington..... 694,403

Steam boiler, C. B. Reardon, reissue..... 11,974

Steam drier, rotary, F. B. Giesler..... 692,366

Steam engine, oscillating piston, J. G. Loper..... 694,485

Steel by the open hearth process, manufacture of, W. B. Hughes..... 694,752

Steering gear, R. E. Sack..... 694,791

Stenotype plate holder, Yarnold & Nolen..... 694,905

Stopper or closure, Abbee & Sewall..... 694,932

Stove, H. E. Atteberry..... 694,712

Strainer, down spout, B. A. Stair..... 694,440

Street sweeping machine, W. G. Dingle..... 694,620

Striking bag adjusting device, W. C. Rastetter..... 694,664

Stripping plate, E. H. Mumford..... 694,489

Studding or partition, metal, P. Bradstedt..... 694,721

Submarine permanent way, K. Leys..... 694

Most Wonderful Book of the age

FREE

By the Famous Writer on Occult Sciences
X. La Motte Sage, A.M., Ph.D., LL.D.
Formerly Professor, Pierce's College, Philadelphia, Pa.
 New York Institute, New York City.
 100 Pages. Profusely Illustrated

This work instructs you how to thoroughly master all the secrets of **Hypnotism, Mesmerism, Personal Magnetism, and other Occult Sciences.**

Quickest and Surest Methods on Earth.

Anybody can learn them and exert a magic influence over others. The acquirement of these powers brings happiness and health; develops will power; gratifies ambitions; gives one the key to personal and social success, and suggests many opportunities to make money.

EXTRACTS FROM UNSOLICITED TESTIMONIALS.

We will Forfeit \$1,000 in Gold if each Testimonial is found other than Genuine

P. B. Baker, A.M., of Searcy, Ark. says:—"It is superior to anything I have ever seen on the subject. I will be pleased to tell anyone what I think of it."

A. J. Merritt, Editor *Western Envoyer*, of Madison, Ind., writes:—"Since receiving your course of instructions I am compelled to say they are far in advance of all others."

J. A. Le Conte, Quitman, Ga., Auditor South Georgia Railway Co., writes:—"After a few trials with increasing success, I put my first subject into a deep sleep."

Dr. W. H. Hammersley, Harrisburg, Pa., writes:—"They (the instructions) cover the whole field and are so plain and simple any person can learn to hypnotize in a very short time. I am not in the habit of giving testimonials, but think your course certainly deserves it."

If at all interested, don't fail to write for this great book. It is sent **Absolutely Free.** We guarantee you success. **New York Institute of Science,** Dept. PT 13, Rochester, N. Y.

\$12 to \$18 a WEEK

PAID IN ADVANCE for sending us addresses of magazine readers. Permanent employment. Men or women can devote part or whole of time to the work. A wonderful opportunity. Write quick before some one else secures the position in your place. Send references, as we send payment in advance. **U. S. Publication Co.,** Dept. 12, 125 East 23d Street, New York.



OSGOOD PORTABLE BOAT CO. THE OSGOOD PORTABLE CANVAS BOAT, BATTLE CREEK, MICH. U.S.A. SAFE DURABLE AND PRACTICAL. BEST HUNTING AND FISHING BOAT MADE.

SEND FOR CATALOGUE. CUT REPRESENTS 12 FOOT BOAT. SIZE OF CHEST 38x17x18.

These boats when folded can be carried on the back, in a buggy, or on the cars. Used by U. S. government. Just the thing for trout fishermen.

CORK WALLS AND FLOORS

as well as Cork Ceilings, are now in vogue among up-to-date architects and builders on account of their durability, artistic beauty and economy.

NONPAREIL CORK is water-proof, sound-proof, germ-proof, a non-conductor of heat or cold; noiseless and sanitary and is excellent for decorative ceilings and walls and for the floors of houses, churches, schools, etc., and the decks of yachts, etc.

THE NONPAREIL CORK MFG CO., Bridgeport, Conn.



The Prairie State Incubator has long been recognized as the best incubator in the world. That is why the U. S. Department of Agriculture uses it exclusively. That's why it won 342 first premiums over all other makes of machines. This year we have made a catalog to fit such a machine. 50 tinted plate pages; 4 original paintings and over 700 half tone illustrations. Mailed free as long as they last. Write for catalogue No. 112.

PRAIRIE STATE INCUBATOR CO., HOMER CITY, PA.
 Largest Incubator and Brooder Factory in the World.

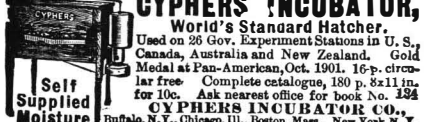

CYPHERS INCUBATOR, World's Standard Hatcher.

Used on 26 Gov. Experiment Stations in U. S., Canada, Australia and New Zealand. Gold Medal at Pan-American, Oct. 1901. 16-p. circular free. Complete catalogue, 180 p. 8x11 in. for 10c. Ask nearest office for book No. 124.

CYPHERS INCUBATOR CO., Buffalo, N.Y., Chicago, Ill., Boston, Mass., New York N.Y.

SET EGGS in the **SURE HATCH INCUBATOR.** Thousands do, and they are making money. Guaranteed for 10 years and hatch every hatchable egg. Any one can run them, because they run themselves. Anyone can own them, because the price is right. Send for our big free catalogue, giving hundreds of actual photographs of poultry yards, etc. Address nearest office, **Sure Hatch Incubator Co.,** Clay Center, Neb., or Columbus, O.

REVERSING STEAM TURBINE.—PARSON'S recently perfected turbine for boats. Illustrations showing details. Contained in **SCIENTIFIC AMERICAN SUPPLEMENT, No. 1158.** Price 10 cents, by mail, from this office, and from all newsdealers.



Doran Bros. & Martin Co.
NIAGARA FALLS
 MAKERS OF
TRADE MARK
SUSPENDERS
 GUARANTEED

nearly 200 trees and a number of shrubs. Many of America's beautiful trees are illustrated by the colored plates. It is complete in itself, employing no technical terms that it does not define, and requiring no other book to make it intelligible, and it is not too large to be a handy companion in the woods, fields and roads, and will prove an excellent textbook for the instruction of beginners. While, perhaps, popular in scope, it does not sacrifice scientific accuracy in any degree.

SOUTHERN WILD FLOWERS AND TREES. By Alice Lounsberry. With illustrations by Mrs. Ellis Rowan. New York: F. A. Stokes Company. 1901. 12mo. Pp. 570. Price \$3.65.

This is the first popular work to cover this extensive field. Upward of one thousand plants are included. The text treats also of the personality of the plants; their uses by the people and of the legends and folk-lore which it has been possible to gather concerning them. There are sixteen colored plates of considerable excellence, and there are 161 plates and diagrams from pen-and-ink drawings, and 16 half-tones from wash drawings showing scenes in which this remarkable flora is found. The author has done a signal service to botany in the production of this book, which is very well made, the green edge being particularly attractive.

PATTERSON'S ILLUSTRATED NAUTICAL ENCYCLOPEDIA. Revised and Enlarged Edition. By Captain Howard Patterson. Cleveland: The Marine Review Publishing Company. 8vo. Pp 514. Price \$3.

The reputation of the author of this work, Captain Howard Patterson, who has been long known as Principal of the New York Nautical College, and the author of excellent professional works for the use of those who follow the sea, is a guarantee that this volume will be all that its name implies. It has the great advantage of being most liberally illustrated; the drawings are clear, and in most of them the parts are freely lettered, with explanatory references tabulated below the cut. While the work is fully up to the necessities of the experienced navigator and naval architect, it is so clearly and simply written and admirably arranged that the layman will have no difficulty in finding quickly what he wants and understanding it when he has found it.

THE ROYAL LIST DIARY AND NAVAL HANDBOOK. A Naval Encyclopedia. London: Witherby & Co. 1901. 8vo. 500 pages.

This work has been prepared especially for the use of naval officers. Its title is somewhat misleading, as it does not convey an adequate idea of the large amount of information contained between the covers. It is a complete naval almanac drawn up with a view to the needs of naval officers both ashore and afloat; and while it has been prepared especially for officers of the British navy, it contains such varied information that it will prove a useful hand-book for any naval officer in our own service. It contains full astronomical data for every month of the year, lists of the navies of the world, articles on the progress of naval construction during the past twelve months, and concludes with several pages of technical data especially selected for the needs of the naval officer. Many new features have been added this year which have not appeared in the previous hand-books.

DIE CHRONOPHOTOGRAPHIE. Im physiologischen Institute der k. Universität in Moskau. Von Prof. Dr. L. Morokhowetz, Director des Physiologischen Institutes, Priv.-Doc. Dr. A. Samojloff und Dr. A. Judin, Assistenten am Physiologischen Institute. Moskau. 1900. Post octavo. pp. 27, two plates.

BIOMETRIKA. A Quarterly Journal for the Statistical Study of Biological Problems. Edited in Consultation with Francis Galton, by W. F. R. Weldon, Karl Pearson, and C. B. Davenport. Cambridge: University Press. London: C. J. Clay & Sons. New York: The Macmillan Company. Price \$2.50 net.

This is distinctly the most ambitious periodical publication that has ever come to our notice. The articles contained in the first number are valuable monographs, all of them, and certainly fulfill the promise made in the opening editorial that "Biometrika shall serve as a means not only of collecting under one title biological data of a kind not systematically collected or published in any other periodical, but also of spreading a knowledge of such statistical theory as may be requisite for their scientific treatment." Future numbers of the magazine will be watched for with interest.

DRYING OILS, BOILED OIL AND SOLID AND LIQUID DRYERS. By Louis Edgar Andés. London: Scott-Greenwood & Co. New York: D. Van Nostrand Company. 1901. 8vo. Pp. 342. Price \$5.

The publishers of this volume are doing a most commendable work in the publication of the remarkable treatises on paints and varnishes they have issued in the last few years. The present volume is fully up to the other works and is written by one of the recognized authorities of the world on varnishes, paints and printing inks.



PERFORATED METALS
 OF EVERY DESCRIPTION AND FOR ALL USES.
THE HARRINGTON & KING PERFORATING CO.
 225 N. UNION ST. CHICAGO, ILL. U.S.A.

AN EXCEPTIONAL OPPORTUNITY

THE GIANT OIL PRODUCTION COMPANY, of Ohio, offers to the readers of this paper, for a limited time, a portion of the first allotment of Capital Stock. The Company is controlled by **Bankers exclusively** and endorsed by financiers generally. Methods and plans are open to investigation, and information is cheerfully furnished. The shares at the present quotation offer the best investment to be had, consistent with reliability and good profits. Write at once for prospectus, terms and references.

THE GIANT OIL PRODUCTION CO.
 428-429 Stock Exchange Building
 CHICAGO, ILL.

MACHINE WORK WANTED

Have your **Models of Engines,** etc., made, and small **Machine Work** done in a thoroughly equipped machine shop. **Estimates cheerfully given.**

H. BARTOL BRAZIER,
 Engineer and Machinist, Manufacturer of Gasoline Vehicles,
 1811-18-15 Fitzwater Street, Philadelphia, Pa.



Better than Red Lead

For making joints in gas pipes, steam pipes, water pipes, compressed air pipes, and putting around gaskets and flanges, caps, headers, bolts and nuts, nothing excels.

DIXON'S PIPE-JOINT COMPOUND.

Joints can be easily taken apart after years of use even when the pipes are rusted. Manufacturers, machinists, engineers, contractors and gas companies freely use and endorse it. Booklet free.

JOSEPH DIXON CRUCIBLE CO.
 Jersey City, N. J.

WELL DRILLING Machines

Over 70 sizes and styles, for drilling either deep or shallow wells in any kind of soil or rock. Mounted on wheels or on sills. With engines or horse powers. Strong, simple and durable. Any mechanic can operate them easily. Send for catalog.

WILLIAMS BROS., Ithaca, N. Y.



There is Risk of Personal Injury in Working Around Machinery

Accidents usually mean loss of income. You can secure for yourself a weekly income while disabled by taking out

An Accident Policy

in The Travelers Insurance Company of Hartford, the oldest Accident Company in America and the largest in the world. These policies guarantee large amounts for loss of legs, arms, hands, feet or eyes. If death ensues, a stated sum is paid.

The Life Policies

of The Travelers Insurance Company appeal particularly to business and professional men because they furnish straight life insurance at the lowest possible cost. Travelers policies are issued on the stock plan and the net cost is known in advance. The difference between the lower cost in the Travelers and the higher cost in the mutual and dividend-paying companies remains in your pocket as a dividend in advance. Let us send you some interesting matter bearing on the superior advantages of The Travelers Policies. Branch offices in nearly every city.

The Travelers Insurance Company
 Hartford, Conn.
 (Founded 1863)

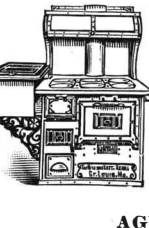

I Pay The Freight — **\$25**

Will ship C. O. D. to any station in the United States for

The "WILLARD STEEL RANGE"

Has 6 8-in. lids, oven 17x12x21, 15 gallon reservoir, large warming closet, duplex grate, burns wood or coal, weighs 400 lbs., lined throughout with asbestos.

GUARANTEED TO BE AS REPRESENTED. Write for free descriptive circulars and testimonials from parties in your section who are using one.

WM. G. WILLARD, Dept. 14, 619 N. 4th St., St. Louis, Mo.
AGENTS WANTED TO SELL FOR CASH OR ON CREDIT.

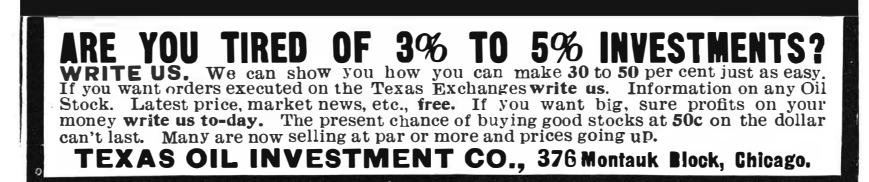

ARE YOU TIRED OF 3% TO 5% INVESTMENTS?

WRITE US. We can show you how you can make 30 to 50 per cent just as easy. If you want orders executed on the Texas Exchanges write us. Information on any Oil Stock. Latest price, market news, etc., free. If you want big, sure profits on your money write us to-day. The present chance of buying good stocks at 50c on the dollar can't last. Many are now selling at par or more and prices going up.

TEXAS OIL INVESTMENT CO., 376 Montauk Block, Chicago.



WARREN'S Natural Asphalt Stone Surfaced Ready Roofing.

The surface is completed at the factory and does not require painting. Durable and economical. Comparatively fire-proof. Has 2 inch lap edge. Genuine Trinidad asphalt. Designed for application without the help of skilled roofers.

Warren Chemical & Mfg. Co., 85 Fulton St., New York.



The "Best" Light

is a portable 100 candle power light, costing only 2 cts. per week. Makes and burns its own gas. Brighter than electricity or acetylene, and cheaper than kerosene. No dirt. No grease. No odor. Over 100 styles. Lighted instantly with a match. Every lamp warranted. Agents Wanted Everywhere.

THE "BEST" LIGHT CO.
 87 E. 5th Street, CANTON, OHIO.



NOISELESS GEARS

We are specialists in **Noiseless Gearing.** If you are interested in anything in this line, write for our catalogue. Our **New Process Gears** are the only Noiseless Gears which are durable. We have pinions in operation transmitting from 350 to 450 horse power. We also make metal gears to order, both spur and bevel, the latter planed accurately to cone lines.

THE NEW PROCESS RAW HIDE CO., Syracuse, N. Y.



Patents Protected

Against Infringers. Dealers in and Manufacturers of **PATENTED ARTICLES.** Owners and Users of **COPYRIGHTS AND TRADE-MARKS** PROTECTED against dangerous litigation at a nominal cost. Booklet on application.

PATENT TITLE & GUARANTEE CO.,
 CAPITAL \$500,000.00.
 Tel. 4232 Cortlandt. 150 Broadway, New York.



D. L. HOLDEN
 REAL ESTATE TRUST BLDG PHILA., PA.
 SOLE MANUFACTURER
REGEALED ICE MACHINES
 SEE FIRST PAGE SCIENTIFIC AMERICAN SEPT. 2, 1899.



NOW READY.

Compressed Air

ITS PRODUCTION, USES AND APPLICATIONS.
 By **GARDNER D. HISCOX, M. E.**
 AUTHOR OF "MECHANICAL MOVEMENTS."
 LARGE 8VO. 820 PAGES. 547 ILLUSTRATIONS.
PRICE, bound in Cloth, \$5.00. Half Morocco, \$6.50.

A complete treatise on the subject of Compressed Air, comprising its physical and operative properties from a vacuum to its liquid form. Its thermodynamics, compression, transmission, expansion, and its uses for power purposes in mining and engineering work: pneumatic motors, shop tools, air blasts for cleaning and painting. The Sand Blast, air lifts, pumping of water, acids and oils; aeration and purification of water supply; railway propulsion, pneumatic tube transmission, refrigeration. The Air Brake, and numerous appliances in which compressed air is a most convenient and economical vehicle for work—with air tables of compression, expansion and physical properties. A most comprehensive work on the subject of Compressed Air.

A special illustrated circular of this book will be sent to any address on application.

MUNN & CO.,
 Publishers of the Scientific American, 361 Broadway, New York.

Waltham Watches.

"Constant as the Northern Star."

"The Perfected American Watch," an illustrated book of interesting information about watches, will be sent free upon request.

American Waltham Watch Company,
Waltham, Mass.

THOROUGH INSPECTIONS

AND INSURANCE AGAINST LOSS OR DAMAGE TO PROPERTY AND LOSS OF LIFE AND INJURY TO PERSONS CAUSED BY

STEAM-BOILER-EXPLOSIONS

HARTFORD STEAM BOILER INSPECTION AND INSURANCE CO.

J. M. ALLEN - PRESIDENT
J. B. PIERCE - SECRETARY
L. B. BRAINERD - TREAS.

W. B. FRANKLIN - VICE PRESIDENT
F. B. ALLEN - VICE PRESIDENT
L. E. MIDDLEBROOK - ASST. SECY.

Columbian Spirit.

A Chemically Pure Methyl Alcohol. Price in bbls. and 1/2 bbls., \$1.50 per gallon. Columbian Spirit cannot be taken internally, but for manufacturing purposes is the equal of alcohol. It is a water white spirit testing 95 per cent. of pleasant odor and free from impurities.

MANHATTAN SPIRIT CO.
Sole Manufacturers, BUFFALO, N. Y.

NEW ENGLAND WATCHES

have a world-wide reputation and are made to suit all sorts and conditions of people. Booklets and Catalogues sent on application.

THE NEW ENGLAND WATCH CO.
37 Maiden Lane, New York
137 Wabash Ave., Chicago
Spreckels Building, San Francisco.

STEWART'S WONDER

The Exponent of Highest Art in
ACETYLENE BURNERS Sample 25c. in stamps
Ask for catalogue C.
STATE LINE MFG CO., Chattanooga, Tenn., U. S. A.
307 Chambers St., New York.

CHARTER ENGINE USED

ANY PLACE BY ANY ONE FOR ANY PURPOSE
Stationaries, Portables, Sawing Outfits, Hoisters, Engines and Pumps.
Fuel—Gasoline, Gas, Distillate.
Send for Illustrated Catalogue and Testimonials, and State Your Power Needs.

CHARTER GAS ENGINE CO., Box 148, STERLING, ILL.

WE MAKE A SPECIALTY OF
GREY IRON CASTINGS
FOR AUTOMOBILE WORK
UTICA STEAM ENGINE AND BOILER WORKS
UTICA, N. Y.

BOMOSA COFFEE
BEST GROWN

BEST AND MOST ECONOMICAL **33c.**
1-lb trade-mark red bags, Good Coffees, 12c. and 15c. Good Teas, 30c. and 35c.

COOK BOOK FREE
to customers, bound in cloth, 325 pp., 2,500 receipts.

The Great American Tea Co.
31 & 33 Vesey St., New York.
P. O. Box 290.

JESSOP'S STEEL THE VERY BEST
FOR TOOLS, SAWS, ETC.
WM JESSOP & SONS L2 91 JOHN ST. NEW YORK

Computing Figures
mentally is probably the hardest kind of toil known. The Comptometer makes it easy, is twice as quick, insures accuracy and relieves all mental and nervous strain. Why don't you get one?
Write for Pamphlet.

FELT & TARRANT MFG CO.
62-50 ILLINOIS ST., CHICAGO.

TYPEWRITERS
Absolutely New **MANHATTAN** at much less than manufacturers prices. Second-hand, all makes. Send for Catalogue.
F. S. WEBSTER CO., 333 Congress St., Boston, Mass.

Works of Excellence.

You should learn all about the 1902 Winton construction.

The **IMPROVED \$1,200 MODEL** (8 1/2 H. P.) and the new **TOURING CAR** (15 H. P.)

15 Horse Power (actual).



are positive leaders in their respective classes. Catalog, which fully describes our complete product, has just been published. It is yours for the asking.

THE WINTON MOTOR CARRIAGE CO.,
486 Belden Street, Cleveland, Ohio, U. S. A.
Branches in New York, Chicago, Boston, Philadelphia.

Scales All varieties at lowest prices. Best Railroad Track and Wagon or Stock Scales made. Also 1000 useful articles, including Saws, Sewing Machines, Bicycles, Tools, etc. Save Money. Lists Free. **CHICAGO SCALE CO.,** Chicago, Ill.

WE HELP **Inventors.**

Manufacturer of Electrical, Mechanical and Scientific Apparatus
FREDERICK
216 William

THE ASSISTANCE OF A COMPETENT ENGINEERING DEPARTMENT GIVEN TO INVENTORS.

Factory Equipped with the Latest Tools and Machinery
PEARCE,
St., New York

Cracks in Floors

Are unsightly, unclean and unsanitary. **Grippin's Wood, Crack and Crevice Filler** is the only perfect and permanent remedy, and is conceded to fill a universal want. A clean paste, easily and quickly applied. Adapted to all kinds and conditions of wood. Average cost about \$1.00 per room of 200 square feet. Write to-day for our booklet and testimonials. Enclose stamp.

GRIPPIN MFG. CO.,
Dept. C., Newark, N. J.



GARDNER GRINDER FOR FLAT SURFACES
ACCURATE & RAPID
CHESLEY & CO. CHICAGO, ILL. U.S.A.

CRUDE ASBESTOS AND ASBESTOS FIBRE

R. H. MARTIN,
MINES and WORKS, THEFTFORD, P. Q. CANADA.
OFFICE, ST. PAUL BUILDING
220 B'way, New York.

BRAKE FRICTION IN CENTER OF HUB.

Coasts on Balls. Write for Circular Box X.

YOU WANT THE BEST SO BUY THE BARWEST Coaster Brake



Simple. 9 Pieces. Light. Guaranteed Satisfactory.

THE BARWEST COASTER BRAKE CO., 83 Chambers St., New York.

A Combination of Irresistible Excellence

"HARTFORDS" and "DUNLOPS"

The **Hartford Single-Tube Tire** has ever been regarded as a strictly high-grade equipment. Its great speed, strength and splendid wearing qualities are a guarantee of its uniform quality and care in construction

The **Dunlop Double-Tube Tire** is remarkable for the simplicity and ease with which it can be repaired. It combines all the best features of other double-tube tires, with a few special virtues of its own

The unexcelled quality and high-grade construction of these two tires have made them supreme in their respective fields

We have in stock, and will supply, the proper size and weight tires for any kind of wheels. Let us advise you regarding the tires best adapted to your needs

Users of our tires will save delay by dealing with our branch houses in all principal cities, and which are in charge of our direct representatives

Is made of only the finest materials

These are the only tools you will need

The HARTFORD RUBBER WORKS COMPANY
HARTFORD, CONN., U. S. A.

One Man Equals Five

when it comes to applying paint, single stain or white wash, if the one man works with **PATTON'S AEREO-PAINTER**. It pays for itself right away if used for interior whitewashing of factories and exterior painting of large warehouses and outbuildings. Requires no more paint than hand painting. Does good work. Use the

Aereo-Painter

for applying **TOR-ON** shingle stain and you have a combination of efficiency and economy that cannot be beaten. Circular on application.

PITTSBURGH PLATE GLASS CO., General Distributors.
PATTON PAINT CO., 227 Lake St., Milwaukee, Wis.



THE NEW MARSH MOTOR CYCLE
Model 1902. Price \$175.

A Gasoline Motor made with crank-disk, shaft in one piece, extra strong bearings, exhaust valve mechanism entirely within base, perfect lubrication, secured against dust, carburetor of the float-feed type which has reached the greatest perfection. This Motor Cycle is the latest acquisition in the art. Made of the best material, simple and perfect in every detail. Constructed by high skilled experts in every department and is without a peer. Full descriptive circular on application.

MOTOR CYCLE MANUFACTURING CO., Brockton, Mass., U.S.A.

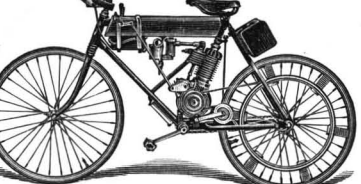

Another Wonderful Invention by Mergenthaler OF LINOTYPE FAME

The Mergenthaler-Horton Basket Machine Co.

CAPITAL, \$10,000,000

Stock Now Selling at **50c.** A SHARE Par Value \$1.00

TO BE ADVANCED WITHOUT NOTICE

...OFFICERS...

President, H. H. WARNER Treasurer, CHARLES R. BARLOW Secretary, SIDNEY B. WHITLOCK
Transfer Agents, The Corporation Trust Co. of New York

Object and Scope of the Company

The Mergenthaler-Horton Basket Machine Company is organized to do the entire Fruit Basket business of the United States. It is qualified to manufacture for and supply the entire enormous demand for fruit baskets by means of its automatic basket-making machines, which are the only basket machines ever made, invented or patented. These machines are protected by sweeping fundamental patents based on absolutely original mechanical ideas. The work of these machines is a marvel to all who watch them. The baskets made by them are stronger, better and more uniform than the BASKETS MADE BY HAND, which heretofore has been the ONLY KNOWN WAY of manufacturing baskets. One of these machines operated by one girl DOES THE WORK OF TWELVE MEN.

RIGID INVESTIGATION SOLICITED

The machines may be seen in operation at the Robison Basket Company's factory, Painesville, O., at Elmira, N. Y., at the machine shops of Emmett Horton, one of the inventors, and at Sodus, N. Y. The practical working of the machines is now shown in every office of the Company. If you cannot go personally so see the exhibition, write to some friend to make the examination for you. These machines are among the greatest inventions of the age. They take rank with the Cotton Gin the Sewing Machine and the Mergenthaler Linotype. Fifty-one positive automatic movements made in three seconds in turning out one single basket reflect the same mechanical brain and genius as does Mergenthaler's other famous invention, the Linotype, just mentioned.

The Company Has No Bonds, No Preferred Stock, and No Debts

Subscribers to the stock of the Mergenthaler-Horton Basket Machine Company may send or bring their subscriptions to the executive office of the Company named below. Check, drafts and money orders should be drawn to the order of Charles R. Barlow, Treasurer. No subscription accepted for less than 100 shares.

Facts and Figures

The past year's demand for fruit baskets amounted to over TWO BILLION BASKETS, worth at wholesale over ELEVEN MILLION DOLLARS. These baskets were all made by hand. The saving in labor by the use of the Mergenthaler-Horton Basket Machines in making the above output of hand-made baskets would have amounted to more than TWO MILLION DOLLARS. The profits of the manufacturers of these hand-labor baskets amounted to \$1,357,000, which show saving and profits to the Company of OVER THREE MILLION THREE HUNDRED THOUSAND DOLLARS, OR OVER THIRTY-THREE PER CENT. ON THE ENTIRE CAPITAL ON THE PRESENT VOLUME OF BUSINESS. The demand for fruit baskets of all kinds is increasing at the rate of 150,000,000 baskets per year.

Shareholders Control an Absolute Monopoly

It is entirely within the province of this Company's work to regulate the growing of fruit and to control its movement to market. The Company is an absolute monopoly, but it is a monopoly of the people, since its stock is held and will be held by the people all over this country, and every shareholder, no matter how small, has a voice in the Company's affairs, because there are no non-voting shares.

Large Profits for Early Investors

A portion of the capital stock of the Mergenthaler-Horton Basket Machine Company has been offered to the public for popular subscription at 40c. for one dollar shares. This allotment has been so rapidly taken up that it has been advanced to 50c. and a further advance to 60c. will take place without notice. Shares may be reserved by telegraph to any office of the company.

THE MERGENTHALER-HORTON BASKET MACHINE CO.

EXECUTIVE OFFICES, 287 BROADWAY, NEW YORK

NEW YORK BOSTON PHILADELPHIA CHICAGO
PITTSBURG CLEVELAND WASHINGTON

AN INVESTMENT OF MERIT

For the purpose of increasing its output so as to supply the demand for

ELECTRIC CLOCKS

a LIMITED AMOUNT OF STOCK (par value \$10 per share) is offered for public subscription in blocks of not less than ten (10) shares at **SIX DOLLARS (\$6) PER SHARE.**

This is not a Speculation, but a safe, sound, progressive, legitimate business proposition, managed by men of integrity and highest business qualifications. Address for prospectus and full particulars,

EDW. A. SIEGEL, Sec'y, Office and Salesrooms, 102 Fulton St., New York

THE UNITED STATES ELECTRIC CLOCK CO.