

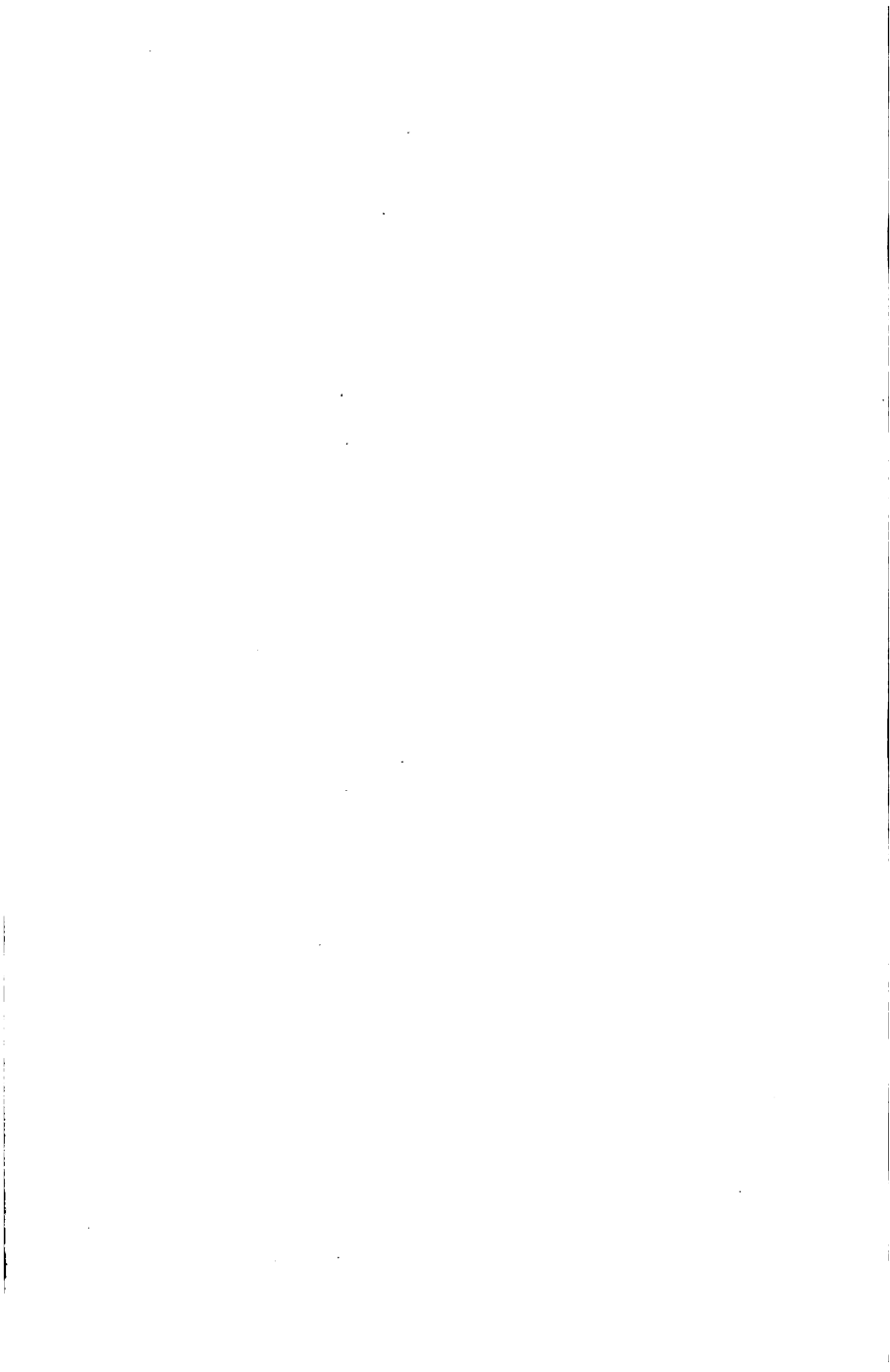

# SEWAGE WORKS ANALYSES



# SEWAGE WORKS ANALYSES

BY

GILBERT J. FOWLER, M.Sc. (VICT.) F.I.C.

*Superintendent and Chemist, Manchester Corporation  
Sewage Works*



**New York:**

**JOHN WILEY & SONS  
EAST NINETEENTH STREET**

**London: P. S. KING & SON**

**1902**

T 11733  
K 7

BRADBURY, AGNEW, & CO. LD., PRINTERS,  
LONDON AND TONBRIDGE.

## PREFACE.

---

THE following book has been written in response to several requests for an account of the methods of analysis in use in the laboratory of the Manchester Corporation Sewage Works.

Through the courtesy of Mr. F. Scudder, the author has also been able to include descriptions of some of the more important processes employed in the laboratory of the Mersey and Irwell Joint Committee.

In general, it may be said that the Joint Committee's methods are designed for cases where samples from different works have to be critically examined, the Manchester methods for the analysis of a large number of samples of sewage and effluents of the same general character.

The successful application of modern bacterial processes will necessitate careful chemical control. It is hoped, therefore, that the following book will prove of use to the increasing

number of chemists who are interested in the scientific treatment of sewage.

The methods here described are such as a considerable experience has shown to be capable of being rapidly executed, and of giving results of an accuracy amply sufficient for practical requirements.

In conclusion, the author wishes to express his indebtedness to the scientific advisers of the Royal Commission on Sewage Disposal for many helpful suggestions.

# TABLE OF CONTENTS.

CHAP.		PAGE
I.	THE CHEMICAL CONTROL OF SEWAGE PURIFICATION PROCESSES . . . . .	I
II.	THE DETERMINATION OF ABSORBED OXYGEN . . . . .	21
III.	THE DETERMINATION OF AMMONIA . . . . .	38
IV.	THE DETERMINATION OF NITRITES AND NITRATES . . . . .	61
V.	THE DETERMINATION OF DISSOLVED OXYGEN . . . . .	75
VI.	THE DETERMINATION OF CHLORINE, ACIDITY AND ALKALINITY, AND IRON COMPOUNDS . . . . .	86
VII.	THE DETERMINATION OF SOLIDS IN SOLUTION AND SUSPENSION . . . . .	101
VIII.	THE ANALYSIS OF GASES FROM THE SEPTIC TANK AND FROM BACTERIAL FILTERS . . . . .	112
—————		
TABLE I.	ATOMIC WEIGHTS . . . . .	126
TABLE II.	THE METRIC SYSTEM . . . . .	127
TABLE III.	CONVERSION TABLE—GRAINS PER GALLON, QUANTITY IN ONE MILLION GALLONS, PARTS PER 100,000 . . . . .	128
TABLE IV.	CONVERSION TABLE FOR RECORDING QUANTITY OF SEWAGE DEALT WITH PER GIVEN AREA . . . . .	129
USEFUL DATA . . . . .		131



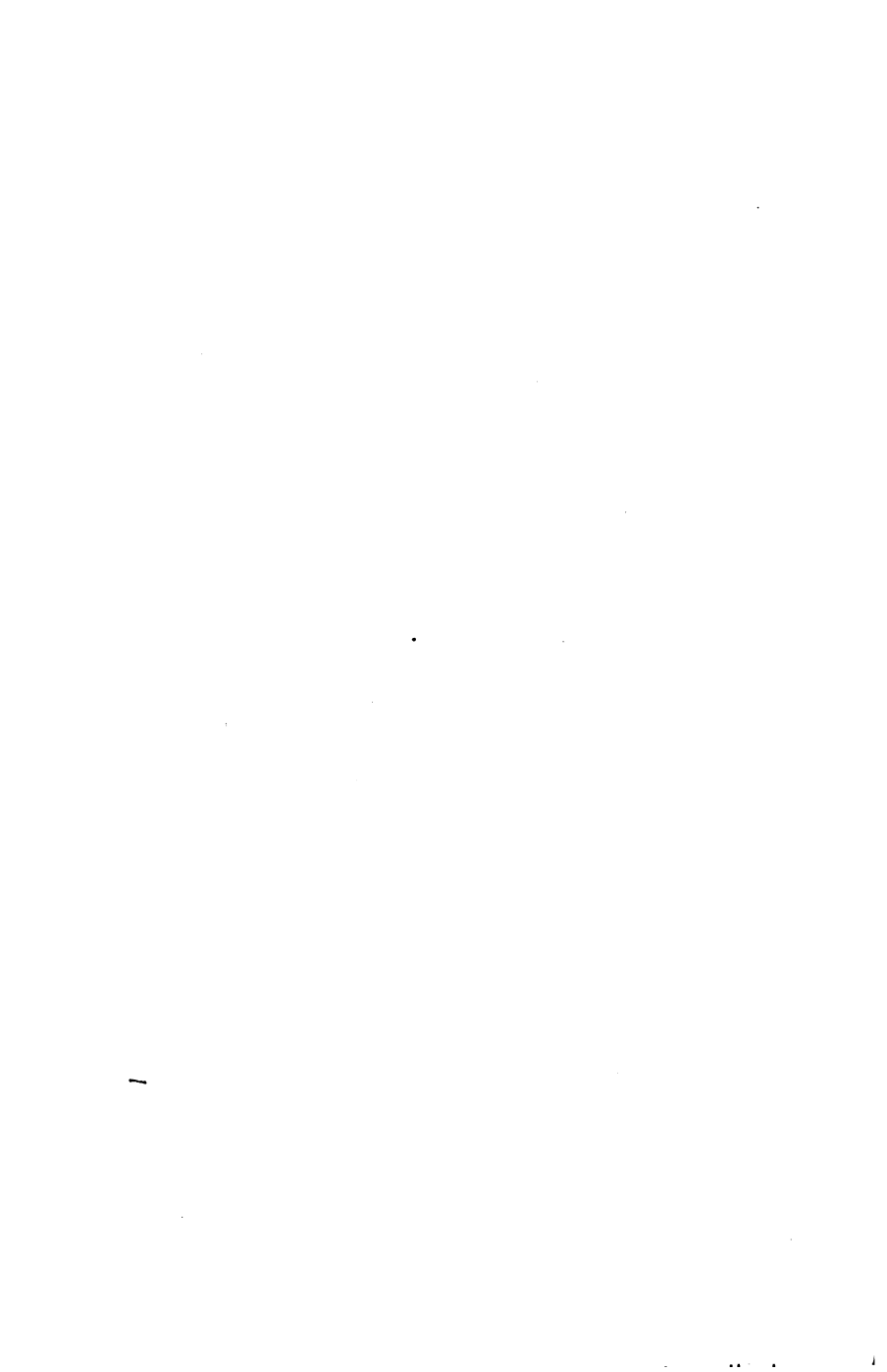

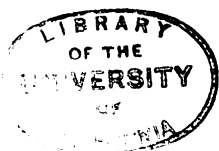

# SEWAGE WORKS ANALYSES.

---

---

## CHAPTER I.

### THE CHEMICAL CONTROL OF SEWAGE PURIFICATION PROCESSES.

THE efficiency of any process of sewage purification is measured by the difference between the impurities in the liquid before and after the process in question.

For the most part the amount of impurity present can only be accurately determined by chemical analysis, although valuable information can be obtained from the physical characters of the liquid, such as its colour, opacity, smell, etc.

Chemical analysis is in all cases necessary in order to determine whether an effluent is sufficiently purified to enter a stream, as it may often be free from smell or from matters in suspension, and yet contain much impurity in solution which will develop putrefaction later on.

The chief sewage treatment processes in practical operation may be broadly divided into two classes—

- (a) *Mechanical or Disposal Processes.*
- (b) *Biological or Purification Processes.*

(a) *Mechanical Processes.*—Under this head would be classed such methods as the removal of garbage and detritus by catch-pits and screens, and the settling out of suspended matters in detritus or sedimentation tanks.

The process of *chemical precipitation* is to a large extent mechanical, the precipitate produced by the chemicals used (in general, lime, sulphate of alumina, or lime and copperas) dragging down the lighter suspended matters and leaving a clear effluent.

A certain amount of true chemical action may also take place when chemicals are added, *e.g.*, the formation of carbonate of lime by interaction of the lime with the carbonic acid and carbonates of the sewage, the neutralisation by lime of the acids present in manufacturing sewage, the combination of the hydrates of iron and aluminium with dyes and other partially soluble impurities.

The total of the impurities present is, however, unaltered by ordinary chemical treatment; the grosser solids and fine flocculent suspended matters are coagulated by the chemicals and precipitated as sludge, while the substances actually in solution pass away in the effluent, and unless the chemicals have been added in such quantities as to sterilise the latter, these impurities will undergo putrefaction, if the necessary conditions arise.

Another process which may be mentioned here is *mechanical filtration*.

Many forms of mechanical filters have been devised, and to some extent made use of, their chief function being to arrest any suspended matter which may have escaped removal by settlement or chemical treatment.

(b) *Biological Purification Processes.*—The processes mentioned in the foregoing paragraph are not strictly speaking sewage purification processes, inasmuch as the impurities removed are not destroyed, but only collected together, so as to be more conveniently disposed of; *e.g.*, the garbage from screens requires to be burnt or tipped, the sludge from settling tanks must be pressed into cakes, dried in lagoons, or sent away to sea in the liquid state. By biological processes alone is there true purification.

These processes make use of the micro-organisms originally present or capable of development in the sewage to altogether change the organic impurities in the sewage and convert them into harmless inorganic substances.

In the *septic tank* the changes which take place are chiefly brought about by so-called anaerobic organisms which are active in absence of air. By the activity of these organisms much of the solid impurity in the sewage is liquefied and converted into gas, and the substances in solution are altered and broken down in such a way as to render them more easily attacked by another class of organisms, which are active in presence of oxygen or air, and which are developed in the soil (in the case of land

#### 4 SEWAGE WORKS ANALYSES.

filtration), or in the various forms of bacterial filters.

Under certain circumstances it may be possible to apply crude sewage directly to land or to bacterial filters, but in these cases the amount which can be purified per given area is much less than when some preliminary treatment is used.

In some cases a combination of mechanical and biological treatment may be made use of, *e.g.*, when the effluent from sedimentation tanks or from chemical treatment is applied to bacterial filters or to land.

Of bacterial filters there are two types, the *contact bed* and the *continuous filter*.

In the case of the contact bed the sewage or tank-effluent is allowed to run on till the bed is full; it is held in contact for a given time, after which the bed is discharged and allowed to rest empty for a certain period.

Continuous filters are usually constructed of greater depth and with coarser material than contact beds, and the sewage is delivered upon them in a continuous shower by various forms of sprinkling apparatus.

The changes which take place in all these processes are much more complex than those which are effected by any of the mechanical or disposal methods in class (a), and chemical control is absolutely necessary if they are to be maintained at their greatest efficiency.

## THE GAUGING OF SEWAGE FLOW.

In order accurately to estimate the work done by any of the foregoing processes it is necessary that the volume of sewage dealt with should be known as exactly as possible.

The gauging of large volumes of water belongs to the province of the engineer, but it is essential that the chemist should be acquainted with the chief methods in use for this object.

A rough estimate of the quantity of sewage entering a works in dry weather may be made when the population connected with the sewers is known, a certain quantity per head being allowed, and a further estimate being made for trade effluents. It is obvious, however, that the quantity per head will vary very much according to the water supply, the character of the manufactures carried on, the state of trade, etc. In towns with old and leaky sewers much subsoil water often enters, and thus interferes with an accurate estimate.

It is necessary therefore to actually measure the quantity of sewage delivered. This is accomplished by means of various forms of recording gauges, *e.g.*, Bailey's Sewage Recorder, or the Palatine Company's Recording Gauge. The principle of these instruments is similar, *viz.*, the motion of a float, which rises and falls with the sewage, is recorded by a pen on a revolving drum worked by a clock. A tracing is thus obtained

giving the height of the sewage at any hour of the day.

The rates of flow corresponding to these heights are obtained from engineering tables which are worked out from different formulæ according to the conditions under which the measurement is made.

The flow may thus be measured :—

- (a) In a sewer of known dimensions and fall.
- (b) Over a V notch leading from a still body of liquid.
- (c) Over a rectangular weir of known dimensions discharging over a thin edge from a still body of liquid.
- (d) In a rectangular channel of known dimensions and fall, and with a free exit.

For the formulæ and tables necessary to calculate the flow under these conditions, engineering works should be consulted, *e.g.*—

“Memorandum of Formulas and Tables of Velocities and Discharges of Sewers,” T. de Courcy Meade, City Surveyor, Manchester.

“Sanitary Engineering,” Lt.-Col. Moore, Chaps. III., IV. and V.

“Tables and Diagrams for use in designing Sewers and Water Mains,” W. Santo Crimp and C. Ernest Bruges.

“Flow of Water,” Ganguillet and Kutter, translated into English by Rudolph Hering and J. C. Trautwine.

The records obtained by such methods as the

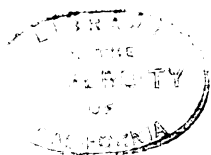



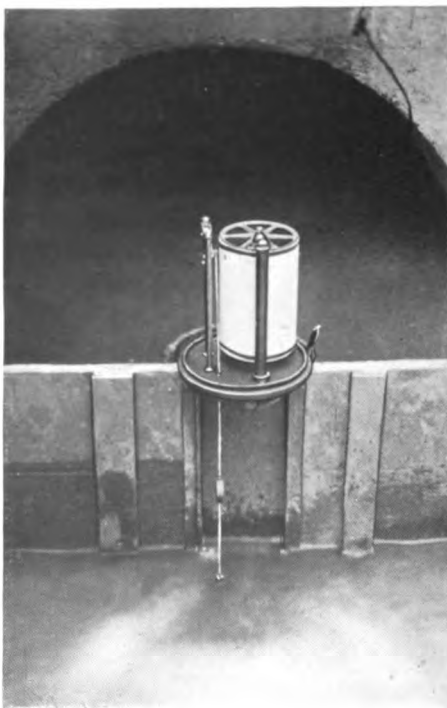

FIG. 1.—KENT'S METER FOR MEASURING  
DISCHARGE FROM BACTERIA BEDS.

*[To face page 7.]*

above may be usefully checked by noting the time which a tank of known dimensions takes to fill at different periods of the day.

In cases where the above methods cannot conveniently be used owing to the absence of the necessary fall, *e.g.*, when measuring the discharge from filters, a meter which will work under a low head of water must be used.

Such an instrument has recently been devised by Messrs. Kent of London, and is used for measuring the discharge from the bacteria beds now in course of construction at Manchester. It can be placed in the pick-up channel from the bed and is effective under three inches of head.

The meter is shown in position in Fig. 1. The water escapes from behind a dam through a rectangular orifice, closed by a true-fitting flap valve, hinged at the top. The valve is attached to a lever which carries the recording pencil. As the valve rises with increased flow, the lever rises with it and a record of the height during the discharge is obtained on the chart attached to the drum, which revolves by clockwork. The actual discharge can be calculated from the curve traced by the pencil.

A modification of this instrument has also been devised suitable for measuring the amount of water entering the bed. Such a measurement when compared with the measurement of the discharge affords a means of more accurately determining the volume of the "drainings" from the bed.

## APPLICATION OF ANALYTICAL METHODS.

In order to better understand the application of the methods of analysis given in the following pages it will be convenient here to shortly indicate their relation to the control of the chief processes of sewage treatment or purification as above described, further details being separately given in the case of each process.

*Methods of Sampling.*—If accurate conclusions are to be drawn as to the efficiency of any process, it is obvious that great care must be taken to obtain representative samples.

*Methods of Sampling where Flow is Continuous.*—In order that the samples taken at the inlet and outlet of a precipitation tank, for instance, should be strictly comparative, it is evident that they must not be taken at the same time, as the effluent sample will then represent the sewage of some previous time, according to the rate of flow through the tank.

Approximately comparative samples may be obtained if the rate of flow through the tank is known and the effluent sample taken at a time when the sewage in question is passing away from the tank.

It is better, however, to take a sample of the sewage and effluent at least every hour during the day. The sampling of the tank effluent should, however, only be begun after time has been allowed for the corresponding sewage to flow through the tank. In the case of the septic tank this interval

may amount to twenty-four hours. In the case of chemical precipitation tanks it may not be more than two hours. By making up an average sample in equal proportions from these hourly samples, the error due to the mixing of the inflowing sewage with the previous contents of the tank is largely minimised.

If the average sample in each case is made up of portions of hourly samples measured in proportion to the flow of sewage and effluent at the time, a still more representative sample is obtained.

The same principles of sampling apply to any process where the flow through the installation is continuous but variable, as for instance, septic tanks and continuous or "trickling" biological filters.

*Sampling of Liquid Entering and Leaving Contact Beds.*—In sampling the liquid entering and leaving a contact bed it is in general sufficient to take two or three samples and mix them, during the filling and emptying of the bed, as the rate of flow on and off the bed should be so regulated as to be pretty constant.

In all cases where the analysis of the sample cannot be made at once, the sampling bottle should be completely filled, and the stopper kept in until the sample is required for analysis. If more than a day must pass before analysis, the samples should be kept in a cool place, preferably in an ice-box. It may in some cases be advisable to sterilise the samples by addition of a little corrosive sublimate, or by making slightly acid with sulphuric acid.

*Efficiency of Catch-pits and Screens.*—This is determined by the weight of material removed in a given time from a given volume of sewage.

The detritus or garbage thus removed should be weighed from time to time after thorough draining.

An average sample collected from the quantity thus weighed may be taken for a proximate analysis (p. 103).

#### THE CONTROL OF CHEMICAL TREATMENT.

In order to determine whether enough chemical has been added to the sewage, a sample should be taken immediately after the addition of the chemical and allowed to settle. No more chemical should be added than is just sufficient to cause coagulation and pretty rapid settlement with good clarification. To add more increases the volume of sludge without increasing the purity of the effluent. Moreover, an excess of either lime, alumina, or iron, tends to produce an effluent containing these substances in solution from which they will afterwards separate.

When lime and copperas are used together it is essential that the lime be always appreciably in excess of the copperas, in order that precipitation may not take place irregularly in the tanks, owing to unprecipitated iron compounds coming into contact with the lime. When, therefore, it is necessary to increase the amount of chemicals added, the lime should always be increased first.

The presence of excess of lime is indicated by

the crimson colour produced on addition of phenol-phthalein.

For the more exact control of the chemicals added, it may occasionally be necessary, especially with manufacturing sewage, to carefully determine its acidity or alkalinity at different times (see p. 89).

In order to determine the total amount of work done by the chemical treatment, comparative samples of the sewage and effluent should be analysed, the samples being shaken before analysis. If it is required to know the work done by the chemicals alone, apart from the settlement in the tanks, then the sewage samples should be allowed to settle before analysis. As a matter of fact it is difficult to obtain a satisfactory sample of shaken sewage, owing to frequent presence of suspended matter in large pieces. The average of a large number of analyses may be taken, however, to furnish a sufficiently accurate result.

The chief chemical data required to determine the amount of impurity in sewage and effluent are, the amount of oxygen absorbed by a known quantity of the sample in four hours and in three minutes, the free ammonia, the albuminoid ammonia and the organic ammonia, chlorine, total solids in solution and suspension, and sometimes the amount of iron.

The precise significance of these determinations will be indicated in the succeeding chapters.

A fair measure of the impurities present is given by the four hours' oxygen absorption test and the

albuminoid ammonia. The purification effected is generally calculated in percentage, the oxygen absorption or the albuminoid ammonia of the sewage being taken at 100.

Thus, if the albuminoid ammonia of the sewage was .75, and that of the effluent .15 grains per gallon, the percentage purification effected would be

$$\frac{100 \times (.75 - .15)}{.75} = 80.$$

#### MEASUREMENT OF SLUDGE PRODUCTION.

In all processes involving the production of sludge the quantity produced should be carefully measured, either by collecting in storage tanks of known dimensions, or by recording the quantity passed through pumps or ejectors. The percentage of water contained in it should also be determined from time to time. It is obvious that the actual quantity of solids removed can only be calculated when both the volume and composition of the sludge are known. Thus, a sludge containing 85 per cent. water contains 50 per cent. more solid matter than a sludge containing 90 per cent. water.

#### THE CONTROL OF THE SEPTIC TANK.

The work of the septic tank may also be judged by the above tests. The determination of suspended matter in the sewage and effluent is of particular importance in this case, as the amount passing away tends to be higher than when chemical

treatment is made use of. When the suspended matter passing away becomes excessive a certain amount of the sludge should be removed. It is also important that determinations of the sludge present in the tank should be made from time to time (see p. 109).

By determining the amount of solids entering and leaving the tank during a given period, throughout which the rate of flow through the tank is known, and by determining the amount of sludge left in the tank at the end of that period, some idea may be formed of the actual destruction of sludge taking place in the tank.

Analyses of the gases evolved are of importance, as the composition of these varies with the state of the tank (see p. 112), there being more carbonic acid present in the gases in the early stages of working of a new tank than after it becomes fully septic.

Moreover, the composition of the gas has been found to vary with the composition of the sewage, there being apparently a greater percentage of hydrogen in purely domestic sewage than in a sewage containing a large proportion of manufacturing effluents.

The composition of the gas is also found to vary according to the length of time the sewage remains in the tank,\* and, altogether, it is probable that with further research a knowledge of the composition of the gases evolved in the

\* Report of the Massachusetts State Board of Health, 1900, p. 392.



septic tank will be found of much value in judging of the condition of the tank at any time.

It is important, for instance, that bacterial filters which have been dealing with a well-septi-cised effluent should not receive merely settled sewage, as not only will they fail to adequately purify it, but the conditions of their activity tend to be disturbed. The analysis of the septic tank gases may, in such a case, serve to show whether septic changes are fully active in the tank.

#### THE CONTROL OF BACTERIAL FILTERS AND CONTACT BEDS.

In addition to the determinations of oxygen absorbed, albuminoid ammonia, etc., above mentioned, it is important to observe here the quantity of nitrite and nitrate present in the filtrate, as these are the final oxidation products of nitrogenous organic matter. The dissolved oxygen present in the filtrate should be determined from time to time, and also the composition of the air in the interstices of the empty bed.

In the early stages of working, the effluent from bacteria beds generally contains more free and saline ammonia than is present in the tank effluent applied, owing to the conversion of urea and albuminoid compounds into ammonium salts (see Chap. III.). As the activity of the bed increases, the ammonia compounds are oxidised to nitrates, and there will then be less free ammonia in the effluent from the bed than there is in the tank effluent (see Chap. IV.).

The percentage purification effected can be calculated, as in the case of chemical precipitation, from the difference between the oxygen absorption and albuminoid ammonia numbers before and after filtration.

If the percentage purification rapidly decreases, or if the formation of nitrates diminishes to a marked extent, it is, in general, a sign that the filter is being overworked. The diminution of nitrates is usually accompanied by an increase in the production of nitrites. The presence of these in quantity may therefore generally be taken as a sign that the bed requires rest.

On the other hand, a knowledge of the dilution of the sewage or tank effluent will indicate when it is possible with safety to increase the volume put upon the bed.

It frequently happens—during the first flush of a storm, for instance—that although the sewage increases in volume it still remains concentrated. After the first flush has passed, however, the sewage becomes dilute, and may be dealt with by the bacterial filters at a greater rate. The dilution can generally be estimated by a determination of the chlorine number (see Chap. VI.).

Further details with reference to the chemistry of the changes taking place in the septic tank and the bacterial filters will be found in the following pages.

#### METHOD OF RECORDING RESULTS.

The quantities to be determined in the analysis of sewage are for the most part so small that they

cannot conveniently be expressed in percentages. The simplest method is undoubtedly to record results in parts per 100,000. To be consistent, the sewage should then itself be measured in cubic metres, when the quantity of impurity present would bear a simple relation to the total volume of sewage.

In England, however, liquids are still measured in gallons, and therefore in the following pages the results are determined in grains per gallon, so that the amount of impurity, etc., in the total volume of sewage can easily be calculated.

The results recorded in grains per gallon can readily be converted into parts per 100,000, if it is remembered that one grain per gallon is one part in 70,000. To convert grains per gallon into parts per 100,000 the results must be divided by  $\cdot 7$ . On the other hand, grains per gallon will be  $\cdot 7$  of parts per 100,000. A table will be found on page 128 in which the corresponding values of these two methods are given over a convenient range of numbers.

In determining the *nitrogen* in the various forms in which it occurs in sewage and sewage effluents, it is important that the results should all be expressed in similar terms, in order to be comparable. As the nitrogen, whether present as ammonia, albuminoid compounds or nitrates, is eventually determined as ammonia, it has been found convenient to record it in terms of the ammonia produced in each case.

The Royal Commission on Sewage Disposal ask for the results to be expressed in terms of nitrogen, *i.e.*, ammoniacal nitrogen, albuminoid nitrogen, nitric nitrogen, etc. In this case the ammonia produced in the analytical process must be multiplied by  $\cdot 82$  (*i.e.*  $\frac{N}{NH_3} = \frac{14}{17}$ ) in order to give the value as nitrogen.

Calculation may of course be saved if the strength of standard solutions and the quantity of the sample taken for analysis are so arranged as to give the result required at once. In the following descriptions alternative quantities are given where it appears necessary.

It may be here remarked that it is possible to attempt too great refinement in the methods used for the analysis of sewage, inasmuch as except when sterile it is constantly subject to progressive changes in composition. Analyses which record a fourth or even third place of decimals give really a fictitious appearance of accuracy.

#### DEGREE OF PURITY NECESSARY IN AN EFFLUENT.

Considerable difference of opinion exists as to the degree of purification necessary to be obtained in an effluent, and various standards of purity or limits of impurity of a somewhat arbitrary character have been provisionally adopted by various conservancy boards.

For example, the Mersey and Irwell Joint Committee class as good any effluent which absorbs

less than one grain per gallon of oxygen from permanganate in four hours, and which evolves less than one grain per gallon albuminoid ammonia.

In the reports of the chief inspector to the Ribble Joint Committee sewage effluents are classed as good if the albuminoid ammonia liberated is below  $\cdot 1$  part per 100,000, suspended matter absent, and the presence of nitrates confirmed.\*

The Derbyshire County Council define a good effluent as one which contains less than  $\cdot 1$  part per 100,000 of albuminoid ammonia, and which contains more than  $\cdot 5$  parts per 100,000 of nitrogen as nitrates. It should also be so thoroughly oxidised that it does not absorb more oxygen after incubation for one week than it does at the time of collection.

While such "limits" have their undoubted uses in stimulating authorities to efficiently purify their sewage, yet it is obvious that they are of an empirical nature.

When, for example, an effluent flows into a tidal river or into the sea, or where the volume of effluent is very small in comparison with the volume of river water, a degree of purification represented by the  $\cdot 1$  grain per gallon albuminoid ammonia of the Mersey and Irwell Joint Committee would probably be altogether unnecessary, as the river would contain enough oxygen to oxidise the residual impurity. On the other hand, such an effluent

\* W. Naylor, "Rivers Pollution Standards," "Journal of the Sanitary Institute," vol. xix., part. i., p. 24.

might be quite insufficiently purified to enter a stream which is afterwards used for a water supply.

Cases of this sort are illustrated by the Thames above the intakes of the London water companies, or by the Dee above the Chester water supply. The Massachusetts experiments on sewage purification were undertaken in order to diminish the occurrence of typhoid in towns deriving their water supply from sewage-polluted rivers. In this case a high degree of purification had to be aimed at, and the experimental filters were constructed for the most part of sand.

Again, the effluent may contain organic matter in excess of the limits allowed by any of the above-mentioned authorities, and yet maintain in solution an amount of oxygen or of nitrates more than sufficient to oxidise this residual impurity after a short lapse of time. Moreover, the oxygen absorbed from permanganate by the effluent may be due to oxidisable substances other than putrefactive organic matter, resulting from manufacturing processes which may be incapable of causing a nuisance or of robbing the stream of oxygen.

Apart from such provisional limits of impurity, it is evident that the character of the effluent as a whole must be considered together with the stream into which it flows.

This is indeed recognised by the authorities themselves, who in taking action have regard, in general, to all the circumstances of the case.

Broadly speaking, it may be taken that no serious

pollution will occur in practice if the effluent is so far purified that it will always leave a fair surplus of dissolved oxygen in the stream into which it flows. This may be roughly tested by mixing the effluent with an equal volume of the stream and incubating the mixture for two days, during which time no putrefaction should occur.

It may sometimes happen that the effluent produced is better than the stream which receives it. For example, the Manchester Ship Canal in the summer months is itself in a state of putrefaction before the Manchester effluent enters it.

In such a case the effluent must be judged by other tests than the one just mentioned. For such tests reference may be made to Chap. V., p. 82.

Briefly, the method consists in presenting a known amount of dissolved oxygen to the effluent, by mixing it with a given volume of aerated water and noting the diminution of dissolved oxygen which occurs after two days' incubation.

For further information as to the principles of sewage purification and the methods used in various cases the following works may be consulted :—

DIBDIN : "Purification of Sewage and Water."

RIDEAL : "Sewage and Sewage Purification" (Sanitary Publishing Co.).

LAFAR : "Technical Mycology" (Griffin & Co.).

"Reports of the Massachusetts State Board of Health" (P. S. King & Son, Westminster).

"Manchester Sewage Reports" (P. S. King & Son, Westminster).

## CHAPTER II.

## THE DETERMINATION OF ABSORBED OXYGEN.

## THEORY OF THE PROCESS.

WHEN an organic substance—*e.g.*, coal—is burnt it combines with oxygen and is said to be oxidised.

The amount of oxygen combined in this way is evidently a measure of the quantity of coal or other combustible or oxidisable substance burnt.

The organic matter in sewage could be obtained in the dry state by evaporation, and in like manner its amount could be estimated by determining the amount of oxygen required to burn it.

It is more convenient, however, to oxidise the organic matter while in solution, by addition of some compound which will readily yield up its oxygen to the oxidisable substances present.

Such a compound is potassium permanganate, and the oxidation thus carried out is termed "moist combustion."

The amount of "oxygen absorbed" from potassium permanganate in acidified solution is taken as a measure of the organic or other oxidisable matter present.



The action of the permanganate may be better understood from the following equation:—

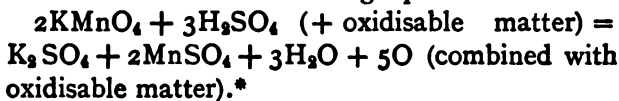

This indicates that 316 parts of pure potassium permanganate will yield 80 parts of oxygen to oxidisable matter, in presence of sulphuric acid, or 395 grm.  $\text{KMnO}_4$  will yield 100 grm. oxygen. If 395 grm.  $\text{KMnO}_4$  is dissolved in 1 litre (1000 c.c.) of water, each c.c. of the solution will yield  $\frac{1}{10}$  mgrm. oxygen.

In order to determine exactly the amount of oxygen absorbed from the permanganate it is necessary to add excess of this reagent to the liquid to be tested, and after a given time to determine the oxygen still unabsorbed.

This can be most accurately accomplished by addition of potassium iodide, when iodine is liberated in amount equivalent to the unabsorbed oxygen thus:—

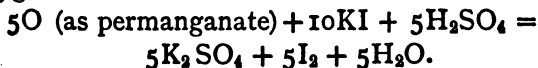

This iodine and consequently the unabsorbed oxygen can then be determined by addition of

\* Potassium permanganate may be looked upon as a compound of the basic oxide  $\text{K}_2\text{O}$  and the acid oxide  $\text{Mn}_2\text{O}_7$  (thus  $2\text{KMnO}_4 = \text{K}_2\text{OMn}_2\text{O}_7$ ). In the above equation the  $\text{Mn}_2\text{O}_7$  is reduced to the basic manganous oxide  $\text{MnO}$  with liberation of 5 atoms of O. The sulphuric acid serves to neutralise the  $\text{K}_2\text{O}$  and  $\text{MnO}$ , forming potassium and manganous sulphates.

sodium thiosulphate solution of known strength, when sodium tetra thionate and sodium iodide are formed, thus:—

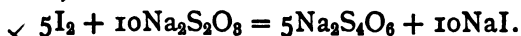

The exact point at which the iodine is all combined may be determined by the addition of a few drops of starch solution, which gives a deep blue colour with free iodine. When all the iodine is combined the blue colour is at once discharged. The method is carried out in detail in practically the same manner in the laboratories of the Mersey and Irwell Joint Committee and of the Manchester Corporation.

#### SOLUTIONS REQUIRED.

For the determination of oxygen absorption the following solutions are therefore required:—

✓ *Potassium Permanganate.*—395 grm. of the pure crystallised salt is dissolved in 1 litre of water which has been *very faintly* tinged with permanganate solution in order to oxidise any impurities in the water. It is often convenient to dissolve three times the above quantity and dilute to 3 litres in a large Winchester bottle; but it is not advisable to make up much more than a day's supply at once, as the solution is liable to be reduced by floating dust, etc.

✓ *Sulphuric Acid.*—One part of the pure acid is *carefully* added to 3 parts of water contained in a large thin flask, which should be gently rotated as the acid is added, in order to prevent too great

heating. The mixture must be cooled before use, or before transferring to a bottle. As in the case of the water used for dissolving the potassium permanganate, it is advisable to add to the cold diluted acid a few drops of potassium permanganate solution, until a faint but permanent pink tinge is produced.

*Potassium Iodide.*—Ten grms. of potassium iodide are dissolved in 100 c.c. of water. It is not advisable to make up a larger quantity of potassium iodide solution than is needed for immediate requirements, as it suffers decomposition when exposed to air and light.

*Starch Solution.*—Two grms. of starch are rubbed down with a little water to a smooth cream; this is poured carefully into a litre of already-boiling water in a large flask (if added too quickly, the water may boil over). The solution is boiled for a few minutes after the addition of the starch, till quite clear, and then allowed to cool under the water-tap. After settling, the clear liquid is decanted for use.

*Sodium Thiosulphate.*—This may conveniently be made of such a strength that 1 c.c. = 2 c.c. of the permanganate solution. For this purpose, about 7 grms. pure crystallised sodium thiosulphate (“hyposulphite of soda”) are dissolved in 1 litre of water (or three times this quantity may be taken). A blank test is then made with a mixture of 70 c.c. of distilled water, 10 c.c. of the sulphuric acid, and 50 c.c. of the permanganate solution. A few

drops of the iodide solution are added to this till the clear yellowish-brown colour of the iodine is obtained. The thiosulphate solution is now run in from a burette till the iodine colour is reduced to a pale yellow, a few drops of starch solution are added and a small additional quantity of thiosulphate run in till the blue colour just disappears.

If the thiosulphate is present in exactly the right proportion, 25 c.c. of the solution should be equivalent to the 50 c.c. of permanganate. If the solution is strong, as will be probably the case, say 24 c.c. thiosulphate = 50 c.c. permanganate, then for every 24 c.c. remaining of the thiosulphate solution, 1 c.c. of water must be added, viz.,  $\frac{1000 - 24}{24} = 32.3$  c.c. (or  $\frac{3000 - 24}{24} = 124$  c.c., if 3 litres have been made up).

With a little practice a solution of thiosulphate may be in this manner easily adjusted so that 25 c.c. = 50 c.c. permanganate. The solution does not keep long unchanged, and should be readjusted every day at least, but the slight trouble thus involved saves a great deal of calculation where many analyses have to be made.

The method above described for adjusting the thiosulphate solution closely resembles the method used for determining oxygen absorption, the 70 c.c. distilled water being replaced by the sample to be tested.

## METHOD OF CARRYING OUT DETERMINATIONS.

*Measurement of Solutions.*—In measuring quantities of sewage or effluent it is inadvisable to use a pipette, owing to risk of sucking up noxious emanations, or even some of the liquid itself into the mouth. A 100 c.c. graduated measuring cylinder will be found convenient, the liquid being always measured from the tangent to the meniscus.

The various reagents can be added most expeditiously from burettes, these being slightly widened at the top to admit of rapid filling. The burettes should always be kept corked when not in use, to prevent entrance of dust, etc.

Where only a few drops of a reagent have to be added, a dropping bottle may be used. This is made by simply cutting a notch in the side of the cork which fits the neck of the bottle containing the reagent. On inverting and shaking the bottle, the liquid is delivered in drops.

To carry out the determination, 70 c.c. of the sample to be analysed are taken (more if it contains very little oxidisable matter, less if it contains very much), 10 c.c. of sulphuric acid are added, and then 50 c.c. of the permanganate solution. The mixture is allowed to stand four hours in a stoppered bottle. For this purpose, the glass jars in which stick potash is sold may be conveniently used. While standing, the bottle should be kept corked.

It is important that excess of permanganate should always be present during the four hours.

If it becomes markedly decolourised before the four hours have expired, a second, and, if necessary, a third quantity of acid and permanganate solution is added. It frequently also happens, if suspended oxidisable matter is present, that the solution begins to be decolourised at the bottom. In this case it should be shaken from time to time to thoroughly oxidise the suspended matter.

At the end of four hours a few drops of the potassium iodide solution are added till the clear orange colour of the iodine is obtained. The sample is then titrated with thiosulphate and starch solution as described above.

The number of c.c. of thiosulphate added is carefully noted.

The oxygen absorption is calculated as follows:—

When 10 c.c.  $\text{KMnO}_4$  = 1 mgrm. O,

1 c.c.  $\text{Na}_2\text{S}_2\text{O}_3$  = 2 c.c.  $\text{KMnO}_4$ .

If  $a$  = c.c. of permanganate used,

$b$  = c.c. of thiosulphate used,

$\frac{a - 2b}{10}$  = grains of oxygen absorbed per  
gallon of sample.

For example, if 70 c.c. of the sample have been taken, 50 c.c. of permanganate added, and 22 c.c. of thiosulphate are needed for the final titration, then one gallon of the sample will absorb—

$$\frac{50 - (22 \times 2)}{10} = \cdot 6 \text{ grains per gallon oxygen.}$$

In some cases (*e.g.*, where only a few samples have to be examined) it may not be convenient to adjust the thiosulphate solution to correspond

exactly with the permanganate as above described, then the oxygen absorbed by each sample must be calculated as follows, from a blank experiment made every day :—

Example from Mr. Scudder's Note-book :—

<i>Test.</i>	<i>Blank.</i>
10 c.c. sulphuric acid.	10 c.c. sulphuric acid.
50 c.c. potassium permanganate.	50 c.c. potassium permanganate.
70 c.c. sewage effluent.	70 c.c. distilled water.
Required 24.0 c.c. $\text{Na}_2\text{S}_2\text{O}_8$ solution.	Required 27.7 c.c. $\text{Na}_2\text{S}_2\text{O}_8$ solution.
$\left. \begin{array}{l} \frac{50 \text{ c.c. KMnO}_4 \text{ solution}}{27.7 \text{ c.c. Na}_2\text{S}_2\text{O}_8} \end{array} \right\} = 1.8 \text{ factor.}$	

Multiply the thiosulphate figure obtained in the test by the factor, and the amount of unused permanganate will be obtained.

$24.0 \times 1.8 = 43.2$  c.c. permanganate solution.

50 c.c.  $\text{KMnO}_4$  solution — 43.2 c.c. = 6.8 c.c.  $\text{KMnO}_4$  used.

1 c.c.  $\text{KMnO}_4 = 0.1$  mgrm. oxygen.

$6.8 \times 0.1 = 0.68$  mgrm. oxygen absorbed by 70 c.c. sewage effluent.

= 0.68 grains oxygen absorbed per gallon, four hours' test.

In doing a large number of determinations, it will be found most convenient and satisfactory to measure out the acid and permanganate first into the bottles, and then add a sample to each bottle in turn.

The iodine and thiosulphate must be added to



## SEWAGE WORKS ANALYSES.

the first sample of the series four hours after it has been mixed with the acid and permanganate.

The time of titration may be rather more than that required to add the sample to the permanganate in the first instance. The action of the permanganate can, however, be stopped at any point by addition of potassium iodide; but if this is allowed to remain long before addition of thio-sulphate, error is likely to arise, owing to a further liberation of iodine from the iodide by the action of sulphuric acid in the presence of light.

The following are some typical examples of the results of the application of this test to sewage and effluents of various descriptions—

Description of Sample.	Oxygen absorbed, 4 hours' test.	
	Grains per Gallon.	Parts per 100,000.
<b>MANCHESTER SEWAGE</b> (containing much manufacturing refuse)—		
Sewage (sample shaken before analysis) ... ..	8.57	12.24
Sewage (sample settled before analysis) ... ..	5.84	8.34
Effluent from chemical precipitation (lime and copperas) ...	4.88	6.97
Effluent from open septic tank ...	5.88	8.40
Effluent from open septic tank after 1 contact on bacteria beds ...	1.87	2.67
Effluent from open septic tank after 2 contacts on bacteria beds ...	.58	.83
<b>OLDHAM SEWAGE</b> (mainly domestic)—		
Sewage ... ..	3.60	5.14
Effluent after settlement in tanks...	2.00	2.86
Filtrate from single contact ...	.55	.80



*Substances other than Domestic Sewage indicated by Four Hours' Test.*—Although the amount of oxygen absorbed is a good measure of the impurities present in domestic sewage, yet in cases where manufacturing refuse is present, the permanganate is reduced by substances other than sewage. In some cases these may be equally capable of putrefaction, and consequently of producing a nuisance.

The following are examples of such substances:—

- Brewery waste, yeast, etc.
- Size manufacturers' refuse.
- Abattoir refuse.
- Paper waste.
- Distillery waste.
- Tannery and fellmongering refuse.
- Wool-scouring refuse.

Other substances, however, may be present which are not putrefactive, but which absorb oxygen. Such are the following:—

- Various coal-tar products, *e.g.*,
- Phenol.
- Naphthylamine.
- Naphthol, etc.
- Naphthalene sulphonic acids.
- Pyridine bases.
- Dyes, *e.g.*—
- Indigo.
- Logwood, etc.
- Inorganic salts, *e.g.*—
- Thiocyanates.
- Sulphites.

Iron-pickle, etc.

Nitrites.

*Three Minutes' Oxygen Absorption Test.*—The determination of the oxygen absorbed by permanganate in three minutes, *i.e.*, practically instantaneously, gives a means of differentiating between one class of oxidisable substances and another, and in conjunction with the incubator affords an excellent method of determining the amount of putrefaction which is capable of taking place in a sample of sewage or effluent.

For strictly comparative tests the following method, closely resembling the process for determining the oxygen absorbed in four hours, is recommended:—

Seventy c.c. of the sample are taken (more if it contains very little oxidisable matter, less if it contains very much), 10 c.c. of sulphuric acid are added, and then 50 c.c. of permanganate as before; but the action of the permanganate is stopped by the addition of potassium iodide at the end of three minutes, and the sample titrated as before with sodium thiosulphate and starch.

When a large number of samples has to be examined the following method will be found convenient:—

Add the acid and permanganate solution to all the bottles necessary, including (if the thiosulphate is not exactly adjusted) the blank test. Then start at one end of the row and each half-minute add 70 c.c. of the effluent to be tested.

When the seventh bottle is reached the first bottle will have stood three minutes, and is stopped by adding an excess of potassium iodide solution. When the eighth bottle is reached the second will be stopped, and so on, until the series is complete. Each one is then titrated in succession with thio-sulphate, until the blank is reached from which the factor is obtained, as in the four hours' test.

The proportion of permanganate to sample should be such that at least 30 per cent. of the permanganate solution remains unchanged.

The results are calculated as in the case of the four hours' test.

*Substances other than Domestic Sewage which affect the Three Minutes' Test.*—The following substances which may occur in sewage containing manufacturing waste are completely oxidised by acid permanganate at once:—

- Iron pickle.
- Sulphites.
- Sulphocyanates.
- Sulphides.
- Nitrites.
- Phenol.
- Naphthylamine.
- Naphthalene sulphonic acids.
- Indigo.

The other substances specially mentioned when describing the four hours' test will, of course, also affect the three minutes' test.

*Use of Three Minutes' Test by Workmen.*—

Experience in any particular sewage will show that a fairly constant average relation exists between the three minutes' oxygen absorption and the four hours' oxygen absorption, albuminoid ammonia, etc., tests.

Thus, in the case of many domestic sewages a three minutes' oxygen absorption of '25 grain per gallon indicates satisfactory purification.

With Manchester sewage, which contains much oxidisable manufacturing refuse, '5 grain per gallon may be accepted.

The three minutes' absorption test may therefore be applied in a modified form as a rough-and-ready test for the control of bacteria beds, when the number of samples would render continual complete analyses impracticable.

In order to place the test in the hands of an intelligent workman the following modification may be adopted:—

'395 grm. of permanganate is taken and made up in the laboratory to one litre with 200 c.c. sulphuric acid (1 acid,  $3H_2O$ ), and 800 c.c. water. A strong glass cylinder (*e.g.*, a potash jar) is graduated with a file in two places, the lower mark indicating 140 c.c., and the interval between the two marks corresponding to 20 c.c.

It is then easy for the workman to measure 140 c.c. of the sample to be tested and to add 20 c.c. of the acid permanganate.

If the colour completely disappears in three minutes, the sample is inadequately purified.

A little practice in noting the rapidity of the de-colourisation will soon enable a workman to judge of the character of the purification he has obtained.

It is important that the permanganate solution should be freshly made up every few days.

#### THE INCUBATOR TEST.

When a sample of sewage or effluent undergoes putrefaction, products such as sulphuretted hydrogen are formed, which are rapidly oxidised by permanganate; *i.e.*, the three minutes' oxygen absorption of a sample after putrefaction is greater than when the sample is fresh.

Upon this fact Mr. F. Scudder, chemist to the Mersey and Irwell Joint Committee, has based a convenient method for ascertaining the tendency of a sample to undergo putrefaction.

A determination of the oxygen absorbed in three minutes by the sample is made. A small bottle is then *completely filled* with the sample, the stopper is inserted, and the full bottle placed in an incubator and maintained at a constant temperature corresponding to a warm summer day for five or six days, and the three minutes' oxygen absorption again determined.

In the Mersey and Irwell Joint Committee's laboratory 75° F. (24° C.) is the temperature chosen, and the sample is kept in the incubator five days.

In the laboratory of the Manchester Corporation Sewage Works 80° F. (26° C.) is taken, and the sample incubated for six or seven days.





FIG. 2.—THE HEARSON INCUBATOR.

*[To face page 35.]*

The time and temperature chosen are, to some extent, a question of convenience. It is preferable, for example, that samples should not have to be taken from the incubator on Saturday or Sunday.

The most convenient and trustworthy form of incubator is the Hearson incubator (see Fig. 2). It is essentially a water-jacketed chamber, heated by a regulated gas supply. The temperature is controlled by means of the expansion and contraction of a capsule containing a liquid of suitable boiling point. As the temperature rises, the capsule expands, lifting a weighted rod, which cuts off the gas supply. Full directions for setting up and adjusting the incubator are given with the apparatus. A 4-oz. or 8-oz. bottle is the size suitable for ordinary incubator tests.

A simple incubator can be made by fitting up an ordinary water-jacketed air-bath with a Page or Reichardt gas regulator.

The difference between the three minutes' oxygen absorption before and after incubation is a measure of the change which has taken place in the sample. If the oxygen absorption increases, the production of easily oxidisable substances such as sulphides is indicated, and the amount of increase is therefore a measure of the putrefaction which has taken place; or in other words, the difference represents the tendency of the sample to cause a nuisance when exposed to conditions favourable to putrefaction. An exception may occur in the case of effluents containing nitrates. In this case the



nitrites may be reduced by the organic matters present, with formation of nitrites. These absorb oxygen from permanganate immediately, and it may happen in this way that the three minutes' test is greater after incubation than before, but no putrefaction has taken place. In such cases nitrites should be looked for and determined if found, by the Griess-Ilosvay test described later (p. 64).

If nitrites are found to be present, they may be destroyed by adding a little urea to the acid solution, when the following reaction occurs:—

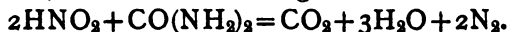

The titration with permanganate, etc., may then be repeated.

In the case of a sample which contains dissolved oxygen or nitrates, the three minutes' test will in general be less after incubation than before, even if nitrites are present. Such decrease, therefore, indicates efficient purification.

It may sometimes happen in the case of sewage containing manufacturing refuse that substances are present which either retard or even entirely inhibit putrefaction. Or so much lime is sometimes added in chemical treatment that the resultant effluent is sterile. In such cases little if any change will be indicated by this test.

To properly judge of the character of such an effluent, it should be mixed with an equal volume of the stream into which it is destined to flow, and the mixture re-incubated. The effect of the sterilising substance is thus diminished or entirely

prevented, and putrefaction will take place if the sample is not properly purified.

Of considerable interest is the determination of dissolved oxygen and nitrates in a sample after incubation. This will be further referred to in Chapters IV. and V.

The following examples will illustrate some of the points referred to in connection with the incubator test.

Description of Sample.	3 Minutes' Oxygen Absorption. Grains per Gallon.		Putrescibility.
	Before Incubation.	After Incubation.	
Raw sewage ... ..	4'24	7'00	-
Raw sewage containing waste acid ... ..	4'08	4'44	+
Raw sewage containing waste tar products ... ..	5'98	5'54	+
Open septic tank effluent ...	2'66	4'97	-
Effluent from $\frac{1}{2}$ -acre bacteria bed, early stage of working...	1'62	1'62	x
Effluent from $\frac{1}{2}$ -acre bacteria bed, later stage of working ...	'77	'65	+
Effluent from experimental bacteria bed, second contact ...	'14*	'20	+
Effluent from experimental bacteria bed, second contact ...	'18*	'18	+
Ship canal water (dry weather)	1'08	1'64	-
Ship canal water (wet weather)	'24	'16	+

Note:— + indicates non-putrefactive.  
 - indicates putrefactive.  
 x indicates questionable.

\* In these two cases nitrites were present after incubation, equivalent to '04 and '06 respectively. After treatment with urea the numbers after incubation would therefore be '16 and '12.

## CHAPTER III.

## THE DETERMINATION OF AMMONIA.

THE majority of organic substances occurring in sewage contain nitrogen, which can in various ways be determined in the form of ammonia.

One of the chief nitrogenous substances in sewage is urea or carbamide,  $\text{CO}(\text{NH}_2)_2$ , which is a normal constituent of urine. By the action of an organism (*micrococcus urei*) which is always present in urine the urea is rapidly converted into ammonium carbonate thus:—



A certain amount of ammonium carbonate is therefore always to be found in sewage, and it rapidly increases in quantity if the sewage is allowed to stand some time before analysis. It can easily be driven off by boiling, and constitutes the main source of what is generally spoken of as *free ammonia*.

Some of the nitrogen in sewage occurs in such compounds as—

*Glycocoll* (amido-acetic acid,  $\begin{matrix} \text{CH}_3\text{NH}_2 \\ | \\ \text{COOH} \end{matrix}$ )

*Leucine* (amido-isocaproic acid,  $\begin{matrix} \text{C}_5\text{H}_{10}\text{NH}_2 \\ | \\ \text{COOH} \end{matrix}$ )

*Asparagin* (amido-succinamic acid,

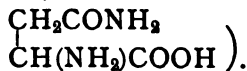

These substances and others of an allied but more complex composition yield ammonium salts of the corresponding acids on putrefaction. Thus—

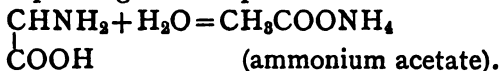

Such ammonia is also in part given off on boiling, especially with addition of a little sodium carbonate.

The addition of sodium carbonate when boiling off the “free” ammonia also neutralises any acids present in the sewage from manufacturing processes, which otherwise might combine with some of the “free” ammonia to form fixed salts, and thus prevent its evolution on boiling. The total ammonia given off on boiling with sodium carbonate is therefore sometimes described as free and saline ammonia.

The above compounds and others, *e.g.*, uric acid, and bodies of an albuminous character, such as proteids, etc., yield ammonia at once on boiling with a strongly alkaline solution of potassium permanganate.

The ammonia thus obtained, as it is derived in part from albuminoid substances, is generally spoken of as *albuminoid ammonia*.\*

The increase of free ammonia at the expense of albuminoid ammonia, which is observed when

\* Wanklyn & Chapman, “Water Analysis.”

sewage is allowed to stand, is due to the conversion of the above substances, together with urea, into ammonia salts by the action of the organisms present in the sewage. These and similar changes probably occur in the early stages of working bacteria beds, referred to on p. 57.

A further quantity of ammonia can be obtained when sewage is heated for some time with strong sulphuric acid and then neutralised and distilled with caustic soda. This is generally termed *organic ammonia*, and is derived from such substances as are not broken up by the methods used for determining free and albuminoid ammonia.\*

The quantitative estimation of the ammonia evolved by either of the foregoing methods of treatment is effected by NESSLERISATION. This process is based on the following reaction:—

When an alkaline solution of mercuric iodide is added to a solution containing ammonia, a brown precipitate is formed. If the ammonia is present in small quantities, a brown coloration only is produced, the depth of colour depending on the quantity of ammonia present. The brown precipitate is generally considered to have the formula  $\text{NHg}_3\text{I}$ ,  $\text{H}_2\text{O}$ .

By comparing the tint given by the ammonia in the sample to be analysed with a series of standard tints produced by adding Nessler reagent to known quantities of ammonia, the amount of ammonia present in the sample can be determined.

\* See Rideal "Sewage and Sewage Purification," Chap. V.

For the complete process of distillation and Nesslerisation, the following apparatus and solutions are necessary:—

#### SOLUTIONS.

*Nessler Reagent.*—62·5 grms. potassium iodide are dissolved in about 250 c.c. distilled water, 10 c.c. of this solution are set aside, and into the remainder is *carefully* run a cold saturated solution of mercuric chloride. A brilliant red precipitate of mercuric iodide forms, and at first quickly redissolves on shaking. The addition is continued till a permanent precipitate forms. This is redissolved by the potassium iodide held in reserve, and more mercuric chloride is added drop by drop until after stirring a slight red opalescence remains; 150 grms. of caustic potash are dissolved in distilled water, allowed to cool and added gradually with continued shaking, to the opalescent solution. The whole is made up to 1 litre, allowed to settle, and the clear liquid decanted into a bottle.

The Nessler solution improves on keeping, hence it should be made up some time before it is required. Special attention must be given to the end point of the addition of mercuric chloride to the iodide solution. If the potassium iodide be in excess, the Nessler will not be delicate, and the colour with ammonia will be long in reaching full density. On the other hand, the addition of an excess of mercuric chloride will give an excess of mercuric iodide, which will dissolve when the

potassium hydrate is added, and the Nessler will be excessively delicate, the colour striking full rapidly; but it is liable, after the ammonia tubes have stood about ten minutes, or even less, to become turbid and deposit a red crystalline precipitate, so that, whilst maximum delicacy is required, this turbidity is to be avoided. Practice is the only guide to making a good Nessler solution. One c.c. of Nessler solution ought to show colour with 0.008 mgm.  $\text{NH}_3$  (0.8 c.c. of the centinormal ammonium chloride solution in 50 c.c. pure water).

Stick potash is best dissolved in water in an earthenware basin. Thin glass vessels are apt to crack during the operation.

*Ammonia-free Water.*—This is best obtained in quantity by distilling from a tin or copper still, rejecting the distillate until it is free from ammonia when tested with the Nessler reagent. About one quarter of the original volume should be left in the still after each distillation, and the last 50 c.c. of the portion collected should be tested to see that it is free from ammonia. The still must be frequently cleaned, or organic matter will accumulate in the residue.

*Sodium Carbonate.*—100 grms. of dry sodium carbonate,  $\text{Na}_2\text{CO}_3$  are dissolved in a litre of water, the solution filtered and boiled till 50 c.c. fail to show any indication of the presence of ammonia when tested with Nessler reagent.

*Alkaline Potassium Permanganate.*—This is best

made up in quantities of 3 litres; 24 grms. of potassium permanganate are dissolved in about 500 c.c. of tap water, 600 grms. of potash are separately dissolved, and the solutions mixed and thoroughly boiled in a flask. This is best done in quantities not exceeding a litre (in case of breakage). The boiled solutions are then mixed and made up to 3 litres with distilled water free from ammonia.

*Standard Ammonium Chloride.*—This should be made up with the greatest care, as one litre will last a long while, and the accuracy of a large number of determinations will depend upon the correctness of the standard solution.

The ammonium chloride as ordinarily obtained should be purified by sublimation. For this purpose a few grms. are heated in a porcelain dish on a sandbath over which a large glass funnel is inverted. The salt sublimes and condenses on the inner side of the funnel in a powdery condition. Only the whitest portions of the sublimate should be taken for solution.

3.15 grms. of the purified salt are dissolved in a litre of ammonia-free water. The temperature of the water should be carefully adjusted to be equal to that for which the litre flask is graduated (usually 15°C.) as there is considerable reduction of temperature when ammonium chloride dissolves in water.

One c.c. of the solution contains 1 mgm. ammonia.\*

\* If 3.8215 grms. ammonium chloride are taken, each c.c. contains 1 mgm. nitrogen.



For general use more dilute solutions should be made from this normal standard solution.

*Decinormal Solution.*—100 c.c. of the normal solution are diluted to 1 litre. One c.c. of this solution contains .1 mgm. ammonia.

*Centinormal Solution.*—100 c.c. of the decinormal solution are diluted to 1 litre. One c.c. of this solution contains .01 mgm. ammonia.

In making these dilutions, care must be taken that the liquid at the time of measurement has a temperature equal to the graduation temperature of the flask.

The following is Mr. Scudder's description of the estimation of ammonia as carried out in the laboratory of the Mersey and Irwell Joint Committee:—

“The distillation is carried out in 32-oz. round-bottomed Bohemian flasks. The condenser tubes are made of block tin, placed in a copper box, through which a stream of water passes, so as to ensure that the distillates are of a constant temperature, which is a most important point to observe when Nesslerising. 700 c.c. of distilled water are placed in the flask, 1 c.c.  $\text{Na}_2\text{CO}_3$  solution added and 50 c.c. distilled over and tested for ammonia. If not quite free, a second 50 c.c. is distilled (this second 50 is invariably free). The flask is allowed to cool, and a measured quantity of the sewage effluent is added, varying from 10 c.c. to 70 c.c., according to whether the effluent is crude sewage, tank effluent, or filtered effluent.

The flask is connected with the condenser, and 250 c.c. distilled over and collected in a 250-c.c. flask for estimation of free and saline ammonia; a final portion of 50 c.c. is next distilled into a Nessler tube and tested for ammonia; but almost invariably it is found to be free.

“Whilst the distillation has been going on, 50 c.c. of the alkaline permanganate are put into a nickel basin with 20 c.c. distilled water and boiled for a few minutes to expel any ammonia; 50 c.c. of the alkaline permanganate (previously boiled) is then added to the flask, and the distillation continued, the distillate being collected in a 100-c.c. flask, then in 50-c.c. Nessler tubes, until 250 c.c. of distillate have been collected.

“It is important to observe the rate at which the albuminoid ammonia forms, and this is recorded in the note-book (see examples to follow).

#### “NESSLERISING.

“Twelve Nessler glasses are chosen having the 50 c.c. mark at least  $4\frac{1}{2}$  inches from the bottom. Each glass in the set must have the 50 c.c. mark at exactly the same height. These glasses are kept specially for standards. For all other purposes tubes 6 in.  $\times$  1 in. (preparation tubes), with a file mark at 50 c.c., are found useful and cheaper than Nessler glasses.

“When much work has to be done it is convenient

to have pieces of wood 9 in.  $\times$   $1\frac{1}{2}$  in.  $\times$  1 in. with five holes to fit the tubes, so that the tubes can all stand in proper order and without danger of falling.

“The standard tubes are held in a piece of wood, 9 in.  $\times$  7 in.  $\times$   $1\frac{1}{2}$  in., containing twelve holes.

“*Procedure.*—Measure out into a preparation tube part of the 250 c.c. distillate containing the free and saline ammonia, also a part of the 100 c.c. albuminoid ammonia distillate—the amounts to be taken vary so much with sewage effluents that experience alone can guide. When measured out make all up to the 50 c.c. mark. The standards are now prepared by measuring out known amounts of the standard centinormal ammonium chloride. The standards used are 0.5 c.c., 1 c.c., and so on, increasing by 0.5 c.c. up to 5.5 c.c., or eleven in all. The tubes are then made up to the 50 c.c. mark with distilled water; 1 c.c. Nessler solution is now added to all the tubes, mixed and allowed to stand five minutes, so that the colour may fully develop. If any fraction of the distillate is seen to be too deep in colour, or shows no colour in half a minute, it is better to take larger or smaller fractions from the bulk. After five minutes the spare tube of the set of twelve Nessler glasses is taken and the contents of the first preparation tube emptied into it and compared with the standards.

“A piece of white filter-paper should be placed on the bench, and the colour observed by looking

down through the tube to the white surface. (A piece of filter-paper, 6 in.  $\times$  6 in., gives a finer white surface than a glazed plate.)

“If the tube does not match any standard exactly, but lies between two, the difference must be judged by putting the tube between the standards above and below, and comparing the three.

“Some observers can note a small difference of this kind more easily by looking through the meniscus from the side. When the number has been fixed, it is noted. The Nessler glass is then emptied and the contents of the next preparation tube poured into it.

“By carrying out this method the highest accuracy is obtained with the smallest number of Nessler glasses. A full range of standards is prepared at the same time as the test liquids, and all stand under the same conditions.

“The maximum colour that can be compared with accuracy by this method must not exceed that produced by 5.5 c.c. of the standard ammonium chloride solution.

“Examples from laboratory note-book:—

I. A bad effluent, 25 c.c. taken for analysis.

A. Free and Saline Ammonia.

Distillate 250 c.c. = 52.5 c.c.  $\text{NH}_4\text{Cl}$ . solution  
(10 c.c. = 2.1).

Next 50 c.c. = 0.0

Total = 52.5

As 25 : 70 :: 52.5 = 52.5  $\times$  2.8 =

147.00 c.c.  $\text{NH}_4\text{Cl}$ . = 1.47 grains per gallon.

## B. Albuminoid ammonia.

Distillate 100 c.c. = 9.4 c.c.  $\text{NH}_4\text{Cl}$  solution  
(50 c.c. = 4.7).

Next 50 c.c. = 2.8 c.c.  $\text{NH}_4\text{Cl}$  solution

„ 50 c.c. = 1.8 c.c. „ „

„ 50 c.c. = 1.5 c.c. „ „

Total = 15.5

(Next 50 c.c. = 1.1 not included.)

As 25 : 70 :: 15.5 = 15.5 × 2.8 =

43.4 c.c.  $\text{NH}_4\text{Cl}$  = 0.434 grains per gallon.

## 2. A fair effluent, 50 c.c. taken for analysis.

## A. Free and saline ammonia.

Distillate 250 c.c. = 70.0 c.c.  $\text{NH}_4\text{Cl}$  solution  
(10 c.c. = 2.8).

Next 50 c.c. = 0.0

Total = 70.0

As 50 : 70 :: 70 = 70 × 1.4 = 98 c.c.  $\text{NH}_4\text{Cl}$   
= 0.98 grains per gallon.

## B. Albuminoid ammonia.

Distillate 100 c.c. = 4.8 c.c.  $\text{NH}_4\text{Cl}$  solution  
(50 c.c. = 2.4).

Next 50 c.c. = 1.1 c.c.

„ 50 c.c. = 0.6 c.c.

„ 50 c.c. = 0.0

Total = 6.5 × 1.4 = 9.1 c.c.  $\text{NH}_4\text{Cl}$

= 0.091 grains per  
gallon.”

The following is a description of the apparatus and methods employed in the Manchester Corporation Sewage Works laboratory :—



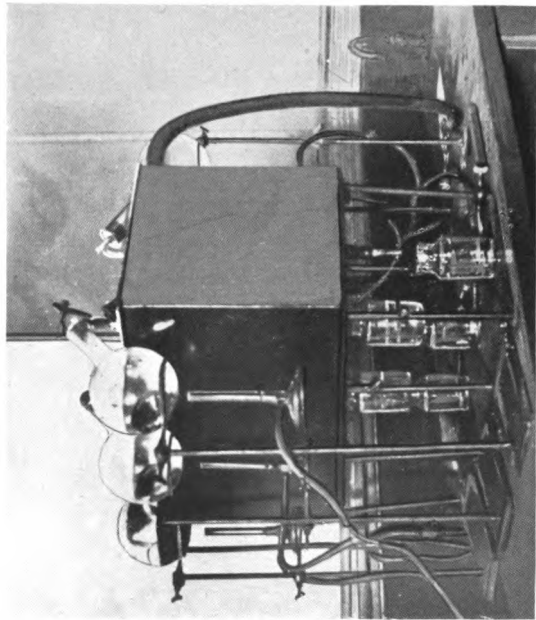

FIG. 3.—CONDENSING TANK FOR AMMONIA DETERMINATIONS.

[To face page 49.]

*Description of Apparatus.*—For making a number of distillations the apparatus shown in Fig. 3 has been found satisfactory.

A rectangular sheet iron tank, Fig. 3, is fitted with six vertical bulbed condensers. The upper ends of these are connected with six ordinary flasks of about one litre capacity (32 ozs.), while the lower ends dip into glass jars or cylinders in which the ammoniacal distillate can be collected. A constant stream of water circulates through the tank.

The particulars of construction of the condensing apparatus are as follows :—

The rectangular tank measures two feet in length, thirteen inches in breadth, and twelve inches in height. The water is brought in by a tube reaching to the bottom of the tank at one corner, and is taken off at the upper and diagonally opposite corner, so that the heated water is regularly displaced throughout the tank. The tank is supported on a strong iron stand of corresponding length and breadth, and ten inches in height. Three detachable stays are fitted at regular intervals across the top of the tank, pierced with holes at each side to receive the glass condenser tubes. Flanged holes are correspondingly placed in the bottom of the tank, and the tubes are fixed watertight into these with collars of wide indiarubber tubing.

The outside diameter of the tubes is half an inch, the diameter of the holes three-quarters of an inch.

The total length of each tube is twenty inches, and there are four bulbs on each tube, one inch in



diameter. The bulbs are two inches apart and five inches from the ends of the tubes. The bore of the exit tubes from the flasks being only slightly less than that of the condenser tube, the joint is easily made by a piece of indiarubber tubing which fills the annular interspace.

*Stokes' Colorimeter.*—This instrument is shown in Fig. 4. It consists essentially of two glass cylinders, 100 c.c. capacity, joined at the base by an indiarubber tube.

One of the cylinders is graduated into c.c., and can slide in a clamp which is attached to a vertical brass support. The second cylinder rests on a sloping glass plate, beneath which is a piece of white opal glass.

In these two cylinders is placed a known amount of ammonia. For this purpose .5 mgm. is generally taken, *i.e.*, 5 c.c. of the decinormal ammonium chloride solution (1 c.c. = .1 mgm.  $\text{NH}_3$ ), and diluted to 100 c.c. with ammonia-free water; 4 c.c. of Nessler solution are added, and the mixture is poured into the colorimeter.

When the cylinders are level with one another, the liquid stands at the 50 mark.

A third cylinder is taken of such dimensions that .25 mgm. ammonia dissolved in 50 c.c. ammonia-free water, together with 2 c.c. Nessler solution, gives a coloration exactly equal to the standard when the reading on the graduated tube is 50. This standard cylinder is always used for making the comparative colour tests.

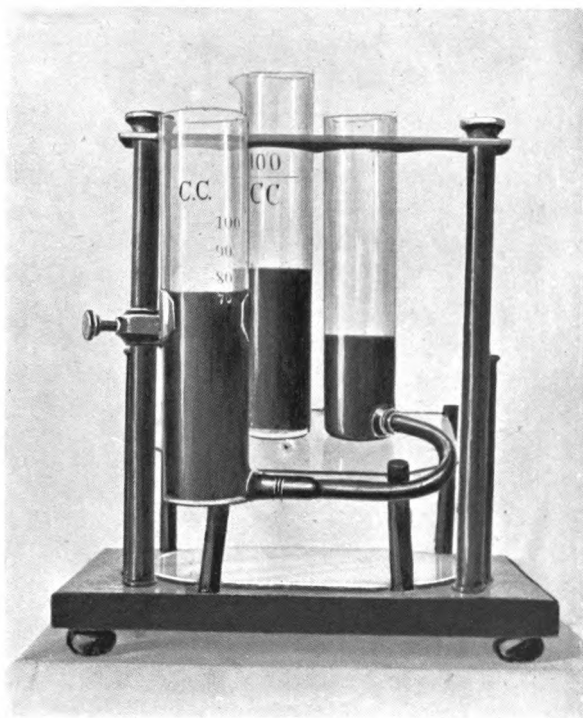

FIG. 4.--THE STOKES' COLORIMETER

*[To face page 50.]*



Fifty or 100 c.c. of the ammonia distillate, according to the amount of ammonia likely to be present, are taken, and 2 or 4 c.c. Nessler reagent added, and the mixture allowed to stand at least ten minutes in order to attain the room temperature, and for the depth of tint to reach a maximum. The coloured solution is then poured into the standard cylinder, which is placed on the glass plate. The graduated cylinder of the instrument is then moved up and down until the tints in the plain cylinder of the instrument and the standard cylinder correspond. This identity of tint is best judged by observing the cylinders through a card perforated with two holes about half an inch in diameter, coinciding with each cylinder. A good light should be directed on to the plate of opal glass beneath the cylinders.

The level of the liquid in the standard cylinder is then read. From this reading the amount of ammonia in the cylinder examined can be calculated thus:—

Supposing the reading to be, for example, 64, and the amount of ammonia in the two connected cylinders to be .5 mgm., then the amount corresponding to the cylinder to be tested will be

$$\frac{100 - 64}{100} \times .5 = .18 \text{ mgm.}$$

When the amount of ammonia distilled over from the sample is large it should be made up to a known quantity, and a given proportion taken.

The standard solution in the colorimeter should be made up afresh about every four hours, to avoid possible changes, although experiment has shown that little, if any, change takes place in eight hours.

#### DETERMINATION OF FREE AND SALINE AMMONIA.

The quantity of the sample taken varies with the amount of impurity present: for sewage and tank effluents, 35 c.c., for filtrates, 70 or 140 c.c., are taken. The 35 c.c. are diluted with 500 c.c. of tap-water\* and a few drops of  $\text{Na}_2\text{CO}_3$  solution added; 200 c.c. are then distilled off into glass jars containing a layer of ammonia-free water, into the end of which the condenser dips. The solution of ammonia thus obtained is made up to 250 c.c., and 50 c.c. taken and Nesslerised.

Example. 35 c.c. of sample taken.

Reading of colorimeter = 45.

$$\frac{100 - 45 \times 5}{100} = \text{mgm. ammonia in the } 50 \text{ c.c. of distillate taken.}$$

$$= \cdot 275.$$

$$\cdot 275 \times 5 = \text{mgm. ammonia in } 250 \text{ c.c. of distillate, i.e., in } 35 \text{ c.c. of sample.}$$

$$= 1\cdot 375.$$

\* Manchester tap-water contains very little ammonia. The water used should in all cases be carefully analysed from time to time and allowance made for any ammonia present.

$$1.375 \times 2 = \text{mgm. ammonia in}$$

$$70 \text{ c.c. sample, i.e.,}$$

$$\text{grains ammonia per}$$

$$\text{gallon of sample.}$$

$$= 2.75.$$

From the above calculation it can be seen that the grains per gallon of ammonia are readily arrived at by the following simple calculations:—

If 35 c.c. of the sample are taken, then

$$\frac{100 - \text{reading of colorimeter}}{20} = \text{grains per gallon}$$

$$\text{ammonia.}$$

If 70 c.c. of the sample are taken, then

$$\frac{100 - \text{reading of colorimeter}}{40} = \text{grains per gallon}$$

$$\text{ammonia.}$$

#### DETERMINATION OF ALBUMINOID AMMONIA.

This is determined by adding 50 c.c. of alkaline permanganate to the liquid from which the free ammonia has been expelled, together with 100 c.c. of tap-water, and distilling off 150 c.c. in portions of 100 c.c. and 50 c.c., and collecting in "Nessler glasses" of these dimensions.

The amount of ammonia present in each Nessler glass is determined by Nesslerisation.

If the amount of ammonia contained in the last 50 c.c. of distillate is large, it may be necessary to distil a third lot of 50 c.c.; or a small correction, determined by experience, can be made equivalent to the amount still left in the sample.

If the amount of ammonia in the second or

third distillates is too small to be conveniently determined by the colorimeter, a subsidiary standard may be made as follows: A 50 c.c. Nessler glass is graduated by pasting a paper strip on the outside. This should extend above the 50 c.c. mark to the level reached when the volume of liquid is increased by 2 c.c. The total height corresponding to 52 c.c. may then be divided into five equal parts; 5 c.c. of the centinormal ammonium chloride solution—*i.e.*, .05 mgm.  $\text{NH}_3$ —are added to the glass, made up to 50 c.c. with ammonia-free water and 2 c.c. of Nessler solution added.

The 50 c.c. of distillate to be tested are mixed with 2 c.c. of Nessler solution, and the tint produced compared with the standard just described, by placing the two Nessler glasses (which should be of the same dimensions) side by side, and looking down through the solutions at a piece of white paper. If the tint in the sample is paler than the standard solution, the latter may be poured into a third Nessler glass until the depth of tint in the two cylinders is equal. The number of divisions or parts of a division at which the liquid now stands on the scale is then read. Quantities of ammonia greater than .05 mgm. can easily be read on the "Stokes" instrument.

Example:—

The total quantity of albuminoid ammonia is calculated as follows:—

.35 c.c. of sewage taken.

First distillate 100 c.c. gives reading on the "Stokes" instrument 40.

$$\text{Then ammonia in first distillate} = \frac{100 - 40 \times .5}{100} \\ = .30 \text{ mgm.}$$

Ammonia in second distillate gives reading on the "Stokes" instrument 88.

$$\text{Then ammonia in second distillate} = \frac{100 - 88 \times .5}{100} \\ = .06.$$

Ammonia in third distillate = 3 divisions on subsidiary scale = .03 mgm.

The total ammonia determined in 35 c.c. of the sample will therefore be—

$$.30 + .06 + .03 = .39.$$

To this should be added .015, the amount which experience shows will, as a rule, be contained in the next 50 c.c. if distillation is continued, the amount of ammonia in the last distillates generally decreasing by 50 per cent. in each 50 c.c. A further small correction must be made for the amount of albuminoid ammonia given off when 500 c.c. of Manchester tap water is distilled with alkaline permanganate; this is taken at .025 mgm.

The total amount of ammonia present in the 35 c.c. of sewage will therefore be—

$$.39 + .015 - .025 = .38.$$

In 70 c.c. the quantity will be doubled, *i.e.*, the number of grains per gallon of ammonia in the sewage will be .76.

This calculation, though tedious to describe, is quickly made.



Continual practice renders it possible to judge of quantities of ammonia, in the last distillates, less in amount than '05 mgm. In this case the making of a subsidiary standard may be dispensed with.

The use of the "Stokes" colorimeter, and the adoption of estimated values (based on experience) for the later distillates, renders the methods used in the Manchester Sewage Works laboratory rather more rapid than those described by Mr. Scudder, and where a large number of samples

	Free and Saline Ammonia.		Albuminoid Ammonia.	
	M. & I. J. C.	M. C.	M. & I. J. C.	M. C.
1899	1'76	1'77	'311	'284
1900	1'87	1'97	'339	'297

derived from the same sewage have to be compared, the results are entirely satisfactory for the purpose.

Mr. Scudder's methods, on the other hand, serve to more sharply distinguish one class of sample from another, as he finds that raw sewage or imperfectly purified effluent will continue to give off ammonia almost indefinitely when distilled with alkaline permanganate, while with a good effluent there is a well-defined end point.

The free ammonia determinations give almost identical results in the two laboratories; the albuminoid ammonia figures tend to be slightly lower

in the Manchester Corporation laboratory. On the previous page are the averages of the numbers obtained in the analysis of duplicate samples in the years 1899 and 1900. In the following table are given some examples of the ammonia numbers in certain typical sewages and effluents.

Description of Sample.	Grains per Gallon.		Parts per 100,000.	
	Free and Saline Ammonia.	Albumi-noid Ammonia.	Free and Saline Ammonia.	Albumi-noid Ammonia.
Manchester sewage (average settled sample) ... ..	2'04	'31	2'91	'44
Manchester sewage (average shaken sample) ... ..	2'08	'50	2'97	'70
Sewage (Lawrence, Mass.) ... ..	3'46	'68	4'99	'98
Sewage (Accrington) ... ..	3'57	'315	5'11	'45
Open septic tank, Manchester	2'03	'36	2'90	'51
Effluent from experimental bed, first contact ... ..	'65	'146	'93	'21
Effluent from experimental bed, second contact... ..	'225	'06	'32	'09

The following examples show the difference in the relation between the ammonias in the septic tank effluent and the filtered effluent before and after nitrification has become active in the bacteria bed.

Description of Sample.	Grains per Gallon.		Parts per 100,000.	
	Free and Saline Ammonia	Albumi-noid Ammonia.	Free and Saline Ammonia.	Albumi-noid Ammonia.
Septic tank effluent ... ..	2'00	'31	2'86	'44
Bacteria bed effluent (nitrification active) ... ..	1'10	'12	1'57	'17
Septic tank effluent ... ..	1'55	'27	2'21	'39
Bacteria bed effluent (nitrification slight) ... ..	1'75	'16	2'50	'23

## DETERMINATION OF ORGANIC AMMONIA.

This is best determined by the method of Kjeldahl, which depends on the fact that when nitrogenous organic matter is heated with concentrated sulphuric acid it is broken up, the whole of the nitrogen being converted into ammonium sulphate. On making alkaline, the ammonia can be distilled over and Nesslerised.

For the purpose of the estimation 30 c.c. of the sample may be conveniently taken. This, after a small addition of sodium carbonate, is distilled with steam till the distillate shows no indication of free ammonia.

The distillation with steam is carried on in the apparatus shown in Fig. 5.

The steam is generated in 32-oz. flasks, and passed into the 8-oz. flask containing the sample. This flask should be further heated by a Bunsen burner to prevent the steam from condensing in it. The steam and the distillate from the sample are condensed in the small tube condenser, of a similar type to that described on p. 49, but containing only two tubes.

The tank is eight inches square and twelve inches high, the stand ten inches high. The glass tubes used are similar to those in the larger condenser.

During the progress of the distillation the sample is concentrated to about 5 c.c. This is transferred to an 8-oz. Jena flask with a long neck (a special form of flask is made for this determination),

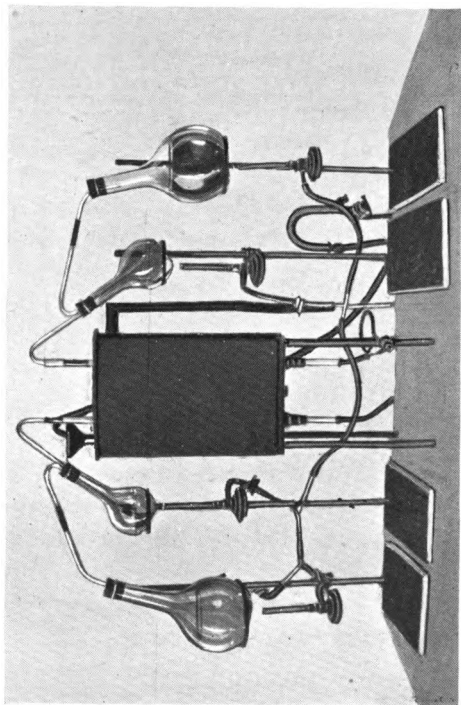

FIG. 5.—APPARATUS FOR DISTILLING WITH STEAM.



LIBRARY  
OF THE  
UNIVERSITY  
OF  
CALIFORNIA

and 20 c.c. pure sulphuric acid (free from nitrogen, either as nitric acid or ammonia) added.

The mixture is heated carefully over the bare Bunsen flame (under a hood with a good draught) for about half-an-hour; a little phosphoric anhydride ( $P_2O_5$ ) is then added and the mixture further heated till quite clear. After allowing to cool somewhat the mixture is poured into about 200 c.c. of water, and after complete cooling made up exactly to 250 c.c.; 50 c.c. of this solution are then taken and made alkaline with a saturated solution of caustic soda; 500 c.c. of tap-water are added, and the ammonia distilled off and Nesslerised in lots of 100 c.c.

In order to allow for any ammonia unavoidably present in the reagents or apparatus, a control experiment should be made, taking 35 c.c. of distilled water and repeating the above process from the beginning. The amount of ammonia found by the control experiment should be only a small fraction of that present in the sample.

The relation between the organic ammonia, determined as above, and the "albuminoid" ammonia, has been found to vary within fairly wide limits with different samples.

The Kjeldahl determination in all cases gives higher values than are obtained by distillation with alkaline permanganate.

Further investigation is needed in order to determine the cause and extent of this variation under different conditions.

60 SEWAGE WORKS ANALYSES.

The following examples will, however, serve to give some idea of the differences likely to be met with.

The numbers given for the Kjeldahl determination include, in all cases, the "albuminoid" ammonia.

Description of Sample.	Organic Ammonia.		Albuminoid Ammonia.	
	Grains per Gallon.	Parts per 100,000.	Grains per Gallon.	Parts per 100,000.
Sewage ... ..	1'50	2'11	'86	1'23
Sewage ... ..	1'38	1'97	'51	'73
Open septic tank effluent ...	1'62	2'31	'36	'51
Open septic tank effluent (filtered through paper) ...	1'24	1'77	'23	'33
Open septic tank effluent ...	1'32	1'88	'41	'59
Open septic tank effluent (filtered through paper) ...	'85	1'21	'32	46

## CHAPTER IV.

THE DETERMINATION OF NITRITES  
AND NITRATES.

THE final product of the oxidation of the nitrogen of sewage is nitric acid. The process of conversion of ammoniacal nitrogen into nitric acid is known as *nitrification*, and is brought about by specific micro-organisms.

The greater part of the sodium nitrate (*Chili saltpetre, nitrate of soda*) and potassium nitrate (*saltpetre, nitre*) of commerce has probably been formed by such nitrification processes in recent or geologic times.

The process of nitrification proceeds, however, in stages, the ammonia being first oxidised by one set of organisms to nitrous acid, and the nitrous acid, in its turn, to nitric acid, thus:—

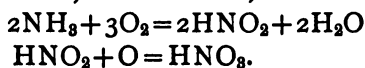

For nitrification to proceed it is necessary that some base—*e.g.*, either ammonia or lime—should be present to combine with the nitrous or nitric acid as formed.

Another group of organisms have the power, in presence of oxidisable matter, of reducing



nitrates to nitrites, and these again can be reduced to nitrogen, or even ammonia, by still other forms.

Such a process is known as *denitrification*.

A purely chemical denitrification process may take place by the interaction of the nitrous acid, produced as above, with urea, thus:—

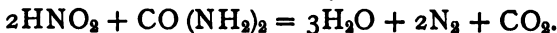

All these processes probably go on simultaneously in a bacterial filter or contact bed, the predominance of nitrification over denitrification depending, among other things, on the efficiency of aeration. In the absence of sufficient oxygen, denitrifying changes predominate.

The determination of nitrites and nitrates is therefore of the greatest importance in controlling the working of a bacterial filter.

The method of recording the results obtained has been described on p. 17.

#### THE DETERMINATION OF NITRITES.

As nitrites are rapidly developed on allowing a sample of sewage or effluent to stand in contact with air, either by oxidation of ammonia or reduction of nitrates already present, it is important that this determination should be made as soon as possible after the collection of the sample. If the lapse of some time is unavoidable before the sample can be analysed, the bottle should be kept carefully closed, and the analysis made as soon as possible after opening, and at the same time

as the nitrate determination is made. It may happen, if the nitrite is determined some time after the nitrate, that the ratio of the nitrite to the nitrate may be quite different from what it was when the sample was taken, owing to the rapid development of nitrite on standing.

The determination of nitrites depends on the formation of a pink azo dye by the action of nitrous acid on a mixture of naphthylamine and sulphanilic acid (known as Griess-Ilosvay reagent). The depth of tint varies with the quantity of nitrous acid present. The reaction is as follows:—

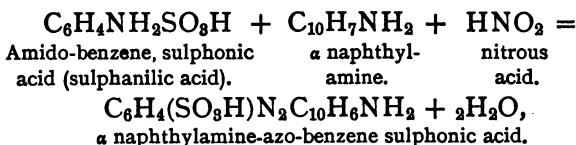

For the determination of nitrites the following solutions are necessary:—

*Standard Solution of Potassium Nitrite.*—This is made by dissolving rather more than 1 grm. of potassium nitrite in 200 cc. of water, and titrating 10 c.c. with standard permanganate and sulphuric acid.

The nitrite solution should be diluted with a considerable volume of boiled distilled water, say 100 c.c. water to 10 c.c. nitrite solution. The solution is first acidified, and the permanganate then run in till a permanent pink colour is obtained.

The permanganate and sulphuric acid used for determining oxygen absorption may be utilised.

10 c.c.  $\text{KMnO}_4 = 5.31$  mgm.  $\text{KNO}_2 = 1.06$  mgm.  
 $\text{NH}_3 = .869$  N.

The strength of the nitrite solution thus obtained is adjusted so that 1 c.c. contains nitrogen equivalent to 1 mgm.  $\text{NH}_3$  or 1 mgm. N, according as the results are to be expressed as ammonia or nitrogen.

This solution can be diluted as required. For working purposes a solution containing nitrogen equivalent to .01 mgm.  $\text{NH}_3$  per c.c. will be found convenient.

It is not advisable to keep a dilute solution for any length of time, as it rapidly oxidises; and even the stronger solution should be checked against permanganate at frequent intervals.

The solution is best retained in a number of small bottles, which should be kept completely filled and in a dark place until the solution is required for use.

*Griess-Ilosvay Solution.*—This is prepared by mixing equal parts of two solutions:—

(a) 1 gm. of sulphanilic acid ( $\text{C}_6\text{H}_4\text{NH}_2\text{SO}_3\text{H}$ ) is dissolved in 14.7 grms. of glacial acetic acid and 285 c.c. water. This is best done by warming the sulphanilic acid with the glacial acetic, to which an equal bulk of water has been added. The remaining water should be added carefully, the mixture being warmed and stirred to keep the sulphanilic acid in solution.

(b) 0.2 gm.  $\alpha$  naphthylamine ( $\text{C}_{10}\text{H}_7\text{NH}_2$ ) is dissolved in 14.7 gm. glacial acetic acid and 325 c.c. water. As in the case of the sulphanilic

acid, the naphthylamine is best dissolved by warming first with the acid, to which about twice its volume of water has been added, (in order to prevent formation of an anilide by combination of the acid and the naphthylamine,) and afterwards adding the remainder of the water.

The greater proportion of these solutions should be kept separately, not more than two or three days' supply of the mixture (*i.e.*, the Griess-Ilosvay solution) being made up at once, as it tends to turn pink, owing to development of nitrite in the solution from ammonia in the air. The amount of nitrite is determined quantitatively as follows:—

Five c.c. of the standard solution of  $\text{KNO}_2$  (1 c.c. = .01 mgm.  $\text{NH}_3$ ) are made up to 50 c.c. in a small Nessler glass with distilled water, and 2 c.c. of the Griess-Ilosvay solution added; 35 c.c. of the sample are taken, and 2 c.c. of the Griess-Ilosvay solution added.

The sample is then transferred to a 50 c.c. Nessler glass of equal dimensions with the one containing the standard solution, and made up to 52 c.c. with distilled water.

Both standard and sample are allowed to stand for fifteen minutes before comparing the pink coloration in each. The depth of tint is then compared by pouring out either the standard solution or the sample, whichever has the deeper tint, until the columns left in the Nessler glasses appear of equal tint on looking down the glass at a piece of white paper. If a paper scale is gummed

on to the Nessler glasses, as in the determination of small quantities of ammonia (see p. 54), the ratio between the sample and the standard is easily determined.

Thus, if the scale is divided into five parts, each part =  $\cdot 01$   $\text{NH}_3$ . If the columns are equal in tint when the standard stands at 2, this indicates that  $\cdot 02$  nitrite (expressed in terms of  $\text{NH}_3$ ) is present in 35 c.c. of the sample, *i.e.*,  $\cdot 04$  mgm. in 70 c.c. or  $\cdot 04$  grains  $\text{NH}_3$  per gallon, or  $\cdot 03$  grains N per gallon if the nitrite solution has been adjusted to give results in terms of nitrogen.

With constant practice it is easy to estimate at sight with sufficient accuracy the quantities of nitrite corresponding to the depth of tint.

In the laboratory of the Mersey and Irwell Joint Committee nitrites are determined by the depth of yellowish-brown colour produced by the addition of meta-phenylene-diamine ( $\text{C}_6\text{H}_4(\text{NH}_2)_2$ ). The results are expressed in grains of nitrous nitrogen per gallon.

The following are Mr. Scudder's notes on the method:—

“ ESTIMATION OF NITRITES.

“ Standard solutions:—

“ 1. *Meta-phenylene-diamine*.—Eight grms. of the hydrochloride of this base are dissolved in a litre of distilled water, and, if necessary, decolourised by animal charcoal, and made acid with hydrochloric acid.

“ 2. *Dilute Sulphuric Acid*.—One part sulphuric acid to three of distilled water. The solution is

rendered faintly pink by the addition of standard permanganate of potash solution.

“3. *Sodium Nitrite*.—Dissolve 1·10 grms. of silver nitrite in boiling distilled water, and add a pure solution of sodium chloride until no further precipitation of silver chloride occurs. Cool and make up to a litre. Allow to stand twenty-four hours, and then dilute 100 c.c. of the clear liquid to a litre and fill into 6 or 8 oz. stoppered bottles, and keep them in the dark.

“1 c.c. sodium nitrite = 0·01 mgm. nitrogen.

“*Procedure for Testing*.—The test is made with the original sewage effluent if clear enough, but in turbid effluents the colour must be removed by shaking the effluent with a little alumina ferric cake and allowing it to settle. 10 c.c., 25 c.c., and 50 c.c. of the clear effluent are measured into Nessler glasses and made up to the 50 c.c. mark with distilled water. The standards are made up from the sodium nitrite solution, using exactly the same standards as in ammonia estimations. All are made up to the 50 c.c. mark, and to each is added 1 c.c. dilute sulphuric acid, and 1 c.c. meta-phenylene-diamine. They are allowed to stand at least twenty minutes, and the colours are then compared as in Nesslerising.

“Example :—

50 c.c. sewage effluent = 5 c.c. standard sodium nitrite.

= 0·05 mgm. nitrogen.

= 0·07 grain nitrogen per gallon.”

## THE DETERMINATION OF NITRATES.

When a solution containing nitrate or nitrite is subjected to the action of a reducing agent, such as nascent hydrogen, it is converted in various stages, involving the formation of nitrous acid and hydroxylamine, finally into ammonia, thus:—

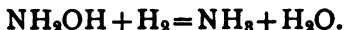
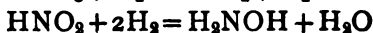

The nitrogen present as nitrate can thus be determined by reducing to ammonia and estimating the ammonia by Nesslerisation. This method has been found in practice to be simple, at the same time giving very accurate results.

It is obvious, however, that any nitrite present will also be reduced; the nitrogen combined as nitrite must therefore be separately estimated and deducted from the nitrogen as nitrate.

The most satisfactory method of reducing nitrates has been found to be by means of the *copper zinc couple*.

This is prepared as follows:—

A piece of zinc foil about six inches long by two inches wide is rolled into a cylinder about half an inch in diameter, then dipped for a moment into strong hydrochloric acid, to clean the surface of the metal, and afterwards well washed in water. The clean cylinder is now transferred for a few moments to a three per cent. solution of copper sulphate until evenly coated with a black layer

of copper. It is then again washed by gently immersing in clean water so as not to dislodge the film of copper.

Before bringing the solution into contact with the couple, it is advisable to drive off any free ammonia, as otherwise the total amount of ammonia to be determined by Nesslerisation is inconveniently large, and the free ammonia must be deducted from the total ammonia present after reduction.

Any error in the determination of free ammonia will therefore affect the nitrate determination.

The free ammonia is most conveniently driven off with steam in the apparatus described on p. 58, in connection with the method for determining organic ammonia. In this way the addition of large quantities of water, which may contain nitrates and cause the experimental correction to be too high, is avoided. As the ammonia is dissolved in the condensed distillate, there is also no risk of its escape into the laboratory to interfere with the Nessler test.

Seventy c.c. of the sample are taken and distilled with steam till no free ammonia can be detected in the distillate on Nesslerisation.

The residual solution from which the free ammonia has been expelled is now poured into a glass cylinder six inches high by one inch in diameter and the zinc copper couple, prepared as above, added. Thorough contact of the couple and the solution is thus ensured.



On slightly acidifying the solution with acetic acid (1 acid: 2 water), an evolution of hydrogen occurs which reduces the nitrate to ammonia. For the reaction to be complete it should be left over night, and for further precaution a known amount of the solution may be tested for nitrites in the morning. If these are present, it is evident that the reduction to ammonia is incomplete and must be further continued. This is, however, seldom, if ever, necessary.

If reduction is complete, the solution is poured off from the copper zinc couple into a litre capacity flask, the couple is washed free from adhering liquid and the washings are added to the flask.

Any free acid still remaining must be neutralised with a little powdered sodium carbonate; tap-water is then added to make up the volume to about 500 c.c., and the ammonia distilled off and estimated as on p. 52.

From time to time a blank experiment should be made, the whole process being conducted as above, with the exception that distilled water is substituted for the sample.

Any ammonia found in the blank experiment must be deducted from the total amount obtained from the sample.

The following is Mr. Scudder's description of the method used in the Mersey and Irwell Joint Committee's laboratory. It is useful where results are required to be obtained in one day;

the method above described, however, requires no greater amount of actual manipulation, and has been found to work in well with the daily routine. The results given are also exceedingly trustworthy.

The caustic soda used for neutralisation, as in the method described by Mr. Scudder (*seq.*) may if added in excess in certain cases liberate a little ammonia from albuminoids and cause the nitrate determination to be somewhat high.

#### “ ESTIMATION OF NITRIC NITROGEN.

“ Seventy c.c. of the sewage effluent are placed in a nickel basin, 0.5 c.c. normal carbonate of soda solution added, and evaporated to dryness on a water bath to remove free and saline ammonia. The residue is dissolved in distilled water and transferred to a 6 by 1½ inch preparation tube with mark scratched at 50 c.c.

“ The liquid is made up to the mark with distilled water; 5 c.c. of 25 per cent. pure hydrochloric acid (distilled from  $H_2SO_4$  to render  $NH_3$  free) is added. Next add a piece of thin aluminium sheet, weighing from 0.5 to 0.7 grm., and measuring about two inches by one inch, which has been amalgamated either by dipping it into mercuric chloride solution or, preferably, by standing twenty minutes in Nessler residues and then washing with distilled water. A vigorous action at once commences, the nascent hydrogen reducing the nitric nitrogen to ammonia, and to prevent escape of vapour

Description of Sample.	Ammonia from Nitrites.		Ammonia from Nitrates.		Nitrous Nitrogen.		Nitric Nitrogen.	
	Grains per Gallon.	Parts per 100,000.	Grains per Gallon.	Parts per 100,000.	Grains per Gallon.	Parts per 100,000.	Grains per Gallon.	Parts per 100,000.
Effluent from bacteria bed (nitrification active) ... ..	Trace	Trace	'63	'90	Trace	Trace	'52	'74
Effluent from similar bacteria bed (nitrification not yet set in) ... ..	Nil.	Nil.	'01	'01	Nil.	Nil.	'01	'01
Effluent from bacteria bed shortly before period of rest ... ..	'06	'09	'22	'31	'05	'07	'18	'26
Effluent from bacteria bed shortly after period of rest ... ..	'02	'03	'63	'90	'02	'03	'52	'74
Effluent from second contact bacteria bed showing active nitrification ... ..	'01	'01	1'22	1'74	'01	'01	1'00	1'43

NOTE.—The numbers are not calculated beyond the nearest second place of decimals.

a cork, fitted with S-shaped protection tube, filled with glass wool moistened with water, is inserted. No ammonia can escape, as it is held by the acid solution. In this manner one grain nitrogen as nitrites and nitrates per gallon can easily be reduced to ammonia in one hour. After reduction the acid solution is just neutralised with caustic soda liquid (which has been boiled free from ammonia) in a flask and distilled. The ammonia in the distillate is then determined by Nessler solution, exactly in the same manner as a free ammonia estimation. From the amount of ammonia found, the quantity of nitric nitrogen is calculated in the usual way, viz., by multiplying the amount found per gallon of effluent by 0.82."

The examples, on the opposite page, determined in working the bacterial contact beds in Manchester, will illustrate the application of the results obtained by the foregoing methods, and also the different systems of recording the analytical figures (see p. 17).

The quantity of sewage or tank effluent which can be safely put upon a continuous filter can be controlled by similar observations.

It may be here noted that the activity of the nitrification process should properly be estimated by the amount of nitrogen in the liquid passing on to the filter, which is recovered as nitrate in the filtered effluent. Such a comparison can only be made from continuous observations extending over a prolonged period. Isolated analyses

## 74 SEWAGE WORKS ANALYSES.

do not sufficiently allow for the effect of periods of rest.

The following numbers are the average results obtained from the experimental contact beds in Manchester during a period of three months.

Description of Sample.	Grains per Gallon.		
	Free Ammonia.	Albuminoid Ammonia.	Ammonia from Nitrates.
Open septic tank effluent ...	1·94	·34	Nil.
Bacteria bed effluent (first contact) ... ..	·77	·10	·75
Bacteria bed effluent (second contact) ... ..	·26	·04	·98

From the above figures it will be seen that of the total ammonia found in the tank effluent—*i.e.*, 2·28 grains per gallon—·75 grains, or about 33 per cent., has been converted into nitrate in the first contact bed; and this is increased to ·98 grain, or about 43 per cent., in the second contact bed.\*

A considerable percentage of ammonia is unaccounted for in the above figures, and doubtless has escaped as nitrogen in consequence of denitrification changes, such as are described on p. 62.

\* The second contact bed in this instance was worked at twice the rate of the primary bed.

## CHAPTER V.

## THE DETERMINATION OF DISSOLVED OXYGEN.

THE determination of dissolved oxygen in an effluent, or in the stream into which it flows, is of importance as showing the reserve of this element available for further purification.

It is also of importance to determine the rate at which an effluent will take up oxygen from fully aerated water. This indicates clearly the effect which such an effluent will have upon a stream.

A very satisfactory method for the determination of dissolved oxygen is that of Dr. Thresh.\*

This depends on the liberation of nitric oxide (NO) in the solution to be tested, which combines with the dissolved oxygen to form nitrogen trioxide ( $N_2O_3$ ). The NO is liberated by the interaction of sodium nitrite, potassium iodide, and sulphuric acid. The  $N_2O_3$  formed liberates free iodine from the potassium iodide present, equivalent to the oxygen in solution. This iodine can be determined by addition of sodium thio-sulphate solution.

\* "Journ. Chem. Soc.," 1890, p. 185.

The various reactions are expressed by the following equations:—

The potassium iodide, sodium nitrite, and sulphuric acid react to form free I and N O.

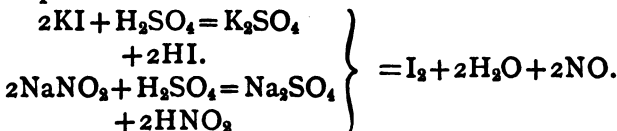

The nitric oxide liberated combines with the oxygen in the water to form  $\text{N}_2\text{O}_3$  thus:—

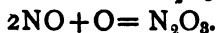

In contact with the hydriodic acid a further quantity of iodine is liberated equivalent to the oxygen present, thus:—



The total iodine liberated reacts with the sodium thiosulphate added, thus (sodium tetrathionate and sodium iodide being formed):—



If the iodine liberated in the initial reaction is separately determined, the remainder of the iodine is equivalent to the oxygen present.

The following solutions are necessary for carrying out the determination:—

(1.) 5 grm. *sodium nitrite* and 20 grm. *potassium iodide* are dissolved in 100 c.c. of water.

(2.) *Sulphuric Acid*.—This is made up in the proportion of 1 acid to 3 water, with the precautions given on p. 24.

(3.) *Starch Solution*.—Made up as on p. 24.

(4.) *Standard Sodium Thiosulphate Solution*.—This



LIBRARY  
OF THE  
**UNIVERSITY**  
OF  
CALIFORNIA



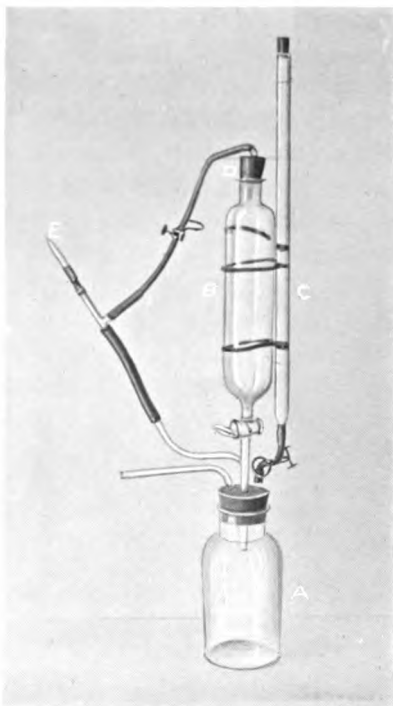

FIG. 6.—THRESH APPARATUS FOR DETERMINING DISSOLVED OXYGEN.

*[To face page 77.]*

should be made of such a strength that 1 c.c. = .25 mgm. oxygen. For this purpose rather more than 7.75 grm. are dissolved in 1 litre of water, and the solution is then titrated against an amount of iodine liberated from acidified potassium iodide by 25 c.c. of the standard permanganate used for determining oxygen absorption (see p. 23). The 25 c.c. of permanganate should be equivalent to 10 c.c. of the thiosulphate. If the solution of the latter is too strong—*i.e.*, if say 9 c.c. are equivalent to 25 c.c. of the permanganate—then water must be added in the proportion of 1 c.c. to every 9; *i.e.*,  $\frac{1000-9}{9} = 110$  c.c. of water is to be added to the 991 c.c. remaining after titration.

The apparatus used is shown in Fig. 6. A is a bottle capable of holding about 500 c.c. This bottle is closed by an indiarubber stopper with four holes. Through one is inserted a tap cylinder B holding 300 c.c.; through another passes a piece of glass tubing to which is attached the end of the burette C by a piece of indiarubber tubing which is closed by a pinch-cock. The remaining two serve for the inlet and outlet of a supply of coal-gas, which can be passed into B as required through a well fitting indiarubber stopper D, any excess being burnt at E.

Before describing the analytical process, it is important to draw attention to the method of taking samples for determination of dissolved oxygen.

Such samples should always be drawn from a

still pool of the liquid, with every precaution to avoid splashing or exposure of a large surface to the air.

This is best accomplished by syphoning the liquid into the bottle. For this purpose the sample bottle is provided with a double-bored stopper, through one hole of which the syphon tube passes to the bottom of the bottle, through the other a tube for sucking out the air. By immersing the bottle and the end of the syphon under the liquid and drawing out the air, the liquid rushes in and fills the bottle with the minimum absorption of oxygen. By connecting a second bottle with the first, and filling both bottles with the water as before, the water in the first bottle can be collected without coming into contact with air at all.\*

Having thus obtained the required sample, the oxygen dissolved in the liquid is determined as follows:—

The sample is carefully poured, or better, syphoned, into the cylinder B until this is filled to the neck of the stopper; 1 c.c. of the nitrite-iodide solution is added, together with 1 c.c. of sulphuric acid.

The solutions, being heavy, flow to the bottom of the cylinder; the stopper D is now inserted, and the whole apparatus inclined once or twice in order to mix the reagents in B. The reaction above described then takes place, fifteen minutes

\* Letts' "Sanitary Record," 1901, p. 423.

being allowed for complete diffusion. During this time the air in A is displaced by coal-gas, which (after allowing time for the air to be driven out of A) can be burnt at E.

The solution in B, when reaction is complete, is allowed to flow into A by opening the tap of B; the liberated iodine is then titrated against sodium thiosulphate run in from C, 2 c.c. of starch being added through the tap of B for exactly determining the end reaction.

The total iodine thus determined is derived from three sources:—

- (a) The oxygen dissolved in the sample used.
- (b) The oxygen dissolved in the reagents.
- (c) The nitrous acid from the nitrites.
- (d) The nitrous acid which may be present as nitrite in the sample.

The iodine due to (b) and (c) is determined by adding through the tap of B, 2 c.c. of the nitrite iodide solution, 2 c.c. acid, and 4 c.c. starch, and distilled water equal to twice the volume of thio-sulphate used in the analysis, and titrating as in the actual experiment. Half the oxygen value thus obtained represents the amount due to (b) and (c).

If a series of determinations have to be made, the oxygen dissolved in the thiosulphate solution should be separately estimated. For this purpose, a known amount, say 20 c.c. of distilled water, may be taken, and the dissolved oxygen contained in it determined;  $\frac{1}{20}$ th of the amount found may then be assumed to represent the dissolved oxygen



in 1 c.c. of the thiosulphate. A correction can then easily be made in each experiment according to the amount of thiosulphate used.

To obtain the correction due to (*d*), the amount of nitrite expressed in terms of ammonia present in the sample may be determined by the methods given on pp. 62 and 67. The oxygen equivalent required will be  $\frac{1}{17}$ ths of this ammonia value.

The oxygen dissolved in the sample may be calculated as follows:—

- a* = weight of oxygen in milligrammes per litre.  
*b* = c.c. thiosulphate equivalent to oxygen dissolved in the reagents.  
*c* = c.c. thiosulphate equivalent to nitrous acid from nitrite added.  
*d* = c.c. thiosulphate equivalent to nitrous acid from nitrite in sample.  
*e* = total number of c.c. of thiosulphate used.  
*f* = capacity of B.

$$\text{Then } a = \frac{1000}{f} (e - b - c - d) \times \cdot 25$$

(1 c.c. thio. =  $\cdot 25$  mgm. O).

If the volume of B is exactly 250 c.c., then

$$a = (e - b - c - d).$$

By multiplying the results thus obtained by  $\cdot 07$  the quantity of oxygen present in grains per gallon is ascertained.

In order to obtain the number of c.c. of oxygen per litre, the number of milligrammes per litre should be divided by the weight of 1 c.c. of oxygen, viz., 1.4336 mgm.

The thiosulphate solution should be kept in the dark to avoid changes in composition due to the action of light, and should be restandardised from time to time.

The method employed by Mr. Scudder for determining dissolved oxygen is that of Roscoe and Lunt.\* The method is briefly as follows:—

A solution of indigo is exactly decolourised by a standard solution of sodium hyposulphite. The indigo is re-oxidised by addition of the sample containing dissolved oxygen, and the amount of oxidised indigo and consequently of dissolved oxygen, determined by titration with the standard hyposulphite.

The process as originally described requires considerable time and trouble in setting up the apparatus in the first instance, although the actual method of analysis is simple. A portable modification of the apparatus has, however, been devised by Mr. Scudder suitable for making analyses of river water, etc., on the spot. Other improvements in this method have been described by Dr. Gerland.†

Another method for rapidly making determinations with a fair degree of accuracy has been recently described by Prof. Ramsay.‡ This

\* "Journ. Chem. Soc.," vol. lv., 1889, p. 552. See also Sutton, "Volumetric Analysis," pp. 297—304.

† "Journal Society of Chemical Industry," vol. xv., 1896, p. 15.

‡ "Journal Society of Chemical Industry," vol. xx., 1901, p. 1071.

depends on the measurement of the blue tint produced when the sample containing dissolved oxygen is added to a solution of ammoniacal cuprous chloride.

To determine the *rate of absorption* of dissolved oxygen by a sample of sewage or effluent, a number of bottles should be completely filled with equal volumes of the sample and of tap-water which has been well shaken with air. These may be left with the stoppers inserted for any desired time, and at intervals the dissolved oxygen in the mixture determined.

A curve may then be plotted of the amount of oxygen left in the mixture after different periods of standing.

Very valuable information can thus be obtained as to the readiness with which an effluent will rob a stream of dissolved oxygen, or, in other words, of the amount of oxygen in solution which must be presented to the sample in order to prevent putrefaction (see Table, p. 83).

If similar experiments be conducted in open shallow vessels, the rate of disappearance of dissolved oxygen will be much slower, or complete absorption of the oxygen may not take place at all. As, however, it often happens that only the upper stratum of the stream comes much in contact with the air, *e.g.*, in a canal or sluggish river, a good effluent should be required in most cases to withstand the test in a closed bottle.

The method employed by Mr. Scudder for

such a determination is described by him as follows:—

“*Dissolved Oxygen Test.*—100 c.c. of the sewage effluent are added to 900 c.c. fresh water (tap-water is used in my laboratory) in a half Winchester quart bottle, and shaken up to mix, then

Description of Sample.	Time standing at Temperature of Laboratory before Analysis.	Dissolved Oxygen. Grains per Gallon.
Mixture of tank effluent from chemical precipitation with equal volume of aerated tap-water.	Nil.	·478
	2 hours	·408
	4 hours	·327
	24 hours	Nil.
Mixture of open septic tank effluent with equal volume of aerated tap-water.	Nil.	·366
	1 hour	·307
	2 hours	·245
	3 hours	·171
	4 hours	·105
	5 hours	·113
	6 hours	·040
Mixture of effluent from second contact bed with equal volume of aerated tap-water.	Nil.	·439
	2 hours	·436
	4 hours	·436
	24 hours	·397
	48 hours	·358

allowed to stand at least half an hour to allow small air bubbles to rise to the surface. The dissolved oxygen in the diluted effluent is determined.

“Two 10-oz. stoppered bottles are filled with the diluted effluent and placed in the incubator at a



temperature of 75° Fahr. After standing twenty-four hours one of the bottles is taken out and the dissolved oxygen in it determined. After forty-eight hours the other bottle is taken out and the dissolved oxygen estimated.

“It was found that owing to the pressure some of the stoppered bottles cracked round the bottom. In order to avoid this, the plan now adopted is to fit to the bottle an indiarubber stopper containing a piece of very narrow glass tubing, bent to S shape, to allow for expansion of the liquid. Equally accurate results are obtained with this modification.”

Another device, with the same object, is to provide the bottle with an indiarubber stopper containing a piece of narrow glass tubing closed at the upper end by a small piece of glass rod joined to the tube by close-fitting indiarubber tubing. A certain amount of expansion is thus permitted by the indiarubber.

The results are expressed in grains of dissolved oxygen absorbed per gallon of sewage effluent.

The following numbers were obtained on incubating mixtures in equal proportions of ship canal water and effluent from a second contact bed, for six days at 80° F. (26° C.). They illustrate the fact that in presence of oxidisable matter the dissolved oxygen tends to disappear sooner than the nitrate. In cases where the ship canal was in a bad condition, the nitrate in the mixture also wholly or for the most part disappears. The results are expressed in grains per gallon.

Ammonia from Nitrites and Nitrates.			Dissolved Oxygen.			Putrescibility.		
Before Incubator.		After Incubator.	Before Incubator.		After Incubator.	After Incubator.		
Effluent from second contact bed.	Ship Canal water.	Mixture.	Effluent from second contact bed.	Ship Canal water.	Mixture.	Effluent from second contact bed.	Ship Canal water.	Mixture.
'36	'19	'48	'54	'60	Nil.	+	+	+
'85	'13	'38	'51	'26	Nil.	+	-	+
'35	'17	'30	'40	'14	Nil.	+	×	+
'80	'02	Nil.	'27	'23	Nil.	+	-	-

Finally, it will be of interest to include some results obtained by incubating various samples with nine volumes of aerated tap-water for two days at 80° Fahr.

Sample.	Dissolved Oxygen. Grains per Gallon.	
	At Once.	After 2 Days in Incubator.
Tank effluent from chemical precipitation ... ..	'699	Nil.
Effluent after septic tank and one contact (½-acre bed) ...	'717	'414
Effluent after septic tank and two contacts ... ..	'711	'610

## CHAPTER VI.

### THE DETERMINATION OF CHLORINE, ACIDITY AND ALKALINITY, AND IRON COMPOUNDS.

#### DETERMINATION OF CHLORINE.

THIS determination is of value as it affords a measure of ascertaining whether the samples taken before and after a purification process really represent the same sewage.

The chlorine is present in domestic sewage chiefly in combination with sodium, as sodium chloride or common salt. In manufacturing sewage it may also occur as ferrous chloride (iron pickle) in the waste liquors from galvanising works, or as salt in spent dye liquor. Occasionally in snowy weather, when salt is used on the streets, the chlorine number in the sewage is abnormally high. But in any case it is unaffected by ordinary sewage purification processes, and if the sample of effluent really represents the same sewage that was purified, then the chlorine number should be nearly, if not quite, identical in the two cases.

The chlorine number also gives a very good idea of the actual dilution of the sewage, as it decreases simply in proportion to the dilution.

The determination of chlorine depends on the fact that silver nitrate precipitates chlorine from chlorides in solution as a white precipitate of silver chloride, thus:—

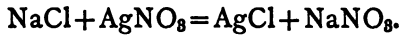

If to the solution containing chlorides a few drops of potassium chromate solution are added, then as soon as all the chlorine has combined with the silver, a deep brown precipitate of silver chromate is formed. The formation of the red silver chromate indicates, therefore, the end of the reaction, and if the volume of the sample is known, and if the volume and strength of the silver solution necessary for a complete precipitation of the chlorine is also known, then the amount of the latter present can be calculated.

The following solutions are required for the determination.

*Standard Silver Nitrate Solution.*—4.795 grms. pure silver nitrate are dissolved in one litre of pure distilled water. No turbidity should be formed when the solution is made.

Each c.c. of this solution is equivalent to one mgm. chlorine.

*Potassium Chromate Solution.*—Twenty grms. recrystallised potassium chromate are dissolved in 200 c.c. water.

To make the determination 35 c.c. or 70 c.c. of the sample are taken, according to dilution, in a white porcelain dish; 2 c.c. of the chromate are added and the silver solution added from a burette

until, after stirring, the red colour of the silver chromate is just apparent. The number of c.c. of silver solution is equal to the number of mgms. of chloride in the quantity of sample taken. If less or more than 70 c.c. of this are used for the determination, the quantity present in 70 c.c. (*i.e.*, the number of grains in a gallon) must be calculated. For example :—

Thirty-five c.c. of the sample required 7·2 c.c. of the standard silver nitrate solution before a permanent red precipitate of silver chromate was produced.

The sample therefore contains  $7\cdot2 \times 2$  mgms. chloride in 70 c.c.—*i.e.*, 14·4 grains chlorine per gallon.

If the liquid to be tested is acid (*e.g.*, from the presence of iron pickle) a drop or two of ammonia should be added to the measured solution which is then boiled till neutral, or pure caustic soda (free from chloride) added very carefully till the solution is exactly neutral. If the sample contains much suspended matter, this should be filtered off, the paper being moistened only with the sample, and the chlorine determined in a known volume of the filtrate. Some slight source of error is to be found in the presence, especially in septic tank effluent, of sulphides in solution, which cause a precipitation of silver sulphide and thus give slightly higher results. Such differences are, however, seldom large enough to seriously affect the results. The slight diminution in the chlorine

figure which is noted after septic tank effluent has been treated in bacterial filters is no doubt partly due to this cause.

In the case of Manchester sewage, sulphocyanates are present in the waste liquor from ammonia recovery processes. These are precipitated by  $\text{AgNO}_3$  in a similar manner to chlorides, but as they are oxidised in bacterial filters there is an apparent loss of chlorine in the filtrate, due really to oxidation and disappearance of the sulphocyanates in the tank effluent.

The following examples will serve to show the relation between the chlorine figures in sewage which has passed through various purification processes, or which has been diluted by rain:—

	Chlorine (Grains per Gallon).
Sewage ... ..	... 11.1
Effluent after chemical treatment	... 11.0
Open septic tank effluent. ...	... 11.4*
Filtrate from first contact bed	... 10.9*
Filtrate from second contact bed	... 10.5*
First flush of storm water ...	... 9.6
Storm water ... ..	... 3.8

#### DETERMINATION OF ACIDITY AND ALKALINITY.

It has been already explained (Chap. III.) that ordinary sewage invariably contains ammonium carbonate arising from the decomposition of urea.

\* These figures show the slight decrease in the chlorine number, due to oxidation of sulphides and sulphocyanates in the Manchester septic tank effluent, by the bacterial filters.

It will also contain in solution free carbonic acid, either from incipient decomposition of carbonaceous matter or from the decomposition of ammonium carbonate, by mineral acids sent into the sewers from manufacturing processes. These will also liberate fatty acids from the soap present in the sewage. The sewage as it enters the works may also sometimes contain free alkali, *e.g.*, chloride of lime; or free mineral acid, *e.g.*, hydrochloric acid from iron pickling waste, or sulphuric acid from benzol washings.

The changes taking place in the septic tank result in the formation of carbonic acid and also of sulphuretted hydrogen, both of which gases dissolve in the effluent and give it a weakly acid reaction when tested with a reagent known as phenol-phthalein.

The determination of the alkalinity or acidity of a sewage from time to time is essential for its proper chemical treatment. It affords besides valuable information as to the character of the liquid entering or leaving the septic tank or being put upon the bacteria beds.

For the determination of acidity and alkalinity the following solutions are necessary:—

*Phenol-phthalein.*—This is an organic compound of the formula  $\text{CO} \begin{array}{c} \diagup \text{C}_6\text{H}_4 \diagdown \\ \diagdown \text{O} \diagup \end{array} (\text{C}_6\text{H}_4\text{OH})_2$ . It is a white solid, formed by heating together phenol and phthalic anhydride. It has the property of forming crimson compounds with alkalis, which are

decomposed by  $\text{CO}_2$ ,  $\text{H}_2\text{S}$ , and organic as well as mineral acids. Its indications are, however, untrustworthy in presence of much ammonia or ammonium salts.

To prepare the solution, 5 grms. of the solid substance are dissolved in 1 litre of 60 per cent. alcohol.

*Methyl-Orange* is an azo dye (para-dimethylaniline-azo-benzene-sulphonic acid  $\text{C}_6\text{H}_4(\text{SO}_3\text{H})\text{N}_2\text{C}_6\text{H}_4\text{N}(\text{CH}_3)_2$ ); it gives a yellow colour with alkalies and alkaline carbonates, which is turned pink in presence of free mineral acid. It is unaffected by carbonic acid and many organic acids.

To prepare the solution 1 grm. of the solid substance is dissolved in 1 litre of distilled water.

Solutions of the above indicators are generally supplied ready made up.

*Standard Sulphuric Acid.*—In order to obtain a normal solution of sulphuric acid, 50 grms. of the pure acid are dissolved carefully in a litre of water. Several grms. of purest sodium carbonate ( $\text{Na}_2\text{CO}_3$ ) are carefully heated (best in a platinum dish) over the blow-pipe flame and allowed to cool in a desiccator.\* One grm. of this dried carbonate is carefully weighed and dissolved in distilled water, and a few drops of methyl orange added. The standard acid is run in from a burette till the solution is just pink. This volume of acid equals 1 grm.  $\text{NaCO}_3$ . It is well to check this deter-

\* A large glass bell-jar, under which a small beaker containing strong sulphuric acid, or calcium chloride, is placed, makes a convenient desiccator.



mination by a second, similarly carried out; or 1 grm.  $\text{Na}_2\text{CO}_3$  may be dissolved in 250 c.c. of water, and 50 c.c. of this solution taken for titration. Three or four titrations may thus be made, and the mean value multiplied by five will give the volume of the acid equivalent to 1 grm.  $\text{Na}_2\text{CO}_3$ . The volume of acid is then calculated which is just equivalent to half the molecular weight expressed in grms. of sodium carbonate, viz., 53 grms., the equation being as follows:—

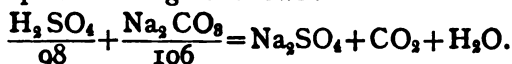

If, as should be the case, this quantity is rather less than a litre (the acid being purposely taken rather strong), then such quantity of distilled water should be added that 1 litre of the acid will contain exactly 49 grms.

Thus, supposing 50 c.c. of the sodium carbonate solution required 3.5 c.c. of the acid solution for neutralisation, then 1 grm.  $\text{Na}_2\text{CO}_3$  will require  $3.5 \times 5 = 16.5$  c.c. of acid; 53 grms. will therefore require  $53 \times 16.5 = 874.5$  c.c., and this quantity of acid will contain 49 grms.  $\text{H}_2\text{SO}_4$ .

The quantity of acid remaining after titration should therefore be diluted in the proportion of 874.5 c.c. to 1000 c.c., or 874.5 c.c. may be taken and diluted exactly to 1 litre with distilled water, and the rest of the acid rejected.

One c.c. of this acid now contains 49 mgms.  $\text{H}_2\text{SO}_4$ . .53 grm.  $\text{Na}_2\text{CO}_3$  should be exactly neutralised by 10 c.c. of the acid.

The standard acid thus obtained may be checked by re-titrating against pure sodium carbonate.

For ordinary use a decinormal solution should be prepared by diluting 100 c.c. of the above acid to 1 litre.

One c.c. of the above acid now contains 4.9 mgms.  $H_2SO_4$ .

*Standard Caustic Soda.*—This may be prepared by dissolving between 20 and 30 grammes metallic sodium in distilled water. The sodium should be cut to a clean surface before weighing, and then cut into small pieces, which are carefully added to the water contained in a shallow earthenware, or better, silver dish. When all the sodium is dissolved the solution is made up to 1 litre, and titrated against the normal acid prepared as above described. After titration the soda solution must

be so diluted that 1 c.c. = 1 c.c.  $\frac{N}{10} H_2SO_4$ .

Thus, supposing 10 c.c. of the acid required 7 c.c. of the caustic soda solution for neutralisation, then for every 7 c.c. of caustic soda solution left after titration 3 c.c. of distilled water must be added.

Distinction must be drawn between what may be conveniently termed *free* and *combined alkalinity*.

*Free alkali* is indicated by giving a crimson coloration with phenol-phthalein. It can therefore be determined by adding a few drops of phenol-phthalein and then standard acid from a burette, to the sample, till the crimson colour

disappears. Free alkali is seldom present in sewage, except occasionally as chloride of lime; but if lime has been used for chemical treatment, some free lime should be present in the effluent.

The results given when phenol-phthalein is used as an indicator must only be considered as approximate, as its action is influenced by the presence of ammonium salts and by variations in the conditions of working. Moreover the presence of iron compounds in the sewage further interferes with its accurate use as an indicator. By working always in the same manner, however, comparative results may be obtained which will show any marked changes in the acidity or free alkalinity of the sewage.

It is important, particularly in controlling the addition of lime to the sewage, to always use the same strength and the same amount of phenol-phthalein.

By *combined alkalinity* is meant alkaline carbonates, *e.g.*, ammonium carbonate.

To determine combined alkalinity a few drops of methyl orange are added to a measured volume of the sample and standard acid added until the carbonate is decomposed, *i.e.*, until the methyl orange is turned pink.

*Free carbonic acid* is determined by adding phenol-phthalein and then standard alkali till a crimson colour is obtained.

*Free mineral acid*, on the other hand, will give a pink colour with methyl-orange, and standard

alkali must be added till this is changed to yellow.

70 c.c. are usually taken for the estimation, and the sample should be filtered, if necessary, before the standard solution is added from a burette.

The acidity or alkalinity may be conveniently recorded in terms of the number of c.c. of decinormal alkali or acid required per 70 c.c., or from these values may be calculated the number of grains per gallon of lime as CaO equal either to the acid or alkali present.

Examples:—

*Acidity.*—Raw sewage containing iron pickle, 70 c.c. required  $5.20$  c.c.  $\frac{N}{10}$  NaOH.

Acidity =  $5.2$  in terms of c.c.  $\frac{N}{10}$  NaOH per 70 c.c.

The number of grains CaO to which this is equivalent per gallon is calculated as follows:—

Each c.c. of the decinormal soda solution is equivalent to half the molecular weight of lime CaO (expressed in milligrammes), divided by 10,

*i.e.*,  $\frac{56}{2 \times 10}$ . The acidity is therefore equivalent to

$$5.2 \times 2.8 = 15.36 \text{ grains CaO per gallon.}$$

Lime must therefore be added at this rate in order to neutralise the acidity of the sewage.

#### DETERMINATION OF IRON.

The determination of the amount of iron present in the ferrous or ferric state is of importance where iron compounds are used for chemical treatment,

or where iron pickling liquor is present in the sewage. In both cases iron will be found in the effluent after chemical treatment; but if sufficient lime has been added the amount present is only small. An excess will tend to separate out afterwards, either as oxide, if the liquor is oxidised in a bacteria bed, or as sulphide, if it should be under conditions liable to set up putrefaction.

Where septic treatment is in force the iron pickle will enter the septic tank and be partially deposited therein as sulphide. The amount of iron in suspension, and solution entering and leaving the tank is of importance in determining the length of time the tank should run without at any rate partial emptying; and also in determining the quantity of mineral matter passing away on to the bacterial filters.

#### FERROUS IRON.

The determination of ferrous iron depends upon the depth of blue coloration produced when potassium ferricyanide is added to the sample in presence of acid. The solutions required are:—

*Ferrous ammonium sulphate*  $((\text{NH}_4)_2\text{SO}_4\text{FeSO}_4 \cdot 6\text{H}_2\text{O})$ .

·35 gramme of this salt is dissolved in 500 c.c. distilled water—1 c.c. contains ·1 mgm. iron. This solution rapidly oxidises and should be made up afresh every day.

*Potassium Ferrocyanide*.—Saturated solution.

*Sulphuric Acid*.—One part acid is carefully mixed

with two parts water, the total volume of the mixture being conveniently about one litre.

To make the determination a number of standards are made up from the standard ferrous-ammonium sulphate, containing varying quantities of iron from .1 mgm. to .5 mgm. These are contained in 50-c.c. Nessler glasses, 10 c.c. of sulphuric acid (one part acid to three of water) are added, and then potassium ferricyanide, until the blue colour formed attains a maximum; 35 c.c. of the sample are taken and treated similarly to above, and the depth of colour noted and compared with the above standards.

Thus, if the shade is between the standards .2 mgm. and .3 mgm., the amount is taken at .25 mgm., *i.e.*, .5 in 70 c.c. or .5 grain per gallon.

Instead of making up a number of standards, the same method may be adopted as is used for the determination of small quantities of ammonia and nitrous acid (see pp. 54 and 62). A graduated Nessler or reagent tube may be used for one standard solution containing .5 mgm. Fe, and the comparison made by pouring out the solution until the colour is brought down to that produced by 35 c.c. of the sample contained in a glass of equal dimensions, or if the sample contains more iron than the standard it may be reduced in the same way.

#### FERRIC IRON.

The determination of ferric iron depends upon the depth of red coloration produced when  
S.W. H

potassium sulphocyanate is added to the sample in presence of acid. The solutions necessary are the following:—

*Iron Ammonium Alum.*—

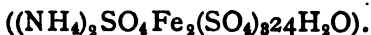

1·8685 grms. are dissolved in 1 litre of distilled water—

1 c.c. = '1 mgm. iron.

*Potassium Sulphocyanate.*—This is used as concentrated as possible.

*Sulphuric Acid.*—One part acid to two parts water.

The determinations are carried out as in the case of ferrous iron, iron alum solution being used to make the standard solution, and potassium sulphocyanate instead of potassium ferricyanide to produce the coloration.

It is very important that excess of sulphocyanate should be present in the case of each comparative test. The colour increases up to a certain constant limit with increase of sulphocyanate.

It is important that iron in solution should be determined as soon as possible after collection of the sample, as it tends to separate out on standing. Thus a sample of sewage which gave '36 grains per gallon Fe in solution when analysed at once, gave only '19 when analysed after one week's standing.

#### IRON IN SUSPENSION.

Where much of the iron present is in suspension in the liquid—for example, in the case of sewage or

septic tank effluent which contains some proportion of iron pickle—the most accurate method of determining the iron is to filter, say, 140 c.c. or more through a Swedish filter-paper, wash and burn the paper and residue, and fuse the dry mineral matter in a porcelain or platinum crucible with a little fusion mixture (equal parts of sodium and potassium carbonate). The fused mass is extracted with dilute hydrochloric acid and boiled with a little nitric acid. This solution may be made up to 500 c.c., and the iron in 50 c.c. of this determined colorimetrically as above.

If the total amount of iron present is large, the colorimetric method may be usefully checked by a direct volumetric determination of the total iron in suspension.

For this purpose the solution after fusion and extraction with acid is filtered if necessary, and a small piece of pure zinc added to reduce the ferric iron to the ferrous state. The ferrous solution can then, after removal of the zinc and addition of a crystal or two of manganous sulphate, be titrated directly against standard permanganate. With small quantities of iron the permanganate used for the oxygen absorption tests may be employed. It is added carefully to the solution till a permanent pink colour is obtained, the manganous sulphate preventing the free hydrochloric acid present from affecting the permanganate.



100 SEWAGE WORKS ANALYSES.

10 c.c. permanganate = 1 mgm. oxygen = 7 mgms. Fe.

Thus—

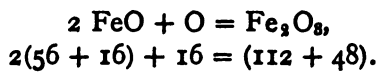

## CHAPTER VII.

THE DETERMINATION OF SOLIDS IN  
SOLUTION AND SUSPENSION.

## SOLIDS IN SOLUTION.

THE determination of the total solids *in solution* is not of the same importance as the various analytical processes hitherto considered, as many of the substances in solution are quite harmless from the point of view of the purity of the effluent and are uninfluenced by the process of purification. Such, for example, are the chlorides normally present in sewage, and other inorganic salts, such as sodium or calcium sulphates, which are derived from various manufacturing processes.

Moreover the determination of the total solids in solution when performed in the usual way by evaporation of the liquid on the water-bath, may give erroneous results on account of the volatilisation with steam of such substances as ammonium carbonate and certain organic compounds present in sewage.

A more correct determination could be made by evaporation of the liquid at the ordinary temperature *in vacuo*, but even this method is liable to error in a less degree.

As a comparative determination where absolute accuracy is not necessary, it is, however, not without interest.

The determination of solids in solution before and after any purification process may at any rate serve to show whether more or less matter is present in solution after the process, and thus help to give some information as to the changes going on.

It has been found, for instance, that there is less matter in solution in the effluent from the septic tank than in the sewage entering it, pointing to a conversion of some of the matters in solution into gases or readily volatile substances.

For the purpose of such estimations a convenient quantity, generally 140 c.c., of the sample after filtration through paper, (moistened only with the sample,) is evaporated in a weighed platinum basin over the water-bath, dried at 100° to 110° C. in a drying oven, cooled in a desiccator and weighed.

The increase in weight of the basin gives the quantity of matter in solution.

When a number of determinations have to be made the greater part of the evaporation may be done by boiling down in conical flasks and transferring the concentrated liquid to the platinum dish for final evaporation to dryness.

Somewhat different values will be obtained if the sample is filtered through porous porcelain or through parchment which will retain certain colloidal substances present more or less in a state of emulsion.

## SOLIDS IN SUSPENSION.

Of more value is the determination of the total *solids in suspension*. The direct determination of the amount and character of the suspended matters in raw sewage is rendered difficult by the fact that much of this is of such a character that it escapes collection when the ordinary samples are taken. Heavy sandy detritus and floating garbage must therefore be separately collected, weighed in bulk, and one or more as nearly as possible average samples taken for a proximate analysis.

This is effected by drying about a pound of the sample in a large basin over the water-bath, or on an iron plate over a small flame (care being taken to avoid charring). Large pieces of coal, clinker, wood, etc., may be picked out and separately weighed. The finer portions can then be separated by sieving, and a determination of the organic and volatile constituents made by ignition of weighed portions of the residue on each of the sieves. Most of the clay present will pass through the finest of the sieves used, and may be separated from any intermixed sand by washing.

In this way a very fair estimate can be obtained of the value of the detritus for burning in a destructor, or for use as a manure.

It is of great importance to know the amount of solids in suspension passing away from sedimentation tanks, or remaining after treatment with

chemicals, or in the septic tank. Such a determination will indicate the amount of matter likely to be deposited in a stream or on the surface of bacterial filter-beds. If a corresponding determination is made of the solids in suspension in the sewage, then the amount of matter deposited in the tanks by a given volume of sewage can be calculated.

The further determination of the proportion of mineral as compared with the organic and volatile constituents of the suspended matter indicates how much of the latter is possibly resolvable into gaseous or soluble bodies by the actions taking place in the septic tanks, in the bacterial filters, or in the stream into which the effluent flows.

The most accurate method of carrying out such determinations without special apparatus is to filter a known volume of the sample through a weighed filter-paper, wash, dry at  $100^{\circ}$  to  $110^{\circ}$  C and weigh.

The mineral matter can then be determined by burning the filter-paper in a weighed crucible, heating the residue to redness, moistening with ammonium carbonate, to convert any free lime present into carbonate, heating, and weighing, the weight of residue left after burning off the organic matter representing non-volatile mineral matter.

The filter-paper used should be specially prepared to leave practically no ash. Such a paper is placed in a glass weighing-bottle, heated in the

drying-oven to 110° C., cooled in a desiccator\* and weighed, then reheated and weighed again till constant. The same operation of drying, reheating, and reweighing till constant is repeated after the suspended matter has been collected on the filter.

Examples:—

Quantity of sample (raw sewage) taken = 210 c.c.

Weight of bottle + filter paper

+ suspended matter = 10.5044 grms.

Weight of bottle + filter paper = 10.4345 grms.

Weight of suspended matter = .0699 grms.

.0699 gm. in 210 c.c. = .0233 gm. in 70 c.c.

= 23.3 grains per gallon

$= \frac{23.3}{.7} = 33.3$  parts per 100,000 total suspended

matter.

The filter-paper and suspended matter were ignited in a platinum crucible, the weight being as follows:—

Weight of crucible + residue after

heating . . . . = 29.6790 grms.

Weight of crucible . . . . = 29.6392 grms.

Mineral residue, after heating . = .0368 grms.

.0368 gm. in 210 c.c. = .0123 gm. in 70 c.c.

= 12.3 grains per gallon.

$= \frac{12.3}{.7} = 17.6$  parts per 100,000

of mineral matter.

\* For this purpose a bell-jar, under which is placed a small dish of strong sulphuric acid, may be used.

The organic or volatile matter present will be represented by the difference between these two values:—

$$23.3 - 12.3 = 11.0 \text{ grains per gallon.}$$

$$33.3 - 17.6 = 15.7 \text{ parts per 100,000.}$$

To save time, a number of filter-papers may be dried in a bottle in the drying-oven at once, and a single paper used as required.

When the sample contains a large amount of suspended matter, *e.g.*, in storm-water, a sufficiently accurate determination may be made by allowing, say, 700 c.c. of the sample to stand, when the greater part of the suspended matter will settle out. The fairly-clear liquid may be syphoned off, and the deposit washed on to a smooth toughened filter-paper (*e.g.*, Schleicher and Schüll, No. 575), washed and dried in the air-bath at 100° to 110° C. After drying, the suspended matter can be scraped off the smooth paper into a weighed crucible and weighed. On igniting, moistening with ammonium carbonate, and reheating, the proportion of mineral matter may be obtained as before.

Where a large number of determinations have to be made, they may be much facilitated by the use of a centrifugal machine. There are many types of these, all depending on the fact that if a solution containing suspended particles is rapidly whirled round, the particles tend to collect at the bottom of the liquid if they are





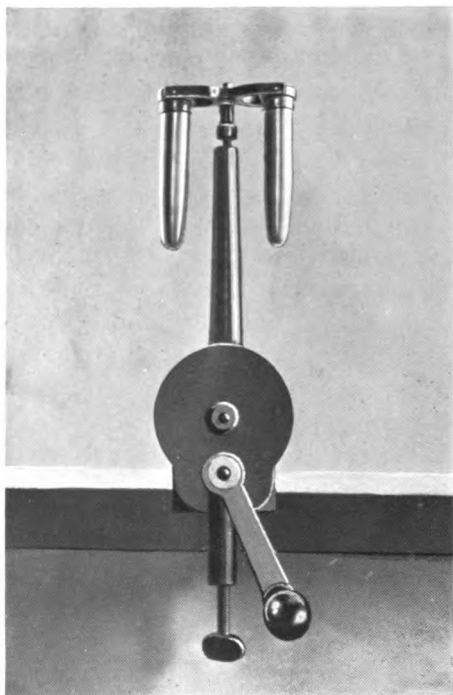

FIG. 7.—CENTRIFUGE FOR DETERMINING  
SUSPENDED MATTERS.

*[To face page 107.]*

heavier than the latter, at the top if they are lighter.

A convenient form of centrifugal machine is shown in Fig. 7. It is known as the High-speed Medical Centrifuge, and consists essentially of two tapering aluminium tubes swinging loosely at each end of a horizontal metal support attached at the centre to a vertical rod, which can be rapidly rotated on turning the handle, actuating the mechanism within the instrument. Glass tubes to contain about 10 c.c. of the sample to be tested are provided with the instrument to fit into the aluminium tubes.

On turning the handle, the aluminium tubes, with their contents, swing into a horizontal position, and can be whirled round at the rate of 2,500 revolutions per second.

The operator should be protected by a wire screen round the instrument, in case the aluminium tubes and their horizontal support should become detached during the whirling operation.

After a few minutes' whirling all the suspended matter in the sample will be found collected at the apex of the glass tube.

It is well to fix an indiarubber ring round the vertical pillar, to prevent jarring of the aluminium tubes against the pillar as the machine is brought to a standstill.

The amount of liquid which can be whirled at once in the machine is limited, but as the whirling operation takes but a short time, the clear

liquid can be poured off from the deposited matter, a fresh quantity added, and the whirling repeated.

By using graduated tubes an approximate idea of the quantity of suspended matter present can be obtained by simply noting the volume of the deposit in different cases, but as this depends on the character of the suspended matter, whether light or heavy, and on the amount of whirling and consequent compression to which it has been subjected, it is better to actually weigh the deposit.

This can be done with sufficient accuracy by pouring off the liquid in the tube, adding a few drops of distilled water, and stirring with a platinum wire to loosen the deposit, then transferring this to a weighed crucible, carefully evaporating off the small amount of water in the air-bath at 100° to 110° C., cooling in the desiccator, and weighing.

The amount of mineral matter in the deposit can be determined as before.

*Determination of the Total Solids in a Tank.*—It is often of great interest and importance to determine, as exactly as possible, the actual quantity of solid matter present, either in a sedimentation or septic tank.

This can be accomplished with a fair amount of accuracy by the use of the dipping tube, shown in Fig. 8, by which a section of the tank can be withdrawn and examined.

The tube, whose length depends upon the depth of water in the tank, is conveniently made in sections joined by an indiarubber band, the free-ends being protected by brass collars, the whole being mounted on a strong board which is marked at intervals of six inches. Through the length of the tube a stout string passes, which is attached at the lower end of the tube to an indiarubber ball. By pulling the string tightly the ball closes the lower end of the tube. The string can then be fixed to a nail driven into the upper end of the board.

In order to obtain a section of the tank, the tube is slowly and carefully lowered to the bottom, the ball and string being kept loose. The level of the water inside and outside the tube should be as nearly as possible the same throughout the operation, or the section will not be a true one. When the tube has reached the bottom of the tank, it should be raised just sufficiently to enable the ball to be pulled tightly over the lower end. The string is then fixed and the tube drawn up. There should be no escape of water at the bottom of the tube. After allowing a few minutes for settlement, the level



FIG. 8.

of the sludge in the tube may be read, and the contents emptied into a pail from which, after stirring, a sample may be drawn.

Similar sections should be taken at various points round the tank in order to obtain an average. The total solids, both mineral and volatile, per gallon of the mixed sample thus obtained can then be determined by any of the above methods.

Knowing the capacity of the tank in gallons, the total solids present in it can be calculated.

Example :—

A section, taken in the above manner, of the open septic tank in Manchester was found to contain 3624·6 grains of solid matter per gallon. As 15·68 grains per gallon is equivalent to 1 ton per million gallons, 3624·6 grains per gallon will be equivalent to 231·2 tons per million gallons. As the capacity of the tank was 1,125,000 gallons, the amount of suspended matter contained in it was 260 tons.

*Determination of Composition of Sludge.*—Such a determination as above described gives the actual amount of solid matter in the tank, assuming that the latter could be obtained in a dry state.

The actual amount of wet sludge depends, as explained on p. 12, on its density; and it is important, therefore, to determine the percentage of water contained in the sludge.

This can be done with sufficient accuracy by evaporating down about 200 grams. of an average

sample in a weighed porcelain dish, drying in an air-bath at 100° to 110° C., cooling and reweighing.

The loss of weight represents the water present.

## CHAPTER VIII.

## THE ANALYSIS OF GASES FROM THE SEPTIC TANK AND FROM BACTERIAL FILTERS.

THE analysis from time to time of the gases given off from the septic tank, or of those present in the interstices of bacterial filters, affords valuable information as to the respective processes.

## GASES EVOLVED FROM THE SEPTIC TANK.

The changes which go on in the septic tank are not yet perfectly understood, the proportion of the gases evolved varying according to the conditions in the tank (see Chap. I.). The gases for the most part, however, consist of marsh-gas (methane  $\text{CH}_4$ ), hydrogen (H), carbon dioxide ( $\text{CO}_2$ ), and nitrogen (N), resulting from the decomposition of nitrogenous organic matter and cellulose.

A possible decomposition of albumen, resulting in the formation of marsh-gas, etc., is given in the following equation:—

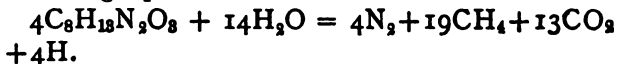

Cellulose is known to be decomposed by an

organism *bacillus amylobacter*, partly at any rate, according to the following equations:—

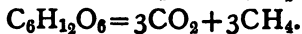
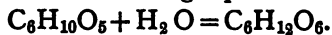

#### GASES PRESENT IN THE INTERSTICES OF BACTERIAL FILTERS.

The changes taking place in the bacterial filters are chiefly of the nature of combustion, and for this to take place to the best advantage there should, of course, be an adequate supply of oxygen present.

Some nitrogen may be evolved from denitrification changes, such as have been described on p. 62, which will lessen the proportion of oxygen in the interstices of the bed.

The analysis of air drawn from the interior of a contact bed during rest, or from a continuous filter at any time, will show the state of aeration at various depths. If the proportion of carbonic acid present in such a bed is excessive, and at the same time but little oxygen is found, a period of rest is evidently necessary.

#### METHOD OF COLLECTING SAMPLES.—GAS FROM SEPTIC TANKS.

The gas may be collected from either the open or closed septic tank by means of a bottle provided with an indiarubber stopper with two holes. Through one of these a glass tube, A, passes to the bottom, through the other a second tube, B, passes just beyond the stopper (see Fig. 9). A



piece of indiarubber tubing and a pinch-cock serve to close each tube.

To collect a sample of gas from the open tank, the bottle is filled with water, and the longer of the two tubes, A, is joined to a funnel which dips below the surface of the water in the tank. The exit tube, B, of the bottle should also be brought beneath the water level. Both pinch-cocks are then opened, and if the sludge below the bottle is stirred, enough gas will quickly be evolved to fill the bottle, the water escaping by the short tube. When the bottle is full of gas the pinch-cocks are closed while the bottle is still immersed, and the sample is brought into the laboratory for analysis.\*

The same arrangement may be used for the closed tank, the longer tube being attached to a vent tap in the roof instead of to a funnel. In order to collect a sample of gas the exit valve of the tank should be closed and the sewage headed up in the tank, thus creating a pressure which forces the gas into the bottle.

#### GASES FROM BACTERIA BEDS.

To collect the gases from bacteria beds a narrow iron tube ( $\frac{1}{4}$ -inch internal diameter) is hammered into the bed to any desired depth. In order to prevent chokage of the end of the tube as it enters the bed, a small cork is inserted which

\* The rate of evolution of gas from an open septic tank may be determined, and the collection of samples facilitated, by the provision of a small sheet iron gas-holder, which can be suspended at different points along the margin of the tank.

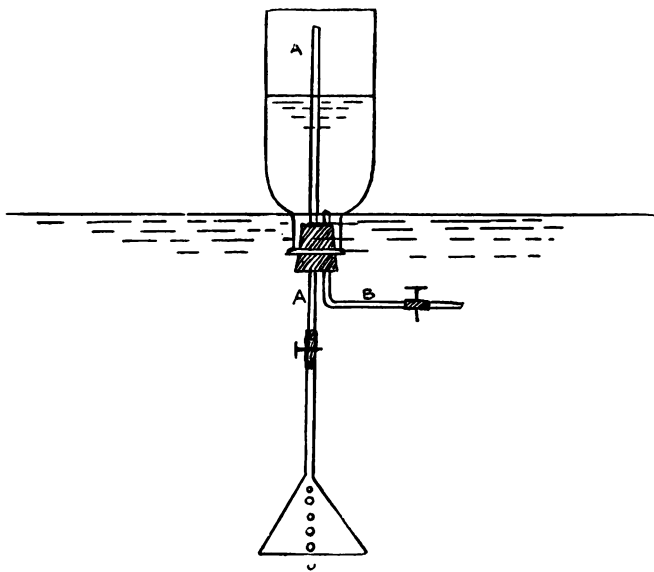

FIG. 9.

[To face page 114.]





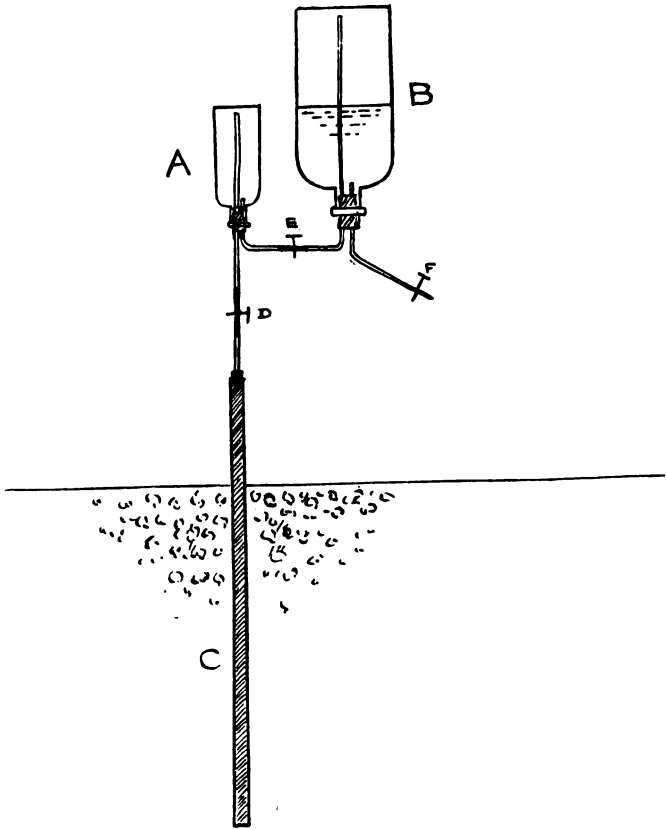

FIG. 10.

[To face page 115.]

is afterwards knocked out, while the tube is still in position, by means of an iron rod inserted in the tube and hammered at the upper end.

The gases may then be drawn from the bed in a way somewhat similar to that by which they are obtained from the septic tank.

The arrangement is shown in Fig. 10. The upper end of the iron tube C is fitted with an india-rubber stopper through which passes a narrow glass tube. The sampling apparatus is joined by an india-rubber connection, D, to the end of this tube. This connection can be closed by a pinch-cock. All connections must be air-tight to ensure that the gas is actually drawn from the bed at the depth reached by the iron tube.

In collecting samples of gas from bacterial filters it is necessary to reject the first portions withdrawn, as they are likely only to represent the gas within, or immediately surrounding, the iron tube. It is convenient, therefore, to use two bottles connected up as in Fig. 3. The smaller bottle, A, may have a capacity of 8 oz., a half Winchester may be used for the larger bottle, B. To obtain a sample, both bottles are filled with water, the stoppers and tubes inserted and the pinch-cocks closed. Connection is then made with the bed at D without opening the pinch-cocks. The pinch-cocks E and F are then opened, and finally the pinch-cock D. The water flows away through F, and the gas from the bed is withdrawn through the sample bottle A. When the bottle B is

nearly empty all the pinch-cocks are closed, and A is removed for analysis of its contents.

By using only the one small bottle A for collecting the gas the operation can be carried out by one manipulator, but in this case, when the bottle is nearly empty, the end of the iron tube must be closed by the pinch-cock D and the bottle A removed, refilled with water, and at least one other collection of gas made before it is safe to assume that a true sample has been obtained.

In drawing samples of gas from continuous filters, the iron tube may be inserted laterally, and the glass connection to the sampling bottles bent at right angles so that the bottles may still be held vertically.

#### ANALYSIS OF THE GASES.

*General Description of the Method.*—*Septic Tank Gases.*—These consist for the most part of methane or marsh-gas ( $\text{CH}_4$ ), hydrogen (H), carbon dioxide ( $\text{CO}_2$ ), and nitrogen (N).

The carbon dioxide is determined by noting the amount of gas absorbed by potash from a given volume of the sample.

The marsh-gas and hydrogen are determined by exploding the volume of the sample remaining after removing carbon dioxide with excess of oxygen, noting the contraction in volume after explosion and measuring, by potash absorption, the amount of carbonic acid produced.





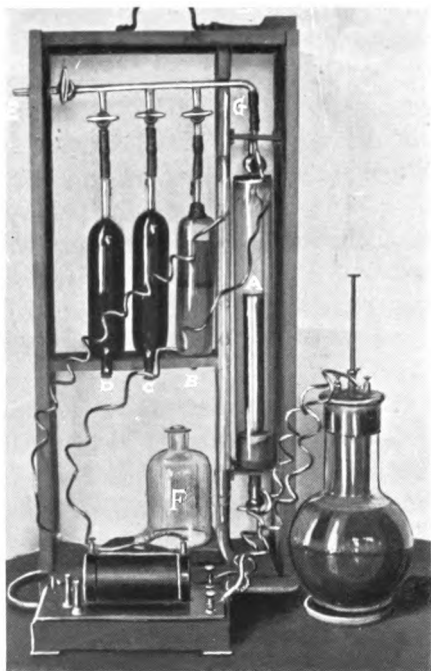

FIG. 11.—APPARATUS FOR GAS ANALYSIS.

*[To face page 117.]*

From these data the percentages of hydrogen and marsh-gas can be calculated.

*Gases from Bacteria Beds.*—In this case it is important to determine the percentage of carbon dioxide and of oxygen.

The carbon dioxide is determined by potash absorption as above mentioned. Afterwards the oxygen in the same sample is absorbed by potassium pyrogallate and the decrease in volume noted. The residual gas, after removing the oxygen and carbon dioxide, is assumed to be nitrogen.

*Apparatus and Reagents.*—In order to analyse the gases thus obtained, a modified form of Orsat's gas analysis apparatus will be found convenient (see Fig. 11).

A is a graduated cylinder surrounded by a water jacket, provided with platinum wires for sparking, and connected with a mercury reservoir, F, and a narrow levelling tube G. B, C, D are cylinders for absorption reagents, containing lengths of narrow glass tubing to form a large surface on which the absorption of gas by the reagent can take place. B contains strong potash solution; C and D contain alkaline pyrogallate.

The solutions are made up as follows:—

*Potash solution.*—240 grms. stick potash are dissolved in 1 litre of water.

*Alkaline Pyrogallate.*—As this solution cannot, of course, be kept exposed to the air, as it rapidly absorbs oxygen, enough only should be made up at one time to fill one of the two pipettes, C and D.

Each pipette holds about 200 c.c. The solution is therefore made by dissolving 40 grms. of pyrogalllic acid in 200 c.c. of the above potash solution.

*Battery and Coil.*—The sparking apparatus consists of a single bichromate cell and a Ruhmkorff coil capable of giving  $\frac{1}{4}$  inch spark.

The bichromate cell is of about 1 litre capacity. It is charged with 600 c.c. of water, 200 c.c. of concentrated sulphuric acid, and 100 grms. of potassium bichromate. The solution should be made in a separate vessel, *e.g.*, a litre flask. The bichromate is first dissolved in the water and the acid is added carefully; the mixture is allowed to cool before being put into the cell.

*Oxygen.*—A supply of oxygen is also required when analyses of the gases from the septic tank have to be made.

Enough for a number of determinations can be made by heating a mixture of potassium chlorate and manganese dioxide (1 part  $\text{MnO}_2$ , 6  $\text{KClO}_3$ ) in a flask, rejecting the first portion of gas evolved, and collecting a litre flask full over water.

The flask when full is closed while under water with a double bored indiarubber stopper, through one hole of which is passed the stem of a tap funnel, and through the other a delivery tube bent at right angles and closed by a piece of indiarubber tubing and a pinch-cock. By opening the pinch-cock and allowing water to run through the tap funnel, the oxygen can be driven out of the flask as required.

In order to free the oxygen from any traces of carbon dioxide or chlorine which may have come over from the manganese dioxide and chlorate, a little caustic soda solution should be introduced into the flask from the tap funnel (care being taken that none finds its way into the exit tube of the flask), and the oxygen left in contact with the solution over night before use.

#### ANALYSIS OF SEPTIC TANK GASES.

To carry out the analysis of a sample of the gases collected in the manner described, the shorter tube of the bottle containing the sample is attached to the apparatus at E, the taps to the reagent cylinders being closed and the graduated tube and capillary tube full of mercury.

The longer tube of the bottle is attached by an indiarubber junction to a tube full of water dipping into a beaker of water. On opening the screw clips and lowering the mercury in the graduated tube, or eudiometer, of the Orsat apparatus, any desired quantity of gas can be drawn into the eudiometer. At the same time water enters the bottle from the beaker to take the place of the gas. Not more than 20 c.c. should be taken for a complete analysis. Before noting the volume of gas taken, the mercury should be adjusted to as nearly as possible the same level in the eudiometer and the open levelling tube. The taps and pinch-cocks may then be closed and the sample bottle removed.

The carbonic acid present is first determined

by opening the tap connected with the potash cylinder, and by raising the mercury reservoir, carefully passing the gas sample into the potash cylinder.

The gas should be allowed to stand in contact with the potash for five minutes, and then returned to the eudiometer and the volume remeasured, care being taken to level the mercury as before.

This process should be repeated till the volume of the gas remains constant. A volume of oxygen should now be added from the oxygen flask equal to more than twice the volume of the gas taken, *i.e.*, if 20 c.c. of gas have been taken, at least 60 c.c. of oxygen must be added, or the combustion on subsequent explosion will be incomplete.

The oxygen is added simply by joining the exit tube of the oxygen flask to the apparatus and running in water from the tap funnel carefully, the mercury reservoir being simultaneously lowered until the requisite quantity of oxygen has been sent into the apparatus. The volume of the gas and oxygen is now measured, the pinch-cock and tap at the inlet being closed. The mercury reservoir is now lowered till the level outside the eudiometer is slightly lower than the level inside. The bottom tap of the eudiometer is then closed.

The mixture is now sparked from the bichromate battery and coil. The operator should be protected by a screen when the spark passes, in case of accident.

The tap communicating with the mercury reservoir is now opened and the gas allowed to cool for about ten minutes, when another reading is taken. Further readings should be taken at intervals of five minutes until no further contraction is observed, the volume being then carefully recorded. The difference between this volume and that of the mixed gases is the contraction on explosion. The gas in the eudiometer is now passed into the potash tube by opening the corresponding tap and raising the mercury reservoir.

When all the gas is passed over, the tap may be closed and the mercury reservoir lowered. On opening the tap the gas passes back into the eudiometer and may be again measured. The contact with potash should be repeated until the volume is constant. The volume absorbed represents the carbon dioxide formed on explosion.

These measurements are really sufficient to determine the composition of the gas, but it is useful, as a check, to pass the residual gases into alkaline pyrogallate solution, measuring the absorption and repeating the contact till the volume is constant as before. The volume absorbed equals the volume of residual oxygen.

The following data are then available given in the order in which they are determined :—

- a.* Original volume of gas taken.
- b.* Volume after absorption of  $\text{CO}_2$  by potash.
- c.* Volume of gas after addition of oxygen.
- d.* Volume of gas after explosion.

*e.* Volume of gas after explosion and contact with potash.

*f.* Volume of gas after contact with alkaline pyrogallate.

From these data the composition of the gas can be calculated as follows:—

$a - b$  = volume of carbon dioxide.

$c - d$  = contraction on explosion.

$d - e$  = volume of carbon dioxide produced by explosion.

$e - f$  = volume of residual oxygen.

The volume of carbon dioxide produced by the explosion is equal to the volume of marsh-gas (methane) present in the original sample, as is seen by the following equation:—

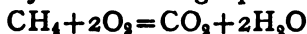

1 vol. 2 vols. 1 vol. (steam condensed).

From this equation it is also seen that the combustion of the marsh-gas is responsible for a contraction after explosion equal to twice its own volume.

Any further contraction must, therefore, be due to combustion of hydrogen (unless other gases such as ethylene ( $\text{C}_2\text{H}_4$ ) or carbonic oxide (CO) are present, and this has not been found to be the case). Of this further contraction two-thirds represent the volume of the hydrogen, thus:—

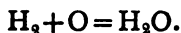

2 vols. 1 vol. (condensed to liquid).

The volume of the methane, therefore, will be  $d - e = x$ .

The volume of the hydrogen will be  $\frac{2(c-d-2x)}{3}$ .

The following example obtained in practice will illustrate the method of calculating the results.

The eudiometer being graduated from the bottom, the volumes corresponding to the readings are obtained by subtracting the latter from 100.

	Reading.	Volume = 100 - Reading.
Volume of gas taken = <i>a</i>	82.2	17.8
Volume of gas after contact with potash = <i>b</i>	83.4	16.6
Volume of gas after addition of oxygen = <i>c</i>	21.2	78.8
Volume of gas after explosion	47.2	52.8
Volume of gas after explosion and cooling = <i>d</i>	50.2	49.8
Volume of gas after contact with potash = <i>e</i>	63.8	36.2

Volume of *carbon dioxide* present =  $a - b = 1.2$

Contraction on explosion =  $c - d = 29.0$

Volume of carbon dioxide produced

by explosion =  $d - e = 13.6$

*i.e.*, volume of *marsh-gas*.

The contraction on explosion due to the marsh-gas will be 27.2 (*i.e.*, twice 13.6).

The contraction on explosion due to hydrogen will, therefore, be  $29.0 - 27.2 = 1.8$ .

The volume of hydrogen present will, therefore, be  $\frac{1.8 \times 2}{3} = 1.2$ .



These volumes are calculated to percentages as follows:—

$$\text{Percentage of CO}_2 = \frac{1.2 \times 100}{17.8} = 6.75$$

$$\text{Percentage of CH}_4 = \frac{13.6 \times 100}{17.8} = 76.40$$

$$\text{Percentage of H} = \frac{1.2 \times 100}{17.8} = 6.75$$

$$\begin{array}{r} \text{Percentage of N} = \\ \text{(by difference)} \end{array} = \frac{10.10}{100.00}$$

#### ANALYSIS OF GASES FROM BACTERIA BEDS.

This analysis of the gas collected from the interstices of bacterial filters is a comparatively simple operation. From 70 to 100 c.c. may be measured in the eudiometer (as described on p. 119), and passed first into the potash cylinder and the contraction in volume noted. This should be repeated once or twice till no further change in volume occurs. The total contraction equals the volume of *carbon dioxide* present.

The gas is then similarly subjected to the action of alkaline pyrogallate. The contraction in volume equals the volume of *oxygen* present.

Any residual gas may be assumed to be *nitrogen*.

Example:—

	Reading.	Volume=100 - Reading.
Volume of gas taken ... ..	11.4	88.6
Volume of gas after contact with potash ... ..	13.4	86.6
Volume of gas after contact with alkaline pyrogallate ... ..	28.2	71.8

Volume of carbon  
dioxide present =  $88.6 - 86.6 = 2$  c.c.

Volume of oxygen  
present =  $86.6 - 71.8 = 14.8$  c.c.

These volumes are calculated to percentages as follows:—

$$\text{Percentage of CO}_2 = \frac{2 \times 100}{88.6} = 2.2 \text{ per cent.}$$

$$\text{“ “ O} = \frac{14.8 \times 100}{88.6} = 16.7 \text{ “}$$

$$\text{“ “ N} = \frac{81.1}{100.0} \text{ “}$$

(by difference)

TABLE I.

THE SYMBOLS AND ATOMIC WEIGHTS OF THE ELEMENTS MET WITH IN SEWAGE ANALYSIS.

Element.	Symbol.	Atomic Weight.
Hydrogen ...	H ... ..	1'00
Carbon ...	C ... ..	11'97 (12)
Nitrogen ...	N ... ..	14'01 (14)
Oxygen ...	O ... ..	15'96 (16)
Sodium ...	Na (Natrium) ... ..	23'00 (23)
Magnesium ...	Mg ... ..	23'94 (24)
Aluminium ...	Al ... ..	27'04 (27)
Silicon...	Si ... ..	28'00 (28)
Phosphorus ...	P ... ..	30'96 (31)
Sulphur ...	S ... ..	31'98 (32)
Chlorine ...	Cl ... ..	35'37 (35'5)
Potassium ...	K (Kalium) ... ..	39'03 (39)
Calcium ...	Ca ... ..	39'91 (40)
Chromium ...	Cr ... ..	52'45 (52'5)
Manganese ...	Mn ... ..	54'80 (55)
Iron ...	Fe (Ferrum) ... ..	55'88 (56)
Zinc ...	Zn ... ..	65'10 (65)
Silver ...	Ag (Argentum) ... ..	107'66 (108)
Mercury ...	Hg (Hydrargyrum) ... ..	199'80 (200)

NOTE.—The numbers in brackets approximate sufficiently to the exact atomic weights to be used without sensible error in the calculations required in this work.

TABLE II.

## WEIGHTS AND MEASURES OF THE METRIC SYSTEM.

*Weights.*

1 milligram	= the thousandth part of 1 gram. or 0.001 gram.		
1 centigram	= the hundredth " " " 0.01 "		
1 decigram	= the tenth " " " 0.1 "		
1 gram	= the weight of a cubic centimetre of water at 4° C.	1.0	"
1 decagram	= ten grams.	10.0	"
1 hectogram	= one hundred grams.	100.0	"
1 kilogram	= one thousand "	1000.0	"

*Measures of Capacity.*

1 millilitre	= 1 cubic centimetre or the measure of 1 gram. of water.
1 centilitre	= 10 cubic centimetres or the measure of 10 grams. of water.
1 decilitre	= 100 cubic centimetres or the measure of 100 grams. of water.
1 litre	= 1000 cubic centimetres or the measure of 1000 grams. of water.

*Measures of Length.*

1 millimetre	= the thousandth part of one metre or 0.001 metre.
1 centimetre	= the hundredth part of one metre or 0.01 metre.
1 decimetre	= the tenth part of one metre or 0.1 metre.
1 metre	= the ten-millionth part of a quarter of the meridian of the earth.

TABLE III.  
CONVERSION TABLE.

Quantity per Gallon.	Quantity in One Million Gallons.		Parts per 100,000.
Grains.	Cwts.	Lbs.	
'25	0	35'71	'36
'50	0	71'42	'71
'75	0	107'13	1'07
1'00	1	30'85	1'42
1'25	1	66'56	1'79
1'50	1	102'29	2'14
1'75	2	26'00	2'50
2'00	2	61'71	2'86
2'25	2	97'42	3'21
2'50	3	21'14	3'57
2'75	3	56'85	3'93
3'00	3	92'57	4'29
3'25	4	16'28	4'64
3'50	4	52'00	5'00
3'75	4	87'70	5'36
4'00	5	11'43	5'71
4'25	5	47'14	6'07
4'50	5	82'85	6'42
4'75	6	6'56	6'79
5'00	6	42'29	7'14

TABLE IV.

CONVERSION TABLE FOR RECORDING QUANTITY OF SEWAGE DEALT WITH PER GIVEN AREA.

Gallons per square yard.	Gallons per acre.	Cubic metres per hectare (10,000 square metres).
10	48,400	543'4
15	72,600	815'1
20	96,800	1086'8
25	121,000	1358'5
30	145,200	1630'2
35	169,400	1901'9
40	193,600	2173'6
45	217,800	2445'3
50	242,000	2717'0
55	266,200	2988'7
60	290,400	3260'4
65	314,600	3532'1
70	338,800	3803'8
75	363,000	4075'5
80	387,200	4347'2
85	411,400	4618'9
90	435,600	4890'6
95	459,800	5162'3
100	484,000	5434'0
105	508,200	5705'7
110	532,400	5977'4
115	556,600	6249'1
120	580,800	6520'8
125	605,000	6792'5
130	629,200	7064'2
135	653,400	7335'9
140	677,600	7607'6
145	701,800	7879'3
150	726,000	8151'0
155	750,200	8422'7
160	774,400	8694'4

## 130 SEWAGE WORKS ANALYSES.

CONVERSION TABLE—*continued.*

Gallons per square yard.	Gallons per acre.	Cubic metres per hectare (10,000 square metres).
165	798,600	8966·1
170	822,800	9237·8
175	847,000	9509·5
180	871,200	9781·2
185	895,400	10052·9
190	919,600	10324·6
195	943,800	10596·3
200	968,000	10868·0

## USEFUL DATA.

- 1 ton = 1,015 kilogrammes.
- 1 lb. = 453·6 grammes.
- 1 oz. = 28·35 grammes.
- 1 grain = ·0648 grammes.
- 1 gallon = 4,544 cubic centimetres.
- 1 fluid oz. = 28·35 cubic centimetres.
- 1 acre = 4046·7 square metres.
- 1 sq. yard = ·836 square metres.
- 1 cubic foot of water contains 6·228 gallons.
- 1 gallon of water weighs 10 lbs.
- 1 gallon of sludge, 90 per cent. moisture, weighs 11 lbs.  
(about).
- 15·68 grains per gallon = 1 ton per million gallons.



**The Septic Tank System of Sewage  
Treatment is the best and most  
economical.** . . . . .

As now laid down it embodies the  
improvements suggested by six years'  
practical experience. . . .

---

**Over 180 Installations to date.**

---

**THE SEPTIC TANK SYNDICATE,  
EXETER LIMITED,  
AND WESTMINSTER.**

# INDEX.

- ABSORBED Oxygen** *See* Oxygen.  
**Acidity and Alkalinity, Determination of,** 89  
**Alkaline Pyrogallate,** 117  
**Alkaline Potassium Permanganate,** 42  
**Alkalinity, Free and Combined,** 93  
**Ammonia, Determination of,** 38  
    **Albuminoid,** 39, 53  
    **Free and Saline,** 39, 52  
    **Organic,** 40, 58  
    **Water, Ammonia-free,** 42  
**Asparagin,** 39  
**Atomic Weights of Elements, Table,** 126
- Bacillus Amylobacter,* 113  
**Bacteria Beds, Gases from:**  
    **Analysis of,** 117  
    **Samples, Method of collecting,** 115  
**Bacterial Filters,** 4  
    **Control of,** 14  
    **Gases present in,** 113  
**Bailey's Sewage Recorder,** 5  
**Biological Processes,** 3
- CARBONIC Acid, Free,** 94  
**Catchpits and Screens, Efficiency of,** 9  
**Caustic Soda, Standard,** 93  
**Centrifugal Machine,** 106  
**Chemical Treatment,** 2  
    **Control of,** 10  
**Chlorine,** 86
- Colorimeter, Stokes',** 50  
**Combined Alkalinity,** 94  
**Contact Beds,** 4  
    **Control of,** 14  
    **Sampling Liquids entering and leaving,** 9  
**Continuous Filters,** 4  
**Conversion Table,** 128, 129
- DATA, Useful,** 131  
**Denitrification,** 62  
**Disposal Processes,** 2  
**Dissolved Oxygen** *See* Oxygen.
- EFFLUENT, Degree of Purity necessary in,** 17  
**Elements, Symbols and Atomic Weights, Table,** 126
- FERRIC Iron,** 97  
**Ferrou's Ammonium Sulphate,** 96  
**Ferrou's Iron,** 97  
**Filters, Continuous,** 4, 14  
**Filtration, Mechanical,** 2  
**Flow of Sewage, Gauging,** 5  
**Four Hours' Test, Substances other than Domestic Sewage indicated by,** 30
- GASES, Analysis of:**  
    **Bacteria Beds,** 117  
    **Bacterial Filters,** 113  
    **Samples, Methods of collecting,** 113, 114  
    **Septic Tank,** 112, 116, 119

- Gauges for recording Sewage Flow, 5  
 Glycocoll, 38  
 Griess-Ilosvay Solution, 64
- HEARSON Incubator, 35  
 High-speed Medical Centrifuge, 107
- INCUBATOR Tests, 34  
 Iodide Potassium, 24  
 Iron Ammonium Alum, 98  
 Iron, Determination of, 95  
   Ferric, 97  
   Ferrous, 96  
   Suspension, Iron in, 96, 98
- KENT's Meter, for measuring Discharge from Filters, 7  
 Kjeldahl Method of determining Organic Ammonia, 58
- LEUCINE, 38
- MEASUREMENT of  
 Sludge Production, 12  
 Solutions, 26  
 Measures and Weights of the Metric System, Table, 127  
 Mechanical Filtration, 2  
 Meta-phenylene-diamine, 66  
 Methyl-orange, 91  
*Micrococcus Urei*, 38  
 Mineral Acid, Free, 94
- NESSLERISATION, 40  
 Nitric Nitrogen, 71  
 Nitrite, Sodium, 66  
 Nitrites and Nitrates, determining, 61
- ORGANIC Ammonia, 40, 58  
 Orsat's Gas Analysis Apparatus, 117  
 Oxygen, Absorbed :  
   Determination of, 21  
   Four Hours' Test, 26  
   Three Minutes' Test, 31
- Oxygen, Dissolved, Determination of :  
 Ramsay's Method, 81  
 Rate of Absorption, 82  
 Roscoe and Lunt's Method, 81  
 Test for, 20, 82  
 Thresh's Method, 75
- PALATINE Company's Recording Gauge, 5  
 Permanganate Alkaline Potassium, 42  
 Phenol-phthalein, 90  
 Potash Solution, 117  
 Potassium Solutions :  
   Chromate, 87  
   Iodide, 24  
   Nitrite, Standard, 63  
   Permanganate, 23, 42  
   Sulphocyanate, 98  
 Purification Processes, 3  
 Purity necessary in an Effluent, Degree of, 17  
 Pyrogallate, Alkaline, 117
- RAMSAY, Prof., Method of determining Dissolved Oxygen, 81  
 Results of Analysis, recording, 15
- SAMPLING, Methods of, 8, 113  
 Screens and Catchpits, Efficiency of, 10  
 Septic Tank :  
   Control of, 12  
   Gases in, Analysis, 112, 116  
   Purification Process, 3  
 Silver Nitrate, Standard Solution, 87  
 Sludge :  
   Composition, Determining, 110  
   Production, Measuring, 12  
 Sodium :  
   Carbonate, 42  
   Nitrite, 67  
   Thiosulphate, 24, 76



Solids, Determination of:  
in Solution, 101  
in Suspension, 103  
Tank, Total of Solids in, 108  
Solutions, Measurement of, 26  
Starch Solution, 24, 76  
Stokes' Colorimeter, 50  
Sulphocyanate, Potassium, 98  
Sulphuric Acid, 23, 76, 96, 98  
Dilute, 66  
Standard, 91  
Symbols of Elements, Table, 126

THREE Minutes' Oxygen Absorption Test, 31  
Thresh, Dr., Method of Determining Dissolved Oxygen, 75  
Treatment, Chemical, Control of, 10

WATER, Ammonia-free, 42  
Weights and Measures of the Metric System, Table, 127  
Workmen, Use of Three Minutes' Test by, 32

## **The Self-acting Triple Tank System of Sewage Treatment by Bacterial Agency**

**IS THE BEST AND MOST  
UP-TO-DATE.**

This method effects a saving of £91 per annum for each 100,000 gallons of sewage treated per day, as compared with chemical treatment and the labour in connection therewith.

## **The Self-acting Triple Automatic Apparatus for Filling and Emptying Bacteria Beds**

Can be attached to existing works at low cost.  
Automatic and reliable in their working.  
No cog-wheels to get out of order.  
No syphons and no fear of blocking.

ILLUSTRATED PAMPHLET POST FREE.

**HALLER & MACHELL,**  
Civil Engineers, DEWSBURY.

# FREDK. JACKSON & CO.,

14, Cross Street,

MANCHESTER.

TELEGRAPHIC ADDRESS: APPARATUS, MANCHESTER.

TELEPHONE NO. 2088.

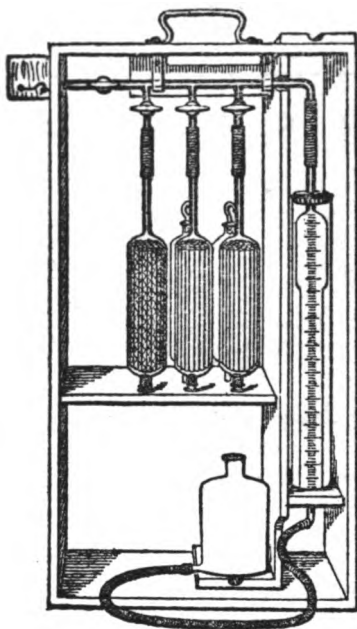

Balances,

General Chemical  
Apparatus, and  
Pure Chemicals.

Hempel, Orsat,  
and other

GAS ANALYSIS  
APPARATUS.

Frederick Jackson & Co.  
supply the various  
sections of Apparatus  
described in this  
work.

Price of the Apparatus for Gas Analysis, as described on  
page 117, **£3.**

Or with Battery, Coil, and Connections, complete, **£3 15s.**

Illustrated Price Lists free on application.

# CHARLES HEARSON & Co., Ltd.

---

*. . Incubator Makers,*

BY APPOINTMENT TO



HIS MAJESTY THE KING.

*Manufacturers of . . .*

**BIOLOGICAL and**  
**EMBRYOLOGICAL**  
**INCUBATORS,**  
ALSO  
**STERILIZERS, AIR PUMPS, EMBEDDING APPARATUS, &c.**

Scientists requiring special apparatus for Laboratory Work should avail themselves of our extensive knowledge and practical experience in every branch of Physical and Mechanical research.

---

*Address for full particulars :*

**BIOLOGICAL DEPARTMENT,**  
**235, Regent Street, W.,**  
**London, England.**

THE  
Royal Commission  
ON  
Sewage Disposal.

HENRY CROUCH'S  
"D. P. H."  
MICROSCOPE,

Fitted with  
1-in.,  $\frac{3}{4}$ -in.  
and  $\frac{1}{2}$ -in.  
(Oil-immersion, N.A.  
1.30) Objec-  
tives,  
Circular  
Dust-  
proof  
Triple  
Nose-  
piece,  
Three  
Eye-  
pieces,  
Abbe Condenser  
and Case, was  
supplied to  
H.M. Government  
for the work  
of the Royal  
Commission.

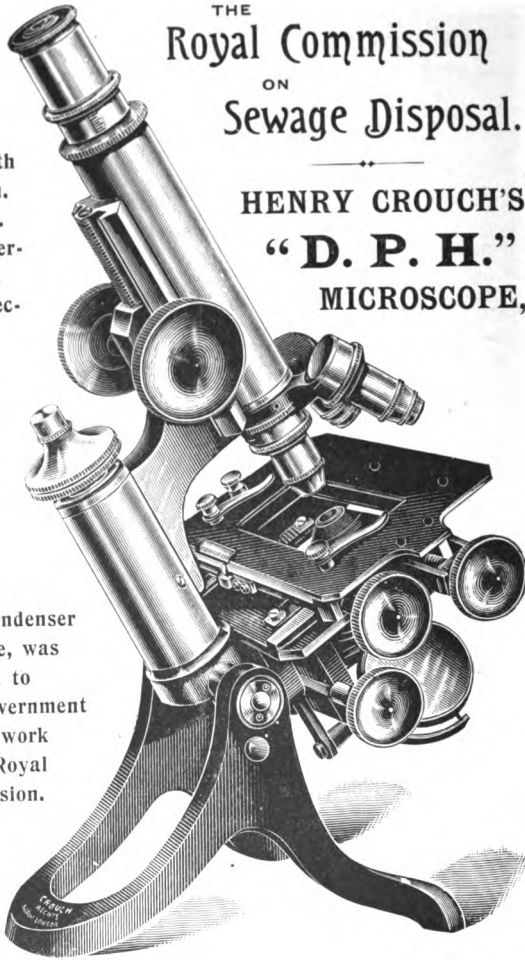

THE "D. P. H." MICROSCOPE.

*Full Particulars on application to*

**HENRY CROUCH,**

92, Duncombe Road, LONDON, N.

# **MATHER & PLATT, LD.**

---

---

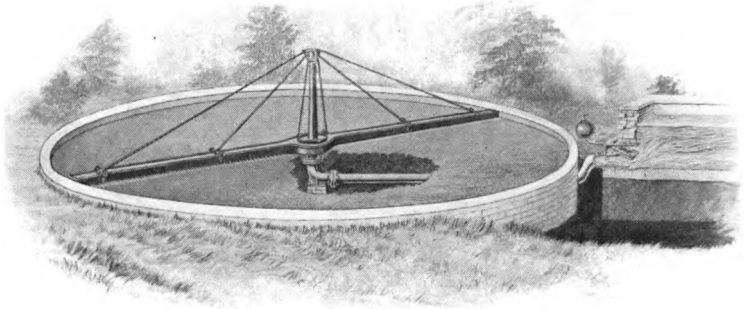

## **PATENT DISTRIBUTING GEAR**

For delivering Sewage to Filter Beds in regular succession, in measured quantities, or at regular intervals.

## **PATENT RETAINING AND DISCHARGING VALVE**

For "holding in contact" any required length of time.

## **PATENT REVOLVING SPREADER**

*(As Illustrated above).*

Reference, on application, to works already carried out, and appointments for seeing the same in operation.

---

---

# **MATHER & PLATT, LD.**

**Mechanical, Electrical, and Hydraulic Engineers,  
Salford Iron Works, MANCHESTER.**



# CARL ZEISS,

Optical Works, JENA.

*Branches: LONDON, BERLIN, FRANKFORT, and VIENNA.*

## Microscopes for Bacteriological Research.

### PHOTO- MICROGRAPHIC STAND.

**NEW MODEL.**

With wide body-tube, very sensitive new fine adjustment, specially designed for use with our Micro-planars, as well as for Photography with the very highest powers.

It can also be used with the same facility as any other Stand for ordinary visual observation.

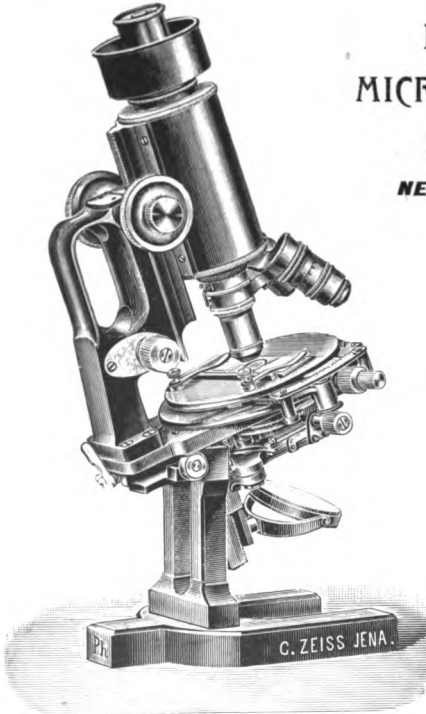

For full description of this, and of our Achromatic Objectives necessary for the highest class of Bacteriological Research, see NEW CATALOGUE OF MICROSCOPES, 1902, sent free on application to—

**CARL ZEISS, 29, Margaret St., Regent St., London, W.**

SOME REASONS WHY  
**ALUMINOFERRIC**

IS SO EXTENSIVELY USED FOR

**Sewage Purification.**

---

It is the best and most economical precipitant,

It gives a clear, colourless, and non-putrescible effluent,

It yields a less weight of sludge than any other precipitant,

It is exceedingly easy to use, requiring scarcely any labour,

And "holds the field" as a precipitant after many years' practical use.

---

SOLE MANUFACTURERS:—

**PETER SPENCE & SONS,**  
Manchester Alum Works,  
MANCHESTER.

THE  
STODDART  
CONTINUOUS SEWAGE  
FILTER.

---

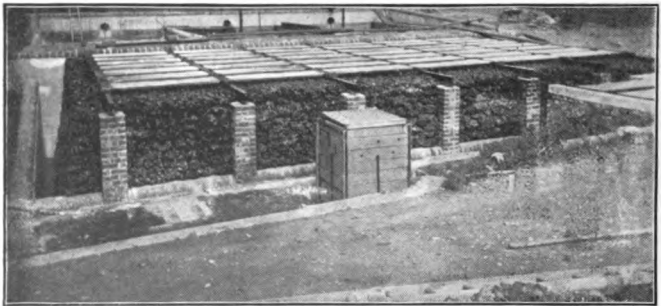

The Cheapest and most Reliable means of rendering  
Sewage permanently inoffensive.



*For all Particulars apply to . . .*

F. WALLIS STODDART,  
Western Counties' Laboratory,  
BRISTOL.

---

# X

# ADAMS'

## PATENT SEWAGE LIFT COY.,

(S. H. ADAMS, A.M.I.C.E.)

Engineering Specialists in the Manufacture  
of . . .

AUTOMATIC APPARATUS for

BACTERIA BEDS,

CONTINUOUS or

INTERMITTENT FILTERS, &c.

(Circular up to  $\frac{1}{2}$  acre, Rectangular  
beyond—or for less),

SEWAGE PUMPING Without Cost,

As installed for . . .

H.M. WAR OFFICE,

„ BOARD OF WORKS,

HOME AND FOREIGN GOVERNMENTS,

INSTITUTIONS, MANSIONS, &c.

Amongst others the Corporations of—

York, Manchester, Birmingham, Croydon, Epsom,  
Ealing, Sutton, Newmarket, St. Albans, Carlisle.

GOLD MEDAL, PARIS, &c.

*Works :*

**YORK, ENGLAND.**

*London Offices :*

**7, OLD QUEEN STREET,  
WESTMINSTER.**

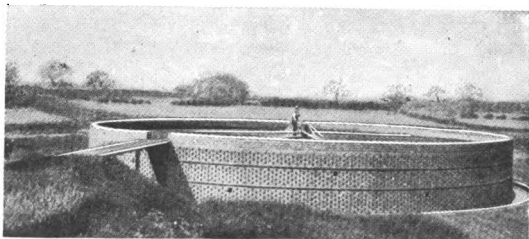

**THE YORK FILTER.**

# ROSS' NEW 'STANDARD'

## MICROSCOPE STANDS.

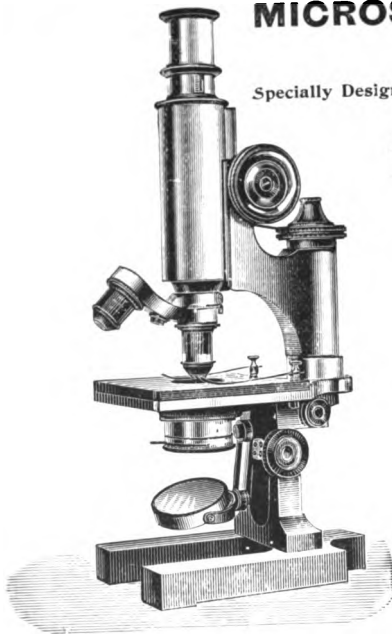

Specially Designed for

**BACTERIOLOGY,**  
**and every department of**  
**Microscopical Research.**

**bridged Specification.**

The **Body Tube** has the Continental length of 160 mm with the standard screw of the Royal Microscopical Society.

The **Stage** is attached to the lower portion of the limb so that great rigidity is secured. The stage plate is of vulcanite.

The **Mechanical Stage** has rectangular movements of about two inches.

The **coarse adjustment** is unusually substantial and sensitive. The motion obtained is sufficiently accurate for all necessary focussing without using the fine adjustment except in the case of high power objectives.

The **fine adjustment** affords an extremely sensitive and decided movement by the direct act on of the micrometer screw.

**FINEST ENGLISH OBJECTIVES AND OTHER ACCESSORIES.**

*"The best and most serviceable English Instruments  
ever offered at such Moderate Prices." . . . . .*

.....

For Prices and other particulars see Catalogue.

**ROSS, LTD.**

Estd. 1830.

**Branches**—31, Cockspur Street,  
Charing Cross, London, S.W.  
35, Boulevard du Temple, Paris.

**Agencies** in all Foreign Countries.

**Manufactory**—

Clapham Common, London, S.W.

**Manufacturers of MICROSCOPES,  
TELESCOPES, FIELD GLASSES,  
PHOTOGRAPHIC APPARATUS, &c.**

**111, New Bond St.,**

**LONDON, W.**

Medals and Highest Awards at all Great Exhibitions.  
**GRAND PRIX, PARIS, 1900.**



