

TT
520
R789



THE PRACTICAL DESIGNER

Revised Edition



For
Women's and Misses'
Jackets, Coats and Capes

Volume

1

By Prof. J. Rosenfeld

The Leading Pattern Company

DESIGNERS AND PUBLISHERS

PRACTICAL DESIGNER BUILDING

222 East 14th Street

New York, N. Y.



Class _____

Book _____

Copyright N^o _____

COPYRIGHT DEPOSIT.



THE PRACTICAL DESIGNER

REVISED EDITION
AN ENCYCLOPEDIA TO DESIGNERS AND CUTTERS

--FOR--

Women's, Misses', Juniors',
Children's and Infants'
Jackets, Coats, Capes, Waists, Skirts,
Riding Habits, Dresses and Underwear

-- WITH --

Grading, Special Garment Cutting,
Sketching and Tailoring

According to the most up-to-date and practical method.



SPECIALLY DESIGNED FOR SELF-INSTRUCTION

BY

Prof. I. ROSENFELD

PUBLISHED BY

The Leading Pattern Co.

NEW YORK. N. Y. 1918.

Copyrighted by Isidor Rosenfeld. Entered in the library of Congress Washington D. C. 1918

T1515
T1789

17. 16

33

AUG 21 1918

©CLA503175

(Eisen v. ...)

101



Prof. J. Rosenfeld

DEDICATED
TO THE MEMORY OF
BERNATH-ROSENFELD

THE PRACTICAL DESIGNER

I N D E X

VOLUME No.1

WOMEN'S AND MISSES' JACKETS, COATS AND CAPES.

Title	Page
Introduction	1
Grammar of Proportions	5-6
Rule of Proportions	7-8
Study of Height Proportions	9
How to Simplify Proportions	10-11
Proportional Height Scale	12
Study of Width Proportions	13
System of Practical Proportions	14-15
Test of Systematical Knowledge	16
Operative and Speculative Methods	17
Authority on Systematical Drafting	18
Model Testing	19
System of Practical Value	20-21
Study of Numbers	22
Scale Method for Drafting	23
Instructions to Begin	24
Measurement to Use	25
Measurement Figures	26
Standard Proportions for Women	27

WOMEN'S JACKETS, COATS AND CAPES.

Women's Foundation No. 1	30-31
Women's Foundation No. 2	32-33
Women's Blouse	34-35
Eton Jackets	36-37
Eton with Dart in Front	38
Eton with French Seam	39
Eton Front with Dart on Top	40-41
Half-fitting Jacket	42-43
Half-fitting Single-breasted French Seam—Broad Back	44-45
Half-fitting Double-breasted French Seam—Narrow Back	46-47
Vienna Front Half-fitting Jacket	48-49
Front Side Body Half-fitting Jacket	50-51
How to Make a Lost Dart in Front	52
Half-fitting Front with Dart on Top	53
Mannish Jacket with Shawl Collar	54-55
Half-fitting Jacket, Revere Front	56-57
Kimono Jacket, Shawl Collar	58-59
Collarless Kimono Jacket	60-61
Raglan or Balmaacan Jacket	62-63
Tight-fitting Foundation	64-65
Tight-fitting Jacket	66-67
Tight-fitting Jacket, Two Darts in Front	68-69
Tight-fitting French Seam Jacket	70-71



THE PRACTICAL DESIGNER

INDEX

Fourteen Gore Garment	72-73
Eighteen Gore Jacket	74-75
Double-breasted Box Coat	76-77
One-piece Box Coat	78-79
Raglan Top Coat	80-81
Long Half-fitted or Hipless Coat	82-83
Kimono or Balmaacan Coat	84-85
One-piece Balmaacan Sleeve	86-87
Raglan Sleeve on Top of Armhole	88-89
Collarless Coat with Deep Armhole and Sleeve	90-91
Short Two-piece Cape	92-93
Short Circle Cape	94-95
Circle Cape with Dart in Shoulder	96-97
Long Cape	98-99
Opera Cloak	100-101
Inverness or Cape Coat	102-103
Single-breasted Riding Coat	104-105
Cut-a-way Front for Riding Coat	106-107
Double-breasted Riding Coat	108-109
Single-breasted Collarless Vest	110-111
New Collarless Vest	112-113
Double-breasted Vest with Collar	114
How to Draft all Kinds of Different Sizes	115-116-117
Proportional Measurements for Stouts	118
Short and Stout Proportions	118
Study of the Stout Form	119
Box Coat for a Stout Form	120-121
How to Cut out Pattern from a Stout Form	122
Stout Half-fitting French Seam Jacket	123-124-125
Yoke for a Coat	126-127
Hood	128-129
Standing Collar	130
Automobile Collar	131
Turn-over Collar	132
Storm Collar	133
Sailor Collar with Stand	134
Convertible Collar	135
Foundation of Sleeve without Fullness	136-137
How to Finish Sleeve without Fullness	138-139
Sleeve with Direct Fullness	140-141
One-piece Sleeve with Fullness on Bottom	142
One-piece Sleeve with Fullness on Top	143
One-piece Tight-fitting Sleeve	144-145
Raglan Sleeve	146-147
Raglan Sleeve with Dart in Shoulder	148-149
Sleeve in Space of Armhole	150-151
One-piece Sleeve on Top of Armhole	152-153
How to Draft a Cuff	154

THE PRACTICAL DESIGNER

I N D E X

MISSES' JACKETS.

Problem of Misses' Sizes	226-227
Misses' Blouse Foundation	228-229
Misses' Blouse, Size 16 (Complete)	230-231
Misses' Half-fitting Jacket with Vienna Front	232-233
Misses' Half-fitting Jacket with French Seams	234-235
Misses' Single-breasted Tight-fitting French Seam Jacket	236-237
Standing Collar	238
Automobile Collar	238
Turn-over Collar	239
Storm Collar	239
Misses' Sleeve without Fullness	240-241
Rules and Regulations for Misses' Sleeves	242

Volume No. 2.

WOMEN'S AND MISSES' SKIRTS AND RIDING BREECHES.

Standard Proportions for Women's Skirts	155
Important Details on Skirts	156-157
Skirt Foundation	158-159
Two-piece Skirt	160-161
Five Gore Skirt	162-163
Six Gore Skirt	164-165
Seven Gore Skirt	166-167
Nine Gore Skirt	168-169
Eleven Gore Skirt. Flare Skirt	170-171
Fifteen Gore Skirt	172-173
Empire or Girdle Skirt	174-175
Flounce Skirt	176-177
Ripple or Circle Flounce Skirt	178-179
Princess Skirt	180-181
Peg Top Skirt-Standard Model	182-183
Circular Skirt	184-185
Circular Pleated Skirt	186-187
Many Width Circular Skirt	188-189
Tunic Skirt	190
Double Girdle Belt	191
Side Pleat Allowance on Skirt	192-193
Stout or Maternity Skirt	194-195
Extra Stout Skirt	196-197
Width of Bottom Changes on Skirts	198-199
Skirt with Seams Allowed	200-201
Size Changes on Skirts	202

THE PRACTICAL DESIGNER

I N D E X

MISSES' SKIRTS

Standard Proportional Measurements	243
Misses' Skirt Foundation	244-245
Misses' Five Gore Skirt	246-247
Misses' Five Gore Skirt with Seams Allowed	248-249
Rules and Regulations for Front Panels	250

WOMEN'S RIDING SKIRTS, BLOOMER'S, BREECHES AND PANTALOONS.

Problem of Riding Habits	204-205
Divided Riding or Bloomer Skirt	206-207
Side Saddle Riding Skirt-Front Part	208-209
Side Saddle Riding Skirt-Back Part	210-211
Bloomers-Front Part	212-213
Bloomers-Back Part	214-215
Riding Breeches-Front Part	216-217
Riding Breeches-Back Part	218-219
Pantaloons-Front Part	220-221
Pantaloons-Back Part	222-223
Riding Garment Illustrations	224

Volume No. 3.

WOMEN'S AND MISSES' BLOUSES, WAISTS AND PRINCESS DRESSES.

Women's Blouse	252-253
Women's Blouse (Continued)	254-255
Women's Blouse (Complete)	256-257
Deep Armhole Blouse	258-259
Drop Shoulder Blouse	260-261
Russian Blouse	262-263
Middy Blouse	264-265
Kimono Blouse Foundation	266-267
One-piece Kimono Blouse	268-269
Balmaacan Kimono Blouse	270
Kimono Blouse with Under Sleeve	271
Shirt Waist	272-273
Shirt Waist Lining	274-275
Blouse Lining with Two Darts in Front	276
Yoke on Blouse	277
Pleat Allowance on Blouse	278-279
Tunic Skirt for Blouses	280
Standing Collar	281
Turn-over Collar	282
High Standing Collar	283
Sailor Collar	284-285
Shield for Sailor Collar	286-287
Rolling Collar	288
Flat Collar	289



INTRODUCTION

RECOGNIZING the needs of a more up-to-date work on designing and pattern cutting for women's, misses', juniors', children's and infants' garments with all its branches, I continue this revised edition with a much greater development on the garment problem. Through many years of practical experience in teaching methods of designing and garment cutting for women's, misses', juniors', children's and infants' garments, and through a wide acquaintance with the needs of the trade, I have learned that a more simplified method of designing and pattern making is needed. I have therefore set my mind to a more clearly understood view of describing the art in many different calculations and to have it more and more simplified, which will be more acceptable to the student.

In my last publication, I have shown some of these views, which I am glad to say has been greatly appreciated and to show to my book-lovers that I appreciate their patronage, I now continue my work in a more up-to-date and practical way. Designers and pattern cutters will find this work of great value for its contents, as I have tested and found out all suggestions for all sorts of garment cutting: scales of several methods; calculations by which everyone who is interested will find his own views in them as they are fully explained in each foundation of garmentdom, which has been used in the past or which may be created in the future for women's, misses', juniors', children's and infants' garments.

The interest of this work impresses me to write such system from the out-grow of my long experience of teaching methods of designing and pattern cutting. As I fully believe that this method will lead everyone who studies this work to a mechanical controlling of up-to-date designing and pattern cutting for all kinds of female garments, as this work is to be a combination of simplicity and accuracy, which has never been published on these details. The natural result, I believe, will be found only by those who will carefully study this work and carefully read its pages, one by one, and will study the great many explanatory pages on this subject and also its practical points and how their effects are combined of many years traveling through the field, which leads to the most practical controlling without hesitation.



THE PRACTICAL DESIGNER

The system illustrated and explained in this revised edition, will undoubtedly give full understanding to the reader, why, or to what extent, a system is necessary as the methods in these pages are so distinctly described showing its great usefulness by its scientific points and, at the same time, the reader will find every impression made on these pages, step by step, worthy and well spent so that the enlargement of this edition is not only made to occupy more pages for this valuable work, but to give the great many more valuable facts, which will serve as a solid ground to every branch on designing and garment cutting and which will also be beautified by its modern features, which are explained thereon. I therefore hope it will be found so and appreciated by those interested to study this work.

I am sure that the one who studies this work will be led to a more mechanical controlling of practical knowledge, which will increase their power of up-to-date methods. The satisfaction I feel in completing this work, as I believe it to be, will enable the reader to master correct forms and explanations and to convey by means of his own ideas as they are often suggested in every line of business and by doing so, I am most sure that the student will employ the best method of this branch by applying his method and needs on positive proportions and practical details upon this work, which will lead them to great increase of power on the subject of designing and pattern making for women's, misses', juniors', children' and infants' garments.

The value of this book in which I am describing my methods is not only covering one or two branches of clothing the female body and describing its doings in one particular way, but I am giving full explanation of how to master every particular garment and producing the same in several different ways, which will teach practically every style on each branch, such as, women's, misses', juniors', children's and infants', coats, jackets, skirts, waists and dresses including grading, sketching, fitting, tailoring and dressmaking in many practical ways, and which will enlarge the talent of every student of this branch and connect them to the needs that are to be used from time to time.

I therefore hope that the methods as taught in this valuable work will bring that result, which I, as author, sincerely desire.

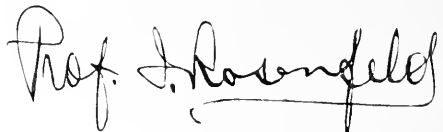

Author.



I. ROSENFELD'S SYSTEM

GRAMMAR OF PROPORTIONS FOR PATTERN CUTTING

FOR FEMALE GARMENTS

The grammar of proportions for pattern cutting for female garments is adapted from the first 10 numbers, which are producing the height and width proportions of the woman's body. These numbers are called grammar numbers and they are as follows: 1, 2, 3, 4, 5, 6, 7, 8, 9, 10 and shall be divided into 2 classes, called odd numbers and even numbers and they are originators of the height and width proportions.

To begin, let us first produce the regular width proportion number, which is size 36 for the woman's form therefore, let us write out the grammar numbers, 1, 2, 3, 4, 5, 6, 7, 8, 9, 10 and connect the odd and even numbers as follows. Now connect the odd numbers 1 and 3 and 5 and 7 and add these numbers as 1 and 3 is 4; 5 and 7 is 12. Now connect the even numbers, 2 and 4 is 6; 6 and 8 is 14 and add these numbers, which are 4 and 12, and 6 and 14, which amounts to 36 inches which is the size of the garment and the beginning number of the width proportions.

In order to get the other width proportional numbers add the beginning number of 36, which is 3, to the total amount of 36, which will make 39 inches for the standard bust measurement. To get the waist measurement, take $\frac{1}{3}$ of 36 inches and 1 inch less which is 11 and take these 11 inches from 36, which leaves 25 inches for the waist measurement. To get the hip measurement take $\frac{1}{2}$ of 36 and add it to the waist measurement, which is 25 inches and this will make 43 inches for the standard hip measurement.

To get the height proportions, the grammar numbers are again used as at the beginning 1, 2, 3, 4, 5, 6, 7, 8, 9, 10 and connect the beginning and ending numbers between 1 and 10. You will note that when we make connections of the first and last numbers of the 10 grammar numbers, which will now directly produce the total standard height for size 36, it will produce 5 different sections of 11 inches, which the total amounts to 55 inches and as these 55 inches do not fulfill the total for the standard height, we add one additional amount equal to one of these 5 sections, which amounts to 11 inches and then it will give a total of 66 inches, which is the total standard height for the size 36 form. Now continue and add the first and last numbers of the 10 grammar numbers as follows: 1 and 10 is 11. 2 and 9 is 11. 3 and 8 is 11. 4 and 7 is 11. 5 and 6 is 11.



THE PRACTICAL DESIGNER

Now use again the first numbers as 1 and 10 is 11 and multiply these numbers which makes 6 times 11, which amounts to 66 inches or 5 feet 6 inches, which is the total height of the body. This method is a necessity in order to know the increase or decrease for different height and width proportions. If the proportional measurements are changed, we shall know how much the measurements are increased or decreased, which may be changed from time to time.

The height proportions, which are given above by this method are only for women's sizes. The smaller sizes, which are misses, juniors, children and infants are also herewith explained according to the change of height necessary for their ages. The operation of each will be found in the following pages. The height for the different sizes are as follows:

Womens regular proportions are 5 feet 6 inches.

Misses' Sizes	18 shall measure in height 5 feet 5 inches.
	16. 5 feet 4 inches.
	14. 5 feet 3 inches.
Juniors' Sizes	18. 5 feet 4 inches.
	17. 5 feet 3 inches.
	16. 5 feet 2 inches.
	15. 5 feet 1 inch.
	14. 5 feet.
	13. 4 feet 11 inches.
Children's Sizes	14. 5 feet.
	12. 4 feet 10 inches.
	10. 4 feet 8 inches.
	8 4 feet 4 inches.
	6. 4 feet
Infants' Sizes	4. 3 feet 8 inches.
	3. 3 feet 6 inches.
	2. 3 feet 4 inches.
	1. 3 feet

1 or dividing the height see lesson called THE STUDY OF HEIGHT PROPORTIONS.

I. ROSENFELD'S SYSTEM

RULE OF PROPORTIONS

The rule of proportions already explained will be found equally divided and acceptable to the female figure and serves well to bring out the many valuable sections of the form. The height of the body is divided into 3 principal parts. The first part is the head space from the top of the head to the socket bone; the second part is the natural waist length in back, from the socket bone to the hollow of waist and the third part is the straight skirt length in front from the natural waist to the ground.

In order to better describe the height proportions, we are following the standard height of the female figure, which is 5 feet 6 inches or 66 inches including the space of the head. The total height is divided into 8 units. These units are planted for simplified purposes, as follows: 1 unit covers the head space; 2 units covers the total waist length in back and 5 units covers the length of skirt in front. In order to have each unit of the total height well memorized see diagram on this page giving the total height of the body and how to divide it into 8 units. This diagram is showing each unit separately and marked from 1 to 8 sections. To simplify this action divide the height of a 5 feet 6 inch form, which amounts to 66 inches into the various sections and indicate the amount of each section and the total amount of all sections.

One-eighth	amounts to	8 $\frac{1}{4}$ inches
Two-eighths	" "	16 $\frac{1}{2}$ inches
Three-eighths	" "	24 $\frac{3}{4}$ inches
Four-eighths	" "	33 inches
Five-eighths	" "	41 $\frac{1}{4}$ inches
Six-eighths	" "	49 $\frac{1}{2}$ inches
Seven-eighths	" "	57 $\frac{3}{4}$ inches
Eight-eighths	" "	66 inches

for the height of 5 feet 6 inches.

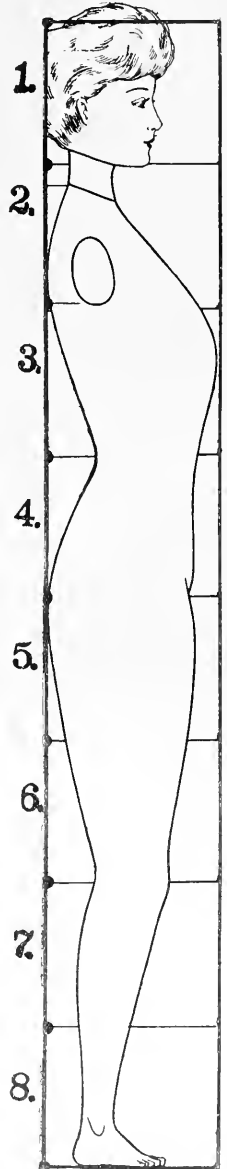

THE PRACTICAL DESIGNER

THE STUDY OF HEIGHT PROPORTIONS

In order to simplify the method of height proportions watch diagram on opposite page, which will fully describe the method of height proportions. Having the total height of a figure measuring 5 feet 6 inches, which amounts to 66 inches draw a straight line of this total height A and B and square a line on top from A to C and there measure $\frac{1}{2}$ of the length amounting to 33 inches. Before going any further immediately figure out $\frac{1}{8}$ of the total height which amounts to 8 $\frac{1}{4}$ inches for this particular height and measure from A to J $\frac{1}{8}$ of height, J to I $\frac{1}{8}$ of height and also from I to E $\frac{1}{8}$ of height, which will make $\frac{3}{8}$ of height used at point E and draw a line across from E to F, which will indicate the space from the top of head to the natural waist line and it will be understood that the balance which is from E to B will be the straight full length of skirt. Now take $\frac{1}{3}$ of the space from A to E and this will make J which is the head space. Then take 1 inch below J, which makes K and divide the space from K to E, which makes I and raise up $\frac{3}{4}$ of an inch to make L. Now make clear these spaces to yourself as follows:

The space from A to J is the head space. From J to K is 1 inch for collar stand. From K to E is the natural waist length and in order to divide the waist length for back depth and under-arm length, figure the back depth from K to L and the under-arm length from L to E. Note that the lines at K, L and E are drawn into the figure. It shall be understood that the natural waist length for this height is 15 $\frac{1}{2}$ inches, back depth 7 inches and under-arm length 8 $\frac{1}{2}$ inches. From A to C is $\frac{1}{2}$ the total height. Now draw a line from C to B and cross a line from E to F. Divide the space from E to F which makes G and sweep or curve from G to H. This will make the space from E to H 10 $\frac{1}{2}$ inches for the full hip length. In order to continue divide the space from H to B which makes M. From M to N raise up 2 inches which will give the proper point for the knee. The total space between E and B gives the full length of the skirt as mentioned above. This will finish the entire height of the body and it shall not make any difference whatever the height may be, shorter or taller, the very same method of dividing shall be used.

The size may be connectable to any height as the height is regulated by its own length according to the divisions given in this problem, or the table elsewhere given in this work. When the height increases, the length of the natural waist in front and back also increases in the same manner. The scale which is given includes the allowances needed in drafting. To make the system of proportions perfectly clear and easy to use for the student, a table of sizes is prepared which will quickly assist in obtaining results of these measurements. It is to be understood that this method is only used for women's or misses' sizes. For junior's, children's and infants' garments follow the same method of dividing the height for the natural waist length. These 3 different models differ greatly in the preparation of the back depth because they do not wear any tight corsets and therefore the change is made between the socket bone and the waist line, which calls for the back depth.

For children's sizes for instance, take size 10 for which the waist length is about 13 inches. Divide these 13 inches which will make 6 $\frac{1}{2}$ inches and take off only $\frac{1}{4}$ of an inch from 6 $\frac{1}{2}$ inches, which will leave 6 $\frac{1}{4}$ inches for back depth and for under arm length 6 $\frac{3}{4}$ inches. The reason these changes are made in the different sizes is to lengthen the deepness of the back length which is needed for this size regarding the good-fitting garment.

For infants' sizes for which the model size is 4 and the waist length is 10 inches, in this case, divide the waist length in half and use 5 inches for the back depth and 5 inches for under-arm length which means an equal division. In order to prepare the back depth, divide the waist line. For instance for junior's size 15, which amounts to 14 $\frac{1}{4}$ inches take $\frac{1}{2}$ of this which makes 7 $\frac{1}{8}$ inches and take off a $\frac{1}{2}$ inch from 7 $\frac{1}{8}$ inches making 6 $\frac{5}{8}$ inches for back depth. Now add a $\frac{1}{2}$ inch which you have taken off from 7 $\frac{1}{8}$ and add it to the lower half of 7 $\frac{1}{8}$ which will make the under-arm length 7 $\frac{3}{8}$ inches.

I. ROSENFELD'S SYSTEM

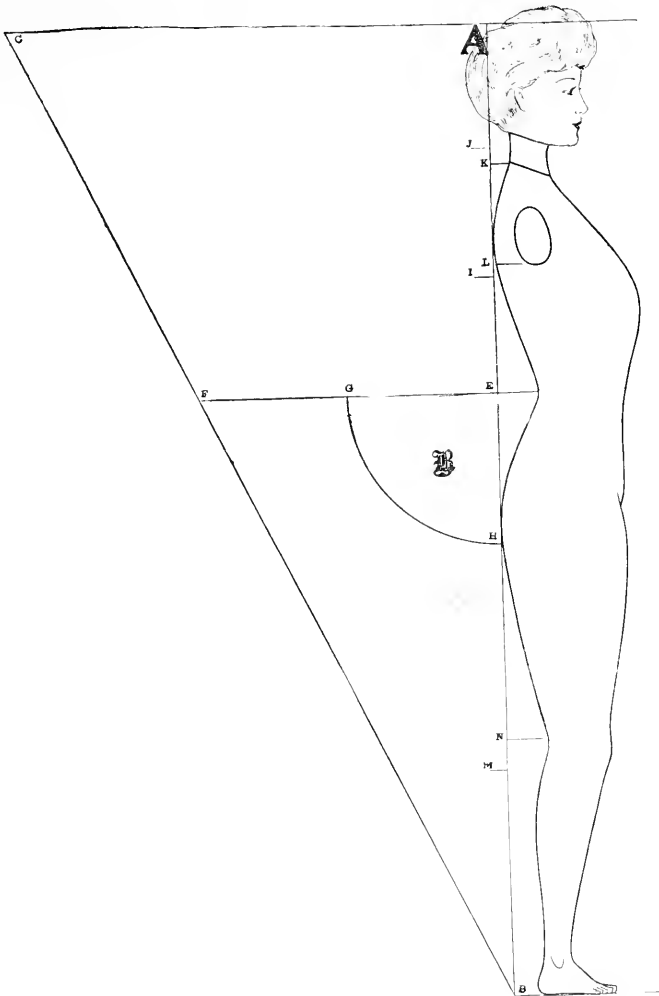



THE PRACTICAL DESIGNER

HOW TO SIMPLIFY THE PROPORTIONAL HEIGHTS

The proportional and automatic table of sizes on the opposite page gives the length for back depth, under-arm, natural waist length and skirt length, ranging from 5 to 6 feet and is arranged to correspond with the width of breast from 32 to 48 inches and it can be easily calculated to any size. The first number in each small box on the opposite table of proportions is the natural waist length, the second number is the back depth and the third number is the under-arm length. On the bottom of this table of proportions we have the proportional skirt length for any height wanted. The sides and back lengths are to be followed according to the style of length for skirts, which may be indicated by the all around hip measurement from time to time. Therefore, if the style of hip is large or small, the side and back lengths may be increased or decreased in length. The complete length is placed under the height number and it gives the length of the front skirt. This table gives 147 different sizes and many more combinations, which are valuable and simplifies the method of obtaining correct measurements. In applying it in practical use, we give the following examples, which will make it clear and easily understood.

Suppose we have a person measuring 36 breast and whose height is 5 feet 6 inches and we want to find the proportional measurements used for drafting. First look for the breast size 36 on the left side of the opposite table and on top of that table the height of 5 feet 6 inches. Now find size 36 squaring with a straight line to 5 feet 6 inches and we find in the little box space $15\frac{1}{2}$ inches natural waist length, 7 inches back depth and $8\frac{1}{2}$ inches under-arm length. For instance, let us take another example, size 42 and 5 feet 10 inches in height. First look below 5 feet 10 inches and then opposite size 42 and we find there the length of waist $16\frac{7}{8}$ inches, $7\frac{7}{8}$ inches back depth and 9 inches under-arm length. In the same way we find each and every size for use.

In drafting proportionate garments apply the sizes found on the scale or table of proportions and when the height increases or decreases find the proper size. This can be easily found because it is seldom necessary to try more than two sizes. The manner of using the table for short or tall persons is the same as for the regular form. By using the table of proportions in the manner explained, any size corresponding to the form can be easily found and it is therefore valuable not only for the regular height, but also for the tall and short forms.

I. ROSENFELD'S SYSTEM

PROPORTIONAL HEIGHT SCALE TABLE FOR FEMALE FIGURES

Height in Feet	5	5/1	5/2	5/3	5/4	5/5	5/6	5/7	5/8	5/9	5/10	5/11	5/12
SIZES													
32	13 $\frac{3}{4}$ 6 7 $\frac{3}{4}$	14 6 $\frac{1}{8}$ 7 $\frac{7}{8}$	14 $\frac{1}{4}$ 6 $\frac{1}{4}$ 8	14 $\frac{1}{2}$ 6 $\frac{3}{8}$ 8 $\frac{1}{8}$	14 $\frac{3}{4}$ 6 $\frac{1}{2}$ 8 $\frac{1}{4}$	15 6 $\frac{5}{8}$ 8 $\frac{3}{8}$	15 $\frac{1}{4}$ 6 $\frac{3}{4}$ 8 $\frac{1}{2}$	15 $\frac{1}{2}$ 6 $\frac{7}{8}$ 8 $\frac{5}{8}$	15 $\frac{3}{4}$ 7 8 $\frac{3}{4}$	16 7 $\frac{1}{8}$ 8 $\frac{7}{8}$	16 $\frac{1}{4}$ 7 $\frac{1}{4}$ 9	16 $\frac{1}{2}$ 7 $\frac{3}{8}$ 9 $\frac{1}{8}$	16 $\frac{3}{4}$ 7 $\frac{5}{8}$ 9 $\frac{1}{4}$
34	13 $\frac{7}{8}$ 6 $\frac{1}{8}$ 7 $\frac{3}{4}$	14 $\frac{1}{8}$ 6 $\frac{1}{4}$ 7 $\frac{7}{8}$	14 $\frac{3}{8}$ 6 $\frac{3}{8}$ 8	14 $\frac{5}{8}$ 6 $\frac{1}{2}$ 8 $\frac{1}{8}$	14 $\frac{7}{8}$ 6 $\frac{5}{8}$ 8 $\frac{1}{4}$	15 $\frac{1}{8}$ 6 $\frac{3}{4}$ 8 $\frac{3}{8}$	15 $\frac{3}{8}$ 6 $\frac{7}{8}$ 8 $\frac{1}{2}$	15 $\frac{5}{8}$ 7 8 $\frac{5}{8}$	15 $\frac{7}{8}$ 7 $\frac{1}{8}$ 8 $\frac{3}{4}$	16 $\frac{1}{8}$ 7 $\frac{1}{4}$ 8 $\frac{7}{8}$	16 $\frac{3}{8}$ 7 $\frac{3}{8}$ 9	16 $\frac{5}{8}$ 7 $\frac{1}{2}$ 9 $\frac{1}{8}$	16 $\frac{7}{8}$ 7 $\frac{5}{8}$ 9 $\frac{1}{4}$
36	14 6 $\frac{1}{4}$ 7 $\frac{3}{4}$	14 $\frac{1}{4}$ 6 $\frac{3}{8}$ 7 $\frac{7}{8}$	14 $\frac{1}{2}$ 6 $\frac{1}{2}$ 8	14 $\frac{3}{4}$ 6 $\frac{5}{8}$ 8 $\frac{1}{8}$	15 6 $\frac{3}{4}$ 8 $\frac{1}{4}$	15 $\frac{1}{4}$ 6 $\frac{7}{8}$ 8 $\frac{3}{8}$	15 $\frac{1}{2}$ 7 8 $\frac{1}{2}$	15 $\frac{3}{4}$ 7 $\frac{1}{8}$ 8 $\frac{5}{8}$	16 7 $\frac{1}{4}$ 8 $\frac{3}{4}$	16 $\frac{1}{4}$ 7 $\frac{3}{8}$ 8 $\frac{7}{8}$	16 $\frac{1}{2}$ 7 $\frac{1}{2}$ 9	16 $\frac{3}{4}$ 7 $\frac{5}{8}$ 9 $\frac{1}{8}$	17 7 $\frac{3}{4}$ 9 $\frac{1}{4}$
38	14 $\frac{1}{8}$ 6 $\frac{3}{8}$ 7 $\frac{3}{4}$	14 $\frac{3}{8}$ 6 $\frac{1}{2}$ 7 $\frac{7}{8}$	14 $\frac{5}{8}$ 6 $\frac{3}{4}$ 8	14 $\frac{7}{8}$ 6 $\frac{3}{4}$ 8 $\frac{1}{8}$	15 $\frac{1}{8}$ 6 $\frac{7}{8}$ 8 $\frac{1}{4}$	15 $\frac{3}{8}$ 7 8 $\frac{3}{8}$	15 $\frac{5}{8}$ 7 $\frac{1}{8}$ 8 $\frac{1}{2}$	15 $\frac{7}{8}$ 7 $\frac{1}{4}$ 8 $\frac{5}{8}$	16 $\frac{1}{8}$ 7 $\frac{3}{8}$ 8 $\frac{3}{4}$	16 $\frac{3}{8}$ 7 $\frac{1}{2}$ 8 $\frac{7}{8}$	16 $\frac{5}{8}$ 7 $\frac{5}{8}$ 9	16 $\frac{7}{8}$ 7 $\frac{3}{4}$ 9 $\frac{1}{8}$	17 $\frac{1}{8}$ 7 $\frac{7}{8}$ 9 $\frac{1}{4}$
40	14 $\frac{1}{4}$ 6 $\frac{1}{2}$ 7 $\frac{3}{4}$	14 $\frac{1}{2}$ 6 $\frac{3}{8}$ 7 $\frac{7}{8}$	14 $\frac{3}{4}$ 6 $\frac{3}{4}$ 8	15 6 $\frac{7}{8}$ 8 $\frac{1}{8}$	15 $\frac{1}{4}$ 7 8 $\frac{1}{4}$	15 $\frac{1}{2}$ 7 $\frac{1}{8}$ 8 $\frac{3}{8}$	15 $\frac{3}{4}$ 7 $\frac{1}{4}$ 8 $\frac{1}{2}$	16 7 $\frac{3}{8}$ 8 $\frac{3}{8}$	16 $\frac{1}{4}$ 7 $\frac{1}{2}$ 8 $\frac{3}{4}$	16 $\frac{1}{2}$ 7 $\frac{5}{8}$ 8 $\frac{7}{8}$	16 $\frac{3}{4}$ 7 $\frac{3}{4}$ 9	17 7 $\frac{7}{8}$ 9 $\frac{1}{8}$	17 $\frac{1}{4}$ 8 9 $\frac{1}{4}$
42	14 $\frac{3}{8}$ 6 $\frac{5}{8}$ 7 $\frac{3}{4}$	14 $\frac{5}{8}$ 6 $\frac{3}{4}$ 7 $\frac{7}{8}$	14 $\frac{7}{8}$ 6 $\frac{7}{8}$ 8	15 $\frac{1}{8}$ 7 8 $\frac{1}{8}$	15 $\frac{3}{8}$ 7 $\frac{1}{8}$ 8 $\frac{1}{4}$	15 $\frac{5}{8}$ 7 $\frac{1}{4}$ 8 $\frac{3}{8}$	15 $\frac{7}{8}$ 7 $\frac{3}{8}$ 8 $\frac{1}{2}$	16 $\frac{1}{8}$ 7 $\frac{1}{2}$ 8 $\frac{5}{8}$	16 $\frac{3}{8}$ 7 $\frac{5}{8}$ 8 $\frac{3}{4}$	16 $\frac{5}{8}$ 7 $\frac{3}{4}$ 8 $\frac{7}{8}$	16 $\frac{7}{8}$ 7 $\frac{7}{8}$ 9	17 $\frac{1}{8}$ 8 9 $\frac{1}{8}$	17 $\frac{3}{8}$ 8 $\frac{1}{8}$ 9 $\frac{1}{4}$
44	14 $\frac{1}{2}$ 6 $\frac{3}{4}$ 7 $\frac{3}{4}$	14 $\frac{3}{4}$ 6 $\frac{7}{8}$ 7 $\frac{7}{8}$	15 7 8	15 $\frac{1}{4}$ 7 $\frac{1}{8}$ 8 $\frac{1}{8}$	15 $\frac{1}{2}$ 7 $\frac{1}{4}$ 8 $\frac{1}{4}$	15 $\frac{3}{4}$ 7 $\frac{3}{8}$ 8 $\frac{3}{8}$	16 7 $\frac{1}{2}$ 8 $\frac{1}{2}$	16 $\frac{1}{4}$ 7 $\frac{5}{8}$ 8 $\frac{5}{8}$	16 $\frac{1}{2}$ 7 $\frac{3}{4}$ 8 $\frac{3}{4}$	16 $\frac{3}{4}$ 7 $\frac{7}{8}$ 8 $\frac{7}{8}$	17 8 9	17 $\frac{1}{4}$ 8 $\frac{1}{8}$ 9 $\frac{1}{8}$	17 $\frac{1}{2}$ 8 $\frac{1}{4}$ 9 $\frac{1}{4}$
46	14 $\frac{5}{8}$ 6 $\frac{7}{8}$ 7 $\frac{3}{4}$	14 $\frac{7}{8}$ 7 7 $\frac{7}{8}$	15 $\frac{1}{8}$ 7 $\frac{1}{8}$ 8	15 $\frac{3}{8}$ 7 $\frac{1}{4}$ 8 $\frac{1}{8}$	15 $\frac{5}{8}$ 7 $\frac{3}{8}$ 8 $\frac{1}{4}$	15 $\frac{7}{8}$ 7 $\frac{1}{2}$ 8 $\frac{3}{8}$	16 $\frac{1}{8}$ 7 $\frac{5}{8}$ 8 $\frac{1}{2}$	16 $\frac{3}{8}$ 7 $\frac{3}{4}$ 8 $\frac{5}{8}$	16 $\frac{5}{8}$ 7 $\frac{7}{8}$ 8 $\frac{3}{4}$	16 $\frac{7}{8}$ 8 8 $\frac{7}{8}$	17 $\frac{1}{8}$ 8 $\frac{1}{8}$ 9	17 $\frac{3}{8}$ 8 $\frac{1}{4}$ 9 $\frac{1}{8}$	17 $\frac{5}{8}$ 8 $\frac{3}{8}$ 9 $\frac{1}{4}$
48	14 $\frac{3}{4}$ 7 7 $\frac{3}{4}$	15 7 $\frac{1}{8}$ 7 $\frac{7}{8}$	15 $\frac{1}{4}$ 7 $\frac{1}{4}$ 8	15 $\frac{1}{2}$ 7 $\frac{3}{8}$ 8 $\frac{1}{8}$	15 $\frac{3}{4}$ 7 $\frac{1}{2}$ 8 $\frac{1}{4}$	16 7 $\frac{5}{8}$ 8 $\frac{3}{8}$	16 $\frac{1}{4}$ 7 $\frac{3}{4}$ 8 $\frac{1}{2}$	16 $\frac{1}{2}$ 7 $\frac{7}{8}$ 8 $\frac{5}{8}$	16 $\frac{3}{4}$ 8 8 $\frac{3}{4}$	17 8 $\frac{1}{8}$ 8 $\frac{7}{8}$	17 $\frac{1}{4}$ 8 $\frac{1}{4}$ 9	17 $\frac{1}{2}$ 8 $\frac{3}{8}$ 9 $\frac{1}{8}$	17 $\frac{3}{4}$ 8 $\frac{1}{2}$ 9 $\frac{1}{4}$
PROPORTIONAL SKIRT LENGTH													
Front	37 $\frac{1}{2}$	38 $\frac{1}{8}$	38 $\frac{3}{4}$	39 $\frac{3}{8}$	40	40 $\frac{5}{8}$	41 $\frac{1}{4}$	41 $\frac{7}{8}$	42 $\frac{1}{2}$	43 $\frac{1}{8}$	43 $\frac{3}{4}$	44 $\frac{3}{8}$	45



THE PRACTICAL DESIGNER

THE STUDY ON WIDTH PROPORTIONS

There is somehow or other a misunderstanding regarding the importance of width proportions in behalf of the chest, bust, waist and hip measurements for women's garments. The majority fail to think of this great importance and this is why the question of the standard measurement for bust, waist and hip was never answered. The bust measurement especially, was a misunderstood question.

It often happens that a bust measurement is not known, or if it is known, it is not known how much the bust should be for a 36 size or how the bust should be increased for the size wanted and so it happens with all other width measurements, such as waist and hip. I have therefore prepared a practical outline shown on the opposite page for simplifying this method by clearly showing and explaining how to make and test such measurements for yourself. To control these width proportions have patience and read carefully the further instructions. See diagram on opposite page.

To begin showing the operations of the width division, draw a line from A to B. This is $\frac{1}{3}$ of 36 amounting to 12 inches. C is half of A and B. Now make a circle by C to meet A and B and this circle will measure 36 inches representing size of chest measurement. Then draw a line from C to D and this space measure also 12 inches or $\frac{1}{3}$ of 36. Now connect lines from A to D and from B to D and measure for bust from A, B and D and up to A. This will give bust measurement 39 inches. Now divide between A and C, which makes E and between C and B, which makes F and connect with lines to D. Measure these lines from F to D and E to D. This will give waist measurement, 25 inches. For hip measurement make from C to D $\frac{1}{3}$, which is from C to G, and measure from C to G. From A, B, D and A will give hip measurement, 43 inches. These width measurements are the standard proportional measurements for size 36, which will serve in the future for knowing if an increase or decrease is made in the change of width proportions.

The above mentioned instruction of how to produce width proportions, is only to prove how such proportions are produced, which is also shown and described with a diagram to make things clearly understood. It shall be well understood and well memorized of how much space there is from the chest or size to bust measurement, from bust to waist and waist to hip and it shall be clearly understood that the use of these are to a great extent necessary in knowing the changes of measurements made, from time to time. These instructions, which are produced on diagram on the opposite page may be followed for all proportional sizes, which are as follows: sizes 36, 38 and 40. We do not include 42 and 44 because these two sizes are forming to somewhat stoutness of which the waist measurement may be increased in width. Changes on width proportions for either size are only made in order to build the model of fashion for each season and such measurements can be had by the author of this book, free of charge.

I. ROSENFELD'S SYSTEM

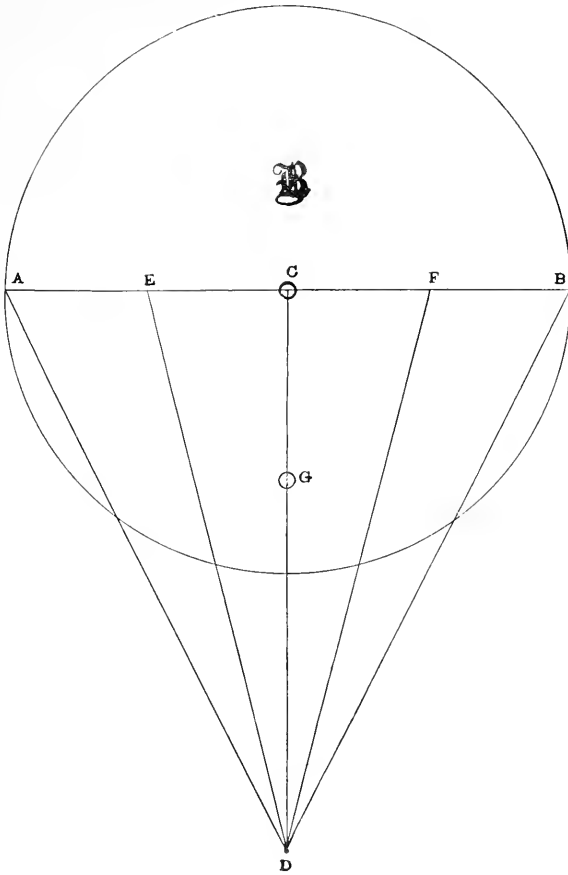

THE PRACTICAL DESIGNER

THE SYSTEM OF PRACTICAL PROPORTIONS

The system of proportions is divided into two different divisions, which are height and width proportions and these are explained in the front pages of this book, each and everyone separately, but in order to make the system of proportions practical for use, it will be necessary to produce first the measurement of the average or standard height, which is 5 feet 6 inches and also take the regular size number, which is 36 and which will then make the combination of the height and width proportions by which is meant that the size 36 shall have $15\frac{1}{2}$ inches natural waist length. In order to well understand the relationship between the height and width proportions, it is first necessary to understand that 5 feet 6 inches is the average and medium height and size 36 is the average and standard width for the model use. It shall therefore be understood that 5 feet 6 inches is the regular height and size 36 is the regular width for proportionate combinations. In order to have a clearer view on this subject see diagram of each of these methods, which are the systems of height and width proportions or a grammar of proportions or a grammar of garment cutting, which is shown in the very beginning pages fully explaining this subject.

When the connection between height and width proportions are already understood and made, it is necessary to see what shall be the increase of the natural waist length in back for the next size of the very same height. You will find full explanation in the front pages that when increasing 1 inch additional to the height, the waist length in such case, increases $\frac{1}{4}$ of an inch and the reason you may understand when studying height proportions. But let us now see the difference of how to obtain the waist length or how much shall be increased of the waist length when preparing a size 38 of the same particular height as the 36 model is based on. For instance, if the waist length for size 36 according 5 feet 6 inches amounts to $15\frac{1}{2}$ inches, increase for the waist length for size 38, $\frac{1}{8}$ of an inch for the very same height and remember that when we figure or desire to obtain the waist length according to the height or any other measurement by height, divide the entire height into 8 divisions. We find that when the waist length is obtained according to the height it is proportionately gotten from $\frac{1}{4}$ of the height and it is to be understood that in case of increasing that height of 1 inch, it is necessary that the $\frac{1}{4}$ of an inch is additionally increased to the waist length and which then makes the waist length of 5 feet 7 inches, $15\frac{3}{4}$ inches. When not having the height increased but only the size increased divide the $\frac{1}{4}$ of an inch between size 36 and size 38 into half, which will make the waist length for size 38 $15\frac{5}{8}$ inches. It shall be understood that the waist length for the same height and different sizes is not increased for the purpose of increasing the waist length, but is prepared for the development of each larger size for the very same height, or shorter for smaller sizes and to make this clear that everything should be understood look into this matter the following way.

When the total height is increased 1 inch, the waist length is increased $\frac{1}{4}$ of an inch because the waist length is a production of $\frac{1}{4}$ of the total height and in such case the $\frac{1}{4}$ of an inch, which is increased in waist length is equally divided into $\frac{1}{8}$ for back depth and $\frac{1}{8}$ for under-arm length. When the waist length does not increase in height but for size only, in such case, increase $\frac{1}{8}$ for the waist length because the height remains and the $\frac{1}{8}$ of an inch is there to increase the back depth which indirectly increases the waist length, thereby, the armhole is made larger or smaller for the smaller sizes.

I. ROSENFELD'S SYSTEM

TEST OF SYSTEMATICAL KNOWLEDGE AND THEIR PRINCIPLES

The system of designing and pattern cutting shall be carried out with a great many principles. The first one of the principles is to know the different sorts of fitting: as the tight-fitting, half-fitting, three-quarter fitting and full fitting. Every one of these garments shall be adopted in a different manner and shape. The tight-fitting garment has its strict fitting points and the spaces between gores are not changeable for any reason. Before testing the waist and hip for tight-fitting patterns have seams taken off both sides of the gores and after measuring for each gore, it shall amount to half of the waist measurement wanted for the size. The half-fitting garments shall be tested the same way as the tight-fitting, except the waist. It is not necessary that the waist for half-fitting garments should be tested. Should you want to measure it measure half of the size wanted without the seams taken off. For size 36, the waist should measure 18 inches, including seams, or it shall measure 3 inches more than the waist measurement. The hip for tight or half-fitting garments shall always be full and shall be tested for tight and half-fitting alike, with the exception that the half-fitting garment may be one inch larger. The waist of the half-fitting garment shall be increased with the curving or shaping of the waist, which makes it three-quarter fitting. The full fitting garment, called the box coat, is only cut in two parts. No shape or waist effect is required, therefore the waist shall not be tested. The hip is to be measured and direct allowance is to be made for fullness.

Model patterns should be tested before they are used for fashion work or grading. The testing should begin at the depth of size, natural waist length or full length coat. The size should be carefully examined at the neck and arm-hole, as these parts of the garment are the most important parts built for the size, otherwise the size number is not measured across the chest and is only a controlling number for its use.

The bust measurement is directly adapted for the connection to the size or so-called chest measurement and is an increase on the chest line and shows the development of the bust. This bust measurement is changed into action after drafts are required. The bust line can, therefore, be adapted, which is drawn from the back depth point to the front part between the regular breast and waist line at the front part where the bust can be measured for testing the bust measurement if necessary, and by all means all seams shall be deducted in order to get the actual measurement of the bust.

When measuring waists, measure on the waist line and towards the front and measure on the long waist line and not on the straight waist line. The bottom of short coats shall not be measured. Full length coats or capes shall measure half way as much as the full length of the garment. Suppose the length of the coat or cape is 50 inches, half of coat or cape shall also measure 50 inches. This means that the full bottom shall be 100 inches. It shall be understood that this width is the fullest to be made, but in order to follow the style from time to time, you can make the width of bottom of long coats and capes accordingly.



THE PRACTICAL DESIGNER

THE OPERATIVE AND SPECULATIVE METHODS ON PATTERN CUTTING

The art of **designing** is divided into two different branches, which are operative and speculative. By the operative method we create all fundamental divisions, which we use from time to time to prepare all foundation lines for pattern drafting of all model patterns employed for manufacturing of all kinds of garments. The foundation patterns are no doubt the most necessary, as they are the foundations of every particular style. It is necessary, therefore, to understand that these outlines are the operative parts in connection with designing and pattern cutting for all kinds of branches on garment cutting, which will therefore be known that all systematical productions of proportions and pattern drafting are the most constructive parts on garment production.

The **speculative method** is an entirely different proposition of carrying out the production of styles which are produced from time to time. It is, no doubt, necessary that in order that we may build styles, we are in need of many well controlling ideas so that we may be able to produce well developed ideas, which means taste and effects and are, therefore, called the speculative branch on designing and pattern cutting.

Taste and effects are positively no systematical productions. It is a self production of well tried out experience of garment production and of a great deal of confidence, which is the main controlling idea on this subject. It shall therefore be understood that in order to gain confidence through ourselves, it is necessary for us to become well acquainted with all the modern and practical peculiarities of how to prepare all the proportions, so that we shall know each and every part of the garment separately in order that we may not be kept back in going forward with all the practical work. It is also necessary that before we may employ a method of any style, we need to have the acquaintance of how to produce all proportions and systematical foundation patterns for all different principles for making connections of style by which we practice the speculative method on designing and pattern making.

I. ROSENFELD'S SYSTEM

AUTHORITY ON SYSTEMATICAL DRAFTING

There was a question asked, which has never been answered yet and that is—What do we call systematical pattern drafting? If there is such, how can we prove same to a mechanical controlling that every person may learn its full understanding?

Authority on systematical drafting can be easily proved to those who are in favor of knowing How, Why and When. The systematical production of pattern drafting is to be applied to a system of producing proportions before beginning systematical drafting, and when employing such methods of first producing proportional measurements, we no doubt employ the practical system of pattern drafting. In order to explain its practical use, I shall begin as follows:

Before commencing to draft, it shall be understood by the pattern drafter that we are making use of inches, and every one of the inches we employ in drafting is divided into eight-eighths. It shall therefore be understood that we have eight-eighths to an inch and put these numbers down as follows: 1, 2, 3, 4, 5, 6, 7, 8. Now let us add—1 and 8 are 9, 2 and 7 are 9, 3 and 6 are 9, 4 and 5 are 9. After these addings we find 4 times 9, for which the total amounts to 36, which immediately serves for the woman's model size, which gives us instruction that we are to use a woman's model size 36. In order not to waste any space, look for full proportions of size 36, which you will find in the proportional tables in the following pages and let us now continue with another important division for drafting. It shall also be understood that in order to produce a systematical outline of pattern drafting, we need to understand that drafting consists of two actions, which means two productions, teaching us that the human form is built in two different manners, called height and width. As I have before described how to obtain the breast, which is the width measurement, I shall therefore show how to obtain the waist length in back, which is the production of the height, and in order to continue in placing such waist length, we need again remember the eight divisions of the inches and at the same time, we need to take the proportional height of the body, which is considered as 5 feet 6 inches, of which the entire instruction or pages are shown in the front part, and also showing how to obtain all measurements according to either height, but in order to describe the eight divisions of an inch, it shall be understood that the height division is also divided into eight equal parts and serves for each and every part of the human form; $\frac{1}{8}$ of the total height of the body will serve for head space; $\frac{2}{8}$ for the full waist length in back and $\frac{5}{8}$ will serve for the full length of skirt in front.

Now we are about ready to know what authority on pattern drafting is, and in order to clearly understand it, it is necessary to know that we need a method of producing all measurements of width and height proportions, and at the same time to comply with the methods which give us a well-understood operation, which is the medium height for practical use according to such height proportion and which is the average width measurement for such as a model size. For such instruction see the front pages or the Grammar of Designing and Garment Cutting and the beginning of this article will fully simplify the entire method herewith described, which will be of great help in considering how to obtain all proportionate measurements by systematical methods for the height and width proportions for all the different sizes.



THE PRACTICAL DESIGNER

MODEL TESTING

In beginning to draft a model pattern for style use, it is proper to test or measure the life model or the figure, which is to be used in making the fitting. It shall therefore be understood that no matter what method is employed or what system of pattern drafting is used, we are to get the exact measurement of body that we are to fit and not to use measurements of table of proportions if we have certain models to be followed.

To obtain measurements for the regular size production for blouse or waist or jacket and coats follow diagram on the opposite page. We first take measurement of the neck at 1, which is useful for button-up neck, especially, when a standing collar is wanted. The second measurement is all around chest, which is taken strictly under the arm, giving us a guide for the exact size of the garment. The third measurement is bust, which is taken all around the body, right under the arm, over the chest part of the bust. The fourth measurement is all around waist, which is to be taken at the hollow part of the waist. The fifth measurement is the hip measurement taken over the fullest part of the hip for about 6 inches below the waist line. The waist and hip measurements as mentioned above can also be used for separate skirts or one-piece dresses.

The following measurements, which are the tight knee measurement, at 6, the calf measurement at 7 and the ankle measurement at 8 are only used for riding breeches or bloomers, and are to be taken tight as shown on the diagram. Additional measurements, which are called back depth and waist length are to be taken at the center back, which is described in the first lesson of drafting with all necessary instructions. The sleeve length shall be taken at the right hand inside seam of the arm as shown on the opposite diagram from 10 to 11. Each and every measurement is to be taken a certain way. The neck, chest and waist measurements are always to be taken snug. The bust and hip measurements are always taken full. The knee, calf and ankle measurements shall be taken tight. A wrist measurement shall be taken at 11 and should be taken medium, being neither too tight nor too loose. As a rule, this measurement is to be followed according to style from time to time. Note that this method of taking measurements is not for special use, as other instructions are specially designed for special measurements, which are to be found on pages where special measurements are given.

I. ROSENFELD'S SYSTEM

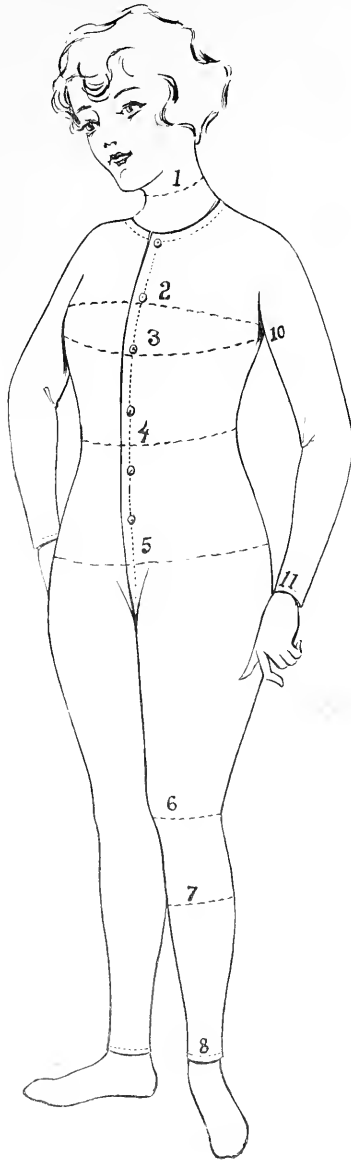



THE PRACTICAL DESIGNER

SYSTEM OF PRACTICAL VALUE

The system, illustrated and explained in this work, is placed on original outlines and useful measurements. The platform measurements used for this system are as follows: Size, which may be called all around chest measurement, bust, waist and hip. These measurements are an outgrowth of Width Proportions. Except these measurements, we have back depth and natural waist length and these measurements are an outgrowth of the Height Divisions. The simplicity of this system lies in the constructional conditions where connections are made at the beginning. As the height and width measurements are combined, they work their necessity. To operate this system, the student only needs to know the size of the garment wanted and the length of the natural waist. Any bust measurement can be connected to any size. The waist and hip we can either increase or decrease. The foundation lines are the same for all kinds of styles or fittings wanted.

The original outgrowing numbers for the model size can be obtained by carefully studying its needs for the trade. The model size used for manufacturing women's garments is size 36. The size 36 shall therefore carry out all its width measurements to be enrolled from its size. The first outgrowing measurement we call the bust, the next measurement is the waist and then the third measurement is the hip. These three measurements are controlled by size 36 only and can be changed at any time wanted regarding style of model, which means if smaller or larger bust, waist and hip wanted for the same size, otherwise, these are the standard methods of how to obtain width measurements. The size of the model shall always be obtained by measuring around the chest and as a rule, this measurement will always be over built with $1\frac{1}{2}$ inches on the figure and therefore use $1\frac{1}{2}$ inches less. If for instance, the chest of the figure measures $37\frac{1}{2}$ inches, use therefore 36 inches only for the actual chest measurement.

The Misses' model size is 16 and measures 34 inches around the chest. This chest measurement is used as a guide number. The bust measurement is developed from the chest. In order to get the bust, add the first number of 34, which is 3 to 34, and it will then make 37 bust measurement. Regarding the waist measurement take $\frac{1}{3}$ of 34, which is $11\frac{1}{3}$, which leaves $22\frac{2}{3}$ inches, and this space shall be fulfilled to 23 inches for waist measurement. Regarding hip measurement, add half of size 34 to the 23 waist measurement, which will make 40 hip measurement.

The Juniors' model size is 15 and measures 33 inches around the chest. This Juniors' chest measurement is used for the size guide. The increase of bust for this size is 1 inch less than the Misses' size. The Misses' size increases 3 inches and the Juniors' only 2 inches. This will make for Juniors' size 15, 33 inches chest and 35 inches bust measurement. The waist for this size is $24\frac{1}{2}$ inches. For the hip measurement for this size, add 6 inches to the breast measurement, which is 33 and it will then make 39 inches hip measurement.

The Children's model size is 10 measuring 30 inches around the breast. The waist for this size is $25\frac{1}{2}$ inches, 1 inch more than for the Juniors, as the child of this age is built full in the waist. The hip measurement for this form is very flat, add 4 inches to the breast number which will give you 34 inches hip measurement.

The Infants' model size is 4 and measures 24 inches breast. The waist for this size is 23 inches and hip 30 inches. You will note that the waist measurement for this size is closer to the breast as the waist measurement is entirely full as an infant is, as a rule, built similar to a stout in form. Note carefully the above instructions, which will serve as a good guide for memorizing proportionate measurements for all model sizes.

I. ROSENFELD'S SYSTEM

THE STUDY OF NUMBERS AND THEIR PRACTICAL USE TODAY

A question which is worth while to consider is—Where do numbers come from and of what importance are they to us. No doubt that those who are using numbers today have gained a great deal and know the great help which it has given to the world and to every human being and is, no doubt, a special help to the garment cutting line. Now let us see what it particularly does for us.

In order to cover the human form by the calculation of numbers, this method is based on the number of inches, as we particularly use inches, of which 36 inches makes 1 yard and divide 36 inches into 8 sections called eight-eighths. To better express my idea, I shall first divide 1 inch, which is also a division of 8 equal sections which means $\frac{1}{8}$ of an inch. At the same time, you may note that for the cutting and designing line we are using a certain ruler, which may be a divisional square or any other instrument for drafting patterns, which is 24 inches in length. This 24-inch ruler has several divisions, which are known as follows: Two-thirds, one-half, one-third, one-fourth, one-sixth, one-eighth, one-twelfth, and one-sixteenth, and are known as divisions of sizes of whatever size desired, from time to time, and may be used as taught for certain systems. The understanding that I wish to make is—Why do we use 8 divisions, and the very first answer to this question is that the first number of a yard is 1 inch, which contains eight-eighths and the other reason is that 8 is $\frac{1}{3}$ of 24 or $\frac{1}{3}$ of the average ruler or instrument in length used for drafting, as mentioned above. Now what else can we learn of numbers?

To continue, write down again the numbers from 1 to 8, as for instance 1—2—3—4—5—6—7—8, and add all these together to one number and you will note that there is 36 inches, and this will bring a number of 36, which will show that 36 is the proper model size for women's garments. This is not all we can learn of numbers. We can write many pages about them, but if you will study you will find a great many points on this subject, which will be of advantage to yourself.

There is also a way of how to obtain the breast number of all model sizes, which may be found as follows: Understand that the breast measurement of women's sizes is 36 and in order to obtain the breast measurement of a 16 misses' model, deduct 2 inches of 36, which is 34 inches, for size 16 breast measurement. To obtain the breast measurement of a junior's model 15, deduct 3 inches from 36, which makes 33 inches for the size 15 breast measurement for a juniors' model. To obtain the breast measurement for a size 10 child's model, deduct 6 inches from 36, which will make 30 inches for the size 10 breast measurement of a child's model. To obtain the breast measurement for an infants' size 4 model, deduct 12 inches from 36, which makes 24 inches breast measurement of an infants' model size 4. Remember that these breast measurements are not the bust measurements, but only the actual breast measurements, which may be called chest.

THE PRACTICAL DESIGNER

SCALE METHOD FOR DRAFTING

In order to simplify the drafting shown in this work, there is herewith given a key of how drafting can be fully understood the most simplest way. The system herewith shown can be followed up in two different ways, which means by a division of a scale or regular inches and you will note that everything is explained in both ways, by scale and inch method.

By scale method is meant that certain spaces will read one-sixth, one-third or one-fourth and after the scale divisions, you will also note that there is always the amount in inches mentioned, which will simplify each step in drafting. It shall therefore be understood that the entire divisions used in drafting are as follows: two-thirds, one-half, one-third, one-fourth, one-sixth, one-eighth, one-twelfth and one-sixteenth, and the amounts for each for size 36 are as follows:

Two-thirds--12 inches, One-half--9 inches, One-third--6 inches, One-fourth-- $4\frac{1}{2}$ inches, One-sixth--3 inches, One-eighth-- $2\frac{1}{4}$ inches, One-twelfth-- $1\frac{1}{2}$ inches, One-sixteenth-- $1\frac{1}{8}$ inches, and for other larger or smaller sizes accordingly.

For Misses' model size 16 for which the breast measurement is 34 inches, the divisions will be, Two-thirds-- $11\frac{3}{8}$ inches, One-half-- $8\frac{1}{2}$ inches, One-third-- $5\frac{5}{8}$ inches, One-fourth-- $4\frac{1}{4}$ inches, One-sixth-- $2\frac{7}{8}$ inches, One-eighth-- $2\frac{1}{8}$ inches, One-twelfth--1 and seven-sixteenth inches, One-sixteenth--1 and one-sixteenth inches.

For Juniors' model size 15 for which the breast measurement is 33 inches the divisions will be, Two-thirds--11 inches, One-half-- $8\frac{1}{4}$ inches, One-third-- $5\frac{1}{2}$ inches, One-fourth-- $4\frac{1}{8}$ inches, One-sixth-- $2\frac{3}{4}$ inches, One-eighth--2 and one-sixteenth inches, One-twelfth-- $1\frac{3}{8}$ inches, One-sixteenth--1 inch.

For Child's model size 10 for which the breast measurement is 30 inches, the divisions will be, Two-thirds--10 inches, One-half-- $7\frac{1}{2}$ inches, One-third--5 inches, One-fourth-- $3\frac{3}{4}$ inches, One-sixth-- $2\frac{1}{2}$ inches, One-eighth-- $1\frac{7}{8}$ inches, One-twelfth-- $1\frac{1}{4}$ inches, One-sixteenth--fifteen-sixteenths of an inch.

For Infants' model size 4 for which the breast measurement is 26 inches, the divisions will be, Two-thirds-- $8\frac{5}{8}$ inches, One-half-- $6\frac{1}{2}$ inches, One-third--4 and five-sixteenth inches, One-fourth-- $3\frac{1}{4}$ inches, One-sixth--2 and three-sixteenth inches, One-eighth-- $1\frac{5}{8}$ inches, One-twelfth-- $1\frac{1}{8}$ inches, One-sixteenth--thirteen-sixteenths of an inch.

Your attention is particularly called to the fact that the amounts mentioned above for each division is only half the amount as we employ only half amounts for drafting as all patterns are drafted half way for each and every size. Two-thirds of 36 would fully amount to 24 not 12 or half would amount to 18 not 9, but you may therefore understand that for drafting we use only half the amount as it is to be found on every ordinary divisional square. In order that you may obtain divisions for the different sizes, you will find a table of all kinds of divisions in the following pages, which will simplify the way of obtaining divisions for any size desired, larger or smaller. You may also note that that particular table may be used for all sorts of divisions, which are as follows: Dividing gores for different tight-fitting jackets or to be used more particularly for dividing the gores of skirts or for many other purposes of dividing, which may be needed from time to time.



I. ROSENFELD'S SYSTEM

INSTRUCTIONS TO BEGIN

THOSE who are not familiar with pattern drafting, will kindly follow these instructions. In order to begin, take a sheet of paper of one yard in length; the paper shall not be less than 30 inches in width which is the regular width of drafting paper for patterns and begin to draw a square line at the right angle at the top. See to it that there shall be a 6 inch space left on the top before making the square line. When the square line is drawn, you are about ready to begin to use the measurements necessary for the drafting.

Remember, that you have to stand on one certain position next to the draft. In order to get well acquainted with it, therefore stand next to the line which is placed to the edge of the paper, length way, which is between the top and bottom line of whatever these lines may be called. You will notice that such instructions are given on the first diagram.

Regarding instruments used for the drafting, all we need is an ordinary yard stick or tape measure, or, in order to produce good square lines, you may use an ordinary tailor's square to obtain good square lines.

Our system of drafting is explained in two different manners which is done in the most simplified way so that you can follow it up by inches or regular divisions. You may use either one of the methods which appears to you the most simple one as they are both very simple.

In order to be most sure of all details used in drafting, you will be kind enough to follow the following rules: Do not try to work at the very beginning on $\frac{1}{4}$ or $\frac{1}{2}$ inch size drafting, use full inch, in order that you shall obtain the original size of drafting for each and every lesson which will make things clear to you right at the beginning. Do not measure the space of the diagram because it will only confuse you in your work. All you need to do is to read the diagram carefully and follow spaces as described opposite the diagram.

In order to succeed in the easiest way of getting a lesson done in the most shortest time possible, do not try immediately to follow up the diagram, but read carefully first over the description without following up the diagram and after having been well acquainted with the reading, begin again to read in a quiet way the description and follow up at the same time the diagram for the spaces and all rules as they are explained.

When beginning a lesson, study well the beginning lines which will as a rule, instruct you how to go on with other lessons and such actions will simplify each and every lesson in the most simplified way. Do not overlook this, but follow all these instructions and by doing so, you will greatly succeed in your technical undertakings.



THE PRACTICAL DESIGNER

THE MEASUREMENTS WHICH WE USE AND HOW WE USE THEM.

In order to begin a system of drafting the right way, we first have to prepare a set of good measurements in such form that the student shall well understand them and from where such measurements are out-grown and the use of each measurement, therefore may be well understood. It shall be therefore also understood that each and every measurement brings a different use which builds a part of the garment and therefore such measurements are carrying great responsibility. It is therefore necessary to study well every particular measurement which I herewith give as follows: When taking measurements, remember that the following instruction is given how to take measurements for a regular size 36 and this rule may be applied to any other regular sizes. The table of regular proportions are therefore given in these pages and in order to know what they particular are, keep in mind the following instruction.

The size is a measurement which we call the actual chest measurement which you can see taken all around the chest on the opposite page on figure No. 6 taken over the smallest part over the chest.

The bust measurement is an all around measurement over the fullest part of the bust which is shown on figure No. 7. This measurement serves for the purpose of knowing the fullest increase of bust measurement because this measurement may be increased or decreased from time to time to any one of the regular sizes.

The waist measurement is taken all around the smallest part of the figure which is shown on figure No. 8 and no matter what style it may be, the waist measurement shall always be taken tight.

The hip measurement is taken 6 inches below the waist as shown on figure No. 9.

The back depth is a measurement taken from the socket bone down to the opposite deepness of the armhole which is shown on figure No. 3. This measurement serves for the purpose of having a proper deepness between the socket bone to the armhole deepness.

The natural waist length is a measurement showing the waist length in back which is shown on figure No. 4 and it shall be understood that this measurement shall always be taken in the same manner, no matter what it may be, short or long waist.

The inside sleeve length shall always be taken at the inside of the sleeve, which is shown on figure No. 10.

The measurement for the collar shall be taken all around the neck not too close, neither too loose and therefore, there is no particular rule of taking measurements for the collar, but it shall be taken around the lowest part of the neck not under the chin and it shall be understood that such neck measurement is taken without seams and when instructions of how to cut such collar will be given, we will have to allow for additional seams.

I. ROSENFELD'S SYSTEM





THE PRACTICAL DESIGNER

Standard Proportional Measurements

FOR WOMEN'S GARMENTS

ACCORDING TO THE HEIGHT OF 5 FEET 6 INCHES.

Copyrighted by

PROF. I. ROSENFELD.

Size or all around chest	All around Bust	All around Waist	All around Hip	Back Depth	Natural Waist Length	Inside Sleeve Length	All around Neck	Half width of back
32	35	23	41	$6\frac{3}{4}$	$15\frac{1}{4}$	17	13	$6\frac{3}{4}$
34	37	24	42	$6\frac{7}{8}$	$15\frac{3}{8}$	$17\frac{1}{2}$	$13\frac{1}{2}$	7
36	39	25	43	7	$15\frac{1}{2}$	18	14	$7\frac{1}{4}$
38	41	26	44	$7\frac{1}{8}$	$15\frac{5}{8}$	$18\frac{1}{2}$	$14\frac{1}{2}$	$7\frac{1}{2}$
40	43	27	45	$7\frac{1}{4}$	$15\frac{3}{4}$	$18\frac{3}{4}$	15	$7\frac{3}{4}$
42	45	$28\frac{1}{2}$	46	$7\frac{3}{8}$	$15\frac{7}{8}$	19	$15\frac{1}{2}$	8
44	46	30	47	$7\frac{1}{2}$	16	19	16	$8\frac{1}{4}$

TAKE SPECIAL NOTICE that these measurements are standard measurements for these sizes and all those who own this work, are entitled to get every season a new table of proportionate measurements which is published each and every season with changes made on forms from time to time.



W O M E N ' S

JACKETS, COATS AND CAPES



THE PRACTICAL DESIGNER

WOMAN'S JACKET FOUNDATION

Lesson No. 1

I shall now commence to explain the drafting of a foundation of a woman's model size 36 and in order to succeed in drafting, the student has to remember every step which is made at the beginning as the beginning lines according to this system are always to be repeated for each and every garment. It shall therefore be understood that this system is based on the most simplified method because the very first foundation lines are to be used for all the continuous lessons. The foundation lines shown in the first lesson are covering the space of the body from the neck down to the natural waist length and it therefore consists of 3 lines which are called Top line, Breast line and Waist line and in order to begin use the following standard measurements of size 36.

Back depth.....	7 inches
Natural waist length in back.....	$15\frac{1}{2}$ inches
All around breast or size.....	36 inches
All around bust.....	39 inches
All around waist.....	25 inches

Now begin to draft; draw a square line from A to R and from A to C and remember that the line from A to R is the Top line and from A to C is the center back line to which you have to stand next in order to have the draft in front of you in the proper manner. Now measure from A to B 7 inches back depth and from A to C $15\frac{1}{2}$ inches natural waist length. Then draw a line across from B to W and from C to X. After these lines are crossed measure from A to D, B to E and from C to F $\frac{1}{3}$ of size or 12 inches for size 36 and draw a line from D, E to F.

Now begin the width of back; take half of B to E which makes G and allow from G to H $1\frac{1}{4}$ inches and then measure the space between B to H and place the same from A to I and draw a line from I to H. From A to J measure $\frac{1}{6}$ of size or 3 inches for size 36 and from J to K raise up 1 inch and from K draw a line out against I to L.

Now produce the back shoulder; draw a line from K against I to L. This space shall be 6 inches for size 36 but in order that this space or width of shoulder shall come up naturally without memorizing this width of shoulder for each and every size a square ruler shall be applied on this line from K to L to meet H and it will prove or bring the original width of shoulder for every size systematically. Now make the ink line for the center back; make from C to M 2 inches and draw a line from M up to A and remember that this space between C to M is always 2 inches for all women's sizes. Before we go any further remember the name of each cross line made at A, B and C. The line from A to R is called Top line; the line from B to W is called the Breast line and the line from C to X is called Waist line. If there are any other cross lines to be produced for the continuous lessons each additional line will have its proper name. See next lesson for continuation.

I. ROSENFELD'S SYSTEM

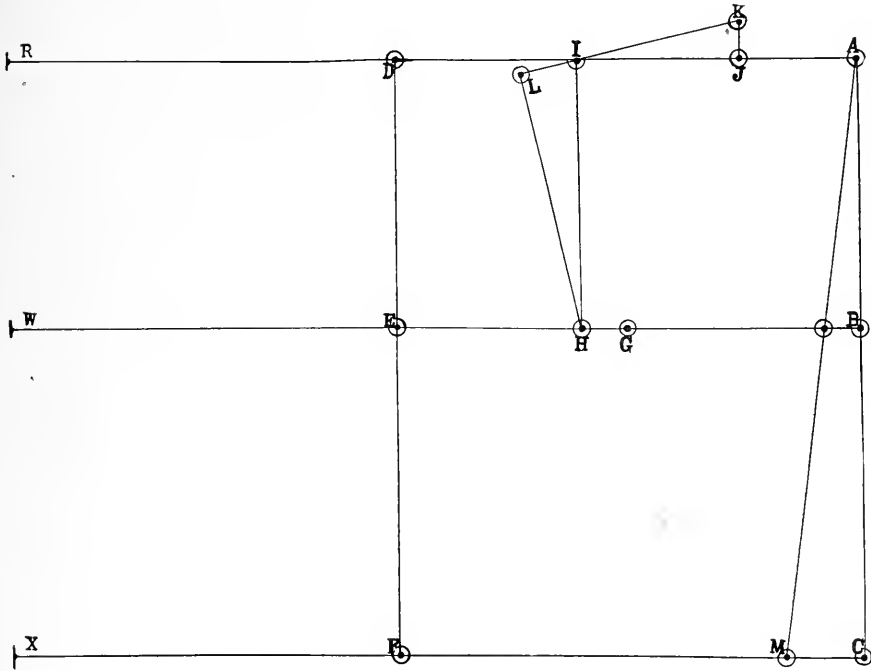

FACE DIAGRAM FROM THIS SIDE OF THE SHEET OF PAPER

Lesson No. 1



THE PRACTICAL DESIGNER

WOMEN'S GARMENT

LESSON NO. 2.

In order to begin lesson No. 2, we need to remember the entire foundation of the first lesson, therefore, now prepare the entire first lesson and continue lesson No. 2 as follows:

From E to N and from D to O is 1 sixth of size or 3 inches for size 36 and draw a line up from N to O. When making this step, it shall be remembered that we are preparing the outline for the front part. Now measure again from O to P and from P to O also 1 sixth of size or 3 inches for size 36. It shall be understood that we need to draw a line up from P to Q and as soon as the line is drawn up to Q, draw a line from Q to the ink line at the back depth which makes T and as soon as this line is complete, measure the width of back shoulder from K to L and place the same from Q to U which makes the front shoulder; then draw a line from U to N which makes the front armhole.

Now prepare the front neck; measure from P to R 1 sixth of size or 3 inches and allow $\frac{1}{2}$ inch and raise up a line with $\frac{3}{4}$ inches to S for the high neck in front.

Now measure the bust; measure from T to V half of bust measurement. For instance, this bust measurement amounts to 39 inches, therefore take half of this amount, $19\frac{1}{2}$ inches from T to V and from V to W allow 3 inches for seams and draw a square line down from W to X and Y. When this line is complete, we finish the entire edge of the front by drawing a straight line from S against W down to Z. By having this line complete, this line allows and shows the amount increased for fullness in front.

When being this far advanced with this foundation, it shall be understood that we are about ready with this foundation which will be completed in the next lesson ready for use. The next lesson will finish this foundation in a blouse which consists of 2 parts, front and back.

I. ROSENFELD'S SYSTEM

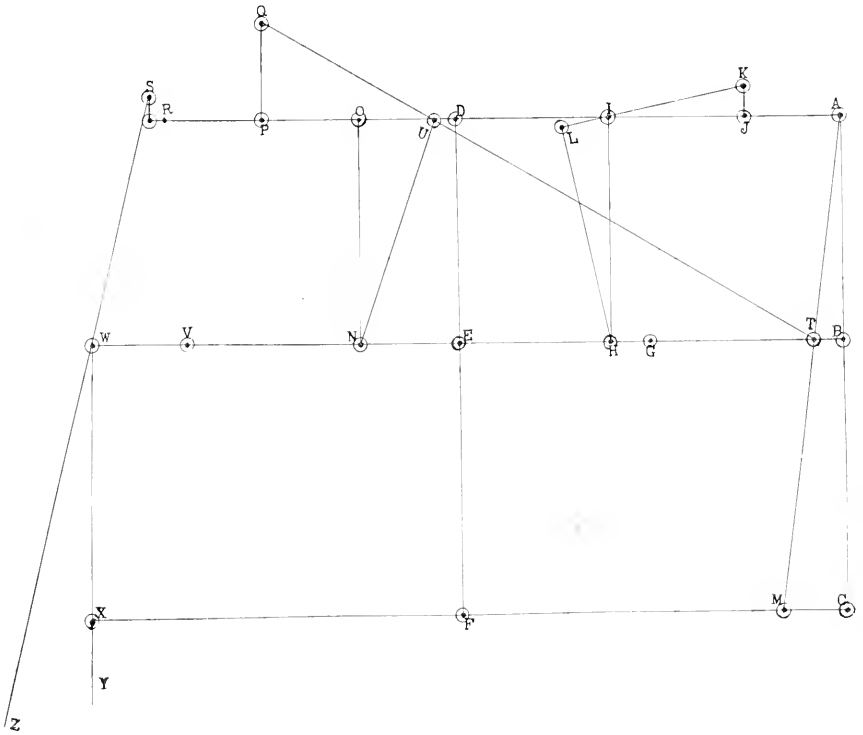

LESSON NO. 2.

THE PRACTICAL DESIGNER

WOMEN'S BLOUSE.

LESSON NO. 3.

This lesson will complete the first and second lessons and when this lesson is complete, it is showing a blouse. To continue this lesson, we positively need to complete first the outlines of the first and second lessons and then we continue as follows:

To begin lesson No. 3, divide the armhole in order to bring an underarm seam and in order to get the under arm seam in the center of the armhole, divide between H and M which makes AA and draw a line from AA down to BB. Now take out both sides of AA at the breast line from AA to E and from AA to EE $\frac{3}{4}$ of an inch and on the waist line both sides of BB to DD and to CC 2 inches to each side and connect with side seam line from E to DD which completes the side seam for the front and from EE to CC which will complete the side seam for the back. When these lines are drawn, we are about ready to make all curves necessary for the entire blouse.

To begin to curve, curve first the shoulders as shown on the diagram at L and T take off of both shoulders $\frac{1}{4}$ of an inch and make such curves with a round stick from K lost to L for the back shoulder and from P lost to T for the front shoulder. Now make the curves for the armhole at the back from L to EE and for the front armhole from T to E as shown on the diagram. Remember, when making the curves of the armhole or the front, there shall be the highest a half inch space where the main brake is made for the front armhole above M. The main brake at this armhole means where the curve crossing the line which is drawn from T to M below CC and below DD $\frac{1}{2}$ inch and then curve from II below CC as shown on the diagram and also below D with a $\frac{1}{2}$ inch out to the straight line to X and curve from X to Z. From Y to Z is $1\frac{1}{2}$ inches. Remember, that the space between W and X may be changed. The full length of this space is 3 inches but for the entire waist line this can be changed to 2 or $1\frac{1}{2}$ inches the shortest, and then when this space is decided, a line is drawn from DD to X out to Y.

The neck curves shall be made so that the curves shall not be too strong, meaning not too much curved out or not too straight. Curve proportionally and begin at the back first from A to K which completes the neck curve at the back and from P to R is the front neck curve. Notice that this neck curve is raised from Q to R $\frac{3}{4}$ inches which gives a close high fitting neck, but when lower neck wanted, this amount of $\frac{3}{4}$ must not be increased and the neck curve can then be made from P to Q.

To cut out this blouse draft, it shall be kept in mind that when this pattern is cut out, it is all ready for use and all seams are allowed and therefore no seams whatever shall be allowed. In order to begin to cut out, we, as a rule, begin the back and therefore begin to cut from A to II and from A to K and L, from L all around the armhole to EE, from EE to CC to the lower bottom line and from II to CC to the lower curve line. This instruction will make the back part cut-out.

To cut out the front part, begin at T up to P, from P to R, R to Z and from Z to X according to the curves of the lower part to DD. Now continue cutting the armhole from T all around to E and down to the bottom of the side seam from E to D down to the curve line as shown on the diagram. This will complete how to cut out the entire pattern of front and back.

Now remember, that seams are allowed all over to this pattern and when placing the edge of the front or the edge of the back to the double fold of the goods where no seam is wanted, deduct $\frac{3}{8}$ inch for such half seam which will double that amount to $\frac{3}{4}$ to the double cloth or any material what it may be from time to time and this seam shall be deducted for the simple reason because the seam may increase the garment where such seam is not used and it will therefore be deducted where such seam is not wanted.

I. ROSENFELD'S SYSTEM

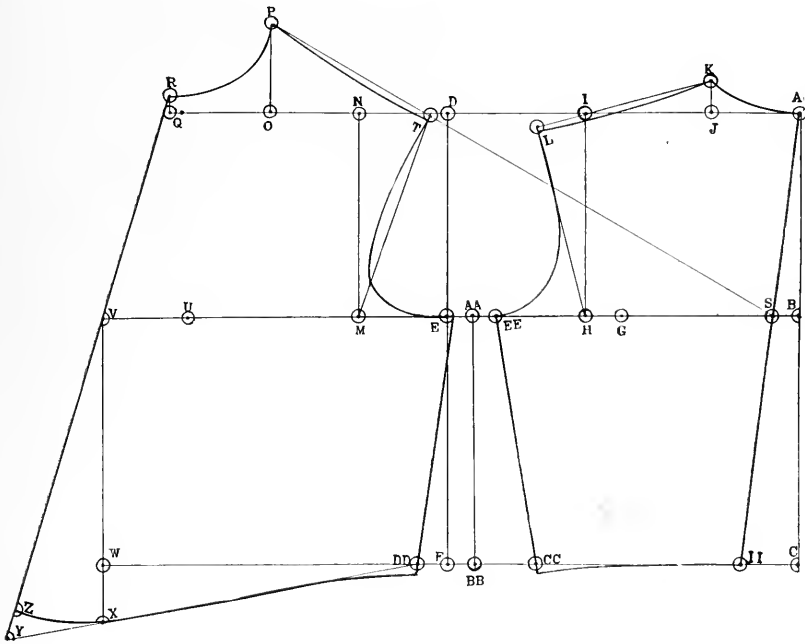

Lesson No. 3.



FACE DIAGRAM FROM THIS SIDE OF SHEET OF PAPER





THE PRACTICAL DESIGNER

ETON JACKET

LESSON NO. 4.

The Eton is built on the same outlines as all other garments, these garments are planned to natural waist length only. From A to B is 7 inches depth, from A to C is $15\frac{1}{2}$ inches natural waist length; now draw lines from A to W, from B to R and from C to V. Now make the outlines the same as the others from B to G is $\frac{2}{3}$ of size or 12 inches and from C to E is also 12 inches; now draw a line from E to G and up to the top line, now divide B and G which makes H, from H to I is $1\frac{1}{4}$ inches, draw a line from F to Q, from Q to P is $\frac{1}{6}$ of size or 3 inches, from P to O is also $\frac{1}{6}$ of size or 3 inches, from P to W is $\frac{1}{6}$ of size or 3 inches and a seam allowed. From C to 8 is 2 inches, draw a line from 8 to A, now connect a line from the front neck point O to the back depth T. Measure the back shoulder from L to M and make the same from O to U for the front, shoulder and connect a line from U to F.

Now begin to make the side seam, this seam can be placed at any part of the armhole. This diagram is showing how to make the underarm seam towards the back and therefore divide between I and G which makes N. From N to 5 and 6 is $\frac{3}{4}$ inches on both sides, now draw a straight line down from N to make 7 from 7 to E and 10 of both sides take out 2 inches. Now connect lines from 5 to 10 and from 6 to E. The length of waist shall be made shorter in back for this garment by a $\frac{1}{2}$ inches as shown on diagram as 8 to D, 10 to 4, E to 9.

Now measure the bust, from T to S is $19\frac{1}{2}$ inches, this is 39 bust measure, from S to R there is 3 inches for seams, now make a straight line down from R to V and Y, from V to Y is $\frac{1}{2}$ of size or $2\frac{1}{4}$ inches, this makes a long waist in front. From W to Z is $\frac{3}{4}$ inches, this space is only raised up in order to get the close tight fitting neck. From Z to 1 is 1 inch for button stand, from R to S is also 1 inch, from Y to X is 1 inch for button stand.

Now begin to curve from Z, R, V and Y, this line is the edge of front. From Z to 1, R to 2, Y to X is 1 inch allowed for button stand. Curve this the same as the inside line from Z to Y. For hook and eye front, use the inside front without the button stand and for buttoning purposes include the 1 inch space for button stand. Now we begin to curve from A, L, M to 5 also curve on both sides of the side body to 5 and 6. Now curve the armhole from 6 to G round up to U. From U to O is the front shoulder, the two shoulders should be curved alike, now curve the neck from O to Z and the hook for buttoning from Z to 1. Now curve the bottom of the waist from D to 4 and from 9 towards Y. We curve at Y a $\frac{1}{2}$ inch up and finish up to X, this completes the Eton coat without any dart in front, this will make a loose front and no gathering is required.

Note that if you desire to have a full waist length for this Eton follow the action of the blouse of Lesson No. 3.

I. ROSENFELD'S SYSTEM

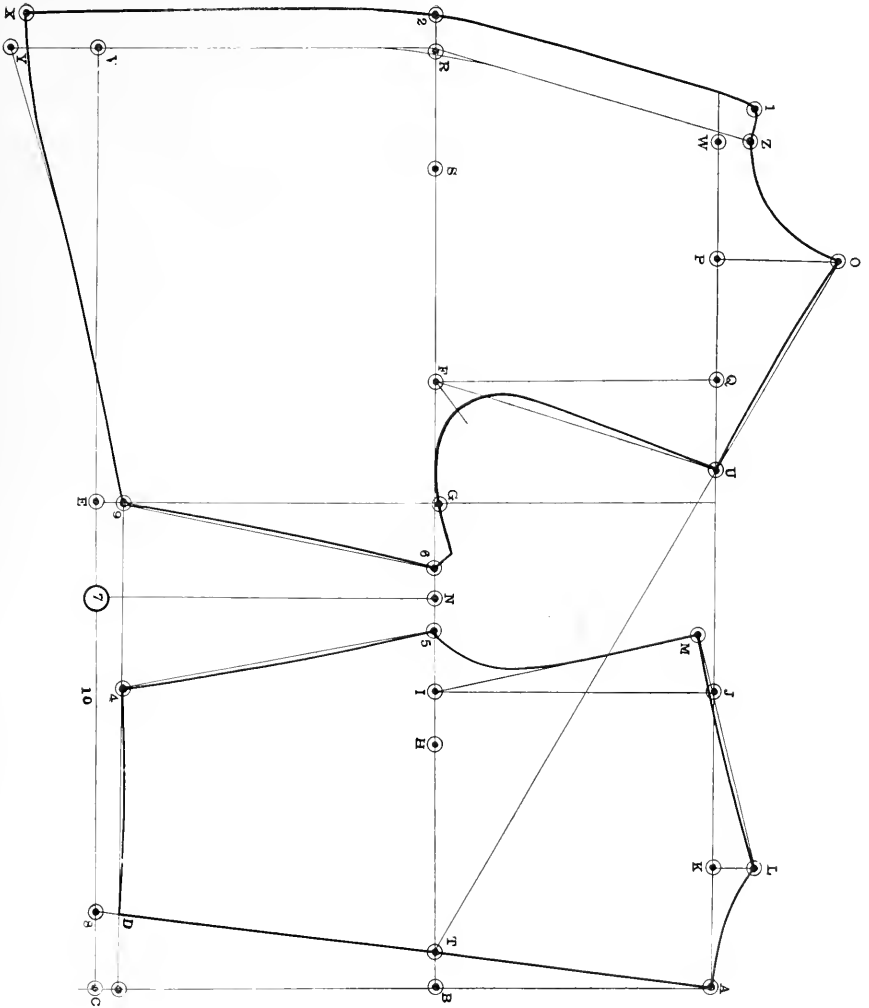

THE PRACTICAL DESIGNER

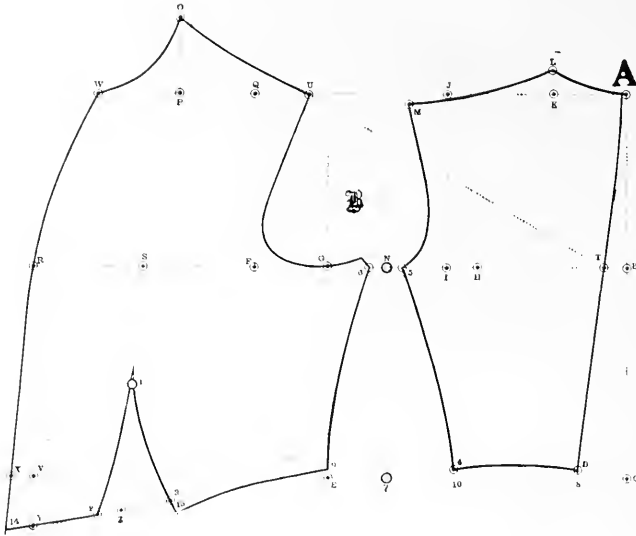

ETON WITH DART IN FRONT.

LESSON NO. 5.

This draft is made the same way as the first Eton, the front of this Eton is changed for the dart in front, therefore allow from V to X $2\frac{1}{2}$ of an inch, from V to Y is the same as the first draft $2\frac{1}{2}$ inches, now draw a line from R to X down to 14. In order to get the dart in front, we divide the chest F to R which makes S, now measure the space from R to S and take the same from 14 to Z, from Z to S makes the dart line, and divide this line which makes 1 for the height of the dart. From Z to 2 is 1 inch, from Z to 3 is 2 inches. Now draw lines from 1 to 3 and Z to 2 now measure from 1 to 2 and make the same from 1 to 15, now curve from 1 to 2 and 1 to 15, also from 9 to 15 and from 2 to Y up to 14 as shown on diagram.

Now curve carefully the front from W to R, X and 14; from 2 to 14 curve up as shown on diagram, this front has no button stand. This completes the Eton coat with dart in front.

The dart of this front can be raised higher to suit the former model. Such change may be made from the original height of dart raised up 1 to $1\frac{1}{2}$ inches and curve lost to the bottom of waist as shown on the diagram. The length of waist in back can also be used full as shown on Lesson No. 3.



THE PRACTICAL DESIGNER

ETON FRONT WITH DART ON TOP.

LESSON NO. 7.

In order to prepare this pattern the most easiest way we need first to cut out the 2 parts of the french seam front of a eton jacket and then mark out first the outside part of the front on a separate sheet of paper which is as follows, from A to G, G to F, H to I and I to J and finish from J to F. When this front part is already marked out connect the 2 lower parts of the 2 fronts where the dart appears as usual on the eton jacket and lap over at that place the inside front pattern from J to C and from N to O with $\frac{3}{4}$ of an inch which is the usual amount of taking off seams and then there will remain a dart opened on top of the front; but be very careful that before placing these 2 patterns together to make this dart on top of front, it is first necessary for us to take even the 2 fronts from the top point of the shoulder so that when you will make the connection of closing the dart at the bottom, there will not be any misunderstanding of matching the equal lengths between the 2 fronts at the upper dart. Now when you have already placed the 2 fronts to lap over $\frac{1}{2}$ of an inch at the lower part where the usual dart is, continue in marking out the entire inner front part which is from O to D, D to E, E all around the armhole to A, A to B and B to C.

Now finish the bottom with a new curve from B to F as shown on the diagram and now allow a seam on the top dart. Remember that there is 2 different ways of preparing this pattern which is without seams or with seams allowed. If the pattern of this front is prepared with front seam all the way down there is no use of allowing a special seam as it is shown on this diagram between D and I, down to M and between I and K down to M; but if this pattern is prepared just by a dart front and then split from the dart up to the shoulder then it is absolutely necessary to allow a special seam as it is shown on the diagram before.

This pattern can also be prepared from another pattern and also for another purpose. When a dart on top is wanted for another jacket all we need to do is to cut out the jacket with a dart below the bust as a rule and then split the same way from the dart up to the shoulder point and then close the lower dart and then you will see there will come an opening from the bust point up to the shoulder point for the use of a dart on top of shoulder and all you have to do is to allow for seams of $\frac{1}{2}$ inches to each and which will make then $\frac{3}{4}$ inches for seams or for the entire seam or when such top dart is prepared by a french seam jacket you do not have to allow any seam directly as the seam is already allowed to both parts of the front. Always remember that this action is only suited to a half fitting jacket and it will not be very practical for a tight fitting garment.

I. ROSENFELD'S SYSTEM

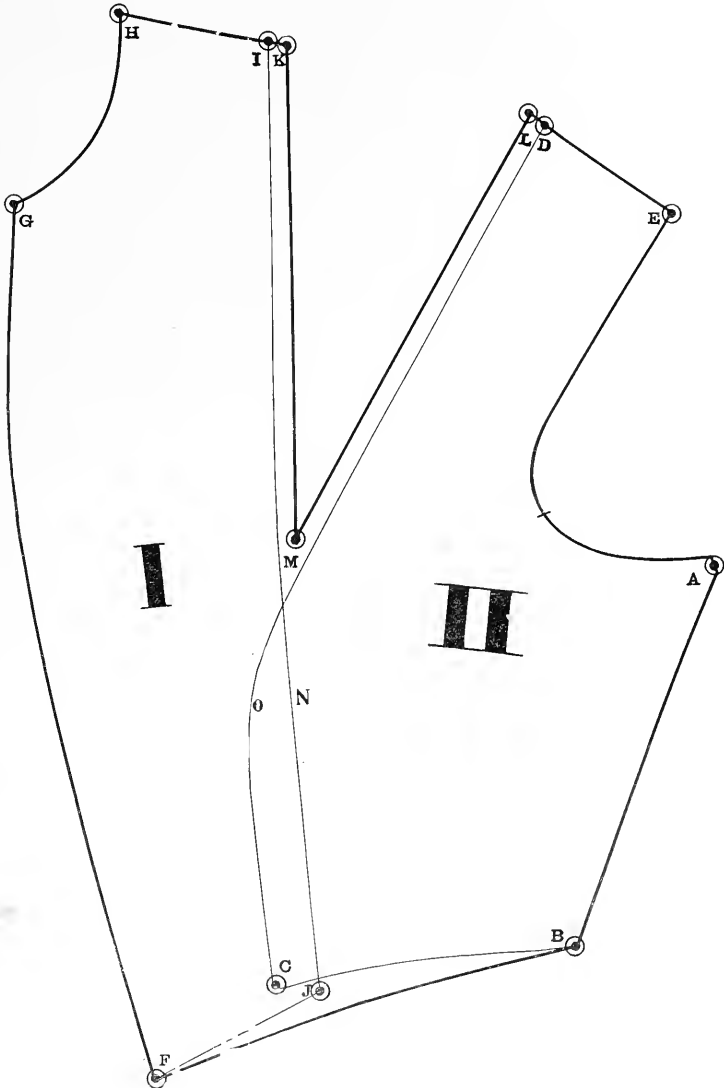



THE PRACTICAL DESIGNER

HALF FITTING JACKET

LESSON NO. 8.

This garment begins the same way as the others with the exception of its style which is half fitted; this diagram is also followed by the same measurement as all other drafts.

To begin, measure the depth of natural waist length and hip length at A, B, C, to D as all others; from B to G and D to E is $\frac{2}{3}$ of size, or 12 inches; now divide B to G which makes H; from H to I is $1\frac{1}{2}$ inches. Now draw a line from I to J, this is the width of back line. From A to K is $\frac{1}{6}$ of size or 3 inches; from K to L is 1 inch. Draw a line from L to J and M to I. Now take half of M and I which makes 25; N is 1 inch below 25; from M to N is the armhole at the back, then take half of I and H which makes 26. Take a straight stick from J against 26, and draw a line at the same time from 26 to V and make a mark at 4, which is on the hip line, from 4 to 2 is 1 inch and from V to 3 is also 1 inch. Now cross a line from 3 to 4, from 3 cross a line between 1 and 26; 21 is $\frac{1}{2}$ inch, raise up from the side body from N for a seam allowance. From G to 5 and E to 6 is $\frac{3}{4}$ of an inch; this $\frac{3}{4}$ of an inch is here planned the opposite way than the tight-fitting garment; the $\frac{3}{4}$ of an inch space is not used as this garment is cut with one side body and we only occupy one seam instead of two. To make clearly understood between the tight-fitting and half-fitting, for a tight-fitting, this $\frac{3}{4}$ of an inch is increased for a seam; for a half fitting, this $\frac{3}{4}$ of an inch is decreased, as we do not need the seam for this garment as the garment has one gore less than the tight-fitting garment.

Now begin the front; from 8 to 9 is $\frac{1}{2}$ of an inch; from 6 to 14 is 1 inch, from E to 23 is $\frac{3}{4}$ of an inch. Then cross lines from G to 9, from 9 to 14 and from 7 to 23. Begin the front shoulder from O to T; cross a line from O to 24, the front shoulder; this is always the same width as the back shoulder. Draw a line from 24 to F for the front arm hole. Now measure the bust; from T to U is half of bust measurement; from U to 1 is 3 inches for seams. Cross a square line from 1 to 22 from Y to Z is $\frac{3}{4}$ of an inch; this is half of the regular allowance. From Y to 12 is $2\frac{1}{4}$ inches always. Now cross lines from 9 to 12 and from 1 to Z and 20; from 20 to 13 is $\frac{1}{2}$ inch.

Now begin the dart: X is half of F and 1. Measure 1 to X and take the same from Z to 28. Now cross a line from X to 28, 15 and 11. Then divide X to 15 which makes 10. This is the line for the dart in front. The dart for half-fitting garments is a half decrease, as the tight fitting garment, from 15 to 16 is $\frac{1}{2}$ inch; from 15 to 17 is $1\frac{1}{2}$ inches. Now cross a straight line from 15 to 27 and draw a straight line down to 19; from 27 to 19 should be the same as from 16 to 18. All outlines are now ready. Begin to curve: from A, L, M to N; from N to V and 2, this completes the back.

Now begin the side body; from 21 to 3 and 4, also from 21 to 5, 7 and 23, and bottom from 4 to 23. Then begin the front; from G, 9, 14 and 19 the armhole, from G to 24 and shoulder to O; from O to W, 1, Z and 13 to 18 as shown on diagram. This completes the half-fitting jacket.

I. ROSENFELD'S SYSTEM

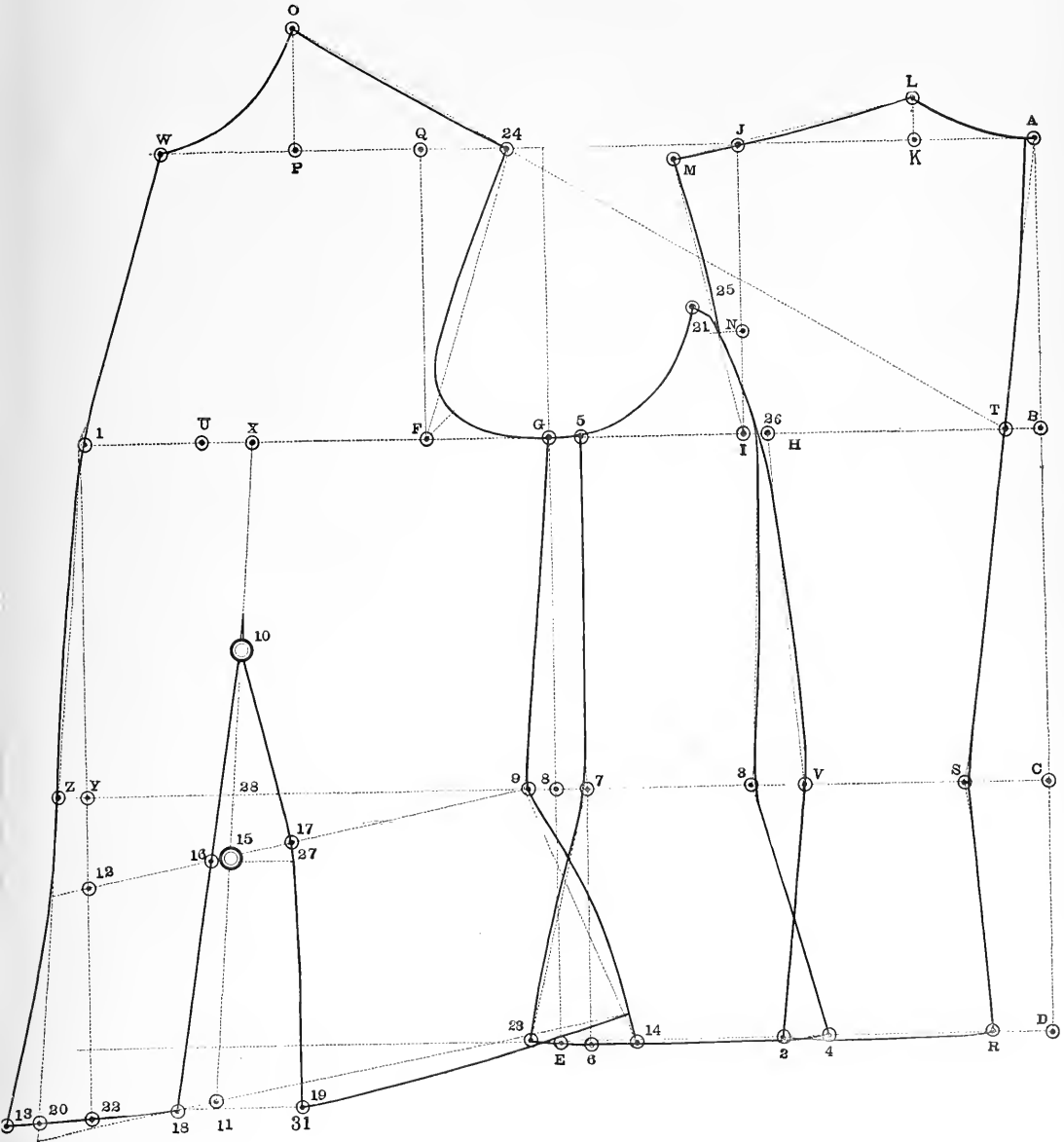

THE PRACTICAL DESIGNER

HALF-FITTING SINGLE-BREADED FRENCH SEAM JACKET

BROAD BACK

LESSON NO. 9

This jacket is drafted on the same principles as the first half-fitting jacket with the exception of the french seams. Therefore use the same foundation lines and begin as follows: Draw a line down from J between the equal space of H and I down to 1 at the waist line and, at the same time, mark 4 on the hip line. Extend from 4 to 2, $\frac{3}{4}$ of an inch and draw a line all the way to the bottom from 1 and 2 to 48 and from 1 to 3 take out $\frac{3}{4}$ of an inch and connect with a curved line for the inner back part from J against the straight line at the breast line down to 3 and curve from 3 to 4 lost to 49 at the bottom. Allow $\frac{3}{4}$ of an inch for the french seam from N to M and take out for a half-fitting jacket from G to 5 and E to 6, $\frac{3}{4}$ of an inch and extend from E to 23 and 6 to 14, $\frac{3}{4}$ of an inch and make hip curves as usual.

The front part foundation is also continued as usual with the exception of the french seams, which are to match the back part. Therefore make the actual width of shoulder for the front from O to 24, which shall be the same as from L to M. Then measure the space from L to J of the back shoulder and apply the same to the front shoulder from O to 29 and connect a line from 29 to 25. Now measure the space at the back shoulder from J to N and apply the same to the front shoulder from 24 to 30 and draw a parallel line from 30 to 25 to be lost with a curve down towards 25, 17 and 14 down with a straight line to 32. The dart and the allowance for dart is the same as for the first half-fitting jacket and shall therefore be followed according to the first instruction of such dart.

For the single-breasted button stand, allow $1\frac{1}{2}$ inches and therefore allow from V to 33 on the breast line and from 7 to 34 on the waist line $1\frac{1}{2}$ inches and draw a straight line down in front from 33 against 34 down to 35 and 36. Now mark the opening for the lapel showing on this diagram at 37, which is showing the long lapel and can be made either way desired. Extend down the opening line by making from O to 38, 1 inch and then draw the line from the opening to 37, 38 and 39 and measure from W or where the straight line meets with the curve of the neck and measure from there to 42, 3 inches or if a narrow facing is desired for a single-breasted garment, make $2\frac{1}{2}$ inches. Then make from 42 to 43, $2\frac{1}{2}$ inches for a double-breasted lapel on this single-breasted garment and connect 43 to the opening point to 37. The notch of the collar lapel between 42 and 44 shall be 2 inches and the opening between collar and lapel notches shall be a $\frac{1}{2}$ inch. The space from 39 to 40 is 1 inch parallel curved to O and from 39 to 41 is $2\frac{1}{2}$ inches for the outside width of collar. The trace line at the front beginning at the front edge from 34 lost to the bottom at 35 is showing how to make the cut-a-way front and the space between 35 and 36 is $1\frac{1}{2}$ inches for lengthening the front to show the proper finish at the bottom of the front. The slit in the center back shall be lowered with 2 inches from the natural waist line and therefore note that from S to 50 is 2 inches below the waist line and the width of the hook for slit from 50 to 51 is $1\frac{1}{4}$ inches all the way down to the bottom to 52. Otherwise this garment is complete with all seams allowed

The pockets shall be placed as follows: The breast pocket from F to 53 is 1 inch and from 53 to 54 is $\frac{1}{4}$ of size or $4\frac{1}{2}$ inches for size 36. The biasness for the pocket from U to 54 is 1 inch and the width of the vell for the breast pocket is $1\frac{1}{4}$ inches finished. The lower pocket shall always be placed in the middle space between waist and hip line and place the pocket in from the dart at 56 a $\frac{1}{2}$ inch to leave the proper space for a seam and from 56 to 55 shall measure a $\frac{1}{2}$ inch more than the upper breast pocket, which therefore amounts to 5 inches all finished. Allow for additional seams for the flap, and the width of flap shall be 3 inches finished and also allow additional seams when making up such flap.

I. ROSENFELD'S SYSTEM

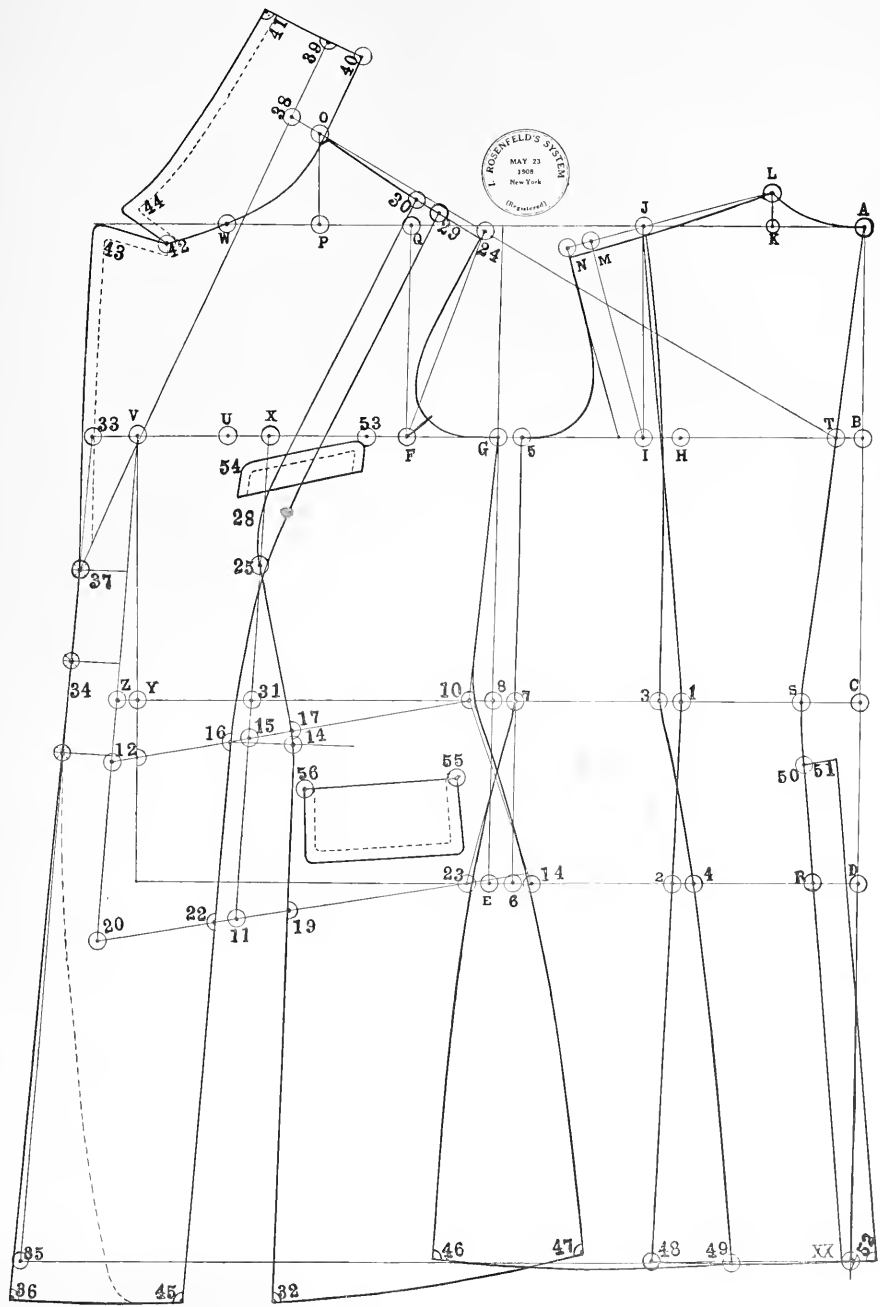



THE PRACTICAL DESIGNER

HALF-FITTING DOUBLE-BREADED FRENCH SEAM JACKET

NARROW BACK

LESSON NO. 10

This garment is drafted on the same principles as the last lesson and changes only with the narrow back. To begin measure from S to 5, $\frac{1}{6}$ of size amounting to 3 inches for size 36 and Y to 7 measure 1 inch more amounting to 4 inches for this size. From 5 to 6 take out 1 inch and from 7 to 31 allow $\frac{3}{4}$ of an inch for increase of hip. Then allow $\frac{3}{4}$ of an inch for the back shoulder width from M to N and then divide the shoulder from L to N making 48. Now connect a straight line from 48 against 5 and from 5 to 7 and then connect with a curved line for the inner part of the back from 48 to 6 and from 6 to 31. To finish the back part entirely, take out from G to 8 and E to 27, $\frac{3}{4}$ of an inch as usual and if a more fitted side seam is wanted at the back take out at 8, $\frac{1}{4}$ of an inch and from 9 to 11, a $\frac{1}{2}$ inch and finish the side seams of the back and front as usual.

The french seams at the front shall be equally divided to meet the french seams of the back. First get the correct width of shoulder from O to U, which is about 6 inches for regular size, which is to be found at the back shoulder from L to M and divide from O to U making 32. Allow both sides of 32 to 33 and 34, $\frac{3}{8}$ of an inch making altogether $\frac{3}{4}$ of an inch for seams and connect 33 to 28 and from 34 draw a parallel line to 51 and curve from 51 towards 28, 19, 20 and 24. Remember that the dart and the allowance for dart from Z to 1 is the same as the lesson before or the same instruction as the first half-fitting jacket, which is shown in lesson No. 8.

The double-breasted front shall have an increase of 3 inches for the double-breasted lapping over, which is from X to 25 on the breast line and 43 on the bottom line shall be 3 inches. The beginning of the button stand shall be equally taken between the hip and waist line, which is therefore found between 25 and 3 on the front edge line making when equally divided 26. Now extend for collar stand from O to 35, 1 inch and connect from 26 towards 35 and 36. From 35 to 36 is $\frac{1}{6}$ of size and a $\frac{1}{2}$ inch allowed amounting to $3\frac{1}{2}$ inches for size 36. When the line is drawn from 36 to 26 and passing along on the neck curve, measure from W to 40, 3 inches for all sizes alike and extend from 40 to 39 a bias line up according to taste and then measure also 3 inches for the double-breasted lapel and measure from 39 to 26, which completes the double-breasted lapel. Then make the collar notch by drawing a line from 40 to 41, which shall be 2 inches and the space between 39 and 41 shall be a $\frac{1}{2}$ inch. The width from 36 to 37 is 1 inch to be drawn parallel to O and from 36 to 38 shall be $2\frac{1}{2}$ inches and curve there as shown on diagram by allowing about a $\frac{1}{4}$ of an inch at 38. This jacket is otherwise complete with all seams allowed.

I. ROSENFELD'S SYSTEM

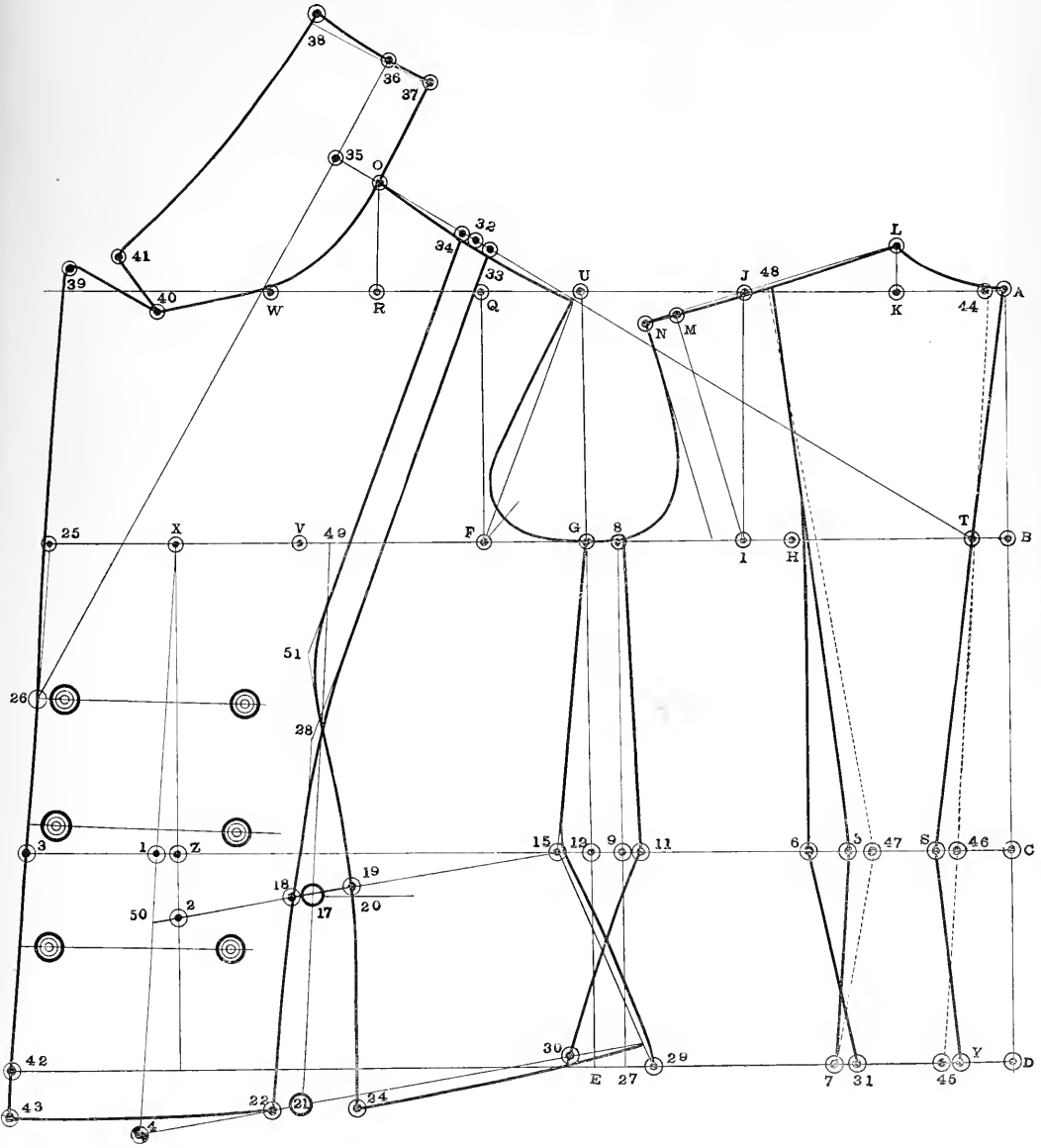



THE PRACTICAL DESIGNER

VIENNA FRONT, HALF FITTING JACKET

LESSON NO. 11.

To begin this jacket, it is necessary to prepare first the very first half fitting jacket as shown in the front pages. You will note that this jacket is exactly the same as the first half fitting jacket with the exception that the front of this jacket is changed for this particular style as follows:

To begin, you change that front for this particular style of the Vienna front. Raise up at the front of armhole from N to BB $1\frac{1}{2}$ inches and lost with a curve to AA as shown on the diagram. You will note that AA is the beginning point of the dart or the place of bust and therefore allow from BB to CC $\frac{1}{4}$ of an inch and follow with that $\frac{1}{4}$ of an inch parallel a curve lost to AA down to 25 which is the Waist-line. In order that this action shall be properly prepared it is necessary to know that these 2 new curves are to be positively alike in their shape of form. In order to make distinct the 2 different parts of the front, you will note that BB is connected at A and followed down to 22 and 27 which makes it the outside part of the front. The inside part of front is the part which is to be cut out from CC, AA down to 25, 26 and 28; otherwise the entire jacket is the same as the first half fitting jacket.

Remember that this jacket has all seams allowed just as well as the others and the space between CC which is $\frac{1}{4}$ the amount is therefore allowed for the usual seams so that there shall not be any confusion of having any seams to allow and therefore remember again that all seams are allowed already.

I. ROSENFELD'S SYSTEM

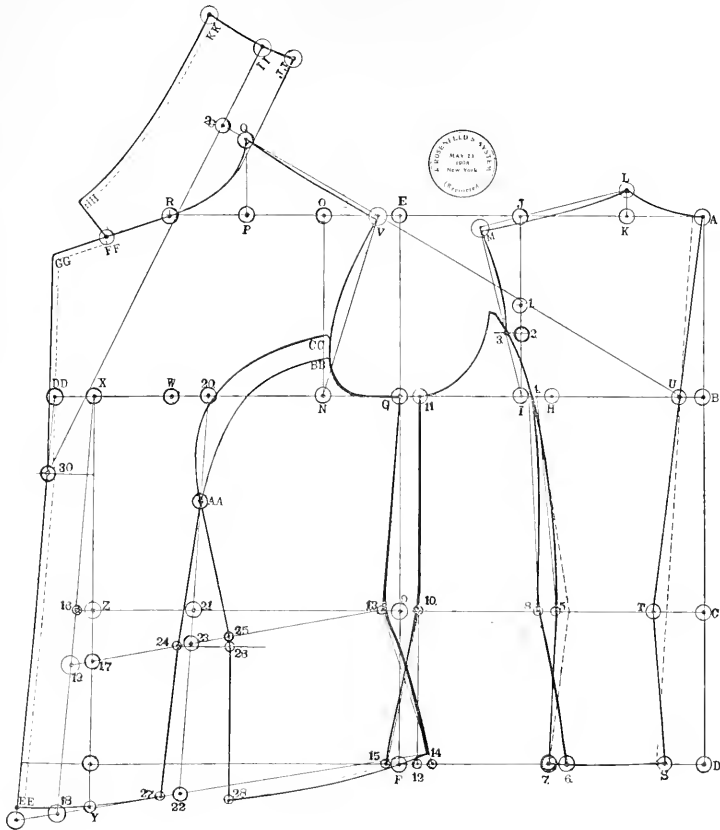



THE PRACTICAL DESIGNER

HALF-FITTING JACKET WITH FRONT SIDE BODY

LESSON NO. 12

This jacket is drafted on the same foundation as the first half-fitting jacket with the exception that this jacket has no allowance for any dart as it does not carry a regular ordinary dart. The amount which this jacket is taken out at the front side body is about a $\frac{1}{2}$ inch and it therefore does not need any special allowance in front.

To begin, make the entire draft of the half-fitting jacket without the dart in front and make from N to 18, $1\frac{1}{2}$ inches and draw a straight line down to 23, 20 and 19. Note that 23 is the place of bust, which is between the breast and waist line. 20 is the long waist in front and 19 is the bottom of jacket. Now make a curve from 24, which is the place of sleeve notch at the front armhole and curve to 23 down to 20 and 19, which will complete the outside front part of this jacket.

To prepare the inner part of the front or the side body of the front, begin to curve again at 24 to 23 and take an equal space of $\frac{3}{4}$ of an inch between 20 and 21 and 19 and 22 and curve from 23 to 21 down to 22.

Note that a slight change has been made on account of the seams at the front side body and therefore allow from G to 11, $\frac{3}{8}$ of an inch and draw a straight line down to 9 and lost down to the hip as usual. Also note that for this jacket we do not take out $\frac{3}{4}$ of an inch at 9, which is at the front side seam at the waist line because the dart at the front side body between 20 and 21 is too near the side seam and the amount of $\frac{3}{4}$ of an inch supposed to be taken out at 9, is taken out at 20 and 21. Otherwise remember that this jacket is drafted exactly the same way as the first half-fitting jacket, which is shown on pages 42 and 43 with the exception that the allowance of dart in front is not made because there is no regular dart given on this jacket and the dart that is taken out is fulfilled with the amount of $\frac{3}{4}$ of an inch that is left at 9 and therefore do not expect this jacket to produce the amount of bust effect as the first half-fitting jacket produces.

For button stand and collar for a single-breasted half-fitting jacket allow a $\frac{1}{2}$ inch from X to 25 and Z to 26 and draw a line from 25 to 26 and then mark the opening which can be placed anywhere below the breast line and which is on this draft about 3 inches below breast line from 25 to 27. The stand from Q to AA is 1 inch and draw a line from 27 towards AA to CC and make from CC to AA, $\frac{1}{6}$ of size and a $\frac{1}{2}$ inch allowed amounting to $3\frac{1}{2}$ inches for size 36 and measure from CC to DD 1 inch for collar stand connected with Q. From CC to EE make $2\frac{1}{2}$ inches for width of collar in back and curve the front neck from Q towards R down to 28 and measure for lapel facing on the neck curve from BB to 28, $2\frac{1}{2}$ inches for the single-breasted front and from 28 to 29 measure $2\frac{1}{2}$ inches for a double-breasted lapel and connect 29 to 27. From 28 to 30 shall be 2 inches and connect with a curve from EE to 30 and the space between 30 and 29 shall be a $\frac{1}{2}$ inch opened and watch diagram closely for all curves and otherwise this jacket is complete.

I. ROSENFELD'S SYSTEM

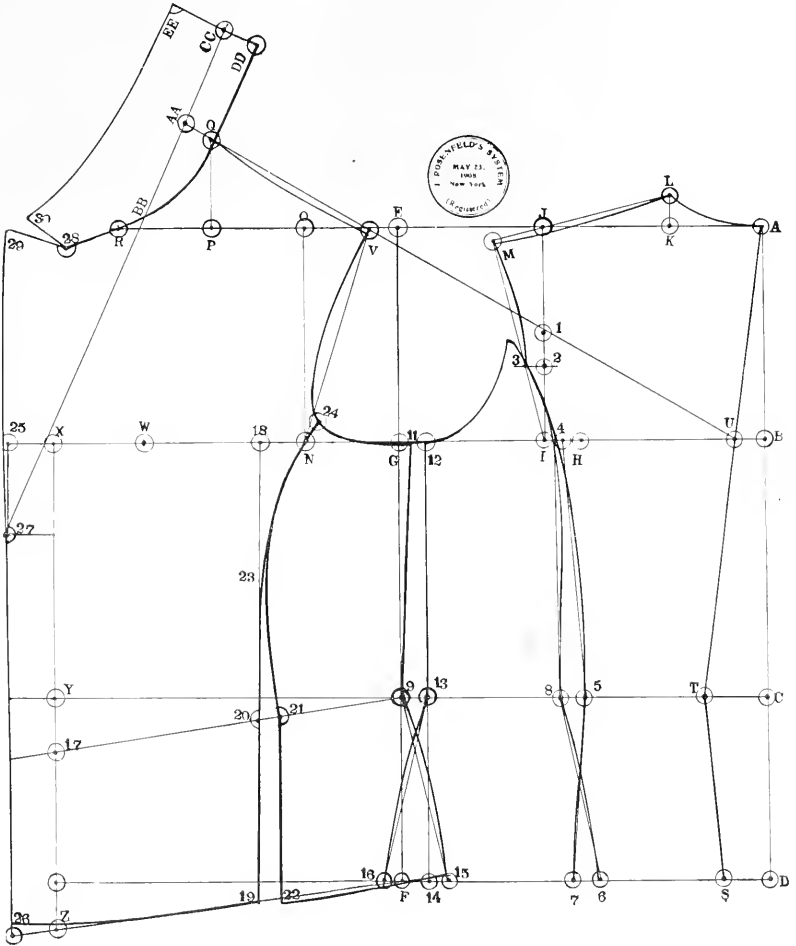

THE PRACTICAL DESIGNER

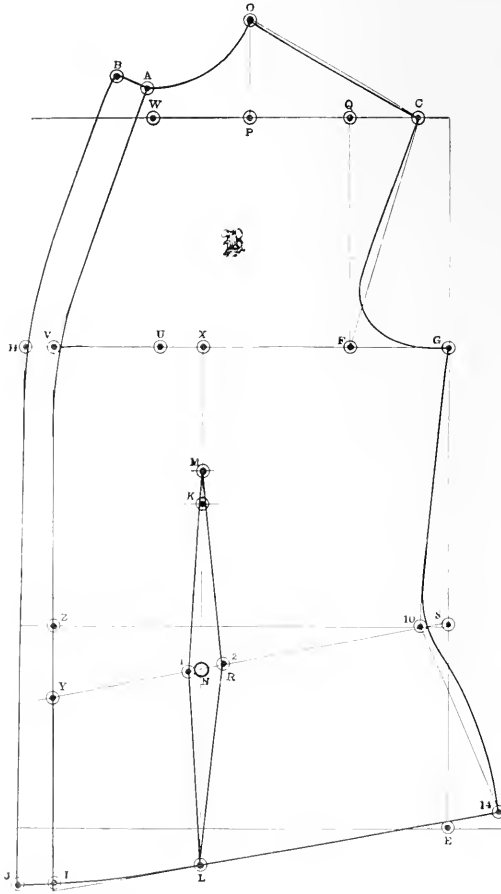

HOW TO MAKE A LOST DART IN FRONT

LESSON NO. 13.

The lost dart can be adopted to any garment wanted. As a practical point, I shall recommend this lost dart for half fitting garments only. For tight-fitting garments, this dart is not sufficient and a larger amount cannot work. To begin, make from Z to Y 2 inches for long waist, and no allowance is made in front except the button stand. The dart line is made in front the same way, from F to V take half of X, now measure from X to V and take the same amount from Y to N, this is on the long waist. Now divide from N to X makes K, now take out 1 inch sides of N, from N to 1 is $\frac{1}{2}$ of an inch, from N to 2 is $\frac{3}{4}$ of an inch. Now draw lost line from K to L, again from M, K, R to L, this completes the front with the lost dart.

I. ROSENFELD'S SYSTEM

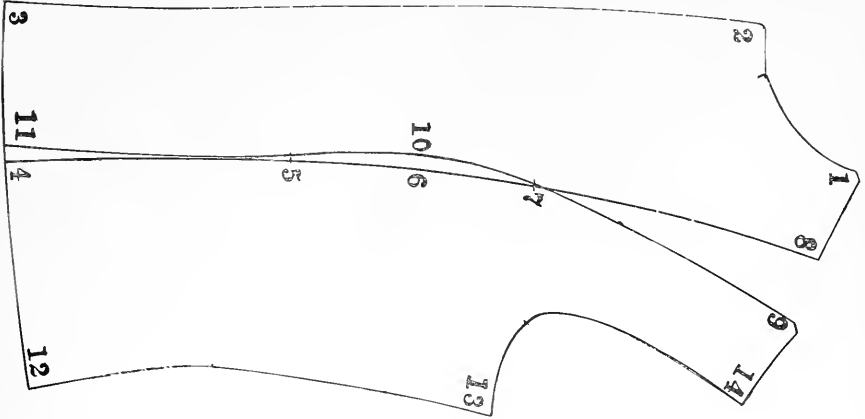

HALF FITTING FRONT WITH A DART ON TOP.

LESSON NO. 14.

In order to begin a half fitting front with a dart on top we need the two front parts of a half fitting french seam garment and those are prepared and cut out from the original draft to use them as follows. Copy first the outside part of the front which means the bottom part from 1 2 3 4 5 6 7 and 8 as shown on the diagram and when this front part is already marked out take the inner part of the front which is carrying the armhole and place the same over to meet at the top notch at 7 and also to meet the lower notch at the bust at 5 so that there will be about $\frac{3}{4}$ of an inch lapping over from 6 to 10 which is the point of the bust and at the same time see that at the bottom from 4 to 11 should also lap over $\frac{3}{4}$ of an inch as we are closing the same up from 4 to 11 all the way up to 7 where the beginning of the dart is. Then continue to copy the entire inner part of the front from 7 9 14 all around the armhole from 13 down to 12 and 11 and then make the entire curve out to 3. Remember that before matching the two fronts together see to it that the space from 8 to 7 and 9 to 7 shall be alike so that when the dart is sewed together both parts will come out alike at the top of shoulder, otherwise this lesson is complete. This top dart may also be prepared from any half fitting garment having a dart on bottom, in such case, all that may be done to close the dart on bottom split from top shoulder to the bust point. The diagram above is showing this of a french seam half fitting garment as this is more practical.



THE PRACTICAL DESIGNER

MANNISH JACKET WITH SHAWL COLLAR.

LESSON NO. 15.

This garment is built on the half fitting foundation; this garment fulfills the requirements of the two part jacket. To begin, we draw the same outlines as always from A to B; C and D is the depth natural waist length and hip length. The width of back is built the same way; I is the width of back line and G is the regular box line; divide from I to G which makes N. Now draw a line from N to R and 2; take both sides of N, $\frac{3}{4}$ of an inch at 4 and 5; both sides of R, 2 inches at 20 and 21; from 2 to 3 is 1 inch. Then cross lines from 4 to 21 and 2, also from 5 to 20 and 3, this completes the side seam.

This garment requires an underarm seam; this underarm seam is lost to the pocket. To mark the place for the pocket, draw a line down from F to 16 which is at the pocket. The pocket is 2 inches below the waist line. Draw a line somewhat slanting towards the front; this line is the foundation line for the pocket, now measure the pocket. The center of the pocket which is the line down to 16 shall be the guide line, and from the center line allow on both sides of 17 and 18 $2\frac{1}{2}$ inches so that the pocket measures 5 inches.

The underarm seam shall begin from G to 10 is 1 inch and from 18 to 11 is also 1 inch; draw a straight line from 10 to 11 and shape both sides as shown on diagram. The style of this garment does not require any dart and therefore there is no allowance in front on the waist line. The button standard for this garment is $1\frac{1}{2}$ inches as for all half fitting garments.

This garment is cut with a shawl lapel. To begin shape the neck for the garment very low from O to W down. Mark the opening at 6; then draw a line from 6 to 12; from O to 12 is 1 inch for collar stand; from 12 to 13 is 1 sixth of size, or 3 inches; from 13 to 14 is 1 inch; draw a line from 14 to O, now measure from 13 to 15 allowing $2\frac{1}{2}$ inches for width of collar, then draw a parallel line from 15 to 19 and curve from 19 to 6 for the original shawl lapel.

For the top collar, draw a line from 14 to 22 and curve all round 14, 13, 15, 9, 19 and 23, this is the top collar. The under collar is from 9, 15, 13, 14, O and W to 24. The top collar should be traced out before the front is cut out; and curve the side body before cutting out the pattern. This completes the sack with a shawl collar.

I. ROSENFELD'S SYSTEM

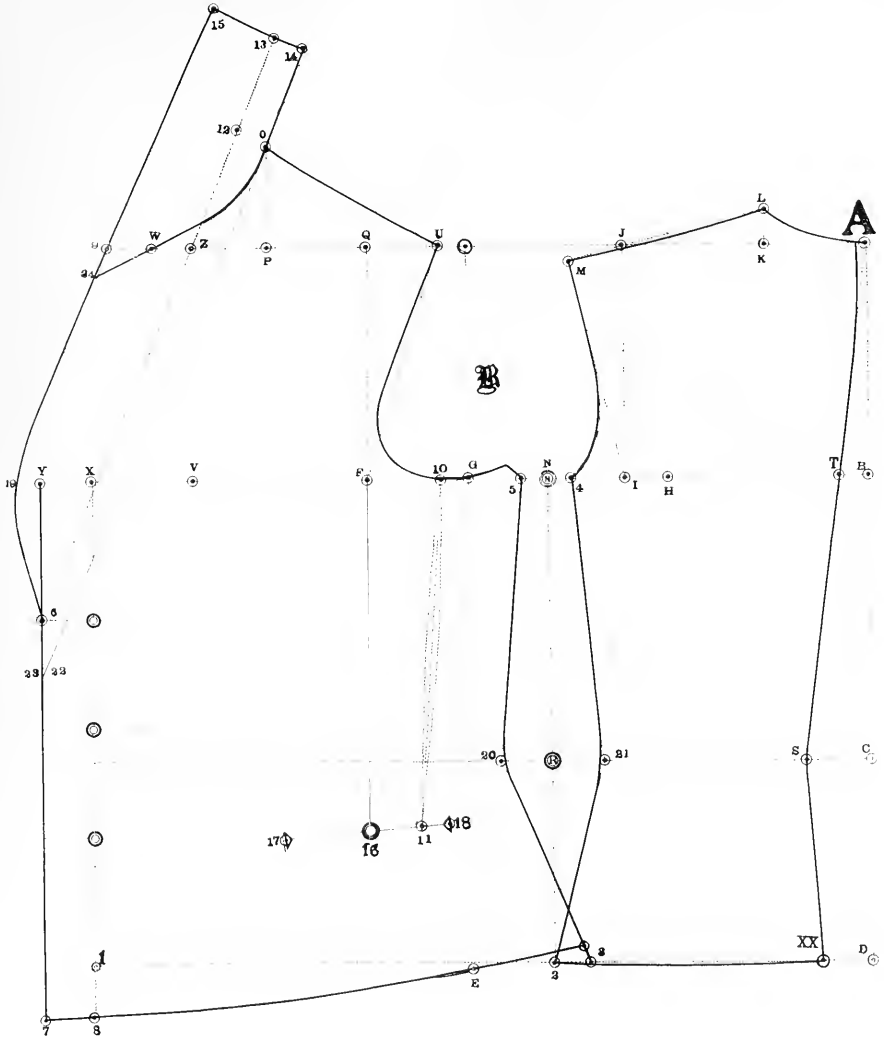

THE PRACTICAL DESIGNER

HALF FITTING JACKET, REVERE FRONT.

LESSON NO. 16.

This jacket is built on a half fitting foundation and it is specially changed for this particular style. Note that the back is exactly a half fitting french seam back and the inner part of the back is one piece with the front which is connectable to this style of garment; but by all means a seam can be placed under the arm opposite to the pleat showing on the side or it might be connectable into the inside pleat which is nearer to the under-arm. In order to fully understand the style of this garment you will note that the sketch of the entire garment is shown on the diagram.

To begin draw lines as usual and use measurements of size 36 or as you may desire. If followed by size 36, measure from A to B 7 inches back depth and from A to C $15\frac{1}{2}$ inches natural waist length; from C to D 6 inches hip length and from A to E is 36 inches full length of the jacket. From A to F and D to H is $\frac{1}{2}$ of size as usual which amounts to 12 inches for the regular size 36. Now draw a line from F, G to H and divide for the back as usual from B to G which makes I and from I to J allow $1\frac{1}{4}$ inches.

Now continue with the front which will be probably more important in order to obtain this style of jacket. Now allow from G to P and from Q to R and from R to S and T $\frac{1}{6}$ of size all over or 3 inches for size 36 and then measure the bust as usual from 8 to V and from V allow to W 3 inches for seams. Note carefully that as far as that, this diagram is the same as the standard foundation which you may remember that whatever style you may desire, the foundation is always to be drawn the same way without any changes.

To continue, we now allow a button stand of 3 inches from W to X and draw a line down from W to 11 and from X to Y. From 10 to 11 is 2 inches which indicates the length of waist in front and where the revere is stopped for this style of garment. To fully understand this revere style which means a split into the front showing a split revere, we begin the same by measuring as usual from T to 9 3 inches which is the same as the button stand and at 9 raise up $\frac{1}{4}$ of an inch and then make a round stick curve lost from 9 towards X down to Y. In order to fully understand how the line at Y and 12 is situated, measure from 11 to 12 6 inches which will make the space between the waist length or between 10 to 12 8 inches for this size and you may also remember that this space should remain for all sizes alike and that this particular space is not followed by the size; but for the style only and it is therefore to remain for all sizes the same style, now make a parallel curve line from T to 11 to follow the shape of the edge line which is drawn from 9 to Y and after, on both sides of 11 make $1\frac{1}{2}$ inches which shows cut across and ready for stitching from T to 11 on both sides to 11 as shown on the diagram and note the sketch on the diagram which will complete this revere in the proper manner.

The darts for this jacket which brings a trifle fitting at the side, are situated opposite the front part of the armhole. To begin to mark the darts, draw a line opposite the line from P to Q and 13 down to the waist length and another dart at 14; between 13 and 14 is $1\frac{1}{2}$ inch space and at the bottom of the dart No. 14, begin the split which is made between 19 and 20. 20 is the half space between the under-arm line and No. 4 or half way between 11 and 2 and it is about $1\frac{1}{2}$ inches below the waist line. From 19 to 15 is about 4 inches deepness and the edge of the front pleat from 15 to 17 is opposite the dart No. 13. The space between 15 to 16 and 17 to 18 is a 2 inch space, the center of that is split as shown on the diagram to be used for pleats when the darts at 13 and 14 are taken out, it is understood that the point at 20 will move in more towards the back.

I. ROSENFELD'S SYSTEM

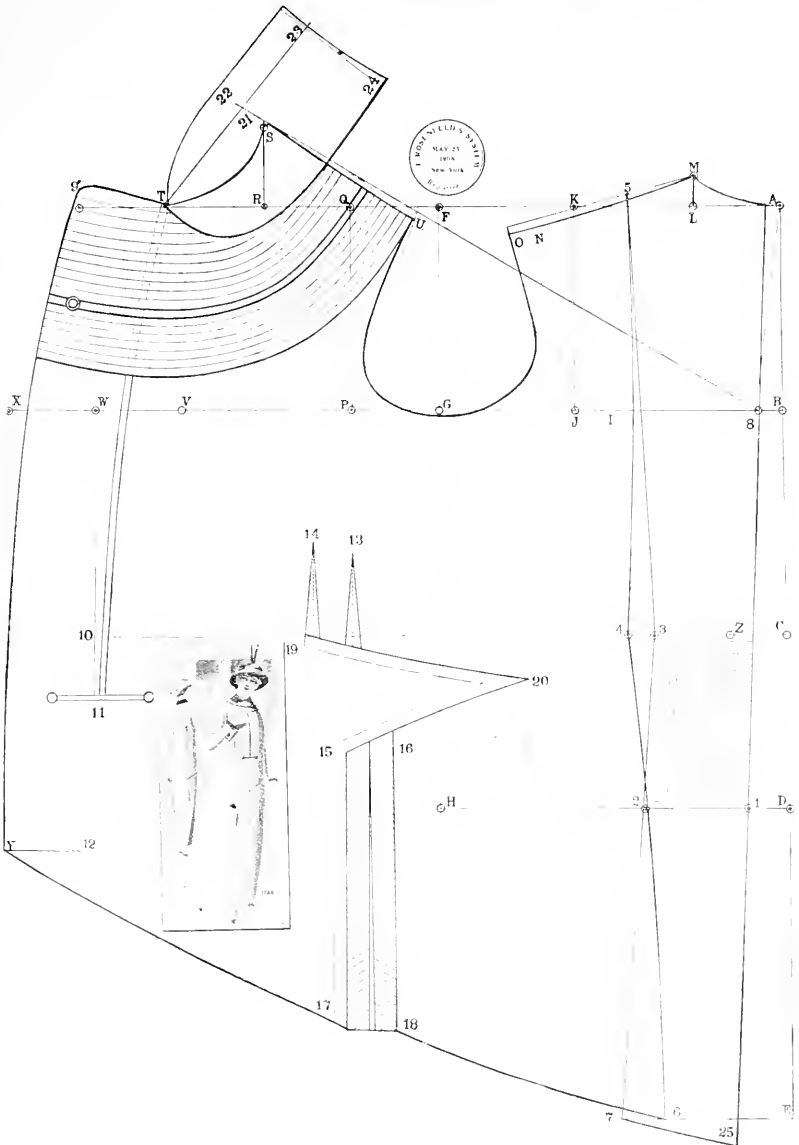

The bottom is finished with a curve to make it cut-a-way, from E to 7 is the straight line; draw a line for a no seam back allow from the bottom line to 25 $1\frac{1}{2}$ in. and curve from 25 to 7. Now curve from 6 to 18 and a parallel line from 18 to 17 which makes the bottom pleat straight from 17 to Y curve as shown. The collar for this jacket is a lay over collar, it is drafted the reversed way as shown. The upper part of the jacket has stitching around the neck. The collar is drafted the reversed way. The width from 23 to 24 is 3 in. curve towards the front as on diagram lost to T.

THE PRACTICAL DESIGNER

KIMONO JACKET, SHAWL COLLAR

LESSON NO. 17.

To begin the kimono jacket, it is necessary to prepare the foundation, as usual all the way out to the bust with seams allowed and at the very same time we may allow $1\frac{1}{2}$ inches button stand for this jacket as a butterfly jacket is a half fitted foundation and this amount of button stand makes the allowance for the single breasted front for half fitted jackets and the double breasted front may also be used and for such allow 3 inches for button stand. When the entire foundation is prepared, make for the length of jacket from 1 to 5 about 36 inches in length and begin to draft direct for the kimono jacket.

Divide the arm space between 14 and 22 which will make 29 and from 29 draw a line down to the hip line which makes 32 and then take out both sides of 29 to 12 and $30\frac{3}{4}$ inches and on the waist line on both sides of 31 to 33 and 34, take out $1\frac{1}{2}$ inches on each side and draw a line after from 12 to 34 and 30 to 33 which will make the two side seams for the front and back. Now draw the hip line from 33 to 32 down to 35 and from 34 to 32 down to 36; this will complete the under arm seam for this jacket.

In preparing the kimono sleeve, we need to decide about a certain deepness for the arm which is the rule of this garment: that at least $1\frac{1}{2}$ inch deepness has been made from the regular armhole. For instance for this style of garment we are making 2 inches deep and therefore measure from 12 to 37 2 inches and cross a line from 37 to 38.

Now prepare the back part, cross a line from the back shoulder from 13 to 16 out to 39. From 16 to 39 is 12 inches; but remember that this is a certain length and that we may follow any length as desired. These 12 inches will make about half length sleeve and the proper sleeve length may be followed at the under arm length which may be found in the following instructions. Now draw a line from 39 down to 40 and in order to obtain the measurement for this width, we need to measure the space between 38 and the top line which is produced of the back shoulder and then apply the same amount from 39 to 40 and connect a line from 40 to 38. This rule of measuring the width of sleeve to the top line of the same is to see that we obtain the parallel width of sleeve and when this is done, curve at 38 as shown on the diagram.

The front kimono sleeve, we start somewhat different than the back part. To begin in crease from 26 to 41 4 inches and connect with a line to 27 which is the regular width of shoulder at the front and after measure the width of back sleeve from 39 to 40 and apply the same from 41 to 42 with 1 inch increased or 1 inch more. For instance if the sleeve width from 39 to 40 is 8 inches, then make from 41 to 42 at the front sleeve 9 inches in width and connect from 42 to 37 and curve as shown on the diagram. To know every situation of the kimono draft, note the following instruction. Why it is necessary to increase the front sleeve from 26 to 41 4 inches. This is done for the simple reason that the front shoulder line is more slanty than the back shoulder seam as this slantness of the front is brought by the high raising of the front neck and these 4 inches will bring the seam at the proper place when the kimono is made with a shoulder seam.

The cut-a-way part of the jacket is connected from the full length in back to the opening in front. To begin the same make a round curve from the center of the back from 5 to the side seam of the back to 35 and cross a straight line to the side seam of front from 35 to 36 and then make a suitable cut-a-way curve from 36 to the opening or beginning of shawl collar in the front 44. The shawl collar for this jacket is the same as shawl collar on the mannish jacket less than 18, the difference of this may be that this shawl is built with a long opening reaching to the waist line and having a connection with a cut-a-way front as you will note in the diagram.

I. ROSENFELD'S SYSTEM

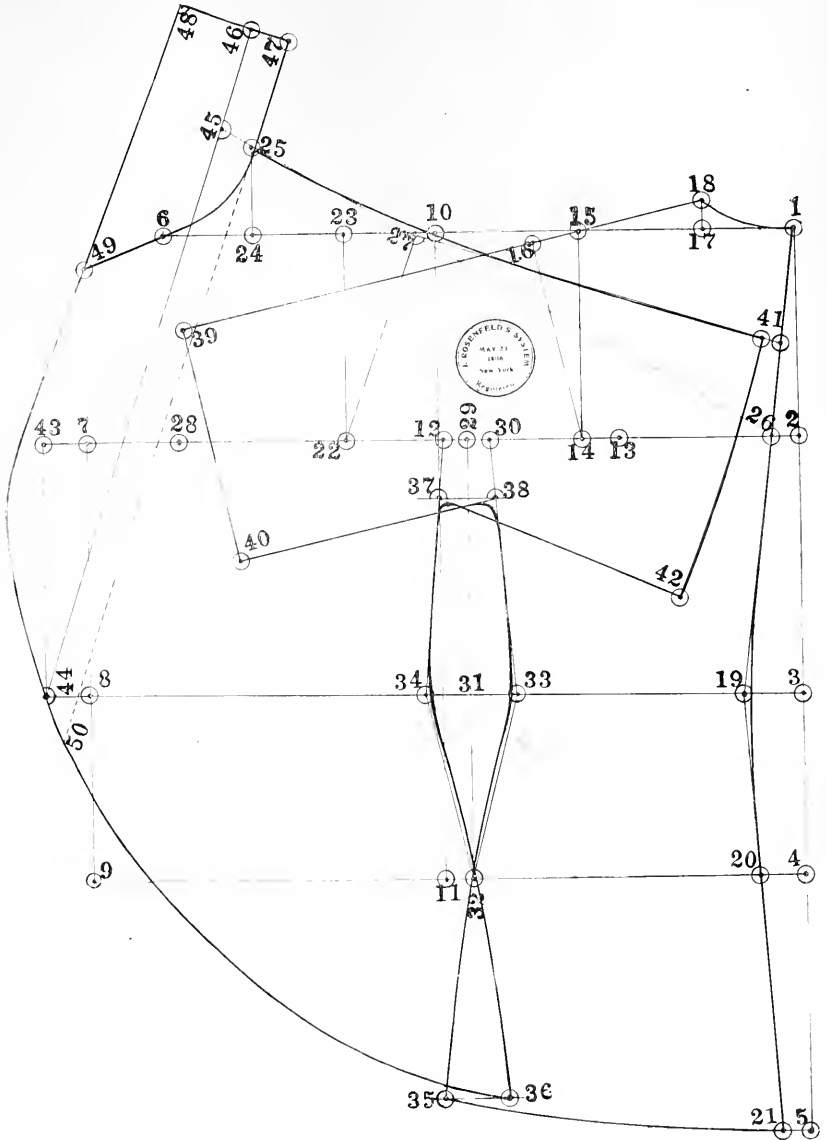



THE PRACTICAL DESIGNER

COLLARLESS KIMONO JACKET.

LESSON NO. 18.

This jacket is drafted on the same foundation as others and is showing two features. The first one, the jacket as the kimono with shortened sleeves and the collarless effect. The collarless part may be more important than the kimono effect as the kimono effect has been already explained in the previous pages.

To describe the changes on this kimono sleeve, note these instructions. The deepness of the armhole of this jacket is taken half of the armhole length which is from X to Z. This is half the under-arm length. The shoulder seam at the back is round and in order to obtain the same, use the round stick or a curved ruler from the regular shoulder from N to the bust point V and square a line from V to 14 to connect 14 to 1 as usual. You will note that No. 14 rests on the waist line and this is not done to particularly rest on that waist line; but it is followed by the deepness of this width which has been measured as usual from the top line from the deepness of the armhole; this completes the back part.

The front shoulder remains as it is and this is not increased with 3 inches in width; but is used as usual which is drawn from R to T and all there is to be done that the measurement of the top sleeve from the back which is from M to V is increased and the same amount which is about 20 inches is placed at the front shoulder seam from R to 13. Now square a line down from 13 to S and from S connect to 2 as usual. This round and flat action of the shoulder seam for this jacket is done as this diagram is describing flat or round shoulder kimono sleeve which you will note by the miniature cut attached to this diagram describing the style of the entire jacket.

The collarless effect of this garment is the second interest in this lesson which is produced as follows: If a collarless coat or jacket is wanted, it is necessary to allow and to raise the height of neck. As a rule, we first begin with the back. Raise from A to 11 1 inch; also from M to 12 1 inch and then curve from 11 to 12 and from 11 to K lost with a curve as shown on the diagram; this completes the front part. Now increase from R to 10 at the front part also 1 inch and curve from 10 lost to V which is the bust line and you will note that this diagram is a strong lap over instead of double breasted effect and you will therefore note the straight line drawn from R to V down to 7 which will make the space of increase of the double breasted effect from 6 to 7 about 4 inches. It is necessary to note that this garment is not particularly cut double breasted; but this action is brought by this particular style which brings this full lap over front. The collarless effect itself can be allowed to any short opening or to any style of buttoning garments, single or double breasted, and all the collarless garment may dictate to us that it is a garment that has no collar whatsoever attached; but the amount for the stand which is as a rule covered by the collar is allowed to the neck which serves for that purpose and covers the space of a stand and makes the garment have a close fitting neck; this diagram is otherwise complete.

I. ROSENFELD'S SYSTEM

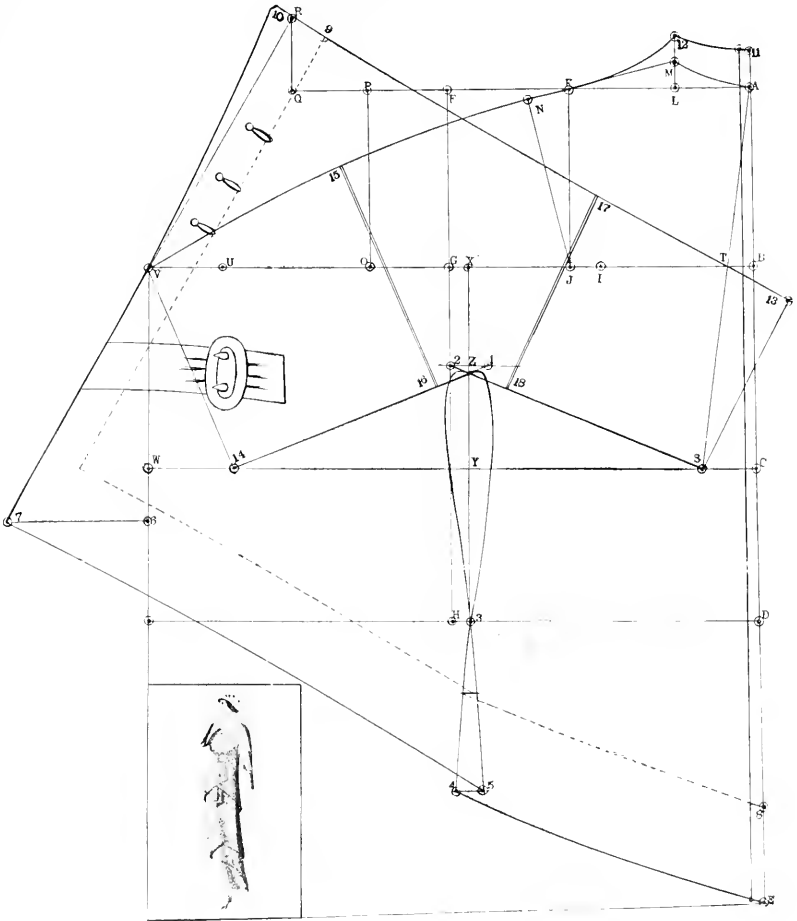

THE PRACTICAL DESIGNER

REGLAN OR BALMAACAN JACKET.

LESSON NO. 19.

To begin this draft, make complete foundations as usual on the style of a half fitting jacket and divide immediately the armhole space between I and P which will bring the center under-arm as for a blouse. To continue, draw straight lines down from the center armhole at AA down to CC to the hip line, then make the armhole lower from AA to FF about $1\frac{1}{2}$ inches and cross a straight line out towards the front and back from FF to HH and from FF to GG and remember that the balmaacan sleeves need positively a deeper armhole than the usual armhole is for about $1\frac{1}{2}$ inches at least. Now take out both sides of FF to PP and QQ, $\frac{3}{4}$ of an inch and both sides of BB on the waist line, $1\frac{1}{2}$ inches and then connect with straight lines from PP and QQ to the waist line and from the waist line to the hip line both to one connection to CC and curve then from CC for the back to DD and for the front to EE which is to be curved with a round stick to bring the exact curve needed. When this seam is all complete, continue of preparing the sleeves.

To begin this balmaacan sleeve, shape first the deep armhole at the back from M to QQ and the front the same way to PP and after draw a line from the point of back neck from L towards the curve of the armhole and also the same way at the front with the exception that from S to DZ. Now make the straight line to the curve of the front armhole and then place the square to both lines, front and back, to point out each shoulder point as shown on the back at RR and at the front at UU and then measure from RR to TT $1\frac{1}{2}$ inches and from CU to VV $1\frac{1}{2}$ inches and make curves as shown on the diagram at the back from L to TT lost to the armhole and the same way at the front from DZ to VV also lost to the armhole and then this will complete the armhole for this particular sleeve.

To continue the sleeve, now measure for the sleeve directly from I to II and from P to JJ $\frac{1}{4}$ of size which amounts to $4\frac{1}{2}$ inches for size 36 and then raise this line up from JJ to KK and from II to L and also make a straight line down from JJ to LL and from II to MM and follow carefully the measurements of each and every space as follows: From II to L amounts to 8 inches and from JJ to KK amounts to $8\frac{1}{2}$ inches. You will note that the front sleeve is a half inch more than the front. This is done to follow the effect of the front armhole as the front armhole is somewhat longer. Now note that at L, we allow $\frac{1}{2}$ inch at the sleeve and then use the same line which is drawn from the armhole from L to RR and from R to SS there is allowed only $\frac{1}{4}$ of an inch and curve the same way from L to SS and lost to the armhole curve to QQ. Now draw the line the same way from KK; first increase $\frac{1}{2}$ inch as shown on the diagram, and for the front sleeve, divide particularly from KK to the breast line as the notch is showing which makes WW and there allow $\frac{3}{4}$ of an inch and curve as shown from KK to the raise up of W and lost to the armhole curve of the front down to PP.

Now finish the inside seam; when the upper part of the sleeve is complete, measure from JJ to LL and from II to MM, 18 inches inside sleeve length and note that this measurement has to be increased always from the breast line so that the under sleeve length will always follow its rule and whatever amount the armhole is deeper, the inside sleeve will shorten the very same amount. Now draw a line from LL to MM and measure the entire space from LL to MM which is supposed to be 18 inches. If you desire to have the bottom width of sleeve 12 inches, measure from MM to OO 6 inches and from LL to NN also 6 inches and make a curve with the round stick from NN to PP and from OO to QQ which will finish the inside sleeve length. The bottom of the sleeve is finished by raising from LL to EZ and from MM to FZ $\frac{1}{4}$ inches and curve to the inside sleeve length to OO and NN as shown on the diagram.

I. ROSENFELD'S SYSTEM

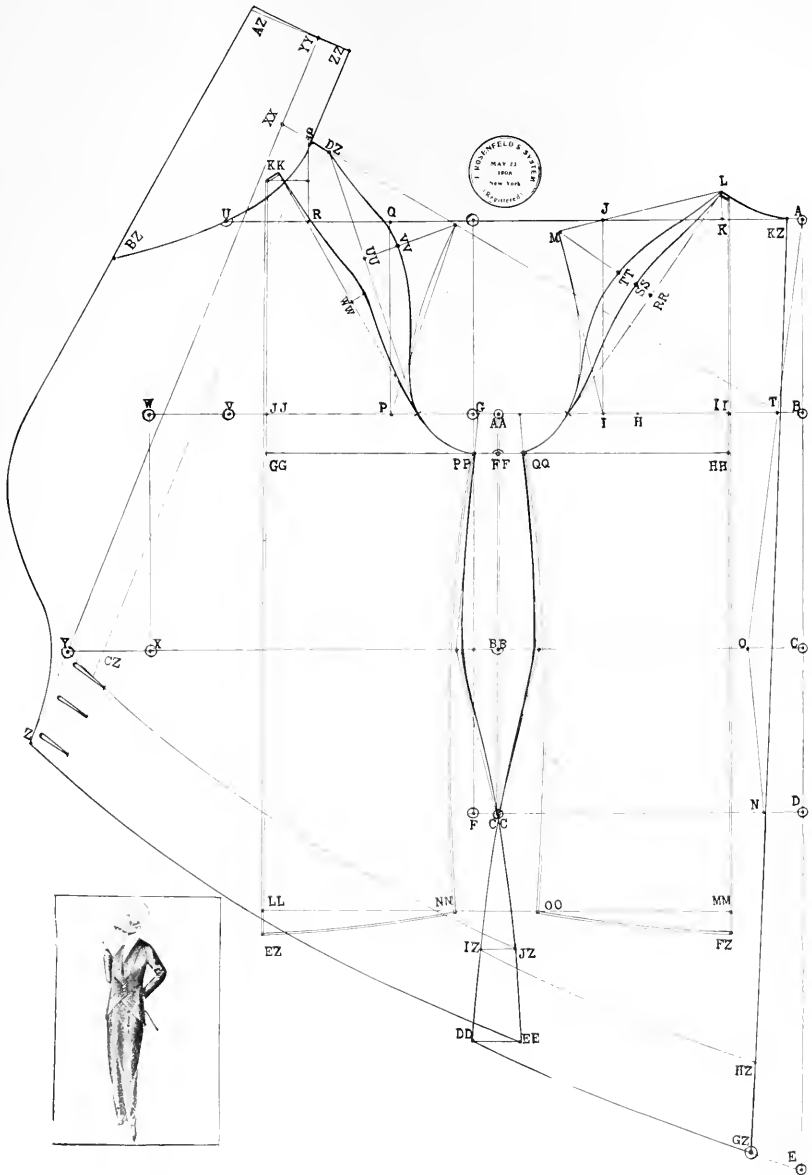

This jacket is cut without a seam at the center back and therefore deduct a seam at A and draw a straight line to the point at N down to the bottom at GZ. This jacket is a cut-a-way which is to be followed according to the standard rule of cut-a-way garments. Always make a sweep from the front to the back as shown on the diagram.

THE PRACTICAL DESIGNER

TIGHT FITTING FOUNDATION.

LESSON NO. 20.

This lesson is particularly switching off to a tight-fitting garment and by all means we are to follow the foundation lines of the first and second lessons and therefore, in order to begin, complete the foundation lines of the above mentioned lessons with the exception that we make the following changes. Instead of drawing the front armhole line from U to P we raise from P to V $1\frac{1}{2}$ inches and we connect a line from U to V which will lead the tight-fitting armhole in front and except this we do not make any use of the edge line at the front as shown in the last lesson. Now continue as follows:

In order to continue this foundation for a tight-fitting garment we prepare another line 6 inches below the waist which is called the hip line. This line is placed from C to D and it is always 6 inches below the waist line and draw a line across from D parallel with C.

Now begin the back; from D to N is $1\frac{1}{2}$ inches always and connect a line from N to O. The space between C and O is always 2 inches. Now measure from N to 1 $\frac{1}{6}$ of size or 3 inches for size 36 and make 1 inch less from O to 2 which makes that space 2 inches. Now connect a line from 1 to 2 and from 2 to H.

Now begin the side body; from 2 to 6 is 1 inch which will make a decrease at the waist; allow an increase for hip at the hip line from 1 to 5, $\frac{3}{4}$ of an inch. Now draw a line from 5 to 6 and from 6 up to H.

Now begin the side seam at front and divide for two side bodies. Allow from G to 7 and E to 8, $\frac{3}{4}$ inch and draw a line from 7 down to 8. Now divide at the breast line from 7 to H which makes 10 and at the waist line from 9 to 6 which makes 11 and draw a line from 10, 11 down to 12. From 10 to 13 is 1 inch up for the raising of the side bodies at the armhole.

Now divide the side bodies; when the line is drawn for the side bodies take out on both sides of 11 to 14 and 15, $\frac{3}{4}$ of an inch, draw a line up from 14 and 15 up to 10 and allow both sides of 12 at the hip line to 16 and 17, $\frac{3}{4}$ inches for the increase of hip and connect lines from 15 to 16 and from 14 to 17. When these lines are all complete it shall be understood that we have decreased the waist both sides of 11, as the waist is a great deal smaller than any other width measurement used for this garment and the hip again, we have increased at the hip line at both sides of 12 as the hip is the fullest measurement of all the width measurements used for this garment. This diagram is complete.

The next lesson will show how to complete the entire tight-fitting garment.

I. ROSENFELD'S SYSTEM

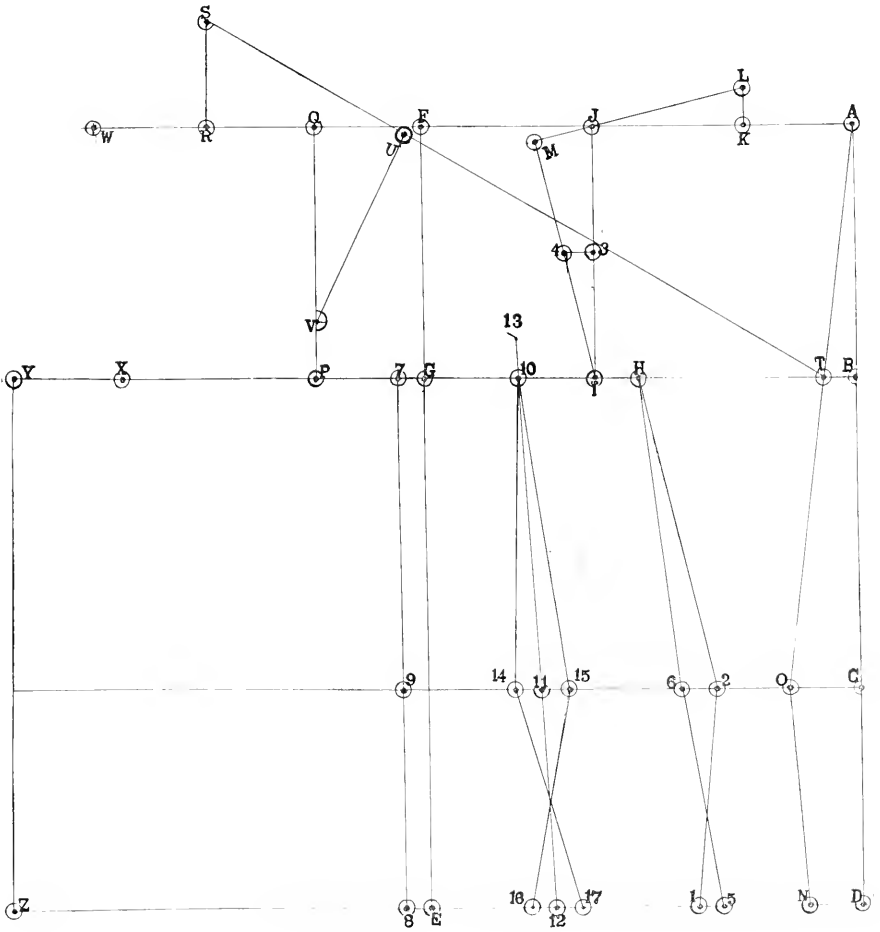



THE PRACTICAL DESIGNER

TIGHT FITTING JACKET.

LESSON NO. 21.

This lesson will complete the tight-fitting garment. From 4 to 14 is 1 inch. Now draw a line from 14 to N $\frac{1}{4}$ of an inch space in front from N, from 13 to 15 is 1 inch, from E to 16 is also 1 inch now cross a line from 14 to 16 and from 4 to 15, this is a full increase of the side hip. From 18 to 19 is $1\frac{1}{2}$ inch, from 18 to 20 is $2\frac{1}{4}$ inches or 1 eighth of size. Now draw a line from 14 to 20 to reach 21, draw a line from 1 against 19 to reach 21 and 22. Measure from 21 to 22, 6 inches, also correct from 14 to 16, 6 inches for hip space. Draw a line from 22 to 16, this will finish the length of hip in front.

Now we begin the outline for a dart in front, divide the chest from F to 1 to make 23. Now take the amount between 1 and 23 and place same from 19 and 24 and draw a line from 23 against 24, 26 and 25. Now divide the space from 23 and 26 to make 30, from 26 to 27 is 1 inch, 25 to 28 $1\frac{1}{4}$ inches, from 26 to 29 is 3 inches. Now connect lines from 30 to 27 and from 30 to 29 and 31. Now draw a line from 27 to 28, cross the parallel lines with the waist from 27 to 31. Now connect a square line from 27, 31 and 32. The space between 31 and 32 shall be carefully even in length in order to have the dart of this garment correctly understood.

Begin to curve at the neck part and back at A. We first test a sixth of a size from L to A and whatever is over-built towards A. We curve down to T which is the depth of the size line, now hollow the both shoulders, also curve from M to 34, from 34 to H to XX as shown on diagram. From X we directly begin to curve and finish at Z, now we increase from 34 to X a $\frac{1}{2}$ inch up, $\frac{3}{8}$ for a seam and we again curve for the side from X to H to No. 3. From 3 to 2 we again curve separately from the waist line, now curve from X with a seam allowed to 5, at 5 raise the seam allowance for the inside side body and curve to G. N, now at the same time we complete the front armhole, from U to V and N, this completes the work of the armhole, we again begin to curve for the inside side body, begin the side curve from 5 to 9 and 10 to be finished strong at the waist line now we start with the curve from the waist to the hip line from 9 to 12 and 10 to 11. This places the curves on the hip.

Now begin the side hip curving, from 4 to 15, have the same amount of curving as 9 to 12, from 14 to 16 make a strong curve which is about $\frac{3}{4}$ of an inch, this part of the garment should always carry the strongest curve as this is the strongest part of the hip wanted for a tight fitting garment. Now begin to curve the dart in front up from 30 about 1 inch begin to curve from 27 and 28 also from 30, 29, 31 and 32, at 30 always curve strong in order to have the dart lost at the finishing of 30 and up to 1 inch. Now curve from 16 to 32 and from 28 to 22 and a $\frac{1}{2}$ inch up as shown on diagram. Now begin to curve the neck from O to 39, from 39 curve to 1, from 1 to 19, from 19 to 21 and 22, always increase to front by shaping with $\frac{1}{2}$ inch towards the front at 22.

This completes the tight-fitting garment. This garment can be used for all sorts of tight-fitting outlays wanted.

I. ROSENFELD'S SYSTEM

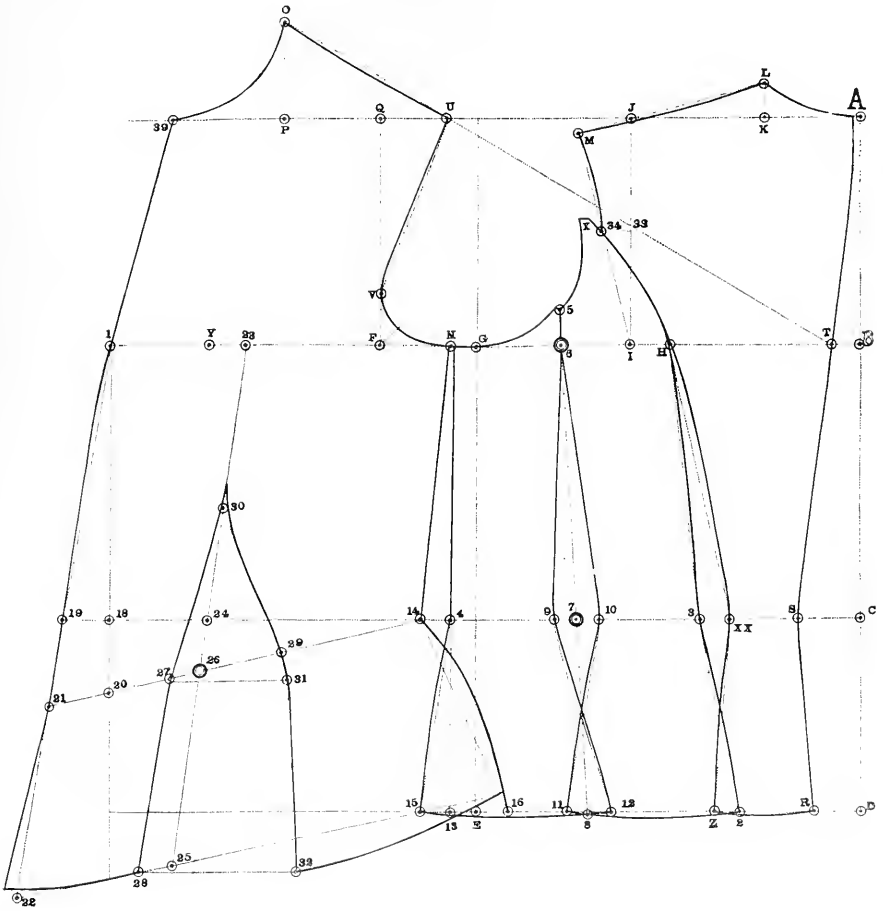



THE PRACTICAL DESIGNER

TIGHT FITTING JACKET TWO DARTS IN FRONT.

LESSON NO. 22.

This lesson begins the same way as lesson 3; this diagram is showing two darts in front also the button stand and collar. To begin the darts, we take half of N to 14 which makes 23. Now take half of 1 and 21 which makes 24, this line shows us the height of raising up the darts for the bust. Now begin to make the space between the darts, from 24 to 25 is $2\frac{1}{2}$ inches, from 25 to 26 is 3 inches, from 21 to 27 is $2\frac{3}{4}$ inches, from 27 to 28 is $3\frac{1}{4}$ inches. Now draw lines from 25 to meet 27 and 29 also from 26 to meet 28 and 30. Now we make the side lines for the dart, from 27 to 31 is $\frac{1}{2}$ inch, from 27 to 32 is $\frac{1}{2}$ inch, from 28 to 35 is $\frac{1}{2}$ inch, from 28 to 36 is 2 inches. Now cross parallel lines from 35 to 37, now make all side lines for the darts from 25 to 31, 48 also, from 29 to 48 is $\frac{1}{4}$ inch, connect 25 to 32, 47 is $\frac{1}{4}$ from 29. Now draw lines from 26 to 35 and to 46, from 46 to 30 is $\frac{1}{4}$ inch, again draw lines from 26 to 36 to meet 37 and square a line from 35 to 37 down to 38, this completes the two darts in front.

The button stand for a tight fitting jacket is 1 inch, the allowance shall always be made on the breast and hip lines. From 1 to 20 is 1 inch and from 22 to 50 is also 1 inch for botton stand, from 50 to 51 is $\frac{1}{2}$ inch allowed from the waist line lost.

Now begin the collar and lapel; in order to begin the collar we shall first decide the opening of the coat, the opening shall always be marked on the outside of the button stand; for short lapels we begin the lapel on the breast line. Before we begin to draft the collar, we make 1 inch space for collar stand from O to 42, this is from the front neck point to the stand line for the collar. Draw a line from 20 to 42 and 43, from 42 to 43 is $\frac{1}{2}$ of size or 3 inches, 43 to 44 is 1 inch, connect 44 to O and curve the neck to W down to 39 and 40, from W to 39 is 3 inches, this space can be changed to any width wanted. From 39 to 40 is 2 inches lapel notch from 39 to 41 is the collar notch, this space should always be $\frac{1}{4}$ inch less than the lapel, from 43 to 45 is $2\frac{1}{2}$ inches and draw a line to 41, $\frac{1}{2}$ inch lower than the notch of the collar, and shape out the collar between 45 and 41 and finish up at 39.

Now curve the front from 20 to the waist part of the front and from the waist begin to shape out with a $\frac{1}{2}$ inch from 50 to 51, curve the bottom of front now curve 14 to 16 with 6 inches, from 37 to 38 and 35 to 46 shall also be 6 inches now curve from 16 to 38, curve from 46 to 47 and 48 to 49, 49 is a $\frac{1}{2}$ inch curved up from 50.

Remember that when cutting out patterns notches shall be made at the waist line for the back part at S and XX, on the back side body at 3 and 10 on the inner side body at 9 and 4 and on the front at 14 and also at the lapel beginning at 20 and at the notch of lapel of 39. This completes the diagram with all seams allowed.

I. ROSENFELD'S SYSTEM

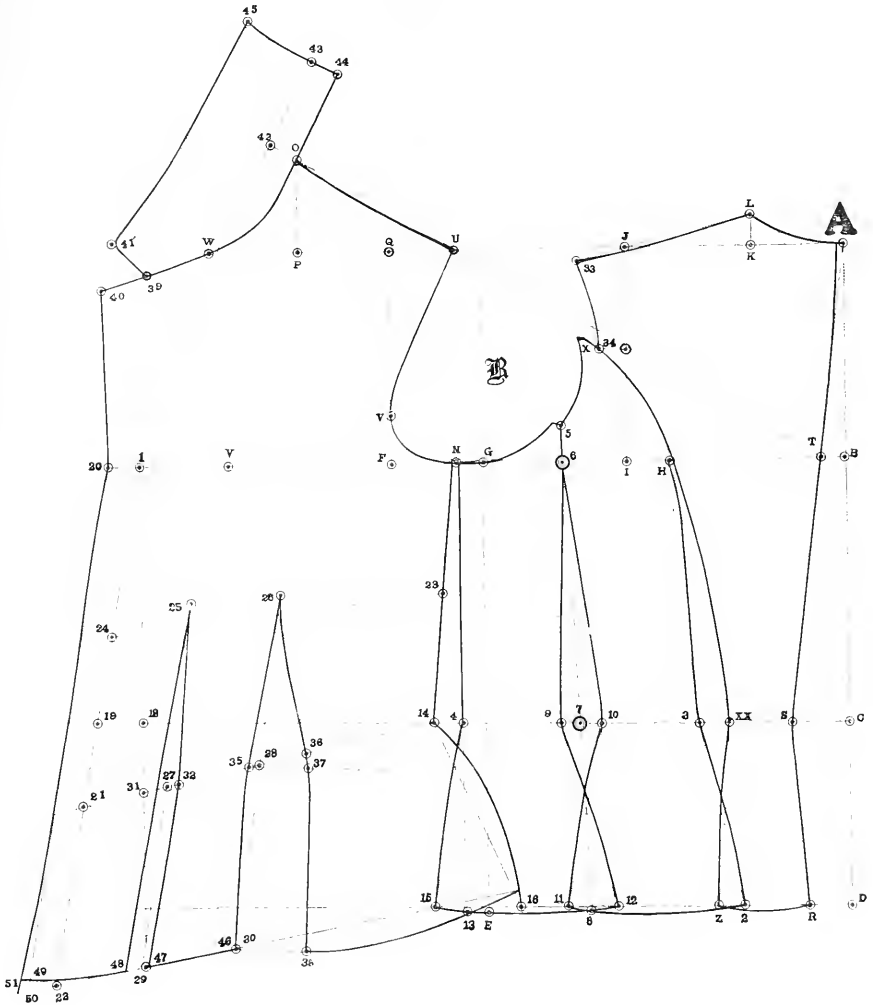



THE PRACTICAL DESIGNER

TIGHT FITTING FRENCH SEAM JACKET.

LESSON NO. 23.

This garment is drafted the same way as lesson 3; this draft is only changed with the french seams. In order to begin, we allow on the back shoulder from M to 34, $\frac{3}{4}$ of an inch for a seam which is placed in the middle part of the back shoulder which is called french seam at 33. 33 is half between L and 34; from 33 draw a straight line down to X; from X to 3 is 1 inch and draw a line with round stick to meet the straight line on the breast line at 46 and up to 33. The curve from 26 to 6 shall not be very round in order to correspond with the straight line of the back from 25 to 5; this completes the french seam at the back.

Now begin the french seam at the front; in order to begin take half of O and U which makes 35, now allow $\frac{1}{2}$ on both sides to 37 and 38 for a full seam to correspond with the back shoulder. Draw a line from 37 to 30 which is lost to 27 and 28; this makes the outside front; from 37 draw a line to 47 down to 31 and 32; and curve, this space shall be $\frac{3}{4}$ of an inch parallel space all the way down between 37 and 38 and 30 to 47. Now it shall be understood that this $\frac{3}{4}$ of an inch is a production or an allowance for a seam which is occupied on this part of the garment from the top of shoulder to the bust. Now curve at 47 to 30 crossing the connection down to 31 and 32. This completes the french seam in front.

In order to allow the button stand as a rule the entire draft is to be first completed, and after we make 1 inch button stand as this is a tight fitting jacket which is made from 1 to 20 and from 22 to 35, and when the same is allowed make allowance for collar stand which is from O to 42, 1 inch and then draw a line from 42 to the decided opening of the lapel or where the first button is to be placed of which we are supposed to have it on the breast line at No. 20, and draw a line therefore from 20 against 42 to 43. Between 42 to 43 is one sixth of size and $\frac{1}{2}$ inch which amounts to for this size $3\frac{1}{2}$ inches and finish with a line from O to 44 to make the entire collar stand.

To continue in making the proper neck curve for the collar, curve from O against W out to 39 and measure from the traced line at that neck curve to 39, 3 inches for the facing of the lapel and then make for the lapel between 39 and 40, 2 inches and for the collar notch between 39 and 41, $1\frac{3}{4}$ inches. You will note that this lapel is showing a double breasted effect, and therefore the line between 39 and 40 is traced up instead of a plain sloping line as we make the single breasted lapel and now make a curved line therefore between 40 and 20.

The width of collar is $2\frac{1}{2}$ inches between 43 and 45 and make therefore the curve connection between 45 and 41 and we make the same curve for all collars. Before cutting out such pattern, be careful and curve the front edge a trifle opposite the waist line at 21 and allow a trifle spring at the bottom around 35 and raise up also a curve at 35 beginning from 28 out to 35. This completes this garment.

I. ROSENFELD'S SYSTEM

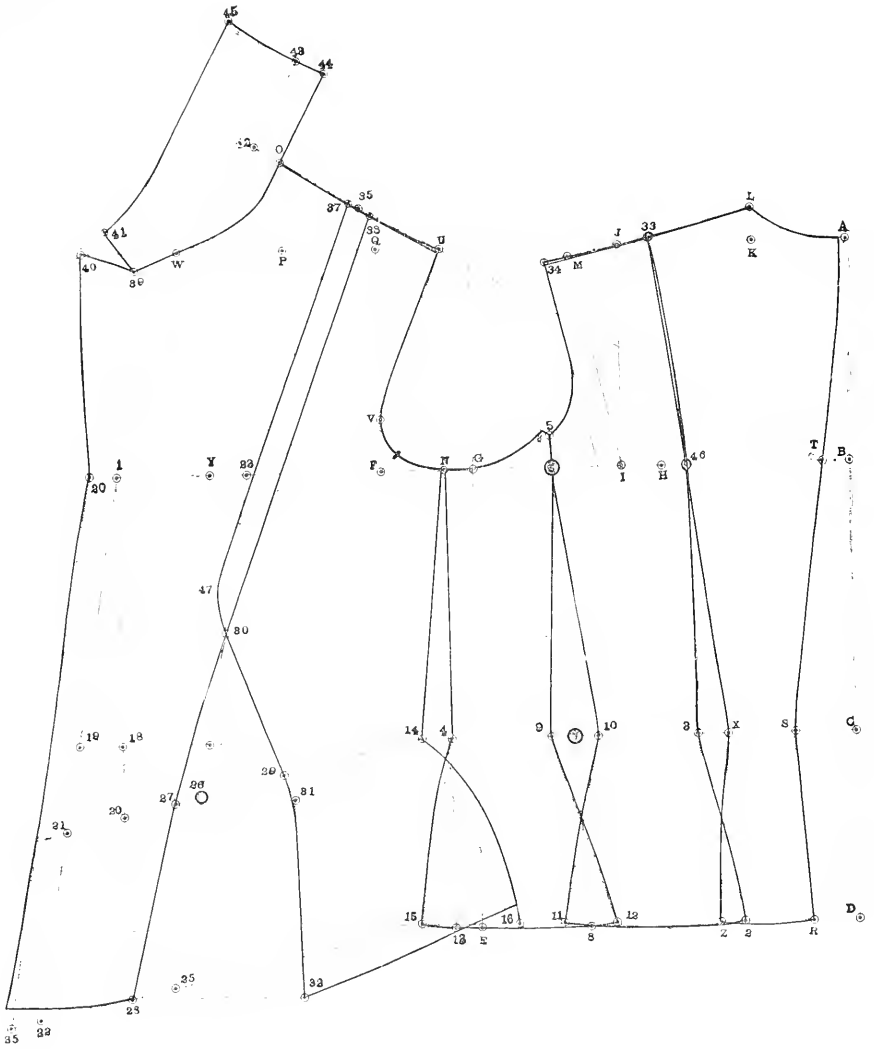

THE PRACTICAL DESIGNER

FOURTEEN GORE GARMENT

LESSON NO. 24.

The foundation of this diagram is the same as the others. Now we begin the different actions at the back which are as follows: from S to X is one twelfth of size or $1\frac{1}{2}$ inches, from R to Z is 1 more inch or $2\frac{1}{2}$ inches, from X to 3 is $\frac{1}{2}$ inch to be taken out, from Z to 2 is $\frac{3}{4}$ of an inch lapped back for the hip increase. From 3 to 10 is also $1\frac{1}{2}$ inches, from 2 to 39 is also $2\frac{1}{2}$ inches. Now take out from 10 to 9 again a $\frac{1}{2}$ inch, from 39 to 40 allow $\frac{3}{4}$ of an inch. The difference between the hip and the waist is always 1 inch, if the gore measures on the hip line $2\frac{1}{2}$ inches, it measures on the waist $1\frac{1}{2}$ inches.

Now divide the shoulder for 2 seams. Before we place the french seams, we allow from M to 34, $\frac{3}{4}$ of an inch for one seam as on diagram and after we divide for the shoulder seams. From L to 43 is 2 inches, from 34 to 44 is also 2 inches, now connect straight lines from 43 to X and from 44 to 10. After completing the straight lines, draw curved lines from 3 to 43 and from 9 to 44, these curved lines shall meet on the breast line with the straight lines. now make the lines from the waist to the hip as follows: From X to Z, from 2 to 3, from 10 to 39 and from 9 to 40, now take half of H and N which makes 6, also half of 9 and 15 which makes 7, now draw a line from 5, 6, 7 and 8; from 6 to 5 is 1 inch up, now decrease the waist part at 7 and increase the hip at 8, now both sides of 7 take out $\frac{3}{4}$ of an inch to 4 and 14 and both sides of 8, allow $\frac{3}{4}$ of an inch to 11 and 12 and connect lines from 6 to 4 and 14, also from 4 to 11 and from 14 to 12, and then allow from 13 to 41, 1 inch and connect with 15; this finishes the side seam.

Now begin to build the front part as usual; from 15 to 16 is always 1 inch for tight-fitting garments, from 18 to 19 is $1\frac{1}{2}$ inches and from 18 to 21 is 2 inches, this part of the garment is also the same for all tight-fitting garments.

Now begin the darts in front; to have a proportional raise up for the darts, we divide N to 16 which makes 23, also from 1 to 22 which makes 24, now cross a line from 23 to 24. Measure from 24 to 25, $2\frac{1}{2}$ inches, and from 25 to 26, 3 inches, now make these spaces on the waist line with a $\frac{1}{4}$ inch more than on the top line, as from 22 to 27 is $2\frac{3}{4}$ inches, and from 27 to 28 is $3\frac{1}{4}$ inches, now draw lines from 25 to 27 down to 29, also from 26 to 28 down to 30, and decrease the waist in front, both sides of 27 and 28, from 27 to 31 is $\frac{1}{4}$ inch, and from 27 to 32 is a $\frac{1}{2}$ inch, from 28 to 35 is $\frac{1}{2}$ inch and from 28 to 36 is 2 inches, from 29 to 51 and 50 is a $\frac{1}{4}$ inch also 30 to 52 is a $\frac{1}{4}$ inch, now draw lines from 25 to 31 down to 50, draw lines from 25 to 32 and 51, from 26 to 35 to 52, from 26 to 36, to 37. At this part of the garment be very careful, draw a parallel line from 35 to 37 and square a line down to 38, from 37 to 38 shall be 6 inches, also from 16 to 42 now connect 42 to 38 with a curve.

Now begin to make the french seams in front; in order to begin, measure the space at the back from L to 43 and make the same from O to 45, now measure from 44 to 34 and make the same from U to 46, now allow from 45 to 20 $\frac{3}{8}$ of an inch and from 46 to 17 also $\frac{3}{8}$ of an inch. Now this space from 17 to 20 will match the width of 43 and 44, now connect lines from 20 to 25, 17 to 26, also connect a line lost from 45 to 25; from 46 draw a line against 54 and remember that the space of 54 is $\frac{1}{4}$ of an inch for bust increase as there is no increase made at the first french seam as it is built near the front and then connect with curves from 54 down to 26, 36, 37 to 38. Now make all curves as shown on diagram from 25 to 31 and 50 again from 25, 32 and 51, now curve the bottom from 52 to 51, 50 and 49, 49 is a $\frac{1}{2}$ inch up from 48. This completes the 14 gore fitting garment.

I. ROSENFELD'S SYSTEM

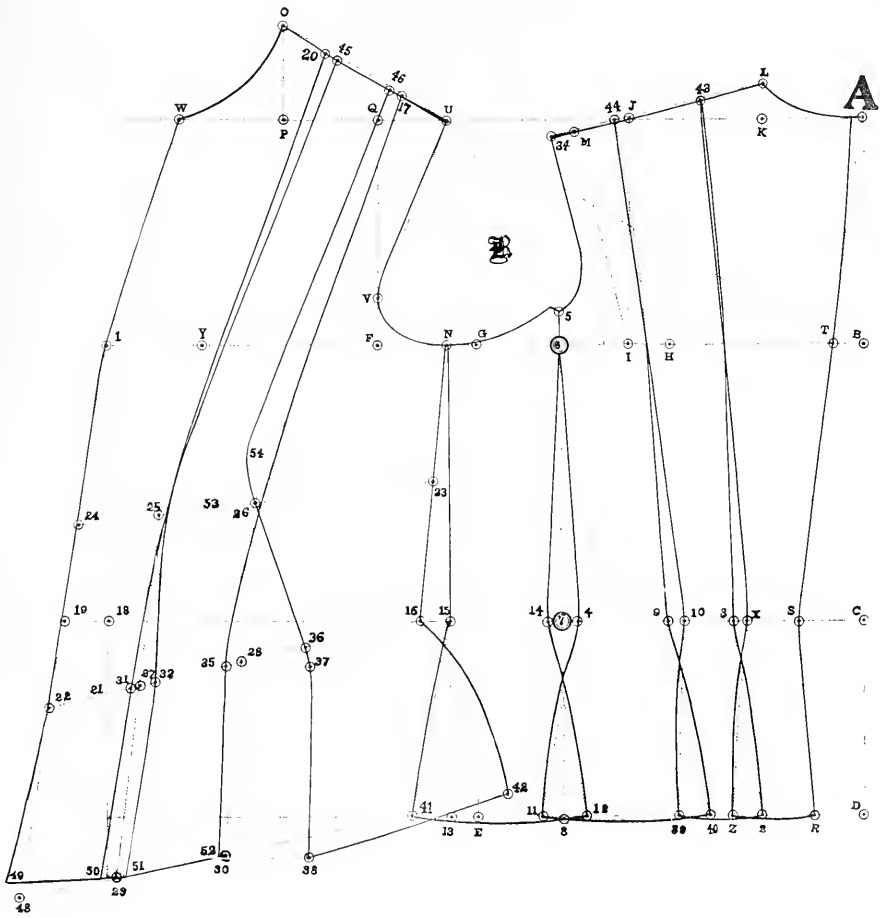



THE PRACTICAL DESIGNER

EIGHTEEN GORE JACKET

LESSON NO. 25.

The foundation of this garment is the same as the fourteen gore. The difference in this is, that this has one more seam running across the shoulder which gives one additional gore in back and front parts. Begin to work at the back, from R to Z is $2\frac{1}{4}$ inches, from S to X is $1\frac{1}{4}$ inches which means one inch less than on the hip line, between X and 3 is $\frac{1}{4}$ of an inch, from Z to 2 is $\frac{5}{8}$ of an inch lapped over to the back, from 3 to 4 is $1\frac{1}{2}$ inches, from 2 to 11 is $2\frac{1}{2}$ inches, this makes the second gore. From 4 to 5 is $\frac{3}{4}$ of an inch and from 11 to 12 is $\frac{5}{8}$ of an inch. From 5 to 66 is $1\frac{1}{2}$ inches and from 12 to 13 is $2\frac{1}{2}$ inches, this completes the third gore at the back. From 13 to 14 is $\frac{3}{4}$ of an inch, from 66 to 7 is a $\frac{1}{2}$ inch and this begins the two inner side bodies and we therefore now complete the french seams at the back. Therefore divide the back shoulder; from I to 43 is $1\frac{1}{2}$ inches, from 34 to 44 is also $1\frac{1}{2}$ inches, now take half of 43 to 44 which makes M, now draw a straight line from 43 to X, from M to 4, from 44 to 66; now make curved lines with the round stick from 43 to 3, from M to 5 and from 44 to 7, this completes the french seam at the back.

Now begin the side bodies; from 7 to 8 divide which makes 9, divide also from I to N which makes 6, now draw a line from 6 to 9 and 15, from 6 to 5 is $\frac{3}{4}$ of an inch for the raise of the armhole, now take out on the waist line on both sides of 9, 55 and 56, $\frac{1}{2}$ inches and allow on the hip line from 15 to 16 and 17, $\frac{1}{2}$ of an inch, now draw lines from 6 and 55 to 56 which is the waist line, from 55 to 17 and from 56 to 16, from G to N and E to XX is always $\frac{3}{4}$ of an inch, from 8 to 10 is 1 inch, now make $\frac{1}{4}$ inch space from N to the front way of armhole and draw a line to 10, from F to 19 and XX to 18 is each 1 inch, now draw lines from 8 to 18 and 10 to 19.

The foundation of the front is the same as other tight-fitting fronts; the french seams are also similar to others and matched to the back part of this garment. We make the outlines for the darts, from N to 10 take half which is 23 and from 1 to 25 which makes 24 and draw a line from 23 to 24, this shows the height of the darts raising up at the front.

Now make the spaces for the darts, from 24 to 20 is 2 inches, the same is from 20 to 21 and from 21 to 22, now measure the spaces on the waist line, from 25 to 26 is $2\frac{1}{4}$ inches, the same is from 26 to 27 to 28, now draw lines for the dart from 20 to 26 down to 46 from 21 down to 27 to 45, and from 22 to 28 down to 35, now take out between 26 and 29 a $\frac{1}{2}$ inch, from 27 to 30 is $\frac{1}{2}$ inch, from 28 to 31 is $1\frac{1}{2}$ inches. Now draw lines from 20 to 29 and 47, from 21 to 30 and 48, from 22 to 31 and 36, from 46 to 47, $\frac{1}{4}$ of an inch, from 45 to 48 is about $\frac{1}{8}$ of an inch. Measure from 28 to 35 and make the same from 31 to 36, now connect 10 to 19 with 6 inches and curve 19 to 36, now curve from 35 to 48, 45, 47, 46, to 32; 32 is a $\frac{1}{2}$ inch curved up from 50.

Now begin the french seams at the front, from O to 37 is the same as from I to 43, from U to 38 is the same as from 34 to 44, now divide the space between 37 to 38 which makes 39, from M to 43 and 44 and make the same from 39 to 40 and 41. Now cross a line from 41 to 20 and 40 to 22, now cross a line from 37 lost to 20 as this place of garment shall not be increased for the bust. Now draw a line from 38 to 53, the space between 22 and 53 shall be $\frac{3}{4}$ of an inch as the bust is only increased on this part of the garment.

Now begin to curve, from 37 to 20 down to 26 and 46, from 41 to 20 down to 29 and 47, from 39 to 21 down to 27 and 45, again from 21, 30, down to 48, from 40 to 22 down to 28 and 35, from 38 to 53 down to 31 and 36, when cutting out this garment seams should be allowed on the back parts at 43 and 44 and also at the front parts at 38 and 40 and 37 to 41 lost to the waist. This completes the 18 gore tight-fitting garment.

I. ROSENFELD'S SYSTEM

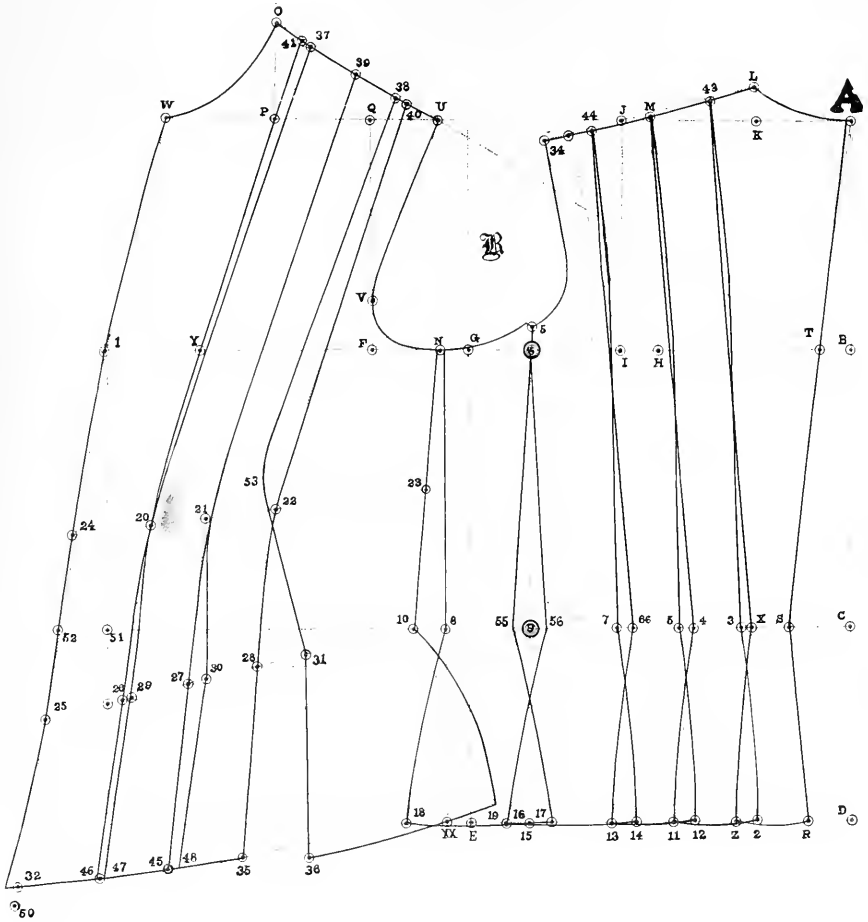

THE PRACTICAL DESIGNER

DOUBLE BREASTED BOX COAT

LESSON NO. 26.

This garment is drafted on the very same outline as the short box coat. The only difference of this garment is that the space between the armhole is divided between I and G which makes 4, and from 4 to 5 is $1\frac{1}{2}$ inches taken out. The hip is also measured as usual from 1 to R is $\frac{2}{3}$ of hip measurement or 14 inches for the 42 hip measurement; from R to 3 is 2 inches allowed for fullness. This space can also be changed to 1 inch if less fullness or narrow bottom is wanted. If no fullness whatever is wanted at this space no allowance shall be made except the hip measurement. Now draw a line as usual from 4 to E down to 11 and from 5 to 3 down to 13 which will finish the two side seams for front and back. The measurement for this garment is absolutely the same as for all other garments.

The button stand of this garment is 4 inches which gives this front a double breasted effect. We first allow from Z to W is $\frac{1}{4}$ of an inch which makes a raised up neck or button up neck and then we measure from W to 10, from Z to 9, X to Y, 7 to 8, 4 inches for button stand. From 9 to 11 is $1\frac{1}{2}$ inches or a double amount of the space between Z to W. Now curve as shown on the diagram from W to 10, 9 down to Y and draw a line down straight from 8, 14 and 15, from 14 to 15 is $1\frac{1}{2}$ inches which will finish the entire length of the front. The dart at W which is cut in from W to 23 is about 4 inches deep and only $\frac{1}{2}$ of an inch is to be taken out both sides of the center line and lost at 23, this dart will bring more bust to the garment.

The breast pocket is placed from F to 19, 1 inch forward and the size of the pocket is followed by $\frac{1}{4}$ of the size of which this amounts to $4\frac{1}{2}$ inches for size 36 which is measured from 19 to V. From V to 21 is about 1 inch which makes this pocket slanty and the flap which is over this pocket which is from 19 to 20 and 21 to 22 is about 2 inches width, this is a matter of taste.

The lower pocket is always followed by the guide line of the front armhole which is drawn from G to F down to the half space between the waist and hip line from the center of this line, measure 3 inches to both sides, to 17 and 18, which makes this pocket 6 inches for this size, or it shall be followed according to $\frac{1}{3}$ of the size for the entire pocket amounting to 6 inches for size 36. The place of this pocket might be also on the hip line for a very long coat and the size of pocket shall remain the same amount. The width of this pocket flap is about 3 inches this is also to be followed according to taste and style.

The bottom of this coat. In order to finish the bottom of this coat place front from 11 to 12 about $\frac{1}{2}$ of an inch which will give a round finish to the back and after measure the space between 4 and 12 and apply the same for the side seam of the front from 5 to 13 and connect with a round curve to front from 13 to 15.

If a shaped effect is wanted, on such as this garment, you may follow the dotted line on the side seam which will show how to shape this garment on the side about 1 inch on each side, follow the curve from 4 to 12 for the back part and from 5 to 13 for the front side. Now make all curves as shown on the diagram. The inside line at the center of back from A to N is showing how to deduct $\frac{1}{2}$ an inch if no seam is wanted at the center of the back. This completes this garment.

THE PRACTICAL DESIGNER

ONE PIECE BOX COAT

LESSON NO. 27.

The one piece coat is no doubt known as a box effect coat. It is therefore necessary to know that in order to obtain a one piece coat, we need to cut out the front and back of a box coat draft, in order that we may obtain or prepare a one piece coat and if however, a one piece coat is needed, not only in a long garment, but also in a short garment, you may also be able to prepare the same for the Eton jacket if such a short garment is wanted; or it may be also prepared of a short box coat for a short jacket. It is positively necessary to know that this style of coat consists of front and back, and then prepare in one piece which cannot be anything else but a loose fitting garment.

In order to obtain a pattern for a one piece garment such as a two piece, cut out both parts of the garment which consists of front and back and mark out the back first as follows: Place the center of the back part to the edge of paper from 1 to 2 and then mark all around from 1 to 3, 4, 5, 6, to 2 and call this your copy of the back part of your coat. To continue be careful to draw a short line across at 5 towards 7 and connect then the front part at that particular space which means that the front part is lapped over from 6 to 7, 1 inch which means a 1 inch deduction for no seam at the under-arm, and in order to continue in marking out the entire front, be very careful and lap the bottom of the front into the back at 8 just as much as you desire to get the bottom of the coat; but in order to do so, it will be necessary for us to measure across from 2 to 9 and see that the space between 2 to 9 shall not amount to more than the width of cloth that you may expect to use for this particular garment. Now for instance, the average width of cloth is about from 26 to 27 inches double width. It is therefore necessary to measure between 2 and 9, 26 inches and then settle down with the entire front and mark from 9 to 8 which completes the bottom of the front and then mark from 8 to 7 which completes the side seam and which is undoubtedly closed for this garment.

Now finish the front, continue in marking around the armhole from the front from 7 up to 10 to 11, 12, 13 and down at the front to 9. When having the front entirely marked out be careful and see that the connection is made properly between the front and back. When making a one piece garment it will always be necessary to deduct $\frac{1}{2}$ inch all over the upper part of the back which means at the neck and shoulders and which is shown from 1 to 14, 3 to 15 and 4 to 16 in order to make a good shape of armhole.

Now change the armhole from the back towards the front which you may notice with traced lines from 5 up towards 10 which will make this armhole more comfortable for a garment of this kind and to all garments which may be built on a one piece foundation.

The dart which is shown at 12, is taken out, not to better fit this garment as this garment can fit without it, but rather for the purpose of producing a trifle bust effect to this garment and this may be therefore removed on any other part of the neck between 11 and 12, and as this is the best place for such dart, I therefore recommend to use the same at that particular place where the neck from 11 to 12 is finished or where the hook or lap over of the front is, which is from 12 to 13. The dart at 12 shall be from 3 to 4 inches deep.

Do not forget that no other connections are necessary for a one piece garment and no additional seams whatever should be allowed as this particular foundation is cut with seams, but should there be a necessity of cutting entirely without seams, it can also be obtained by following up our method which is to be found in this book, which will show you how to obtain a foundation pattern without any seams allowed and for preparing that kind of a foundation in a one piece garment, the rules may be applied on the same style as this diagram is showing, with the exception that the seam under the arm between 5 and 7 is not to be deducted, otherwise this diagram is complete.



THE PRACTICAL DESIGNER

RAGLAN TOP COAT

LESSON NO. 28.

This garment is drafted on the same principles as the long box coat. To begin draw all lines as usual, **N** is the full length of coat, from **B** to **G** is $\frac{2}{3}$ of size or 12 inches for size 36. **H** is half of **B** and **G**, from **H** to **I** is $1\frac{1}{4}$ inches, draw a line up from **I** to **J** and draw a line from the shoulders as usual. Now divide **I** to **G** which makes 4, now draw a line from 4 to **E** down to the bottom line 11, this makes the side seam of the back. Now measure from 4 to 5, $1\frac{1}{2}$ inches, now complete the front shoulder as usual.

Now measure the bust and allow 3 inches for seams to **X**, from **X** draw a straight line down to 1, this is the hip line, now measure from 1 to **R** the hip measure and from **R** to 3 is 2 inches, now cross a line from 5 to 3 down to 13.

The bottom. In order to finish the bottom, take from 11 to 12, 1 inch up and curve to **N**. Now measure from 4 to 12 and make the same from 5 to 13; now allow the button stand, from **X** to **Y** and from 7 to 8 is $2\frac{1}{2}$ inches, now draw a line in front from **Y** to 8 and 14 to 15 and connect 15 to 13 with a curved line.

The lapel of this garment is the same as others, from **W** to **Z** is 3 inches, from **Z** to 10 is $2\frac{1}{2}$ inches. This space can be changed to any width wanted, now connect 10 to **Y** with a curve. The trace of the collar and lapel is showing the effect when the collar and lapel is finished.

Now begin the raglan shoulders. first start at the back from **L** to 4 draw a line, now place a square on the line half way to meet the shoulder point from 2 to **M**; now divide 2 and **M** which makes 6, now curve as shown on the diagram, from **L** to 6 down to the armhole at 4. Now begin the front shoulders, from **O** to 23 is $\frac{3}{4}$ of an inch, now draw a line from 23 to the armhole notch at 30. Now square a line across from 24 to meet the shoulder point at **U**, divide from 24 to **U** which makes 25. Now curve from 23 to 25 and 30; this completes the raglan shoulder at the front and back.

The pockets for this coat are as usual; this top pocket is marked for a flap instead of a vell as shown on the diagram. The side pocket is marked from the regular pocket. In order to begin the side pocket, draw a straight line down from **F** to 32 which reaches the hip line and 31 is the waist line; divide from 31 to 32 which makes 16 where the regular pocket takes place. Measure from 31 to 26, $1\frac{1}{2}$ inches, also from 32 to 27, $1\frac{1}{2}$ inches draw a line from 26 to make place for the side pocket, now mark the vell as shown on the diagram.

I. ROSENFELD'S SYSTEM

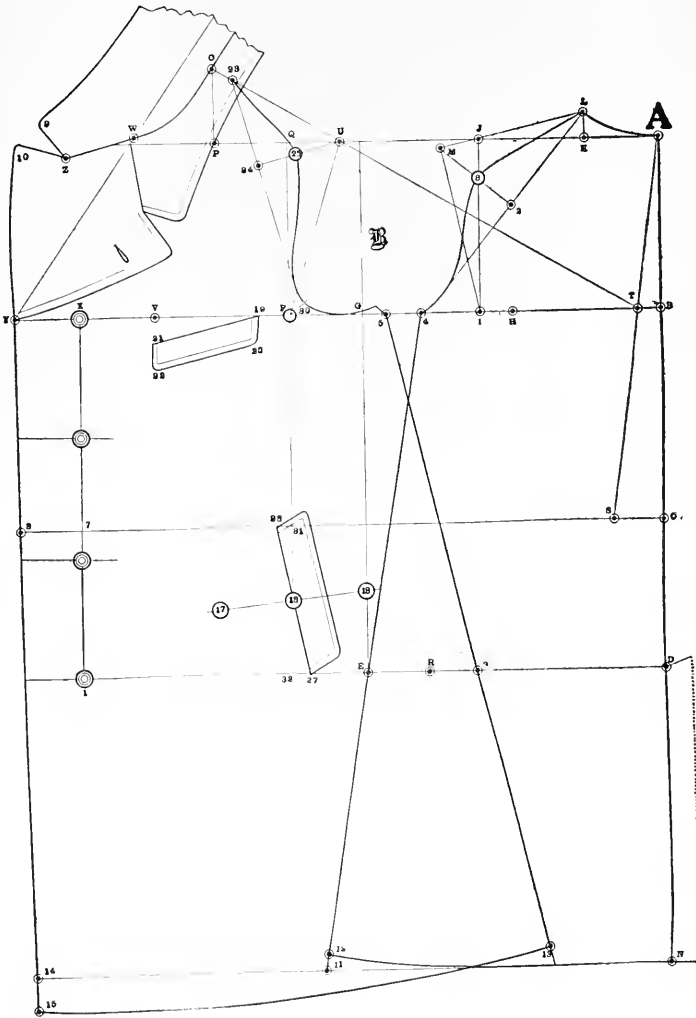



THE PRACTICAL DESIGNER

LONG HALF FITTED OR HIPLESS COAT.

LESSON NO. 29.

To begin to draft, use the regular foundation line and measure for the depth, waist and hip. The full length of this garment is about 42 inches. The width of back for this garment is the same as usual, $\frac{3}{4}$ of an inch is allowed for seams, from M to N is $\frac{3}{4}$ of an inch allowed; the space at waist line for the back from 12 to 16 is $\frac{1}{6}$ of size or 3 inches for size 36 and 1 more inch at the hip line, which makes it 4 inches from 11 to 18; between 16 and 19 is $\frac{1}{2}$ of an inch; from 18 to 17 increase for the side body a $\frac{1}{2}$ inch. Now draw straight lines down from 16 against 18 down to 21 and from 19 to 17 down to 20. At the under-arm from G to N and E to 5 is $\frac{3}{4}$ of an inch towards the back, now cross a line from 9 against 8 down to 5 and take out $\frac{1}{2}$ inch from 8 to 10 and from 4 to 3, then draw a line from 9 to 10 against E down to 25, this is the side seam at the back.

To begin the side seam for the front, draw a line from G to 3 against 5 down to 22, this will complete the two side seams for the front and back. The french seams crossing the shoulders are divided in half, which is at the back from L to N and which makes 26; at the front shoulder divide from O to U, which is the regular width of shoulder built according to this back space or L to M. The center of the front shoulder is 27; from 27 to 37 is $\frac{2}{3}$ of an inch and from 27 to 36 is also $\frac{2}{3}$ of an inch, this amounts to $\frac{2}{3}$ of an inch allowed for the french seams which we allowed at the back from M to N.

Now continue the front part, divide the front for the dart line from F to Y which makes X. Allow on the waist line from 6 to 7, $\frac{1}{4}$ of an inch and take the space from Y to X at the waist line from 7 to 30, draw a straight line down from X to 30 down to 29. Now divide from 30 to X which makes 28; connect 36 to 28 and draw parallel lines from 37 and 38 and curve from 38 to 28 as shown on the diagram to 31 down with a straight line to 32. The space between 30 and 31 all the way down to 29 and 32 is $\frac{3}{4}$ of an inch.

The button stand for this garment which is from Y to Z is $2\frac{1}{2}$ inches as a single breasted top coat, the opening begins half between breast and waist lines, the collar begins at the stand line which is from O to S, 1 inch. Draw a line from the opening at 2 up to S and W. From S to W is one sixth of size which is 3 inches and allow $\frac{1}{2}$ inch more for a seam. From W to 23 is 1 inch for collar stand. From W to 24 is 3 inches width of the collar and curve parallel to V lost to 2. In order to get a top collar for this garment, follow the broken line from 23 to XX.

The pocket for this garment is cut bias, start 1 inch below the waist line from 31 to 34, the inside edge of the pocket is 35 which is about $1\frac{1}{2}$ inches for the edge of the side body of the front and about half way of the hip space the opening of such pockets is about 5 or 6 inches.

The bottom for all long coats shall be finished round. In order to do so, measure the space always between the waist down to bottom line from C to 15 which is about 25 inches. Connect this 25 inch to each seam, this is from 16 to 21, from 19 to 20, from 10 to 25, from 3 to 22 and in front from 13 to 14 is $1\frac{1}{2}$ inches. Now curve the bottom as shown on the diagram and all seams are allowed.

I. ROSENFELD'S SYSTEM

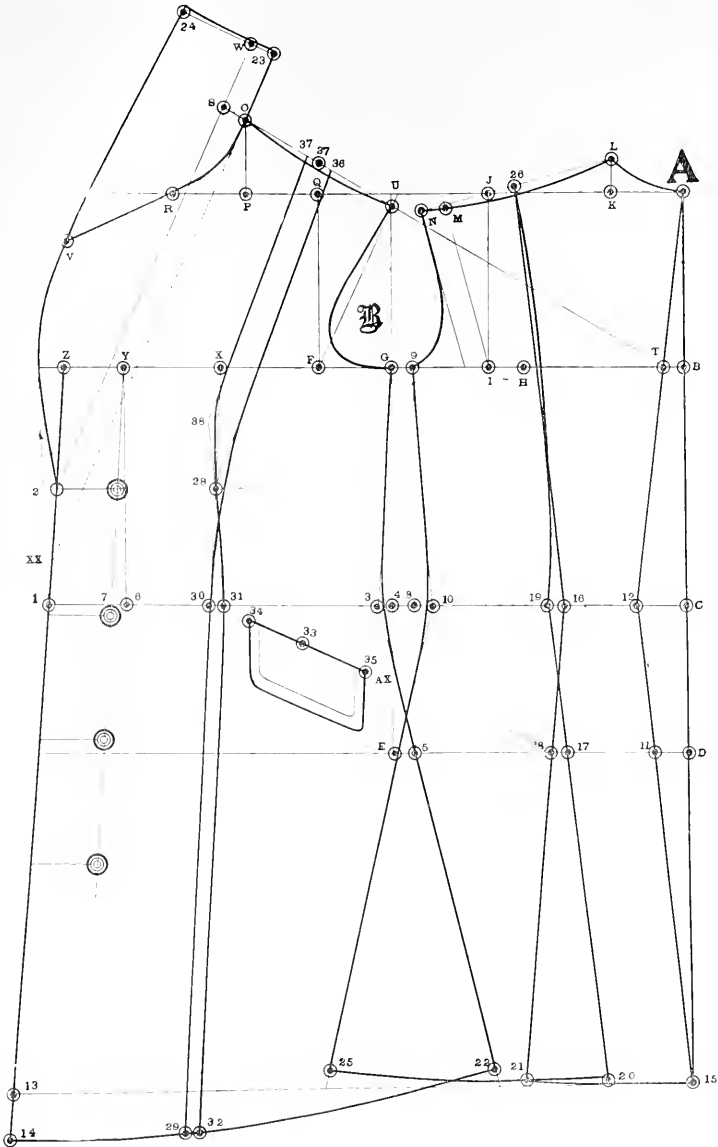

THE PRACTICAL DESIGNER

KIMONO OR BALMAACAN COAT.

LESSON NO. 30.

To begin this draft make foundations as usual and draft immediately a box coat, with one exception that the side seam shall be equally divided in the center space of the armhole, as this garment is a kimono style. Note carefully the entire style of this diagram before going any further. This coat is drafted entirely loose which will serve as a kimono coat, cape, balmaacan coat or cape.

To begin, divide the space of the entire armhole, which is between 15 and 21, which makes 31, and take out both sides of 30 to 12 and 31, half inches each side and then draw a line down from 31 against 13 which is the regular side line reaching on the hip line. Now draw a line down to the bottom to 32 which will complete the foundation of the back.

To continue with the front, measure on the hip line from 29 to 33, two thirds of hip measurement which will amount to 1 $\frac{1}{2}$ inches for 42 hip, and from 33 to 34 allow 1 inch for fullness and then draw a line from 12 against 34 down to 35 which will make the side seam for the front to be sewed to the back. After both sides of the front and back are complete, finish the bottom as usual from 32 to 44 is 1 inch up and then curve from 44 to 5. Now measure from 31 to 44 and apply the same amount from 12 to 45 and then allow at the front bottom from 10 to 55, 1 $\frac{1}{2}$ inches and draw curved lines from 45 to 55.

Now begin the kimono effect in back, divide between 12 and 36 which makes 38 and draw a line across to 40 where the connections of the both side seams are. As a rule, first begin the back part for a kimono style. From 19 to 37 at the back shoulder, deduct a seam and draw a line from 18 against 37 out to 28, a line which may be a trifle curved. Now measure from 37 to 28 about 16 inches which will give about $\frac{3}{4}$ length sleeve and square a line down from 28 to 39. This line must be square by the first line. You will note that this line from 37 to 28 rests on the breast line, but this rule must not be followed exactly. Now in order to finish the sleeve, measure from 40 parallel to the top line in order to get that particular width and apply the same from 28 to 39 and then connect a line from 39 to 40 and make a curve as shown on the diagram at 56 which will make the under-arm of that sleeve curved, which brings the result of better fitting; this completes the back part.

The front part kimono sleeve is followed partly according to the back sleeve. To begin, draw a line from 40 against 3 which is the action of the back sleeve, as you note that the back sleeve at 39 also rests on the waist line. Now measure the under part of the back sleeve from 39 to 40 which is about 10 inches and apply the same amount at the front part of the under sleeve length from 40 to 42. Measure the space between 37 and 28 of the back sleeve and apply the same amount from 41 to 43 and note that in order to finish the width of sleeve of the front from 42 to 43, you first measure the space between 28 and 29 of the back sleeve which amounts to 9 inches and allow 1 inch at the front part from 42 to 43 which makes 10 inches and connect with a straight line from 42 to 41 and curve to 41 a trifle as shown on the diagram and then curve the front armhole at 57 the same as the back part is curved at 56.

To begin the balmaacan style on this kimono coat, be careful to obtain the same curve as shown on the diagram. To begin allow from 15 to 58, $\frac{1}{2}$ inch and from 21 to 59, 1 inch and begin to make a curve from this style at the back part first from 18 to 58 down to 40 over to 56 lapping over somewhat towards the front. The front curve is made from 24 to 22, 59 to 40 lapping over to the back at 57. You will note that these points at 56 and 57 are making some small allowance when the sleeves are separated from the front and back, it will give an allowance which gives a sufficient amount for a well raising armhole. When cutting out the back, follow the same curve as for the sleeve from 18 to 58, 40 to 56. The front part follow on the same style with one exception, we begin the front from 24 down to 59 and 60 down to 57. You will note that at 60 a $\frac{1}{2}$ inch is taken out for better fitting around the bust, and note carefully that the points at the under-arm, both sides of 0 to 56 and 57 are used for both sleeves and front and back, which gives sufficient fullness for a well raising sleeve. Do not forget when cutting out, a seam is to be allowed on the sleeve, and front and back. The collar of this coat is drafted similar to others with the exception that this collar is a convertible with a short lapping out when not buttoned up.

I. ROSENFELD'S SYSTEM

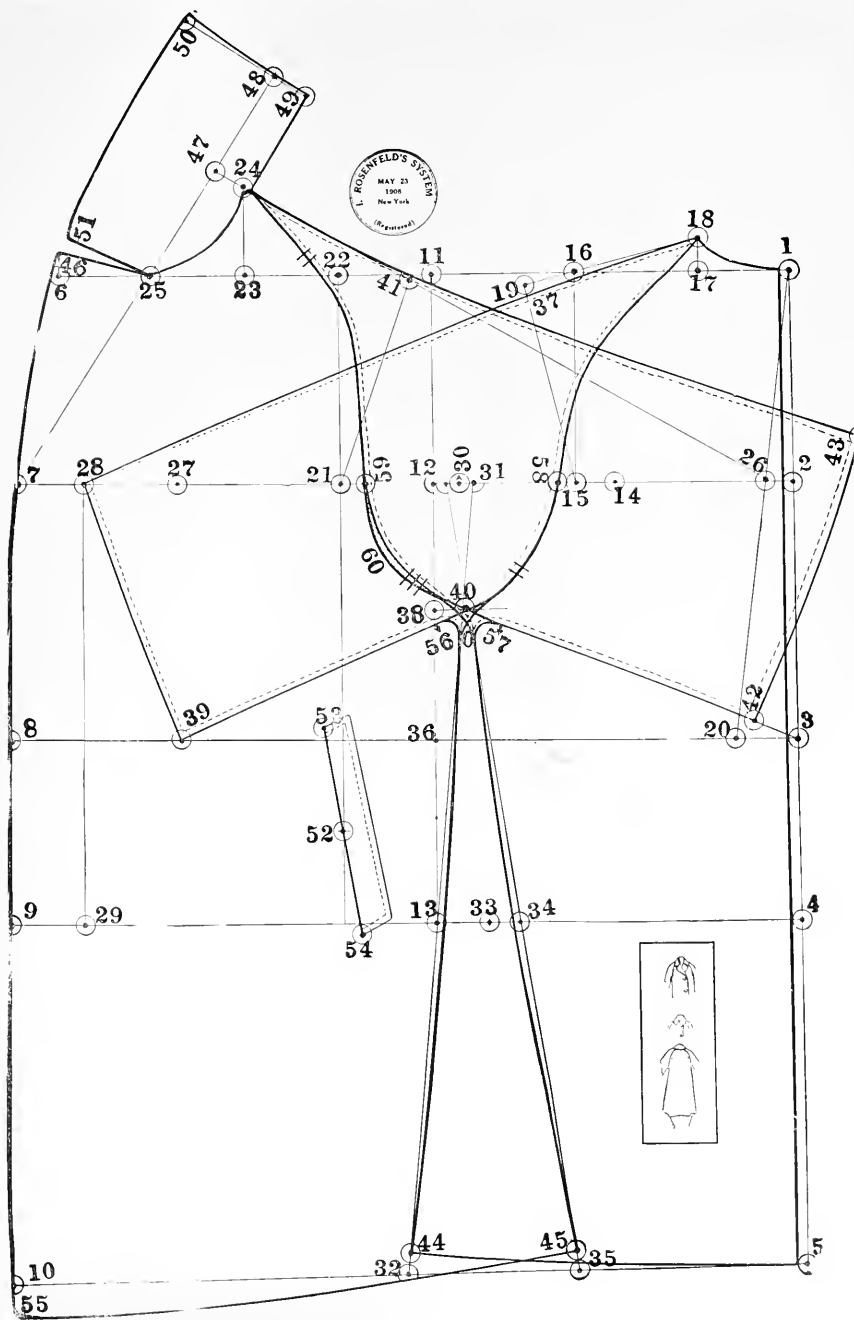



THE PRACTICAL DESIGNER

ONE-PIECE BALMAACAN SLEEVE

LESSON NO. 31.

To obtain a one-piece balmaacan sleeve, it is necessary to make a draft of a balmaacan coat and prepare all curves that are necessary and trace off the sleeve of each part, front and back. Then mark out each one on a separate sheet of paper to be able to unite the 2 sleeves of front and back in one piece. Before going any further, it should be also understood that the balmaacan sleeve can also be made up in two pieces, which means a seam on the shoulder and this is merely a production of style or taste.

To begin the one-piece balmaacan sleeve, first mark out the back part on a separate sheet of paper as follows: From 18, 62, 61, 56, 39, 58, 28, 19, to 18. Note that from 18 to 19 is the width of shoulder space, which is about 6 inches for size 36 and when this is understood apply the shoulder of the front sleeve to 18 and 19, which makes from 24 to 14 the proper connection. Then you will note that the amount of about $1\frac{1}{2}$ to 2 inches will be lapped over from 28 to 43 by the front sleeve. This amount is not done directly, but comes indirectly when placing the 2 sleeves together at the shoulder between 18 and 24 and 19 and 14. Now follow and mark out the entire front and draw lines from 24, 63, 64, 57, 42, to 59 and 43 up to 14 and 24. When the 2 sleeves of front and back are now marked out as far as this, note the change of width in cuff, if desired.

The width of sleeve at the bottom is now changeable to any width desired. The original width of this one is between 39 and 40 amounting to 18 inches and if we desire to have some amount less which is about 15 inches instead of 18 inches, we shall deduct 3 inches of this amount and therefore, in such case, deduct $1\frac{1}{2}$ inches from 39 to 58 and $1\frac{1}{2}$ inches from 42 to 59 and then make a direct curve from 58 to 59, which will make 15 inches the width of bottom sleeve or the cuff part of the sleeve. Draw a line from 58 to 56 and 59 to 57 and curve at 56 and 57 as shown on the diagram, which will fit correctly the connection of the armhole at the front and back. Note that seams are allowed at both shoulder parts at front and back from 18, 62, 61 to 56 and towards the front from 24, 63 to 64 and 57.

The notches at the back, which will show at 62 and 61 indicates that one notch at 62 and two notches at 61 will meet to the back as shown on the first diagram and two notches at 63 and 3 notches at 64 will indicate that this belongs to the front of this coat or cape, which will also be noticeably marked at the first diagram or the original draft of the same. Should you desire to have this sleeve longer, you should first increase the length 39 and 42 and then use the same action regarding taking a particular width of cuff as shown by the curves between 58 and 59. The exact instruction may be used in all such cases. This diagram is otherwise allowed with all seams as per the above instructions

I. ROSENFELD'S SYSTEM

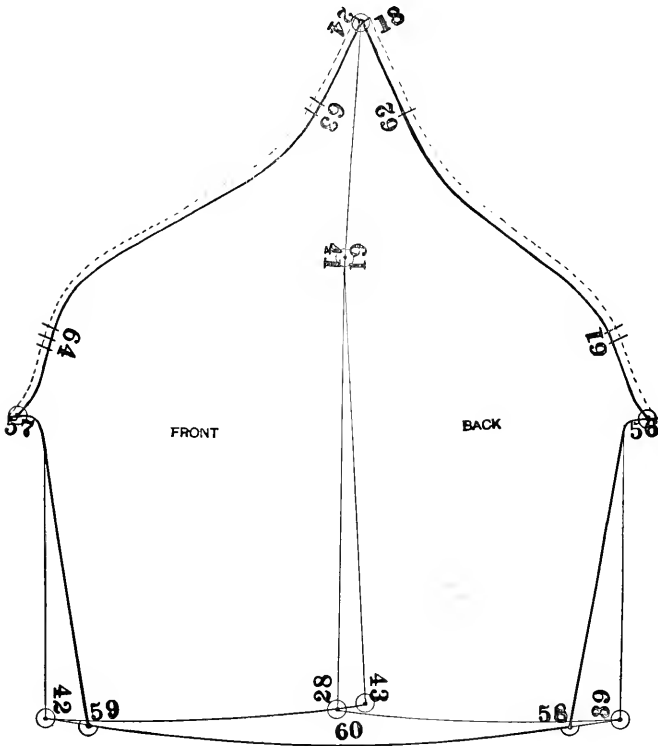



THE PRACTICAL DESIGNER

RAGLAN SLEEVE ON TOP OF ARMHOLE

LESSON NO. 32

In producing the raglan sleeve on top of its armhole, it is no doubt first necessary to prepare the foundation of a box coat, which is given in the front pages of this work and in order to commence you may understand that it does not make any difference if the armhole is the regular deep armhole or a direct deep armhole. The method of producing a raglan sleeve on top of armhole is about the same. The difference is that the curve of the sleeve will follow according to the deepness of the armhole of whatever is needed from time to time. You may therefore well understand that in order to begin to prepare the box coat foundation continue as follows:

To begin measure from I to AA and from F to BB $\frac{1}{4}$ of the size amounting to $4\frac{1}{2}$ inches for size 36 and draw a square line up from BB to FF and from AA to EE. Now draw a line down from BB to CC and from AA to DD. Then connect a line from EE to FF which makes the highest point of the top sleeve. From EE to II and from FF to JJ is $\frac{3}{4}$ of an inch which curves the sleeve at the shoulder point to the neck and then increase from BB to V 1 inch and at AA for the extending curve of the back sleeve where the dotted line is showing increase $\frac{1}{2}$ inch. Now make the curve at the back part sleeve from II, AA down to D and the front sleeve curve from JJ to V down to CC. From CC to H and from DD to GG is 1 inch; both to be connected with a round curve to QQ. This completes the center seam of the top sleeve.

Now let us continue in preparing the armhole part of the top sleeves. From II to KK and from JJ to O is $\frac{3}{4}$ of an inch and in order to finish the back curve first measure the space between M to 6 and apply the same amount from 6 to 2 and then make a curve from KK to 2 down to RR. Remember that RR is about the center space between I to G. The front curve of the sleeve is planned by drawing a straight line from the front armhole from 30 to O. Take half of same which makes MM. From MM to NN is 1 inch. Now curve from O to NN down to 30 which finishes at OO. OO is the center space between G and 30. To make the under sleeve draw a straight line down from OO to QQ and from RR to SS and take out at the waist line at both sides of PP to WW to $2\frac{1}{2}$ inches and this will finish the inside seam at the under sleeve. To complete the outside seam of the under sleeve allow from TT to VV 1 inch and curve from RR to VV down to SS, which makes the elbow line for the under sleeve. To finish the same elbow line for the back part top sleeve allow from TT to UU 1 inch and curve from 4 to UU down to SS.

To finish the inside seam to the front top sleeve curve from OO to 31 down to QQ and this completes the entire sleeve to be drafted on top of the armhole and remember that this sleeve draft has all seams allowed. In order to know which is which on the sleeve draft, note that the back top sleeve is to be noted across the waist line from S to UU. The front top sleeve is from YY to 31 and the under sleeve is to be noted or traced from VV to WW. This completes the raglan sleeve draft on top of the armhole. If a deep armhole is wanted make only changes on the armhole and follow the same instructions for the sleeve draft with the changes of the deepness of the armhole.

I. ROSENFELD'S SYSTEM

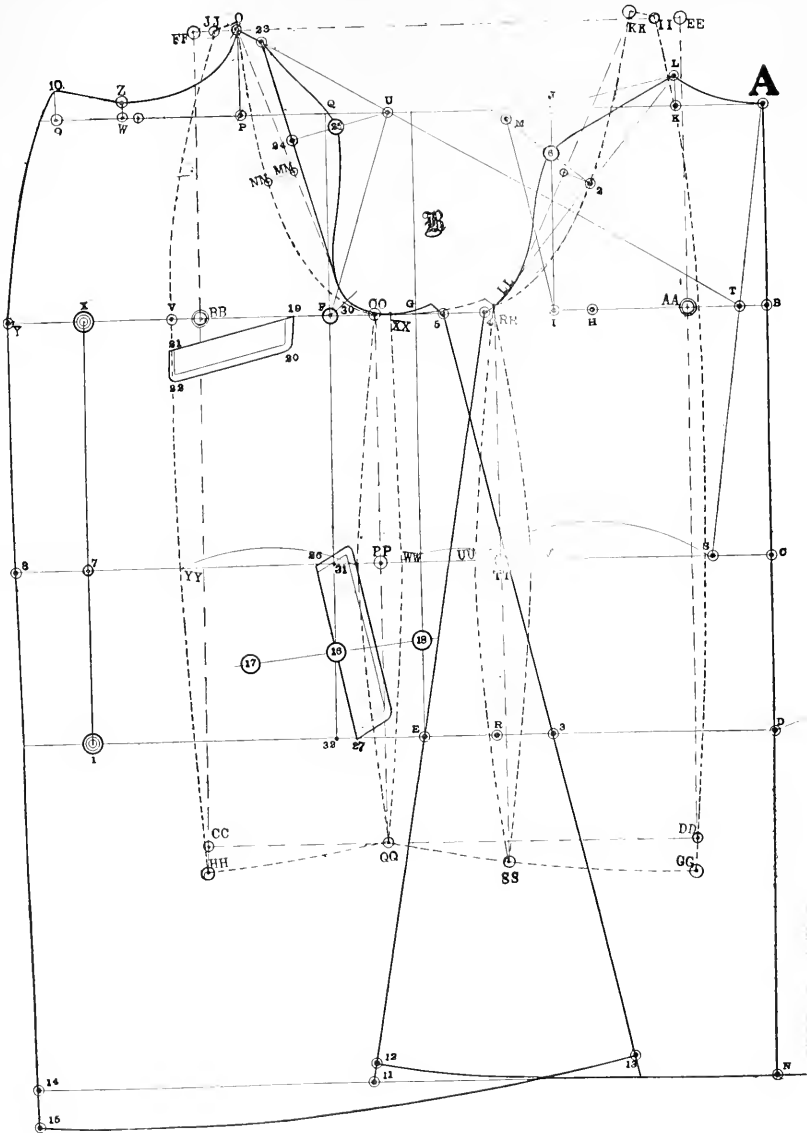



THE PRACTICAL DESIGNER

COLLARLESS COAT WITH DEEP ARMHOLE AND SLEEVE

LESSON NO. 33.

In order to begin a collarless coat, it is to be understood that we are to make the regular foundation as usual and then allow 1 inch for a stand instead of having a collar attached to this garment, which would form a stand from the collar. To prepare the same watch the diagram on the opposite page and see the regular neck curve, which is from A to L and finish to the back shoulder to M and the front neck and shoulder is from O to Z and from O to U. To make the self-raising stand, which is called collarless, we allow from A to +, 1 inch and from L to 6 also 1 inch and make the lost curve from 6 towards the shoulder lost at M. This completes the self-raising stand or collarless.

The front self-raising neck, which makes it collarless, make the shoulder curve from O to 7 and between O and 7 is 1 inch allowed the same as the back and from 7 make a lost curve to 9, which is the edge of the front. It shall be understood that the collarless garment, as a rule, is buttoned up without any out-lay of lapel and therefore most of the time there is a flat collar placed on such garment and remember the allowance of the back and front the self-raising stand should always be alike whatever amount may be allowed.

The deep armhole with the one-piece sleeve draft is also shown on the opposite page. To begin the same, divide the armhole from the center seam, as shown on the diagram. C is the center between I and F. Both sides of 5 as usual take out $\frac{3}{4}$ inches. Now make the deep armhole from about 2 inches, which is between G and Y and 3 and W. Then cross a line out to FF and EE and curve the armhole from MM to W and from U to Y. This completes the deep armhole.

To prepare the one-piece sleeve for this deep armhole, measure from F to PP and BB to DD $\frac{1}{2}$ of size amounting to $4\frac{1}{2}$ inches for size 36; also measure the same from I to AA and AA to CC. Then connect CC to DD with a line and curve immediately the top curve of sleeve from C to W and DD to Y. Now measure the lengths for the sleeve which is to be 18 inches for the inside sleeve length from AA to II and from BB to PPP and cross a line from I to HH and measure the space between II and HH which is about 17 inches and it is to be understood that this amount will be too wide for the width of sleeve. Suppose we need a 1 $\frac{1}{4}$ inch cuff, we measure from II to KK, 7 inches and from HH to JJ also 7 inches and make the curve line for the inside sleeve seam from KK to W and JJ to Y. Now finish up the bottom of the sleeve by allowing from II to LL and HH to MM $\frac{3}{4}$ of an inch and curve from MM to JJ and LL to KK. This completes the entire draft of the sleeve.

To cut and make the sleeve in one piece, we trace out the front and back sleeve and place it together from CC to LL and DD to MM. It will then make a one-piece sleeve prepared for the deep armhole. The same method can be used for regular armholes.

I. ROSENFELD'S SYSTEM

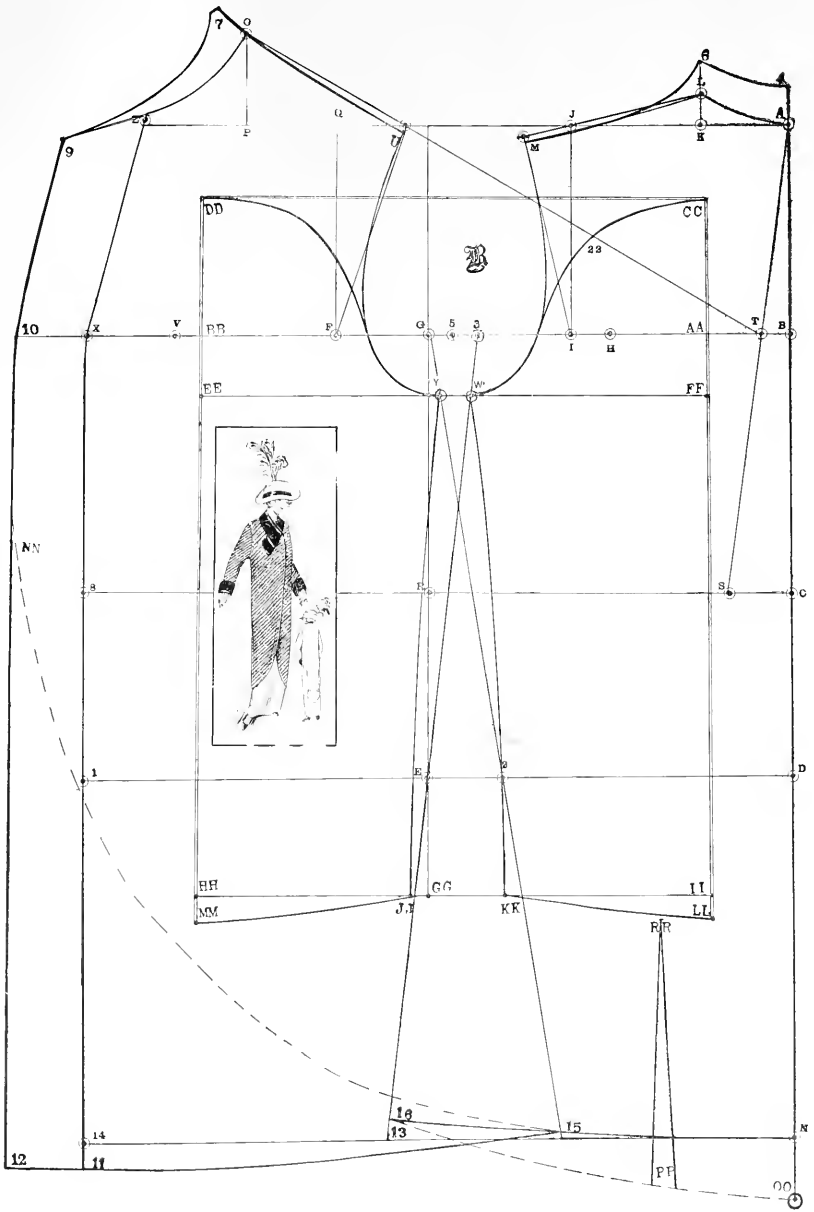



THE PRACTICAL DESIGNER

SHORT TWO-PIECE CAPE

LESSON NO. 34

This cape is drafted on the usual foundation lines, and measurements are as follows: Size 36 inches, bust 39 inches, depth 7 inches, waist length $15\frac{1}{2}$ inches, full length 22 inches.

To begin draw the outlines as usual. From A to B is the depth; from A to C is the natural waist length; from C to D is 6 inches, hip length. Now cross all lines from B to C and from D to E is $\frac{2}{3}$ of size or 12 inches. H is half of G and B; from H to I is $1\frac{1}{4}$ inches. Now raise a line from I to J. From A to K is $\frac{1}{6}$ of size or 3 inches, K to L is 1 inch, G to F is $\frac{1}{6}$ of size or 3 inches and draw a line up to Q. From Q to P and P to O is also $\frac{1}{6}$ of size or 3 inches; from P to R is $\frac{1}{6}$ of size and from R to S is $\frac{3}{4}$ of an inch with a seam allowed; from S to 4 is $\frac{3}{4}$ of an inch up for buttoning up neck.

Measure the bust as usual from T to X and allow 3 inches for seams from X to V. Now cross a line down from V to pass Z at the waist line down to the bottom or hip line. Allow from Z to 1, $\frac{3}{4}$ of an inch on the waist line and curve from 4, V and 1 down to 2 and allow a button stand of $1\frac{1}{2}$ inches from 4 to 5, from V to W and from 2 to 3 and curve the line parallel according to the inside line. The buttoning hook at the neck between 4 and 5 amounts to $1\frac{1}{2}$ inches and 5 is about $\frac{1}{2}$ inch higher than 4.

In making the shoulder curves for the front and back begin the back first, curving with the round stick from L passing J to Z, which meets the waist line at the front. Take a certain length from A down to the bottom line, which is showing on the diagram at the hip line at D and sweep by L from D to the curve line, which makes N. Now measure the space from L to N in order to prepare this measurement for the front part. To begin the front curve of the shoulder seam, curve from O passing U with a curved line of the round stick to meet Y, which is the waist line at the back and the incline of the center back and apply the measurement of the back from L to N to O and M and curve or sweep from M by O to meet the front bottom line at 2 and 3 and complete all curves at the back and front neck. Otherwise, this is complete.

I. ROSENFELD'S SYSTEM

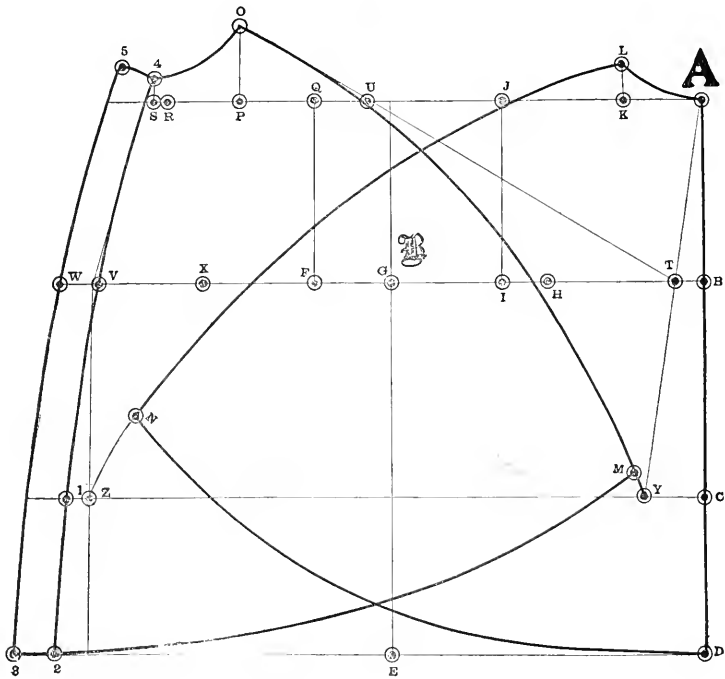



THE PRACTICAL DESIGNER

SHORT CIRCLE CAPE

LESSON NO. 35

In order to begin the circle cape, it is first necessary to prepare a front and back pattern of a box coat or a front and back pattern of a short two piece cape. It is absolutely immaterial which one of these two styles of patterns you make.

When patterns are all complete place the back part of the pattern to the edge of the paper and mark all around as shown on the diagram and then place the front pattern by matching the two shoulder seams together at C and D which will connect the two parts of the body, which consists of front and back. You will note that the back is marked out as follows, beginning from A to B and then continue it from A to C, C to D and D down to H.

Mark out the front by placing the two shoulders together at C and D and copy the front neck from C to F, F to G and then mark the shoulder and side seam the same as the back and when the entire two patterns are exactly copied, draw a line from the shoulder point from C and D out to F and then curve the bottom of that cape by a sweep from C to B and to E and G. You will note that G is the last point of curve, which is the bottom of the front.

Remember as per the instruction of this diagram the way the two shoulder seams are placed together, this cape is prepared to be placed on top of a coat or jacket as a cape, in such case, would make it much larger if the cape would be prepared for direct use, not to be placed on top of the coat; but should you want a cape to be prepared for its direct use without being connected to any other garment, it is necessary to deduct $\frac{3}{4}$ of an inch at the shoulder seam from C to D, which will make the neck of this cape just as closely and snugly fitted as a jacket or coat. Remember therefore these changes before making any further use of a cape.

I. ROSENFELD'S SYSTEM

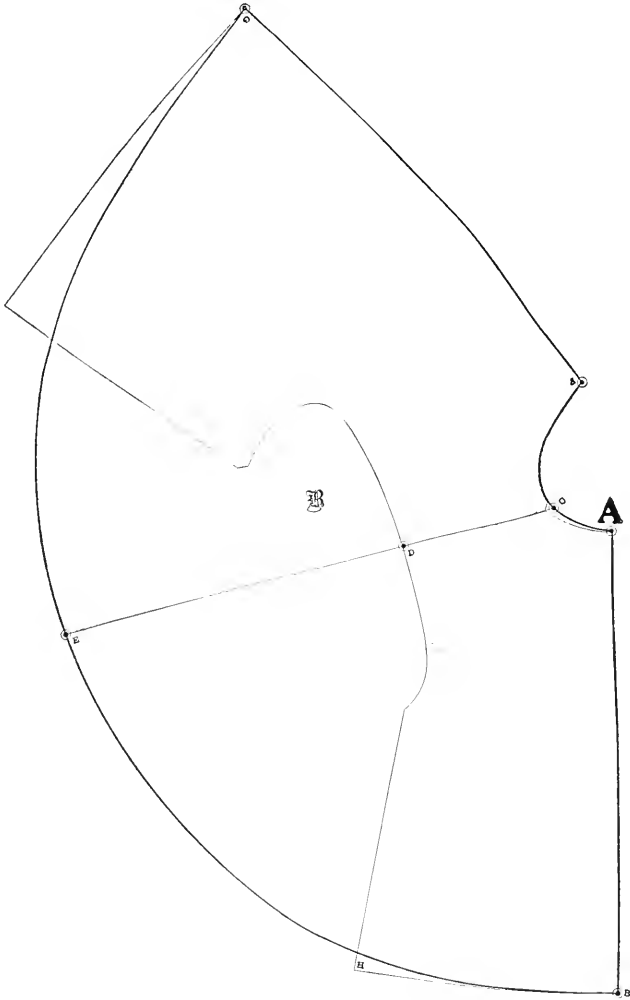



THE PRACTICAL DESIGNER

CIRCLE CAPE WITH DART IN SHOULDER

LESSON NO. 36.

To produce a circle cape with a dart in shoulder, it is again, as a rule, necessary to mark out the back to the edge of the paper as before and it is immaterial for this cape if you use the front and back part of a box coat or a short cape. No doubt, that if we can use the front and back part of a box coat, we can simply make use of the front and back part of a blouse pattern.

Now begin and mark out the back pattern all around from A to B, A to C and C to E. You will note that C to E is the width of shoulder. In order to continue in connecting the front to the back, take a space of $1\frac{1}{2}$ inches between C to D and connect the 2 inner shoulder points of the armhole together at E and F and place the front shoulder point at D to be connected to that $1\frac{1}{2}$ inch opening space between C to D and then continue in marking out the pattern from D to I, I to J and further, as usual. When the entire front and back pattern is marked out take the center between C and D, which makes G, and draw a straight line down out against the shoulder point at E and F out to H and then make a curve for the bottom of the cape by sweeping by G to B out to H and J. This will complete the cape with a dart in shoulder.

Remember that at the shoulder seam from C to E and E to F has all necessary seams allowed. If the pattern you are using has seams allowed and, no doubt, you know that if your pattern will be drafted according to the instruction of this book, your pattern will positively have all necessary seams allowed and you will also find instruction in this work of how to obtain a method of cutting direct without seams. Look for all such in the index pages.

I. ROSENFELD'S SYSTEM

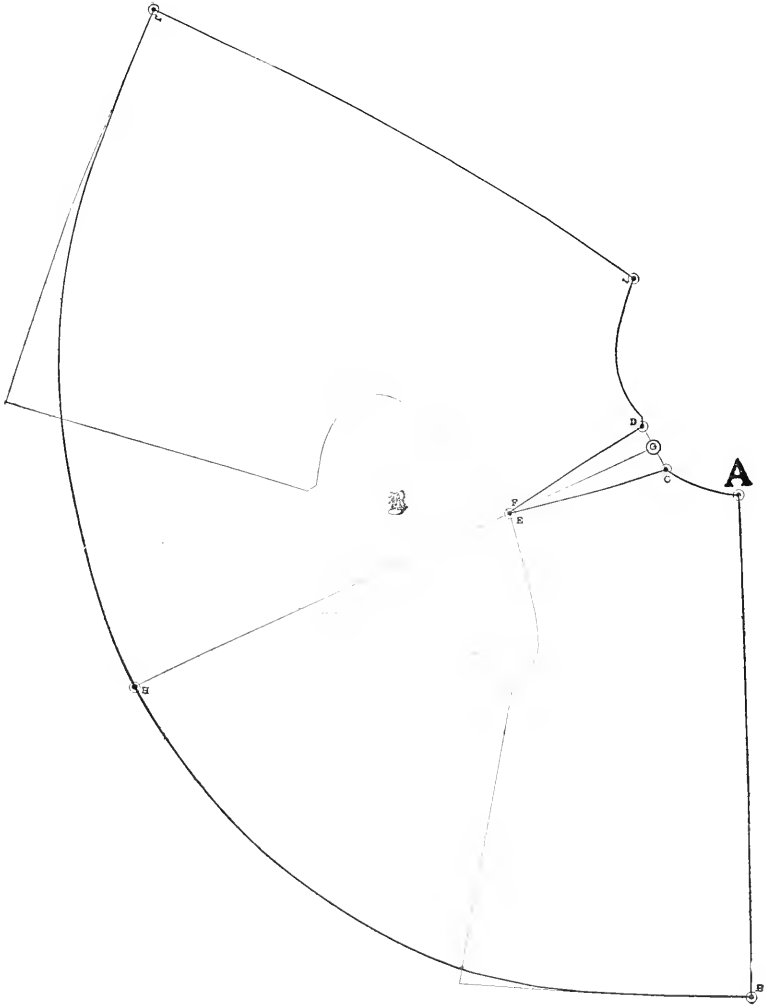



THE PRACTICAL DESIGNER

LONG CAPE

LESSON NO. 37

This cape is also begun the same way as the others. It carries the same measurements and shall measure from 50 to 54 inches in length. To begin draw outlines as usual; from A to B is 7 inches depth, A to C is $15\frac{1}{2}$ inches natural waist length. C to D is 6 inches hip length, A to E is 50 inches full length. Now draw all outlines for the back as usual. I is the width of back line and G is the regular box line

Now draft the outlines for the front and draw a straight line from X to Z. From Z to 1 is $\frac{1}{2}$ inch, cross a line from X down to the bottom 4; from 3 to 4 is 2 inches. Now make the button stand from W to 15, from X to 2 and from 4 to 3, 2 inches.

The bottom of a long cape shall carefully be considered before it is made. The bottom width for all the full length garments shall measure the same as the length; this cape measures 50 inches in length, these 50 inches shall be divided as follows: From E to 13 shall measure 20 inches in the back, from 9 to 12 shall measure 30 inches. To make this clearly understood, divide always the amount in half and 5 inches less for the back and 5 inches more for the front. Now draw the back side lines from M against 10 down to the bottom line 13 and the front side from U down to the bottom line against E.

Make curves at the shoulders, as shown on the diagram. Begin the back from L lost with a curve at J down to M and 14. Now curve the front, from O lost with a curve passing U down to 12, as shown on the diagram.

To get the proper lengths at the side seam, measure from L to 14, which is the side seam at the back and apply the same measurement from O against 12, which is the front shoulder seam and finish up the bottom at the front, at the very same time, from 3 to 9 is 1 inch and make a curve from 12 to 9, which will finish the bottom of the front. The back shall also be curved by raising up from 13 to 14, $\frac{3}{4}$ of an inch and make a curve from 14 to E, which is the bottom of the center back. Otherwise this cape is all finished.

If a narrow bottom of this cape is wanted, it shall be mostly deducted of the front side seam at 12 inside, which is on the side of the front bottom and lost with a straight line up at the shoulder curve connecting up at U, as shown on the diagram.

I. ROSENFELD'S SYSTEM

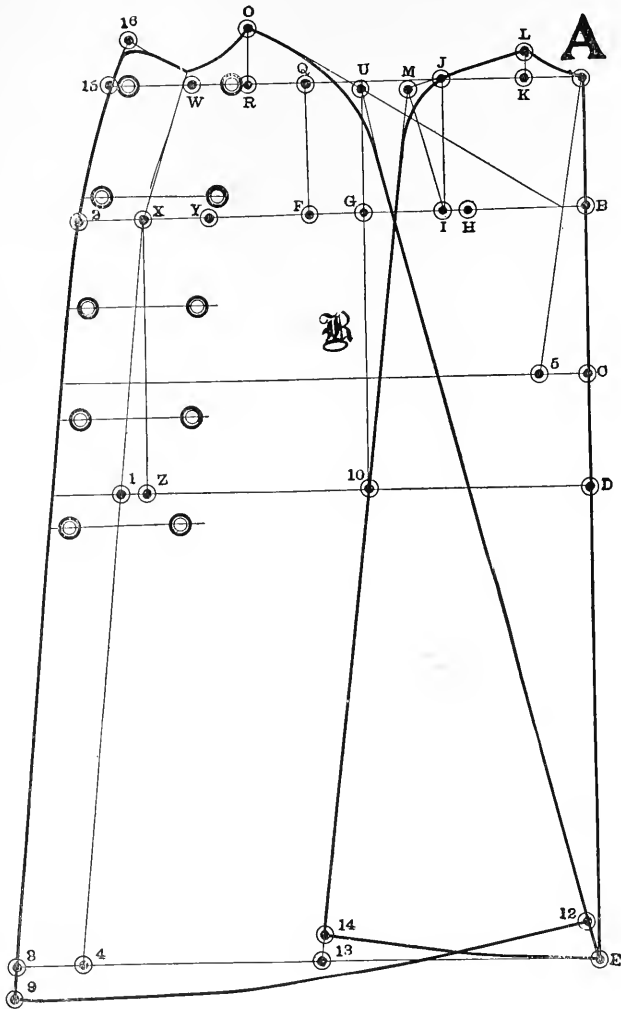



THE PRACTICAL DESIGNER

OPERA CLOAK

LESSON NO. 38

This garment is drafted on the same outlines as all others. In drafting it, it is changed to a great extent as it is only used for evening wear. To begin draw all lines as usual, from A to B is 7 inches depth; A to C is $15\frac{1}{2}$ inches natural waist length; C to D is 6 inches hip length and A to E is 50 inches full length. Now cross all lines, from B to G and D to J is $\frac{2}{3}$ of size or 12 inches for size 36.

Make the width of back as usual; H is half of B and G. H to I is $1\frac{1}{4}$ inches, now draw a line up to M and produce the shoulder to N. From G to the star (*) is $\frac{1}{6}$ of size or 3 inches for size 36. Measure the space from I to the star (*) and make the same from the star (*) to O, or that can be done in a different manner, as follows: You may change this method by measuring from G to O, 9 inches or for more fullness 12 inches, and after you divide between I and O, which will make the star (*) in the center of the space; now cross a line up from O to Q, from Q to P is $\frac{1}{6}$ of size or 3 inches, from P to R is also $\frac{1}{6}$ of size or 3 inches, from P to 3 is $\frac{1}{6}$ of size or 3 inches, from 3 to 4 is $\frac{3}{4}$ of an inch. Now make the armhole curve sweep by the star from 1, 10 to O.

The bust for this garment is not measured the same way as for others. From O to T measure $\frac{1}{4}$ of size or 9 inches for size 36. Now cross a line down from T to U and from U to V is $\frac{1}{2}$ of an inch. Cross a line from 4 to T, V down to Z and W. W is 2 inches below Z. 4 to 6 and W to 8 is 4 inches button stand for a double-breasted front. This front can be made for any style front wanted.

Now make the front shoulder, from R to F is 6 inches; now draw a line from F to O, make the circle for the globe by the star from O to 10 and I, which covers the armhole. The over space of fullness is gathered into the armhole, from O to F and N and I, when the shoulder seam is connected. The back of this cape can be made either way, with or without a seam in the back. If no seam in back is wanted, use the straight line from A to E. This cape shall be cut shapy as it is called the ripple style.

To draft the ripple back draw out a line from the depth point 2 out to the waist point C, this increases from E to 3; now curve from A to 2 towards the waist point at C down to the bottom at 3 and curve the bottom from 3 to 8, as shown on the diagram.

I. ROSENFELD'S SYSTEM

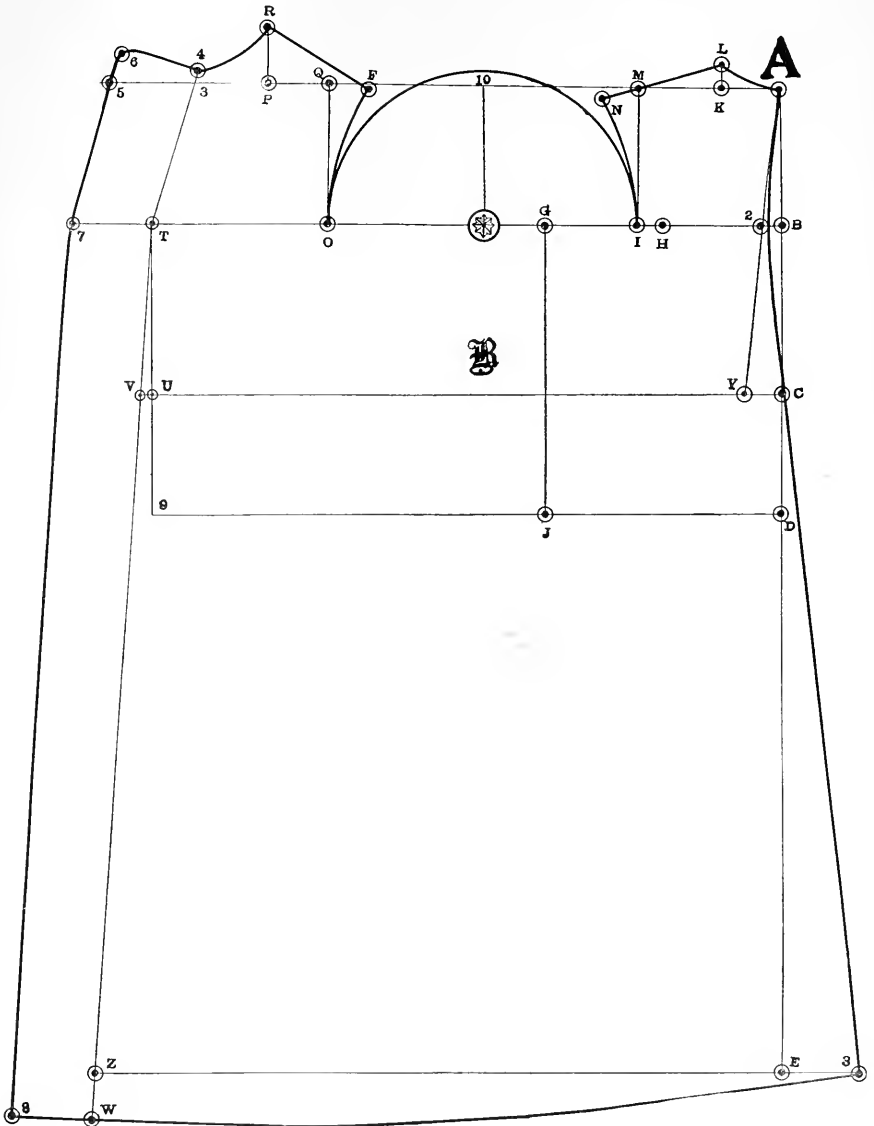



THE PRACTICAL DESIGNER

INVERNESS OR CAPE COAT

LESSON NO. 39

This garment is drafted on the same outlines as the box coat. To begin to make the changes of this garment, divide from I to G, which makes 4 and draw a line from 4 to M.

Begin the front, from 4 to 5 is $1\frac{1}{2}$ inches, draw a line to 3 down to 13, divide G to W, which makes 16 and cross a line from 16 to 17. Now curve the first armhole from U to 17 and curve also the back shoulder from L to J and M down with a straight line to 12 and 12 is 1 inch up from 11. Now make the front cape; make a round line from the front shoulder from U to C and sweep from C by O towards the front, which makes 6. The front of the cape part begins at the neck from Z, X and 8 down to 6 and from 7 to 8 is $\frac{3}{4}$ of an inch. At the front shoulder at U and 2 make a lost dart to 18, which will show an effect of an armhole to the upper cape. The button stand for this garment is 2 inches only, as there is no use for any more.

This garment shows a button up neck therefore raised up from 20 to Z, $\frac{3}{4}$ of an inch and allow for button stand from Z to 10, 2 inches. Now curve from O to Z, 10, Y and 9 down with the straight line at 14; from 14 to the bottom curve is always $1\frac{1}{2}$ inches. This garment shall be cut of a full box coat and has no sleeves as the armhole is not cut in the usual way. The armhole begins at U and finishes at 17. 17 is taken opposite from 16 and 16 is taken half way between G and W at the side line. The cape begins from O, U, 2 and C around to 6 and up to 8, X, Z to O and as this cape covers the armhole, this style of coat therefore does not require a separate sleeve.

The inverness or cape coat shall be made up as follows: When having the back, front and cape cut out and in order to close or sew the shoulder seam and side seam together, prepare the cape first; place the cape between front and back shoulder seams so that the cape shall be sewed together between front and back at one time. This completes the inverness or cape coat.

I. ROSENFELD'S SYSTEM

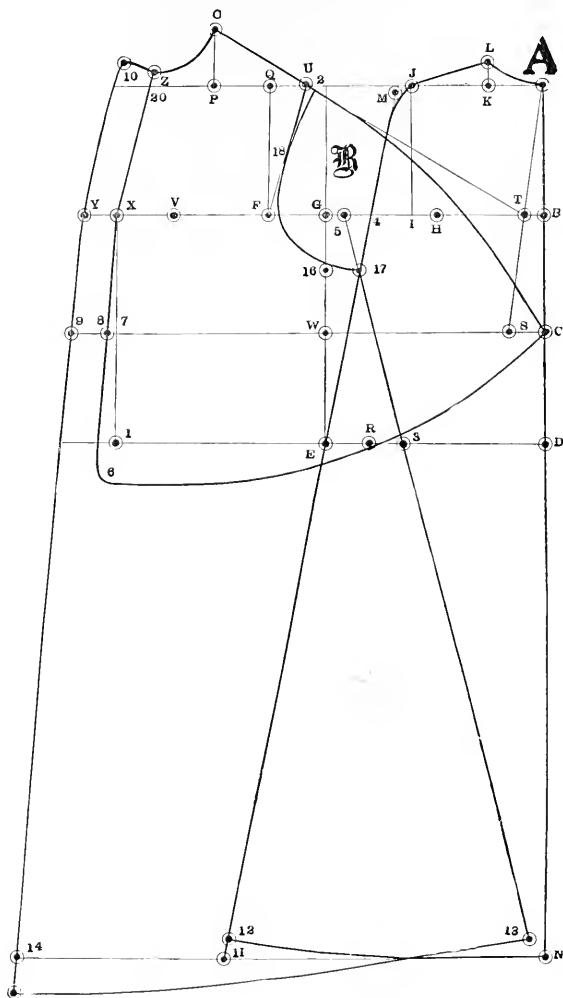

THE PRACTICAL DESIGNER

SINGLE BREASTED RIDING COAT

LESSON NO. 40

This garment is drafted on the same principles as the first tight-fitting jacket in lesson 3. Some of the measurements are changed regarding this style of garment as it is used mostly for horse-back riding purposes and measurements are as follows:

Depth 7 inches	Bust 39 inches
Natural waist length 15½ inches	Waist 25 inches
Fashionable waist length 17½ inches	Hip 43 inches
Size or Chest 36 inches	Full length 40 inches

To begin, draw outlines the same as for all other jackets and coats. From A to B is 7 inches depth; A to C is 15½ inches natural waist length; A to D is 17½ inches fashionable waist length; A to XX is 40 inches full length of coat. Now measure from C to Z 6 inches for the regular hip line. Cross lines from A to W, B to 20, C to 19, D to 15, Z to 11 and XX to 13. After having all lines crossed begin to make the same outlines as always and complete the tight-fitting jacket of lesson 3 to the natural waist length and follow further instructions. Now make the center back line as always all the way down to the bottom from S to R down to XX and also continue the inner back line from 36 against 11 down to 12 and immediately make the fashionable waist line at D, which is 2 inches below the natural waist line at C and when having the entire upper part finished as the first tight-fitting jacket finish the lower parts at the fashionable waist line, as follows: From 43 to 2 is ⅔ of an inch, both sides of 8 to 50 and 51 is always ⅔ of an inch. From 30 to 15 is also ⅔ of an inch and from 32 to 52 is ¾ of an inch. Now make curves on fashionable waist line from 2 to 51, from 50 to 15, from 52 to 31 and from 28 to 55. At 55 raise up ½ inch for curving as for all jackets on the bottom. The dart for this garment is also made the same as the first tight-fitting jacket with the exception that this dart is reaching only to the fashionable waist line.

Now begin the skirt part; cross the front line from 33 down to 13; from 13 to 16 is 2 inches, now cross a line from 16 to 25; from 25 to 28 and from 16 to 17 is 1 inch space. Now cross a line from 28 to 17, which is the front edge of the skirt. Square a line from 2 to 1 this is 6 inches hip length; now cross a line from 1 to 5 and from 1 to 5 is half of hip measure 43 or 10¾ inches. Now cross a line from 2 against 5 to 41. This space from 2 to 41 is longer with ⅔ of an inch than the space from 43 to 12; now allow from 5 to 54, ¾ of an inch for roundness and now finish the bottom of the skirt with a round curve from 41 to 16 and 17.

Now begin to curve all parts of this garment. When curving watch the diagram carefully; begin at the back, from L to A and connect with 1⅞ of size or 3 inches and curve to T. Now curve both shoulders from M to 34 down to 36 and 43 this is the back at the fashionable waist line. At 43 to 2 and 12 to 40 allow 1 inch all the way down the same way as from 46 to 47 and XX to 41. The 1 inch allowances at the skirt and back is allowed for a side pleat, which this particular style of coat needs. Now curve the side body from X, H and 3 to 2; from 2 to 15 curve as shown; from 8 up to 50 and 51 is ½ inch. Now curve the sides from 9 and 10 to 50 and 51, from N to 4 and 15, from 14 to 52 and 52 to 31. Now curve the dart on front from 30 to 27, 28, 29 and 31; from 28 to 55; 55 is 1 inch up from 35; now curve the front from 20 to 53 and 55. This completes the single breasted riding coat.

I. ROSENFELD'S SYSTEM

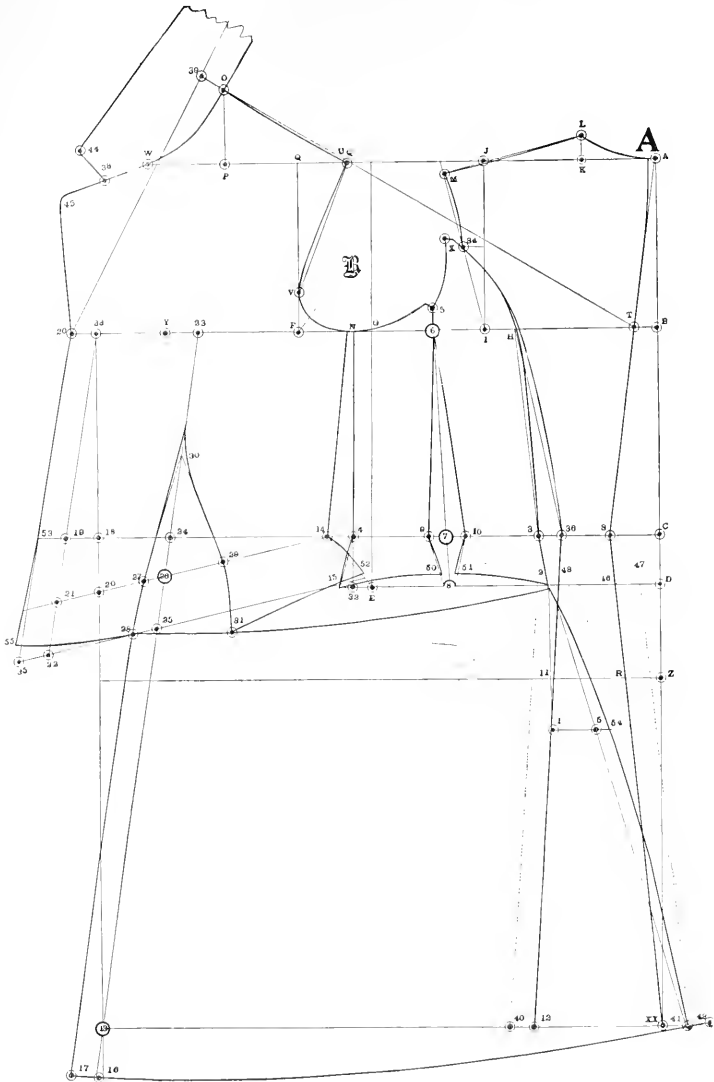



THE PRACTICAL DESIGNER

CUT-AWAY FRONT FOR RIDING COAT

LESSON NO. 41

To prepare the cut-away front for the riding coat, it is necessary to first understand that the front part of the coat is not cut-away but the skirt, which is cut away and we therefore cut out the front part and the skirt of the draft and place them together as per instruction herewith given and shown on the opposite diagram.

When having the front and skirt part already cut out from the draft, mark out first the front part of the riding coat as follows: Place the edge of the front pattern on the sheet of paper in the same manner as you draft a pattern and then mark out the edge of the front from the lapel down to the bottom, which is from A, B, C and D and then mark out the inner part of the same pattern from D, X, F and all around, as shown on the diagram. When you have the front entirely marked out, then draw a straight line down to the edge of the front from B, C and D down to E and place the front edge of the skirt to that line between D and E and mark out the entire skirt as follows: From D to J; K down to M and L and then finish the bottom from L to E.

Now remember that you are about to make the cut-away curve and it is therefore necessary for you to know that the cut-away part should begin at the very last button of the front, which begins at C and then make the curves, as you will note, shown on the diagram. For a less amount of cut-away, curve from C to G; for more cut-away, curve from C to H and for a great deal more, curve from C to I. Remember that these amounts for making the skirt cut-away is in connection with style and also taste and it is therefore necessary for you to use your own judgment in this case but follow always this rule of how to apply or connect the combining of the front part of the coat to the skirt producing a cut-away front for the riding coat.

I. ROSENFELD'S SYSTEM

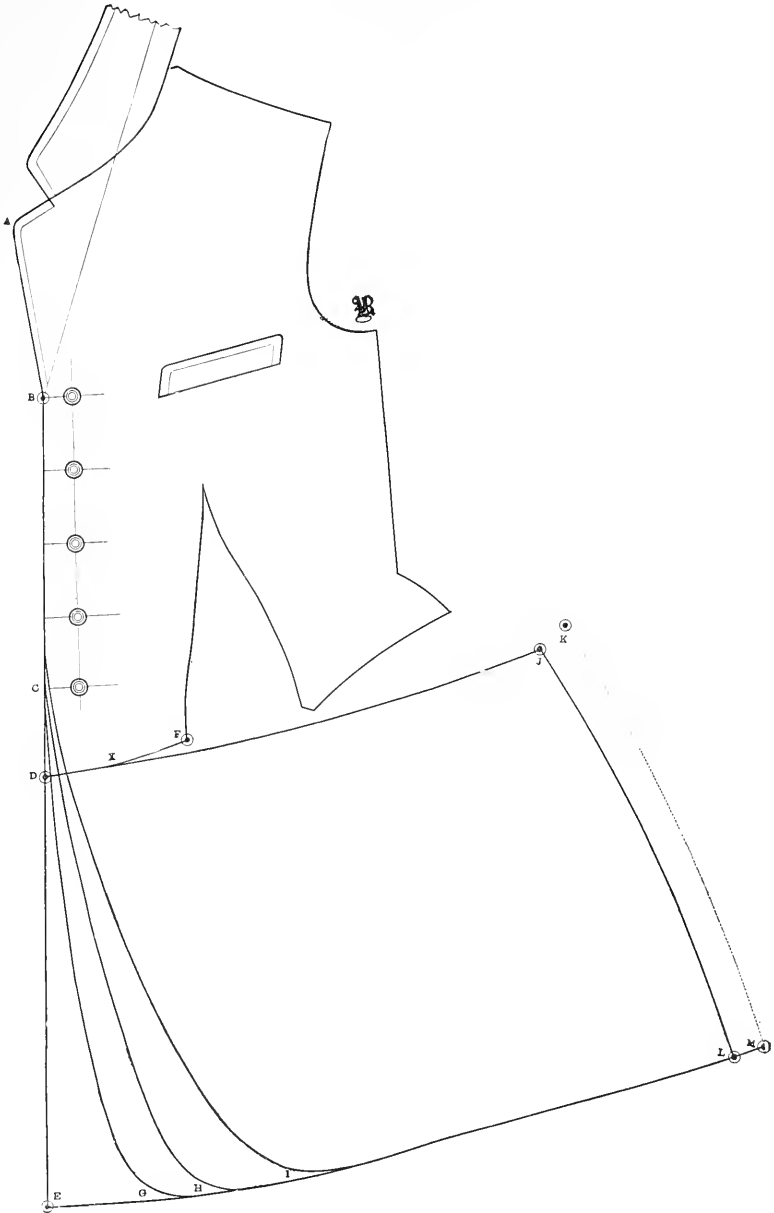

THE PRACTICAL DESIGNER

DOUBLE BREASTED RIDING COAT

LESSON NO. 42

This garment is cut the same way as the single-breasted riding coat with the difference that this is cut with a double-breasted front. The 1 inch button stand is not allowed on this front. When the draft is complete until the bust at Y and seams allowed at 33, we draw a line from 33 to 19, 21 and 22, as always. Now draw a straight line from 22 up to 37 where the rever for the double-breasted front begins. Now curve the bottom of front from 28 out to the edge of front to 35 and begin the rever. Measure from 35 towards the front, at the bottom curve, $2\frac{1}{2}$ inches around the breast line. From 38 to 39 is $3\frac{1}{2}$ inches; cross a line from the bottom line up to 41, 39 and 56, which makes the edge line of the rever.

Now mark the place for the buttons; for the first button divide from the bottom waist line up to 39, which makes 41 and draw a line from 41 to 42, which makes the stand line for the collar. 42 is 1 inch from O and cross a parallel line from 44 to 37 and raise a line up from 37 to 40, as shown on the diagram. This space from 37 to 40 shall measure about 3 inches, this can be changed for more or less. Connect from 40 to 41 with a curve, as shown on the diagram and this will complete the front.

The skirt part for this garment is increased with additional width of the rever, which is 2 inches and it is increased from 57 to 58 and on the bottom from 16 to 17 with 2 inches. The flap on the skirt is 2 inches lower from the waist: from 45 to 46 is 2 inches; the size of this flap is $\frac{1}{4}$ of the size or 9 inches; from 46 to 47 is $4\frac{1}{2}$ inches, 46 to 48 is $4\frac{1}{2}$ inches; 47 to 49 is 3 inches and 48 to 50 is also 3 inches. By all means, this garment is finished the same as the single-breasted riding coat. This completes the double-breasted riding coat.

I. ROSENFELD'S SYSTEM

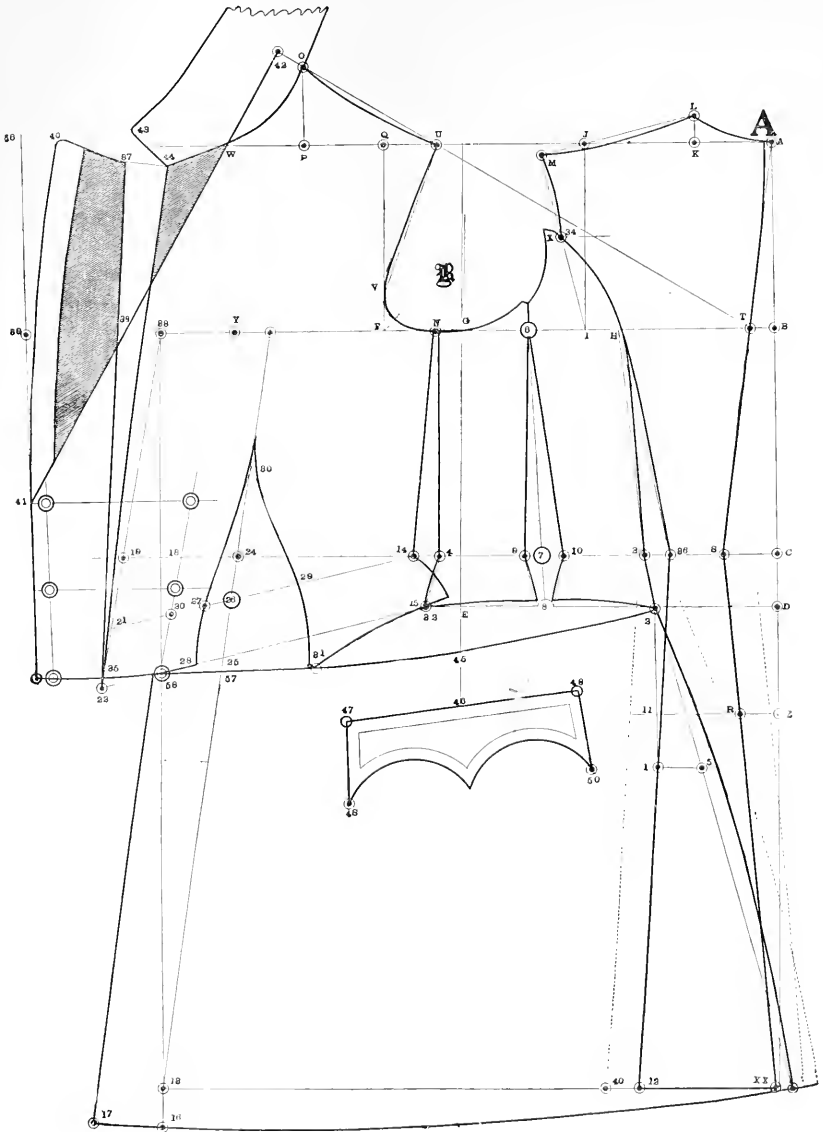

THE PRACTICAL DESIGNER

SINGLE BREASTED COLLARLESS VEST

LESSON NO. 43

This vest is drafted on the same foundation as the other garments and measurements are as follows:

Size 36 inches	Depth 7 inches
Bust 39 inches	Waist length 15½ inches
Waist 25 inches	Opening 15 inches
Full length in front 26 inches	

Now begin drafting the same way as usual. From A to B is 7 inches back depth; A to C is 15½ inches natural waist length; C to D is 3 inches hip space. Now draw lines as usual, from B to G and C to E is $\frac{2}{3}$ of size or 12 inches. Make the width of back as usual and also make the back shoulder as usual, to M. Divide for the side seam from I to G, which makes 7 and draw a line down to I3. Take out of both sides of 7, $\frac{3}{4}$ of an inch at 9 and 10 and on the waist line both sides of 8 take out 1½ inches to 11 and 12 and on the bottom line both sides of 13 to 14 and 15 take out 1 inch and curve the back from 10, 12 to 15 and the front side seam from 9, 11 and 14.

Now begin the front; from G to F is $\frac{1}{6}$ of size or 3 inches and draw a line from F to Q to P, which is $\frac{1}{6}$ of size or 3 inches. From P to O is also $\frac{1}{6}$ of size or 3 inches, now draw a straight line up from P to R. O to R is $\frac{1}{6}$ of size or 3 inches. Cross a line from the front shoulder from O to T and make the front shoulder as usual. Measure the bust from T to U. U to V is 3 inches for seams and cross a line down from V to 2. X is the waist line; X to Y is $\frac{3}{4}$ of an inch and draw a line from V to Y and Z.

To begin measuring the opening and full length, measure from A to L and place the same to R and O down to V. R to V is 15 inches opening and from R to 2 is the full length in front which is 26 inches and 1 inch more allowed for workmanship is 27 inches and cross a line from 2 to 14. 14 is 1 inch from 13 the same as 15 to 13.

Make the dart as usual. Divide the chest and draw a line from 3 to 25; 4 to 5 is 1 inch; 4 to 6 is 2 inches and curve the dart from 19, 1 inch up, down to 5 and 20. Again from 19, 6 to 21 cross a parallel line from 20 to 21 and shape 21 to 14. Curve the shoulder and armholes as shown. The shoulders shall be $\frac{1}{2}$ inch less in width and shape the side and back, as shown on the diagram.

The place for the pocket is from E to 16. 1 inch on the long waist line; 16 to 17 shall be 4 inches for the size of the pocket for size 36. This means a $\frac{1}{2}$ inch less than $\frac{1}{4}$ of this size; the width for the vell shall be 1 inch finished. This completes this pocket and there is no other pocket necessary for ladies' vests.

I. ROSENFELD'S SYSTEM

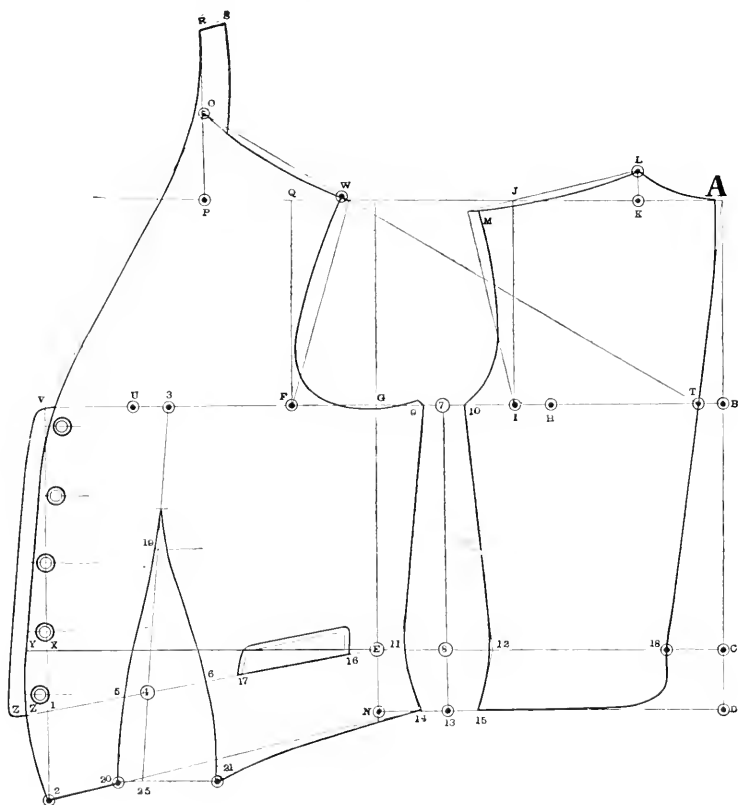



THE PRACTICAL DESIGNER

NEW COLLARLESS VEST

LESSON NO. 44

The foundation of this vest is the same as the others. Note that this underarm seam is taken in the center of the armhole, which is between 9 and 16 and half of this amount makes it center at 25. Now draw a line from 25 to 27 and take out both sides of 25 to 6 and 28, $\frac{3}{4}$ of an inch to each side and both sides of 26, which is on the waist line, take out $1\frac{1}{2}$ inches each side and make use of the round stick curve to 28, 30 and 32, which completes the back side seam. To make the front part, complete the side seam also with a round stick curve. From 6, 29 down to 31 and the front part of this vest is prepared as usual, which means by the bust measurement and a straight line down from 23 down to 24, which is about the bottom of this vest.

The opening of this vest is taken between the top line and breast line, which is marked at 37, which is taken between 14 to 23. The neck, which makes it a collarless vest and high-buttoned, is prepared with the usual action of the neck which is from 18 to 14, $\frac{1}{6}$ of size and from 14 connected with a round line to the bust at 23 lost to the waist line at 39 to reach the bottom or full length at 38.

The full length is finished with the 6 inch allowance from the waist line down which makes it from 39 to 24. 39 is the regular waist line and 24 is 6 inches below 39 and the hook of the bottom of this vest in the front, which is at 40 is between 39 to 38. From 24 to 38 is 1 inch, which makes this front curvy or cut-away to fit this vest better at the bottom part of the front.

The dart for this vest is only a split in a bias way just crossing the center of the pocket and in order to explain this dart better, it is necessary for me to explain the place of the pocket.

The pocket is placed in from the edge of the side seam of front about 1 inch and the height part from the bottom to the pocket between 31 and 41 is 3 inches and in the front from the bottom line up to 42, the space is $3\frac{1}{2}$ inches and therefore draw a line from 41 to 42 and make the vell of this pocket from about 1 inch in width and between 41 and 42 shall be $\frac{1}{4}$ of the size, which makes $4\frac{1}{2}$ inches for size 36. The dart cuts across the pocket from 43 to 44. It is about the double amount of the height of the pocket from the bottom line up of the front, which will make this amount not more than 7 inches from 43 to 44. To finish this vest note the important changes from the ordinary foundation which are as follows: The shoulder is 1 inch narrower for each front and back. The ink line at the back is straight down from 1 to 34 and curve as shown on the diagram. The neck piece, which is to be one piece with the front which is placed from 19 to 20 is $\frac{1}{6}$ of size or the same space as the back is from 1 to 12. The width of that piece from 20 to 35 and 19 to 36 is about $1\frac{1}{4}$ inches. The button stand which is placed at the edge of the front from 37 down to 40 is about 1 inch and it may be changed to a trifle wider or narrower.

I. ROSENFELD'S SYSTEM

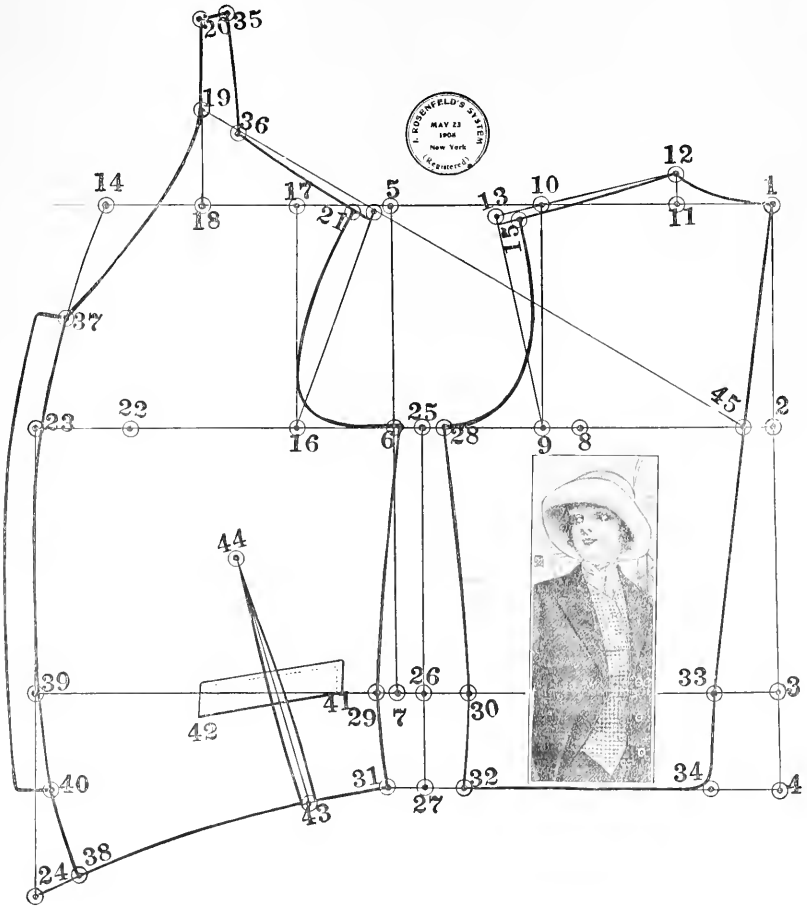

THE PRACTICAL DESIGNER

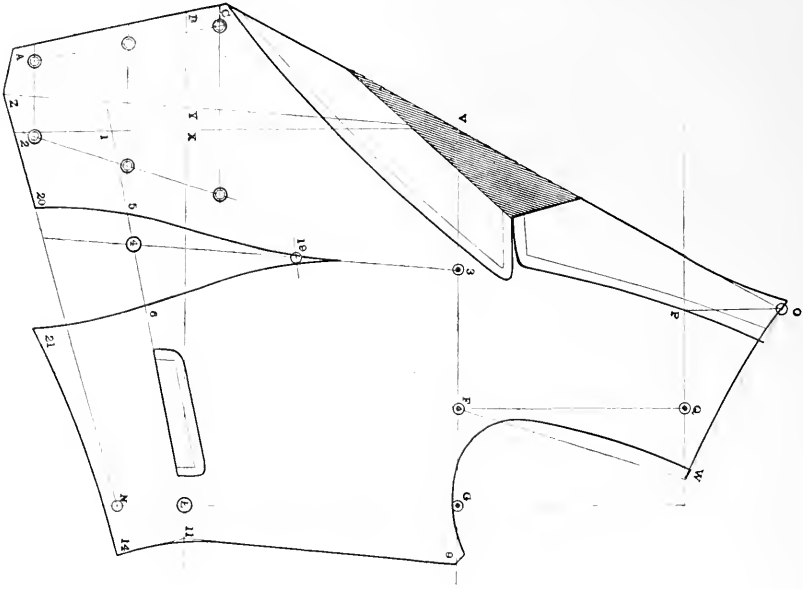

DOUBLE BREASTED VEST WITH COLLAR

LESSON NO. 45

The front of this vest is drafted the same way as the first vest draft. This front has a special allowance for the double-breasted buttoning. To begin this double-breasted front, first complete the single-breasted front and after increase for the double-breasted on the waist line, from Y to B is 3 inches, on the bottom from Z to A is $1\frac{1}{2}$ inches. Now cross a line from A to B up to C, this is the outside of the front. Measure the opening as usual from O to V and cross a line from O to V down to C to reach the front and curve from O, as shown on the diagram. Now mark the style of the lapel on the pattern as wanted. Take special notice to measure the opening for a double-breasted the same as for single-breasted.

I. ROSENFELD'S SYSTEM

HOW TO DRAFT ALL KINDS OF SIZES

LESSON NO. 46

To draft all kinds of sizes, we only need to look over the table of proportions in order to get measurements for the depth and natural waist length for the size wanted. After having the depth and waist length, we begin to draft as usual. Now suppose we want to draft a size 40 for which measurements are as follows:

Size	40 inches	Depth.....	7 $\frac{1}{4}$ inches
Bust	43 inches	Waist length.....	15 $\frac{3}{4}$ inches
Waist.....	27 inches	Hip	45 inches

In drafting, we first use the depth and natural waist length and after we use the size number as usual and for this size we use 40. To begin draw lines as shown on the diagram from A to B is 7 $\frac{1}{4}$ inches depth A to C is 15 $\frac{3}{4}$ inches natural waist length and C to D is 6 inches hip space always and cross all lines as usual from B to G and D to E is $2\frac{3}{8}$ or 13 $\frac{3}{8}$ inches. Now take half of B to G which makes H, H to I is 1 $\frac{1}{4}$ inches and cross a line up from I to J. From A to K is $\frac{1}{6}$ of size or 3 $\frac{3}{8}$ inches for this size and K to L is always 1 inch.

Begin the back shoulder and draw a line from L, J to M and square a line down to I. From D to S is always 1 $\frac{1}{2}$ inches and C to Q is 2 inches and this part is not changeable for women's garments. From S to Z is $\frac{1}{6}$ of size or 2 $\frac{3}{8}$ inches; from Q to R is 1 inch less than from S to Z or 2 $\frac{3}{8}$ inches and cross lines from Z to R and R to H. Now divide from I to J, which makes N and cross a line from N to O. Curve the back from O to R; from Z to Y is $\frac{3}{4}$ of an inch; R to 4 is 1 inch and cross lines from Y to 4 and from 4 to H. Shape from O to H and 4. O to P is $\frac{3}{4}$ of an inch up and a $\frac{1}{2}$ inch allowed for a seam. Allow from G to I and E to 2, $\frac{3}{4}$ of an inch and draw a line from I to 2, 3 on the waist line; take half of 3 and 4, which makes 5; from H to I, which makes 6. Now cross a line from 6 to 5 down to 27 and 6 to 7 is 1 inch. From both sides of 5 take out $\frac{3}{4}$ of an inch at 25 and 26; both sides of 27 allow $\frac{3}{4}$ of an inch on the hip line and cross lines from 6 to 25 and 26 to the waist line; also from 25 to 29 and 26 to 28 down to the hip line. (Continued on the following page.)

THE PRACTICAL DESIGNER

LESSON NO. 46 (Continued.)

Begin the front the same as usual. from G to F is 3 inches for all sizes larger than 36 and for smaller sizes, this space shall be $\frac{1}{6}$ of the size. Otherwise, this draft is followed as usual. Now draw a line from F up to 30; 30 to 31 is $\frac{1}{6}$ of size, whether the size is larger or smaller; the same is used from 31 to 32 and from 31 to 33. Cross the shoulder line from 32 to T and now measure the front shoulder. Before measuring the front shoulder, measure the back shoulder from L to M and place the same amount for the front shoulder from 32 to 34, from F to 37 is $1\frac{1}{2}$ inches; now cross a line from 34 to 37 for the front armhole.

Measure the bust: from T to 8 is half of 43 bust, which amounts to $21\frac{1}{2}$ inches; from 8 to 9 is 3 inches for seams. Now cross a line down from 9 to 38. 10 to 11 is $2\frac{1}{4}$ inches or if a standard front waist line is wanted, this space can remain 2 inches for all sizes, larger or smaller. Measure from 1 to 36, $\frac{1}{4}$ of an inch and from 3 to 24 is 1 inch; from E to 35 and 2 to 34 is 1 inch. Now cross lines from 3 to 34 and from 24 to 35, from 36 to 24 connect a line, which begins for the front side seam and cross a line for the long waist line in front from 24 against 11 to 40 and also the line in front edge from 9 to 14.

Now mark the dart in front as usual; divide across the chest from F to 9, which makes 15, measure the space from 9 to 15 and space the same from 12 to 39 on the straight waist line. Then cross a line from 15 down to 17 and 21; divide from 15 to 17, which makes 16; 16 is the beginning of the dart; from 17 to 18 is 1 inch; from 21 to 22 is 1 inch; from 17 to 19 is 3 inches. Now cross lines from 16 to 18 also to 19 and 20 and cross a line from 18 to 22 and square a line out from 18 to 20 down to 23. This space from 20 to 23 shall measure the same as from 18 to 22 and connect 23 to 35. Now curve the armhole as usual. This draft completes the outline of how to work different sizes.

I. ROSENFELD'S SYSTEM

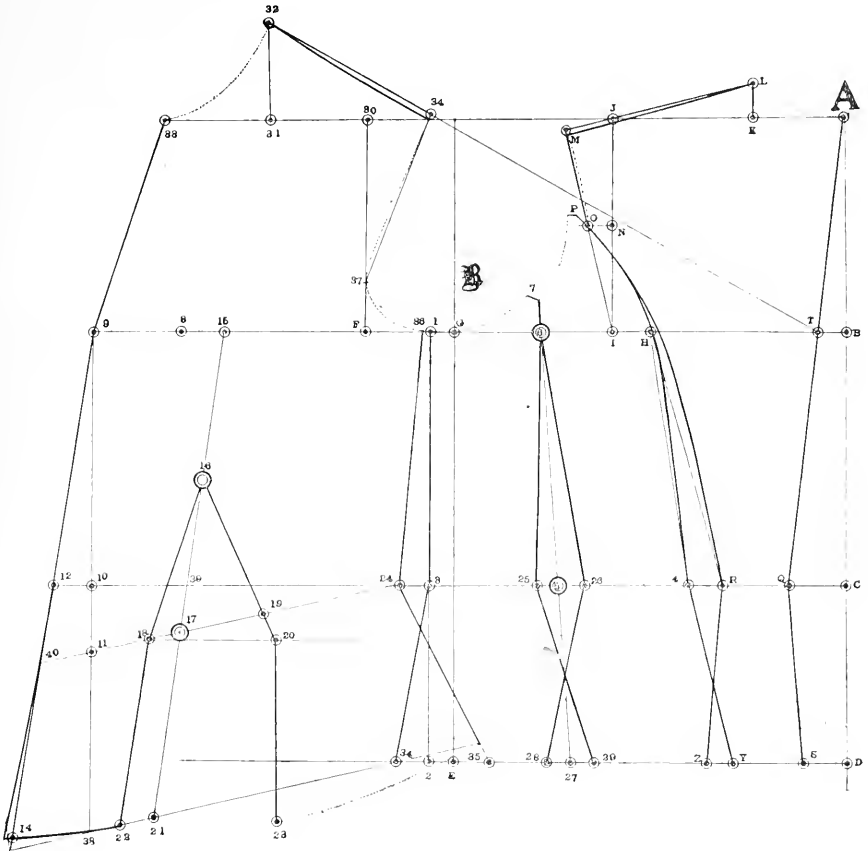

THE PRACTICAL DESIGNER

Proportional Stout Measurement for Women's Garments---for Height of 5 feet 6 inches.

Size or Chest	Bust	Waist	Hip	Back Depth	Natural Waist Length	Side Length	Inside Sleeve Length	Width of Back
40	43	30	45	7½	15½	8	18	7¾
41	44	31	46	7¾	15½	7¾	18	8
42	45	32	47	7¾	15½	7¾	18	8¾
43	46	32½	47½	7¾	15½	7¾	18	8¼
44	47	33	48	8	15½	7½	17¾	8¾
45	48	33½	48½	8¼	15½	7¾	17¾	8½
46	49	34	49	8¼	15½	7¾	17¾	8¾
47	49½	34½	49½	8¾	15½	7¾	17½	8¾
48	50	35	50	8½	15½	7	17½	8¾
49	50½	35½	50½	8¾	15¾	6¾	17½	9
50	51	36	51	8¾	15¾	6½	17¼	9¾
51	52	37	52	8¾	15¾	6½	17¼	9¼
52	53	38	53	8¾	15¼	6¾	17	9¾
53	54	39	54	8¾	15¼	6¾	17	9½
54	55	40	55	8¾	15¼	6¾	17	9¾

Short and Stout Proportions---for Height of 5 feet 4 inches.

38	41	28	43½	7¾	14¾	7¼	17	7¾
39	42	29	44	7½	14¾	7¼	17	7¾
40	43	30	44½	7¾	14¾	7¼	17	7¾
41	44	31	45½	7¾	15	7¼	16½	8
42	45	32	46½	7¾	15	7¾	16½	8¾
43	45½	33	47	8	15	7	16½	8¼
44	46	34	47½	8¼	15	6¾	16½	8¾
45	47	35	48	8¼	15	6¾	16¼	8½
46	47½	36	48½	8¾	15	6¾	16¼	8¾
47	48	37½	49	8½	15	6½	16¼	8¾
48	49	38	49½	8¾	15	6¾	16¼	8¾



I. ROSENFELD'S SYSTEM

THE STUDY OF THE STOUT FORM

LESSON NO. 47

In measuring the stout form, we will find a great change in formality. The changes are shown in many respects, as there are regular stouts, short stouts and extra stouts. The regular stout form is built in regular depth and natural waist length. The width of back is proportional to its size. The bust measurement is increased for its proportional use. The waist is increased or over-built for the size of chest and bust measurements, as a rule, for the stout forms.

The short stout form is changed by all means. The depth is always regulated by the size of the garment. The natural waist length is short according to the regular length. The sleeves are also very short. The bust, as a rule, shows full on short builds but it is not over-built. The waist is the only over-built part. The increase is about 2 or 3 inches like the regular stout form. The side body is a great deal shorter than it is for regular builds as the depth is regular in length and the waist length is very short. The neck for this form is also very short.

The extra stout form is changed in measurements regarding the height. The depth and waist length is very long. The neck is high for this form and the sleeve length is increased according to the height of forms. The regular length for sleeves is 18 inches; the short sleeve length is from 16 to 17 inches. The extra stout sleeve length is 19 to 20 inches.

- The neck for stout forms is short and large in size.
- The chest for stout forms is very flat.
- The bust for stout forms is medium.
- The waist for stout forms is unlimitedly large.
- The hip for stout forms is long effected and flat.

The hips for stout forms are small, therefore, the bottom of the skirt might be too narrow. In case of having a narrow bottom for skirts, it should be increased to the regular width of bottom desired. This increase shall begin from the hip or side seam, equally divided on both front and back. Regarding measurements for stouts, see index for table of stout proportions.

THE PRACTICAL DESIGNER

HOW TO DRAFT A BOX COAT FOR A STOUT FORM

LESSON NO. 48

The stout coat is commenced the same as the others, except the change of the stoutness. The measurements for this garment are taken as usual.

Size.....	40 inches	Depth.....	7 $\frac{1}{4}$ inches
Bust.....	43 inches	Waist length.....	15 $\frac{3}{4}$ inches
Waist.....	30 inches	Hip.....	45 inches
Full Length.....	30 inches	Sleeve Length.....	18 inches

Begin to draft as usual: from A to B is 7 $\frac{1}{4}$ inches back depth, A to C is 15 $\frac{3}{4}$ inches natural waist length. C to D is 6 inches hip space, A to E is 30 inches full length of coat. Now cross all lines as usual and measure from B to G and D to H, $\frac{2}{3}$ of size as always and cross a line from H to G up to the top line. Divide from B to G, which makes J. From J to I is 1 $\frac{1}{4}$ inches and draw a line up from I to K, from K to L is $\frac{1}{6}$ of size or 3 $\frac{3}{8}$ inches for this size. From L to M is 1 inch and draw a line from M to K and N and square a line down to L. From C to 12 is 2 inches and cross a line from 12 to A.

The front begins from G to O 3 inches: now raise a line up from O to P; from P to Q is $\frac{1}{6}$ of size, also from Q to R and to F. Now cross a line for the front shoulder from R to T and measure the back shoulder from M to N and place the same amount to the front shoulder from R to 9. Cross a line from 9 to O for the front armhole. Now measure the bust from T to S; from S to 8 is 3 inches for seams: now cross a line from 8 down to Z.

Now begin the stoutness; look over your waist measurement for this stout size. Also look for the waist measure on the regular size and see the difference between the two measurements. The regular waist measure for size 40 is 27 inches and for this stout, the waist measure is 30 inches: the difference of these two measurements is 3 inches. Now take half of these 3 inches, which is 1 $\frac{1}{2}$ inches and allow from V to W. Now cross a line from 8 to W and down to Y. Separate the front and back; take half of I to G, which makes 2; from 2 to 4 is 1 $\frac{1}{2}$ inches. Now cross a line from 2 to H down to 15; 16 is 1 inch up from 15 and curve from 16 to E. Measure the front hip, from 18 to X is 45 hip to be measured on $\frac{2}{3}$; from X to 3 is 2 inches for fullness; from U to Z is 3 inches. Now complete the side lines from 2 to 16 and take the same with $\frac{1}{4}$ of an inch longer from 4 to 7 and make a curved line from 7 to Z and Y. This completes the bottom of the front. Now begin the stout part; cross a line down from O to 10 for the pocket place; from 10 to 5 and 6 is 3 inches both sides or full 6 inches for the pocket. Now cross a line from 5 to W; on both sides of W to 13 and 14, take out $\frac{3}{8}$ of an inch; this amount shall be half the amount of V to W, which is the increase for stoutness, this amount shall be folded up as shown on the diagram. Now split for under-arm seam from G to I is 1 inch; from 6 to H is 1 $\frac{1}{2}$ inches and split from I to H before folding up the front. See next lesson.

I. ROSENFELD'S SYSTEM

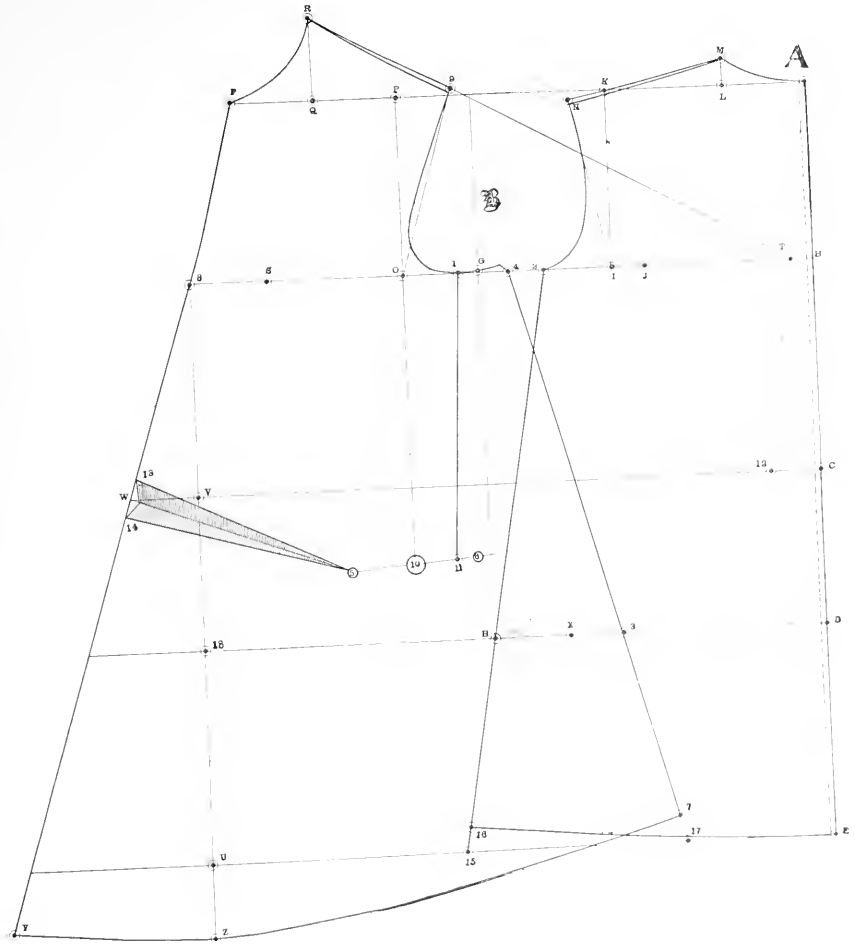

THE PRACTICAL DESIGNER

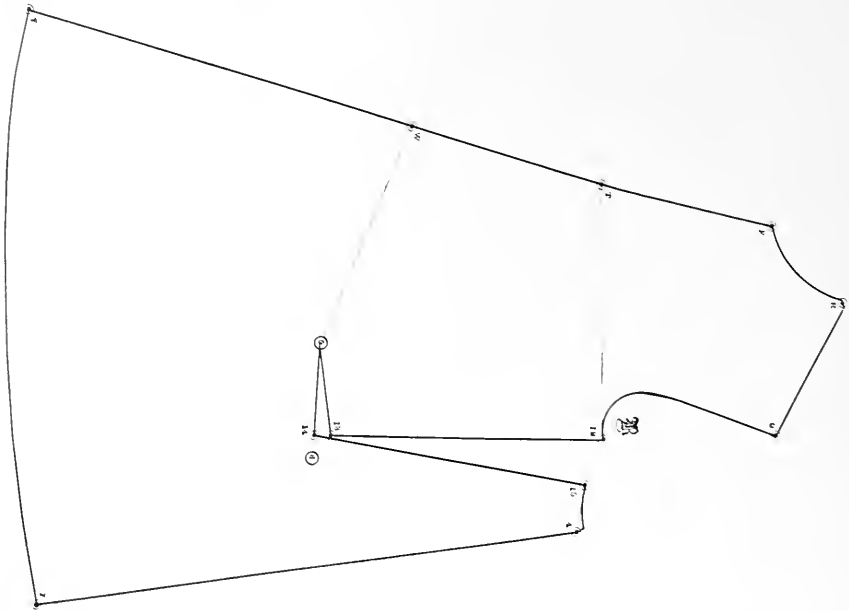

HOW TO CUT OUT THE PATTERN FROM A STOUT DRAFT

LESSON NO. 49

To cut out the stout draft, when the draft for the stout jacket is all complete, begin to cut the front from R to 9, 12, G, 4, 7, Z to Y. The front shall not be cut unless everything is complete. Now cut in the front from 12 to 13, which is the side seam under the arm, also cut in at the pocket place from 13 to 5, when this is cut in and folded up in front as prepared from 5 to W on the original draft on both sides of W, 13 and 14 lost to 5, and after when the fold is made straighten out the front as shown on this diagram. Now see that when the fold in front is made, the pocket space and side seam between 14 to 13 and 12 to 15 shall be opened, as shown on the diagram. Allow the button stand. The button stand can be allowed also before the fold is made for the stoutness and straighten cut as usual.

I. ROSENFELD'S SYSTEM

STOUT HALF-FITTING FRENCH SEAM JACKET

LESSON NO. 50

In beginning be careful and examine the measurements by which this garment is changed for the stout form and always look for the increase of waist, which is the only measurement that makes a form stoutly built. Note that this diagram is also showing how to cut this stout pattern by special measurements and such instruction can be found under the heading of Special Measurements. For this regular size stout form use measurements as follows:

Size 42 inches	Depth 7 $\frac{3}{4}$ inches
Bust 44 inches	Waist length 15 $\frac{1}{2}$ inches
Waist 32 inches	Hip 44 inches
Full Length 28 inches	Sleeve Length 17 $\frac{1}{2}$ inches

Now begin to draft; draw lines as usual from 1 to 5 and 1 to 6 and measure then from 1 to 2, 7 $\frac{3}{4}$ inches back depth, 1 to 3, 15 $\frac{1}{2}$ inches waist length, 3 to 4, 6 inches hip length and from 1 to 5, 28 inches full length of jacket. Now cross all lines from 1 to 6, 2 to 7, 3 to 8, 4 to 9 and 5 to 10. Draw lines as usual and remember that the only change that there is to be made in this garment is that we are now drafting a pattern for a stout form a half-fitting jacket with french seams instead of a plain box coat, as shown in the last pages and therefore make the usual outlines and measure from 2 to 12 and 4 to 14, $\frac{2}{3}$ of size, which will amount to for this size 42, 14 inches and then draw a line from 14 up to 12 and 11 and divide immediately for the width of back between 2 and 4 and 12, which makes 15 and from 15 to 16 allow as usual 1 $\frac{1}{4}$ inches and raise up to 17 and then complete the back neck as usual from 1 to 18, $\frac{1}{6}$ of size, which will amount to for this size 3 $\frac{1}{2}$ inches and raise up from 18 to 19, 1 inch and make the shoulder as usual from 19 to 20 down to 16 and allow from 20 to 21, $\frac{3}{4}$ of an inch for the french seam at the back all the way through to 16. This completes the back foundation.

The front part is now continued by increasing from 12 to 21 up to 22, 3 inches and from 22 to 23 and 23 up to 24, $\frac{1}{6}$ of size for which each space will amount to 3 $\frac{1}{2}$ inches for this size and the same amount allow from 23 to 6, which will complete the front neck space. Before going any further, make the incline of the back and measure from 4 to 33, 1 $\frac{1}{2}$ inches and from 3 to 32, 2 inches and draw lines from 1 to 32 and from 32 against 33 down to 34 and then cross a line from 24 or 26 to 27. In order to understand the change at 24 and 26, it shall be done as follows: When using this as a regular size, the line from 27 shall be connected to 24 and when followed by special measurements, which may be connected between 21, 26 and 25; it may be followed as a special measurement for same will prove satisfactory and this will be fully explained and found under the heading of Special Measurements. For regular size connect a line from 24 to 27 and use the neck curve from 24 to 6.

The bust measurement shall be measured from 27 to 28 where we always do allow half of bust measurement, which is 22 inches for 44 bust. From 28 to 7 is 3 inches allowed for seams and from 7 cross a line down to 8, 9 and 10. The french seam at the back begin by measuring from 32 to 35 on the waist line $\frac{1}{6}$ of size which is 3 $\frac{1}{2}$ inches for this size and 1 inch more on the hip line between 33 and 36 and then divide the shoulder space of the back from 19 to 21, which makes 38 and connect a straight line from 38 to 35 and from 35 down to 36 and 37. (Continued on the following page.)

THE PRACTICAL DESIGNER

LESSON NO. 50 (Continued.)

To begin the side body, take out $\frac{3}{4}$ of an inch space between 35 and 39 and allow from 36 to 40, $\frac{3}{4}$ of an inch and cross a line from 39, 40 down to 41, which may also be done by a curve of the round stick. Take out between 12 and 42 and 14 to 44, $\frac{3}{4}$ inches and from 42 to 43 is the edge of the back side body towards the under-arm and curve from 42 to 14 down to 46 for the hip part of the same side body and this completes the entire back with the side body. The front part can now be built by taking out from 13 to 43, $\frac{3}{4}$ inches and connecting 45 to 12 and also from 45 towards 44 and 63 curved by a round stick. Before going any further, prepare the space of a dart, which means we have now to consider the space or the allowance for the stoutness in front.

The stoutness shall always be looked up in a very cautious manner and in order to do so, compare the waist measurement of a regular size 42 supposed to be and the waist measurement of this measurement, which means that the regular waist measurement for 42 might be 29 inches. Now see for instance, that the waist measurement for size 42 is 29 inches and the waist measurement of this measurement, which we herewith use is 32 inches. This means that this stout waist measurement is an over-growth of 3 inches and therefore take half of this amount, which is $1\frac{1}{2}$ inches and allow additional in front between 8 and 30 at the waist line in front $1\frac{1}{2}$ to the $\frac{3}{4}$'s, which we always use or allow for the half-fitting jacket or coat, which will make the space between 8 and 30 about $2\frac{1}{4}$ inches and as soon as the amount of this $2\frac{1}{4}$ inches is allowed between 8 and 30, draw a line from $4\frac{1}{2}$ to 7 and from 7 down against to 30 to 57, which will make the edge of the front and then divide at the waist line between 8 and 30 and take half of this which makes 29, which is specified by the spear and which is about ready marked for making a dart line.

The dart shall begin by dividing the chest from 21 to 7, which makes 46 and taking out the space between 7 to 46 and then measure the space from 29 or the spear to 47, which may be then clear that the space between 7 to 41 is 9 inches and the half of that is therefore from 7 to 46, $4\frac{1}{2}$ inches and make from 29 to 47 also $4\frac{1}{2}$ inches and draw a line from 46 to 47 down to 49. Now divide between 46 and 47, which makes 48 and will show the beginning of the dart or the height of the bust. Measure from 8 to 31, $1\frac{1}{2}$ inches, which means $\frac{1}{2}$ inch shorter as we always make for regular sizes 2 inches and then cross a line from 45 to 31 and measure on that line at 50, which is the long waist line for the dart line from 50 to 51 a half inch and from 50 to 52, $1\frac{1}{2}$ inches and connect a line from 48 to 51 and 52 and square a line down from 51 to 53 down to 56 and from 52 to 54 and 55 and from 49 to 53 is a half inch. The french seam in front is worked as usual. Take half of the front shoulder from 26 to 58 of which half is 59 and allow both sides of 59 to 60 and 61, $\frac{3}{8}$ of an inch and make connections for french seam to 48, as usual. Take special notice that the entire stoutness is to be worked at the dart in front and special allowance has to be made for such stoutness at the straight waist line above the usual allowance which can be found additionally allowed from 29 to 30 and as this jacket is built on a half-fitting foundation for which the usual allowance for the dart is $\frac{3}{4}$ of an inch from 8 to 29 and an additional allowance for stoutness is to be allowed from 29 to 30 and this special allowance is to be increased with half the amount of whatever the increase between regular and large waist measurement which makes stoutness for this particular size.

I. ROSENFELD'S SYSTEM

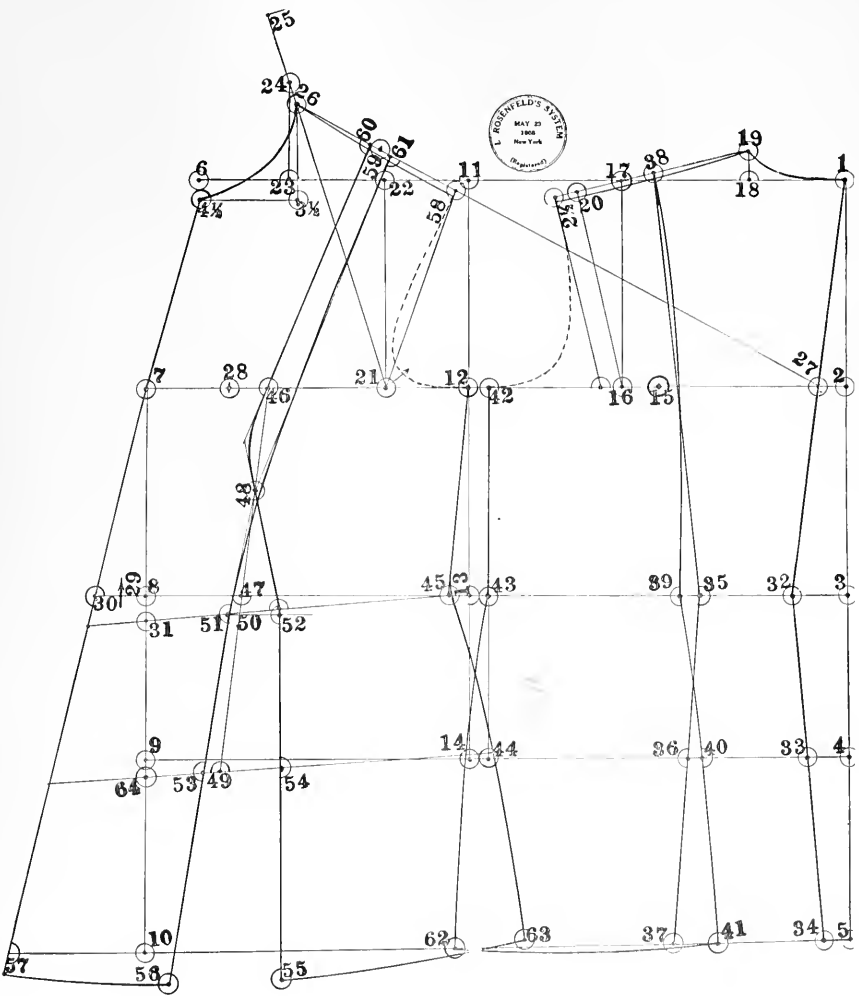



THE PRACTICAL DESIGNER

YOKE FOR A COAT

LESSON NO. 51

To make a pattern for a yoke, it shall be understood that we are to prepare a front and back part of the garment and a garment of this kind consists of only 2 pieces which is front and back. It shall be furthermore understood that when the yoke is already prepared, the pattern of the foundation for the same can be involved or changed for many different styles as for instance: The different norfolk styles, which are in connection to a yoke style, jacket or coat, is the upper part, which makes the yoke as a rule, remains in separate parts for each on front and back.

To begin drawing the outlines for the changes of making a yoke, draw first a line across the breast, as shown on the diagram and first begin the back. The breast line at the back is from A to B. Now raise from A to E and from B to F an amount of $1\frac{1}{2}$ to 2 inches and then draw a line across from D to F. The difference there is between $1\frac{1}{2}$ to 2 inches space of the yoke is that if we make 2 inches space the curve comes out more scalloped or more deep looking and when only having between A and E and D and F, $1\frac{1}{2}$ inches space the curve comes out kind of flat. It is therefore more practical to use the 2 inch space. To continue, divide the space between E and F, which makes N and then draw a straight line from N to M and curve from E to M and M to F. This action makes one scallop and a half back or two scallops or the total width of back. Should you desire to have an additional scallop in the center back, which means 3 scallops in the entire width of back; use the following rule. Take a step of 1 inch from N to O and draw a line down from O to P and then curve from F to P and from P to R down to A and then you will note that at point A, you are getting an additional half scallop, which will bring the result for a full scallop and the back is opened in full.

Now continue with the front; draw your straight breast line as shown on the diagram from X to D and then draw a straight line at the front of armhole, which is shown at C and remember that you are now to raise the same amount from C to G and D to H as you have raised at the back part from A to E and B to F. Continue in dividing the scallops for the front yoke and remember that at the front you have an amount of about $2\frac{1}{2}$ to 3 inches allowed for a button stand, which is from H to L and divide the space from L to G, which makes J and draw a straight line from J to K and then curve the front yoke from G to K and from K to L and H. Should you want a center scallop in the front the same as the back you may change your curve at the front and instead of curving from L to H, curve from L down to D, as shown on the diagram. This will complete the yoke part of the front. It shall be remembered when having the entire draft made already on the front and back, it is ready to be cut out and when cutting out the pattern all we need to do is to make a split or cut a part between the upper and lower part of the front, which will split the yoke from the lower part of the front and back and do not forget that you are to allow seams for both the upper part which is the yoke and the lower part, which is the front and back and if you should desire to have a lap seam, remember it is to be used on the lower part of the front and back and not on the upper part, which is the yoke. The amount for a lap seam allowed is for yourself to decide. If you desire to have a 1 inch lap seam allow $\frac{1}{2}$ inch for same and the full amount to $1\frac{1}{2}$ inches.

I. ROSENFELD'S SYSTEM

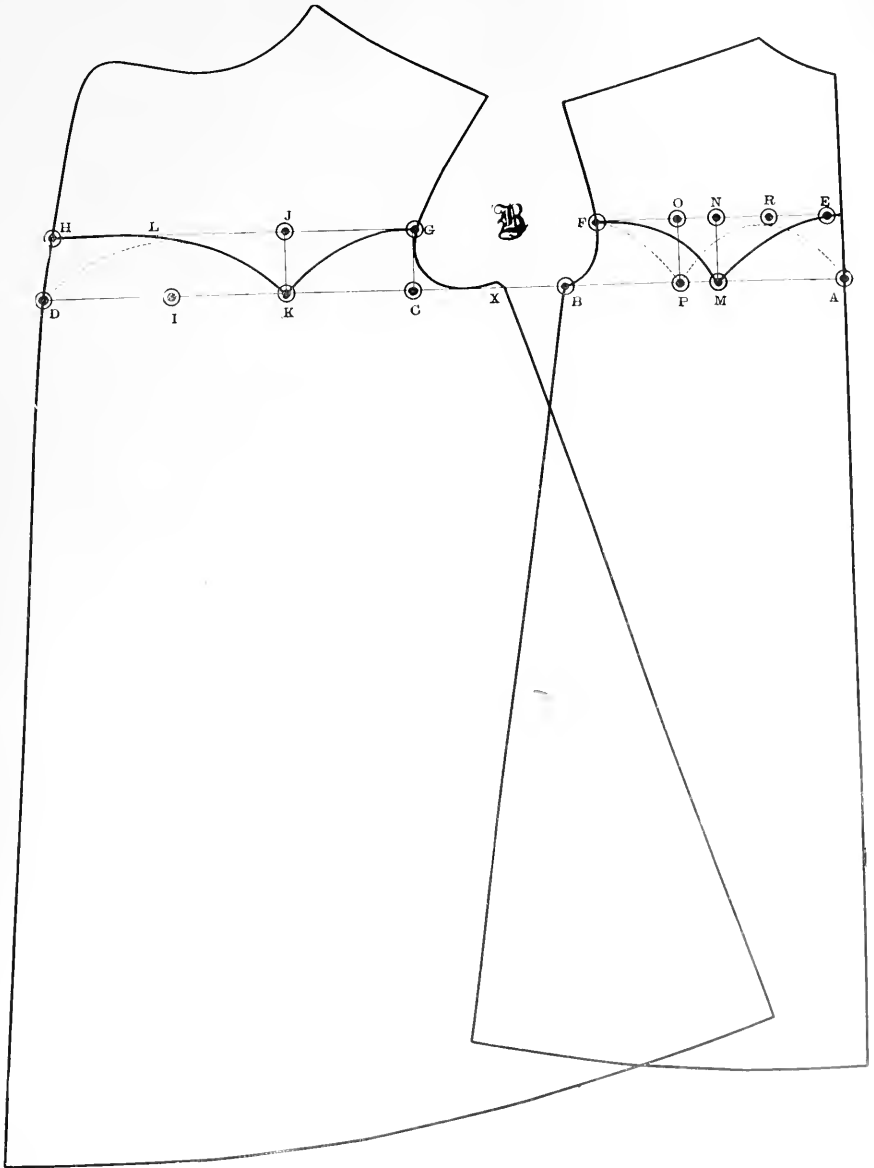



THE PRACTICAL DESIGNER

THE HOOD

LESSON NO. 52

To begin the hood, we make use of the front and back of a box coat or cape. To begin, mark out the back neck and shoulder from A, B, C and D. Now connect the front shoulder seam at E, and F and C and D and mark out the front neck from E to K, as shown on diagram number 1. Divide the front neck from K to E, which makes I and from I to J is 1 inch. Now curve from J to the width of shoulder at F and D to G. Now make the length of this hood from A to B 12 inches the same is from B to G and square out the shoulder line from E, C, F and D out to H opposite G. Then finish the curve from J and F down to G and from G to L is $\frac{1}{3}$ of G to B. Make the round curve from L to H; this part appears at the neck part when the hood is all folded up, as shown on diagram 2, between A and L and finishing at H. After completing this hood, see diagram No. 2.

When the hood is all cut out, it is followed up as shown on the diagram, from A to B is the length in back or from the neck down on the back, which makes a point at B, fold up L by a brake from B to H, which will bring the point to the center back at B, as shown on the diagram. The connection of the neck part is from A, I and J. The curved line from J to H lays over the shoulder when A to I is buttoned to the neck part of this hood.

To cut this hood on cloth, place the bottom part of the hood from B to L on the fold of the goods so as not to have the seam shown when the hood is folded up as shown on diagram 2 from B to L. This completes the hood.

I. ROSENFELD'S SYSTEM

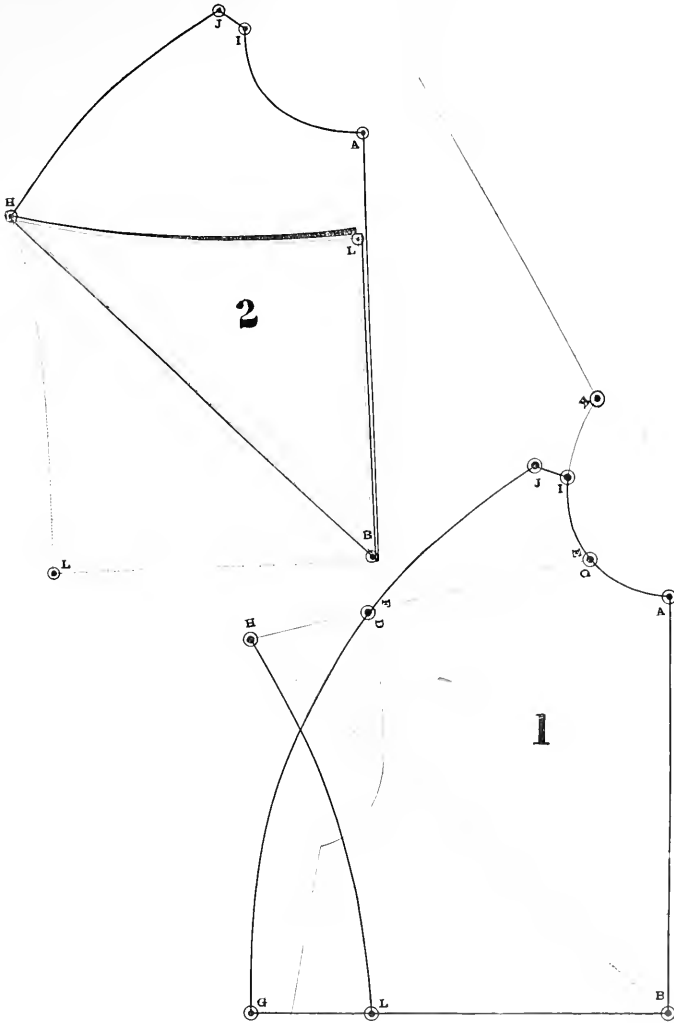

THE PRACTICAL DESIGNER

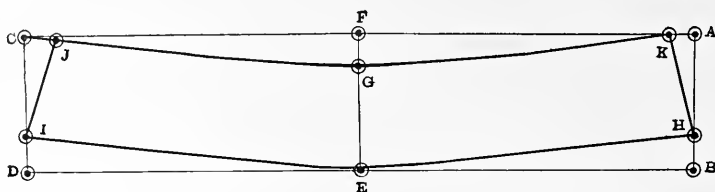

STANDING COLLAR

LESSON NO. 53

In drafting patterns for collars, follow these instructions. Measure carefully the neck of a pattern you intend to use this collar for. Such measurements can be taken two different ways; with or without seams. It shall be understood that when the neck is measured including the seams of the garment, in such case, no additional seams shall be allowed when beginning to draft the collar. If seams are deducted of all neck parts of the pattern before the measurements are taken, in such case, allow for seams, which is about 1 inch to be allowed to the collar. It shall now be remembered that the best way to take the measurements of the neck including seams so that there are no seams to be allowed when making the draft of the collar but when measurements are taken from the measurement of the table of proportions there shall always be one additional inch for the seam of the collar.

Now begin to draft; each and every collar has its foundation which consists of several lines. For instance, when beginning the standing collar use the all around measurement of the neck and draw lines from A to B and B to D. From A to B is 3 inches for the height of collar and B to D is 15 inches including 1 inch seam for this collar. It shall be understood that these 15 inches for the collar includes the 1 inch seam so that the neck measurement amounts to 14 inches only. The additional 1 inch is allowed as there is one complete seam to be used for this collar. Now raise up from D to C, 3 inches and connect a line from C to A. Divide between A and C and B and D, which makes the center line E to F. In order to get the collar in shape raise from B to H and D to I, 1 inch and from F to G also 1 inch lower.

Make the curves as shown on the diagram from A to K and C to J, mark $\frac{1}{2}$ inch and connect K to H and J to I and then curve from K and G to J and from H and E to I. This completes the standing collar useful for all garments. It shall be understood that the foundation for a standing collar shall be 1 inch wider than the actual width of collar is supposed to be. You will note on the above diagram that the foundation is 3 inches in width and when the collar is all complete and curved, the width of the collar is only 2 inches. It should therefore be understood that whatever width of collar you may desire to have the foundation for same shall be 1 inch wider as 1 inch is occupied for curving. At the same time the size of collar is to be drafted 1 inch larger, which is to be occupied for the seams at the 2 edges, which is from I to J and H to K.

I. ROSENFELD'S SYSTEM

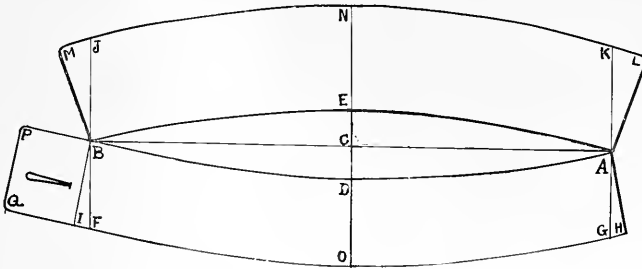

AUTOMOBILE COLLAR

LESSON NO. 54

To begin this collar, first prepare a foundation similar to the standing collar. In beginning this collar directly draw a line from A to B and make the space 14 inches and 1 inch allowed, which makes 15 inches including seams. Make from C to D, 1 inch and curve a line from A and D to B. Now measure from A to G, D to O, and B to F, $2\frac{1}{2}$ inches for the width of under collar or which we may call the stand of this collar. Extend from G to H and F to I, $\frac{1}{2}$ inch and connect a line from H to A and I to B. This completes the under collar or the foundation of this collar.

Now begin the upper part or top collar. Measure from C to E, 1 inch and make curves from A, E to B, which will be the opposite curve A, E to B. Now measure from A to K, E to N, B to J is 3 inches for the width of top collar and extend the top collar from A to L and G to M with 1 inch and then curve the entire upper collar from A and L to K and from K, N, J and M to B. This will complete the entire collar. After the entire collar is finished allow a tab for lapping over when buttoning, which shall be attached to the under collar and therefore run out a curved line from the under collar from B to P and I to Q and allow 2 inches for this spacing between B to P and I to Q and if an additional tab is wanted at the other end of the collar, which is sometimes necessary for a more comfortable buttoning add 1 inch space at the under collar from A to H, which will be continued with curving out at the under collar the same as the other side with the only exception that this tab is to be 1 inch instead of the other tab at P and B, which is 2 inches and curve as shown on the diagram.

To cut out, notice that it consists of 2 pieces, under collar and top collar and when the entire collar is cut out, space between E to D; from A to B is thrown away or in order to cut out the collar properly, begin to cut the collar all around at the outside and the inside cut from A and D to B and from A and E to B so that the entire inside space at C is all destroyed.

THE PRACTICAL DESIGNER

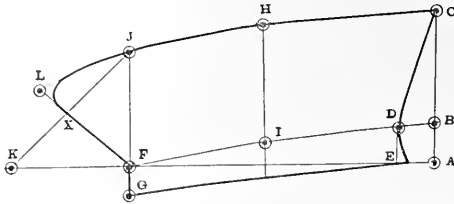

TURN-OVER COLLAR

LESSON NO. 55

The turn-over collar is cut in half sizes only. When measuring the neck wanted, use half of measurement. Now remember, the amount of the neck measurement and if taken with seams use the amount as taken and if measurements are taken without seams, allow 1 inch for two half seams.

Now begin to draft, draw a line from A to C and A to F; A to B and A to E is 1 square inch up to D. Measure from E to F the half amount of neck measurement and 1 inch for seams and divide the same, which makes I. Draw curved lines from B and D to F and allow from F to G a half inch and draw a curved line from E to G, as shown on the diagram.

The collar stand for this collar is between D and E and F to G and when the lines from A to C, I to H and G to J are all drawn up, measure the width of collar from B to C, I to H and F to J about 3 inches in width and in order to get the front part of this collar in proper shape, measure from F to K the same amount as the width of collar and draw a line from K to J and divide, which makes X and draw a line from F against X to L and measure from F to L the same space as the regular width of collar and curve as shown on the diagram from E and D to C and from C, H, J and L to F. Remember that the fold of the stand is at D and I to F. This completes the collar.

I. ROSENFELD'S SYSTEM

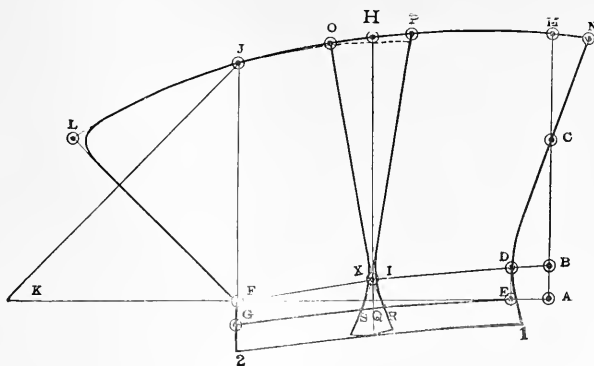

STORM COLLAR

LESSON NO. 56

The storm collar is continued of the same foundation as the lay-over collar, the lesson shown before this and in order to make the different changes, use the following instructions. To begin, draw the same foundation as the lesson before and draw a line from D to C out to M, which will increase the fullness in width of collar, which is needed in order that this collar shall not draw any fullness or brake when laying over. The width of this collar is about 6 inches, which shall be allowed from B to M, I to H, F to J and F to L. In order to prepare the front part of this collar at L, we also use the rule of the lesson before. We increase from F to K the same amount as the width of collar and divide from J to K and draw a line from F to L. Now curve from N, M, P, H, O, J and L to F.

The collar stand for this storm collar is increased in width about $\frac{3}{4}$ of an inch, which is additionally allowed from E to I and G to 2. This collar is now divided in two equal parts between F and E, which makes Q and draw a line up from Q to H. This line will divide the collar in two parts which is needed to make this collar well fitted and which will also make this collar in 4 pieces. In order to prepare this collar allow from H to P $\frac{3}{4}$ of an inch and H to O $1\frac{1}{2}$ inches and connect O to X down to S and P to I down to R. Also prepare the stand of this collar allow at the bottom both sides of Q to S and R $\frac{3}{8}$ of an inch. Remember that this allowance at top and bottom is allowed for the spring effect for this collar. When the collar is cut out allow special seams at the place where it is special splitted at P and O down to S and R, as a rule, we do not allow for these particular seams when making the foundation of this collar and the reason why we do not do so is to keep the two foundations for this and the lesson before this in one solid action or rule.

Curve this collar as follows: From I, D and C to N; N and M to O down to X and S and from S to I. This completes the back part of the collar. The front part for this collar begins from R and I to P and from P and J to L; from L and F to 2 and from 2 to R. This completes the front part of the collar. When these parts are cut out do not forget to allow seams on both sides of P and O and S and R. This completes the collar.

THE PRACTICAL DESIGNER

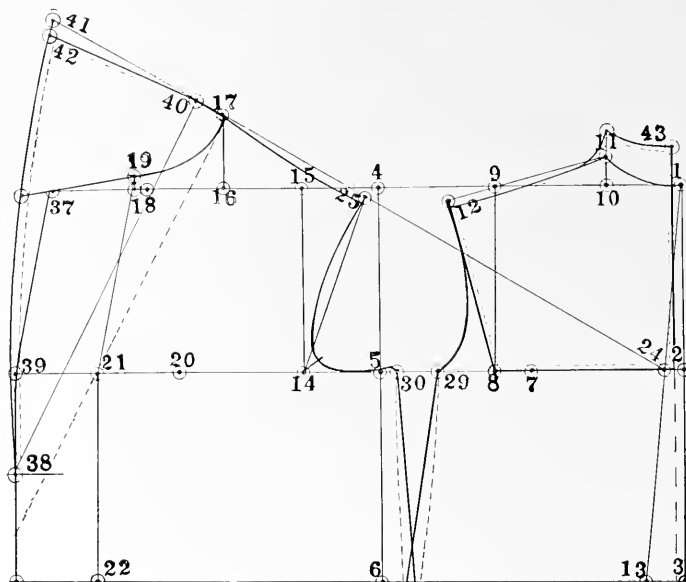

SAILOR COLLAR WITH STAND

LESSON NO. 57

For the sailor collar with stand, we need a front and back of a jacket or coat as this sailor collar is built according to the neck of the garment and it may be most convenient that as soon as the draft is made a collar can immediately be built on the draft. To begin the sailor collar at the back raise a collar stand from 1 to 43, $1\frac{1}{2}$ inches and at 11, 1 inch from the regular back neck and connect 11 with a curve to 12, which actually means that the back part of the jacket or coat is the foundation for this sailor collar, which is noticeable by the trace lines, which are marked on the back diagram from 43 to 11, 12, 8 and 2 up to 43. This completes the back part of the sailor collar.

The front part is conducted as follows: Cross a straight line out from 17 up to 41 and at the same time mark the breast line at 38 and connect with the usual stand line from 40 to 38. Between 17 and 40 is 1 inch for the usual collar stand and then measure the width of collar, which is followed by the width of shoulder of the back from 11 to 12 and place the same from 17 to 41 and connect with a curve from 41 to 38. The actual collar width in front is from 41 to 42. The inner dotted line from 40 to 17 all the way down to 38 is the allowance for the facing part for the finishing of collar. Note that no separate under collar is necessary. The entire front collar from the opening up to the shoulder seam can be in one piece. It is understood that the collar has a shoulder seam just as well as the jacket and coat is built and no additional seams are to be allowed.

To cut out or separate this sailor collar trace off the sailor collar of the back as follows: From 43 to 2 and 11 to 12 down to 8 and 8 to 24. The top collar of the front is to be traced from 17 below 38 up to 42 and to 17. Both of these parts shall act as the original top collar. For under collar only double the back collar and for the front of the collar, the front remains in one piece with lapel which acts as under collar for the front.

I. ROSENFELD'S SYSTEM

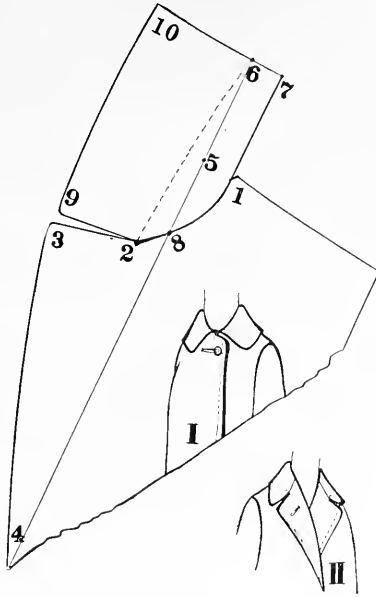

CONVERTIBLE COLLAR

LESSON NO. 58

The convertible collar is such that can only be drafted into the neck of the front and is to serve for a garment which is to be buttoned up and also lay out as a lapel, which shows the shape effect of the coat when unbuttoned. To begin this collar mark out the front, especially, the neck carefully from 1 to 8 and then continue the lapel part from 2 to 3 down to 4. 4 is the opening length for this coat or jacket and this opening may be decided and, as a rule, shall always be a long opening rather than a short one. To continue with this always extend from 1 to 5, 1 inch for stand space and connect with a line from 4 against 5 up to 6. From 5 to 6 is $\frac{1}{6}$ of size and 1 inch allowance which amounts to $3\frac{1}{2}$ inches for size 36 and the width between 6 and 7 is also 1 inch and connect 7 to 1. Now measure the space between 8 and 2 amounting to $1\frac{1}{2}$ inches, which is one-twelfth of size 36 and then see that both the lapel and collar notches from 2 to 3 and 2 to 9 shall each be 3 inches and the space between 9 and 3 shall not be more than $\frac{1}{2}$ inch opened and then curve from 3 to 4 for the lapel and from 9 to 10 for the collar. The space between 6 and 10 is $3\frac{1}{2}$ inches which is about $\frac{1}{2}$ inch more than the width of collar in front from 2 to 9.

Important for tailoring. This collar will serve for the two different purposes as shown in diagram No. 1 and No. 2. Note that the dotted line from 6 to 2 shows the folding part of under collar for the buttoning up of garment and the canvas in there has to be so prepared that the folding seam of two separate parts of the canvas are to meet on the trace line from 6 to 2 so that the collar may fold strongly when buttoned up at that particular line. Should the collar be used as a shape lapel, which means unbuttoned as shown on diagram No. 2 it will fold on the straight line from 6 to 4. Notice that according to this instruction all seams are already allowed



THE PRACTICAL DESIGNER

FOUNDATION OF SLEEVE WITHOUT FULLNESS

LESSON NO. 59

Before beginning to draft a sleeve, we need to remember the size of the garment to which this sleeve is to be used and, as a rule, we make use of different sizes of model patterns, which are as follows: We use for women's size model, size 36. For misses' size model, size 16 of which the breast measurement is 34. For juniors' size model, size 15 of which the breast measurement is 33. For children's size model, size 10 of which the breast measurement is 30, and for infants' size model, size 4 of which the breast measurement is 24 inches.

To begin the sleeve for size 36 draw a square line from 1 to 4 and 1 and 5 and mark from 1 to 2, $\frac{1}{3}$ of size, which is 6 inches for size 36 and divide the space between 1 and 2, which makes 9. Now mark the inside length of sleeve from 2 to 4 which is 18 inches for size 36 and divide the space between 2 and 4 to make 3 in order to make the line for the elbow. To continue cross all lines from 1 to 5, 2 to 6, 3 to 7 and 4 to 8 and measure from 1 to 5 and 4 to 8, $\frac{1}{2}$ of size, which makes 9 inches for size 36 and draw a line down from 5 to 8; measure from 6 to 0 one-twelfth of size which amounts to $1\frac{1}{2}$ inches for size 36, connect with a line from 0 to 9, divide from 0 to 9 which makes 11 and draw a square line down from 11 to 12 and divide between 11 and 12 which makes 13. Now remember that these lines are the foundation lines for the sleeves and whenever we need the sleeves we are to draw these lines all the time. The next lesson will continue how to finish the sleeve. Also remember that these foundation lines might be drawn for any size wanted. All you have to do is to use the breast measurement of any size desired for any style of garment.

To obtain different sizes of sleeve drafts, we need to look up the different breast measurements and use the breast measurement for the sleeve draft of whatever size it may be from time to time and if in case we need a size 34, use $\frac{1}{3}$ of size of that 34 just as well as we use $\frac{1}{3}$ of size for size 36 and also use the $\frac{1}{2}$ of size for the width of sleeve and the length of the inside, which is also to be found on the table of proportions for this size. For juniors' and children's sizes and just as well for misses' sizes, remember that we use as a size number the chest or breast number and positively not the bust number as the bust number is only to be used for the increase of bust measurements and for nothing else.

I. ROSENFELD'S SYSTEM

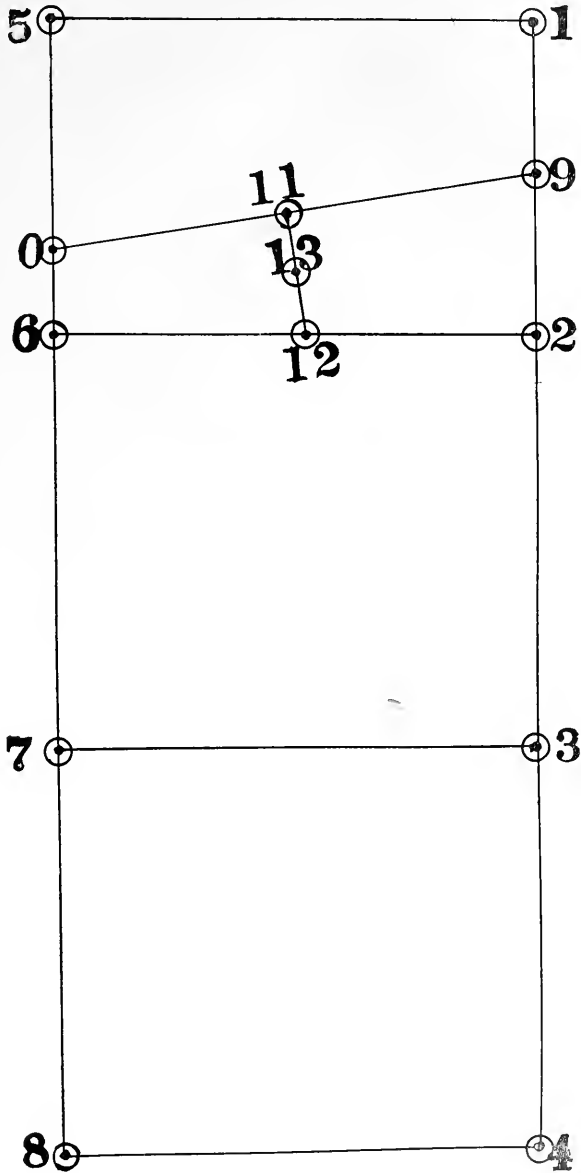



THE PRACTICAL DESIGNER

HOW TO FINISH SLEEVE WITHOUT FULLNESS

LESSON NO. 60

In order to complete the first lesson, continue as follows: Divide the space at the bottom line from 4 to 8, which makes 14. From 14 to 15 is 2 inches and from 15 draw a line against 8 out to 17 and 18 allowing from 8 to 17, 1 inch and from 17 to 18 also 1 inch. Now allow from 7 to 19, 1 inch which is at the inside part of the elbow and connect 17 to 19 and 18 to 7 and allow from 6 to 23 and 6 to 24, $\frac{1}{2}$ inch to both sides and then connect 7 to 24 and 19 to 23, which will complete the inside part of the top and under sleeve. Now finish the outside part of under sleeve, which is the outside elbow and connect 15 with a straight line to 3. Measure from 15 to 16, $1\frac{1}{2}$ inches and from 3 to 22, $2\frac{1}{2}$ inches and connect with a straight line from 16 to 22 and from 22 against 25 and from 11 to 25 is 1 inch and up $\frac{3}{4}$ of an inch which will complete the outside part of the under sleeve. The outside part of the top sleeve is from 9 to 3 down to 15.

To make the curves for the entire sleeve, as a rule, we first make the top curves of the sleeve which are as follows: To continue first making the top sleeve curves, make a sweep curve with a tape or a piece of string from 0 to 9 or from 9 to 0 and sweep by 13 and then finish with a small curve from 0 to 24, which will complete the top curve of the top sleeve. Now finish the top curve of the under sleeve. Remember that at 25 we raise up with a straight line $\frac{3}{4}$ of an inch and headway for about $\frac{1}{2}$ inch for the seams and then curve free hand down against 11 down to 23. This will complete the upper curve of the under sleeve. When having the upper parts all finished curve the brake at the inside elbow 19 and 7 and at the outside elbow, at 3 and 22, curve off a small amount in order not to have the elbow too curvy. In order to finish the sleeve, watch the diagram and you will note that the under sleeve is somewhat longer and you will also note that the under sleeve is lengthened by the straight line, which is drawn out from 4 to 8, which will bring the sleeve from about $\frac{1}{2}$ inch longer for the top sleeve, which is below 17 and below 16 and connect with a parallel line from 16 to 17 according to the top sleeve.

In cutting out the top and under sleeve the most simplest way, fold the sheet of paper on which the sleeve draft is made and cut out double the top sleeve and leave the $\frac{1}{2}$ inch of the under sleeve at the bottom for the under sleeve which is $\frac{1}{2}$ inch lower than the top sleeve and when the top sleeve is all cut out, cut that $\frac{1}{2}$ inch off at the bottom of the top sleeve and as soon as you are through with the top sleeve, cut out the under sleeve from the original draft of that sheet of paper and then notch the top and under sleeve according to the following instructions. Place the top and under sleeve together at the outside seams. Begin at the beginning of the top and place the notch at the top and elbow and again take it even at the bottom and notch between bottom and elbow, which will leave about $\frac{1}{2}$ inch of the amount in the length of top in sleeve at the elbow, which is to be given in. Then make also notches at the inside seam at the sleeve in the similar way. Place the two seams at the top and bottom and make notches between the center space of top to elbow, and bottom up to elbow, and at the inside sleeve, you will find that the under sleeve is about $\frac{1}{2}$ inch longer, which is to be given in when the seam is sewed up. These actions will bring the sleeve ready for mechanical tailoring. Remember that all seams are allowed.

I. ROSENFELD'S SYSTEM

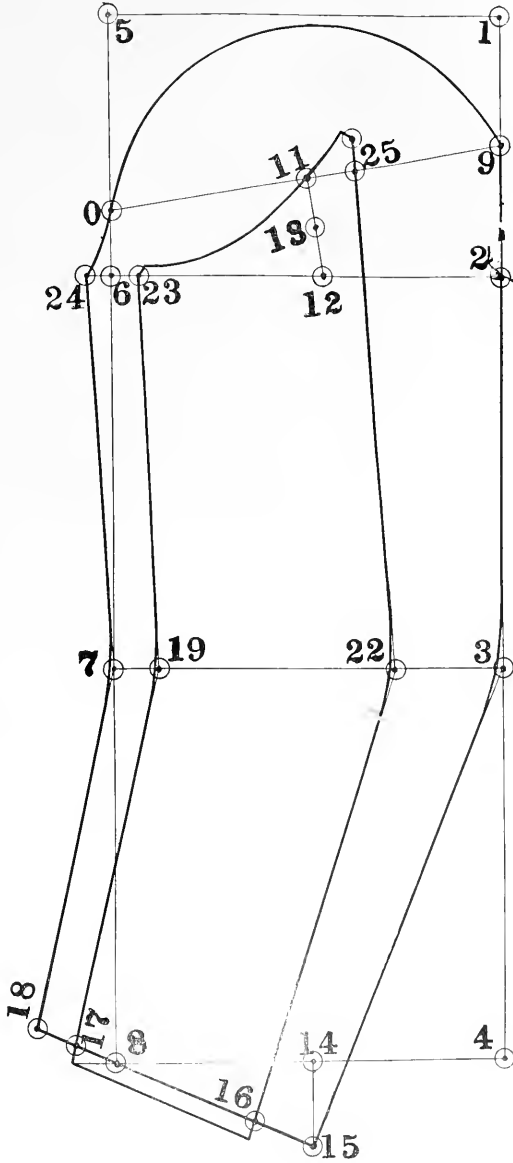

THE PRACTICAL DESIGNER

SLEEVE WITH DIRECT FULLNESS

LESSON NO. 61

This sleeve begins the same way as the first sleeve with the exception that this sleeve gives the increase of fullness in drafting. To begin, measure from A to B $\frac{1}{3}$ of size or 6 inches for size 36 and from B to D is 18 inches for the inside sleeve length. Cross all lines from A to F, B to S, E to H and D to I and measure from A to F $\frac{2}{3}$ of size or 12 inches for size 36. Now draw a line from F to I; from G to V is $1\frac{1}{2}$ inches; C is half of A and B and cross a line from C to V. Take half of C and V, which makes Y and square a line down from Y to make U and half of Y and U is the star (*); from G to S and to W is a half inch to each side. H to N is 1 inch for the inside elbow curve. To begin the width of cuff or bottom of sleeve divide the bottom line from D to I, which makes J and draw a line down to K. From J to K is 2 inches and cross a line from K against I out to P. From I to O is 1 inch and O to P is also 1 inch.

Now begin the outside elbow from E to X is 2 inches, X to M is 3 inches, K to L is 2 inches and now cross lines from K to X and up to C, this is the outside of the top sleeve. Now cross lines from L to M up to T, this is the outside of the inside sleeve. From Y to T is $\frac{3}{4}$ of an inch. Now allow from L to R a half inch and from O to Q is also a half inch and cross a line from R to Q, which finishes the under sleeve. Now cross lines for the inside elbow from Q to N and P to N; also from W to N and S to N. If all these connections are made to N, this action brings a strong break of the inside elbow. If a straighter sleeve is wanted, do not draw the outside seam for the top sleeve to N but only to H, which means S to H and from H to P for the top sleeve and the under sleeve shall be made from W to N down to Q.

Now curve the top sleeve by the star (*) from V to C and shape from V to S to the inside elbow N and also curve the under sleeve at the armhole from T to W, as shown on the diagram. To cut out this sleeve place another sheet of paper underneath the draft and cut all around the top sleeve. After having cut out the top sleeve use the bottom pattern as the top sleeve and cut out from the original draft the under sleeve. You will notice on the diagram that there is two ways of curving the inside seam of this sleeve, more broken elbow or straighter towards the inside part of this sleeve. It is shown in order that you may use it for your own taste.

I. ROSENFELD'S SYSTEM

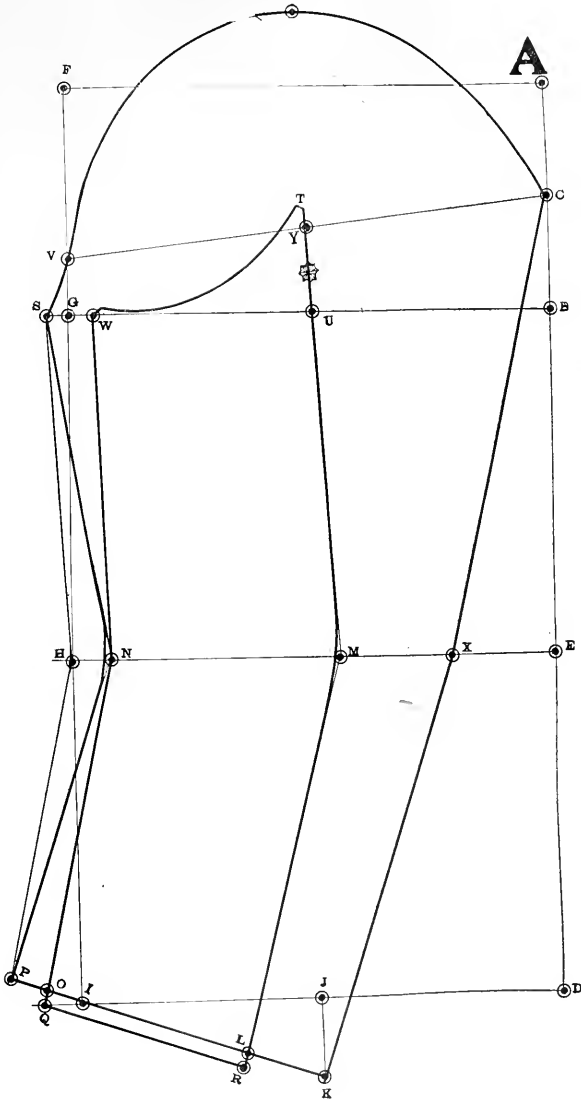

THE PRACTICAL DESIGNER

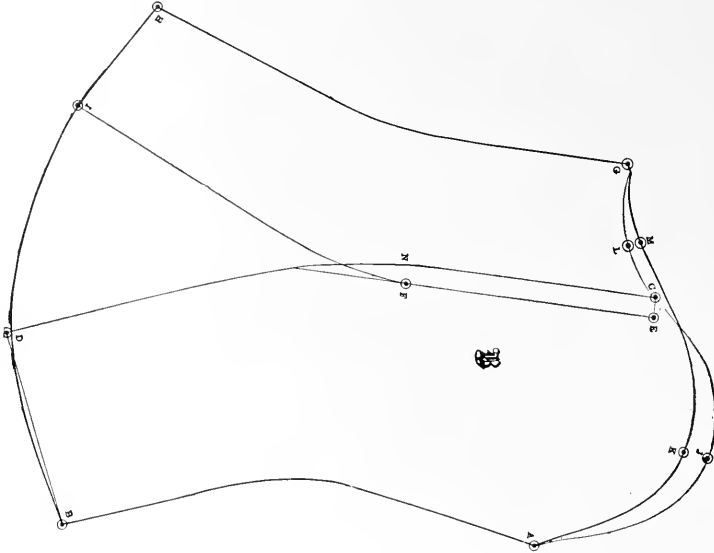

ONE-PIECE SLEEVE WITH FULLNESS ON THE BOTTOM

LESSON NO. 62

To begin this one-piece sleeve use a cut out pattern of the first sleeve. Mark out first the top sleeve from A to J, C, N, D, B to A. Now connect the under sleeve at C and from C to E and N to F lap over $\frac{3}{4}$ of an inch, which is deducted for having no seam at the outside of the sleeve. N and F is the elbow. Mark out the under sleeve all around, as shown on the diagram, from E to F, I, H, G, L and E.

Now curve the bottom of the sleeve from B to D and I and H. The bottom of this sleeve gives a full effect cuff. Now curve the top of the sleeve from A to K and M to G. From J to K is 1 inch decreased from the top sleeve and from L to M is 1 inch increased for the under sleeve. This makes the one-piece sleeve with fullness on the bottom. There are several styles of sleeves which can be taken out of this one-piece foundation as for instance, if we desire to have the sleeve with fullness on bottom, this sleeve will answer the purpose as this sleeve is full on the bottom and is ready for gathering around the cuff. Should a dart be desired from the wrist to the elbow, in this case all we need to do is to cut out the open space which is between the top and under sleeve between D and I lost to the elbow. At the very same time, if we desire to have a smaller amount of dart to be taken out, it can also be done by measuring over the entire amount and specifying or occupying a certain measurement for the width of cuff. Now for instance if a 12 inch cuff is desired, we need to measure the entire space between D and I and if we find there 18 inches, we allow 1 inch for seams and therefore we use the balance of 17 inches and if the 12 inch cuff is desired deduct the same of 17, which leaves 5 inches over for taking out for such dart. For further instruction, see next lesson.

I. ROSENFELD'S SYSTEM

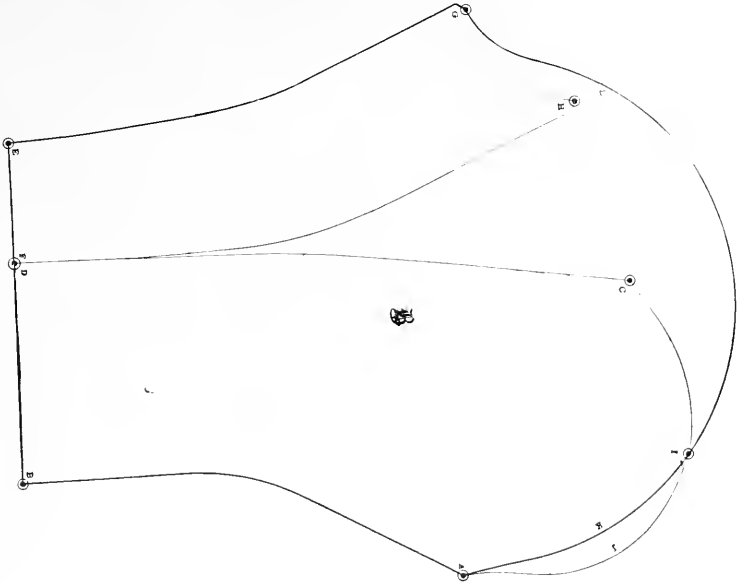

ONE-PIECE SLEEVE WITH FULLNESS ON THE TOP

LESSON NO. 63

To begin this sleeve, cut out the first top and under sleeve and mark out the top sleeve from A to B, D, C, I, J to A. Now connect the under sleeve at the bottom to the top sleeve at F to D and E, as shown on the diagram. Then mark all around the under sleeve to G and H down to F. When both sleeves are marked out, begin to make the top curve from A, K, I and L to G. From J to K is 1 inch and from H to L is also 1 inch. From J to K decrease the fullness of the top sleeve and from H to L increase the fullness of the under sleeve. To cut out begin from A to K, I, L, G, E, F, D, B and A. This completes the one piece sleeve with fullness on top.

The fullness of the sleeve might be used in many different ways. The first change that we can make out of this foundation is changing it to a sleeve with several darts on top if desired, which will serve for the sleeve of cut out darts at top instead of gathering or pleating. The next use we can make out of this sleeve is shirring in the top to the measurement of the armhole of the garment so that the sleeve will show a globe effect when set in the armhole. No doubt that all these actions of sleeves are a style production and these changes are therefore the most handy ones that might be used from time to time.



THE PRACTICAL DESIGNER

ONE-PIECE TIGHT-FITTING SLEEVE

LESSON NO. 64

To begin this sleeve cut out the original or the first sleeve without fullness and mark out the top sleeve on a sheet of paper as shown on the diagram from A, C, W, D, B, S to A. Now connect the under sleeve on the top part at C and E. From C to E and W to F is $\frac{3}{4}$ of an inch space lapped over as no seam is wanted there. When the under sleeve is connected mark all around from E, C, G, H, I, F to E and now mark the connection. Curve on the top from A, K, M to G and when curving make changes as follows: From J to K is 1 inch decreased for fullness of the top sleeve and from L to M is 1 inch increased for the under sleeve. This completes the curve for the sleeve on top. Now lock over the sleeves carefully after the top and under sleeves are connected. As the sleeve is now marked out, it is useful for a dart on the outside elbow as shown from D to X and I to X.

For a tight-fitting one-piece sleeve cross a line from the bottom at both inside lengths B to H, cross a line from E to F down to N, measure both sides for the size of cuff as much as desired on both sides from N. The cuff shall measure $\frac{1}{4}$ of the size or 9 inches for a size 36 and allow 1 inch more to the width of cuff for seams which makes 10 inches for this cuff. Now make from N to O 5 inches, also from N to P. This makes a straight cuff from O to P, and when a lap over is wanted on the top of sleeve, divide N and O, which makes Q and from Q to R is 2 inches. Curve from O to R, R to P and shape both sides of the inside sleeve; from T to U is $\frac{1}{2}$ inch and from S to V is also $\frac{1}{2}$ inch and curve as shown on the diagram from A and V to O and from G and U to P. This completes the two kinds of sleeves useful for all kinds of garments.

To cut out the dart sleeve follow A, S, B, D, X, I, H, T, G, M, K to A. To cut out the tight-fitting sleeve follow A, V, O, R, P, U, G, M, K to A. If a wider cuff is desired for a one-piece tight-fitting sleeve, divide equally the amount in half of such amount and allow half from N to O and the other half N to P. For instance if a 12 inch cuff is wanted allow 1 inch more for seam which is 13 and allow from N to O, $6\frac{1}{2}$ inches and N to P also $6\frac{1}{2}$ inches, which will make this complete 13. This completes this diagram.

I. ROSENFELD'S SYSTEM

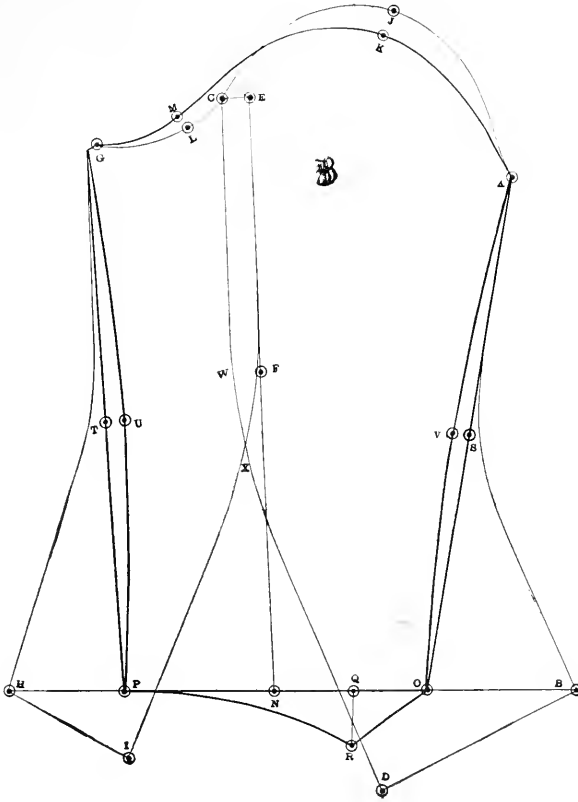



THE PRACTICAL DESIGNER

RAGLAN SLEEVE

LESSON NO. 65

To begin the raglan sleeve, we first need to prepare the draft of the first sleeve draft without fullness and when such is complete, we begin to make the changes for the raglan sleeve as follows:

In beginning the top raglan sleeve, divide the upper part of the completed draft from 1 to 5 which will make 26 and from 26 draw a line up to 27 and measure from 26 and 27 the width of shoulder, which is 6 inches for size 36 and then draw a bias line to 28 and make the space from 27 to 28, $\frac{3}{4}$ of an inch. Now connect with a line from 28 to 10 and from 27 to 9. This will complete the outline of the raglan sleeve. You will note that when these lines are finished, we need some curving as shown on the diagram. You will also note that towards the front part of the top sleeve we curve a small amount out at the line where we begin at 28 and when we curve towards the lower part of the top sleeve around 10, we allow a small amount of $\frac{1}{4}$ inch lost at 10 to 24. Towards the back part of the raglan sleeve, we take a small amount out and begin at 27 and allow about $\frac{1}{8}$ of an inch when finishing the curve at 9. The curve at 9 when finished shall remain sharp pointed so as to have a guide where the outside length of the sleeve begins or where the curving from 27 to 9 finishes.

The under sleeve for the raglan sleeve is to remain the same as always and no changes are to be made at the under sleeve. When cutting out the raglan sleeve act the same way as when cutting out any other sleeve. Place another sheet of paper under the draft and cut around the top sleeve first and when having it cut out let the duplicate of the blank sheet, which is placed underneath the draft to serve as the top sleeve and from the original draft, which is the upper sheet, cut out the under sleeve as usual and make notches also as explained in the first draft.

I. ROSENFELD'S SYSTEM

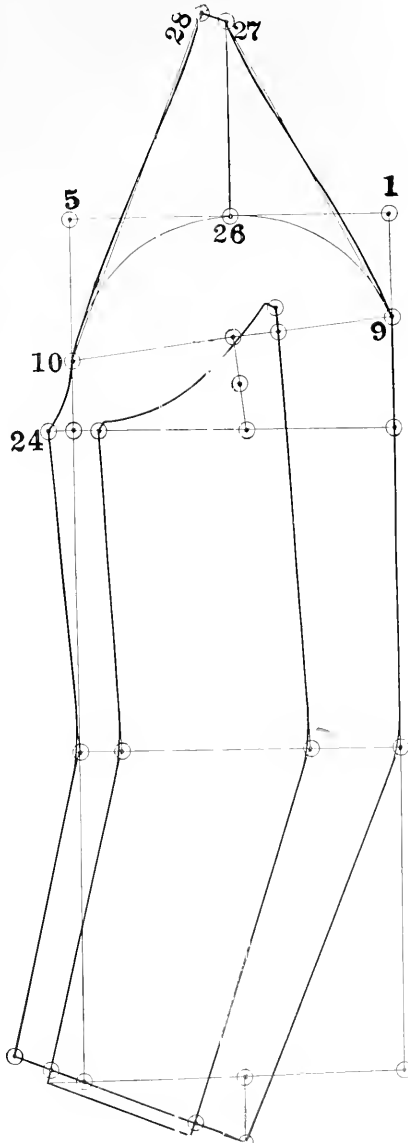



THE PRACTICAL DESIGNER

RAGLAN SLEEVE WITH A DART IN SHOULDER

LESSON NO. 66

The raglan sleeve with a dart in shoulder is begun the same way as the first raglan sleeve with the exception that when the space between 1 and 5 is divided, which makes 26, draw a line up to 26 and 27 and there measure the width of shoulder, which is about 6 inches for size 36 and cross a line at 27 and take out both sides of 27 to 28 and 29, $\frac{1}{2}$ inches to each side and draw a line up from 28 to 30 and from 29 to 31 as shown on the diagram. These bias lines shall be extended upwards $\frac{1}{2}$ inches at 30 and 31 and then connect a line as shown on the diagram from 30 to 10 and 31 to 9. Now make curves from 28 and 29 lost to 26, which makes the dart for this sleeve on shoulder. Now continue in making the split for the seams all the way down the top sleeve and in doing so, divide the top sleeve at the elbow from 3 to 7, which makes 8 and divide also the top sleeve at the bottom from 15 to 18, which makes 2. Now connect with a curved line from 2 to 8 up to 26 lost to 28 and 29 as shown on the diagram.

Great care should be taken that all these lines should be curved with a round stick so that the seams will be formed according to the shape of the entire top sleeve. It should also be remembered that when cutting apart this top sleeve, the seams shall be allowed to both sides of 2, 8, 26, 28 and 29 as there is no special amount allowed for it when drafting the sleeve as this action is not necessary. It shall also be remembered that all other seams for this draft are all allowed in drafting according to this system.

Remember when setting in the sleeve in the armhole of the raglan coat, we need to have the top of the sleeve a great deal larger than the armhole of the coat is, especially, in the front, because the more we give in for the sleeve towards the front of armhole the better the fitting of such sleeve will be.

I. ROSENFELD'S SYSTEM

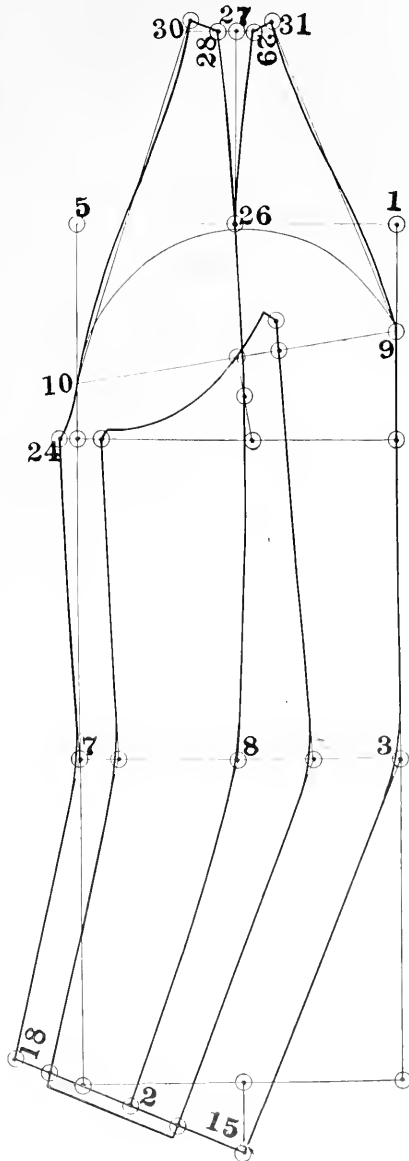



THE PRACTICAL DESIGNER

SLEEVE IN SPACE OF ARMHOLE

LESSON NO. 67

This draft is showing how to draft a two-piece sleeve in the space of the armhole of any garment drafted, before such draft is cut out. It shall be well understood that no matter what style or size, if such garment is cut by proportionate or special measurement, this action is always the same and all curves for all parts including the armhole of this draft should be made before beginning this sleeve draft.

To begin the sleeve draft draw a straight line for the inside sleeve length from T to Z and measure any length of sleeve; for size 36 measure 18 inches, which is the proportionate length for the inside sleeve length and at the very same time figure that this foundation draft is also to be size 36 and therefore shall also draft the size 36 sleeve. Now measure from T to 2 $\frac{1}{3}$ of size, which amounts to 6 inches. Draw a line down from K to 4, which is 18 inches for inside sleeve length and from K to 3 is also $\frac{1}{3}$ of size, which amounts to 6 inches. It shall be understood that the point K is the half space of B and 1 which is half of the back space and draw a line from 2 to 3 and measure from T to 6, $1\frac{1}{2}$ inches and from K to 5, 3 inches. Now cross a line from 5 to 6 and divide this line which makes 7 and draw a square line down from 7 to 8 and divide it which makes 9. With 9 we make a circle from 6 to 5 or 5 to 6, which makes the curve of the top sleeve.

Now begin to build the inside part of sleeve and allow both sides of T to 17 and 18, $\frac{1}{2}$ inches. The elbow of the sleeve is followed by the waist line and you will notice when you look after this matter that the elbow always reaches the waist line for every human body if built proportionately. We use this waist line as elbow line, which makes 15 for the top sleeve and from 15 to 16 is 1 inch, which makes the inside part of the under sleeve. 19 is the elbow of the top sleeve and from 19 to 21 is $2\frac{1}{2}$ inches, which makes the elbow for the under sleeve. Now divide the bottom space from 4 to Z, which makes 10 and 10 to 11 is 2 inches. From 11 draw a line against Z and measure from Z to 13, 1 inch and from 13 to 14 also 1 inch. From Z to 12 draw a straight line out and measure 1 inch and allow the space from 20 to 24 as given from 13 to 12, which is about $\frac{3}{8}$ of an inch. From 7 to 22 is 1 inch, which increases the armhole of the under sleeve and from 22 to 23 raise up $\frac{3}{4}$ of an inch. At 23 raise for seams space $\frac{3}{8}$ of an inch and curve as shown passing 7 to 18 and finish the top sleeve curve in the front from 6 to 17. Now make connections as shown on the diagram from 17 to 15 and 14 and from 18 to 16 down to 13 and 12. This completes the inside part of the sleeve and the outside part of the sleeve connects from 5 to 19 down to 11 and from 23 to 21 down to 24. This completes the sleeve draft in the space of the armhole.

It shall be understood that in order to make this draft in the armhole we need the acquaintance of the original separate sleeve draft and also the acquaintance of a separate draft of a blouse or a jacket. This sleeve consists of two parts, top sleeve and under sleeve.

I. ROSENFELD'S SYSTEM

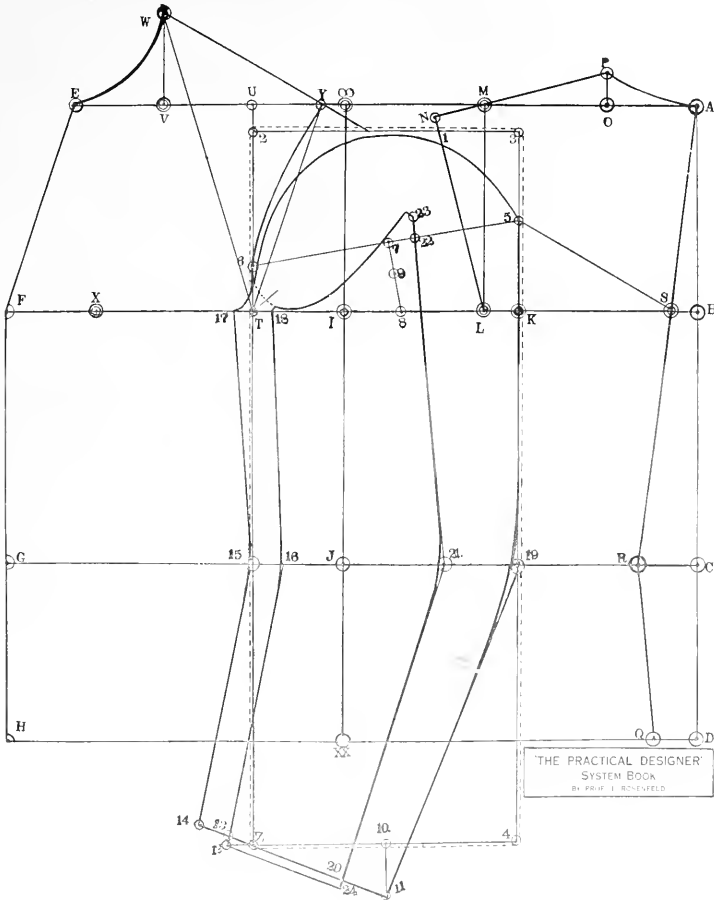

THE PRACTICAL DESIGNER

ONE-PIECE SLEEVE ON TOP OF ARMHOLE

LESSON NO. 68

This lesson shows how to draft a one piece sleeve in connection with the armhole and to begin prepare the entire foundation of the jacket, coat or blouse. It shall be understood that the garment has to be drafted with a center under-arm seam. Complete the foundation as usual and if a deep armhole is wanted, specify the space of such deepness, which is showing on this diagram from AA to FF and from BB to EE and cross this line from EE to FF, which will meet the curve at the armhole at W and Y. When the bottom of this armhole is complete, curve the deep armhole from M to W and from U to Y, which will complete the entire deep armhole. Now begin to divide for the center under-arm seam and no matter what it may be, a jacket or a blouse this rule follows the same action. Divide from I to F, which is the entire space of the armhole, which will bring 5 and take out both sides of 5 to 3 and $G, \frac{3}{4}$ inches and draw a line down to suit the style of the garment. It shall be understood that this is a box coat; the lines drawn for the front and back side seam are followed according to the instruction of a box coat, which is followed according to the hip measurement shown in the following pages. If it is a blouse, it shows the different operations of how to produce it for the waist action to suit the waist measurement for a blouse, which is also shown in the following pages.

To begin the one-piece sleeve for this armhole measure from I to AA and F to BB, $\frac{1}{4}$ of the size, which amounts to $4\frac{1}{2}$ inches for size 36 and draw a line up from AA to CC all the way down to II and the same way draw a line up from BB to DD and all the way down to HH. Then measure from AA to CC and from BB to DD, $\frac{1}{4}$ of size, which amounts to $4\frac{1}{2}$ inches for size 36 and connect a line from CC to DD, which makes the top line of the sleeve. The entire upper part of this sleeve, which meets the space of this armhole, is from FF to CC and EE to DD and the measurement for producing this upper part sleeve shall always be measured from AA to CC and BB to DD, which will amount to $\frac{1}{4}$ of size for any size you wish or whatever size the original draft of the garment may be. Now curve the top parts of the sleeve in connection to the armhole at the back from CC to W and at the front from DD to Y. This completes the center armhole curve of the entire sleeve.

The bottom of this sleeve is finished by drawing a straight line across from II to HH and to complete the bottom of sleeve to a certain measurement needed for the width of cuff, measure the space from II to HH. For instance, this space amounts to about 18 inches, we need to decide how much about we wish to have remain for the measurement of the cuff. For instance, we wish to have about 13 inches for the width of sleeve at the bottom when finished, allow an additional inch for seams, which will amount to 14 inches including seams. As this space amounts to 18 inches, deduct 4 inches, which is an over-built space. Divide the entire space including seams, which is half of 14 which amounts to 7 inches and take from II to KK, 7 inches and HH to JJ also 7 inches. Then draw a curved line up from KK to W and JJ to Y. To finish the bottom of the sleeve entirely allow from II to LL and HH to MM about 1 inch and connect with a curved line from LL to KK and MM to JJ. This will complete the entire one-piece sleeve connected to a deep armhole.

It shall be understood that this deep armhole and one-piece sleeve explanation shall be worked the same way to any garment, if it is a garment consisting of two pieces, which is front and back with an equal divided armhole and an under-arm seam. Notice that this diagram is also showing a certain style of coat of which the style of the garment is showing on a small sketch placed in the center of the diagram, a set-in sleeve with a deep armhole, which this entire diagram is showing. The dotted lines on this diagram are showing how to make this coat a cut-a-way front. This completes this diagram.

I. ROSENFELD'S SYSTEM

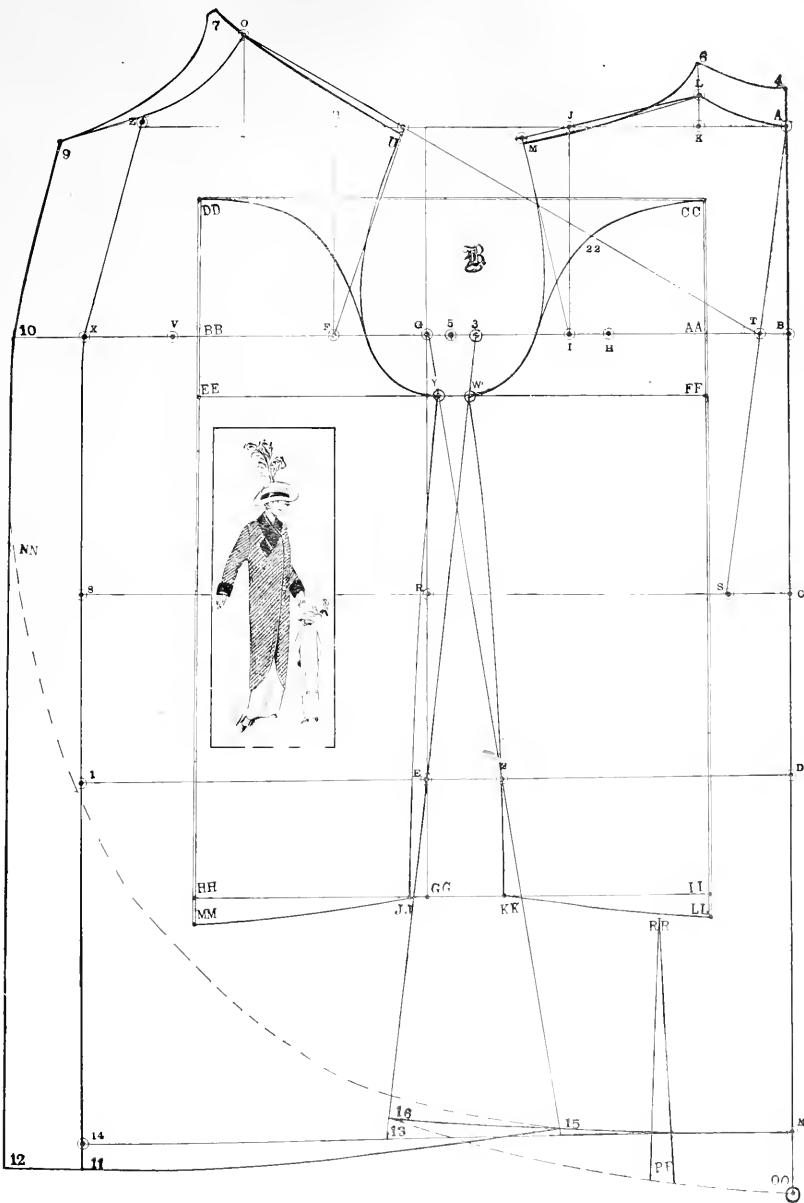

THE PRACTICAL DESIGNER

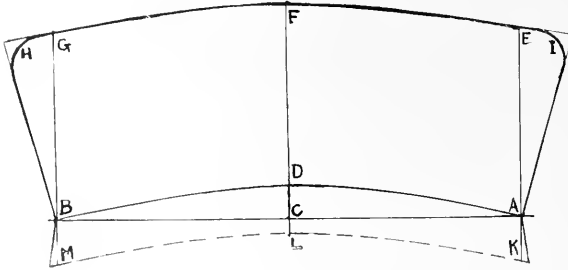

HOW TO DRAFT A CUFF

LESSON NO. 69

To begin the cuff, draw a line from A to B and this shall be the amount for the cuff, which is about 12 inches and 1 more inch for seams, which is altogether about 13 inches. Now take one-half of A and B making C and draw a line up from A, B and C. From C to D is $\frac{3}{4}$ of an inch and make a curved line from A, D to B. Now make the width of cuff; from A to E, D to F and B to G is the width of cuff, which is about 4 inches. This width for the cuff can be changed in regard to style or taste. Make a curved line from E and F to G the same as the line below. From E to I and G to H is 1 inch for extending the width of cuff on the top part. Then connect a line from A to I and B to H and make curves at I and H, as shown on the diagram. From A to K, D to L and B to M is $1\frac{1}{2}$ inches allowed for the bottom facing or turn-in of this cuff. Now curve the bottom from K and L to M as shown with the broken line.

It should be understood that the cuff can be built with or without a facing or turn-in. The cuff without facing, as a rule, is attached to the edge of the bottom of the sleeve for a cheaper class of work, but for a better class of work there is for facing allowed about $1\frac{1}{2}$ inches to which the lining of sleeve is finished. Cuffs in all cases, as a rule, are built according to the size and width of sleeve at the bottom or wrist, but it is advisable to cut the cuff about $\frac{1}{2}$ inch larger when heavy materials are used.



MISSES'

JACKETS, COATS AND CAPES

STANDARD PROPORTIONAL MEASUREMENTS FOR MISSES' SIZES

Size	Breast	Bust	Waist	Hip	Back Depth	Natural Waist Length	Inside Sleeve Length	Width of Back	Collar
14	32	35	22	39	6 $\frac{1}{2}$	14 $\frac{3}{4}$	17 $\frac{1}{2}$	6 $\frac{3}{4}$	12
16	34	37	23	40	6 $\frac{3}{4}$	15	17 $\frac{3}{4}$	7	12 $\frac{1}{2}$
18	36	39	24	41	7	15 $\frac{1}{4}$	18	7 $\frac{3}{4}$	13

The width of back measurement on this table is showing only half of actual measurement and seams are allowed.

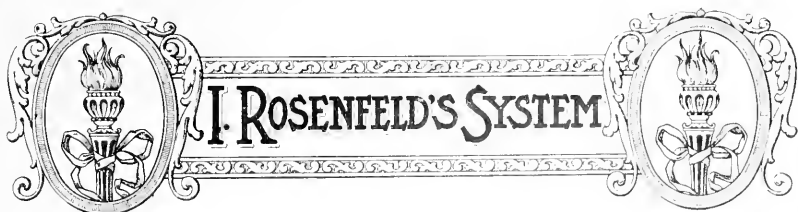



THE PRACTICAL DESIGNER

THE PROBLEM OF MISSES' SIZES

In beginning to draft patterns for misses' sizes, it shall be understood that there is a table of proportions for misses' sizes, which is shown in front of this page and which is to be followed in three different sizes, which are sizes 14, 16 and 18. It shall be understood that these numbers are the ages of such persons and serve as a guide for size. In addition to these numbers, we have chest and bust measurement. The size 14 is measuring 32 chest and 35 bust. The size 16 is measuring 34 chest and 37 bust. The size 18 is measuring 36 chest and 39 bust and the other additional measurements are to be found on the table of proportions and great care shall therefore be taken in following up the additional measurements in order to know the difference of these measurements between the women's and misses' sizes.

Note the difference between back depth and waist length as they are a great deal shorter for misses than for women and so are the chest and bust measurements a great deal smaller and it is because they are specially designed to clothe young women. The waist and hip measurements are also smaller to correspond with the chest and bust measurement and for better results, it is advisable to compare the entire table of proportions for misses with the table of proportions for women's sizes in order to have a better understanding on the entire subject.

In continuing for further progress on pattern drafting for misses' sizes, remember that all instructions are followed the same as the women's with the exception of the change of measurements. By this is meant that the spaces amounting to 1/4 inch or 1/2 inches or any other amount, which is used in inches is allowed the same way as for women's sizes. For instance, in allowing seams, raise of a collar stand, or the allowance for the width of back, the amounts are all the same. The space of hip measurement, which is the space between waist and hip line shall always be $\frac{1}{3}$ of the size, which half way means $\frac{1}{6}$ of the size, or to better say, the space for size 16, which is followed by chest 34 shall be between waist and hip line $5\frac{1}{6}$ inches, which may be found on an ordinary divisional square. The amount for darts, whatever it may be, shall be taken out the same way as for women's sizes and also the spaces between gores shall be continued the same as usual.





I. ROSENFELD'S SYSTEM

THE PROBLEM OF MISSES' SIZES---Continued

When preparing the model size for misses, size 16 is the most practical one for use, which is the middle size between 14 and 18 and therefore size 16 serves the same purpose for misses as the 36 for women. In drafting, we use size 16 only as a guide and we use 34 as the actual chest measurement by which all details of the pattern is drafted as the size 36 used for the women's sizes. In addition to the chest, we use 39 bust for completing the fullest part of the bust. It shall be understood that the 34 chest measurement for size 16 is by no means a size 34 because the additional measurements for size 16 are a great deal different from the 34 woman's size. It would be advisable that the measurements for size 16 should be carefully compared with the measurements of size 34, which will serve for a most practical outline in the future.

When the foundation draft is prepared for the misses' size, it is to be used for all kinds of garments without any exception, which means that the foundation draft is the same for all kinds of blouses, waists, jackets, coats and capes. The sleeve foundation is also prepared the same way with the exception of various changes to suit the shape of the various different garments as mentioned above.

When foundation patterns are complete according to the rules as mentioned above, they can be positively used in the same manner as a size 36 pattern for the various styles desired to be carried out for misses' sizes with the understanding that the size 16 misses' pattern is used for such, which means that the habits of the two foundation patterns, which are the size 16 for misses or 36 for women are about alike in shape with the exception of measurements. The carrying out details for styles shall therefore be for both alike. When completing styles when measurements for neck are to be used or cuff measurements are to be used, see the difference between the misses' size 16 and the women's size 36 and by no means follow such measurements according to size 34, which may conflict with the proper completing of the style suitable for misses' sizes.



THE PRACTICAL DESIGNER

MISSES' BLOUSE FOUNDATION

LESSON NO. 105

Before commencing to draft a misses' size, remember that all details of drafting for misses are about the same as for women with the exception that trifle changes are made on the proportional measurements for size 16, which are as follows:

Chest. 34 inches	Hip. 40 inches
Bust. 37 inches	Back Depth. $6\frac{3}{4}$ inches
Waist. 23 inches	Waist Length. 15 inches

Now begin to draft; draw a square line from A to R and A to C. Measure from A to B $6\frac{3}{4}$ inches back depth and from A to C 15 inches natural waist length. Now draw a line from A to R, B to W and C to X. After all these lines have been crossed, measure from A to D, B to E and C to F, $\frac{2}{3}$ of size, which amounts to $11\frac{3}{8}$ inches for size 16 or for 34 chest and draw a line down from D, E to F.

Now produce the width of back; take half between B and E on the breast line, which makes G and allow from G to H, $1\frac{1}{4}$ inches and then draw a line up from H to J, which will make the width of back. Now measure from A to J $\frac{1}{6}$ of size amounting to $2\frac{3}{4}$ inches in full for this size 16 and raise 1 inch up from J to K, which makes the back neck space. Now connect with a line from K against I to L and square a line down from L to H, which brings the entire width of back and width of shoulder. Now finish the entire width of back by making 2 inches from C to M and then draw a line up from M to A, which completes the entire back foundation.

To continue the front foundation measure between E and N and D and E $\frac{1}{6}$ of size or $2\frac{3}{4}$ inches for this size and allow the same amount from O to P and from P to R and from P to Q. Then draw a line from P to Q and connect Q to the back depth point at the back to T and measure from K to L and apply the same from Q to U and connect U to M.

Now measure the bust from T to V and allow 3 inches for seams from V to W and then draw a line from W to Y, which makes the entire line of front. When being as far as this, allow a seam at the front neck from R towards the front and raise up at that place $\frac{1}{2}$ inch to S and then draw a line from S against the bust to W down to Z, which will complete the entire edge of this front foundation and which is showing a space of fullness of blouse between Y and Z.

I. ROSENFELD'S SYSTEM

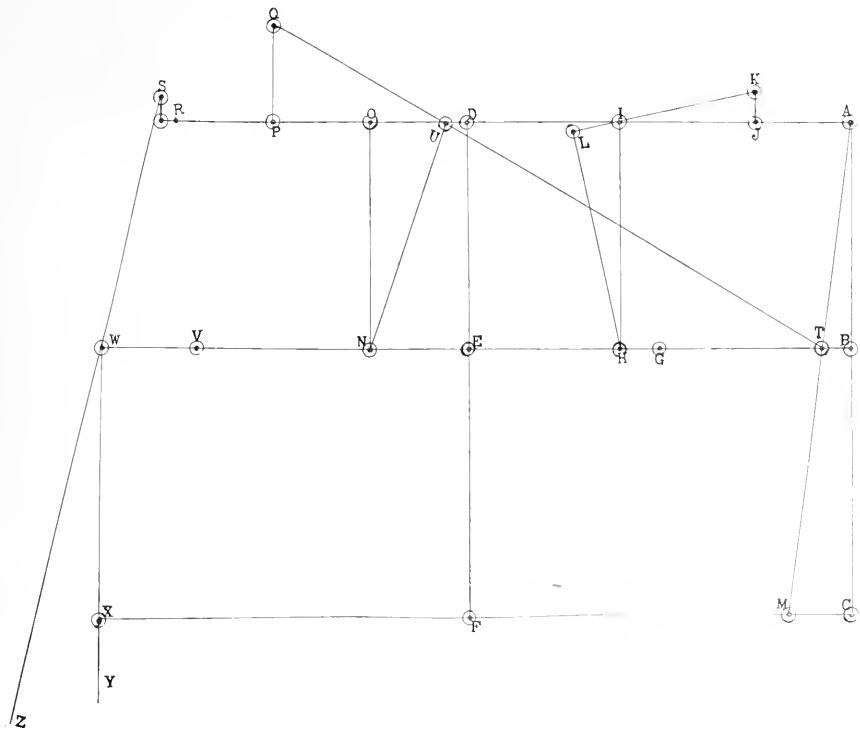



THE PRACTICAL DESIGNER

MISSES' BLOUSE---SIZE 16

LESSON NO. 106

This lesson will complete the first foundation in the form of a misses' blouse and to continue it is therefore necessary to be well acquainted with the first outlines and measurements. To continue, divide the armhole space between H to M, which makes AA and draw a line down to BB and take out on both sides of AA $\frac{3}{4}$ of an inch to E and EE. and on both sides of BB to CC and DD take out $1\frac{1}{2}$ inches and connect lines from EE to CC and E to DD which completes the side seam of the front and back.

Now finish the bottom of the blouse and allow from W to X, 2 inches and connect with a line from DD to X out to Y. From Y to Z is about 1 inch up and now allow below CC and DD, $\frac{1}{2}$ inch and finish the bottom of the back from II, $\frac{1}{2}$ inch below CC, and the bottom of the front begin to curve a $\frac{1}{2}$ inch below DD to X up to Z.

Now make all curves; deduct $\frac{1}{4}$ of each shoulder point at L and T and curve from L to K and from T to P. Now continue in curving the armhole from L to EE, which completes the armhole of the back and from T to E make a curve of the armhole in front and curve, at the same time, from A to K the back neck and from P to R the front neck. Note that the misses' blouse size 16 is now complete and all there is to be remembered regarding its proportional measurements is that in the beginning of the foundation, we are to use the different spaces of proportions suitable for 34 inches chest, but the inch spaces for all actions remains the same as for women's sizes with the exception of the back depth and waist length.

Now cut out the pattern as it is all ready for use with all necessary seams allowed and begin to cut out the back first. Remember that before cutting if no seam is desired on the center back, you may deduct $\frac{3}{8}$ of an inch for a seam all the way down from A to II and continue cutting out then from A to K, K to L, L to EE, EE to CC, CC to II up to A. This completes the cutting out of the back. Now continue cutting out the front and you may deduct a seam in front from R to Z if you do not want a seam and deduct the same amount, in such case, as you deduct in the center back and therefore begin to cut out from T to P, P to R, R to Z, Z to X and DD up to E. Then cut out the armhole of the front from T to E, as shown on the diagram. This completes how to cut out the entire blouse pattern, which consists of front and back.

I. ROSENFELD'S SYSTEM

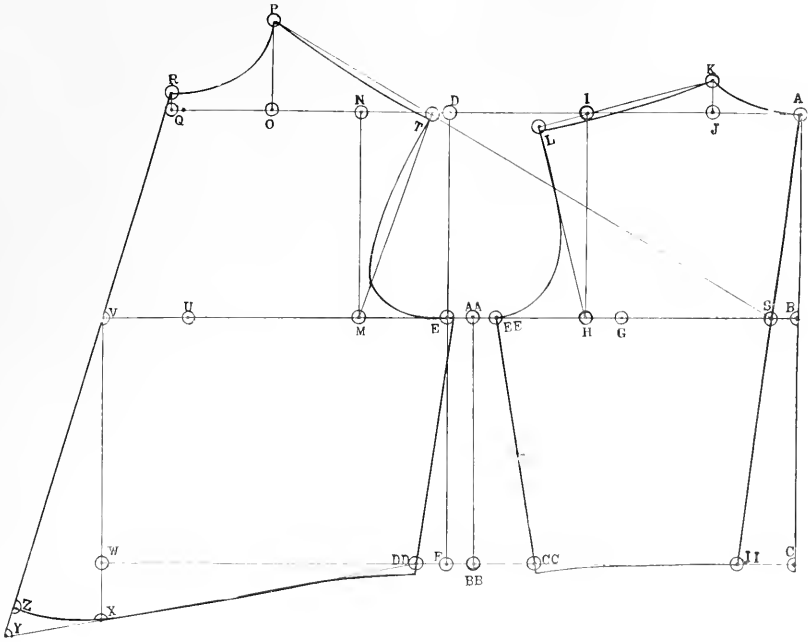



THE PRACTICAL DESIGNER

MISSES' HALF-FITTING JACKET WITH VIENNA FRONT--SIZE 16

LESSON NO. 107

To begin this jacket prepare first the foundation of size 16 as usual and as soon as we draw the foundation lines to the waist line, continue making the hip line, which is $\frac{1}{3}$ of size between C and D amounting to $5\frac{3}{4}$ inches for size 16 according to chest 34 and then draw the hip line. Now remember that by the foundation we mean that all the lines are complete and also the seams are allowed in front as usual.

In continuing to draft the half-fitting jacket, divide the space between H and I, which makes 4. Then place a ruler from J against 4 reaching all the way down to the hip line and then draw a line from 4 to 5 and, at the same time, make a mark on the hip at 6. From 6 to 7 allow $\frac{3}{4}$ of an inch and connect from 5 to 7. Then divide the space between J and I and take half between J and I, which makes 1. From 1 to 2 lower 1 inch and then draw a line out from 2 to 3 and curve from 3. Then continue the curve between the half space of 4 and I and curve down to 5, which is at the waist line. This completes the back part.

Now continue in making the side body, measure from 5 to 8, $\frac{3}{4}$ of an inch and connect with a line from 8 to 6 and from 8 draw a line up against the back curve between 4 and I and then curve again for the side body from 3 against the curve between 4 and I down to 8, which is at the waist line. Remember that at point 3 raise about $\frac{3}{4}$ of an inch forwarding $\frac{1}{2}$ inch for seam towards the armhole, which will prepare the curve for the armhole. To finish the side body towards the front, take from G and 11.9 and 10 and F to 12, $\frac{3}{4}$ inches and then draw a line. Allow from F to 15, $\frac{3}{4}$ of an inch and connect from 10 to 15, which will complete the hip of the side body and the inside seam of the side body will begin from 11 down to 10 and 10 to 15. If a smaller hip is desired at the side body make a line instead of from 10 to 15, from 10 to F.

To continue the front part, take out from 9 to 13, $\frac{3}{4}$ of an inch and allow from 12 to 14 also $\frac{3}{4}$ of an inch. Now connect 14 to 13 and 13 to G, which completes the side seam of the front. Allow from Z to 16, the front of the waist line $\frac{3}{4}$ of an inch, which is the extension for the dart and draw a line from X to 16 down to 18. From Z to 17 make 2 inches and draw a line from 13 out to 17, which makes the long waist line in front and measure from 13 to 14 and 19 to 18, 6 inches for the hip space in front and prepare the dart. Take half for the dart line between N and X, which makes 20. Measure the space from 20 to X and place the same on the waist line from 16 to 21 and draw a line down from 20 against 21 down to 22. Now divide the space between 20 and 21 making AA, which is the beginning point of the dart and take out the amount for the dart at the long waist line. 23 is the center on the long waist line and from 23 to 24 take out $\frac{1}{2}$ inch and from 23 to 25 take out $1\frac{1}{2}$ inches. From 22 to 27 is $\frac{1}{2}$ of an inch and draw lines from AA to 24 down to 27 and from AA to 26 down to 28 and then square a line by 24 to 26 down to 28. Remember that the space between 24 and 27 and 26 and 28 should be alike and then make all curves.

To prepare the vienna front raise from N to BB $1\frac{1}{2}$ inches and curve from BB to AA. This curve belongs to the outside part of the front and in order to make the curve for the inner part of the front, allow from BB to CC, $\frac{3}{4}$ of an inch and curve parallel from CC to 20 down to AA where the dart is and then continue down to 25 and 28. This will complete the vienna front with all seams allowed. Now allow for the button stand $1\frac{1}{2}$ inches and prepare the collar as always and make all curves as shown on the diagram.

I. ROSENFELD'S SYSTEM

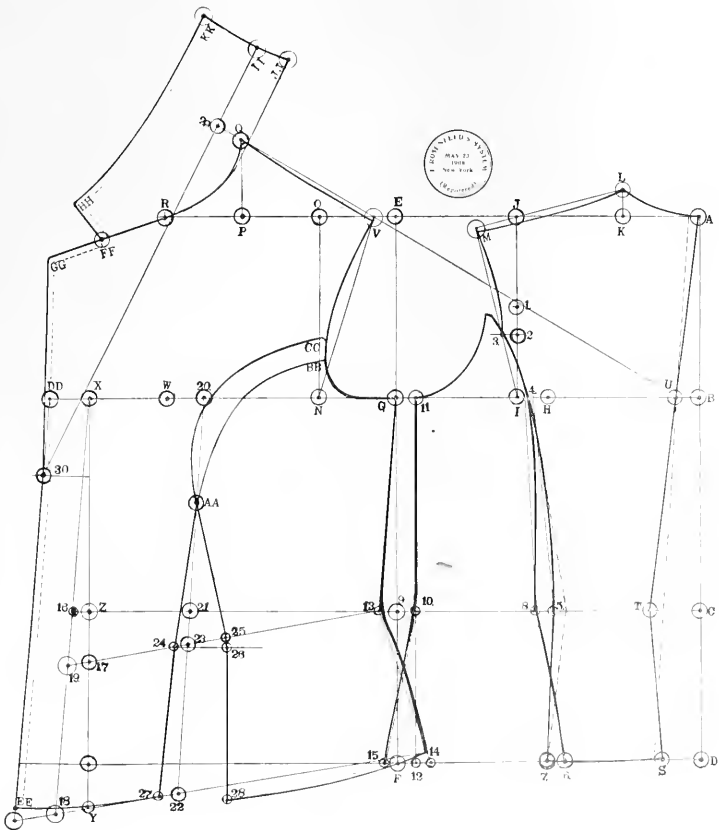

THE PRACTICAL DESIGNER

MISSES' HALF-FITTING JACKET WITH FRENCH SEAMS

LESSON NO. 108

To begin this jacket first prepare the first foundation of the misses' size 16 and continue with the similar actions as the first half-fitting jacket.

To begin the back note that the traced lines at the back at 71 and 17 are showing how to work this back without center back seam and measure at the hip line from 4 to 14, $1\frac{1}{2}$ inches and at the waist line from 3 into the brake line of the back 2 inches as a rule, and draw a line up to the neck point from the waist line to 1 and down from the waist line against 14 down to 17. To begin the back without a seam, deduct at the back neck from 1 to 71, $\frac{3}{8}$ of an inch for a seam and connect with a straight line down to 17 and then measure on the waist line from 72 to 73, $\frac{1}{6}$ of size, which amounts to $27\frac{3}{8}$ inches for this size 16 and measure on the hip line from 14 to 16, 1 inch more which will amount to $37\frac{3}{8}$ inches. Then draw a line from 73 against 16 down to the bottom line 18 and from 73 draw a line up to 10. The space between 10 and 20 is about $1\frac{1}{2}$ inches and connect 73 to 10 and continue with the side body. From 73 to 15 is $\frac{3}{4}$ of an inch increased when we wish to have a seam back and the same changes then have to be made from the center back, which is at 72 to the inner body line and if this change is made from 73 to 15, increase $\frac{1}{2}$ inch from 22 to 16 and connect down to 18, as usual.

Now continue the side body; from 15 to 21 is $\frac{3}{4}$ of an inch, from 16 to 22 is $\frac{1}{2}$ inch. Now connect 21 to 22 down to 23 and 21 against 8 up to 10 where it will combine with the back french seam. The space from 19 to 20 is $\frac{3}{4}$ of an inch and this is allowed for a french seam. From 6 to 24 and 7 to 25 take out $\frac{3}{4}$ inches as for all half-fitting jackets. From 27 to 28 also take out $\frac{3}{4}$ of an inch as usual.

Now begin the front part and at the hip allow $\frac{3}{4}$ inches which is from 7 to 44 and 25 to 43. Prepare the dart as usual and then continue with the french seam in front. In continuing, it is necessary to measure the space from 12 to 10 and apply the same at the front from 32 to 62 and connect with a line from 62 to 47, which is the height of the dart in front and then measure the space at the back from 10 to 20 and apply the same from 61 to 63 and connect 63 to 47. Now note that there is about $\frac{3}{4}$ of an inch space between 62 and 63 at the front shoulder, the same as there is specially allowed at the back from 19 to 20. Make curves at the front from 62 lost down to 49, which will complete the french seam at the outside part of the front and to curve the inner part of the front, begin from 63 lost, as shown on the diagram, at 47 down to 51 and 58.

The shawl collar for this jacket is showing a long shawl opening. The opening is rested on the straight waist line and as this is a single-breasted half-fitting jacket, allow for the button stand from 39 to 40, $1\frac{1}{2}$ inches and draw a collar stand line from 40 against 64 out to 65 and remember that the space between 32 and 64 is always 1 inch for the collar stand and the same between 65 and 66. From 64 to 65 is always $\frac{1}{6}$ of size and $\frac{1}{2}$ inch, which amounts to altogether for this size $27\frac{3}{8}$ inches and a $\frac{1}{2}$ inch for seam. Curve the neck from 32 to 33 straight out to 68 and connect a line from 68 to 40 to finish the lapel and then measure the collar width from 65 to 67, 3 inches and curve the space from 67 to 68, which will then finish the shawl collar. The space from 68 to 69 is a trimming, which may be produced of braids or any other material.

To make the front cut-a-way a trifle, as this diagram represents, draw a line from 40 to 37. You will note that 37 is a straight front line. Now curve from 40 to 57 and see that the space from 49 to 57 and 51 to 58 shall always be one length.

I. ROSENFELD'S SYSTEM

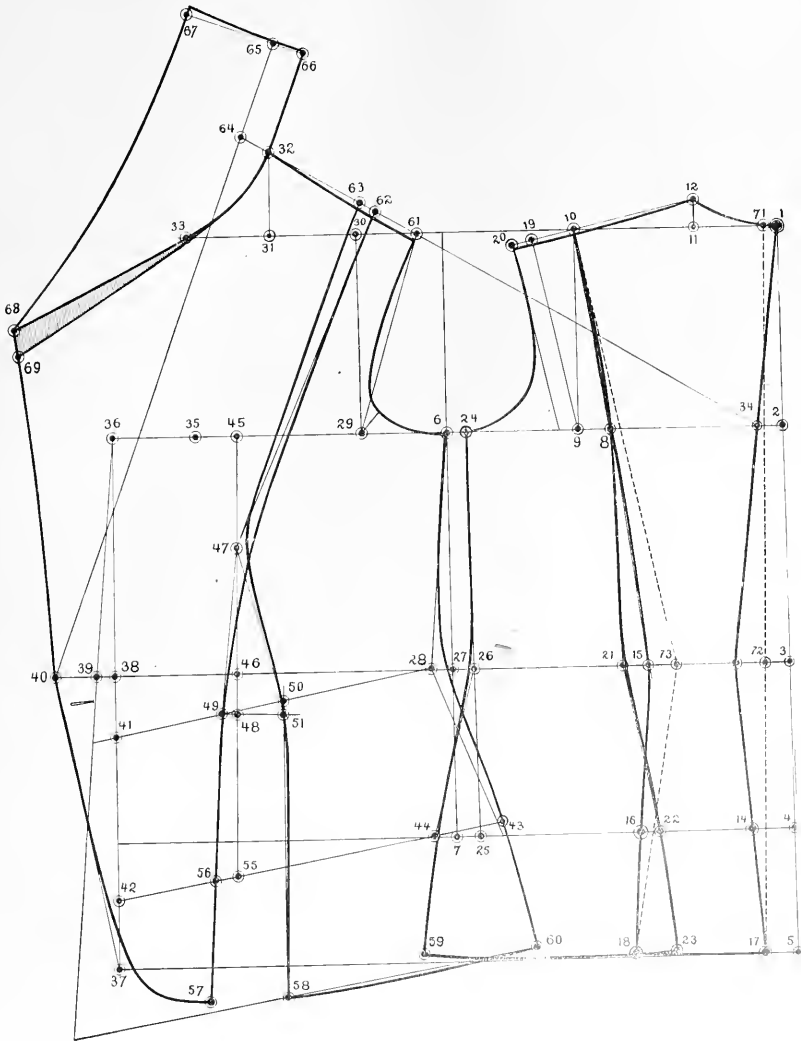



THE PRACTICAL DESIGNER

MISSES' SINGLE-BREADED TIGHT-FITTING FRENCH SEAM JACKET

LESSON NO. 109

The single-breasted tight-fitting french seam jacket for misses' sizes is drafted on the same principles as size 36 with the exception of its measurements, but the rules are to be followed as for size 36. To begin therefore, make the entire foundation lines for the misses' size and then continue as follows:

Now begin the back part of the french seam jacket. From R to Z is $\frac{1}{6}$ of size amounting to $2\frac{7}{8}$ inches for size 16 according to chest 34 and from S to X 1 inch less, which amounts to $1\frac{7}{8}$ inches. From X to 3 is 1 inch taken out and from Z to 2 is $\frac{3}{4}$ of an inch lapping over the side body to the back. Before continuing allow from M to 34, $\frac{3}{4}$ of an inch all the way down, as shown on the diagram, and then divide between L to 34, which makes 33 and draw a line from 33 to X and a curved line again for the side body from 33 to 46 down to 3 and connect 3 to 2 and X to Z.

Now complete the entire side body belonging towards the back and in order to continue with the same, allow from G to N and E to 13, $\frac{3}{4}$ of an inch. Now draw a line from N to 13 and then divide between H and N, which makes 6 and between 3 and 4, which makes 7 and then draw a line from 6 and 7 down to 8. From 6 to 3 draw a line up 1 inch. On the waist line each side of 7 to 9 and 10 take out $\frac{3}{4}$ inches and on the hip line each side of 8 to 11 and 12 allow $\frac{3}{4}$ inches and connect 9 to 12 and 10 to 11 and also connect both sides of 9 and 10 up to 6 lost to 5. From 13 to 15 allow $\frac{3}{4}$ of an inch and this will complete the back space with the side body.

Then continue the front part. From 4 to 14 take out 1 inch and at N towards the front take out $\frac{3}{4}$ of an inch. From E to 16 allow $\frac{3}{4}$ of an inch and then connect with a line from 16 to 14 and 14 to N. Now prepare the dart in front as usual for the tight-fitting garments and divide the space over the chest from F to 1 of which half makes 23 and apply the same on the straight waist line from 19 into the dart line in front and then measure or make the long waist line from 18 to 20, 2 inches and connect from 14 to 20 out to 21 for the long waist line and remember that for tight-fitting garments we allow in front from 18 to 19 always $1\frac{1}{2}$ inches. 26 is at the center dart line connected with the long waist line and then take out for the dart between 26 and 27, 1 inch and from 25 to 28, 1 inches and between 26 and 29, 3 inches and then connect all the lines for the dart from 30 to 27 down to 29 and from 30 to 29 down to 31 and square a line from 27 to 31 down with a square line to 32.

To prepare the french seam in front divide the shoulder as usual from U to O, which makes 35. From 35 to each side to 37 and 38 allow $\frac{3}{8}$ inches, which will equal $\frac{3}{4}$ of an inch which is allowed to the back and then connect a line from 38 to 30, which will finish the outer part of the front and then draw a parallel line from 37 to 47, which should be lost with a curve to 30 down to 29, 31 and 32 and this will complete the french seam in front. Always take care that the space between 27 to 28 and 31 to 32 shall always be one length. The button stand and collar for this tight-fitting jacket is exactly the same for misses' size 16 as for women's size 36.

I. ROSENFELD'S SYSTEM

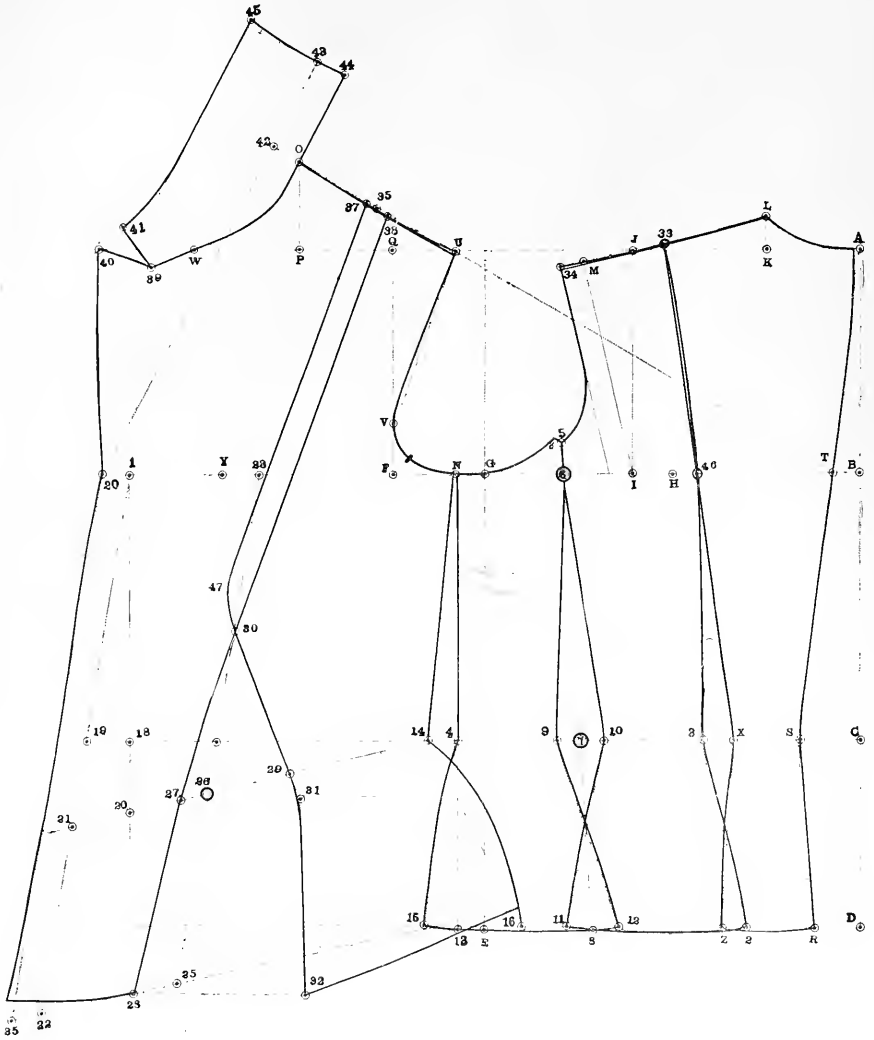

THE PRACTICAL DESIGNER

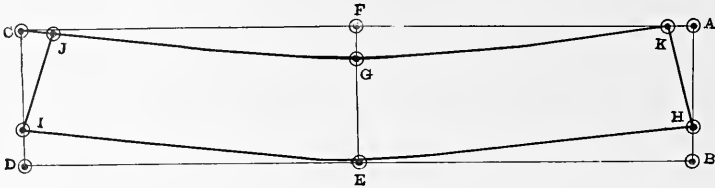

STANDING COLLAR

LESSON NO. 110

In beginning collars for misses' sizes all there has to be remembered is the difference in neck measurement between women's and misses' sizes. You will find on the table of proportions for misses' that the neck measurement for size 16 misses' is 13 inches and therefore the amount for all collars should be 13 inches for misses instead of 14 inches as for women and otherwise all instructions are about the same. All there has to be remembered is that the width of collars never change and the amount of space used for width remains for all sizes alike. To fully understand each collar follow up each collar separately.

For the standing collar for which diagram is shown above, the space between A and B is 3 inches for width and the space between B and D is 1 inch more than the neck measurement which means that if the neck space is 13 inches, the space between B and D shall be 14 inches. E to F is half between B and D. From B to H and D to I is 1 inch up and G is 1 inch down and A to K and C to J are $\frac{1}{2}$ inches each.

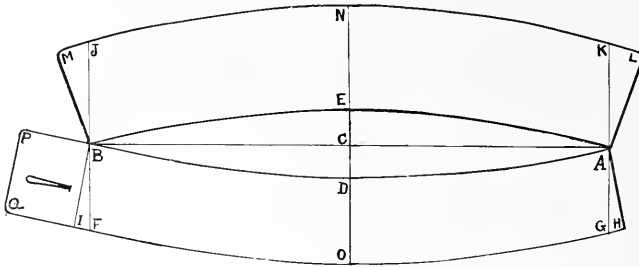

AUTOMOBILE COLLAR

LESSON NO. 111

The automobile collar is built on the same principles as the standing collar as changes explained in lesson for women's size collar with the understanding that the width of collar between A and L and B and M, which is the top collar remains and so does the under collar remain from A to H and B to I. The space from C to D and C to E also remains 1 inch and therefore all there has to be remembered in addition to the width is the measurement of the neck which is 13 inches for size 16 and therefore the space between A and B shall be 14 inches for this collar, which makes the 1 inch more allowed for seams.

I. ROSENFELD'S SYSTEM

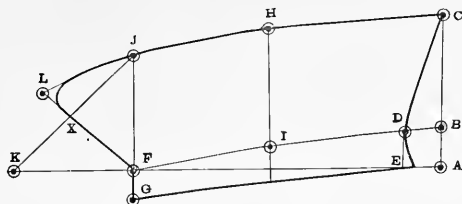

TURN-OVER COLLAR

LESSON NO. 112

The turn-over collar is cut in half size and therefore take half of the neck measurement for size 16 misses' and 1 inch more, which means that half of 13 is $6\frac{1}{2}$ and 1 inch more is $7\frac{1}{2}$ inches and work the width of collar from B to C, I to H and F to L the same as for women's and also the other details for this collar. The width of this collar shall not be more than $3\frac{1}{2}$ inches and which will make it 3 inches when finished.

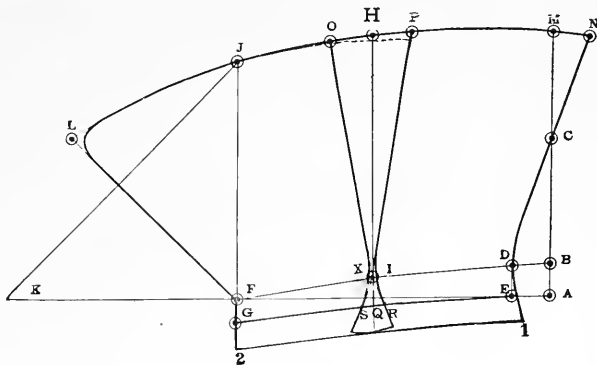

STORM COLLAR

LESSON NO. 113

The storm collar is a continuation of the turn-over collar and is therefore to be continued the same way as it has been continued for women. Regarding width, it would be necessary to know that the width of the collar is the same width of the shoulder, which is 6 inches in width for size 36 from B to M and this would be too wide for the shoulder of a misses' size 16 and therefore we make a trifle change of making it not more than $5\frac{3}{4}$ inches in width from B to M, X to O and F to L. The stand for this collar can remain exactly the same as for women, which is from A to B 1 inch and F to G $\frac{1}{2}$ inch. Then allow the same additional stand of $\frac{1}{2}$ an inch from G to 2 and E to 1. For complete instruction for other collars, see the different collars of shawl or notch lapel on the pages where it is fully explained for women's sizes.



THE PRACTICAL DESIGNER

MISSSES' SLEEVE WITHOUT FULLNESS--SIZE 16

LESSON NO. 114

To begin this sleeve, follow the same rules as for 36 with the difference of the change of size and see diagram No. 1. Draw lines as usual from A to F and A to D. From A to B is $\frac{1}{3}$ of size or $5\frac{1}{4}$ inches for this size. Take half of A and B, which makes C.

Now begin the inside length of the sleeve. From B to D is inside sleeve length, which is $17\frac{1}{2}$ inches for this size. E is half way between B and D. Now cross all lines from A, B, E and D. D to I and A to F is half of size or $8\frac{1}{2}$ inches for size 16 according to 34 chest. Now connect a line from I to F. From G to V is one-twelfth of size or $1\frac{3}{8}$ inches. Take half of C and V, which makes T and square a line down from T to the straight line to U and see diagram No. 2 for continuing.

To continue finishing this sleeve, watch carefully diagram No. 2. From T to X is 1 inch and then divide from I to D, which makes J. From J to K is 2 inches and draw a line from K against I. Make from I to O 1 inch, O to P 1 inch and H to N also 1 inch in for the inside sleeve at the elbow. From G to S is $\frac{1}{2}$ inch out for the top sleeve and from G the same $\frac{1}{2}$ inch can also be taken out if desired for a narrower under sleeve and otherwise draw a line from G to N and N to O, from P to H and H up to S. From K to L is $1\frac{1}{2}$ inches and from E to M is $2\frac{1}{2}$ inches. Now connect a line from K to E, L to M, M to X and X to W, $\frac{3}{4}$ of an inch up and $\frac{3}{8}$ of an inch seam allowed towards the front.

Now begin to curve the top part of the sleeve with a circle, which is made by the star (*), which is to be found between T and U. The curve shall begin at V and finish at G and then finish with a curve from V to S. Now curve the under sleeve from W and raise the seam, as shown on the diagram, and curve towards G, from G to N and N to O. The inside curve at the elbow line at N and H should be somewhat filled in so as not to have the lines broken and then the same amount shall be deducted at the outside of the elbow of this sleeve at E and M.

Note that the line at the inside brake of the sleeve from S to N to P shall not be used unless a very curvy sleeve is desired, which is very seldom used. The under sleeve is longer with a $\frac{1}{2}$ inch, which is to be guided by the straight bottom line from Q to O and draw the parallel space of the same amount from I to R. Otherwise this sleeve is complete with all seams allowed. For different changes of sleeves follow instruction of women's sizes and use this foundation pattern of misses' size 16.

I. ROSENFELD'S SYSTEM

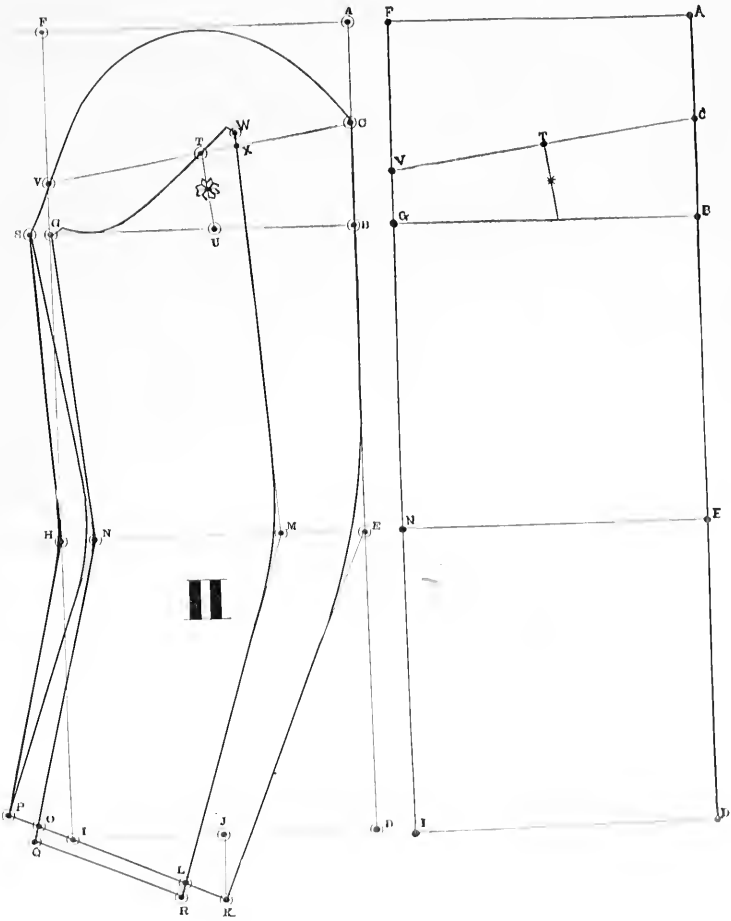



THE PRACTICAL DESIGNER

RULES AND REGULATIONS FOR MISSES' SLEEVES

In continuing to prepare various kinds of stylish sleeves, remember that when the foundation pattern is complete according to misses' size 16 or according to 34 chest measurement follow the instructions of different kinds of sleeves the same as for women's sizes with the only exception that sleeve length has to be carefully followed, which may be found on the table of proportions placed in the beginning part of misses' sizes.

The various styles that may be continued from the foundation pattern are as follows: One-piece sleeve with fullness on bottom of which we can obtain a one-piece tight-fitting sleeve, a bishop sleeve which contains gathering around the cuff part or a sleeve of which we can take out a dart on the bottom. The next production of sleeve may be a raglan sleeve, which is to be connected to a sleeve draft before cut out. We are to remember that the increase we make for a raglan sleeve shall be followed carefully according to the width of shoulder for size 16 if the sleeve is prepared for a size 16. It will therefore be necessary to refer to the different kinds of sleeves on the various pages where instruction is given under the heading of women's sizes for all kinds of sleeves.

LIBRARY OF CONGRESS



0 013 973 147 5