

A18

TT 520

.W 85

Work's Ladies' Tailor System

A SELF INSTRUCTOR
IN THE ART OF
CUTTING AND FITTING
LADIES' GARMENTS

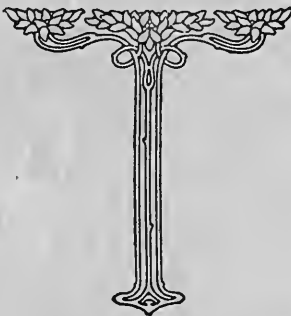

W. A. WORK, PROP'R
22 N. FOURTH ST., HARRISBURG, PA.

COPYRIGHTED, 1914

Publishes the Latest Fashions Quarterly



TTS20
. W85

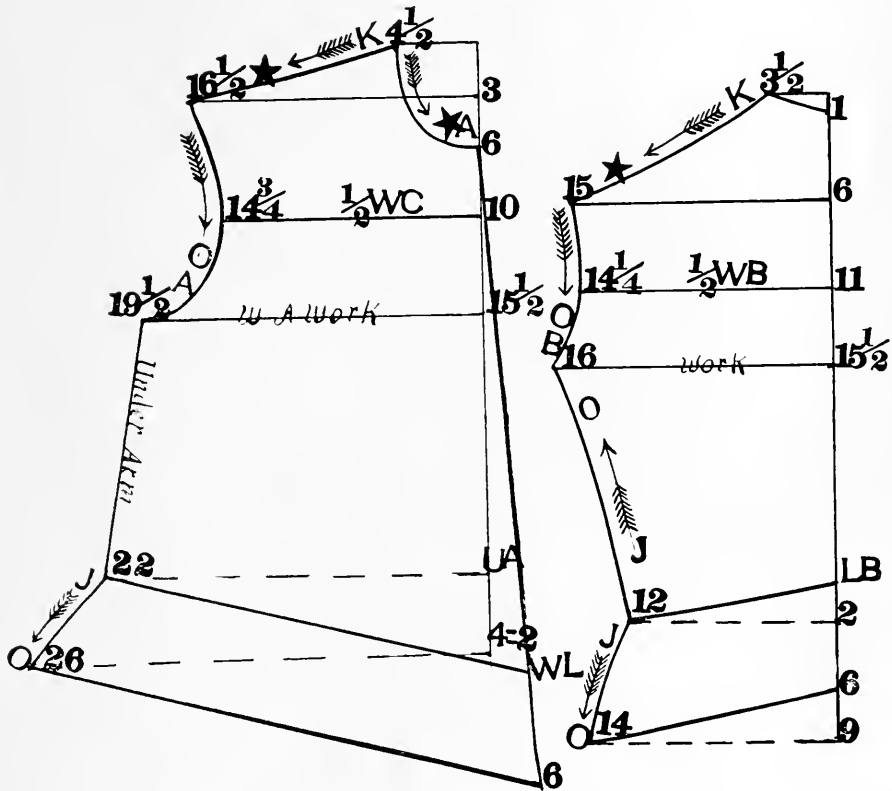

No. 82

FRONT

Locate points 3, 6, 10 and $15\frac{1}{2}$ down base line with scale. From point $15\frac{1}{2}$, locate under arm with rule; locate 4 below U A and 2 opposite and outside base line. From point 6 (neck), run front of waist through point 2, locating waist line one inch longer than length of front; 22 is opposite U A, 26 opposite 4, with scale. Draw lines, get shoulder and width of chest same as for back.

DRAFT BACK FIRST

Locate points 1, 6, 11 and $15\frac{1}{2}$ down base line with scale. From point 1, locate length of back with rule. Locate 2, 6 and 9 below LB with scale opposite 2. Locate 12 and opposite 9, 14, also with scale. Draw lines at right angle from points 6, 11 and $15\frac{1}{2}$. Locate points out on lines with scale. Make shoulder from $3\frac{1}{2}$ to 15 with rule, get $\frac{1}{2}$ width of back on line 11 with rule, take some off shoulder and run arms eye to inside points. Run under arm line from 12 to 16; measure down from 16. Locate under arm then run waist and hip line.

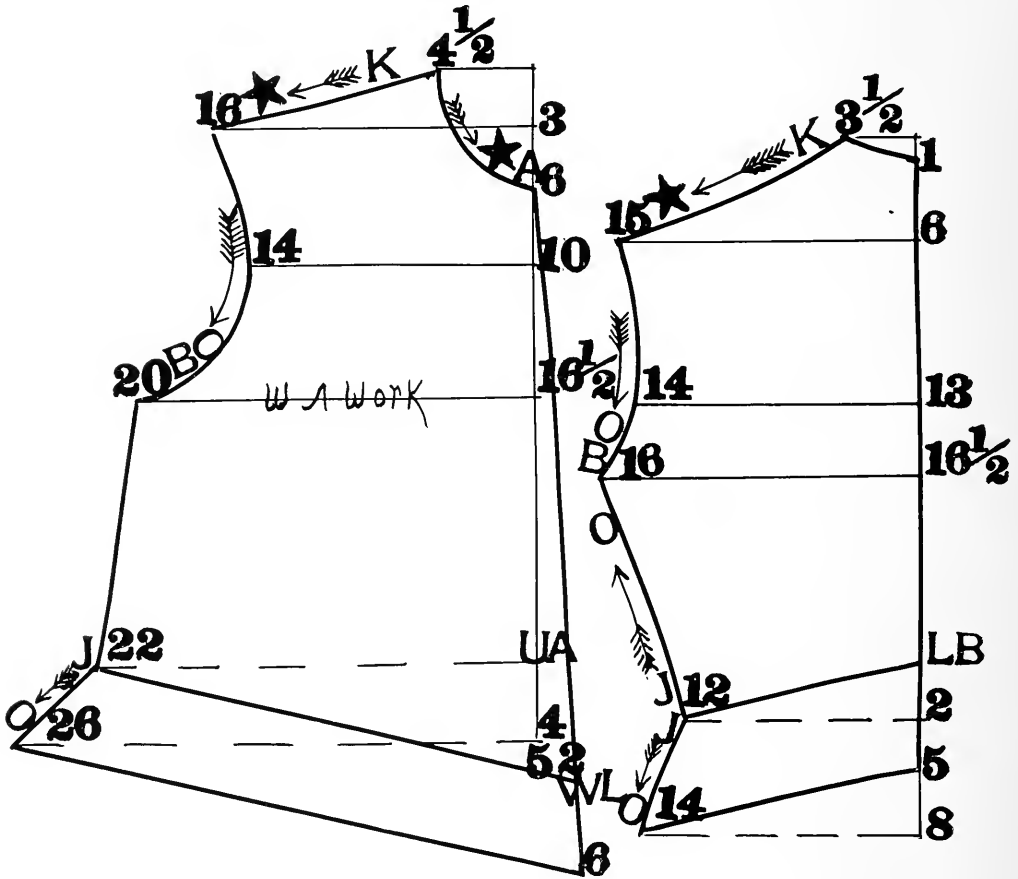

No. 121

LADIES' MANNISH WAIST

This waist has a seam on shoulder. Draft same as for shirtwaist. Get under arm, on back, from 16 to 12, $\frac{3}{4}$ inch less than under arm measure.

Front.—Make under arm from 20 to 22, $\frac{3}{4}$ inch less than regular measure.

For sleeve, use diagram No. 122.

©GIA375684

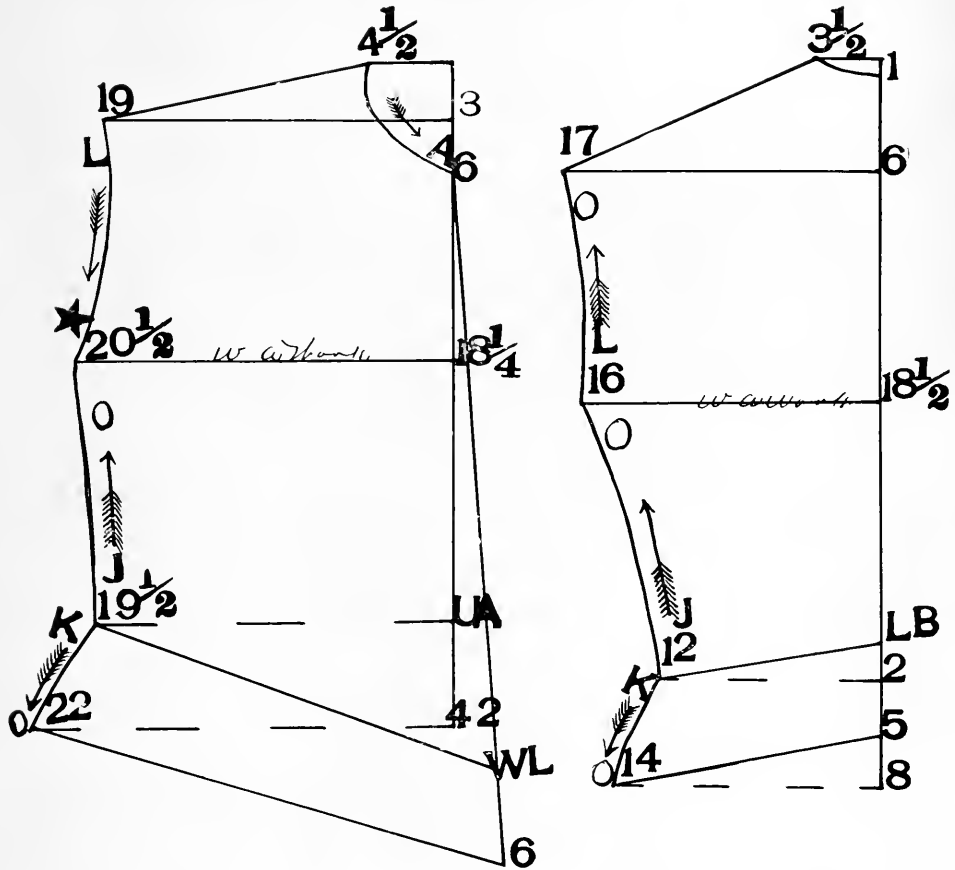

No. 134

THE NARROW, WIDE, DROP SHOULDER WAIST

This waist has no seam on shoulder and a wide arms eye effect. Use scale corresponding with bust measure. Locate UA $\frac{3}{4}$ inch less than under arm. For sleeve, use diagram 139.

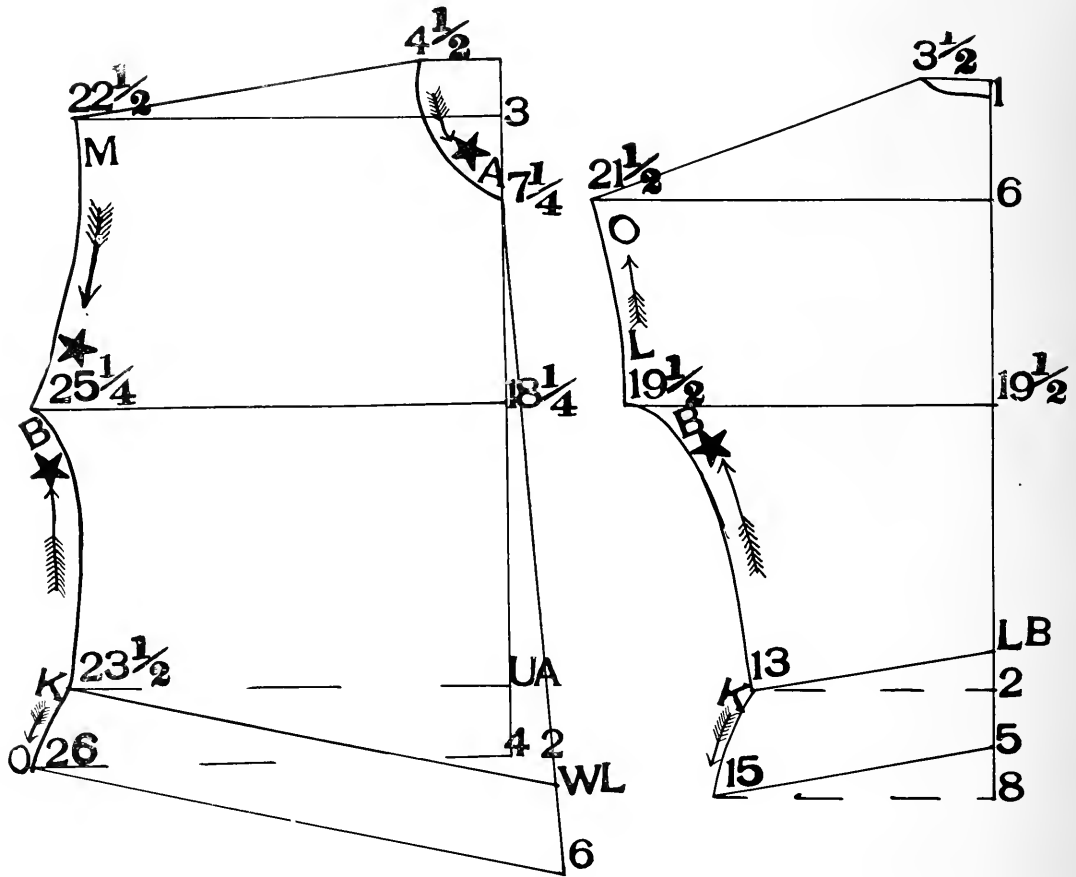

No. 137

THE LONG DROP SHOULDER WAIST

Draft same as for all shirt waists.

Under arm is $\frac{3}{4}$ inch less than regular measure.

Use diagram 138 for sleeve.

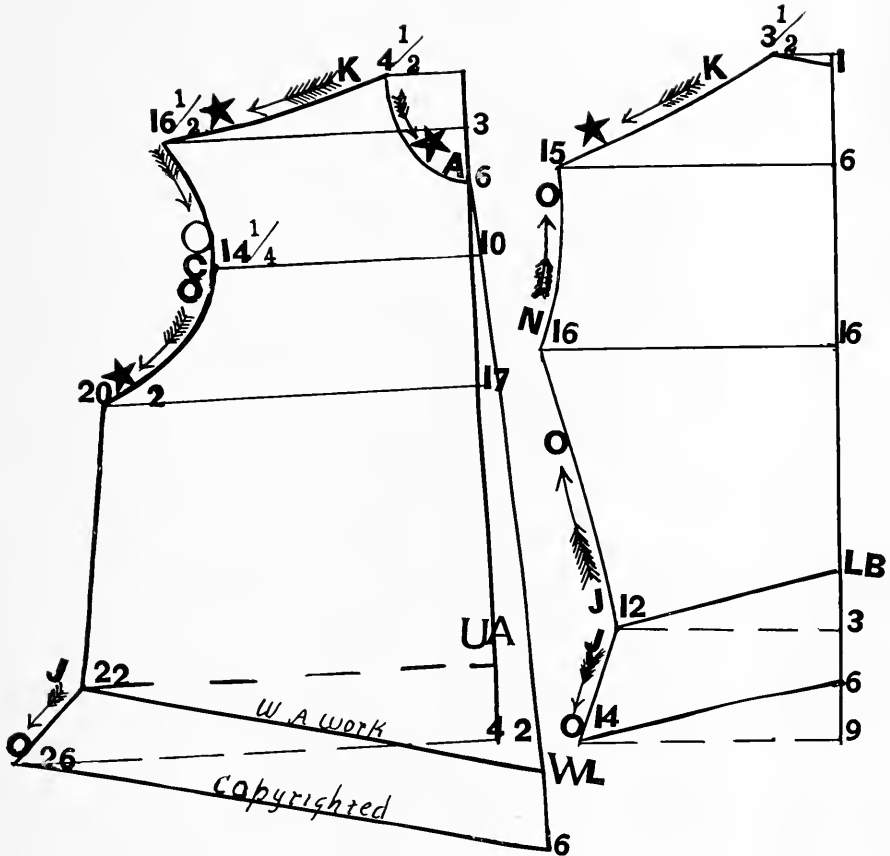

No. 151

LADIES' WAIST WITH SET-IN SLEEVE

Use scale corresponding with bust measure.

This waist has seam on shoulder. Draft same as for all shirt waists.

Make under arm $\frac{3}{4}$ inch less than under arm measure.

For sleeve, use diagram 124.

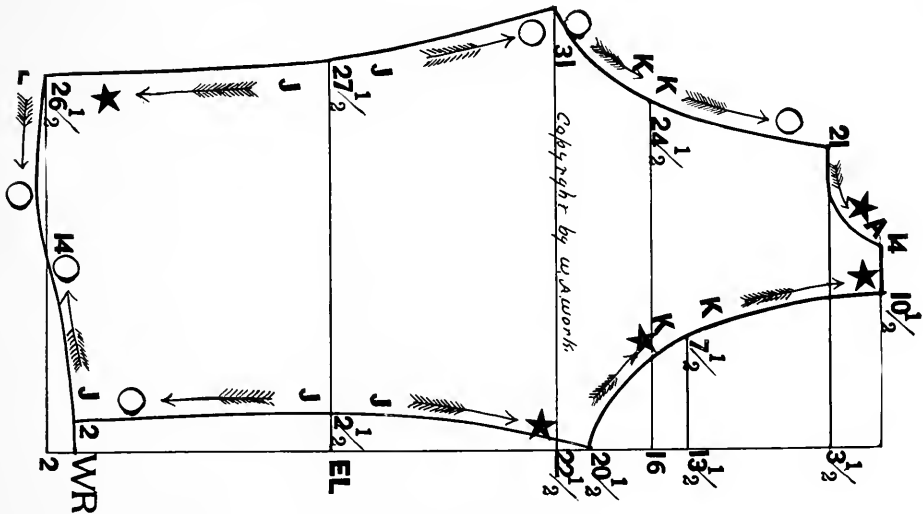
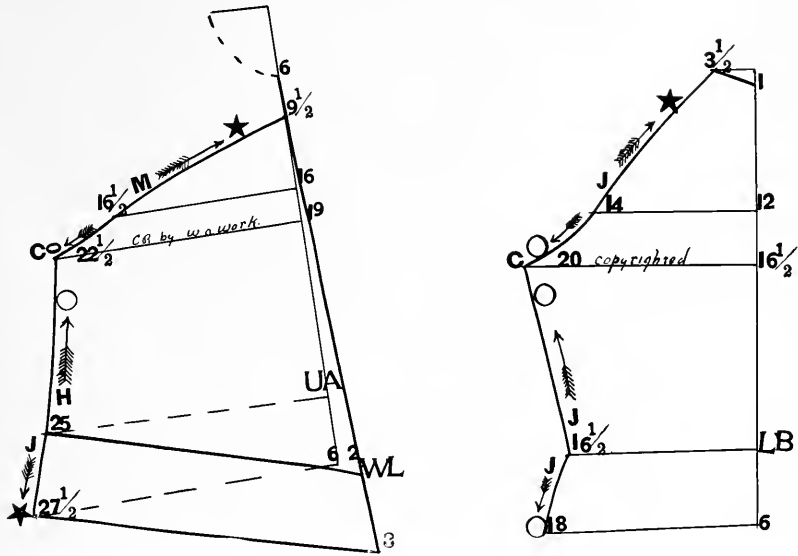

No 153

THE RAGLIN WAIST WITH YOKE SLEEVE

Take measure and draft same as shirt waist effects.

Use scale corresponding with bust measure. Get length of back from point 1. Use full under arm measure.

In drafting front, get under arm from point 19 and length of front from point 6, waist line one inch longer than regular measure.

Use same scale for sleeve, getting elbow and wrist from point 22 1/2. This sleeve is drafted flat.

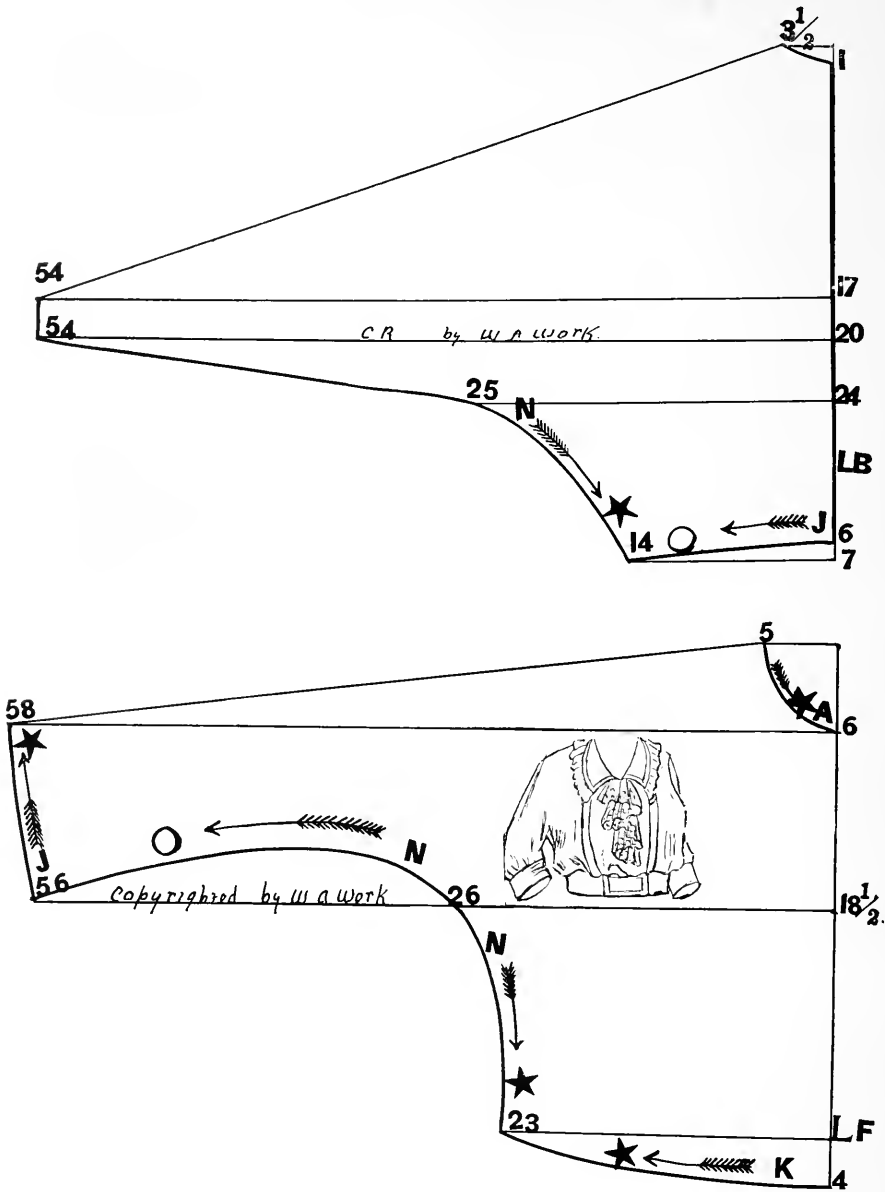

No. 154

THE BAT WAIST

Use scale corresponding with bust measure. Get lengths of back from point 1. Get 6 and 7 below LB with scale.

For front, get lengths from point 6. Waist line is 4 below LF with scale.

Join shoulder seams and cut goods solid, with no seam on shoulder.

This waist is a poor fitter but is one of the fads of the day and is worn extensively.

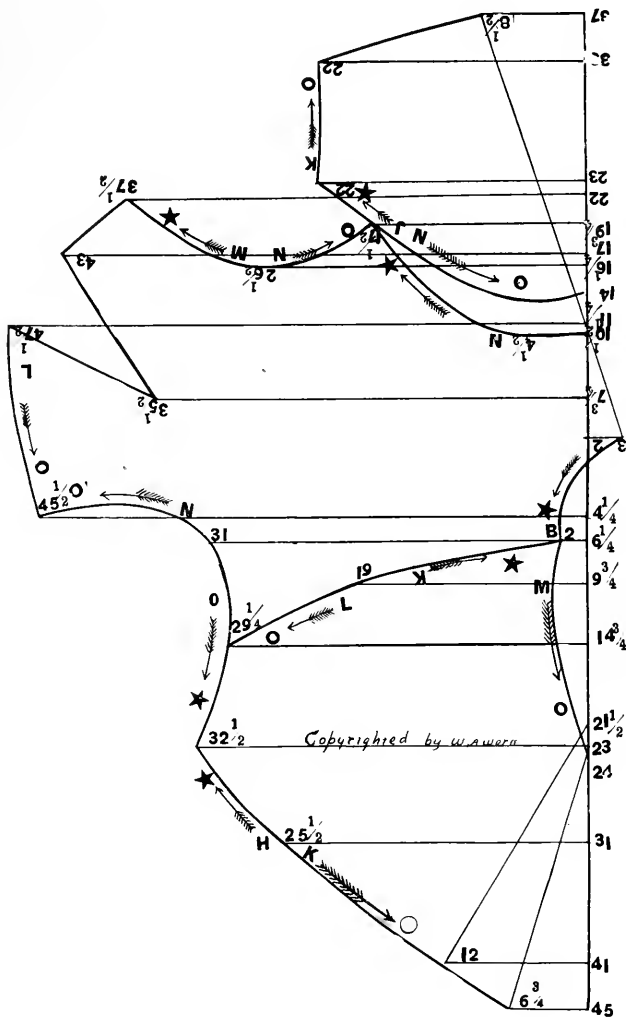

No. 171

LADIES' RAGLAN WAIST

The sleeve of this waist forms back and front yoke. The drafting is done entirely by scale. Begin with scale at back of neck about half way on base line locating points to 37, then down base line from back of neck to 45.

Draw lines at right angle and connect with rule.

Use scale corresponding with bust measure.

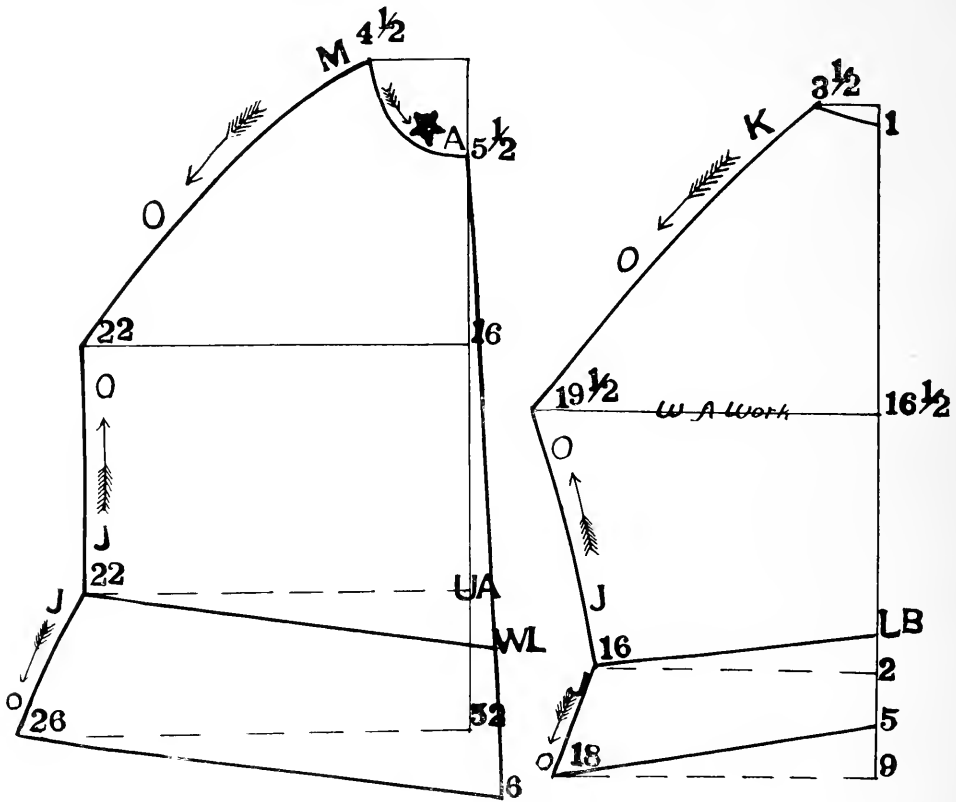

No. 142

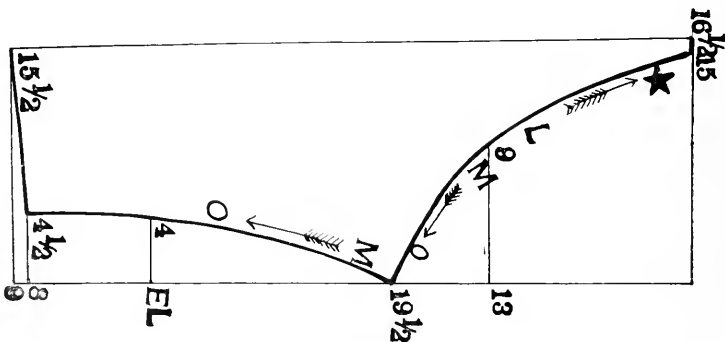

No. 143

No. 142

THE RAGLAN WAIST

Use scale corresponding with bust measure. Draft same as for all shirt waists. Under arm is $\frac{3}{4}$ inch less than regular measure.

No. 143

Sleeve for Raglan Waist

Draft same as all sleeves. From point $19\frac{1}{2}$, get length to elbow. 8 and 9 is with scale. Fold on straight line. Cut double.

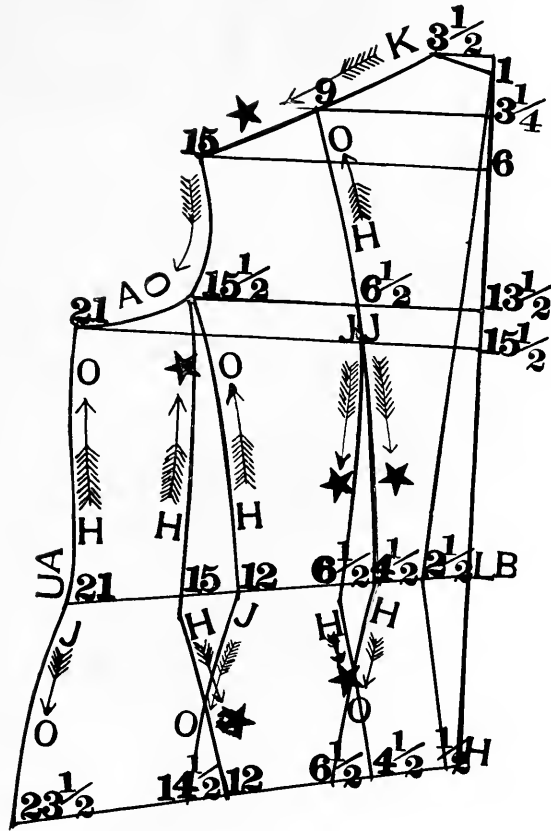

No. 80

BACK OF LADIES' FITTED WAIST

New Style

This waist is panel front and back. Use same scale. Get LB and UA same as for old fitted waist. Hip line is 6 inches below L.B. Slope with waist line.

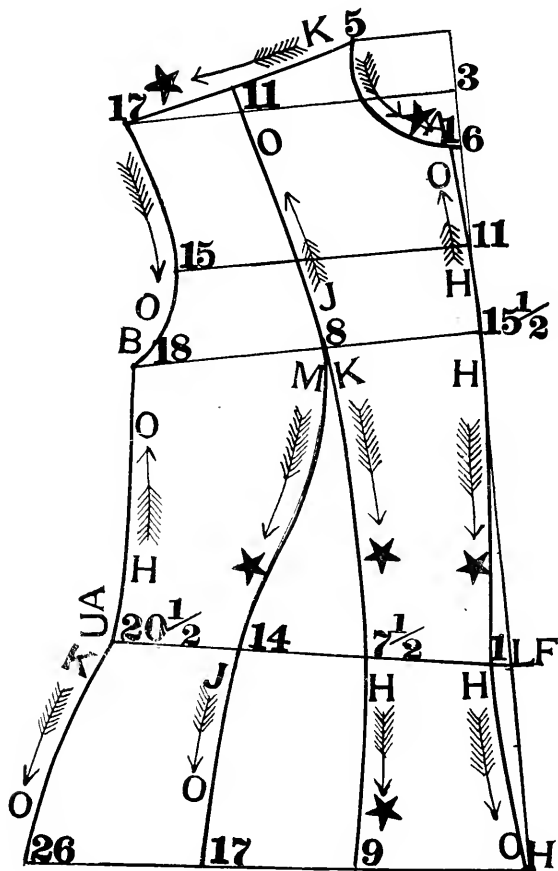

No. 81

Front of Ladies' fitted waist. Use scale corresponding with bust. Measure and draft same as for front of old fitted waist. Waist line is 6 inches below L.F.

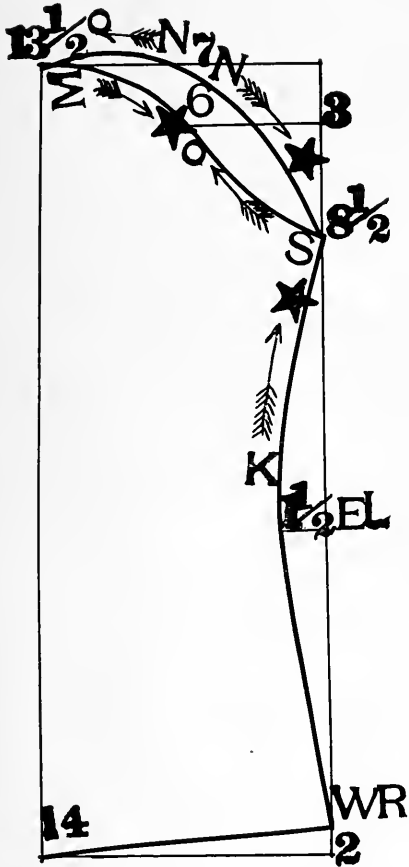

No. 124

LADIES' SET-IN SLEEVE

Ladies' Set-in Sleeve is for Mannish Waist No. 123.
Draft same as for all sleeves.

Get elbow and wrist from point $8\frac{1}{2}$. This sleeve is full length. Fold on straight line; cut double.

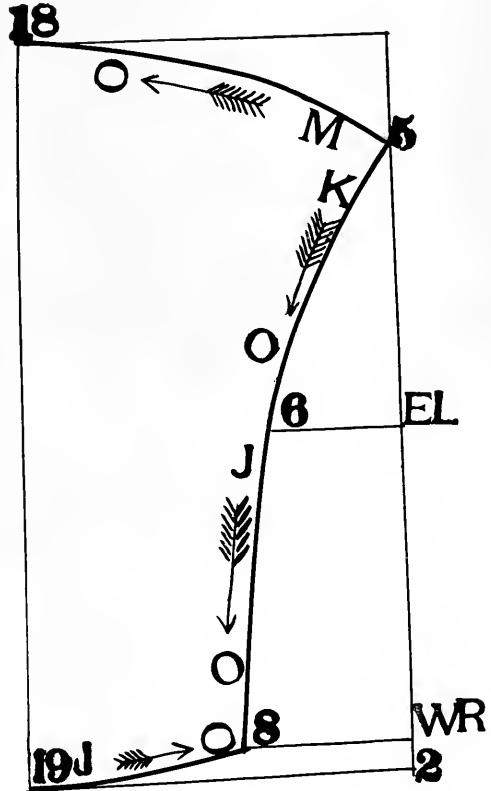

No. 122

LADIES' RAGLAN SLEEVE

This sleeve is for Mannish Waist No. 121.
Use scale corresponding with bust measure.

Get EL and WR from point 5. Locate WR 2 inches less than regular length to wrist, the 2 inches less is for cuff. Fold on straight line; cut double.

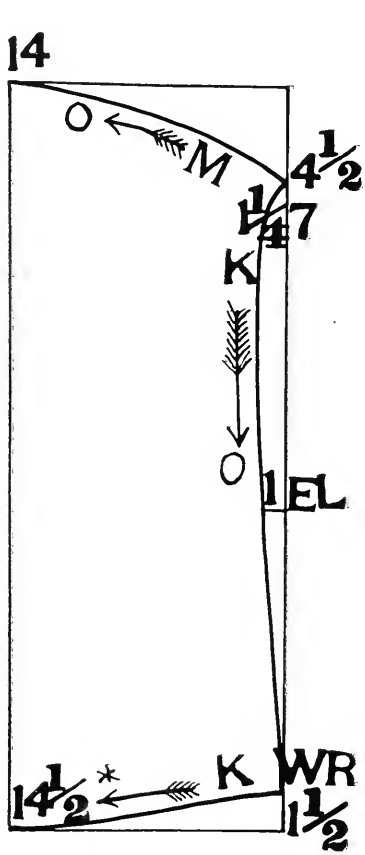

No. 138

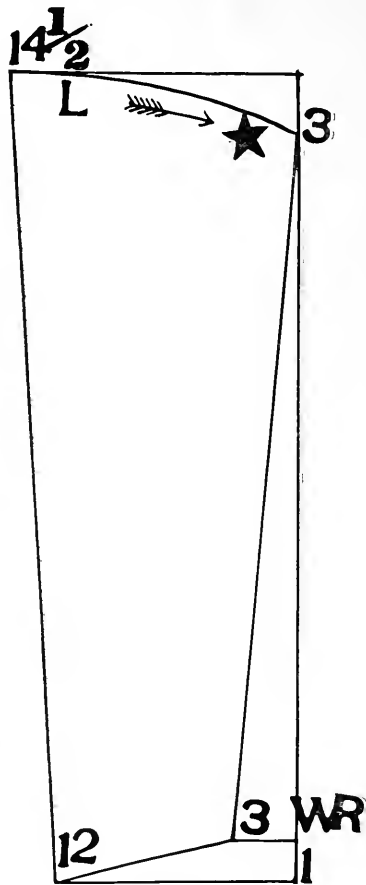

No. 139

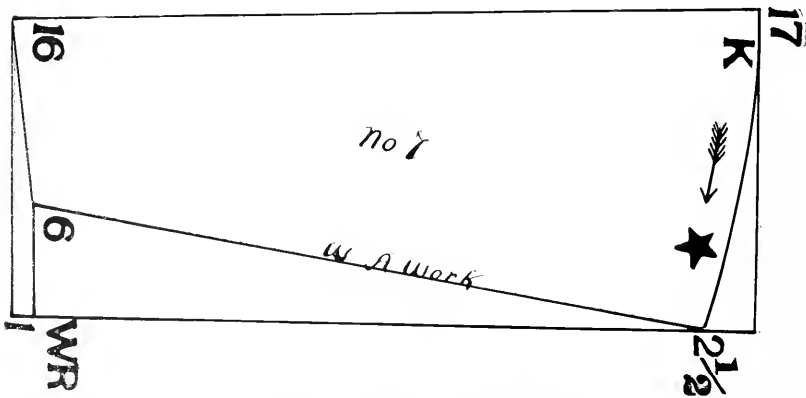

LADIES' WAIST SLEEVES

No. 138 is for drop shoulder waist No. 137; No. 139 is for waist No. 134. Draft same as for all sleeves.

No. 7, Gents' Shirt Sleeve. Use scale corresponding with chest measure. Make wrist 3 inches less than length of arm on inside seam.

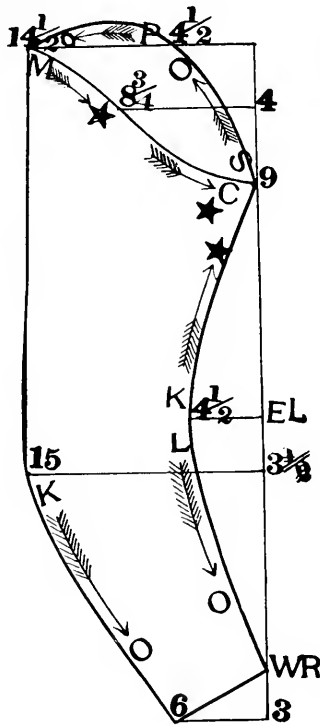

No. 88

LADIES' DRESS SLEEVE

This sleeve has a seam to elbow only. Get elbow and wrist from point 9. $3\frac{1}{2}$ below EL and 3 below WR is with scale. Fold on straight line from $14\frac{1}{2}$ to 15. Cut double, beginning at elbow.

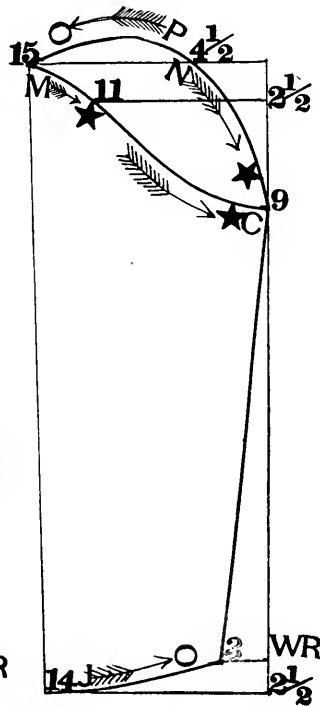

No. 87

SHIRT WAIST SLEEVE

Use scale corresponding with bust measure $2\frac{1}{2}$ and 9. From point 9, get length of sleeve to wrist, less two inches. The two inches less than full length is for cuff. Fold on straight line from 15 to 14; cut double.

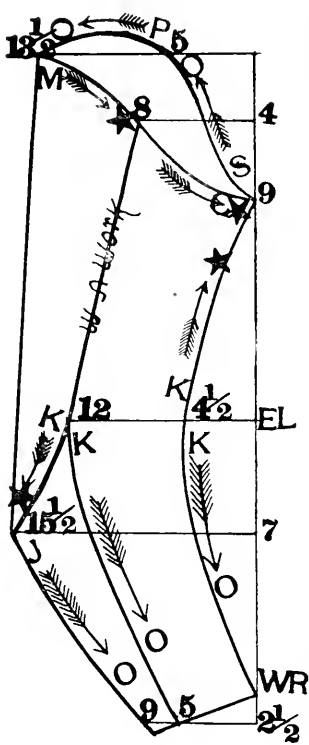

No. 90

LADIES' DRESS SLEEVE

This sleeve is in two parts, upper and lower. Get full length from point 9. 7 is below E.L. $2\frac{1}{2}$ below WR with scale. Fold on line from $13\frac{1}{2}$ to $15\frac{1}{2}$. Begin cutting at E.L. or $15\frac{1}{2}$; cut to 9 to WR all around sleeve. Open out, cut from $13\frac{1}{2}$ to 8 to 9, also from 8 to 12, then to 5; cut from 12 to $15\frac{1}{2}$ which leaves upper and lower sleeve.

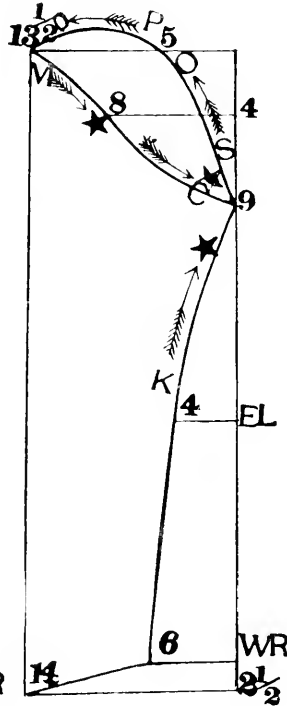

No. 89

LADIES' ONE-PIECE CLOSE-FITTING SLEEVE

From point 9, get EL and WR, full length P. Measure at EL from 4 to straight line and from 6 to 14. Sleeve can be made as tight or as loose as desired by taking up or letting out on inside seam. Fold on straight line; cut double.

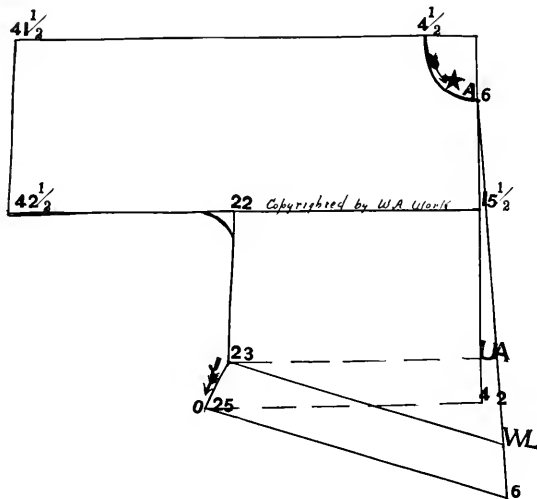
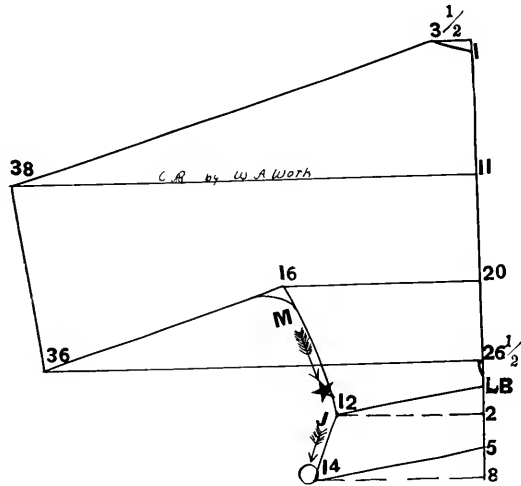

No. 155

LADIES' KIMONA WAIST

Use scale corresponding with bust measure.

Get length of back from point 1.

Make under arm one inch less than regular measure.

In drafting front, get under arm from 15 1/2 and waist line from point 6. Make waist one inch longer than regular measure. Join shoulder seams together and cut goods solid. No seam on shoulder.

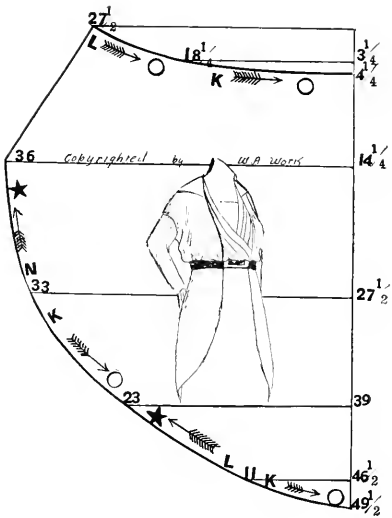

No. 156

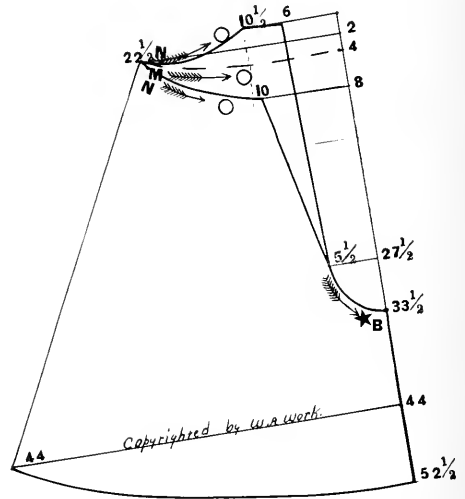

No. 157

LADIES' PEPLUM EFFECT

Use scale corresponding with hip measure.

Draft entirely by scale. This foundation can be cut in many ways. Can be made shorter at back and square instead of rounding.

THE MARCELLA DRAWERS

No. 157 is Marcella Drawers.

Use scale corresponding with hip measure.

Locate all points down base line with scale. Measure down from $33\frac{1}{2}$ locating bottom at desired length. Lines from $5\frac{1}{2}$ to 10 and to $22\frac{1}{2}$ is front. Line from $5\frac{1}{2}$ to 6 and $10\frac{1}{2}$ is back fold on straight line from $22\frac{1}{2}$ to 44 and cut double.

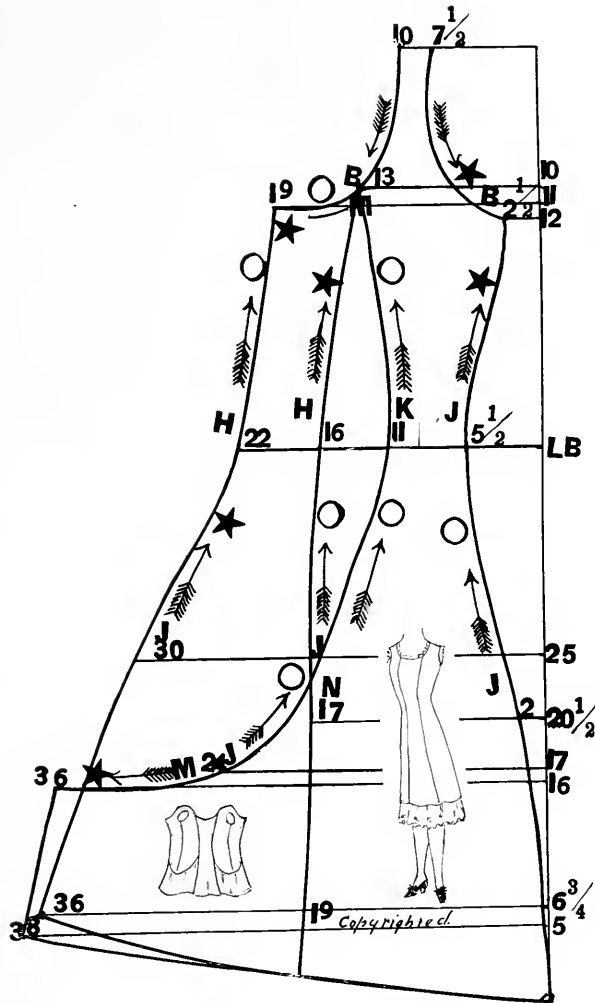

No. 162

COMBINATION CORSET COVER AND DRAWERS

No. 162 is Back. Use scale corresponding with bust measure.

From upper right hand corner, get length of back. From 19, get under arm. From length of back or waist line, get length of drawers; get from 5 to 25 up with scale. Center back lines lap entirely over side form and must be separated with a tracer.

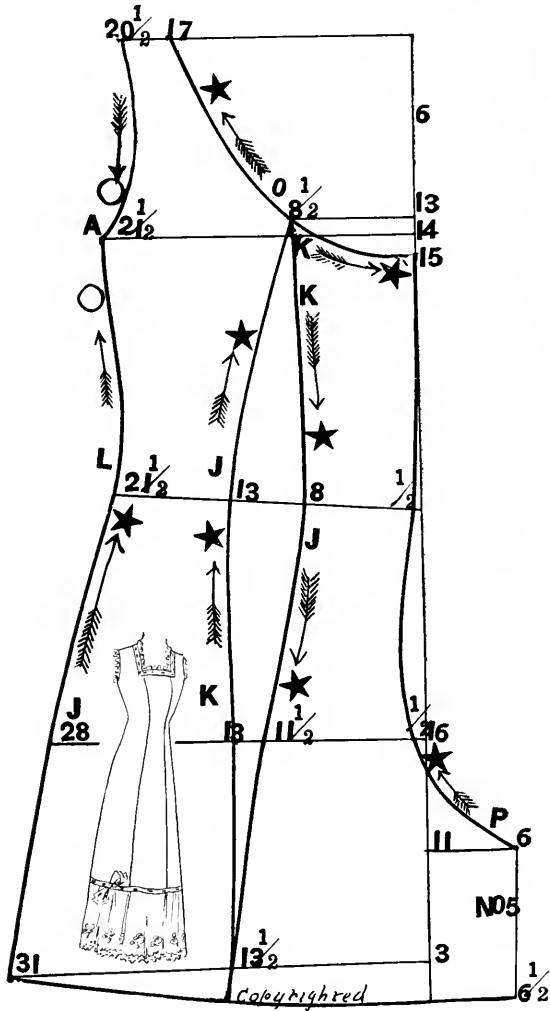

No. 163

LADIES' COMBINATION CORSET COVER AND DRAWERS

No. 163 is Front. From point 6, get length of front or waist line. From 21, get under arm. From waist line get desired length of drawers. 3 to 16 is up from length with scale.

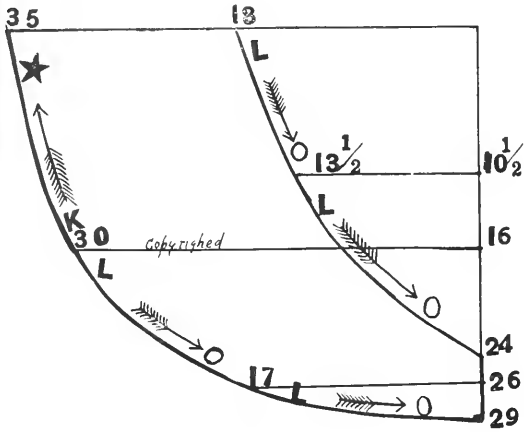

No. 7

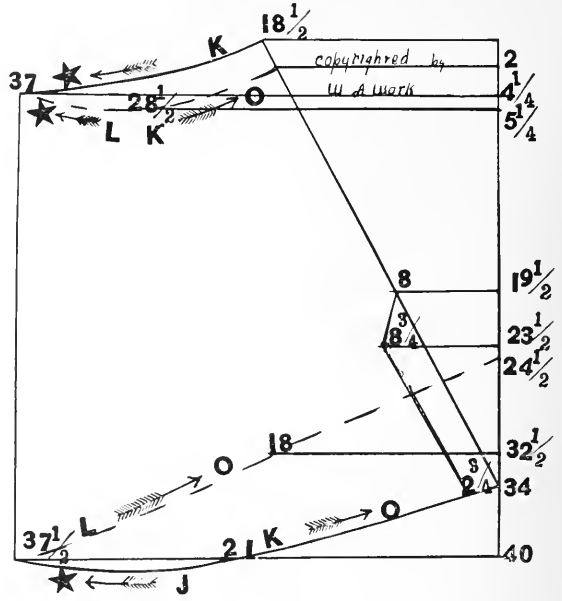

No. 5

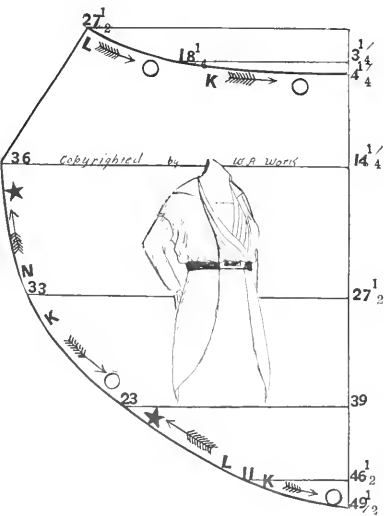

No. 156

LADIES' PEPLUMS

One with illustration is the round pointed at back Peplum. No. 5, is Long Skirt Peplum, gathered. No. 6, is Coat Peplum, gathered. No. 7, is Hip Peplum. Use scale corresponding with hip measure.

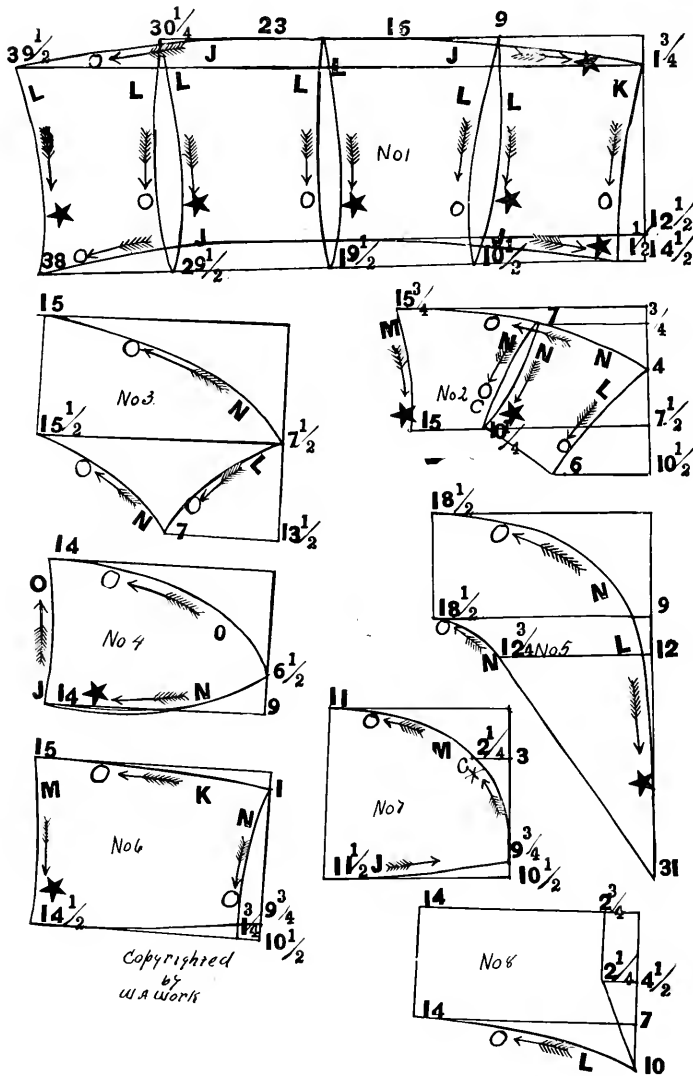

No. 169

LADIES' GIRDLE AND COLLARS

No. 2 and No. 3 is the Madici Collar. No. 2 is the foundation. No. 5 is the Shawl Collar. No. 4 is Folding Collar. No. 6 and No. 7 is Standing Collar. No. 8 is a Turn-over Collar. No. 1 is Girdle Foundation. For Collars 3, 5, 7 and 8, fold pattern on straight line; cut double. Use scale corresponding with bust measure.

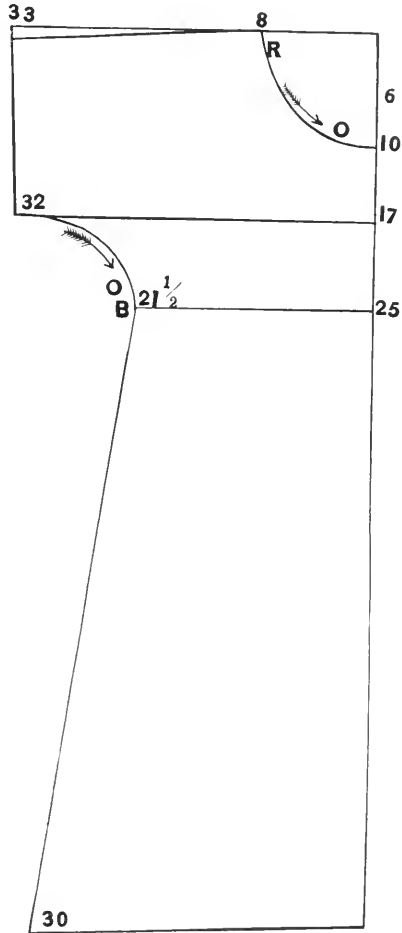

No. 168

KIMONA APRON AND NIGHT GOWN

Use scale corresponding with bust measure.

Get length from point 6 as long as desired.

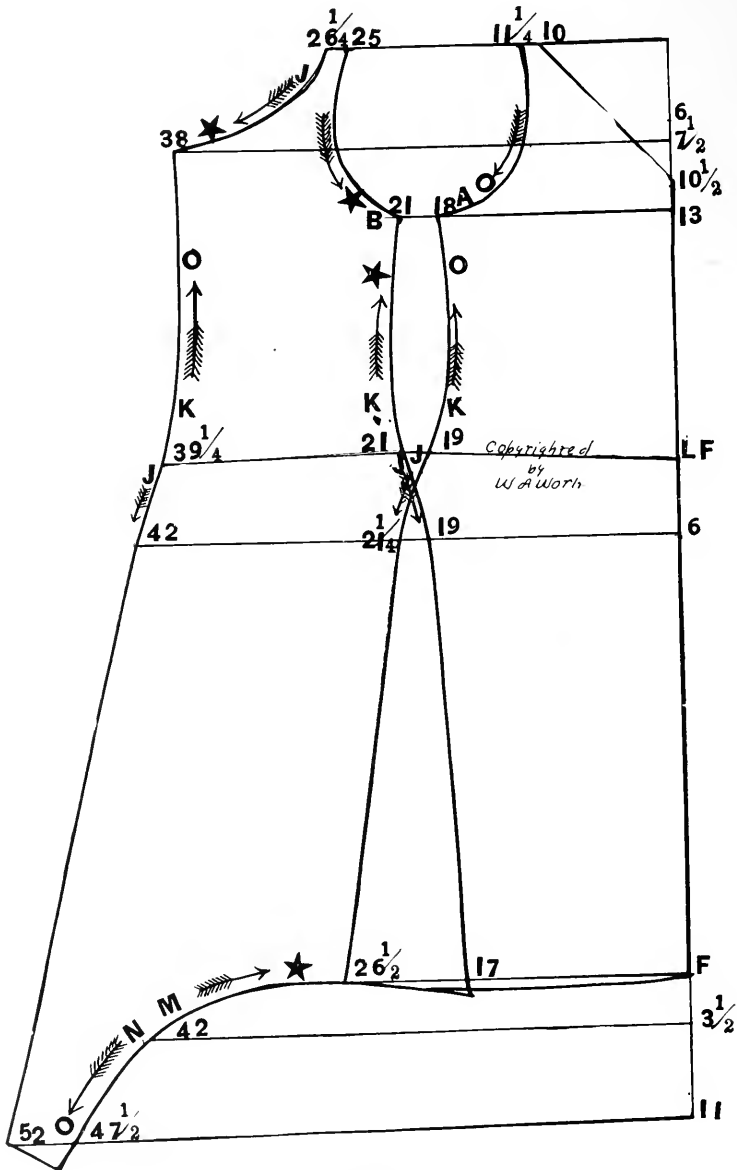

No. 167

COMBINATION SLIP AND ENVELOPE DRAWERS

Use scale corresponding with bust measure.

Get LF from point 6.

Get length of drawers from LF to just above the knee; each side laps over in drafting.

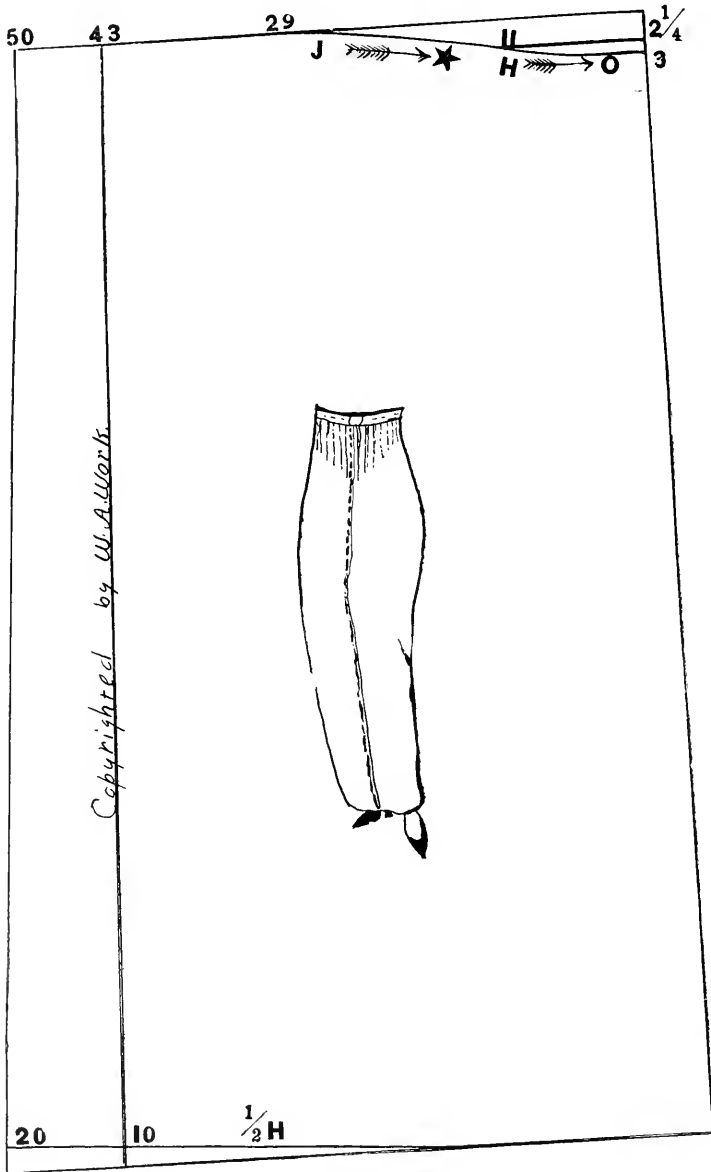

No. 166

LADIES' THREE GORE PANEL BACK SKIRT

This skirt has seam in front. Used for narrow material. Can be gathered, tucked or draped up by fizing. Use scale corresponding with hip measure.

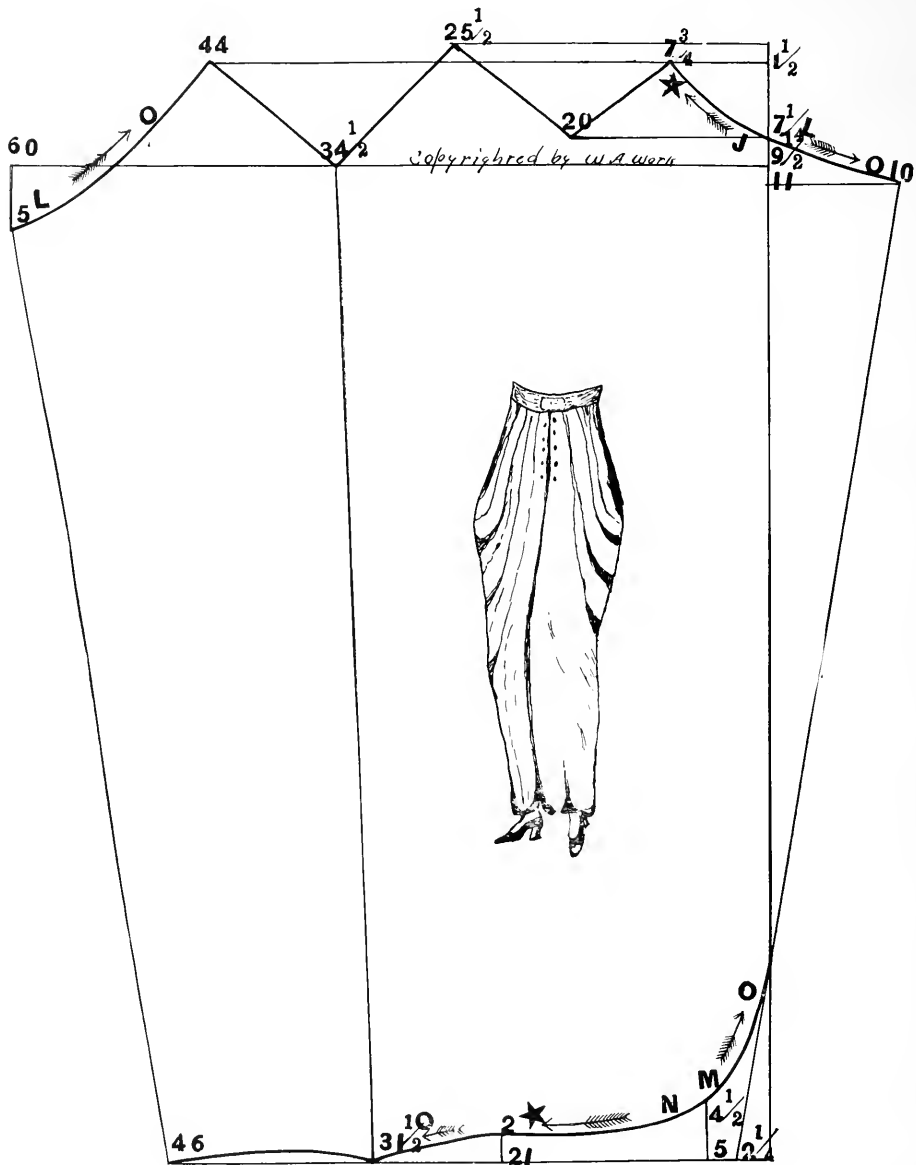

No. 164

LADIES' TWO PIECE, SIDE SEAM, PEG TOP SKIRT

Use scale corresponding with hip measure.

Get length of front from point 9. Draping up is done same as for all Peg Top Skirts.

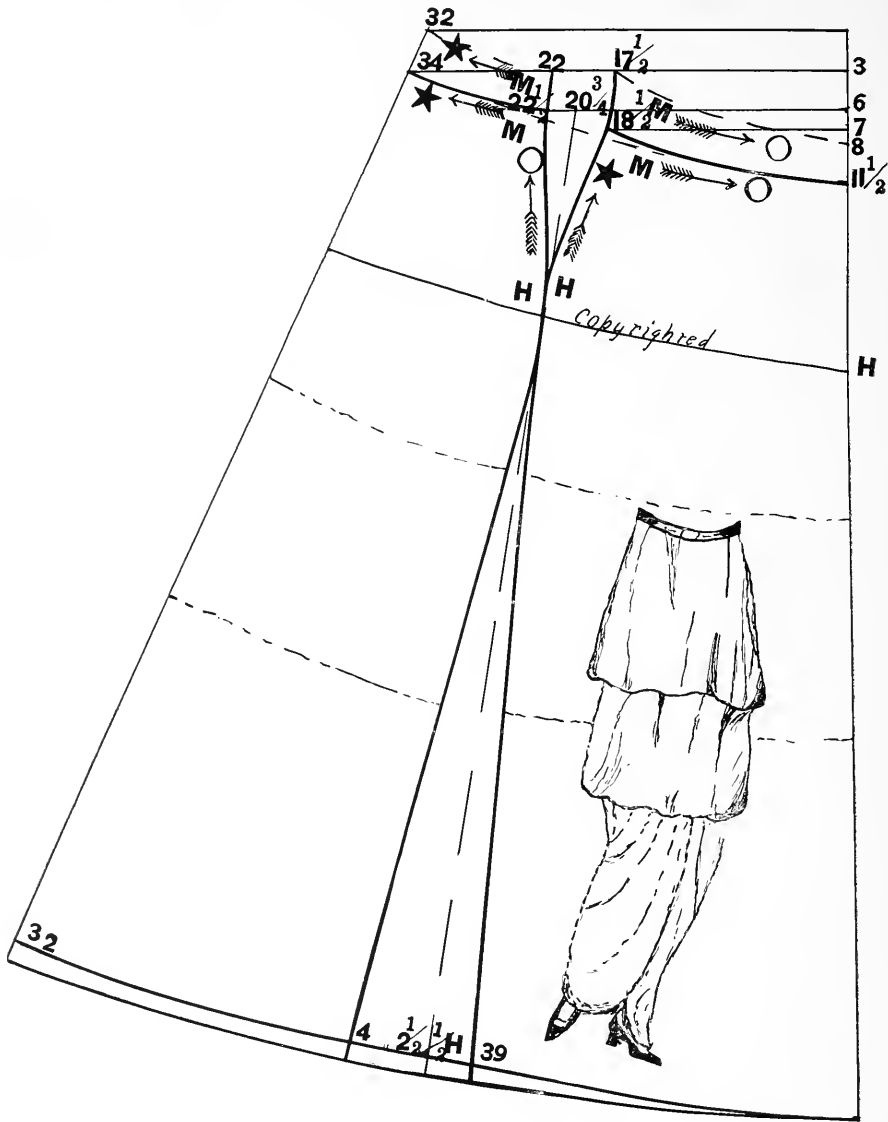

No.161

THE THREE TIER SKIRT

Use scale corresponding with hip measure taken over largest part of hips. Get lengths to floor from point $11\frac{1}{2}$ which is waist line; dotted line from 8 is high waist line. No half hip is taken on hip line as this skirt is much larger than hips at hip line.

39 is from front with scale, 4 is from $\frac{1}{2}$ Hip. Cut out on lines 39 and 4. These lines can be set in or out according to how wide you wish skirt at bottom.

Dotted lines are for tiers. They can be set as desired. Cut on these three dotted lines as each tier must hang free from waist line. Make lower tier as long as possible, if you are not tall, so as not to cut your height.

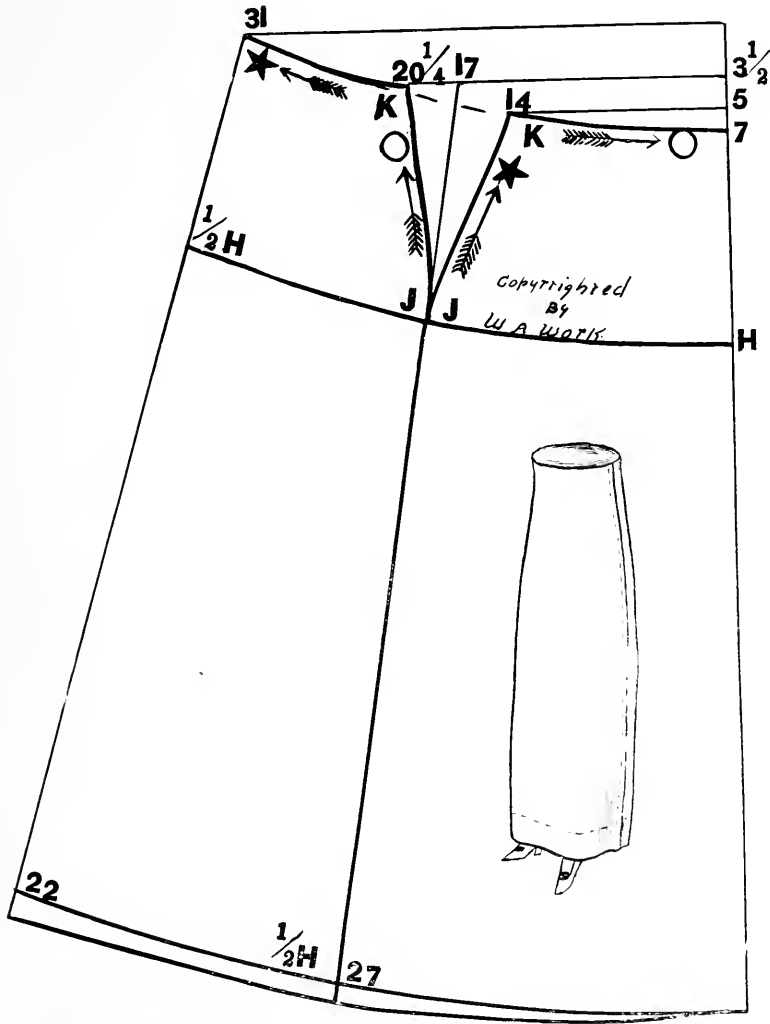

No. 158

LADIES' TWO GORE SIDE SEAM SKIRT

Use scale corresponding with hip measure taken over largest part of hips. Swing hip line same distance from waist line measure was taken from figure. This measure is never less than 7 inches, and on many ladies it is 8 and even 9 inches below waist line.

Locate $\frac{1}{2} H$ on hip line. Run center back from 31 to 22. If there is a difference between center back line and $\frac{1}{2} H$, take this difference out on each side of centre gore dart at hip line.

This diagram will give the right shape for all up-to-date side seam two gore skirts. Most all draped skirts are made from this foundation.

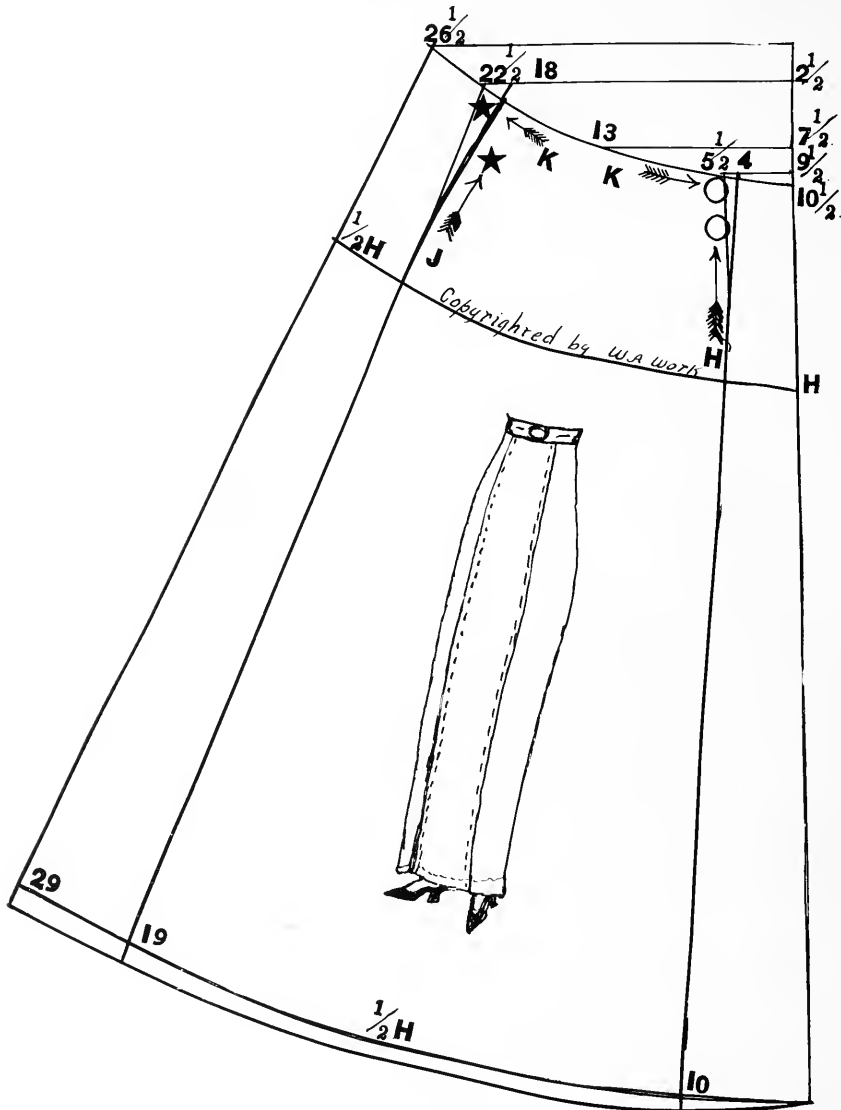

No.159

LADIES' FRONT AND BACK PANEL FOUR GORE SKIRT

Use scale corresponding with hip measure taken over the largest part of hips. The hip line is located on pattern same distance from waist line, measure was taken on figure. It is never less than 7 inches on many figures 8 and 9 inches below waist line. Measure out on hip line locating point at one half hip measure. Run back panel from $26\frac{1}{2}$ to 29 and from $22\frac{1}{2}$ to .19.

If there is a difference between $\frac{1}{2}$ hip point and center back line, take this difference out at back gore dart on line from $22\frac{1}{2}$ to 19. This diagram is the foundation for all up-to-date panel skirts.

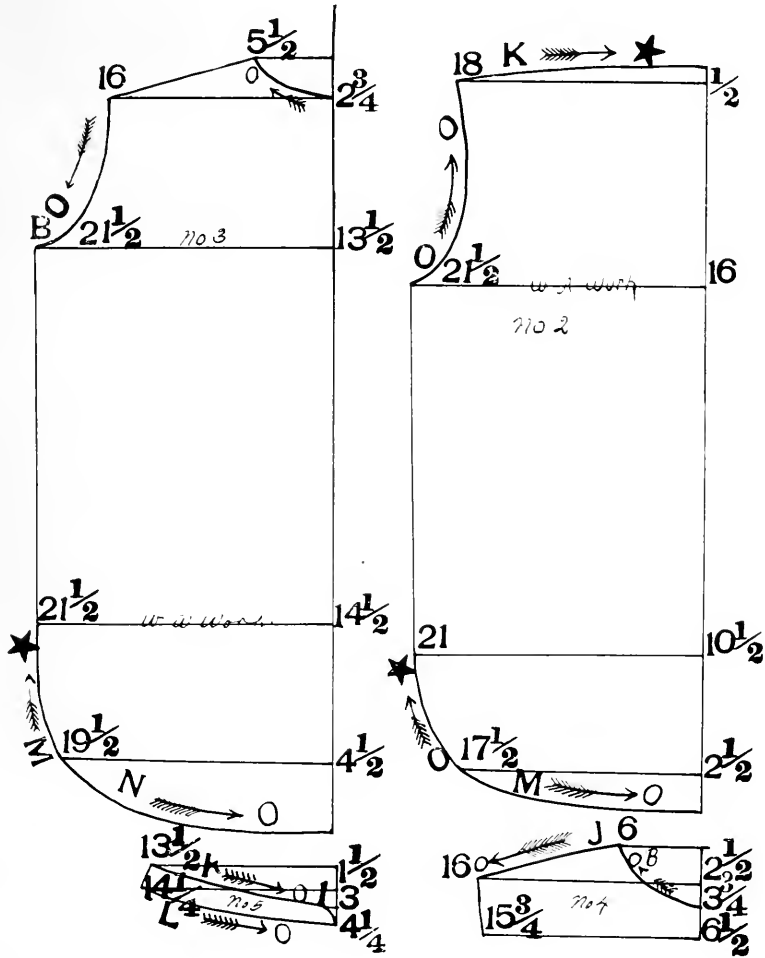

No. 143

GENTS' SHIRT

No. 2 is back; 3, front; 4, yoke; 5, collar band.

Use scale corresponding with chest measure.

If in doubt as to length, back can be made at 56 with scale; front, 54. The better way is to locate length with tape, back from $\frac{1}{2}$; front, $2\frac{3}{4}$.

For sleeve, use diagram No. 7.

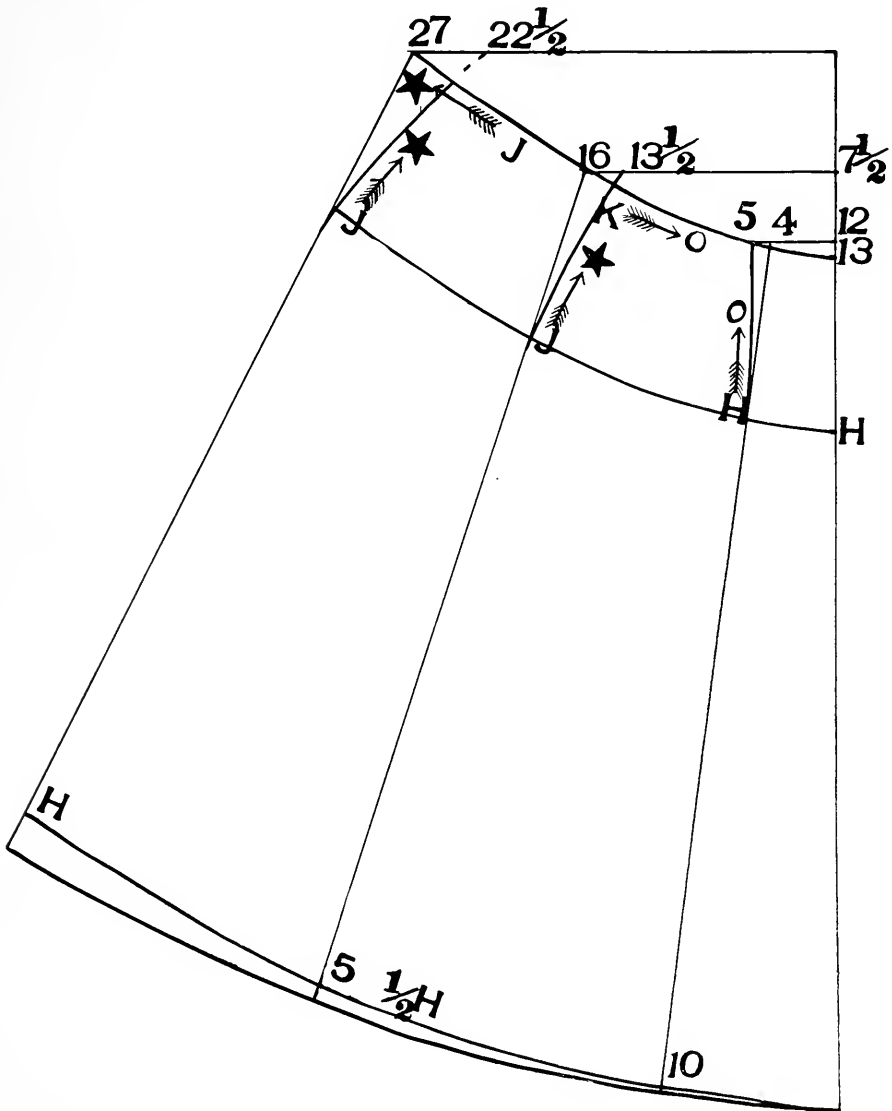

No. 135

LADIES' FIVE GORE SKIRT

Use scale corresponding with hip measure.

Draft same as for all skirts.

This diagram gives the newest shape in five gore skirts.

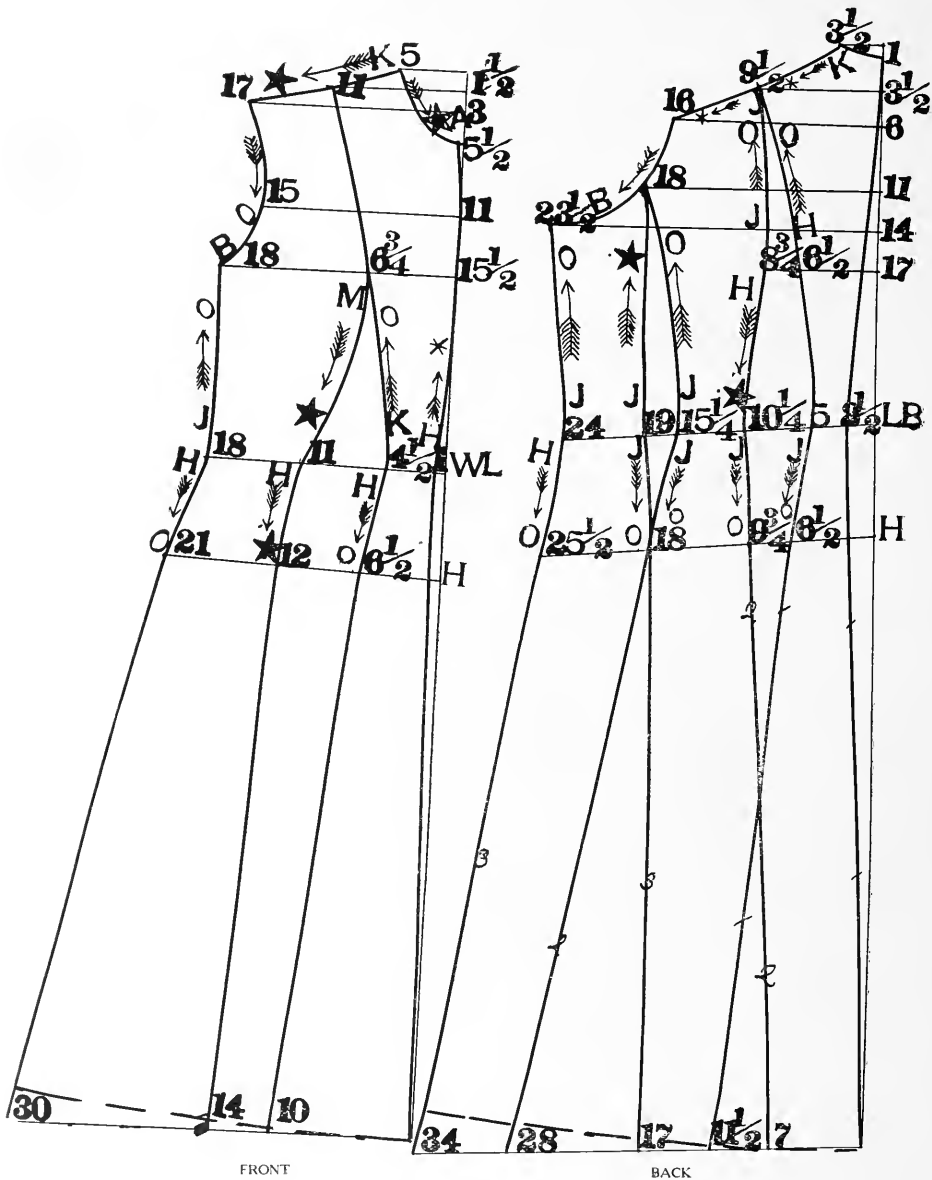

No. 129

LADIES' PRINCESS SLIP

Use scale corresponding with bust measure.

Locate waist line from point 5½. Hip line is 6 inches below WL. Get length of skirt front from WL. Cut through from 11 on shoulder to 10 on bottom of skirt, and from 6¾ to 14 also on bottom of skirt.

No. 130

LADIES' PRINCESS SLIP

Use scale corresponding with bust measure.

Draft same as for fitted lining No. 80 and No. 81. Get length of skirt from LB. Hip is 6 inches below LB. Back and under arm laps over side back. To separate, first cut on lines marked 1, then cut on lines 3, then paste on side back lines 2, which was cut off in cutting off back and under arm.





Work's Ladies' Tailor System

We are anxious to secure the services of ladies everywhere, to sell **Work's Ladies' Tailor System**, and wish to direct your attention to a few facts in regard to same. It is the most complete system, for cutting and fitting ladies' garments, now in use. It is the only system in use, that drafts according to mechanical drawings and publishes new diagrams, or drawings, when the fashion changes, giving the new shapes in every detail. There is no other system doing this valuable work, which is absolutely necessary. Fashions are continually changing, new shapes are worn. Unless a system gives the new shapes, when the styles change, you cannot cut them by that system.

We respectfully invite you to investigate. If it is true that shapes of garments are always changing with the different fashion of each season, and if it is true that you cannot draft them unless your system gives some idea of the new shapes, then **Work's Ladies' Tailor System** is, by all means, the system you should use. Everyone is aware that styles and fashions change. If you will consult any skilled mechanic, he will tell you, if you are called on to construct anything that has changed in shape, that you will have to secure a drawing giving the new shape desired, with complete specifications, as there is no other way. It is a fact, that every lady who sews should have a guide, that will enable her to construct the garment by measurement--there is no such thing as fitting correctly by eye guess or block pattern. It is becoming more generally recognized every day, that fitting is dressmaking; that the fit is the most important thing about a dress. Therefore, it is generally understood by those who sew, that they should have a good system.

In vicinities, where this fact is known, our agents have been able to teach every lady in their community this system. Ladies are clearing \$100.00 per month, selling **Work's Ladies' Tailor System**, one of the most useful articles that is on the market to-day. Write for terms and full information. We also furnish system to dressmakers. Give your apprentice **Work's Ladies' Tailor System**, and she will become a good fitter, and a good fitter makes a successful dressmaker. If she is a poor fitter, she is destined to be an unsuccessful dressmaker--it makes no difference how well she sews.

Write for terms to-day. Address all communications to

W. A. WORK, PROP'R
22 NORTH FOURTH STREET HARRISBURG, PA.

LIBRARY OF CONGRESS



0 013 964 959 A ●