

A MANUAL
OF
YACHT AND BOAT SAILING.

NEW AND ENLARGED EDITION.

BY
DIXON KEMP,
AUTHOR OF "YACHT DESIGNING."



LONDON:
"THE FIELD" OFFICE, 346, STRAND, W.C.

1880.

231. h. 23.

LONDON :
PRINTED BY HORACE COX, 346, STRAND, W.C.

PREFACE TO THE SECOND EDITION.

THE favourable reception accorded to the First Edition of "Yacht and Boat Sailing," was extremely gratifying, and is sufficient evidence that the information it contained was of a useful and practical character. I received many kind expressions of approval from yachtsmen and boat sailers, and many useful hints. Some of the suggestions have been acted upon in the present edition, with, I trust, a serviceable result.

In the opening chapters of the First Edition an endeavour was made to elucidate, in as simple a manner as possible, the natural laws which govern floating bodies; these chapters have been amplified, and some practical rules have been added for determining with certainty suitable relative proportions of length, breadth, and depth for yachts of all sizes. No attempt has, however, been made to unnecessarily introduce subjects which properly appertain to naval architecture and not to yacht sailing; only those elementary principles which influence the general behaviour of vessels when under sail have been dealt with, and it will always be an advantage to yachtsmen to be thoroughly acquainted with these. Indeed, I have found that a desire is general among yacht owners to acquire a knowledge of these principles; but the desire has seldom been gratified on account of the great mental effort the acquisition of such knowledge demanded. I have attempted to overcome this difficulty, and to explain the application of the principles referred to in a manner which will prove readily comprehensible.

Many new branches of yachting and boating have been introduced into the work. The designs of two well-known 5-tonners—Freda and Lorelei—are, by the kindness of their original owners, for the first time made public, and the designs of many other yachts and boats, not hitherto published, have been added to the list of plates. The old matter relating to boats has undergone amplification and, where necessary, revision; so that the instruction on every subject is in accord with the latest and most approved practice.

The most important additions introduced are the subjects of canoe designing and canoe sailing. The articles on these subjects were kindly written for me by Mr. W. Baden-Powell, Mr. E. B. Tredwen, and Mr. C. G. Y. King.

During the last decade canoe sailing has become a popular pastime, and no work on boat sailing would be now complete if it did not contain instructions in this new branch of the art of boat sailing. This art has been carried to a very high state of perfection by Mr. Baden-Powell, Mr. Tredwen, and others; and their minute elaboration of the details of canoe fitting and canoe handling surpasses anything hitherto attempted on other kinds of sail-boats. The only danger is that such precise and skilled experts as Mr. Baden-Powell and Mr. Tredwen will, so far as racing is concerned, render canoe sailing too difficult an art for the majority of men who are fond of handling small boats; but, apart from canoe racing, there is no doubt that they have perfected a form of sailing which is highly diverting, and which anyone could practice with precision after a very little experience.

So far as canoe racing goes, its present tendency appears to be towards making canoes practically uncapsizable or yacht like, and before another decade has passed it is probable that a kind of miniature or model yacht will take the place of the racing canoe. However, the canoe proper—flat floored and easy of transport—will always be retained for lake and river travelling.

DIXON KEMP.

104, PALACE GARDENS TERRACE,
KENSINGTON, LONDON, W.,
March 1, 1880.

PREFACE TO THE FIRST EDITION.

IN LAUNCHING the "Manual of Yacht and Boat Sailing," I desire to acknowledge the valuable aid which I received during its compilation. Mr. J. Beavor Webb compiled the tables for rigging and blocks, and gave me the lines of the Itchen Boats; Mr. G. L. Watson, of Sauchiehall-street, Glasgow, made the drawings of Clyde Sailing Boats, and wrote the chapter thereon; Mr. C. P. Clayton gave me the lines of the New Brighton Sailing Boats, and much information concerning their outfit and management; and he, too, with Mr. W. B. Forwood, gave me the instruction I required concerning Windermere Yachts; Mr. W. Baden Powell gave me the drawing and particulars of the Gunter Sprit Rig introduced by him; Mr. T. Stow, yacht builder, of Shoreham, gave me the lines of the Brighton Beach Boat; and Mr. J. R. Wills, of Penzance, the design of the Penzance Lugger. Some of the information on other subjects I obtained from correspondents of THE FIELD, and I believe the source is in each case acknowledged in the text.

DIXON KEMP.

CONTENTS.

| | | |
|---|-------------|-----|
| PREFACE | <i>page</i> | iii |
| INTRODUCTION | | 1 |
| CHAPTER I. | | |
| Displacement and Buoyancy—Stability | | 3 |
| CHAPTER II. | | |
| Centre of Lateral Resistance | | 14 |
| CHAPTER III. | | |
| Effort of the Wind on Sails—Centre of Effort..... | | 19 |
| CHAPTER IV. | | |
| The Action of the Rudder and Steering Efficiency | | 29 |
| CHAPTER V. | | |
| Sail-carrying Power and Speed | | 41 |
| CHAPTER VI. | | |
| Resistance and Speed, and the Influence of Thames Measurement ... | | 48 |
| CHAPTER VII. | | |
| Ballast..... | | 62 |
| CHAPTER VIII. | | |
| Spars | | 68 |
| CHAPTER IX. | | |
| Selecting a Yacht | | 77 |
| CHAPTER X. | | |
| Examination of the Yacht | | 88 |
| CHAPTER XI. | | |
| Building a Yacht | | 96 |

| | | |
|--|----------------|----------|
| | CHAPTER XII. | |
| The Equipment of the Yacht | | page 114 |
| | CHAPTER XIII. | |
| Seamanship | | 145 |
| | CHAPTER XIV. | |
| The General Management of a Yacht | | 194 |
| | CHAPTER XV. | |
| Yacht Racing | | 205 |
| | CHAPTER XVI. | |
| Centre-board Boats | | 243 |
| | CHAPTER XVII. | |
| Brighton Beach Boats | | 299 |
| | CHAPTER XVIII. | |
| Centre-board Sloops | | 303 |
| | CHAPTER XIX. | |
| Una Boats | | 308 |
| | CHAPTER XX. | |
| New Brighton Sailing Boats | | 314 |
| | CHAPTER XXI. | |
| Lake Windermere Yachts | | 327 |
| | CHAPTER XXII. | |
| Itchen Boats | | 336 |
| | CHAPTER XXIII. | |
| Clyde Sailing Boats | | 347 |
| | CHAPTER XXIV. | |
| Yachts of Five and Ten Tons | | 358 |
| | CHAPTER XXV. | |
| Lough Erne Yachts | | 367 |
| | CHAPTER XXVI. | |
| Boats of the Irish Model Yacht Club..... | | 369 |
| | CHAPTER XXVII. | |
| Penzance Luggers, Galway Hooker and Pookhaun, Norwegian Pilot Boat, Coble, &c. | | 372 |

Contents.

ix

| | | |
|---|-----------------|----------|
| | CHAPTER XXVIII. | |
| The Jullanar | | page 386 |
| | CHAPTER XXIX. | |
| Double Boats | | 394 |
| | CHAPTER XXX. | |
| Ice Yachting | | 398 |
| | CHAPTER XXXI. | |
| Canoes..... | | 407 |
| | APPENDIX. | |
| Dictionary of General Information | | 487 |
| | APPENDIX II. | |
| Steering and Sailing Rules | | 580 |
| <hr/> | | |
| Index | | 582 |

ERRATA.

Page 16, fourth line from bottom, for " B " read " A."

Page 75, in third paragraph, add " Diameter at hounds 0·8 of diameter at deck."

Page 121, " Table for sizes of cordage." The jib halyards are chain. The sizes for topsail halyards are the same as for fore-halyards; and for upper topsail halyards (or, as they are more frequently called, " trip halyards ") the same as the size for jib topsail halyards.

Page 254, top line, for " Plate IV." read " Fig. 65."

LIST OF PLATES.

| | TO FACE PAGE |
|---|--------------|
| I. SPAR, RIGGING, AND SAIL PLAN | 114 |
| II. DOUBLE CENTRE BOARDS | 247 |
| III. BOAT FOR ROWING AND SAILING | 255 |
| IV. BOATS OF 10FT., 12FT., 14FT., 15FT., AND 20FT., DITTO ... | 261 |
| V. SAIL PLAN FOR 17FT. BOAT | 275 |
| VI. SAIL PLAN OF "LE LISON" FRENCH CENTRE-BOARD YACHT | 276 |
| VII. SAIL PLAN CHINESE LUG SAIL | 281 |
| VIII. CENTRE-BOARD YACHT "CHARM" | 285 |
| IX. GUNTER SPRIT RIG | 291 |
| X. BRIGHTON BEACH BOAT | 299 |
| XI. "ALEET," CENTRE-BOARD YACHT | 307 |
| XII. UNA BOATS | 312 |
| XIII. "ELAINE," NEW BRIGHTON BOAT | 316 |
| XIV. SAIL PLAN OF "ELAINE" | 320 |
| XV. "JABBERWOCK," NEW BRIGHTON BOAT | 322 |
| XVI. WINDEEMERE YACHTS | 332 |
| XVII. WINDERMERE YACHTS | 332 |
| XVIII. WINDERMERE YACHTS, SAIL PLAN | 333 |
| XIX. ITCHEN BOAT, 30FT. AND 27FT. | 341 |
| XX. ITCHEN BOAT "WILD ROSE" | 342 |
| XXI. ITCHEN BOAT "CENTIPEDE," 22FT. 8IN. AND 21FT. | 343 |
| XXII. ITCHEN BOAT, SAIL PLAN | 344 |
| XXIII. ITCHEN PUNT | 346 |
| XXIV. CLYDE BOAT PLAN | 350 |
| XXV. CLYDE SAIL BOAT, GENERAL PLAN | 355 |
| XXVI. DESIGN FOR YACHTS OF 10 TONS AND 5 TONS | 361 |
| XXVII. "LORELEI," 5 TONS YACHT | 362 |

| | TO FACE PAGE |
|--|--------------|
| XXVIII. "FREDA," 5 TONS YACHT | 362 |
| XXIX. "WITCH," LOUGH EENE YACHT | 368 |
| XXX. "HEATHEN CHINEE," IRISH MODEL YACHT CLUB BOAT ... | 371 |
| XXXI. PENZANCE LUGGER..... | 375 |
| XXXII. GALWAY HOOKER | 380 |
| XXXIII. GALWAY POOKHAUN | 380 |
| XXXIV. SHIP'S BOATS..... | 381 |
| XXXV. "JULLANAE" | 393 |
| XXXVI. DOUBLE BOATS | 395 |
| XXXVII. "NAUTILUS" CANOE..... | 414 |
| XXXVIII. "NAUTILUS" RACING CANOE .. | 426 |
| XXXIX. "NAUTILUS" CRUISING CANOE | 428 |
| XL. "NAUTILUS" CANOE SAIL PLAN..... | 440 |
| XLI. "NAUTILUS" CRUISING CANOE SAIL PLAN | 446 |
| XLII. "NAUTILUS" CRUISING CANOE SPAR AND RIGGING PLAN | 447 |
| XLIII. "PEARL" CANOE | 450 |
| XLIV. "PEARL" CANOE | 451 |
| XLV. "WREN" CLYDE CANOE | 471 |
| XLVI. CLYDE CANOE SAILS | 474 |
| XLVII. MERSEY CANOE | 483 |
| XLVIII. ICE BOAT OF SEA OF AZOFF | 534 |

YACHT AND BOAT SAILING.

INTRODUCTION.

THE ART OF YACHT AND BOAT SAILING cannot be acquired by the mere study of books which treat of the subject, but precise instruction will always be of value to those who have had no experience in youth of the sport, or who have no opportunities of taking advantage of practical coaching. Yacht sailing, like many other arts, is governed by certain scientific principles, easily determinable in theory, although hidden in practice. Experience has taught every sailing master that, if a vessel carries too much weather helm, an addition to head-sail or reduction of after-sail will ameliorate it; and he equally knows that, if a vessel is deficient in stiffness, the application of a lead keel will make her stiffer; but if he were told to *shorten* the arm of the couple upon which acted the force that was turning the vessel's head towards the wind, or to *lengthen* the arm of the couple upon which the statical stability of the vessel depended, he probably would not know what was meant. It may be argued that, if a man knows what to do to correct certain objectionable conditions, it does not matter whether he can account scientifically for the cause and effect, or for the evil and the cure. But it is obvious that a man, although expert in the practice of his art so long as everything worked smoothly, would be liable to meet with a check if any adverse condition refused to yield to remedies within his experience; whereas, if he had a knowledge of the underlying principles of his art, the remedy would be suggested because the cause of the evil would be known. However, the object in view is not to instruct sailing masters in the scientific principles which govern their art, but to give such instruction and knowledge of the practice of that art as may be of service to the purely uninitiated. This knowledge can be most readily imparted if a clear understanding

is first arrived at of the principles and properties which, according to scientific research, govern the performances of sailing vessels. With this purpose in view, will be given, in as succinct form as may be compatible with clearness, a statement of those principles and properties before the general subject of the management of a vessel when under sail is entered upon. The exact application of principles or the determination of properties referred to would be beyond the scope of this work, and can be acquired from some modern work on naval architecture, such as "Yacht Designing."

CHAPTER I.

DISPLACEMENT AND BUOYANCY—STABILITY.

DISPLACEMENT AND BUOYANCY.

THE displacement of a vessel is the quantity or bulk of water (generally represented by a measure of weight) which a vessel displaces or pushes away when she is put into the water. This quantity of water is always equal to the whole weight of the vessel and everything that she contains; that is to say, the vessel will sink into the water until she has displaced a quantity of the fluid equal to her own weight and the weight of everything that she contains.

If the weight of water displaced is also exactly equal in *bulk* to the *bulk* of the vessel, then the latter will sink in the fluid until her entire bulk is immersed; or, in other words, if the body immersed be a solid of the specific gravity of the water, then will the solid sink into the fluid until it is entirely immersed. For example, a cubic foot of African oak weighs 62lb., a cubic foot of fresh water weighs 62½lb., and consequently, if a cubic foot of African oak were placed in fresh water, it would nearly sink to the level of the surface; but a cubic foot of *sea water* weighs 64lb., and consequently, if a cubic foot of African oak were placed into sea water, it would sink until 62lb. of the fluid were displaced (which would be less than a cubic foot), and would sink no deeper, so practically 2lb. of the oak cube would remain above the surface.

This well illustrates the meaning of the term "a vessel's displacement." A vessel weighs, we will say, with all her ballast, spars, sails, gear, stores, crew, and everything belonging to her on board, one ton; then, if she is put into the water, she will *displace* exactly one ton of the fluid. Now a ton of sea water in bulk contains 35 cubic feet; consequently, if the *bulk* of the vessel only equalled 35 cubic feet, she would sink into the water until entirely immersed. But a vessel that weighed one ton would contain in *bulk* a great deal more than 35 cubic feet, measuring her actual body on the outside from keel to deck as if she were a solid; that is, the whole body or bulk of the vessel so measured would probably equal 50

cubic feet. The result would be that the vessel would sink into the water until 35 cubic feet of the hull became immersed, and sink no further; this would leave 15 cubic feet above water.

The buoyancy of a vessel may be taken as a force equal to the weight of water it displaces; or, in other words, any given weight of fluid will support a similar solid weight of equal bulk. The quantity, or bulk, of a fluid which a vessel will displace depends upon the density of that fluid, as previously explained. Thus sea water is denser, or more buoyant, than fresh water; and, consequently, a cubic foot of sea water will support a greater weight in the same bulk than a like quantity of fresh water. Mercury is a fluid so dense that even iron will float in it with only a little more than half its bulk immersed, for the reason that a cubic foot of mercury weighs 849lb., whereas a similar bulk of iron only weighs 480lb.

Thus the displacement of a vessel is always equal to her own weight, including *everything* and *everybody* on board; and providing that the bulk or size of the body of water displaced is smaller than the bulk or size of the vessel (regarding her from deck to keel), then a portion of the vessel will always be above the surface of the water, and this portion of a vessel is called her freeboard, and sometimes "surplus buoyancy."

The truth of the foregoing can be demonstrated by a simple experiment. Take a large basin, such as A (Fig. 1), and fill it carefully to the

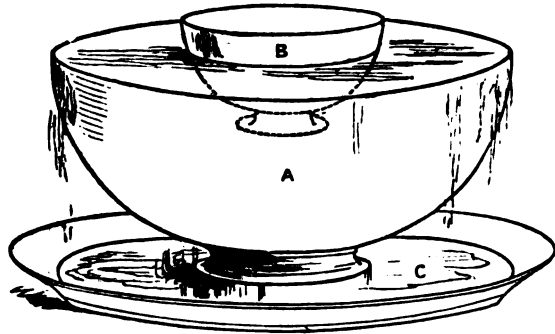


FIG. 1.

brim with water, and stand it in the saucer, C. Then take a smaller basin B, and put it into the water, which of course will overflow into the saucer. If the water that so overflows and the small basin be afterwards put into a scale and separately weighed, they will be found to be exactly equal; and, further, if shot or other substance be put into the small basin B whilst it is floating, still more water will overflow, and if the whole of the water which so overflows be weighed, and the small basin and its contents be weighed, their respective weights will be proved equal.

This experiment can be utilised to arrive at the displacement of the ship from that of the model. Thus say a model of the Kriemhilda is made to half an inch scale (or one twenty-fourth of her real dimensions), and put into a trough filled with salt water to the aperture of a waste pipe; then as the model became immersed, the water would escape by the waste pipe into some vessel, say a large bucket. The escaped water in this particular case would weigh 18·65lb. Now the displacement of the ship to that of the model is simply as the cube of the difference in the dimensions; or say the scale for the ship is twelve times greater than that for the model; then the displacement or weight of the model multiplied by the cube of 12 ($12^3=1728$) would give the displacement of the ship. In the case given above, the scale for the real yacht was to be twenty-four times greater than that of the model, the weight of which was 18·65lb.; the cube of 24 is 13,824, and 18·65lb. multiplied by 13,824 is equal to 257,817lb. There are 2240lb. to one ton; then 257,817 divided by 2240 gives a quotient of 115·59 tons, the exact displacement of Kriemhilda. If the model is made to other scales the displacement can be found by a similar process.

| Scale to 1ft. INCH. | Proportion to real ship. | Cube of proportion by which the weight of displacement of the model is multiplied. |
|------------------------|-----------------------------|--|
| 1 | 12 | 1728 |
| $\frac{1}{2}$ | 16 | 4096 |
| $\frac{1}{3}$ | 19·2 | 7077·8 |
| $\frac{1}{4}$ | 24 | 13824 |
| $\frac{1}{5}$ | 32 | 32768 |
| $\frac{1}{6}$ | 48 | 110592 |
| $\frac{1}{8}$ | 96 | 884736 |

CENTRE OF BUOYANCY.

The centre of buoyancy of a vessel is the centre of the cavity or hole made in the water by the part of the vessel which is immersed; hence it is frequently termed the centre of gravity of the displacement. In speaking of the centre of buoyancy of a vessel, such as a yacht or a ship of any kind,

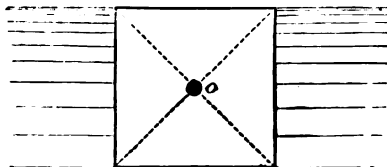


FIG. 2.

only that portion which is immersed is necessarily considered, so that in fact the vessel is treated as if she were cut down to the surface of the water. The centre of buoyancy of an immersed solid of similar sides, Fig. 2, or of an immersed sphere, would necessarily be in the centre of the

block at o —that is, would be equidistant from both sides and ends, and from top and bottom.

But a yacht is not shaped like a rectangular block, nor like a sphere, and, owing to a yacht's irregular form, the centre of buoyancy is seldom at the mid-length of the hull, nor at its mid-depth; but, inasmuch as both sides of a yacht are, or ought to be, alike, the centre of buoyancy is always in the mid fore-and-aft line.

STABILITY.

It has been said that the weight of water which a yacht or vessel of any kind displaces is equal to her own weight, and consequently the pressure of the water on the immersed vessel is equal to her own weight. This pressure is diffused all over the immersed part of the hull, and the pressure of any individual particle of water on the hull is in a direction at right angles to the point of contact. The concentrated pressure, or the resultant of the pressure, on the immersed portion of the hull, acts *vertically* through the centre of buoyancy; and, as before said, this pressure is equal to the weight of the ship. Thus there are two equal forces acting in opposition to each other, and balancing each other—the weight of the displaced water pushing upwards through the centre of buoyancy, and the weight of the ship pushing downwards through its centre of gravity; and these two forces never act in any other than a *vertical* direction.

The centre of gravity of a yacht or ship is a determinable point, where the action of all her weights is concentrated; therefore it is sometimes called, in relation to ships, the "centre of gravity of the whole mass." The "whole mass" includes the hull, ballast, spars, sails, fittings, crew, stores, and everything which the ship or yacht contains that is of any weight at all. If on a plank A (Fig. 3) a number of weights, $a a a a$, &c.

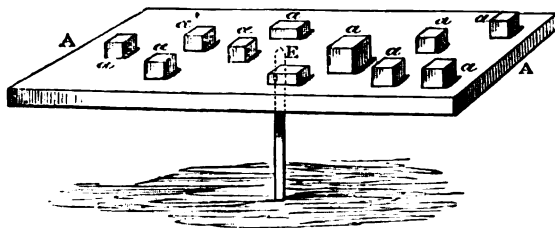


FIG. 3.

be placed at any irregular or equal intervals, and the plank be made to balance on a pointed stake at E, then E will be the common centre of gravity of the plank and all the weights placed upon it. Thus the exact position of the centre of gravity of a ship depends upon the disposition of

her weights—no matter whether these weights be timbers, keel, plank, ballast, spars, rigging, sails, crew, stores, or anything else that is of weight—and it follows in a ship that, if the weights are placed further forward, the centre of gravity will be shifted forward, and the contrary if the weights be shifted further aft. In a like manner, if the weight of the masts, sails, or gear be increased, the centre of gravity, with regard to its vertical position, will be brought higher; on the other hand, if the ballast be increased in weight, or if it be stowed deeper down in the hull, the centre of gravity, with regard to its vertical position, will be carried lower.

Thus we have two distinct, but balanced, forces—the weight of the water the ship displaces acting upwards through the centre of buoyancy, k (Fig. 4), and the weight of the ship acting downwards through its centre of gravity, o .

A necessary condition for the ship to be in equilibrium is that the resultant of the two forces, represented by the weight of the ship acting through o , and the weight of the water she displaces, acting through k , should have effect in the *same vertical line*. (See $a a$, Fig. 4.)

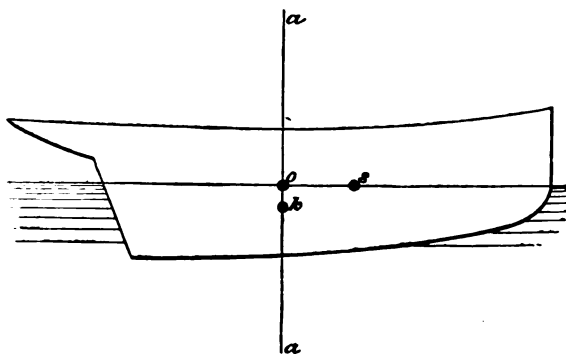


FIG. 4.

If the direction of action of either be shifted, a struggle will instantly commence to regain a position where they will balance each other again, or act in the same vertical line. For instance, let a portion of a yacht's ballast or other weight be shifted forward until her centre of gravity is shifted from o to s , Fig. 4, then the yacht will sink down by the head until the two forces are directly over each other again, as $s k^1$, in the vertical line $b b$, Fig. 5 (p. 8).

Now if the *centre of buoyancy* had been carried to k^1 by the vessel being hove down by the head otherwise than by having a portion of her ballast or weight moved forward, such, for instance, as by a pressure of wind on her sails, she would regain the position depicted in Fig. 4 the

instant the force or pressure which had hove her down was removed. This force that brings a vessel back to her original condition of equilibrium is called her righting power, or statical stability; and for the motion we have described would be termed her longitudinal statical stability. When a vessel is placed among waves, the centre of buoyancy is continuously carried forward or aft, as she is differently water-borne by the passing waves. A constant struggle is thereby maintained between the centre of gravity of the vessel and her centre of buoyancy to keep in the same vertical line $a a$, and an uneasy violent motion is acquired, whose force, to some extent, is dependent upon the urgency of the righting power. A vessel with her weights or ballast stowed low will have this righting power in a greater degree than one with her weights stowed high; and she will be relatively quick in "recovering herself." So also will be a vessel that is very full on the load water-line, and very much cut away under-

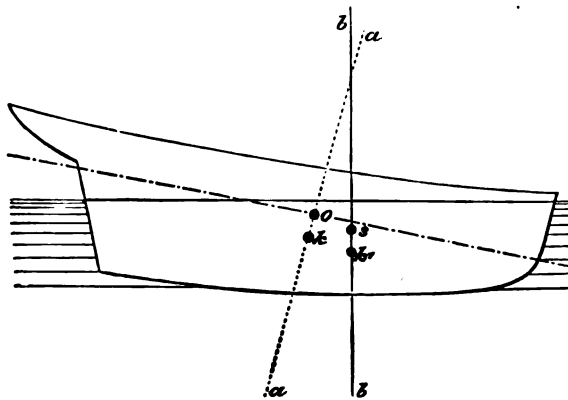


FIG. 5.

neath; whereas a vessel with what is known as a long body will be comparatively easy in her motions during similar wave disturbance. The pitching and scending motions of vessels form a very complex problem, and are by no means wholly dependent on the conditions just adverted to. For instance, the *momentum* acquired during pitching, whilst the bow is left unsupported by the water, or scending, whilst the stern is without support, may be much increased by the distribution of the weights or ballast in a fore-and-aft direction, as the radius of gyration would be thereby lengthened; but the influence on these motions, which any particular condition of a vessel may have, can only be determined in a general kind of way, and are not amenable to any precise calculation.

Hitherto reference has only been made to the longitudinal or fore-and-aft motions of a vessel, but as a yacht's righting power or statical

stability is generally spoken of in connection with her heeling or rolling, it will be best to illustrate it in connection with these transverse motions.

Fig. 6 is a representation of a transverse section of a vessel supposed to be heeled to, say 20° . E is her centre of buoyancy in her *upright* position, and F her centre of gravity. Upon being heeled or inclined, the centre of buoyancy, owing to the irregular shape of the vessel, shifts to some point, E^2 . As the centre of buoyancy has been shifted to E^2 , the resultant of the *water pressure* no longer acts through E, but through E^2 ; and it must be remembered that this resultant always acts vertically, or at

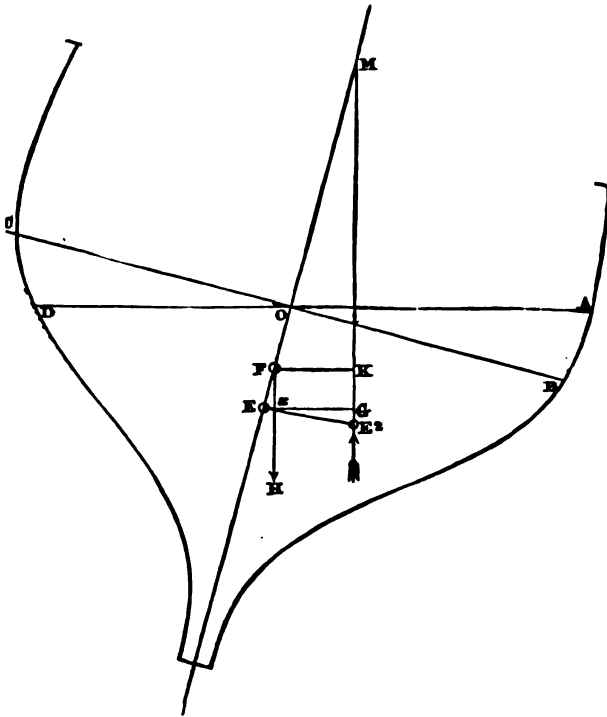


FIG. 6.

right angles to the water-level. The resultant of the force represented by the weight of the ship continues to act vertically downwards through her *centre of gravity* F, that being the point it would act through if the vessel had not been heeled; it is of course assumed that no part of the weight of the ship has been shifted, so as to cause her centre of gravity to shift.

Thus we have the weight of the ship acting downwards through the centre of gravity F, in a direction F H, and the weight of the water displaced acting upwards through the centre of buoyancy E^2 , in the

direction $E^2 M$; and the point M , where $E^2 M$ cuts what is the middle line of the upright position of the ship, is the meta-centre. The length of the righting couple is the horizontal distance between $F H$ and $E^2 M$, represented in Fig. 6 by $F K$ or $x G$.

The wedge-shaped piece of the hull $A B O$ is called the wedge of *immersion*; and the wedge-shape piece $O C D$ the wedge of *emersion*. By naval architects they are usually referred to as the "in" and the "out" wedges. By the wedge of immersion, or the part that is put into the water, being largely in excess of the wedge of emersion, or the part that is taken out, the centre of buoyancy is made to shift very rapidly over to leeward as the vessel is inclined, and so the couple $x G$ lengthens very fast. In all broad and shallow vessels the wedge of immersion, even at small inclination, is much in excess of that of emersion, and so they have considerable stability at small angles of heel—which may be conveniently referred to as initial stability—which stability, however, rapidly vanishes as the deck becomes immersed.

In saying that the wedge put into the water is *larger* than the one taken out, it must not be supposed that the displacement is increased in proportion to the excess. *The displacement always remains exactly the same as the weight of the vessel*; but if the volume of the wedge of immersion be in excess of the volume taken out, then the vessel shifts or rises bodily in the water, to an extent which is dependent upon the *area of the new load water-plane and the excess in the volume of immersion*.

The righting moment or power is computed by multiplying the weight of the ship, or displacement in tons, by the length of the righting couple $x G$ (Fig. 6). That is, if the weight of the ship or her displacement be 40 tons, and the length of the righting couple at 20° inclination be 2ft., then her righting power or *moment of stability* at that inclination will be $40 \times 2 = 80$ foot-tons. If the righting moment of a yacht at 20° inclination be equal to 80 foot-tons, as described, then it will require a steady force equal to 80 foot-tons upon her canvas to maintain her at that inclination.

If a vessel with such a section as that portrayed in Fig. 7 were filled out in the garboards at $O O$ just above the keel, it is plain that the centre of buoyancy (B) would be lowered, and the point M would be brought nearer the centre of gravity (G); therefore the arm of the righting lever $G Z$ would be shortened. But in the case of a yacht the added displacement about $O O$ would be utilised for the stowage of additional ballast; and by this means the centre of gravity (G) would be brought lower; so that it is quite possible that the original distance between G and Z would be maintained.

The effect of increasing the height of the centre of buoyancy relative

to the surface of the water can be illustrated in this way. Assume that the displacement, or rather the hull, is cut away at the garboards as shown at P P, and added to the hull near the load water-line as at R R, then the centre of buoyancy would be higher, and upon inclination of the vessel would shift out farther to leeward than shown by B', so that the distance G Z would be increased, always supposing that G was kept in its original position by shifting the weights lower, such as could be done by putting additional weight on the keel. If the centre of gravity could be brought to K, and, with the centre of buoyancy at B, the length of the righting lever would be K L. As a matter of fact, however, we know of but

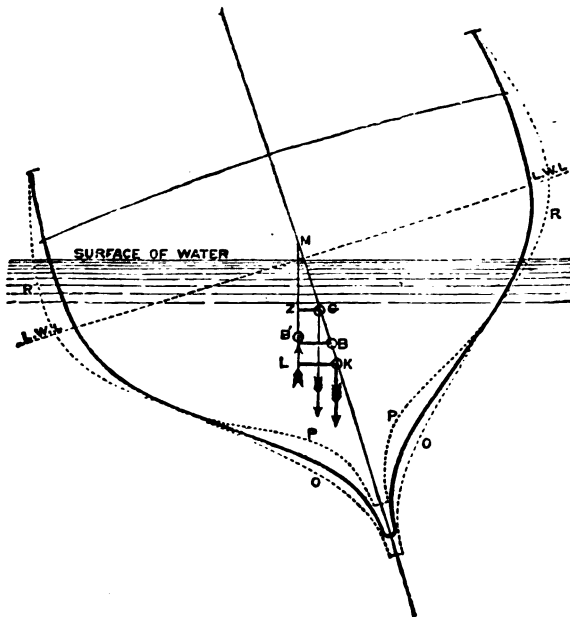


FIG. 7.

few instances where the centre of gravity has been found *below* the centre of buoyancy.

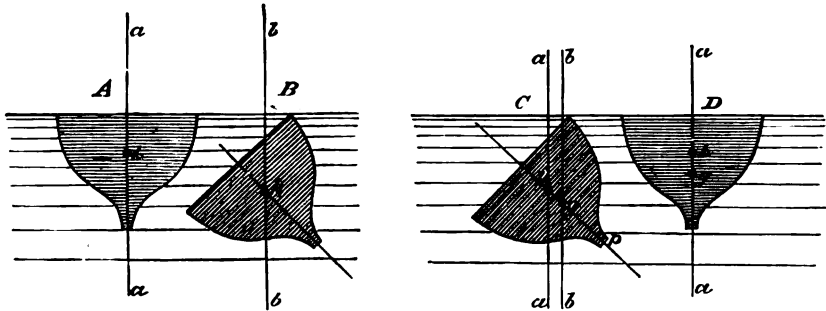
It is obvious that the *weight* of a vessel has largely to do with her stability; thus, if the length of righting lever at 20° inclination be 2ft., and the weight of the vessel, instead of being 40 tons (see page 10), is only 35 tons, then it is plain that the righting moment at 20° inclination will only be 70 foot-tons instead of 80 foot-tons. Therefore, in considering stability, the problem that exercises the naval architect in designing is how to attain a given maximum righting moment; that is, shall he increase the beam and diminish the displacement, and thereby lengthen out the righting couple represented by G Z (Fig. 7)? or shall

he contract the beam and add to the displacement at $O O$, and thereby largely add to the weight that will act on the couple? Of course, by adding to the beam and decreasing the displacement better lines for speed can generally be obtained; but, on the other hand, the longer and fuller bodied vessel will most likely be the better or more easy sea boat, and will have a greater range of stability.

It is quite a common thing to hear a person say that this, that, or the other vessel has "great artificial, but very little natural or structural stability," as if there were various kinds of stability. This confused way of regarding stability is very likely to prevent a clear understanding of the conditions on which stability depends, and it must be understood that there are no such things as "artificial stability" or "natural stability" or "structural stability" or "stability of form" as distinct qualities. In "Yacht Designing" in reference to stability we find the following:

There is no such thing as stability of form *per se*, although it is sometimes convenient to speak of form as if it had absolute stability *independent of the position of the centre of gravity of the vessel*. For instance, let it be conceived that a body of no weight be placed in a perfect fluid, then it would rest as well in one position as another, whatever its form; so that when stability of form is referred to it must always mean the influence that form has on stability in relation to the centre of gravity of the body and its metacentric height.

Or it may be assumed that a homogeneous substance is placed in a fluid, or that a portion of a fluid is turned into a solid, maintaining its inherent bulk, weight, and uniform specific gravity; then such a substance or solid would float in whatever position it were placed. Let A be such a

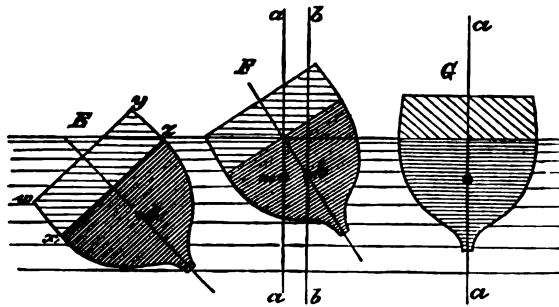


substance or solid; then its centre of buoyancy and centre of gravity must necessarily be at the same point, k ; and, as the resultant of these two forces acts in the vertical line $a a$, the body will be in equilibrium if placed in the position—which may be assumed as its natural one— A . But A will be in equilibrium in any other position; for instance, in that shown by B , as the two forces still act in the same vertical line through k , as

shown by $b b$. It is thus evident that such a substance or solid has no *stability* whatever.

Now the equilibrium can be made *stable* by shifting the point through which the centre of gravity acts. Assume that the specific gravity of the solid, B, is made unequal, so that it becomes denser or heavier about p (see C); it is apparent that on such a change the *centre of gravity* would be shifted to some point, g , and the forces would no longer be acting in the same vertical line. The resultant of the buoyant pressure of the water would act upwards in the line $a a$ through k ; and the resultant of the weight of the body would act downwards in the line $b b$ through g . The horizontal distance between the two lines $a a$ and $b b$ would be the *couple* upon which the two forces acted, until the solid got into the position D, where the two forces would act in the same vertical line, $a a$. The equilibrium of a solid such as D floating would be *stable*, if, upon being inclined from its original position until in the position C, it had the power to regain the position D.

It has been proved that "form" of itself has no stability, and it remains to be shown how the variableness of form in a *partially* immersed body can bring about a stable condition of equilibrium. Let it be assumed that the solid A has an addition made to it, as illustrated in E by $w x y z$. The *bulk* will be increased, but the *weight* is to remain exactly the same,



with the centre of gravity still at k . The body will rise in the water until in the position F, so that a part remains immersed equal in *bulk* to A. Owing to the altered *form* of the immersed part of the solid, the centre of buoyancy has shifted to some point m , but the centre of gravity remains at k . Now the resultant or buoyant pressure of the water in the line $a a$ no longer acts through k , but through m , whilst the weight of the solid still acts through its centre of gravity, k , in the line $b b$. It is quite plain that the solid could not remain in the position F, but would take the original position of A, as shown by G, with the forces of buoyancy and gravity acting in the same vertical line $a a$.

CHAPTER II.

CENTRE OF LATERAL RESISTANCE.

LATERAL resistance is the resistance the water offers to a vessel being moved sideways or laterally; this sideway or broadside motion when a vessel is underway is at right angles, or nearly at right angles, to her forward or direct motion, and is usually termed leeway; thus the resistance to leeway is properly described as "lateral resistance." The *centre of lateral resistance* is usually understood to mean the centre of the vertical longitudinal section of the immersed portion of the vessel, including the rudder. In other words, this immersed longitudinal section is assumed to be a plane; and if this plane be moved through the water in a direction at right angles to its own (the plane's) surface, then the resultant of the resistance it will meet with will act through its centre. For instance, let Fig. 8 be the immersed longitudinal section of a vessel with its centre at x . If a towing line were attached to the point x , the vessel or plane would be towed laterally or "broadside on" through the water, without exhibiting any tendency to turn one way or the other; in fact, the plane representing the longitudinal section of the vessel would keep

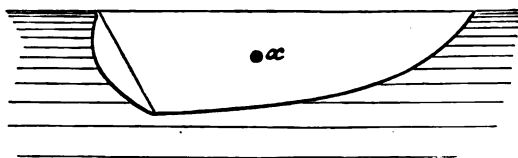


FIG. 8.

normal, or at right angles to the towing line. But if the towing line be attached farther aft, then on being towed the stern would come round towards the line; or if attached farther forward, the bow would turn round towards the line.*

* A simple experiment conducted as indicated with any model and piece of string will determine the centre of lateral resistance, disregarding its actual position, due to forward motion, and which motion would not be given to the model during the broadside towing. The centre can also be found by taking a piece of board shaped to represent the longitudinal

In calculating the centre of lateral resistance of a ship or yacht, it is always assumed that a plane has to be dealt with, and the immersed longitudinal section is taken as that plane. As a matter of fact, the centre of this plane would not be the centre through which the resultant pressure on the side of the ship would act. Owing to the varying form of a ship or yacht, it is almost impossible to determine by calculation the point through which the resultant of the *horizontal* pressure of the water actually acts; and, moreover, if the exact point could be readily determined, the knowledge of it would be of small practical value, for the reason that, owing to the forward motion of the vessel in a line with her keel, there is an excess of pressure on the bow and a constantly decreasing pressure towards the stern; the bow is continually entering "solid" water, whilst towards the stern the water becomes more and more disturbed; and beyond this there will be an accumulation of water rising on the lee bow which has the effect of altering the form of the immersed portion of the vessel, and this of itself carries the centre farther forward. And further, even supposing the centre of pressure could be accurately calculated for the upright position, it would be useless for any other position of the vessel, as a different portion of her hull would be immersed, or its position relative to the horizon altered, each time the vessel rolled or was heeled.

The use of knowing approximately the position of the centre of lateral resistance is that the "handiness" of a vessel can be regulated thereby; and for this use the centre of the plane described by the immersed longitudinal section of a vessel is, fortunately, a sufficiently determinate point, as will hereafter be shown.

It need scarcely be pointed out that a flat surface is more effective in resisting lee way than a convex one; hence a vessel with a large area of dead wood aft, a very sharp flat entrance, and a deep keel will make less lee way than one that has a less flat surface immersed, all other things being equal. It must always be remembered, however, that the upper part of the dead wood aft, owing to the disturbed water it passes through, meets with less pressure than does the dead wood forward, as the bow is always entering new or undisturbed water. Hence "drag," or a much greater draught aft than forward, has been found of great use in keeping the centre of lateral resistance in a required distance aft, as the lower parts of what may be termed a raking keel are continually being moved into solid or undisturbed water. This matter can be illustrated in this way:—

immersed section of the vessel, and suspending it with a plumb line attached to the point of suspension. Mark where the plumb line cuts the board, then suspend the board from another point, and mark where the plumb line intersects the other plumb line mark; the intersection will be the centre. The centre of buoyancy can be determined by a similar experiment; the model for such purpose must be made of clean stuff, and cut down exactly to the water's edge.

In the diagram (Fig. 9) let A be an immersed plane moving in the direction of the arrow s ; and let it be assumed that the plane has also a sideway or lateral motion, as indicated by t . Next, k and a are points or spots on the plane, and x and x^1 are particles of water. As the plane moves forward and glides past x and x^1 , the spots k and a will push them severally on one side, it being always remembered that the plane has sideway motion, and it is resistance to this sideway motion which we are considering. When any other indefinitely near spots on the plane, as b h , arrive abreast of x and x^1 , they find the latter receding, in consequence of the push they received from k and a ; the result is that b and h meet with less resistance to sideway or lateral motion than did k and a ; and so on for g and c , &c. It is thus evident that what is required for an effective surface of lateral resistance is not a number of spots in the horizontal direction, a b c and k h g , but a number in the vertical direction, k a . It

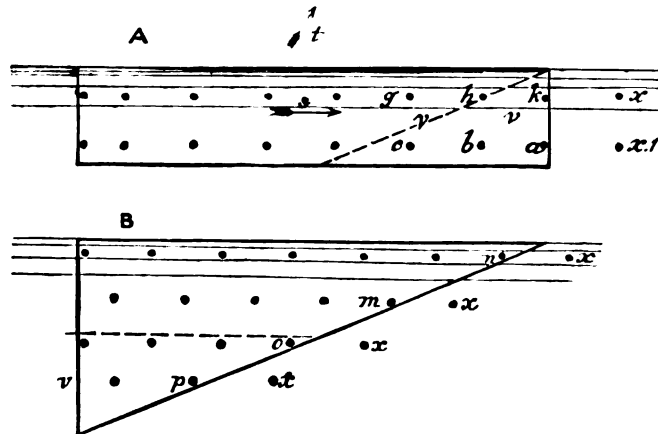


FIG. 9.

would be found inconvenient to so increase the depth at the fore end to obtain an effective surface, but fortunately it is found to be an advantage to have an increase in depth at the aft end. Assume a triangular piece v to be cut off the fore-end of the plane A, and to be placed underneath aft as shown by v in the diagram B; the area of the surface remains exactly the same, but a double number of spots as n m o and p are obtained that will enter solid water to meet particles of water as x x , &c., as the plane advances. It is quite patent that, although of equal surface, the plane B would more greatly resist lateral motion, if attended by a simultaneous forward motion, than would the plane A; and if the ends of the plane had been reversed so that the deep end came forward, similar results would accrue, but as there would then be such an accumulation of pressure about the anterior edge, it would be almost impossible to give a vessel with such

a form a satisfactory sail spread. With the sloping edge turned forward, a quantity of what may be termed perfect pressure, is graduated aft; this feature, coupled with the fact that the centre of gravity of the figure is relatively aft, instead of relatively forward, as it would be with the ends reversed, admits of a convenient and satisfactory arrangement of sail.

There is yet another strong argument in favour of a raking keel, which involves a question of speed. If the triangle v were taken away from A , the surface would be reduced one-fourth; and, consequently, the resistance to forward motion, dependent on surface friction, would be proportionately reduced. It might not be prudent to make this reduction of surface if the effectiveness of the lateral resistance were going to be thereby reduced; but the fact is that the effectiveness of the lateral resistance would be almost unimpaired; a comparatively useless piece of wood would be removed, and a positive gain would ensue in the matter of frictional resistance.

The necessity of keeping the centre of lateral resistance, relatively to the length of the vessel, far aft, and the fashion of much raking the sternpost, led builders to by degrees advantageously increase the rake of keel, and there have been some extraordinary examples of disproportionate draught of water fore and aft;* but at the present time, with perhaps a more intimate knowledge of the theory of lateral resistance, most designers prefer the "rockered" keel to the keel that simply rakes upward in a straight line from the sternpost, as with the "rocker" other important advantages can be secured. By having the greatest draught, or what might be termed the termination of the effective surface for lateral resistance, amidships, the after part or heel of the keel can be very much rounded up—somewhat in the fashion of the fore foot; and, as this is done the necessity for a great rake to the sternpost is removed, and the sternpost is fixed in a position nearly in accordance with the vertical. The effect is, that for the same tonnage—it is assumed that the sternpost on deck is kept at the same distance from the stem piece—a longer body can be obtained, and presumably a more capable, a larger, and faster vessel.† Beyond this, a deeper middle body is practicable, which is found to be of the utmost advantage, as it admits of the weights being stowed lower without being much distributed in a fore-and-aft direction.

* The *Jullanar* has a draught of 14ft. aft, and only 1ft. 2in. forward. (See her lines given further on; see also the lines of *Fiona* in "Yacht Designing.")

† As the Yacht Racing Association has recently altered length on deck for tonnage to length on load water-line, the reason for keeping the sternpost vertical to obtain the greatest length of body for any given tonnage no longer exists.

The effectiveness of triangular centre-boards is well known, and it is astonishing how small a piece of board will check lee way, providing the board is deep and not long. Nevertheless, one supposed disadvantage—especially in small boats—of a keel very much rockered, or of a triangular centre-plate instead of a keel, is that in very disturbed water a vessel's head, in beating to windward, gets "knocked off the wind;" but it is overlooked that if the bow is readily knocked off the wind the same facility exists for "coming-to" the wind during favourable puffs.

A vessel with a much rockered keel will probably steer wildly off the wind, and will require watching, and on any point of sailing she is likely to run off her helm. To meet these drawbacks, some eastern boats (such as those of Bombay) have cambered keels, *i.e.*, the reverse of rockered, as the back of the arch is turned upwards; and a few boats in America and in this country have been fitted with double boards. However, we think that the balance of advantages for close-hauled sailing are overwhelmingly in favour of the rockered keel for yachts or the centre-plate for small boats. If, as before said, the vessel is quick in falling off, she will be equally sensitive in coming to; and a careful helmsman will take his "rocker" farther up to windward than any similarly careful helmsman could a "straight keel," all other things being equal; and further, the helmsman will find the vessel with a rockered keel, when sailing by the wind, a much pleasanter one to steer; she will readily answer her weather helm for a foul puff, or spring to quickly under a little lee helm for a free one. It is undeniable, however, that in sailing very much off the wind the craft with "drag," or a large area of dead wood aft, will require much less helm than one whose heel is rounded up—that is, she will have less tendency to yaw.

CHAPTER III.

EFFORT OF THE WIND ON SAILS—CENTRE OF EFFORT.

EFFORT OF THE WIND.

THE effort of the wind at right angles to the surface of a sail will require more explanation than at first sight may appear to be necessary. In sailing before the wind very diminished speed is attained to what may be realised with the wind abeam, assuming, of course, the sail area to be the same; the reason is that the velocity of the wind, or its effective force, is diminished by exactly the speed of the yacht; or say the real wind is travelling at the rate of 14 miles an hour, and the yacht at the rate of 8 miles an hour, then the *apparent* wind, which is impelling the yacht, will only have the speed of 6 knots past her. The effect of the *apparent* wind on a yacht can be thus briefly explained: a yacht with 1000 square feet of immersed surface would meet with a gross resistance in the water of about 400lb. at a speed of 8 knots, and would have about 2000 square feet area of canvas. If the wind moved at a velocity of 14 knots, it would exert a pressure on a *fixed* sail of about 1lb. per square foot; but as the sail is not fixed, the pressure is diminished until it balances a resistance met with by the yacht in the water at a certain speed, say 8 knots. At this speed the resistance of the yacht would probably be increasing as the cube of the speed; and as the pressure on the sail would be diminishing as the square of the speed, it is quite evident that a limit to an increase of speed before the wind is very suddenly reached. Thus, say it were desired to increase the speed of the yacht to 10 knots, the resistance she would meet at that speed would be about 800lb., and as the wind pressure on the sail would be only that due to a velocity of 4 knots ($14 - 10 = 4$), the sail area would have to be increased to about 8000 square feet to maintain the 10-knot speed of the yacht. Beyond this we can imagine that the sail area could be increased until the yacht attained a velocity equal to the velocity of the wind, when no further increase of speed could be attained.

If a vessel were always sailing before the wind, or nearly so, no illus-

tration would be necessary to show how the impulse of the wind acts in other ways as a propelling power; but, as a vessel can be made to move ahead nearly "in the wind's eye," or, in other words, almost in direct opposition to the direction of the applied force, it is evident that a curious problem has to be solved in accounting for close-hauled sailing. In Fig. 10, D E is a vessel moving ahead in the direction of the arrow and the line D E. The letters F G represent the boom and projection of a sail. The arrow W marks the direction the wind is blowing towards the vessel, *i.e.*, four compass points, or 45° , from her course. The line F H shows the direction of the wind (which is the same as the arrow W)* relative to the plane of the sail, F G. The length of the line F H represents the *force* or strength of the impulse of the wind on the sail.

At the first view it would seem that the force of wind coming from such a direction as W upon a sail trimmed at such an angle as F G could

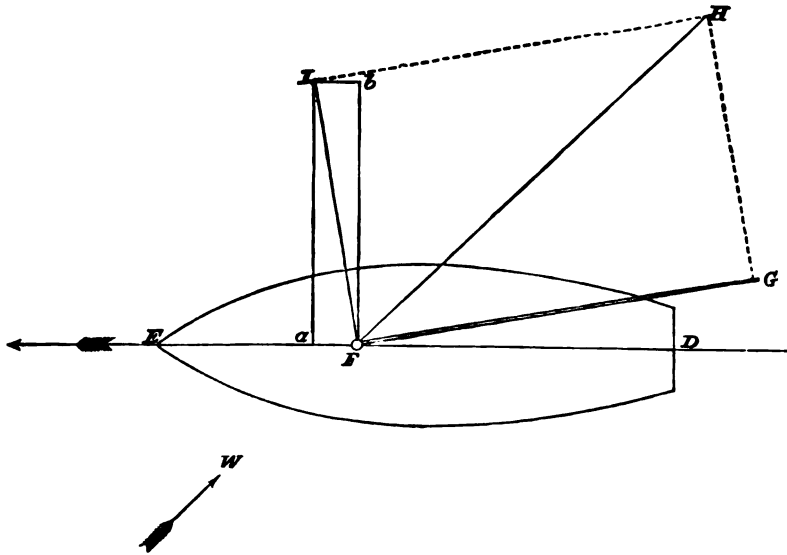


FIG. 10.

only drive the vessel astern in an oblique direction; but the force F H as it strikes the sail is decomposed or resolved into other forces, so that in reality the force is not exerted in the direction that it is apparently applied to the sail. The line F H will be regarded as the *diagonal* of a parallelogram or four-sided figure, such as F G H I. The wind F H by the construction of the figure is resolved into other forces—the first, F G, along the plane of the sail or direction of the boom, and has little or

* This is the *actual* direction of the wind; the *apparent* direction is indicated by the vane on the topmast and is the direction that should be taken for strict illustrations. (See "Yacht Designing," page 64.)

no effect; the other force is exerted at right angles to the plane of the sail, and in Fig. 10 is represented by the line $F I$.

The force $F I$ (which represents the whole horizontal exertion of the wind on the sail) is apparently employed in driving the vessel sideways, although at the same time a little ahead; but $F I$ (the force exerted on the sail) is decomposable into three other forces, two acting horizontally and one vertically, thus: let $F I$ be the diagonal of a parallelogram $F a I b$; then the line $F b$ represents the magnitude of the force that is driving the vessel to leeward in a direction at right angles to her keel; and the line $F a$ represents the magnitude of the force that is driving her ahead in the direction of her keel.

The third or *vertical* component of the pressure tends to add to the immersion of the vessel; but unless she were heeled to a very considerable angle this part of the pressure would have little effect, and in no case could serious or important consequences arise through the extra immersion due to the vertical pressure of the wind.

If a vessel resembled a true hemisphere, with no keel or dead wood of any kind, it is certain that she would, under the influence of a wind pressure, proceed to leeward in the direction $F b$ much faster than ahead in the direction $F a$; but a yacht is so formed that she offers very great resistance to lateral or sideway motion, and very little to headway. In similarly formed vessels, the difference between the resistance to lateral motion and to forward motion is generally taken as proportional to the area of the midship section and the area of the longitudinal section, it being always understood that only the immersed portions of these sections are referred to. This proportion roughly is as 10 to 1; but in reality it does not show the actual relative value of the lateral resistance and resistance to forward motion which depends upon the form of the vessel and her area of immersed surface. For speeds of 6 knots this relative value will be found by simply comparing the resistance due to surface friction and the resistance to broadside motion. Thus, say a vessel has 1000 square feet area of immersed surface, and a plane of 450 square feet area for lateral resistance; at six knots the frictional resistance on the immersed surface, consequent on forward motion will be equal (nearly) to $\frac{1}{2}$ lb. per square foot or 250 lb. in the aggregate. That is, the whole force required to move the vessel at a speed of six knots will be 250 lb., that being the total resistance at such a speed.

The resistance on the plane of 450 square feet (see Fig. 8, page 14), to *lateral* motion will not be one of "friction," but of direct pressure, and at a speed of six knots would be 112 lb. per square foot, or 50,400 lb. in the aggregate. But the vessel would not have this enormous lateral

motion, as the force that would drive the vessel ahead at the rate of six knots an hour would have very little influence in driving her sideways. In the diagram (Fig. 10) let $F a$ represent a force of 250lb. which overcomes the resistance to forward motion, and $F b$ a force which is three times 250lb. or 750lb. The force of 750lb. is exerted on a plane of 450 square feet area, which is equal to 1.66lb. to the square foot, and the resistance that would balance a force of 1.66lb. per square foot would be met with at a speed of 0.68 knot. Then, if the headway were six knots, and the leeway 0.68 knot, the "angle of leeway" would be 6° . We are not aware if anyone has actually tested the leeway a yacht will make when close-hauled under a wind pressure that will give her headway at the rate of six knots an hour; but it has been variously estimated from 3° to 11° , or from $\frac{1}{4}$ point to 1 point of the compass. We are inclined to think, so far as our observation goes, that a cutter yacht when sailing a course 4 points from the wind will, including leeway, make a course of about $4\frac{1}{4}$ points; it would, however, be impossible to ascertain this accurately, as the wind does not remain sufficiently constant in strength and direction even whilst a mile could be traversed.

CENTRE OF EFFORT AND PROPULSION.

If the wind always blew at right angles to the plane of a sail, the

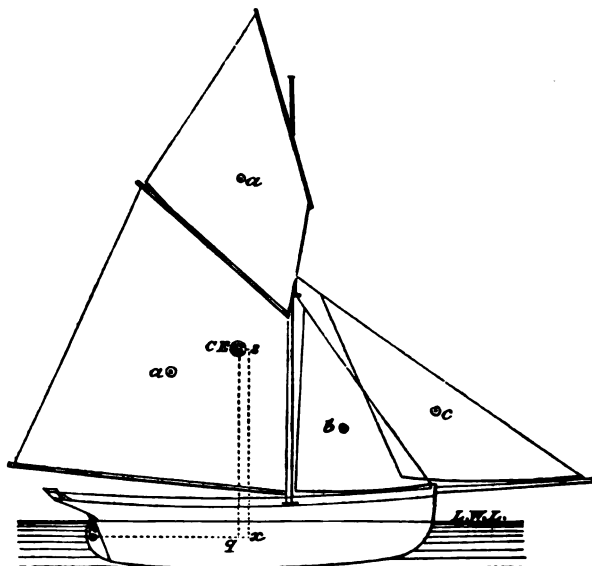


FIG. 11.

effort of that wind would be exerted through the centre of gravity of the sail plane; that is, if the whole effort of the wind were concentrated on

one point of the sail, that point would necessarily be the centre of the plane. This point is usually termed the "centre of effort" of a sail. If a vessel has many sails, such as a cutter yacht, Fig. 11, the total effort of the sails is exerted collectively through a point which represents the centre of gravity of the *whole* of the sails combined. In Fig. 11 the centre of effort of each sail is marked at *a b c d* (*d*, for the topsail, appearing in cut as *a*), and the common centre of gravity of the four sails lies at the point C E, and this point is termed the CENTRE OF EFFORT of the sails.

The most effective angle for the sails to make with the direction of the wind can be theoretically determined upon the assumption that the sails are real planes, and not such as they are, more or less concave surfaces. In "Yacht Designing" this problem is worked out in detail, together with the speed per hour a vessel of 150 tons ought to make upon different points of sailing, assuming the sail area and force of the wind to be constant, as follows:—

| Angle of yacht's course to direction of real wind in compass points. | Angle for sails of yacht with her keel. | Speed of the yacht per hour in knots. |
|--|---|---------------------------------------|
| 3½ | 9° 20' | 6.50 |
| 4 | 10° 15' | 7.30 |
| 4½ | 11° 30' | 8.00 |
| 5 | 12° 30' | 8.75 |
| 6 | 14° 40' | 10.00 |
| 8 | 19° 30' | 11.20 |
| 10 | 27° | 11.40 |
| 12 | 37° | 10.40 |
| 16* | 90° | 8.90 |

* Dead before the wind.

(It must be understood that the "sail angle" set forth in the table is purely theoretical, and in practice the sails will be trimmed according to the requirements of the vessel and the judgment of the sailing master.)

The "real wind" is the true direction of a wind, such as would be indicated by a vessel's vane if she were at anchor or motionless. When a vessel moves obliquely towards the wind, the direction of that wind, as shown by the vane, apparently alters or draws more ahead in the path of the vessel, or, in other words, the vane blows nearly fore and aft. This *apparent* wind is the force that had to be considered in solving the problem referred to above; but in speaking of the course a vessel makes with the wind the *real* direction of the wind is understood. In beating to windward this real direction can be readily determined by aid of the compass; thus, assuming a vessel on one tack heads N.W., and when put about that she heads N.E., then between N.W. and N.E. are eight compass points, and the vessel on either tack evidently had pointed four

points from the direction of the real wind, which was at N.; but the course, if judged from the vane or flag, would probably be set down as only three points from the wind. The vessel would be said to "turn in eight points" if there were only eight compass points in the arc she described in being put from one tack to the other.

From the table just given we learn that a yacht's speed increases as the angle of her course with the real wind increases, until she brings that wind a little abaft the beam (the vane would show the wind a little forward of the beam), and we have a difference of speed of nearly a knot an hour set down between the courses of $3\frac{1}{2}$ and 4 points. This seems a very important difference, and it will be well to inquire if by "squeezing" a vessel so close to the wind the loss of speed is compensated for. In beating to windward the proportion the real distance to be reached bears to the distance traversed is for $3\frac{1}{2}$ points as 1 is to 1.3; for 4 points, as 1 is to 1.414; for $4\frac{1}{2}$ points, as 1 is to 1.6; and for 5 points, as 1 is to 1.825. Thus, if a vessel had to beat twenty miles dead to windward, the distance sailed, according to the following courses (disregarding leeway) would be:

| | | |
|-----------------------------|--------------------------|--------|
| $3\frac{1}{2}$ points | $20 \times 1.3 = 26$ | miles. |
| 4 points | $20 \times 1.414 = 28.3$ | " |
| $4\frac{1}{2}$ points | $20 \times 1.6 = 32$ | " |
| 5 points | $20 \times 1.825 = 36.5$ | " |

There unquestionably could be a great gain here in economising distance, but the matter for consideration is this: would the gain in distance compensate for the loss in speed? As we know what the speed per hour is on different points of sailing, this question can be answered by a very simple calculation. Thus:

| | Hours. | Minutes. |
|---|--------|----------|
| $3\frac{1}{2}$ points from the wind | 4 | 0 |
| 4 " " " | 3 | 53 |
| $4\frac{1}{2}$ " " " | 4 | 0 |
| 5 " " " | 4 | 11 |

Thus, say, two cutters of 75 tons each, equal in every respect as to speed, stability, and spread and effectiveness of canvas, set out to beat 20 miles to windward, and one lay $3\frac{1}{2}$ points from the wind and the other $4\frac{1}{2}$ points, there would be no loss or gain; but if one of them lay 4 points from the wind she would gain 7 minutes, and if she lay 5 points from the wind she would lose 11 minutes. Thus for a cutter beating to windward a course of 4 points from the wind would appear to be the most advantageous.

It must not be supposed, if of two vessels of 75 tons each one is a schooner, and the latter makes a course of $4\frac{1}{2}$ points from the wind, and

the cutter 4 points, that there will be, providing their general speed and area of canvas be equal, only seven minutes' difference between them at the end of a twenty miles' thrash to windward. The schooner will probably be the equal of the cutter with the wind abeam; but it is a very different matter when the wind and the sails make a very small angle, as in close-hauled sailing. For such sailing a great portion of the sails near the upper, lower, and after edges are ineffective; consequently, the greater the number of parts a vessel's sails are in, the more edges there will be, and the greater will be the loss of propelling power; and, further, the eddied wind thrown off by the sails greatly interferes with the direct or impelling currents of wind. Beyond this, a schooner suffers in stability, inasmuch as she has to carry the weight of two masts and two sets of rigging, instead of one mast and one set of rigging, and for any given area the heeling moment of the sails of a schooner will be greater as the centre of effort will be higher; for this reason (though otherwise she might have been equal), she would not carry her canvas so effectively, as the effectiveness of the canvas is practically reduced in proportion to the sine of the angle of heel.

This leads us up to the point that sails are not really planes, but surfaces which are more or less concave. There is no doubt that the

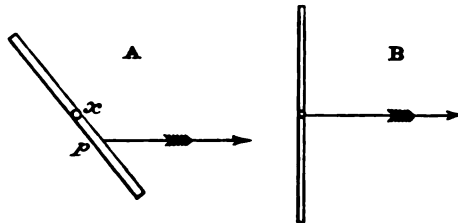


FIG. 12.

general pressure on a surface is equal whether that surface be a plane or a concave one, providing the areas are equal; but, on surfaces like those of sails, it is not the direct pressure (such as it would be when sailing dead before the wind) that drives a vessel ahead; but, as previously explained, a component of the wind force which strikes the sail at some angle. The exact value of this component for a concave surface is, so far as we know, undeterminable; but experience has taught us that it is vastly larger for flat surfaces. The oft-quoted example of the America's sails as against the wind-bags of British yachts in 1851, and the practice in consequence of the last quarter of a century, are sufficient evidence of the truth of this.

When the wind force applied to a sail comes obliquely from ahead, as in close hauled sailing, there is a plus pressure on the fore part of the sail, and Mr. Osborne Reynolds' illustration has very completely proved

that the centre of pressure is far ahead of the centre of area, as indicated by the letters *a, b, c, d*, Fig. 11, page 22. Let A (Fig. 12) be a projection of a plane moved obliquely through water or the air, in the direction of the arrow, by a line attached at *p*. So long as the line is kept attached at *p* the plane will keep in an oblique position, and the centre of pressure will be at *p*; but if the line were attached to the centre of the figure at *x*, the plane would move square to the line of pull, as shown by B, and the centre of pressure would necessarily be at *x*. If when the line were attached at *p*, the centre of pressure remained at *x*, it is apparent that upon pulling the line the plane would be overbalanced, and would assume a horizontal position.

Mr. Wm. Froude has given this subject a great deal of attention, and, in speaking of sails, says :

A striking indication of a distribution of fluid pressure on a curved surface is supplied by the *primâ facie* paradoxical curvatures into which sails often arrange themselves under the effect of wind, as is specially noticeable in jibs. In these sails especially many sail-makers, for reasons which it would be out of place to enter on here, cut the canvas with an extravagant roundness or convexity of outline on the anterior edge of the triangle (or "luff of the sail" as it is called) before roping it; and as the rope is made somewhat shorter than the rectilinear dimension of the side of the triangle, the prominent edge of the convexity becomes gathered in, so as to form, immediately behind the rope, a narrow tapered belt of slack canvas, which becomes conspicuously bagged out by the pressure of the wind. Now it is a most noticeable fact, familiar doubtless to all who have studied the "sit" of sails, that when the vessel which carries such a sail is "close-hauled," that is to say, when the wind strikes the sail obliquely from ahead, say at an angle of 45° with the line of the keel, the general wind pressure which the reaction of the rest of the sail produces swells out the "baggy" belt of canvas, not simply to leeward, but also so much forward that an observer viewing it in a direction at right angles to the vessel's course can see the convexity protruding itself ahead of the bolt rope, although, from the direction of the wind current as a whole, that part of the sail, when thus protruded by the internal pressure, must experience externally also a considerable direct pressure on its convex or (so to call it) leeward side. As the vessel is pressed closer to the wind, it is this part of the sail which will first begin to flap or "lift;" but this will not happen until the greater part of the windward surface of the sail is brought so nearly edgways to the wind, that the flatter, or less "baggy," portions of its surface are nearly relieved of pressure.

There is no doubt that, if the fore part of sails did not go into the "bag" described by Mr. Froude, they would be much more effective; and, within certain limitations, the heavier the canvas, or the more rigid and unstretchable it can be made by narrowness of cloth or other means, the more wind will the sails usefully resolve. Sailing masters generally well understand the importance of having the fore part of a sail flat and "unbaggageable." Hence, during a match, we frequently see them wetting the luff of a main sail, to shrink the flax and so strain this part of the sail flatter. But in old-fashioned sails (and in some ill-cut modern ones), the after part of the sail also went into a bag, and the idea was that the wind should not be allowed to escape. But the real effect of a bag in

the after part is to make a "back sail;" and, of course, a back sail retards a vessel's progress, and, in the case of after sail, helps to turn the vessel's head towards the wind, by pressing her stern to leeward. This bagginess in the after part is more or less apparent in all sails, and in the case of one set on a gaff the mischief of the tendency to turn the vessel towards the wind is somewhat remedied as the peak goes off to leeward, so that actually only little more than half the sail remains at the angle the boom is trimmed to. The conclusion is that the general pressure on a baggy sail is the same as on a flat surface of equal area if that pressure be applied at right angles to the plane; but if applied obliquely the component of the pressure (represented by $F a$, Fig. 10) which drives the vessel ahead is smaller, with a baggy sail, whilst the pressure that drives her to leeward, and assists in heeling her, is much larger. Before the wind this is a matter of no consequence; but by the wind it is evidently of the utmost importance that the sails should be perfectly flat, and that they should be well cut, without folds or girts of any kind, and that they should never go into bags in consequence of the canvas being soft or elastic.

It has been said that the centre of lateral resistance represents the point through which the resistance of the water to the sideway motion of a vessel acts, and the centre of effort of the sails represent the point through which the force acts which endeavours to impart sideway or broadside motion to the vessel. It is therefore evident, if these two horizontal forces do not act in the same vertical line, that some disturbance must take place in the direction of the vessel's motion. In short, the *horizontal* distance represented by $x q$ or $C E s$ in Fig. 11 is a coupling lever tending to turn the vessel towards the wind. When such conditions exist, a vessel requires what is known as "weather helm;" that is, if the vessel's head has a tendency to fly up in the wind, the rudder is turned to leeward by bringing the helm or tiller to windward. (The distance k, x in Fig. 11 shows the length of the lever upon which the rudder acts to turn the vessel, but this part of the subject will be fully treated in the next chapter.) It is obvious that if $C E$ were directly over x no such lever would exist, as the force accumulated in $C E$ would have no tendency to turn the vessel, either on or off the wind, and the vessel would "steer herself." If on the other hand x were at q , and $C E$ at s , it is clear that the effort of the sails would be striving to turn the vessel's head *off* the wind, and she would in fact require "lee helm." Thus, two bad faults in a vessel whilst sailing by the wind are dependent on the fact that the centre of effort of the sails does not act in the vertical line in which is the centre of lateral resistance. It would appear to be a very simple matter to so arrange a vessel's sails that the

centre of effort came over the centre of lateral resistance, presuming the latter to be determined; but, owing to the concavity of the sails, and the fact that the pressure varies considerably on them (there being always a plus pressure on the fore part or luff of the sail), the centre of effort cannot be accurately computed. That is, it is always some distance ahead of the calculated centre, as already shown; but as the centre of lateral resistance is likewise ahead of the calculated centre, it is found in practice both safe and useful to treat the calculated centres as if they had been correctly determined. In "Yacht Designing," in summing up this question we find the following: "Experience teaches us that, to obtain the largest average of advantages, the calculated centre of effort of the sails should be some distance forward of the calculated centre of lateral resistance, and this distance may vary from .01 to .03 of the length of the load line. With such a ratio as .03 the vessel may carry 'lee helm' in light winds and be slack in stays, and probably a ratio of .02 will be a safe one to adopt. Thus, if a vessel be 50ft. on the load line, then $50 \times .02 = 1\text{ft.}$, which is the distance the calculated centre of effort of the lower sails is to be ahead of the calculated centre of lateral pressure on the immersed surface of the hull."

This, it should be understood, refers to racing yachts with much rockered or very raking keels; for cruisers it will be better and safer to have the centre of effort and centre of lateral resistance in the same vertical line. In the case of yawls it is generally found that the calculated centre of effort requires (relatively to the centre of lateral resistance) to be a little further aft than in either cutters or schooners, as the mizen is not a very effective sail on a wind.

As the longitudinal component (*F a*, Fig. 10, page 19,) of the force of the wind acts through the centre of effort of the sails considerably above the centre of lateral resistance a couple is formed (*C E, q*, Fig. 11) tending to depress the bow; but as the longitudinal stability of a vessel is so great, but little depression will actually take place. Thus, take the case of *Seabelle* at a speed of 7 knots, her resistance in the water would be about half a ton and the distance (*C E, q*) is 50ft., and at such speed the moment would be (50×0.5) equal to 25 foot tons, which would only cause *Seabelle* to be depressed by the head $1\frac{1}{2}$ in. Of course, as the resistance increased, as it would very rapidly in the case of vessels with full bows driven at high speed, the moment would increase and the bow would be further depressed. In small yachts and boats, which are made to carry sail areas (by aid of trimming ballast up to windward) out of all proportion to their size, the depression of the head is often very considerable, and has to be met by shifting some of the ballast or crew farther aft.

CHAPTER IV.

THE ACTION OF THE RUDDER AND STEERING EFFICIENCY.

THE ACTION OF THE RUDDER.

A VESSEL moving through water is steered or turned by the action of a couple, the arm of which is the centre of lateral resistance and the centre of effort of the rudder (see kx , Fig. 11, page 22). The streams of water that meet the oblique surface of the rudder when it is put over represent a pressure which can be decomposed into a force acting at right angles to its surface; and it is evident that the application of this force would cause a vessel pivoted on a vertical axis through her centre of gravity to rotate about that axis, and the speed of the rotation would be dependent upon the magnitude of the force applied, the extent of area of the rudder, and the length of the arm of the couple before referred to. But a vessel is not so pivoted, and turns as it were in a ring and, at first, about an instantaneous axis, which does not pass through the centre of gravity of the ship. The following conditions dependent upon the putting over a rudder to turn a vessel are gleaned from a paper read by Dr. Woolley before the British Association.

Assume that Fig. 13, on the next page, is a yacht proceeding in the direction of the arrow A . B is the rudder put over to starboard to an angle of 35° by the tiller being pushed to port, and the arrow D represents the magnitude of a force acting upon the rudder in a direction at right angles to its surface; a will be regarded as the point of application of that force; but the force D can also be taken as an equal force acting in a parallel direction through the *centre of gravity* of the yacht x , and shifting the vessel sideways in the direction of the arrow E , combined with the couple of the force whose arm is represented by the distance the centre of effort of the rudder, a , and the distance the centre of the lateral resistance, o , are apart.

The effect is that the direct forward motion of the vessel becomes altered to one of rotation in the direction shown by the curved arrow t about an instantaneous axis k , thus determined: draw xq at right angles to D through the centre of gravity; and draw xy (equal to the radius of gyration of the vessel) at right angles to xq . Next join qy , and yk is drawn at right angles to qy , cutting xq in k produced; and k is the instantaneous axis. By "instantaneous axis" is meant the point upon which the vessel turns upon feeling the first influences of the rudder, and this point generally lies considerably before the centre of gravity; hence it always appears that the stern of a vessel moves much faster than her head in turning; and this is really so at first, but when the vessel is kept turning the axis of rotation shifts aft until it rests in the centre of gravity of the vessel.

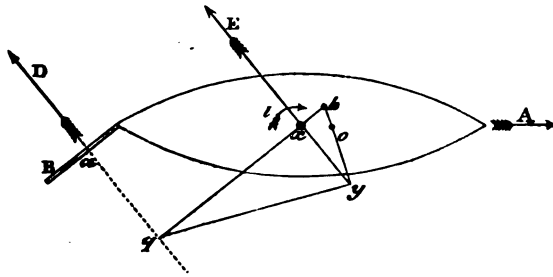


FIG. 13.

Components of the force in the direction E or D are employed partly in checking the vessel's way, and partly in driving her sideways nearly at right angles to her keel.* These components ultimately balance each other, and the vessel then continues to turn under the influence of the couple formed by ao round a vertical axis passing through the centre of gravity, c . Dr. Woolley, in reference to handiness in turning, says:

"Sensibility to the helm, *i.e.*, quickness and readiness in a ship to go about, is a most important quality. At the first moment the angular acceleration, which is the measure of this sensibility, varies directly as the moment of the water-pressure on the rudder, and inversely as the product of the weight of the ship and the square of the radius of gyration about a vertical axis through the centre of gravity."

The angular acceleration or turning motion is at first very small, and its initial magnitude mainly depends upon the rapidity with which the rudder is moved so as to bring pressure on it, and upon the radius of

* When a yacht carries weather helm the rudder is turned to leeward, but the turning power of the rudder is balanced by the arduousness of the pressure on the lee bow; hence the whole effect of the rudder is to check the forward speed and to press the vessel bodily to windward; and the latter influence may considerably lessen the leeway.

gyration of the vessel. As the angular velocity is accelerated, so does the resistance to rotation increase until the moment of resistance balances the moment of the couple formed by the pressure on the rudder. The angular velocity, or turning motion, then becomes uniform.

Now the moment of the water pressure on the rudder varies as the length of the couple ao and the area of the rudder; and the radius of gyration is dependent upon the length of the ship and the stowage of her weights, and thus a long vessel would have her already slow turning further diminished by the stowage of weights in her ends.* If the arm of the couple on which acts the pressure on the rudder be shortened, the steering efficiency will be diminished; and it has been contended that a raking sternpost so shortens the arm of the couple. But, so far as we can judge, this is a mistaken contention, as generally the centre of lateral resistance is carried farther forward by the raking sternpost than is the centre of effort of the rudder.

Beyond this, there is usually a much greater length of sternpost when it rakes, and generally the area of the rudder is thereby increased, inasmuch as the breadth only of the rudder appears to be regarded as a matter of importance, and not its depth, so far as yachts are concerned. Some yachts with raking sternposts have enormous rudders, and, although there may be some danger in using them in the case of sternway and in ascending, there is no doubt that they are efficient. But a rudder hung on a raking sternpost is not wholly effective, inasmuch as a component of the pressure on it is exerted in a vertical direction, and tends to drag the vessel's stern under. This can only be regarded as a disadvantage, and a further disadvantage is that the rudder is difficult to put over, as it has to be lifted every time; but the latter difficulty is overcome by making the tiller longer than would be required for a similar rudder hung on an upright sternpost.

With regard to resistance to rotation, this mainly depends upon the area of the immersed longitudinal section, and particularly upon the amount of dead wood fore and aft. By reducing the dead wood fore and aft the resistance is proportionately decreased, and, moreover, the radius of gyration would be somewhat shortened by the reduction of the fore and aft weight; but almost equal effects would be produced by taking away from the dead wood forward and aft, and concentrating it in the middle

* The bad effect of weights in the "ends" of small boats is very noticeable, and we have known cases where a boat has been cured of a tendency to miss-stays by simply concentrating her weights or ballast amidships. On the other hand, a very old practice to insure a boat staying is for someone to get into the bow as the helm is put down; but the bow should be relieved of the weight directly the boat is head to wind, or the boat may fail to "fill" or fall off.

of the vessel under the keel. The effective surface for lateral resistance would be maintained, and the radius of gyration would be still shortened.*

To sum up, the quickness of a vessel in answering her helm and the smallness of the circle in which she will turn depend :

1. Upon the smallness of the weight of the vessel and her radius of gyration.
2. Upon the area of the rudder, and the length of the couple upon which it acts, and upon the time it takes to put the rudder over.
3. Upon the area and form of the immersed longitudinal-vertical section of the vessel.

The double-boarded boat as depicted in Fig. 14, affords peculiar advantages for lengthening the arm of the turning couple, as by lifting the board (*h*) the centre of lateral resistance is thrown very much forward,

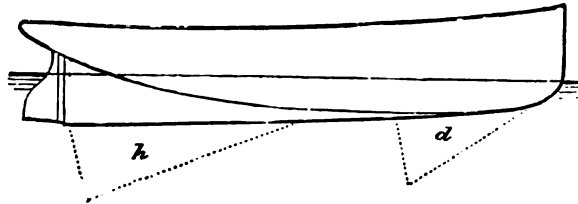


FIG. 14.

and the area of dead wood at the after end (which might be necessary in a sailing vessel to check leeway or to balance sails) is considerably reduced. In tacking, if the vessel's "way" were stopped as she came head to wind, and the rudder thereby became useless, the fore board *a* could be raised and the after board lowered, and thus the head of the vessel, by aid of the fore sails, would readily fall off the wind.

All kinds of fanciful forms have been given to rudders, and a practice came in a few years ago of putting the greatest breadth near the surface of the water. We believe this practice was owing to a vessel once having

* Large centre-board yachts are frequently said to be more sluggish in stays than keel yachts, and no doubt there is some truth in this, although, looking to their immersed form alone, they ought undoubtedly to turn quicker than keel yachts. In the races between the *Cambrisa* and the centre-board yachts in America in 1870, it was repeatedly shown that she was quicker in stays than any of her competitors, but we are inclined to think that the superiority in this respect was due to her raking sternpost, to her handier rig, and, in strong breezes, perhaps, to her greater weight, so that she carried her way until well round on the other tack. If two vessels are to be impelled by an equal force at equal speeds, and one vessel is heavier than the other, then it will take a greater time to get the heavier vessel up to the required speed than it would the lighter vessel; so also when the force is withdrawn it will take a greater time to exhaust the momentum due to the speed of the heavier vessel than it would the momentum of the lighter vessel. Thus heavy vessels (although they may be turning in a circle of greater radius) are said to "shoot" far in stays, and fill on the other tack without losing way. However, the assumed advantages which a heavy vessel has in this respect will be only apparent in strong winds when the momentum, due to high speeds, is very great; and the advantages do not exist for a vessel that has continuous propulsion whilst turning, as a steamship has.

the lower half of her rudder accidentally carried away, and the subsequent report that she steered better with the part than with the whole. We are inclined to think that in this case the inefficiency of the entire rudder depended on its being too big for the crew to use; at any rate, an experiment made by Mr. Froude with a model of H.M.S. Encounter clearly proved that the lower half of a rudder is more effective than the upper half. The rudder was in two parts, *i.e.*, squares of equal dimensions, and it was found that the upper half required to be put over to 20° to balance the lower half at 10° , in order that the vessel might follow a straight line. In the case of a very raking sternpost there may be a small advantage in having the broadest part of the rudder in the top half, as its centre of effort would thereby be carried farther aft; but generally there can be no doubt that the deeper the main area of the rudder is immersed, clear of the fulness of the after body, the more effective it is. As a clean run aft is a great assistance to the effectiveness of the rudder, it is quite possible, if an experiment similar to that tried on the Encounter were tried with a yacht, that a less difference in the effectiveness of the two halves might be found. The advantage of keeping the rudder well immersed—both in smooth and disturbed water—is so well understood by small boat sailers that we find many small and shallow craft with their rudders dropping considerably below the keel. The only disadvantage of this arrangement is that, if the boat carried much weather helm, and if the centre of effort of the rudder were much below the centre of lateral resistance, the pressure on the rudder would tend to increase the boat's heel, although not to a considerable extent. (These rudders are so hung that in shallow water they lift without unshipping.)

There appears to be no definite rule for determining the breadth of rudders in sailing yachts, but generally we find the breadth to be one-twentieth of the length on the load line, and about one-thirtieth of that length in steam yachts. With regard to the efficiency of broad and narrow rudders, it would appear, from experiments made for the Admiralty some years ago, that a rudder of, say, 3ft. in breadth, put over to an angle of 30° , would have double the efficiency or turning power of one ft. in breadth put over to half the angle, or 15° ; and the force required to move the rudder would be the same in either case. Thus there can be no increase in the efficiency of a rudder by the mere addition of breadth without an increase in the power to use it, and a very large rudder, if used so as to obtain its greatest efficiency—which is found to be when put over to an angle of about 35° —means a great retardation of speed; or, the smaller the circle a vessel is made to turn in, the more speed will be retarded. So far as small steam yachts are concerned, no rudder offers greater advantage for facility

in using it and efficiency than Gumpel's, as, owing to its construction, it does not take an equal force on the tiller to balance the water pressure on the rudder. (This rudder was fully described in *The Field* of June 20, 1874, and Oct. 23, 1875.) A variety of steering gear has from time to time been introduced, which, by the aid of the wheel, has enabled one man to do the work of two or three. Of these contrivances none promise better results than that of Mr. G. L. Watson; but, so far as racing yachts are concerned, we think a long tiller and relieving tackle must be relied upon.

As a rule no calculation is made in fitting a vessel with a tiller, farther than making it bear some proportion to the length of vessel; if the rudder cannot be readily used with the tiller, extra tackles are fitted to it, or the tiller is discarded and a larger one used in its place. However, a very simple calculation will approximately show the force that would be required at the tiller head for any given area and angle of rudder, length of tiller and speed. At a speed of 6 knots the resistance of a plane moved at right angles to its surface is 112lb. per square foot, and the resistance increases as the square of the speed; also, the resistance to a plane moved obliquely in water, varies nearly as the sine of the angle of inclination. Then, say that the rudder is 12ft. deep and 5ft. broad, equal to 60 square feet, and put over to an angle of 30° ; then $112 \times 60 \times (0.5 \text{ sine of angle}) = 3360\text{lb.}$ That is, the pressure on the rudder put over 30° whilst the vessel is moving at a continuous speed of 6 knots, will be 3360lb. This force of 3360lb. is exerted on a lever, the length of which is the distance the centre of pressure on the rudder is from the stern post. We have shown that the centre pressure on planes moved obliquely in fluids is not at the geometrical centres, and experiments have shown that the resultant of pressure on a rudder, when inclined to 30° , is at or near one-third the breadth from the anterior edge, or edge next the stern post. This has been well proved by "balanced" rudders pivoted at or near one-third their breadth from their front edge; no power is required to put the rudder, so pivoted, over beyond that necessary to "move" the water, to overcome the friction of pintles, rudder post, and the effort that would be required to move the rudder if the vessel were not in the water.

If the rudder were a rectangular parallelogram, the resultant of pressure on it would thus be 1.666ft. from its edge next the stern post, and the length of lever on which the pressure on the rudder acted, would therefore be 1.666ft.; and the product of 3360lb. \times 1.666ft. is 5597.7, which is the moment in foot pounds that would have to be overcome by a force at the tiller head. The magnitude of this required force can be calculated by a very simple equation: thus, say the tiller is 10ft. long, then the force required at its head to balance the moment of the rudder, when put over to 30° , will be thus found:

$$\frac{3360 \times 1.666}{10} = 559.81b.$$

That is to say, a steady pressure of 560lb. would be required at the tiller head to keep the rudder over at 30° if the vessel were moving at a continuous speed of 6 knots.

All other things being equal, the diameters of the circles vessels will make in turning are in direct ratio to their dimensions. Thus, take two yachts, one of 25 tons and the other 200 tons : their length would be 50ft. and 100ft., and the yacht of 50ft. should in turning describe a circle of just half the diameter of the one 100ft. long. The latter will describe a circle in turning of about twice her own length, or 200ft. in diameter (assuming her to be under uniform steam power, with her helm over to 35°), at a speed of eight knots in about two minutes, as the direct speed would be retarded nearly two thirds. Under sail, however, and in getting from one tack to the other, a yacht does not describe a circle, but only one fourth, or the arc of a quadrant, if she lies four points from the wind ; and presuming a yacht in tacking traversed the whole arc of a quadrant from the force of a direct speed of eight knots an hour, she would be a little under half a minute in getting from one tack to the other. But we know that a yacht of 100ft. long cannot get from one tack to the other in half a minute, nor does she describe exactly the arc of a quadrant. However, for the purpose of illustration, we can assume that a yacht maintains uniform speed whilst turning. In Fig. 15 (p. 36) A N D form a quadrant, and let E be a yacht proceeding in a direction parallel to B A D, with the wind blowing as shown by the arrow, four compass points or 45° from her course. The yacht when in the position F would be head to wind, and when at H would be on the other (port) tack, on a course at right angles to that at E. But the speed of the yacht would diminish from the time her helm was put down, and when she arrived at F, head to wind, her propelling power would be gone entirely. She would proceed a little farther on the arc of the quadrant under the influence of her rudder, but would eventually pay off, under the action of her head sails, and come fairly on the other tack (proceeding in a direction parallel to A N), somewhat in the direction K.

As a matter of fact, the portion of the circle which a yacht describes in tacking is always of greater radius than her own length, or the circle in diameter is greater than twice that length. The helm cannot (and frequently it would be inadvisable so to do) be put over to 35° suddenly in large yachts, and generally the yacht will be head to wind before the helm is so over to 35°. Thus in a large yacht, say of 100 tons, the helm cannot very well be put down too quickly, or indeed even quickly enough. On the other hand, in small vessels, the helm may be put over

too suddenly, and, by forcing the yacht to describe a segment of a circle of very small radius, her way becomes deadened; so that, when she gets on the other tack, she rests motionless in irons, instead of springing off almost with way unchecked. This is a very important matter, as successful

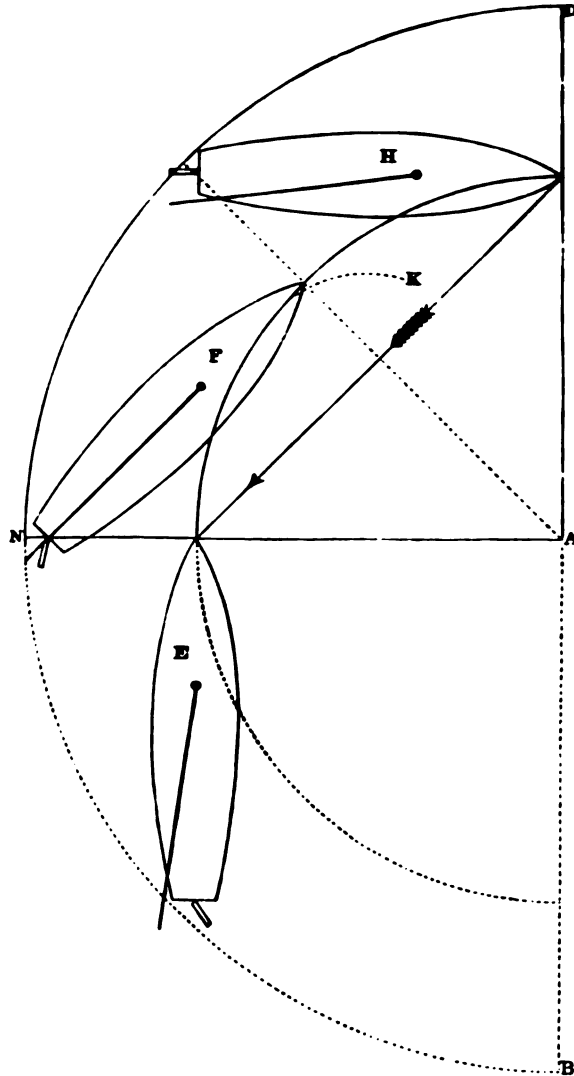


FIG. 15.

tacking does not depend upon merely getting from one tack to the other, but in getting *off* on the other tack without losing way. The helmsman of a large craft cannot easily make a blunder, as generally the speed with which he can walk a tiller down to leeward is that most suitable for

preserving continuous way in tacking. This is not the case in small vessels, as the tiller can be put over with one hand suddenly, and the vessel brought head to wind (when, of course, all her propelling power is gone) in from five to ten seconds. Now it is obvious that some turning power is required after a vessel is head to wind, as at that point she is only half-way towards getting on the other tack, and no help can be obtained from the rudder if there be no way on the vessel. Thus, if a vessel's way be stopped before she be fairly on the other tack, the head sails will have to be kept a-weather; but in smooth water at least, and in a whole-sail breeze, a skilful helmsman will never require such aid, but will tack his vessel fairly by the influence of the rudder, the head sheets being lightened up of course; but not before the luff of the sails begin to lift, and as a rule the jib sheet should be the first to be eased, as it will be the first to lift when the yacht is about half way towards the head to wind point. The sail will no longer be of use as a propelling force, and what little wind it holds will now only tend to check the vessel coming into the wind.

It should not be lost sight of that in performing the first half of the operation of tacking—that is, bringing a vessel head to wind—the assistance given by the sails to the vessel in turning does not retard or deaden the vessel's way like the action of the rudder. By letting fly the head sheets at the right moment, the centre of effort of the other sails would be thrown so far aft, that a very long arm would be formed by the couple $C E s$ (see Fig. 11). It is also quite possible to tack a vessel by working her sails without putting the helm down at all, especially if she carries a fair amount of weather helm; upon letting go the tiller and jib sheet the vessel would fly head to wind, and, the fore sheet being kept a-weather, her head would soon pay off; it might, however, be found necessary to ease the main sheet before she would gather way, as the foresail being aback would necessarily tend to put stern way on her. At the meeting of the Institution of Naval Architects in 1871 the late Sir E. Belcher, speaking on the handiness of sailing ships, stated that when he was in charge of the Samarang he gave a written order to the officers that the helm was never to be put down in tacking. The helm was let go, and the vessel came head to wind, the head yards were braced aback, and thus the Samarang was always got round. Possibly this was a smart thing to do, but there can be no doubt of the value of the rudder for quick staying, if used judiciously.

The rudder action of vessels propelled by screws is attended by some anomalies which cannot always be accurately pre-determined. In the first place, the action of a propeller on a ship whose helm is amidships tends to turn her; that is, a right-handed screw will turn the ship's head to starboard, and a left-handed one to port; and from experiments made with

the Great Britain in 1845 it was known that a propeller, if suddenly reversed, would tend to turn a ship against her helm until her way was stopped. In spite of this knowledge, much attention does not appear to have been given to the subject until three or four years ago, when several accidents were clearly traceable to the fact that the vessels under port or starboard helm, whilst their screws were being reversed to deaden their way, turned the opposite way to that expected. Professor Osborne Reynolds gave the subject much attention, and at last, in 1877, succeeded in getting a committee appointed, consisting of himself, Mr. James R. Napier, Sir William Thomson, and Mr. W. Froude, to inquire into the matter. The committee made experiments with the Duke of Argyll's steam yacht *Columba*, the Earl of Glasgow's steam yacht *Valetta*, and several large steamers in the merchant navy.

The result of the experiments bore out all that was previously known or suspected of the action of the screw on the steering. With the steamer going nine or ten knots ahead, the engines were suddenly stopped and reversed; simultaneously with the reversal of the engines, the helm was put hard a-port, the vessel, of course, still forging ahead. According to what is usual, with the helm hard a-port the ship's head should have turned to starboard; but, instead of doing this, her head went off to port twenty-eight degrees, or about two and a half compass points, before the vessel's way was stopped. Next, the ship was turned full speed ahead again, and when she had full way on the engines were stopped and reversed as before, but the helm was put hard a-starboard. Between the moment of reversing the engines and that of the ship's way being stopped, the ship turned forty degrees to starboard, or nearly four points, or nearly one-eighth of a circle. The experiment was tried over and over again, and the invariable result was that, during the interval of reversing the engines and the stoppage of the ship, the rudder acted just contrary to the way expected.

A fact hitherto not generally known was brought to light, that the effect of the screw is largely governed by its immersion, and that its influence is greatest on the steering when it is near the surface "churning" the water. When deeply immersed it has little or no effect of itself in turning a ship one way or the other, and never under the most favourable circumstances—that is, with the screw near the surface, and a low speed—could the ship be got round in a circle less than double the radius of the one she would describe under the influence of her rudder with the engines turning ahead.

Also it was clearly proved that an experiment is required for every individual vessel, and for varying speeds; thus, one steam yacht, with helm hard one way or the other, may keep a straight or nearly straight course

whilst her engines are reversed and before she stops, and another may turn in direct opposition to the way she should turn under the ordinary influence of a rudder. It is thus necessary that a simple experiment should be made for every screw steam yacht, so that her master might be acquainted with her behaviour as to steering whilst her engines are being reversed. It can, perhaps, be said that a vessel turning through a arc of twenty or forty degrees cannot be of much consequence when her way is being stopped; and it might not be if it was clearly understood which way she was going to turn. It might, however, be of the utmost consequence, if the vessel whilst losing her way turned thirty degrees to port, instead of thirty degrees to starboard. This would practically be a difference of sixty degrees, or two-thirds of a quadrant, and would be quite sufficient to bring about a disaster.

One other result of the experiments was to make patent what was not very generally known, that the reversal of the engines of a screw steamer has but inconsiderable effect on stopping her way; and that the distance required to bring a screw steamer to rest mainly depends upon her size, weight, form, and speed. The distance may roughly be put down as five or six times her own length.

These peculiarities should be well known and be well considered by all in charge of screw steamers, as it is quite plain that "full speed astern" may often bring about a collision, whereas steaming ahead and using the rudder might avoid it. This may be especially the case if a steamer is approaching another, or approaching a shore, in an oblique direction. Say that the ship or shore bears on her port bow six or seven lengths off, and by continuing she would strike the ship, or in the case of the shore go aground; if she ported her helm and reversed, she might be carried stem on to the very object she hoped to avoid; whereas by porting her helm and steaming ahead she might have cleared it, or by only stopping the engines, and not reversing them, she might have gone clear.

A screw steamer will generally turn in a circle whose radius is about four times her own length, and stop in a distance equal to about six times her own length; thus far, if the object to be avoided were six lengths off, it could be cleared by turning under full speed. This, however, supposes that the steamer can be given her full rudder power (about thirty-five degrees) at once; whereas the fact is that it takes a very considerable time to get a rudder hard over when a steamer is at full speed, and very seldom is there power enough at the helm—perhaps only one man—at the moment to do it. Of course, by stopping the engines the power gained by the helmsman over the rudder would be increased; and generally it would appear to be the wisest plan, when a screw ship gets into such a position

that it is almost certain she will strike some object ahead, for her to stop her engines and put the helm over just as if the engines were still turning ahead. Of course, the engines could be reversed, and the helm put the other way, to assist the effect of the backward motion of the screw on the turning; but, unless the person in charge is thoroughly acquainted with the behaviour of the ship under all conditions, simply stopping the engines and making as much use of the rudder as possible would appear to be the wisest course, as, if the screw is not revolving, the vessel will, of course, steer like an ordinary sailing ship.

As before said, very few steam yachts behave exactly the same under the influence of the rudder during stern way, or under the influence of the screw alone with the rudder amidships; and it will be found incumbent in most cases to make an experiment with every steamer in order to discover her peculiarities. In the first place, it should be ascertained how far she will go before losing way when the engines are stopped from full speed ahead, and from half speed ahead; also the distance she will traverse before losing way whilst assisted by the engines being reversed. Next it should be ascertained how many compass points the vessel will turn before losing way; and how many points she will turn and in what direction, before losing way, whilst the engines are being reversed. Also, the steering should be thoroughly tested whilst the steamer has stern way on.

CHAPTER V.

SAIL-CARRYING POWER AND SPEED.

THE success of a yacht in competitive sailing is no doubt largely dependent upon her power for carrying sail, and this "power" is represented by the statical stability of the vessel. A reviewer of "Yacht Designing," said: "We are glad to find so much importance has been placed upon stability as to lay down as an axiom, in which we (the *Engineer*) most heartily concur, that nearly all the failures in yacht designing are traceable to the want of exact knowledge on the part of the designer of the laws by which the stability of floating bodies is governed; or that if these laws are understood, the means for quantitatively proving this operation in sailing yachts have not been exercised."* In Chapter I. an attempt was made to explain, as simply as possible, the laws which govern stability; but the mode of calculating its exact value for any particular model would involve a labour much beyond our present purpose. It was explained by Fig. 6 (page 9) that the righting moment or energy of a vessel to recover her equilibrium, after being heeled to any angle was represented by the length of her righting lever $\times G$ (corresponding to the angle of heel) multiplied by the weight of the vessel. It is thus obvious if a vessel has so much energy to regain her equilibrium after being heeled, that an equal energy must have been employed in heeling her from that position of equilibrium. In the case of a sailing yacht that energy is represented by a force of wind blowing upon the sails, and exerted collectively through the centre of effort on a coupling lever, the arm of which is the distance the centre of effort is above the centre of lateral pressure or centre of lateral resistance. In Fig. 11 (page 22) this arm is represented by the distance CEq . To fully explain how the sail moment must equal the righting moment to keep a vessel at any angle of heel, it will be necessary to

* See the *Engineer*, Dec. 22, 1876.

employ a few figures, abstracted from "Yacht Designing" concerning the well-known racing cutter *Kriemhilda*. (We select that vessel because she is one of the few whose exact stability has been proved.) The area of the *Kriemhilda's* sails (including topsail) is 5622 square feet, and the centre of effort is 46ft., above the centre of lateral resistance. The moment of these sails will be $5622 \times 46.5 = 261,423$; and, presuming the wind pressure to be equal to 1lb. per square foot, the heeling moment of the sails would be 261,423 foot-pounds. The righting moment in foot-pounds of *Kriemhilda* must next be arrived at. Her displacement is 115 tons, which, reduced to pounds, is 257,600lb.; at 16° inclination *Kriemhilda's* righting lever is 1ft. long, so that for that angle of heel her righting moment would be 257,600lb. multiplied by 1, which in turn would be 257,600 foot-pounds, or nearly equal to the heeling moment of the sails. As the moment of stability at 16° inclination does not quite equal the moment of the sails, she would be heeled a little beyond 16° .

Generally, in speaking of the "stiffness" of a yacht, the term is only used in a relative sense, and if a vessel is said to be not very stiff, nothing more is meant than that she is not so stiff as some other vessels under a similar area of canvas and wind pressure; that she is in any danger through not being stiff is a contingency never dreamt of. Now, so far as most English yachts of the deep V type are concerned, it may be said that they are absolutely uncapsizable; but it is not so with regard to many shallow yachts and boats of this country and America. The relative safety or danger of the two different types of vessel can best be illustrated as a curve of stability as shown by Fig. 16.

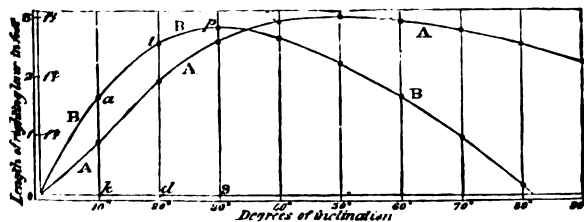


FIG. 16.

The distances a, k, t, d, p, s , represent the length of the righting lever (see w, G , Fig. 6) of a vessel, heeled respectively to $10^\circ, 20^\circ, 30^\circ$, &c.; then the curved line B passing through the spots at the termination of the distances (as at a, t, p , &c.) is the "curve of stability." The curve A represents the curve of stability of an English yacht of the deep type, and it will be seen that the righting lever is longest when the vessel is heeled to 50° , where it is 3ft. long; this would be termed the vessel's

maximum stability. The curve B represents the curve of stability of a vessel of equal length, but of greater beam, and much less depth and weight. It will be seen that this vessel has the greatest length of righting lever at 30° inclination, where, like the other, it is nearly 3ft. long; this is the shallow vessel's maximum stability.

From 0° up to 30° it will be seen that the shallow vessel has much the longer length of righting lever; but it is quite possible that the deeper vessel would have as much actual righting power as she would have a *greater weight* acting on the lever; but, assuming the weight, or displacement, of the two vessels to be equal, the shallow one would have the greater righting power up to 30° , when some portion of the deck would be immersed.

Now, it is this greater stiffness at initial angles of heel which, whilst it is of the utmost advantage for speed, forms the element of danger in shallow vessels. It can be supposed that a vessel, B, is sailing at an angle of 15° , and that a sudden acceleration of wind force heeled her to 30° , the point where her maximum stability would be reached; then, if the wind force were not instantly removed the vessel would increase her heel if she got the least beyond the 30° until she finally lost all stability, or righting power at 80° and capsized. But if a similar force were applied to a vessel with a curve of stability like A, when she reached 30° inclination there she would stick, and it would take a very large increase of wind to carry her to 50° , the point where her maximum stability would be reached; and even then there need be little danger of capsizing, as the decrease in the length of the righting lever is so slow, that at 90° there is nearly as much righting power as the shallow boat has at 30° . (As a matter of fact, no wind force could lay a yacht, with such a curve of stability as represented by A, flat on her beam ends, inasmuch as long before she reached 90° the wind would have lost nearly all its effect upon the sails.*) The curve B, no doubt, very accurately

* A correspondent, under the signature of "Trial," made the following remarks upon this statement:

"This supposes the wind to be always horizontal in its direction. But, I believe, it is now a recognised truth in meteorology that the wind sometimes blows in what are termed 'vertical currents,' which strike upward or downward at an angle which varies according to circumstances. Of the existence of these vertical currents we have familiar evidence in the manner in which fragments of straw and other light articles are often lifted up into the air, and in which smoke is blown into the streets of a town from the chimneys of houses, and down to the surface of the sea from the funnels of steam vessels. Any unusual prevalence of vertical currents appears to indicate the approach of either rain or storm.

"It appears evident that no angle of inclination could with certainty save a vessel from the danger of receiving the full weight of the wind coming thus at right angles to the plane of her canvas.

"The greater danger to a yacht of the first-class English build would be damage to sails, spars, and rigging, because the force of the wind itself must be checked and its direction turned when

represents the curve of stability of such a vessel as the American yacht *Mohawk*, which was blown over during a squall off Staten Island last summer. The vessel was at anchor, and, no doubt, from this cause felt the force of the squall more severely. Her maximum stability would be reached say at 30° , and then the squall that put her over so far would take her to the vanishing point in less time than it takes to write it. But it is quite possible that the *Mohawk* would not have gone clean over on her beam ends if her ballast and heavy cabin furniture had not shifted, inasmuch as when she got to 60° the wind must have had decreased effect on the sails; and, as the squall passed over very quickly the *Mohawk* might have righted but for the reason stated. However, beyond the accident of the ballast and heavy furniture shifting, the *Mohawk* was subject to another condition, which rendered her righting quite impossible: she had a very large "well" or cockpit aft, into which the main cabin opened, and soon after the deck became immersed the water rushed into the cabin, and then, of course, her chance of righting was gone. Now, from the manner of stowing the ballast in a deep yacht, there would be little chance of its shifting until the vessel got beyond her beam ends, when it might certainly come tumbling through the skylights. However, deep yachts, such as the *Vanessa*, *Kriemhilda*, *Seabelle*, or other similar yachts, are in no danger, even if hove down on their beam ends, providing water is not allowed to get inside their hulls. The case, however, is very different with shallow vessels and with some steamers, which have their centres of gravity high; and it is necessary for their safety that they should never be sailed very near the angle of heel where their maximum stability is reached. In practice, in small shallow boats, this is well understood, and the helmsman throws his little craft in the wind directly she is struck by a squall, or lets go sheet or halyards, whichever comes readiest to hand.

The stability or stiffness of a yacht under canvas will principally interest English yachtsmen as a matter affecting speed; and every novice knows that the more canvas a boat will carry at any given angle of heel, the faster she will be, all other things being equal. To demonstrate that power to carry canvas affects speed, it will be convenient to take two vessels of very opposite types, such as the American

it strikes the sea; and, as a yacht of that character retains a substantial 'righting' power even at the angle of 90° , she ought to recover herself even if thrown on her beam ends, provided she escapes the danger of taking in water to a dangerous extent by skylights and hatches.

"What would become of the crew on deck I presume not to determine.

"It seems quite clear that a vessel of the broad, shallow style, so much in favour in America, would be exposed to a far more serious danger, although up to the angle of 80° her stability might be superior to that of the English vessel."

centre-board schooner *Columbia* and the English schooner *Seabelle*. The linear dimensions of the *Columbia* are 98ft. on the load line, and 25·7ft. beam; her displacement is 150 tons, and her area of lower sail 8770 square feet. The *Seabelle* is 90·5ft. on load line, beam 19ft., displacement 155 tons, and area of lower sails 5780 square feet.

The displacement of these two vessels is practically the same, but the sail area of *Seabelle* is less than two-thirds that of *Columbia*, or, in other words, the sail area of *Columbia* is 50 per cent. the greater. We have been witness that the *Columbia* has made 12·5 miles per hour in a lower-sail breeze blowing a little abaft the beam, the wind pressure being equal to 2lb. per square foot. *Seabelle* under similar conditions has made 11·4 knots per hour. At a speed of $12\frac{1}{2}$ knots the resistance met with by *Columbia* would probably be increasing as the fourth power of the speed, and if her sail area were reduced to an equality with *Seabelle's*, her speed would be reduced in the ratio of $\sqrt[4]{\frac{1}{3}}$ or about $\frac{1}{1.15}$; or to about equality with *Seabelle's* speed.

If these two yachts set out to sail a course of 50 miles with a strong leading wind, the *Columbia* would accomplish the distance in four hours, and the *Seabelle* in four hours twenty-three minutes. Here are two vessels of exactly the same displacement; but one, by adding 35 per cent. to her beam, and only 8 per cent. to her length, is enabled to carry nearly 50 per cent. more canvas; and it is quite fair to assume that the advantage gained by the *Columbia* is mainly due to her greater area of canvas, and not to any superiority of model. That is to say, if two designers of yachts are given a displacement of 150 tons to work upon, and one produces a vessel that will carry 50 per cent. more canvas than the other, it is quite evident that the vessel with the larger area of canvas should be very much the faster, as it is unlikely that her designer would allow her to suffer from defective modelling of entrance and run. [As a matter of curiosity, we might here state that the measurement for competitive sailing under the rules of the New York Yacht Club was until two years ago one of displacement,* and if *Seabelle* and *Columbia* set out to compete under these rules, they would have been rated upon equal terms, or rather *Seabelle* would have given a few seconds time. We need not stop to inquire whether this would be an equitable arrangement, but it can be assumed that English yachtsmen consider the advantages which are due to length and beam are fairly taxable, as both these quantities are terms in the Y.R.A. measurement formula. By this

* The measurement is now altered to cubical volume, which is a measurement like our custom house rule, only the measurements are taken externally instead of internally; or the rule can be regarded as the same as displacement, with the part of the vessel above water added.

formula *Columbia* would be rated as of 264 tons, and *Seabelle* 140, and the time allowance would be 16 minutes for a course of 50 miles.]

The *Seabelle* and *Columbia* are representatives of extreme types, but among vessels so little varying in form as those belonging to this country, very varying stability characteristics are to be found. These varying characteristics can best be illustrated by curves of stability, which exhibit the righting power at successive angles of inclination, and a suitable contrast will be found in the curves for *Jullanar* and *Florinda* for the purpose of illustration.

The *Jullanar* affords an example of the kind of curve of stability a vessel has with a low centre of buoyancy and low metacentric height (see Fig. 6, page 9), brought about by a heavy displacement obtained by depth of body ballasted with lead. Her metacentre falls below the load water-line; yet, owing to her great depth of body, and the great weight of lead stowed in that depth, her centre of gravity is low, and is, in fact, an inch or two below her centre of buoyancy. Still the metacentric height is limited, and at small angles of heel the righting lever (x G, Fig. 6) is short; but that lever continues to increase up to the time that *Jullanar* would be on her beam ends, when it is more than double what it would be at an inclination of 30° —a condition which renders *Jullanar* absolutely uncapsizable. She thus has the finest seagoing elements possible—low metacentric height for ease, and illimitable range of stability for safety. *Jullanar's* success in extremely strong winds, as compared with her performances in light winds, is directly attributable to the peculiarities of her stability curve. *Florinda* is an example of a yacht with less depth of body than *Jullanar*, and a higher centre of gravity. Under lower sail, with a wind force of 1·7lb. per square foot of canvas, *Florinda* would heel 15° , whilst *Jullanar* would heel 17° ; but if the force were increased to 3lb. per square foot, *Florinda* would heel to 35° , whilst *Jullanar* would only fall over 30° . It will be seen by referring to the annexed stability curves, that at 24° (about the deck edge) the stability of *Jullanar* and *Florinda* are equal; at any further inclination the stability of *Jullanar* makes a very rapid gain on *Florinda*. At 20° inclination *Florinda's* deck begins to be immersed, whilst none of *Jullanar's* deck is put under until she reaches an inclination of 26° . This fact, coupled with her depth of body and her extraordinary low centre of gravity, can be regarded as the cause of her long range of stability, and the cause why in strong winds *Jullanar* is able to beat *Florinda*.

The *Seabelle* is a vessel somewhat similar to *Jullanar* so far as the vertical position of her centre of buoyancy is concerned, and her curve of stability resembles that of *Jullanar*. The *Rose of Devon*, on the other

hand, like *Florinda*, represents a shallower type of vessel, and the curves of stability of these two are of similar character. *Rose of Devon*, however, has a high centre of gravity as she is ballasted wholly with iron; her curve, with 20 tons of lead on her keel, is shown by the dotted line. The character of the curve remains the same, but owing to the greater length of righting lever due to the lower centre of gravity the "righting power in foot tons" is largely increased for any angle of heel.

It has been sufficiently shown that sail-carrying power is a very large factor in the elements which make up a vessel's success in competitive sailing; and generally, as that power cannot be increased by adding to

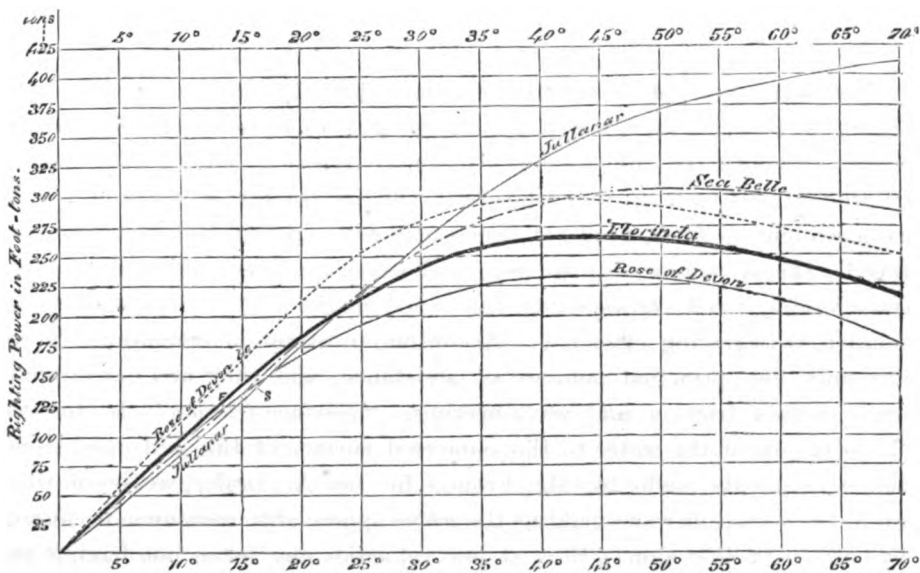


FIG. 17.

beam and length without such additions being adequately taxed for competitive sailing, the designer exercises his ingenuity in depth and ballasting. Thus, if we find two vessels of equal length and breadth, and one exhibits an advantage over the other, that advantage will be nearly always traceable to greater sail-carrying power. The conditions upon which this power is dependent have already been explained, and the importance of well considering them has been sufficiently exemplified by the reference to the relative stability of such distinctive types as *Seabelle* and *Columbia*, *Jullanar* and *Florinda*.

CHAPTER VI.

RESISTANCE AND SPEED, AND THE INFLUENCE OF THAMES MEASUREMENT.

It has been assumed, in the last chapter, that the qualities of the two yachts as to form, upon which their resistance to motion depended, were equal, although one by reason of inferior stability might have much greater propulsive force than the other. Of course this equality of speed as dependent on form, need not necessarily exist, and in fact, at very high speeds, the resistance, due to form and other qualities, might vary very considerably; and consequently the speed might vary independently of relative sail-carrying efficiency. According to recent investigations there are only two principal sources of resistance, and they are consequent upon surface friction and wave-making. "Surface-friction" is due to the adhesion of the water to the immersed surface of the hull; and from the experiments made by Mr. Froude for the Admiralty, we learn that up to the period of wave-making the *whole* appreciable resistance is caused by surface friction alone; thus at low velocities any form, not having an absolutely flat or blunt end, would only have surface friction to contend with. A fairly modelled yacht of, say 50ft. in length, moved at a velocity of five knots an hour, need make scarcely any waves, and the resistance she would encounter would be almost entirely due to the friction of the water on the surface of her copper. From the foregoing it can be gathered that, so far as the resistance due to surface friction is concerned, it will be advantageous for a yacht to have a comparatively small area of surface immersed, and for that surface to be of the most uniformly perfect smoothness. The frictional resistance of perfectly clean copper (with no nail heads or other uneven protrusions), upon a vessel 50ft. long, is equal to 0.246lb. per square foot at a speed of six knots per hour; and the resistance increases uniformly as the 1.83 power of the speed.* But

* Practically the resistance is $\frac{1}{2}$ lb. per square foot at six knots, and 1lb. per square foot at twelve knots. Thus a well formed yacht with 1000 square feet of surface moved at the rate of six knots an hour would only require a tow rope strain or nett propelling force of 250lb.

if the vessel be coated with fine sand, the resistance is equal to 0.405lb. per square foot, and increases as the 2.06 power of the speed. For medium sand, such as may be met with on the shore, the resistance is as much as 0.488lb per square foot, and the resistance increases as the 2.2 power of the speed. The advantage of having a perfectly clean and smooth surface is therefore paramount, and the advantage will be most marked when sailing in light winds, which of course means low velocities.

The form of vessel which yields the least surface for friction for any fixed displacement is one of round full lines, with the dead wood forward and aft reduced as much as practicable; but very full lines are incompatible with high speeds, as the wave-making resistance assumes enormous proportions in bluff bowed vessels. That form which most nearly accords with the wave-line theory is the one which can be made to move at the highest velocities without any very sensible wave-making; * and it should be always remembered that directly wave-making commences, the resistance no longer increases at about the square of the speed, but very rapidly ascends, and may reach even as high as the 6th power of the speed.

For the sake of great internal accommodation, it is considered an advantage to have a considerable parallel length of middle body, or, as shipwrights call it, "straight of breadth." Mr. Froude has recently made some experiments in this direction with a view of determining how far a perfectly straight piece of middle inserted between two good ends affects resistance. The results of his experiments were communicated to the Institution of Naval Architects in March, 1877,

* Mr. Colin Archer, a naval architect resident at Laurvig, in Norway, has propounded a new application of the wave-line theory, and he argues that, so long as the displacement of a vessel is disposed longitudinally so as to accord with the wave form, actual wave-lines need not be present in the vessel at all. In fact, he argues that very considerable fulness is admissible in the horizontal lines of the bow providing that the displacement or immersed solid represented by the bow is graduated in the proportions of the wave form. The Jullanar affords accidental evidence of the correctness of this theory within the limits of speed which English sailing yachts are capable of realising; but experiments are still wanting to prove the absolute independence of the wave form of all wave-lines for developing a maximum speed for any given length of load line and given displacement. The horizontal or water lines of Jullanar could, however, be very easily turned into "wave-lines" by adding to her dead wood forward. To "fair" the lines and terminate them in the dead wood, a contrary flexure would be necessary, and so wave-lines would at once be brought into existence. These fine ends of the lines are an essential part of the early theory of the wave form for the gradual opening of the water by the entrance, but Mr. Archer's theory throws some doubts upon this being an essential characteristic of the wave bow. At any rate, by adding a quantity of dead wood to the Jullanar, the wave form proportions of the displacement of her bow would be destroyed, although "wave-lines" might be called into existence. Whether or not the "wave-lines" would be of greater value for the attainment of speed than the "wave form" we cannot at present say; but this much is certain, that by adding to the dead wood the area of immersed surface would be largely increased, and that of itself could only be regarded as a disadvantage as the frictional resistance would be proportionally increased.

and are most interesting. So long as a moderate speed, not exceeding 12 knots, with a ship 160ft. long, was maintained, the insertion of 40ft. of middle body affected the speed in almost a direct ratio to the increased surface; but at higher speeds the resistance increased in a greater ratio, and presented some peculiarities.

At the higher speeds a succession of waves followed the bow wave along the side of the ship, and if the crest of the last of these waves came at about the middle of the length of the after body, the forward pressure on this part of the ship was increased, and there was a consequent decrease in the total resistance; but when the speed was so altered that there was a hollow in place of the crest in the position indicated, there was a decided increase in the total resistance. It would therefore appear that increasing a vessel's length by making an addition to the middle body need not necessarily be accompanied by a favourable character of wave-making. The *Guinevere* is the best example we know of a yacht with a great straight of breadth, although of course she has not parallel sides, such as could strictly be termed so. The inference is that if 20ft. (equal to about 70 tons displacement) were taken out of *Guinevere*, her resistance, say at speeds of about 9 knots per hour, would be slightly diminished. At the speeds where the resistance due to wave-making would be very sensibly felt, the case would be different, and greater advantage might be gained by a reduction of her length; but the fact that the sail-carrying power had been considerably reduced by the abstraction of 70 tons displacement would have to be weighed against this.

This leads us to consider an important matter which has a direct influence on the proportions of yachts. Under the present rule* for estimating the builder's price for a yacht, and for classing yachts for competitive sailing, beam is heavily taxed, as already stated; and the operation of this rule effectually prevents a designer making a large use of beam to obtain great sail-carrying power. Accordingly, as beam can only be used in a restricted way, great employment is made of weight or displacement. A "long body" is given by making the fore-and-aft lines as straight and full as may be considered consistent with the expected speed, and the depth and sharpness of the body are only limited by the same considerations; † but it seems pretty certain that, for any

* See "Builder's Measurement," in the Appendix.

† It is generally supposed, and we have frequently seen it stated in print, that a body moving in water meets with resistance in proportion to the depth of its immersion. Mr. Froude, however, in his report on resistance clearly shows that relative depth of immersion has little to do with the resistance of bodies moving in fluids. As a body is immersed more and more deeply below the surface water of greater density is displaced, and the frictional resistance varies as the density of the water; but, as a matter of practical usefulness, the increase of density for any depth likely to be reached by the immersed portion of a vessel is so small (only increasing $\frac{1}{10}$ at a depth of

given length and weight of vessel, better results, so far at least as speed is concerned, would be obtained in smooth water with fresh winds if beam were left entirely unrestricted.

With regard to cruising yachts—or yachts built entirely with a view of getting the most possible comfort whilst afloat—it cannot be contended that the rule of measurement should necessarily operate against beam. In short, it is the builder's interest to make the vessel as broad as possible, as he is paid by the ton, and under this rule beam increases tonnage nearly eight times as fast as length, if the proportion of length to beam is as five to one. But as a matter of fact the person for whom the yacht is to be built knows this condition of the rule as well as the builder; and as 8ft. of length is of more value for internal accommodation than 1ft. of breadth, it is not surprising that owners are willing to put up with as little beam as possible. However, for cruising, a yacht is generally given a greater proportion of beam to length than a racing yacht; and either a cutter or a yawl has more beam than a schooner. For any given beam a schooner is generally made longer than a cutter, in order that she may have an appropriate fore and aft spread for her canvas; or, to put the matter differently, say a certain length is given to the hull more than would be given to a cutter of the same beam, then it is concluded that the schooner rig will be the more suitable, as the length of boom, gaff, and bowsprit of the cutter rig may be found inconveniently extended.

The proportion which beam should bear to length is subject to a great variety of opinions (see "Beam" and "Length" in the appendix), but the true reasons for giving a cruising yacht more beam than a racing yacht are these: In the first place initial stability, or resistance to be heeled from an upright position at the commencement of inclination, is directly proportional to the beam, and as it is very desirable for comfort that a cruising yacht

6000 feet) that it is safely neglected in all calculations of ship resistance. An opinion is also sometimes entertained that water is more difficult to displace or push on one side as the depth increases; this, however, is not the case. In reference to this subject, Mr. W. H. White, in his work on "Naval Architecture," says, "If a plane were immersed very deeply, it would create little or no surface disturbance, and therefore require less force to propel it at a certain speed, than would a plane of equal immersed area moving at the surface with a portion situated above that surface. This statement is directly opposed to the opinion frequently entertained, which confuses the greater *hydrostatical* pressure on the plane, due to its deeper immersion, with the dynamical conditions incidental to motion. If the deeply immersed plane were at rest at any depth, the pressures on its front and back surfaces would clearly balance one another. When it is moved ahead at a uniform speed it has at each instant to impart a certain amount of motion to the water disturbed by its passage; but the momentum thus produced is not influenced by the hydrostatical pressures on the plane, corresponding to its depth of immersion. Water is practically incompressible: apart from surface disturbance, the quantity of water, and therefore the weight, set in motion by the plane will be nearly constant for all depths, at any assigned speed. In other words, if there were no surface disturbance, the resistance at any speed would be independent of the depth." (See "Salt and Fresh Water," in the Appendix at the end of this volume.)

should be kept as upright as possible, she is given such a proportion of beam as will ensure her having a fair amount of initial stability. For cruising, nothing can be more uncomfortable and inconvenient than for a yacht, even in moderate breezes, to be always over on her side; it will be impossible to walk about her deck, and the discomfort and disorder below are unbearable. In the next place a very narrow racing yacht would have a quantity of lead inside and outside, and this is incompatible with a comfortable cruising yacht; and a very narrow yacht, *unless she has great depth*, would make very bad weather of it in a heavy sea; she would lie down and wallow in the sea, would always have her lee deck full of water, and would be a difficult and dangerous craft to handle. On the other hand, a yacht which has a great proportion of beam to length may be proportionately deficient in depth of body, and she will then be lively in a sea, and be of inferior speed, excepting, perhaps, in smooth water, or with a quarter wind.

The results of experience indicate that for a cruising yacht the length should be about $4\frac{1}{2}$ times the beam, or in other words, the beam should be equal to the length on the load water line multiplied by 0.225; or, say the length is 80ft., then $80 \times .225 = 18\text{ft.} = \text{beam}$. For yachts of less length, say of 40ft., the proportion might be increased to .23, but as small yachts have generally more proportionate depth than larger yachts, this ratio need not be exceeded.

The ease and capability of a yacht in a sea way are not wholly dependent upon length and breadth, but are largely dependent upon her depth under water and her height out of water.

With regard to the height of freeboard a great difference of opinion would appear to exist, inasmuch as yachts of 150 tons exist with only 2ft. 9in. of side above water at the lowest point of the deck, and yachts of 40 tons are frequently given as much side as this. One rule for determining freeboard is based on the assumption that a yacht should have so much side that when she is heeled none of her deck is immersed until a certain angle of heel is reached. This angle is generally put at 30° for small yachts of 5 tons, and diminished to 24° for yachts of larger tonnage. This rule is a trustworthy one so long as the yachts are of from four times to four and a half times their beam in length; but when the length much exceeds these proportions it is inapplicable. For instance, the Jullanar is nearly six times her beam in length, or 16.88ft. to 100ft., and if her freeboard had been apportioned by the rule that her deck was to reach the water at 24° inclination, she would only have been given 3ft. 2in. of side at the lowest point. This would have been a sufficient proportion for a yacht, say 72ft. long and 16ft. broad,

equal to 77 tons; but the Jullanar is 27ft. longer, and has the propelling force in the way of sails of a yacht of nearly double tonnage; she therefore requires increased side to assist her stability so that she may carry her canvas effectively, and at the same time keep her as dry in a seaway as the shorter and slower yacht (see page 46). It is thus quite plain that the freeboard of a yacht should not be decided upon by her beam alone, irrespective of her length; neither would it be satisfactory to decide upon freeboard by length without reference to beam, and a rule is required that will include both length and breadth in its terms. It is found that the freeboard* of well-proportioned yachts of four and half beams to length varies as their half-breadths multiplied by the sine of 24° ; also that their freeboard varies pretty regularly as the square root of one-fifth their length on the load water-line; and the mean of these two quantities will give an approximate height of freeboard for yachts of any proportion of beam.

The rule formulated would be

$$\frac{(\text{Sin. } 24^\circ \times \frac{B}{2}) + \sqrt{(\frac{L}{5})}}{2}$$

The rule applied to a particular example such as Jullanar:

$$\frac{(0.4 \times \frac{16.88}{2}) + \sqrt{(\frac{100}{5})}}{2} = 3.9.$$

The sine of 24° is 0.4; half of 16.88 is 8.44ft., and $8.44\text{ft.} \times .4 = 3.37\text{ft.}$ Next one-fifth the length of 100ft. line is 20, and the square root of 20 is 4.47. Next 4.47 added to 3.37 and divided by 2 make 3.9, and the exact freeboard of Jullanar at the lowest point is 3.9ft. For Freda, 5 tons,

the freeboard by the rule would be $\frac{(0.4 \times \frac{6.1}{2}) + \sqrt{(\frac{30.5}{5})}}{2} = 1.9\text{ft.}$, which is

equal to her freeboard. Applied to an Itchen boat $\frac{(0.4 \times \frac{8}{2}) + \sqrt{(\frac{23}{5})}}{2} = 1.9\text{ft.}$, which is the exact freeboard of the 23ft. Itchen boat described further on; in short, the rule, if applied to yachts of any extreme proportions, will give a suitable height of freeboard for them.

In designing merchant ships it is usual to consider freeboard in relation to depth as well as length and breadth, but as a yacht's freeboard may be regarded as an unalterable quantity after she is once ballasted, depth under water need not enter into the calculation, as the quantity of freeboard given by the rule is sufficient for any depth a yacht is likely to reach, and is at the same time appropriate for shallow yachts; indeed,

* Freeboard here means the least height of side from the water surface to the deck.

the freeboard might be reduced for very deep yachts without unfavourably influencing their performances; but in shallow yachts freeboard becomes an element in insuring safety, as it largely assists in lengthening out the range of stability.

Great depth of body under water, coupled with good freeboard, will insure a great range of stability; and, coupled with suitable length, ease, power, and dryness in a sea way; indeed so valuable has depth proved for these qualities that in reducing length and breadth a corresponding decrease in depth is seldom resorted to; thus whilst in large yachts of 300 tons we find the depth only equal to about half the beam, in small yachts of 5 tons the depth is nearly equal to the whole beam. [Depth as here used means the distance from the load water-line amidships to the top side of the keel at the centre of length of the vessel.] However, although depth does not vary directly as the beam varies, we find that it does vary in a ratio with the cube root of the beam, and a suitable depth for a yacht of any given beam can be found from the formula.

$D = \frac{B \times C}{\sqrt[3]{B}}$ where C is a constant quantity, found (on examining the proportions of many existing yachts) to be 1.2, when the beam is .225 of the length. For example, say the beam of a yacht is 8ft., thus :

$$\text{Depth amidships} = \frac{8\text{ft.} \times 1.2}{\sqrt[3]{8}} = 4.8\text{ft.}$$

The 8ft. beam is multiplied by the constant 1.2, and the product is then divided by the cube root of 8. The cube root of 8 is 2, so the sum would be :

$$\begin{array}{r} 1.2 \\ 8 \\ \hline 2) 9.6 \\ \hline 4.8\text{ft.} = \text{Depth amidships.} \end{array}$$

Similarly the draught of water amidships (which will depend upon the depth of wood keel and metal keel) can be roughly found by simply altering the value of C from 1.2 to 1.6 :

$$\text{Draught amidships} = \frac{8\text{ft.} \times 1.6}{\sqrt[3]{8}} = 6.4\text{ft.} \quad \text{or, } \begin{array}{r} 1.6 \\ 8 \\ \hline 2) 12.8 \\ \hline 6.4\text{ft.} = \text{Draught amidships.} \end{array}$$

The extreme draught aft would be two or three inches in excess of this, according to the requirements of the lateral resistance; but the ratio of depth of body to breadth will be found a suitable one for all yachts with a ratio of .225 of beam to length.

The value of C for depth amidships can be found from the following table for varied proportions of length and breadth :

| Ratio of Breadth to Length. $\frac{\text{Breadth}}{\text{Length}}$ | Value of C in the Formula Depth = $\frac{B \times C}{\sqrt[3]{B}}$ |
|--|--|
| 0.200 | C = 1.25 |
| 0.225 | C = 1.20 |
| 0.250 | C = 1.15 |
| 0.300 | C = 1.10 |
| 0.350 | C = 1.05 |
| 0.400 | C = 1.00 |

It must be clearly understood that this is not an attempt to set up an arbitrary value for depth in yachts of varied proportions and sizes. But the formula is the outcome of the examination of many yachts of different sizes and different proportions of breadth to length, and so far can be taken as a guide to determine depth, if depth be not already determined by some other conditions.

We have hitherto only considered the proportions of length, breadth, and depth from a cruising point of view, but the proportions would only require very slight modification for a yacht intended to compete under the Y.R.A. tonnage rule; but it is pretty certain that this tonnage rule—whether wisely or not need not be considered—has checked the full realisation of speed that a yacht of any given weight or displacement should be capable of.

It was shown in the last chapter that, with a given displacement, an excess of beam is an enormous advantage for effective sail-carrying power; and, according to some experiments made by Mr. Froude, and recorded by Mr. W. H. White in his valuable work on "Naval Architecture,"* an increase of beam may result in a decrease of resistance. In designing two river gun boats for the Royal Navy of 110ft. length, and 6ft. draught of water, the question arose as to whether it would be more advantageous for speed to give them a breadth of 34ft. instead of 26ft. Experiments were made, and the result was clearly pronounced in favour of the greater beam. The broader vessel had practically no straight of breadth, or great length of middle body; and she thus obtained a longer entrance and longer run, with a greater area of midship section. The displacement of the broader vessel was 370 tons, and that of the narrower 350 tons. The resistance of the broader boat at a speed of nine knots was only two-thirds that of the other, and this great advantage was mainly due to lesser wave-making. Whether in the case of vessels propelled by sails the advantage would be maintained by good performance in a strong wind and disturbed sea is

* See the "Manual of Naval Architecture," by Mr. W. H. White, page 461.

perhaps open to doubt (assuming of course that there was no limitation in the draught of water), as there is no question that a long and deep body with any given length and weight has some advantages over a short and shallow body in a sea. Still there equally can be no question that vessels like the *Guinevere* and *Seabelle* would have an accession of good qualities by a moderate increase to their beam, even though such increase were attended with additional displacement.

The lines of the famous cutters, *Kriemhilda* and *Vol-au-vent*, in a certain degree, form a notable illustration of the use of length of body for a sailing vessel under some circumstances. The *Kriemhilda* is remarkable for her long body, and comparatively full entrance and run. The *Vol-au-vent*, of equal displacement, length, breadth, and depth, has a greater area of midship section, and her ends are finer; in fact, she has a shorter and fuller middle body. So far as the evidence of the performances of these two vessels go, there is not much doubt that for high speed in smooth water the *Vol-au-vent* has some advantage; but in a much more marked degree the advantage rests with the *Kriemhilda* when sailing in a disturbed sea. If the *Vol-au-vent* had been given a little more beam, she would, in all probability, judged through the *Arrow*, have exceeded the performances of *Kriemhilda* on all points of sailing, and under all conditions; but an addition of 1ft. to *Vol-au-vent*'s beam would, under the present tonnage rule, have put a penalty of 12 tons upon her for competitive sailing, and no doubt the penalty would justly value the effect of the additional beam. Thus far the rule apparently operates with the strictest precision; but it is only fair to state that, if the rule took no cognisance of beam, both *Vol-au-vent* and *Kriemhilda* would probably have been given a foot more beam, and both would have been the better for it.

No doubt the difficulty in the way of successfully making any experiments with beam in the direction indicated is the Thames rule of measurement adopted by the Y.R.A. The penalty put upon beam, and the absence of any restriction upon depth or ballasting, have left, for the purposes of competitive sailing, little opportunity for the naval architect to make extended experiments based on the results of recent investigations of the laws of resistance. His ingenuity, consequently, is almost wholly directed to the question of stability as dependent upon depth of ballasting, and yachts are necessarily of one stereotyped form, as the results of the investigations referred to are not, so far as sailing vessels are concerned, so conclusive as to lead one to suppose that the certain penalty which is imposed upon beam in the tonnage rule for competitive sailing would be balanced by an accession of speed and other essential qualities for match sailing. This condition has been very seriously deprecated; but

it is some satisfaction to know that the Thames rule has encouraged a type of vessels that, for sea-going qualities, cannot probably be surpassed. The practical operation of the rule has been to produce a type of vessel which, although, for any given displacement, incapable of developing the highest speed under favourable circumstances for such, is for general accommodation and comfort, and good behaviour in a sea, excellent; and no other rule yet proposed has promised to develop such sterling qualities. As a means of comparing the speed or other qualities of yachts for competitive sailing, the Thames rule is approximately a correct one, as all the yachts sailing under it are of one type; but it is contended that the rule, by virtue of the penalty it places on beam, is not just in its operation upon yachts when the ratio of beam to length greatly varies. There is some truth in this; but, whilst realising the unjustness of the penalty placed upon beam, we must not lose sight of the dangers which would surround its removal.

Beyond these considerations the Thames rule of measurement is generally recommended, as an appropriate means of valuing yachts for competitive sailing, on the assumption that it gives results roughly proportional to sail-carrying power. Disregarding for the present that in the rule breadth is subtracted from length, the Thames rule is $\text{Length} \times \text{Breadth} \times \text{Half-breadth}$. The divisor 94 is a constant, and does not alter the relative value of the products obtained under the rule. The rule can be otherwise expressed, thus: $L \times \left(\frac{B}{2}\right)$, or $\frac{L}{2} \times B^2$; or the relative value under the rule would be maintained if the formula were simply $L \times B^2$. This brings us directly to the argument that the Thames rule gives a rough approximation to the sail-carrying power of a yacht, inasmuch as the sail moment of yachts is assumed to be proportional to the square of their breadth multiplied by their length, or $L \times B^2$. The sail moment is the area of sail multiplied by the height the centre of effort of the sails is above the centre of lateral resistance; thus we should have a constant proportion from $\frac{\text{sail spread} \times \text{height C.E.}}{L \times B^2}$. A constant proportion might be obtainable from the foregoing equation if breadth and depth of yachts were proportional through all sizes; but, as a matter of fact, the proportions of length, breadth, and depth vary a great deal; it is therefore not surprising to find that the sail moment is not uniformly proportional to $L \times B^2$. Thus, for the Sappho, 377 tons, we find the sail moment is 4.6 times the product of $L \times B^2$; for the Kriemhilda, 106 tons, the sail moment is 8 times the product $L \times B^2$; for the Freda, 5 tons, the sail moment is 11 times the product $L \times B^2$. It is thus quite clear that if an attempt were made to canvas yachts proportionally to the product $L \times B^2$, an unsatisfactory sail plan might very possibly result. It has already been pointed out

that the depth of yachts varies nearly as the cube root of their beam; and their sail spread, *if length, breadth, and depth were proportional*, would vary nearly as $L \times B^2$; hence it may be inferred that the sail spread will be approximately proportional to $L \times B^{\frac{4}{3}}$ or $L \times \sqrt[3]{B^2}$. It will be gathered from the foregoing that the Thames rule is not so strictly exact in estimating the pretensions of yachts for competitive sailing as sometimes thought; but this in practice is of little consequence so long as the yachts sailing under the rule are of one type.

The Y.R.A. rule fails because it takes no cognisance of changes made in the proportional quantities of beam and depth to length; this is of small consequence so long as the ratio of beam to length remains constant, but when that ratio is increased too great a tax becomes placed upon beam; and when the ratio is decreased the tax upon beam is too small. The intention of the Thames rule to class yachts for competitive sailing according to their sail spreads, or, in other words, according to their ability to carry sail, is no doubt a correct one, and we have ascertained how far a rule based on $L \times \sqrt[3]{B^2}$ would give results approaching the sail spread found in existing yachts. The rule it was found required modification, as it gave too much sail spread for comparatively small yachts; but with the $\frac{2}{3}$ power of the beam modified to $\frac{2^4}{3}$ power of the beam, or $\sqrt[3]{B^{2^4}}$, almost the exact sail spread of existing yachts was found, thus: $(\sqrt[3]{B^{2^4}}) \times (L \times 6)$. The constant 6 is merely introduced to bring the proportional sail spread, or "power," up to the exact spread, and does not alter the relative proportion of sail as between yacht and yacht.

The speed performances of yachts will be found to vary very nearly as the $\frac{2}{3}$ power of their sail spreads, and it will be thus easy to make the power for sail spread become the basis for a time allowance. In the table which follows the $\frac{\text{Sail spread}^{\frac{2}{3}}}{1.25} = \left(\frac{\sqrt[3]{\text{Sail spread}^2}}{1.25} \right)$ will be found given for a number of yachts. The divisor 1.25 has merely been introduced in order to reduce the value of sail spread $\frac{2}{3}$ by a regular proportion, so that the time scale of the Y.R.A. might be conveniently used. The Y.R.A. time scale for fifty miles, and applied to each yacht's rating $\frac{\text{sail spread}^{\frac{2}{3}}}{1.25}$ on a supposed course of *twenty-five miles*; in an adjoining column the actual time for Y.R.A. tons for a *twenty-five miles* course is given.

The table affords evidence that a rule for apportioning time upon the sail spread, as found by the formula $(\sqrt[3]{B^{2^4}}) \times (L \times 6)$, would be more just in its operation so long as depth varies as the cube root of the beam; but some other mode of ballasting might be introduced which would influence the value of depth. This very possibly might be the

case, but it is scarcely an argument in favour of retaining a rule which, as can be proved, is actually inaccurate in its operation.

| YACHT. | Length. | Breadth. | Y.R.A. Tons. | Sail Power = $\sqrt[3]{(B^2) \times L \times C.}$ | Actual Sail Area. | Sail Power $\frac{\dagger}{1.25}$ | 25 Miles Time. | 25 Miles Y.R.A. Time. |
|------------------------------|---------|----------|--------------|--|-------------------|-----------------------------------|----------------|-----------------------|
| | FT. | FT. | | | SQ. FT. | | M. S. | M. S. |
| Boadicea..... | 131.5 | 25 | 377 | 10336 | 10761 | 380 | 0 0 | 0 0 |
| Sappho..... | 122 | 27 | 377 | 10212 | 10233 | 377 | 0 12 | 0 0 |
| Guinevere..... | 121 | 23.5 | 294 | 9000 | 8611 | 346 | 2 19 | 3 6 |
| Columbia (centre-board)..... | 98.5 | 25.7 | 264 | 7950 | 8000 | 319 | 4 22 | 4 27 |
| Aline..... | 100 | 21.8 | 210 | 7032 | 6710 | 294 | 6 24 | 7 13 |
| Gwendolin..... | 100 | 21 | 197 | 6846 | 6903 | 288 | 6 55 | 8 6 |
| Seabelle..... | 90.5 | 19.1 | 144 | 5724 | 5780 | 256 | 9 52 | 12 0 |
| Florinda..... | 85.7 | 19.3 | 138 | 5520 | 5257 | 249 | 10 33 | 12 32 |
| Jullanar..... | 99 | 16.9 | 128 | 5680* | 5000 | 254 | 10 3 | 13 28 |
| Arrow..... | 79.2 | 18.7 | 117 | 4930 | 4770 | 232 | 12 19 | 14 36 |
| Formosa..... | 83 | 16.9 | 103 | 4780 | 4890 | 227 | 12 52 | 16 10 |
| Iona..... | 71.2 | 14.6 | 66 | 3612 | 3400 | 189 | 17 26 | 21 42 |
| Coryphée..... | 63.3 | 12.1 | 40 | 2802 | 2900 | 159 | 21 44 | 27 54 |
| Bloodhound..... | 59.8 | 12.3 | 40 | 2676 | 2600 | 154 | 22 32 | 27 54 |
| Maia..... | 50 | 9.7 | 20 | 1848 | 2000 | 120 | 28 45 | 36 24 |
| Vanessa..... | 47 | 9.8 | 20 | 1746 | 1732 | 116 | 29 35 | 36 24 |
| Maggie..... | 44.5 | 8.8 | 15 | 1542 | 1580 | 106 | 31 50 | 39 24 |
| Florence..... | 39.7 | 7.8 | 10 | 1230 | 1270 | 92 | 35 21 | 44 46 |
| Lily..... | 36.6 | 8.1 | 10 | 1152 | 1095 | 88 | 36 28 | 44 46 |
| Freda..... | 30.5 | 6.1 | 5 | 800 | 800 | 69 | 42 30 | 52 50 |
| Vril..... | 28.3 | 6.7 | 5 | 768 | 756 | 67 | 43 24 | 52 50 |
| Itchen..... | 23 | 8 | 5 | 700 | 660 | 63 | 44 46 | 52 50 |
| Alert †..... | 19.2 | 7.2 | 3½ | 550 | 430 | 54 | 48 35 | 57 0 |

The time between any two will be found by subtracting the smaller time from the greater.

The measurement most generally urged as the best to replace the Thames rule is that of displacement; but it cannot be contended that displacement of itself would afford any means of calculating the relative capabilities of different yachts. This was clearly shown in the last chapter, and the inference is that, if displacement were made the standard of value for competitive sailing, yachts would be built shallow and broad, in order that a great sail area might be carried upon a small displacement. It has been suggested that this tendency of the rule could be checked by making the displacement bear a certain minimum proportion to the length, breadth, and depth, or, in other words, that there should be a limit to the coefficient of fineness; but any limitation in this way, if otherwise unobjectionable, would not realise the desired object, as the proportion of displacement to the length, breadth, and depth would, under any circumstances, be pretty much the same in either a deep or shallow yacht.

The broad and shallow yacht would carry the largest amount of

* Has exceptionally small head sails.

† The Alert is a small centre-board yacht.

canvas, and so would have the greatest speed. As speed is the desideratum in racing yachts, it is right that a designer should be left entirely uncontrolled in developing that quality for a certain value—say the displacement. This appears to be reasonable enough, and would be entirely unobjectionable if no other qualities were sought in a yacht than those of mere speed. But, as yacht racing is not so much the aim of yachtsmen as cruising, they very properly look with great suspicion upon any innovation that would be likely to introduce a yacht deficient in the sterling qualities that the present type are known to have.

To forcibly illustrate the nature of the deficiencies that might be expected in yachts if displacement became the standard of value for yacht racing, we can take the case of the *Seabelle* and *Columbia*. The internal (available) capacity of the two yachts is about equal, but the expense of working the *Columbia* would be at least 50 per cent. greater than the expense of working the *Seabelle*. A yacht like the *Columbia* would be an indifferent sea boat, and her great spar and sail area, that would be of such importance for smooth-water sailing, would be only a dangerous incumbrance in a sea;* further, there is the positive danger that such a yacht might capsize if unskilfully handled. These deficiencies are quite sufficient to horrify any English yachtsman; and supposing that displacement became the basis for time allowance in competitive sailing, the only advantage of a *Columbia* would be that she would win prizes if matched against yachts of the *Seabelle* type. Thus, whilst we are fully alive to the objections to the Y.R.A. rule, we are entirely opposed to the proposal, most generally advocated, to change it for that of displacement: for the reason that, whilst the Y.R.A. rule places some check upon the full development of speed, it induces good sea-going qualities; whereas a measurement by displacement, whilst admitting unrestricted development of speed, would induce very bad sea-going qualities.

Whilst rejecting displacement if used by itself as a standard of

* On Oct. 18, 1871, the English yacht *Livonia* and American yacht *Columbia* sailed a match in New York Bay. They started in a fine whole sail breeze, which during the match much increased. The *Columbia* found it prudent to take in topsail and *stow her foresail*. The *Livonia* started nothing but her balloon maintopsail. In America a measurement of displacement and other causes (mostly of a local character, limiting draught of water) have induced a beamy, shallow type of vessel, undeniably fast and weatherly in moderate winds, but generally ill-adapted for such cruising as English yachts undertake. That the shortcomings of the English yachts *Cambria* and *Livonia*, in their contests for the American Cup, were to some extent attributable to their deficient sail areas compared with those of their antagonists is certain. In the club races no booming out or square sails were allowed, and the *Cambria* and *Livonia* were invariably beaten by the centre-board yachts before the wind; in the "scrub" races (sweepstakes got up independently of the club) booming out and any description of sail were allowed; the American yachts had none but their fore and aft sails to boom out, and the *Cambria* had square sails; the result was that she could more than hold her own "down wind" when in these scrub races.

competitive sailing, we are of opinion that it could be satisfactorily used in connection with the manner it enters into the calculation of statical stability. A rule based upon the statical stability of yachts would be unerring in its application, and if any number of competitors had equal stability success would be dependent upon form, apart from influences which may be termed accidental; but as exact calculations of stability involve such immense labour, we see no prospect of such a scientific test ever being applied to match sailing.

CHAPTER VII.

BALLAST.

THE displacement of a vessel is a quantity which enters very largely into any consideration of her stability, as was abundantly shown in a former chapter, and in no way does the knowledge of a yacht's displacement more largely assist the naval architect in his labours than in the matter of ballast. Most English yachts are built of pretty much the same scantling, and have similar internal fittings and spars; yet the weight, exclusive of ballast, of any two yachts of equal length and breadth may vary considerably, as will be gleaned from the following table, abstracted from "Yacht Designing":

| Name of Yacht. | Weight of Ballast in Tons. | Ratio of Ballast to Displacement. | Displacement in Tons. | Tonnage Y. R. A. Rule. |
|-------------------|----------------------------|-----------------------------------|-----------------------|------------------------|
| Sappho | 80 | ·345 | 232 | 376 |
| Guinevere | 112 | ·377 | 297 | 294 |
| Gwendolin | 90 | ·445 | 202 | 192 |
| Cambria | 65 | ·389 | 167 | 193 |
| Aline | 70 | ·368 | 190 | 207 |
| Seabelle | 73 | ·471 | 155 | 140 |
| Egeria | 60 | ·422 | 142 | 152 |
| Livonia | 70 | ·325 | 215 | 264 |
| Florinda | 52 | ·361 | 144 | 136 |
| Jullanar | 80 | ·506 | 158 | 128 |
| Formosa | 60 | ·462 | 130 | 103 |
| Arrow | 40 | ·377 | 106 | 117 |
| Kriemhilda | 52 | ·452 | 115 | 106 |
| Vol-au-vent | 54 | ·450 | 120 | 104 |
| Fiona | 50 | ·463 | 108 | 79 |
| Iona | 35 | ·486 | 72 | 66 |
| Myosotis | 26·5 | ·541 | 49 | 40 |
| Bloodhound | 26·5 | ·564 | 47 | 40 |
| Vanessa | 16·5 | ·579 | 28·5 | 20 |
| Maia | 16 | ·500 | 16 | 20 |
| Lily | 6·75 | ·523 | 12·9 | 10 |
| Pastime | 8·44 | ·538 | 15·6 | 10 |
| Kohinoor | 8 | ·544 | 14·7 | 10 |
| Florence | 8·5 | — | — | 10 |
| Freda | 4·6 | ·605 | 7·6 | 5 |
| Vril | 4·6 | ·676 | 6·8 | 5 |

It is very evident that, the greater quantity of ballast a vessel has in proportion to her displacement, the lower ought to be her centre of

gravity, and, as a sequence, the greater ought to be her stability. A yacht builder, therefore, even if he disregards the simple calculation of the displacement of a vessel he is commissioned to construct, will know that, so far as sail-carrying power is concerned, an advantage must accrue from making the fabric of the hull as light as possible, consistent with security, if the vessel be intended for racing.

But, as already pointed out, it must not be concluded that of two vessels of equal length, breadth, and draught of water, and equal scantling so far as sizes of timbers, beams, and planking go, the weight of the hull need be the same. The probability is that the vessel of the larger displacement will carry the greater proportionate weight of ballast, as is very pointedly exemplified in the case of the *Sappho* and *Guinevere*. Now the *Sappho* is a much lighter-built boat than *Guinevere*; yet, in proportion to displacement, it will be seen that she carries a smaller quantity of ballast. The reason of this is dependent upon the different forms taken by the vertical sections in the two vessels. The *Guinevere's* midship section is of the peg-top form, and the greatest girth of the midship frame, from the load line to the keel, is 16ft.; the *Sappho* has a section very flat from the bilge to the garboard, and then very curved. The consequence is that the girth or length of the frame, from the load line to the keel, is nearly 20ft.; and there will be a proportionate excess of length in nearly every frame; and as a consequence, an excess of plank as well. For this reason, unless vessels of similar linear dimensions be also of similar form, they need not have the same ratio of ballast to displacement. It will be noticed in the table that as the tonnage size of the yachts decreases the ratio of ballast to displacement increases; the cause of this is that depth in a small yacht is relatively greater than in a large one—or, in other words, the depth is not made to decrease in proportion to the decrease in the other two dimensions of length and breadth.*

A very great change has been wrought in the manner of ballasting yachts during the last quarter of a century, and we cannot help declaring that generally a better type of vessel for speed and weatherliness has been built since ballasting has received greater attention. Scrap iron, fire bars, and even stone, were the common form of ballast in the first days of the Squadron, with a few shot bags to trim to windward in the event of match sailing. We all know that, as the pastime of yachting developed, a taste for yacht racing was very rapidly disseminated, and ballast shifting came to be regarded as part of the science of the sport; and thus success, in fair sailing breezes, frequently rewarded the man who had the greatest weight of shot bags, and the greatest number of men

* See page 52.

to shift them. There is no denying that the absence of restrictions upon the shifting of ballast was introducing us to a very bad type of vessel, and the thanks of the present generation are due to the men who some twenty years ago succeeded in placing a stringent prohibition upon the practice of trimming ballast to windward. In 1856, in all competitive sailing, it was made a point of honour with yacht owners that they would not permit ballast to be shifted during a race; and at the present time a man who is convicted of a breach of the rule is—or rather would be, as no breaches of the rule are brought to light—regarded as a little worse than a thief, and would certainly be ostracised by every yacht club in the kingdom. There is nothing heinous in the mere act of shifting ballast; but when the non-doing of it is made an affair of honour, it follows that dishonour must attend a breach of the rule.

When the prohibition of shifting ballast came into operation, it was only reasonable that yachtsmen and yacht builders should devise some plan to enable the yachts to continue to carry the enormous spars and sail areas that shifting ballast had called into existence. The shot bags that had been shifted from bilge to bilge were permanently located in a solid form in the bottom of the hull, and metal keels—generally of iron—became fashionable. Then lead keels were timorously introduced; but the man who owned a yacht that would not stand up without a lead keel was regarded with a feeling which was a mixture of contempt and pity. Indeed, lead ballast generally was contemned, and when a yacht first appeared with “all lead ballast,” many so little understood the subject as to predict that she would “get caught some day, and sink like a stone.” This comical prediction, so far as we know, has not been verified, and “all lead” for racing vessels is now commonly employed as ballast. There seems to be no limit to the proportion of ballast to be carried outside, and, whilst the general practice during the last three or four years has been to put about one fourth of the ballast outside, on the keel or in the garboards; we have seen as much as four-fifths of the total ballast put outside some 10 and 5 tonners. Generally we agree that the employment of a lead keel has advantages; and probably the practical failure of one or two attempts which have been made to balance a bad type of vessel—built to evade the effects of a tonnage rule—by the aid of weights stowed very low, will check any evil influence the unlimited employment of lead as ballast might be supposed to have.

In some remarks on ballast, in “Yacht Designing,” the following occurs: “The principal advantage of using lead as ballast is that, owing to its greater specific gravity or smaller bulk for any given weight, it can be stowed as a whole in a lower position in the hull than a similar weight

of iron, and thus bring about a lower position of the centre of gravity of the vessel, which simply means that, with any given weight, greater stability can be acquired by using lead as ballast than by using iron. Next, as the centre of gravity of a vessel can be brought so much under command by the use of lead and lead keels, advantage has been taken of this to decrease the displacement for any given linear dimensions, and thereby increased fineness of lines has been obtainable. In this respect the employment of lead as ballast has had a beneficial effect. It has enabled naval architects to design vessels equal in accommodation to those of much greater cubical contents, that necessarily had to provide a large space for ballast, and at the same time to nearly equal in initial stability and speed the broad shallow vessels which are deficient in internal accommodation."

In order to get the centre of gravity of the ballast as low as possible, the practice is, in most racing yachts, though not in cruisers, to distribute the weights in a fore-and-aft direction; and in order that as much weight as possible can be got into a metal keel, the latter is frequently made to reach five-sixths of the length of the vessel, measured from the heel of the keel. For smooth-water sailing nothing but clear gain, so far as stability is concerned, will result from having the weights well distributed in a fore-and-aft direction; but the case will be different among waves, no matter whether the ballast be lead, iron, quicksilver, or pumice stone. The longer the radius of gyration and the greater the metacentric height are made, the more violent will be the pitching and scending motions among waves, and the vessel will dive, and be very wet and uneasy. But, on the other hand, if the weights are much concentrated, the vessel, whilst diminishing the momentum that caused her to plunge into a wave or "dive," will be extremely lively, and probably rise to every wave crest, large or small. The vessel with the longer radius of gyration will not so accord with the waves; and, although she may be "carrying her canvas better," yet will she so bury herself, that to sail her must be a work of great difficulty and even danger to spars. In moderate weather, and among comparatively small waves, the case might be somewhat different, as the momentum acquired would be unimportant, and the fore-and-aft motions of a vessel with a long radius of gyration would consequently be slow; whereas, a vessel with her weights much concentrated would tend to keep time with the waves, or would be what is termed "lively," and the sails would not "sit" quietly. This is particularly noticeable in little boats, and often among *small* waves better results are obtained by stowing the weights well fore-and-aft. As a general rule, the best place for the ballast is in the middle third of the length of the vessel; and if one third, more or less, of the ballast takes the form of a lead keel, the latter should not

be greater in length than four-sixths of the length of the vessel on the load water-line.

Various ingenious methods of ballasting have from time to time been adopted or proposed, and we have seen it suggested that ballast should be slung, or that it should have elastic bearings. It need scarcely be pointed out that moving-ballast among waves would be a very bad thing, as the momentum acquired by the ballast would in effect augment the general momentum of the vessel: and further, if the ballast were "slung," it would shift to leeward upon the vessel being heeled by a wind force, and would be in effect like trimming ballast to leeward instead of to windward. The most ingenious and elaborate plan yet adopted in the way of ballasting is that introduced by Messrs. Harvey and Pryer; it consists of lead floors with angle iron inserted; lead keelson, with lumps of lead underneath it between the floors moulded to fill the spaces, and a lead outside keel. This plan was very successfully tried in the *Seabelle*; she is wonderfully stiff, and is said to be easy among waves; at any rate, she has on two or three occasions done so well against a heavy head sea that there cannot be a doubt on this point, and it may be concluded that her ballast plan has had no detrimental effect upon her qualities as a sea boat.*

So far as small vessels are concerned, it is unusual now to have wood cross floors and keelson, for two reasons: firstly, because it is almost impossible to get grown floors for vessels with sharp bottoms, or great "rise of floor" as it is termed; and, secondly, because the throats of wood floors and the keelson occupy a space which is much better filled by ballast. The keel of a ten-tonner in "siding" or breadth is more than double what it was before the era of lead keels, and this great breadth is resorted to partly that a heavy lead keel may be carried, and partly that the strength lost by the absence of floors and keelson may be compensated for.

The upper edges of the wood keel between the frames are sometimes cut away, in order to give additional space for ballast; in fact, every care is taken that all the crevices are filled, and that the ballast is cast so as to be stowed as much like a solid mass as possible. Some ten years ago a plan was introduced of running about half the ballast into the vessel hot; and certainly this plan so far fulfilled its object, that the ballast was solid, and all the small spaces were filled.† But the plan was objected to for the

* See a plate of *Seabelle's* Ballast Plan in "Yacht Designing." Since *Seabelle* was built Messrs. Harvey and Pryer's "patent floors" have been used in several yachts. The *Miranda* and *Bakaloun* have them; whilst the *Corinne* schooner, built by Mr. Ratscy, and the *Ada* yawl, built by Messrs. Camper and Nicholson, have lead floors without the angle iron, the latter being inserted within the lead when casting merely to increase the strength. All these vessels are fine able sea boats.

† See "Lead Ballast" in the Appendix.

reason that if anything went wrong with the frame of the vessel, or if the ballast required shifting, it was such a very great labour to cut the solid mass out. The best plan is to have two-thirds of the ballast cast from moulds, in blocks of from 2cwt. to 4cwt., as may be convenient, and the remainder in ingots, square and triangular in shape, of 1cwt. and $\frac{1}{2}$ cwt. each. Some loose ballast will always be required to trim the vessel in a fore-and-aft direction, and the large blocks, whilst they are difficult and dangerous to move, cannot be "stowed" if shifted from the places they were moulded to fill. The moulds for the lead ballast should be made very exact, so that the lead blocks fit between the frames without loss of space. At the same time, care must be taken that the blocks do not rest on the plank.

Sometimes in small vessels the spaces between the heels of the timbers and the keel are filled with concrete (made of shot and cement) up to the level of the top of the keel, hogging piece, or keelson. If this plan is adopted, all the surfaces of the spaces should be well tarred, and the concrete should be well worked into every crevice, otherwise the damp may rot the heels of the frames and the plank, or foul bilge water may accumulate.

CHAPTER VIII.

SPARS.

A GREAT many arbitrary and empirical rules have been from time to time proposed for the placing of masts in yachts, and for regulating their lengths; but, as there appears to have been an inability to base these rules upon the actual stability of a vessel, they are little better than clever guesswork, and might very well prove fallacious; in fact, a yacht is generally sparred upon what may be termed a principle of comparison. The builder, according to his judgment and experience (which generally lead him to a right, but occasionally to a wrong, result), fixes upon the lengths of the spars without any reference to rules whatever, as he is conscious that the rules, although mysteriously contrived, might lead him astray. The result of the chance system is that the masts very frequently have to be reduced, and not unfrequently have to be increased in length.

No doubt masts affect the stability of a vessel to an enormous extent, and we find in *Seabelle* that 30 per cent. of her ballast goes to counteract the leverage of her masts alone. A cutter is better off in this respect, as she has only one mast; but even in a cutter as much as 20 per cent. of the ballast was found to be required to balance the moment of the mast. As masts so largely affect the stability of a vessel, it will perhaps be conceded that a little more care and trouble should be taken in deciding upon their lengths. The position of a vessel's centre of gravity can be appropriately calculated before she is built, and the exact influence the mast will have on that centre will form a large item in the calculation. The objections which we have heard urged against making these calculations are, firstly, that they are very troublesome; and secondly, that in the hands of an incompetent person they might be as misleading as any empirical rule. The obvious reply to these objections is, that, troublesome as the calculations may be to those who ordinarily construct yachts, plenty of men can be found who would undertake them; and to the second objection we would reply by the

question, Why should such calculations be placed in the hands of incompetent persons? But a naval architect would not be content with calculations, but would test the stability of a vessel he had designed, unmasted, when afloat. After these experiments had been conclusively made, the effect of a certain length and weight of mast upon the stability could be easily calculated. The sail area would next be determined by the stability of the vessel thus masted, as explained in Chapter V. It might be found that the figure and area of the sails allowed of the masts being reduced; and there would be this certainty, that, whatever was wrong with the vessel, she was neither over-sparred nor over-canvased. It certainly does seem incredible that, when there is a certain way of proceeding, some yacht constructors should persist in deciding on the length of spars by "rule of thumb," and then giving the length of those spars to the sail maker, who gets as much canvas upon them as he conveniently can.

One of the so-called "rules" referred to is to make the length of the lower masts proportional to the beam; and, although this rule might easily be misleading, yet it is as much to be relied upon as some of the others, which are a little more complicated.

LENGTH OF SPARS FOR SCHOONERS.

For schooners, the rule was to make the foremast, measured from deck to hounds, equal to the breadth multiplied by 2·7, and length of the masthead equal to 0·18 the length of mast from the deck to the hounds.

Mainmast, equal to the breadth \times 2·85, with length of masthead equal to 0·18 of the length of mast from deck to hounds.

Main boom equal in length to the length on the water line multiplied by the fraction 0·58, and main gaff equal in length to 0·7 of the length of the boom.

Length of fore gaff equal to 0·322 of the length on the load water line.

Bowsprit (or bowsprit and jib boom taken together) outside the stem, equal to breadth \times 1·75.

Fore spinnaker boom equal to the length from foremast to bowsprit end, because fore spinnaker is used as bowsprit spinnaker.

Main spinnaker boom equal to length of mainmast deck to hounds \times 1·2; but generally the main spinnaker boom is made so that it will just clear under the triatic stay without its being unshipped at the gooseneck.

The length of main topmast from fid to hounds, or to sheave hole for topsail halyards, ·65 of the length of mainmast deck to hounds; the foretopmast, ·9 of the length of maintopmast.

Working gaff topsail yard, equal to the length of the gaff over which it is set.

LENGTH OF SPARS FOR CUTTERS.

For cutters, the length of mast, deck to hounds, can roughly be put at 3 times the greatest breadth, and masthead 0·25 of the length deck to hounds.

Main boom, equal to the length on load line multiplied by 0·9.

Main gaff, 0·63 of main boom.

Angle of gaff with horizon, 50° to 55°.*

Bowsprit outside the stem, equal to the breadth of the vessel multiplied by 2; or ·45 of the length on the load water-line.

Length of bowsprit housed is usually the length of bowsprit outside multiplied by ·4.

The topmast of cutters in length, from fid to hounds, is usually ·8 of the length of the lower mast deck to hounds. In small cutters of 40 tons and under, the ratio is frequently ·9, and occasionally a 10 tonner may be met with the length of topmast equal to length of lower mast.

Topsail yards vary in length a great deal, but to some extent are guided by the length of the gaff over which they are set. Formerly all racing vessels carried a "balloon topsail," or a topsail with a long head yard, whilst the foot was extended beyond the gaff by a foot yard or jack yard. The head yard of a balloon-topsail was from 1·3 to 1·5 the length of the gaff over which it was set. The No. 1, or working-topsail† had a yard equal to the length of the gaff, and No. 2 topsail a yard equal to ·6 of the length of the gaff. Cutters, however, do not now always carry a balloon topsail, but have a big working topsail with a head yard of from 1·1 to 1·2 the length of the gaff, and 2nd topsail ·7 of the length of the gaff.

Spinnaker booms vary in length from 1·1 to 1·3 the length of lower mast deck to hounds.

These proportions for cutters appear to be followed with tolerable exactness, but are of course variable, as will be gathered from the table which follows. In this table, the length on the load line is given, and the breadth, and the proportions the spars bear to these dimensions.

Formerly the ratio of main boom to length on the load line was given at ·97, but of late years the length of vessels in proportion to their breadth has been much increased; and the main booms now are more nearly 0·85 of such length.

The ratio of the length of the bowsprit is given in terms of the length

* Twenty years ago sails were cut much flatter in the head than at present; but a sail with a high peak appears to stand as well as one with a low peak, and a much larger sail for the same weight of spars can be obtained by increasing the peak.

† Called a working topsail because a vessel can work to windward with it in a whole sail breeze.

of the load water-line, but it does not bear a constant proportion to that length; in fact, the length of bowsprit is generally more nearly double the extreme beam; but obviously the length of the bowsprit and the length of boom or gaff must depend upon the requirements of the centre of effort of the sails, and upon their figures or shapes.

LENGTH OF SPARS FOR YAWLS AND KETCHES.

The mainmast of a yawl in length, deck to hounds, is about 2·9 times her beam; the length of main boom is governed by the distance between the mainmast and mizenmast. Main gaff about ·75 of the length of main boom. The length of the mizenmast of a yawl, from step on deck to hounds, is usually ·7 of the length of the mainmast deck to hounds; occasionally, however, it is no more than ·6 of the length of mainmast. The mizen boom is ·5 of the length of main boom. Mizen yard ·65 of the length of main gaff.

The bowsprit of a yawl is generally about ·4 of the length on the load water-line, and rarely is as long as the bowsprit of a cutter of similar size. The first impression would be that a yawl, owing to her mizen being stepped so far aft, would require a longer bowsprit than a cutter, but in practice this is not found to be the case. In fact, as a rule, a yawl carries a very slack helm on a wind in moderate breezes, and the reason is that the eddy wind from the mainsail strikes the fore cloths of the mizen sail from the leeward, so that all the fore part of the sail generally lifts, and this unsteadiness in turn disturbs the currents of air that are approaching the mizen sail from to windward, the final result being that for close-hauled sailing the mizen is a much less effective sail than is generally supposed. In sailing "along" the wind one, two, or three points free, the mizen is generally sheeted somewhat flatter than the mainsail, so that the eddy wind from the latter does not disturb it. The mizen then does its full share of work.

The mainmast of a ketch in length, deck to hounds, is about 2·7 times her beam. The mizenmast of a ketch, deck to hounds, is about ·8 of the mainmast.

The ketch rig has seldom been adopted for yachts, one reason probably being that, the mizen mast being stepped forward of the sternpost, it comes very much in the way of the tiller, and the boom has to be kept a great height above the deck. Another objection to the ketch rig is that the sails are necessarily narrow in proportion to their height, and for this reason their heeling movement for any given area is greater than is the heeling movement of the squarer sails of a cutter or yawl.

It must be clearly understood that the rules given for finding the dimensions of spars are only applicable to racing yachts; for cruising yachts the spars should be at least 8 per cent. less; or 1ft. should be

taken off every 12ft. 6in. of the proportions found by any of the rules. For example, if the beam of a cutter yacht be 8'33ft., then her mast would be three times her beam, or $8'33 \times 3 = 24'99$ ft. = length of mast deck to hounds. This would practically be 25ft., and as there are two lengths of 12ft. 6in. in 25ft., the mast for cruising would require to be reduced exactly 2ft., that is to say, to 23ft. The other spars would be reduced in proportion.

| Name. | Rig. | Length of L. W. L. | Extreme Beam. | Ratio of Beam to B length = L | Extreme draught of water. | Length of Mainmast, Deck to Hounds. | Ratio of Foremast to Mainmast. | Ratio of Mainmast to Beam. | Length of Bowsprit outside Stem. | Ratio of Length of Bowsprit to Length L. W. L. | Extreme Length of Main Room. | Length of Main Gaff. | Length of Topmast Fld to Halyard Sheave. | Area of Lower Salts. |
|-----------------|------|--------------------|---------------|-------------------------------|---------------------------|-------------------------------------|--------------------------------|----------------------------|----------------------------------|--|------------------------------|----------------------|--|----------------------|
| | | FT. | FT. | | | FT. | | | FT. | | FT. | FT. | FT | SQ. FT |
| Sappho | s | 122 | 27 | .221 | 13 | 73.0 | 0.94 | 3.07 | a 66 | 0.55 | 81 | 47 | 48 | 10223 |
| Guinevere... | s | 121 | 23.5 | .192 | 12 | 69.5 | 0.93 | 2.95 | 44 | 0.36 | 77 | 44.5 | 45 | 8611 |
| Shamrock ... | s | 105 | 25.5 | .243 | 12 | 66.0 | 0.91 | 2.64 | b 39 | 0.37 | 64 | 39 | 38 | 6985 |
| Livonia | s | 107.5 | 23.5 | .220 | 12.8 | 66.0 | 0.95 | 2.80 | 38.5 | 0.35 | 70 | 43 | 44 | 7618 |
| Columbia ... | s | 98.5 | 25.5 | .259 | 5.9 | 69.5 | 1.00 | 2.70 | c 57 | 0.57 | 72.5 | 34.5 | 41 | 8000 |
| Aline | s | 100 | 21.7 | .217 | 11.6 | 63.0 | 0.93 | 2.90 | 34 | 0.34 | 63 | 36 | 36 | 6710 |
| Cambria ... | s | 100 | 21.1 | .211 | 12.4 | 62.0 | 0.93 | 2.95 | 41 | 0.41 | 63 | 37 | 35 | 6418 |
| Gwendolin ... | s | 100 | 21 | .210 | 13 | 63.0 | 0.92 | 3.03 | 39 | 0.39 | 70 | 39 | 35 | 6903 |
| Egeria | s | 93.7 | 19.2 | .205 | 12.5 | 58.0 | 0.90 | 3.00 | 32 | 0.34 | 63 | 36.5 | 35 | 5988 |
| Seabelle..... | s | 90.5 | 19.1 | .211 | 12 | 59.5 | 0.87 | 2.13 | 36 | 0.40 | 63 | 38 | 38 | 5780 |
| Pantomime ... | s | 91.5 | 19.3 | .211 | 12 | 57.5 | 0.92 | 3.00 | 31.5 | 0.34 | 58 | 35 | 34 | 5657 |
| Dracena ... | s | 80 | 18.0 | .225 | 10 | 52.0 | 0.94 | 2.90 | 28 | 0.35 | 48 | 30 | 30 | 4005 |
| Flying Cloud | s | 73.5 | 15.7 | .213 | 9.5 | 46.0 | 0.95 | 2.93 | 23.5 | 0.33 | 46.5 | 28 | 28 | 3632 |
| Florida ... | y | 85.7 | 19.3 | .225 | 11.9 | 54.5 | 33.5d | 2.83 | 36 | 0.42 | 56.5 | 42.5 | 44 | 5257 |
| Jullanar ... | y | 99 | 16.9 | .170 | 13.8 | 53 | 36d | ... | 24.5 | ... | 56.5 | 42 | 38.5 | 5000 |
| Caroline ... | y | 75 | 16.1 | .215 | 11.5 | 43.5 | 24d | 2.72 | 31 | 0.41 | 50.7 | 37.0 | 35 | 3700 |
| Oimara | y | 95 | 19.9 | .209 | 13 | 58.5 | ... | 2.93 | 47 | 0.50 | 70 | 47.5 | 48 | 5500 |
| Kriemhilda ... | c | 79.3 | 17.5 | .221 | 12.3 | 47.5 | ... | 2.72 | 36 | 0.45 | 65 | 43.5 | 44 | 4405 |
| Formosa ... | c | 82 | 16.9 | .206 | 12.5 | 48.7 | ... | 2.88 | 34 | 0.41 | 68 | 45 | 42 | 4890 |
| Vol-au-vent ... | c | 79.5 | 17.4 | .219 | 12.4 | 48.5 | ... | 2.79 | 34 | 0.42 | 67.5 | 43 | 42.5 | 4500 |
| Arrow | c | 79.2 | 18.7 | .236 | 11.5 | 49.3 | ... | 2.70 | 34 | 0.43 | 64 | 46 | 41 | 4770 |
| Fiona | c | 73.5 | 15.8 | .215 | 12.2 | 44.5 | ... | 2.78 | 34 | 0.46 | 60 | 38 | ... | 3720 |
| Iona | c | 71.2 | 14.6 | .205 | 11 | 48.5 | ... | 3.02 | 32 | 0.45 | 57.5 | 35.5 | ... | 3400 |
| Sixty | c | 70 | 14.2 | .203 | ... | 44 | ... | 3.10 | 30 | 0.43 | 55.5 | 36.5 | 42 | 3400 |
| Bloodhound | c | 59.8 | 12.8 | .205 | 9.4 | 38.0 | ... | 3.14 | 28 | 0.46 | 49 | 31.5 | 31 | 2600 |
| Coryphée ... | c | 63.3 | 12.1 | .191 | 9.9 | 40.0 | ... | 3.30 | 27 | 0.42 | 52 | 34 | 32 | 2900 |
| Gleam | c | 59 | 12.5 | .212 | 9 | 36.5 | ... | 2.90 | 26 | 0.44 | 48 | 32.5 | 32 | 2500 |
| Myosotis ... | c | 59 | 12.4 | .210 | 10 | 37.0 | ... | 3.00 | 27 | 0.45 | 47 | 31.5 | 31 | 2450 |
| Sayanora ... | c | 50 | 9.7 | .194 | ... | 34 | ... | 3.61 | 24 | 0.48 | 46 | 27 | 28 | 2050 |
| Vanessa ... | c | 47 | 9.8 | .209 | 7.8 | 31.5 | ... | 3.18 | 24 | 0.51 | 39 | 27.5 | 26.5 | 1732 |
| Maia | c | 50 | 9.7 | .194 | 8.8 | 34.5 | ... | 3.55 | 24.5 | 0.50 | 43 | 30.0 | 30.7 | 2000 |
| Ildegonda ... | c | 40 | 9.5 | .237 | 7.5 | 29.0 | ... | 3.08 | 20.6 | 0.51 | 36 | 27.0 | 25 | 1550 |
| Dudu | c | 39 | 9.7 | .248 | 6.9 | 28.2 | ... | 2.87 | 20 | 0.51 | 33.5 | 24.0 | 25.5 | 1520 |
| Torch | c | 43.5 | 9.0 | .207 | 7 | 28.5 | ... | 3.20 | 20.3 | 0.47 | 34.5 | 23.4 | 24.2 | 1530 |
| Maggie | c | 44.6 | 8.8 | .197 | ... | 29.0 | ... | 3.30 | 21 | 0.47 | 37 | 25.5 | 26 | 1580 |
| Lily | c | 36.6 | 8.1 | .221 | 6.8 | 25.0 | ... | 3.09 | 17 | 0.46 | 31.5 | 23.0 | 24 | 1095 |
| Pastime ... | c | 37.3 | 7.8 | .209 | 6.8 | 25.0 | ... | 3.20 | 17 | 0.45 | 31.5 | 22.5 | 22 | 1000 |
| Florence ... | c | 39 | 7.8 | .200 | 6.5 | 27.0 | ... | 3.46 | 19 | 0.48 | 32.5 | 24.3 | 22.5 | 1190 |
| Quiraing ... | c | ... | ... | ... | ... | 27.8 | ... | ... | 20 | ... | 33 | 24 | 25.5 | 1207 |
| Vril | c | 28.3 | 6.5 | .230 | 6.5 | 22.0 | ... | 3.00 | 14.5 | 0.51 | 24.8 | 19.0 | 18.5 | 756 |
| Freda | c | 30.5 | 6.1 | .200 | 5.3 | 21.0 | ... | 3.44 | 15.5 | 0.50 | 26 | 18.5 | 18 | 800 |

a Bowsprit, 30ft. ; jibboom, 36ft.

b Bowsprit, 24.5ft. ; jibboom, 20ft.

c Bowsprit, 24.5ft. ; jibboom, 33ft.

d Length of mizenmast deck to sheave hole.

In determining upon the length of main boom, the designer of the sail plan will be almost wholly guided by the figure of the sails; nevertheless, it must be always borne in mind that the shorter the boom is, the lighter it will be, and the more the weights—which are necessarily above the centre of gravity—can be reduced, the stiffer the vessel will be. Some confusion, however, occasionally appears to exist about this matter in consequence of the erroneous supposition that the quarters of a vessel bear the weight of the boom by some independent support, and sailors frequently say of a vessel, “She’ll never bear the weight of that great boom with those lean quarters.” It has already been pointed out that any weight a vessel carries has its support through the common centre of gravity of the vessel (Fig. 3); and lean quarters will no more interfere with a vessel carrying a long and heavy main boom than a lean bow will. But a long, heavy boom, the same as a long, heavy bowsprit, will tend to increase the momentum acquired during pitching and scending in a sea way; and, moreover, it will also tend to increase this momentum because a main boom is somewhat free in its action, and is not stayed in an immovable position, the same as a mast or a bowsprit is. Then, again, a main boom is always more or less off the lee quarter, and thus assists in heeling a vessel; and, of course, the heavier a boom is, the more potent this assistance will be. But a “leanness” of the quarters has nothing to do with this matter, further than that lean quarters affect the general question of stability.

In giving a vessel a light boom, however, it should never be lost sight of that about the worst thing in a vessel’s outfit is a weak boom. With a weak boom the mainsail can never be made to stand properly if there be the least semblance of a breeze; and, moreover, so far as danger to the crew goes, a worse accident cannot happen to the spars than the breaking of the main boom.

With regard to the placing of the masts, a great many rules have been given; but the soundest advice is to keep them as near to the centre of gravity of the vessel as possible, if it is sought to make a yacht easy in a sea-way. The weight of the masts, by lengthening out the radius of gyration, much increases the violence of pitching; and the shorter the masts are, and the nearer they are stepped to the centre of gravity of the vessel, the less they will operate to aggravate pitching. A quarter of a century ago, the *America* introduced the fashion of raking masts aft, and no doubt there was some reason in it, if it were absolutely necessary that masts should be stepped very far forward. By raking the masts aft, their weight was carried aft in proportion to the sine of the angle of rake, and so, although a mast might have been stepped very far into the bows of a

vessel, yet would its weight fall very near the centre of gravity. However, experience soon undid this fashion, as it was ascertained that sails of better figures, which could be more easily worked, were to be obtained by stepping the masts a trifle further aft, and upright.

So far as cutters are concerned, the general rule appears to be to step the mast 0·4 of the length on the load water-line abaft the fore side of the stem.* This position is found to be near enough to the centre of gravity of a vessel to avoid any bad effect on her ease in a seaway; and generally, if any good results through stepping a mast 6in. further forward or aft, the good is traceable to the altered position of the centre of effort of the sails rather than to the shift that has been made to the weight of the mast. Of course, if the centre of effort of the sails cannot be altered or adjusted, without shifting the mast, this extreme measure must be adopted; but the constant craze some sailing masters have for shifting masts backwards and forwards should never be gratified from the mere assertion of "I'm sure this 'ere vessel would do a great deal better if her mast was moved six inches further aft; we shifted the Old Nailsick's six inches aft, and she went as well again afterwards." This is usually the skipper's "theory," and, as the builder is very properly anxious to do anything to improve his construction, the mast is generally shifted after the skipper's sententious opinion. A mast may require shifting: but often a little addition to the fore foot, or a little taking away from it, or a trifling alteration to the sail plan, will correct a vessel's indifferent performance and handiness when sailing on a wind.

The mast of a yawl is generally placed a little farther forward, or about ·38 of the length on the load line abaft the fore side of the stem. The mast is placed so far forward in order that the mainsail may be large, as the Y.R.A. have limited the extension of the boom aft the stern end of the load water line to two-fifths the beam. The mizen mast of a yawl generally has a slight rake aft, in order that the main boom may clear it, as frequently the length of counter will not admit of it being stepped sufficiently far aft to clear the boom if no rake be given.

With regard to schooners, the present plan, in order to secure good weatherly qualities, is to make them as much like cutters as possible. In racing schooners at least the comfort of a good large boom foresail is an unknown thing; but the advantage of having a big mainsail, or as much canvas as possible in one piece, is too great to be sacrificed for comfort. In

* A quarter of a century ago, when vessels were shorter in proportion to breadth, a cutter's mast was usually placed 0·334 to 0·371 of the length on the load line abaft the fore side of the stem, and even then so long was the main boom that it had a very great overhang abaft the taffrail.

a like way the exigencies of yacht racing have gradually turned the once comfortable yawl, with her mizen stepped close to her rudder-head, into a vessel that, so far as her ease in a sea is dependent on her spars, might almost as well be a cutter.

The masts of a ketch are thus placed; mainmast 0·11 of the length of load water line *forward* of the centre of length of load water line; mizen-mast 0·4 *abaft* the centre of length.

The sizes or girths of spars vary a great deal according to the pine chosen, but the general fashion now is to have Oregon or Vancouver pine for masts, and red Riga pine for booms and bowsprits. The diameter of schooner's masts at the deck is generally from ·023 to ·025 of the length from deck to hounds; thus, say a schooner has a mast 30ft. from deck to hounds, then the diameter at the deck will be $30 \times \cdot 025 = 0\cdot 75$ ft. or 9in.; this will be for tough Oregon or Riga pine; for pines of less breaking strength ·027 will be a better proportion. The diameter of the mast at the hounds is generally about ·85 of the diameter at the deck; or, if the diameter at the deck be ·75ft., then $\cdot 75 \times \cdot 85 = \cdot 637$ ft., or 7½in.

The diameter of a cutter's mast at the deck varies from ·025 of the length deck to hounds for 5-tonners, to ·03 of the length deck to hounds for yachts of 100 tons and upwards.

The diameter of a yawl's mast is from ·025 to ·0275 of the length deck to hounds.

The diameter of topmasts at the heel is ·02 the length heel to hounds; and the diameter at the hounds is ·6 of the diameter at the heel.

The bowsprit is more tapering, and the diameter at the stem head varies from ·028 to ·04 of the length of bowsprit outside, whilst the diameter at the sheave or outer end is only ·72 of the diameter at the stem head.

The diameters of main booms vary considerably, and of course will be greatest if the sails be not laced. A cutter's main boom generally has a greatest diameter near the sheet of ·016 to ·02 of its length; the diameter of the fore end, next the mast, is usually about ·7 of the greatest diameter; whilst the diameter of the outer end is about ·75 of the greatest diameter. A yawl's main boom in diameter is usually ·016 of its length. For a laced sail the diameter of a boom is frequently reduced as much as 25 per cent.; and were it not for laced sails, schooner yachts would not venture upon such a great length of boom as they do.

The diameter of a topsail yard at its centre of length is ·015 its whole length. The diameter at the ends ·73, the greatest diameter.

A balloon-topsail yard, or the big working-topsail yard, is generally strengthened amidships by battens of American elm, put on with seizings.

The diameter of a spinnaker boom is generally from $\cdot 012$ to $\cdot 014$ of its length, and the diameter at the ends $\cdot 85$ of the greatest diameter.

A great many contrivances have at various times been introduced with a view of lightening spars; but the old-fashioned "grown stick" has not yet been displaced. The *Black Maria*, some twenty odd years ago, appeared with "built" spars, something on the principle of a cooper's cask; but the plan gained no favour among English yachtsmen. Later—we think it was in 1863—hollow steel spars were tried in England; but, after two or three masts were carried away rather suddenly, funnel masts were unceremoniously discarded as much too dangerous. In 1868 someone proposed the boring of masts, and Mr. Michael Ratsey was commissioned to bore the masts and bowsprit of the *Cambria*. The boring was performed by long augers inserted at either end, and meeting in the centre of the spar's length. The "bore" was about 4in. in diameter, and no doubt the spars were very much reduced in weight thereby. The *Egeria* afterwards had her masts bored; but the plan was speedily condemned, as in the following year the *Cambria's* foremast-head tumbled off. However, this did not deter the owner of the *Cambria* trying bored spars again; but Mr. Ratsey thought it prudent to put three heavy iron bands round the mastheads at equal intervals, and to have masthead pendants, in addition to the usual pendants and runners. This had the effect of strengthening the mastheads; but the weight of material used in so strengthening them was equal in weight to the centre piece which had been abstracted from the spars; and, moreover, the greater portion of the weight was concentrated at the masthead, instead of being distributed throughout the whole length of the spar. Yachtsmen, thereupon, not unnaturally concluded that no benefit was to be derived from bored spars; but the *Cambria* continued to carry them, and crossed the Atlantic twice with them. Last year the John Harvey Company, of Wivenhoe, introduced a new kind of built spar; the spar was sawn through its whole length, and a piece taken out of each half, tapering to correspond with the tapering of the spar. In boring, the bore was, of course, of uniform diameter throughout; hence the weakness at the mastheads. The John Harvey Yacht Building Company, before putting the spars together, ploughed and tongued each side, and then bound the whole together with iron bands. The *Miranda* schooner has raced throughout two seasons with a bowsprit made in this way, and in heavy weather. The spar has stood well, but a similarly made main-boom became damaged through imperfect fitting at the sheet-strop.

CHAPTER IX.

SELECTING A YACHT.

IN selecting a yacht, a man, as in making other purchases, will be guided by his tastes and his means. If he is really fond of the sea, and looks forward to the sailing with the professional keenness of a middy or apprentice, his desire will be to get something which he can manage himself. If, on the other hand, the dawning yachtsman has boundless wealth, is a little of a sybarite, and determines to spend two or three months afloat because it is the fashion, he, too, will get a yacht to his taste; but she will probably be a big stately schooner, or an equally big, but little less stately-looking yawl, as big cutters are no longer fashionable for cruising.

The man who desires to eventually become a thorough yacht sailor should begin his apprenticeship on board a cutter, and she will not be bigger than 5, 10, 15, or 20 tons. If she is as big as 10 tons, he should make all the passages in her when shifting ports, and not bid farewell to her at one pier head, and welcome her arrival from another pier head at the next watering place on the coast. If a man goes about attended by the uncomfortable feeling that he shirks all the real daring and adventure of yacht cruising he is not likely to make a perfect yacht sailor; as sailing in ten or twenty matches during a summer, and sleeping in a snug berth in smooth water for a couple of months or so, are of little value compared with the under-way drill inseparable from making passages, it being understood, of course, that the owner does his "trick at the wheel." But it is not only the ten-ton ship that is big enough to convey the manly form of the youthful yachtsman from port to port; many owners of 5-tonners as bold as Will Watch, "take the helm and to sea boldly steer"; and these are the ones we always find to be the best sailor-men, even though they do not win so many prizes. Of course, living in a 5-tonner to the majority of yachtsmen would be utter misery, and perhaps

death. The budding yachtsman has been in the habit, perhaps, of spending a couple of hours every morning over his toilet, surrounded by all the luxuries of the upholsterer's art—velvet-pile carpet, satin damask, cheval glasses, watercolour drawings, Dresden china—and perhaps a valet-de-chambre. The man that has been used to this sort of thing must have the big schooner or yawl, for he will find no room for them inside a 5-tonner. He must carry his clothes in a bag, or cram them into a locker 2ft. by 6in.; go on his marrowbones to shave; into the sea for his bath—it is only one step and overboard;—and if he is addicted to cosmétique, he will probably find a piece of “common yellow” a good substitute. The cuisine, of course, would not be such as would raise water bubbles in the mouth of a valetudinarian; the carnivorous propensity will mostly be gratified by steak which, when cut, will resemble the Mudhook Yacht Club burgee of *rouge et noir*; and savoury soups and luscious salmon will be luxuries only obtainable in “canister” form. With all this, the five-ton man will very rapidly become a sailor, and the little ship below will be as neat and cosy as a women's boudoir; he will have a place for everything, down to a housewife; and at the end of one summer there will not be a part of the ship, from the breast-hook forward to the transom-frame aft, that he will not know the use of.

Of course, for real comfort at sea, the bigger the yacht a man can afford to have the better; but it will seldom be advisable to go beyond 300 tons, as very large sailing vessels are more or less, according to size, unhandy in narrow channels and crowded roadsteads. A yacht of 150 tons and upwards should be schooner-rigged; and we are inclined to think, if her size reaches 300 tons, or say 120ft. in length on the load water-line, that she should have three masts, with all fore-and-aft canvas. “Square rig forward” is generally recommended for a three-masted vessel, as square topsails may be of occasional use in backing and box-hauling, or in scudding in a heavy sea, when small trysails set on the lower masts might get becalmed whilst the vessel was between the crests of two seas; but the extra weight aloft, and the extra gear, are to some extent a set-off against these advantages.

A yacht from 150 to 80 tons downwards can also be schooner-rigged, but many yachtsmen prefer the yawl rig for these and intermediate tonnages. The yawl will be the more weatherly craft, will reach as fast, and be faster down the wind. The actual weight of spars will be less for the sail area; there will be less gear; and there will be no mainmast obtruding in the main cabin, or in one of the berths abaft it. It is undeniable, however, that in heavy weather the schooner, appropriately canvased, is a very easy and handy vessel. In a “fresh gale” (see “Winds”

in the Appendix) she would be under main trysail, reefed fore staysail and fourth jib (foresail stowed); a yawl under similar conditions would have main trysail, or double-reefed mainsail, reefed foresail, and fourth jib, with mizen stowed, and would be quite as handy, and would perhaps lie-to a little more quietly. As there will be no difference in the number of men required to work either rig, size for size, we are on the whole inclined to think that the yawl rig is to be preferred for yachts under 150 tons.

But the yawl for comfort must be the real thing, and not merely a big cutter with a long counter, and a mizen mast stepped on the archboard for the sake of "tonnage allowance for rig." This latter class of yawl has really a greater weight of spars in proportion to sail area than a cutter. The main boom is, in a yacht say of 100 tons, within 10ft. or 11ft. as long as the main boom of cutters of equal tonnage; the mast is as long, the bowsprit is as long, the topmast is as long, the gaff is generally longer in proportion to length of boom; and the weight of the mizen-mast, bumpkin, yard, boom, and rigging is generally about ten times the weight of the extra length and extra size of the cutter's boom. These are not the yawls that have an advantage over even large cutters for comfort; and the mizen mast is often stepped in such an insecure manner that it is not safe to put any sail on it in a real blow, when it might, according to the notions of the sailing master, save the crew some trouble to get under way with mizen and head sail alone instead of with trysail. Now, the modern *racing* yawl has so little advantage in snugness over a cutter of equal size, that our advice always would be, for racing—to enjoy the sport with an equal amount of comfort—have a cutter up to 120 tons, and above that tonnage a schooner—say one of 140 tons.

But the cruising yawl proper is a very snug vessel indeed, and has nearly all the good qualities of a cutter, and is really a more comfortable craft, and can be worked with fewer hands, which of course means with less cost. Her mizen mast will be stepped nearly close to the rudder head, instead of at the extreme end of the counter; her bowsprit will be shorter and lighter than the bowsprit of a similarly sized cutter (see page 71); her mast will be lighter than a cutter's; and so will her boom, gaff, and topmast be lighter. Her mizen mast will be so stepped that it will be safe in the most violent wind storm to put sail upon it; and this may be often of real advantage in clearing out from an anchorage in a hurry.

On the reduction of weight of spars and gear the advantage of the yawl mainly depends, apart from the assumed advantage of having the sails more subdivided than they are in a cutter.

We have calculated what the difference in the cubical contents of the spars of the *Kriemhilda* (106 tons) would be if she were changed from

cutter to yawl, her length of mainmast remaining the same. Difference in mast, 20 cubic feet; difference in bowsprit (3ft. shorter), 12 cubic feet; difference in main boom (12ft. shorter), 25 cubic feet; difference in main gaff, 4 cubic feet—making a total difference of 61 cubic feet, or one ton weight. The topmast would remain about the same. The bulk and weight of mizen spars would be as nearly as possible as follows: mast, 16 cubic feet; boom, 4 cubic feet; yard, 3 cubic feet; boomkin, 2 cubic feet; or a total of 25 cubic feet, making a net reduction of about 12cwt. The difference in the weight of rigging and blocks would be from 4cwt. to 5cwt., making a total reduction in the weight of spars and rigging of about 17cwt. The removal of this weight would bring about nearly 2in. difference in the vertical position of the centre of gravity of the yacht, and would be equal, so far as influencing her stiffness went, to the taking of 2 tons of lead from the top tier of ballast inside and putting it under the keel outside. The effect of the reduced spars on the momentum acquired during pitching will be mainly governed by the reduction made in the bowsprit; that is, by the influence that reduction has on the longitudinal radius of gyration. To reduce the momentum to its utmost limit, the bowsprit should be reefed close in, and mizen mast unstepped and stowed amidships.

To what extent the bowsprit of a yawl is reduced in comparison to a cutter's may be gathered from the following "facts." The yawl *Florinda*, 138 tons, has a 36ft. bowsprit outboard; the yawl *Corisande*, 153 tons, has 36ft. bowsprit outboard; the cutter *Oimara*, 162 tons, has a 47ft. bowsprit outboard; the cutter *Kriemhilda*, 106 tons, 36ft.; the cutter *Vol-au-vent*, 104 tons, 34ft.; the cutter *Formosa*, 102 tons, 34ft. It is thus apparent that a yawl has nearly 20 per cent. less bowsprit than a cutter. With regard to the length of main boom, we can state that *Florinda* would have 15ft. more boom as a cutter, and, although with that extension her calculated centre of effort would (minus the mizen) be shifted 1.6ft. farther forward, yet would she require a bigger jib when sailing by the wind. To turn *Vol-au-Vent*, *Kriemhilda*, or *Formosa* into yawls under the existing Y.R.A. rule, 11ft. of the main boom of each would have to be cut off, and then, in spite of the presence of a mizen, 3ft. or 4ft. of the bowsprit would have to follow. As a proof of this it can be mentioned that eight or nine years ago, the *Hirondelle* was converted to a yawl, but her bowsprit was not reduced, and it was found necessary to sail her with it reefed in to the first or second fid, and even then she was by no means troubled with weather helm.

It will be gathered that the advantages of a yawl are mainly dependent on the general weight of her spars and rigging being less than are the

weight of the spars and rigging of a similarly sized cutter. Taking a cutter and merely reducing her boom in length, whilst all her other spars and her rigging and blocks remain unaltered, and encumbering her with a mizen, would be no advantage at all, either for racing or cruising; in fact, the mizen would far exceed in weight the trifling reduction that had been made in the main boom; hence many "converted cutters" are failures as yawls. Neither has a racing yawl, as frequently sparred up to the present Y.R.A. main-boom regulation,* any advantage in point of weight of spars and rigging over the weight of spars and rigging of a similarly sized cutter—there are exceptions of course—and it could not be expected that such a yawl would obtain any advantage, even with rig allowance, in competitive sailing, so far as sailing by the wind goes. Down the wind and along the wind the inferiority is less patent, and occasionally a heavily sparred yawl, with her rig allowance, will beat the cutter.

Allowing—as there is not the least doubt about the matter—that a judiciously sparred racing or cruising yawl has less weight of spars than a cutter of similar tonnage, we come to the consideration of the usefulness of the mizen sail. About this matter opinions will widely differ. For sailing to windward, most sailors will agree that the mizen sail is not worth its attendant weight of spars and rigging; but as to the extent it affects the handiness of the craft there will be no such agreement. In 1875 the *Oimara* was converted to a yawl for her winter cruise to the Mediterranean; but, before she was clear of the Clyde, the mizen went by the board. She proceeded without a mizen, and with her yawl boom sailed all over the Mediterranean, and for two seasons, in a similar guise, cruised in British waters. Her sailing master informed us that he never felt the want of the mizen in any weather that he encountered; and this is conceivable when we consider that generally, in heavy weather, the first sail to stow on board a yawl is the mizen. This brings us to consider whether, after all, the advantages of the yawl are not entirely dependent upon her resemblance to a very reduced cutter, with short boom and bowsprit; and whether the advantages would not be increased by the absence of the mizen altogether? The fact that the mizen can be stowed in bad weather, to avoid reefing the mainsail, is hardly an argument in favour of having one; and, as what may be termed its active advantages in affecting the handiness of a vessel are not of much importance, we think that the "reduced cutter," as before hinted, has all the advantages of a yawl without the incumbrance of a

* Owing to the alteration in the manner of taking length, the present regulation as to yawls' main booms is that it shall not extend more than two-fifths of the beam abaft the stern end of the load water-line, instead of one-fifth the beam abaft the sternpost on deck. This regulation will cause some yawls to reduce their main booms a trifle, whilst others will be able to lengthen them a little.

mizen. Of course, a cutter with her main boom inside her taffrail is not a very sightly craft; but with the boom-end plumb with the taffrail, and bowsprit proportionately shortened, the beauty of the cutter rig would not be outraged, and the general weight of spars, rigging, and blocks could be very much less than the weight of spars of a yawl with similar sail area. However, in a fashionable cutter, where the tonnage approaches 100 tons, the main boom becomes a very awkward stick to handle, and for cruising there is not the smallest doubt that a yawl of 80 or 100 tons with a main boom plumb with the rudder head is a much more comfortable craft to work than a cutter of similar tonnage. We have evidence of the objection taken to long booms in the case of the large pilot vessels and fishing vessels, as whilst they are invariably cutter-rigged up to about 80 tons, we find that the schooner rig is preferred above that tonnage.

A modification of the ketch rig is much in use by coasters, and we have often heard it recommended as superior to the yawl rig; but with this we do not agree, as, owing to the narrowness of the mainsail, there is no rig which, area for area, yields such a heeling moment as does the ketch rig. The final conclusion which we arrive at is that, for the yawl to possess any advantages over a snug cutter, she must be very judiciously sparred, and it should be always recollected that the mere fact of carrying a mizen does not make a comfortable sea boat. The yawl's mast can be a trifle less in diameter than a cutter's (we are assuming that the sail area is to be nearly equal), the bowsprit can be very much less, the boom can be very much less, and so can the gaff; the standing and running rigging can be lighter, and so can be the blocks; but great care should be taken that the spars and rigging of the mizen do not exceed the total reduction that has been made in the weight of the main spars and rigging. The weight of mizenmast and rigging on the counter will not, it is true, punish a vessel like a heavy bowsprit outside the stem; but it must be remembered that almost the sole advantage of a yawl, so far as behaviour in a sea goes, depends upon her total weight of spars being less than would be the total weight of spars of a cutter with a similar sail area. The supposed requirements of a racing yawl are incompatible with the advantages generally claimed for the rig; it is, however some satisfaction to know that the yawls which have hitherto been most successful are those which have been sparred and rigged with an intelligent appreciation of the conditions upon which those advantages depend. Apart from behaviour in a sea, the principal advantage of the yawl rig is that, even if her spars as a whole be equal in weight to those of a cutter of similar size, she can be handled with a smaller crew; but this advantage will not be very apparent until 70 or 80 tons are reached.

A snug cutter of 80 tons can be as easily handled and as cheaply worked (six A.B.'s would be required for either) as a yawl of 80 tons, and a cutter should be preferred on account of her grand sailing qualities. The line is drawn at 80 tons for this reason: a gig's crew must be had out of either yawl or cutter, and if four hands be taken away in the gig, two will be left on board to work the yacht with captain and mate; and even a 60-tonner cannot very well do with less than six A.B.'s for the reason just given. But, whereas six men may work an 80-tonner, whether cutter or yawl, six would be hardly enough for a 100-ton cutter, although they might be quite equal to a yawl of that tonnage; and moreover, if there was anything like a breeze, and four men had to leave the cutter in the gig, it would be hardly prudent to leave the sailing master and mate with two men only on board.

Of all the rigs which the ingenuity of man has devised, not one is equal to the cutter, whether for clawing to windward, reaching along the wind, or running down wind. A cutter with a true wind will beat as far to windward in a day as a yawl will in a day and a quarter; will walk off with a light air when the medley-rigged craft is as good as brought up; and in a breeze under topsail is even more comfortable and easy than the yawl. But the cutter must be snug; there must be no aping the racing cutter, and all the spars must be pretty nearly reduced to the dimensions of the yawl: that is, the boom end must about plumb the taffrail; the bowsprit—say for a 100-tonner—must only be about eighteen inches longer than the yawl's; the mast must only be a little heavier; the topmast must be no longer; and the gaff must be in due proportion to the boom. A common argument in favour of yawls as against cutters is this: a racing cutter of 80 tons is said to be an expensive vessel to work, is an awkward vessel to tackle in a sea, and is wet and uncomfortable, therefore do not have a cutter. But, on the other hand, if you wish to do a little racing without sacrificing comfort or incurring expense you are disinclined to, have a yawl of 80 tons; the allowance for rig will put the vessel on an equality with the cutter, and she will win plenty of prizes; this means that, in the yawl rig a really comfortable cruiser can be had combined with qualities good enough for racing successfully.

There is possibly a very great delusion about this. A yawl to be a successful racer must be ballasted and canvassed pretty much as a cutter of equal size, and the expense of racing such a yawl will differ very little from that of racing a cutter; probably, tonnage for tonnage, the expense would be the same. There is as much difference between a cruising yawl and a racing yawl as there is between a cruising cutter and a racing cutter, and it is a great mistake to suppose that a racing yawl includes the comforts of a good cruising cutter of equal size.

The ultimate conclusion is, that the particular rig will depend upon the size of the yacht, and for cruising the rig should be: cutter up to 80 tons; yawl from 80 to 150 tons; schooner above that tonnage.

In deciding on a yacht for racing, the first thing to exercise the mind is, of course, which is the best size to have? A builder will not unnaturally recommend something very large—something that one can live in with comfort and with all the luxuries of shore life, and at the same time strike an imposing figure in the yachting world. But, as a rule, very large craft are disappointing. If a schooner is decided upon, it will be best not to go much beyond 200 tons; and a yawl should not exceed 150 tons, nor a cutter 120 tons. It can be argued that years ago, in the latter half of last century and at the commencement of this, very large cutters, sometimes exceeding 200 tons, were afloat, and were so much superior in every good quality which a sailing vessel should have, that they were always referred to with pride as the "national rig." This is very true; but the 200-ton cutter of fifty years ago was a very different kind of craft from what a 200-tonner of the present day would be. These old cutters were only about 80ft. long on the load line, with an extreme beam of 25ft.; they had taunt masts, and what appeared to be long main booms, as so much projected over the taffrail aft; but in fact their main booms were comparatively short—about 65ft., or no longer than *Kriemhilda's*, which we reckon as of only 106 tons. A 200-ton cutter, built according to existing ideas as to proportion of beam to length, would be a very different kind of ship indeed; she would be about 100ft. long, and have no more than 22ft. beam; but, instead of being weighted with stone for ballast, she would carry probably 100 tons of lead, and her main boom would be at least 80ft. long. Having had some experience in handling a cutter's main boom that was a little over 70ft. in length, we are quite of opinion that a 200-ton cutter, or even one of 150 tons of the modern school, is not a desirable kind of racing craft; and 120 tons—which means about 90ft. length of load line, or more than the length of the old *Alarm* when she was a 193-ton cutter—is quite a prudent limit to strike.

But a man may be uninfluenced by considerations of size, comfort, prudence, or cost; he may simply want to shine as the owner of a successful racing craft, and pile up a huge, if almost meaningless, heap of prizes in one year. If such is the desire, search must be made amongst the records of matches sailed during the last decade, and little difficulty will be found in coming up with the magic size for prize-winning. So far as the record of the last decade goes—or, indeed, the record of the last thirty years might be taken—we think there is not much doubt that the most useful size, so far as cutters are concerned, for successful racing, has been 60 tons or

near that tonnage. Mosquito, Volante, Fiona, Vanguard, Iona, Neva, have achieved more in the way of prize-winning than any of the same rig of 100 tons and upwards; but within the last four years the 60-ton racer has almost disappeared, and the 100-tonners have constantly proved quite equal to the time allowance they have to concede whenever in competition with yachts of inferior size. Evidence was afforded a few years since that this condition of things might arise. In 1873 the Kriemhilda, of 106 tons, in the face of almost unexampled competition, won more than any cutter had previously done, and the brilliancy of the achievement was enhanced by the circumstance that, excepting on two occasions, she won a first prize every time she started, and came in first every time but once, and all the matches were sailed in good breezes. This latter circumstance somehow appears to have a great deal to do with a big vessel's success; and if there has been a succession of light baffling winds during the summer, it is generally found that the smaller vessels have come off the best, so far as prize-winning goes. It is therefore still quite possible that, for competition in the large class, a cutter of from 60 to 80 tons should be chosen, as the probability is, if the vessel be a good one, such as Ratsey or Fyfe builds, that a very valuable amount of plate will be collected. On the other hand, more *éclat* naturally attends the successes of a big craft: she is generally ahead of the fleet—and the sympathies of the crowd invariably go with the leading craft; and if she wins (say from a 60-tonner), she is almost certain to be three or four miles ahead at the finish. This feature in itself is, no doubt, a most impressive one, both on the owner and on the spectator; and there can be no question about the *éclat* of winning with a 100-tonner eclipsing the splendour of winning with a 60-tonner. This certainly is the vanity of the thing; but there are vanities in sport as there are in other occupations, and if it is a man's vanity not only to win prizes, but to revel in the glory of "coming in first" in the cutter class, then he must have a vessel of 100 tons or 120 tons. If, on the other hand, his vanity, if more peculiar, is less ambitious—is to win, one way or another, the greatest number and the greatest value of prizes—then he may have his wish gratified by owning a yacht not larger than 80 tons nor smaller than 60 tons.

Cutter racing is not confined to 60-tonners nor to 100-tonners. Within the last ten years classes have sprung up, and no class has earned more laurels than the 40-tonners. Three builders—Hatcher, Fyfe, and Ratsey—have made this class, and hitherto no other builder has been able to compete with the productions of these famous constructors. For real sport, there is not much doubt that the 40-tonners are to be preferred to the vessels in the larger class: there is no time allowance; the exact merits of the vessels, and of their handling, are easily read; and, as a

rule, the winning vessel can only arrive first at the goal by contesting every inch of water sailed through. An attempt was made five or six years ago to establish a 60-ton class, but it was unsuccessful, mainly because sailing committees did not promptly stop the introduction of vessels which were a few tons over the class. However, we do not think a 60-ton class was much to be admired, and probably a class of 80-tonners would have been more successful. With regard to the 40-tonners, a man fond of the sport need have no hesitation about building for their class: if he succeeds in heading the class, he will have performed a very imposing feat; and, under any circumstances, if a vessel is "built up to the class," he is certain to have most lively sport from beginning to end, and will become acquainted with the art of yacht sailing in the very best school. Some gentlemen keep 40-tonners for the love of the sport of racing them, and live in large comfortable cruising schooners during their season afloat; however, if a man has not too much money, he will find a 40-tonner comfortable enough, and his sailing master will seldom report the weather too bad to show out of port in.

The 20-ton class is a very numerous one, but improvement so far appears to be at a standstill, inasmuch as the *Vanessa*, built in 1873, and as yet unaltered, has matched all comers up to the end of last season (1878); and in no class is competition more keen than in this, and if it would be hard to put a vessel in the 40-ton class that would come out with the longest string of winning flags at the end of the season, it would be even a little more difficult to do so in the 20-ton class. It is not likely that anyone would "yacht" in a 20-tonner for the sake of the mere repute of owning a yacht; a man, to own, race, and live in one of these craft, must love the art of sailing, be enthusiastic in competition, and think of gaining the honours of the match by sheer hard sailing, and not of getting the prize by fluking or wrangling. This also must be said of the 10-ton class and the 5-ton class; and so long as these small classes exist, so long will there be evidence that love of the art of yacht sailing is one of the most striking characteristics of the British gentleman. Some men, of course, revel in the passive pleasure of sailing about in a yacht, without knowing anything or caring anything about the mariner's art, just as some men will derive pleasure from riding on the back seat of a drag, and knowing and caring nothing about the tooling of the cattle in front of him. These are the gentlemen whose yachts we meet and hear of in all sorts of out-of-the-way ports; and as they make "life on the ocean wave" as pleasant as it is possible to make it, be assured that they are agreeable men to cruise with.

A few words should be here interpolated about the 15-tonners. Seven

or eight years ago they were certainly a favourite class, but the 20's, 10's, and 5's have almost dispossessed them in favour. However, most of the 15-tonners that have been known to fame—such as Dudu, Queen Ildegonda, Satanella, Torch, Fairlie, Glide—are still in existence; and, as this fleet is being augmented by three new craft, the class shows signs of revival. The class is recognised by the Y.R.A., and a great many contend that it should have been encouraged instead of the 10-tons class. There can be no doubt that a 15-tonner is a more comfortable cruising craft than a 10-tonner, and the expense of working the former need be but a trifle more than that of working a 10-tonner; and, as the modern 15-tonner, as exemplified in the *Maggie*, has all the accommodation of a 20-tonner of ten years ago, it would not be surprising if we found the 10-tons class giving way to it.

CHAPTER X.

EXAMINATION OF THE YACHT.

HAVING decided upon the size of the yacht, the next step will be to find a suitable one of that size. If the intending purchaser advertises his wants, he is certain to have a great many vessels offered him, and all will be highly recommended by the agents of the vendors; each vessel will be the best sea boat of her tonnage, the strongest built, the best found, and the handsomest; and, moreover, the present owner is almost certain to have recently spent several hundred or thousand pounds upon her reconstruction or redecoration. The intending purchaser will be delighted; and, after having got through particulars of the yachts which have been offered for sale, something like bewilderment will naturally follow, and the task of making a final selection will be a little difficult. The best plan will be to begin with treating all the answers as mere information of vessels for sale. Find out when they were built, and by whom, from Lloyd's Register,* and if those that seem unobjectionable, so far as age is concerned, are suitable also in price, go to see them. Then, if one appears to be in every way a desirable craft, bid for her, "subject to a survey and inspection of inventory, showing her hull and equipment to be in a seaworthy and thoroughly satisfactory condition." It will always be necessary to have a vessel surveyed before completing a purchase, unless it is found by Lloyd's Register that the yacht is quite new, or has recently been surveyed. If a survey be required it will be performed upon application by one of Lloyd's surveyors, or by a yacht builder; but if a builder be employed, it will be well not to have the one that built the vessel, as he may not unnaturally incline towards making a more favourable report on her condition than the circumstances may warrant. The fee for surveying will probably be five guineas, with travelling expenses.

* Lloyd's Society for the Registration of Ships (White Lion-court, Cornhill) issue a special book for yachts, stating their tonnage, when and how built, when altered, when repaired, when last surveyed, and all information that it is necessary to possess.

A man may perhaps desire to act as his own surveyor ; if he does, he will act very unwisely, as it is only by long experience, and a perfect knowledge of the construction of vessels and of the strains they are subject to, that a man can become competent for such surveys. Nevertheless, as the yachtsman who takes to the sport enthusiastically, and with a resolve to be "thorough," will necessarily want to know in a general kind of way the "marks" to distinguish a good vessel from a bad one, some instruction must be given him.

In the first place as to age. Speaking generally, a yacht should not be more than twenty years old ; we do not mean that all yachts upwards of that age should be broken up or sold into the coasting, or fishing, or piloting trade ; but that yachts so old as twenty years should be put through a very searching survey. Yachts seldom are broken up, and their fate is to lie year after year in mud docks for sale, and till they are far on the shady side of thirty. Do not be tempted by cheapness into buying one of these ; it would certainly end in mortification and disappointment. If the vessel were merely patched up with oakum and paint, she would be a perpetual trouble and expense ; and if repaired or renewed as she ought to be, a new vessel had much better be built, as it would be cheaper in the end.

Therefore do not buy a thirty-year old vessel, and one so old as twenty years should only be selected with very great caution ; the condition of such an old craft will depend upon the way she has been used and "kept up," and upon the amount of repairs and "renewing" she has undergone. For instance, some vessels at the end of fifteen years are stripped, newly planked, and decked, and all doubtful timbers and beams replaced by new ; such a craft would be good for another ten years without further outlay, and she might be bought with as much confidence as a perfectly new vessel. Or if the yacht was originally well built in the best manner by one of the best builders she may at the end of fifteen years require neither new plank nor new frames, but if she has seen much service she is almost certain to require new decks. The condition of a yacht at the end of fifteen years will very greatly depend upon the quality of the materials used in her construction, upon the sizes of the timbers and their disposition, and upon the thickness of the planking, and upon the strength of the fastenings. Some idea of what these should be can be gleaned from the tables (given farther on)* compiled from the practice of the best builders of yachts. The timbers (called also frames, and first, second, and third futtocks, where the lengths of the frames are in two, three, or more pieces) will be "double," that is, two timbers will be

* See also Lloyd's Rules in the Appendix.

placed close together, or nearly close together, and act as one frame. Then there will be a space, and hence "timber and space" means the distance from the centre of one double frame to the centre of another. Some builders do not place the timbers of a double frame quite close together, as some ventilation is considered a good thing; but greater strength is obtained if the timbers of each double frame are close together, and the general practice is to so place them close together.

Occasionally a single-framed vessel is to be met with—that is, instead of two timbers being worked closed together to form one almost solid frame, one single timber forms each frame, placed at regular intervals. These vessels, unless the timbers are of superior size and placed very close together, should be regarded with great suspicion; the space from centre to centre of the timbers should be at least 25 per cent. less than in a double-framed vessel, and the sizes should be 15 per cent. greater; and if the timbers are too long to be all in one piece, the "shifts" or lengthening pieces of the timbers should be so arranged that two shifts never come on the same horizontal line in adjoining timbers. In almost all vessels the frames of the bow forward of the mast are single, and in some old vessels these bow frames might be found to be of fir; these frames will require a great deal of inspection and pricking. Some 20-tonners which we have met with have had single frames 12in. from centre to centre in the middle of the vessel, these frames extending over a distance equal to half the length of the vessel; similar frames were used in the bow and stern, but the spacing was increased to 16in. There does not appear to be any objection to this plan, and it has a slight advantage in weight of timber. A plan adopted by Mr. Alex. Richardson in framing the 10-tonner *Lily* was as follows: Sawn frames (4½in. by 2in. under platform, tapering to 2½in. by 2in. under deck) were spaced 3ft. apart, and between each pair of these were three steamed timbers 2in. by 1½in.; this framing has stood fairly well, and for lightness could be recommended. The Harvey Ship and Yacht Building Company use alternate sawn and steamed frames, with a double skin. This plan has now had a fair trial, and, so far as the experience of five years goes, it appears likely to be very durable, and has an advantage in lightness. In regard to "materials," all the frames should be of oak and so should be the stem piece, stern post, dead woods, knight heads, apron, beams, shelf, bilge strakes, and keelson; the keel will generally be found to be either English or American elm. The garboard strakes are generally of American elm, and it is best that the planking above should be of American elm or oak to the load water-line, and teak above to the covering board or deck edge. Very frequently, however, only the garboard strake is of American elm, and the remainder red pine or pitch

pine, with a top strake of oak. Again, sometimes the first four strakes above the garboard are of American elm, and the first four strakes below the deck of oak or teak, and the remainder pine. Occasionally oak plank is used at the bilge, with a wale or "bend" of oak above the water-line; and, again, sometimes the plank is all oak from keel to plank sheer, and nothing in the way of wood material can exceed the strength or durability of a vessel so planked.

The floors and keel fastenings of yachts are now variously contrived. Twenty years ago a builder never thought of constructing a vessel without grown floors and a keelson; but, owing to the increasing sharpness in the bottoms of vessels, or increasing "dead rise," it became very difficult to find suitably grown floors. The result was that iron floors were cast, and these, whilst having an advantage in strength and durability, have the additional recommendation of forming excellent ballast. In some cases (almost always in vessels of 40 tons and under) grown floors, or floors of any kind, are dispensed with entirely; the heels of the first futtocks are brought down to the keel and connected by iron ∇ knees, which are securely bolted in the throat through a hogging piece and keel.

If a yacht is met with that has these iron knee-floors, it should be ascertained if she has been ballasted with lead; if it turns out that her ballast has been lead, it will be necessary to have the iron knees very carefully examined, as lead very quickly destroys iron. It should also be ascertained whether or not the floor bolts and other fastenings are of iron; if they are, it is just possible that the lead ballast may have eaten off their heads.

If the yacht be twelve or thirteen years old, it will be incumbent to examine her very thoroughly inside and out, unless it is satisfactorily shown that she has recently been so examined, and all necessary repairs made. To effectively examine a yacht the copper should be stripped off, and the planking scraped clean; if, however, the copper be good it will be a pretty fair evidence that the plank underneath is sound, as the copper in such a case is not likely to have been on more than three years; and, of course, the plank and caulking would have been thoroughly examined and made good when the vessel was re-coppered.

If it is stated that the vessel does not require re-coppering nor needs stripping, it will be well to be present when she is hauled up high and dry, or as the water is pumped out of the dry dock into which she has been placed, as the case may be; as, if there are wrinkles or folds in the copper, giving evidence of strains, it is quite possible, where the opportunity exists, that these "wrinkles" would be "dressed" out. The

wrinkles will generally appear in a longitudinal direction, under the channels and under the bilge over the floor or futtock-heads. But if the vessel has been subject to very severe racking or twisting strains, or has bumped on a rock or on very hard ground, the wrinkles may run diagonally or in half circles across the copper. Very long and deep yachts, that have not been properly strengthened longitudinally by internal bilge strakes and continuous diagonal braces across the frames, may be subject to great racking or twisting strains; if there be evidence of such strains, the yacht need not be condemned, but she will require strengthening, and should be put into the hands of a competent builder. In a case where the copper shows unmistakable signs that the vessel works or strains, she should be thoroughly examined in the vicinity of the supposed strains, and be strengthened and fastened in the manner which a builder from his experience may consider necessary. If iron fastenings have been used in the vessel, it is very likely, unless the heads have been counter sunk and well cemented, that iron rust stains will show on the copper; if such stains are met with, it will be best to have as much of the copper stripped off as the case requires, so that the fastenings may be driven out and new ones put in. The keel should be examined for strains and splits; and if the keel or false keel be worn away from the through bolt fastenings, the bolts should be cut off and re-clinched, and if necessary a new false keel should be fitted.

The stern-post, rudder-post, rudder braces, and pintles must be examined, and if the rudder-post is twisted, or braces or pintles much worn, there will be work for the shipwright.

The chain plates and chain-plate bolts and the surrounding planking and its caulking should be closely examined for flaws and strains, and so also should the stem piece and bobstay shackle plates.

Signs of straining on deck will mostly be apparent in the seam of the covering board abreast of the mast, at the stem, knightheads, bowsprit bitts, and near the mast partners. If the seams are unusually wide here, as they frequently may be in a yacht that has been much pressed with canvas, "sailed hard" in heavy seas, or that has been weakly built, some strengthening will be required by more hanging knees under the beams, and additional knees at the mast partners, or new beams, partners, and knees altogether. If the covering board shows signs of having opened badly in the seam, or lifted from the top strake, the beam ends and shelf or clamp will require very careful examination—the shelf and clamp especially at the scarphs and butts.

To examine the frames of the vessel, the ballast should be removed, and some of the ceiling and some of the outside plank should be stripped

off. Lloyd's surveyors, in examining an old ship, usually cut out listings from the plank the whole length of the ship; and they also similarly cut listings from the ceiling inside, under the deck, and over the floor heads; planks are taken off, too, at different parts of the ship, equal in the whole to her length; and the beam ends are examined either by taking out the top strake under the covering board, or by boring under the covering boards. Fastenings, such as trenails and bolts, are driven out, to further test the condition of the frames and fastenings; and the condition of the oakum and caulking is ascertained by examination in several places. If the ship or yacht be completely ceiled up inside, it is obvious that the whole of the framing cannot be examined by such means; but generally a yacht is not so closely ceiled, and an application of a knife to the frames will soon determine whether they are rotten or not.

There is scarcely any limit to the number of years frames of autumn-cut oak will last; but occasionally a sappy piece will find its way among the frames, and it may not last a year, or the frames may decay in consequence of leakage and defective ventilation; but from whatever cause rot may arise, any frame so affected should be removed. Heels and heads of floors and frames are the most likely places to find rot; but of course it may occur in any part of a frame, and, if possible, every timber in a vessel should be thoroughly examined from heel to head.

Old decks are a great trouble to keep tight; and if there is any sign of "weeping" either under the deck at the seams, round the skylights, shelf, or mast, there will be sufficient evidence that caulking is necessary. New decks, however, frequently give trouble in this way if they have been carelessly caulked, or if the yacht has been weakly constructed, or if the caulking was done during wet weather and not under a shed. As the plank dries, it shrinks away from the caulking and paying, and leakage is the inevitable result; this condition can be somewhat ameliorated by wetting the deck two or three times a day, but wet decks are almost as bad as leaky ones, and re-caulking and stopping will be the best remedy. It is the fashion now to lay the deck plank very close together, in order that narrow seams may be obtained; narrow seams of course look very nice, but, as the seams are scarcely wide enough to receive the caulking iron, very little oakum is driven into the seams, and as the marine-gluce paying or putty stopping dries, leaks are the result.

The spars will require careful inspection, and if either has cracks running transversely or diagonally, it will be pretty sure evidence that it is sprung. The longitudinal cracks or fissures are not of much consequence unless they gape very much, run deep and from one into another right round the spar; sometimes, however, if the cracks have not been stopped

with putty or marine glue, the wet might have got in and caused decay. The insertion of a knife into various parts of the crack will soon settle this matter. The mainboom should be examined for "springs" near the outer end chiefly; the bowsprit at the gammon iron, or stem head, and at the outer end above and about the sheave hole; the mast, about the deck and under the hounds. The masthead will require very careful examination under the eyes of the rigging for rot, and right away to the cap for wrings, which generally show themselves by a lot of little cracks.

The rigging, blocks, and sails will of course require an overhauling. The standing rigging is now generally made of galvanised iron wire or steel wire; if it has seen much service, rust from the inner strands will show itself, and the "lay" of the strands will have been stretched nearly straight. Hemp and manilla rope, if much worn, with a washed-out appearance, should be in certain places unlayed, or untwisted, and if there be any signs of stranding, or if the tar is dried up, the rope will have seen its best day. The shells of the block will require examination for splits, and the hooks, eyes, sheave, and pin for flaws of whatever description. The sails should be laid out and examined; if the stitching in the seams or roping be worn and ragged, if the canvas be black looking, very soft and thin, admitting a great deal of daylight through the woof, then the sails will be only fit for a fisherman or coaster. As a rule, a suit of sails will last through four or five summer cruises; but three months' knocking about, winter cruising in the Mediterranean or elsewhere, will do as much harm as two summer cruises, and it will never be prudent to start on a long winter cruise with sails that have seen more than three seasons' wear. Of course sails may have been exceptionally well cared for—never rolled up wet or unfairly stretched—and the vessel may have been in the happy condition of never having been under way in much of a breeze. Then if they are six or seven years old, and an expert pronounces them fit for a winter's cruise, they can be depended upon; but to be caught in a breeze is bad enough, and it is a great deal worse if when so caught some of the spars, rigging, blocks, or sails give out. A mainsail is most likely to go at the clew or to split from foot to head, but occasionally they split right across from leech to luff. A jib will go all ways; its head will come off, tack or clew will come off, and sometimes they will split or burst out of the stay rope. For racing, a mainsail is of little use after the second year, and even with the greatest possible care they will hardly do the third, as they get thin and soft and fly right away from the spars into bags with the least weight in the wind. The owners of some small yachts have a new mainsail every season, and this is quite necessary if the yacht is sailed

in as many as thirty or forty matches, and if the sail has been frequently reefed.

Lastly, the ground tackle or holding gear must be examined. The anchors and chains should be galvanised, and be of the weight and size set forth in the tables for yachts of different tonnages, which will be found farther on.

CHAPTER XI.

BUILDING A YACHT.

SOME men seem to have quite a passion for building yachts, whether for cruising or racing, and do not believe in the paraphrased adage that "fools build yachts for wise men to buy." So far as a racing yacht is concerned, it is quite natural that a man should wish her first success or fame to be identified with his name, and that he would not care to own a vessel which had already become famous under another man's flag. On the other hand, there are plenty of men who, directly they hear that a yacht is successful, and read of her wonderful exploits in the reports of matches, long to possess the wonderful craft. And so it happens that there is always something for the builder to do. The man who finds excitement in building is always certain to fancy that there is something even in his last success that can be improved upon; and he is glad to meet with the obliging purchaser who so covets the possession of the property he is anxious to discard.

The man who knows nothing whatever of yachts and yachting, in setting out to build, will be mainly troubled to know which builder to go to. He will hear that one builder is famous for cutters, another for yawls, and another for schooners; whilst another, more wonderful than all the rest, is famous for every kind of craft, from the tiny *Una* to the bold Mediterranean cruiser of 300 tons. Then, again, one builder is celebrated for the soundness of the materials he uses; another for the excellence of his fastenings; and another, perhaps, for his disregard of the quality of both materials and fastenings. All this will be very perplexing to the man who has yet to serve his apprenticeship at the sport, and he at last dives into it with something like the feeling with which he took his first header, and inwardly appeals to the honour of the builder:

Build me straight, O worthy master,
Staunch and strong, a goodly vessel,
That shall laugh at all disaster,
And with wave and whirlwind wrestle.

And probably the master does build him a staunch and strong and goodly vessel. But there need be no doubt about the matter. Lloyd's Society for the Register of Shipping have long been in the habit of superintending the building, and afterwards classifying a vessel; and if builders generally objected, and no doubt correctly, that Lloyd's rules were not quite adapted for yacht building, principally on the ground that those rules required the scantling of a yacht to be unnecessarily heavy, reasons for the objection are now swept away; Lloyd's have, during the past two years, modified those rules so as to accord with the undoubted soundness of the practice of the best builders, and there is now no reason why even a yacht intended for racing should not be classed. It may not be considered prudent to use materials to qualify her for the highest grade of seventeen years, but at least every yacht, whether intended for racing or not, should be built of materials to take a twelve year's class. The highest grade of class is A 1 seventeen years, and a vessel that is qualified for this high class is certain to be a "staunch and strong and a goodly vessel;" and it will be of little consequence, so far as these qualities go, which builder has the construction of the vessel, as it will be the duty of the surveyors to see that the work is carried out in a proper manner. The owner will know and feel that he has a vessel which will come out of the heaviest storm unstrained, and should he wish to dispose of her the unquestionable character which she has for strength will facilitate her sale at a full value. Therefore the advice to a man who knows little about yachts cannot be too urgently repeated—always build up to Lloyd's rules and under Lloyd's survey. No matter how high the repute of the builder may be, he will be only the more willing to agree to the survey, and will take delight in showing that he, so far from having any objection to build up to Lloyd's rules, will actually exceed their requirements, both in quality of timber used and in fastenings.

Vessels of the racing sort, of 40 tons and under, are now built with keels out of all proportion to the sizes of their other scantling: thus the *Lily* has a keel sided (by "sided" is meant its transverse thickness) amidships 10in., or as large as the keel of a vessel of 100 tons. This enormously thick keel of course tapers fore and aft, and is only so thick amidships in order that a heavy weight of lead or iron might be carried underneath. A similar weight could only be carried on a smaller wood keel by greatly increasing the draught, and then the strength and thickness of the keel might be unequal to the weight of the lead and to the boring for the necessary bolts. Sometimes a lead keel, or keelson, is worked inside, fore and aft, between the heels of the timbers and on

top of the keel proper, and this plan will be fully described further on ; in the accompanying drawing, Fig. 18, *aa* are the timbers, the heels of which meet on the middle line of the wood keel *b*; *c* is a wrought-iron knee, bolted to the sides of the timbers, and meeting the keel at *d* in the form of a plate, through which a bolt passes to the under-side of the wood keel at *e*. Across the heels of the timbers the transverse wrought-iron plate *f* is bolted, the same through-bolts serving for knee and plate; the knees are alternately placed the fore side and aft side of the timbers. Fig. 19 shows a broadside view of the construction, *a* being the double timbers, *b* the wood keel, *c* the iron knees, *d* the plate

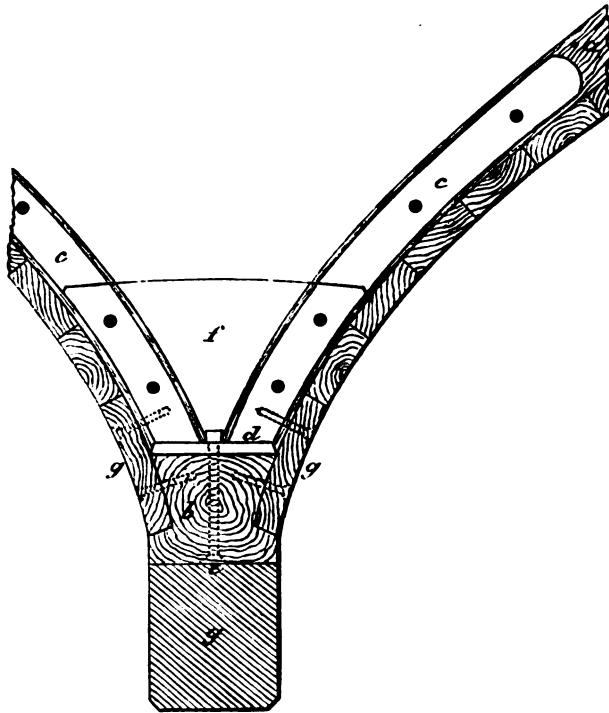


FIG. 18.

for the keel fastenings *e*; *f* the iron transverse plate, *g* the lead or iron keel, and *h* the bolts for the same. In Fig. 18 *g g* are very deep garboards, fastened, as shown, with long yellow metal or copper spikes; but one bolt might be made to go through garboard and keel.

This mode of construction has recently received a fourteen years' class at Lloyd's for a 25-ton cruising craft, and no doubt it is well adapted for small vessels, for which grown floors cannot be obtained, nor suitable iron floors cast. The iron knees and plates should have two coats of Stockholm tar or black varnish before fixing, and another

coat or two before the lead ballast is stowed (the ballast will, of course, be cast to fit between the timbers). The ballast should be removed every season, and the iron knees and plates re-tarred or varnished; and if attention be paid to them in this respect, they will not much suffer from the deleterious action of the lead.

Perhaps the most approved way of constructing the floor and keel of a yacht, where grown floors are dispensed with, is according to a plan adopted by Mr. Ratsey. We are unaware who has the honour of introducing the plan, but so long ago as 1858 it was used. Fig. 20 is an illustration of this plan, as pursued in the Formosa cutter, built by Mr. Ratsey. It will be seen that the heels of the timbers *a a* abut on

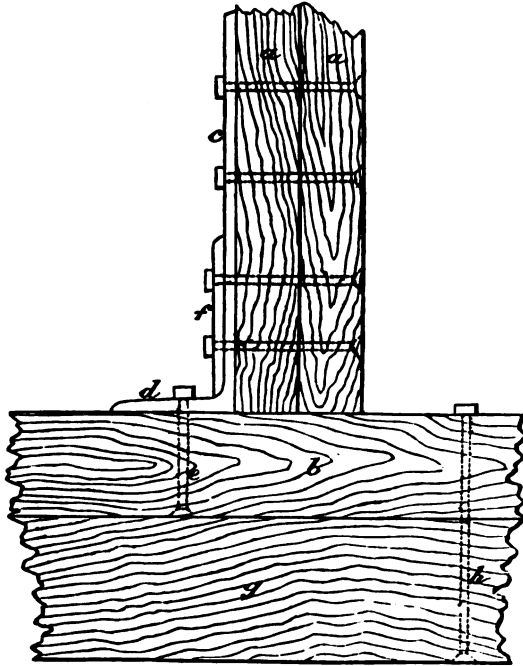


FIG. 19.

to an inside keel *c*, which is generally termed a hogging piece; whilst the actual heels of the timbers are joggled into the main keel *d*. The heels of the timbers are bolted through keel and hogging piece. The frames or timbers are further secured to the hogging piece and keel by the iron knee floors *n n*, and the throat of the knee floor carries a long bolt through hogging piece, keel, and lead keel *e*. The garboard strakes, *b*, are bolted through the main keel, and altogether the structure is made as solid and immovable as if it were one whole piece. In building according to this plan great care is necessary in fitting the heels of the timbers into the joggles in the keel and hogging piece, and

equal care is necessary in placing the bolts. Sometimes the heels of the timbers are not joggled to the side of the keel or hogging piece at all, but simply spiked or through bolted to one or the other, or both. Occasionally the siding of the hogging piece is a little less than that of the main keel, and in such case the heels of the timbers are made to rest on the edges of the top of the keel, which form the stepping line carried fore and aft into the dead wood. Yet another plan of constructing the floors of the vessel is sometimes met with: no hogging piece is used, but the heels of the timbers are so cut or

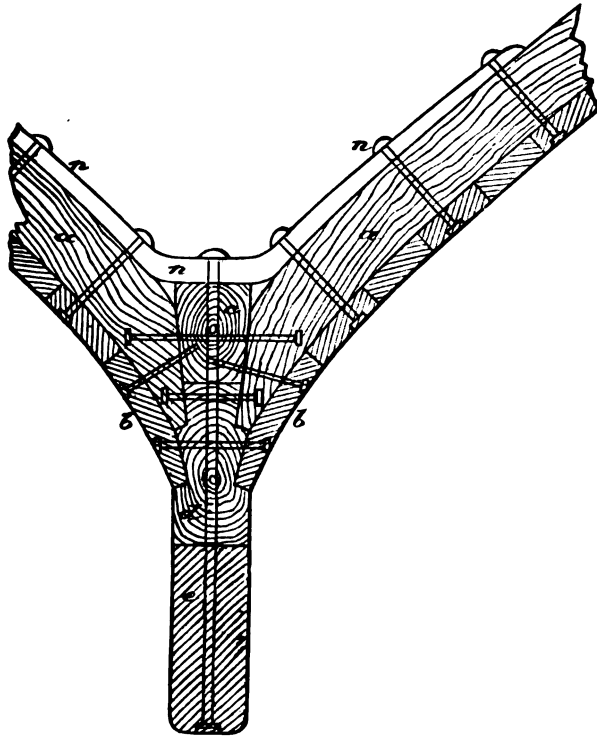


FIG. 20.

joggled that half rests on the top of the keel and half on the side; the heels are spiked through the keel and secured by iron knee floors, which may be either fitted to the sides of the timbers, as shown in Figs. 18 and 19, or to their inner surfaces, as shown in Fig. 20. (This plan will be illustrated further on in describing Lake Windermere yachts.)

Mr. Dan Hatcher, of Northam, on the Itchen, has for many years used a plan for fixing floors which can be recommended for small yachts. In Fig. 21 *b* is the keel, about 8 inches sided amidships for a 10 tonner. A stepping channel, about 4 inches deep, is cut out along its entire length for

the heels of the timbers *s s* to rest on, and a bolt *f* passes through the heel of each timber and the keel. Besides this an L angle iron knee, *a*, holds the timbers together. The through bolt *d e* passes through the knee floor, keel and lead keel. Occasionally a through bolt is driven through garboard and keel, and through garboard and every frame.

Messrs. Waterman, yacht builders, of Devonport, have recently adopted another plan of securing the floors by angle iron, as illustrated by the annexed sketches, Figs. 22 and 23.

Each floor is formed of two angle irons, one flange looking forward, the other aft, worked over on oak frame (See Fig. 22).

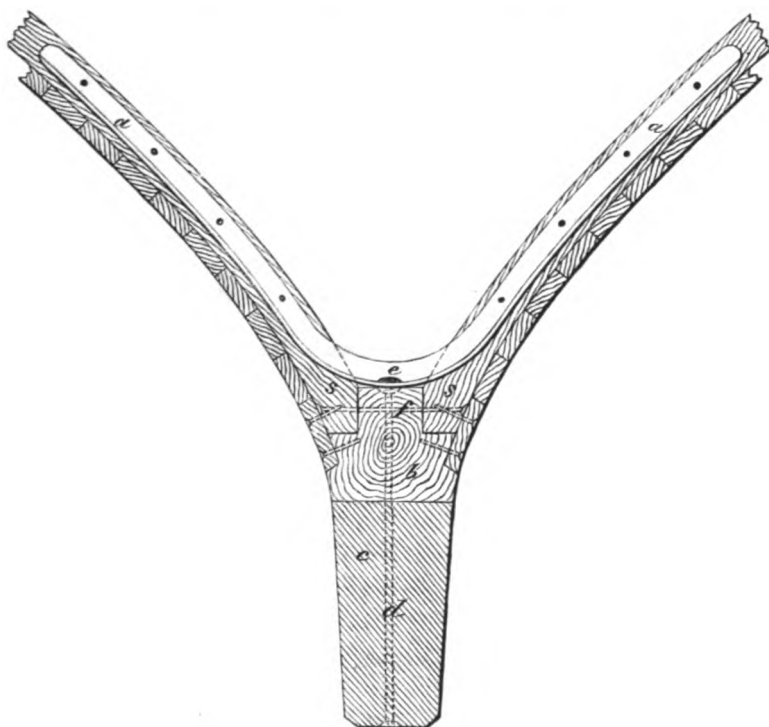


FIG. 21.

The angle irons and oak frames are bolted together with iron tie bolts, and the oak frame is fastened to plank with copper bolts passing through the middle at *p* (see Fig. 23), and clenched on washers inside; and besides these fastenings, metal dump nails are driven through each plank near its edges. By this plan iron does not come in contact with copper.

The angle iron is bent to cross the keel; fitted between the floor throats thus formed is an oak chock (*c* Fig. 23), which rests on the angle iron and keel, and on this the bolt through lead and wood keel is fastened

with nut and screw, so that the angle iron will not be weakened by being pierced for through bolts.

The angle iron floors will be secured to the wood keel with coach screws. The oak floor arms will project about a foot above the angle iron, and to these the timbers will be scarphed. The intermediate timbers run from gunwale to gunwale. Most of the intermediate timbers will be steamed, but where extra strength is required larger worked timbers will be put in.

It would be difficult to say which plan is to be preferred, as each is used where some special object is in quest. For instance, in Fig. 18 we see a vessel with an abnormally broad wood keel, and the keel is so broad solely because she should carry a considerable weight of metal

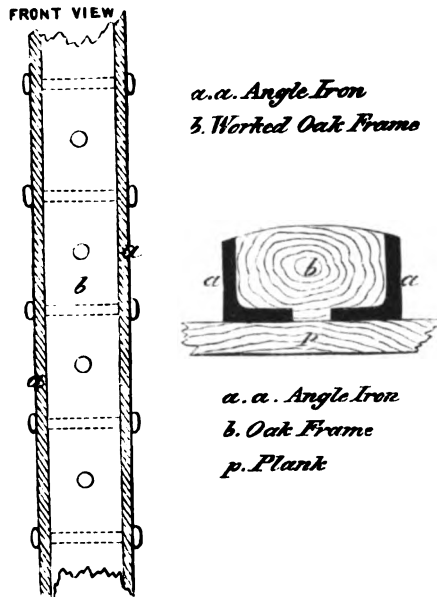
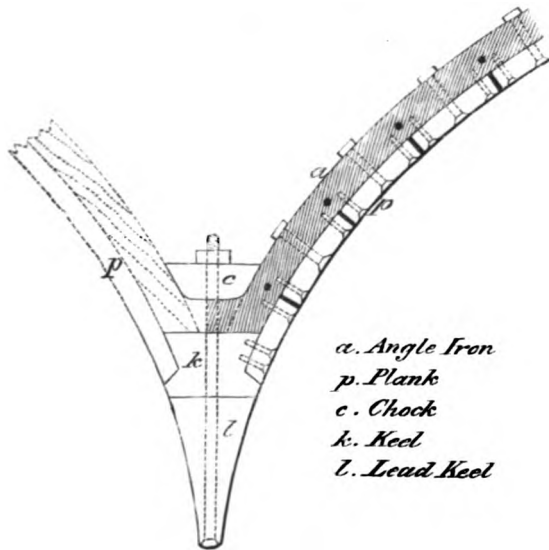


FIG. 22.

under it; it is manifest that no hogging piece is required here to prevent sagging or hogging, and such an addition to the structure would only be taking up space which would be much better occupied by ballast. Then, as the keel is so broad in its siding, too much or unnecessary displacement might be the result if the heels of the timbers were butted to the side of the keel; hence the heels rest on the top of the keel, and the strength of the structure is insured as shown. In striking the ground there would not be the least possibility of the keel being driven up through the vessel, and all wrenching or twisting strains are amply provided for by the iron knees and transverse plates. So far as Fig. 21 goes, the hogging piece and main keel can be regarded as all one piece, strength and rigidity

being supplied in depth instead of by breadth, as an object existed in having the lead keel deep in proportion to its breadth. Any chance of the keel going up through the bottom of the vessel is met by the heels of the frames being joggled into it, and by the garboards being rabbeted into it lower down; beyond this there are the iron knee floors, which would have to be crushed or broken, or unfastened, before the keel could make an entry into the hold of the vessel. Next we come to the plan of half joggling the heels of the frames to the top of the main keel; and it is obvious that this plan, if the heels are at all cross-grained, is a very insecure one. The plan of having a hogging piece of less siding than a keel, so as to admit of a stepping line for the heels of the timbers, has no advantages over the plan shown by Fig. 21, but is one that might very well be adopted where the hogging piece is of metal.



*a. Angle Iron
p. Plank
c. Chock
k. Keel
l. Lead Keel*

FIG. 23.

The plan of butting the heels of timbers to the sides of a keel without any joggles or stepping line whatever has been objected to, because there is a probability of the garboards, in case a vessel got ashore and bumped heavily, being driven out of the rabbets. In a vessel with a flat floor this assuredly would be the case, as the iron knees would most likely part in their angles at the first heavy bump; in fact, they would have to bear the brunt of the shock. But even with a great rise of floor, the garboards may be crushed out of the rabbets, if the heels of the timbers are not butted into the keel; in fact, a case occurred in 1877 where a vessel of some 120 tons weight got on some rocks, and her garboard strakes were split and forced out of the rabbets. The smallest

movement of the heels of the timbers down the side of the keel would serve to wrench the garboards away from their fastenings or crush them; whereas if the heels were properly butted into the keel they could not shift, and no undue strain would come on the garboards in case of bumping.

Fig. 24 illustrates the old-fashioned orthodox structure of a vessel's floor: *a* is a grown floor, sometimes joggled as shown, and sometimes not, to the main keel *k*. The keelson is shown by *s* and garboard by *g*, bolted through the keel. The keelson floor and keel are bound together by through bolts, as shown by *b*. The strength of these wood floors is mainly dependent upon the grain in the throat running as shown in Fig. 24. If the grain in the throat is vertical, the chances are that the through keel bolt would split the floor.

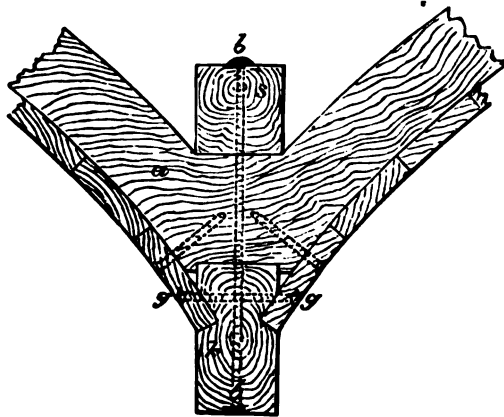


FIG. 24.

In many yachts the floors are of cast-iron of the form shown by *a* (Fig. 24), upon the heads of which the heels of the first futtocks are dowelled, and the heels of the sister timbers are brought down to, and rest on, the top of the keel. There is no denying the strength of the grown floor and cast-iron floor plan, and the keel would be knocked into sawdust before it would come smashing through the cabin floor.

The other parts of the vessel, whether large or small, should be constructed according to the recognised practice. However, it is seldom that a shelf is met with in 10-tonners, a clamp only doing duty as a shelf to take the deck-beams and fastenings and timber-head fastenings. When a clamp only is fitted in a 10-tonner, the top strake (under the covering board) should be of oak, and bolted through timber, clamp and all.

The proper plan of construction for this part of the vessel is shown by Fig. 25; *a* is a timber or frame; *b* a deck beam; *c* the shelf; *d* the clamp; *e* the ceiling; *f* the outside plank; *g* the top strake or sheer strake; *h* the covering board; *i* the deck plank; *j* a stanchion; *k k* bolts

through every beam; *l* a dowell; *m* a bolt through every frame; *n* a hanging knee bolted as shown; *o*, in the other sketch, shows a section of pieces of timber fitted between deck beams to take the fastenings of the covering board. Each piece of timber is bolted to the shelf.

The number of hanging knees depends upon the size of the yacht, and the minimum number allowable is set forth in the Table E in page 109.

A vessel, although built of good material, is frequently less strong than she ought to be in consequence of the butts of the plank coming too near each other. Lloyd's rule is that butts should not come nearer than 5 feet to each other on adjoining planks; and no butts are allowed

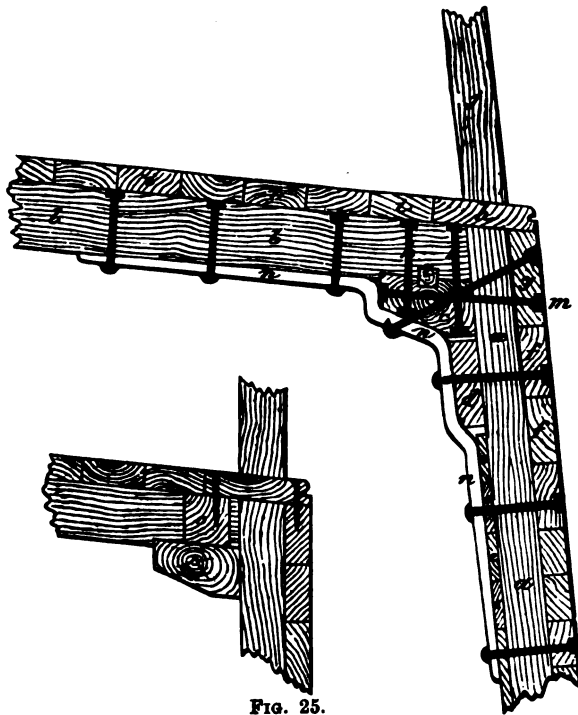


FIG. 25.

on the same timber unless three strakes come between them. This rule should be very particularly attended to, especially in vessels that have but one or two inside strakes, and but few through fastenings.

Various plans have been used for strengthening and binding together the fabric of the hull; but the diagonal iron braces previously referred to are only used in large yachts of great length. In yachts of eighty feet and under in length, thick strakes of hard wood or pitch pine are worked under the clamp and shelf, and run the whole length of the vessel, and are through-fastened with metal bolts. Similarly two bilge strakes along the curve of each bilge on each side are worked and through-fastened.

Limber strakes are also sometimes worked over the heels of the first futtocks which join the heads of the floors, and are through-fastened. A limber strake in a cruising vessel with a floor construction, such as that shown in Figs. 19 or 20, where there is no keelson, would greatly add to the strength of the vessel; but in yachts of 50 tons and under it would scarcely be necessary to have a "thick strake" above the bilge strakes. Outside a wale or bend is worked and through-fastened; but where all the planking is of hard wood, the wales are dispensed with.

It must be understood, if the yacht about to be built is intended for racing rather than cruising, that it will be an advantage to reduce the scantling, and increase the spacing so far as may seem compatible with strength. The plank also (if the owner is not particular about obtaining a long term of years in Lloyd's Register, see Tables A, B, and C), from the bilge upwards, can be of red pine instead of teak or oak, and the deck beams can also be of red pine; the bulwarks of red pine, and the stanchions and rails reduced in size so far as may appear consistent with strength. There are racing vessels, of similar tonnage, with as much as two-fifths difference in the size and height of stanchions; and in a 200-ton vessel half a ton of weight might very well be disposed of in this way. Of course it is only fair to say that some of our most successful racing vessels, such as *Florinda*, *Corisande*, or *Gwendolin*, are built of the heaviest material and full scantling. However, although this may show that a vessel can be so built and succeed as a racer, it is at least an open question whether she would not have been a still greater success had her scantling been reduced.

The metal fastenings of yachts (see Table D) form a subject about which there is a great deal of opposite opinion. The builder who constructs cheaply contends stoutly that there is nothing like iron; on the other hand, the builder who always asks and gets a good price for his work would as soon think of fastening a yacht with cabbage stumps as with iron. Others recommend iron for dead-wood bolts, shelf bolts, and floor bolts, with Muntz' metal for plank fastenings. Others recommend Muntz' metal for all bolts, and a mixture of Muntz' metal and trenails for plank fastening. There is no doubt that iron has advantages, so far at least as long dead-wood bolts are concerned. Iron can be driven very much tighter than copper-rod, and its strength is greater. We have seen iron bolts, that had been made hot and dipped in varnish or oil before they were driven, taken out of a vessel thirty years old, long before galvanised iron was heard of, as clean and bright—in fact, the varnish unperished—as they were at the moment of driving. On the other hand, if the iron were driven through a shaky piece of timber, or loosely driven, so that salt water might get

to it, decay of the iron would be very rapid; hence preference must be given to copper or Muntz' metal. Galvanised iron is often used for shelf fastenings, and it is less objectionable there; but preference should be given to Muntz' metal for all dead woods, as it can be driven as tightly as iron, and, if of the best quality, will clench as well.

Lloyd's give an additional year to all ships or yachts that are fastened from the keel upwards (to within one-fifth the depth of hold amidships from the deck) with yellow metal or copper bolts and dumps, or trenails; in such case the fastenings for the upper strakes of plank to the deck must be properly galvanised, it being also understood that the iron bolts for frames, beams, &c., are to be galvanised. And a further two years are granted if *no trenails* are used at all.* Whether trenails or bolts are used, one is to be put in each plank or strake at every timber; two-thirds of the trenails are required to be driven through, and the butts of the plank must be through-bolted with copper or yellow metal; and the bilge strakes and limber strake should be through-bolted.

Trenails are scarcely adapted for vessels of less than 50 tons, on account of the small size of the timbers; and even in these they should be very sparingly used (and only in the bottom plank), as a 3in. timber must be very considerably weakened if it is bored with holes to receive 1in. trenails.

A.

NUMBER OF YEARS ASSIGNED BY LLOYD'S TO THE DIFFERENT DESCRIPTIONS OF TIMBER USED IN YACHTS; THE SAME TO BE OF GOOD QUALITY, PROPERLY SEASONED, AND FREE FROM DEFECTS.

| DESCRIPTION OF TIMBER. | Keel. | Stem, Sternpost, Apron, Deadwood, Knightheads, Hawse Timbers, Frame Timbers, Beams, and Hooks. | Outside Planking. | | Shelves, Clamps, Limber and Bilge Strakes, and Keelsons. | Upper Deck, Waterway, Covering-board, and Roughstree Timbers. | Rudder, Windlass, and Fallbitt. — Mainpieces. |
|--|-------|--|---|--|--|---|---|
| | | | From top of Keel to two feet below Load-line. | From two feet below Load-line to Plankbeer | | | |
| East India Teak | 14 | 14 | 14 | 14 | 14 | 14 | 14 |
| English, African, French, Adriatic, Italian, Spanish, and Portuguese Oaks, Greenheart, Morra, and Iron Bark..... | 12 | 12 | 12 | 12 | 12 | 12 | 12 |
| Pitch Pine, Oregon and Huon Pine, Larch, Hackmatack and Cowdie or Kaurie Pine | — | — | 10 | 9 | 9 | 9 | — |
| Northern Continental Oak..... | 10 | 9 | 12 | 9 | 9 | 9 | 9 |
| Dantzic, Memel, Riga, and American Red Pine..... | — | — | 9 | 8 | 8 | 8 | — |
| English Elm and American Rock Elm..... | 14 | — | 14 | — | — | — | — |
| Spruce Fir, Swedish and Norway Red Pine. | — | — | 6 | 6 | — | — | — |

* Lloyd's also give an extra year if the vessel is built under cover.

B.
SIZES OF TIMBERS, KEELSON, KEEL, PLANKING, &c.

| | 5 | 10 | 20 | 30 | 40 | 50 | 75 | 100 | 150 | 200 | 250 | 300 |
|---|--------|---------|---------|---------|--------|--------|---------|---------|---------|---------|--------|---------|
| Tonnage, Y.R.A. | in. 15 | in. 16 | in. 17 | in. 18 | in. 19 | in. 20 | in. 22 | in. 23 | in. 24 | in. 25½ | in. 27 | in. 28½ |
| Timber and Space (double frames) | 3 | 3½ | 4 | 4½ | 5 | 5½ | 6 | 6½ | 7½ | 8 | 8½ | 9½ |
| Floors, sided and moulded * at keelson | 2½ | 3 | 3½ | 4½ | 4½ | 5 | 5½ | 6 | 6½ | 7½ | 7½ | 8½ |
| Futtocks (timbers), sided and moulded at floorheads | — | — | 3½ | 3½ | 4½ | 4½ | 5 | 5½ | 6 | 6½ | 7 | 7½ |
| 2nd Futtocks, sided | — | — | 3 | 3½ | 4 | 4½ | 4½ | 5 | 5½ | 5½ | 6½ | 6½ |
| 3rd Futtocks and Top Timbers | 1½ | 2 | 2½ | 3½ | 3 | 3½ | 3½ | 4½ | 5 | 5½ | 6 | 6½ |
| † Top Timbers, moulded and sided at heads | 4 | 4½ | 5½ | 6 | 7 | 7½ | 8½ | 9 | 9½ | 10 | 10½ | 11 |
| Keel, Stem, Apron, Starnpost, and Deadwood, sided and moulded .. | 4½ | 5 | 6 | 7 | 8 | 9 | 9½ | 10 | 11 | 11½ | 12 | 12½ |
| Keelson, sided and moulded | — | — | 2½ | 2½ | 2½ | 2½ | 2½ | 3 | 3½ | 3½ | 3½ | 4 |
| Wales, ¼ depth of ship | 1½ | 1½ | 1½ | 1½ | 1½ | 2 | 2½ | 2½ | 2½ | 2½ | 3 | 3½ |
| Bottom Plank, from keel to wales | 1½ | 1½ | 2 | 2 | 2½ | 2½ | 2½ | 2½ | 3 | 3½ | 3½ | 4 |
| Sheer Strakes at upper edge, Upper Deck Clamp, where no shelf is fitted | 1½ | 1½ | 2 | 2 | 2½ | 2½ | 2½ | 2½ | 3 | 3½ | 3½ | 4 |
| Ceiling | 1½ | 1½ | 2 | 2 | 2½ | 2½ | 2½ | 2½ | 3 | 3½ | 3½ | 4 |
| Bilge Plank or Stringer inside, Thick Strakes, over long and short floor heads and Limber Strakes | 1½ | 1½ | 1½ | 2 | 2½ | 2½ | 2½ | 2½ | 3 | 3½ | 3½ | 4 |
| Shelf, sided and moulded | 3 | 3½ | 4 | 4½ | 5 | 5½ | 6 | 6½ | 6½ | 7½ | 7½ | 8½ |
| Plankbeer | 1½ | 1½ | 2 | 2½ | 2½ | 2½ | 2½ | 2½ | 2½ | 2½ | 2½ | 3 |
| Flat of Deck | 1½ | 1½ | 2 | 2½ | 2½ | 2½ | 2½ | 2½ | 2½ | 2½ | 2½ | 3 |
| Scarp of Keel or Keelson | 5ft | 5ft 3in | 5ft 6in | 5ft 9in | 6ft | 6ft | 6ft 3in | 6ft 6in | 6ft 9in | 7ft | 7ft | 7ft |

* Sided means the thickness of the timber between its two straight or flat sides; and "moulded" the thickness between the curved sides. Sometimes the siding is increased a little, and the moulding proportionately decreased.

† The sizes of the timbers should diminish gradually from size at floor head to that of top timber heads.

The butts of planks to have not less than five feet shift, unless two strakes of plank intervene between the two wherein the butts occur on the same timber.

F.
ANCHORS FOR SAILING YACHTS.

| Yacht Tonnage. | Number of Anchors. | 1st Anchor. | | 2nd Anchor. | | 3rd Anchor. | | 4th Anchor. | |
|----------------|--------------------|---------------------------|-----------------|---------------------------|----------------|-------------------------------|----------------|------------------|----------------|
| | | Weight. | Test. | Weight. | Test. | Weight. | Test. | Weight or Stock. | Test. |
| | | Cwts. | Tons. | Cwts. | Tons. | | | | |
| 5 | 2 | With Stock $\frac{1}{2}$ | — | With Stock $\frac{1}{2}$ | — | — | — | — | — |
| 10 | 2 | With Stock 1 | — | With Stock $\frac{1}{2}$ | — | With Stock 20lb. | — | — | — |
| 20 | 2 | With Stock $1\frac{1}{2}$ | — | With Stock $\frac{1}{2}$ | — | With Stock 35lb. | — | — | — |
| 30 | 2 | Ex. Stock $1\frac{1}{2}$ | — | With Stock 1 | — | With Stock 50lb. | — | — | — |
| 40 | 2 | 2 | $4\frac{1}{8}$ | With Stock $1\frac{1}{2}$ | — | With Stock $\frac{1}{2}$ cwt. | — | — | — |
| 50 | 3 | $2\frac{1}{2}$ | 5 | Ex. Stock $2\frac{1}{2}$ | $4\frac{1}{8}$ | With Stock $\frac{1}{2}$ | — | — | — |
| 60 | 3 | 3 | $5\frac{1}{8}$ | $2\frac{1}{2}$ | $5\frac{1}{8}$ | With Stock 1 | — | — | — |
| 75 | 3 | $3\frac{1}{2}$ | $6\frac{1}{8}$ | $3\frac{1}{2}$ | $5\frac{1}{8}$ | With Stock $1\frac{1}{2}$ | — | — | — |
| 100 | 3 | $4\frac{1}{2}$ | $6\frac{1}{8}$ | $4\frac{1}{2}$ | $6\frac{1}{8}$ | With Stock $1\frac{1}{2}$ | — | — | — |
| 125 | 3 | 5 | $7\frac{1}{8}$ | $4\frac{1}{2}$ | $7\frac{1}{8}$ | Ex. Stock $1\frac{1}{2}$ | $4\frac{1}{8}$ | — | — |
| 150 | 4 | $5\frac{1}{2}$ | $7\frac{1}{8}$ | $5\frac{1}{2}$ | $7\frac{1}{8}$ | 2 | 5 | 1 | — |
| 200 | 4 | $6\frac{1}{2}$ | $8\frac{1}{8}$ | 6 | $8\frac{1}{8}$ | $2\frac{1}{2}$ | $5\frac{1}{8}$ | 1 | — |
| 250 | 4 | 7 | $9\frac{1}{8}$ | $6\frac{1}{2}$ | $8\frac{1}{8}$ | 3 | $5\frac{1}{8}$ | $1\frac{1}{2}$ | — |
| 300 | 4 | 8 | $10\frac{1}{8}$ | $7\frac{1}{2}$ | $9\frac{1}{8}$ | $3\frac{1}{2}$ | $5\frac{1}{8}$ | 2 | $4\frac{1}{8}$ |

Some anchors, such as Cole's, are carried of about 20 per cent. less in weight than given in the table.

G.
CHAINS FOR SAILING YACHTS.

| Tonnage. | Chain Cable. | | | Stream Chain. | | | Hawser. | | Warp. | |
|----------|----------------|-----------------|-----------------|---------------|---------|----------------|---------|----------------|---------|----------------|
| | Minimum Size. | Test. | Breaking Test. | Length. | Length. | Size. | Length. | Size. | Length. | Size. |
| 5 | Ins. | — | — | 50 | — | — | 40 | $3\frac{1}{2}$ | 40 | $2\frac{1}{2}$ |
| 10 | $\frac{1}{16}$ | $3\frac{1}{16}$ | $5\frac{1}{2}$ | 60 | — | — | 45 | 4 | 45 | 3 |
| 20 | $\frac{1}{8}$ | $4\frac{1}{8}$ | $6\frac{1}{2}$ | 60 | — | — | 50 | $4\frac{1}{2}$ | 45 | 3 |
| 30 | $\frac{1}{8}$ | $5\frac{1}{8}$ | $8\frac{1}{2}$ | 60 | — | — | 60 | $4\frac{1}{2}$ | 45 | 3 |
| 40 | $\frac{1}{8}$ | 7 | $10\frac{1}{2}$ | 75 | — | — | 60 | 5 | 50 | 3 |
| 50 | $\frac{1}{8}$ | 7 | $10\frac{1}{2}$ | 90 | — | — | 75 | 5 | 60 | $3\frac{1}{2}$ |
| 60 | $\frac{1}{8}$ | $8\frac{1}{8}$ | $12\frac{1}{2}$ | 105 | — | — | 75 | $5\frac{1}{2}$ | 75 | $3\frac{1}{2}$ |
| 75 | $\frac{1}{8}$ | $8\frac{1}{8}$ | $12\frac{1}{2}$ | 120 | — | — | 75 | $5\frac{1}{2}$ | 75 | $3\frac{1}{2}$ |
| 100 | $\frac{1}{8}$ | $10\frac{1}{8}$ | $15\frac{1}{2}$ | 135 | — | — | 75 | 6 | 90 | $3\frac{1}{2}$ |
| 125 | $\frac{1}{8}$ | $10\frac{1}{8}$ | $15\frac{1}{2}$ | 150 | 45 | $\frac{1}{16}$ | 75 | 6 | 90 | 4 |
| 150 | $\frac{1}{8}$ | $11\frac{1}{8}$ | $17\frac{1}{8}$ | 150 | 45 | $\frac{1}{16}$ | 75 | 6 | 90 | 4 |
| 200 | $\frac{1}{8}$ | $13\frac{1}{8}$ | $20\frac{1}{8}$ | 150 | 45 | $\frac{1}{16}$ | 75 | $6\frac{1}{2}$ | 90 | 4 |
| 250 | $\frac{1}{8}$ | $15\frac{1}{8}$ | $23\frac{1}{8}$ | 165 | 45 | $\frac{1}{16}$ | 75 | $6\frac{1}{2}$ | 90 | $4\frac{1}{2}$ |
| 300 | 1 | 18 | 27 | 165 | 45 | $\frac{1}{16}$ | 75 | 7 | 90 | $4\frac{1}{2}$ |

The weight of chain cable per fathom can be found by multiplying the square of the diameter (diameter²) by 54.

Some ten years ago it seemed likely that composite vessels would quite supersede those entirely of wood construction; but so far the composite plan has not advanced in favour. This is really a matter for surprise, as the composite build offers this advantage over the wood structure: so very much more room is obtainable inside on the same weight or displacement. The great question was ten years ago, could a composite vessel be so fastened as to be insured against the possibility of the fastenings giving out? We think the question has now, after ten years, been satisfactorily answered by such vessels as Oimara, Selene, Nyanza, or Garrion, built by Steele and Co., of Greenock; the Sunbeam and Modwena, built by Bowdler and Chaffler, at Liverpool; the Bella Donna and Seabird, built by Hatcher; and many others. None of these vessels have, so far as we know, ever shown the slightest signs of straining, nor have their fastenings decayed; in fact, so far there seems every chance of their out-enduring any of the wood yachts which were constructed at about the same period. For a composite yacht it is best that all the planking (excepting, of course, the deck) should be of hard wood, and that the plank fastenings should be of Muntz' metal screw bolts sunk in the plank, and so insulated that galvanic action could not be set up with the outside copper, the bolts, and the frames. Mr. J. S. White, of East Cowes, has, within the last two years, provided the necessary plant for composite construction, and has built three large yachts according to that system of construction. We may perhaps take this as evidence that composite vessels are gradually coming into general use.

Lloyd's have compiled a table of scantlings for composite and iron yachts, and will in future class such as are built up to their rules. Steel, however, is likely to supersede iron, as Lloyd's will give the same class for one-fifth less weight.

A great many experiments have from time to time been made with compositions for preventing the fouling of the bottom of ships; but up to the present time no specific has been discovered, and the opportunity for someone to realise a large fortune still exists. So far as yachts are concerned, they are generally sheathed with copper; and, for these waters at least, the bottom can be kept clean enough by a couple of scrubblings throughout the season. One of the compositions, such as Jesty's, Day's, Peacock's, or Martin's, is sometimes put over the copper; but, for racing at least, we prefer the copper without the composition, as clean copper has a smoother surface than either of the compositions imparts. Of course, for a racing yacht, the copper cannot very well be cleaned too often; and a month is quite long enough for the vessel to be without a scrub, although there are but few who get one so often. The Admiralty

have been making some experiments with zinc as a sheathing for iron ships (the iron being first protected by a slight wood skin), but so far zinc does not appear to offer many advantages. Copper, on the other hand—if the ship be kept constantly moving, or moored, say, in a five-knot tide—will keep comparatively clean, on account of the extensive exfoliation which goes on of the oxychlorides and other soluble salts produced by the action of the salt water on the copper. Oxychlorides are similarly and much more rapidly formed on zinc, but are not so readily soluble; hence very little exfoliation takes place, and a corroded and rough surface is the result, the zinc being finally eaten through. Zinc, therefore, we may conclude, is unsuitable as a sheathing for yachts, especially as evidence exists that such sheathing $\frac{1}{2}$ in. thick has been eaten through in one year. An alloy of copper (2) and zinc (3), popularly known as Muntz' metal, is largely used as a sheathing for ships; but it is scarcely so good as copper for yachts, as, owing to its greater stiffness, it cannot be laid so well. Another objection to Muntz' metal sheathing is that it does not exfoliate to the extent copper does, and that after being under the influence of salt water any considerable time—say three or four years—the metal becomes rotten; but this defect, it is said, can be remedied by an addition of a small quantity of tin to the alloy. For composite ships Muntz' metal sheathing has some advantage, as it sets up very little, if any, galvanic action with iron; but the risk of galvanic action from copper sheathing in a well-constructed composite ship is so remote that copper is to be preferred even to these, if the difference in cost is not a consideration.

A curious feature in connection with yacht construction is that naval architects should have had so little to do with the designing of yachts. Yacht builders, as a rule, keep draughtsmen, who are instructed as to a design, and thus the builder becomes his own architect. That this plan has succeeded there can be no doubt, and it might even be questioned whether an architect could at present compete with the builder, if the latter bestowed so much time on a design as he ought. But, as a rule, builders are too much occupied with the cares of their business to devote much time to the mathematical consideration of a design; and it is only their experience, and a prudent purpose not to depart in any radical way from a model which practice has proved to be possessed of undeniable good qualities, that keep them from blundering into failure. If we were asked to give a reason why the business of designing happens to be in the same hands as the business of building, we could give no satisfactory answer, if a true one. The truth is that, in the early days of yachting, a naval architect who confined the exercise of his talents to the designing of yachts would have found his occupation by no means a lucrative one,

and perforce the builders were compelled to do their own designing, mostly on the pattern of Government cruisers, with such trifling alterations as their experience permitted them to venture upon. Occasionally gentlemen made models of yachts, and the late Mr. Joseph Weld and Mr. T. Assheton Smith had a large share of success; it is even claimed for Mr. Smith that he invented or discovered the value of "wave lines" before Mr. Scott Russell did. But, be this as it may, there can be no doubt that he was as clever at designing as the professional builders of the day. Builders were, in fact, compelled to do their own designing, because the profession of a yacht-naval architect would have been unprofitable. But if builders as a matter of necessity did their own designing fifty years ago, it can scarcely be said that a similar necessity exists now, although the custom does. During the last ten years there have been, on the average, fifty vessels of all rigs and sizes built annually, and it might be assumed that the emoluments for designing these would keep a goodly number of naval architects in the necessities of life. The few who have made yacht-naval architecture a study and profession have undoubtedly succeeded well enough to lead to the conclusion that, with more opportunities, they would make a very considerable advancement in yacht design. Builders would be relieved of a great source of anxiety, as the responsibility of a vessel answering the requirements or expectations of the person for whom she was built would be shifted from their shoulders to those of the architect. Such a shift of responsibility would unquestionably be an advantage for the yacht owner, as it is much more likely that a scientifically trained architect, who has opportunities of tracing causes of success or failure, would achieve any given object than that a builder would, whose business occupations necessarily restrict the exercise of his attention and experience on the important work of designing. It is, therefore, satisfactory to note that yacht designing is gradually gaining recognition as a profession; and if improvement is to be made in the form of yachts, we must look for it from the hands of professional yacht designers.

CHAPTER XII.

THE EQUIPMENT OF THE YACHT.

THE equipment of a yacht embraces generally everything that is used or required for working her. Usually it is understood to consist of the spars, standing and running rigging, sails, various tackles or purchases, anchors, chains, warps, boats, lights, &c. The diagram, Plate I., and the references, will assist the explanations that will follow of the various parts and uses of a vessel's outfit or equipment.

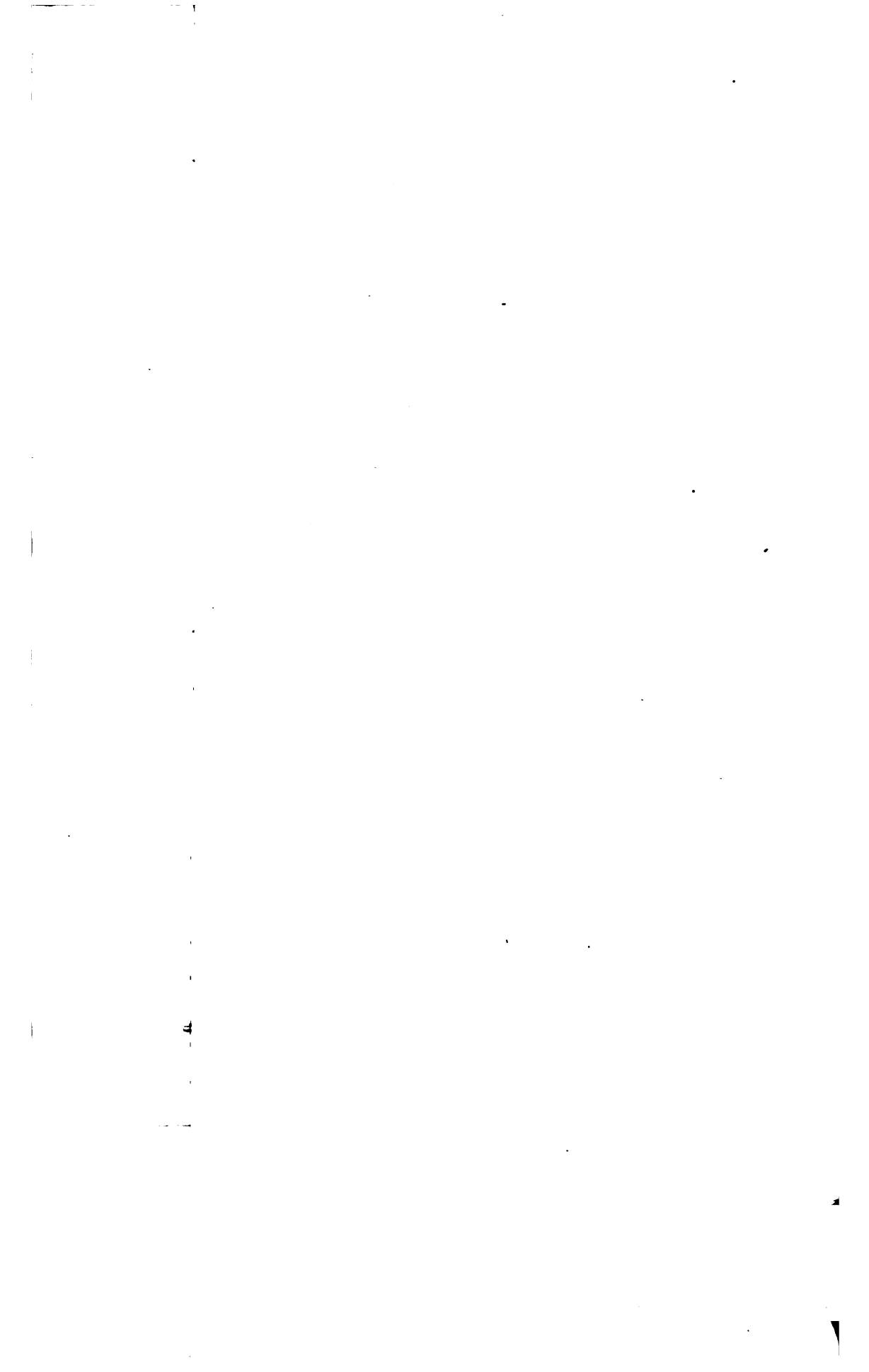
SAILS.

- | | |
|---|--|
| <p>A. Mainsail. <i>a.</i> Clew of mainsail, with traveller on the horse 13 (chain outhaul and tackle shown underneath boom). <i>b.</i> Main tack. <i>c.</i> Throat. <i>d.</i> Peak earing. <i>e.</i> Head. <i>f.</i> Foot and roach of sail. <i>g.</i> Luff or weather leech. <i>h.</i> Leech, or after leech. <i>i.</i> First, second, third, and close reef cringles. <i>j.</i> First, second, third, and close reef points. <i>k.</i> First, second, third, and close reef cringles or luff cringles.</p> <p>B. Foresail. <i>a.</i> Luff. <i>b.</i> Foot. <i>c.</i> Leech. <i>d.</i> Head. <i>e.</i> Tack. <i>f.</i> Reef points.</p> | <p>C. Jib. <i>a.</i> Luff. <i>b.</i> Foot. <i>c.</i> Leech. <i>d.</i> Head. <i>e.</i> Tack.</p> <p>D. Gaff Topsail. <i>a.</i> Clew. <i>b.</i> Tack. <i>c.</i> Weather earing, or head earing. <i>d.</i> Peak earing. <i>e.</i> Head. <i>f.</i> Foot. <i>g.</i> Luff. <i>h.</i> Leech.</p> <p>E. Jib Topsail. <i>a.</i> Luff. <i>b.</i> Foot. <i>c.</i> Leech. <i>d.</i> Head. <i>e.</i> Tack.</p> |
|---|--|

SPARS.

- | | |
|---|---|
| <p>1. Mast. 2. Top Mast. 3. Bowsprit. 4. Boom.</p> | <p>5. Gaff. 6. *Topsail yard. 7. Spinnaker boom. 8. Hounds, bolster, and yoke.</p> |
|---|---|

* Formerly balloon topsails, with a footyard or jackyard, were common in all racing yachts; they are now generally done away with, excepting in schooners and yawls, as they greatly increase the weight aloft, without much increasing the size of topsail.



**Ti
re
st:
ck
w
of**

SPARS—continued.

- | | |
|--|---|
| <ul style="list-style-type: none"> 9. Cap. 10. Masthead. 11. Pole of topmast. 12. Truck. | <ul style="list-style-type: none"> 13. Iron horse at boom end for mainsail out-haul to travel on. 14. Mast hoops. |
|--|---|

RIGGING.

- | | |
|---|--|
| <ul style="list-style-type: none"> 1. * Main rigging shrouds. 2. * Sheer pole, termed also sheer batten and sheer stretcher. 3. * Dead eyes and lanyards. 4. * Fore stay. 5. * Pendant. 6. * Runner. 7. Runner tackle. 8. Fall of runner tackle. 9. * Topmast stay (topmast back-stays or shrouds not shown.) 10. * Topmast shifting backstay, or "pre-venter backstay." 11. Tackle of shifting backstay. 12. * Bobstay. 13. Bobstay tackle and fall. 14. Main halyards. 15. Peak halyards. 16. Main sheet. 17. Topping lifts. 18. Reef-earing or pendant. 19. Foresail halyards. 20. Foresail sheet rove through block on clew of sail. 21. Foresail tack. 22. Jib halyards. 23. Jib sheets fast to clew of sail. | <ul style="list-style-type: none"> 24. Jib tack. 25. Jib traveller. 26. Jib outhaul. 27. Jib downhaul and foresail downhaul. 28. Topsail halyards. 29. Topsail upper halyards, or tripping halyards. 30. Topsail sheet, leading through block with pendant, fast round masthead. 31. Topsail tack. 32. Topsail tack tackle. 33. Topsail clew line. 34. Jib-topsail halyards. 35. Jib-topsail tack. 36. Jib-topsail sheet, fast to clew of sail. 37. Mainsail downhaul. 38. Spinnaker-boom; topping lift. 39. Spinnaker-boom; after guy. 40. Spinnaker-boom; hauling and standing parts of whip purchase of after guy. 41. Spinnaker-boom; fore guy. 42. Spinnaker outhaul, the hauling part on the under side of the boom. 43. Spinnaker outhaul, on the upper side of boom; this is the part made fast to spinnaker tack. |
|---|--|

The parts of the rigging marked thus * are termed "standing rigging," and the other parts "running rigging."

HULL.

- | | |
|--|---|
| <ul style="list-style-type: none"> 1. Load water-line. (L.W.L.) 2. Keel. 3. Sternpost. 4. Budder. 5. Deadwood. 6. Forefoot, termed also gripe. 7. Stem. 8. Freeboard. 9. Counter. | <ul style="list-style-type: none"> 10. Archboard. 11. Taffrail. 12. Quarter timbers. 13. Covering board or plank sheer. 14. Rail, or rough tree rail. 15. Channel. 16. Chain plates, or channel plates. 17. Bobstay shackle plates. |
|--|---|

FIG. 26.

HULL.

- | | |
|---|--|
| <ul style="list-style-type: none"> 1. Floor. 2. Frames or timbers. 3. Keel. 4. Garboard. 5. Bilge. | <ul style="list-style-type: none"> 6. Deck. 7. Deck Beam. 8. Bulwark stanchions. 9. Channels and channel plates. |
|---|--|

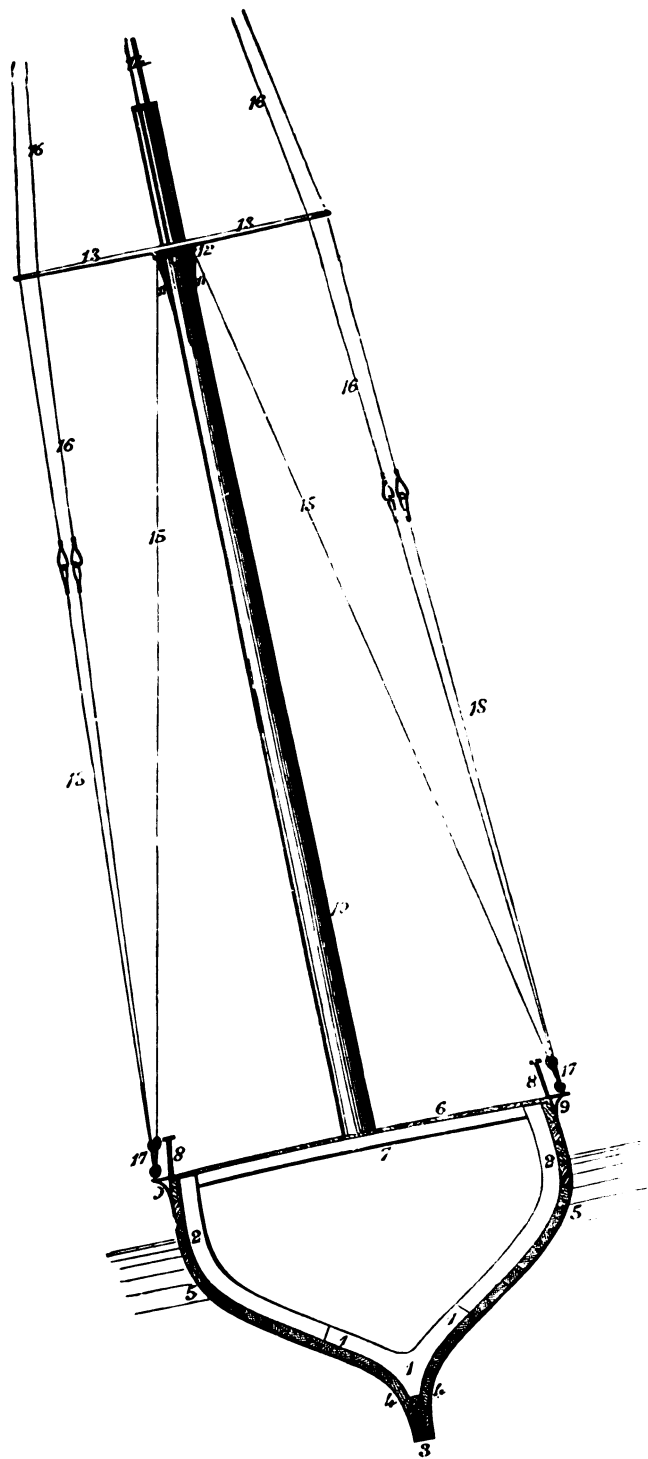


FIG. 26.

MAST AND RIGGING.

- | | |
|--|---|
| <p>10. Mast. 11. Hounds. 12. Yoke or lower cap and bolster. 13. Crosstrees. 14. Topmast.</p> | <p>15. Main rigging or shrouds. 16. Topmast shrouds or backstay. 17. Backstay falls or tackles. 18. Legs of topmast backstays taken off when the topmast is housed.</p> |
|--|---|

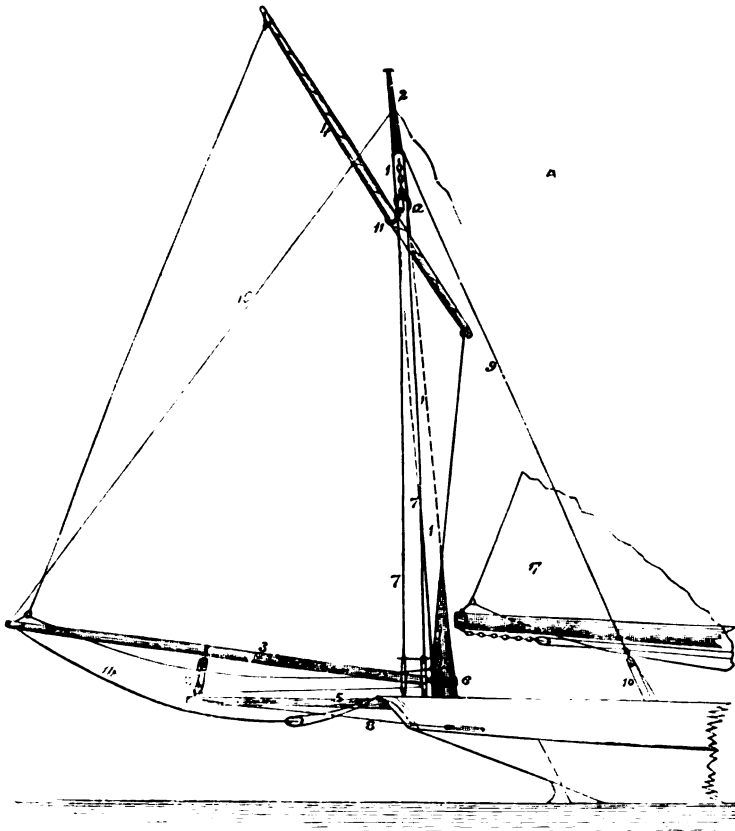


FIG. 27.

MIZEN OF YAWL.

- | | |
|---|---|
| <p>1. Mizzen mast. 2. Pole of mizzen mast. 3. Mizzen boom. 4. Mizzen yard. 5. Mizzen bumpkin. 6. Spider band on mast. 7. Mizzen shrouds set up with lanyards and sheer pole. 8. Mizzen bumpkin guys or shrouds. 9. Mizzen shifting stay, one on each side. 10. Tackle for mizzen shifting stay. 11. Strop on mizzen yard. 12. Iron traveller on mizzen mast, with chain tye or halyard passing through sheave hole above. The tackle on the chain</p> | <p>halyard is hidden on the other side of the mast. 13. Mizzen sheet leading in board. 14. Mizzen outhaul and whip purchase slackened up. The outhaul is also sometimes arranged in this manner; the outhaul is first put over the end of the boom by a running eye, then passes through a single block on the clew cringle of the sail, through a sheave hole in the boom end, and then on board. In such case there is no whip purchase. 15. Mizzen tack and tack tackle. 16. Mizzen topping lift. 17. Mainboom and part of mainsail.</p> |
|---|---|

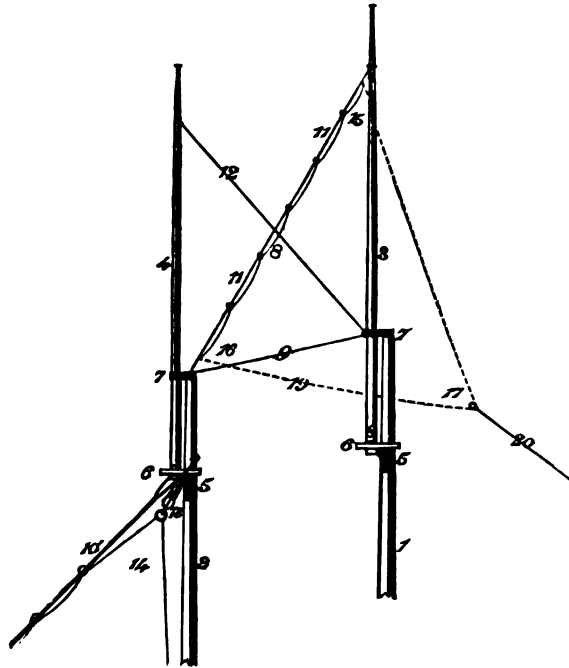


FIG. 28.

MASTS AND RIGGING OF SCHOONER.

- | | |
|---|---|
| <ul style="list-style-type: none"> 1. Mainmast. 2. Foremast. 3. Main topmast. 4. Fore topmast. 5. Hounds or cheeks of mast. 6. Lower cap on which crosstrees rest, fore side of topmast. 7. Cap. 8. Topmast fid. 9. Triatic stay. 10. Forestay. | <ul style="list-style-type: none"> 11. Main-topmast stay. 12. Fore-topmast backstay. 13. Fore-staysail halyards. 14. Head of fore-staysail. 15. Head of main-topmast staysail. 16. Tack " " 17. Clew " " 18. Luff " " 19. Foot " " 20. Sheet " " <p style="margin-left: 40px;">leading to quarter rail.</p> |
|---|---|

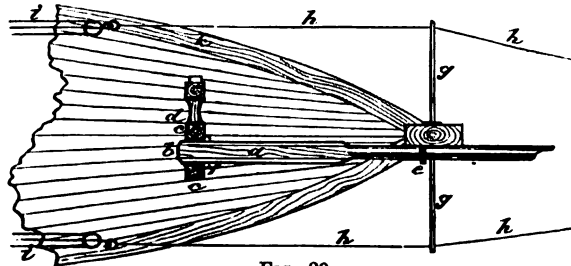


FIG. 29.

FOREDECK FITTINGS, BOWSPRIT AND RIGGING.

- | | | |
|---|--|---|
| <ul style="list-style-type: none"> a. The bowsprit. b. Heel of bowsprit. c. Bitts. d. Windlass. | <ul style="list-style-type: none"> e. Gammon iron, also called span shackle. f. Fid. g. Whiskers. h. Wire shrouds. | <ul style="list-style-type: none"> i. Tackle for setting up shrouds. <p style="margin-left: 40px;">N.B. The block is usually an iron fiddle one here.</p> <ul style="list-style-type: none"> k. Covering board. |
|---|--|---|

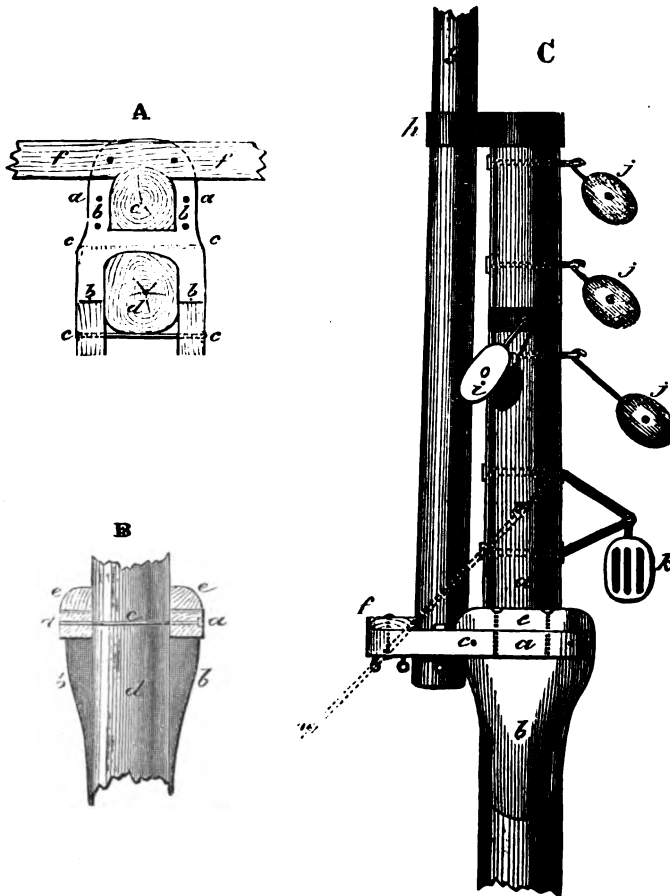


FIG. 30.

MASTHEAD FITTINGS.

Fig. A shows a view of the top side of the yoke or lower cap.

a is the yoke with an iron band round it.

b is a U-shaped iron plate, sometimes fitted over the yoke in front, where the topmast passes through.

c is an iron bolt.

d is the mast.

e is the topmast.

f the crosstrees fitted on the fore side of topmast as shown.

Fig. B is the yoke and mast viewed from aft.

a, the ends of the aft arms of yoke.

b, the hounds.

c, iron bolt at aft side of mast.

d, the mast.

e, bolsters on which the rigging rests.

Fig. C shows a broadside view of the yoke and masthead.

a, the yoke.

b, the hounds.

c, iron bolt.

d, the masthead.

e, bolster.

f, crosstrees.

g, topmast.

h, iron cap.

i, jib halyard block (one on each side of mast, on iron hoop).

j, peak-halyard block.

j, " "

j, " "

j, " "

k, Main-halyard block, and span bolt. This bolt should be long enough to keep the parts of the halyards clear of the yoke. Sometimes a single bolt is used with strong spur and plate below.

The sizes given for blocks in the following table are for cutters; for yawls or schooners of equal tonnage take the sizes set down for the tonnage next below; thus, say a yawl is 100 tons, then take the sizes for blocks from the column assigned to 80 tons.

TABLE OF SIZES OF BLOCKS FOR YACHTS OF VARIOUS SIZES.

IRON STROP BLOCKS.

| NAME OF BLOCK. | Description. | | TONS. | TONS. | TONS. | TONS. | TONS. | TONS. | TONS. | TONS. | TONS. |
|---------------------------------------|--------------------|--------------------|--------------------|----------------------|----------------------|----------------------|----------------------|----------------------|----------------------|-----------------------|------------------------|
| | Number. Double. | Number. Single. | Cut. 5. Yawl 7. | Cut. 10. Yawl 14. | Cut. 15. Yawl 20. | Cut. 20. Yawl 30. | Cut. 30. Yawl 40. | Cut. 40. Yawl 60. | Cut. 60. Yawl 80. | Cut. 80. Yawl 100. | Cut. 100. Yawl 120. |
| | | | Size. | Size. | Size. | Size. | Size. | Size. | Size. | Size. | Size. |
| | | | Ins. | Ins. | Ins. | Ins. | Ins. | Ins. | Ins. | Ins. | Ins. |
| Main halyards <i>a</i> | 2 | — | 4½ | 5 | 5½ | 6 | 7 | 8 | 9 | 9½ | 10 |
| Peak halyards | — | 5 | 4½ | 5 | 5½ | 6 | 7 | 8 | 9 | 9½ | 10 |
| Mainsheet | 1 | 1 | 4½ | 5 | 5½ | 6 | 7 | 8 | 9 | 9½ | 10 |
| Mainsheet lead | — | 2 | 3 | 4 | 4½ | 5 | 5½ | 6 | 6½ | 7 | 7½ |
| Jib halyards | — | 3 | 4½ | 5 | 5½ | 6 | 7 | 8 | 9 | 9½ | 10 |
| Fore halyards | — | 2 | 3 | 4 | 4½ | 5 | 6 | 6½ | 7 | 7½ | 8 |
| Bobstay (iron blocks) . | 1 | 1 | 4½ | 5 | 5½ | 6 | 7 | 8 | 9 | 9½ | 10 |
| Bowsprit shrouds <i>b</i> . . . | 2 | 2 | 6 & 3 | 6½ & 4 | 7 & 4½ | 7½ & 5 | 8 & 5½ | 8½ & 6 | 9 & 6½ | 9½ & 7 | 10 & 7½ |
| Pendant blocks | — | 2 | 3½ | 4 | 4½ | 5 | 5½ | 6 | 6½ | 7 | 7½ |
| Runner tackle <i>b</i> | 2 | 2 | 6 | 6½ | 7 | 7½ | 8 | 8½ | 9 | 9½ | 10 |
| Main outhaul | — | 1 | 3 | 3½ | 4 | 4½ | 5 | 5½ | 6 | 6½ | 7 |
| Topsail sheet | — | 1 | 2¾ | 3½ | 4 | 4½ | 5 | 5½ | 6 | 6½ | 7 |
| Topmast backstays <i>c</i> . . . | 4 | 4 | 3 | 3½ | 4 | 4½ | 5 | 5½ | 6 | 6½ | 7 |
| Preventer backstays . . . | 2 | 2 | 3 | 3½ | 4 | 4½ | 5 | 5½ | 6 | 6½ | 7 |
| Preventer backstay whips | — | 2 | — | 3½ | 4 | 4½ | 5 | 5½ | 6 | 6½ | 7 |
| Jib tack | — | 1 | — | 3½ | 3½ | 4 | 4½ | 5 | 5½ | 6 | 6½ |
| Jib purchase | 1 | 1 | 3½ | 3½ | 4 | 4½ | 5 | 5½ | 6 | 6½ | 7 |
| Jib purchase runner . . . | — | 1 | — | — | — | — | — | 5 | 6 | 7 | 8 |
| Main purchase | 1 | 1 | 3½ | 3½ | 4 | 4½ | 5 | 5½ | 6 | 6½ | 7 |
| Peak purchase | 1 | 1 | 3½ | 3½ | 4 | 4½ | 5 | 5½ | 6 | 6½ | 7 |
| Topping lifts | — | 2 | 3½ | — | 4 | 4½ | 5 | 5½ | 6 | 6½ | 7 |
| Topping lift purchase . . . | — | 4 | 3 | 3½ | 4 | 4½ | 5 | 5½ | 6 | 6½ | 7 |
| ROPE STROP BLOCKS. | | | | | | | | | | | |
| Jib topsail halyards . . . | — | 2 | 3 | 3½ | 4 | 4½ | 5 | 5½ | 6 | 6½ | 7 |
| Spinnaker halyards . . . | — | 1 | 3 | 3½ | 4 | 4½ | 5 | 5½ | 6 | 6½ | 7 |
| Spinnaker guy whip . . . | — | 1 | — | 3 | 3½ | 4 | 4½ | 5 | 5½ | 6 | 6½ |
| Spinnaker topping lift . . | — | 2 | 3 | 3½ | 4 | 4½ | 5 | 5½ | 6 | 6½ | 7 |
| Trysail sheets | 2 | 2 | 4½ | 5 | 5½ | 6 | 6½ | 7 | 7½ | 8 | 8½ |
| Fore sheets | — | 4 | 3½ | 4 | 5 | 5½ | 6 | 6½ | 7 | 7½ | 8 |
| Reef-tackle (fiddle dbl.) | 1 | 1 | 6 & 3½ | 6½ & 4 | 7 | 7½ | 8 | 8½ | 9 | 9½ | 10 |
| Boom guy | 1 | 1 | — | 3 | 3½ | 4 | 4½ | 5 | 5½ | 6 | 7 |
| Tack tackles | 3 | 3 | 3 | 3½ | 4 | 4½ | 5 | 5½ | 6 | 6½ | 7 |
| Burton | — | 2 | — | 3 | 4 | 4½ | 5 | 5½ | 6 | 6½ | 7 |
| Gaff topsail sheet whip . . | — | 1 | — | 3½ | 4 | 4½ | 5 | 5½ | 6 | 6½ | 7 |
| Down-hauls (forward) . . . | — | 3 | — | 3 | 4 | 4½ | 5 | 5½ | 6 | 6½ | 7 |

(a) In vessels of twenty tons and over, the upper throat halyard block is a threefold, as one part of the halyards is required for the purchase, and another for the hauling part.

(b) The double blocks on the bowsprit shrouds and runner tackle are fiddles.

(c) A five-tonner has only four single blocks for backstays, two on each side.

TABLE OF SIZES OF CORDAGE FOR YACHTS OF VARIOUS SIZES.*

| NAME OF ROPE. | TONS. | TONS. | TONS. | TONS. | TONS. | TONS. | TONS. | TONS. | TONS. |
|--------------------------------|--------------------|----------------------|----------------------|----------------------|----------------------|----------------------|----------------------|-----------------------|------------------------|
| | Cut. 5. Yawl 7. | Cut. 10. Yawl 14. | Cut. 15. Yawl 20. | Cut. 20. Yawl 30. | Cut. 30. Yawl 40. | Cut. 40. Yawl 60. | Cut. 60. Yawl 80. | Cut. 80. Yawl 100. | Cut. 100. Yawl 120. |
| | Cf. | Cf. | Cf. | Cf. | Cf. | Cf. | Cf. | Cf. | Cf. |
| | Ins. | Ins. | Ins. | Ins. | Ins. | Ins. | Ins. | Ins. | Ins. |
| Main halyards | 1½ | 2 | 2½ | 2½ | 2½ | 3 | 3½ | 3½ | 3½ |
| Peak halyards | 1½ | 2 | 2½ | 2½ | 2½ | 3 | 3½ | 3½ | 3½ |
| Main-sheet | 1½ | 1½ | 2 | 2½ | 2½ | 2½ | 3 | 3½ | 3½ |
| Jib halyards | ¾ | ¾ | ¾ | ¾ | ¾ | ¾ | ¾ | ¾ | ¾ |
| Fore halyards | 1½ | 1½ | 1½ | 1½ | 2 | 2½ | 2½ | 2½ | 3 |
| Bobstay tackle | 1½ | 2½ | 2½ | 2½ | 3 | 3½ | 3½ | 3½ | 4 |
| Bowsprit shrouds tackle | 1½ | 1½ | 1½ | 1½ | 2 | 2½ | 2½ | 2½ | 3 |
| Pendant blocks | 1½ | 2 | 2½ | 2½ | 2½ | 3 | 3½ | 3½ | 3½ |
| Runner | 1½ | 1½ | 1½ | 1½ | 2 | 2½ | 2½ | 2½ | 3 |
| Main outhaul | 1 | 1½ | 1½ | 1½ | 1½ | 2 | 2½ | 2½ | 2½ |
| Reef pendants | 1½ | 2 | 2½ | 2½ | 2½ | 3 | 3½ | 3½ | 3½ |
| Topsail sheet | 1½ | 1½ | 1½ | 2 | 2½ | 2½ | 2½ | 3 | 3½ |
| Topmast backstays | 1½ | 1½ | 1½ | 1½ | 1½ | 2 | 2½ | 2½ | 3 |
| Preventer backstays | 1½ | 1½ | 1½ | 1½ | 1½ | 2 | 2½ | 2½ | 3 |
| Preventer backstay whips | — | 1½ | 1½ | 1½ | 1½ | 2 | 2½ | 2½ | 3 |
| Jib tack | 1½ | 2 | 2½ | 1½ w | 1½ w | 1½ w | 2 w | 2½ w | 2½ w |
| Jib purchase | 1½ | 1½ | 1½ | 1½ | 1½ | 1½ | 2 | 2½ | 2½ |
| Jib purchase runner | — | — | — | — | — | 1½ w | 1½ w | 2 w | 2½ w |
| Main purchase | 1½ | 1½ | 1½ | 1½ | 1½ | 1½ | 2 | 2½ | 2½ |
| Peak purchase | 1½ | 1½ | 1½ | 1½ | 1½ | 1½ | 2 | 2½ | 2½ |
| Topping lifts | 1½ | 2 | 2½ | 2½ | 3 | 3½ | 3½ | 3½ | 4 |
| Topping lift purchase | 1½ | 1½ | 1½ | 1½ | 1½ | 1½ | 2 | 2½ | 2½ |
| Jib topsail halyards | 1½ | 1½ | 1½ | 1½ | 1½ | 1½ | 2 | 2½ | 2½ |
| Spinnaker halyards | 1½ | 1½ | 1½ | 1½ | 1½ | 1½ | 2 | 2½ | 2½ |
| Spinnaker guy whips | 1½ | 1½ | 1½ | 1½ | 2 | 2½ | 2½ | 2½ | 2½ |
| Spinnaker topping lift | 1½ | 1½ | 1½ | 1½ | 1½ | 1½ | 2 | 2½ | 2½ |
| Trysail sheets | 1½ | 1½ | 1½ | 1½ | 2 | 2½ | 2½ | 3 | 3½ |
| Fore sheets | 1½ | 1½ | 1½ | 1½ | 2 | 2½ | 2½ | 3 | 3½ |
| Reef tackle (fiddle) | 1 | 1½ | 1½ | 1½ | 1½ | 1½ | 2 | 2½ | 2½ |
| Boom guy | 1 | 1½ | 1½ | 1½ | 1½ | 1½ | 2 | 2½ | 2½ |
| Tack Tackles | 1 | 1½ | 1½ | 1½ | 1½ | 1½ | 1½ | 2 | 2½ |
| Burton | — | — | 1½ | 1½ | 1½ | 1½ | 2 | 2½ | 2½ |
| Gaff topsail sheet whip | — | — | — | 1½ | 1½ | 1½ | 1½ | 1½ | 1½ |
| Down-hauls (forward) | — | — | — | 1½ | 1½ | 1½ | 1½ | 2 | 2 |

(w) Wire jib tack and jib purchase runner.

Cf. Circumference.

In the case of jib halyards the size of the iron of the link is given.

* The relative strength of hemp and wire rope will be found in a table in the Appendix under the head of "Wire Rope."

CIRCUMFERENCE IN INCHES OF WIRE FOR STANDING RIGGING.

| NAME. | TONS. | TONS. | TONS. | TONS. | TONS. | TONS. | TONS. | TONS. | TONS. |
|-------------------------------|--------------------|----------------------|----------------------|----------------------|----------------------|----------------------|----------------------|----------------------|-----------------------|
| | Cut. 5. Yawl 7. | Cut. 10. Yawl 14. | Cut. 15. Yawl 20. | Cut. 20. Yawl 30. | Cut. 30. Yawl 40. | Cut. 40. Yawl 60. | Cut. 60. Yawl 80. | Cut. 80. Ywl. 100 | Cut. 100. Ywl. 120 |
| Shrouds | 1½ | 1½ | 1½ | 1½ | 2½ | 2½ | 3 | 3 | 3½ |
| Pendants | 1½ | 1½ | 1½ | 2 | 2½ | 2½ | 3½ | 3½ | 3½ |
| Bowsprit shrouds | 1½ | 1½ | 1½ | 2 | 2½ | 2½ | 2½ | 3 | 3½ |
| Forestay | 1½ | 1½ | 2 | 2½ | 2½ | 2½ | 3½ | 3½ | 3½ |
| Bobstay pendant | 1½ | 1½ | 2 | 2½ | 2½ | 2½ | 3½ | 3½ | 3½ |
| Topmast stay | ¾ | ¾ | 1 | 1 | 1½ | 1½ | 1½ | 2 | 2½ |
| Topmast backstay | ¾ | ¾ | ¾ | 1 | 1½ | 1½ | 1½ | 2 | 2½ |
| Topmast preventer backstay .. | ¾ | ¾ | 1 | 1 | 1½ | 1½ | 1½ | 2 | 2½ |
| No. of shrouds a side | 2 | 2 | 3 | 3 | 3 | 3 | 3 | 4 | 4 |
| No. of backstays a side | 1 | 1 | 2 | 2 | 2 | 2 | 2 | 2 | 2 |
| Copper bobstay bar* | ¾ | ¾ | ¾ | 1 | 1½ | 1½ | 1½ | 1½ | 2 |

STANDING RIGGING.

MAIN RIGGING.

The most satisfactory plan of measuring off the rigging for a yacht is to make a "spar plan" to scale—that is, a plan showing a broadside view of the yacht with all her spars in their places, as shown by Plate I. and Fig. 26. The latter plan, Fig. 26, is necessary to obtain the correct lengths of the lower-mast shrouds and topmast backstays, as merely taking the length deck to hounds makes no allowance for the "spread" the rigging is to have. (Of course an elaborate drawing is not required, but the scale must be carefully adhered to.) A further allowance must be made for the eyes of the rigging going one over the other, and this allowance will be equal to twice the diameter of a shroud. For instance, the eye of the starboard fore shroud is put over the masthead first; then the port fore shroud, which follows, must be cut longer than the starboard rigging to the extent of twice the diameter of a shroud (twice the diameter is equal to two-thirds of the circumference, the circumference being three times the diameter). For the second starboard shroud, which goes on next, the allowance will be four times the diameter; and so on. (The forestay goes over all, resting on the throat or main halyard bolt.) (See page 119, Fig. 30.) For the eye and splice an allowance equal to one and a half the circumference of the masthead must be made; for the dead-eye an allowance equal to one and a

* The eyes in the bobstay bar must not be welded or braised. The ends of the bar should be heated and hammered back by striking the end of the bar on the anvil end on; when the end is driven up twice as thick as the other part of the bar, the hole can be drilled or punched—drilling is to be preferred.

half the circumference of the same. The eye to go over the masthead should be one and a quarter the circumference of the same at the hounds; the eye at the other end of the shroud should be one and one-eighth the circumference of the dead-eye, so that the latter could be removed if split or damaged, and replaced. The length for each shroud is measured from the top of the bolster to the dead eyes; the drift or space between the upper and lower dead-eyes, or from the channel to the top of the upper dead-eye, will be about the height of the bulwark.

There are two plans for fitting the shrouds, one known as "single eye," and the other as "pairs." In the former plan each shroud has its own eye; but when shrouds are fitted in pairs the wire goes from one dead-eye up round the masthead, and down to the next dead-eye (on the same side). A seizing close up to the bolster, round both shrouds, forms the eye. This is the old-fashioned plan, and the one still followed in ships, we believe. The objection to it is that if the eye bursts a pair of shrouds are gone; and even if one shroud burst, the strain on the remaining one will generally draw it through the seizing so as to make it useless. All that can be said in favour of the "pair" plan is that there are just half the number of eyes to go over the masthead, and consequently there is a trifle less weight aloft and a neater-looking masthead.

There are three plans in use for covering the eyes of rigging; 1. Parcelling and serving with spun yarn; 2. Covering with canvas and painting it; 3. Covering with leather.

The first plan is cheapest, but will require renewing every year; the third is the most costly, and lasts the longest; whilst the second is most used, and perhaps looks the neatest. The eyes at the lower ends of the shrouds are generally served with spun yarn; but leather looks neater, and will not turn white, as spun yarn will, by the continual washing whilst dragging through the water; an occasional blacking or varnishing will remove the washed-out appearance that a spun-yarn serving might get.

The lanyards are rove in this manner: A Matthew Walker, or wall knot, is made in one end of the lanyard; the other end is rove *out* through the foremost hole of the upper dead eye; in through the corresponding hole of the lower dead eye; out through the centre hole of the upper dead eye, and so on, the hauling part coming in through the aftermost hole of the lower dead eye and is then set up by a luff upon luff tackle.

Wall knots and Matthew Walkers have, however, been known to draw, and now a frequent practice in racing vessels is to have an eye spliced in one end of the lanyard, which eye is shackled to an eye bolt in the channel rather ahead of the foremost chain plate; the other end of the lanyard is rove *out* through the foremost hole of the upper dead-eye (always com-

mencing with the starboard fore shroud) *in* through the corresponding hole of the lower dead-eye, and so on; passing round the aft side of the mast, and ending with the port fore shroud: on the port side the lanyard is shackled to the channel under the after hole of the upper dead-eye.

Very great care must be taken in setting up rigging so that an equal strain is brought on all its parts.

Yachts of from 5 to 15 tons usually have two shrouds a side; those from 20 or 80 tons three shrouds a side; and those above 80 tons four shrouds a side.

When wire rigging was first introduced, great objection was taken to it, on account of its rigidity; and it was declared that the elasticity afforded by

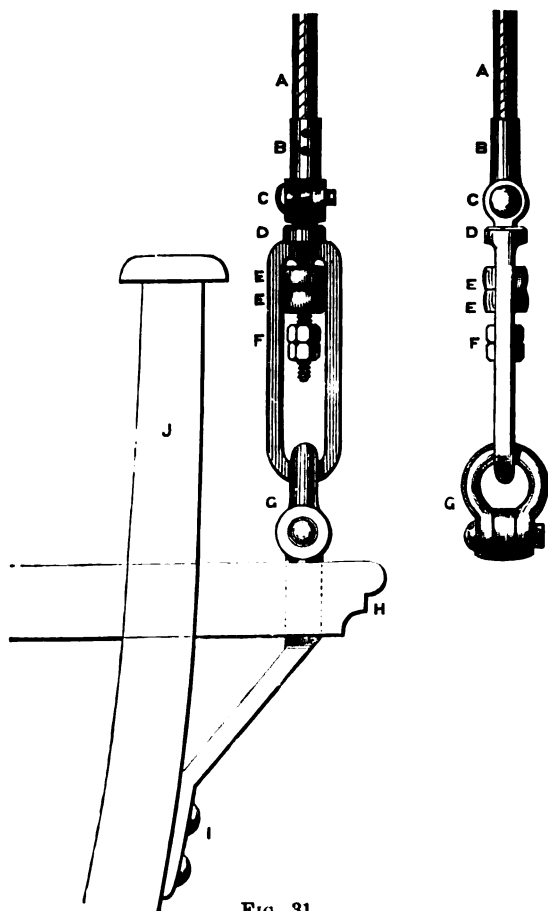


FIG. 31.

the lanyards would not compensate for the lost elasticity of the hemp shrouds. Various plans were suggested to supply the deficient elastic quality of wire rigging, such as spiral spring lanyards, and screw lanyards with india-rubber buffers.* The fact is, however, that the elasticity sought to be given to the wire rigging is not required, and indeed would be a great source of danger. Mr. W. John, in his elaborate report to Lloyd's Committee in 1877 on the dismasting of ships, shows the very considerable elasticity that wire rope has, and the general elasticity of wire shrouds and hemp lanyards combined. From his report we learn that the stretch wire rope is

* The late Captain Keane, of East Cowes, proposed the following plan for elastic lanyards in the *Field*, of March 15th, 1873: A (Fig. 31) is a shroud; B, shod, to be made of good length to prevent stripping, or an eye could be turned in to take a shackle; C, a bolt; D, a collar to receive the bolt for screw nuts; E, india-rubber buffers of the required number and size; F, screw nuts (two in number), to prevent stripping; G, shackle; H, channel; I, chain plate; J, bulwark.

capable of before breaking is very considerable, and that not half of that stretch and strength would be exhausted when the mast had arrived at its breaking point, due to bending.*

Thus so far there is little danger that a yacht's spars will be lost in consequence of the wire rigging giving out; and, as in ships it is found that if a mast is so lost, it is generally through some defective ironwork or careless fitting of the rigging.

It has been contended that a yacht's main rigging should be elastic, because, if she were sailing in squalls or under the influence of successive shocks of wind force, if the rigging did not give to some extent, it would be like attempting to drive a railway train by a succession of blows from a sledge hammer. In stating the case thus ludicrously the fact is entirely overlooked that a vessel's heeling facility affords much greater relief to such shocks than could the elastic property of any rigging, unless indeed the latter were to be so stretchable as to be perfectly useless for stays. In fact, Mr. John clearly shows in his report that, so far as safety goes, the rigging cannot be set up too rigidly, and the less it stretches the better. It was found that in very heavy weather with a ship rolling and pitching

* Mr. W. John, in his report, gives the following formula for ascertaining in tons the breaking strain of wire rope. The square of the circumference of the rope in inches, multiplied by 1.034; that is to say, if the rope be 2in. in circumference, the breaking strength will be $2 \times 2 \times 1.034 = 4.13$ tons, or about 25 per cent. less than authorities on the subject have usually given. The size of steel wire of equivalent strength is generally given as 0.8 of the size of the charcoal iron wire rope; that is to say, if the iron be of 2in. circumference, the equivalent strength in steel would be thus found $2 \times .8 = 1.6$ in. or $1\frac{1}{2}$ in. However, from experiments made by Mr. John, it would appear that the strength of the steel wire varies very considerably, and, whilst the ratio in some cases with soft steel was less than that given, in other cases with hard steel, the ratio of strength was greater.

The breaking strain in tons of single rope, such as the lanyards, was found to be equal to the square of the circumference in inches, multiplied by the fraction 0.2545.

The whole breaking strain in tons of the lanyards, rove in six parts, was found to be equal to the square of the circumference of a *single* part multiplied by the fraction .843. The joint strength of the six parts is considerably less than six times the single part, and the disparity varied between 2.97 and 4.98; and it would appear that ill-made or defective dead eyes had a great deal to do with the apparent loss in strength.

The stretch of lanyards in six parts was found equal to the strain in tons multiplied by the distance from centre to centre of the dead eyes, and divided by six times the square of the circumference in inches of a single part of the lanyards.

The stretch of wire rope was found to be equal to the length of the shroud multiplied by the strain in tons, and divided by the square of the circumference and by 20.

Generally it is found that wire rope, when the strain is removed, does not "take up" all that it has been stretched, and ultimately the stretching quality of the wire will be lost without much loss in strength. The stretching quality of wire rope to some extent depends upon the core being of hemp, and to reduce the stretch it has been suggested that the core should be of wire. Wire rope stretches more rapidly as the strain increases, whereas hemp rope stretches less rapidly; but these peculiarities are mainly observable as the ropes approach the breaking point.

The weight of iron or steel wire rope per fathom can be found by dividing the square of the circumference (circumference²) by 1.1; the weight of hemp rope by dividing the square of the circumference by 4. (See also "Wire Rope" in the Appendix.)

heavily, three-fourths of the ultimate strength of the mast and rigging might be tried at any one moment, and that a succession of such trials would inevitably end in disaster. On this subject Mr. John says: "The margin of strength found to exist in the masts and rigging, to meet the heavy strains arising from heavy weather, is so small that every inducement should be offered to builders and owners to increase the support afforded to the masts, and especially when it is known that so much good can be done in this direction, without adding to the top weight, by simply reducing the elasticity of the shrouds. Wire rigging set up by screws unquestionably affords the most suitable and efficient support to iron masts; and it is to be hoped that the practice of adopting them, which has been growing up lately, will extend, and become far more general than heretofore. Where hemp lanyards are adopted the drift between the dead eyes should be reduced to a minimum, and they should be most carefully kept set up. Bobstays, it is considered, should be increased in size, and all eye bolts, pins, and shackles connected with them should be fitted with the greatest care *and of a strength at least equal to that of the bobstay.*"

This was written especially in relation to iron masts, but it is applicable to wood masts, and only in a slightly modified degree, as, although wood masts can be bent to a greater extent than iron or steel masts without breaking, yet will a wood mast reach its breaking point before the elasticity and strength of the wire rigging are exhausted, as previously stated.

So far as the requirements of match sailing go, there can be no doubt that the more rigid the rigging can be kept the better are the results. The old-fashioned theory is that the rigging should be very elastic, and that the masts should have plenty of play. This curious fallacy has been maintained by still more curious arguments and theories; and we have known some sailing masters slack up the rigging to give it the required elasticity. It is obvious that the mast would have to supply the elasticity under such circumstances, as the strain would not come upon the rigging until the mast had been very considerably bent—perhaps almost to the breaking point. We need not dwell upon the bad effects of slack rigging* and a yielding mast further than to say, that anything which tends to render the application of the propelling force intermittent, or to absorb any portion of it and reduce its effect, must in some measure detrimentally influence the speed of a vessel; and if rigid rigging is necessary for the good performance of sailing ships, it is equally necessary for the attainment of the highest results in competitive yacht sailing.

* In selecting wire shrouds, pendants, or stays, care should be taken that flexible wire is not supplied; as flexible wire stretches very badly, "takes up" again very little, and "constant setting-up and never taut" will be the inevitable result.

TOPMAST RIGGING.

The topmast rigging will be cut (due allowance being made for the cross-trees), fitted, and served in the same manner as the main rigging, but the eyes at the lower end of the shrouds will be turned in round galvanised iron thimbles, to take the hooks of the setting-up tackles, or falls, as they are termed.

Each topmast backstay is usually in two parts, the lower part being the leg, which is in length equal to the housing length of the topmast. A thimble is eye-spliced into the upper and lower end of the leg, and a shackle joins it to the shroud.

Yachts above 10 tons usually have two topmast shrouds, or two backstays as they are more generally termed, on each side, and one "preventer" or shifting backstay each side. In yachts of 10 tons and under one backstay and one preventer each side are generally considered sufficient; in these vessels a thumb cleat is usually fitted to the cross-trees, and when the yacht is at anchor the preventer is put in this and set up with its tackle, for the sake of tidiness. In large yachts a cleat or score is also provided on the cross-trees, for the preventers when not in use. A favourite plan, however, is to set up both preventers from their eye bolts aft on the counter; and the only objection to this plan is, that there is more gear for the yards or jibbooms of passing craft to pick up if they come dangerously near; on the other hand, so far as appearance goes, it makes a yacht look a little more rigged.

Schooners, in addition to topmast shrouds and preventers, have a main-topmast stay which leads from the shoulder of the main-topmast to the foremast head (see Fig. 28); some cruising schooners further have a standing fore-topmast stay, which leads from the fore-topmast shoulder to the mainmast head.

The shifting or "preventer" backstays will be measured for length from the shoulder of topmast to taffrail, and then deduct from this length about six or seven feet for the setting-up tackle. In large vessels this tackle always consists of two double blocks, the standing part being generally made fast to the upper block, and then the fall leads from the upper block; but sometimes the tackle is put the other way up, so that the fall leads from the lower block. The advantage of this plan is that several hands can get on the fall for a "drag;" the other plan, however, is more shipshape, and if the fall be put under the cavel round a belaying pin, with a couple of hands to "swig" and one to take up the slack, the tackle will always be set up taut enough. The tackles are hooked to the

trysail sheet bolts on the quarter. In some racing yachts a capital plan is adopted to avoid any possible mishap before the backstay can be properly set up: a tail block is seized to the lower end of the preventer just above the eye; a single rope is rove through this block, and one end of it made fast to the cavel aft; a knot is tied in the other end to prevent the rope unreeving. The rope is of sufficient length to admit of the preventer being carried into the main rigging without it being unrove. When shifting the backstays, as in gybing, one hand takes hold of the hauling part of this "whip" to leeward, and hauls the backstay aft and gets it set up fairly taut, whilst another hand prepares the tackle for hooking on as the boom settles over. If backstays are properly worked in this way, a topmast should never be lost in gybing.

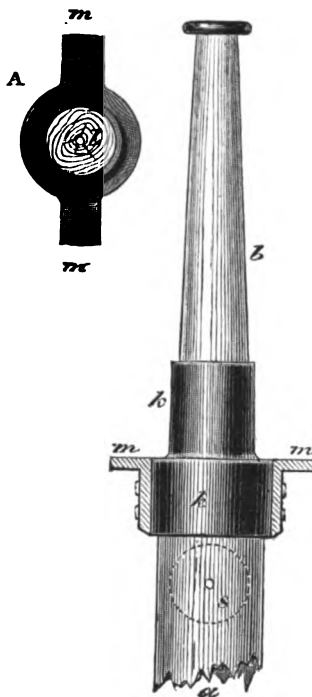


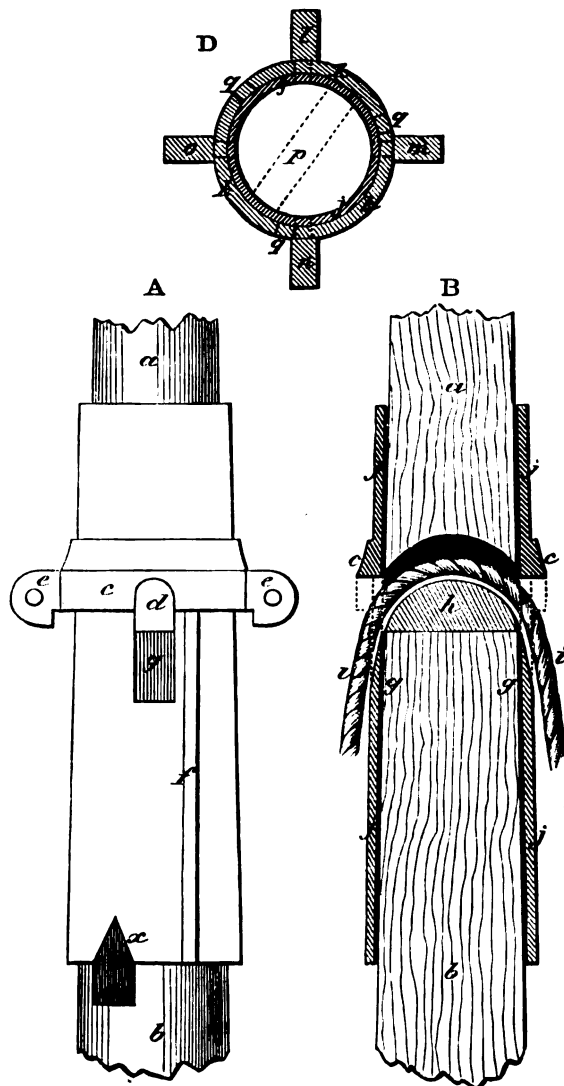
FIG. 32.

In all yachts it is a great advantage to be able to get the topmast quickly on deck, and in those of 40 tons and under the man-of-war plan of sending the rigging up on a funnel can be recommended. A topmast on deck, instead of up and down the mast, is as good as a reef; and in small yachts of 5 and 10 tons, where the stick can be easily "man-handled," the funnel arrangements can be made use of. Mr. Beavor Webb adopted the plan in the *Freda*, and Mr. Baden-Powell in the *Kohinoor*, and both commend it. In the annexed diagram *a* is the topmast, and *b* the pole of the topmast; *s* topsail halyard sheave; *k* is the funnel; *m* and *m* are two catches rivetted to the funnel; the catches rest on the cap of the mast in a fore-and-aft direction when the topmast is lowered, and prevent the funnel going down through with the topmast. The funnel, it will be seen, is made to fit on the shoulder of the topmast, the lower part of the funnel being greater in diameter than the upper part. Fig. A shows the funnel viewed from above, *o* being the shoulder, *b* the pole of topmast, and *m m* the catches. All the topmast rigging, including preventers, also spinnaker and jib topsail halyard blocks, are fitted on the funnel over the shoulder. A stout rope grommet should be fitted on the shoulder of the cap as a bolster to prevent the rigging being cut. In lowering the topmast the halyards must be unrove from the sheave *s*; then, when unfitted, the topmast will

come down; but the funnel, with the catches resting on the upper cap, will remain at the masthead—that is, the lower half of the funnel will be inside the cap, and the upper half above the cap. All the rigging, &c., of course remains on the funnel. To get the topmast up again, the pole will be shoved up through the funnel, and, when clear of the cap, a hand aloft will reeve the halyards through the sheave hole *s*. In lowering whilst racing, the flag would have to be taken off before bringing the pole through the funnel, as it might foul. So also if there are signal halyards, they must be unrove. Any good brazier would make the funnel, and rivet or weld the iron catches on. The funnel would, however, be better made of copper. Care should be taken that the lower part of the funnel is made as deep as the cap, and that it fits inside the cap easily, but not too loosely. The upper part of the funnel must be high enough to take all the rigging eyes and tails of blocks. The man-of-war funnels have no lower part, and the catches when the topmast is down have to be lashed to the cap; this of course takes up time. A topmast, with the funnel as described and as fitted by Mr. Webb in the *Freda*, can be got on deck in one minute, and be got up again in nearly as little time.

Mr. Thomas Butler, of Barrow-in-Furness, invented a topmast funnel, on the plan shown in the annexed diagram (Fig. 33), and uses it in his 3-ton yacht for getting his topmast on deck without unrigging. The funnel (shown by A) is cast in brass, about $\frac{3}{16}$ inch thick. *a* is the pole of the topmast, which is fixed or jammed in the funnel, and does not come below *c*. *b* is the lower part of the topmast. *x* is a stud to insure the funnel getting on the right part of the topmast. *c* is a shoulder to strengthen the funnel, and rests on the masthead cap when the topmast is lowered. *d* is a hole in the funnel through which the halyard is rove. *g* is a part of the funnel bevelled away to prevent the halyard being cut. *f* is a rib, of which there are three. (As the funnel is necessarily larger at the bottom than at the top, the top part would fit loosely in the masthead cap; hence the ribs are made to taper to nothing at the bottom, and just fill out the cap when the funnel is lowered inside the cap.) *e e* are two eyes; of these there are four, two for shrouds, one for topmast forestay and one for shifting backstay. They can either be cast with the funnel or rivetted in afterwards. B is a section of the funnel, viewed nearly broadside on; *j j j j* shows the thickness of the brass, and *g* the bevellings; *i* the halyard; *k* is a piece of hard wood fitted on the upper end of the topmast, as shown, instead of a sheave. If a sheave were used, it would require a broad one with a good deep score in it. D is an end-on view of the funnel; *l* is the fore eye, looking in a fore-and-aft line corresponding with *n*; *o* and *m* are the two eyes for the shrouds; *q q q* are the ribs; *k k* are the shoulders;

p is the opening for the halyard; j is the funnel. If other halyards are required, tail blocks can be made fast round the shoulders for them to run through.



Scale.—3in. to the foot.

FIG. 33.

The feature of this arrangement is that the topmast may be got on deck, or rather all that portion of it which is below the topsail-halyard sheave hole, leaving the pole and funnel, with the signal and topsail-halyards, and be sent up again without anyone going aloft to reeve the halyards or fid, as the heel rope can be trusted to keep the topmast up.

If necessary, in a squall topsail and topmast could be lowered altogether by letting go the heel rope; this is of great consequence in small boats, as it enables a larger topsail to be used than a pole mast will admit of without the latter being too big for a sea way.

Various plans have been devised for fidding and unfidding topmasts from the deck, and the "tumbler" plan has been in fashion some time. In Fig. 34, A is a pawl which drops into a score in the topmast as the

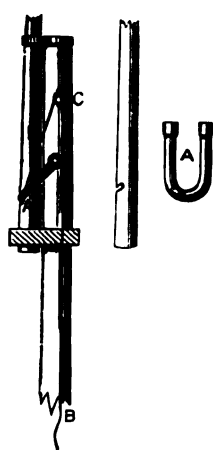


FIG. 34.

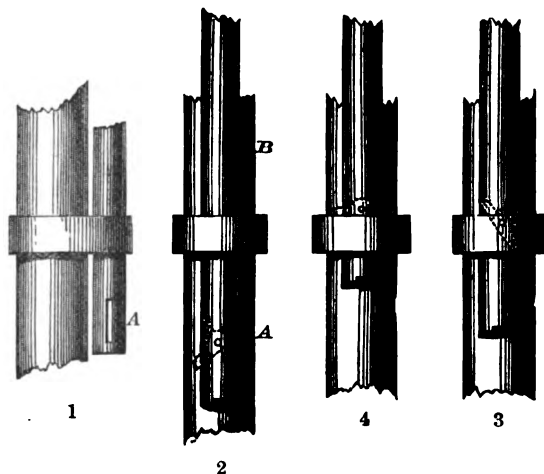


FIG. 35.

latter is got up. When the topmast has to be lowered, haul on the heel rope; and when the topmast is lifted sufficiently high, pull on the small rope B (which passes over the sheave C) until the pawl is clear of the score. The topmast can then be lowered.

The "self-fidding topmast" (Fig. 35) has been in use of late, and was designed and thus described by Mr. Augustine L. Dunphy:

"The fid consists of a properly-shaped bar of iron working rather stiffly on a pin in the heel of the topmast, the slot (see A, 1) in which is cut specially to suit the peculiar action of the fid; a stout bolt, B (2), firmly screwed into the masthead, completes the whole of the mechanical part of the arrangement.

"To Fiddle the Topmast.—The fid is placed in position, as shown at A (2), by hand whilst the topmast is down, and then, hauling on the heel rope, the topmast rises until the projecting part (A) of the fid strikes the bolt B (a score is cut in the cap, so as to enable the fid to clear), and is pushed into a horizontal position when the heel rope is slacked, and the topmast will fall a few inches, fided as securely as by the old-fashioned bolt (see 4, Fig. 35).

“*To Unfid.*—Haul on the heel rope until the topmast is chock up; the fid rising with topmast again strikes the bolt B, thereby changing its position to that shown in (3); ease up the heel rope, and the topmast is free to come down.

“A little extra care is necessary in sending up the topmast, as if driven up too high the fid is fidded and unfidded, when a hand must go aloft to right, or the topmast lowered so as to place the fid in position again. This fid has been in almost constant use, and has never failed me in any case. It will act equally well when the mast is at any angle, and dispenses with the tripping lines, which are always getting foul or being carried away. It never fails to bring down the topmast.”

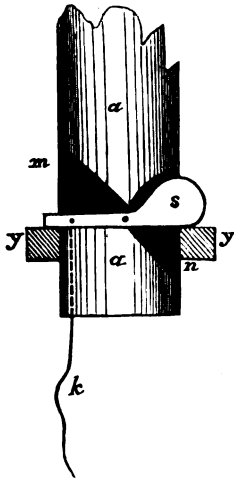


FIG. 36.

One of the most approved plans of self-unfidding topmast is shown by Fig. 36. *a* is the topmast, *y* the yoke, *s* is an iron tumbler fid, pivoted by a bolt shown above *a*. *m* and *n* are slots cut in the topmast, *k* is a small line fastened to the fid, and passed up through a hole bored in the heel of the topmast. To unfid hoist on the heel rope until the tumbler falls into the slot *n*, then lower away. To fid, hoist by the heel rope until the slot *n* is above the yoke. Then pull on the line *k* until the fid is in the horizontal position shown in the drawing. We think this fid is to be preferred to either of the other two.

THE MASTHEAD PENDANTS AND RUNNERS.

The pendants are made of wire rope, and are put over the masthead before the shrouds, and are covered with canvas. The pendant is usually in length two-thirds the distance deck to hounds. The lower end of the pendant is shod, or, if not shod, an eye is turned in. A single block is shackled to this end of the pendant, and through the block the runner is rove.

The runner is sometimes made of rope, but in large racing vessels more frequently of flexible wire rope. The runner in total length is generally three-fifths the distance deck to hounds. Each end of the runner has a thimble-eye splice, with a strong hook at the end of the standing part, which leads aft to be hooked to an eye bolt on the rail. In some cruising yachts the standing part of the runner is shackled to the eye bolt in the rail, but the general practice in racing vessels is to

have a hook, as the runner has so frequently to be let go to let the boom off. The tackle is shackled to the end of the other part, and usually consists of a fiddle block and single block below, but sometimes the upper block is a common "double." The fall of the tackle always leads from the upper block. With the wind much forward of the beam, very little strain comes on the runner; but they should be kept well set up, or otherwise the mast may go forward, and bring about a slack forestay, and throw an undue strain on the aftermost shrouds.

FORESTAY.

The forestay goes on "over all;" but now the practice is to have the eye, or collar, large enough to go well up the masthead, above the yoke and over the throat-halyard-block bolt. The collar encircles topmast as well as the yoke: and the eye should be made so that the splice comes just under the crosstrees. (See page 119.) The yoke will then give the spread to the collar necessary to allow the topmast to go up and down without touching it. The collar should be leathered. The stay leads down to the fore side of the masthead, where it is rove through a hole. The end is then made into a bight (with a thimble in it), well seized (sometimes a bullseye is spliced in), and set up with a lanyard to the bitts. In reeving the forestay through the stemhead it must not be forgotten that the iron hanks or rings for the foresail must go on it first.*

TRIATIC STAY.

Formerly, in schooners, a mainstay led from the mainmast head to the deck, forward towards the foremast, and was set up by a tackle, one on either side; in tacking or wearing, the lee one had to be eased up, and, if smartness were not displayed the mainmast would fall aft, as the stay had to fulfil the same duty for the mainmast that the forestay does for the foremast. This plan was found very inconvenient in racing schooners, and, about twenty years ago, the fashion became general to carry a stay, termed a triatic, to the foremast head, a larger forestay being introduced to bear the extra strain thrown upon it. The disadvantage of this plan is that it entails some trouble in tacking or gybing, as double fore-topsail sheets and tacks are required. The fore topsail has to be clewed up every time the schooner is put on a different tack, and the sail re-tacked and re-sheeted to leeward of the stay. To obviate this trouble, double triatics, or jumpers, have been tried, the lee one being always eased up;

* In schooners, when the bowsprit goes out over the stem, the forestay is set up to the span-shackle by a screw bolt and nut.

but there was still the difficulty of getting the clew over the main-topmast stay, and the danger of not getting what had been the lee triatic (now the weather one) set up before the vessel filled. On the whole, the single standing triatic gives the least trouble and is the safer, but, of course, one will sometimes give way. If such an accident occurs, it is usual to take one of the main runners forward, and set up.

TOPPING LIFTS.

In vessels under 20 tons there is one topping lift a side, and the standing part is hooked to an eye in an iron band round the boom. The topping lift is rove through a single block shackled to an eye on the cheeks of the mast. The hauling part of the topping lift has an eye, to which the purchase block is hooked or shackled; the purchase consists of a double and single block.

In vessels from 20 to 50 tons the topping lift is single, with the addition of a runner, the standing part of which is fast to the rail, or to the cavel abreast of the mast.

In vessels above 50 tons it is usual to have double topping lifts, with runner and tackle to the runner; in such case the standing part of the lift is shackled to the block at the masthead, and leads thence through the block on the boom, and back through the block at the masthead.

Some large vessels have a single topping lift a side, made of flexible wire and covered with canvas. These, of course, have the runner and tackle. These topping lifts look neater than the double (rope) ones, and, so far as we know, overhaul themselves just as readily.

Very small craft have only one single topping lift, and of course, when under way, this one is always slack if to leeward, whereas the practice in larger craft is always to have the weather lift set up and belayed hand taut.

BOWSPRIT SHROUDS.

Bowsprit shrouds are now invariably made of wire rope, and have a thimble eye-splice in each end; one end is shackled to the iron crane at the bowsprit end, the other to the setting-up tackle. This tackle formerly was always outboard, hooked to an eye-bolt on the top strake, where it not only dragged through the water and picked up weeds, but was not so readily got at when reefing the bowsprit. The tackle consists of an iron fiddle block and a single block, the latter being at the after end of the tackle. (See Fig. 29, page 118.) An eye bolt is fitted in the deck to take the tackle. This bolt should go through a beam, and have

a plate and spur on deck; the strake of deck plank where the bolt is should be of hard wood, and the bolt should be a very strong one. Several vessels have lost their bowsprits through this bolt drawing, crushing through the plank, or breaking off short. Notable instances occurred in the match for the Queen's Cup at Cowes in 1874, when the *Morna* schooner and *Kriemhilda* cutter lost their bowsprits. Oddly enough, the *Kriemhilda* lost her bowsprit at Torquay the year before from the same cause, and so did *Iona*, and numberless other cases have occurred. Hatcher fits a band, with an eye in it, round one of the stanchions, for the shroud tackle block, and this appears to be a good plan. Another fruitful cause of mishap to bowsprits has been the practice of having an iron shoe instead of a thimble eyesplice in the shroud for the shackle. Even when the shoe is a long one, it will occasionally strip in consequence of the wire parting where the rivets go through, and a shoe should never be trusted for any part of the wire standing rigging.

BOBSTAY.

Various ingenious plans have been invented for bobstays, as no part of a yacht's gear so frequently gives out; but the most usual plan of making up a bobstay is as follows: a copper bar shackled to the stem, and about as long as the bowsprit is high out of the water; then a wire pendant and tackle. The tackle has a single block next the pendant, and a double one at the bowsprit end, the fall leading inboard at the stem. The cordage selected for the tackle is usually bolt rope. A common practice in racing vessels is to have a "baby bobstay," or preventer which is not set up quite so taut as the other; this preventer has no doubt saved some bowsprits, but, on the other hand, it has undoubtedly been the cause of many being carried away. Constantly setting up the jib, or the strain of the jib alone, or the strain of the bowsprit when set down to a crook, will soon cause the fall to stretch or "come up," and then an equal strain comes on both. But very frequently the preventer is set up a little tauter than the other; in such cases, if there be any weight in the wind, the preventer is almost certain to part, and the other if the jerk be very great, may go with it. If the main bobstay should go first, it would be hardly reasonable to expect the other and weaker one to stand; it may, it is true, just save the bowsprit, but the sailing master will have so little confidence in the preventer that he will order the jib sheets to be eased up, and will gill his vessel along, whilst the other bobstay is being patched up, if such a thing as patching be practicable. Another danger attending the practice of having two bobstays is that the main one is never quite so stout and

strong as it otherwise would be; and, as it is almost certain that an unequal strain will come upon them, one only has practically always to do the work. Therefore by far the wiser plan is to have one stout and strong bobstay, equal in fact to the united strength of the two.

RUNNING RIGGING.

JIB TACK, JIB HALYARDS, AND JIB SHEETS.

The jib tack requires to be of great strength, and is made indifferently, accordingly to the judgment of the person who has the fitting out of the yacht, of rope, chain, or flexible wire rope. Rope does very well in vessels under 40 tons, but wire is to be preferred, and it is found to stand better than chain. The jib tack *t* is fast to the traveller *a* (Fig. 37), and leads down through a sheave hole *s* at the bowsprit end (inside the cranse iron) a block is shackled to the end of the tack through which the outhaul is rove. The standing part of the outhaul is put over one of the bitts with a running eye; the hauling part leads on board by the side of the bowsprit.

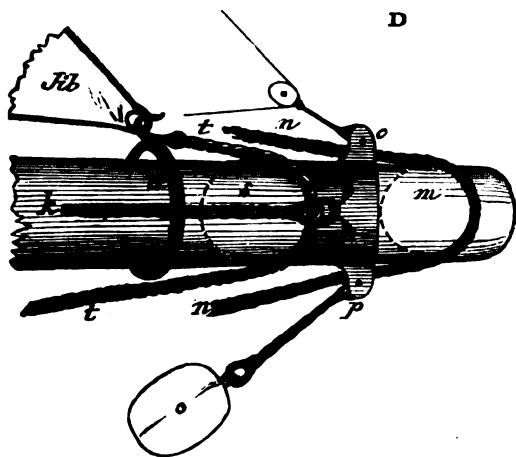


FIG. 37.

A single rope inhaul is generally fast to the traveller.

The score in the end of the bowsprit has necessarily to be very large, and frequently it is made wider than it need be; at any rate the sheave hole is a source of weakness, and generally if the end of the bowsprit comes off it is close outside the sheave hole, the enormous lateral strain brought on the part by the shroud *k* causing

the wood to give way. To avoid such accidents as these one or two yachts have the sheave outside the iron, as shown by *m*. The tack *n* passes between two ears or "lugs" on the cranse iron at *o* and *p*. To *o* the topmast stay is fitted, and the bobstay block at *p*. Of course if the score and sheave were put at *m*, the other score and sheave *s* would be dispensed with. Generally when the end comes off at the sheave *s* the bowsprit immediately afterwards breaks close off at the stem, unless some one is very smart at letting the jib sheets fly, or in putting the helm down. With the sheave hole at *m* no such accident would happen.

Jib halyards are, as a rule, made of chain, as it runs better, and the

fall stows in a smaller compass when the jib is set; in fact, the fall is generally run through one of the chain pipes into the forecabin, where it helps a trifle as ballast. However, several large vessels, such as *Livonia*, *Modwena*, and *Arrow*, have had Manilla rope. The jib halyards are rove through an iron (single) block (which is hooked or shackled to the head cringle of the jib), and then each part leads through an iron (single) block on either side of the masthead (see Fig. 30). The hauling part usually leads down the port side of the mast; the purchase is shackled to the part that leads through the block on the starboard side. In vessels above 40 tons a flexible wire runner is invariably used in addition to the purchase; one end of the runner is shackled to an eye bolt on deck, and the other, after leading through a block on the end of the jib halyard, is shackled to the upper block of the purchase. The purchase consists of a double and single block, or two double; in the former case the single block is below, with the standing part of the tackle fast to it; but where two blocks are used, the standing part of the tackle is made fast to the upper block. As a great deal of "beef" is required to properly set up a jib, it is usual to have a lead of some kind for the "fall" * of the purchase on deck, such as a snatch block. It is, of course, necessary to have a "straight" luff to a jib, but very frequently the purchase is used a little too freely; the result is that a link gives way in the halyards, the luff rope of the jib is stranded (generally near the head or tack, where it has been open for the splice), and sometimes the bobstay-fall is burst. (We once saw the latter mishap occur on board the *Oimara* during the match at Southsea.) These mishaps can be generally averted by "easing" the vessel whilst the jib is being set up, choosing the time whilst she is in stays or before the wind.

Jib sheets in vessels under 30 tons are usually single, but in vessels larger than 30 tons they are generally double.

FORE HALYARDS, FORE TACKS, AND FORE SHEETS.

The fore halyards are usually fitted as follows: The standing part is hooked or shackled to an eye bolt under the yoke on the port side, then through a single block on the head of the sail, and up through another single block hung to an eye bolt under a yoke on the starboard side. No purchase is necessary, as the sail is set on a stay; but in yachts above 10 tons the tack leads through the stem head and is bowsed down by a tackle. The tackle consists of a single and double block, or two doubles according to the size of the yacht. In yachts of 40 tons and upwards the tack is usually made of flexible wire rope. Fore sheets in yachts under 15 tons

* The "fall" of a tackle is the part that is taken hold of to haul upon.

are usually made up of two single blocks. The standing part is made fast to the upper block (hooked and moused or shackled to the clew of the sail). In larger vessels a double, or single, or two double blocks are used, the hauling part or fall always leading from the upper block. In very large vessels, such as 100-ton cutters or yawls, or 140-ton schooners, "runners" are used in addition to tackles. These are called the standing parts of the sheets: one end is hooked on the tackle by an eye; the other end is passed through a bull's eye of *lignum vitæ* on the clew of the sail, and is then belayed to a cavel. The sail is then sheeted home with the tackle.

MAIN AND PEAK HALYARDS, MAIN TACK, MAIN SHEET, AND MAIN OUTHAUL.

The main or throat halyards are generally rove through a treble block at the masthead, and a double block on the jaws of the gaff. The hauling part of the main halyards leads down the starboard side of the mast, and is belayed to the mast bitts. The main purchase is fast to the standing part, and usually consists of a couple of double blocks, and the lower one is generally hooked to an eye bolt in the deck on the starboard side. In vessels under 15 tons it is unusual to have a main purchase, and when there is no purchase the upper main halyard block is a double one, and the lower a single. However, many racing 10-tonners have a main purchase, and the 5-tonner *Freda* has one. The principal object in having a main purchase in a small craft is that the mainsail can be set better, as in starting with "all canvas down" the last two or three pulls become very heavy, especially if the hands on the peak have been a little too quick; and a much tauter luff can be got by the purchase than by the main tack tackle. Of course the latter is dispensed with in small vessels where the purchase is used, and the tack made fast by a lacing round the goose-neck of the boom. By doing away with the tack tackle at least 6 in. greater length of luff can be had in a 5-tonner, and this may be of some advantage. The sail cannot be triced up, of course, without casting off the main tack lacing; but some yacht sailers consider this an advantage, as no doubt sailing a vessel in a strong wind with the main tack triced up very badly stretches the sail, and looks very ugly.

The peak halyards in almost all vessels under 140 tons are rove through two single blocks on the gaff and three on the masthead, as shown in Plate I. and Fig. 30. Some vessels above 140 tons have three blocks on the gaff, and in such cases the middle block on the masthead is usually a double one. The standing part of the peak halyards to which the purchase is fast leads through the upper block and down on the port side.

A common practice in racing vessels now is to have a wire leather-covered span (copper wire is best) with bull's-eye for each block on the gaff to work upon, and this plan no doubt causes a more equal distribution of the strain on the gaff.

The main tack generally is a gun tackle purchase, but in vessels above 60 tons a double and single or two double blocks are used. In addition, some large cutters have a runner rove through the tack cringle, one end being fast to the goose-neck of the boom, and the other to the tackle. In laced mainsails the tack is lashed to the goose-neck.

The main sheet should be made of left-handed, slack-laid, six-stranded Manilla rope. The blocks required are a three-fold on the boom, a two-fold on the buffer or horse, as the case may be, and a single block on each quarter for the lead. Yachts of less than 15 tons have a double block on the boom, and single on the buffer.

Most American yachts have a horse in length about one-third the width of the counter for the mainsheet block to travel on. For small vessels, at any rate, this plan is a good one, as the boom can be kept down so much better on a wind, as less sheet will be out than there would be without the horse. A stout ring of indiarubber should be on either end of the horse, to relieve the shock as the boom goes over.

The mainsail outhaul is made up of a horse on the boom, a shackle as traveller, a wire or chain runner (attached to the shackle, and rove through a sheave hole at the boom end), and a tackle. (See Plate I.) In small vessels the latter consists of one block only; in large vessels of two single, or a double and single, or two double blocks. The old-fashioned plan of outhaul, and one still very much in use, consists of an iron traveller (a large leather-covered ring) on the boom end, a chain or rope through a sheave hole and a tackle. This latter plan is perhaps the stronger of the two; but an objection to it is that the traveller very frequently gets jammed and the reef cleats have to be farther forward than desirable, to allow the traveller to work. Sometimes, instead of a sheave hole, the sheave for the outhaul is fitted right at the extreme end of the boom, on to which an iron cap is fitted for the purpose.

TOPSAIL HALYARDS, SHEETS, AND TACKS.

The topsail halyards in vessels under 10 tons consist of a single rope rove through a sheave hole under the eyes of the topmast rigging.

Yachts of 10 tons and over have a block which hooks to a strop or sling on the yard, or, if the topsail be a jib-headed one, to the head cringle. The standing part of the halyard has a running eye, which is put over the

topmast, and rests on the eyes of the rigging; the halyard is rove through the block (which is to be hooked to the yard), and through the sheave hole at the topmast head. It is best to have a couple of thumb cleats on the yard where it has to be slung; there is then no danger of the strop slipping, or of the yard being wrongly slung.

When the topsail yard is of great length, as in most yachts of 40 tons and upwards, an upper halyard is provided (called also sometimes a tripping line or trip halyard, because the rope is of use in tripping the yard in hoisting or lowering). This is simply a single rope bent to the upper part of the yard, and rove through a sheave hole in the pole, above the eyes of the topmast rigging. The upper halyards are mainly useful in hoisting and for lowering to get the yard peaked; however, for very long yards, if bent sufficiently near the upper end, they may in a small degree help to keep the peak of the sail from sagging to leeward, or prevent the yard bending.

The topsail sheet is always a single* Manilla rope. It leads through a cheek block on the gaff end, then through a block shackled to an eye-bolt under the jaws of the gaff. In most racing vessels nowadays a pendant is used for this block, as shown in the diagram (Plate I.). The pendant should go round the mast with a running eye. By this arrangement the strain is taken off the jaws of the gaff and consequently off the main halyards. The hauling part of the rope is generally put round one of the winches on the mast to "sheet" the topsail. The topsail tack is usually a strong piece of Manilla with a thimble spliced in it, to which the tack tackle is hooked.

Jib-topsail halyards and main-topmast-staysail halyards are usually single ropes rove through a tail block on topmast head; but one or two large vessels have a lower block, with a spring hook, which is hooked to the head of the sail. In such cases, the standing part of the halyards is fitted on the topmast head with a running eye or bight.

SPINNAKER HALYARDS, OUTHAUL, &c.

Spinnaker halyards are invariably single, rove through a tail block at the topmast head.

The spinnaker boom is usually fitted with a movable goose-neck at its inner end. The goose-neck is generally put into its socket on the mast, and then the boom end is brought to the shank. At the outer end are a

* The Oimara, cutter, had double topsail sheets rove in this way: one end of the sheet was made fast to the gaff end; the other end of the sheet was rove through a single block on the clew of the sail; then through the cheek block at the end of gaff, through a block at the jaws of the gaff, and round the winch.

couple of good-sized thumb cleats, between which the after and fore guy are put, there being a running eye in each. The fore guy, when one is used, is a single rope; the after guy is a pendant with a block at the end, through which a rope is rove. The standing part of this rope is made fast to a cavel-pin, or cleat on the quarter, and so is the hauling part when belayed. The after guy thus forms a single whip-purchase (see Plate I.). The outhaul is rove through a tail block,* at the outer end of the spinnaker boom. The topping lift consists of two single, a double and single, or two double blocks, according to the size of the yacht.

Formerly a bobstay was used; but, if the boom is not allowed to lift, it will bend like a bow; in fact, the bobstay was found to be a fruitful cause of a boom breaking, if there was any wind at all, and so bobstays were discarded. The danger of a boom breaking through its buckling up can be greatly lessened by having one hand to attend to the topping lift; as the boom bends haul on the lift, and the bend will practically be "lifted" out.

Small yachts seldom have a fore guy to spinnaker boom, but bend a rope to the tack of the sail (just as the outhaul is bent) leading to the bowsprit end; this rope serves as a fore guy, or brace, to haul the boom forward; and when the spinnaker requires to be shifted to the bowsprit, the boom outhaul is slackened up and the tack hauled out to bowsprit end. Thus double outhauls are bent to the spinnaker tack cringle, and one rove through the sheave hole or block at the spinnaker boom end, and the other through a block at bowsprit end. But generally the large spinnaker (set as such) has too much hoist for the jib spinnaker, and a shift of spinnakers has to be made; even in such case no fore guy is used in small vessels, but to let the boom go forward one hand slackens up the topping lift a little, and another the after guy, and, if there be any wind at all, the boom will readily go forward. Generally, instead of a sheave in the boom, a tail block is used for the outhaul as it is found difficult to get a fair lead with the sheave. A hole is made in the boom end, through which the tail of the block is passed and secured. In a five-tonner the after guy is a single rope without purchase, and the topping lift is also a single rope, rove through a block under the lower cap.

As spinnaker booms are now carried so very long, they will not go under the fore stay; consequently, when the spinnaker has to be shifted, the boom must be unshipped. To shift the boom, the usual practice is to top it up, lift it out of the goose-neck, and then lower the end down the

* Formerly a hole was cut in the boom end, and a sheave fitted for the outhaul to run through; this plan is now abandoned, as, unless the boom happens to come with one particular side uppermost, an unfair lead may result.

fore hatch or over the side of the vessel until the other end will clear the forestay.

When spinnakers were first introduced no goose-neck was used, the heel of the boom being lashed against the mast. A practice then sometimes was to have a sheave hole at either end of the boom, with a rope three times the length of the boom rove through each sheave hole. One end of this rope served as the outhaul, the other for the lashing round the mast. To shift over, the boom was launched across to the other rail, and what had been the inboard end became the outboard end. Of course the guys had to be shifted from one end to the other. As spinnaker booms are now of such enormous length, it would be almost impossible, and highly dangerous, to work them in this way, although it might do for a five-tonner.

Spinnaker booms when first fitted with the goose-neck were no longer than the length from deck to hounds, so that they could be worked under the forestay without being unshipped. However, it would appear that the advantages of a longer boom are greater than the inconvenience of having to unship it for shifting, and now, generally, a spinnaker boom when shifted and topped up and down the mast, reaches above the upper cap.

The following plan was worked during the summer of 1876 in the *Lily*, 10-tonner, but we have never met with it elsewhere. The arrangement was thus described: Take a yacht of say 65 tons, and suppose her 70ft. long and 15ft. beam, with a mast measuring 60ft. from deck to cap, from which if 9ft. is subtracted for masthead, and 4ft. more allowed for the angle made by the forestay, a spinnaker boom, to swing over clear, cannot exceed 43ft. (as the goose-neck is 3ft. from deck), which of course is much too little to balance the mainboom and sail. It is proposed to have a boom of 42ft., and another smaller one of 21ft. made a little heavier than the long one, and fitted with two irons 7ft. apart; the longer one to be made in the usual manner, with bolts in both ends, for the goose-neck; but the sheaves in the ends to be, one vertical, and the other horizontal. It will then make a very snug storm boom for the balloon jib when shipped singly, whilst the smaller one, by leading a tack rope (or outhaul) through the block on the outer iron will do very well for the staysail. In the drawing, in case No. 1, the boom is on end and ready for letting fall to starboard; and in No. 2 dipped and falling to port. A A (No. 1) represents the 42ft. boom, and B B the 21-footer; the dotted line *b b* the arc the boom would travel if not let run down; and the dotted line *c c* the actual line it travels when housed. C in the small diagram represents the outer iron or cap on the end of the small boom (which can be made square or round; in the diagram it is made square, to prevent twisting), and *a* a bolt to which the standing part of the

heel rope is made fast by clip hooks ; the rope passes through the horizontal sheave at *h*, and back to the block on the cap at *f*. The fall can be belayed to a cleat on the small boom, or would greatly ease the strain on the gooseneck if made fast on the rail or to the rigging. When gybing it would only be necessary to top the boom by the lift, let go the heel rope, and let it run down ; then swing over, lower away, and haul out the boom when squared. It would be better to hook on the Burton purchase to the cap at *e*, both as an extra support and to make sure of the boom whilst swinging. This plan would not only obviate the danger and trouble of

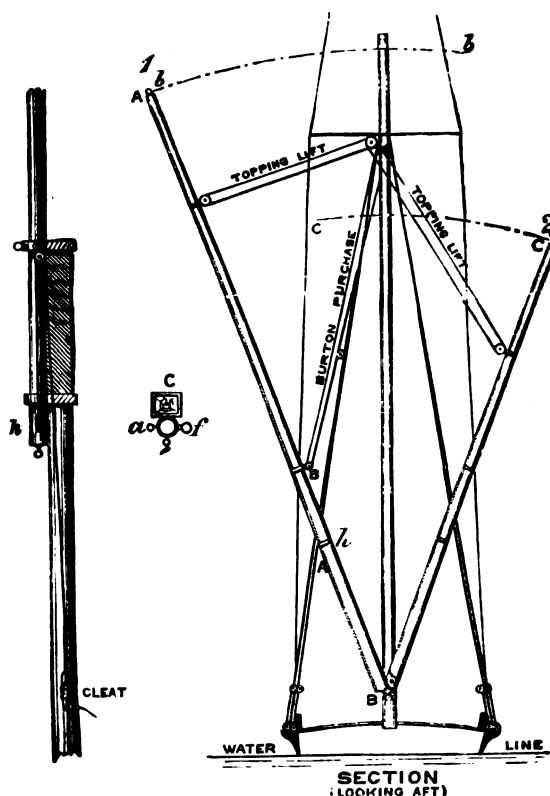


Fig. 38.

dipping the boom, but give a 57ft. spar, besides giving greater strength, the boom being double where the most strain comes ; and the extra weight is a positive advantage, as helping to balance the main boom. Of course this plan would allow of almost any length of spars, as a 40ft. lower boom would give a 74ft. spar, and still leave 8ft. between the irons ; and in these days of excessive spars and canvas no doubt it would be attempted to balance a ringtail, but the lengths given seem a good comparative length for any class.

A more simple plan for "telescoping" a spinnaker boom is shown by Fig. 39, *a* is the inner part of the boom; *c* is a brass cylinder with an angular slot in it at *s*. This cylinder is fixed tightly to the outer part of the boom by the screw bolts *i i*. The two parts of the boom meet inside

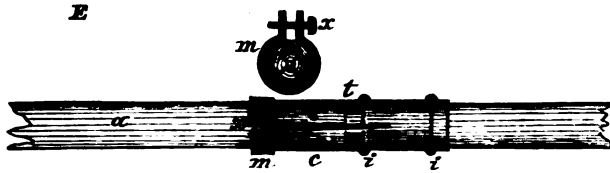


FIG. 39.

the cylinder at the ticked line *t*. When the two parts of the boom are to be used together, the ring *m* is put on the cylinder. The inboard part of the boom is then put into the cylinder, and the whole is firmly screwed up by the thumb-screw *x*. Both parts of the boom have their ends "socketed" so as to take a goose-neck, and thus either part can be used alone.

CHAPTER XIII.

SEAMANSHIP.

SEAMANSHIP comprises the practice of the whole duties of a sailor, including all kinds of work upon rigging, making sail, taking in sail, steering, reefing, working the ship, heaving the lead, and whatever else relates to the management of a ship. Before a man can be called a seaman, he must have practised all the duties enumerated, and be capable of performing them in a satisfactory manner without supervision; he is then called an able seaman, as distinct from an "ordinary seaman," who is a young sailor not yet versed in the practice of the seaman's art. A seaman, as generally understood, is one who is versed in the art of square rig sailing, but there are "fore and aft rig" men as well, and the instruction given in this chapter will relate to the duties of the latter alone, as the square rig, so far as yachts are concerned, may be said to have entirely disappeared.

To SET THE MAINSAIL.—Take the coats off. Hook on the peak halyards, and mouse the hooks. Overhaul some of the main sheet, and belay on both quarters. Top the boom up five or six feet clear of the crutch, taking care that the crutch is not lifted out of the sockets, and dropped overboard. When the boom is topped up,* haul the main sheet taut, and belay. Cast off the tyers or gaskets, leaving one as a "bunt gasket" amidships at present to keep the sail from blowing out. See that the purchases have been well overhauled (fleeted); and that the peak downhaul and the topsail sheet are rove. Man the peak halyards, cast off the bunt tyer, and hoist the gaff end between the topping lifts, guiding it with the peak line. When the gaff shows above the lifts, hoist away on the throat halyards, and let the sail go up with the gaff as nearly as possible at right angles to the mast. If the sail is peaked before the throat is up (*i.e.*, if the peak of the sail goes up faster than

* It is a practice in racing vessels to unhook from the boom what is to be the lee topping lift whilst hoisting, so that the mainsail will not girt across it, and cause a delay.

the throat), it will be hard work getting the throat up, if it can be got up at all without resorting to the purchase. Get the throat as high as possible with the halyards, and belay. Leave the peak for the present, and pull the sail out on the foot by the outhaul. Purchase up the throat as high as required, and set the peak up, using the peak purchase until the sail begins to girt in the throat; a few girts here will not matter, as the peak will be sure to settle down a good deal. Sometimes in small yachts, after the throat is set up hand-taut, the peak is got as high as it can be without the purchase. The sail is then set up by the main purchase, "peak and all" going up bodily. When the foot of the sail is laced to the boom the tack is always lashed down to the gooseneck, and the main purchase brings the luff of the sail taut—like a bar of iron. When the sail is not laced (it is seldom laced in a cutter), the tack-tackle is generally hooked on after the throat and peak are up, and the luff of the sail is brought taut by this tack-tackle. But the better plan for a racing yacht is to make the tack fast before hoisting by passing a lashing through the tack cringle and round the gooseneck of the boom; then pull the sail out on the boom; it will be found that the main (throat) purchase will get the luff of the sail much tauter than the tack-tackle can. We are speaking now of setting the sail to the best advantage; but it is quite possible that the skipper may want the tack triced up, for which purpose the tricing line will be hooked on to one of the mast hoops near the throat, and to the tack cringle of the sail.

When the sail is set, the tyers should be made up in neat bunches, and the sail coats should be folded up ready for stowing away in the sail room.

It is the practice to always have one reef earing rove, and if the weather looks at all threatening a second one should be rove. The first earing should be fast round the boom, then, if the outhaul should burst, or the clew of the sail tear out, the sail will not fly in along the boom nor get adrift. In anticipation of such accidents a common plan is to pass a tyer through the clew cringle and round the boom, three or four times.

If whilst sailing the peak should settle down so much as to require setting up, the best time to choose for doing so will be when the vessel is head to wind in stays. The weight of the boom should be taken by the weather topping lift.

In bending a new mainsail great care should be taken not to get any strain on the head or foot at first. In first hoisting take the weight of the boom with the topping lifts; set the throat up taut by the halyards, and then get the peak a little more than half up. Then set the luff taut with the tack-tackle, and afterwards set the peak up,

but still leave the leech slack. If the weather is damp and any strain comes on the foot, ease the outhaul and let the traveller in. So also if the sail is set and it should rain, ease in the traveller. It is a good plan, especially if the sun is out, to hoist the sail up several days before getting under way, and as it blows about with head and foot slack, it will stretch fairly. If a chance occurs it is an excellent plan to run before a good strong wind for some hours, especially if the leech of the sail appears to be unduly slack. After a few days the head can be hauled out fairly taut on the gaff, and the foot on the boom; but the traveller should always be eased in for rain or dew, and no great strain should be allowed to come on the foot until the sail is fairly stretched. Even for an old sail the traveller should be eased in a little if the sail gets wet, and if it appears necessary the tack or throat purchase should be eased as well for rain or dew.

TO REEF A MAINSAIL.—Get the reef tackle on deck and bend it to the reef pendant or earing (previously rove), and hook the fore block to the eye bolt or strop on the boom. Take the weight of the boom by the weather lift, and ease the main sheet, if required, to allow the boom being tossed up. Cast off the main tack, if the sail be not a laced one. Ease up the main and peak purchases till the sail has settled down a reef, and if necessary ease up the halyards by the fall; no more of the peak than actually necessary should be settled down, as the peak will be the heaviest work to get up again. Put plenty of strength on the reef tackle (ease the helm a little, so as to take the weight of the wind out of the sail) and harden the earing down on the boom until the last inch is got. Should the cringle not come right home pass a tyer two or three times through it and round the boom. This “preventer” lashing is commonly rove when match sailing with a reefed mainsail. Then roll the foot of the sail up tightly and neatly, and tie up the reef points (see Fig. 40); set up the throat by the purchase, and then the peak. Bowse the tack down. Ease up the topping lift and trim the sheet. A racking should now be put on the earing, and the reef tackle cast off. Then make the earing fast by jamming turns round the boom. Reeve another earing and hook the tackle on to haul down the second reef if necessary. Never reef a new unstretched mainsail if it can be avoided, but stow it and set the trysail if necessary.



FIG. 40.

TO SHAKE A REEF OUT.—Set taut the weather topping lift to take the weight of the boom. Untie all the reef points, and be careful that not one is left tied, as the sail may be torn thereby. Ease up the tack-tackle and unhook it. Ease up the reef earing. The reef will now be

fairly shaken out, and the mainsail can be set by the purchases, always recollecting to set the throat up first. Bowse down the tack, ease up the topping lift, and trim the sheet.

To STOW A MAINSAIL.—Put the tyers at proper intervals across the boom. Ship the crutch. Set taut the topping lifts. Overhaul main and peak purchase. Lower the boom by the topping lifts into the crutch. Haul taut the main sheet and belay; cast off the falls of main and peak halyards, and lower (by the main the faster) and gather in the sail on deck. Belay the peak halyards so that the gaff end rests on (say) the port side of the boom. Pull the foot of the sail up on the top of the boom so that the roach just hangs over on one side, say the port side; next take the leech of the sail and lay it along on the top of the foot. Then the whole of the bag of the sail will be on the starboard side. Take hold of this part and lift up and roll over, repeating the operation until the sail is rolled up in a snug bag. Then hoist the gaff up clear of the boom and lift the sail up on the foot, which has been previously laid along the boom. Throw the ends of the tyers over the gaff, and haul up the sail snug to the gaff; then take the ends of the tyers under the boom up over the gaff again, and tie. Unhook peak halyards and put on the mainsail covers. The peak halyard blocks can be then hooked on again, or hooked to a sling passing under main boom, and will thus keep the boom from sagging with its own weight. When the peak halyards are not so hooked on, an X crutch should support the boom amidships.

To STOW THE MAINSAIL AND SET THE TRYSAIL.—In heavy weather it is always better to set a trysail than a close-reefed mainsail, as the mast is thus relieved of the heavy strain of the main boom and gaff. Get the trysail gaff clear of the other spars on deck. Get the trysail on deck, and the trysail sheets. Prepare to heave to under the two head sails. Ship the boom crutch. Set the topping lifts taut. Overhaul the main and peak purchase. Settle the main boom down into the crutch. Haul the sheet taut and belay. Stow the mainsail and make it up on the boom. Put a lashing on the boom from each quarter, or secure the boom in the crutch by tackles on to each quarter. Take off main and peak halyards and hook the same to the trysail gaff. Unhook the topping lifts, and make them fast in main rigging. Ship the jaws of the trysail gaff to the mast, and make fast the parrel round the mast, the gaff end resting on the deck. Lace the trysail to the gaff. Bend the sheets and belay both hand taut. Hoist and toggle on the parrels, or strops, or lacing (as the case may be) on the luff of the sail round the mast, as the sail goes up.

If the yacht be yawl rigged, and the mizen has been stowed, it

should be set before the mainsail is taken off, as the mizen will keep the yacht's head up to the sea. The storm mizen, of course, would be chosen for this purpose.

TO SET A STAY-FORESAIL. (In a schooner this sail is termed the fore staysail, and the foresail is the gaff sail set abaft the foremast; in cutters the foresail, although, as in a schooner, set on the forestay, is simply termed the foresail or staysail; the proper term is stay-foresail).—Take off the coat and hook on or bend the sheets, hauling in slack of port or starboard one (or both), and belay. See that the downhaul is bent to the head cringle, and hoist away.* When the sail is high enough, hook on the tack tackle and bowse down.

TO REEF A STAY-FORESAIL.—Cast off the tack tackle and lower the sail; unhook the sheets; tightly and neatly roll up the foot of the sail and tie the reef points. Hook on the sheets to the reef cringle and belay; re-hoist the sail; hook the tack to the reef cringle and bowse down with the tackle.

TO SHIFT A STAY-FORESAIL FOR A BALLOONER.—Let go the halyards and haul down the foresail by the downhaul; unhook the halyards from the head cringle; hook them on to the balloon foresail with downhaul; and, as the sail is hoisted, toggle the luff on to the forestay, or hook on as the case may be; carry the lee sheet aft and belay (slack) as the crew start hoisting. When the head is chock-a-block bowse down the tack. Trim the sheet. On a wind the sheet is generally brought inside the main rigging, or between the main rigging and the topmast back-stays. For reaching, the sheet is carried outside of all.

TO SET A JIB.—Carry the sail forward tack first. Hook the tack cringle to the traveller; hook on the halyards and downhaul to leeward of the forestay and foresail; belay the sheets hand taut, or one a-weather, as required. Hoist away by the halyards until the sail is about half up; then haul the tack out by the traveller outhaul, hoist the sail and set taut with the purchase. Trim the sheets. Always be careful that the jib sheets are rove through the right holes; nothing shows up the careless mate so much as the sheet for first jib rove through the holes for second jib, or the contrary.

In light winds it will be found less trouble to pull the jib out on the bowsprit before hoisting, and with a few stops uncut.

Generally in getting under way the jib is set up in stops, that is, before it is unrolled. The jib is hoisted up some distance, and then the

* The downhaul is sometimes kept rove through the hanks and leads through a block inside the stem head. In a racing yacht it is best not to have downhaul rove through the hanks, because it is so frequently necessary to shift for a balloon foresail.

tack is pulled out on the bowsprit, the sheets being loose, as otherwise the stops would be broken. Upon getting under way the stops are easily broken by hauling in the jib sheet.

When the second jib is set the bowsprit should be reefed, and double-reefed for third jib; otherwise the strain from the jib may cause the bowsprit to break, as the traveller would come far inside the support of the bobstay, and "nip" the spar.

Before purchasing up a jib the runner-tackles should be always set taut, and, if necessary, swigged upon. If the runners are slack, the effect will be to pull the mast forward and slacken the forestay instead of to straighten the luff of the jib. It is also necessary that the bobstay should be set well taut by its tackle.

To SHIFT A JIB.—Ease up the purchase, slack up the outhaul and pull in by the inhaul, and gather the sail in board by the sheet and foot; then pull the head of the sail down by the downhaul, gathering the sail in-board, and "muzzling" it as it comes on deck over the lee bow. The purchase should always be eased before the outhaul is let go. If the outhaul is let go first, the jib will fly in, and cause such a jerk that the bowsprit might be sprung or the bobstay burst.

If possible, the jib should be shifted when the vessel is before the wind; and often a sailing master will run his vessel off whilst the crew are getting the jib in, so that the sail is becalmed. Sometimes two or three or more hands go on the bowsprit, and gather the sail up as it comes down, but in bad weather the traveller is always let run up close to the stemhead.

If it is seen beforehand that one jib will have to be shifted for another, the tack of the jib which is to be first used is *lashed* to the bowsprit end; the other jib is run out by the traveller and stopped along the bowsprit. To shift, haul taut the weather sheet; one hand cut the lashing at the bowsprit end; as the jib flies aft haul in by the mainparts of the sheet, and pull down by the downhaul. Hook the halyards, downhaul, and sheets on the other jib and hoist away.

In light weather when a bowsprit spinnaker is carried, it is unusual to let the jib run in, but several of the hands stow it along the bowsprit.

TO SET A GAFF TOPSAIL.—Bend the sail to the yard; lace the weather earing first, and then haul the head taut along the yard, and lace the peak earing through and through. Tie the stops round the yard, or lace, as the case may be. Bend the sheet to the clew cringle (*see* Fig. 41). See that the sheet is inside the topping lift, and that it passes under the yard from the mast side before it is bent to the clew cringle. See that the clew line is fast to the clew cringle. Hook on the halyards and

bend the trip halyards (see Fig. 42), and hoist the sail clear of the deck. Hook on the tack tackle, and put a mousing on the hook.

To keep the sail from blowing away from the mast, it is usual to have a "lazy tack," which consists of a short line, one end of which is fast to the tack cringle of the sail; the other end is passed round that



FIG. 41.

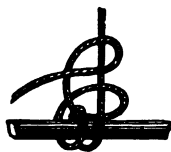


FIG. 42.

part of the main or peak halyards which has been belayed to the mast bitts, and is then made fast to the tack cringle the same as the other end was; the line thus forms a kind of traveller, and the main or peak halyard serves as a jackstay.

A gaff topsail should be always sent up to windward, and if the halyard and sheet are to leeward they should be shifted over.

Hoist on the trip halyards until the peak is well up inside the topping lift (the peak will always be the aft end of the yard), then hoist away on all, hauling out the sheet as the sail goes up; otherwise, if the sail blows about, the sheet may get a turn round the gaff end. When the yard is so high that the point where the trip halyards are bent is level with the trip halyard sheave in the topmast, leave the trip halyards adrift, and all hands hoist by the other halyards. When the yard is chock-a-block, belay. Bowse down the tack to the last inch, and belay. Set taut the trip halyards. Pass the lacing and haul taut round the masthead. Haul out the sheet until the sail sits as desired. *A topsail should never be sheeted until the tack has been bowed down.* If during sailing it is found that the tack requires bowing down, the sheet should be eased up first.

Before the topsail is sheeted, a look should always be given to the topmast stay. The topmast should cant forwards a trifle, so as to insure plenty of drift for the sheet.

If the head of the sail be very short, the trip halyards will not be used.

In the case of a jib-headed topsail, the same precaution must be observed in bending the sheet by passing it under the sail from the side next the mast. The sail will be hoisted as fast as the masthead-man can lace it.

In running before the wind with the boom square off, if the topsail is to windward of the gaff the sheet should be eased a little, and, if

necessary to relieve the strain on the weather cloths, the lacing or tack should be eased as well.

TO TAKE IN A GAFF TOPSAIL.—One hand will go aloft to cast off the lacing. When all is ready for lowering, cast off the halyards and trip halyards from the belaying pins. Ease up the tack tackle; but do not cast off the “lazy tack.” Lower away by the halyards, but keep the trip halyards hand taut, until the yard is “up and down” the mast. Ease up the sheet, and lower away all. If there be much wind, several hands must be put upon the tack to haul down, as the belly of the sail is certain to blow in between the parts of, or over, the peak halyards, and will thus prevent the sail lowering. The hand aloft will keep the heel of the yard inside the topping lift as it passes down.

As the yard comes down between the topping lift and the mainsail, haul forward by the tack (casting off lazy tack), so that the heel of the yard (the lower end) goes forward.

When the sail is on deck, unbend the halyards and make the ends fast to a belaying pin. Unbend the sheet, and make it fast round the boom. Roll the sail up on the yard; or unbend it, roll up, and stow below.

Formerly the practice was to lower the topsail to leeward of the mainsail, as it was thought to come down more freely under the lee of the lower sail; but the difficulty is that the sail or yard is almost certain to get foul of the topmast rigging or lee crosstrees, and the crew cannot handle it so well from the lee scuppers. Very often in attempting to take in a topsail to leeward it will take charge and blow out, whereas if it were to windward it would lie flat on the mainsail, and could not blow away. So now the practice is, if the tack be to leeward, for a hand to go aloft in the lee rigging or up the mast hoops and unhook the tack tackle, whilst another hand goes aloft on the weather side to the masthead, and lowers a line to him to bend to the tack. When the line is so bent, the hand at the masthead pulls the tack up over the peak halyards, so that the sail can be got down to windward. The heel of the yard is pushed to the weather side of the mast whilst lowering.

TO SET A SCHOONER'S FORE GAFF TOPSAIL.—The sail should be sent up stopped to the yard, with the clew and tack cringles clear. Bend on the halyards, and hoist to the masthead. The hand aloft will then bend on the lee sheet and lee tack to the cringles; then the weather sheet and tack will be bent, first passing them over the maintopmast stay. When this is done, hoist the sail chock-a-block, bowse down the lee tack, then sheet home the lee sheet by the winch.

TO WORK A FORE GAFF TOPSAIL.—When the order comes “ready about,” ease up the sheet and tack; clew the sail well up. The fore-

masthead man will clear the tack and sheet over the maintopmast stay, and must well overhaul the same. As the vessel comes head to wind, bowse down the tack as smartly as possible, at the same time haul out the sheet; but do not sheet home until the topsail is tacked, as it must always be recollected that a topsail cannot be properly set if it is sheeted before the tack is down.

To SET A JIB TOPSAIL.—Pass along the sail head first, one hand going to bowsprit end with the head cringle in his hand. In large vessels this hand bestrides the bowsprit end outside the topmast stay, with his face towards the vessel; generally in such small vessels as five-tonners there is not such a "seat" at the extreme end, and the hand will sit on the bowsprit weather shrouds if the sail has to be hanked. Bend the sheets, and pass them outside of all. Haul in the lee sheet, and place one hand to attend to it, and ease up if necessary. Hook or toggle the hanks on to the topmast stay, cutting the stops and hoisting as the hanks are so hooked or toggled. When all the hanks are on, hoist to the required height, set the tack down, and trim the sheet.

A jib topsail in a five-tonner is sometimes set flying, as the bowsprit end of such small craft is not a pleasant place for a man of the customary weight of eleven stone. At the bowsprit end a tail block is fast; through this block a rope is rove, both ends being kept in-board. To set the sail, bend both ends of this rope to the tack cringle, and bend the halyards to the head cringle. Haul the sail out on the bowsprit by the *under* part of the outhaul, and hoist at the same time. The bight of the outhaul will therefore come in-board, and its *upper* part will serve as the inhaul when the sail has to be handed. The sail can be hoisted to any required height. One hand, of course, must go to the bowsprit end to pass the sheet.

If the halyards are to windward the sail can be hoisted to windward; if otherwise it will be hoisted to leeward of the foresail and jib.

In strong winds a jib topsail should never be hoisted so high as in light airs, as the higher it is the more strain it will bring on the topmast.

Also, in strong winds, one hand should always be stationed at the sheet to ease up during strong puffs. A good plan is to put a tail-tackle on the sheet. The sheet can then be eased or hauled in as required very readily by the tackle.

To SET A SCHOONER'S MAIN TOPMAST STAYSAIL.—See that the halyards are on the lee side of the main-topmast stay. Bend on the halyards, tack and sheet; see that the sheet has been passed outside the main rigging and main-topmast rigging. Hoist to foremast head in a bunch; then, as the hand aloft hooks the hanks on the main-topmast stay, the deck

hands will hoist. When hoisted, set the tack taut, and belay. Trim the sheet. It is very usual for the sheet to lead to the boom end; it cannot very well be got too far aft.

To SET A SQUARESAIL.—The yard has a strop and thimble eye seized in it at the centre of length of yard; on the fore side of the mast a wire jack stay or jumper reaches from masthead to deck, on which the thimble eye on the yard strop travels. The braces are rove through single blocks at each yard arm, and one end made fast to the cavel aft, the other part is for hauling. The fore braces are single ropes leading from each yard arm through single blocks at the bowsprit end. The lifts go from each yard arm through single blocks hooked to the upper cap at masthead, and lead to the deck. When at anchor the yard is generally lowered half-way down, and then pointed up and down the mast. It is more ship-shape, however, to lower the yard down to about level with the tier of mast hoops and square across, with all the braces and lifts set taut. The only objection to the latter plan is that it may be fouled by passing vessels.

To set the sail, reeve the earings through the block at each yard-arm, and through a block near the strop on the yard amidships; then hoist the yard up. Bend or hook one end of each earing to the corner head cringles of the sail, and hook the four halyards to the middle cringle; hitch the lizard to the cringle or hook of halyard block. (The lizard is a short piece of rope with an eye at one end; the eye travels on the jumper, and the tail is fast to the sail; thus the sail is kept from blowing away.) Bend on the tack and sheet; then hoist by the halyards, and afterwards pull out the weather earing; take in the slack of the lee earing. Get out the boom with fore and after guys on it, and the outhaul rove through the sheave hole at boom end; bend the outhaul to the tack cringle of the sail, and haul out.

To take in the sail, let go the weather and lee earing; then let go the sheet, and tack outhaul, and gather the sail aboard; then, when the sail is all in-board, let go the halyards and haul down with downhaul. As the sail is hoisted by the foresail halyards, the fore downhaul will be used as well.

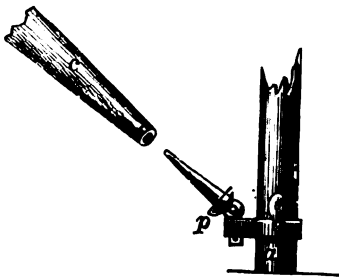


FIG. 43.

To SET A SPINNAKER.—The boom must be got ready first. Hook or bend the lower block of the topping lift to the boom (it is usually a tail block.) Reeve the outhaul in the sheave hole or block at the spinnaker boom end; be careful that the part of the outhaul which has to be bent to the tack cringle is on the fore side of the spinnaker boom topping lift and over

the fore guy; put on the after guy and fore guy.* Hoist the boom well above the rail, and launch forward until the gooseneck† can be shipped in the socket; hoist until the boom is "up and down" the mast, and high enough for the lower end to be shipped on the gooseneck. (It is usual to put the gooseneck in the socket on the mast first, and then bring the socket which is in the end of the boom to the shank—see Fig. 43—*c* is the boom and *p* the gooseneck, *a* the mast.) Lower the boom and haul aft, or "square the boom." If the boom be already shipped and "up and down the mast," one or two hands will take the guys aloft and put over the end. The standing part of the after whip will be made fast to the quarter, and the hauling part rove through a sheave hole or turned round a pin. The hand aloft will cast off the boom lashing, and push it away clear of mast and cross-trees for lowering by the topping lift.

See that the halyards are clear and on the fore side of the spinnaker boom topping lift. Bend on the halyards and the outhaul to the sail (see Fig. 41). If the spinnaker is to answer the purpose of bowsprit spinnaker as well, another outhaul must be bent, leading through a block on bowsprit end. Generally the fore guy in such cases is made to do duty for this purpose; but if there be a fore guy beside the tack outhaul, care must be taken in bending the latter to see that it is *over* the fore guy, and not *under*. Bend on the sheet and belay, with one hand to attend to it to ease up if necessary. Hoist away on the halyards, and when the sail is up chock-a-block put all hands on the outhaul, easing up the sheet all that is necessary, so as to make the sail lift in order that it may be boom-ended; drop the boom down and trim the sheet. In light winds, the sail is very frequently pulled out on the boom whilst it is being mast-headed. This is all very well if there be plenty of help at hand, and if there is not much wind; but generally, if the sail be hauled out on the boom first, it is found almost impossible to get the head up chock-a-block. If the sail cannot be boom ended, well slack up the sheet and haul it in again as the tack is brought to the boom.

To prevent the sail going up full of turns, there is a swivel at the head, but this will not always prevent turns, as the swivel is likely to jam if any part of the sail fills; and a good plan is for a man to stand by the mast and run the luff of the sail through his hands as it goes up.

* A fore guy is not always used in small yachts.

† Square goosenecks are going out of fashion now, as it is some difficulty to get the socket fair for taking the gooseneck. With a round gooseneck and round socket this difficulty is avoided. If the boom should be shipped unfair, a spike in one of the holes will easily twist it round.

TO TAKE IN A SPINNAKER.—Top the boom up, well clear of the rail, otherwise when the sail is taken off it the boom may drop into the water and be broken. Take hold of the foot of the sail, let go the outhaul, and haul the sail in smartly by foot and sheet; gather the sail in to the mast, well muzzling it, and then let go the halyards, and haul down.

The halyards should never be started until the sail has been hauled in-board from the boom; if the halyards are started first, and there be much wind, the sail is almost certain to blow away and then get into the water, and cause a great deal of trouble.

TO SET A SPINNAKER ON THE BOWSPRIT.—Bend on the tack and halyards to leeward of jib and foresail; hoist and then pull out by the outhaul; trim the sheet; take in the jib, or let it run down by the head and stow and stop along the bowsprit.

TO TAKE A SPINNAKER IN FROM THE BOWSPRIT.—Pass the weather sheet round the fore stay to leeward and make fast to the bitts; let go the outhaul, and haul the sail in-board smartly by the weather sheet and by the foot over the lee bow. In strong winds it will be sometimes necessary to let the sail fly in by cutting the tack adrift. In such cases the best plan, if there is only one sheet, is to bend a line to this sheet, with a running bight in it. Take this line forward, and haul the bight close up to the clew cringle of the sail. One hand will go out on the bowsprit and cut the tack (outhaul), which he will not allow to unreeve, and will bring the end in-board with him. As the sail flies aft, smartly haul it in-board by the line that has been bent round the sheet, and get hold of the foot as soon as possible; gather the sail together, so that it cannot blow out whilst the foot is being hauled in-board; when the foot is all in-board gather the sail together and lower by the halyards.

It should be clearly understood that the halyards must not be started until the foot is hauled in and the sail gathered together; and, should the sail blow out, "spill" it by gathering the folds together, or it may take command and blow away, and perhaps at the same time pull someone overboard, or foul the lee crosstrees and be torn.

TO SHIFT A SPINNAKER BOOM.—Man the topping lift and hoist away. Slack up the fore guy, ease up the after guy as required, and do not let the boom swing forward. When topped carry the after guy and whip forward, passing it outside runners and rigging. Top the boom until it is lifted clear out of the gooseneck; lower by the topping lift, whilst three or four hands take it by the heel and carry it aft on the side of the mast it has to be next used. When sufficiently low and far enough aft to admit the upper end passing under the fore stay, launch forward again and hoist away; ship the gooseneck as before, and reeve the guys. Sometimes,

where the forehatch is near the mast, as in small vessels, the heel of the boom is lowered into the forecastle; this, of course, is a simpler plan than launching the heel of the boom aft. If handled with care, the heel of the boom can be lowered over the side.

In small yachts which have spinnaker booms as long as the deck length is overall, the general practice is to top the boom a few feet and then let it swing forward. The boom is then unshipped and launched aft on the opposite side of the mast. When the fore end can be cleared of the forestay or foresail sheets, it is launched forward again, gooseneck re-shipped, and guys made fast.

TO SET A RINGTAIL.—In the first place, an iron hoop has to be fitted at the main boom end (similar to the upper cap at masthead) to take the boomkin. One hand must get on the main boom. Bend the main peak downhaul to the boomkin (generally called ringtail boom), and hoist it to the main boom; steady it through the iron at the main boom end; cast off the peak downhaul; reeve an outhaul through the sheave hole in the end of the boomkin, and launch the spar the required distance out; then lash the heel to the main boom. In reeving the outhaul, care must be taken that the hauling part only is outside the topping lift. The head of the ringtail is bent to a yard, with three or four spare feet for inner end. Bend the main peak downhaul to this yard for a halyard; bend both ends of the downhaul to the tack cringle (the clew cringle for the sheet will be in-board). Hoist the sail, then pull out to boomkin end by the under part of the downhaul, and sheet as required.

To take this sail in, the first thing to do is to haul it in by the sheet and inhaul whilst the outhaul is slacked up. Lower by the halyards as fast as the sail is gathered in. The boomkin will be got on board by aid of the peak downhaul.

TO SEND UP A TOPMAST.—Lash a tail block to the upper cap at masthead; through this reeve a rope and bring down to deck; reeve an end through the sheave hole in topmast, and make it fast some distance below the shoulder, stopping the end securely. (The heel of the topmast should be aft.) Hoist away; point the topmast through the lower cap; then make the heel rope fast to topmast, cast off the other rope, and hoist the topmast up through the upper cap by the heel rope. Put the eyes of the rigging over the pole, topmast stay over all; reeve the halyards, lash on the tail blocks for jib-topsail and spinnaker halyards, and then send up the topmast by hauling on the heel rope and fid. Set up the backstays by the tackles.

The topmast will be sent down by reversing the order given above.

TO HOUSE A TOPMAST.—Ease up the topmast stay and backstay falls.

Hoist away on the heel rope until the topmast is sufficiently above the lower cap for the hand aloft to unfid. Settle down the topmast by easing up the heel rope. When lowered, so that the eyes of the rigging come close to the cap, belay the heel rope and lash the heel of topmast to the mast. Unshackle the legs; hook the tackles on again in, and set hand-taut.

If the vessel has much list, the topmast will not come down very readily, and the weather backstays should be kept taut, so as to keep the topmast in the line of the mast, and to prevent it breaking by ragging to leeward with its own weight. Also if there be much sea it may be found necessary to steady the topmast by the preventer. Generally the vessel should be eased or hove to whilst a topmast is being housed if there be much wind and sea.

Plans for fidding and unfidding topmasts from the deck without going aloft are given on page 131.

TO REEF A BOWSPRIT.—If the jib is set, ease up the sheets and belay them, well slack. Cast off the bobstay fall and the falls of the shrouds and topmast stay. Knock out the fid, and then launch the bowsprit in by the shroud tackles; fid and set up all the tackles.

TO TAKE A REEF OUT OF THE BOWSPRIT.—Overhaul all the tackles; launch the bowsprit out with heel rope and tackle, or by the rack-plate and wheel; fid and set the tackles taut again.

In setting up the bobstay tackle, it is usual in racing yachts, before starting in a match, to set the bowsprit end down until it nearly touches the water.* This is done in order to give more hoist and drift for the jib, as by frequent setting up the blocks would soon come “chock-a-block;” moreover, the bobstay fall is certain to “come up” or stretch a good deal, so much so that very frequently at the end of a match a bowsprit, instead of being bent downwards, is steeved in the air.

TO GET UNDER WAY RIDING HEAD TO WIND AND TIDE, TO RUN BEFORE THE WIND.—Heave short; set the jib in stops; take the foresail coat off and hook on the halyards and sheets; top the boom and cast the gaskets off the mainsail. To cast to starboard, put the helm to port, heave the

* Although no doubt this is a convenient way of allowing for the stretching of the fall of the bobstay, yet it is attended by some risk to the bowsprit. The spar is bent until it nearly reaches its breaking point, and if any further strain comes upon it, as there might whilst diving into a head sea, the bowsprit is in great danger of being broken; or if the shrouds and tackles should stretch badly, as they sometimes will, the bowsprit would most likely break, as a lateral strain would come on the bowsprit besides the downward strain. The safest plan is to set the gear up so that there is neither a downward nor upward curve in the bowsprit, and there should be as little stretch as possible in the gear. In 1878 a few yachts tried flexible wire falls to the bobstay, but after being well set up they stood very little strain, and two or three bowsprits were lost through the fall bursting.

anchor up smartly; as the anchor is a-weigh break out the jib and set the foresail, keeping the port jib and foresheet taut. As her head goes off set the mainsail, steady the helm, and trim the sheets.

TO GET UNDER WAY RIDING STEM TO TIDE WITH WIND ASTERN, TO RUN BEFORE THE WIND.—Heave short; loose the mainsail; set jib and foresail; break out the anchor, and when a-weigh set the mainsail.

TO GET UNDER WAY RIDING HEAD TO TIDE AND STERN TO WIND, TO BEAT TO WINDWARD.—Heave short; set the jib in stops, and hook on the fore sheets. To cast to port: put the helm to starboard, heave up the anchor; break out the jib, set the foresail (with starboard sheets hauled flat) and smartly set the mainsail. If the mainsail is set before the anchor is a-weigh, the peak should be dropped down.

TO GET UNDER WAY WHEN RIDING HEAD TO WIND AND TIDE BY CASTING TO STARBOARD, TO PROCEED ON PORT TACK CLOSE-HAULED.—Heave short; set the jib in stops; hook on the fore sheets with the port one fast. Set the mainsail. Put the helm to port, and heave up the anchor. As the anchor is a-weigh break out the jib with port sheet hauled a-weather. Slack off the mainsheet. As the vessel's head pays off let draw the head sheets, haul in mainsheet and sail her.

TO GET UNDER WAY; RIDING HEAD TO WIND AND TIDE, BY CASTING TO PORT TO PROCEED ON PORT TACK.—Heave short; set the jib in stops; bend on the fore sheet, with starboard one fast. Set the mainsail. Put the helm to starboard; get the anchor; break out the jib, hauling starboard sheet in; ease off the main boom a little on the port quarter; keep the helm to starboard till the vessel's head wears off so as to bring the wind on the port quarter; the main boom will then gybe over; trim the sheets and sail the vessel. It may sometimes be advisable not to set up the peak of the mainsail until after the vessel has wore round. In the case of a yawl the mizen would be set to get under way with, and not the mainsail.

TO GET UNDER WAY AND LEAVE AN ANCHORAGE TO RUN FOR IT.—If possible choose slack-water time or when the tide is running to leeward. Set the trysail, reefed foresail and fourth jib. Watch for "smooths" to heave up the chain; but, if the sea is so bad that the vessel pitches head and shoulders under, so that there might be danger in pinning her down by heaving short, or if she sheers about so as to get the cable jammed hard athwart the stem, then unshackle the chain, make fast the buoy rope outside the hawse pipe, wait till the vessel sheers the way she is wanted to cast, then slip the chain and sail her.

If the vessel is wind rode, and on a lee shore, it will be prudent to claw out to sea for an offing. Set the storm canvas as if for a thrash to windward. Heave short, set the jib with the sheets slack, set the foresail,

and if the vessel is to be cast on the port tack, haul in the port foresheet; put the helm to port; slack out a little mainsheet. As the vessel sheers to starboard break out the anchor or slip, and when she pays off enough so as to make sure of not flying to again, ease the fore sheet over, trim the main sheet and sail her. If the vessel does not gather way, but drives towards the shore, stand by to let go the anchor again: if one anchor has been slipped, the other should be ready on the bow. If there is not too much sea, the kedge with hawser bent to it should now be carried out in a boat; then as the anchor is hove short haul in on the hawser. When the anchor is off the ground haul the vessel ahead by the hawser, when the kedge is apeak, sheet the jib, and break out the kedge. When anchored on a lee shore a vessel should never wait till the wind and sea gets so bad that it is neither safe to remain nor to attempt to leave.

TO TACK A CUTTER.—When the order is given “ready about,” the fore deck hands will go to their stations at fore sheets and jib sheets, and one of the after guard to the main sheet, seeing all are clear. The cry of “Helm’s a-lee” will be the signal that the helm is being put down; ease up the jib sheet as the jib begins to lift, and overhaul it. If the vessel is coming round smartly, ease up the fore sheet or fore sheet purchase as well; the hand aft hauls in the main sheet. When the vessel has passed the point “head to wind,” begin to haul in the jib sheet, and get the sail sheeted and belayed before the vessel is full again and gathers way; handle the fore sheet in the same way, and overhaul the main sheet. Care must always be taken not to pull the jib sheet over the forestay, and get a strain on it before the vessel has passed the “head to wind” point, or is filling on the opposite tack to the one upon which she has been sailing; otherwise a back sail will be formed, and the vessel may fall off again. On the other hand the jib, when the time comes for working the sheets, must be sheeted with all despatch; as, if the vessel is allowed to fill before the jib sheets are in, it will be hardly possible to get them in properly without a tackle if there be a nice breeze. So with the fore sheet.

In tacking a vessel in a sea, the fore sheet should as a rule not be let go until it is seen whether the vessel is going to fill on the other tack or not, as the sail may be wanted to pay her head off: when the vessel fills, the fore sheets must be handled with smartness. If there is much sea, a “smooth” should be watched for, to tack in. Never, if it can be avoided, attempt to tack with a big comber rolling in on the weather bow, as a “miss-stays” may be the consequence, to say nothing of the water that might be thrown on deck.

The helmsman will soon find out how the vessel likes the helm put down for quick staying; but generally the vessel should be kept a good full before giving lee helm. Then at first ease the helm down gradually, so as to shoot a good distance, and make as big a circle as possible, but be very careful not to keep the vessel shooting till her way is stopped; as she comes near head to wind, put the helm right over to the rail, and keep it there till the vessel fills and gathers way on the other tack; keep the vessel a little off a good full till she is reaching along, and then bring her to wind "full and bye."

To TACK A YAWL.—The only way in which tacking a yawl is different from tacking a cutter is that there is the mizen stay to work. The stays lead forward from the mizen-mast head, and are set up by tackles; only the weather one is set up. The weather tackle is overhauled in tacking, and the lee set taut, and forms the weather one when the vessel has filled on the opposite tack. Generally a yawl does not stay so quickly as a cutter, and more frequently requires backing off by the foresail.

To TACK A SCHOONER.—Keep the vessel a good full. As the vessel begins to come to ease up the jib sheet, but do not let it "fly"; overhaul the fore-sheet purchase and fore-staysail purchase, and overhaul fore-topsail tack and sheet and clew up. As the vessel comes head to wind cast off standing part of foresheet and forestaysail sheet. As she passes the point "head to wind" haul in jib sheets and belay; haul in the standing part of the fore sheet and fore-staysail sheet and belay; then be smart with the purchases and get the foot of the foresail as straight as possible; fore-staysail sheet not quite so "straight," as there should be a little flow in the after leech, owing to the angle made by the luff of the sail, and if the foot be pulled "bar taut," the leech will generally be so too. Tack and sheet the foretopsail.

In hauling in the foresheet all hands should be outside it, and not between the sheet and the rail. Care should also be taken that the fall of the purchase is clear and ready to hand directly the standing part of the sheet is fast. One hand should be selected to stand by the foresheet cavel, and he should belay. Directly the order "belay!" is given all hands should haul on the fall of the purchase; the belaying hand taking care that a turn of the standing part of the sheet is caught round the cavel. It is highly important that the fore sheet of a schooner should be well taut; as, if the foot be slack, the sail, not being set on a boom, is certain to bag more or less. And when sailing close-hauled and the wind frees a trifle, the foresheet should always be the last one to be checked.

STERN WAY IN TACKING.—In square-rigged ships "stern way" is

commonly the result of letting the head yards lie aback during tacking, but a fore-and-aft vessel, in tacking under ordinary conditions, should not be subject to stern way. However, sometimes, even in smooth water, if a vessel has been brought head to wind either too suddenly or too slowly, she may get stern-way, or be placed in the situation known as "in irons," when she will neither fall off on one tack nor the other, after being brought head to wind. If the vessel has sternway, it must be recollected that the action of the rudder is different from what it is with head way; that is to say, if during stern way the helm be put to starboard, the action of the water on the rudder will force the stern to port and the bow to starboard; and if the helm be put to port, the stern will be forced to starboard and the bow to port. Under the influence of head way just the opposite results are obtained. The rudder has very reduced effect in turning a vessel one way or the other during stern way.

Let it be assumed that a vessel has been sailing on the port tack, and on the helm being put down that she failed to get farther than head to wind, or that she got in irons; the result would be that the wind would drive her astern—this would soon be discovered by looking at the water over the quarter or stern, as the "wake" will show in eddies along the side of the vessel. The helm would be to starboard, and would have to be shifted to port, and the starboard fore sheet and jib sheet hauled in, and the main sheet slacked up. The stern would gradually drive to starboard, and the bow, under the influence of head sails aback, would go off to port. The head sails being aback would of course increase the stern way, and directly the vessel's head was well off the wind, and the vessel insured against coming to again, the head sheets should be eased up and hauled in to leeward. She would require to fall off till the wind was brought nearly abeam before she gathered headway.

Under the influence of stern way the pressure of water on the lee quarter can be made to help turn the vessel just the same as the pressure on the lee bow helps to press the bow towards the wind when a vessel moves ahead. Or suppose the vessel be head to wind, and has stern way on, and it is desired to cast her head to port, or fill her on the starboard tack; then if she be listed or heeled to port by all hands going on the port side or port quarter, the arduousness of the pressure on the port quarter will press the stern to starboard, and necessarily the bow turns to port.

Thus, it will be frequently found, that the bow of a vessel, if she has sternway, and is heeled, will very rapidly fall off to leeward; even though the head sails are not aback, and the rudder, from the way it is turned, should prevent her doing so.

It should, therefore, be remembered, that when a vessel gets in irons, and is under the influence of stern way, that she should be, if possible, listed on the side it is sought to make the lee side. Easing the main boom off will allow the stern to come up against the wind more rapidly, and will help heel the vessel.

MISSING STAYS.—To get in irons or to get stern way on a vessel is not exactly missing stays, as to miss stays means to come up head to wind and then to fall off on the same tack again—in fact, to fail in going about. Generally a vessel has a tendency to miss stays through having too little after-canvas; that is to say, the centre of effort of the sails is too far ahead of the centre of lateral resistance. The fault may be cured by reducing the head sail; by increasing the after sail; by shifting the mast aft without reducing the sail; by rounding up the fore foot and heel; or by rounding up the heel.

But a vessel may generally stay well enough, and only fail in going about through meeting a sea on her weather bow as she is brought to the wind; or through the wind following her round; or through the helm being put down too quickly or too slowly; or through the head sails being badly worked; or through her having insufficient way on when the attempt was made to tack. Whatever the cause, directly it is seen that the vessel is going to fall off on the same tack again after coming to, lose no time; haul the fore sheet, and jib sheet too, if necessary, up to windward, slack off the main sheet, and, if the vessel has stern way, bring the helm amidships. Directly she has fallen six or seven points off the wind, ease over the head sheets and trim them to leeward; and as she gathers headway haul in the main sheet, and sail the vessel a good full and try again. At the next attempt, as the helm is put down, ease up the jib sheet smartly and haul in the main sheet, but let the fore sheet lie till the vessel falls off on the desired tack.

GYBING OR WEARING.—To gybe or wear is to keep the vessel off the wind by bringing the helm to windward until the wind comes astern and then on the opposite side to which it has been blowing. This manoeuvre has sometimes to be resorted to when a vessel miss-stays. Set taut the weather-topping lift. Ease off the main sheet until the boom is well off the lee quarter, and if there be much wind or sea, trice up the main tack and lower the peak; if a topsail is set it should be clewed up. Have as many hands as can be spared at the main sheet. Put the helm up. As the vessel's head goes off and brings the wind nearly astern, rally in the main sheet, and be careful that there is a smart hand stationed to take a turn with it. As the vessel comes nearly stern on to the wind, overhaul what has been the weather runner; catch a turn with the main sheet; and, as the

boom goes over, meet her with the helm, so that she does not fly to, head to wind. Ease up the topping lift, and trim tacks and sheets.

If the vessel be already before the wind with the main boom square off, when it is necessary to gybe her, take the same precautions, if there be much wind, by tricing up the main tack, lowering peak, and clewing up topsail, not forgetting to set the weather topping lift well taut, if it is not already taut, as it certainly should be. Luff a little, and get in some of the main sheet; when the boom is on the quarter (at about an angle of 45° with the keel), steady the helm and put up gradually, still getting in the main sheet. Hook on what has been the lee runner and set taut. Then, as the wind is brought astern, overhaul the weather runner, belay the main sheet, let the boom go over, and meet the vessel with the helm. Overhaul the lee-topping lift, and trim tacks and sheets.

These are the ordinary precautions taken in gybing whilst cruising; but in match sailing, unless something like a gale of wind be blowing, the main tack is not triced up, nor is the peak lowered. There will, however, be the topmast preventer backstay to attend to. Station one man at the weather preventer to overhaul and unhook the tackle as the boom comes amidships. One hand to the fall of the whip of the lee preventer, who must haul the backstay aft as fast as the main boom is brought aboard; he must get the whip as taut as he can, and belay before the boom is gybed. The tackle must be then hooked on the preventer to set it up. In large vessels two hands should be told off to the lee preventer.

In a schooner similar precautions will be taken, and there will be the foretopmast preventer backstays to attend to, and the fore-topsail should be clewed up. The fore sheet can be left until after the main boom is over.

CLUB HAULING.—Club hauling may have to be resorted to in a narrow channel sometimes when there is neither room to stay nor wear. Get an anchor on the lee bow with a warp bent to it; lead the latter to the lee quarter. Have the cable ranged on deck unshackled; put the helm down, and keep shooting with the sails shivering. When way is stopped, let go the anchor; as she is brought head to wind let all the cable run out through the hawse pipe, and haul in on the spring. The anchor, of course, will be got in over the stern.

Another better plan for a small vessel is to bend a warp to the kedge, and as the helm is put down drop the kedge over the stern, then hold on and haul in on the warp.

To **HEAVE TO.**—Haul the fore sheet up to windward, and the jib sheet until the clew just clears the forestay; ease the main sheet until the vessel lies quiet with her helm amidships, or a little to leeward. A vessel will lie like this very quiet, just forging ahead perhaps a knot an hour or

so, and occasionally falling off, when she will take a great list as the wind comes abeam; directly, however, the after canvas is well filled she will spring to again, and if she is coming up with too much way on, so as to be likely to get head to wind, she must be checked by weather helm. To lie-to very dead so as to pick up a boat or speak another vessel, &c., it will be well to let the jib sheet fly.

In heaving to in heavy weather the mainsail is stowed and boom lashed, in the crutch, to each quarter. Instead of the mainsail a reefed trysail is set, or storm trysail, which is either jib-headed or has a very short gaff, and is hauled up close to the hounds in order that it should not get becalmed when the yacht is in the hollow of the sea. Bowsprit is run in until the outer end is within a few feet of the gammon iron, and storm jib set on it, with both sheets fast, and clew hauled up to windward of the forestay. Foresail stowed. Trysail sheet (a luff tackle) hauled aft. In the case of a schooner the storm jib can be tacked inside the forestay to the bits, with clew just to windward of the foremast; main trysail close reefed, or storm trysail, as the weather requires.

A yawl would be hove to just the same as a cutter, but if she were riding to a floating anchor a storm mizen might be set, but no other sail. As a rule the more sail a vessel will bear when she is hove to in bad weather the better, as the sail will tend to check the weather rolling; for this reason ships usually heave to under topsails, as the lower sail might be becalmed in the trough of the sea; for the same reason the trysail is cut narrow and high, and the same amount of canvas nearer the deck would not be nearly so effective. Sail at the extreme ends of a vessel is never required, and a yawl hove to under storm jib and mizen would not lie nearly so quiet as she would if hove to under storm trysail and storm jib inside the forestay, as every time the headsail was becalmed she would be fetched to against the sea very hard by the mizen, or as the mizen was becalmed as she scended, she would fall off to a troublesome extent.

The helm can be left to take care of itself, or the tiller lines will be belayed on each side, slack, so as to allow a great deal of freedom for falling off with the sea. The general practice, however, is to have a hand to attend to the helm to humour the vessel as she falls off and bring her to again quietly up to the sea. A vessel will generally fall off as the crest of a wave comes in on the weather bow, and come to as the bow is in the hollow of a wave, or as the crest of a wave lifts the stern. Shallow vessels fall off much more freely than deep vessels, and come to with much more way on. The principal danger is that, if much way be gathered in coming to, a vessel should also meet with a big comber on the weather

bow; to avoid this danger the man at the helm should meet the vessel as she runs off, and bring her to with the helm so that she fairly bows the sea, always being careful not to get her head to wind. At the same time, as before said, a vessel must be allowed to fall off freely with the sea, to the extent perhaps of three or four points, or until the wind was nearly abeam; but in bringing her to, her head should never be allowed to come within a couple of points of the wind.

TO HEAVE TO AFTER RUNNING BEFORE A HEAVY SEA.—Give warning below that the vessel is about to be brought by the wind, and see that everything is well secured about the deck. Watch for a "smooth" (which is brought about by several large waves meeting, and being broken up and dispersed into several small ones). Put the helm down, rally in the mainsheet smartly; meet the vessel with the weather helm before she gets head to wind. Trim the head sheets as necessary. If the vessel has been running with a great deal of canvas set, it must be reduced as the vessel is brought to the wind; and the throat of the mainsail should be lowered half down, and the tack triced up as the vessel comes to.

TO HEAVE TO TO PICK UP A BOAT.—It will be supposed that the wind is blowing off shore, and that the yacht is in the offing waiting for the boat. As the boat gets off into deep water, where the yacht will reach in past to leeward of her from fifty to one hundred yards clear; then put the helm down, and shoot up towards her, keeping the jib sheet and fore sheet fast so as to lie a-weather as she fills on the other tack; or the jib sheets can be slackened well up so that the jib can blow about. If well judged the boat will now be close under the lee side of the yacht, and a hand will be ready to throw a line into her as she comes alongside. If the wind is blowing on the shore similar tactics will be observed, but a greater sweep must be taken in coming to, and the main sheet must be well rounded in as the helm is eased down. Sometimes under such conditions the yacht will run in to windward of the boat and wear round, but generally it is safer to keep to leeward and bring the yacht to.

SQUALLS.—If a squall is long foreseen, the sailing master will of course have snugged down and got his vessel so as to meet it end on if possible; but if caught unawares lose no time in letting jib sheets fly, and haul down the foresail. Set the topping-lifts taut; let the throat run half down the mast, and trice up the main tack. Or let the peak drop down between the topping-lifts until the gaff is about square to or at right angles to the mast. Then haul up the main tack and the mainsail will be scandalised. If the sail be a laced one the throat must be let down instead of the peak, keeping the peak downhaul fast to the centre of the boom to leeward to prevent the sail blowing out. In short handed vessels the throat is

generally let down in preference to the peak, as the sail is the more easily managed, and the throat can be got up again if necessary more easily than the peak could.

If the vessel has the wind abaft the beam when she is actually struck, put the helm up a little to keep her before the squall. If the squall strikes her before the beam, put the helm down. If the vessel gets struck or knocked down on her side before the sails can be lowered, and will not come to, cast off the jib sheets, pull the foresail down by the downhaul. Haul the main boom well aboard, cast off the throat halyards and the throat will fly down, then cast off the peak halyards and haul in on the peak downhaul. If the vessel does not right get the kedje up if a bottom can be reached, bend the hawser to it and let go over the stern; then the vessel may wear round so that the wind will take her on the other side. If the ballast or anything else shifts to leeward, trim it back to windward. Close up the companion hatchways and skylights to keep the water out.

TO SCANDALISE A MAINSAIL.—Set taut the topping lifts. Trice up the tack as high as possible, and lower down the peak between the lifts.

SAILING BY THE WIND.—Sailing a vessel successfully on a wind is quite an art, and no amount of tuition will make a man a good helmsman if he be not "to the manner born." However, there is scarcely a yacht sailor who does not think he can steer a boat on a wind better than any other man. Still the fact remains, that some men cannot sail a vessel on a wind, and no amount of instruction will teach them to know for themselves when a vessel's sails are full or when they are "near." Some vessels are so beautifully balanced—that is, their centre of effort and centre of lateral resistance are nearly in the same vertical—that in moderate breezes they will "sail themselves" on a wind and only require a little weather helm now and again as the wind heads them. Yet a bad helmsman will find more difficulty or do worse in steering one of these vessels than he would in steering a very hard-mouthed vessel—one that carries a lot of weather helm, for we never suppose that a vessel carries lee helm. The well-balanced vessel is what may be called sensitive to her helm, or "tender mouthed," and the least touch of her helm will bring her to, and the gentlest pull on the weather tiller lines will take her off; such a vessel steered by a man with a "coarse hand" will be always "off" or "near," and never really "full and bye;" one minute he will slam the helm down to bring her to the wind, and the next haul it savagely to windward to keep her off the wind; whereas, if the vessel had been left alone with a free tiller, or with only the very slightest strain on the weather tiller lines, she would keep herself full

and at the same time eat to windward as she luffed to every free puff. A vessel that carries a lot of weather helm does not require such delicate handling, and a man may tear away at the weather tiller lines until he is black in the face and he cannot do much harm; he will be delighted to find he has got hold of something to "hold on by," and all the strength in his arms will no more than keep the vessel out of the wind. But, although a good helmsman cannot be made out of a naturally bad one, it does not follow that a few hints would not be of service to the inexperienced who may have the light hand, quick eye, and sensitive skin of a perfect timoneer.

In the first place the sails should be as nicely balanced as possible, so that in a topsail breeze, when the channels are barely awash, the weather tiller lines only require to be kept just taut, with the rudder turned no more than six or seven degrees off the keel line. We are, of course, assuming that the sail plan has been so judiciously arranged that the effort of the sails when effectively trimmed, will be balanced by the lateral pressure on the hull. If the sails are so well balanced then the weather helm will about equal five or six degrees in a moderate breeze, and it should not much exceed this nor be much less; if it is much in excess the vessel will be what is called ardent, and her constant effort to fly to will necessitate the helm being kept "right across her keel," which will very much interfere with her speed. On the other hand, if much less than six degrees of weather helm is carried in such a breeze the vessel will be what is called "slack," and will require constant doses of lee helm, and the result will be that the vessel will crab to leeward, and in tacking will be so slow in coming to that she will probably lose all her way before she gets head to wind, and then will require helping round by the foresail.

If the vessel in a nice breeze does not seem to gripe as she ought—that is, does not make much effort to fly to, and so cause a good strain on the weather tiller lines to keep her off the wind—first see what the effect of drawing in the main sheet a trifle will do; if this only improves matters a trifle, and the boat seems dead in the water or does not pass through it with any life, go forward or to leeward, under the foot of the mainsail near the mast, and have a look at the jib sheets and foresheet. See that the jib sheets are not pinned in, and that they are rove through the right holes. If the first jib be set and the sheets rove through the second jib-holes, the foot will be in a curve and the sail more or less in a bag; the effect will be to drag the vessel's head off the wind, and not assist in driving her ahead an inch. If the sheets be rightly rove, but hauled in too flat, the foot of the jib will be straight enough, and the sail generally be flat enough; but the effect will be that the sail, being trimmed too

flat, will, as in the other case, press the vessel's head off the wind, and be of little service towards driving her ahead. It requires some experience of jibs and the way of trimming their sheets to know when they are trimmed so as to be most effective, and it would be difficult to frame advice on the point; but the leech should be straight, the foot gently curved or "flowing" with the sheet, and the luff should not lift—*i. e.*, shake. If the luff lifts it will be a sign, as a rule, that the sail is not sheeted flat enough. On the other hand, the clew should be well off the lee rail, and the sheet and the foot should make a gentle flowing curve from bowsprit end to sheet hole; if the sheet and the foot, when the sails are full, make a "straight line," it will be a pretty sure sign that the sheet is too flat. It is a good plan to have the jib sheets marked at the sheet holes by a piece of yarn, for sailing by the wind. But of course it must always be remembered that a jib must be sheeted to suit the strength of the wind.

If the vessel carries an excessive amount of weather helm, more than previous experience of her sailing would lead one to expect, and does not pass through the water freely, it may be relieved by easing off the mainsheet a trifle, and flattening-in the jib sheets, but the mainsheet must not be so much eased as to cause the sail to lift, nor must the jib sheet be flattened-in so as to make the jib simply a pressing sail. In vessels that are broad across the deck at the bow the jib sheets can be much better trimmed, as there is less chance of getting the sheets too flat; hence, as a rule, second jibs are always made to stand better than first jibs, as they do not go out so far on the bowsprit, and the angle made by the sheet is therefore coarser. [In very narrow vessels outriggers are frequently used to lead the sheets through and get more spread.]

It can be supposed that the sails are all nicely trimmed, doing their work properly, and that the vessel carries just the right amount of weather helm, and will fly to directly the weather tiller lines are released. Under these conditions the tiller is handed over to the young helmsman, and we will first say a few words as to the position he should take. As a rule, the steersman stands near to or sits on the weather rail, and this is undoubtedly the best position; he can then look into the jib and foresail, see when they are inclined to lift, and at the same time watch the luff of the mainsail and the vane or flag, which, if there be a topsail set, should flicker just on the weather side of the yard. But sometimes in light winds a man may sit on the lee rail and watch the head sails from under the lee of the mainsail, and this will be occasionally a capital position if a jib topsail be set. The weather tiller-line must, of course, be rove through the sheave in the weather rail, then, with the fall in his

hand to leeward, the helmsman can keep his vessel off or bring her to at will. Of course, we do not mean that a man might always equally well sit down to leeward and steer, but there is no better place for seeing the sit of the sails, and an occasional visit to leeward will often prevent the necessity for shouting out "How are our head sheets?" which invariably produces a general scramble of the crew to the lee bow, and a meaningless chorus "All right, sir!" Some men we have seen get a deck cushion and sit down by the side of the tiller and hug it as if they had got hold of the neck of a favourite donkey. They may be very good helmsmen, but their hunched-up appearance, as they squat on their haunches cuddling the tiller, necessarily makes one form a very poor opinion, at least, of their "style," and frequently the man can be put down as more or less of a sloven.

It can be concluded that the best position for the helmsman when sailing on a wind is as near the weather rail as possible; he can then really see for himself what the head sails are doing, and the admonition "She's near for'ard" need never be heard.

The jib is perhaps the best guide for the young helmsman, and if he steers by that alone, he ought always to be able to keep his vessel full and yet not allow her to get off the wind. With a nice topsail breeze—not strong enough to lay the vessel in to the deck—the luff of the jib will be just rippled, or the canvas into which the luff rope is stitched will more or less "bag," and will be in a constant state of quivering (see p. 26); but the luff of the sail must not be allowed to lift, *i.e.*, to go into large folds, as, if it does, it will be a sign that the vessel is too near. If you are keeping the vessel a good full there will be no ripples or wrinkles in the luff of the jib—unless the jib be a very old and badly-stretched one—and all the sails will be quiet.

In sailing by the luff of the mainsail, as some men do who cuddle the tiller, the young helmsman may be apt to get his vessel off the wind, as he will be constantly thinking she is "near," through the eddy wind out of the foresail making the luff of the mainsail shake. The luff of the mainsail is thus a not very trustworthy guide for the inexperienced helmsman; still, as a rule, when the luff of the mainsail lifts and the disturbance begins to travel aft across the belly of the sail in waves, it will be a pretty sure sign that the vessel is "starved of wind," and a little weather helm should be given her.

Sailing by the vane, whip, burgee, or racing flag, is sometimes said to be the easiest and at the same time the most trustworthy guide for close-hauled sailing; but a very little experience will soon prove the fallacy of this. If the vessel is moving along at a good pace, say five or six knots an

hour, the flag will blow aft nearly in a line with the keel (see page 23), and if there be a square-headed topsail set, the flag will flicker on the weather side of the yard. But in such light winds as we are now assuming to blow, there may be quite a different current of wind aloft. Thus we frequently hear the remark "She's near for'ard" responded to by the helmsman, "She's all full aloft—look at the flag,"—and probably the flag will be right across the vessel. Or the flag may blow out to windward of the topsail yard, or droop and cause the helmsman to think that he has got his vessel head to wind, and he will of course haul the tiller to windward. This, perhaps, will cause a shout of "Bring her to!" or "Let her luff, she's all off the wind," and an appeal to the vane or racing flag will only show what a misleading guide it is. In fact, trying to sail the vessel by a vane, or by the luff of a topsail, will be certain to cause "remarks" to be made forward, and as these remarks have always an irritating effect on the steersman, he had better sail on a wind by the head sails than by the flag, especially so as he will thereby be able to keep the lower sails doing their work, and it is the lower sails which must be mostly depended upon for getting through the water.

An old hand will sit down by the tiller and, perhaps, close his eyes, and still fairly sail a vessel on a wind, as long practice will tell him how she heads by the feeling of the wind on his face. He will not deign to look at jib, mainsail, or flag, but will give the vessel lee or weather helm just as he feels the wind on his face comes freer or shorter. This really is a very good guide, and the steersman when he gets thoroughly acquainted with the sailing of a vessel on a wind will find a "chill" on his face a very trustworthy hint as to the doing of a paltry, shy, or baffling wind.

In sailing on a wind, keep an eye on the head sails, after sail, upper sail, and vane, and the other eye to windward, for nine times out of ten the direction of an impending puff can be seen as it travels towards the weather bow of the vessel, rippling the water in its course. If the dark ripples are seen coming broad on the bow, you will know that it will be a good luffing puff, and as it takes hold of the vessel, ease the weather tiller lines, and let her luff to it freely, but do not allow the jib to lift; then, if the puff is a mere "chill," out of a passing cloud, perhaps, and leaves the wind as before, do not wait till the puff has passed over before the helm is hauled a-weather again, or the vessel will be left nearly head to wind, and this would be a very lubberly proceeding; therefore, before the "free puff" has blown itself out, haul up the helm and get the vessel full and bye again.

If you see that the puff is a strong one, of the nature of a squall, do not get nervous and luff before it strikes the vessel, unless of course it is considered prudent to shoot up head to wind to meet it. If you begin luffing and lifting the sails before the squall strikes you will deaden the way of the vessel, and then the squall will have much greater effect in heeling the vessel, and will perhaps take the topmast away—as a very frequent cause of topmasts being broken is by being caught in a puff when the vessel has no way, or but little way on.

But puffs as frequently come ahead as broad on the bow, and the head puffs are the more difficult to deal with. Keep a good look-out for these “nose-enders,” and if lucky enough to see one before it reaches the jib, keep the vessel off a little, and, if possible, prevent the sails lifting at all. These puffs will be most frequently met with when sailing along under high land or under trees; one minute a puff will come broad on the bow or on the beam and lay the vessel in to the skylights, and the next one will come right ahead and bring her upright as a monolith; and what with luffing to one puff and keeping away for another, the helmsman will have his vigilance very highly tested. He, of course, will not be able to keep the sails from lifting at all, as the puffs are more or less revolving, and Palinurus himself could not successfully dodge them; still, with care, a vessel should never be allowed to get head to wind so as to want backing off by hauling the foresheet to windward and easing off the mainboom—this would not be seamanlike, and would betoken great inattention.

In luffing to free puffs, or in keeping away for foul ones, do not “slam” the helm about; that is, do not shove it down as if you were trying to avoid striking something, or haul it up as if you were bearing away round a mark. In most cases easing the tiller lines will enable the vessel to luff all that is necessary, and when free puffs are about a very light hand should be kept on the tiller lines, and the vessel will dance herself to windward and eat out on the weather of one whose tiller has been held in an iron grip during all the puffs. Get all the luffing possible out of a vessel, and never miss the smallest chance of a gripe to windward, even to a quarter of a point of the compass; but do not put the helm down so coarsely that there is a danger of bringing the vessel nearly head to wind; if this is done the helm will have to be put hard up to get her off the wind again, and nothing so interferes with good performance on a wind as too much ruddering. A good helmsman must have a light hand and unceasing vigilance, as “weatherly qualities” are in no small manner dependent on the way a vessel is steered. Therefore it cannot be too frequently repeated that

the faintest semblance of a luffing puff must never be disregarded, and the vessel must at the same time be humoured so tenderly to it, that no one shall see what the helmsman is about unless by watching his movements very closely. On the other hand, in using weather helm in keeping off to avoid a foul puff, it will not do to be too slow with the helm, or the vessel will be stopped, and without way on, it will be some trouble to get her full and going again. Therefore always put the helm up as promptly as possible, but do not haul it savagely on to the weather rail as if you were going to sail "large" for the rest of the day. If a puff is not seen coming broad on to the bow look out for one coming ahead, and directly the jib shows the slightest sign of lifting, drag steadily on the weather tiller lines; if the puff is a very bad one, the helm must be smartly hauled aweather, but as a rule the foul puffs will not vary in direction more than a couple of points from the direction of the true wind, and they must be accorded with by as delicate a use of the helm as for "luffing puffs."

Thus the secret of close-hauled sailing consists in such a constant watching of the wind and such a use of the helm to meet its variations, that the vessel is always "full and bye," and never "near" and never "off" the wind. When a man can so sail a vessel, he will be a perfect helmsman, and will make her eat to windward as fast as the very best professional skipper could.

Speaking of professional skippers reminds us that many of these have a funny habit of "sawing" the helm backwards and forwards; that is, they haul on the weather tiller lines and then ease them without apparent motive, generally accompanying the performance with a corresponding see-sawing motion of the body, by first resting on one foot and then on the other. Probably this peculiar habit was acquired on board fishing vessels in the winter, when the men might find sawing the helm and working their bodies about promote warmth. It certainly is no assistance to a vessel, and is very "bad form."

Sailing a vessel in a strong wind, say with the scuppers full of water, will not be quite such a delicate operation; still, the wind will vary a great deal, and the very most must be made of the free puffs, and the effect of foul ones reduced as much as possible. The vessel will of course carry a great deal more weather helm, and when the sails are nicely trimmed the jib will be found the most reliable sail to steer by, as the luff of the mainsail will lift a great deal from the mere effect of the wind out of the foresail. Look out for the very hard puffs, and do not allow the vessel to needlessly bury herself; on the other hand, do not get frightened at a little water on deck, and throw

the vessel in the wind. Sail her along heartily, even to the rail under, but never forget to ease the tiller lines for the smallest freeing of the wind; and for the very heavy puffs do not luff before they strike, but luff into them as they strike; the vessel will then not be knocked down so badly, and will walk off with increased speed by the aid of the puff.

It must not be supposed that it is a good thing for a vessel to be sailed with her rail under and the water nearly up to her skylights; but in sailing on a wind she should not be luffed up for the mere sake of getting her out of such a condition if it is only a passing puff that has laid her in; luffing, as a rule, in close-hauled sailing, is to take advantage of free puffs; but occasionally when the puff is very strong, and neither free nor foul, advantage may be taken of its strength to do a little luffing, and at the same time clear the lee deck of water; in such luffing the chief care of the helmsman will be not to get the vessel so near the wind as to much stop her way or risk getting in irons.

Frequently in match sailing a vessel is found to be heading for her mark, and the hope of the helmsman will very properly be that she will fetch without making a tack; but he must not get anxious about it, and hug the wind; if he does the vessel's way will be deadened, she will make an unusual amount of leeway, and it will be a hundred to one against her fetching. He must sail her along boldly, not courting another tack, but exercising all his care in keeping her an exact full, and she will probably fetch; never mind if her head now and again falls to leeward of the mark, it will probably come to windward of it again; but on no account get nervous and try to *steer* for the mark. If such an attempt is made, the mark will not be fetched, and the attempt will be quite contrary to the principle of the art of close-hauled sailing, which art cannot be regulated by steering for fixed marks. There is an old saying that "keep a vessel full and she will eat herself to windward, but by trying to sail her in the wind's eye she will crab to leeward." Occasionally a little "niggling," as it is called, may be indulged in if the mark is very near; but even then the vessel must not be sailed so fine as to cause the head sails to actually lift; and when within fifty yards or so of the mark she should be ramped along a good full and shot up to windward of the mark with good way on, as if she be gilled up to the mark with little way on, and got met at the last moment by an unfriendly puff, a collision with the mark would be almost a matter of certainty. This, although a most humiliating spectacle, very often happens, as skippers will do almost anything to save a tack; but it is only the smartest of them that can

judge when a tack can be profitably saved and when not. (See "Over-reaching.")

SAILING A VESSEL ON A WIND IN A HEAVY SEA.—It will require some nerve to sail a vessel successfully on a wind in a heavy sea. Often a haunting fear that the bowsprit will be carried away, or the deck swept by a green sea, makes a man have the vessel's sails constantly lifting; the result is that she tumbles about in the sea like a log, sags to leeward, and gets the character of being a bad sea boat. Do not fear the breaking of a bowsprit or a green sea on deck; be not unmindful of either, but above all things keep the vessel ramping full; this is the secret of success in sailing on a wind in a sea. Of course it is assumed that the vessel is properly canvassed: if she has two reefs down in the mainsail, that the foresail is single reefed, third jib set, bowsprit reefed, topmast housed, and everything securely lashed on deck. The vessel should be canvassed so that in the true strength of the wind the covering board would be well out of the water—a fourth of the height of freeboard. In a sea it will not do to sail a vessel rail under, as a weight of water on deck and the fact of the vessel being over on her side will greatly interfere with her good performance; therefore a vessel should be canvassed so that her rail will not go under, and in the squalls she must be eased judiciously with the helm, always remembering that although occasional easing may be prudent the chief aim must be to keep her full. The main boom should be eased off a couple of feet or so farther than it is in smooth water, and the weather topping lift should always carry the weight of the boom. The head sheets should also be eased, but not so much as to cause the jib to lift badly, as the jib will be wanted to keep the vessel out of the wind.

As a rule the vessel will be found to pitch pretty regularly, and one sea being very much like another, the vessel will be sailed through all, hard and a good full. Do not let her sails shake, as her way will be stopped; she will then pound the sea and jump two or three times into the same hole. Those on board will say "what a horrid bad sea boat she is, that she pitched two or three times to the once of any other vessel, and always had her deck full of water." But keep a wary look-out for the big seas. One will be seen rolling in on the weather bow, gradually gaining in height, and perhaps rising, pinnacle like, just at the point where the vessel will meet it. This is the wave to be ready to meet; it will rise higher and higher as it gets towards you, and will either curl over and break up by its own exhaustion, or from the fact of its meeting the vessel, and there will be in either case a ton or two of water on deck. Just before the big wave reaches the vessel there will be an

unusual hollow or deep trough, and into this she will and must go; before she can recover herself the big wave will roll over and fairly swallow her up; then there will be a smooth; a number of small waves will be formed; the vessel will give one or two deep dives—the result of her bow being thrown up by the big wave—and then be steadied for a minute or so in the smooth.

When a big sea like this is seen on the weather bow, the vessel's helm should be eased down a little just before the sea reaches her, so that she may take it more fairly stem on; but in luffing into the wave do it in good time, and directly she is fairly into it put up the helm again, and fill her sails before she has time to get head to wind. The object in easing the vessel is of course to ease the shock both by deadening her way and by presenting the stem to the sea instead of the bluff of the bow; therefore directly the sea and the vessel have met, the effect is over, and the vessel must be filled instantly; that is, she must be put off the wind again to a good full and bye.

The most tiresome of all seas to sail a vessel in are those which are met with on a weather-going tide in more or less shallow water, such as on the Brambles, at the mouth of Southampton Water, or on the Bar at the entrance to the Mersey, or at the Nore. Here the sea is furrow-like; that is, the troughs are long and deep, and the crest of the waves are a succession of sharp ridges instead of the long-backed waves met with in deep water. So long as a vessel keeps time with these waves, that is, so long as she only pitches once into each hollow, there will be a regular succession of pitching and scending; but if, through the wind heading her, or through careless steering, her way becomes deadened, and she pitches twice into the same hollow, or if she does so through meeting a trough of unusual length, there will be trouble on deck in the way of water, as the vessel will meet the wave crest just as she takes her second dive instead of when she scends from her first. There will be two or three very quick dives after this, and the helmsman must keep the vessel full; not shake her up because she is taking these unpleasant plunges, but keep her full in order to keep her going through the sea, and to get her into the regular fall and rise of the waves again, or, as the sailors say, make her toe and heel to the same tune.

It can be supposed that the vessel is sailing in a pretty regular sea, and that she rises, and at the same time cleaves through a wave as at A (Fig. 44). Whilst she is going up through the wave, or scending, she will show a tendency to come up to the wind, as her stern will be so little pressed by the water that it will go off to leeward. She will stop

in suspense for a moment and then pass rapidly through the wave, and the next moment will be in the position B (Fig. 45), when her bow, being unsupported, it will fly off the wind. This latter tendency must be guarded against, as in another moment the vessel will be in the position C (Fig. 46),

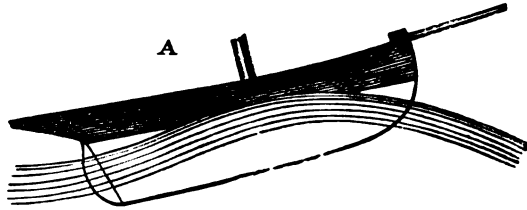


FIG. 44.

with water well nigh up to the bowsprit bitts. She will rise streaming with water at *d*, and take the position A again, and so on *ad nauseam*. Very frequently a vessel will shoot so far through a wave when in the position A, that she even gets farther through it than shown by B; this is what a vessel does that is sailed fast through a sea with a lot of canvas and

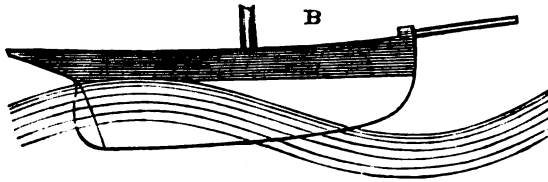


FIG. 45.

with a tremendous momentum, due to the speed and weight of the vessel and her manner of ballasting. Often three bigger waves than usual will come one after the other and then there will be a smooth but frequently the three are thought to follow, when in reality the

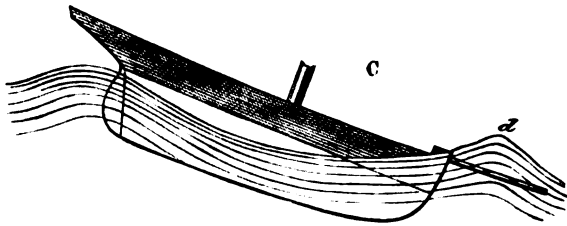


FIG. 46.

vessel is only plunging from the effects of the motion imparted to her by one big wave. At any rate when the vessel gets into the position B, she should be put as fairly into the sea ahead of her as possible. If there is no big sea ahead she will fall harmlessly enough into the trough and will hardly require easing.

In sailing a vessel hard through a sea like this, the motion will necessarily be unpleasant, as, instead of rising leisurely as it were to the waves, and pitching gently, the vessel will more or less of her own momentum throw herself ahead; this will not only make the motion quick and unpleasant, but will put a great strain on the gear, but as it is more a question of getting through the sea than riding over it with comfort and with safety to the gear, the last words on this subject will be, keep a firm hold of the weather tiller lines.

SAILING OFF THE WIND.—Sailing off the wind means that the vessel is more away from the wind than the close-hauled point, and applies up to the time when the wind blows four points abaft the beam, when the wind would be quarterly. In sailing with the wind abeam, the head sheets must not be eased up too much, but a good strain must be kept on them, as the vessel is almost certain to gripe a great deal, and to show a tendency to fly to; of course, if the head sheets are eased up so that the sails are always lifting, this tendency will be much more urgent.

Neither must the mainsheet be eased off too far; if it is, the weather cloths of the sail will "lift" and go into folds. If the fore part of the sail does so lift, the mainsheet must be drawn in a little until the sail has the full weight of the wind and falls "asleep." Frequently the luff of the sail may be quiet enough, but the topsail may lift, and that will be a sign that the mainboom wants hauling aboard a little, so as to get the peak more inboard, and thus make the topsail stand better. But the mainsail must not be pinned for the mere object of making the topsail stand; if the luff of the latter be to windward of the topmast, the cause of its lifting may be the eddy wind round the topmast.

With the wind abeam the vessel will be laying her course, and the helmsman will have to steer by compass or by keeping some object straight on for the bowsprit end. Every tendency the vessel shows to fly up in the wind must be promptly met by the helm; do not hold the helm as if the object was to keep it rigidly in one position, nor wait until the vessel's head has ranged up two or three points. Watch the compass card or the object you are steering for, and directly the vessel brings her head to windward give her a little weather helm and keep her straight if you can. If she shows a tendency to fall off, meet her promptly with a little lee helm, and always remember that the object is to make her keep a straight course, and to prevent her yawing either on or off the wind. It will not be a question of keeping the sails full and no more than full, but that of making the vessel go straight as an arrow for her object, always recollecting that if she yaws about that of itself will stop her way, and there will be also the retarding action of the rudder to bring her back on

her course; therefore using a little helm promptly will prevent yawing, and the checking of the vessel's way from this cause will be reduced to a minimum.

But a vessel may gripe through the wind shifting more aft, or she may show a tendency to run off through the wind coming more ahead, therefore the vane must be watched, and the blowing of the wind on the face should also be regarded. In match sailing especially, slight alterations in the wind should be observed, and we have frequently seen the mainsheet laid along the weather side of the deck in the hands of the crew, who slackened off or drew in the boom to suit every slight alteration in the wind. Of course this would only be done in very light winds, but all cases and alterations in the wind that make a palpable difference on the amount of weather helm carried, should be promptly provided for by trimming the sheets.

With a beam wind if there is much strength in it—so strong that a topsail lays her in to the deck edge—the vessel in the puffs will now and again shove her rail under, but she should never be permanently sailed with more than two or three planks of the deck awash. Sail should be shortened without hesitation if the reach is a long one, and if the wind seems bent on a good steady blow. But if it is a mere puff, or if the reach be a short one of a half mile or so, the vessel must be eased to get the water off deck, and ramped along again in the lulls. Some judgment must be exercised in so easing a vessel, as if her sails are made to lift very much her way will be stopped; on the other hand, if she has to sail with her lee deck full of water up to the rail, that will stop her way, and so the aim must be to stop her speed as little as possible from either cause, and as before said, if the reach be long and the wind a lasting one shorten sail.

SAILING OFF THE WIND IN A HEAVY SEA.—In sailing along the wind in a sea—it would not be attempted if the sea were very heavy—the helmsman will find some difficulty in keeping his vessel from griping-to or running off, as the sea will carry her about a great deal. He should be well prepared to give her lee helm promptly if she shows a sign of running-off, and should either keep the lee tiller line in his hand, or the tiller itself, or should have someone to leeward of the tiller, the latter if the vessel be a big one, say of 70-tons, or upwards. If the vessel gripes-to, she must be given weather helm; but checking the tendency to “run off her helm” will require the most care, and lee helm should be given a vessel directly her head begins to fall off when sailing along the wind. With a heavy beam sea a sensation will be experienced of slipping down the side of the waves as the seas pass under her; but the great danger will be from a beam sea breaking aboard, and, as before said, if the sea is very heavy, she should be either put head to it or before it.

TO RUN BEFORE THE WIND IN A HEAVY SEA.—Have the boom topped up, so that the boom end will clear the combers if possible during the lee roll. Bend the boom-guy by making fast with a clove-hitch the thimble end to the boom, about two-thirds of the length of the boom from the mast. Take the guy forward, pass the bight round a cleat or snatch block, and bring the end back, and reeve through the thimble, and belay. Sometimes the guy is simply taken forward and belayed, or set up by a tackle.

If the sea is very heavy the mainsail should be stowed and trysail set. The squaresail, reefed, should be always set under such circumstances, but it is best to have the trysail as well, because if an accident happened to the squaresail, the vessel can be brought to wind and hove to under the trysail. The trysail should be sheeted pretty flat, as the sail will then tend to check the weather rolling and inclination to fall off. The foresail would be lowered, but a small jib should be always kept set.

Another reason for preferring a trysail to a close-reefed mainsail is that the head of the sail would be higher, and would keep the wind whilst in the trough of the sea, whereas a close-reefed mainsail might be becalmed. For the same reason, to avoid being becalmed, a reefed square sail should always be hauled close up to the hounds.

In running before a wind and sea great care must be taken that the vessel does not get by the lee; that is, that she does not run off so much as to bring the wind on the other quarter and gybe. The lazy guy would most likely prevent the boom coming over; if it did not look out, and keep clear of the main sheet if you are near the counter; and lie down on deck, as, if the boom is brought up suddenly by the runner, it may break and sweep the deck.

Supposing the vessel gybes without any other accident, "meet" her promptly with the helm, and do not let her fly to; then prepare to gybe the vessel back again if necessary; get in some of the main sheet; drop the throat or peak down; put the helm up and gybe her handsomely.

If when running under squaresail the vessel broaches to, that is, flies up into the wind and gets aback, brace the squaresail sharp up, and haul the weather jib sheet taut; keep the helm hard up until the vessel is before the wind again. If the vessel flies-to quite head to wind, the squaresail must be stowed and the foresail set, if necessary, to back her head off.

It is generally supposed that a large quantity of sail must be carried when running before a heavy sea, in order to keep ahead of the waves; or, in other words, to avoid being pooped. This is not exactly the case, as the speed of large waves is much too great for any vessel to run away from them; thus an Atlantic wave 200ft. in length (such as would be

met with in a brisk gale) travels at the rate of twenty miles an hour, and no vessel could run at that speed. The height of such a wave might be about 35ft., but probably would be not more than 15ft. and the object of having much canvas set would be that a vessel might not get becalmed in the trough of the sea, and by suddenly losing her way cause an overtaking wave to be broken up; a quantity of water might then possibly fall on board. [It must always be understood that it is not the water which travels, but only the wave motion]. This would be termed "pooping," and to avoid such accidents square topsails have been much recommended for large cruising yachts, as, owing to their loftiness, they are unlikely to get becalmed in the trough of the sea. However, pooping more frequently happens from quite a different cause, in this way: as a wave advances it will sometimes grow in height and lose in length, and as a wave form cannot be sustained after a certain proportion of height to length has been reached, the crest of the wave becomes suddenly sharp and still higher, and ultimately curls over on the side it has been advancing. If this breaking up of a wave—which under such circumstances might rise to a height of 50ft.—should happen close to the stern of a vessel, she will be inevitably pooped; that is to say, some of the water will fall on board, and the crew will have to hang on for their lives.

Large deep sea waves, when they approach shallowness, alter in form and lose their speed; they become shorter and higher (deep-sea waves whose original height was 40ft. have been said to raise to 150ft. as they approach the coast), and then the crests, travelling faster than the troughs, topple over in broken masses. Hence waves in shallows or near the coast are more dangerous than deep-water waves.

CARRYING AWAY A BOWSPRIT.—Directly the bowsprit is gone, ease the main sheet and haul the fore sheet a-weather; but if the vessel has been reaching well off the wind, she must be brought to wind, and in either case hove to. If the bowsprit is carried away near the stem, in consequence of a shroud bursting, the outer end will fly aft. Lower the jib and unhook from the traveller. Put the bight of a rope under each end of the bowsprit, the end of the inner part of each rope being fast on the deck; haul on the other part, and thus roll or par-buckle (see Fig. 47) the bowsprit up the side of the vessel to the deck. Then clear the gear. The bowsprit may be got out again with sheepshanks

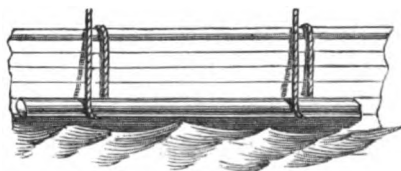


FIG. 47.

in the shrouds. If the end of the bowsprit breaks off outside the jib-tack sheave hole, let the jib sheet fly; or, better still, take the jib in alto-

gether, as most likely a change will have to be made. Get the end of the bowsprit on deck, take the gear off, and fit it to the bowsprit end again in the best manner possible.

If the topmast should not be carried away by the loss of the bowsprit, try and save it. Let go the topsail sheet and halyards, and get the topsail down. Take the jib topsail halyards or spinnaker halyards forward, and set taut as a topmast stay, to steady the topmast.

CARRYING AWAY A BOWSPRIT SHROUD.—Let the jib sheet fly. Put the helm down and bring the vessel on the other tack immediately; if there is not sea room to keep the vessel on the other tack, let the jib run in and heave to. Then repair damage.

CARRYING AWAY A BOBSTAY.—Let the jib sheet fly and heave to. If it is the fall that has broken, the bobstay will have to be fished up and a new one rove. If the shackle on the stem or the bar is broken so that it cannot be repaired, and there is no second shackle or bar on board, the vessel must be sailed without a bobstay. Reef the bowsprit in, set a small jib, and do not sheet the jib too taut. In squalls, or when falling into a wave hollow, ease the vessel with the helm. Many fishing vessels, some of 80 tons, are never fitted with bobstays; but of course they have very short bowsprits.

If there is any sea, the vessel should not be sailed without a bobstay and with no jib set, as the bowsprit would under such conditions most likely be carried away. The stay rope of the jib will support the bowsprit, but the jib sheet should be well lightened up.

CARRYING AWAY A TOPMAST.—A topmast when broken invariably falls to leeward, and it would be very difficult to give directions for clearing the wreck away. It will hang by the topsail sheet from the gaff, by the tack over the peak halyards, by the backstay over the peak halyards, and by the topsail halyards if they were belayed to windward. In clearing the wreck and unreeving, be careful not to let anything go until it has been properly secured or lashed, so as not to tumble on deck.

CARRYING AWAY A MAST.—The best thing to do, if the weather is very heavy, is to unreeve sheets, tacks, lanyards, and tackles of shrouds, and ride to the wreck, as it will make a capital floating anchor. When the weather moderates, the mast can be got alongside, the gear cleared, and the sail got on board. In a large vessel the mast will probably be too heavy to handle, and will have to be made fast astern. In a small yacht the mast may be rigged as a jury mast. Supposing the mast has been carried away five or six feet above the deck, put the heel of the mast against the stump on the aft side so that it cannot fetch away; take the lower main halyard block forward to stem head; put guys on the masthead, and lead one to each side of the yacht. Lift the masthead,

and set taut by the main halyards, and when the latter have got sufficient purchase hoist the mast to a perpendicular, steadying by the guys. When upright lash the mast to the stump, seize bights in the shrouds to shorten them, and set up by the lanyards. If the mast be worked round to the fore side of the stump, the boom gooseneck can be shipped as before. Set the mainsail reefed or double reefed as required, or set the trysail.

If the mast be carried away close to the deck, unship the stump, and step a spare spar to lash the heel of the mast to. Or the broken mast could be stepped. In this case it would be better to improvise sheers by taking a couple of spars, such as topsail yard and trysail gaff; and, after lashing their ends together, rear them over the mast hole, one leg in either scupper. A tackle should be lashed to the apex of the sheers for hoisting the mast by. Keep the sheers in their place by guys leading forward and aft.

Sheers might be used for getting the mast and boom on deck, or for rearing the mast on end at first, by rigging them aft, when the heel of the mast is to be lashed on deck.

In case of a mast being carried away close under the hounds, preparations for getting the rigging and halyards aloft again can be made by throwing a line over the masthead, and hauling a tackle to pull a man aloft by. If the masthead is carried away, the main halyard block can be lashed above the rigging round the yoke. The peak hoisted by one of the topping lifts, or by a couple of blocks of the peak halyards, one to be lashed to the masthead over the main halyard block.

When the masthead is badly sprung above the yoke, but is kept from falling by the topmast, let fly the jib sheets, heave the vessel to, and lower the mainsail as quickly as possible. Lower the topmast half-way down, and lash the heel to the mast. Unhook main and peak halyard blocks, and unreeve jib halyards. Then prepare for rehoisting mainsail as if the masthead were carried away. The topmast will keep the mast head from falling.

CARRYING AWAY THE FORE STAY.—Ease up fore and jib sheets, slack out the main sheet, and run the vessel off the wind. Put a strop round the bowsprit close to the stem, and set the runner up to it. An instance has occurred of both runners being carried away when doing duty as a forestay. An end of the cable was then hauled to the masthead by the foresail halyards, and a bight taken round the mast above the yoke. The cable was then set up through the hawse pipe.

CARRYING AWAY A RUNNER.—The greatest strain comes on the runners (by runners is meant the pendant runners and tackle), when the wind is a little abaft the beam; and if the weather one is carried away, the vessel should be instantly thrown head to wind, and put on the other tack

until the runner is repaired. The vessel should be met by the helm when head to wind, and not put on the other tack until the main sheet is hauled in. If there be not sea room to sail the vessel when on the other tack, heave to.

CARRYING AWAY A TRIATIC STAY.—If the triatic be carried away, and the mainmast does not go with it, put the helm up, slack out the main sheet, and run the vessel off the wind. Take the lee main runner forward, outside the main rigging, and set up to the fore-runner bolts. If there be a fresh breeze, stow the mainsail, and then repair the damage.

CARRYING AWAY A TOPMAST BACKSTAY.—Throw the vessel up in the wind, let fly the topsail sheet, jib topsail sheet or spinnaker sheet, and if the damage cannot be quickly made good take in the topsails.

TO ANCHOR WHEN ON A WIND WITH WEATHER-GOING TIDE.—Get the anchor ready on the bow, and some cable ranged on deck. Have the mainsail ready for lowering. When nearly abreast to leeward of the spot where the anchor is to be let go, lower the main sail and put down the helm; when head to wind bring the helm amidship, take in jib and foresail and shoot to the spot where the anchor is to be let go. Unless there is so little wind that the vessel will be wind rode when she is brought up it is important that the mainsail should be stowed before she comes to anchor; otherwise as she swung round to before the wind with the tide, the consequences might be very awkward.

TO ANCHOR WHEN ON A WIND WITH LEE-GOING TIDE.—Have the anchor and cable ready. Have jib and foresail ready for lowering. When abreast to leeward of the spot where the anchor is to be let go take in jib and foresail, put the helm down and shoot up head to wind, and when way is deadened let go the anchor and stow the mainsail; or if plenty of hands are on deck, lower the mainsail as the vessel is brought to. The vessel will of course lie head to wind and tide.

TO ANCHOR WHEN RUNNING BEFORE THE WIND, BUT AGAINST THE TIDE.—Stow the mainsail, take in the jib, put the helm down, shoot head to wind, lower the foresail, and let go the anchor.

Or stow all the sails, and do not alter helm. When the tide has brought the vessel to a standstill, let go the anchor.

TO ANCHOR WHEN RUNNING BEFORE THE WIND, AND WITH THE TIDE.—Take in jib and foresail, haul in the main sheet, put down the helm, and when head to wind keep shooting till way is stopped; let go the anchor, and stow the mainsail.

If moorings have to be picked up, the same course will be followed; but judgment must be exercised, so that when the vessel shoots up to the watch buoy her way is almost or quite stopped.

ANCHORING IN AN OPEN ROADSTEAD.—In coasting it may be frequently convenient to bring up for the night under the land, but if the weather looks at all bad seaward, the precaution should be taken to unshackle the cable and bend the watch buoy on. Then if the sea did get up in a great hurry the cable could be slipped, and recovered on another occasion.

To MOOR.—Veer out chain about double the length of cable it is intended to ride by; when the vessel has dropped astern and brought the cable taut, let go the second anchor; veer out chain, and heave in on the anchor first let go until an equal length of chain is out. If the yacht will not drive to a spot suitable for the second anchor, send out a kedge and warp in the boat; warp the yacht to the kedge, and let go the anchor. Or the second anchor and chain can be carried out in the required position in a boat. In such case, only as much chain as it is intended to ride by need be veered out to the first anchor.

The quantity of chain to ride by will greatly depend upon the nature of the bottom, the strength of the tide and wind or sea. Generally about three times the depth of water at the top of flood is sufficient for a smooth-water berth.

To UNMOOR.—Heave in on one anchor, and pay out chain on the other. Break the first anchor out of the ground, cat, and then get the other. In some cases the second anchor might be got by the boat under-running the chain.

THE MANAGEMENT OF OPEN BOATS.

Small open boats must never be regarded as if they possessed the qualities of deep and heavily ballasted yachts. They should not be sailed "gunwale under" as a small yacht is, and the puff or squall which a small yacht can be sailed through with impunity, will necessitate the open boat being thrown head to wind with head sheets eased up, or off the wind with aft sheets eased.

No system of ballasting will much increase the range of stability of a boat—(by boat is meant something of the type of the Surbiton gigs)—and it must be clearly understood that it is not the initial stability, or the stiffness of the boat at small angles of heel upon which her safety depends, but upon her range of stability, that is to say upon the amount of stability or power to recover herself she has, when heeled to very great angles when the gunwale might be pressed under water. For competitive sailing, a boat to succeed must resist being heeled at all very potently, that is, she

must have great initial stability, so as to be able to carry a large area of canvas without heeling more than to a point midway between her water-line and gunwale. This stiffness is more dependent upon breadth of beam than upon the weight of ballast carried low, and an inexperienced boat-sailer finding a boat very stiff at first might be tempted into pressing her beyond the danger point.

On the other hand, depth of hull of itself does not add to stability, but by ballasting it does, and lengthens out the range of that stability so that a boat may always have righting power at any possible angle of heel, providing she does not fill with water and sink : (see pages 8 and 42.) Thus safety does not so much depend upon the great stiffness which enables a boat to carry a large press of canvas without heeling to any considerable extent, as upon the range of her stiffness or the continuation of that stiffness, even up to the time when she might be blown over on her beam ends. Now shallow open boats have a very low range of stability, and directly their gunwales are put under, they are likely to be blown over. A high side out of water in a large way increases the range of stability, and the higher, in reason, a boat's side is out of the water the safer she will be.

Boats are most frequently capsized in disturbed water, and the cause is generally ascribed to a sudden squall, or to the fact that the boat being unduly pressed, some of her loose ballast shifted to leeward. But a boat among waves might be, and no doubt frequently is capsized without any accession of wind or movement of the ballast.

It can be supposed that a boat is sailing with a beam wind, and with a beam sea, and that her inclination, due to the pressure of wind on her sail is 15° . If she got into the position shown in Fig. 48, she would practically be inclined to 30° and she would probably upset. Assuming that the boat had no sail set, she would not get into such a position, as she would accommodate herself to the wave surface and her mast would correspond to the perpendicular drawn to the wave surface (see Fig. 48). Even with sail set the boat would more or less so accommodate herself to the wave surface, minus her steady angle of heel ; but the increased pressure on the canvas, due to the righting moment of the boat, which would have to be overcome, would prevent her recovering herself entirely. That is, if the boat be heeled to 15° relative to the horizon, or to the normal surface of the water represented by the vertical line, and a wave came to leeward as shown, she would be in the position of a heel of 30° relative to the perpendicular to the wave surface ; but, inasmuch as the wind pressure is only capable of heeling her to 15° the boat would ultimately recover herself to that extent, and her mast would be represented by the vertical.

However, long before a boat could so recover herself, she might be swamped or blown over.

With a beam sea a boat will roll a great deal, and this condition is a prolific source of accidents. If a boat is being sailed at a permanent angle of heel of 15° , and by the action of the wave she is made to roll another 15° , she will frequently be in the position of being heeled to 30° ; and if the extreme part of the roll should occur jointly with such a position as shown in Fig. 48, the boat would inevitably upset.

Next it can be supposed that the boat is being sailed at a permanent angle of heel of 15° , that she has an extreme roll of 15° , and that there came a sudden wind squall. Then if the extreme leeward roll, and the squall took place together when in the position shown by Fig. 48, she would blow over and nothing could save her. But she need not be in such a position as that depicted and yet be blown over: if the boat has a heel of 15° , and an extreme leeward roll of 15° , then if the extreme roll and a squall occurred together the boat would be upset, whatever her actual position among the waves, whether she was on the trough, on the side, or on the crest of a wave. Further it must be always understood that a force of wind which will, if applied steadily, heel a boat to 15° , will if applied suddenly heel her to double that inclination; thus it is not so much the force of the squall as the suddenness of its application wherein lies the danger.

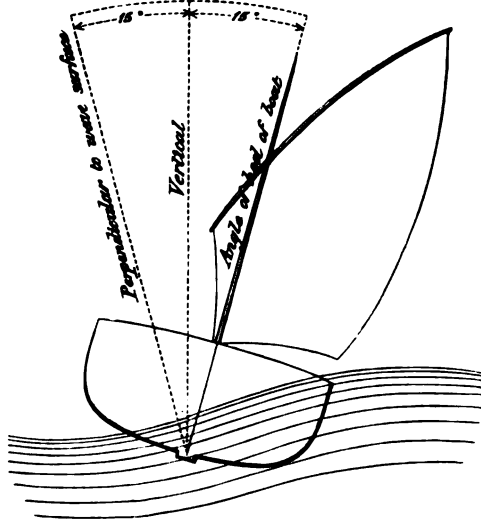


FIG. 48.

When a boat is among waves (especially with a beam wind), ballast should not be trimmed to windward, nor should the passengers sit on the weather gunwales, as a boat after being in a position similar to that shown

by Fig. 48 will take a very heavy weather roll, possibly fly up in the wind, be taken aback, and blown over.

The canvas that will permanently heel a boat to 15° may be carried safely enough in smooth water with a beam wind, but the case is altogether different among waves, and so much canvas should not then be carried, perhaps by one half. Many ships' boats and pleasure boats are annually lost through recklessness in carrying canvas in rough water; and, although a boat may go out among waves a dozen times without being subject to either of the coincident conditions described, yet may she the very next time: therefore immunity is not necessarily impunity. It will thus be seen that there is very considerable danger attendant upon sailing a boat among waves, a danger perhaps not always understood.

In sailing among waves the ballast should be well secured, the passengers should sit in the bottom of the boat, and the main sheet should be kept in the hand. If the sea is abeam the boat should be watched very closely, and if a bigger wave than usual rolls in on the weather beam, ease the sheet and run off the wind a little, the wave will then pass harmlessly under the boat. Do not luff with a beam wind or sea, and in keeping away never forget to ease the mainsheet.

In sailing by the wind among waves the danger of being blown over will be considerably less, but nevertheless there is danger, and it must not be assumed that because an experienced and skilful boat sailer sails a mere cockle-shell safely about among waves, that anyone could do so without experience or skill. In boat sailing safety mainly depends upon knowing what is dangerous.

In sailing by the wind the mainsheet might be belayed with a slippery hitch, with the fall close to the hand (resting over the knee is a good plan) and the foresheet should lead aft. If there is much sea do not pin the mainsheet in, but the foresheet can be drawn fairly taut. Luff the boat fairly into the big seas that roll in on the bow, and fill her again promptly. The foresail will be found of great assistance in taking her head off, and hence it should be sheeted pretty flat. In puffs and squalls the boat should be luffed up and the foresheet eased, and always do this before the gunwale gets under; as when the gunwale goes under, the boat soon loses way and then the power of luffing will be gone, and the boat may perhaps fill and sink. If a boat does not come to quickly and relieve herself of wind, let fly the main sheet and ease her that way, but recollect in all cases that whatever is done must be done promptly.

If the boat has a mizen the main sheet can be eased at the time of putting the helm down, as the mizen will bring the boat head to wind, but generally in luffing for squalls the mainsheet need not be eased;

but the foresheet should be, as that will allow the boat to fly to more readily.

If the boat has only a mainsail and mizen, ease the mainsheet in luffing if the squall be heavy, and leave the mizen to bring her to.

In luffing for squalls, should the boat get head to wind, haul the foresheet a-weather, put the helm up, keep the mainsheet eased off and press down what is to be the lee quarter: (see foot-note in the Chapter on New Brighton Boats.) If the boat has only one sail, haul the boom on what is to be the weather side and put the tiller on the opposite side; as the boat gets sternway on she will pay off, then right the helm, ease the boom over, and sail her. If the boat has a mizen as well as mainsail, the mizen sheet should be eased whilst the boom is held over. If an oar is handy, the boat can be helped off the wind by a "back-water" stroke or two off the lee quarter, or a forward stroke or two on the weather bow. But the boat sailer must not get nervous and throw his boat head to wind for every little catspaw or small sea; he must, whilst being careful that his boat is not capsized by a squall or filled by shipping water, sail her boldly but not recklessly, and keep her a "good full," or she will surely drive to leeward. It is particularly incumbent that a boat should be kept full when sailing among waves, hence the great necessity of her being appropriately canvassed. However, if the boat is sailing across a weather-going tide she may be "squeezed" a little, but never allow the sails to lift.

Whilst tacking a small boat always remember that it is not the tiller of a big yacht that is grasped, and do not shove the helm down with all the force at hand; bring the boat head to wind with the tiller about half over, then put it hard up and ease again to amidships as the vessel gathers good way. With a big boom mainsail a small boat in smooth water will shoot head to wind and fill on the other tack in less time than it takes to write it, but in a sea she may require some help, and the moment for tacking should be when a "smooth" comes on the water. If there is an uncertainty about the boat coming round, do not let go the foresheet until the boat's head is fairly off on the other tack. If the boat has no head sail, haul the boom aboard as the helm is put down, and keep it to windward until she pays off. Never forget that a boat can always be helped round by an oar.

Above all things never attempt to tack with a big wave coming in on the weather bow.

SAILING ALONG A WEATHER SHORE.—In sailing along a weather shore, it is generally found safer with a boom mainsail to luff up in the wind and ease the foresheet, if there be one, than to ease the mainsheet and

attempt to relieve the boat without much altering her course; however, if the weather shore be the bank of a river and close aboard, there will be the risk of going stem on into the bank; and this will be especially awkward if the boat has a long bowsprit. It is not pleasant to go into the bank of a river, but it would be preferable to capsizing. Still, in match sailing a great deal of valuable time might be lost by luffing up, and a boat can be relieved and kept going by judiciously easing the mainsheet and running her off; but never deliberate as to what shall be done—that is, whether the boat shall be luffed up at the risk of running into the bank, or whether the sheet shall be eased and the boat run off the wind. Always remember in the case of squalls that “he who hesitates is lost.”

SAILING ALONG A LEE SHORE.—When sailing along a lee shore in squally weather (if it is a matter of choice, always work the weather shore), smartly luff up to the squalls in preference to easing the mainsheet, and thus keep the boat going. If the squall be very heavy, the foresheet should be let fly so as to bring the boat head to wind quickly. If the mainsheet is eased off much the boat loses way, and then by help of her foresail may take off against her helm and shove her nose ashore; so easing the mainsheet in squalls should be avoided, if possible, when sailing along the lee bank of a river or by the side of mud or sand flats. Generally the boat will “come to” quickly enough without the foresheet being eased; but, if the squall looks to have much weight in it, ease the sheet and luff up in good time; then prepare to lower the mainsail, if necessary.

In lowering a sail in squalls, great care should be taken to spill the sail as it comes down, as, if it fills and blows out in bags, it may not only cause trouble in handing it, but upset the boat.

RUNNING BEFORE THE WIND AND SEA.—Running before a wind and sea in a small boat may to the inexperienced appear a very simple and safe operation; but, in reality, it is a very dangerous one, and many a small boat has been lost in attempting to “run away” from a sea. The two principal dangers will arise from getting by the lee and broaching to: the boat’s head will be most likely to fall off to leeward, or rather her stern lift to windward, as a wave crest passes underneath her bottom from astern. But with equal peril she might have “broached to” as the wave crest lifted her bow; the boat’s head will be turned towards the wind, and then, if she be not well managed, she will get broadside on to the waves, and the next roller will almost inevitably swamp her. If the rig be mizen, mainsail, and foresail, the mizen should be stowed before the boat is put before the

wind ; the lee foresheet should be belayed slack, and the weather one should be led aft. As the boat begins to fly to, haul the weather foresheet in, and put the helm up ; but very frequently the helm is not of much use if the boat is among breakers in shallow water, as she will be carried along on the back of a comber. Thus it very frequently happens that a boat that has successfully battled with the waves in the offing comes to grief as she gets among the surf to try and effect a landing or to run over a bar into harbour. In running over a surf an oar off the quarter will be found much more effective than the rudder to steer with, but the oar should always have a line fast on it, and it should be belayed to the gunwale, in case it has to be left when the sail requires attention.

A small boat, if there is much wind, and especially if there be sea as well, should never be run dead before the wind, but with the wind a little on the quarter ; then gybe over, and run on the other tack, to make the destination.

In gybing, always haul the boom well aboard as the helm is put up. As the wind passes from dead astern and comes on the other quarter, taking the boom over, shift the helm promptly and prevent the vessel flying to.

GENERAL CAUTIONS.—Great care should always be taken when passing under the lee of a ship at anchor or other large object, if there is anything like a breeze, as when the boat draws clear she will have but little way on, and to be met then by the full blast of the breeze will cause her to heel more than if she were moving at her best speed ; or, if she has to go under the lee of a passing or meeting vessel, she will equally get becalmed, though not for so long a time ; she will, however, get the breeze again much more suddenly than if the passing ship had been at anchor, and may consequently be knocked down more. None of the crew of a boat should ever sit on the gunwale when passing under the lee of a ship, as the sudden loss of wind will bring the boat upright, and so much weight on one side may cause the crew to be pitched into the water, or possibly, if the boat got caught aback as she heeled to windward, she might capsize.

The first best thing to do is to give all objects such a wide berth that the boat cannot be becalmed by them. If the boat is beating to windward, and would have to bear up very much to clear the ship at anchor, it would be better to make a board and weather the ship ; this can also be done, if managed in good time, to weather a ship that is *meeting* the boat, *i.e.*, is running before the wind ; but a boat should never be put across a vessel unless so far ahead as to render collision impossible. If in the attempt to weather a ship there seems a doubt about doing it, do not commence squeezing or nipping ; ramp the boat along, and tack or bear up in good

time and go under the ship's stern if both are beating, and under her lee if the ship is free.

If there be no choice, and the small boat has to pass under the lee of the ship, then have the mainsheet cast off and held ready and clear to run out; if the boat has nearly lost her way before she gets the breeze again she will scarcely answer her helm to luff; and if she is knocked down to near the gunwhale edge let the sheet fly without hesitation.

If the passing vessel be a steamer going at a great speed, she will leave a considerable wash, and small boats should avoid this, although it is the delight of some boat sailers to get into it and ship "green water," as they love to call it.

If the boat carries lee helm trim her by the head a little, or if the mainsheet will admit of it harden it in and ease the foresheet a trifle; at all events so manage that the boat carries enough weather helm to fly up in the wind when the tiller is let go. If a boat carries lee helm she may refuse to come head to wind, and under some circumstances this might be highly dangerous.

A single hand should never attempt to row and sail at the same time; if occupied with rowing he cannot attend to the helm and sheets, and the prudent course would be to lower the sail and propel the boat entirely by oars. In case the rig includes a mizen or foresail, one or both could be kept set, but the foresheet should be belayed so that a slight pull on the fall will release it.

The crew of the boat should invariably sit on the bottom boards on the weather side, or if there be much sea amidships. No one should be allowed to climb the mast if the boat is under way, as the weight aloft might capsize her. Nor should any of the crew stand on the thwarts so that they might get thrown down in the lee side of the boat when she lurched, or otherwise imperil her safety.

In cases where the mainsheet leads through a block, through a bull's-eye, through a thimble, through a hole, or other similar arrangement, the boat sailer should ever and anon cast his eye on the fall of the sheet and see that there are no turns or kinks in it. If the fall be coiled up, see that the running part is uppermost and the end underneath. New rope and wet rope are specially liable to get foul turns in them. It will also be prudent to see that nothing like a boat's stretcher, mop handle, thole pin, or bailer lies in the coil of a fall of a sheet.

REEFING.—In reefing, the tack and sheet should always be shifted to the reef cringles before the foot of the sail is rolled up and the points tied. Always roll up neatly and as tightly as possible, not only for the look of the thing, but because otherwise the points for the second or third reef

may not reach in case they are required. In shaking out a reef always untie the points and loosen the foot before shifting the tack and sheet.

ROWING IN A SEA.—The principal thing to avoid in rowing in a sea is getting broadside on to the waves ; if a boat gets into such a position she may roll over or be knocked over or be swamped. If possible, row head to the sea, and if the boat is carried too far to windward, take the opportunity of running her off whenever a smooth presents itself. In running before the sea the boat will most likely show a tendency to broach-to, and so get into the trough of the sea that way, this tendency must be instantly checked. In landing on a beach through a surf, it is frequently a good plan, if the boat is not sharp sterned, to row her in bow to the surf, or stern first.

In boarding a vessel that is under way, always row up under her lee. In boarding a vessel at anchor, always bring the boat's head up to the tide, and take a good sweep in coming alongside. Give the order " In bow " when about fifty yards off, and " Oars " (the order for the men to toss their oars in), so that the boat shoots alongside with her way nearly stopped. Avoid if possible going alongside a vessel stem on.

As a rule a boat should always be beached through surf with her sails stowed, as, if she got broadside on among the breakers with sail up a capsize would be inevitable. Upon nearing the beach on a flat shore recollect that here the wave water itself is moving, and will carry the boat along until it finally casts her up on the beach : as each wave overtakes the boat care must be taken that it does not twist her round broadside on.

As the water at the stern may be moving faster than that at the bow, the tendency of the stern wave will be to turn the boat round if the wave does not take the boat fairly end on. This effect of the overtaking waves can be reduced by towing something astern—a spar broadside on, for instance, made fast to a bridle—and by approaching the shore stern first, so that the bow is presented to the overtaking waves.

If the beach is a steep one the best plan is to row in as hard as possible, choosing at last as the moment for beaching when a sea begins to break and pour in on the beach.

CHAPTER XIV.

THE GENERAL MANAGEMENT OF A YACHT.

THE OWNER, MASTER, MATE, &c.

THERE is no code of regulations for the discipline of a yacht, but generally the custom of the merchant service is observed. The master is not required by law to have a certificate of competency, and frequently he is only capable of making coasting passages. However, many masters of large vessels are skilful navigators, and could take a yacht to any part of the globe. The chief requisite in a master for a yacht, whose cruising does not extend beyond the English and Irish Channels, is that he should be a thorough master of fore-and-aft sailing, and that he should be clean and tidy in his habits, able to enforce cleanliness and tidiness in the crew, have perfect command over the crew, and carry out the owner's wishes cheerfully and respectfully. Most yacht masters rise from "before the mast" after they have served a season or two as mate or second mate, and generally they assume their new station with a full appreciation of its consequence—that is, they are alive to the serious responsibility of being in charge of a vessel—take her about with a caution and patience that are unceasing, and are always on their dignity in their intercourse with the crew. Some men, however, appear to be quite incapable of feeling that dignity, and at one moment are too familiar with the crew, and the next squabbling with them. Such a man should not have charge of a yacht, and if an owner wishes to cruise in comfort he will get a sailing master who, above all things, is "master of the crew," conducts himself as such, and is observed as such.

The master has sole control on board, subject of course to the wishes of the owner, who ought, however, never to have occasion to interfere with the discipline or working of the yacht. If the owner has any fault to find against the conduct, whatever its nature, of any member of the crew, he should make that complaint to the master; it will show the master that he is responsible for the discipline, good behaviour, and

efficiency of the crew, and the crew will not have the opportunity of saying they do not know who is master, or that the owner is master, and that the titular master is only so in name.* But if the owner observes any misconduct or gross inefficiency on the part of any member of the crew, and the master apparently does not notice it, then the owner should bring the master's attention to it, and, if necessary, insist on the delinquent being discharged. This will really strengthen the position of the master, and inspire him to take command of the crew, instead of being content with a kind of slovenly discipline.

The owner should always keep up a kind of formality in addressing the sailing master, and address him as Mr. So-and-so, and not as Harry or John, as the case may be. The owner in this way can do a great deal towards inspiring the crew with respect for the master, as, if it is seen that the owner treats the master with a flippant familiarity, the crew will do so too. The crew should always address the master as "Sir," and not in an offhand way, such as "All right, skipper," or "All ready, captain."

If the owner wishes any work done on board, or requires the gig or boat, he should tell the master of his wishes or send a proper message to him, and not issue direct orders to the crew; all such usurpations of the proper duties of the master are subversive of discipline, and should be carefully avoided. If the owner goes on shore and wishes the boat to return for him, he should give the orders to the master; but if he forgets to do this he should upon landing give the order to the coxswain, whose duty it will be to repeat the order; thus, if the owner says, "Come for me at half-past four," the coxswain will answer, "Half-past four, sir," to show that he understands the order.

The master should always ship the crew, and generally should be allowed to ship the mate as well.

The mate, like the master, should always be addressed as "Mr.," alike by the owner, master, and crew. When the master is on deck the mate's place is forward, and he superintends the setting and taking in sails, and generally sees that the master's orders are efficiently carried out. He also takes charge of the yacht's rigging, and sees that all necessary work is done upon it, and from time to time reports the condition of the rigging, spars, and sails, to the master.

When orders are given to get under way, he superintends all the necessary preparations for getting the anchor and making sail; so also in bringing up, he prepares for taking in sail and letting go the anchor.

* In some small vessels the owner is actually master, and then he deals with the crew as such.

When the master is below, the mate goes aft and takes charge of the deck and issues orders as if he were the master; but, although it may be his watch on deck, he does not make any serious alteration in the vessel's course or shorten or set sail, or reef without informing the master of what he is about to do. Then if the master considers it necessary, he goes on deck himself, and perhaps summons his watch from below.

The boatswain takes charge of the sail room and ship's chandler's stores, sees that all the tackles, spare sails, &c., are properly stowed and in good order. With the mate he superintends the washing down, scrubbing, cleaning of brass work, and blacking down the yacht or rigging.

The coxswain of a boat has to see that she is kept clean and in readiness for use, rows the stroke oar when passengers are in her, and takes the yoke lines when only the crew. The coxswain of the owner's gig has usually one shilling or so a week extra for taking charge of her, and he, as before said, is held responsible by the master for her condition and the condition of everything belonging to her.

WATCHES, BELLS, THE HELM, THE CREW.

WATCHES.—The master is always in charge of the deck, excepting when long passages are being made; then watches are set. The master takes the starboard watch, and the mate the port watch. The second mate is in the master's watch, or, if no second mate, the boatswain. The two mates generally tell the men off into their respective watches when they are shipped. If the yacht is short-handed in making a passage, the steward musters in the master's watch and the cook in the mate's. The watches are usually set at eight o'clock of the first night at sea, and the master takes the first watch; but on leaving a foreign port for home the mate takes the first watch. Following out the axiom that the "master takes the ship out, but the mate brings her home," the mate has charge of the navigation on the homeward voyage, if he is capable of the duty, the master superintending only.

When a yacht is in harbour, or when only sailing about in the daytime and bringing up at night, no watches are kept, and the whole crew, including master and mate are on deck. When sailing about for a few hours in the daytime the master takes sole charge of working the yacht and generally steers. He issues all orders, and the mate sees that they are carried out. Thus, in working to windward, if the yacht has to be

tacked, the master says "Ready about!" The mate answers "All ready, sir." The master then puts down the helm, saying "Helm's-a-lee!" the mate answers "Helm's-a-lee, sir!" and directs the crew to ease up the head sheets and haul them aft again as required. When the master hails with "Ready about," none of the crew should bawl out "All right, sir," or answer in any way whatsoever, but if the mate is not on deck, the second mate or boatswain should take his place, answer "All ready, sir," and see that the head sheets are worked properly. The master will see that the aft sheets are properly worked. With a good and attentive crew, the first hail of "Ready about," or even a sign, will send all the men to their stations, and the more quietly a yacht can be worked the better it will be for the nerves of the passengers.

In making long cruising passages watches are set, and the master and mate take alternate watches, as before stated. The twenty-four hours are divided into seven watches thus—five of four hours duration, and two of two hours, the latter being called "dog watches" and always occur between four and eight o'clock in the afternoon. The object of having dog watches is to obtain an uneven number, as otherwise the same men would always be on duty in particular watches. During the dog watches—from four o'clock to eight—a great deal of liberty is allowed the men, and the watch below as well as the one on deck do their own odd jobs, tell yarns, sing, and generally amuse themselves in such a way as is consistent with the good working of the yacht.

Generally when going to sea the first watch is set at eight p.m., and the master takes that watch. Eight bells are struck and the port watch retires below. At twelve o'clock (midnight) the port watch is called by the second mate or boatswain going to the fore hatch or scuttle, and hailing "Port watch ahoy!" or "Eight bells sleepers!" The watch below should answer "Ay, ay!" turn out immediately, and be on deck in five minutes. Any lagging is regarded as very bad form, and a man is looked upon with contempt who does not turn up on the first summons. The watch lasts from twelve to four, and is termed the middle watch. At four a.m. the sleeping watch would be called in the same way, to come on deck and take the morning watch from four to eight, and so on for the forenoon watch, afternoon watch, the "dog watches," and first watch again. When in harbour, or at moorings, an "anchor watch" is kept by one man, whose spell is two hours, the port and starboard watch supplying the men on alternate nights. This watch looks out for any dangers that a yacht may be in, summonses the watch below if necessary, and strikes the bells.

BELLS.—As a rule, "Bells" are only struck on board yachts between

eight in the evening and eight in the morning, but in large yachts they are regularly struck all through the twenty-four hours, whether the yacht is at sea or in harbour.

The bells are struck in this way: one stroke (or one bell) is half-past twelve; two strokes struck quickly (or two bells) one o'clock; two strokes struck quickly, followed by one (or three bells), half-past one; a double two (or four bells) two o'clock; a double two and one (or five bells) half-past two; a treble two (or six bells) three o'clock; a treble two and one (or seven bells) half-past three; four double strokes (or eight bells) four o'clock. Then commences one bell for half-past four, two bells for five o'clock, and so on, eight bells struck every four hours.

But during the dog watches after four bells have been struck for six o'clock, one bell is struck for half past six, two bells for seven o'clock, three bells for half-past seven and eight bells again for eight o'clock.

HELM.—When watches are set it is usual for one of the crew to steer, and not the master or mate. Two men out of each watch are usually selected (generally among themselves) to steer, who are known to be good helmsmen. Each man is at the helm for two hours, and this is called a "trick." When the time has expired the other man goes aft as four bells are struck. If he does not go immediately he is reminded by the hail "Spell O!" The man who relieves should always, if the weather will permit, come aft along the lee side, and, crossing over the tiller, from the lee side to weather side, come behind the other helmsman, and take the lines out of his hand from abaft.

The man, as he gives up the helm, states the course as E.S.E., or "Full and by," as the case may be. It is the duty of the new comer to repeat the course, to show that he understands it, and the officer in charge of the deck, should be near to hear that the course is correctly given. The relieved man retires behind the other one, crosses the tiller, and finds his way forward along the lee side of the yacht.

If the officer of the watch requires the course altered, he gives the course anew, as E. by S., or "keep her off," or "bring her to," or "no more away," &c., and it is the duty of the man at the helm, to repeat the order audibly, to show that he understands it. In bad weather, it is usual to place a second hand at the helm, and then the man whose trick it is, stands to windward of the tiller with the weather tiller line in his hand, and the other to leeward with the lee tiller line. He assists in pushing the tiller to windward, or hauling it to leeward, as occasion requires. Frequently a young hand is given a spell at the helm in light winds, in order that he may gain a knowledge of steering.

THE CREW.—When an order is given to any member of the crew by the master or the mate, such as “Ease the fore sheet,” or “Take in the slack of that rope,” it is the duty of the man to audibly repeat the order to show that he understands it, as “Ease the fore sheet, sir,” &c. While the crew are at work, or during the watches from 8 a.m. to 4 p.m., there should be nothing like “recreation” permitted on the fore deck or in the fore-castle, but the men should go about their work quietly, never converse loudly, nor hail one another from one end of the vessel to the other. All orders should be obeyed instantly and cheerfully, with a ready response or a cheery “Ay ay, sir!” Nothing could be worse than for the crew when an order is given to sit and stare, and then to leisurely proceed to do it with an air which plainly says, “I am doing it, but you might just as well have done it yourself.” In most cases, in working the yacht the master should give the order to the mate, who will direct the particular man or men who are to carry out the order. As before said, the order should be obeyed with alacrity; if it is not, it will appear that the men do not know how to execute it, or that they are so stupid that they do not understand it, or that they are such bad sailors that they do not know that a seaman’s first duty is ready obedience.

Whenever any member of the crew shows the least slackness in executing orders or in any way neglects the ship’s work, shows symptoms of insubordination, indulges in mutinous talk, gives insolent or even pert answers, he should be instantly warned by the master of the mistake he has made, and upon the second offence should be given his “discharge ticket.” If a seaman obeys all orders promptly and executes them conscientiously, he will be respected by the master and other officers; but if he is doubtful in obedience and a sloven in his work, the master, very properly, will have a contempt for him, and will take advantage of the first opportunity for unshipping him.

The master should take every precaution to prevent drunkenness among the crew, and should never overlook more than one offence in a season. This rule should be observed with great strictness.

Smoking should be permitted on the fore deck after dinner and during the dog watches. Smoking should not be permitted at other times, nor should smoking be ever permitted below.

LIBERTY MEN, DISCIPLINE, &c.

As a rule, there is very much more difficulty in maintaining discipline on board, when a yacht is seldom under way. The yacht is in such

thorough order, that after she is washed down, the brass work cleaned, and her sides "chamoied," there is nothing left to do, except perhaps row the owner on shore, and bring him off again. The men have nothing to do but eat and sleep, and as they cannot be doing this all day, there comes a longing for going ashore. The master, of course, has to be asked for "liberty," and if he refuses, the man has a fit of sulks, and takes the first opportunity of being insolent. This is frequently the origin of squabbling on board; but, on the other hand, sometimes the master allows too much liberty, and almost permits the crew to leave and rejoin the vessel when they please. This is worse than no liberty at all, and usually ends with the men who stay on board from week's end to week's end, abusing those who are everlastingly on shore, and the result is a regular fo'c'sle row. The best plan is for the master, directly the yacht is in commission, to have some system about liberty. The usual plan is for the crew to have alternate evenings on shore, or "watch and watch," if circumstances permit; starboard watch goes on shore one night, and port watch the next.

It is useless to tell an owner that he should not keep his yacht at anchor for weeks at a stretch, but get under way every day; there may be a variety of reasons why he does not want to get under way, but one is enough, and that is, the yacht is his own, and he need only get under way when he chooses. As a rule, the master will know the habits of the owner, and only engage men who he knows can stand a life of comparative idleness and confinement.

A great many complaints are made about yachts' crews, and some very hard things have been said against them; no doubt many yacht sailors are ill-behaved, sometimes indolent, sometimes intemperate and dirty in their habits, and frequently show an extraordinary spirit of insubordination. Now, we are not inclined to wholly blame the crews for this; in the first place, they are almost entirely untutored in anything like discipline, or the discipline they are used to is of the most relaxed character; there is no restraint on their habits, and if they exhibit anything like insubordination, the master, perhaps as ignorant as they are, has no code or system to guide him in restraining it. It should be understood that very much more is expected from a man who is engaged from a seaman of the mercantile marine. He should be very active, be pleasant in his manners, and be as well conducted as a highly trained man. He must be a seaman. Now all that is to be expected of a yacht sailor is that he should be a thorough seaman, and that he should be a gentleman; he may be as ill-shapen as

Caliban, and as rough in his manner, and dirty in his person as a pitman, but no one will complain of this. He is kept in restraint by very severe laws, but the very nature of the characteristics expected in a yacht sailor forbids the application of the Merchant Shipping statutes to him in their integrity. A yacht sailor must be governed by quite a different hand, and in a large measure discipline and good behaviour on board must rest with the moral force of the master rather than with any restraints that could be employed under the Merchant Shipping Act. No Act of Parliament will make men clean in their persons, polished in their manners, or shapely in their forms; and a master in seeking these characteristics in a crew can only employ the means adopted for such ends in a household. He will take particular care, of course, that the men he engages are seamen; and he must exercise the same care in seeing that they are men who have the other qualifications for a yacht sailor.

We hear a great deal about men saying "this is not yacht rules," and "that is not yacht rules," but if the seamen venture to say this we immediately think that the master does not know what "yacht rules" are, if there be any such rules. We have already shown that such rules as there are for working ship, are in accordance with the custom of the Merchant Service, and should be, and we believe are, rigidly observed. The other rules for the good conduct and personal behaviour of the men must rest entirely with the master; if he has the moral force necessary to govern men he will have a happy and orderly yacht's crew; if he has not, and attempts to supply the deficiency by the application of statutes that were intended for quite a different condition of things he will always be master of a bad crew.

Masters as a rule have that necessary moral force, and the very fact that most of them rise from "before the mast" is evidence of this. And this brings us face to face with the fact that yacht sailors, taken as a whole, are not the ungovernable and ill-assorted lot of men that we are sometimes asked to believe; and most masters exhibit a wonderful tact in maintaining what is not so much discipline as a ready compliance and respectful demeanour.

WAGES OF THE CREW—CLOTHES—GENERAL EXPENSES.

The expenses of yachting is largely governed by the number of hands employed, and the magnitude of this part of the necessary expenditure can be calculated from what follows.

It is usual to pay the master of a yacht by the year, and the wages vary according to the size of the yacht and the qualifications sought. Thus, the master of a 10-tonner may only have 50*l.* a year, whilst one in charge of a 100-tonner may have 100*l.*, and one in charge of a 300-tonner as much as 200*l.* Again, if a master for a racing yacht is required, very nearly as much will have to be paid for one to take charge of a 40-tonner as for one of 200-tons. Again, sometimes a master is paid 2*l.* or 2*l.* 10*s.* a week whilst the yacht is in commission, and 10*s.* per week whilst she is laid up; when such is the rule the master does not always keep charge of the yacht whilst she is laid up, but the owner pays a trifling sum per week—ranging from 5*s.* to 10*s.*—to a shipkeeper who may be an agent who undertakes such work, or a yacht sailor; but the most satisfactory plan would appear to be to pay the master by the year, and make him live near the place where the yacht is laid up.

The remainder of the crew will be paid as follows—from the time they are engaged commencing to fit out the yacht until she is laid up:—

| | | | | | | | | | |
|-----------------|----------|---|----|----|--------------|----------|---|----|----|
| Mate | per week | £ | s. | d. | Cook | per week | £ | s. | d. |
| Boatswain | „ | 1 | 15 | 0 | Seaman | „ | 1 | 15 | 0 |
| Steward | „ | 1 | 8 | 0 | | | 1 | 5 | 0 |
| | | 1 | 15 | 0 | | | | | |

The master, mate, cook and steward, usually live at the expense of the owner, and if a table is not kept for them they are paid board wages of 12*s.* each per week.

The seamen find their own provisions.

Often 1*s.* per week is kept back from the seamen's wages as conduct money, and if either commits an offence during the week the 1*s.* is stopped; the fine however is seldom inflicted, as few masters have the courage to enforce it.

The coxswain of the gig is usually given 1*s.* per week more than the other men, as before stated. The "dinghy man" whose duty it is to row the steward ashore, &c., for marketing, and to fetch letters off, and generally to do the carrying to and fro, also has 1*s.* per week extra. In racing yachts the masthead man is sometimes paid 1*s.* per week extra.

The steward and cook sometimes have more than the wages given above, and sometimes less. In large yachts where a second steward is carried, the wages given to a good steward are perhaps as much as 2*l.* The second steward's wages will vary from 1*l.* to 1*l.* 10*s.* according to whether he is a man or a boy, and to his efficiency.

We have known a professed cook to receive as much as 5*l.* per week, but generally a sufficiently good cook can be obtained for 1*l.* 10*s.* or 1*l.* 15*s.* It is a common practice in yachts of 70 tons and under to have

a steward who can cook as well; in which case the "cook" is dispensed with. One of the fore deck hands acts as cook for the forecabin, and assists the steward at times in the cabin.

The clothes given to the crews are usually as follows: *

| MASTER. | | £ s. d. | | | £ s. d. |
|--------------------------------|--|---------|--------------------------------------|--|---------|
| 2 blue cloth suits | | 8 8 0 | 1 neckerchief | | 0 5 0 |
| 1 cloth cap and gold band..... | | 1 1 0 | 1 cap..... | | 0 5 0 |
| 1 silk neckerchief | | 0 6 0 | 2 pairs of shoes | | 1 2 6 |
| 1 pair canvas shoes | | 0 7 6 | | | |
| 1 pair leather shoes | | 0 15 0 | | | |
| | | | | | 8 19 6 |
| | | 10 17 6 | COOK. | | |
| | | | Similar to Steward. | | |
| MATE. | | | SEAMEN. | | |
| 1 blue cloth suit | | 4 4 0 | 1 pair pilot trousers | | 1 1 0 |
| 1 pair pilot trousers | | 1 1 0 | 2 pairs of white duck trousers | | 0 10 6 |
| 1 frock | | 0 10 6 | 1 serge frock | | 0 10 0 |
| 1 cap | | 0 5 0 | 2 white duck frocks | | 0 12 0 |
| 1 neckerchief | | 0 5 0 | 1 cap | | 0 5 0 |
| 2 pairs of shoes | | 1 2 6 | 1 red cap | | 0 1 6 |
| | | 7 8 0 | 1 straw hat | | 0 4 0 |
| | | | 1 hat or cap riband | | 0 1 0 |
| BOATSWAIN. | | | 1 neckerchief | | 0 5 0 |
| Similar to Mate. | | | 1 pair canvas shoes | | 0 7 6 |
| | | | 1 pair leather shoes | | 0 10 0 |
| STEWARD. | | | | | 4 7 6 |
| 1 blue cloth suit | | 4 4 0 | | | |
| 1 serge suit | | 3 3 0 | | | |

Sometimes the master is given only one suit of blue cloth.

If white duck suits are not given to the men, it is usual to give them a dongaree suit of blue linen to do their rough work in, and an extra pair of pilot trousers.

Very frequently, especially in small yachts, only one suit is given all round, with one pair of shoes. Thus the crew's outfit largely depends upon what the owner considers it necessary to give them.

It has been established over and over again in law courts, that the clothes are a livery and belong to the owner, but it is the custom to allow the men to take them away when the yacht is paid off. If a seaman is discharged for misconduct his clothes are retained. If he takes them away he can be sued for the value of them in the County Court.

It would of course be impossible to estimate what the exact expenses of yachting would be apart from those enumerated, as so much depends upon the owner himself and how he likes the yacht "kept up." Also a great deal depends upon the sailing master, as no doubt the custom of ship chandlers to pay commissions greatly influences unscrupulous masters in

* The number of hands carried by yachts of different tonnages will be found set forth in a table in the succeeding chapter on Yacht Racing.

“making bills.” Roughly the expenses, exclusive of those incidental to the crew as already enumerated, can be set down at 6*l.* per ton, assuming the yacht to be five months in commission from the day she commenced to fit out to the day she laid up. These expenses would be (applied to a yacht of 60 tons) made up as follows :

| | £ | s. | d. |
|---|------------|----------|----------|
| Interest on £2000 | 100 | 0 | 0 |
| Insurance | 50 | 0 | 0 |
| Annual depreciation | 60 | 0 | 0 |
| Repairs and renewal of hull, taking an annual average of 5 years | 70 | 0 | 0 |
| Renewal of sails and rigging, taking an annual average of 5 years | 60 | 0 | 0 |
| Ship Chandlers' stores, oil, paint, varnish, brushes, charts, flags, coke, &c. | 50 | 0 | 0 |
| Hire of store | 10 | 0 | 0 |
| | <u>400</u> | <u>0</u> | <u>0</u> |

The above expenses would not vary much whether the yacht were out four months or six months.

The crew expenses would be as follows :

| | £ | s. | d. |
|---------------------------------|------------|----------|----------|
| Sailing Master, per annum | 70 | 0 | 0 |
| Mate 20 weeks | 35 | 0 | 0 |
| Steward ditto | 35 | 0 | 0 |
| Four seamen ditto | 100 | 0 | 0 |
| Clothes | 45 | 0 | 0 |
| Board wages | 36 | 0 | 0 |
| | <u>321</u> | <u>0</u> | <u>0</u> |

CHAPTER XV.

YACHT RACING.

ONE of the principal causes of success in yacht racing is that of being "always ready;" ready with the entry, ready with the vessel whether she requires copper scrubbed or trim altered, ready with the sails and gear, ready with the instructions, ready in getting into a berth, ready to start, ready for every shift of canvas, ready for every evolution in sailing, and ready to receive the first gun at the finish. Therefore, always be ready and never be above being prepared. The experienced racing man knows that if he is prepared with his spinnaker, and another man is not, after bearing up round a mark, that an enormous advantage will be gained. Or in hauling round a mark if he has got everything in time made snug, and sheets laid along and manned ready for rallying aft, and another man has to luff round with everything adrift on deck, and the boom off the quarter, his vessel will get a quarter of a mile out on the weather of the sloven before the latter has got his boom aboard or jib sheets in. If proper preparation is made for every shift of canvas or manoeuvre in sailing, the vessel will be worked as if all the gear and sails were parts of machinery, but if no preparations are made, everything will be in confusion on board; there will be shouting and bawling and running about, sails sent up head downwards, sheets and halyards bent on foul, or fouled among the numberless coils of ropes on deck, the crew will be distracted, the sailing master hoarse and furious, and the owner mortified to see such an utter want of discipline and system on board his vessel. On the other hand, if everything is ready beforehand, the crew will understand exactly what they have to do, each man will fulfil his task with a cool head and ready hand, the sailing master will be tranquil and manage the vessel cleverly, and the owner will be delighted, and think that half the pleasure of match sailing is in seeing a good crew, who know their work, set about it in a seamanlike and systematic manner. There must be no shirking; whatever a man is set to do, he must do thoroughly, and with a will; if he does not do this he should be

unshipped without compunction, as one lazy, slovenly, or half-hearted hand on board will spoil three good ones.

Now everyone knows that there are various things to be done in yacht sailing at one and the same time, and it will be patent that it is desirable that each thing should be done by the same hands each time, if possible. Nothing looks worse on board a racing yacht if when such a simple order as "check the foresheet a trifle," a half a dozen men or so jump up and rush into the lee bow, when one of the crew could have quietly executed the order. On the other hand it shows a worse spirit if the men begin talking among themselves as to who shall go to do it; but if one hand is told off as the foresheet man, he will know that he has to check the sheet, and if the sheet has to be got in instead of eased, the mate will send another hand or more to help. For the more important stations men always are told off; thus one hand is always selected for masthead-man, bowsprit-end-man, &c.; and so far as the number of the crew will admit, there should be a just and effective division of labour.

CREWS.

Under the Y.R.A. rules, there is no restriction as to the number of hands a yacht may carry in a match, and this plan is found to work best, as no sailing master will carry more hands than are absolutely necessary, and if crews were limited, sails must be limited also, or a yacht would be frequently short handed. The only argument used in favour of limiting hands, is that a man with a lot of money and a disposition to spend it, would, by carrying a number of hands, get an advantage over a man with less money or differently disposed about spending it. The plain answer to this is that no sailing master ever dreams of carrying more than the necessary number of hands, and every yacht should be allowed to carry that number.

Attempts have been made to lay down a rule for so many hands for so many units of a yacht's tonnage, but any such rule fails, for the reason that although one man to every 5 tons may be a good proportion for a yacht of 100 tons, yet one man would not be sufficient for a 5-tonner. For match sailing, the following table will be found to accord pretty regularly with practice. The numbers include master, mate, and boatswain, but not pilot, cook, or steward.

| Size of Yacht. | Ordinary Crew* of racing yacht. | Extra Hands. | Total Racing Crew. | Extra Hands, Amateurs. | Total with Amateurs. | Crew of Cruising Yacht.* |
|----------------|---------------------------------|--------------|--------------------|------------------------|----------------------|--------------------------|
| 5 | 1 | 3 | 4 | 4 | 5 | 1 |
| 10 | 2 | 3 | 5 | 5 | 7 | 2 |
| 15 | 2 | 4 | 6 | 7 | 9 | 2 |
| 20 | 3 | 5 | 8 | 8 | 11 | 3 |
| 40 | 5 | 5 | 10 | 9 | 14 | 5 |
| 60 | 7 | 5 | 12 | 10 | 17 | 6 |
| 75 | 8 | 6 | 14 | — | — | 7 |
| 100 | 10 | 8 | 18 | — | — | 8 |
| 125 | 11 | 9 | 20 | — | — | 9 |
| 150 | 12 | 10 | 22 | — | — | 10 |
| 175 | 13 | 11 | 24 | — | — | 11 |
| 200 | 14 | 12 | 26 | — | — | 12 |
| 225 | 15 | 13 | 28 | — | — | 13 |
| 250 | 16 | 14 | 30 | — | — | 14 |
| 275 | 17 | 15 | 32 | — | — | 15 |
| 300 | 18 | 16 | 34 | — | — | 16 |

* Cook and steward not included.

The number of the ordinary standing crew given for a racing yacht is somewhat in excess of what a cruising yacht would carry, but as the spars, sails, and gear of a racing yacht are so much heavier, the crews must be heavier also.

For racing it will not matter what the rig is, whether cutter, schooner, or yawl, the same number of hands will be required. In a cutter, the sails, spars, and gear are heavier to handle than in a schooner, or yawl of similar tonnage, on the other hand, the number of sails and the extra gear of a schooner or yawl require more hands.

A sailing master will generally endeavour to make up a crew from men who have been in a racing yacht before; this of course cannot always be done, and it follows that somebody must ship the green hands. However, excepting the circumstance that a hand who has been in a racing yacht is already "proved and rated," there is no disadvantage in having one or two green hands, as a couple of matches will make them perfect, if they have been trained as good yacht sailors in other respects. Men widely differ in their smartness and in their habits; and a man may be tolerated in spite of his moral delinquencies and faults of temper, because he is a very smart seaman, but a sloven should be given a very wide berth, as he will not only be offensive to the rest of the crew, but in all probability no seaman. As a rule, the smartest men are the most cleanly in their habits, the most prompt in doing their work, and in obeying orders, and the most satisfied, not to say proud, of their lot. On the other hand, a sloven is dirty in his habits, indolent, slow in obeying orders, and an inveterate grumbler. He quarrels with the catering, with the work he has to do, with the liberty

he gets, and with the places he visits. Such a man should find no berth in a racing yacht, and if a sailing-master unfortunately ships such a creature, and does not instantly unship him when his character is patent, that sailing-master will not be doing his duty to the owner, to himself, or to the rest of the crew. It is frequently said that the men who come from this place, or that place, are better or smarter than others; but this is entirely a mistake. Good Cowes men are as good as good Southampton men; good Colne men are as good as either; and as there is no difference in the degrees of worth of the men, so is there no difference in the degrees of their badness. At Cowes, or Southampton, if a man is shipped who has never been in a yacht before, the probability is, that he will be no seaman at all. If such a one is shipped from the Colne, the probability is that he will know a great deal about seamanship as represented by a smacksman, but he will be a rough hand, and if he has to work upon rigging, or in any way assist in fitting out, his work will be rough; his manner will probably be rough also; he will handle things roughly, and may possibly have a perpetual desire to smoke, and perhaps will expectorate on the deck, and show a partiality for the after part of the vessel. This man will never much improve in his habits, but he will be good at hauling, good at belaying, good at reefing, and good and trustworthy in bad weather.

The cost of yacht racing is very important, and of course, so far as crew expenses go, will depend upon the number of matches sailed. The other expenses, which relate to the hull, sails, spars, and rigging, can be put down at from 50 per cent. to 60 per cent. greater than those for the cruising yacht. The crew expenses will also be a heavy item, as the number will not only be greater, but there will be the extra money, and food and drink on racing days. In most yachts, the practice is to give the men meat, bread, and beer (or, on wet cold days, rum), on the days when matches are sailed; no doubt this practice is in much favour among the crews, as frequently enough food is left to supply the mess another day. However, a fashion has been introduced of paying the men half-a-crown extra for racing days, and making them find themselves in food and drink. This greatly simplifies the accounts, and prevents the owner's good nature, or inexhaustible means being imposed upon.

The expenses of a 10-tonner will serve to show the nature and extent of the cost of yacht racing. It will be assumed that she commences to fit out on the 1st of May, and is laid up on the 30th of September, therefore that she is in commission twenty-two weeks.

EXPENSES OF A RACING TEN-TONNER.

| | £ | s. | d. |
|---|----------|----|----|
| Sailing master (per annum) | 50 | 0 | 0 |
| One Seaman, twenty-two weeks, at 26s. | 28 | 12 | 0 |
| Clothes for master and man | 10 | 10 | 0 |
| Three extra men for twenty matches, 10s. each | 30 | 0 | 0 |
| Winning money for the same, for (say) ten matches, another 10s. each.... | 15 | 0 | 0 |
| Food and drink for forty matches, twenty sailed with amateur and twenty with paid crew, about 1l. per match | 40 | 0 | 0 |
| Winning money to master and man for (say) twenty matches, 1l. each ... | 40 | 0 | 0 |
| Losing money for the same, for twenty matches, 10s. each | 20 | 0 | 0 |
| Pilot for thirty of the matches sailed, at 2l. a match | 60 | 0 | 0 |
| Entrance fees | 20 | 0 | 0 |
| New mainsail * | 26 | 0 | 0 |
| Fitting out expenses | 20 | 0 | 0 |
| Ship Chandler | 10 | 0 | 0 |
| Store | 10 | 0 | 0 |
| Hauling up and launching | 15 | 0 | 0 |
| Insurance | 20 | 0 | 0 |
| | £415 2 0 | | |

As a set off to these expenses, there will be, of course, the prizes, which would probably amount to 200*l.* But even deducting this, it will be seen that racing a 10-tonner is a very expensive amusement.

Of course, these expenses could be very greatly reduced. In the first place, no more than twenty matches need be sailed; next, amateur crews might be more often made use of; a pilot need not be had so often if the owner or his master, or one of the owner's friends is well acquainted with the waters in which the matches are sailed; and a new mainsail need only be had every other year. However, if forty matches were sailed in one season, a new mainsail would be almost a necessity. The expenses of a 15-tonner will not greatly exceed that of a 10-tonner, and the general cost of keeping one, irrespective of racing, will not be much in excess of the smaller vessel. But in a 20-tonner, although two hands might very well manage her, the sailing master takes the form of a regular "skipper." In a 10 or 15-tonner, the master works just as the man does; turns out at six o'clock to scrub down, takes his turn with the other hand at every kind of work and liberty. In a 20-tonner, the skipper does not show on deck until after breakfast, and his greatest exertion is usually steering the vessel and talking to the owner, the same as it is on board of other large yachts.

With regard to one branch of the expenses enumerated, that of "racing money" or the extra money given to crews on racing days, has long formed a vexed question. Formerly it was 1*l.* all round and 5*l.* for the skipper, but during the last quarter of a century, the practice has sprung up of giving the men 10*s.* for racing and losing, and 1*l.* for

* The old mainsail will about pay for other new sails, repairs to sails, &c.

racing and winning. The sailing master is rewarded by a per centage on the nominal amount won (generally 5 per cent.). It need scarcely be said that the yachts which observe this arrangement, are more in favour among the men than those which only give the 1*l.* for winning, and the result is that those who ship in the latter have a standing grievance unless a prize is won for every start. Occasionally an owner who has no knowledge of the customs of yacht racing appears to place an undue value upon the exertions of a crew, and when victory is secured rewards the sailing master and crew out of all proportion to their services. The answer may perhaps be made that the importance of the services is proportional to the desire of the owner to win; this may be so, but the practical effect of such excessive liberality on sailing masters and crew, is to make the former foolishly vain and presumptuous, and the crew insolent and indifferent about everything but racing. Fortunately this evil appears to work its own cure, as the owner soon finds that instead of winning more prizes by paying liberally or foolishly, he wins less and finds that his vessel and crew are hated with undisguised zest by the crews of all other vessels.

If racing money is given at all, the 1*l.* for winning and nothing for losing system does not seem just. A vessel cannot win by the exertion of the crew alone, and if she could, it may be taken for granted that the crews would exert themselves to the utmost without the stimulus of extra pay. A yacht's success depends upon her excellence as compared with the excellence of other vessels, upon her canvas, upon her sailing master and crew, and upon the varying fortune of wind. It therefore does not seem just that if a crew exert themselves to the utmost and lose, that they should have nothing, whereas if they had won, a *douceur* of 1*l.* to each man would have been given. It may be argued that many owners would not race if they had to pay 10*s.* losing money, because they know that their vessels are not so good as some others, and therefore that their chances of winning are more remote. This may justify the owner in not racing, but it is hardly fair to the crew if he does race. If the 1*l.* winning money is fairly earned, the 10*s.* losing money is equally well earned, and the difference of 10*s.* between the two *douceurs* is quite sufficient to keep up the desire to win. But there is still another very strong argument to be advanced on behalf of the 10*s.* losing money plan. The extra men get 10*s.* for coming on board to race, and if these men are given 10*s.* besides their ordinary day's pay to come out of a strange vessel, it certainly is no more than just that the regular crew of the yacht should have 10*s.* besides their day's pay as well. The extra men have comparatively little work to do beyond the pulling and hauling during the race, but the regular crew of

the yacht have most likely a hard day's work before the race, and a harder one after the race. It is not the fact that the work is no harder on board a racing yacht than on board a cruiser; in reality there is no comparing the two, and the life on board a cruiser is ease, luxury, and indolence, compared with the worry, discomfort, and work on board a racing yacht. We therefore think that the general practice of giving racing money is a just one, and that it should be apportioned as follows: 1*l.* for racing and winning first prize, 15*s.* for racing and winning second prize, and 10*s.* for racing and winning no prize. If the losing money is not given, only 10*s.* should be given for winning.

MANAGEMENT OF MATCHES.

The first rule of the Yacht Racing Association,* is that "all races and all yachts sailing therein, shall be under the direction of the flag officers or sailing committee of the club under whose auspices the races are being sailed." All matches are to be subject to their approval, and they have the power to settle all disputes, and their decision is to be final, but they may "upon the application of the parties interested, or otherwise, refer the questions at issue for the decision of the council;" but there can be *no appeal* from the decision of the flag officers of a club, or sailing committee to the Council, nor can a party interested in a dispute demand as a *right* that the matter shall be referred to the Council, the option of so referring disputes to the Council rests entirely with the flag officers or sailing committee. However, the practice is, where both disputants request it, for the flag officers or sailing committee to refer the dispute, and in most cases such a request from one disputant has been complied with. Also in cases where a general principle is involved, or where none of the Y.R.A. rules appear to clearly meet the matter in dispute; or where the reading of a rule is doubtful, or is open to more than one interpretation, the flag officers or sailing committee have of their own accord referred disputes to the Council.

However, whenever the cause of a dispute is clear and whenever a rule exactly meets the case, or whenever there can be no question that a breach of a rule has been committed, the flag officers or sailing committee should decide the case for themselves. They should apply the rules as stringently as possible, but at the same time should remember that the rules were founded upon the principle of "fair play" only, and were

* The full text of the sailing rules of the Yacht Racing Association, as revised for 1879, will be found in the Appendix.

not intended to be penal in their operation; exemplary penalties or decisions should be avoided; on the other hand, that class of protest which has been aptly termed "frivolous and vexatious," should be discouraged.

In most cases breaches of rules are more or less the result of accident or errors of judgment, and in giving decisions regard should be taken of the character of the breach, and of the manner of its occurrence. But a protest should not be dismissed for the mere reason that it has had no effect on the issue of a race, although in certain instances that feature could be properly considered; still in the majority of cases it is impossible to say how far a breach of the rules has influenced a result, even though it be such a trifling matter as carrying an anchor on the bow in a "cruising trim race" or "side lights in a race at night." It is not a sufficient excuse to say that a breach of a rule was the result of an error of judgment, carelessness, forgetfulness, or ignorance; no such pleas are admissible; nor should it be overlooked that a rule may be designedly and persistently broken. On the other hand, a rule might be broken through an entirely accidental cause; such for instance as a delay in the delivery of an entry, or the dragging of moorings; such breaches might reasonably be overlooked, if satisfactorily accounted for; but if a yacht crosses a line too soon through an error of judgment, or touches a mark through an error of judgment, or in a cruising-trim race fails to start with an anchor on the bow, and fails to carry one all through the race, such errors of judgment or persistent breaches of rules could only be regarded adversely.

POSTPONEMENT OF RACES.

The flag officers or sailing committee can only postpone a race on account of unfavourable weather, such as a calm, a fog, or a very heavy wind.

FLAGS.

A yacht which is competing in a match is required to fly a distinguishing "rectangular flag of suitable size." Flags of "suitable size" for yachts of various tonnages will be found under "Flag" in the Appendix.

ENTRIES: POST ENTRIES.

Many a time an owner has been disappointed in sailing because his entry arrived too late, and he should recollect that by the Y.R.A. rules,

a yacht must be entered for a match at *least* forty-eight hours before noon of the day appointed for starting the race. But a *longer* time may possibly be required, and in inserting the dates of a match in a diary, the date of closing the entries should be inserted as well.

A club cannot accept post entries, but sometimes a yacht, which was not properly entered, is allowed to start upon the other competitors signing a paper that they do not object. If the other competitors did not do this, and if the post entry won the prize, the club or regatta committee could be sued by the owner of the second vessel; and he could recover the amount of the prize.

Entries can be made by telegram, and it is considered a sufficiently good entry if proof is given that the telegram was despatched or handed in at the telegraph office *before* noon of the day on which the entries closed. So also if it can be *proved* that a letter was posted in such time that the entry ought in the ordinary course to have arrived before noon of the day on which the entries close, the entry should be considered a good one. A plea of forgetfulness, or a general statement that somebody was "told to enter the yacht, and forgot to do it, or neglected doing it," does not justify the acceptance of a post entry.

Post entries are condemned for two strong reasons; in the first place they are disliked by the owners of the yachts that have already entered in good time; in the second place, they are disliked by clubs and regatta committees, because owners are induced to hang back until the last moment to see if the weather will suit their yachts, or to see if they can arrive in time to sail. The chance of swelling an entry by admitting a late comer, that had not deferred entering for any of the above reasons, is a very remote one, and post entries are now rarely heard of.

A yacht cannot be entered for a race under two rigs, but if there are two or more distinct races at the same time, or a prize for each rig, she can enter under a different rig for each. If it is a race where there is an "allowance for rig," a yacht cannot be entered under different rigs. In a race where there are distinct prizes for more than one rig, and where the rig of the "first yacht in" determines the rig of the winner of the principal prize, an owner may enter a yacht of each rig, but in no case can two yachts of the same rig be entered in a race.

In *all* cases the form of entry provided by the Y.R.A. should be signed by the owner or his representative before the race is started. So also in all cases should the declaration that the rules have been strictly observed be signed before a prize is presented.

In races that are ordered to be re-sailed, from whatever cause, *all* the original entries can start, and no yacht, whether she was among the

original starters or not, requires to be re-entered. The yachts in fact are regarded as the entries in a race which has been postponed.

If a yacht commits a breach of the sailing rules in a race which is unfinished, no action can be taken under the alleged cause for protest; and should the race be re-sailed, the breach of sailing rules is, practically, considered as not having taken place, and the offending yacht starts on exactly the same terms as the others, and can win the prize, providing, of course, no breach of the rules occurs during the re-sailed race.

INSTRUCTIONS.

Sailing committees should be very clear in the instructions they issue as to the manner of starting and the course, and in no case should verbal instructions be given, nor should verbal alterations be made to written instructions.

A sailing committee can, however, if they so choose, issue verbal alterations to instructions; but such verbal alterations, the same as all other alterations, should be clearly made known to the person in charge of *every* competing yacht in the race, otherwise a yacht that had not been made acquainted with the alterations, but had fulfilled the original instructions, could claim the prize, so also could the yacht that won the prize by fulfilling the altered instructions. As mistakes in issuing instructions are usually the result of a simple misunderstanding, the fairest way is to pronounce the race void, and order it to be re-sailed.

A secretary, acting under the direction of the committee or flag officers, can deliver verbal alterations or instructions; but such alterations or instructions would render a race void, or cause the yacht or yachts acting upon such verbal alterations or instructions to be disqualified under a protest, if it were proved that the secretary had acted without authority or direction from the flag officers or sailing committee.

STARTING.

The starting rule of the Yacht Racing Association has now been in use four seasons, and is well understood both by owners and sailing masters. In that rule it is enjoined that the signal flag denoting the race shall be hoisted half an hour before the signal to start is made. This is sometimes supposed to mean that there must be a separate half hour between each race; this, however, is not the case, and so long as the signal flag for a race is hoisted half an hour before the time appointed for the race to be started, the rule will have been complied with. This

may be of great importance at some regattas where there may be several matches to sail. There can be any interval between the starting of the matches that a committee may find convenient ; for instance, the starting of several matches could be arranged thus :—

| Signal flag denoting race. | Time for hoisting signal flag. | | Time of hauling down signal flag, hoisting Blue Peter, and firing preparatory gun. | | Time of hauling down Blue Peter, and firing gun for the start. | |
|----------------------------|--------------------------------|----|--|----|--|----|
| | H. | M. | H. | M. | H. | M. |
| B | 9 | 30 | 9 | 55 | 10 | 0 |
| C | 9 | 45 | 10 | 10 | 10 | 15 |
| D | 10 | 0 | 10 | 25 | 10 | 30 |
| F | 10 | 15 | 10 | 40 | 10 | 45 |
| G | 10 | 30 | 10 | 55 | 11 | 0 |
| H | 10 | 45 | 11 | 10 | 11 | 15 |
| J | 11 | 0 | 11 | 25 | 11 | 30 |

There are two ways of starting yachts in a match, one from anchors or moorings, and the other under way ; the latter is frequently termed a flying start.

If the start is from anchors or moorings, the yacht should be taken to her station in good time ; and to wait for a yacht that is late in getting to her station is hardly fair to those which are in time.

As a rule yachtsmen prefer under-way starts, as it enables them to get the sails properly set, and to know exactly what sail to set. Perhaps, however, if there is a great difference in the size of the competing yachts, the owners of the small ones would prefer a start from moorings with all sail down, as they would be able to haul up their canvas quicker than the larger yachts, and so gain an advantage. This is not fair to the yachts of larger tonnage, and the most just plan is to start yachts under-way, or with after canvas set.

There is another reason why, when starting from moorings, yachts, if the state of the tide and wind permits, should be allowed to set after canvas previous to the signal for the start ; when a start has to be made with all canvas down, a 10-tonner will carry two or three more hands, than she otherwise would, for the sake of getting up the canvas quickly. Five or six men are quite sufficient to work a 10-tonner when once she is underway, but it is the practice to carry eight when the start is from moorings with all canvas down ; a 10-tonner is thus often made to carry about quite an unnecessary deck load. Of course the larger the yacht the greater is the number of these "canvas hoisters," and years ago the practice was to turn them into a boat, waiting alongside, directly the canvas was up. To prevent this practice a rule was passed that no one should join or leave a yacht after the preparatory gun had been

fired. The Y.R.A. have modified this by limiting its application to paid hands.

It will be assumed that the race is for 10-tonners; and, as the method of starting and general conduct of a race is the same for yachts of all sizes, a 10-tonner will answer the purpose of illustration as well as one of larger size. If the start is from moorings, go up to the buoy to pick it up just as you would to pick up any other buoy. (See "Seamanship.") If the yacht is before the wind, lower all sail and go up to the buoy with way so much deadened that the yacht scarcely moves, due allowance of course always being made for tide, whether foul or fair; in beating up to the buoy, the yacht must be rounded to and made shoot head to wind up to the buoy. Get hold of the buoy and hawser and haul about ten or twelve fathoms on board; then bend on the quarter spring to the hawser, veer out the hawser again and belay the spring with some slack aft. In starting from anchors, if the chain has to be slipped, the spring will be bent to the chain as it would be to the hawser. If the anchor has to be weighed, no spring will be bent on. If a yacht starts from her own anchor and slips and the anchor has to be got by a boat, it is best to bend a trip line to the crown of the anchor with a buoy. Also if the anchor has to be weighed in a 5-tonner, it will be found best to put a trip line on the anchor and pull it up over the bow regardless of the cable, which can be got in at leisure.

Too much of the hawser should not be hauled in, as the yacht may drag, and this would render her liable to disqualification; neither should the rudder be put hard across, as that will cause the yacht to sheer and bring the stream of the tide on one bow, or on the broadside, and the force of the stream acting on such a surface may cause the yacht to drag, and this would render her liable to disqualification.

Sometimes when starting from moorings or anchors, permission is given to set after canvas prior to the gun for the start being fired; but if the yacht is riding head to the tide with the wind blowing astern, she could not keep at her moorings with mainsail set. In such cases the sail will not be hoisted till the last two or three minutes. But everything must be got ready long before the five-minutes gun.

The breeze we will assume to be of whole-sail strength, that is that the biggest topsail, not being a balloonier, can be just carried on a wind, and that the first part of the course lies to windward. See that the topsail is bent to the yard, and that the halyards are properly bent; also bend the second topsail, roll it up on the yard, and stow it away with the other spare spars on deck "ready when wanted." Haul No. 1 jib out by the traveller in stops, hook on the halyards, and let it lie on

the bowsprit; get the mainsail (with boom well topped) and the foresail ready for hoisting. If the jib topsail will be wanted, hank it on to the topmast stay, stow it on the bowsprit end, and bend the sheets. See that the sheets are clear for hauling in aft.

See that everything is stowed below that will not be required on deck, and also see that everything that is on deck and not in immediate use is securely lashed. Have an axe ready to cut the quarter spring in case it jammed.

At the five-minutes gun place the crew at their stations.

The helmsman of the day then takes the helm; with him aft will be the pilot, who will also look after the quarter spring and attend to the mainsheet; the mate will cast off the spring or hawser forward, clear the jib-halyards for hoisting, and with another hand hoist the jib and take in the lee jib-sheet; one hand will hoist the foresail and attend to the lee foresheet if necessary; two hands will man the peak halyards, and two the throat, the jib and foresail men tailing on directly they have pulled these sails up. This will be work for eight hands; if the pilot is not allowed to work, the jib-halyard hand will go aft and cast off the spring and jump forward directly it is done.

As the time approaches for the firing of the gun to start, try to realise that everything must be done at once. If the yachts are lying head to wind and tide, and have to fill on starboard tack, the helmsman in the last fifteen seconds will put his helm to starboard, so as to make sure of the wind catching the yacht on the starboard bow. As the gun fires the mate will throw overboard the bow fast, and the quarter spring will be hung on to until the yacht is fairly filled on the right tack, when it will be thrown overboard by the pilot; all hands will hoist away. The pilot will overhaul some of the mainsheet and drag it in again directly the yacht begins to move through the water, and the helmsman will gradually bring her to the wind. Get all the sails set and properly purchased as quickly as possible is advice that cannot too often be repeated, and when they are so set coil up all ropes, &c., and "clear the decks."

If the yachts are to proceed against wind and tide, and to fill on starboard tack (*i.e.*, cast to port), the helm will be put to starboard just before the start, in order to sheer the yacht's head to port or off the wind (in reality the stern will come more to windward than the bow will go off to leeward). Great exertion must be made to get the mainsail up quickly if it is not already set.

In starting to run with the tide and wind, hold on the quarter spring until the vessel is fairly swung round before the wind. If to run before the wind against the tide no quarter spring will be required,

although one is generally bent on. In all cases get the canvas set as quickly as possible, and directly the hands who are hoisting the head sails have got them up hand taut, they should jump on to the main and peak halyards; the purchasing will be done after the sails are fairly hoisted all round.

In starting every caution must be exercised to avoid fouling other yachts; but frequently a foul cannot very well be avoided if a yacht has no way on, and is simply moving with the tide; but if the vessel has gathered way she is under control, and no foul should take place.

In an under-way start great care must be exercised that *no part* of a yacht (her bowsprit, booms, and sails included) is on the line before the signal to start. The strength of the tide and the wind should be so well judged that the yacht can, with full way on, go over the line at the very moment the blue peter is lowered and the gun fired. In all cases the master should strive for a weather berth, especially so if the start is for a thrash to windward. If the yacht is a little too early she must be stopped: yaw her about; haul the foresail up to windward; haul the main boom in; or if the vessel is by the wind it can be run well off her quarter—this only if there be plenty of help to get it in again. In extreme cases the yacht can be put about, but she should not wear unless there be a lot of time, as it will take her right away to leeward.

If the yacht is on the wrong side of the line when the gun fires she must be careful to keep clear of all yachts that are crossing or have crossed the line properly; so also must it be recollected that in under-way starts all yachts are amenable to the sailing rules directly the preparatory (five minutes) gun has been fired; and one of the rules is that yachts coming into position from the wrong side of the line after the signal to start must keep clear of yachts which are starting or have started properly.

Whether the start be from moorings or under way the master should, to the best of his judgment, get the exact canvas up at first that can be carried; and if it is a case of reefing, always remember that it is a great deal easier to let a reef out than take one in.

If it is to be a start before the wind, a reef may be required when the yachts draw on the wind; in such cases the practice is to start with a reef down and jib-headed topsail over it; then when the yacht is brought by the wind the topmast is housed, or got on deck if the rigging is fitted on a funnel).

HEAD-REACHING AND WEATHERING.

It can be assumed that the yachts in the match are close-hauled standing on starboard tack on their first board in the beat for No. 1

markboat; jibs have been purchased up till the luff is as straight as the forestay, peak purchased up, main tack bowsed down, topsail tack hauled down and sheeted home, and sails trimmed to the exact inch of sheet. The water is just squeezing through the lee scuppers, and the helmsman has plenty of weather helm to play upon in luffing to the "free puffs."

Two yachts have started abreast of each other, but one a hundred yards or so to leeward. The one in the lee berth holds much the better wind, and is gradually eating up to the other and head-reaching too. At last she is close up under the lee bow of the craft to windward, and in another half-minute her weather quarter-rail promises to strike the bowsprit or lee bow of the other; which has to give way?

To begin with, we must clearly understand what is taking place. Close-hauled means sailing so close to the wind as a vessel can be sailed with a view of economising distance or time, or both, in reaching a particular object. The vessel that is "weathering," and at the same time head-reaching, can in this case be taken as a standard for the condition of being close-hauled. It is thus quite clear that the vessel to windward does not fulfil that standard, and is in the condition—an uncontrollable one it can be admitted—of bearing away on the other. This, under Rule 22 of the Y.R.A. (the Luffing and Bearing Away rule), a yacht is not allowed to do, and she must luff up to enable the other to clear her. However, the general practice in such a case is for the leeward yacht to be given weather helm to keep clear of the one to windward; then when she has drawn clear ahead the weather tiller lines can be eased, and she will literally fly out across the bow of the other. This, on the whole, is the better course; and further, it is the course that must be followed if the leeward yacht head-reaches from a position astern, as by the Luffing and Bearing Away rule "an overtaking vessel, if to leeward, must not luff, so as to interfere with the yacht she has overtaken, until she has drawn clear ahead."

It may possibly be argued that the leeward yacht is not luffing, that she is (for her) only a bare close-hauled, and that it is the windward yacht that is bearing away. Such a dispute can only be settled in one way: the leeward yacht was in the position of the overtaking vessel, and should have kept clear of the yacht to windward. Therefore in all cases if the leeward yacht is head-reaching, and at the same time weathering, we think it is good policy for her to keep clear of the yacht she is likely to foul to windward. It will not do for the yacht to defer using a little weather helm until her weather quarter is so close under the bow of the yacht to windward that the fact of

putting her helm up would have the effect of swinging her quarter on the bow of the other.

But it may happen that the yacht which is to windward is head-reaching, although not holding so good a wind as the other; in such a case the yachts may converge, and the lee quarter of the windward yacht may be likely to foul the weather bow or bowsprit of the leeward yacht. In this case it will be the duty of the windward yacht to keep clear of the one to leeward, as she is in the condition of a yacht bearing away, and is the overtaking yacht and must keep clear of the other; and moreover, by the rule before referred to, a yacht in the position of the one to leeward, that is being overtaken, may luff as she pleases to prevent another passing to windward; and further, when two yachts have the wind on the same side, and if no question of overtaking is involved, the yacht which is to windward must keep clear of the other.

If the windward yacht has deferred luffing until such time as the bowsprit end of the other is close to her lee quarter, it will be too late to luff, and a little weather helm will probably take the yachts clear. The leeward yacht will be pretty certain to have been well blanketed by the one to windward; her way will therefore be stopped, and the other, under the influence of her weather helm, will lift her stern to windward and forge clear.

When the leeward yacht is passed like this, it will be a good time to choose for getting a pull on any of the purchases that may require it. If the yachts are not too close when the blanketing takes place, it is the practice for the helmsman of the leeward yacht to put the helm down as the sails begin to shake, and make a shoot to windward clear of the wash of the other; but care must be taken not to keep the vessel shooting so long as to lose her way, as she might get in irons.

PORT AND STARBOARD TACK—CROSS TACKING.

One of the most frequent causes of protest arises out of the rule that provides for keeping vessels clear of each other when crossing on opposite tacks. The Y.R.A. rule is simply that of the Board of Trade, which says that "when two yachts are crossing so as to involve a risk of collision, then, if they have the wind on different sides, the yacht with the wind on the port side shall keep out of the way of the yacht with the wind on the starboard side.

In the first place, it must be clearly understood that the rule was not intended to put any penalty or odium on a vessel for being on the port tack; the rule was solely intended to keep yachts clear of each

other, and for this purpose it was necessary that the rule should say which of two positions should be the one which must always yield. It was decided that the port tack should be chosen, but there could be no particular reason for preferring the port tack to the starboard tack for the purpose. It undeniably gives an advantage to starboard tack, and often, so far as match sailing is concerned, a seemingly unfair one; and hence, perhaps, there is often some feeling imported into the situation when two yachts are crossing on opposite tacks.

A yacht on the port tack may be so far ahead of the one on the starboard tack as to be able to almost cross clear ahead of her, but not quite. If there is the least doubt about it, the yacht on the port tack must give way, however hard or apparently unfair it may seem for her to do so. If she does not so give way and fouls the other yacht, or if that other yacht has to bear away or luff to avoid a collision, the yacht on the port tack must be disqualified without hesitation.

But frequently the yacht on the port tack could have crossed clear ahead of the yacht on the starboard tack, providing the latter had not luffed at the last moment, and by so luffing succeeded in striking the lee quarter or boom end of the yacht on the port tack.

Apart from the obligation* of conforming to match sailing rules, if it were proved in court that no collision would have happened if the vessel on the starboard tack had not luffed, the decision would be that the vessel on the port tack should not be liable for any damage done to the other vessel: or that each vessel should pay her own damages. The Board of Trade rule is that, when one of two vessels has to keep out of the way, the other shall hold a steady course, and also that no vessel shall neglect any ordinary precaution in special cases. *On the other hand, the decision of a sailing committee would properly be that the vessel on the port tack was alone in fault. In competitive sailing, the temptation to make close shaves is very urgent, and any decision which would tend to encourage such practices should be avoided as the risks are so great.* By the Y.R.A. rule the yacht on the port tack is bound to give way if a *risk* of collision is involved. It is usual for the vessel on the starboard tack to "nip" a little when one on the port tack is coming for her; and this tells the vessel on port tack that she must not expect her to give way. If, however, a vessel on the port tack is crossing just clear ahead of the other, and that other luffs and touches the quarter of the vessel on port tack, the case is somewhat

* If two yachts agree to sail under and be bound by particular rules, such as those of the Y.R.A., and whilst sailing under them a collision or damage occurred, it would not be right to repudiate such a contract for the sake of appealing to another set of rules which might be different.

altered, and involves wilfulness on the part of the vessel on the starboard tack; but the answer manifestly is that the vessel on the port tack is not justified under the rule in placing herself in a position where the other can touch her, as the risk of collision is clearly involved. However, as the rule was not intended to give a special advantage to the vessel on starboard tack, she should not needlessly bully the unfortunate one on port tack by luffing for the purpose of making a foul.

The right of luffing has been claimed for the starboard tack, because some old rules enjoin that the vessel on the starboard tack should *never bear away* but *luff* or *tack* if a collision is imminent; no such rule now exists, and the right of luffing is claimed by the yacht on the starboard tack on the ground that the vessel on port tack has under Y.R.A. rules unconditionally to get out of the way.

The practice of bearing away by a yacht on the starboard tack is a dangerous one, from the fact that, if the vessel on the port tack also bears away, a collision is almost inevitable, and under the aggravated conditions of accelerated speed. Beyond this, in the event of the vessel on the port tack not giving way, there is generally great difficulty in proving that it was necessary for the vessel on the starboard tack to bear away to clear her. Legal decisions could be quoted in which, in the case of collisions, the vessel on the starboard tack has been distinctly blamed for not having luffed, instead of having kept away; but the Board of Trade rule is absolutely silent on the point, and gives no instructions whatever to the vessel on the starboard tack further than by Article 18, which enjoins that when one of two vessels has to keep out of the way, the other shall keep her course; the Y.R.A. rule is equally silent on the point, and it was found inconvenient to stipulate that where one of two vessels has to keep out of the way the other shall keep her course.*

More cases might, and do in fact, occur, when it would be much easier for the vessel on starboard tack to avoid one which has improperly got across her on port tack, by using a little weather helm instead of lee helm; in fact, if the vessel on starboard tack is to strike the other on the starboard quarter (well aft), it is evident that the collision could be better avoided by the vessel on starboard tack bearing away than by luffing. Of course this assumes that the vessel on the port tack has fairly got across the other, and is thus unable to do anything herself to avoid the impending collision. It is quite natural that the masters of square-rigged ships should prefer

* For instance, the "luffing and bearing away" rule is contrary to the spirit of such a direction as this, and it has been argued that the overtaken vessel should neither be allowed to bear away nor luff to prevent another passing.

bearing away to going about, on account of the ease of the one operation in comparison with the labour of the other ; but if there is any law (beyond the seaman-like custom of the sea) which condemns them in penalties for the consequences of bearing away instead of tacking, the Board of Trade rule ought clearly to warn them of it. In the merchant navy the general practice is for the vessel on port tack to go about some time before she gets near the other ; but in the case of yachts in competitive sailing the vessel on port tack invariably holds on to the last moment, and the vessel on starboard tack, knowing that the other, according to the rule, ought to give way, does the same. And the result is that the question generally amounts to this—What is best to do?—and not what the sailing rule says ought to be done. So far as we know, the rule that the vessel on starboard tack should luff, and not bear away, has never been general ; and, although some clubs have gone so far as to say what the vessel on the starboard tack is to do, we cannot call to mind any case where a yacht has been mulcted in a penalty for bearing away instead of luffing. The clubs which had an instruction on the point before their adoption of Y.R.A. Rules were Royal Dart, Royal Victoria, Royal Cornwall, Royal Albert, Royal Welsh, Royal Cinque Ports, and Corinthian ; all the others (including Royal Squadron and Royal Thames) were silent, simply requiring the vessel on port tack to keep out of the way of the other. The Royal Victoria rule was the most explicit, and ran as follows: “Yachts on the port tack must give way to those on the starboard tack ; and wherever a doubt exists of the possibility of weathering the one on the starboard tack, the one on the port tack shall give way ; if the other keep her course and collision occurs, the yacht on port tack shall pay all damages and forfeit all claim to the prize. The yacht on the starboard tack shall never bear away ; but if she is obliged to luff or tack to avoid the other yacht, the yacht on the port tack (so obliging her to luff or tack) shall lose all claim to the prize.”

We believe this rule was framed by the late Mr. G. Holland Ackers, who had a very strong opinion on the point, and published it as a kind of axiom in his Signal Book, &c. The effect of the rule would be, if stringently enforced, that no protest would stand if the vessel on starboard tack kept away instead of luffed. Would this check the dangerous practice of bearing away ? We think not. We believe that the greatest safeguard will be in sailing committees and the council of the Y.R.A. firmly administering the very letter of the rule, as it now exists, in all cases wherever a risk of collision has been proved through the vessel on the port tack not giving way. It is much too late to talk about disqualification and penalties after a collision has occurred.

A yacht on the port tack can therefore be disqualified under the following conditions :

1. If she is struck by a yacht which is on the starboard tack, no matter how that striking was brought about.
2. If she herself strikes a yacht which is on the starboard tack.
3. If she causes a yacht which is on the starboard tack to luff or tack to avoid a collision.
4. If she causes a yacht on the starboard tack to bear away to avoid a collision.

We will now say a few words on the conduct of a yacht on the starboard tack. It has already been said that it is the practice to nip or luff the vessel on starboard tack a little when approaching one on the port tack, to show the latter that she must give way. The vessel on the starboard tack should never begin to *bear away* unless she positively intends to go under the stern of the one on the port tack. By bearing away it will encourage the belief on board the vessel on the port tack that she is to pass ahead; then if the vessel on the starboard tack luffs and says she will not allow this, it may be too late for the vessel on the port tack either to bear away or tack and avoid the risk of collision. The safer thing for her to do under such circumstances will be to luff or tack, as this will deaden her way. The vessel on the starboard tack should also luff up, and the two will probably come alongside. A protest will follow, and the vessel on the port tack will excuse herself by saying it would not have happened if the vessel on the starboard tack had not begun to bear away. This may be true, but, inasmuch as it was the duty of the vessel on the port tack to keep clear, no matter what the vessel on the starboard tack might do, the former would be disqualified.

A vessel on port tack approaching another on the opposite tack should never be "nipped" in the hope of weathering. It will not aid her if the other "nips" also, and a collision may be the result. A trusty hand should be placed in the lee quarter to watch the other vessel. Pilots, as a rule, cannot be trusted for this task; they are unused to vessels of such speed, and the vessels, so to speak, slip from under their feet, and so their judgment is entirely at fault. If the hand in the lee quarter has the least doubt about weathering, and if you know he can be trusted, put the helm down at once so as to tack well clear of the other vessel, and not have to hustle round under her lee bow and get a tremendous smothering. If it is decided to bear away, begin in good time so that the vessel on the starboard tack may know what you

are going to do. It should be always remembered that the whole onus of keeping clear rests with the vessel on the port tack.

As a rule, a sailing master when caught on the port tack will prefer bearing away to tacking, as less ground is lost, and the risk of getting a smothering is avoided.

In bearing away a hand should be always sent to the main-sheet (whether it be the vessel on port or starboard tack), to slack out some if necessary, to enable the vessel to get off the wind more rapidly. (See also "Approaching a Shore Close-hauled," page 232.)

OVER-REACHING.

In beating to windward for a mark great care must be taken not to over-reach; that is, not to stand on so long as to be able to more than fetch a mark when the yacht is put about. In most cases a cutter yacht will fetch a mark (if not more than half a mile distant) on the next tack if the mark is brought to bear abeam—*i.e.*, at right angles to the keel, or eight compass-points from the direction of the vessel's head. This is supposing that there is no tide. If the tide be going to windward, so much need not be allowed; if the tide be going to leeward, more than eight points must be allowed. The helmsman, by watching his vessel and objects on shore or around on previous tacks, will be able to judge how much should be allowed for tide; and he should always remember that it is better to err by allowing too much than too little, providing of course that the vessel does not over-reach so much as to lose her position in the match.

When working by long boards and a vessel tacks for her mark, say a mile off, and can just lie for it, she should be sailed along a good full, and not be nipped or squeezed; if in the end she does not fetch, it cannot be helped, but it is certain that she will not have lost so much ground by having to tack again as she would have by sailing out a long board with her sails lifting.

WEATHER BOWING.—BEARING AWAY.

A favourite pastime of a sailing master is to "weather bow" another vessel, that is to place his own vessel in such a position on the bow of the other that she immediately intercepts the wind of that other vessel, and causes her head sails to lift. If the vessels are pretty evenly matched, the leading one will be able to put the other under her lee quarter every time they tack. The one to leeward may ramp off, but she will never

get clear unless she is a very much faster vessel. The object of the leeward yacht will be to get into cross tacking, and this her adversary will try to prevent, and tack as frequently as she does. This diversion may possibly be a bad thing for them, so far as the result of the match goes, as their frequent tacking cannot be otherwise than a gain to the yachts which are working by longer boards.

If the leeward yacht finds that the one to windward will not permit her to get into cross tacking, she will probably, as aforesaid, ramp off and endeavour to get through the lee of the weather yacht. For the leeward yacht to do this successfully, that is, to be able to reach far enough ahead to tack across and weather the other one, she must be the faster vessel, or otherwise she will still find the other on her weather bow every time they tack. As the lee yacht is ramped off, the weather one is commonly sailed hard too, or what is known as a "good full." But the helmsman must be very careful with his weather helm, as the windward yacht is supposed to keep her luff, and is not allowed to bear away so as to prevent the other yacht passing to leeward; thus, the windward yacht should be kept no more than a "good full and bye" whilst another yacht is under her lee. In speaking of "bearing away" it must not be assumed that the yachts get very much off the wind; if they did—say three or four points—the effect would be that the leeward yacht would come out clear ahead of the other. This is not the kind of "bearing away" which is practised. Strictly speaking the "bearing away" is simply sailing "ramping full," with a heavy hand on the weather tiller lines. It would be difficult to disqualify a yacht for this under the "bearing away" rule; but, nevertheless, if one yacht is sailing hard, when close hauled, to endeavour to get through the lee of the windward yacht, it would be most unfair for the other to ramp off after her.

A common practice to escape the vigilance of the "weather-bowing" craft is to make a feint at tacking, or, as it is sometimes called, to make a "false tack." The master sings out "ready about!" loud enough to be heard perhaps on board the windward yacht, and the crew go to their stations as if about to tack. The master eases the helm down, but is careful that the yacht does not pass the head to wind point; he keeps her shooting, and one hand hauls the foresheet up, and perhaps takes in the slack of the weather jib-sheet. The master of the windward vessel thinks it is a real tack, and puts his vessel about; the other thereupon reverses his helm and backs his vessel's head off on the same tack again. This trick does not always succeed, but it does sometimes. In practising this subterfuge great care must be taken by the leeward yacht that she is not so close to the windward yacht as to bring about a collision by putting her

helm down. If a collision ensued the leeward yacht would be held to blame.

Frequently a great deal of time is wasted by a sailing master attempting, by "weather bowing," to stop every vessel that comes in his way, big or small; this is very foolish. The first aim should be to get all the speed and advantage possible out of a vessel; secondly, if she comes across a vessel that appears to have as good or better a chance of winning than herself, endeavour to stop her by legitimate means, but do not needlessly waste time with a vessel that has little or no chance of winning; thirdly, if you are beating a vessel that, next to yourself, has the best chance of winning by keeping with her, do not leave her; fourthly, if, when sticking to a vessel you are being beaten by her, part company and try your fortune on a different cast.

APPROACHING A MARK ON OPPOSITE TACKS.

It frequently happens that two yachts are approaching a mark on opposite tacks, and the one on the port tack may be able to weather the mark, whilst the one on the starboard tack cannot do so until she goes on the other tack. In Fig. 49, D will be the mark, A a vessel on the starboard tack, and B the one on port tack. It would be the duty of B to give way, even though it were at the finish of a race, and that she was in a position to cross the line E; she would be clearly ahead of A, but might not be able to quite weather her, and so would have to give way. We recollect a case similar to the above happening at Cowes between the *Kriemhilda* and *Arrow*, in 1874, in a match of the Royal

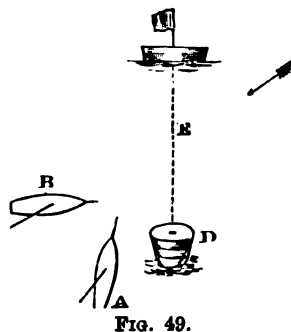


FIG. 49.

Albert Yacht Club; the *Arrow* was on port tack and gave way, but the late Mr. Chamberlayne said he never gave way more reluctantly in his life; yet, as it was clearly his duty to do so, he ordered the helm of the *Arrow* to be put down, and the *Kriemhilda* got round the mark first.

The foregoing case is very clear, and there can be no doubt as to what the vessel on the port tack should do; but the case would be more difficult to deal with if the yachts were in the position with regard to the mark shown in Fig. 50. A is a yacht on the starboard tack; B a yacht on the port tack; D a buoy which the yachts have to round and proceed in the direction of the arrow E. B goes into stays under the lee bow, but a little ahead of A, so that when they arrive at the buoy they are in the

position of A 2 and B 2, and a collision ensues. B will claim the foul, and argue that A should have given her room at the buoy; A will

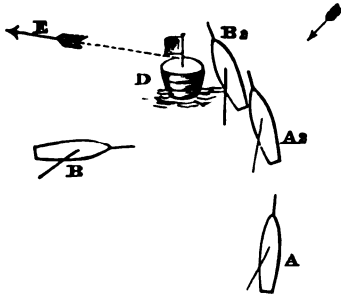


FIG. 50.

claim the foul, and say that B should not have gone into stays in a position where A could strike her. B in this case would be in the right, *provided always that the foul would not have occurred if A had not altered her helm by putting it up.* But B would not be justified in tacking in such a position if she thereby caused A to put her *helm down or luff* to avoid a collision; nor would she be justified in so tacking if a collision ensued, and A did not alter her

course one way or the other. On the other hand, A would not be justified in putting her helm up, and so cause a collision or a fouling of the mark.

ROUNDING MARKS.

By the Y.R.A. rule, yachts must give each other room at marks, but a yacht is not justified in attempting to establish an overlap at the last moment, when it may be impossible for the outside yacht to give room. A yacht in rounding a mark, whether she is hauling round or wearing round, always deadens her way more or less, and if a yacht is close astern so as to be only just clear, it is quite easy for her to make an overlap; but this is just what she is not allowed to do. The overtaking yacht must have, beyond all dispute, established an overlap before the other has altered her helm to round; this means before the other has altered her course and is actually rounding the mark. It frequently happens in light winds that a yacht gets jammed by the tide at a mark, and can only just hold her own abreast of it. A yacht that comes up astern can pass between such other yacht and the mark if there be room; but, if there be not room, she must pass outside.

In running for a mark to haul round, it is generally prudent (if not hauling against a foul tide) to keep well to leeward of the mark, and haul up gradually to it, so that by the time the mark is reached all the sheets are flattened in; in fact, the vessel should be almost "brought to" by the mere hauling aft the sheets, and with as little helm as possible. If the yacht has to be "brought to" against the tide, only a short sweep should be made in rounding; but the sheets must be got aft smartly, so that when the vessel is actually rounding the mark they are properly trimmed. This is particularly necessary if the yacht has to be brought by the wind,

as, otherwise, when the helm is put down she will not come to quickly, and a yacht that may be astern could, by a better hauling of her sheets, come up and cut her out.

If the mark has to be gybed round and the wind is light, the yacht should be run dead for the mark, and should gybe close at the mark, always allowing for tide. The boom can be handled easily, and the shorter the circle the vessel can be turned in, the better. But if there is a strong wind, and an attempt is made to make a short turn by wearing close round the mark, it will probably end in disappointment or disaster. Instead of attempting a short turn, the vessel should haul up to windward of her course a little, and gybe over when one hundred yards or so from the mark; there will then be time to trim the sheets properly, and the vessel will not overshoot the mark nor lose any ground. When a vessel is judiciously rounding a mark like this, she may find one ahead that has attempted to make a short turn of it by gybing at the mark, more or less "all standing." This vessel, before she can be met with her helm, will probably fly to; so look out and go under her stern, if there is room to do so without striking her, and then through her lee. If an attempt is made to keep on her weather, a luffing match will be the result; or perhaps a disastrous collision, as your vessel that gybed first will have great way on, whilst the other, gybing and then flying to, would have almost stopped dead. If a collision under such circumstances did occur, the overtaking yacht would be held to blame, as, although it might have been a lubberly thing to have allowed the leading vessel to fly across the one that was coming up astern, still the latter being the overtaking yacht would have to keep clear. Therefore keep a sharp look-out, and, as before said, if there be room, go under the other vessel's stern, and you certainly will be able to get through her lee. If there be not room to so go under her stern, be ready to give lee helm if necessary to clear her to windward, and you probably will succeed in passing her.

If, when sailing pretty nearly close-hauled, the mark has to be rounded by wearing or gybing, so as to return on a parallel course, the rounding will be an awkward one. If there is much wind it will be prudent to keep well to windward of the mark. Begin to bear up when a hundred yards or so away from it, easing the mainsheet a little, but not touching the head sheets; then as the yacht is nearly close to the mark hard up; as the vessel wears round to nearly before the wind, steady the helm and let the boom go over as easily as possible. Be careful not to ease too much mainsheet; steady the helm directly it is seen that the vessel has had enough to bring the boom over. The object will be to turn the vessel slowly at first, making a long sweep; then quickly, and

then slowly again at the last. In bearing up round a mark in this way care must be taken that neither the boom nor any of the lee rigging touches the mark boat; and if the markboat is flying a large flag, be careful not to touch it, as although merely touching such a flag would not be held to be a foul, still there would be the risk of the flag getting hung up in some of the yacht's gear, and the boat itself might be dragged alongside.

In gybing always be smart with the topmast shifting backstays and the runners; get them hauled taut before the boom actually goes over, and let go the weather backstay and runner as the boom comes amidships.

As a hauling mark is approached always get the sails well set for coming in on the wind. Anything that requires setting up should be attended to before the mark is reached. If a jib requires shifting do not forget that it can be done more easily whilst before the wind than on the wind. Very frequently a vessel is run off the wind on purpose to get in the jib; but this can only be done at a great loss of distance.

Sails will require frequent "setting" during a match, and a sharp look round must be taken constantly, especially when coming to wind from sailing off the wind. In getting a pull on the topsail tack do not forget to ease the sheet first. In setting up the peak of a mainsail always take the weight of the boom with the topping lift. In setting up a jib always see that the runners are taut.

In light weather and with a foul tide, yachts frequently drive back past a mark after fairly rounding it. A case, recently argued, involved the following conditions: In the diagram, Fig. 51, A is a buoy which

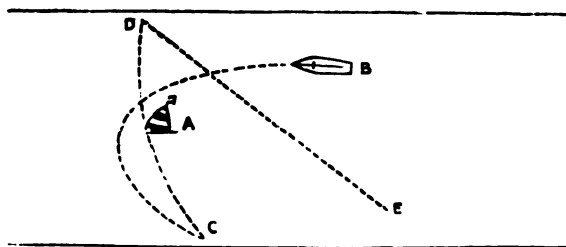


FIG. 51.

has to be rounded on the port hand. B is a yacht running before the wind for the buoy; she hauls round the buoy and stands close hauled to C, where she is fairly above the buoy. The yacht is put about at C, and stands across towards the buoy again, but fails to weather it; she fetches the point D, and stands towards E. It was contended that B not having weathered the buoy in standing from C to D, did not round

it on the port hand. But it is quite clear that if the yacht when at C was clear ahead of the buoy A, the rounding would be a good one.

Let it be supposed that the yacht B was beating to the buoy and weathered it, and then ran up past the buoy to E or to a point abreast of C, it could not be contended that the buoy had not been rounded (it always being understood that a mark has not to be "circumnavigated"). If, when the yacht arrived at E or abreast of C, the wind fell light and the tide carried her back past the buoy, and she ultimately repassed the buoy on the side D, that would not affect the first rounding, which would be held to be a good one.

This case can be differently illustrated; at the finish of a race a mark boat had to be left on the starboard hand in the direction of the arrow (Fig. 52). The yacht instead passed up, leaving the mark on her port side in the direction of the dotted line from A to B; then round the mark until fairly below it at D, where she turned and repassed the mark, leaving it on her own starboard side, thus fulfilling the conditions.

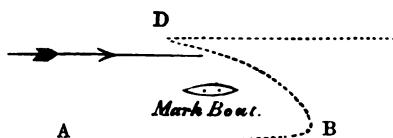


FIG. 52.

In cases like these, the only point to decide is whether the yacht has been in a position to make the rounding a good one. In the first case (Fig. 51) when at C, it would be required to be proved beyond all doubt that the hull and spars were fairly clear of the buoy in a line at right angles to the last course (the course in the direction of B to A), and unless the yacht were clear of the mark by such a test, the rounding would not be a good one. A similar test would decide the other case (Fig. 52) by the position at D.

CAUSING A MARKBOAT TO MOVE HER POSITION.

By the Y.R.A. rules if a mark boat shifts her position the race shall be re-sailed again if a committee chooses to so order it; and if a yacht causes a markboat to shift her position, by veering out chain for instance, a yacht can be disqualified. In light weather, when yachts have been driving with the tide, chain has frequently been veered out by the man in the markboat to enable a yacht to clear without fouling; such a thing ought not to be allowed, and the Y.R.A. rule is quite necessary. It has been objected that the man in the markboat might get frightened and veer out chain when the yacht did not require it to be veered out to enable her to avoid fouling; but a man is hardly likely to get frightened when a yacht is slowly driving in a calm, and if there was any breeze

at all he would have no time at the last moment to give chain to his vessel. Most times a yacht goes "straight for" the markboat, and clears it by an alteration of the helm at the last moment. If, under such circumstances, a man in a markboat got scared, and imagined that he could avoid an impending danger by veering out chain, it would show very great folly, as if the markboat was to be struck it could not be avoided by veering out chain at the last moment.

APPROACHING A SHORE OR MARK CLOSE-HAULED.

When two vessels are standing on the same tack for the shore, a shoal, or other obstruction, and the leeward yacht cannot tack without coming in contact with the windward one, she may hail the windward yacht to go about, but she must herself at the same time tack; but if the obstruction is a *mark* in the course, such as a buoy or vessel, which has to be rounded, the leeward yacht cannot so hail the windward one to go about and give her room to tack. If the leeward yacht requires to tack to weather the mark she should ease her helm, and wait till the other one has drawn clear. [This is the Y.R.A. rule.]

When one of two yachts has to tack, the common practice is for the windward one to wait until the other has actually put her helm down before she does so herself; if this is not done she will probably find that the yacht that was to leeward of her has shot up on her weather quarter—some distance astern perhaps, but still on her weather quarter—instead of under her lee beam or lee quarter. This will be annoying, but naturally it is the thing that the vessel which was to leeward will endeavour to effect; and if previous to tacking her position was under the lee bow of the other, she is almost certain to effect her object whatever the other might do.

The rule clearly says that the windward vessel shall tack directly she is hailed to do so (providing of course that the vessel to leeward is in actual danger of running aground if she holds on any longer), and that the leeward vessel must at the same time tack; but what the sailing master of the leeward vessel generally does is to gently ease the helm down, and sail his vessel to the last moment, so as to bring her round well on the weather quarter of the other. This is not always achieved, for the reason, as before said, that the windward vessel waits until the other is fairly tacking, or else, in staying, sails round in the same way that the leeward vessel does.

If the yachts are abeam and very close together—say not more than a length apart—the windward yacht should put her helm down directly she is hailed. If she waits until the other is putting her helm

down, and then eases her own helm, the bowsprit of the leeward yacht may strike the counter of the other, as the bow of the one will be swinging round against the stern of the other. Therefore, in such a case the windward yacht should be very prompt in putting her helm down, and if the other fails to put hers down at the same time she can be protested against.

The leeward vessel is the judge of her own peril, but this does not justify her in needlessly putting another vessel about, and in all cases actual peril must exist.

If, when a vessel has just tacked for water, she meets another vessel standing in on starboard tack, she should promptly hail that vessel to go about; but if she herself has gathered way on the port tack, the one on starboard tack can force her round again; and it is no excuse for non-compliance if the vessel on the port tack says, "We have just tacked for water." If she has room to tack again without getting aground, she must do so, and then immediately afterwards can hail the vessel on her weather to tack, if necessary, to enable her to avoid striking the ground. As a rule, it is a dangerous experiment for a vessel that has just stayed to attempt to clear another by putting her helm up; the safer plan is to put her helm down.

BEFORE THE WIND UNDER SPINNAKER.

The crew ought to be able to rig and to have all the spinnaker gear ready in five minutes; thus in ordinary weather about that time should be allowed for getting the boom out and spinnaker halyards and outhaul bent, and shifting backstay aft, before bearing up round a mark. If it is to be a dead run, take care that the boom is on the right side, so that the vessel can be run for the next mark without gybing; allow for the tide, if any, scan the wind, and determine which side the spinnaker boom shall be on. If after bearing up it is found that a mistake has been made, and that the vessel will not run for the mark in consequence of the main boom being on the wrong quarter, do not try to make her and get by the lee. When running by the lee the mainsail will be doing but little or no good, and, further, the main boom may come over suddenly and pull down the topmast, or break itself on the runner. Haul up to windward a little, and fill the mainsail; but if it involves hauling up more than a point, and the "run" be a long one, gybe over at once and run straight for the mark.*

* If the run be 12 miles, and the vessel haul up a point and run, say, on port tack for half the distance, and then gybe over and run on the other tack, she will increase her distance to 12½ miles.

If the boom has to go square off, ease up the topsail sheet a little if the topsail tack is to windward of the gaff, and ease the topsail lacing and tack too, if it strains badly across the peak-halyard blocks. If the peak of the mainsail falls aboard, ease the peak purchase a trifle, but not until after the topsail sheet has been eased, as the sudden strain thrown on the after leech and sheet of the topsail might cause something to burst. Take in the slack of the weather topping lift before easing up the peak purchase, or the boom may come down on the rail. The weather topping lift should always carry the weight of the boom in running or reaching with the boom broad off. Be careful, if there be much weight in the wind, not to ease the boom off so far as to allow the gaff to press heavily on the lee rigging, as the jaws of the gaff might thereby be broken.

In heavy weather it will not be prudent to run with the boom square off, nor to run dead before the wind; keep a little to windward of the course, and then gybe over and run for the mark on the other tack.

With the weight of the boom and spinnaker boom shifted forward the vessel will go down by the head, and if she does not like the trim the crew should be placed abaft the tiller lines or on the quarter deck.

If the run be a dead one, the helmsman will have two objects in view: 1. To run straight for the mark. 2. To be careful that the mainsail is not gybed.

OVERTAKING YACHTS.—LUFFING, AND BEARING AWAY.

If, when before the wind, a yacht is ahead, and you cannot pass her, run dead in her wake or a little to windward of her wake so as to cover her; you may do her a little harm in this way and prevent her getting away farther. If you are overtaking a vessel and desire to pass her, give her a wide berth either to windward or to leeward; to leeward for choice, as if the vessels are dead before the wind your antagonist cannot bear away after you to do any harm; if you try to pass to windward, a senseless luffing match will most likely be the result.

If a vessel is coming up fast astern and threatening your weather quarter, and you make up your mind that she shall not pass to windward, do not wait until her bowsprit is over your quarter before you luff, but take a wipe out across her when she is fifty yards off or so. She will then know what you mean to do, will probably be unable to get on your weather at all, and more probably will not try it. If she bears up to attempt to go through your lee, do not follow her off; if you do, it will

probably end, after frequent backing and filling, in her ultimately getting her bowsprit over your weather quarter, and a long luffing match will ensue, followed up perhaps by a protest for bearing away.

When one of two yachts which are close together succeeds in going through the lee of the other yacht, the latter, if possible, should run dead in the wake of her antagonist that has just passed her. If the wind is very light, she may succeed in holding her. But the yacht that has just passed through the lee of the other should luff out to a clear berth, and she may thus be able to rid herself of the intended covering. If there be an obstruction to sea room she will be unable to luff out clear perhaps, and may very likely try to get clear by running off to leeward; but here she will find that the sternmost yacht can follow her, and generally running off the wind in such a case is of no avail. It must be understood that the prohibition contained in the Y.R.A. rule on "luffing or bearing away" is not involved here, as it is presumed that one yacht has passed clean through the lee of the other, and if she drops back again that other yacht which was passed becomes in the position of an *overtaking yacht*. An *overtaking yacht* is not precluded from bearing away provided she does not cause the yacht overtaken to bear away also to avoid collision; but an *overtaken yacht* is forbidden to bear away to hinder another passing to leeward; that is, a yacht that is *overtaken* by another yacht must concede an unmolested passage to leeward.

An *overtaking yacht*, if to leeward, is not allowed to luff so as to cause the yacht to windward to luff to avoid a collision until she (that is the *overtaking yacht*) has drawn clear ahead.

It must be clearly understood that the foregoing relates to "yacht racing" alone. Yachts ordinarily are subject to the customary rule of the road, which enacts that "every vessel overtaking any other vessel shall keep out of the way of the last-mentioned vessel," and "when one of two ships are to keep out of the way the other shall keep her course." It is thus quite clear that by the ordinary rules of the sea a yacht that is being overtaken must neither luff nor bear away to prevent an overtaking vessel of whatever description passing her.

By the rule of the road before referred to, a steam yacht must keep out of the way of all sailing vessels; but there would appear to be one position in which the sailing vessel would have to keep clear of the steam yacht. It frequently happens that a sailing yacht is overtaking a steam yacht in a narrow channel or on the open sea, and the question would arise which was bound by the rules to give way? The sailing yacht would point to Article 15, which says: "If two ships, one of which

is a sailing ship and the other a steamship, are proceeding in such directions as to involve risk of collision, the steamship shall keep out of the way of the sailing ship." This is clear enough; only Article 17 says that every overtaking vessel shall keep clear of the one she is so overtaking. Either rule is imperative, and so far there is not a word to direct the master of a vessel as to which rule he must be bound by under such circumstances. However, some light is thrown upon it by the catechism of examination issued by the Board of Trade for the use of examiners in seamanship. Question 62 asks, "What is to be done by A., whether a steamer or a sailing ship, if overtaking B.?" The answer is, "A. is to keep out of the way of B." It is thus quite clear the Board of Trade intends that in all cases the overtaking vessel, whether she be under steam or sail, or both, must keep out of the way of the one she is overtaking. The popular opinion is, that in all possible directions of approach, the steam yacht must keep out of the way of the sailing yacht; but there is, as we have shown, one direction of approach, at least, under which it is the duty of the sailing yacht to keep clear of the steam yacht. A vessel, it must be understood, is only considered as an overtaking one when she is steering in the direction of the one ahead or in the wake of the one ahead, and only in such case would the sailing vessel have to keep clear of the steamer she might be overtaking.

SAILING ALONG A WEATHER SHORE—OVERTAKING.

In sailing along a weather shore always remember that, although a yacht may "luff as she pleases to prevent another yacht passing to windward," she may not shove the other yacht ashore or on to any obstruction; on the other hand, a yacht overtaking another yacht should not attempt to make an overlap just upon reaching an obstruction. This means that *the leading yacht can keep her luff up to the very moment that an obstruction is reached, even supposing that an overlap will occur simultaneously with reaching an obstruction. If the overtaking yacht goes ashore or in any way receives or inflicts damages under such circumstances, she is solely responsible.**

In all cases remember that the windward yacht can only demand room in case she would, by holding to her course, actually strike a mark or take the ground.

In sailing along a weather shore, if the yacht drags the ground,

* See "Approaching a Shore or Mark" (page 232), as to the rights of the leeward yacht. See also the Y.R.A. rule, "Obstructions to Sea Room."

promptly ease off the boom and put the helm up, and send all hands forward. The boom is run off to give the vessel greater list, so as to lighten her draught, and also to prevent her coming to, and so forge further aground. The object of sending the men forward is, that by tripping the vessel by the head, the draught is lessened. If the vessel drags whilst running along a lee shore, haul the boom in and put the helm down.

CLOSE-HAULED AND SAILING FREE.

According to Rule 19 of the Y.R.A., a yacht that is sailing with the wind free must keep out of the way of one which is close-hauled, and there appears to be only one exception to this rule, which will be alluded to under the "Meeting end on" section. In match sailing yachts are likely to get into positions where one going free might foul one that is close-hauled under the following conditions:

1. In beating for a mark when a yacht that is close-hauled might meet one that has already rounded.

2. In running for a mark when the yacht that is before the wind might meet one that has rounded, and is now close-hauled.

In either case it is the duty of the yacht which has the wind free to give way to the yacht that is close-hauled. In most cases it will be safer for the yacht which is free to go under the stern of the other, as by crossing ahead she might compel the yacht that was close-hauled to bear up or luff, and if she did so, the yacht that had the wind free would be disqualified. (See the last paragraph of "Meeting end on" section.)

MEETING END ON.

In sailing with a beam wind, or if one yacht has the wind abaft the beam and another yacht has the wind on the bow, and they be going in opposite directions, they may meet each other end on so as to involve a risk of collision.

In such a case it is the duty of each yacht (even if one is close-hauled) to put her helm to port: that is, the yacht on the port tack will *bear away*, whilst the yacht on the starboard tack will *luff*, and the yacht on the port tack will thus pass on the lee side of the other. (This is the rule of the road observed by all ships.)

In sailing along a shore, either with the wind blowing on the shore or off the shore, two yachts meeting end on might be in a position where it would, perhaps, be hardly prudent for one of them to use much

port helm. In Fig. 53, let A be a yacht close-hauled, and B one with the wind on the quarter; it is quite plain if B ported that she might go ashore; on the other hand, if A ported sufficiently to give B room she might get herself in irons. Again, if B starboarded and hauled off shore she would pass on the weather side of A, and A would get a temporary blanketing; beyond this B would be violating the rule as to porting. The proper thing to do would be for A to edge out a little in good time so that B should not be required to use so much port helm as to endanger her getting ashore. A very little port helm would bring A out clear on the weather side of B, and the rule of the road would have been complied with.

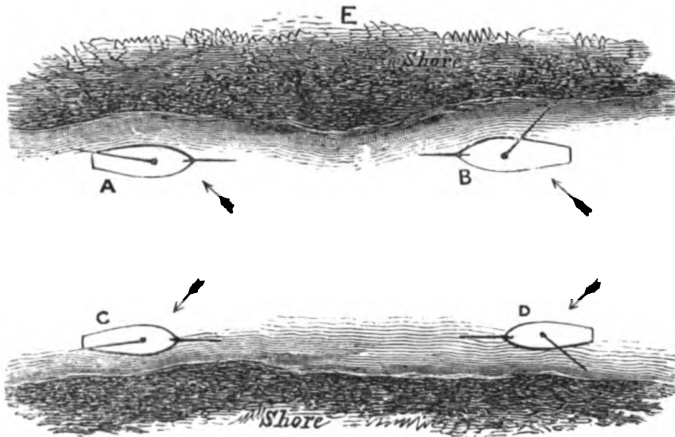


FIG. 53.

But the close-hauled vessel might be on the port tack (see C, Fig. 53), and as she would in such case have to pass on the lee side of the yacht which was free (see D) she would consequently require considerably more room than B, as the main boom of D would be broad off. If C ported sufficiently to clear D and her boom, C would most likely go ashore; but D having plenty of sea room and plenty of sheet to haul upon could make a free use of port helm and clear C to windward in accordance with the rule. In this case almost the entire obligation of avoiding a foul would rest with D.

It must be clearly understood that *this rule only applies when two yachts are meeting end on, so that if no alteration were made in their respective courses a collision would ensue*. If the yacht on the port tack has the other, say a couple of points on her lee bow, and they are sailing parallel courses, it would be manifestly absurd for the yachts to port their helms and cross each other, when by continuing their course unaltered they would clear each other.

If two yachts are approaching, but *not on parallel courses*, they are in the position of crossing vessels, and the yacht which is free must keep out of the way of the yacht which is close-hauled.

SAILING FREE.

In sailing free, if two yachts have the wind on the same side, the one which is to windward must keep out of the way of the other. (This has been already explained.)

But it may so happen that the two yachts may be free and be crossing on opposite tacks. Thus, say the wind is W., and one yacht is steering N.N.W., and the other S.S.W., each a point and a half free, they will be approaching each other at an angle of 134°. In such case it will be the duty of the yacht with the wind on the port side to keep clear of the other, as this would be a clear case of crossing on opposite tacks, and not of "meeting end on." This, however, is a situation not likely to occur in match sailing.

SIDE LIGHTS.

In one of the Y.R.A. rules it is enjoined that all yachts sailing in a match at night shall observe the Board of Trade rules as to the carrying of lights. This rule interpreted strictly would mean that the side lights are to be put in their places at sundown. Sailing masters exhibit an extraordinary aversion to exhibiting side lights in a match, for the reason, as they say, that it is not politic for any vessel to let another know what she is doing. This is a reason that will not hold water, and owners should insist upon lights being carried in their proper places. Of course if a match is within a half hour or so of being concluded at sundown, the rule would not be enforced, but where a case of "sailing at night" is involved, it would be inexcusable not to carry lights. It is sometimes supposed that it is sufficient to have the lights on deck ready to show, but obviously if all the yachts in a match did this the lights would be useless, as if the yachts could see each other so as to know when to show their lights, there would be no occasion for exhibiting them at all.

This is one of the rules which owners should see observed as a matter of honour, and no occasion for protest should ever occur under it.

YACHTS IN DIFFERENT MATCHES.

It is now a common practice for two or three or even more matches to be started on the same day to sail over the same course, and the Y.R.A.

found it necessary to enjoin that the sailing rules apply to all yachts, whether sailing in the same or in different matches. Frequently a big vessel has unjustifiably bullied a small one round when beating to windward, but under the Y.R.A. rules a small vessel which is on starboard tack can force a large one that might be on port tack to give way. It seems scarcely credible that such a rule should be required, and it is even less credible that it should be occasionally observed with doubtful willingness.

SCULLING.

The practice of sculling small boats by moving the rudder backwards and forwards (see "Sculling" in the Appendix) is common in calms, and considerable progress can be made by this means. The question has been raised on several occasions as to the permissibility of such sculling during a match, and two or three protests have arisen out of the practice. It is very useful to scull even large yachts occasionally when they will not come round in light winds, and no one could contend that this was not a legitimate use to make of the rudder; it would be simply "steering," but as no means of propulsion but sails are permissible it certainly is a moot point as to whether sculling, if used as a means of propulsion, should be allowed; and it is satisfactory to note that the Council of the Yacht Racing Association has decided that sculling with the rudder is only permissible for actual steering.

ANCHORING.

Yachts may anchor during a race, but must weigh again, and not slip. Several instances have occurred where a yacht, when kedging in a tideway on foul ground, has been unable to get the kedge on board again. In such a case the crew would heave on the warp until it burst; but if the yacht had let go her bower and chain this could not be done, and the yacht would be compelled to slip and buoy the chain. No adjudication has been made by the Council that exactly bears upon these cases, but the common sense view would appear to indicate that if a yacht burst her warp in endeavouring to recover her kedge, she should not be disqualified on the grounds of slipping. Neither should a yacht be disqualified if after making every endeavour to weigh her bower, she failed and slipped.

Cases have occurred in calms where kedging has been resorted to as a means of propulsion. The kedge has been dropped over at the

bow, and the crew walked aft with the warp, hauled the kedge up over the stern, and let it go again over the bow; or the kedge has been let go over the stern, and recovered at the bow. To get round a mark against a tide such kedging might be successfully practised, but under the rule "that no mode of propulsion except sails shall be allowed," it is clearly forbidden.

SOUNDING.

In the Y.R.A. rules it is enjoined that no instrument other than the lead and line shall be used for sounding. This rule was adopted many years ago by the Thames clubs to stop the practice of shoving a boat along by a pole, yard, or sweep under the pretence of sounding with the same.

HOVE TO ON PORT TACK.

Ordinarily, if a yacht is hove to on port tack and another yacht is approaching her, close-hauled on starboard tack, the one on port tack should in good time fill and get way on and tack or bear away so as to clear the other yacht. But if the yacht on port tack is disabled she could hardly be expected to do this, and the yacht on the starboard tack should keep clear; so also if the yacht on the starboard tack is free and the yacht on the port tack is hove to (whether disabled or not), the former should keep clear.

LEAVING A YACHT DURING A MATCH.

Under most old club rules no one was allowed to join or leave a yacht after the preparatory gun had been fired. This rule was called into existence on the Thames in consequence of the practice of having a number of hands on board a yacht prior to the start to assist in hoisting the canvas, and these men were turned out into a boat directly the canvas was hoisted. But even supposing that such a practice should be prevented, there would appear to be no reason why a mere passenger should not join or leave a yacht during a match, and under Y.R.A. rules it is simply enjoined that no *paid* hand shall join or leave a yacht during a match. This of course gives permission to a passenger or owner to leave, but no paid hand could go from the yacht in a boat to put the passenger on shore.

In the case of a man leaving a yacht by falling overboard, it is assumed to be an accidental circumstance; and if the man has been recovered again by the yacht's own boat or a life buoy, or picked up by another yacht, neither the yacht that lost the man nor the one that picked him up would be disqualified if one or the other afterwards became entitled to a prize by coming in first or by time allowance. But if a yacht or yachts had been in such a position that she or they would in all probability have won the match, had it not been for rendering assistance to recover a man, the committee can order, if they so please, the race to be re-sailed between the yachts which were prevented winning as stated and the yacht that actually did win. Nothing is said about the yacht that lost the man overboard being allowed to take part in the match if ordered to be re-sailed, whatever position such yacht may have been in at the time of the accident; and the inference is that a yacht which is deprived of her chance of winning a race by losing a man overboard must abide by the consequence of her own accident and not be given another chance.

AMENABLE TO RULES.

In a match a yacht is held to be amenable to rules directly the five minutes gun has been fired or the Blue Peter hoisted; and she ceases to be amenable to the rules directly she has completed the course by passing the winning flagboat or mark. A yacht, however, should, after finishing a contest, be most careful to keep clear of all other yachts that have not completed the course, even to the extent of giving way to one sailing free on port tack if she herself is close-hauled on starboard tack.

CHAPTER XVI.

CENTRE-BOARD BOATS.

ALTHOUGH it may be difficult to say what is a boat and what is a yacht, when we are speaking of small craft, yet we think a great deal of this difficulty will be removed if we define a boat to mean a vessel that is not wholly decked, and that can be rowed. In selecting one of these craft that is either open or partly open, the main guide, of course, will be the locality. Thus, if the boat is for Brighton, one of the shallow centre-board beach boats used thereat will be the most suitable, inasmuch as they can be readily "beached" or hauled out of water, it being necessary that they should be so hauled up, as there is no sheltered or safe anchorage at Brighton. For the Thames above bridge, where the winds are light and baffling, a very light centre-board gig is the most useful, as it sails well in light winds, and is easily rowed in calms. On the Mersey, where the boats can lie afloat, and where generally there is more wind and sea than any ordinary boat could well tackle, a heavier and deep keel sailing boat is in use. At the same time, a keel boat quite as light as the Surbiton boats has been introduced on the Mersey; but, in order that they may safely encounter the rough water, are nearly wholly decked in. On the south coast all sorts of sailing boats are to be met with, from the old-fashioned skiff and wherry to very many versions of the Itchen boat.

The centre-board, it appears, was invented, or rather adapted, from the lee-board by Captain Schank, of the British Navy, somewhere about 1774. We have not come across any contemporary record of the invention, but in Charnock's "History of Marine Architecture," published in 1802, the fact is alluded to, together with a description of a boat with a sliding keel built by Captain Schank at Boston, Massachusetts, in 1774, for Earl Percy (afterwards Duke of Northumberland). The engraving Fig. 54, on the next page, represents this boat, and, so far as we know, is the oldest authentic record of the sliding keel. At about the same time Captain Schank was

very strongly urging the English Government to cease building deep ships, and to build shallow ones, fitted with one or more sliding keels. The Admiralty were not, however, to be persuaded into such a startling revolution in naval architecture; still they so far humoured Captain Schank,

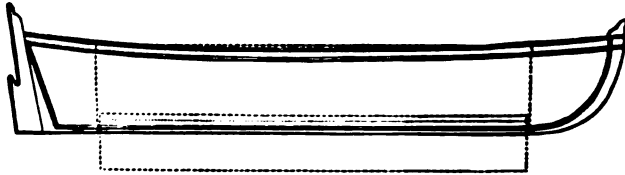


FIG. 54.

that in 1789 a boat was built and fitted at Deptford Dockyard, according to the plan shown in the accompanying engraving Fig. 55. The use of the three boards was as follows: In tacking, or laying to, the centre-board and after board were raised; in wearing the centre-board and fore-board were raised; also in scudding the centre-board and fore-board were raised; going over shallows the three boards were raised. On a wind the three boards were lowered, each to such depth as seemed best to balance the sails. The report of the trials made with this boat seem to have very favourably impressed the Admiralty, and Captain Schank was intrusted to

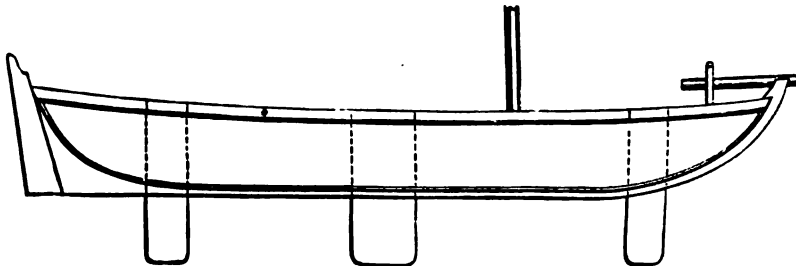


FIG. 55.

design a cutter of 60ft. length and 20ft. beam, with three sliding keels. She had a midship section something like a barge, and a draught of water of 8ft. 6in., and was named the "Trial." She was reported to be a good sea boat, and very handy; but another vessel with centre-boards called the *Lady Nelson* was less favourably reported upon, and the Admiralty, we believe, built no more centre-board ships, and, so far as we were concerned, the invention was lost sight of until the visit of the *America* in 1851 drew attention to them. Not that the *America* had a centre-board, but other American yachts had, and Englishmen about this time became very curious about Transatlantic naval architecture.

The centre-board was still a contrivance something like Earl Percy's, but, instead of being dropped equally fore and aft, was pivoted at the fore end, as shown in the accompanying sketch (Fig. 56) according to a plan introduced by Captain Shuldham, of the British Navy.

The small centre-board American sloop *Truant* was brought over here in 1853, and, although only 20ft. on the water line and 1ft. 2in. draught, beat all the crack 7-tonners in the Prince of Wales' Yacht Club a quarter of an hour in a thrash from Blackwall to Northfleet in a nice breeze, and was very roundly abused for her success. All sorts of stories were current about her shifting ballast, and her crew having their pockets filled with



FIG. 56.

and shot! After this success *Truant* went to the Mersey and Lake Windermere, but what ultimately became of her we do not know. Her rig was as shown in the drawing over leaf (Fig. 57), and is the same as the fashionable sloop of the present day, excepting that the foresail or jib is laced to a foot yard, and tacked at about one-fifth its length from the outer end of the yard on a bumpkin.

The *Una* was the next importation from America, and, although generally resembling the *Truant* in hull, differed in sail plan, as the mast was stepped farther forward, and she had no headsail whatever.

The double centre-board was much advocated in America in 1871, but we believe that no large yacht was built on the plan. However, in 1876 the idea occurred to Mr. W. Jeans, of Christchurch, to have a small craft

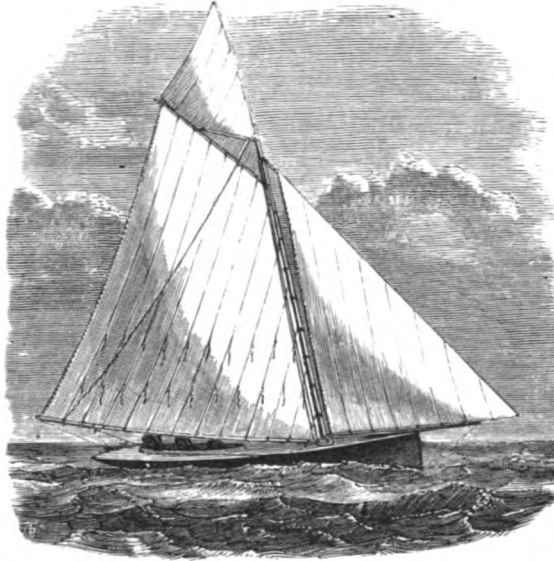


FIG. 57.

provided with two boards, and he published the following description of the boat and drawing (see Figs. 58 and 59):

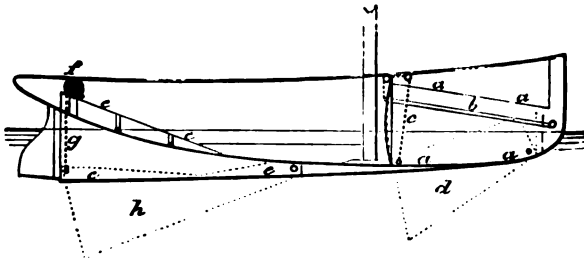


FIG. 58.

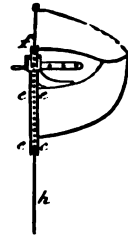


FIG. 59.

The letters *a a a a*, show the fore trunk; *b*, lever; *c*, chain; *d*, keel; *e*, aft trunk; *f*, wheel; *s*, chain; *h*, aft keel.

Mr. Jeans thus referred to his boat:—

“I found her answer remarkably well, both for speed, hardiness, and weatherly qualities. The keels, which are of iron, are situated fore and aft. The fore keel, having its trunk in the cuddy, takes up no room in the boat, and is lifted by a lever and chain band, which runs over a couple of sheaves on the deck beam to get a straight pull. Holes are bored about





an inch and a half apart in the support of the after end of the trunk to take a pin, which regulates the depth of keel. The trunk of the aft keel is the dead wood in the run of the boat. The keel is lifted into its trunk by a small wheel and winch, the wheel being large enough to take up the chain in one turn without overlapping, a dog catching it at any required depth.

“The advantages are these. The keels take up no room in the body of the boat; they can be regulated to carry any kind of helm. By lifting up the fore keel in wearing the boat is much sooner round. If there is a doubt of her not coming about in a seaway, wind up the aft keel, when she will immediately shoot into the wind, dropping it again as soon as she fills on the other tack. In beating to windward in a seaway she will fetch where she points, unlike the ordinary centre-boarder, which, having no grip forward, is knocked to leeward with every sea. She is 12ft. long on the keel, and 6ft. beam, and though of such extraordinary proportions, is remarkably fast, which, I am convinced, partly arises from the proper depths which can be given to the keels, whereby the rudder (except for altering her course) is never out of the line of the keel, consequently never helping to stop her way.”

No doubt the two boards may be found useful under exceptional circumstances, but the single centre-board, as generally in use, is much to be preferred. Such a boat will be more sensitive to slight alterations of her helm, and generally will be more agreeable to sail on a wind. The strongest reason for having two boards would be in the case of a shallow vessel that had to keep the sea, and might have to scud in very disturbed water and generally to encounter heavy weather. However, a yacht of the deep type, with strong fixed keel, would be better adapted for such work.

Two other plans for centre-boards were proposed, in 1877, by Lieut. Tipping, R.N. and Mr. A. J. Lane. The two plans are almost identical, as will be seen by a reference to Fig. 1, Plate II.

Lieut. Tipping, in describing his invention, says: “One of the chief objections to the ordinary centre-board keel is, that the case takes up so much room in the cabin, dividing it completely in half; if the keel be a large one, it comes up to the cabin ceiling when hauled up. To obviate this disadvantage, I propose a plan of extending the deep keel throughout the whole length of the vessel, as shown in the drawing in the above plan, lowering the case considerably, if necessary keeping it under the floor altogether, and getting the same area by length instead of depth. The only disadvantage of extended length that I know of would be that the staying power would be diminished a little; but, on the other hand, a vessel

would stay well with the proposed keel in shallow water, where she would not do so with only a third of the board down if it were on the short system.

“The case extends from stem to stern-post, its planks being countersunk into each, and all riveted together, the heads of which are shown in the drawing. The keel proper is on top of the case, into which the keel is countersunk, and all riveted together. A section of it is shown at *a* in the transverse section, Fig. 2, Plate II. It is securely kneed to stem and stern-post. The case is divided into two compartments by a triangular piece of wood, shown in the centre of sheer plan, shaded. Rivets go through this and both sides of the case, to prevent its closing or opening by warping or straining. The floors are of iron, flat, and bent upon its edge, to fit over the top of keel down side of case, and bolted to timbers acting as clamps to prevent any spring in the case. One is shown in Fig. 2, marked *b*. In the drawing the keel and floors come above the flooring, as the boat's floor is flat, and area of drop keel large; but this of course is not necessary in a slightly deeper build.

“The drop keel is in two pieces; they are hinged together in the centre at *f*; the foremost one pivots in the fore part of the case outside the rabbet, as shown in Fig. 1, Plate II., at *c*. The after keel has a slot cut in it, in which the bolt *d* works as the keel is raised or lowered. They are raised either by a screw working through a stuffing box on top of the keel proper, or by a rope and tackle, as in the ordinary way, the rope working through a pipe or trunk built up above water, as *e*; a wormed wheel would be the most complete, working on the spindle after coming through the stuffing box, but it must be free to rise up in case of striking the ground. On the keel being raised, the upper corners above the hinge will commence to separate, and pass on each side of the triangular piece of wood before spoken of, until they arrive at the top of case, as shown by the dotted lines in Fig. 1, Plate II., which position they will occupy inside the case, the foremost one pivoting on *c*, and the after one receding aft through the length of the slot spoken of.

“An improvement to the slot and bolt might be to hang the aft end by a rope with tackle, and to have the power of dropping it a little at its after end, to counteract weather helm if necessary. I imagine that this system of building would be much stronger than the ordinary plan of splitting the keel for one-third of the length; and I see no reason why it should not be applied to large yachts, enabling them to reduce their draught of water by a couple of feet at all events; and if the keels were made of iron it would keep the weights low.”

Mr. Arthur James Lane, of Surbiton, invented a similar contrivance

(Fig. 3, Plate II.). Mr. Lane proposes that his board should be made of boiler-plate. The fore end of the fore half of the board is pivoted as shown; at A B the plate is doubled, so as to form a case to receive the fore end of the after-plate. This after-plate works on what might be termed an eccentric pivot, as shown at E. The two plates are pivoted together at D, the after-plate being shut in the fore one as already described. The plates are lifted by a rope or chain (attached to the after-plate), and a barrel as at K. The plates when housed have their centre pivot at H, and the after end of the stern-plate goes into the position shown at F.

So far as we can judge, there is not much to choose between the two plans; but, on the face of it, that of Lieut. Tipping's looks the best for work, as more of the board is housed at the ends. However, the other plan has, by virtue of the "hump" (which could be increased) a better hold amidships.

It should be noted that Lieut. Tipping's plan, as shown, is applied to a moderately deep yacht, so that the plates are housed under the platform. Mr. Lane's plan, as shown, is applied to a 17ft. shallow centre-board gig, for rowing or sailing.

It is usual to give a boat of about 17ft. in length six or seven square feet area of centre-board; but in Mr. Lane's plan as much as nine square feet are shown. The area of the immersed longitudinal vertical section of the boat is ten square feet, and the centre of gravity (centre of lateral resistance) is in the same vertical line in each, that is 9ft. abaft the fore side of the stem at the load water-line. The weight of the plates, if of iron $\frac{1}{2}$ in. thick, would be 240lb.; if $\frac{3}{4}$ in. thick, 300lb.; if $\frac{7}{8}$ in. thick, 360lb.; this includes that portion of the plates housed when they are down. However, so much board is really not necessary, and quite sufficient hold of the water could be obtained by a smaller board.

In using either of these contrivances, the sails would have to be very carefully balanced by the centre of lateral resistance, and as the pressure would be greater on the fore part of the board than on the aft part (see pages 15 and 23), it will, in practice, probably be found necessary to have the centre of effort considerably forward of the centre of lateral resistance, to bring about a balance. This really means that the fore board will be doing the greater portion of the work in holding the boat, and this question arises: had not the foreboard be better shifted further aft, and the other half of the board done away with altogether, and thus reduce the surface for friction to a minimum?

Numerous contrivances have been suggested to admit of the inside housing of the board being dispensed with altogether, and a very practical

plan was proposed a short time ago. It consisted of a single plate of iron pivoted at the far end, and made to rest, when hauled up, on one side of the keel. An extension of this plan formed by adding to the plates and forming them into a kind of fan will be found illustrated by Fig. 60. It will be seen that the leaves of the fan are pivoted to the side of the keel at x . The keel is cut away, and a plate, a , bolted over the chamber, so as to form a kind of box or case to take all the leaves when the fan is shut. See the small sketch. The leaves k, k, k , are connected at their after ends by studs and slots. The fan is closed by a bar, working in a pipe p , as shown. The bar is attached to the lower leaf by a stud, which works in a fore and aft slot, s . The lifting bar should be jointed, so that

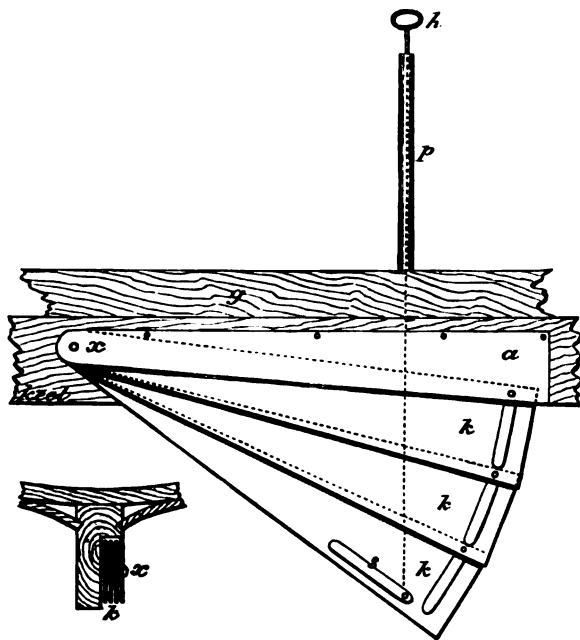


FIG. 60.

when the fan is closed, the handle part, h , will fold down by the side of the pipe. The slots should be cut wide enough to ensure the studs working easily in them. The heads of the studs should be thin, and the edges nicely bevelled off. The number of leaves could be of course increased, but two would in most cases be probably found sufficient and less liable to get locked or jammed.

In 1870 a boat was built by Messenger, and called Wideawake, with a kind of shoe keel. The boat or rather canoe was 15ft. 10in. long, and 3ft. 2in. beam, depth, gunwale to keel, 1ft. 4in. She had an oak keel increasing in depth from 2in. forward, to 6in. aft. To this keel was fitted

a hollow galvanised keel—a kind of case in fact to take the oak keel—12ft. long, made of $\frac{1}{4}$ in. iron (see Fig. 61). The keel was pivoted forward 4ft. from the stem plumb to load line. Care was taken to make the iron case fit the oak keel. The case was raised by a wire fastened to the stern end of the case, and passing through a tube as shown by A B, Fig. 62. The wire passed over a pulley on deck and was secured at mainmast. The keel weighed 28lb.

A better plan than the shoe keel was fitted a few years ago in a small boat, Robin Hood, by Searle, for Mr. W. B. Forwood. She had an oak keel 5in. deep, in the under side of which a slot 9ft. long and 3in. deep was cut; into this slot a galvanised iron plate $\frac{1}{4}$ in. thick, 9ft. long, and 3in. deep was fitted. It was raised and lowered by a rod at each end, working in upright lead pipes.

Among the many curious contrivances to prevent leeway, one exhibited at the Exhibition of 1851 is as strange as any. The designer's idea appears

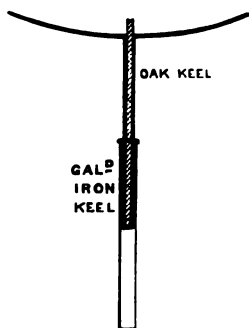


FIG. 61.

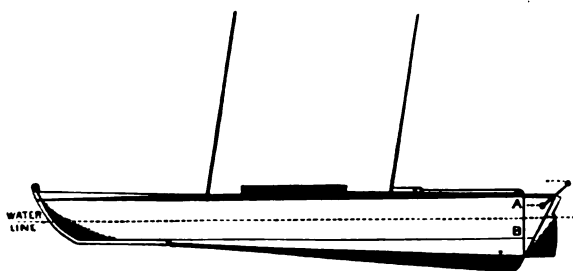


FIG. 62.

to have been, that to obtain the greatest advantage in the way of stability a yacht should be very broad and big above water, and very narrow and small under it (see Fig. 63); and that to get a large amount of lateral resistance, two keels should be had instead of one shaped longitudinally as shown by Fig. 64.

So far as the question of stability is concerned, we need scarcely say more than that it would be much increased if the greatest beam were put on the water line; but as the idea of parallel keels is continually cropping up, it may be well to point out that they cannot be of any advantage. In the first place, there is an extra surface for friction provided by the doubling of the keels, and as surface friction enters so largely into the aggregate resistance of a vessel double keels should be condemned for this reason alone. Secondly, the actual increase in the lateral resistance would be only a very small percentage of the added surface, as the water would practically be locked up between the two keels,

and so really out of the four sides of the keels, only one side (the leeward one of the leeward keel) would meet with lateral resistance.

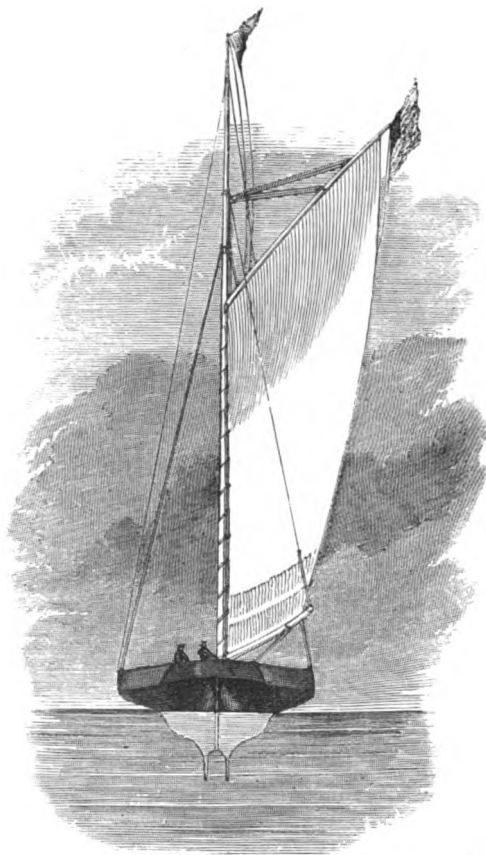


FIG. 63.

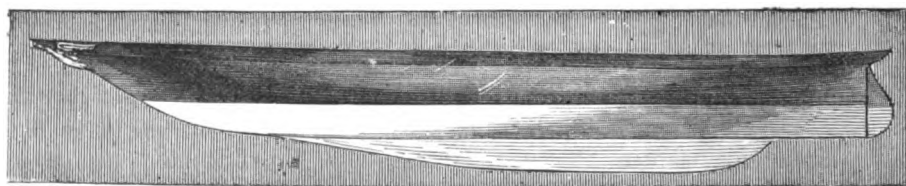


FIG. 64.

Among many other contrivances, the time-honoured lee-board may be mentioned, and the "horizontal keel," descriptions of both of which will be found at the end of the book.

CENTRE-BOARD BOAT FOR ROWING AND SAILING.

The boat most generally in quest on the Thames is the one for "rowing and sailing," or centre-board gig, which has been so laboriously described from time to time in the *Field*. This boat, for the man who likes the exercise of rowing and the pleasure of dodging a wind between the banks of a river, is admirably contrived. But he who has one need be content to limit his cruises to the water upon which she was intended to sail, until he has become a perfect master of the art of boat sailing. He should not be tempted into "cruises" down the river to Sea Reach, to Sheerness, Leigh, or Shoeburyness, as he may be "caught" in a nor'-wester; and then, if he has only been used to open-boat sailing in smooth water, and to very little of that, it may go hard with him. He will find it impossible, even supposing he can reef down and so far handle his craft as to tack her, to get to windward against a lee tide and yeasty sea; and the probability is that, even if the tide be a weather-going one, the sea will be so bad that she will be blown farther to leeward every tack than the tide will carry her to windward. Under these conditions there will be no alternative but to "up helm" and run for it; and, as it may be no more practicable to get into Sheerness than up Sea Reach, the situation of the "outward bound" boat sailer would be decidedly unenviable. Why not put her head to the sea and row her? she is a boat for rowing and sailing. Well, a man cannot row a boat head to sea with much success, and the need of doing so would be a rather severe argument against the sailing qualities of the boat. Then rig and throw overboard a floating anchor, ride to that, and wait till the turn of the tide. Very capital advice, and an old hand might do it, but not a frightened novice. The broad truth is, that a light centre-board gig, easy to row, and not an indifferent performer under canvas in smooth water, is not fit for open water where there might be a real sea—as different to the "magnificent furrows" of up-river as a chalk-pit is to a fox-hole; and even in the hands of a skilled boat sailer, such as a coast waterman, they would be out of place in Sea Reach under canvas.

The annexed diagram (Plate III.) shows a design for a centre-board gig which, whilst having fair sailing qualities, would be no greater labour to row. The drawing is made to half-inch scale; but, as it is rather small to work from, the following tables can be referred to in laying off.*

* Full instructions for laying off are given in "Yacht Designing," but a brief outline of what has to be done can be given here. In the first place, the stem, keel, deadwood, and sternpost should be laid off full size; if a floor cannot be obtained long enough to lay the

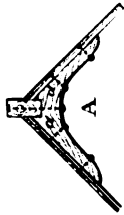
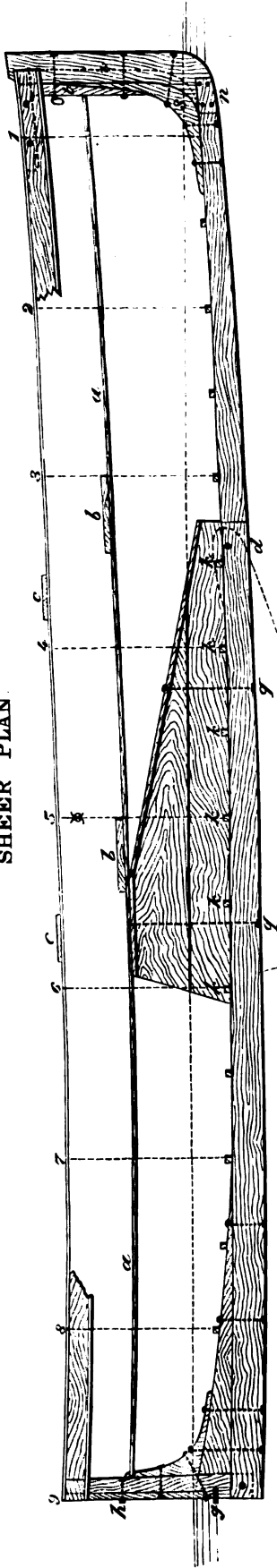
The references to the body plan (Plate IV.) are as under : w is the load water-line (L.W.L.) ; $a a 1$ and $a a 2$; $b b 1$ and $b b 2$; $c c 1$ and $c c 2$ are "diagonals;" o is the middle vertical line, from which all distances are measured ; $p p$ are perpendiculars denoting the extreme breadth ; $m m$ is a kind of base line 10in. below the load water-line, and parallel thereto ; x is a water-line.

The numerals 1, 2, 3, 4, &c., denote the respective sections or timbers, and their stations in the sheer plan and half-breadth plan. No. 9 is the "transom," and of course will be a solid piece of wood, and not a "frame."

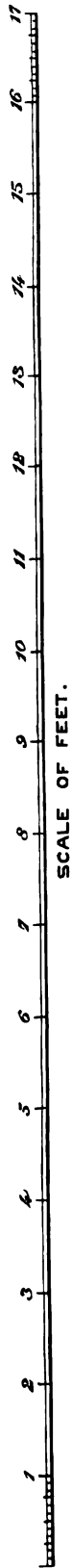
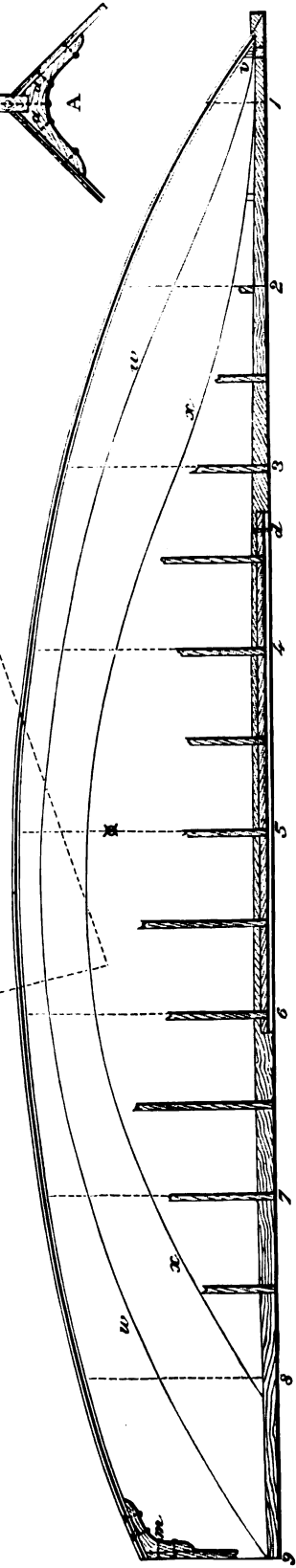
keel off in one piece, it can be divided in two or three pieces ; or a floor can be improvised by placing a sufficient number of deals or planks together, both for the keel and body plan. When the floor is prepared, strike in the load water-line with a chalk line or straight edge ; then, at right angles on either side of this line, set off by aid of an \perp square all the sections 1, 2, 3, 4, &c. On each section mark off the distance from the load water-line to the top of the keel ; and from the top of the keel to its under side. Place a batten (made of inch fir or American elm) over these marks or "spots," as they are called, and chalk in the shape of the keel. The batten can be kept in its place by a nail on either side of each spot. (Of course if the keel has no curve it can be laid off by a simple straight edge or chalk line.) The rounding up of the fore-foot can be obtained by putting in a couple of lines between No. 1 station and the fore-side of the stem, at right angles to the load water-line, and transferring the distances measured on these lines from the sheer plan to the floor. A mould out of a piece of half-inch fir can be made from the drawing on the floor, including stem, dead wood, and sternpost ; but if the keel is to be cut out of a piece of American elm ten or twelve inches deep, then it can be laid off on the timber, striking the load water-line (or a line parallel to it) and sections as described. The remaining portion of the timber can be sawn into floors, &c. The body plan will be laid off by simply transferring the drawing from the paper to the floor. First, the load water-line w will be put in ; then the middle vertical line o , and the perpendiculars $p p$; the base line m will follow ; and then the diagonals a, b, c . The distances given for No. 1 section will be taken from the table and set off on the diagonals a, b, c , each distance to be marked by a "spot" or small cross on the diagonal ; the height of the section from the load water-line to the gunwale, and the depth from the load water-line to the top of the keel, will be taken from the table or from the sheer plan ; the half breadth of the section at the gunwale, and at the load water-line, will be taken from the table or from the half-breadth plan. All the "spots" having been put on the diagonals, and on the water-line, and at the point representing the gunwale height and half breadth, a batten will be placed over the "spots," and its shape chalked in. The batten should be about 6ft. long, $\frac{1}{2}$ in. deep, and from $\frac{1}{2}$ in. to $\frac{3}{8}$ in. thick. The batten will be kept to the "spots" by nails on either side of the batten, not through it. If the curve be unfair, the nails must be slightly shifted until the curve shows fair. If great accuracy is needed, the diagonals can be laid off in long lines to represent a half-breadth plan to further fair the design ; this, however, will be scarcely necessary. Moulds will be made to represent each half section ; but the midhip mould and two others, Nos. 3 and 7, should be a whole one. The moulds can be made from rough $\frac{1}{2}$ in. deal. A piece 2in. wide will represent the middle line o , and the curved parts will be nailed together as required, and fitted with saw, plane, or spokeshave to the lines on the floor. The load water-line must be carefully marked on each mould, both on the perpendicular (o) and on the curve. Having got the building blocks in readiness, set up a line by the aid of a spirit level, at a convenient height above them, to represent the load water-line—a straight edge would do. Put the keel on the blocks, and wedge it up until into its proper position with the load water-line. Then, having got the stem and sternpost into position, fix the representative load water-line to them inside, from the aft side of stem to fore side of stern post. A chalk line should be struck up the centre of both stem and sternpost. The transom and the "full" moulds will then be adjusted and fixed at their proper stations. Presuming the rabbets to have been cut, the planking can be proceeded with, and the floors and timbers fastened in a the planking proceeds.

PLATE III.

SHEER PLAN



HALF BREADTH PLAN.



17ft. Centre-board Boat for Bowing and Sailing.

LAYING OFF TABLE.

| Nos. of Sections. | 1 | | 2 | | 3 | | 4 | | 5 | | 6 | | 7 | | 8 | | 9 | |
|---|-----|-----|-----|-----|-----|-----|-----|-----|-----|-----|-----|-----|-----|-----|-----|-----|-----|-----|
| Sheer Plan and Half-breadth Plan. | ft. | in. | ft. | in. | ft. | in. | ft. | in. | ft. | in. | ft. | in. | ft. | in. | ft. | in. | ft. | in. |
| Heights above L.W.L. to top of gunwale | 1 | 10½ | 1 | 9¼ | 1 | 8½ | 1 | 7¾ | 1 | 6¾ | 1 | 5¾ | 1 | 5¾ | 1 | 6 | 1 | 6½ |
| Depths below load water-line to top of keel | 0 | 2 | 0 | 3½ | 0 | 4¼ | 0 | 5 | 0 | 5½ | 0 | 5½ | 0 | 5½ | 0 | 5¼* | 0 | 5 |
| Depth of keel | 0 | 3 | 0 | 3½ | 0 | 3½ | 0 | 3½ | 0 | 4 | 0 | 4 | 0 | 4 | 0 | 4 | 0 | 4 |
| Half breadths at gunwale | 0 | 7 | 1 | 6½ | 2 | 2 | 2 | 7 | 2 | 9 | 2 | 8½ | 2 | 6 | 2 | 1 | 1 | 5½ |
| Half breadths at L.W.L. | 0 | 2¼ | 0 | 11½ | 1 | 8½ | 2 | 3 | 2 | 5½ | 2 | 5½ | 2 | 0½ | 1 | 3½ | 0 | 1¼ |
| Body Plan. | | | | | | | | | | | | | | | | | | |
| Diagonal a | 0 | 3¼ | 0 | 10¼ | 1 | 2¼ | 1 | 4½ | 1 | 6½ | 1 | 6½ | 1 | 4¼ | 0 | 11¼ | 0 | 3 |
| " b | 0 | 6½ | 1 | 6 | 2 | 1½ | 2 | 5½ | 2 | 7½ | 2 | 7½ | 2 | 4¼ | 1 | 10½ | 1 | 0¼ |
| " c | 0 | 9 | 1 | 11 | 2 | 7½ | 3 | 0½ | 3 | 2½ | 3 | 2½ | 2 | 11½ | 2 | 6 | 1 | 9 |

* Depth to top of dead wood, 3¾in.

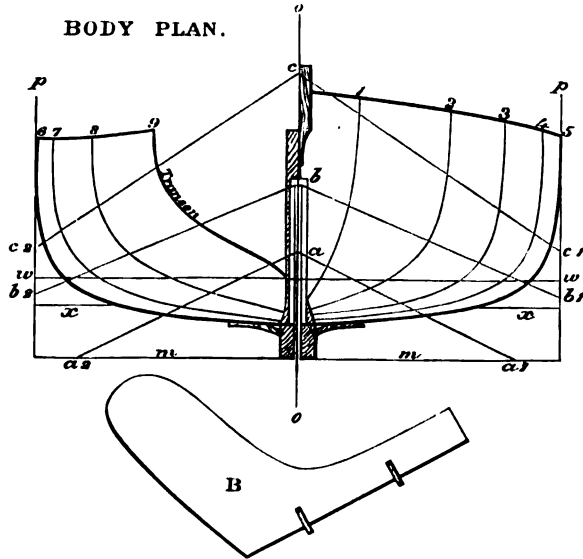


FIG. 65.

The distance *a* (Fig. 65), above the load water-line, *w*, is 3¼in. measured on the vertical line *o*. The distances *a* 1 and *a* 2 from the vertical line *o*, measured along the horizontal line *m*, are 2ft. 3¼in.

The distance *b*, above the load water-line (*w*), is 1ft.; *b* cuts the perpendicular *p* at *b* 1 and *b* 2, 2in. below the load water-line *w*.

The distance *c*, above the load water-line *w*, is 2ft. 2in.; and *c* cuts the perpendicular *p* at *c* 1 and *c* 2, 3¾in. above the load water-line *w*.

z is a water-line struck 3in. below w , but will be of no assistance in laying off, as it does not intersect the frames sufficiently at right angles.

All the half-breadths, and the distances measured from the middle vertical line o along the diagonals to the various sections (as given in the tables), are *without* the plank; so in laying off *no allowance* will have to be made for the thickness of the plank.

The length of the boat is 17ft., and the breadth 5ft. 6in., and the extreme breadth, with the plank on, 5ft. 7½in. Weight of displacement of boat to L.W.L. about 12cwt.

The sections 1, 2, 3, 4, &c., are 2ft. apart, and No. 1 is 1ft. from the fore side of the stem at the L.W.L.

The frames actually will only be 1ft. apart; but every other one is left out in the Body Plan.

The scantling of the boat will be as follows: Keel, sided (thick) amidships 4½in., tapering gradually to 2½in. forward, and 3½in. aft. The moulded depth of the keel will be found in the table.

Stem, 2½in. sided; 4½in. moulded (*i.e.*, its fore and aft thickness) at head, and 5½in. at knee scarp.

Sternpost, 3in. sided and moulded at heel; 2in. moulded at head.

Floors, ¾in. sided and 2in. moulded (deep) at heels, gradually tapering to ¾in. at heads. The floors will be fitted across the keel by ½in. joggles. Timbers at the sides and above floors, ¾in. square.

Plank, ½in. thick. Gunwales, 1in. thick, 1½in. deep.

Stringers (lettered a in the Sheer Plan) 1in. square, fastened through timber and plank. Seats and rowlocks as at $b b c c$.

The centre-board or plate will be 5ft. 4in. long, pinned or pivotted in the keel below the garboard strakes, as shown in the Sheer Plan and Half-breadth Plan (Plate III.) at d , 5ft. 9in. from fore side of the stem at L.W.L. The slot in the keel to admit the plate will be 5ft. 7in. long by ¾in. in width. The floors where this slot comes will have to be cut through. The heels of these floors will be fitted with ½in. joggles, and let in to the under side of the centre-plate case, as shown at $k k k k k k$ in the Sheer Plan. One 4in. copper nail through each heel (outside the centre-plate case) will be sufficient to fasten these floors to the keel. (The case must be very carefully fitted to the shape of the keel, and luted with white lead.) The centre-plate case will be fastened through the keel by long galvanised iron (¼in.) bolts. The case will be made of inch pine; the plate of ¾in. iron.*

* Mr. J. C. Wilcocks gives the following instructions for fitting a centre board case: "If you can get a piece of plank 18in. broad out of which to make the case, so much the better; if not, put the broadest piece you can obtain for the lower portion, and the narrowest at the upper side. Select a piece—if possible without knots—of good sound pine; some use teak or mahogany, but it is unnecessary, although, if you keep the boat brightly varnished,

Sometimes the case is made of galvanised iron, and fitted into the slot. With such cases it will be best to fit a keelson over the heels of the floor, as at *k k*, &c., on either side of the case. These keelsons would

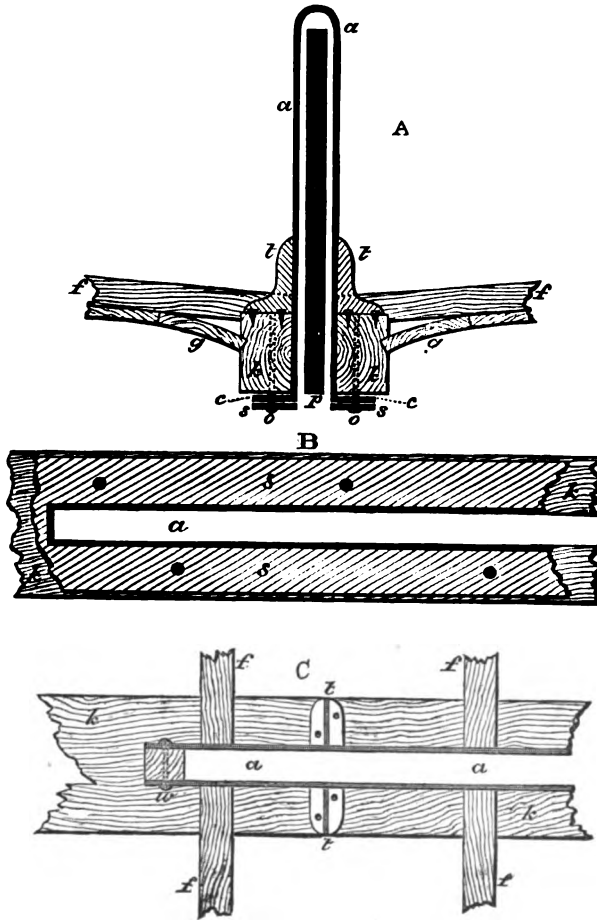


FIG. 66.

require to be about 3in. deep and 2in. broad, with one fastening between each pair of floors. However, as a rule, no such keelson is fitted, a couple

it is to be recommended. In making and fixing the case the most critical work is boring the planks through from edge to edge with a long gimlet like that used by bellhangers; this should be done in a horizontal position, a straight edge being laid on the plank occasionally, whereby to test the directness of the whole, and maintain the direct progress of the gimlet by bringing the straight edge over it, and observing whether the stem of the gimlet is parallel with the straight edge. I had four bolts of galvanised $\frac{1}{2}$ in. iron through each side, those near the extremities being 8in. from ends. These bolts had small heads on them, and passed through the keel, where they were securely riveted on rings. A groove was made in each side of the case at the ends to take a piece of inch fir, which must be carefully fitted and luted with white lead; the slip of fir should be fastened through each side of the case, and the nails rooved and clinched."

of screws or nails in each heel of the floors being considered sufficient. The case would be prevented dropping through the slot in the keel by two small iron knees on either side, riveted to the case and fastened to the keelson.

Mr. W. Baden-Powell has furnished me with the following plan adopted by him in fitting a galvanised iron centre-board case. *a* (see sketch A, Fig. 66) is the iron case, passing through a slot in the keel and turned up underneath as at *c*. Over the lips, *c*, of the case, turned under the keel, an iron keel-band is fitted, as at *s* in Fig. A; and *s* in Fig. B shows the under side of this keel-band. Bolts are put through this keel-band lips of the case, and keel, and fastened with washer and nut upon top of the keel as at *o o*. (The keel-band lips are shown a little apart for the sake of distinctness; of course, in construction all would be drawn close together.) Two small T angle-iron knees are fitted each side of the case (*a*), riveted through the case and screwed down to the keel *k*, as at *t t*. Without these knees the case is likely to get wrenched on one side or the other unless well secured to a thwart. To prevent leakage, a piece of tarred or varnished tape should be laid in the angle of the lips of the case before screwing it up with the keel-band. The latter can be made of inch or thicker iron, as it will serve as outside ballast.

Fig. C shows a view of the case and its fittings, looking down from the inside of the boat; *a* is the inside of the case; *k* the keel; *t* the iron knees; *f f* two floors. *w* is a piece of wood forming one end of the case, and through-bolted, as shown.

The dead wood, knee, and sternpost aft will be through-fastened, as shown in the Sheer Plan; and the sternpost should be tenoned into the keel. Forward the keel and stem will be box-scarphed into each other, and through-bolted, as at *n*. The apron (*s* in the Sheer Plan) will be bolted through keel and stem. The stemson *t* is a kind of filling-up piece, and serves as nightheads for additional plank fastenings forward. The upper through bolt in the stemson should have a ring through it, as shown.

The gunwale (which is equivalent to the clamp or shelf in a yacht, and rests on the timber heads) will be secured to the stem forward by "breasthook," as shown by *a*, diagram A (see Sheer Plan, Plate III.). This breasthook will have one fastening through the stem, and two through each gunwale and top strake, as shown. The gunwale and top strake will be secured to the transom by the knee, as shown at *m* in the Half-breadth Plan, through-fastened. A fastening will also be put through the gunwale and strake into the transom.

The floors should reach from the keel to three or four inches above the load water-line; and the timbers from the gunwale down the sides of the floors to within eight or nine inches of the keel.

The transom will be $1\frac{1}{2}$ in. thick, fitted at the back of the sternpost, as shown in the Sheer Plan.

The rudder will be shaped as shown by the diagram B (under the Body Plan, Fig. 65). Pintles will be dispensed with, and instead gudgeons and braces used, through which a brass rod will pass. This arrangement is necessary, as the rudder will hang considerably below the keel. If the braces are fitted over the gudgeons on the sternpost and a transom at $g h$ (Sheer Plan), the rudder will lift on the rod if the boat drags on the ground, and will not unship.

The rabbet in the stem will be cut at about 2 in. from the inner edges of the stem piece as shown by the ticked line v in the Sheer Plan. The rabbet in the keel (being a continuation of the rabbet in the stem) should be cut not less than one inch from the upper edge; and the same from the upper edge of the dead wood aft, and be deep enough to take a good fastening.

The boat will take about 4 cwt. of ballast with three hands on board; this ballast should either be in the form of shot bags, or flat bricks of lead cast to rest on the top of the floors, but sunk between them. These bricks would be under the platform or bottom board, which should be securely fastened, but at the same time be readily movable. If there is no objection to a cast-iron platform, the "bottom boards" can be dispensed with, and a thin iron slab cast to fit over the floors on either side of the centre plate. For such a boat as the design given the slabs would be 6 ft. long by 1 ft. 6 in. broad, and $1\frac{1}{2}$ in. thick near the keel and $\frac{1}{2}$ in. nearest the bilge. They would be cast with grooves to fit the floors, and the grooves would gradually deepen from nothing at the bilge to $\frac{1}{2}$ in. depth at the keel side. In the stern the usual bottom board or "stern sheet" would be fitted; and forward either a board or a grating would be similarly fitted.

Of course, no plan of lead or iron ballasting will make such a shallow boat as the centre-board gig stiff, in the ordinary meaning of the word, and the large sails (plans of which will be given hereafter, with diagrams of other boats) should not be set unless two or three hands are on board to sit to windward.

The plate or board has been made rather smaller than is usual; but it has been found that a very large board, whilst it adds largely to frictional resistance, does not add proportionately to weatherliness. A very small piece of board will check the leeway tendency of a well-shaped and fast boat, and no doubt quite enough has been shown in the design.

A belief sometimes exists that a centre-board adds to the stability of a boat: so it does if made of iron or other metal, just the same as an iron or other metal keel would; but if the material be wood not heavier than

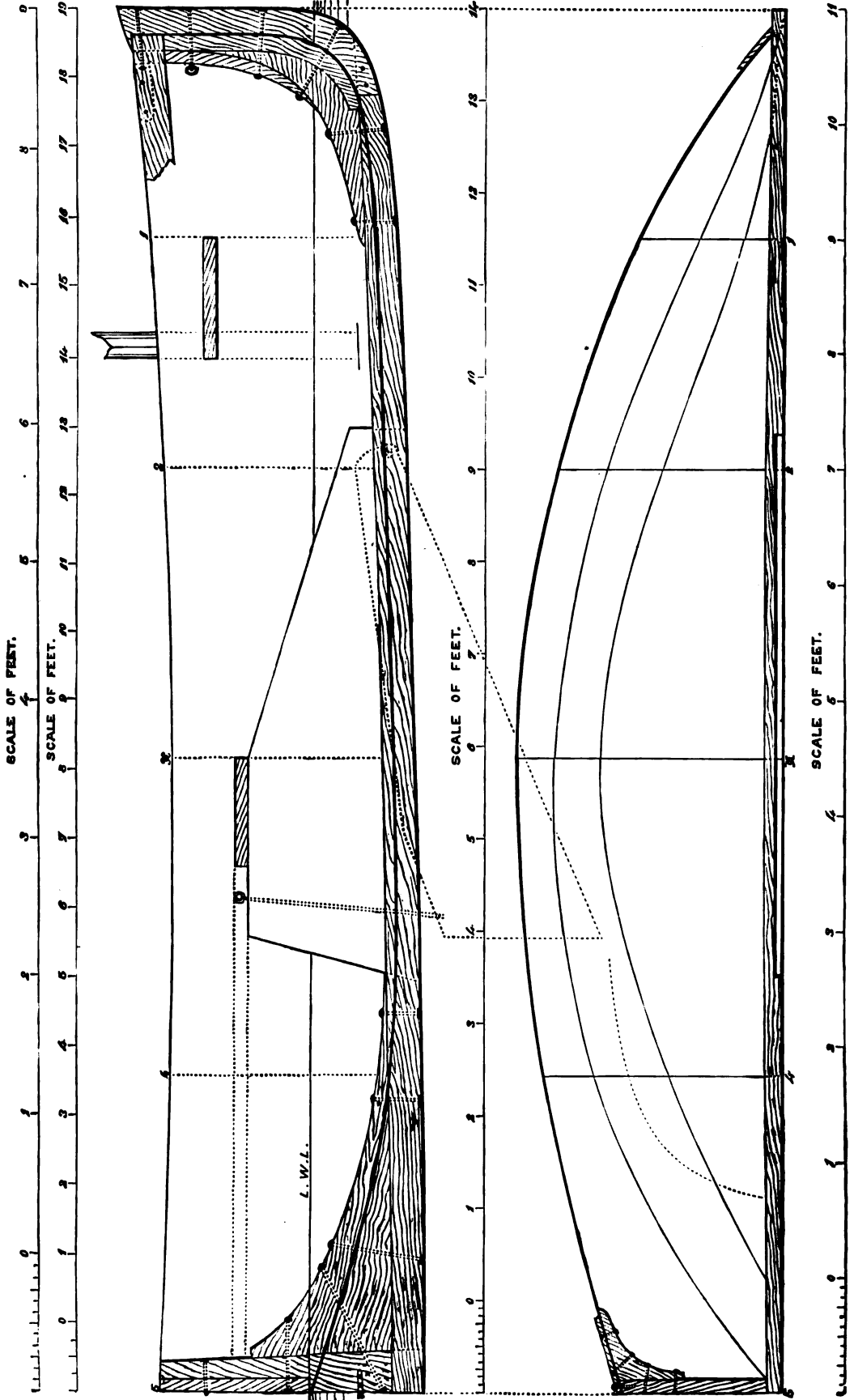
water, the tendency of the board would be to upset the boat, as the wood would strive to come to the surface, or, in other words, to float: thus, the larger a wood board were made, and the deeper it were lowered, the more urgent would be its tendency to assist in upsetting a boat. A board, however, causes the process of heeling to be a little more slowly performed, as the board has to be moved through water, and the resistance to the board being so moved is of the same nature as the resistance of the water to any plane moved in it. Thus, when a boat is once permanently heeled, or has settled down on "her bearings," as it is termed, the board will be of no more use for stability, as its tendency will be to float or come to the surface. If the boat is struck by a squall which only lasts, say, four or five seconds, the board may possibly prevent an upset that otherwise would take place; but if the squall continues, and is of a strength to upset the boat without the board, the boat will be assuredly upset with the board only it may take two or three seconds longer to do so.

The question of decking is one which will naturally arise in selecting a boat. No doubt a locker of some sort, to stow cushions, gear, and sails in, is a desideratum in a boat; but a deck forward and aft, with waterways amidships, as shown in a sketch given farther on, must increase the weight, and for up-river sailing are quite unnecessary. However, if the boat-sailer is equal to the "stress and the strain of wind and the reeling main," and can confidently knock about in the Sea Reach, he will find the decks and waterways a great comfort. They will keep out all the water likely to lop on board, and nothing worse than spray need ever get into the well amidships. A partly decked boat with waterways, built by Messenger, of similar dimensions to the one we have given a design for (Plate III.), but fuller forward and aft, made a trip to Margate and back last autumn; and, whilst she behaved just as she ought in a breeze with some sea, she was not too heavy to row if occasion arose. However, trips to Margate from the Thames, or from Southampton to Portland, are not quite the work for centre-board gigs, and boats much better adapted for the purpose can be built.

A centre-board boat, somewhat deeper, with more rise of floor, also with less length to beam, than the one of 17ft. length, may perhaps be a handier boat in narrow water, where frequent tacking is inevitable, and at the same time be not more laboursome to row. A diagram for such a boat is given on Plate IV., with body plan represented by Fig. 67, and, in order that the drawing may be utilised for boats of varying sizes, tables have been compiled to different scales, so that a boat of 10ft., 12ft., 15ft., or 20ft., can be built therefrom.

The displacement (or weight of water which the boat displaces when

PLATE IV.



Centre-board for Bowing and Sailing of 10ft., 12ft., 14ft., 15ft., and 20ft.

immersed to the load line, or, in other words, the weight of the boat, including everything she carries) of each boat, as given, is not mathematically correct, and need not be so considered; it is only given as a guide for the builder in ballasting, and it may be necessary or convenient to sail the boat lighter or deeper.* With regard to ballast, it will be found in practice that every passenger on board who sits to windward is of more value than an equal weight of ballast in the bottom of the boat would be. Of course there will be a limit to the number of passengers it is desirable to take in a boat of 12ft., and probably most men will conclude that one besides the helmsman is enough. When sailing in smooth water, shifting the ballast to windward can be largely indulged in if a practised hand besides the helmsman is on board to look after it; but in a sea the ballast should be well secured.

The sail dimensions given are for cruising, and are not so large as those of the gigs raced at Surbiton; the difference is about equal to

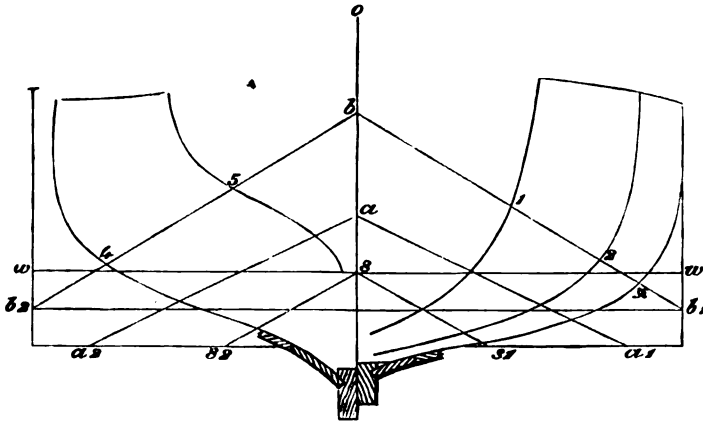


FIG. 67.

one-seventh the linear dimensions—that is to say, the sail of the 14ft. boat, or any of the other boats given, would be one-seventh longer in the foot, one-seventh longer in the head, one-seventh longer on the luff, and one-seventh longer on the leech for a racing outfit.

In all cases where measurements are given they must be adhered to, as the drawings are too small to work from, and "fairing" the moulds will be a matter of judgment.

* The displacement of these boats can thus be found approximately: multiply the length on the load line by the beam on the load line, and the depth amidships to the rabbet of the keel; next multiply the product by the co-efficient 0.32 (see "Yacht Designing," page 76) and the product will be the displacement of the boat in cubic feet nearly. The co-efficient will of course vary according to the sharpness or fulness of the boat. The co-efficient for yachts varies from .25 to .4. The common co-efficient being .32. There are 35 cubic feet of salt water in 1 ton.

BOAT OF 10FT.

| | No. 1 Section. | No. 2 Section. | No. 3 Section. | No. 4 Section. | No. 5 Section. |
|--|-------------------|-------------------|-------------------|-------------------|-------------------|
| | ft. in. | ft. in. | ft. in. | ft. in. | ft. in. |
| Height above L.W.L. to gunwale | 1 2½ | 1 1 | 1 0 | 1 0 | 1 1 |
| Depths below L.W.L. to top of keel | 0 4 | 0 5½ | 0 6 | 0 6½ | 0 7 |
| Half-breadths at gunwale..... | 1 0 | 1 7½ | 1 10½ | 1 9 | 1 0 |
| Half-breadths at L.W.L..... | 0 7½ | 1 4 | 1 8 | 1 4½ | 0 1 |
| Half-breadths <i>s</i> diagonal | 0 5 | 0 8½ | 1 9½ | 0 8 | 0 1 |
| Half-breadths on <i>a</i> diagonal | 0 8½ | 1 2½ | 1 4½ | 1 1½ | 0 4 |
| Half-breadths on <i>b</i> diagonal | 1 0½ | 1 7½ | 1 10½ | 1 8 | 0 10½ |

| | |
|--|-----------|
| Distance No. 1 section is from fore side of stem | 1ft. 7in. |
| " No. 2 " No. 1 section | 1ft. 7in. |
| " No. 3 " No. 2 " | 2ft. 2in. |
| " No. 4 " No. 3 " | 2ft. 4in. |
| " No. 5 (transom) No. 4 " | 2ft. 4in. |

Diagonal *a* is struck 4in. above L.W.L., and *a* 1 and *a* 2 are 1ft. 7in. from the middle vertical line *o*. Diagonal *b* is 11in. above L.W.L. The diagonal *s* at *s* 1 and *s* 2 is 9½in. from the vertical line *o*.

Length, 10ft.

Breadth, 3ft. 9in.

Pin of centre plate from fore side of stem, 3ft. 3in.

Length of plate on top edge, 3ft. 6in.

Length of plate on under edge, 3ft. 10in.

Greatest breadth of plate, 1ft. 2in.

Least breadth of plate, 4½in.

Thickness of plate, ½in.

Weight of plate, 40lb.

Weight of displacement of boat when immersed to L.W.L., 3½cwt.

Weight per inch of immersion at L.W.L., 1cwt.

BALANCE LUG SAIL (see FIG. 68).

| | |
|-----------------------------------|---------------|
| Mast, thwart to sheave hole | 10ft. 0in. |
| Luff of sail | 4ft. 0in. |
| Leech | 13ft. 3in. |
| Foot | 10ft. 0in. |
| Head..... | 10ft. 3in. |
| Tack to peak earing | 14ft. 6in. |
| Clew to weather earing | 10ft. 0in. |
| Area of sail | 80 square ft. |

BOAT OF 12FT.

| | No. 1 Section. | No. 2 Section. | No. 3 Section. | No. 4 Section. | No. 5 Section. |
|--|-------------------|-------------------|-------------------|-------------------|-------------------|
| | ft. in. | ft. in. | ft. in. | ft. in. | ft. in. |
| Heights above L.W.L. to top of gunwale | 1 5½ | 1 3½ | 1 2½ | 1 2½ | 1 3½ |
| Depths below L.W.L. to top of keel | 0 4½ | 0 6 | 0 7 | 0 7½ | 0 8 |
| Half-breadths at gunwale..... | 1 2½ | 2 0 | 2 3½ | 2 1½ | 1 3 |
| Half-breadths at L.W.L..... | 0 8½ | 1 7 | 2 0 | 1 7½ | 0 1½ |
| Half-breadths <i>s</i> diagonal | 0 6 | 0 10 | 0 11½ | 0 9½ | 0 1½ |
| Half-breadths on diagonal <i>a</i> | 0 10 | 1 5½ | 1 8 | 1 4½ | 0 4½ |
| Half-breadths on diagonal <i>b</i> | 1 2½ | 1 11½ | 2 3½ | 2 0 | 1 0½ |

- No. 1 section is 2ft. from the fore side of stem.
- No. 2 section is 2ft. from No. 1.
- No. 3 section is 2ft. 6in. from No. 2.
- No. 4 section is 2ft. 9in. from No. 3.
- No. 5 (transom) is 2ft. 9in. from No. 4.

Diagonal *s* at *s* 1 and *s* 2 is 11½in. from the middle line *o*.
 Height of diagonal *a* above load line, 4½in.; *a* 1 and *a* 2 are from the middle line *o*, 1ft. 11in.
 Height of diagonal *b* on middle line *o* of Body Plan above L.W.L., 1ft. 1½in., and at *b* 1 and *b* 2 is 3in. below L.W.L.

All the half breadths given are without the plank.
 Length from fore side of stem to aft side of transom, 12ft.
 Greatest breadth moulded (*i.e.*, without plank), 4ft. 7in.
 Aft side of mast from fore side of stem, 3ft.
 Weight of displacement of boat when immersed to load line, 6cwt; weight per inch of immersion, 1½cwt.

Pin of centre plate from perpendicular at fore side of stem, 3ft. 11in.
 Length of plate on its under edge, 4ft. 8in.
 Length on its upper edge, 4ft. 3in.
 Greatest breadth of plate, 1ft. 4in.
 Least breadth, 5½in.
 Thickness, ½in.
 Weight of plate, 50lb.
 Siding (thickness) of keel amidships, 4in.; ditto at stem, 2in; ditto at sternpost, 2½in.
 Moulded depth of keel, 3½in.

BALANCE LUG SAIL (see FIG. 68).

| | |
|---|----------------|
| Mast, thwart to sheave hole | 10ft. 0in. |
| Luff of sail | 5ft. 6in. |
| Leech | 16ft. 0in. |
| Foot | 12ft. 0in. |
| Head | 12ft. 3in. |
| Tack to peak earing | 17ft. 6in. |
| Clew to weather earing | 12ft. 0in. |
| Area | 105 square ft. |
| Halyards bent to yard, 5ft. from lower end. | |
| Tack, 1ft. 6in. from fore end of boom. | |

BOAT OF 14ft.

| | No. 1 Section. | No. 2 Section. | No. 3 Section. | No. 4 Section. | No. 5 Section. |
|--|-------------------|-------------------|-------------------|-------------------|-------------------|
| | ft. in. | ft. in. | ft. in. | ft. in. | ft. in. |
| Heights above L.W.L. to top of gunwale | 1 8½ | 1 6 | 1 5 | 1 5 | 1 6 |
| Depths below L.W.L. to top of keel | 0 5½ | 0 7 | 0 8 | 0 8½ | 0 9½ |
| Half-breadths at gunwale | 1 5½ | 2 4 | 2 8 | 2 6 | 1 5½ |
| Half-breadths at L.W.L. | 0 10½ | 1 10½ | 2 4½ | 1 10½ | 0 1½ |
| Half-breadths <i>s</i> diagonal | 0 6½ | 1 0 | 1 1½ | 0 11 | 0 1½ |
| Half-breadths on diagonal <i>a</i> | 1 0 | 1 8½ | 1 11½ | 1 7½ | 0 5½ |
| Half-breadths on diagonal <i>b</i> | 1 5½ | 2 3½ | 2 8½ | 2 4½ | 1 3 |

- No. 1 section is 2ft. 4in. from the fore side of stem.
- No. 2 section is 2ft. 4in. from No. 1 section.
- No. 3 section is 2ft. 10in. from No. 2 section.
- No. 4 section is 3ft. 3in. from No. 3 section.
- No. 5 (transom) is 3ft. 3in. from No. 4 section.

Diagonal *a* above L.W.L., 5 $\frac{1}{2}$ in.; *a* 1 and *a* 2 from middle line *o* (see Body plan, Fig. 44), 2ft. 3in.; diagonal *b* above load line, 1ft. 4in., and at *b* 1 and *b* 2 is 3 $\frac{1}{2}$ in. below the L.W.L.; diagonal *s* at *s* 1 and *s* 2 is 1ft. 1 $\frac{1}{2}$ in. from the middle line *o*.

All the half-breadths given are without the plank.

Length from fore side of stem to aft side of transom, 14ft.

Greatest breadth moulded (i.e., without the plank), 5ft. 4in.

Aft side of mast from fore side of stem, 3ft. 6in.

Weight of displacement of boat when immersed to load line, 8cwt.

Weight per inch of immersion at load line, 1 $\frac{1}{2}$ cwt.

Pin of centre plate from perpendicular at fore side of stem, 4ft. 6in.

Length of plate on its under edge, 5ft. 5in.

Length on its upper edge, 5ft.

Greatest breadth of plate, 1ft. 6in.

Least breadth, 6in.

Thickness of plate, $\frac{1}{2}$ in.

Weight of plate, 110lb.

Siding (thickness) of keel amidships, 4in.; ditto at stem, 2 $\frac{1}{2}$ in.; ditto at sternpost, 3in.
Moulded depth (i.e., depth from top to under side), 4in.

BALANCE LUG SAIL (see FIG. 68).

| | |
|---|----------------|
| Foot | 14ft. 0in. |
| Head, measured along the ticked line (<i>a</i>) | 14ft. 3in. |
| Leech | 19ft. 9in. |
| Luff | 6ft. 0in. |
| Tack to peak earing | 21ft. 0in. |
| Clew to weather earing | 14ft. 8in. |
| Area | 155 square ft. |

Yard is along 6ft. from lower end. Tack is bent 1ft. 9in. from fore end of boom.

BOAT OF 15FT.

| | No. 1 Section. | No. 2 Section. | No. 3 Section. | No. 4 Section. | No. 5 Section. |
|--|-------------------|-------------------|--------------------|--------------------|-------------------|
| | ft. in. | ft. in. | ft. in. | ft. in. | ft. in. |
| Heights above L.W.L. to top of gunwale | 1 10 | 1 7 $\frac{1}{2}$ | 1 6 | 1 6 | 1 7 $\frac{1}{2}$ |
| Depths below L.W.L. to top of keel | 0 6 $\frac{1}{2}$ | 0 7 $\frac{1}{2}$ | 0 8 $\frac{1}{2}$ | 0 9 $\frac{1}{2}$ | 0 10 |
| Half-breaths at gunwale | 1 6 $\frac{1}{2}$ | 2 6 | 2 10 | 2 8 | 1 7 |
| Half-breaths at L.W.L. | 0 11 | 2 0 $\frac{1}{2}$ | 2 6 $\frac{1}{2}$ | 2 0 $\frac{1}{2}$ | 0 1 $\frac{1}{2}$ |
| Half-breaths <i>s</i> diagonal | 0 7 | 1 0 $\frac{1}{2}$ | 1 2 $\frac{1}{2}$ | 0 11 $\frac{1}{2}$ | 0 1 $\frac{1}{2}$ |
| Half-breaths on diagonal <i>a</i> | 1 1 | 1 10 | 2 1 | 1 9 | 0 5 $\frac{1}{2}$ |
| Half-breaths on diagonal <i>b</i> | 1 6 $\frac{1}{2}$ | 2 6 | 2 10 $\frac{1}{2}$ | 2 6 $\frac{1}{2}$ | 1 4 |

No. 1 section is 2ft. 6in. from the fore side of stem.

No. 2 section is 2ft. 6in. from No. 1 section.

No. 3 section is 3ft. 1 $\frac{1}{2}$ in. from No. 2 section.

No. 4 section is 3ft. 5 $\frac{1}{2}$ in. from No. 3 section.

No. 5 (transom) is 3ft. 5 $\frac{1}{2}$ in. from No. 4 section.

Diagonal *a* above L.W.L., 6 $\frac{1}{2}$ in.; *a* 1 and *a* 2 from middle line *o* (see Body Plan, Fig. 67), 2ft. 4 $\frac{1}{2}$ in.; diagonal *b* above load line, 1ft. 5in., and at *b* 1 and *b* 2 is 3 $\frac{1}{2}$ in. below the L.W.L.; diagonal *s* at *s* 1 and *s* 2 is 1ft. 2 $\frac{1}{2}$ in. from the middle line *o*.

All the half-breadths given are without the plank.

Length from fore side of stem to aft side of transom, 15ft.

Greatest breadth moulded (i.e., without the plank), 5ft. 8in.

Aft side of mast from fore side of stem, 3ft. 9in.

Weight of displacement of boat when immersed to load line, 10cwt.
 Weight per inch of immersion at load line, 2cwt.
 Pin of centre plate from perpendicular at fore side of stem, 4ft. 9in.
 Length of plate on its under edge, 5ft. 10in.
 Length on its upper edge, 5ft. 4in.
 Greatest breadth of plate, 1ft. 9in.
 Least breadth, 6in.
 Thickness of plate, $\frac{1}{2}$ in.
 Weight of plate, 130lb.
 Siding (thickness) of keel amidships, 4 $\frac{1}{2}$ in.; ditto at stem, 2in.; ditto at sternpost, 3in.
 Moulded depth (i.e., depth from top to under side), 4in.

BALANCE LUG SAIL (see FIG. 68).

| | |
|--|----------------|
| Foot | 14ft. 0in. |
| Head, measured along the ticked line (a) | 15ft. 3in. |
| Leech | 20ft. 0in. |
| Luff | 7ft. 0in. |
| Tack to peak earing | 21ft. 6in. |
| Clew to weather earing | 15ft. 6in. |
| Area | 168 square ft. |

Yard is along 6ft. 3in. from lower end. Tack is bent 2ft. from fore end of boom.

BOAT OF 20FR.

| | No. 1 Section. | No. 2 Section. | No. 3 Section. | No. 4 Section. | No. 5 Section. |
|--|-------------------|-------------------|--------------------|-------------------|-------------------|
| | ft. in. | ft. in. | ft. in. | ft. in. | ft. in. |
| Heights above L.W.L. to top of gunwale | 2 6 | 2 2 | 2 0 | 2 0 | 2 1 |
| Depths below L.W.L. to top of keel | 0 5 | 0 6 $\frac{1}{2}$ | 0 11 $\frac{1}{2}$ | 1 0 | 1 0 $\frac{1}{2}$ |
| Half-breadths at gunwale..... | 2 0 | 3 4 | 3 9 | 3 6 $\frac{1}{2}$ | 2 1 |
| Half-breadths at L.W.L. | 1 3 | 2 8 $\frac{1}{2}$ | 3 5 | 2 8 | 0 1 $\frac{1}{2}$ |
| Half-breadths <i>s</i> diagonal | 0 10 | 1 5 | 1 7 $\frac{1}{2}$ | 1 4 | 0 1 $\frac{1}{2}$ |
| Half-breadths on diagonal <i>a</i> | 1 5 | 2 5 $\frac{1}{2}$ | 2 9 $\frac{1}{2}$ | 2 4 $\frac{1}{2}$ | 0 7 |
| Half-breadths on diagonal <i>b</i> | 2 0 $\frac{1}{2}$ | 3 4 | 3 10 $\frac{1}{2}$ | 3 4 $\frac{1}{2}$ | 1 9 $\frac{1}{2}$ |

No. 1 section is 3ft. 4in. from the fore side of stem.
 No. 2 section is 3ft. 4in. from No. 1 section.
 No. 3 section is 4ft. 2in. from No. 2 section.
 No. 4 section is 4ft. 7in. from No. 3 section.
 No. 5 (transom) is 4ft. 7in. from No. 4 section.

Diagonal *a* is 8in. above L.W.L., and *a* 1 and *a* 2 are 3ft. 3in. from the middle line *o*.
 Diagonal *b* is 1ft. 11in. above L.W.L., and at *b* 1 and *b* 2 is 5in. below L.W.L.; diagonal *s* at *s* 1 and *s* 2 is 1ft. 7 $\frac{1}{2}$ in. from the middle line *o*.

All the half-breadths given are without the plank.
 Length from fore side of stem to aft side of transom, 20ft.
 Greatest breadth moulded, 7ft. 3in.
 Aft side of mast from fore side of stem, 4ft. 10in.
 Weight of displacement of boat when immersed to load line, 1 ton 6cwt. (1.3 ton).
 Weight per inch of immersion, 4cwt. at load line.
 Pin of centre plate from perpendicular at fore side of stem, 6ft. 3in.
 Length of plate on its under side, 7ft. 6in.
 Length on its upper side, 6ft. 9in.
 Greatest breadth of plate, 2ft. 0in.
 Least breadth, 9in.
 Thickness of plate, $\frac{1}{2}$ in.
 Weight of plate, 200lb.

Siding (thickness) of keel amidships, 5in. ; ditto at stem, 3in. : at sternpost, 3½in. Moulded depth of keel, 6in.

BALANCE LUG SAIL (see FIG. 68).

| | |
|-----------------------------------|-------------|
| Mast, thwart to sheave hole | 15ft. 6in. |
| Luff of sail | 10ft. 0in. |
| Leech | 27ft. 0in. |
| Foot | 20ft. 0in. |
| Head | 20ft. 6in. |
| Tack to peak earing | 30ft. 0in. |
| Clew to weather earing | 20ft. 0in. |
| Area of sail | 300 sq. ft. |

The 10ft. boat, planked with ¾in. mahogany, would weigh, inclusive of centre-plate and case, sails, and spars, about 2cwt. Thus it would take ½cwt. of ballast and one person of 8st. (1cwt.) to bring her down to the intended load line ; but she might with advantage carry one more passenger or 1cwt. more ballast. Every additional cwt. would sink her an inch deeper ; but it is of little use crowding a large quantity of ballast in a shallow boat in the hope of making her stiff. For light rowing the plate, ballast, and sails could be removed.

The 12ft. boat, inclusive of sails, spars, and plate and case, would weigh, with the same thickness of plank, about 2½cwt., and should have at least 2cwt. of ballast, or one person and 1cwt. of ballast, besides the helmsman, for sailing with the large balance lug sail.

The 14ft. boat with ½in. plank, and including centre plate and case, spars, and sails would weigh about 3¼cwt., and would require from 3cwt. to 4cwt. of ballast, according to the number of passengers on board.

The 15ft. boat would be planked with ½in. stuff, and would weigh, inclusive of centre-plate and case, spars and sails, about 3¾cwt., and would require 3cwt. or 4cwt. of ballast, according to the number of passengers on board.

The 20ft. boat would weigh, inclusive of centre-plate and case, spars and sails, about 7cwt. To get her down to the load line, she would take four passengers of 12st. each, and about half a ton of ballast. As such a large boat is not adapted for rowing (excepting on emergencies), it would be advisable to have 5cwt. of iron cast in the form of a keel, with a slot in it for the centre-plate to work in. An iron keel, 12ft. long, with an average width of 4in. and depth of 3½in., would weigh about 5cwt. The iron keel forward would extend as far as the mast and aft to within 3ft. of the stern post. A filling-up piece of wood, well rounded up towards the stern post, will finish the keel off aft, and the same forward tapering to "nothing" at the scarp of the keel with the stem. The iron keel should be 4½in. deep in its mid length, and 3in. at either end. Transversely it would, of course, taper to match the taper of the under side of the wood

keel. The best cruising rig for such a boat would be the balance lug, foresail, and mizen, of about the extreme proportions given for the 17ft. boat (Plate V.); but the mast should be stepped one foot farther aft, and the boomkin for the foresail should be shortened one foot.

Centre-board, boats such as shown in the diagram, are peculiarly adapted for shifting-ballast, as the centre-plate case makes a kind of fore-and-aft bulkhead which will always prevent the ballast sliding to leeward. Still, sliding is not the only danger accompanying the practice of shifting ballast. If a man is single-handed, he might be unable in an emergency to trim his shot bags or other dead weight in time, or his mate may be unable to do so, and it cannot be too often impressed upon the young boat sailer that he must well look after loose ballast in the bottom of a boat (secure it if possible), and never be tempted into carrying a lot of sail on the strength of the ballast being shifted to windward.

SAILS FOR CENTRE-BOARD BOATS.

Opinions are very much divided as to the best kind of rig for a centre-board gig; but, at any rate, the balance lug in some form or other appears to be most generally in favour. It has been contended that a boat rigged with a single balance lug is likely to miss stays, and this is perhaps true in what is termed a "lop;" but a boat with one large sail in the hands of a clever boat sailer, need never miss stays in smooth water at least, unless the wind headed the boat round, and then of course she would miss stays, whatever her rig. It is an advantage to have the sail all in one piece for going to windward—tacking out of the question—and for a single hand it is of course convenient to have no head sails to work. No description of boat will stay quicker or with more certainty than the American cat-boat, or *Una*, and, if not brought head to wind by too free a use of the rudder, they lose very little way in tacking.

On the other hand, a boat with one sail may fail to go about in a disturbed sea, and may get in irons; whereas if she had a foresail the operation of tacking, without getting stern way on, might have been successfully performed by keeping the head sheets aweather. A clever boat-sailer will always work his head sheets without inconvenience even in a lop, as he will see his craft safely filling on the opposite tack before he attempts to "let draw," and, as the head sheets will lead aft, he need not move from his seat. The argument *pro* and *con.* the foresail can, therefore, be summed up thus: In light winds it is an advantage to have the sail all in one piece, especially for beating, and the trouble of working the head

sheets does not exist; but in strong winds and rough water there will be more security in a smaller mainsail, with the addition of a headsail; and, although there will be the trouble of working the head sheets, there need be no difficulty about it even for one hand. Concluding that it is "safest to be safe," it will be best to be provided with a foresail for sailing in rough water.

Another very strong argument in favour of the foresail or jib in addition to the balance lug is this: if there be much wind, the boat when sailing "along," or off the wind, will exhibit a very great tendency to come to against her helm, that is, she will require a great deal of weather helm to keep her out of the wind; this tendency will be greatly relieved by the jib. Again, if there be any sea, the boat will have to be constantly "chucked" up in the wind to avoid a comber that may be coming in on the weather bow, for it will not do to sail boats very hard in rough water; yet must they be kept full, and to avoid getting into irons after luffing to a comber, or to meet a heavy puff, a foresail will be found very useful. The foresail can either be set on a bowsprit or bumpkin, as shown in Plate V. representing the standing lug rig. The manner of fixing the bumpkin will be found described in the chapter on Itchen boats.

Many experienced boat sailers recommend a mizen instead of a foresail, and they argue that a mizen can be made as great a help to a boat's staying as a foresail. There is not much doubt that a mizen is a powerful lever to assist in throwing a vessel's head to wind; but it is of no use for paying a boat's head off, if she gets in irons. However, as shown in Mr. Baden Powell's sketch, if the tiller is carried aft (say 2ft.) of the rudder, to act as a mizen bumpkin, then each time the tiller is put down, or to leeward, the mizen will be brought to windward and push the stern round. This may be so, and, if the boat kept moving through the water, she would no doubt ultimately describe an arc of a quadrant through the wind acting on the mizen; but when a boat is in irons she does not move through the water—at least not ahead, although she may get stern way on. Now if the mizen is kept across the boat whilst she is in irons, it will, if it has any effect at all, drive her astern as well as tend to push the stern on one side. As the latter motion will be counteracted by the direction the rudder is necessarily turned (presuming that the boat is making stern way), we doubt if the mizen can be manoeuvred so as to be of much service in the case of a boat that has no head sail getting into irons. In fact, the proper thing to do, if a boat in a "lop," when under main and mizen sail, did get into irons, would be to let the mizen sheet go, and reverse the helm, and then haul the mainboom over to the side which is to be the weather one when she has filled; then, with stern way on, the boat's head will be boxed off, and she may be

helped by a timely kick from a cross sea. Thus far the conclusion is forced upon us that, if two sails are decided upon, the foresail and mainsail have a slight advantage over the mizen and mainsail.

There may possibly be some advantage in open water in the main and mizen rig, if warning of a "kick-up" has not been taken advantage of to reef. Going into the eyes of an open boat to reef her foresail in a "lop" is by no means a pleasant or safe operation to perform, and indeed it should not be attempted unless a counterbalancing weight is put in the stern; the boat will then plunge violently, but there will be less danger of her being swamped. Now, with the main and mizen rig there will be no foresail to reef, and as the mainsail will be all in board, reefing when *in extremis* will be a comparatively easy operation. Again, if the mainsail has to be lowered in a hurry, the mizen will bring the boat to the wind, instead of taking her off as a foresail might. But the danger as last indicated can easily be avoided by letting go the head sheets before lowering the mainsail. Then the foresail might be found of service for scudding before a strong wind at sea. On the other hand, the mizen might be of use in rowing, in keeping the boat's head to the wind at sea. However, as snugging down should be never deferred, with a rising storm, until the sea got up so as to make reefing a foresail a matter of danger, we still cast in favour of the sloop or main and foresail rig.

The question here naturally arises, if the mizen is of use as well as the foresail, why not have both? We certainly do not see why both should not be had; and, if the wind is so strong as to necessitate the mainsail being stowed, the boat will be fairly handy and manageable under mizen and foresail, although the canvas would scarcely be large enough to get her to windward with the wind dead on end.

The fashion of lacing the sail to a boom is now general whatever the rig, and no doubt the plan has many advantages—the principal of which are that the foot can be kept straighter, and thereby the sail generally flatter, and in easing the sheet little or much the sail does not go into a bag; on the other hand without the boom, if the boat be struck by a squall, the wind will be spilled from the sail directly the sheet is loose; but the case is different with a boom sail; and if the squall be heavy it will be necessary to luff the boat up in good time as well as ease the sheet, and prepare to lower the sail in case the squall should not abate.

To the question of how much sail it is prudent to give an open boat, the answer very much depends upon the requirements and capabilities of the boat-sailer. Sail areas of open boats, we find, vary very considerably; and in proportion to the length of boats multiplied by breadth, range from

1 to 3.* Thus we find some cruising gigs, 17ft. long by 5ft. 6in. in beam (equal to 93·5 square feet), with about 90 square feet of canvas in their sails; whilst other boats, only 14ft. by 5ft. 3in. (equal to 73 square feet) that are raced, have sail areas of 180 square feet, or 2·4 times the area of that found by multiplying the breadth into the depth. The latter proportion will only be safe in the hands of an expert, and the novice should begin with very small sails, or, in other words, the sail area should not exceed the length of the boat multiplied by her breadth.†

Sometimes in the sloop rig the jib or foresail, instead of being tacked outboard to a bumpkin, is laced at its foot to a boom; the sail is then "tacked" by this boom to the stem head, so much sail being forward of the stem as the space between the mast and the stem requires. A pair of sheets are required as usual, and the *weather* one should always take the weight of the sail; the *lee* one is consequently slack, but only so slack that when the boat is put about it takes the strain as the weather sheet. Thus the sheets need no trimming in tacking. The objection to this "revolving jib" is that it cannot be readily "spilled," as after the sheet is gone the sail will sometimes be balanced by the wind; hence the sail may not only be an inconvenient one, but a dangerous one. This objection can be somewhat removed by having the tack fast some distance ahead of the centre of length of the boom.

The "balance lug," Fig. 68—which was introduced at Surbiton by Mr. Burgoine (boat builder, of Kingston-on-Thames), about twelve years ago—is a sail so arranged that it requires no dipping in going about; that is, it lies on the mast on one tack, and from the mast on the other. In this respect it resembles the "standing lug" illustrated on Plate V., and in the New Brighton rig and Mersey canoe rig; but the Surbiton lug has the advantage of a larger piece forward of the mast to "balance" the after part of the sail; hence the term balance lug.

The boom and yard are generally of about the same length, and the length of the mast is in a measure governed by the amount of peak, or round

* Rules for finding the areas of sails are given in "Yacht Designing;" but we have found that the following simple rule gives sufficiently accurate results for all practical purposes: Multiply the length of the sail from the tack to peak earing by the length from the clew to weather earing, divide the product by 2, and the quotient will be the sail area nearly.

† The most successful gigs that compete in the matches of the Thames Sailing Club have enormous sail areas, all in one piece as a balance lug. These sail areas frequently equal three times the area, found by multiplying the length of the boat by the beam; and the boats, being dexterously handled, carry the sail well, and appear wonderfully handy. Of course it would be madness for a mere tyro to think of handling such a sail, even with plenty of live ballast on board. The most handy size for match sailing up river, where short boards only can be made with the wind "dead on end," appears from experience at Surbiton to be the 14ft. boat, and they are given as much as 5ft. 3in. beam to enable them to carry large sails. One of these boats has a sail of the following dimensions: Luff, 9ft; leech, 22ft.; foot, 17ft.; head, 16ft.

given to the head of the sail. If the yard is slung in its amidships, the sail should have great peak, and it will stand or sit better than if the sail be cut flat-headed. If the yard be slung nearer its lower end than amidships, the

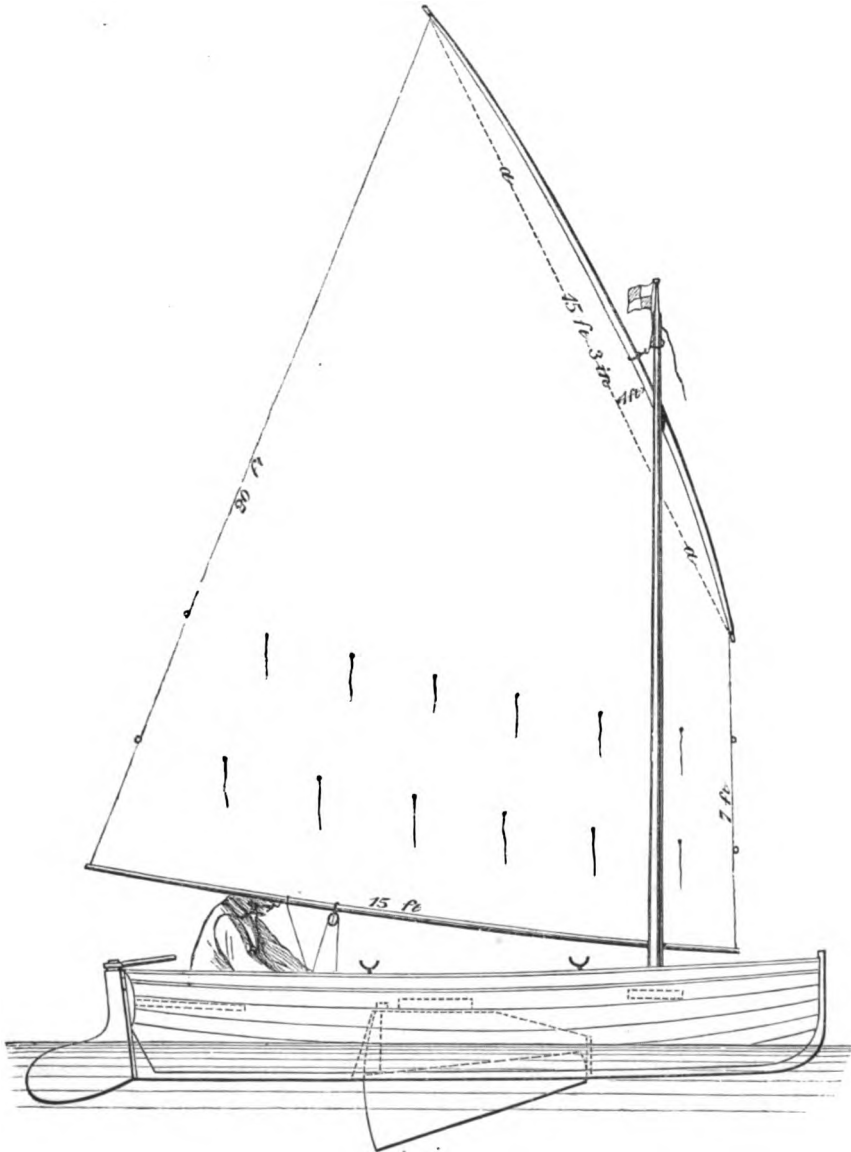


FIG. 68.

sail, if not cut with a high peak, is apt to sag to leeward; and the same might happen if the sail be very flat-headed and slung, say, one-third of the length of yard from the lower end or heel of yard. A good place for

the slings of a well peaked and round headed sail will be about one-tenth the length of yard from its amidships. (The head and foot of the sails are always laced to yard and boom.)

A Surbiton boat, however, has the yard slung at about two-fifths its length from the lower end, but then the head of the sail has not so much round as shown in the diagram. However, a squarer sail and a better standing one can be obtained by slinging the sail nearer amidships and giving as much round to the head as shown in the drawing; the luff will be shorter than is generally given, but this probably will be found an advantage.

About one-seventh of the foot of the sail should be forward of the mast, and in slinging the yard and in bending the tack to the boom care must be taken that this proportion is not much exceeded. If too great a proportion of the sail is put forward of the mast it will not "balance," and in luffing to squalls, especially with the boom off the quarter, it will be found that, although the boat may come to a little, the sail will not spill. This peculiarity may be attended by some danger in the case of squalls or in clearing an obstacle, and may be accounted for by the fact that the ardency of the wind pressure on the fore part of the sail will be so great that it will more than balance the pressure on the greater area of the after-part, which, with the aid of the rudder, should bring the boat head to wind. (See page 26.)

No rig is handier for tacking in smooth water than the balance lug, and should a boat so rigged by any mischance show a tendency to miss stays or get in irons, her head can easily be paid off by holding the foot of the sail over to the side which is to be the weather one. This, of course, will stop the boat, and press her bodily to leeward or force her astern, and the sail should never be kept a-weather a moment longer than is necessary. Should the boat not gather way again quickly after the boom has been put over on the lee quarter again, the main sheet must be eased a trifle.

The sail is hoisted by a single halyard; to one end of this halyard a block is spliced; the other end is rove through a sheave hole in the mast head and bent to the yard; through the block a rope is rove, the standing part of which is made fast to the mast thwart and the hauling part through a block at the mast step. This forms a whip purchase, but if the sail be a large one a gun tackle purchase is used. The halyard is bent or hooked to a thimble-eye strop on the yard. The sail can be kept to the mast by a parrel thus contrived: a grommet strop, with thimble-eye seized in it, will be put on the yard about 6in. above the slings; another similar strop will be put on the yard at about 2ft. 6in. (for a 14ft. boat) below the slings; a line must be spliced to the lower thimble, and rove through the upper one round the aft side of the mast, back through the lower thimble. Thumb cleats must be put on the yard to prevent the strops slipping.

When the sail is set, the line must be hauled as taut as it can be got and belayed.

But a neater plan than this is the mast iron, as shown in the diagram; the halyard is fast to an eye in the iron, and the latter is hooked to the thimble eye strop on the yard. The disadvantage of the iron traveller is that the tack and sheet of the sail must be let go when the sail has to be lowered, or otherwise the sail will not lower. As the sail comes down the fore-end of the boom must be carried forward.

If an iron mast traveller be used the yard will be slung as shown in Fig. 68; if a parrel be used instead of the iron, the yard will be slung a little lower down, as the strop will be hauled close up to the sheave hole; consequently the sheave hole will be a little lower down, and the mast may be a trifle shorter.

A downhaul should always be bent to the yard.

The tack will be bent to the boom abreast of the mast and lead through a block, either on mast thwart, or deck, as may seem most handy. The Surbiton plan for the tack is thus worked: a thimble is stropped to the boom abreast of the mast, and to the thimble 5ft. or 6 ft. of line is spliced; the line is passed once round the mast, back through the thimble, then through a galvanised iron eye-bolt screwed into the mast some convenient distance below, and belayed to a cleat on the mast. For a 15ft. boat a gun tackle purchase should form the tack. In setting the sail it is often found that the luff can be got tauter by swigging on this tack than by hauling on the whip purchase of the halyards.

If topping lifts are used (they may be handy whilst reefing, or to brail the sail up), one part will be made fast to the masthead and lead across the sail, and through a thimble made fast under the boom by a seizing (or it can pass through the thimble in the strop of the main-sheet block) and up the other side of the sail, through a block at the masthead and the "fall" down by the side of the mast.

A wire forestay is generally set up to the stem head, and it is better that a gun-tackle purchase, or double-block purchase should be used for the setting up instead of a lanyard, as the mast (sails and all) can be lowered by it for passing under bridges, &c. The mast should be stepped in a tabernacle, which tabernacle will be open on the aft side and fitted in the aft side of the mast thwart. The forestay will go over the masthead by an eye; a thimble eye will be at the other end of the stay to take the lanyard or hook of the setting up tackle. There will be a single wire shroud each side of the mast fitted the same as the forestay, but set up by lanyards to the eyes of neat chain plates fitted to the gunwale. Sometimes, however,

the lanyard is rove through a thimble seized to the thwart or to a timber, or through a thole hole in a rowlock.

The main sheet is arranged thus; standing part fast to the boom, then through a single block under one gunwale, then through a block stropped to boom and belayed under the other gunwale; for the 10ft. boat, thimbles might be used instead of the blocks.

In the 10ft., 12ft., and 14ft. boat, the "Una" plan of main sheet may be suitable. An end of the sheet is fast to one quarter; the other passes through a block on the boom, and through another block on the opposite quarter. For sailing on a wind it may be found that with the blocks on the gunwales the boom cannot be hauled in flat enough; so unless the blocks are on the transom at the extreme stern the blocks should be fitted inside the gunwale. Another plan is to have the standing part of the sheet fast to the extreme end of the boom; other end through a double block with traveller on a horse; then through a single block on boom back through the double block, and belay by hitching the hauling part round the parts of the sheet above the double block.

Some of the Surbiton boats have the mainsheet thus fitted: A single block on main boom and one on a horse, also one on the deck a little ahead of the horse. The sheet is fast to the block on the boom, then leads through the block on the horse, back through the block on the boom, through the block on deck, and belay.

Another form of the lug known as the "standing lug" or settee sail has been referred to, and is shown in Plate V., adapted from the lugs used in the boats belonging to the New Brighton Sailing Club. (A detailed description of the New Brighton rig will be given further on.) It will be seen that the tack of the sail is close to the mast, and very little canvas is consequently forward of the mast. The dimensions and areas of the sails adapted for the 17ft. boat are as follows:—

MAINSAIL.

| | ft. in. | ft. in. | ft. in. |
|--------------------------------------|---------|------------------------------|---------|
| Head (measured along the yard) | 15 0 | Luff | 3 3 |
| Leech | 18 0 | Tack to peak earing | 17 0 |
| Foot | 11 9 | Clew to weather earing | 13 0 |

This sail is drawn with 1ft. 4in. round to the head.

FORESAIL.

| | ft. in. | ft. in. | ft. in. |
|-------------|---------|------------|---------|
| Leech | 8 6 | Foot | 6 6 |
| | | Luff | 10 9 |

MIZEN.

| | ft. in. | ft. in. | ft. in. |
|-------------|---------|------------------------------|---------|
| Head | 9 0 | Luff | 2 6 |
| Leech | 9 6 | Tack to peak earing | 10 6 |
| Foot | 6 6 | Clew to weather earing | 7 0 |

—

th

or

t

t

,

| | AREAS. | sq. ft. |
|----------------|--------|---------|
| Mainsail | | 119 |
| Foresail | | 27 |
| Mizen | | 38 |
| Total | | 184 |

Area of reduced mainsail for single-hand sailing, 85 sq. ft. (4ft. 6in. to be taken off yard).

The dimensions of these sails will do equally well for the balance lug of the Surbiton type, as practically the only alteration to make would be in lacing the sail to the boom, and having the tack tackle fast to the boom instead of to the sail. The great round to the head will be an advantage, as it makes the sail square; and if the yard be a trifle longer, it is not carried quite so high.

The sail area shown in the drawing is a large one, but with three or four hands sitting to windward the boat would carry it well enough in moderate breezes and smooth water. For ordinary single-handed sailing it would be prudent to have a smaller mainsail, reduced as shown by the ticked line *a*; the sling would then come at *c*. The foresail should also be 2ft. shorter in hoist, and 6in. less on the foot; the mizen would be shortened 2ft. on the head.

The boat could be sailed with mainsail alone without shifting the mast, but she would probably be handier if the mast in such a case were shifted 1ft. farther forward. For turning her into the sloop rig, the mizen would be unshipped, the mainmast shifted 3ft. farther aft, and the foresail tacked to the stem instead of to the boomkin.

For a tyro who knows little or nothing of sailing, the 10ft. centre-board dinghy, rigged with a single balance lug, is a suitable craft for schooling, and, if he is fortunate enough to be located near a place where there is some shallow water, he may find out all about sailing without the assistance of a coach.

For centre board boats of the *Una* type various rigs are used, and on the *Seine* the French have brought into use an adaptation of the "sliding gunter rig." The drawing on Plate VI. illustrates this rig.

The rig, it will be seen, although of the sloop character, differs from the sloop in detail. The mainsail is a kind of sliding gunter, and the arrangements for hoisting and setting it are as follows. The mast is stepped on deck and pivoted in a tabernacle, by which it can be readily lowered for passing underneath bridges, warps, &c. *a* shows the heel of the yard (see Plate VI. and A Fig. 69). On this yard is a wire rope span from *c* to *a* (see large sketch), which passes through a block at *k*. The details of the arrangement will be more clearly understood by studying the smaller

diagrams (Fig. 69). In A, *a* is an iron hoop traveller on the mast. Into the arms of this traveller the heel of the yard is inserted, and is so hinged as to form what is known as a universal joint. The hoisting halyard *n* is made fast to an eye in this traveller and passes through a cheek block on the mast at *x*. Sometimes a block is on the traveller, then (see F) one end of the halyard is put through the cleat on the mast as shown at *y*, and then has a knot tied in it to prevent it unreeving. The other end is passed through the block

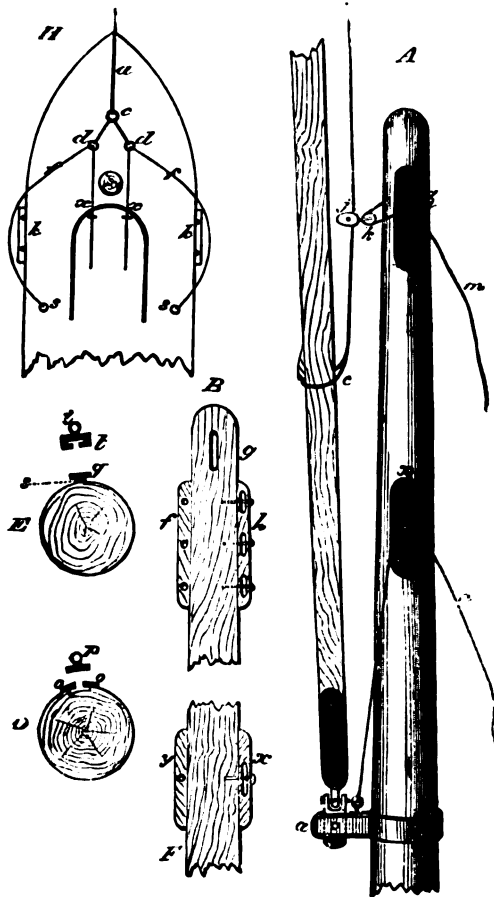


FIG. 69.

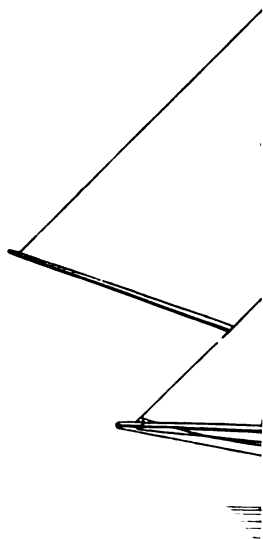
on the traveller, and then through the cheek block at *x*. If the sail is a very large one a whip purchase is also used. A block is seized to the halyard *n*, and through this block a rope is passed, one end of it being fast on deck.

In Fig. A, *c* represents an eye splice in the lower end of the wire rope span kept from slipping by a thumb cleat. This span passes through an iron block *j*. To this iron block a small wood block *k* is seized, and through the latter the halyard *m* is rove. The halyard *m*, in the first place, is rove through a cleat on the mast (see Fig. B) *f*; then through the block *k*, and over the sheave in the cheek block *h* (Fig. B). The halyard at *f* is stopped by a wall knot. In the diagram A, *m* is the hauling part or fall of the halyard. In the smaller sized vessels the

block *k* is not used. One end of the halyard is seized to the iron or brass block *j*, and then passes over the sheave at *k*. In Fig. B, the upper sheave above *h* is used for the foresail halyards; one end of the halyard is stopped by a wall knot after being rove through the hole above *f*; the other end is then passed through a block hooked to the head of the foresail, and then over the sheave above *h*.

The sheave below *h* is used for topping lifts; one end of the topping

PLATE VI.



lift is stopped at the hole *below f*; the other is passed through a thimble seized on the under side of the main boom and is then carried up over the sheave below *h*. The large sheave hole at *g*, Fig. B, is used for spinnaker or square sail halyards. Mast hoops are not often seen. The sail is kept into the mast thus: Diagram D is a section of the mast; *o o* are two brass plates screwed to the lips of a channel cut on the aft side of the mast. *p* is a traveller about two inches deep which works in the channel formed by

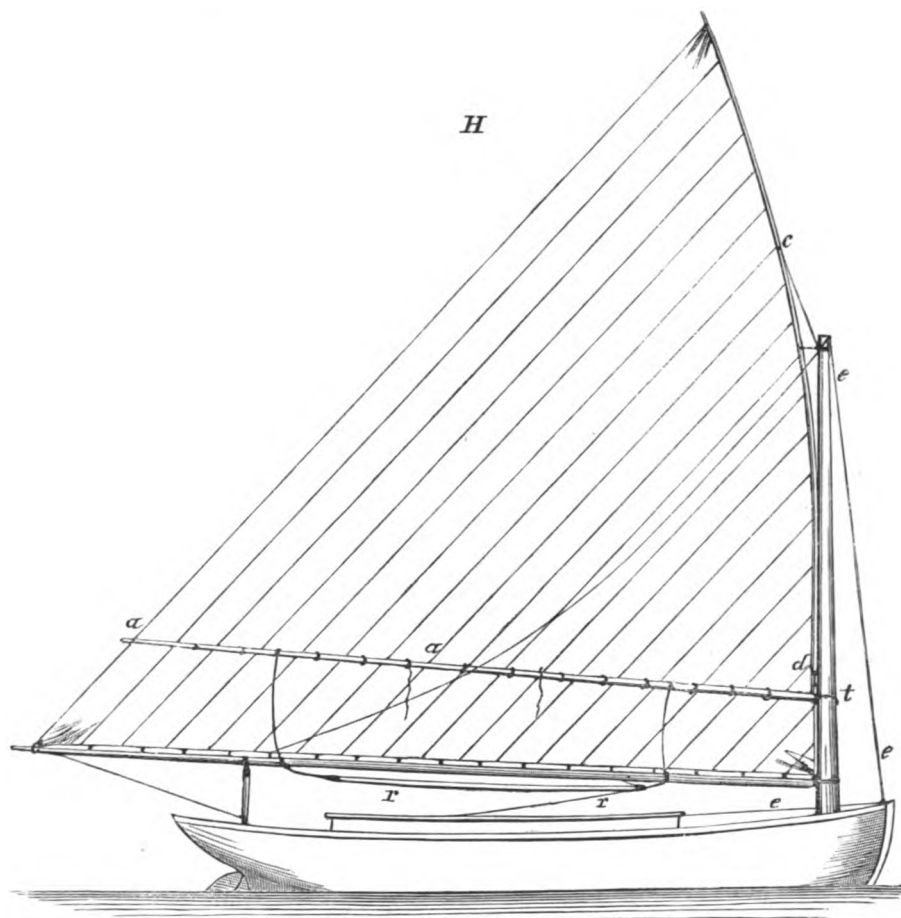


FIG. 70.

o o; the traveller has an eye to which one of the eyelet holes or cringles in the luff of the mainsail is seized. Generally as many of these travellers are used as there would be hoops if hoops were used.

Another arrangement is shown by E: *g* is a T-shaped bar of iron screwed to mast (or sometimes instead of a T-iron a plate of simple bar-iron is screwed over a fillet of wood, as shown by *s*, for lightness); *t* is the small

traveller about two inches square which is shipped over *g*; *i* is the eye for seizing the luff cringles of the mainsail *x*.

If either of these travellers is used, the iron mast-traveller for the yard is dispensed with. A traveller (made with a socket to take a gooseneck on end of the yard) is inserted in the channel *o o* (see D.) or over the guide *q* (see E).

One end of the main sheet is fast to the boom end; it from there leads through a double block on deck, through a single block on the boom, back

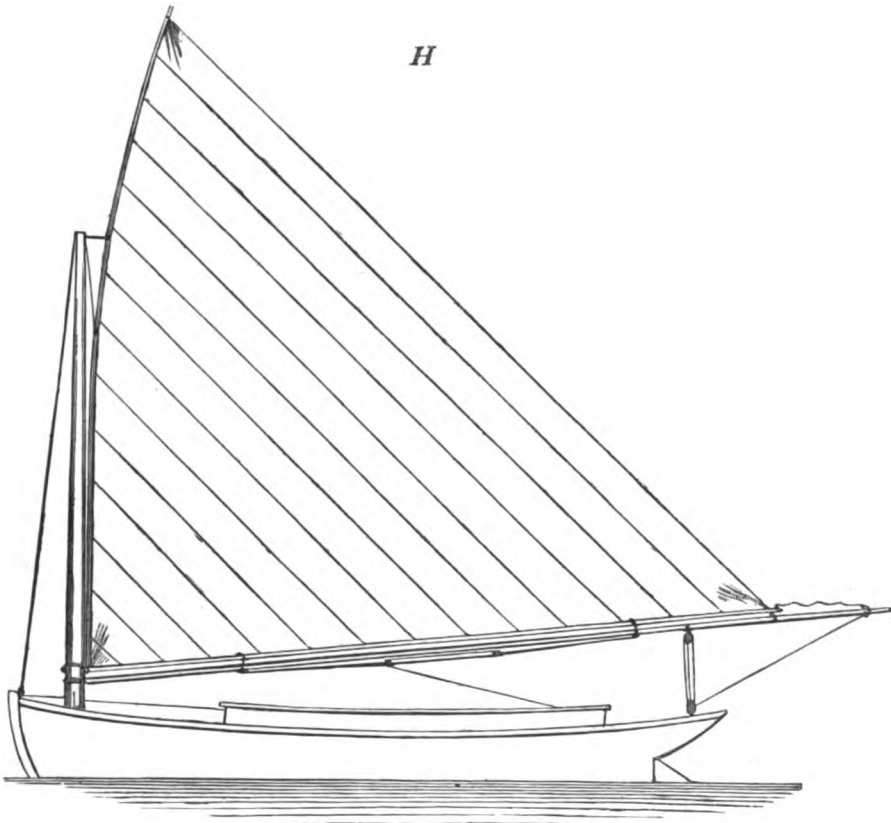


FIG. 71.

through the double block on deck again, then through another single block on the boom and belay.

The bobstay is made of wire rope; one end has an eye in it, and this eye encircles the bowsprit at *v* (see large sketch); it then passes through a block on the stem at the water-line, through another block on the bowsprit end; a tackle is hooked to this end of the bobstay (at bowsprit end) to set it up.

The foresheets are very well arranged for handiness. In diagram H. *a*

represents the line of the foot of the foresail, *c* being the cringle in the clew of the foresail. To this cringle two short pieces of rope are spliced with thimble eye at *d d* as well. The foresheet is fast on the deck to an eyebolt at *s*; it then passes outside the channels *k* through the thimble *d* and through the coamings of the well at *x* and is then belayed. It will be observed that in the diagram the foresail is represented hauled amidships.

The sails that we saw were exceedingly well cut and tabled, and were made of cotton duck.

A very similarly worked mainsail is used in America for the "cat boats" of Rhode Island. An illustration of this rig has been given me by Mr. R. B. Forbes, of Milton, Mass., and is shown by Figs. 70 and 71. *a* is a boom laced to the sail and used for reefing. *r* is a tackle for hauling the reef down. The halyard *c* comes down to and belays to a cleat on the heel of the yard at *d*, close to the traveller *t*. By simply slacking the halyard *e*, and hauling on *r* the sail is reefed (see Fig. 71).

CHINESE LUG SAILS.

The Chinese plan of battening a sail has been very much recommended, and there is not much doubt that battens will keep a sail from going into a bag; the only objection to them of any importance is that they so much increase the weight of the sail. For a sail of the proportions given in the drawing (scale $\frac{1}{4}$ in. to 1 ft.), the battens should be 1 in. thick, and 1 $\frac{1}{2}$ in. deep, tapering towards the ends (three battens, 1 ft. 6 in. distant at the luff of the sail, and 2 ft. at the after leech). A reef band is sown on the sail to receive each batten, and the latter will be lashed at either end to leech and luff of the sail through thimbles; and, again, a thimble will be securely seized to each end of the battens, for the reef earings to be rove through.

The sketch shown on Plate VII. (scale $\frac{1}{4}$ in. equal to 1 ft.), made by Mr. W. Baden Powell, shews the arrangement of battens. Mr. Powell thus describes the gear and fitting of the sail:

"*Rig.*—Mainsail of the largest size the boat will carry in a steady moderate breeze, placed forward so that its centre of effort comes ahead of the centre of lateral resistance of the boat; mizen of the same cut as main, but of such size and so placed as to bring the centre of effort of the whole sail plan aft of the centre of lateral resistance (for a small boat should always carry weather helm; without it safety does not exist).

"*Fitting.*—The mainsail is fitted with a yard, a boom, and three or four battens; the sail is laced to yard and boom; the battens are lashed at their ends to luff and leech, and are, as it were, rove through a horizontal

seam on the sail formed by sewing a 'reef band' across the sail to take the batten. The battens are made of pine, and taper at the ends like topsail yards. They are about 1½ in. in diameter in the middle. The reef earings reeve through thimbles on the boom ends, and belay to 'patent' cleats on the boom.

" *Halyards*.—Toggle on the single part to a becket or strop on the yard. The battens and the yard are kept in to mast by toggle and becket parrels.

" *Tack* is a single rope, leading from the well to a block on deck at side of mast; it then toggles to a becket on boom, about one-eighth the boom's length from fore-end. Both tack and halyards can be fitted with a purchase for setting up, according to the size of the craft.

" The sail should be cut with very great 'peak' (yard as long as oom), so as to allow of a forestay, by which to lower the mast. The mast fitted on a 'tabernacle'* and pinned above deck, is a *sine quâ non*, whether the boat be used for river or sea work; bridges and tow ropes come against your mast in river work—ships' warps in harbours; and, when at anchor fishing, or tide waiting in a sea chuck-up, it is almost impossible to stand up forward and unship the mast, yet the great swaggering stick will not permit your little ship to ride easy.

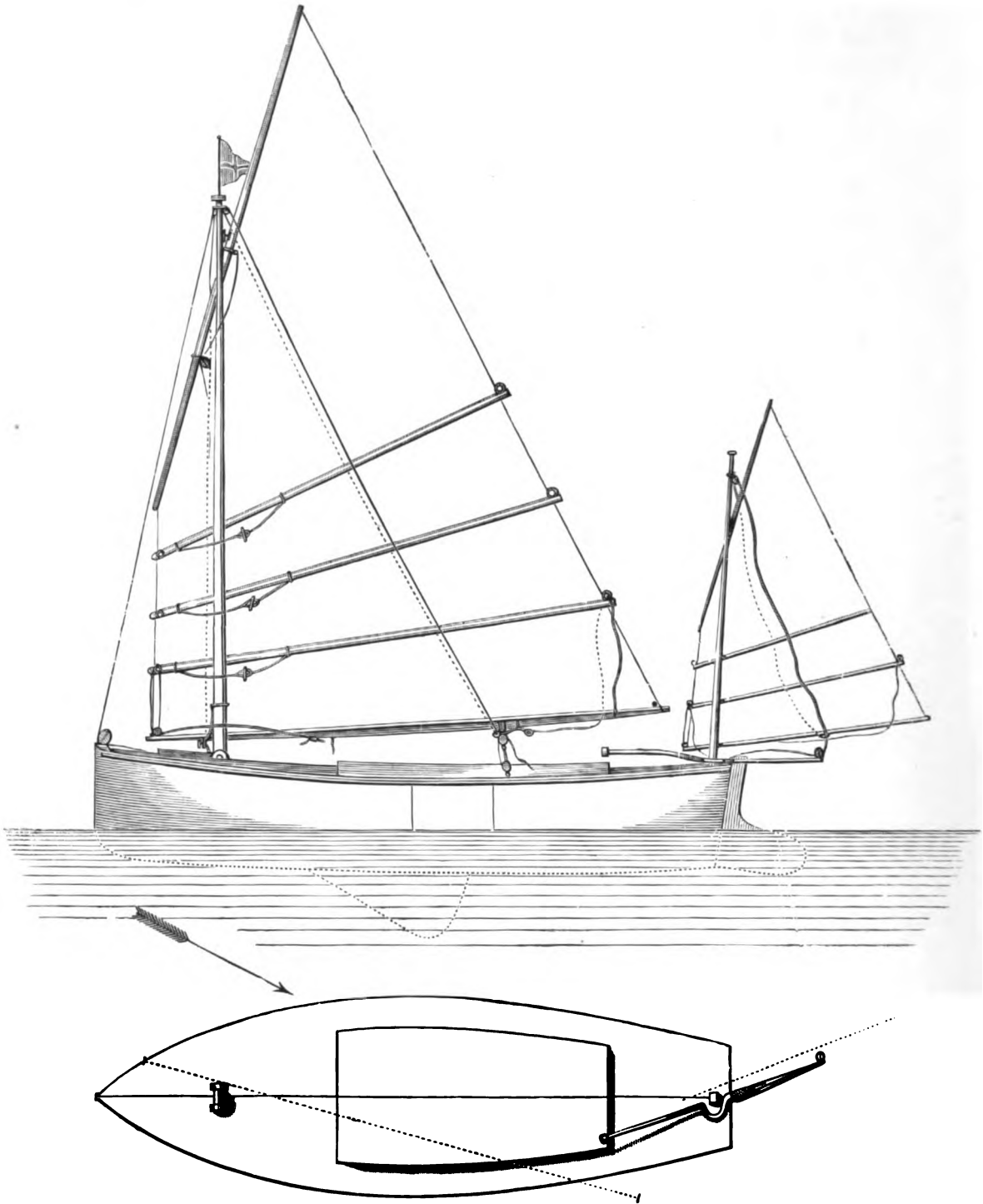
" A topping lift is fitted, standing part fast to masthead, then down one side of sail, to reeve through sheet block strop thimble; then up on other side of sail to and through a block at masthead, and down to the deck. Being through sheet block strop, which toggles on to boom, this topping lift remains with sheet on mast when sail is taken off and stowed away, and is thus ready for a change of sails.

" A kind of gathering line, or sail keeper, is fitted to hold the sail up clear of the deck at the mast when it is lowered down, thus: one end fast at masthead, then down the side of sail on which the mast is not, and round under boom, and up, making it fast round the mast about 1 ft. above the boom: thus, when going to set up sail, you place forward end of boom, yard, and batten all in a bunch, between the mast and gathering ilnes, then the after ends through between the two parts of the topping lift;

* A tabernacle is simply a perpendicular square trunk, or spout, as it is usually open on the aft side, made to take the lower part of the mast; if the mast is stepped on deck (as those of the river barges are) the heel of the mast will be pivoted on a bolt passing athwartships through the sides of the tabernacle above the deck as shown in Plate VII. Brass or iron plates should be fitted to the tabernacle where the bolt passes through, and there should be an iron band or ring on the heel of the mast. In an open boat the mast can be pivoted near the bottom of the tabernacle, thus: a bolt is fixed through the tabernacle (athwartship); on the heel of the mast is an iron band with two scores 1½ in. deep cut in it to fit the bolt; a score is also cut in the heel of the mast to correspond with those in the iron. The mast head is fitted on the bolt by the score, and when on end is kept in its place by an iron or clamp on the thwart as usual. If the mast is pivoted on deck, it will be safer to have holes *through* the iron on the heel of the mast instead of mere scores for the bolt to pass through.



PLATE VII.



Chinese Lug Sail : Main and Mizzen Rig.

toggle the sheet, tack, and halyard on, and the sail is ready to set; the batten parrels can be toggled at any time afterwards, as they only effect a good 'sit' to the sail.

"The tiller should be formed as if double, *i.e.*, one part leading aft, and used as mizen boomkin, and the other on fore side of rudder with a **U** bend in it, to allow it to clear mizenmast. Thus fitted when working ship, on putting the helm down the mizen sheet is brought to wind, and main sheet is off, consequently she would turn like a bicycle; or when the helm is put up, mizen sheet is thereby eased, and off she must go.

"A battened sail can easily be reefed 'in stays,' *i.e.*, while going about, without even checking the boat's way, for the battens do not require the reef points to be tied, except for neatness, unless it is a very deep reef.

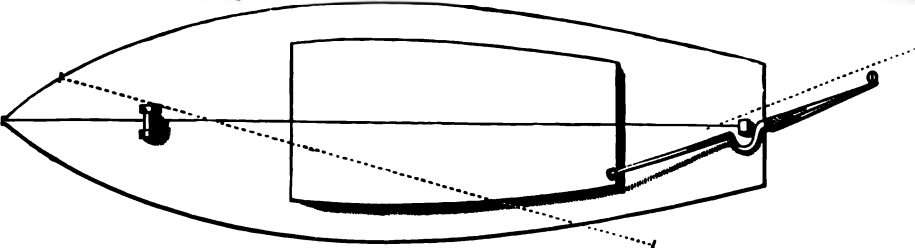
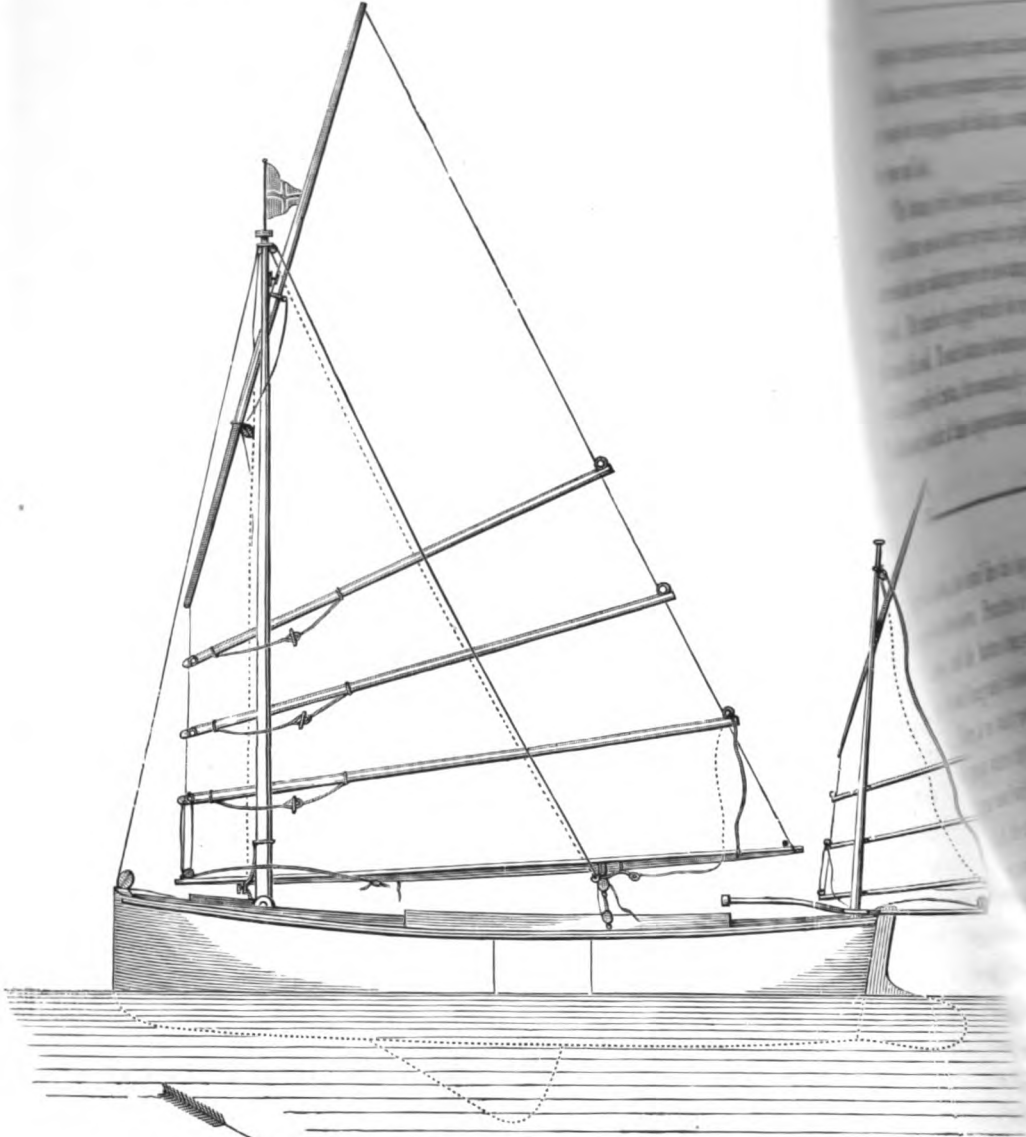
"A boat thus rigged can be hove-to in bad weather at sea, or, when waiting for tide into harbour, thus: take the mainsail off the mast, bunch yard and boom together, and span it with a rope: to the centre of the span fasten your boat's hawser, let the sail and battens hang loose, heave it overboard, and pay out the hawser; lower the mainmast, and haul mizen sheet fore and aft. Thus she will ride head to wind, and the sail will break much of the sea. The storm main lug may then be got ready, in case you have to cut and run."

Mr. Powell found, in canoe sailing that with battens he could carry much more sail (in the ratio 5 to 7) and the canoe would lie closer to wind. Also in running the canoe was much steadier, and did not roll so much as with the sail without battens. In gaff sails, where the peak halyards assist in keeping the sail flat, or in any sail that is well cut and can be kept flat, the advantage of battens will not be great. However, lug sails are very difficult if ill cut to keep flat, and battens in these may be found of service.

The regular "Chinese lug" was thus described by "Mercator," a writer in the *Field* in 1871.

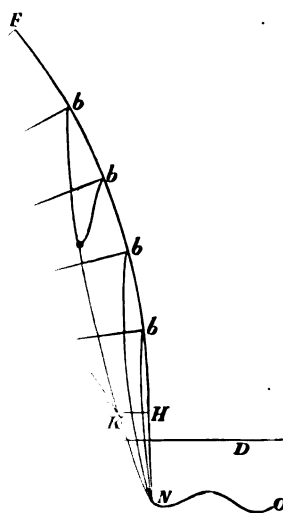
"Almost every district in China has a distinctive type of sail, some highly peaked, others with little or no peak, some with the leech greatly rounded at the peak, others with it cut almost or quite straight, some very narrow at the head and wide at the foot, others wide at the head and much the same width all the way down, some rigged on the starboard side, and others on the port side of the mast, some with sheets leading from all the battens, others with sheets from the lower ones only; in fact, the changes are rung in almost every conceivable way, but all are provided with a brail, but which more resembles in its uses a topping-lift. As to the material of which the sails are made; matting is that most usually

PLATE VII.



Chinese Lug Sail: Main and Mizzen Rig.

l in form is crescent-shaped, or, in other l tends upwards instead of downwards, as he East this kind of keel is common, and nous extent in the model of a Bombay of Edinburgh) in the Naval Museum at this yacht is quite like a half-moon, but ter than aft. There is no advantage in he centre of lateral resistance could be ordinary and, when a small draught is



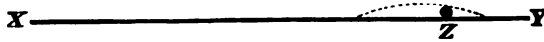
CD, line of gunwale; GH, foot through eye at K, the position KL, AL, and LM; the letters they would be when hauled

d would take little would bring her he fore-body, it and abaft the the middle- e projected we find in not found in

am, and she thus the loftiness of her

employed in native craft of any size, this article being extremely cheap in China, and when dry comparatively light ; but for small boats, twenty to twenty-five feet gigs, and the like, a stoutish duck is the best, both for wear and look.

“The battens, it will be seen (see Fig. 72), are so arranged that the top and bottom ones do duty for yard (or gaff) and boom respectively, the intermediate ones radiating more or less sharply, according to the shape of the sail. The number for a gig would be five or six, to be increased with the size of the sail. To each batten is fastened a loop or parrel, if one may so call it, generally of rattan, but occasionally (in very small boats) of rope. The shape and position of these loops are indicated in the following sketch,



X Y being the batten, the dotted line the loop, and Z the position of the mast, looking down from above. From this it is apparent that these loops do duty as parrels ; and the battens being made of bamboo, there is nothing to prevent the sail being easily hoisted and lowered, even when to windward of the mast. There is no tack proper, but the lower batten is made fast to the mast at the point where they intersect. The halyard (M) exactly resembles the simplest form used with lug sails, and is made fast to the forward portion of the upper batten, the exact place being regulated by the shape and sit of the sail. The luff projects 1ft. or 15in. (or even more, according to the size of the sail) forward of the mast. The sheets generally lead from several of the lower battens, one from each, and by a little mechanical arrangement are united into one sheet in such a way that the pull is everywhere equal. In some boats, where the sail projects some distance over the stern, two sets of sheets are required, one on each side. The sail when set is trimmed so that the lower batten is parallel to the keel. The brail or toppinglift is fitted in a very simple and efficient manner. A line leads from the masthead down the inside of the sail (*i.e.*, the side on which the battens are), through an eye 1ft. or 2ft. from the after end of the lower batten, up again on the outside of the sail through another eye rove in the end of a short pendant from the masthead, and down again to the point where the lower batten and mast intersect, where it is made fast ready for use. The sail thus hangs in the bight of the brail as in a sling. The following sketch (Fig. 72) illustrate the sail described.

At Shanghae the completely battened lug sail is in much favour, and the description of yacht in use there will be found illustrated on Plate VIII., which represents the Charm, Mr. C. J. Ashley.

It will be seen that the keel in form is crescent-shaped, or, in other words, the curve given to the keel tends upwards instead of downwards, as is usual in ordinary vessels. In the East this kind of keel is common, and we find it carried out to an enormous extent in the model of a Bombay yacht (the property of the Duke of Edinburgh) in the Naval Museum at South Kensington. The keel of this yacht is quite like a half-moon, but the draught forward is much greater than aft. There is no advantage in thus giving a vessel "gripe," as the centre of lateral resistance could be got forward without such an extraordinary and, when a small draught is necessary, inconvenient contrivance.

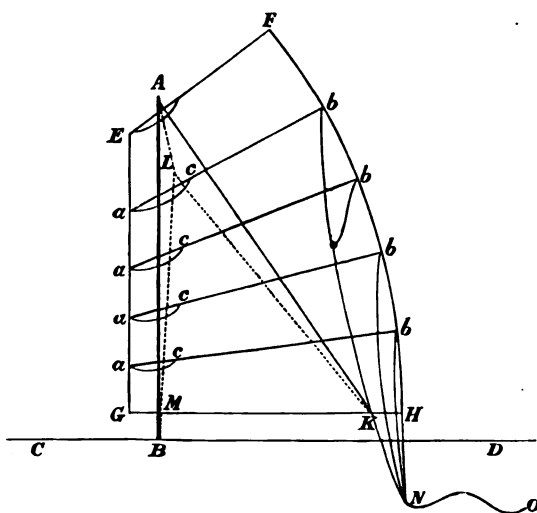


FIG. 72.

"AB, mast; EF, head of sail; EG, luff of sail; *ab*, battens; CD, line of gunwale; GH, foot of sail; FH, leech of sail; *ac*, loops or parrels; AK, brail leading through eye at K, the position of the brail on starboard side of sail being shown by dotted lines KL, AL, and LM; the letters *bN* denote sheets hanging loose (over the sail instead of abaft it, as they would be when hauled in for sailing), leading into a single one, NO."

The Charm, it will be seen, is extremely shallow, and would take little ballast, as her weight of hull, spars, fittings, and stores would bring her down nearly to the load water-line. The floor timbers in the fore-body, it will be seen, are lower than those of the midship body, and abaft the midship section the timbers retain the flatness of the floor in the middle-body. One peculiarity of the after-body is, that the timbers are projected at right angles from the dead wood, and the gentle curve which we find in English yachts (made by filling up the angle in the runs) is not found in the Charm.

The length of the yacht is about three times her beam, and she thus has great stability; and this she needs, looking to the loftiness of her

canvas. The chief excellence of the Chinese lug consists in the flatness of its surface. This flatness is brought about by battens, which are extended across the sail, as shown by 4 (Fig. 73) on the plan, and by the use of bowline-bridles the whole way up the after leach of the sail. These bridles lead into two bowlines, and the bowlines again into one part, the latter leading to a double block on the bumpkin (8) extending from the taffrail, so that hauling on this single part brings an equal strain on each bowline-bridle. These bowline-bridles are numbered 7 in the drawing. To keep the sail into the mast a lacing (5 in the drawing) rove through parrels which extend from the luff of the sail to well into its belly; these parrels are distinguished by 6 on the sail plan. Beyond this, a hauling parrel is used to keep the

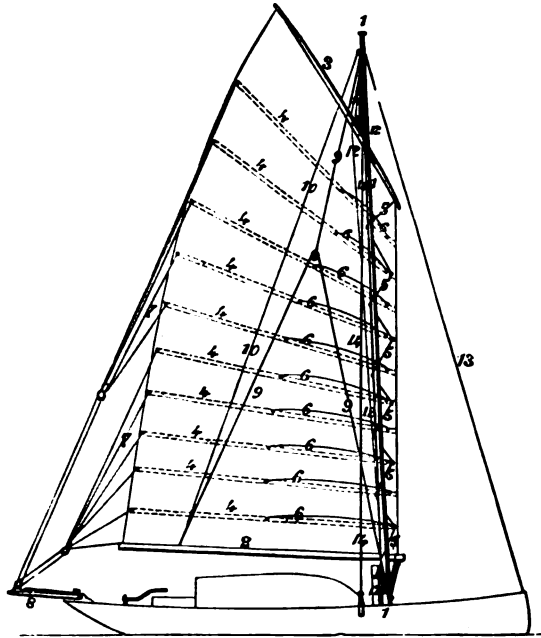
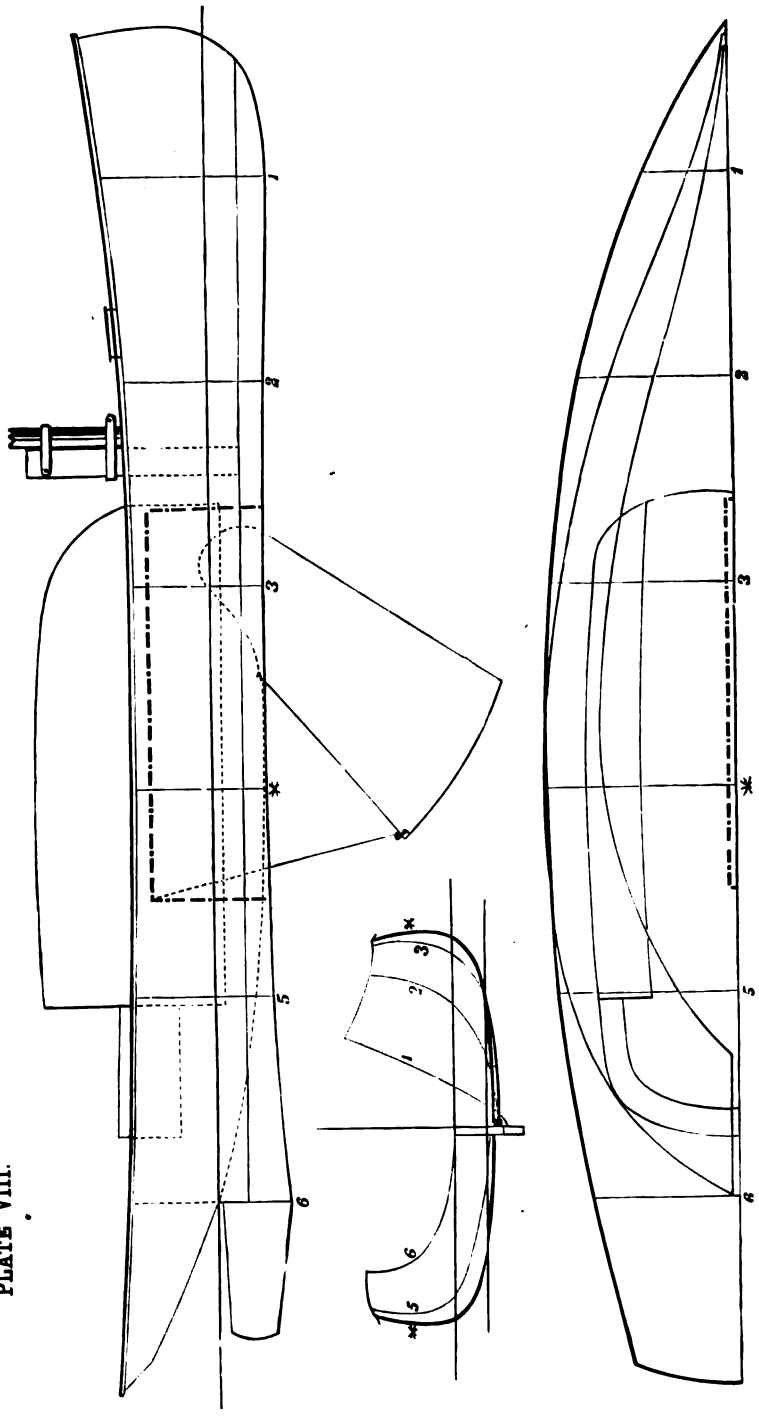


FIG. 73.

yard into the mast, marked 12 on the drawing. The standing part is made fast to the yard, passing round the mast, then through a block on the yard, the hauling part leading to the deck. The topping-lift shown by No. 9 explains itself, the line denoted by figures 10 being the topping-lift on the port side. The topping-lift passes through a single block at the masthead. The other figures indicate as follows: 1, the mast; 2, the boom; 3, the yard; 11, main halyards; 13, forestay; 14, shroud. The mast can be unshipped at pleasure, as the drawing shows; and, as there is neither bowsprit or topmast, such a vessel could be dismantled in a very few minutes. The *Charm* has a booby hatch, and under this there is a great

PLATE VIII.



"The Charm."

deal of room. The centre-board is shown in the sheer plan lowered to its full depth, and the lines — . — show its case. When hauled quite up, the board would protrude above this case; but this need never be done, as the draught could not thereby be made less than it is at all times aft. The dotted lines above the keel aft show the intersection of the timbers with the dead wood; the dotted lines in the middle-body show the plan of the cabin, and the cockpit forming the entrance to the cabin.

The following table refers to Plate VIII., representing the yacht Charm :

| No. of Sections. | Half-breadth at Load Water Line. | | No. of Sections. | Half-breadth No. 2 Water Line. | | No. of Sections. | Height from Load Water Line to Plank Sheer. | | No. of Sections. | Depth from Load Water Line to under-side of keel. | |
|------------------|----------------------------------|-----|------------------|--------------------------------|-----|------------------|---|-----|------------------|---|-----|
| | ft. | in. | | ft. | in. | | ft. | in. | | ft. | in. |
| 1 | 1 | 2 | 1 | 0 | 8½ | 1 | 3 | 4½ | 1 | 1 | 8 |
| 2 | 3 | 10½ | 2 | 2 | 4 | 2 | 2 | 8 | 2 | 1 | 8 |
| 3 | 5 | 6 | 3 | 4 | 0 | 3 | 2 | 5 | 3 | 1 | 7 |
| 4 | 6 | 1½ | 4 | 4 | 2 | 4 | 2 | 5 | 4 | 1 | 7 |
| 5 | 5 | 4 | 5 | 1 | 9½ | 5 | 2 | 6½ | 5 | 1 | 9 |
| | | | | | | 6 | 2 | 9 | 6 | 2 | 2 |

Distance the sections are apart, 6ft. 6in.
 Distance No. 1 section is from fore side of stem at L.W.L., 4ft. 6in.
 Distance water lines are apart, 1ft.
 Length on L.W.L., 37ft.
 Beam on L.W.L., 12ft. 3in.
 Beam, extreme, 12ft. 5in.
 Displacement, 9·26 tons.
 Centre of displacement below L.W.L., 0·736ft.

Metacentre above centre of displacement, 8·2ft.
 Area of sail, 990 sq. ft.
 Luff of sail, 35ft.
 Leach of sail, 54ft.
 Foot of sail, 26ft.
 Head of sail, 21ft.
 Tonnage by B.T.Y.C. rule, 20·3 tons.
 Area of L.W.L., 295 sq. ft.
 Displacement for lin. of immersion at L.W.L., 0·7 ton.

SPRIT SAILS.

Sprit sails formerly were in high favour, but during the last twenty years they have gradually fallen into disuse. It is still a favourite rig, however, among watermen, and they probably adhere to it because the sprit stretches the sail so flat. The old Ryde wherries, celebrated for their fine weatherly qualities, were sprit-rigged, but of late years they have generally adopted the gaff instead of the sprit. The advantages of the sprit over a gaff for setting a sail in a small boat cannot be denied, as by crossing the sail diagonally it takes up all the slack canvas in the middle of the sail, even if it be an old sail. On the other hand, a sprit is an awkward spar to handle, and it need be much longer and heavier than a gaff to set similar sails.

In small boats the luff of the sail is usually laced to the mast through eyelet holes about 2ft. apart; the throat is secured to an iron traveller, or sometimes to a grommet strop. In large sails galvanised iron rings or mast hoops are used. The tack is lashed to a small eyebolt screwed into the

mast. The sail is hoisted by a single halyard and belayed to the gunwale to serve as a shroud. The foresail is also belayed by a single halyard, and belayed to the opposite gunwale. The sprit is supported on the mast by a

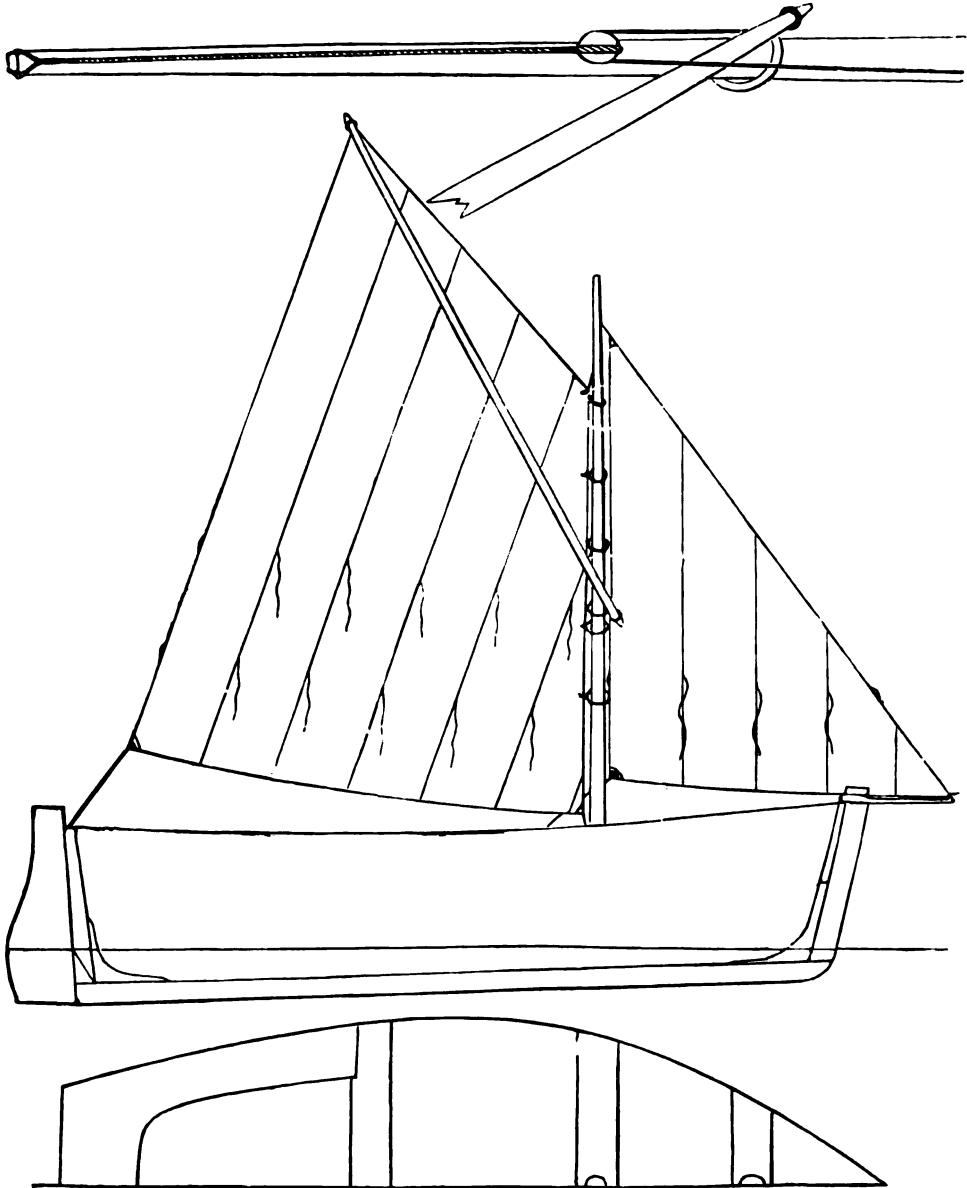


FIG. 74.

strop called a snotter; this strop is a piece of rope with an eye spliced in each end; it is put round the mast, and one end rove through an eye; the heel of the sprit is put in the other eye. After the sail is hauled up on the

mast the upper end of the sprit is put into the eye or loop on the peak of the sail, and then shoved up and the heel slipped into the snotter. The sail is then peaked by pushing the snotter and heel of sprit as high as required; the sail is then sheeted. If the sail is large and the sprit heavy, a traveller and whip purchase are used: (See Fig. 74.)

A pendant with a running eye in it is fitted over the masthead; at the lower end of this pendant is a block, through which the hauling part is rove, one end being fast to the thwart. Sometimes a gun-tackle purchase is used instead of the whip purchase. Either is to be preferred to the snotter alone, as without any other support the snotter will be continually slipping

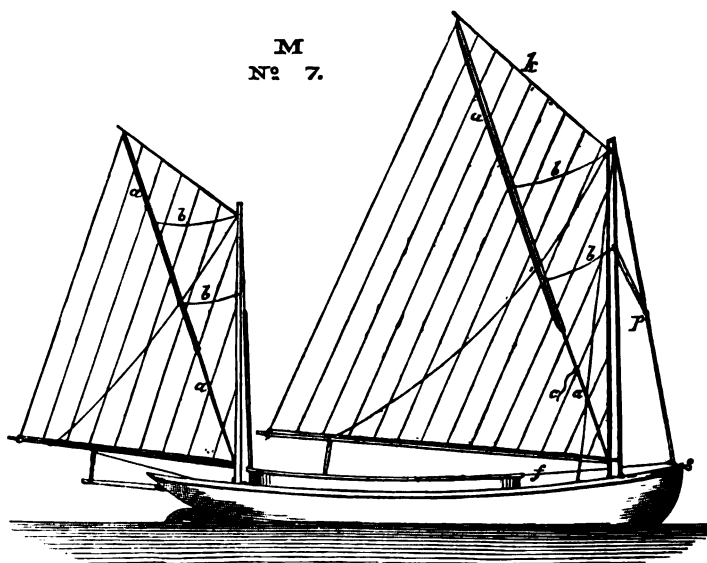


FIG. 75.

down. If there should be much wind when the snotter slipped down the mast the heel of the sprit might go through the bottom of the boat; and this accident has very often happened. The waterman's remedy for this is wetting the mast, but the single whip purchase is to be infinitely preferred, as it not only keeps the sprit from slipping down, but enables the sail to be set better.

An improved form of the sprit sail rig is in use in America, an illustration of which has been made by Mr. R. B. Forbes, as shown (see Fig. 75). The sprit comes down to the gooseneck of the boom and is inserted in a pocket *a*, stitched diagonally across the sail: *b b* are brails on both sides of the sail, but leading through one purchase block *p*; *p*, of course, is a double block. The standing part of the purchase is fast to the stem at *s*, then leads up through the block *p*, down through a block on the stem *s*,

and the fall *f*, to a cleat inside the waterways. *c* is a reef point, one on each side of the mast, round which they are tied when the sail is reefed. When reefing the mast is allowed to rake aft, either by having a long slotted step for the mast, or by pivoting it in a tabernacle. (See the French rig, p. 275.) The process of reefing is very simple: luff into the wind, slack up sheets, haul on the brails; make everything fast, rake the mast, and fill away again. Fig. 76 shows the sails reefed with the upper part of the luff of the sail brailed up. To make a neater "brail up" another pair of brails might be attached to the head of the sail at *k*, and lead to *a*, then to the mast head down to the block *p*. This forms a very easily reefed sail.

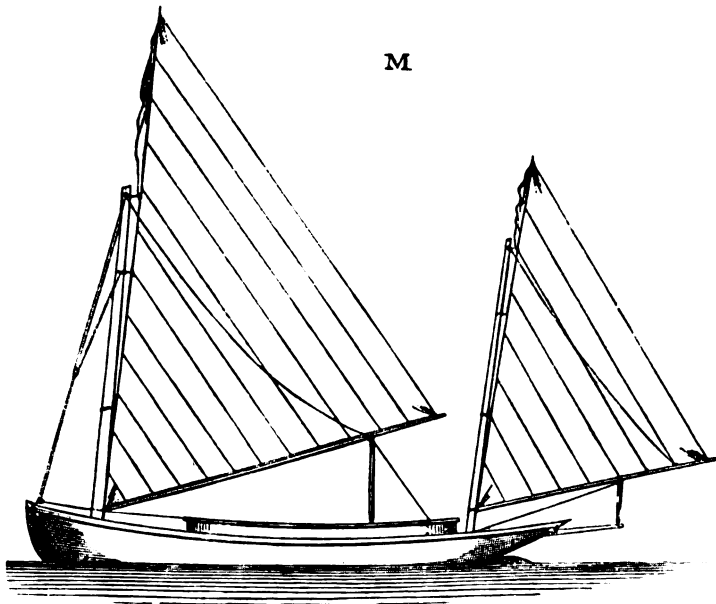


FIG. 76.

Fig. 77 represents another American rig (drawn by Mr. Forbes), and has the advantage of the sails being in three pieces. The main and mizen are fitted on the lateen plan, but are shoulder of mutton in shape. *a* is the halyard made fast to the yard, and leading over a sheave in the mast head to the deck. *b* is another halyard leading through a bull's eye at the mast head and belayed to a cleat on the heel of the yard at *f*. The yard or reefing boom *d* is jointed to a traveller *c*. The reefing tackle is shown by *e*. *rr* are reef points. The foresail is hanked to a wire stay. A short club yard, *g*, is laced to the foot of the foresail; the fore sheet block is fast to this yard, and works on a traveller across the deck.

To reef the sails luff up head to wind and cast off the halyard *a*, and the sail will lower until the traveller *c* rests on the boom at *o*, *b* of course

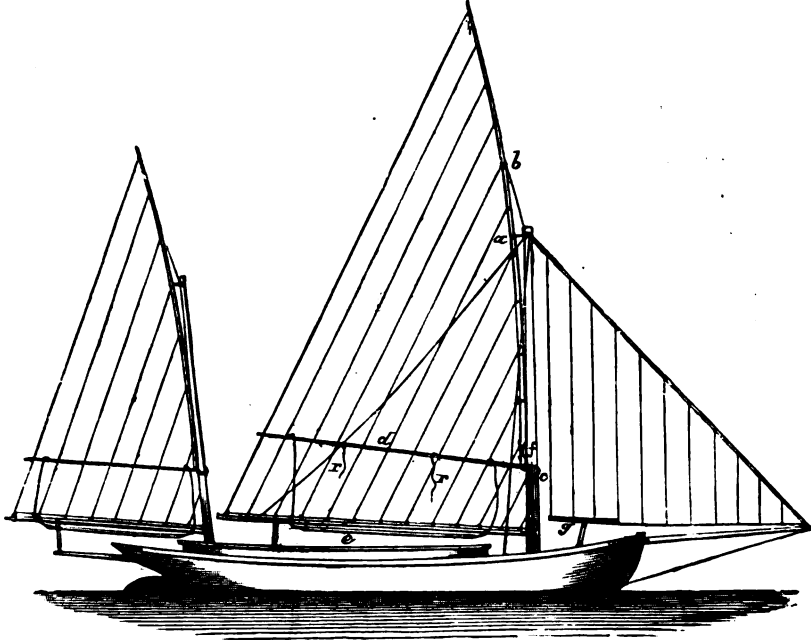


FIG. 77.

coming down to the bull's eye on the mast head. Haul on the reefing tackle *e*, and tie the points at leisure (see Fig. 78). Next let the foresail

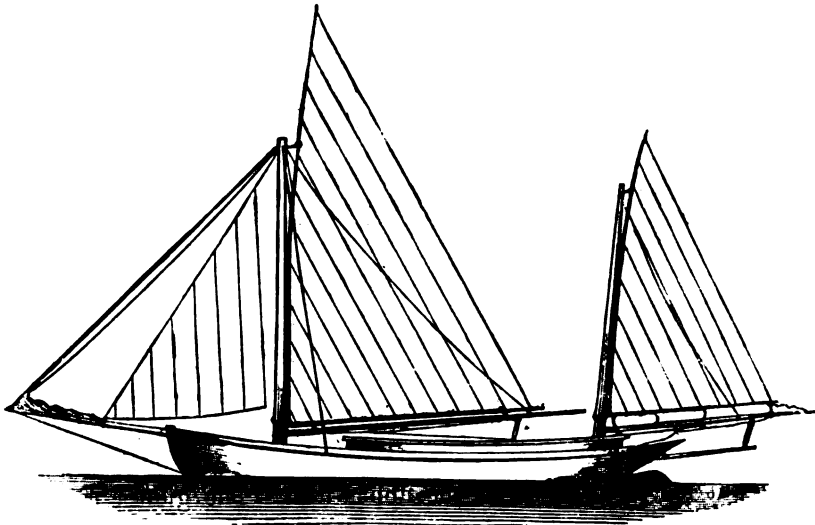


FIG. 78.

run down, and stow it on the bowsprit. To further shorten sail stow the mainsail. The small jib is set flying.

THE SLIDING GUNTER.

The sliding gunter, it has been claimed, has all the advantages of the lug sail; has lighter spars compared with sail area, and is less dangerous. This may be true enough of the old-fashioned dipping lug, which no doubt is a dangerous sail, but we very much question if the gunter will ever be able to compete with the balance lug, in weight of spars or in handiness, effectiveness, or safety.

The mast, it will be seen by Fig. 79, is in two pieces, the upper part sliding on the lower by two irons. When hoisted the lower part of the luff of the sail is laced to the mast. The irons should be of brass or of galvanised iron, covered with leather, and they should be kept well soaped or greased.

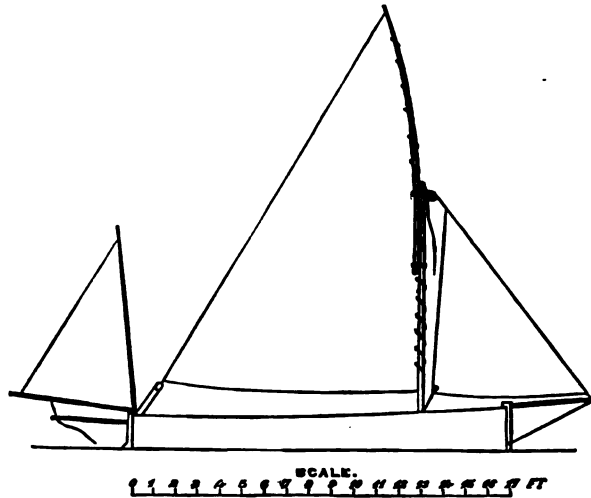
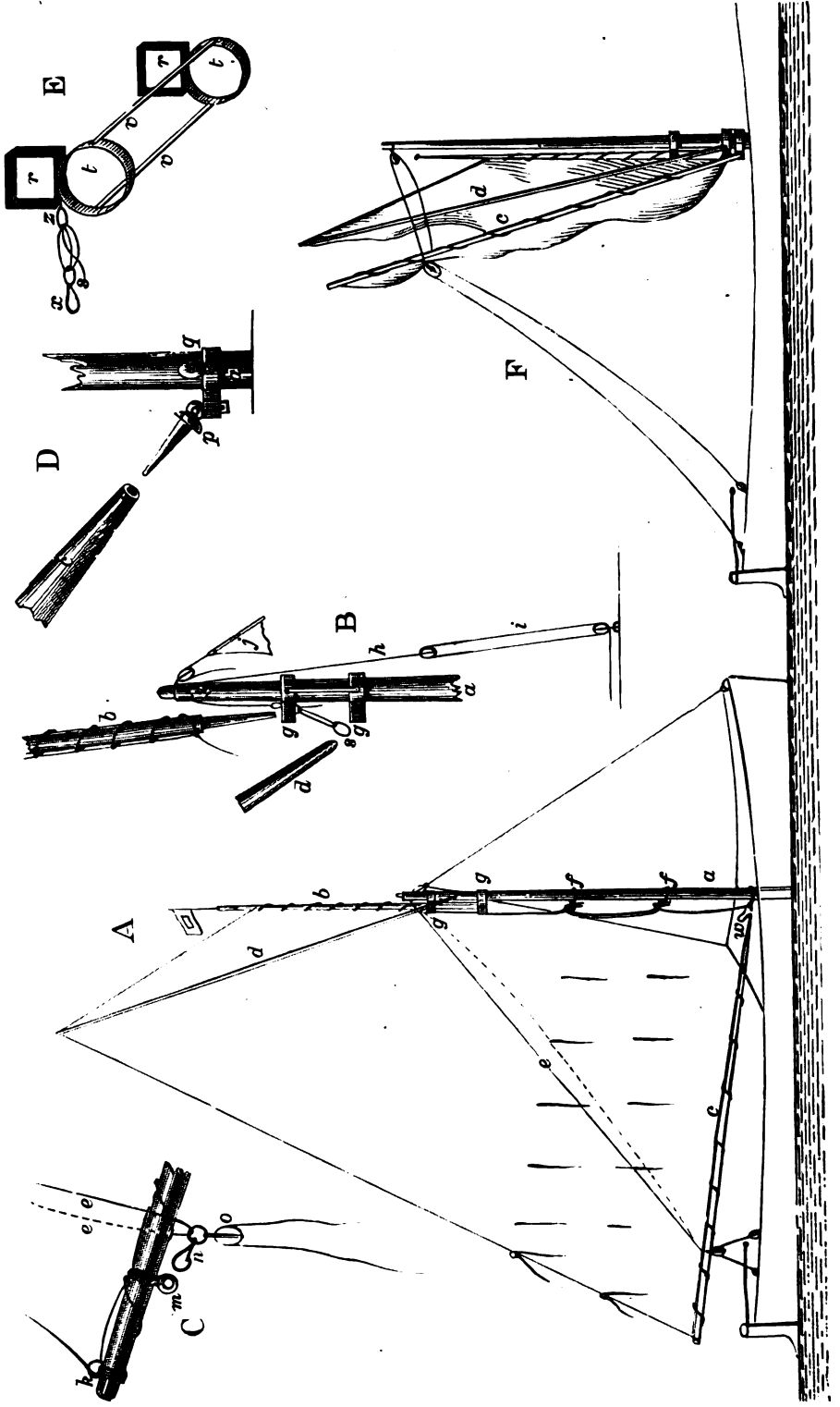


FIG. 79.

The irons are fitted to the upper part of the mast (usually termed the yard), and should fit the lower part very loosely, as a common peculiarity of the iron is to jam either in hoisting or lowering—mostly during the latter operation—especially if the boat be heeled. The yard is hoisted by a single halyard rove through a sheeve-hole at the lower masthead. The halyard is fast to the heel of the yard, and a score is cut out for it on the fore-side of the yard; it leaves the yard at the upper iron. The gunter rig is sometimes applied to long boats with three masts, a stay foresail being invariably used. The sketch given shows a sail fit for a 17ft. boat (such as Plate III.), and has foresail and Mudian mizen.



PLATE IX.



Gunter Sprit Big.

GUNTER SPRIT RIG.

Some years ago Mr. Baden-Powell brought out a rig which was a combination of the gunter and sprit. He first fitted it to canoes, and afterwards to a centre-board gig. The objects sought were a lofty sail, with a mast readily shortened for going under bridges, &c.; reduction of top hamper or weight when reefed down; and mast and spars of such length as could be stowed inside the boat. The rig was intended entirely for cruising, and not meant to compete against the balance lug for racing. The following diagrams (Plate IX.), on a $\frac{1}{4}$ inch scale, will show the rig:

A shows the sail set.
a is the mast.
b, the topmast.
c, the boom.
d, the sprit.
e, topping lift; the ticked line shows the topping lift to leeward.
f, mast hoops.
g, gunter irons.
w, a hook on the gooseneck to hook to the reef cringles when the sail is reefed.
 B is a view of the mast head.
a is the mast.
b is the topmast unshipped from the gunter irons *g*.
d is the sprit unshipped from the smotter *s*.
h is the standing part of the halyard passing through the sheave at the mast head, and fast to an eye on the upper gunter.
i is the purchase for the halyard, the standing part fast to the lower block.
j is the head of the jib.
 C is a view of the boom end.
k is the clew of the sail lashed to boom.
m is a grommet strop with thimble eye.
n is a clip or spring hook on swivel ready to be hooked into the eye *m*.

o is the mainsheet block.
e is the topping lift.
 D is a view of the boom and gooseneck.
p is the gooseneck on the mast *a*.
c is the boom ready to be shipped on gooseneck.
q is a block for the fall or hauling part of the main halyards. (This block can be on the mast thwart or deck; see B.)
 E is a bird's-eye view of the gunter iron.
r is the square part into which the topmast is stepped.
t is the ring traveller shipped on the mast.
v two iron stays or connecting rods which hold the gunters together.
s is the smotter loosely laced.
w is an eye splice to take the sprit, with a thimble seized in at *s*.
s is another thimble with a tail lashed to the gunter. A rope or lanyard is spliced to the thimble *s*, and rove through and through the thimbles *s* and *s*, so that the smotter can be made of a length to suit the length of the sprit.
 F is a view of the sail brailed up by the topping lift, and with topmast housed.

The sail is laced to both boom and topmast, and *tied* to the mast hoops. To stow the sail, lower away by the halyards (which are fast to the upper gunter iron); unship the sheet block from the boom; unship the sprit; unship the topmast from the gunter; unship the boom from the gooseneck; untie the sail from the mast hoops; roll up, and stow away. The mast can be unstepped or not at pleasure.

In large 16ft. craft it was found necessary to have a fore stay.

A down-haul should be bent to the gunter iron.

To reef, lower the topmast (the sprit of course comes down with it) by the halyard to first or second reef band ; lay the foot of the sail neatly in folds along the boom, and tie round the boom with the reef nettles or points.

FALMOUTH LUGGERS.

The following excellent description of the Falmouth luggers was written by Mr. Wilcocks :—

“ The mizen-mast is shown after the manner of the Mount’s Bay craft, much more taunt than is necessary for setting the ordinary mizen, so that the second foresail may be set in its place in light weather. The only different arrangement required would be a longer outrigger, and a mast-hoop or traveller on it, to accommodate the set of the ordinary mizen. The bowsprit should be somewhat longer than here represented (Fig. 80) to get

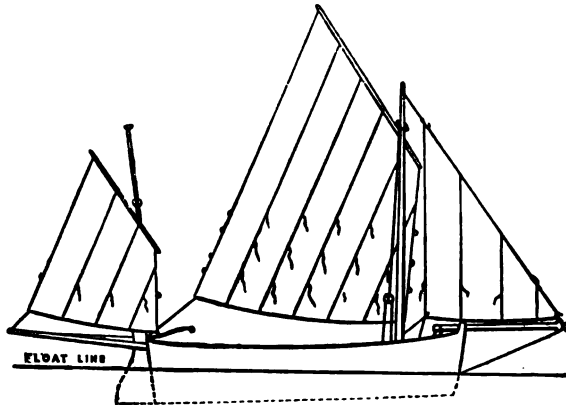


FIG. 80.

the jib a little further out. If the mast were stepped at the position shown by the heel of the bowsprit, the rig would be like the Falmouth boats, and it is a good plan to have such a boat fitted also in this manner. The omission of a jib in the Falmouth boats is for the convenience of dispensing with a bowsprit whilst running alongside shipping. Fig. 81 is a sketch of the Falmouth waterman’s rig. It is in use for boats from 14ft. long up to substantial little craft, apparently of as much as 7 or 8 tons. From the mast being so far forward, we might imagine a boat thus rigged would pitch heavily in a head sea, and I cannot altogether divest myself of this impression ; therefore, should prefer to have two places for stepping the mast, with a moderate-sized jib to balance the after canvas, when the mast

is in its after position. Boats intended to carry their masts so very far forward should be built with additional free-board forward to allow for plunging if caught in troubled water. This is well attended to in the Guernsey fishing boats, which are built very high forward, and answer well. In a large boat it is a good plan to have a horse of galvanised iron across the stern for the main sheet, with a single and double block, the double block grommeted to a thimble traversing on the horse. There will then be no sheet to tend in going about when under the mizen and lug foresail, the only thing required being possibly a touch to the double block, to get it well down to the extremity of the horse. In making the horse, the smith must not forget to weld on a collar to either end, that the traversing thimble may not slip round the turns of the horse at the sides of the boat. In small boats, up to 18ft. in length, a single sheet made

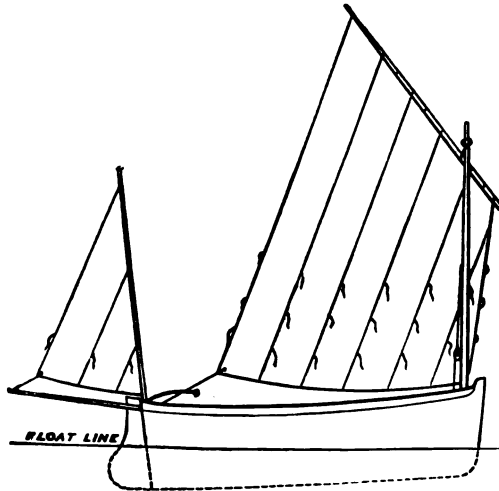


FIG. 81.

fast to a belaying pin through the transom board, is the safer plan, unless the boat be a deep-bodied craft, especially built for sailing. It is often desirable to shorten sail by tricing up the tack in all kinds of sailing craft. For this a tackle must be provided to keep a strain on the luff of the sail, as the peak would otherwise immediately fall on letting go the tack. The upper block should have a pair of sister hooks, which can easily be attached to the second cringle of the sail, and by aid of a small block secured close to the slings of the yard, the tack can be triced up when required. It is an unusual thing to trice up the tack of a lugsail; nevertheless, in anything but a small boat, the handiness is unquestionable, and, in fact, in a boat fitted with one large lugsail, it is often necessary to do so."

LOWESTOFT LATEEN SAIL.

The lateen rig has not been much adopted in the English coast, owing probably to the length and weight of the yard required, and the awkwardness of the reefing arrangements. Sometimes the sail is reefed along the foot, as shown in the engraving of a Lowestoft lateen (see Fig. 82), and

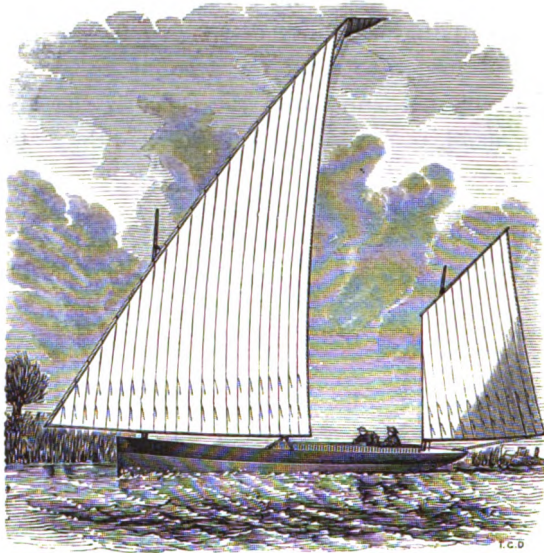


FIG. 82.

sometimes along both foot and head. In the sketch given, the sail is shown with very great peak, but the sails are sometimes planned with the yard more across the mast, and with a longer boom. A lug mizen is generally a part of the rig. The boom is kept to the mast by an iron traveller or ring.

The settee sail is an adaptation of the lateen; the yard does not reach quite down to the tack, so that a short up-and-down luff is obtained to the extent of two or three reefs as shown in Plate V.

ALGOA BAY LATEEN.

The lateen rig is met with all over the world, and is much in use on parts of the African coast. In Algoa Bay, Cape of Good Hope, a curious contrivance for hoisting the sail on sheer masts instead of on a single mast has been adopted; the plan is common to the prahus of the Eastern

seas, and to the river rafts of the Mayaquil rivers. Mr. William Fleming, of Port Elizabeth, Algoa Bay, had a boat fitted in this way as shown by the accompanying sketch drawn by him (Fig. 83); the rig is thus described :

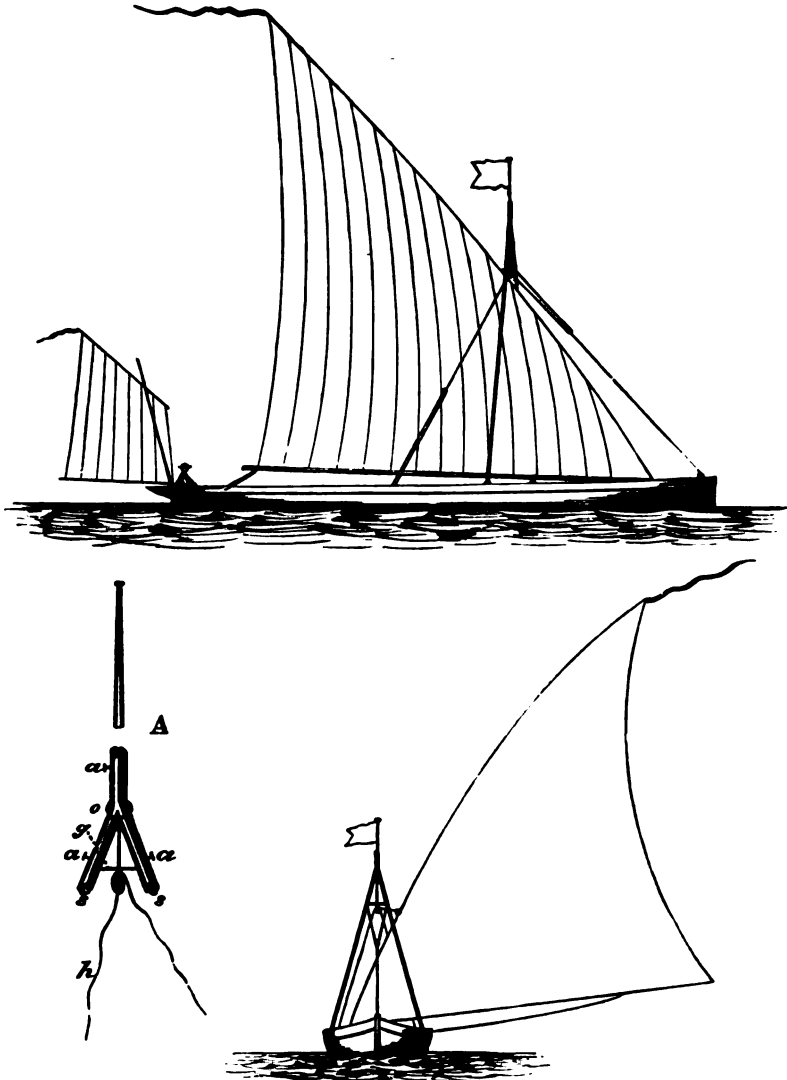


FIG. 83.

In lieu of the usual way of fitting and stepping a mast, two short poles are fixed triangle fashion, and secured to each side of the boat with a goose-neck, so as to move fore and aft. The heads of the poles fit into sockets, *s s* (diagram A), which can be made either of iron (galvanised) or of gun metal; a transverse bar, *g*, keeps the sockets from

opening at the throat. The sockets must be made deep, to fit the spars well in, and a small bolt, *a a*, running right through for further security. The upper socket will hold a flag pole. The forestay will be fast to each mast by a bridle, and the runner and pendants will on either side be fast to a mast. A double block with tail is made fast round the neck of the sockets at *o* (A), for the halyards to work through. The standing part of the halyards is fast on the yard, then leads through the block under the throat of the socket, through a block on the yard, and back through the double block. The advantage of the two mast plan is obvious—no dipping of a lug when going about, and affording scope for any variety of cut

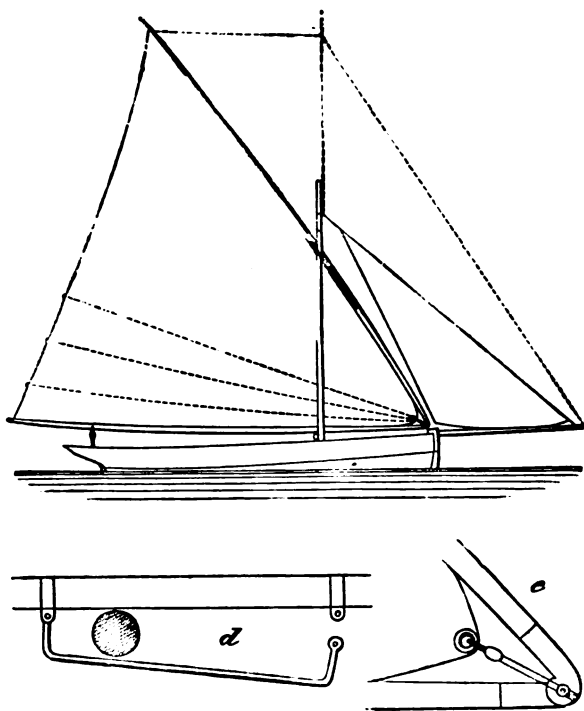


FIG. 84.

sail, peculiarly adapted for lateen rig. Masts and sails can be lowered by the run by just slacking up the forestay, and hauling on it again when required to make sail, without starting halyard, sheet, or tack. The tack of the sail may be fitted to travel on a horse, and kept in any position by a rope rove through a single block, one to be fitted on each side. Wire rope should be used for forestay and the pendants. The plan now suggested has this advantage, that everything can be lowered at a moment's warning, masts and sails snugly stowed in the boat, and if necessary to use oars, no masts stand in the way to prevent doing so effectually.

Commander T. B. Horner, R.N., has proposed the following plan for a lateen sail :

The yard at its heel is pivoted into the fore end of the boom *e*, and can be lowered so as to reef the sail diagonally by the foot, as shown; while the "down tackle" at the mast keeps all in place, and a leathered bar (which may be called the "truss-rod"), fitted to open on a hinge (*d*), acts as a traveller to bind the yard to the mast, and to follow the shifting of it aft as reefed; while a horse and traveller abaft the rudder-head would be useful to keep the boom down in working to windward. The main sheet and down-tackle being overhauled when lowering the yard for furling, the sail would make up upon the boom.

The tack might be triced up like a cutter's, by having a few hoops or a lacing on the yard; while, by being rounded at the luff, a single block purchase, making fast to a belaying pin formed by lengthening the pin of the pivot (as shown at *e*), would stretch all flat again with ease.

A topmast could be added to the rig, and a topsail set as indicated by the dotted lines, the sheet of which might be fitted with an india-rubber stopper at the bitts, to meet the spring of the lateen yard.

CHAPTER XVII.

BRIGHTON BEACH BOATS.

THE Brighton beach boats enjoy a very high repute on the South Coast, and no doubt they are very capable little vessels, and well adapted for the work they are put to. As there is no sheltered anchorage at Brighton, the boats are hauled up on the beach; and a more or less flat floor is necessary for this operation, in order that the boats may be floated as far up on the beach as possible. The boats are fitted with stout bilge keels three or four inches deep, on one of which a boat rests as she is hauled up. Ways are now laid down for hauling the boats up and launching them off; but a few years ago the boats were hauled over the beach, by a capstan, without ways. The latest boats are built with much more rise of floor than formerly, and their sailing qualities are said to be improved thereby.

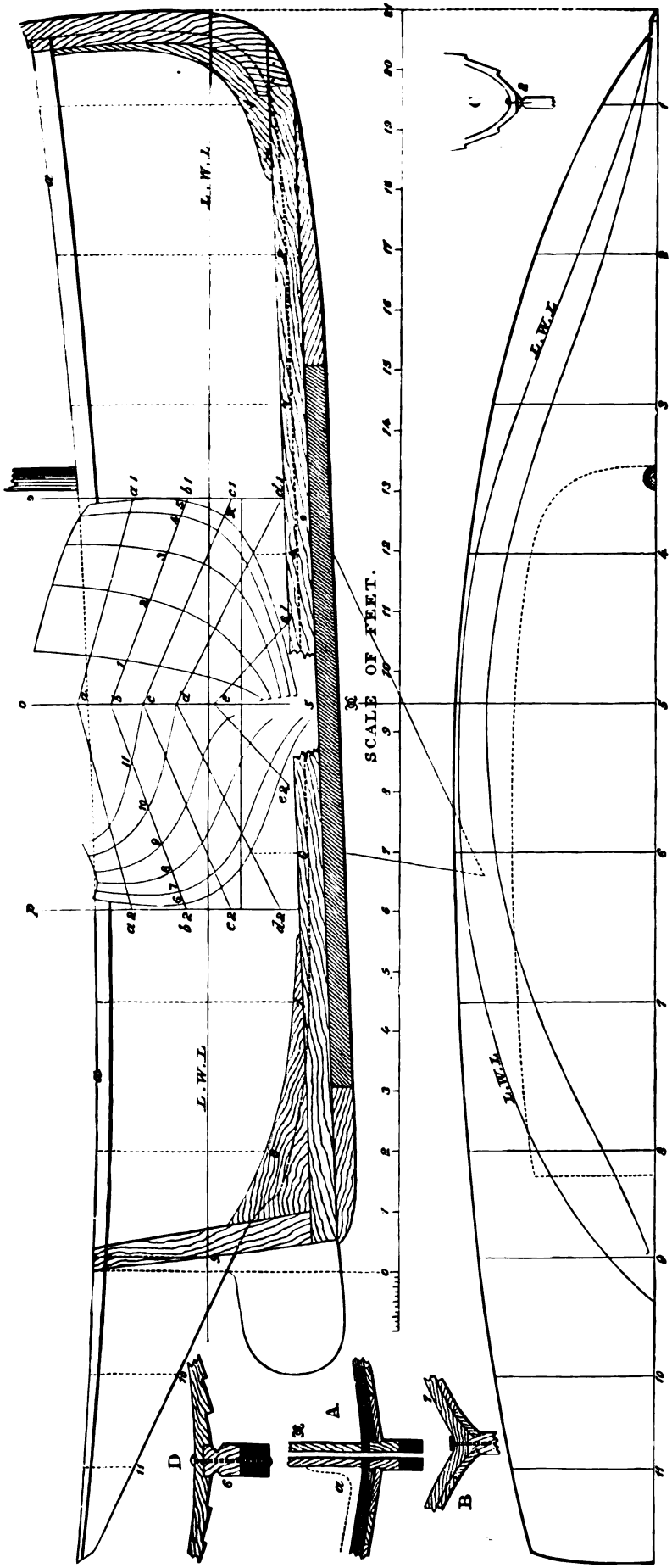
There are many advantages justly claimed for the Brighton beach boats, and especially for those of the Black Joke type, whose lines are given in "Yacht Designing;" they can be run over a sandbank in a foot or two of water to the "smooth on the other side;" whilst the deep boat, of equal length perhaps, must remain pile driving outside in the lop. They can be allowed to take the ground without fear of their not getting upright again; and, if necessary, they can be run ashore to effect a landing. These certainly are advantages which cannot be claimed for a 5-tonner of the modern school, and it is not surprising that for coast work the beach boat is in such very high favour.

Mr. Thomas Stow, of Shoreham, has built many successful beach boats, and the design on Plate X. was taken from a model he made. The "fairing" process required the design, as taken from the model, to be modified a little, and the midship section* is a trifle farther aft than

* The practice in building the Brighton beach boats is to place the midship section at about the mid-length of the boat, and rake it forward a little. Probably better results would be obtained by having the mid-section in the position we have placed it, and, as the after body appears to be all that could be desired as to form and length, there is no object in raking the mid-section forward.



PLATE X.



BRIGHTON BEACH BOAT.

it was in the model; but no important departure has been taken from the original lines as first taken off. It will be seen that some portion of the counter is immersed, and we believe that this is admissible under the rules of the Brighton Sailing Club, whose present rule of measurement takes length from stem to sternpost. The design has a trifle more displacement than the generality of the boats; but this can be considered an advantage.

The rig common to all, we believe, is that known as the cutter, and the boats require a very great deal of head sail; but, as the design given (Plate X.) has a finer entrance than is usual, the probability is that such a boat would require less head sail than the ordinary run of beach boats, and would consequently be less hard on her helm.

The boats are decked-in up to the mast, and the counter is also decked, whilst a water-way is built round the midship sides of the boat about 1ft. wide, with 3in. coamings. The centre plates were formerly much larger than that shown in the design; but, with so much keel under the boat, very little plate is necessary, and, indeed, the boat would hang to windward very well without any plate down at all.

The general floor construction of the boats is shown by Fig. D, representing a floor section at No. 6. The floor is joggled to the keel as shown, and shaped to the mould at each section; the floor is then taken out and joggled and bevelled to receive the plank, as the boats are generally clench built. Where they are carvel built the construction is shown by Fig. A, representing the midship section, with heels of floor cut through to admit the centre plate. The construction at No. 7 station is shown by Fig. B, where considerable depth has to be given to the throat of the floor. Sometimes the floors aft and forward are steamed and bent into their stations, being afterwards removed to be joggled (as shown by Fig. C, representing No. 2 station forward) if the boat is clench built.

The centre-board case is generally of wood with a knee, as shown by *a*, Fig. A, to keep it in its place, and to generally strengthen the floor of the boat.

| | |
|--|-------------|
| Greatest length from fore side of stem plumb at L.W.L. to aft side of stern post on deck | 21ft. |
| Greatest beam moulded | 6ft. 10½in. |
| Greatest beam extreme | 7ft. |
| Weight of hull (exclusive of iron plate, iron keel, and ballast, spars, sails, and crew) | 14cwt. |
| Iron keel | 4cwt. |
| Centre plate | 1½cwt. |
| Ballast inside | 5½cwt. |
| Spars, sails, and gear | 7cwt. |
| Crew | 8cwt. |
| Total weight of displacement to L.W.L. | 2tons. |

Moulding (depth) of wood keel from top to under side, 5in.

Siding (breadth) of wood keel 4in. amidships, tapering to 2½in. forward and 3in. aft.

Siding of stern post, 3in.

Siding of stem, 2½in.

Siding of floors, 1½in.

Siding of timbers, 1½in.

Distance floors are apart from centre to centre, 10in.

Thickness of plank, ½in. (Clench work.)

Length of iron keel, 12ft.; depth, 4in., tapered in breadth fore and aft to shape of wood keel.

| | SPARS. | ft. in. |
|--|--------|---------|
| Mast, deck to hounds | | 19 0 |
| Boom, extreme | | 20 0 |
| Gaff, extreme | | 16 0 |
| Topmast, heel to hounds | | 16 0 |
| Topsail yard | | 18 0 |
| Bowsprit, outside stem | | 16 0 |
| Mast is stepped 8ft. from the fore side of stem. | | |
| Luff of mainsail | | 16 0 |
| Head of mainsail | | 15 6 |
| Foot of mainsail | | 19 3 |
| Leech of mainsail | | 28 0 |
| Tack to peak earing | | 30 3 |
| Clew to throat | | 24 9 |
| Foot of foresail | | 8 0 |
| Luff of foresail | | 18 0 |
| Leech of foresail | | 17 0 |
| Foot of jib | | 16 0 |
| Luff of jib | | 26 0 |
| Leech of jib | | 16 0 |
| Luff of jib topsail | | 24 0 |
| Foot of jib topsail | | 12 0 |
| Leech of jib topsail | | 15 0 |

LAYING-OFF TABLES.

| Sections. | 1 | 2 | 3 | 4 | 5 | 6 | 7 | 8 | 9 | 10 | 11 |
|--------------------------------------|---------|---------|---------|---------|---------|---------|---------|---------|---------|---------|---------|
| SHEER PLAN. | | | | | | | | | | | |
| | ft. in. | ft. in. | ft. in. | ft. in. | ft. in. | ft. in. | ft. in. | ft. in. | ft. in. | ft. in. | ft. in. |
| Heights above L.W.L. to deck* | 2 9½ | 2 6 | 2 3½ | 2 1½ | 2 0 | 1 10½ | 1 9 | 1 9½ | 1 10 | 1 11 | 2 0 |
| Depths to upper edge of rabbet | — | 1 2† | 1 3½ | 1 4½ | 1 5 | 1 6 | 1 7† | 1 3† | — | — | — |
| Depths to top of wood keel | — | 1 0 | — | — | — | — | — | 1 7½ | — | — | — |
| HALF-BREADTH PLAN. | | | | | | | | | | | |
| Half-breadths on deck | 0 10 | 1 11½ | 2 8 | 3 1 | 3 4 | 3 3½ | 3 2 | 3 0 | 2 10 | 2 7 | 2 3½ |
| Half-breadths on L.W.L. | 0 5 | 1 3½ | 2 3 | 3 0 | 3 3 | 3 2½ | 2 9½ | 1 11 | 0 9 | — | — |
| BODY PLAN. | | | | | | | | | | | |
| Diagonal a | 0 9½ | 1 11 | 2 8½ | 3 3½ | 3 5½ | 3 5½ | 3 3½ | 3 1½ | 2 10 | 2 5 | 2 0½ |
| Diagonal b | 0 9½ | 1 10 | 2 8½ | 3 4 | 3 6½ | 3 6 | 3 3½ | 2 11½ | 2 5½ | 1 10 | 1 0 |
| Diagonal c | 0 8½ | 1 8 | 2 6 | 3 1½ | 3 4½ | 3 3½ | 3 0 | 2 5½ | 1 9½ | 1 0½ | — |
| Diagonal d | 0 6½ | 1 5 | 2 1½ | 2 7½ | 2 9½ | 2 8 | 2 4 | 1 8½ | 1 0 | — | — |
| Diagonal e | 0 4½ | 0 11½ | 1 3½ | 1 6½ | 1 7½ | 1 7 | 1 4 | 0 10 | 0 3 | — | — |

* The deck is flush with the gunwale.

† The heels of the floors at Nos. 2, 7, and 8 stations are not joggled as those at Nos. 6, 5, 4, and 3 are (see diagram B). The ticked line in the drawing represents the lower edge of the rabbet 2½in. from the top of keel.

No. 1 station is 1ft. 6in. from the fore side of the stem. Nos. 1, 2, 3, 4, 5, 6, 7, and stations are 2ft. 6in. apart. No. 9 station is 1ft. 9in. from No. 8. No. 10 is 2ft. from No. 9. No. 11 is 1ft. 6in. from No. 10.

a diagonal is struck on the middle vertical line *o* (see body plan) 2ft. 2in. above the load water-line; it cuts the side perpendiculars *pp* at *a* 1 and *a* 2 at 1ft. 3in. above the load water-line.

b diagonal cuts *o* 1ft. 8in. above L.W.L.; cuts *p* 4in. above L.W.L.

c diagonal cuts *o* 1ft. 1½in. above L.W.L.; cuts *p* 4in. below L.W.L.

d diagonal cuts *o* 6½in. above L.W.L.; cuts *p* 1ft. 1½in. below L.W.L.

e diagonal cuts *o* 1in. below L.W.L.; and at *a* 1 and *a* 2 is 1ft. 3in. below L.W.L.

1ft. 4½in. out from *o*.

All the half-breadths given are *without* the plank.

CENTRE-BOARD BOAT
SCALE $\frac{1}{2}$ IN = 1 FT.

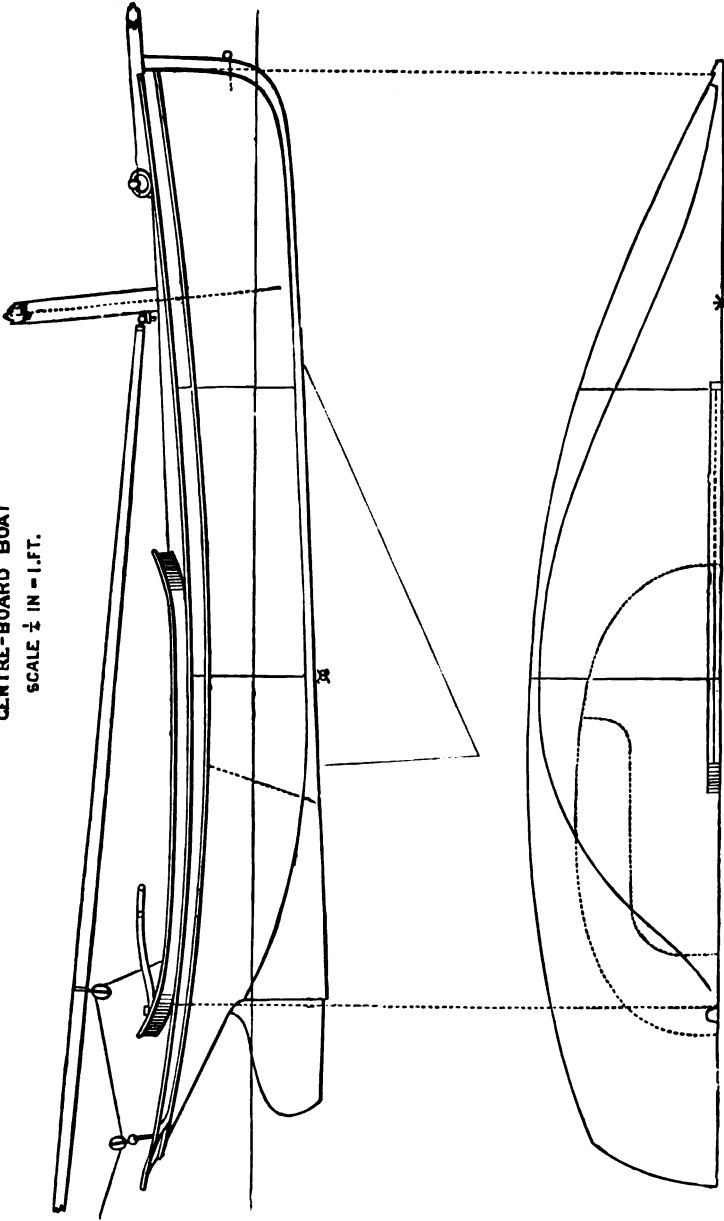


FIG. 85.

CHAPTER XVIII.

CENTRE-BOARD SLOOPS.

A DESIGN for a centre-board boat, somewhat shallower than the Brighton Beach boats, and one admirably adapted for smooth-water sailing, is shown on Fig. 85. It will be seen that the mid-section is very much further aft than in any of the other centre-board boats of which lines are given, and in this respect the design more agrees with the American model. The bow is long and well formed, and no doubt a boat built on the lines would be fast.

| | |
|---|----------|
| Length stem to sternpost on deck | 20ft. |
| Breadth, extreme, with plank on..... | 8ft. |
| Weight of displacement to L.W.L. (about)..... | 1·6 ton. |
| Weight of ballast | 8 cwt. |
| Mast, deck to hounds | 20ft. |
| Hounds to topsail sheave | 6ft. |
| Main boom | 22ft. |
| Main gaff | 12ft. |
| Bowsprit outside..... | 6ft. |
| Siding of stem..... | 2½in. |
| Siding of sternpost | 3in. |
| Siding of keel amidships | 4in. |
| Siding of keel fore end | 2½in. |
| Siding of keel aft end..... | 3in. |
| Thickness of plank..... | ½in. |

In the body plan, Fig. 86, more sections are shown than there are

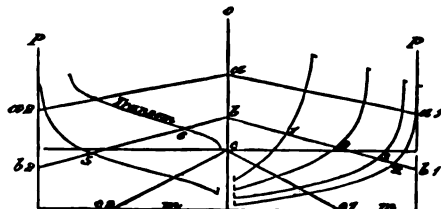


FIG. 86.

stations in the sheer plan; in the sheer plan every other station has been omitted.

LAYING-OFF TABLE.

| | 1 | 2 | 3 | 4 | 5 | 6 |
|--|---------|---------|---------|---------|---------|---------|
| | ft. in. | ft. in. | ft. in. | ft. in. | ft. in. | ft. in. |
| Height above L.W.L. to deck edge..... | 2 0 | 1 8½ | 1 5½ | 1 4½ | 1 4½ | 1 8 |
| Depths to rabbet line of keel | 0 8 | 0 9½ | 0 11½ | 1 1½ | 0 10½ | — |
| Half-breadths on deck | 1 9½ | 3 0 | 3 8 | 3 11½ | 3 10½ | 3 4½ |
| Half-breadths on L.W.L. | 1 1 | 2 4 | 3 5 | 3 9 | 2 11 | 0 1 |
| Half-breadths on diagonal <i>a</i> | 1 8½ | 3 0 | 3 9½ | 4 0 | 3 10½ | 2 10 |
| Half-breadths on diagonal <i>b</i> | 1 4 | 2 5½ | 3 3½ | 3 7½ | 2 10½ | 0 9½ |
| Half-breadths on diagonal <i>c</i> | 0 8½ | 1 2½ | 1 8 | 1 10½ | 1 2½ | 0 1 |

All the half-breadths are without the plank.

No. 1 section is 4ft. from the extreme fore side of stem.

No. 2 section is 3ft. from No. 1.

No. 3 section is 3ft. from No. 2.

No. 4 section is 3ft. from No. 3.

No. 5 section is 3ft. 6in. from No. 4.

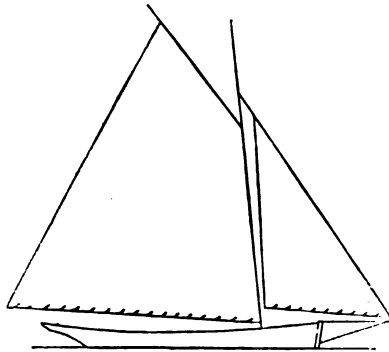
No. 6 section is 3ft. 6in. from No. 5.

Diagonal *a* is struck on the vertical line *o* (Body Plan) 1ft. 6½in. above the L.W.L., and cuts the perpendiculars *p p* 9½in. above the L.W.L. at *a 1* and *a 2*.

Diagonal *b* is struck on the line *o* 8in. above the L.W.L., and cuts *p p* 4in. below L.W.L. at *b 1* and *b 2*.

Diagonal *c* is struck on *o* at its intersection with the L.W.L., and cuts the horizontal line *m* at *c 1* and *c 2*.

The rig it will be seen by Fig. 87 is the ordinary sloop. The mainsheet is thus worked: one end fast to the boom end; the other leads through a block on the counter, then through another block on



SCALE ¼ IN = 1 FT.

Fig. 87.

the boom, and belays inside the boat close to rudder head or on one side of the rudder head.

Of the many successful centre-board sloops and other boats which Burgoine of Kingstown has turned out, none have been more successful than the *Alert*, whose lines, by the kindness of Mr. W. M. Dunnage (her owner), we are able to give. These small craft are built specially for

lake or river sailing, and it is not expected that an Alert would be able to successfully compete in a sea-way with a deep-bodied yacht, or even with a boat of the Itchen type. Nor can it be said that the Alert would be at home on such a river as the Mersey, where the New Brighton boats compete; but on rivers where the stream is less rapid, and the wave disturbance very small, we do not think a better type of boat could very well be designed. In fact, the Alert may be said to be the production of expediency, as a long course of experience has taught Mr. Burgoine the best type of sailing boat, whether it is of the sloop rig or balance lug rig, for such smooth-water sailing as can be had on the Thames between Teddington and Surbiton. The Alert, it will be seen, is a kind of combination of the shallow, the deep-keeled, and the centre-board type, and she appears to have, judged by her performances, a fair share of the good qualities of each type.

The Alert is sloop rigged, with main and fore sail, and her sail area strikes one as being very small; but some of her success to windward is attributable to her snug sail plan. The sails are made of American cotton duck. The topsail is cut on the lateen plan, the yard being up and down the mast. The halyard is made fast to the yard, so that it comes nearly chock-a-block with the halyard sheave in the mast when the sail is hoisted. The heel of the yard comes 9in. or so below the foot of the sail; a heel rope is fast to the yard, which serves as a tack, and (with one turn round the mast) is belayed on deck. Another plan is to have a thimble-eye seized to the heel of the yard, through which the topsail halyard is rove; the halyard thus serves as a kind of jackstay for the topsail yard, and does away with the heel rope or tack. A heel rope, however, is, we think, to be preferred, as in the hurry of hoisting one might forget to reeve the halyard, and there is always the possibility of something going wrong when a hauling rope is made to do duty as a stay as well. As will be seen, Alert has no topmast, the lower mast having a "pole," or mast-head, 8ft. 6in. long, which serves to set the lateen topsail.

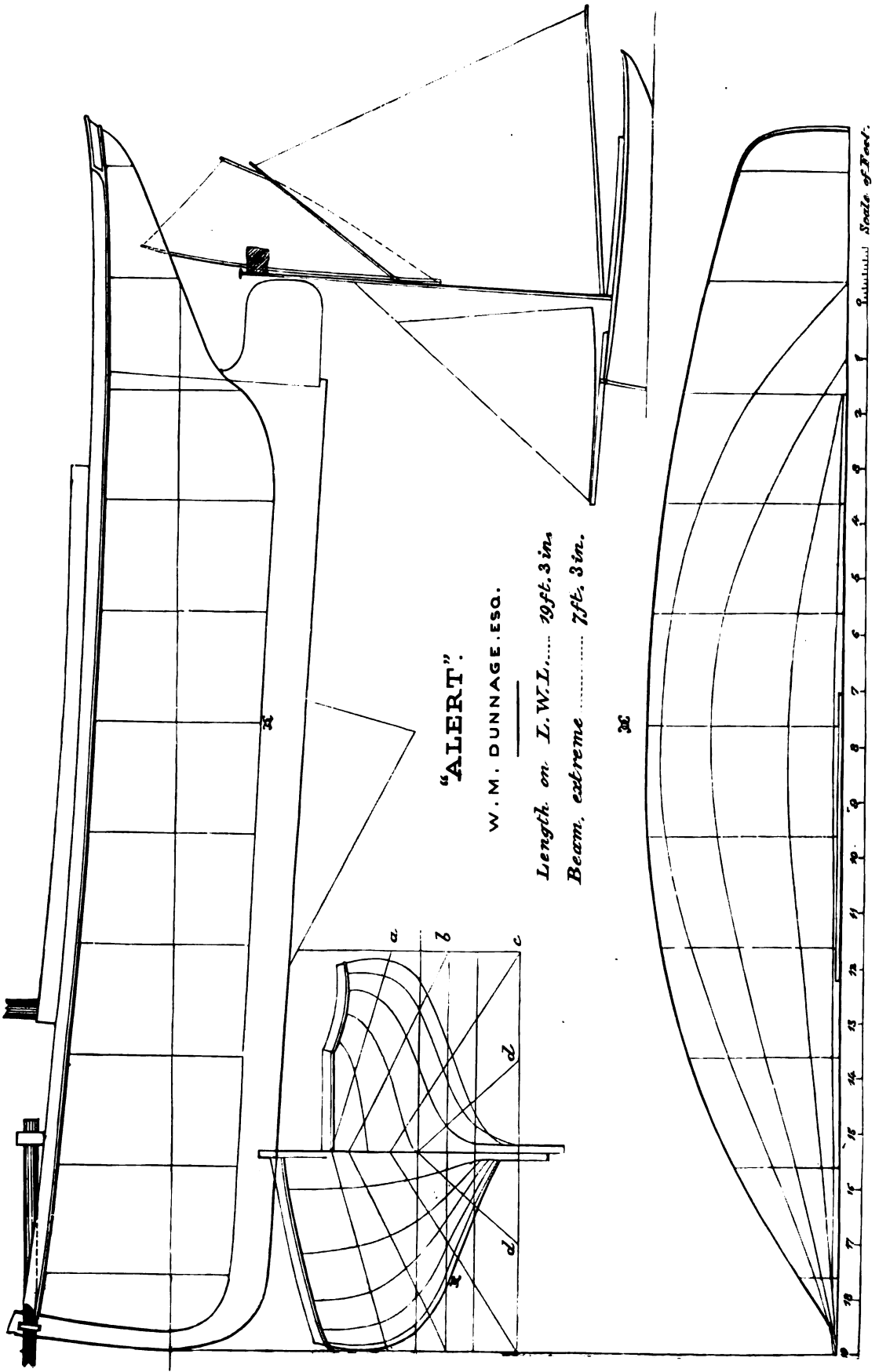
The spinnaker gear is thus fitted. The boom has iron jaws to fit the mast, but no parral. At the outer end is a shoulder; inside the shoulder is a good-sized hole through the boom. Two or three inches from the hole are two thumb cleats. The fore guy passes through a block at bowsprit end, and each end of the guy has an eye-splice, one end being kept on board on port side, and the other on starboard; when in use one of the eyes is put over the boom-end, and back to the thumb-cleats. On the tack cringle of the spinnaker is a grommet strop. To set the spinnaker, the eye of the fore guy is shoved over the boom end back

to the cleat; then the after guy is put on; next the grommet on the tack of the sail is shoved through the hole, and the bight brought up and put over the small end of the boom formed by the shoulder before spoken of. This arrangement effectually prevents the eyes of the guys slipping off. The sail is then hoisted, and the boom launched forward as the sail goes up. Of course the guys and sheet must be attended to as required, but the boom is not squared until the jaws are got to the mast. For lowering, the boom should be eased forward and unshipped before letting go the halyards; the sail can then be easily spilled, and gathered in as the heel of the boom is brought aft.

The iron keel is 14ft. long, measured from sternpost, 4½ in. deep, with an average thickness of 4½ in. The keel shown in the drawing (Plate XI.) includes the iron keel.

| | ft. | in. |
|--|-----|-------------|
| Length, stem to sternpost, at L.W.L. | 17 | 5 |
| Length on L.W.L. | 19 | 3 |
| Breadth extreme | 7 | 3 |
| Extreme draught of water, including centre plate | 4 | 0 |
| Draught of water at heel of keel | 2 | 7 |
| Thickness of iron centre plate | 0 | 0½ |
| Midship section abaft centre of length of L.W.L. | 1 | 8 |
| Centre of buoyancy abaft centre of length of L.W.L. | 0 | 7½ |
| Centre of lateral resistance abaft centre of length of L.W.L.* | 0 | 6 |
| Centre of effort of lower sails abaft centre of length of L.W.L. ... | 1 | 1 |
| Area of load water-plane | 75 | sq. ft. |
| Area of midship section | 5·6 | sq. ft. |
| Displacement | 1 | ton 16 cwt. |
| Displacement per inch of immersion at L. W. L. | 2½ | cwt. |
| Weight of centre plate | ½ | cwt. |
| Ballast inside | 9 | cwt. |
| Weight of iron keel | 7 | cwt. |
| Total ballast | 16½ | cwt. |
| Tonnage Y.R.A. | 3½ | tons |
| Mast, deck to hounds | 16 | 6 |
| Pole | 8 | 6 |
| Deck to hounds of pole (for topmast stays) | 23 | 6 |
| Mast, deck to topsail halyard sheave | 22 | 10 |
| Mast, deck to strop of fore halyard block | 18 | 0 |
| Mast, diameter at deck | 0 | 4½ |
| Main boom | 19 | 6 |
| Greatest diameter | 0 | 2½ |
| Gaff | 12 | 9 |
| Diameter at jaws | 0 | 2 |
| Bowsprit, outboard | 8 | 0 |
| Bowsprit, end to mast | 14 | 0 |
| Bowsprit, diameter at stem | 0 | 3½ |
| Topsail yard | 19 | 0 |
| Diameter | 0 | 2½ |
| Jack yard | 4 | 6 |

* The centre of lateral resistance is in the same vertical, whether with centre plate up or down.



"ALERT"

W. M. DUNNAGE, ESQ.

Length on I. W. L. 19ft. 3 in.

Beam, extreme 7ft. 3 in.

30

| | |
|--|-------------|
| | ft. in. |
| Diameter | 0 1½ |
| Spinnaker boom | 18 9 |
| Diameter | 0 2½ |
| Centre of mast from fore side of stem at L.W.L. | 6 0 |
| Luff of mainsail | 13 6 |
| Leech of mainsail | 24 0 |
| Angle of gaff with horizontal | 5 30 |
| Area of mainsail | 270 sq. ft. |
| Area of foresail | 90 sq. ft. |
| Area of topsail | 70 sq. ft. |
| Total sail area | 430 sq. ft. |

TABLE OF OFF-SETS.

| Sections..... | 1 | 2 | 3 | 4 | 5 | 6 | 7 | 8 | 9 | 10 | 11 |
|--------------------------------|---------|---------|---------|---------|---------|---------|---------|---------|---------|---------|---------|
| | ft. in. | ft. in. | ft. in. | ft. in. | ft. in. | ft. in. | ft. in. | ft. in. | ft. in. | ft. in. | ft. in. |
| Height to plank sheer | 2 2½ | 1 11½ | 1 9½ | 1 8 | 1 7 | 1 6 | 1 5 | 1 4½ | 1 4 | 1 4½ | 1 4½ |
| Half-breadth on L.W.L. | 0 5 | 1 2½ | 1 11½ | 2 8 | 3 1½ | 3 3½ | 2 11½ | 2 7½ | 1 6½ | | |
| Half-breadths, No. 2 W.L. | 0 3 | 0 9½ | 1 3 | 1 9½ | 2 2½ | 2 5 | 2 1½ | 1 5½ | 0 5½ | | |
| Half-breadths, No. 3 W.L. | 0 1½ | 0 4 | 0 6½ | 0 8½ | 0 11 | 1 0½ | 0 10 | 0 5½ | 0 1½ | | |
| Half-breadths, keel | 0 1 | 0 1½ | 0 2 | 0 2½ | 0 2½ | 0 2½ | 0 2 | 0 1½ | 0 1 | | |
| Half-breadths on deck..... | 0 8 | 1 10½ | 2 9 | 3 3 | 3 5½ | 3 6 | 3 5½ | 3 3 | 2 11 | 2 6 | 2 0 |

No. 1 section is 1ft. 4in. from the foreside of stem at the load water-line. The remaining sections are 2ft. apart.

The water lines are 6in. apart.

(a) Diagonal is struck 1ft. 6in. above the load water-line, and cuts the side perpendiculars at 6in. above the load water-line.

(b) Diagonal is struck at 1ft. 2in. above the load water-line.

(c) Diagonal is struck 6in. above the load water-line.

(d) Diagonal is 1ft. 2½in. out from the middle vertical line.

The keel is 5in., sided amidships, tapering to 2½in., the thickness of stem, and 3in. at stern-post. The timbers are 1in. square, and 1½in. deep at the heels.

The plank is ½in. thick.

CHAPTER XIX.

UNA BOATS.

THOSE wonderful little crafts called "Una" boats were introduced to us in 1853, in this way: the late Marquis of Conyngham (then Earl Mount-Charles), was in America in 1852, and in the boat building yard of Robert Fish (now well known as a yacht designer), saw the boat since celebrated as the "Una." He sent her to London by steamer, whence she was transported by rail to Southampton, and then towed to Cowes. The Una, we believe, spent a summer on the Serpentine, but she did not there excite the interest she did at Cowes. In fact, the Cowes people almost regarded the Una as a little too marvellous to be real. To see the Una dodging about on a wind and off a wind, round the stern of this craft, across the bows of that one, and generally weaving about between boats where there did not look room enough for an eel to wriggle, astonished the Cowes people, who had never seen anything more handy under canvas than a waterman's skiff with three sails, or an Itchen boat with two. In short, the Una with her one sail showed such speed, and was so handy, that in less than a year there was a whole fleet of Unas at Cowes, and about the Solent. The genus was named Una after Lord Conyngham's importation, and to this day no class of boat is a greater favourite for smooth-water sailing.

In America, the Una or "cat-rig" as it is termed, is a great favourite, and at Newport, where the rig is mostly seen, the boats enjoy a great reputation for handiness, weatherliness, and speed. There is no doubt that the one sail plan is the best for weatherly qualities and for handiness, if there be no sea, and if it is all turning to windward. In a sea, however, the heavy mast, stepped so far forward, makes the boats plunge dangerously, and the boats themselves are so shallow that they are not very well adapted for smashing through a head sea. Off a wind they are extremely wild, and show a very great tendency to broach to.

This tendency of coming to against the helm is common to all shallow boats when they are sailed off the wind; and if the rudder of a boat has to be kept right across her to check the tendency, speed is of course very much retarded. As a rule it is found that lifting the centre board greatly relieves the weather helm; and as the board is not wanted off a wind, to increase the lateral resistance it is always better to haul it up; the boat will steer all the better for it, and there will be less surface for friction.

Some boat sailers have used a small jib on a short bowsprit when sailing off a wind; the bowsprit would run out through an iron fitted to the stem head, and the heel could be lashed to the mast if no bitts were fitted, as there need not be. A shroud would be required each side, and a bobstay, but if the bowsprit were a mere bumpkin only three or four feet long, no shrouds would be required. If it were found necessary to luff up in squalls, the head sheets should be the first to be started, therefore they should lead aft. A few years ago a boat built on the model of the *Una*, had her mast shifted to 5ft. abaft the stem and a jib or foresail added and mainsail reduced; she was found very easy on her helm when sailing off the wind, as might be expected; but on a wind she would not lie so close, and quite proved the inferiority of the two sails, so far as sailing in smooth water went. The advantages of the one sail are almost wholly confined to sailing to windward in smooth water, and, as sailing to windward under such conditions is the principal charm of sailing a small boat at all, the *Una* rig will retain its popularity.

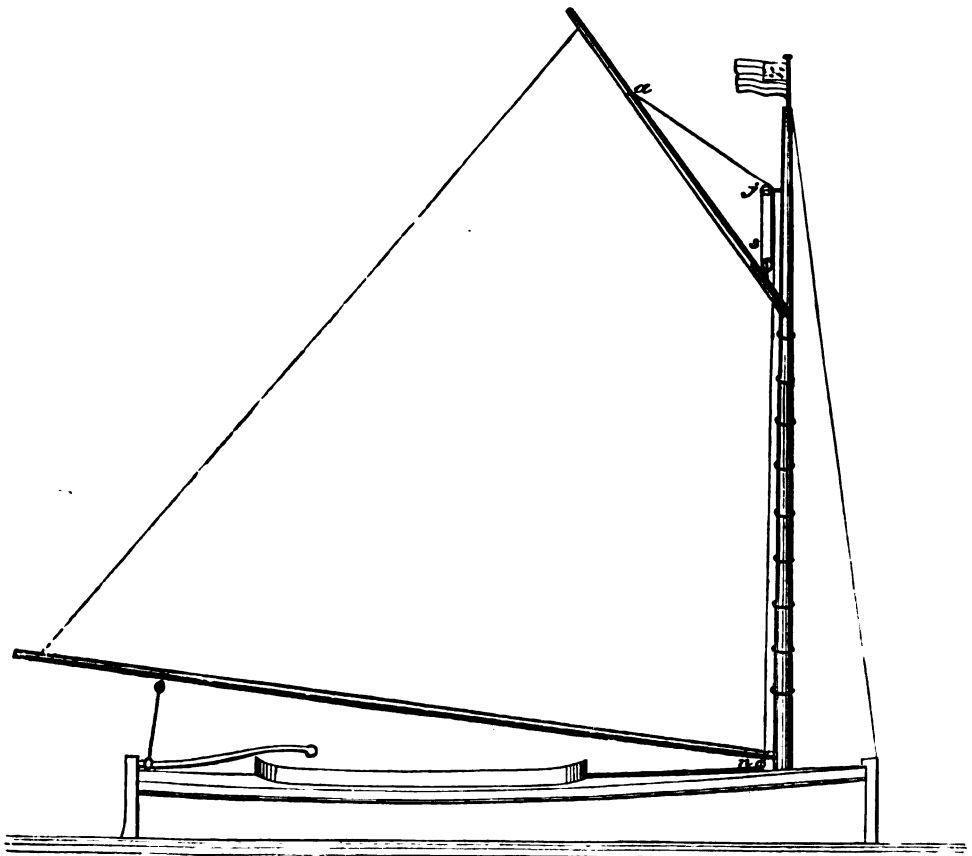
A shallow boat like the *Una* is a little more unsafe perhaps than an ordinary sailing skiff, because they carry so much sail; and a person might be tempted into pressing them, because of the enormous stiffness they show up to the time that their gunwale or deck becomes level with the water.

However, with skilful management "*Unas*" are safe enough, and on the whole are not so dangerous as an open boat of similar length. They should always be luffed to squalls before their deck has a chance of being immersed, and a foot or two of main sheet (which should be held in the hand) given them if they cannot be relieved sufficiently without their being brought head to wind—a course never desirable if it can be avoided, as the boats soon lose steerage way. It is never advisable to let the main sheet go altogether with a boom sail, as it is with one without a boom, as the sail will not spill, and the boom may get in the water, which would be awkward, to say the least, if the boat got stern way on.

The "*Una's*" stores, copied from an inventory of the same, made when she was packed off by rail to Southampton, were as under: One

mast, one boom, one gaff, one pair of oars, one sail, one sail cover, one hatch cover, one rudder and tiller, four blocks, one main halyard, two bell-metal rowing-pins, four pigs of lead ballast. All that need be added to this list is a "baler," and it would do for a Una of the present day.

The rig, it will be seen upon reference to the sail plain, Fig. 88, is simple in the extreme, and even the famed balance lug cannot beat it in this respect. The sail is hoisted by a single halyard. The standing part is made fast on the gaff at *a*, then leads through a double block



SAIL PLAN 'UNA' BOAT 4" INCH SCALE.

FIG. 88.

at *j* on the mast, through a single block *s* on the jaws of the gaff, up through *j* again, and down to the deck where the fall leads through a block *n* by the side of the mast, and belayed on the aft end of centre-board case. The fall can then be taken aft to the hand of the helmsman, who, in case of need, can drop the sail between topping lifts (not shown

in the drawing) without leaving the tiller. The *Una* had no stay at all, but the Cowes fashion now is to have a forestay, which prevents the mast going aft when sailing on a wind. The larger *Una* boats over 20ft. are fitted with topping lifts, and the smaller ones would be all the better for them, as a lift is handy in setting, stowing, or reefing the sail.

The main sheet is made fast to an eye bolt on one quarter, close to the intersection of gunwale and transom; it then leads through a block on the boom, and through a block on the other quarter, the fall coming into the well or cockpit to belay. This plan of fitting the mainsheet is still known as the "*Una*," just as the plan of working the halyards all in one is.

Practically, the Cowes *Una* boat of the present time differs very little from the original. The floor, it will be found, upon reference to the diagrams and tables, is a trifle flatter than the *Una*'s; the quarters are lifted a little, as will be seen upon comparing the transoms; and there is more freeboard—the latter being a very desirable addition. The load water-line of the two crafts are almost identical, as will be found by comparing the half-breadths for the same. The centre-boards are of about equal area, the only alterations being that the modern plan is to pivot the board in the keel below the garboard, whilst formerly they were pivoted in the case inside the boat. The Cowes *Una* has a trifle less draught forward than the original, and the stem piece does not tumble aft; but, in other respects, there is not much difference in the two sheer plans, always of course remembering the increase in the freeboard. The draught of water of the Cowes *Una* forward appears to be excessive, and off a wind at least she would be lightened by the head to the extent of three or four inches.

The design for a Cowes *Una* (Plate XII.) has been made so that it is adapted for either a real "*Una*" of 15ft. 6in. in length, or one of greater size 21ft. in length. The sail plan of the Cowes boat is a smaller one than the *Una* had, but it will be found large enough for ordinary sailing. The sail, of course, will be laced to the boom, and a topping-lift would be found of service to keep the boom up when the peak is lowered, or when running off the wind.

The *Una* is still in existence on the estate of Lord de Ros, in Ireland, the late Marquis of Conyngham having presented her to that nobleman in 1873.

DIMENSIONS, &c.

| | UNA. | | 15ft. 6in. | | 21ft. | |
|--|------|------|------------|------|-------|------|
| | ft. | in. | ft. | in. | ft. | in. |
| Length, extreme | 16 | 0 | 15 | 6 | 21 | 0 |
| Beam, extreme | 6 | 6 | 6 | 6 | 8 | 8 |
| Keel sided amidships | 0 | 7 | 0 | 4½ | 0 | 6 |
| Keel sided fore end | 0 | 2 | 0 | 2 | 0 | 2½ |
| Keel sided aft end | 0 | 2 | 0 | 2 | 0 | 2½ |
| Moulding (depth) of keel | 0 | 2½ | 0 | 4 | 0 | 5 |
| Floors sided | 0 | ¾ | 0 | 1 | 0 | 1½ |
| Floors moulded | 0 | 1½ | 0 | 1½ | 0 | 2 |
| Timbers sided | 0 | ¾ | 0 | 1 | 0 | 1½ |
| Thickness of plank | 0 | ¾ | 0 | ¾ | 0 | ¾ |
| Thickness of top strake | 0 | ¾ | 0 | ¾ | 0 | 1 |
| Mast, deck to hounds | 16 | 0 | 14 | 0 | 18 | 6* |
| Boom | 18 | 0 | 15 | 6 | 21 | 0 |
| Gaff | 9 | 3 | 7 | 6 | 10 | 0 |
| Luff of mainsail | 12 | 0 | 9 | 9 | 13 | 0 |
| Foot of mainsail | 17 | 6 | 15 | 6 | 20 | 8 |
| Head of mainsail | 9 | 0 | 7 | 0 | 9 | 6 |
| Leech of mainsail | 19 | 0 | 17 | 8 | 23 | 6 |
| Tack to peak earing of mainsail | 20 | 0 | 16 | 0 | 21 | 0 |
| Clew to throat earing | 19 | 0 | 17 | 0 | 22 | 9 |
| Centre of mast from the fore side of stem at L.W.L. | 2 | 0 | 2 | 0 | 2 | 6 |
| Diameter of mast at deck | 0 | 4½ | 0 | 4½ | 0 | 5 |
| Diameter of mast at hounds | 0 | 2½ | 0 | 2½ | 0 | 2½ |
| Weight of displacement of boat to L.W.L. (approximate).... | 13 | 0wt. | 14 | 0wt. | 14 | ton. |

* An American 21ft. Cat Boat would have about 3ft. more mast, and 2ft. more boom. The Cat Boat's mast would rake aft ¾ in. in 1ft.

LAYING-OFF TABLE, ¼IN. SCALE.

| | ft. | in. | ft. | in. | ft. | in. | ft. | in. | ft. | in. | | | | | | |
|--|-----|-----|-----|-----|-----|-----|-----|-----|-----|-----|---|-----|---|-----|---|----|
| Heights to top of timbers above L.W.L. | 1 | 6½ | 1 | 3½ | 1 | 1½ | 1 | 0 | 0 | 11½ | 0 | 11 | 0 | 11½ | 1 | 1 |
| Una " " | 0 | 11 | 0 | 9½ | 0 | 8½ | 0 | 8 | 0 | 8 | 0 | 8½ | 0 | 9 | 1 | 0 |
| Depths below L.W.L. to rabbet | 0 | 6½ | — | — | — | — | 0 | 9 | 0 | 8½ | 0 | 6½ | — | — | — | — |
| Una " " | 0 | 7½ | — | — | — | — | 0 | 8½ | 0 | 8 | 0 | 6½ | — | — | — | — |
| Half-breadths on deck | 0 | 8½ | 1 | 9 | 2 | 5½ | 2 | 11 | 3 | 2½ | 3 | 1½ | 2 | 10 | 2 | 1½ |
| Una " " | 0 | 7½ | 1 | 7 | 2 | 4 | 2 | 11 | 3 | 2½ | 3 | 1 | 2 | 9½ | 2 | 3 |
| Half-breadths on L.W.L. | 0 | 4½ | 1 | 2 | 1 | 11½ | 2 | 5½ | 2 | 9½ | 2 | 8 | 1 | 11½ | — | — |
| Una " " | 0 | 4 | 1 | 1 | 1 | 10½ | 2 | 6 | 2 | 9½ | 2 | 8½ | 2 | 1 | — | — |
| Half-breadths on diagonal <i>k</i> | 0 | 7½ | 1 | 6½ | 2 | 2½ | 2 | 8½ | 2 | 11½ | 2 | 10½ | 2 | 5 | 1 | 4½ |
| Una " " | 0 | 7 | 1 | 5½ | 2 | 2 | 2 | 8½ | 2 | 11½ | 2 | 10½ | 2 | 5½ | 1 | 6½ |
| Half-breadths on diagonal <i>m</i> | 0 | 6 | 1 | 2 | 1 | 8 | 2 | 0 | 2 | 2½ | 2 | 1 | 0 | 9 | 0 | 5½ |
| Una " " | 0 | 5½ | 1 | 1½ | 1 | 8½ | 2 | 1½ | 2 | 3½ | 2 | 1 | 1 | 7 | 0 | 6 |
| Half-breadths on diagonal <i>x</i> | 0 | 3½ | 0 | 7½ | 0 | 10½ | 1 | 0½ | 1 | 2 | 1 | 1 | 0 | 9 | — | — |
| Una " " | 0 | 3½ | 0 | 8 | 0 | 1 | 1 | 2½ | 1 | 3 | 1 | 0½ | 0 | 7½ | — | — |

All the half-breadths are without the plank.

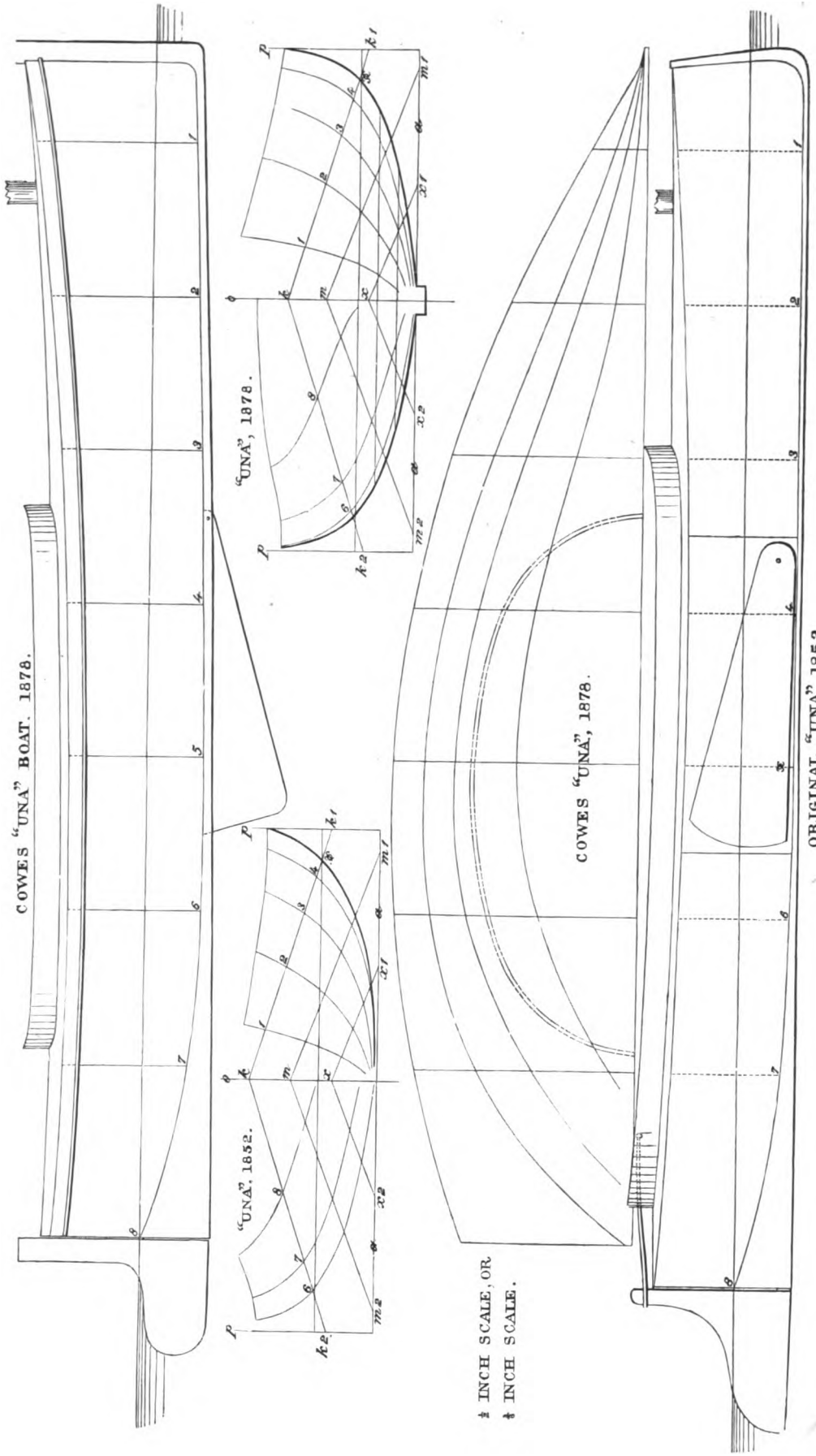
In the body plan of the Cowes Una the midship section is shown on both sides of the middle line, *o*, between Nos. 4 and 6 sections. The station for the midship section is shown at No. 5 in the sheer plan.

No. 1 section is 1ft. 3in. from the fore side of the stern; all the other sections are 2ft. apart, but No. 8 (transom) is 2ft. 3in. from No. 7 station.

In the case of the Una, No. 8 (transom) is 2ft. 9in. from No. 7 station.

Diagonal *k* is struck 10½in. above the L.W.L., and at *k* 1 and *k* 2 cuts the side perpendiculars *p p* 1½in. below the L.W.L.

PLATE XII.



$\frac{1}{2}$ INCH SCALE, OR
 $\frac{1}{4}$ INCH SCALE.



Diagonal *m* is struck 4½ in. above the L.W.L., and at *m* 1 and *m* 2 is 3ft. out from the middle vertical line *o*.

Diagonal *x* is struck 1½ in. below the L.W.L., and at *x* 1 and *x* 2 is 1ft. 6in. out from the middle vertical line *o*.

The base line *a a* is 9in. below the L.W.L., and parallel thereto.

LAYING-OFF TABLE FOR 21FT. "UNA" BOAT, ½IN. SCALE.

| | ft. in. | ft. in. | ft. in. | ft. in. | ft. in. | ft. in. | ft. n. | ft. in. |
|--|---------|---------|---------|---------|---------|---------|--------|---------|
| Heights above L.W.L. to top of timbers | 2 0½ | 1 8½ | 1 6 | 1 4 | 1 3 | 1 3 | 1 3½ | 1 5½ |
| Depths below L.W.L. to rabbet | 0 8½ | — | — | — | 1 0 | 0 11½ | 0 8½ | — |
| Half-breadths on deck | 0 11½ | 2 4 | 3 3½ | 3 11 | 4 3 | 4 2 | 3 9½ | 2 10 |
| Half-breadths on L.W.L. | 0 6½ | 1 7 | 2 6½ | 3 4 | 3 8 | 3 6½ | 2 7½ | — |
| Half-breadths on diagonal <i>k</i> | 0 10½ | 2 0½ | 2 11½ | 3 7½ | 3 11½ | 3 10 | 3 3 | 1 8½ |
| Half-breadths on diagonal <i>m</i> | 0 8 | 1 6½ | 2 3 | 2 8 | 2 11½ | 2 9½ | 2 1½ | 0 7½ |
| Half-breadths on diagonal <i>x</i> | 0 4½ | 0 10 | 1 2½ | 1 4½ | 1 7 | 1 5½ | 1 0 | — |

All the half-breadths are without the plank.

No. 1 section is 1ft. 10in. from the fore side of the stem; all the other sections are 2ft. 8in. apart, but No. 8 (transom) is 3ft. 2in. from No. 7 station.

Diagonal *k* is struck 1ft. 2½ in. above the L.W.L., and at *k* 1 and *k* 2 cuts the side perpendiculars *p p* 2 inches below the L.W.L.

Diagonal *m* is struck 6in. above the L.W.L., and at *m* 1 and *m* 2 is 4ft. out from the middle vertical line *o*.

Diagonal *x* is struck 2½ in. below the L.W.L., and at *x* 1 and *x* 2 is 2ft. out from the middle vertical line *o*.

The base line *a a* is 1ft. below the L.W.L., and parallel thereto.

CHAPTER XX.

NEW BRIGHTON SAILING BOATS.

THE New Brighton Sailing boats differ somewhat from those of a few years ago, the principal change being the introduction of a counter. The counter, it may here be said, is a great assistance to small boats, as it enables them to have longer and better buttock lines, and hence a better or cleaner delivery, no eddies being formed astern. Further, with the counter they have more power with a beam or head wind, and run before a sea drier, and much additional room is obtained on board for working the aft sails. The counters are limited in length to 4ft. 6in., and must be clear of the water at the sternpost when ballasted and in trim for sailing, but without crew on board.

The boats are not allowed to be decked, and no appliances are permitted to keep out water; they have, however, a kind of "fore peak" forward, by fitting a platform level with and forward of the fore thwart, and the counter may be decked as far as the sternpost. To get rid of the water that may be shipped, a 3½in. pump is fitted amidships, with a discharge both sides.

The freeboard is cut down as much as possible, as it tells in the "girth" for measurement;* in the design of the Elaine (Plate XIII.) an attempt was made to compensate somewhat for this deficiency by wash strakes aft.

The Elaine was designed in 1877 for Mr. John Bouch (Com. N.B.S.C.) by Mr. C. P. Clayton, of Park-road, Birkenhead, and to him we are indebted for particulars of the new Brighton Boats. The Elaine has less

* The measurement rule of the New Brighton Sailing Club is as follows: "Take the extreme length from fore part of stem to after part of sternpost; girth at greatest *circumference*, by passing a line from gunwale under the boat's bottom, and back to the same point on the same gunwale. The total size of the boat is obtained by multiplying the girth by 1ft. 7in. (1.58ft.), and adding the product to the extreme length. The boats to be raced in one class, and the maximum size of the racing boats to be 50ft. club measurement." Applying this rule to Elaine, we have greatest girth 16ft. 10in., and length 23ft. 3in., thus summed: $16.83 \times 1.58 + 23.25 = 49.84\text{ft.}$

displacement than these boats are usually given, and she has been most successfully sailed against all the crack boats of the club.

The length of the Elaine from fore side of stem to aft side of sternpost is 23ft. 3in., and her greatest beam 6ft. 4in.; her greatest draft aft with crew (six hands) on board is 3ft. She has 6cwt. of iron on her keel, and 2cwt. of iron inside.

Some of the New Brighton boats are, however, of much heavier displacement. Thus, the Tyro (a very successful boat, designed and sailed by her owner, Mr. G. H. Wilmer), has 24cwt. of iron ballast, 6cwt. of which is on the keel. The weight of the boat is about 14cwt., and of her gear about 6cwt. Her displacement with crew on board is 2·7 tons (54 cwt.). Other boats have 14cwt. or 15cwt. of lead ballast, 8cwt. or 9cwt. of which are placed on the keel. All these boats have deeper and fuller bodies than Elaine, and a trifle less beam.

The displacement of Elaine to the load water-line shown in the drawing (supposed to be with six hands on board) is 2 tons. The light displacement which brings the counter out of water, as at *x* (see Sheer Plan), is 2in. less or equal to half a ton less. The displacement per inch of immersion at the load water-line is $\cdot 25(\frac{1}{4})$ ton.

Six men of about 12 stone each would weigh half a ton, but probably such a heavy crew would not often be found. This number is not found too many for working the sails; and, as a light-displacement boat like Elaine depends so largely on her crew for ballast and stability, it is a serious matter to be one hand short. Probably, as in the case of the centre-board

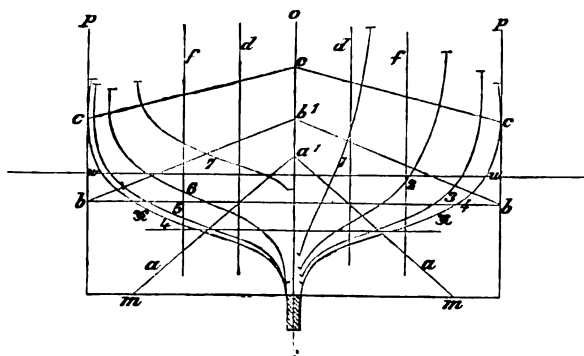


FIG. 89. BODY PLAN OF "ELAINE."

gigs before referred to, five or six hands sitting to windward are much more potent as a means of acquiring stability than any practicable quantity of lead or iron in the bottom of the boat or on the keel would be. In light

winds the crew would stow themselves in the bottom of the boat; but the "half-ton" stowed well to windward is indispensable in anything like a breeze blowing abeam or on the bow.

Of course, with so much weight on the keel, and such great draught and rising floor, these boats cannot very easily be "beached" or hauled up without a cradle, as the Brighton beach boats are; and on the Mersey they usually lie afloat.

The following measurements and particulars refer to the design of the Elaine:—

| Sections | 1 | 2 | 3 | 4 | 5 | 6 | 7 | 8 |
|--|---------|---------|---------|---------|---------|---------|---------|---------|
| SHEER PLAN. | | | | | | | | |
| | ft. in. | ft. in. | ft. in. | ft. in. | ft. in. | ft. in. | ft. in. | ft. in. |
| Heights above L.W.L. to top of rail... | 2 3½ | 1 10½ | 1 7½ | 1 5 | 1 3½ | 1 3½ | 1 5 | 1 7½ |
| Depth to rabbet-line of keel | 1 2½ | 1 5 | 1 6½ | 1 8 | 1 9½ | 1 11 | | |
| HALF-BREADTH PLAN. | | | | | | | | |
| Half-breadths at gunwale rail | 1 1½ | 2 5½ | 2 11½ | 3 1½ | 3 0½ | 2 10½ | 2 5½ | 1 8 |
| Half-breadths L.W.L. | 0 6½ | 1 9½ | 2 7½ | 2 11½ | 2 10½ | 2 8½ | 0 5½ | |
| Half-breadths No. 2 W.L. | 0 4½ | 1 3½ | 2 1½ | 2 5½ | 2 3½ | 1 4½ | 0 1½ | |
| Half-breadths No. 3 W.L. | 0 2 | 0 7½ | 1 0½ | 1 8½ | 1 0½ | 0 5½ | 0 1½ | |
| BODY PLAN. | | | | | | | | |
| Half-breadths on <i>a</i> diagonal | 0 7½ | 1 4 | 1 7½ | 1 8½ | 1 7½ | 1 3½ | 0 5½ | |
| Half-breadths on <i>b</i> diagonal | 0 10 | 1 11½ | 2 8 | 2 11 | 2 10 | 2 4½ | 1 5½ | |
| Half-breadths on <i>c</i> diagonal | 1 0½ | 2 4 | 3 0½ | 3 3½ | 3 2½ | 2 11½ | 2 4½ | |

All the measurements include the thickness of the plank.

In the Sheer Plan the heights are measured to the top of the gunwale, lettered *a*; the depths to the lower edge of the rabbet of the keel *b*.

The top of the keel is shown by *c*.

In the Body Plan (Fig. 89) the diagonal *a* cuts the base line at *m* and *m*, 2ft. 5¼in. from the middle vertical line *o*; and at *a* 1 the diagonal cuts *o* 3in. above the load water-line *w*.

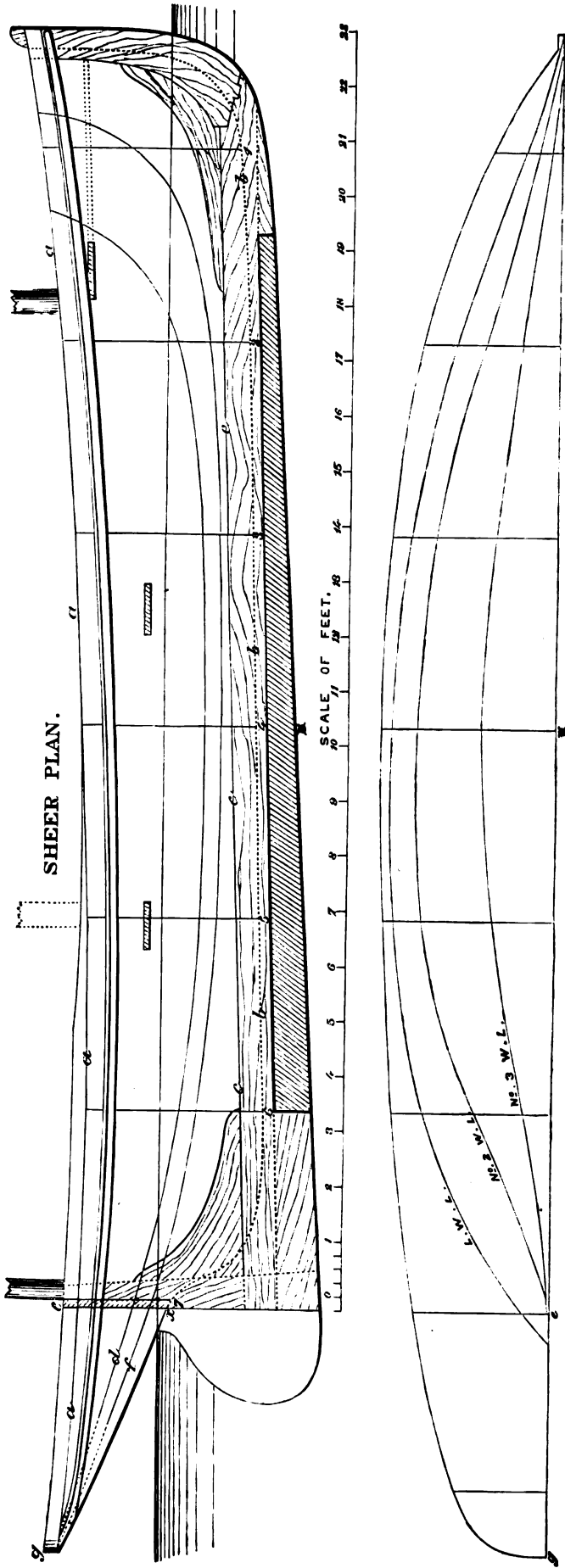
The diagonal *b* cuts the perpendiculars *p p* on the second water-line as shown, and cuts the middle vertical line *o* at *b* 1, at a distance of 10in. above the load water-line *w*.

The diagonal line *c* cuts the perpendiculars *p p* 9½in. above the load water-line *w*, and cuts the middle vertical line *o* at *c* 1, at a height of 1ft. 7¼in. above the load water-line *w*.

The buttock line *d* is 10in. from the middle vertical line *o* (Body Plan), and the buttock line *f* 1ft. 3in. from the middle vertical line *o*.

The vertical sections are 3ft. 6in. apart, and No. 1 section is 2ft. 2in. from the fore side of the stem plumb with load water-line. The water-lines are 5in. apart.

PLATE XIII.



HALF BREADTH PLAN.

"Elaine," New Brighton Boat.

The counter is 4ft. 6in. long, measured from aft side of sternpost or transom at *e* to *g*. (See Sheer Plan and Half-Breadth Plan.)

The keel is sided amidships 3in., tapering to 2½in. at the ends. The keel is 9in. deep, 6in. of which is worked inside, and 2in. outside below the rabbet.

The transom (7 station) is solid, 1½in. thick.

The frames are 1½in. sided, 2in. moulded at heels of floors, and tapering to 1in. at timber heads. Three bent or steamed frames come between each pair of stations shown on the Sheer Plan.

The stem and stern posts are 2½in. sided.

The foremast is stepped 5ft. from the fore side of the stem; the mainmast 16ft. 3in. from the fore side of the stem.

The sails of the Elaine are slightly different to those of the other lugs in use on the Mersey, as they are cut with an excessive roundness to the head (see Plate XIV.). On a plan common in Callao and Monte Video it is recommended as a good expedient for making a sail sit flat. The head of the fore lug of the Elaine has as much as 19in. round, and the yard was bent to nearly fit the sail, or to the extent of 15in. (The yard could be bent by being balanced over a beam with a weight at either end, or it could be shored down at either end, for a week or two.) The sail has never puckered along the yard in consequence of excessive round in the head, nor has it ever shaken in the leech; in fact, it sits like a drum-head.

The yard is 3½in. in diameter at the centre, and tapers well towards the ends. A rock-elm batten, 1in. thick and tapering at the ends, is made to fit the yard by grooving, and runs nearly the whole length of the yard, and is secured to it by lashings or lacings. The yard should be made longer than at first required, as the head of the sail frequently requires pulling out.

The foremast is 4½in. in diameter; it is fixed into a clamp at the after side of the fore thwart; it is stayed with two light wire shrouds set up with lanyards to the gunwales. The purchase to the jib and purchase to the bobstay hold the mast forward.

The fore halyards are single 2½in. rope, leading through a sheave in the centre of the mast, and the yard is hoisted "chock-a-block," the heel or lower part of the yard being

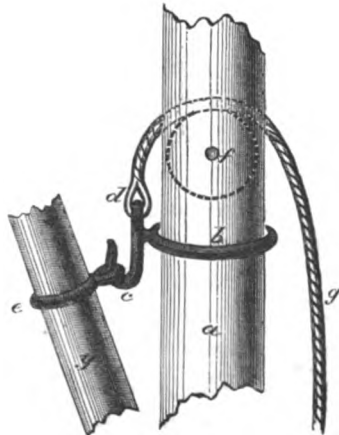


FIG. 90.

kept to leeward. There is a traveller on the mast, as shown in Fig. 90; *a* is the mast; *b* is the traveller; *c* is a hook (a solid weld on the traveller), with an eye at *d*, to which the halyard is eye-spliced, seized or bent; *e* is a selvedge strop round the yard *y*, just long enough to have a thimble seized in it, to take the hook at *c*; *f* is the sheave in the mast; *g* is the halyard, but not hauled taut.

The tack of the sail is set down by a gun-tackle purchase, or double purchase, leading from an eye-bolt on the keelson of the boat; as it takes two or three hands to bowse the tack down with a gun-tackle purchase. Unless the luff of the sail is kept taut, the peak drops and lets the boom down, but never inconveniently or harmfully, and a small pull on the mainsheet puts the matter right. However, there can be no doubt that the peak, if possible, should be kept well set up, and a taut luff will generally succeed in doing this. The tack, tack cringle, and luff rope of the sail must be very strong, to stand the enormous strain put upon it. The head of the sail must be very tightly laced, and the lacing holes are best sewn, instead of "eyeleted."

The boom is fitted to the mast by a goose-neck, made to ship and unship without collar, nut, or pin; the fall of the tack tackle, being generally belayed round the boom at the mast, keeps the boom in its place.

The clew of the sail must be free whilst the tack is bowsed down, the clew is then hauled out on the boom by a traveller similar to the mast traveller. The boom should be a good stiff stick, as, if it bends, a slack leech and belly to the sail will be the result. The sheet is a gun tackle purchase, and on a wind the boom is hauled in as flat as it can be got.

In tacking, the heel of the yard is pulled the other side of the mast by main force as the boat comes head to wind; a short line fast to the heel of the yard is found to facilitate this operation.

In lowering the sail the first thing to do is to let the clew loose and cast off the tack.

In reefing, the tack tackle and hook of the boom traveller are shifted to the reef cringles, the sail set up, and then the reef points tied. Points are put close to the reef cringles, to tie the ends up snugly. The reef bands are 2ft. apart.

The mizen is set the same as the mainsail, but the tack and clew are made fast to the boom by lashings, as the heel of the yard can be easily shifted.

The Monte Videan boats have a claw on the heel of the yard,

made as shown by Fig. 91, to fit on the aft side of the mast; then no dipping is required at all. *a* is the yard, *c* the claw, *d* the mast. Sometimes instead of a claw, a double iron is used, the part which encircles the mast being hinged and fastened by a pin. These contrivances serve to keep the yard steady whilst reefing, and admit of the tack tackle being dispensed with; the tack tackle, however, is generally preferred, as it fairly brings a strain on the luff and foot of the sail.

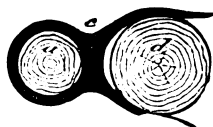


Fig. 91.

The topmasts are generally put up through a split cap *c* (Fig. 92) on the mast head *m*. The top mast is got on end by hand. The halyards and backstays are cleared through the gap *a*. The heel of the top mast has a rope rove through it, by which it is lashed to the mast. Another plan was adopted in the Elaine, thus:

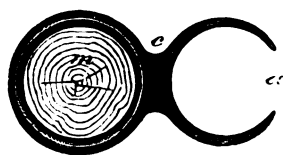


Fig. 92.

An iron cap, A (Fig. 93), is fitted to the topmast *k*, and remains on the topmast a fixture; when the latter is got on end it is shoved up in front of the mast, and "shipped" by putting the part of the cap *a* over the masthead (*m*) as the topmast is got up. The heel of the topmast is then lashed to the mast. The part of the iron *a* must fit loosely on the masthead. Sometimes the parts *a* and *k* are made equal; in such case the masthead, or "pole" of the mast, must be reduced to the size of the topmast. The iron cap is riveted as shown at *r*. B shows the masthead, with topmast, and iron cap fitted on at *a* and resting on the iron rigging hoop *d*. The shroud *s* is hooked to an eye in the rigging hoop *d*. The jib halyards *h* are hooked to an eye at the fore side of the hoop. The Elaine's topmast is 20ft. long, with the cap in the centre of length.

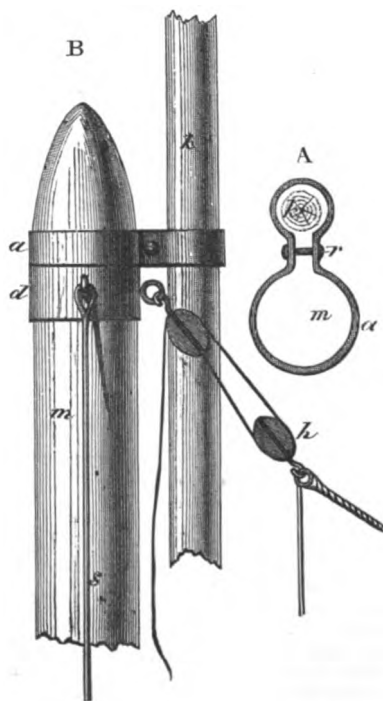


FIG. 90.

Two or three of the boats have topsails on bamboo yards; but they are of no use on a wind, and do not give much additional area. On the other hand, they add to the gear; and,

as the boats are already full of necessary sails, gear, and spars on match-sailing days, everything in the slightest degree superfluous is rigidly condemned.

The bowsprit is shipped through an iron hoop on the stem, and the heel fitted into a socket in the mooring bitt, which is fixed about a foot ahead of the mast; the bobstay is of wire, and is set up with a gun-tackle purchase, the outer block being hooked into an eye at the end of the bowsprit.

There are no shrouds to the mizen mast; the sail is hoisted by single halyards. The foot of the sail is generally laced to a boom. The sheet is taken down to a short bumpkin which ships and unships, and projects about 3ft. beyond the taffrail. The standing part of the sheet is fast to the bumpkin end, it then leads through a strop block on the boom, down through a sheave in the bumpkin end, and from there leads on board. The mizen mast is shipped into a clamp, at one side of the rudder, at the fore side of the transom. Care must be taken that there is plenty of drift between the mizen boom and bumpkin, so as to get the sheet well in.

The jib sheets are led through an eye bolt inside the gunwale, or on one of the fore-thwart knees; they lead aft, and are belayed to a pin in the centre of the thwart, and can consequently be handled without going to leeward.

The main sheet is single, and works on a short iron horse about 1ft. 2in. long, secured to a thwart about two-thirds of the length of the boom from the mast. The standing part of the sheet is fast to a single block on the traveller; it leads through a single strop block on the boom (or a clip hook block, hooked into strop), then back through the block on the traveller and the fall hitched round the parts.

All the boats have jib-booms (for carrying balloon jibs), and these are shipped the same as the topmasts, with a gap in the jibboom iron or cap on jib-boom.

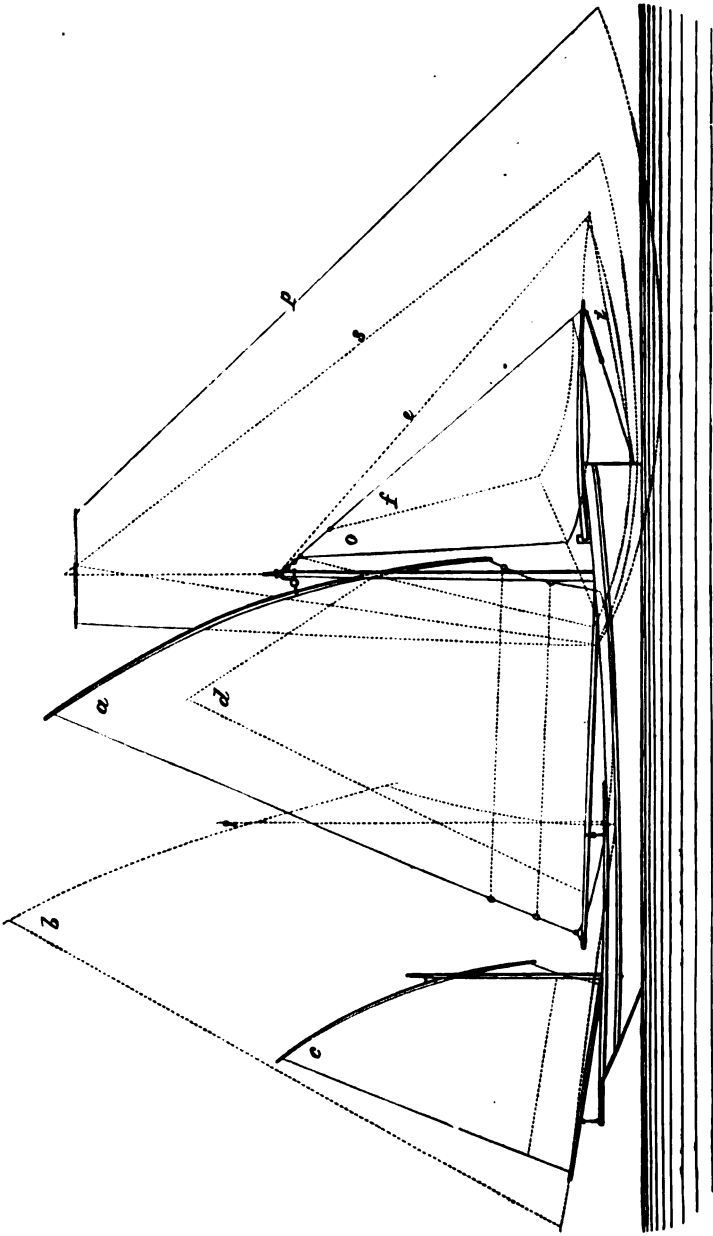
The dimensions of the Elaine sails are as follows:

| | Luff. | Leech. | Head. | Foot. | Tack to peak earing. | Clew to throat weather earing. |
|--|---------|---------|---------|---------|----------------------|--------------------------------|
| | ft. in. | ft. in. | ft. in. | ft. in. | ft. in. | ft. in. |
| Foresail, <i>a</i> | 5 0 | 26 0 | 21 6 | 16 0 | 25 0 | 17 0 |
| Mainsail, <i>b</i> , for running | 10 0 | 28 6 | 18 6 | 18 0 | 27 6 | 21 0 |
| Mizen, <i>c</i> | 3 0 | 14 0 | 18 0 | 9 0 | 15 0 | 9 6 |
| Small sprit foresail, <i>d</i> | 10 0 | 20 0 | 10 0 | 14 0 | 19 0 | 17 0 |
| Balloon jib, <i>e</i> | 20 0 | 14 0 | — | 18 6 | | |
| Working jib, <i>o</i> | 18 6 | 12 6 | — | 10 6 | | |
| Small jib, <i>f</i> | 15 0 | 10 0 | — | 7 6 | | |
| Spinnaker, <i>s</i> | 29 0 | 23 6 | — | 22 0 | | |
| Big Spinnaker, <i>p</i> | 33 0 | 23 6 | 4 6 | 30 0 | | |

† Bobstay of jibboom.

The reference letters refer to Plate XIV.

PLATE XIV.



Sail Plan of "The Elaine."

| | ft. in. |
|--|----------------|
| Mainmast from heel (stepped on top of keel) to sheave hole | 20 0 |
| Foremast ditto | 17 0 |
| Diameter mainmast | 0 3½ |
| Foremast | 0 4½ |
| Fore yard | 21 8 |
| Diameter | 0 3½ |
| Fore boom (mast to outhaul sheave) | 16 6 |
| Diameter | 0 4 |
| Topmast..... | 20 0 |
| Above cap | 10 0 |
| Diameter | 0 2½ |
| Bowsprit, outside..... | 7 0 |
| Diameter | 0 3½ |
| Mizen mast | 10 9 |
| Diameter | 0 3½ |
| Two spinnaker booms | 21ft. and 7ft. |

This season the New Brighton Sailing Club have rescinded the restriction placed upon the sail plan of the boats, and as a consequence, gaff sails and the cutter rig are likely to displace the picturesque lug. The Pearl, a new boat built this year (22ft. 6in. long by 6ft. 8½in. breadth), is cutter-rigged, and her sail plan is representative of the others which have been altered from the lug rig.

DIMENSIONS OF PEARL'S SPARS AND SAILS.

| | ft. in. |
|--|---------|
| Mast, gunwale to hounds..... | 15 0 |
| Mast head | 3 6 |
| Gaff | 14 0 |
| Boom | 26 6 |
| Bowsprit (outboard)..... | 6 3 |
| Jibboom | 6 0 |
| Topmast above cap | 10 0 |
| Topsail yard | 13 0 |
| Ringtail boom (beyond boom-end iron) | 10 0 |
| Ringtail boom inside iron | 6 0 |
| Spinnaker boom | 25 0 |
| Luff of mainsail..... | 13 9 |
| Leech of mainsail | 27 6 |
| Head of mainsail | 13 6 |
| Mast stepped from fore side of stem | 8 0 |

The topmast is fitted with a heel rope, which passes through a sheave hole in the mast head. When the topmast is hoisted the rope is belayed, and no fid is used. Cross trees are hinged to the heel of the topmast, and are pointed up as the topmast (backstays and hal-yards included) is slewed up through the split cap (see Fig. 92). The jibboom is fitted in the same manner as Elaine's. The "ring tail" is fitted similarly to the plan described under the head of "Seamanship" (see *ante*).

A few years ago the New Brighton boats had no counters, and were

fitted with sprit sails, as already explained, and Plate XV. (see Fig. 94 for her body plan) represents such a boat, named the Jabberwock. She was designed by Mr. Clayton, and was very successful.

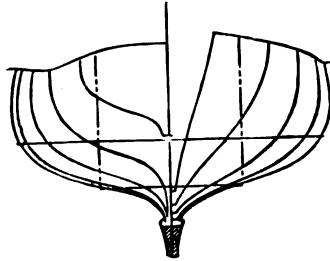


FIG. 94.

The Jabberwock had a length between stem and stern post of 26ft. 6in., and greatest beam of 6ft. 9in., and she had no counter. Her draught aft was 3ft. ; amidships 2ft. 5in. She had 7cwt. of ballast outside on her keel, and 4½cwt. inside, besides a crew of five or six.

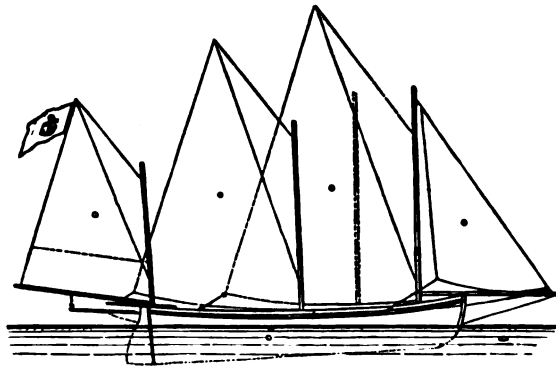


FIG. 95.

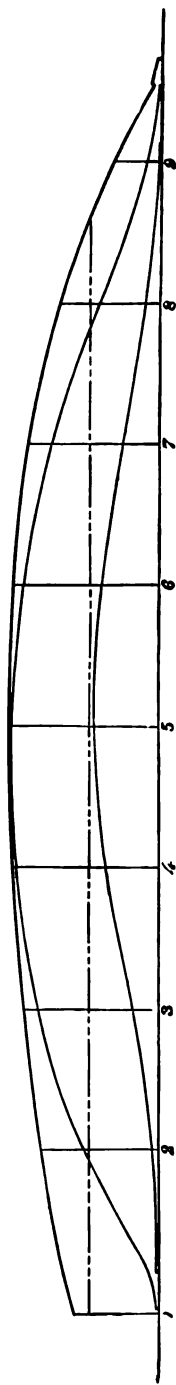
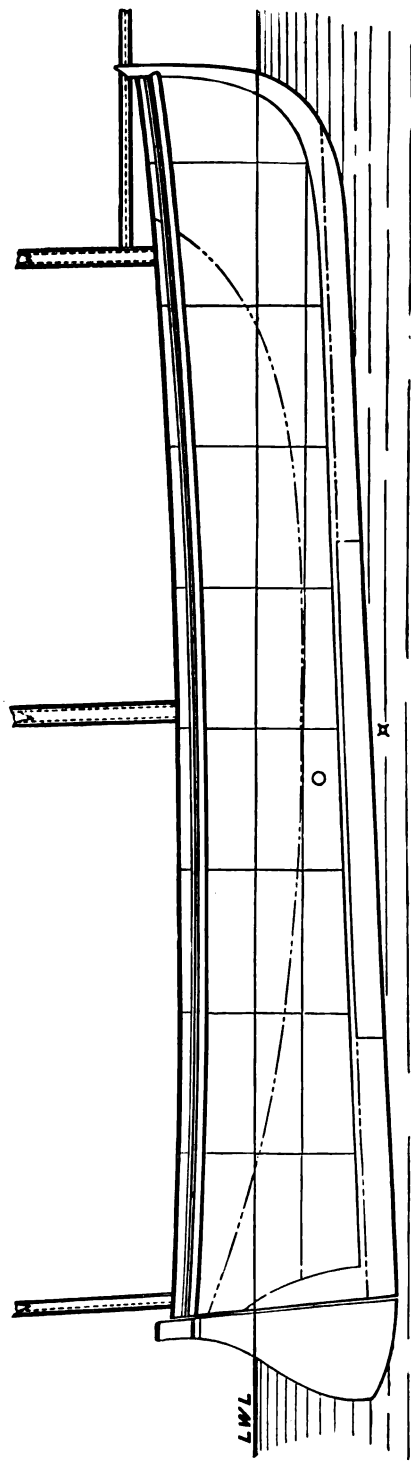
The boat sailed well with jib, sprit-foresail and mizen (see Fig. 95), and was very handy ; the main-sprit being only set in light weather. A very snug rig was made by stepping the mainmast in the thwart shown by the ticked line ; jib tacked to stem head and reefed mizen.

THE MANAGEMENT OF NEW BRIGHTON SAILING BOATS.

Generally the New Brighton Sailing Club boats are moored at the back of the Woodside, or New Brighton stages, and are consequently obliged to unship their masts. Only a few of them are moored sufficiently in the open to enable them to keep their masts standing.

When laying at moorings, the spars are generally secured at one

PLATE XV.



"The Jabbercock."

— 11 —
第 1 卷
第 1 期
第 1 頁

side of the boat, and the sails at the other, covered over with one large sail cover, and lashed to the thwarts.

A little practice soon enables the crews to get up the working lug sails in five or six minutes. The foremast and bowsprit are first shipped. The jib is the first sail set, to act as a forestay, to keep the head of the mast forward; the jib is hauled out with a single outhaul, the halyards having a gun tackle purchase. Belaying pins are placed at the after side of the foremast thwart for securing halyards, &c.

When the jib and jigger are set, the boat is manageable, and can be cast off from her moorings, the big foresail being put up last; this is done, by first hooking on the tack purchase, then getting the yard into position, so that the grommet strop can be hooked on to the mast halyard traveller; when hoisted the tack is bowsed down, a double purchase being necessary in boats of the Elaine size; last of all, the clew of the sail is hooked into the boom outhaul traveller, hauled out, and the fall secured to a cleat on the lower side of the boom.

The main sheet is generally kept in well taut on a wind, the boom not being allowed to sag away over the side, which it would do if the sheets were double, and taken down to the gunwales.

The lug yard is always kept to the leeward of the mast, and as the halyards are rove through a sheave placed fore and aft, in the centre of the mast, it produces a tendency to keep the head of the sail to windward.

In smooth water the boats will always easily stay, under almost any sail, but in rough water, the helmsman must watch his chance so as not to get a lump of sea on his weather bow just before the boat gets up in the wind; the helm must be put down gradually, so as not to stop the boat's way; the jib is passed over as soon as the boat has properly paid off, and gradually eased over, so as not to stop her way. It is often advisable to ease the jib sheet at the same time that the helm is put down to let her come head to wind quickly, and then if the boat shows signs of missing stays, a hand going into the bows tends to bring her head to wind (this being a recognised dodge with Liverpool speculating gigmen),* and this

* The practice of going into the lee bow of a boat as the helm is put down is a very old one; by immersing the bow to leeward, the pressure is increased and the boat's head forced to the wind. On the other hand, by collecting the crew on the weather bow as the helm is put up the boat will wear, or bear up faster. The author of an article on seamanship in the *Encyclopædia Britannica*, in allusion to this subject, says "A practice of seamen in small wherries or skiffs, in putting about, is to place themselves to leeward of the mast. They even find they can aid the quick turning motion of these light boats by the way in which they rest on their two feet, sometimes leaning on one foot and sometimes on the other. And we have often seen this evolution (tacking) very sensibly accelerated in a ship-of-war by the crew running suddenly to the lee bow as the helm was put down. And we have heard it asserted by very expert seamen, that after all attempts to wear ship (after lying to in a storm) have failed, they have succeeded by the crew collecting themselves near the weather

hand can hold out the clew of the jib, and so, if necessary, force her round—care, of course, being taken to reverse the helm if the boat gets stern way on her.

Hauling in the last inch of the jigger sheet, just as the helm is put down, is advisable in racing, as it helps make a boat come to quickly; and then easing it off and not taking it in again until the boat is well under way, allows her to start again quickly.

The mizen lug yard is easily pushed by the helmsman to the lee side of the mast, but the fore lug yard requires a little handling: the easiest and best way to get it over is by fixing a couple of light ropes, about a fathom long, to the foot of the yard, the ends being allowed to drop down at each side of the boom, and by hauling in the weather one, just before the boat comes upright in stays, the yard bends slightly, and passes round the left side of the mast, and flies into its position to leeward, ready for the next tack, this can be done by one hand without jerking the boat unnecessarily, for the most essential element for speed in these as in all other light boats is to get the crew to keep quiet, and if necessary to lay well up to windward, often to the extent of getting one leg and part of the body over the weather side—as the spare spars and sails are lashed up to the sides of the boats, they assist the crew in keeping this position.

Most careful handling of the helm is necessary in rough water, as a very slight touch will often keep a sea out. It is generally found that the light displacement boats are the liveliest, and driest, in rough weather; and those that take a large quantity of ballast have a high freeboard to keep them dry. A full section forward prevents a boat dipping and taking in volumes of water over the bows, but it is decidedly detrimental to speed in lumpy water, as it hammers on the top of the seas, and so stops the boat's way; a long floor with hollow sections near the keel under the mast seems to answer best.

In reefing the fore lug, the halyards are lowered the necessary distance down the mast, then the hook of the tack tackle block is hooked into the reef cringle in the luff, and the tack bowsed down; the clew outhaul traveller hook is then placed into the opposite reef cringle in the leech, and the clew hauled out; last of all, the foot of the sail is rolled up, and tied with the reef points; reef points are also placed close up to the cringles to make the ends of the sail snug. This can be done so neatly that the reefed sail looks as if it had been changed for a smaller one; and as it can

foreshrouds the moment the helm was put up." The man that goes into the lee bow to help bring the boat head to wind should not remain there, but move aft to the quarter on the opposite side; this will assist the boat's head in falling off. (See also page 29; also see "Sternway" in the chapter on "Seamanship.")

be done easily and quickly with practice, it is infinitely preferable to changing sails, and is of great advantage when racing. Reefing the mizen and changing jibs is also often necessary.

The calico lug for running (see *b*, Plate XIV.) is generally kept in the boat bent, with the head laced to the yard, and foot to a boom; the running-lug mast is the full length of the boat inside, and is shipped into a thwart, about two-thirds the distance aft, between the fore and mizen masts, a single light rope backstay is used, and the yard is hoisted with single halyards, and the tack hauled down with a light line to a hook in the thwart, the sheet is always attached to the boom, and does to make up the sail with, it is led over a fair-leader aft in the counter, and then led inboard. The jigger can be unshipped or brailed up, to allow the big sail to receive all the wind. Topping lifts are fitted to the working lugs for handiness, and to enable the fore boom to be shifted to the other side of running lug; this running lug is only used for running or reaching with a beam wind, and would only sit in a very light air to windward.

The balloon jib is hoisted by ready rove single halyards; the jib-boom is shipped with the outhaul ready rove, no bobstay being of any use; after the sail is got out on the jib-boom, the sheet is passed well aft, clear of, and outside, all other gear and rigging to leeward, then, when the halyards are hoisted, the sail is set: these balloon jibs add greatly to the speed in reaching, being very large, and cut with a round foot, which hangs close to the water.

In setting the spinnaker, the topmast having been got on end (as already explained, with a backstay fitted to the shoulder, and halyards ready rove), the backstay is first taken aft and secured; the guy is passed outside the rigging; the halyards and sail are on the fore side of the mast shrouds and hoisted chock-a-block, being passed through the space between the mast and the rigging the sheet is secured to the bowsprit, or lee gunwale; the guy is bent to a small rope cringle in the tack of the sail; the cringle is of sufficient size to take the spritted point of the spinnaker boom, which is then pushed forward, and the goose neck at the inner end shipped into a socket on the mast, or into a rowlock hole in the gunwale ahead of the rigging. It is drawn aft by the guy, and trimmed to the wind. A hand is kept to sit on the boom to keep it down.

A topping lift is used for the big spinnaker booms, then the boom is shipped into its place before the sail is hoisted, care of course being taken that the outhaul is outside the topping lift, and runs clear of the guy. These points being continually forgotten by amateurs, it is advisable to mention them here, half of the time generally employed in setting a spinnaker is wasted in getting the gear straight (see "Seamanship").

In the New Brighton Sailing Club races the boats generally make a flying start, the boats being allowed to pass the line as soon as they can after the second gun, the boats only start from moorings when the tide is too strong to head against, or the wind is light and in the same direction as the tide.

CHAPTER XXI.

LAKE WINDERMERE YACHTS.

LAKE Windermere yachts are somewhat peculiar in form, as will be seen from the accompanying sketch of the *Truant*, owned by Mr. W. B. Forwood.

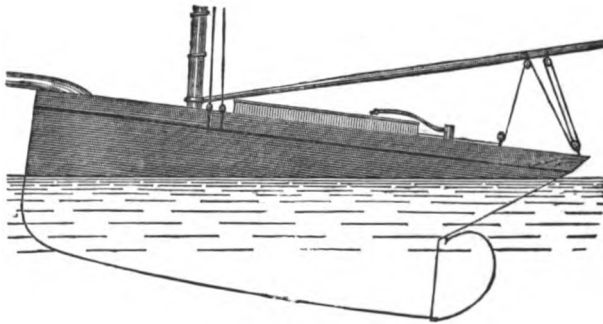


FIG. 96. THE TRUANT.

The fashion of immersing the counter, it appears, arose some six or seven years ago out of an intended evasion of the rule of measurement, which is simple length between stem and sternpost. The Windermere club, with a view of checking the advantages gained by immersion of counter, supplemented the rule by a condition that the counters abaft the sternpost should not exceed 6ft. 6in. in length.

We imagine that the advantages of getting an excess of length by immersing the counter were discovered in this way: The Windermere craft more or less bore by the head, "shoulder," and consequently carry a very great deal of weather helm. Hence they were being continually trimmed by the stern, and always with some advantage; and thus it was realised that an immersed counter is an advantage if length cannot be obtained in any other way without paying a penalty for it.

The Windermere yachts are mostly distinguished for their fine

weatherly qualities, and it is believed by good judges that no other craft in the world of similar length are so good to windward. They are sailed with great boldness, of course; and there need be no fear of sailing them too hard, so far as danger is concerned, as, owing to the great weight they have on the keel, it would be impossible to capsize them.

These boats are the safest that could be built, as they are really uncapsizable; and if wholly decked in, no mishap need ever happen with them, further than the breaking of spars and bursting of gear. They can, moreover, be handled single handed, as there is very little gear to work: but the principal feature that should command the attention of the nervous is their almost absolute safety. Men are continually inquiring for a boat that will not capsize, or one that will not sink; but, whilst it is easy enough to make a small boat unsinkable, it is practicably impossible to make one uncapsizable—we mean, of course, a 20ft. boat of the ordinary type. Now a small yacht built and ballasted like either of the designs we give would be uncapsizable, and it might easily be made unsinkable by having a water-tight bulkhead forward and aft. Of course, if carelessly sailed, such boats might get knocked down nearly on their beam ends, and, if the crew got scared, or were not careful where they had put their hands and feet, they might get a header; but the yacht, directly the pressure on her sails had passed, would right herself. Of course it would be nothing but the result of gross carelessness if a yacht did get knocked down on her beam ends; as in the case of squalls the boat should be luffed, and the jib sheet, if necessary, eased. It will not do to wait until the squall actually knocks the boat over; she must be eased with lee helm directly the first breath of the squall is felt. If the boat gets hove down and loses way, the power of luffing will be gone, and then, if water got into the mainsail, "righting" would be a slow process; and further, if water got into the hold, and if there were no water-tight compartments, the boat would sink. With such craft as these it is always the proper thing to do to ease the head sheets first, and not the aft sheets, as by easing the latter the power for luffing is reduced, and by easing the head sheets it is increased.

Mr. W. B. Forwood, owner of the *Truant*, writing upon the sailing qualities of these craft, says: "The *Windermere* yachts are rigged as sloops, with pole masts. We have found by experiment that they go to windward much faster with one large jib than with two smaller sails. This, I know, is contrary to the general opinion on the subject; but there is no doubt whatever that the yachts are closer-winded with one jib than they are with jib and foressail. When sailing on a wind the main sheet is hauled in as taut as it can be got, the boom forming the smallest possible angle with

the keel. The helmsman steers by the luff of the jib, and, as the boats are very sensitive, they require most careful steering. Very heavy squalls are frequent, and they come down from the mountains without warning and with great fury. The boats are always sailed through these squalls, but are eased a trifle with the helm, so that they do not take the full weight of the wind; great care, however, is taken that they are not eased so much as to lose way. The squalls are generally "revolving," and if the boats were permitted to stop they would probably be taken next moment aback; so they are kept going to keep steerage way on, and follow the wind round. If a squall be very black and heavy, the jib sheet is eased a trifle, so as to luff quickly; but the main sheet is never in such cases started.

"It is astonishing what a weight of wind these boats will bear; they rarely sail without a topsail, and I never yet took a reef in my mainsail. They have 1ft. 6in. waterways, and 6in. coamings to cockpit; still, when very hard pressed, the water sometimes comes in over the coamings. The boats, however, are probably doing their best when only two or three inches of the deck are immersed. In sailing before the wind only fore-and-aft canvas is allowed, and no booming out permitted. As the boats have a tendency to bury their bows in running and reaching, all hands are put on the counter, until the taffrail is almost level with the water; and the more weight there is put on the counter under such circumstances, the better they seem to go. As the boats flare out a great deal above water at the foreside of the rigging (being so short and beamy), they 'shoulder' to leeward, and by trimming aft the shoulder is lifted out of the wave on the lee bow. On a wind the tendency of the boats is to lift their stern and depress their bows, but 'shouldering' does not appear to such an extent."

It is quite clear that a yacht which requires so much weight shifted aft whilst she is moving must be wrong somewhere, and in the case of the Windermere craft we have not long to search for a cause of the defect. The midship section is placed only eight or nine feet abaft the fore side of the stem; and this fact, coupled with 8ft. beam, necessarily gives the yachts a very short and full bow. The bow is given a slight hollow at its extreme fore end; but this of itself is not an important relief, and the bow is essentially one that will bury itself, and be incapable of very high speed, excepting under a propelling power* out of all proportion to the size of the boat. The Windermere yachts have, as may be supposed, a comparatively long and fine after-body, and if they were driven stern first at a speed of nine knots what was the bow end would still subside; only, under

* With a good strong and pretty steady breeze, the yachts have thrashed to windward six miles (equal to eight and a half miles), run seven, and reached eight in 3 hours 35 minutes; this would give a mean speed of nearly seven knots per hour, which must be considered exceedingly good.

such conditions, it would form the stern of the vessel. Most American yachts, which have comparatively short after-bodies (generally the proportion of after-body to fore-body is as 4 to 5) subside by the stern at high speeds, and many English yachts which have long bows and comparatively short runs do the same—notably the cutters built by Fife do so. On the other hand, yachts of the cod's head and mackerel's tail type with short entrance and long run, bore by the head—that is to say, the hollow of the wave forward is so large that the bow sinks into it.

The depression by the bow is, no doubt, in the case of the Windermere yachts, much aggravated by the sail pressure; they have enormous sail areas (about 15 per cent. more than any five-tonner), and as the head resistance they encounter at high speeds is very great, the depression due to the leverage of the sails alone must be very considerable (see page 28). Also the depression may be increased through inequalities in the wedges of immersion and emersion, and these latter influences will always have to be regulated by trimming. However, there is not much doubt that if the Windermere craft were propelled nine or ten knots an hour by steam, in an upright position, they would still "bore," on account of their midship section being placed so far forward. Still the forward position of the midship section need not be an unmixed evil; on a wind, when the speed is necessarily low, the shorter and fuller bow may be a positive advantage, and no doubt there is some reason for the old saying "A full bow eats itself to windward." However true this may be, so far as the ardency of the pressure on the lee bow assisting the boat to windward is concerned, there is now no room for doubting that a long entrance (of course of the proper form) is better for sailing on any point than a short entrance.

As the immersion of the counter is countenanced by the Windermere club, there is no reason why it should not be treated as an integral part of the vessel, as it was in the Jullanar. But, strangely enough, most of the Windermere craft are designed as if they were to be only 20ft. on the load line, with the counter clear of the water at the stern post, the counter being subsequently immersed according to the trim required in sailing. In the design, Plate XVI., the whole length (26ft. 6in.) allowed by the club rule has been appropriated, and the midship section was placed, as it would be in any ordinary yacht of similar length, a little abaft the middle of length of the load water line. The bow is consequently about 4ft. longer than the usual length of bow of a Windermere yacht, and the stern if shorter but not so much as the bow is longer, because the whole length (excepting a couple of inches) has been taken for the permanently immersed length.

Most of the Windermere yachts show a little less bilge, and are fuller

near the garboards, than the designs (Plates XVI. and XVII.); but all, we believe, have the greatest beam at the deck.

The No. 1 design (Plate XVI.) has 8ft. 9in. beam, and would show a hollow line of immersion at 20° heel; but the No. 3 design is very clean on the line of immersion at that inclination.

No. 1 design is possibly of too great displacement to compete with success on Lake Windermere, and would be more suitable for coast sailing, where beaching is not necessary.

No. 2 design (Plate XVII.) has less displacement, and ought to be able to successfully compete with the Windermere yachts.

No. 3 design (Plate XVII.) is of still lighter displacement, and generally (excepting in the form of bow and position of the midship section) is more like the Windermere yachts. The centre of buoyancy is a little farther forward than in either of the other designs; still the entrance is very much longer and finer than that of any Windermere yacht, and the afterbody, for mere fineness, closely resembles the after-body of such a yacht.

As to the capabilities of the designs for competition against the Windermere craft, No. 3 would probably turn out the most successful. So far as theoretic principles go, either design ought to be capable of beating the Lake craft, if the handling were equal; and if No. 3 did not succeed, because her bow is too long and her stern too short, we should have to begin to study the subject afresh, and all the knowledge acquired during the last thirty years in the way of naval science may be regarded, so far as the requirements of Lake Windermere are concerned, as utterly useless.

The topsail shown is not so large as the American sloops of similar size carry. The usual shape of an American topsail is shown in Fig. 56, p. 243). It will be seen that the yard is "up and down" the mast and the foot, laced to a jack yard, extends far beyond the head of the main sail. This sail is known in America as a club topsail; it can be only carried in light winds, and is not adapted for squally weather.

The sails of the yachts are made of duck, and are admirably contrived for flatness by the local sailmaker. The sloop rig, it has been proved by experience, is much the best for going to windward, and on the lake no difficulty is ever experienced in handling it.

The sail plan is shown in the sketch (Plate XVIII.), and it will be seen that the gear is very simple, all running through single blocks. The main halyard block is not shown in the sail plan. The upper block is hooked to an eye in the main rigging iron, about 1ft. 6in. above the jaws of the gaff. The standing part of the halyard is fast to the upper

block; the other end is passed through a block on the jaws, then through the upper block.

The hulls are pumice-stoned outside, and then black leaded, very great attention being paid to the condition of smoothness of the bottom.

LAYING-OFF TABLES.

No. 1. DESIGN.

| Sections | 1 | 2 | 3 | 4 | 5 | 6 | 7 | 8 | 9 | 10 | 11 | 12 |
|---|---------|---------|---------|---------|---------|---------|---------|---------|---------|---------|---------|---------|
| | ft. in. | ft. in. | ft. in. | ft. in. | ft. in. | ft. in. | ft. in. | ft. in. | ft. in. | ft. in. | ft. in. | ft. in. |
| Heights above L.W.L. to deck..... | 2 7 | 2 5 | 2 3 | 2 1 | 1 11½ | 1 10½ | 1 9½ | 1 9½ | 1 9 | 1 9½ | 1 9½ | 1 10½ |
| Depths below L.W.L. to rabbet of keel | 2 0½ | 2 11 | 3 3 | 3 5½ | 3 7 | 3 8½ | 3 9½ | 3 8 | 3 4 | 2 11 | 2 4½ | 1 7 |
| Depths to under side of keel | — | 3 3½ | — | — | — | — | — | — | — | 4 6 | — | — |
| Depths of lead keel | — | 0 ¾ | 1 2 | 1 6½ | 1 10½ | 2 1 | 2 2 | 2 1½ | 2 0½ | 1 10½ | — | — |
| Half-breadths on deck | 1 1½ | 2 1½ | 2 11½ | 3 6½ | 3 11½ | 4 2½ | 4 3½ | 4 3 | 4 2 | 3 11 | 3 6 | 2 8½ |
| Half-breadths on L.W.L. | 0 7½ | 1 4 | 2 1½ | 2 10 | 3 4½ | 3 9 | 3 10½ | 3 10 | 3 7½ | 3 3 | 2 7½ | 1 7 |
| Half-breadths, No. 2 W.L. | 0 4 | 0 10½ | 1 6½ | 2 2½ | 2 8½ | 3 1 | 3 2½ | 3 0½ | 2 8½ | 2 2 | 1 5½ | 0 7 |
| Half-breadths, No. 3 W.L. | 0 1½ | 0 5½ | 0 11 | 1 4 | 1 8½ | 1 11½ | 1 11½ | 1 10 | 1 6½ | 1 0½ | 0 5 | — |
| Half-breadths, No. 4 W.L. | — | 0 2 | 0 4½ | 0 7½ | 0 10 | 0 11½ | 0 11½ | 0 9½ | 0 6½ | 0 2½ | — | — |
| Half-breadths on diagonals, 1 | 0 3½ | 0 8½ | 1 1½ | 1 5 | 1 7½ | 1 9 | 1 9½ | 1 8½ | 1 6 | 1 2½ | 0 9½ | 0 3 |
| Half-breadths on diagonals, 2 | 0 7½ | 1 2½ | 1 10 | 2 3½ | 2 7½ | 2 10½ | 2 11 | 2 9½ | 2 7 | 2 2½ | 1 9½ | 1 1½ |
| Half-breadths on diagonals, 3 | 0 9 | 1 6½ | 2 8½ | 2 10½ | 3 4½ | 3 8 | 3 9½ | 3 8½ | 3 5½ | 3 1½ | 2 7½ | 1 9½ |
| Half-breadths on diagonals, 4 | 0 11½ | 1 10½ | 2 8 | 3 3½ | 3 9½ | 4 1½ | 4 3 | 4 2½ | 4 1½ | 3 9½ | 3 3½ | 2 5½ |

No. 1 diagonal radiates from the middle vertical line of the body plan at 1ft. 4in. below L.W.L., and cuts the lower water line at 1ft. 8½in. from the middle line. No. 2 diagonal radiates from the L.W.L., and cuts the third water line at 2ft. 9½in. from the middle line. No. 3 diagonal radiates from the middle line at 10in. above the L.W.L. No. 4 diagonal radiates from the middle line at 1ft. 9in. above L.W.L., and cuts the side perpendicular 5in. above L.W.L.

No. 2. DESIGN.

| Sections | 1 | 2 | 3 | 4 | 5 | 6 | 7 | 8 | 9 | 10 | 11 | 12 |
|--------------------------------------|---------|---------|---------|---------|---------|---------|---------|---------|---------|---------|---------|---------|
| | ft. in. | ft. in. | ft. in. | ft. in. | ft. in. | ft. in. | ft. in. | ft. in. | ft. in. | ft. in. | ft. in. | ft. in. |
| Half-breadths on deck | 1 1½ | 2 1 | 2 11 | 3 6 | 3 11 | 4 2 | 4 3½ | 4 3 | 4 2 | 3 11 | 3 6 | 2 8 |
| Half-breadths 1ft. above L.W.L. | 0 9 | 1 7½ | 2 6 | 3 2½ | 3 8½ | 4 0 | 4 1½ | 4 1½ | 3 11½ | 3 8½ | 3 3 | 2 5 |
| Half-breadths on L.W.L. | 0 6 | 1 2½ | 2 0½ | 2 9 | 3 3½ | 3 7½ | 3 9 | 3 8½ | 3 6 | 3 1 | 2 5 | 1 6 |
| Half-breadths, No. 2 W.L. | 0 3 | 0 8½ | 1 3½ | 1 10½ | 2 4½ | 2 9 | 2 10½ | 2 9 | 2 4½ | 1 10 | 1 2½ | 0 5½ |
| Half-breadths, No. 3 W.L. | 0 2 | 0 3½ | 0 8 | 1 0½ | 1 4 | 1 6 | 1 6½ | 1 5 | 1 2 | 0 9 | 0 4 | — |
| Half-breadths, No. 4 W.L. | — | 0 2½ | 0 8½ | 0 5½ | 0 7½ | 0 8½ | 0 9 | 0 7½ | 0 5 | 0 2½ | — | — |
| Half-breadths, diagonal (n) | 0 10 | 1 8½ | 2 5½ | 3 1½ | 3 7 | 3 10½ | 4 0 | 3 11 | 3 9 | 3 5½ | 2 11½ | 2 3 |
| Half-breadths, diagonal (a) | 0 6 | 1 1 | 1 7½ | 2 1 | 2 5½ | 2 8½ | 2 9 | 2 7½ | 2 5 | 2 1 | 1 8 | 1 0 |
| Half-breadths, diagonal (m) | 0 2 | 0 5½ | 0 9½ | 1 1½ | 1 4½ | 1 5½ | 1 6½ | 1 5½ | 1 3 | 0 11½ | 0 7 | 0 2 |

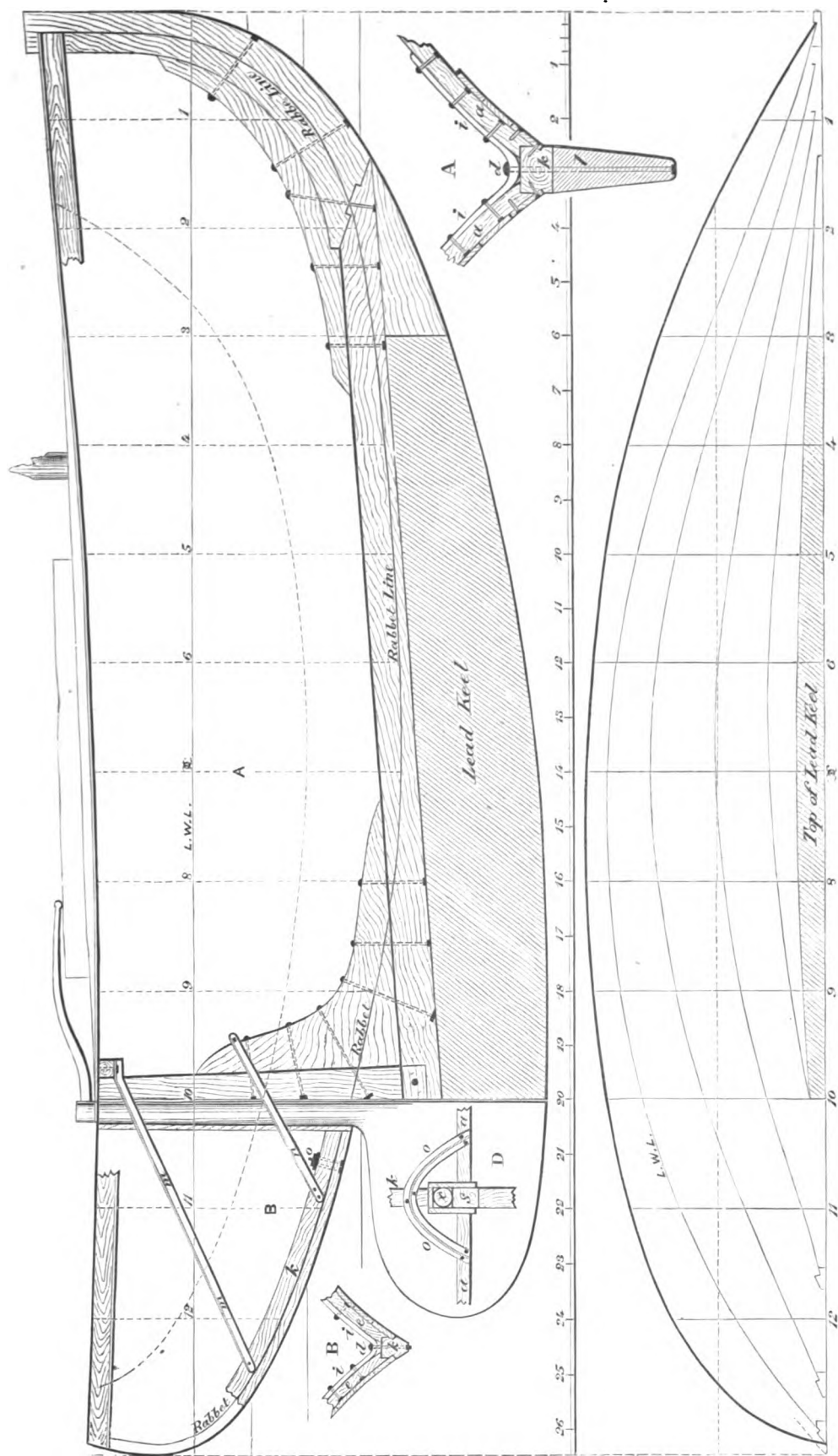
n diagonal is struck 1ft. 6in. above the L.W.L., and cuts the perpendiculars p p, at n 1 and n 2, 7½in. below the L.W.L.

a diagonal cuts No. 3 water line, at a 1 and a 2, 8in. from the perpendiculars p p.

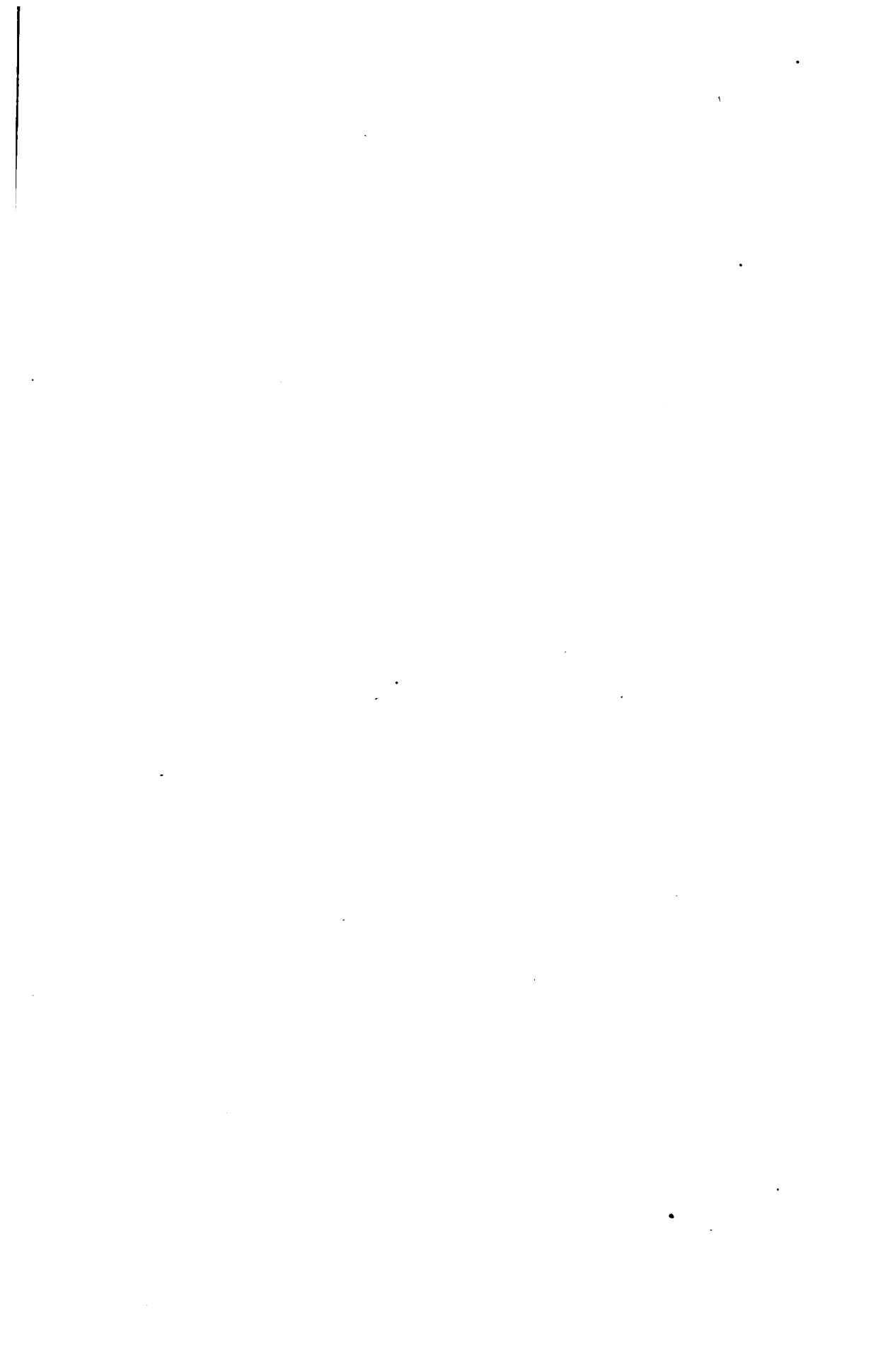
m diagonal is struck 1ft. 5in. below the L.W.L., and cuts No. 4. water line, at m 1 and m 2, 1ft. 6in. from the perpendiculars p p. All the water (horizontal) lines shown in the body plan are 1ft. apart.

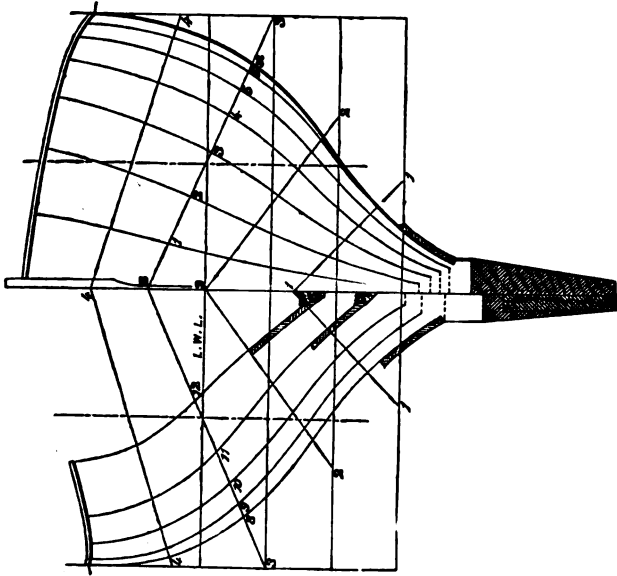
* This depth refers to the filling up piece of wood forward of lead keel, and forming fore foot.

PLATE XVI.

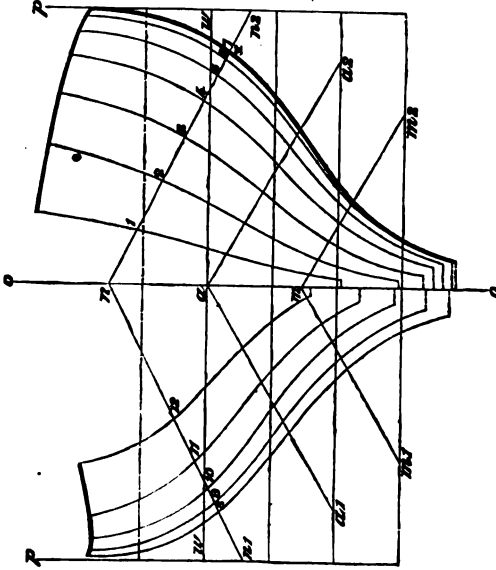


Lake Windermere Yacht, length 26ft. 6in. Design No. 1.

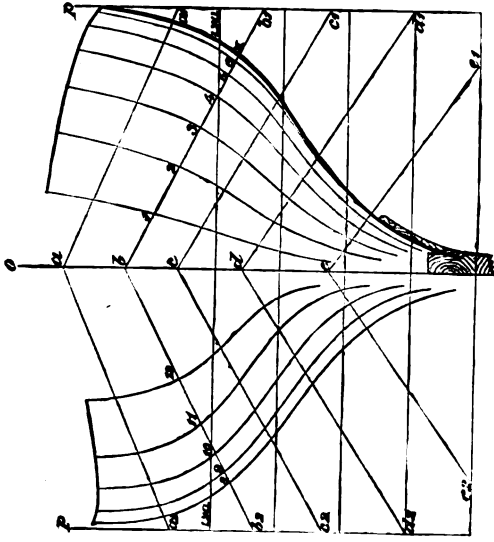




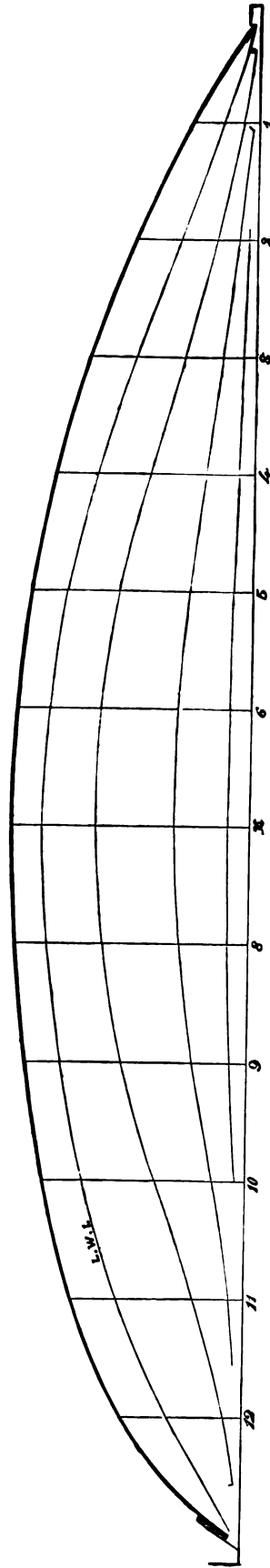
Design No. 1.



Design No. 2.



Design No. 3.

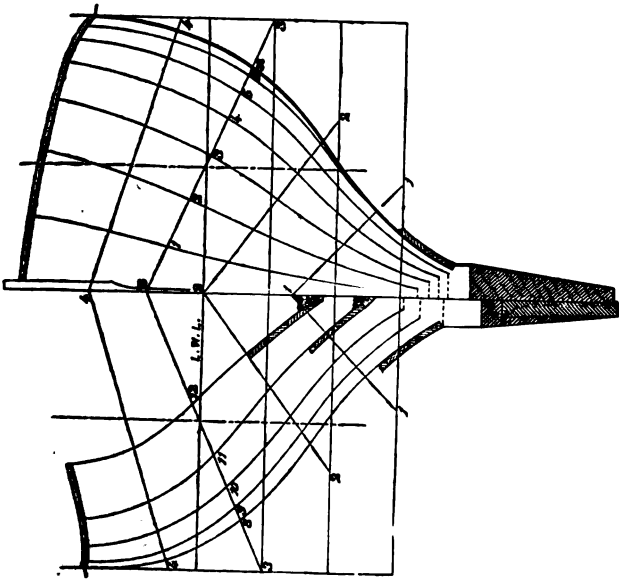


Design No. 3.
Windermere Yachts.

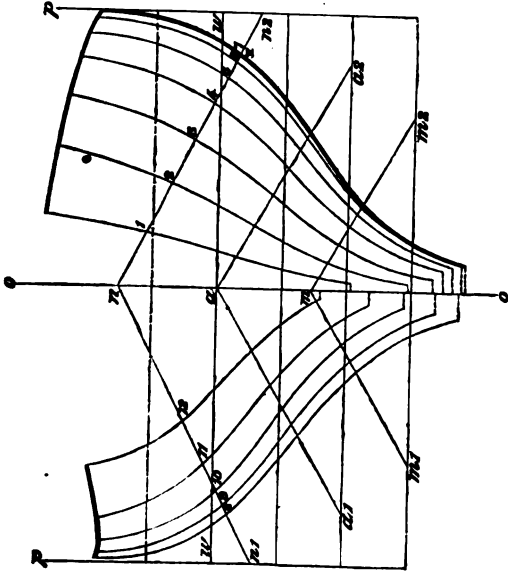




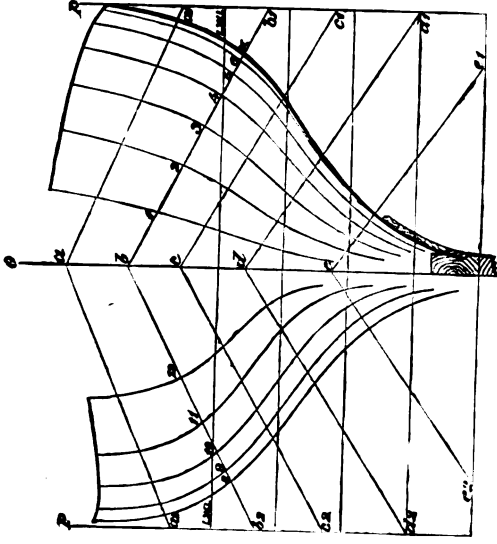
Handwritten notes or markings along the right edge of the page, including a vertical line and several horizontal lines with diagonal hatching.



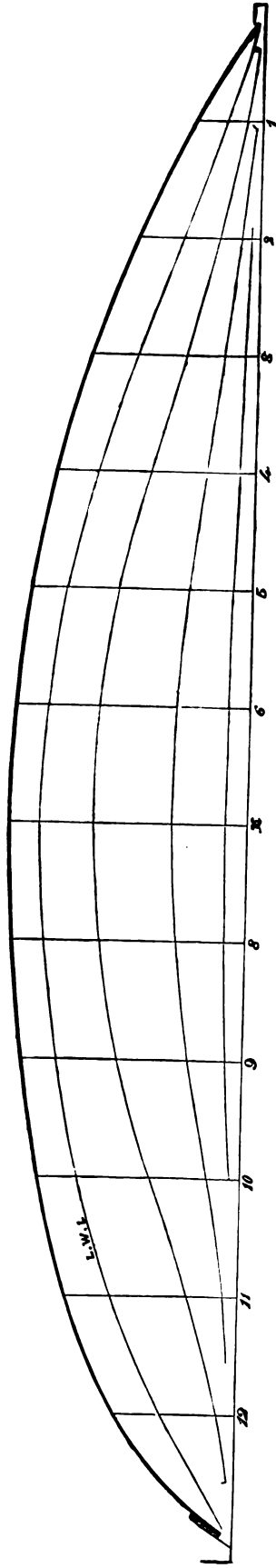
Design No. 1.



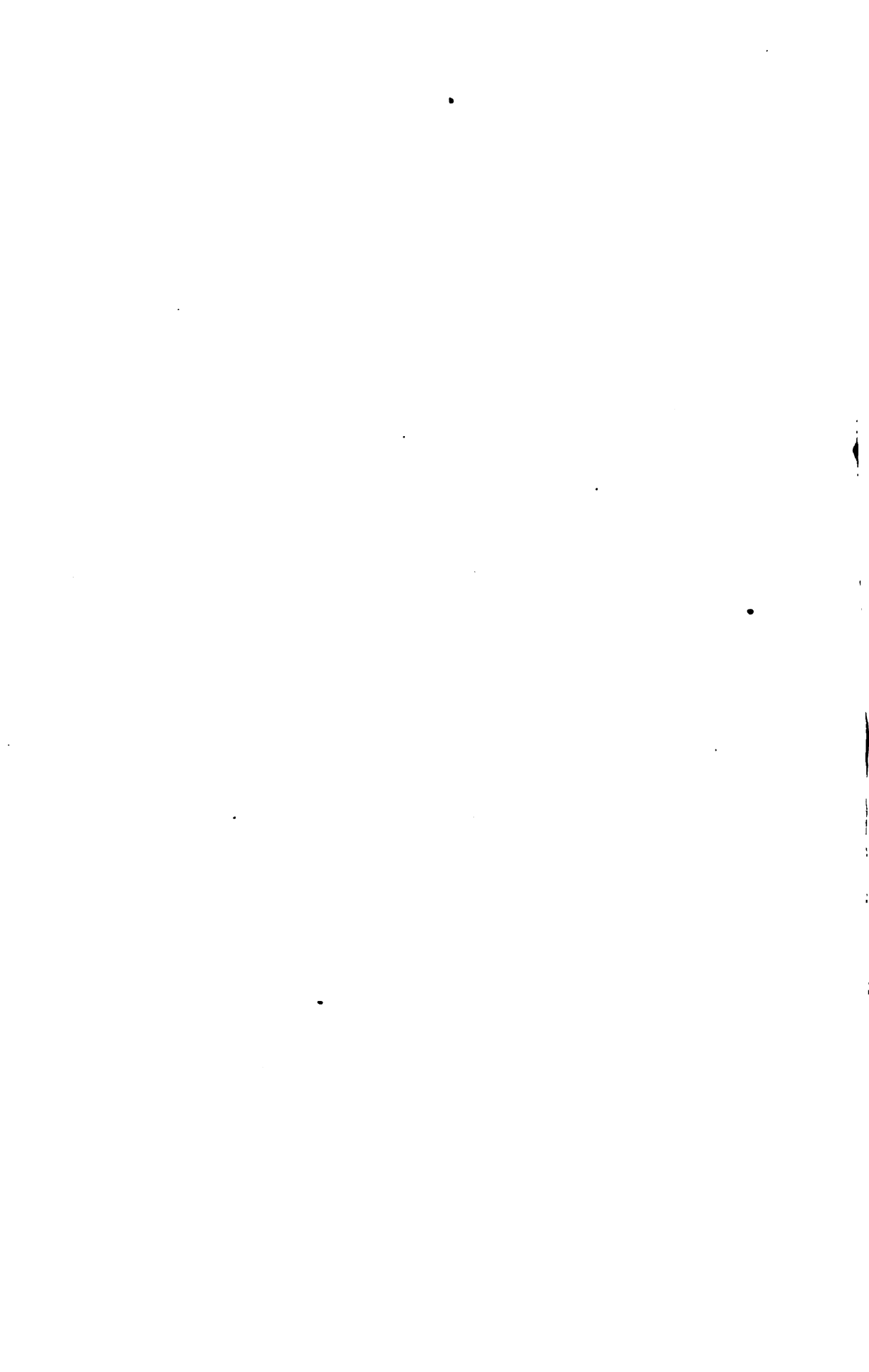
Design No. 2.



Design No. 3.



Design No. 3.
Windermere Yachts.



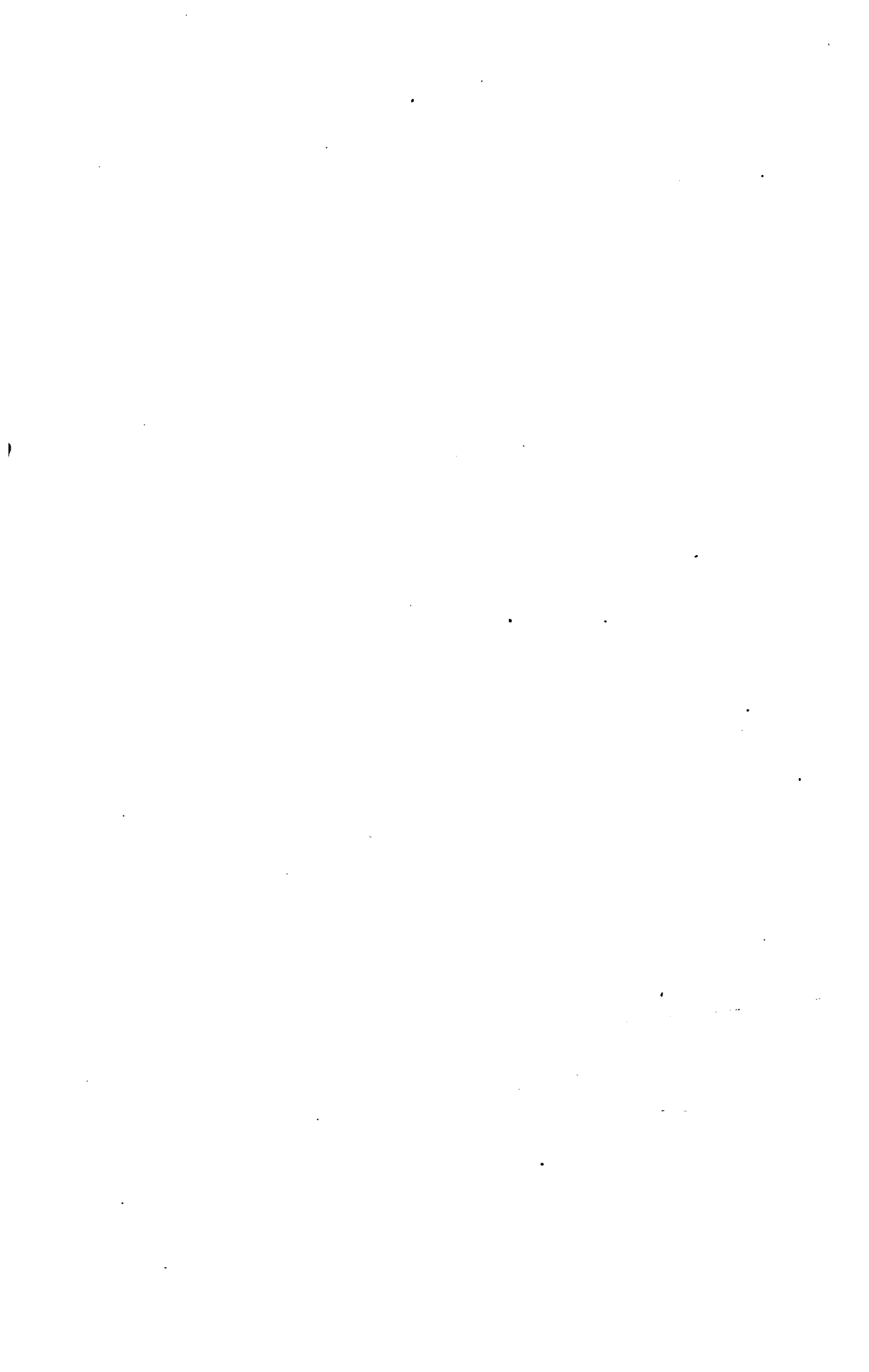
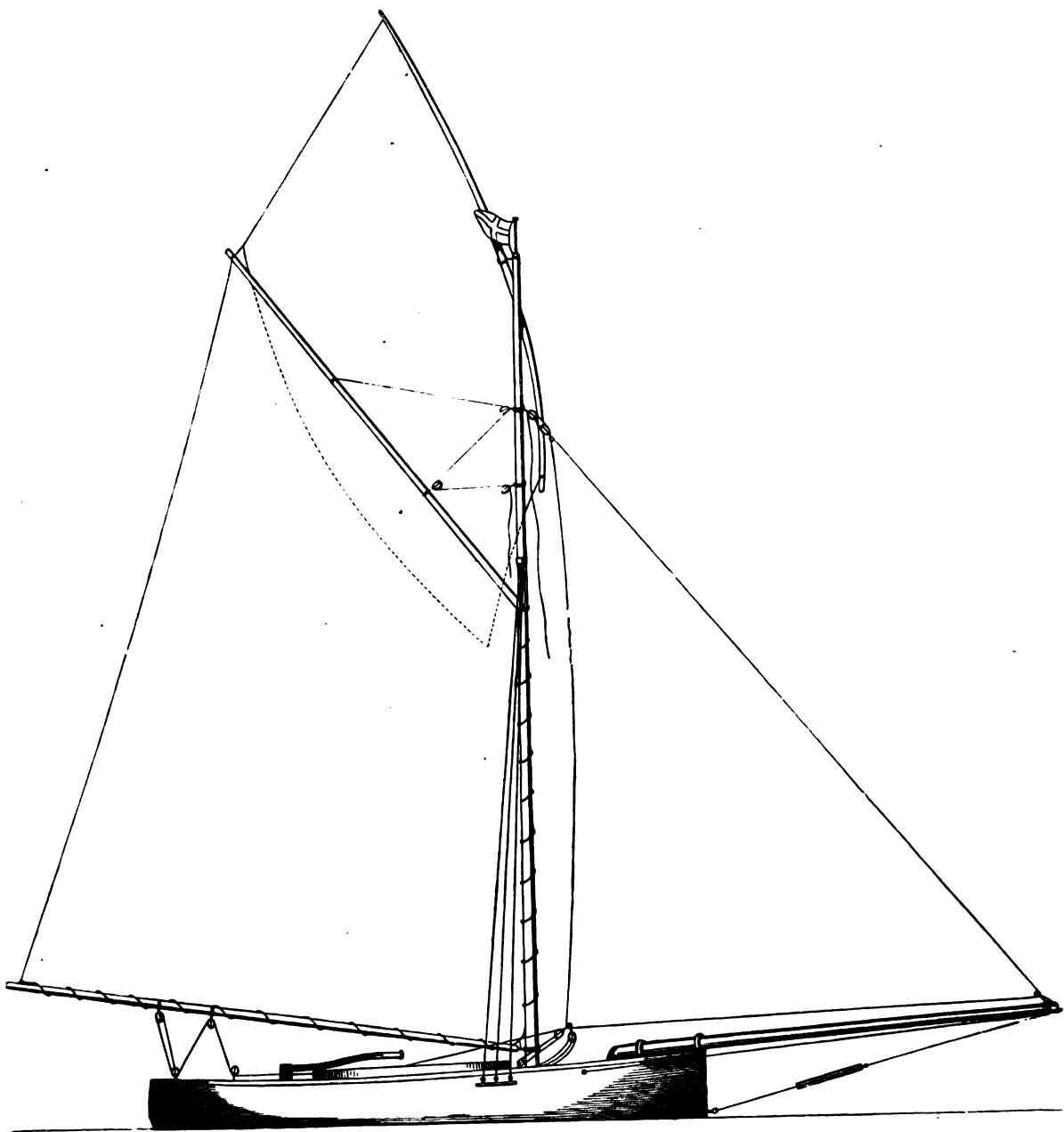


PLATE XVIII.



Sail Plan of Windermere Yacht.

No. 3. DESIGN.

| Sections | 1 | 2 | 3 | 4 | 5 | 6 | 7 | 8 | 9 | 10 | 11 | 12 |
|---|---------|---------|---------|---------|---------|---------|---------|---------|---------|---------|---------|---------|
| | ft. in. | ft. in. | ft. in. | ft. in. | ft. in. | ft. in. | ft. in. | ft. in. | ft. in. | ft. in. | ft. in. | ft. in. |
| Depths below L.W. to rabbet | — | 2 8 | 3 0 | 3 3 | 3 5½ | 3 7½ | 3 8½ | 3 7½ | 3 4 | 2 11 | 2 4 | 1 7 |
| Depths to under side of wood keel | — | 3 1 | — | — | — | — | — | — | — | 4 6 | — | — |
| Half-breadths on deck | 1 1½ | 2 0½ | 2 9 | 3 3½ | 3 8½ | 3 11 | 4 0 | 3 11 | 3 8½ | 3 5 | 2 11 | 2 1 |
| Half-breadths on L.W.L. | 0 6½ | 1 3 | 1 11½ | 2 7½ | 3 1½ | 3 4½ | 3 6 | 3 5 | 3 2½ | 2 9½ | 2 1½ | 1 3 |
| Half-breadths on a diagonal..... | 1 1 | 2 0 | 2 8½ | 3 4 | 3 9 | 4 0 | 4 1½ | 4 0½ | 3 11½ | 3 7 | 3 1 | 2 2 |
| Half-breadths on b diagonal..... | 0 11 | 1 8½ | 2 4½ | 2 11½ | 3 4½ | 3 7 | 3 8½ | 3 7 | 3 5 | 3 1 | 2 7½ | 1 10 |
| Half-breadths on c diagonal..... | 0 8½ | 1 4½ | 1 11½ | 2 5 | 2 9½ | 3 0 | 3 0½ | 2 11½ | 2 9 | 2 4½ | 1 11½ | 1 4 |
| Half-breadths on d diagonal..... | 0 5 | 0 10 | 1 3 | 1 8 | 1 11 | 2 1 | 2 1½ | 2 1 | 1 10 | 1 6 | 1 0½ | 0 7 |
| Half-breadths on e diagonal..... | 0 1½ | 0 4½ | 0 7 | 0 9½ | 0 11½ | 1 0 | 1 0½ | 1 0 | 0 10 | 0 7 | 0 4 | 0 0 |

a diagonal is struck 2ft. 3½in. above the L.W.L., and cuts the side perpendiculars on the body plan at a 1 and a 2, at 7½in. above the L.W.L.

b diagonal is struck 1ft. 4in. above the L.W.L., and cuts the side perpendiculars at b 1 and b 2, at 8in. below the L.W.L.

c diagonal is struck 7in. above the L.W.L., and at c 1 and c 2 cuts the side perpendiculars 1ft. 8½in. below the L.W.L.

d diagonal is struck 5in. below the L.W.L., and cuts the side perpendiculars at the intersection of the same with the 4th water line.

e diagonal is struck 1ft. 9in. below the L.W.L., and at e 1 and e 2 is 3ft. 2½in. from the middle vertical line o.

WINDERMERE (No. 3 DESIGN.)

| HULL. | 1 | 2 | 3 |
|--|--------------|--------------|-------------|
| Length, extreme | 26ft. 6in. | 26ft. 6in. | 26ft. 6in. |
| Length between stem and sternpost..... | 20ft. 0in. | 20ft. 0in. | 20ft. 0in. |
| Greatest beam, moulded | 8ft. 6in. | 8ft. 6in. | 8ft. 0in. |
| Beam on L.W.L. moulded | 7ft. 9in. | 7ft. 6½in. | 7ft. 0in. |
| Draught of water aft at sternpost | 6ft. 5in. | 6ft. 5in. | 6ft. 5in. |
| Displacement | 7·2 tons. | 6·4 tons. | 5·7 tons. |
| Area of midship section | 17·5 sq. ft. | 16·3 sq. ft. | 14 sq. ft. |
| Midship section aft centre of length L.W.L. | 0·8ft. | 0·8ft. | 0·8ft. |
| Centre of buoyancy aft centre of L.W.L. | 0·5ft. | 0·5ft. | 0·2ft. |
| Metacentre above C.B. | 0·7ft. | 0·73ft. | 0·85ft. |
| Centre of lateral resistance aft centre of L.W.L. | 0·0ft. | 0·0ft. | 0·05ft. |
| Centre of effort of sails ahead of C.L. | 0·8ft. | 0·8ft. | 1ft. |
| Weight of lead keel | 4 tons. | 3½ tons. | 3 tons. |
| SPARS AND SAILS. | | | |
| Mast, deck to topsail halyard sheave | 33ft. 6in. | 38ft. 6in. | 34ft. 5in. |
| Bowsprit, outside of stem | 17ft. 0in. | 17ft. 0in. | 16ft. 0in. |
| Main boom, extreme | 25ft. 0in. | 25ft. 0in. | 24ft. 0in. |
| Gaff, extreme | 21ft. 6in. | 21ft. 6in. | 21ft. 6in. |
| Topsail yard | 25ft. 0in. | 25ft. 0in. | 22ft. 0in. |
| Foot of mainsail | 24ft. 3in. | 24ft. 3in. | 23ft. 6in. |
| Head of mainsail | 21ft. 0in. | 21ft. 0in. | 21ft. 0in. |
| Luff of mainsail | 21ft. 0in. | 21ft. 0in. | 19ft. 0in. |
| Leech of mainsail | 36ft. 0in. | 36ft. 0in. | 32ft. 9in. |
| Tack to peak earing | 40ft. 0in. | 40ft. 0in. | 37ft. 6in. |
| Clew to throat | 29ft. 8in. | 29ft. 8in. | 27ft. 0in. |
| Foot of foresail | 23ft. 0in. | 23ft. 0in. | 22ft. 0in. |
| Luff of foresail | 35ft. 0in. | 35ft. 0in. | 34ft. 0in. |
| Leech of foresail | 27ft. 6in. | 27ft. 6in. | 25ft. 0in. |
| Mainsail area | 574 sq. ft. | 574 sq. ft. | 440 sq. ft. |
| Foresail area | 317 sq. ft. | 317 sq. ft. | 272 sq. ft. |
| Total area | 819 sq. ft. | 891 sq. ft. | 712 sq. ft. |

The sections are 2ft. apart, and No. 2 section is 2ft. from the fore side of the stem (Plate XVI.).

The water-lines are 1ft. apart. The timbers numbered at, 1, 2, 3, 4 on the sheer plan will be sawn 2in. sided, moulded 3in. at heels, and tapering to 1½in. at heads. A steamed timber 1½in. square between each pair of sawn timbers.

Stem 3½in. sided; 3½in. moulded at head; 1ft. 2in. at scarp with keel. Keel 11in. sided amidships, tapering to 3½in. at its fore end, and 4in. at its after end. Uniform depth of keel 8in.

The keel of No. 3 design will be 8in. sided amidships, tapering at ends as in No. 1.

The under side of the keel at No. 2 section for No. 1 and No. 2 designs is 3ft. 3½in. below the L.W.L.; the underside of the keel at the sternpost is 4ft. 6½in. below the L.W.L.



The draft forward of No. 3 design is less than the others. The depth to under-side of keel fore and aft will be found in the table for No. 3 design. In other respects the sheer plan accords with each design.

The sternpost is 4in. sided, and 7in. moulded at the heel, where it is tenoned into the keel.

Plank ½in. Top strake 1in.

The general plan of floor construction is shown by figure A, which represents the mid-section; this plan will extend from No. 3 station forward to the sternpost. *a a* are the timbers or frames joggled on to the keel as shown; *k* is the keel; *l* lead keel; *i* stout iron knee floors; *d* head of a yellow metal bolt passing through iron floor, keel and lead keel.

Figure B shows the floor construction of section 11 beyond the sternpost; *k* is the counter keel and *a a* are frames joggled on to it as the frames are to the main keel; *i* is an iron floor knee bolted through the counter keel at *d*.

The rigidity of the counter aft will be maintained by angle iron stays, arranged something in the manner adopted in the construction of Jullanar. The counter keel, *k*, is 4½in. sided and 5in. deep; *m* is a stay of  iron or  iron bolted to the counter keel and to a deck beam; there are two such stays as these, and from the counter keel they gradually spread out until where they are bolted to the deck beam they are 3ft. apart. Two other similar stays as *n* (shown) are fixed to the lower end of the keel, and held together at the back of the dead wood at the sternpost by a bolt. To ensure the keel and counter frame against being forced away from the sternpost a kind of yoke made of

⊥ iron is bolted to the keel and brought round each side of the sternpost, where the ends are bolted to the timbers or frames that abut therefrom. The stretch D shows this yoke *o* bolted to the keel *k* and frames *a a*. The sternpost is shown by *s*, and the rudder post and trunk by *x*. In the sheer plan a section of the ⊥ iron yoke is shown at *o*.

CHAPTER XXII.

ITCHEN BOATS.

THE boats of the Itchen Ferry fisherman have a very high reputation in the Solent, and no doubt they are of a superior model to many coast fishing craft. For many years match sailing amongst them has been an annual occurrence, and probably the contests on these occasions, combined with the true racing spirit which animates all the Itchen-Ferry-men, have tended to produce and maintain a model adapted for speed; and the nature of the work the boats are put to has happily prevented their sterling qualities as hard weather craft being in any way sacrificed to the exigencies of competitive sailing. The standard of value for competitive sailing, we believe, has always been simple length, and if the theoretical tendencies of such a rule is generally to produce mere skimming dishes, it has hitherto had no such effect on the Itchen boats. Of late years too, gentlemen fond of racing small craft, have built boats on the Itchen model, and these, although still competing under the "length rule," do not grow more beamy and shallow, but on the contrary (owing to considerations hereafter to be referred to) show signs of becoming less broad in the beam and deeper. The designs which we give represent these modern racing craft more than the fishing boats, but in a general way the hulls of both fishing and racing craft agree in model.

The design for the 30ft. boat, or 10-tonner (Plate XIX.), was made for a boat of 27ft. length by Mr. Shergold, a well-known draughtsman of Southampton, to compete in the 27ft. class of which Rayonette is such an ornament, but was not built from. The design has not been altered in any way, but a scale was made to correspond with a length on deck of 30ft. 4in. This gave a beam of 9ft. 6in. and a tonnage of $9\frac{3}{4}$ tons, or practically 10 tons.

The Rayonette, we might here say, was lengthened in the spring of

1877, and is now 29ft. 9in. long on deck, but her beam is only what it was when her length was 27ft., that is 9ft. The 30ft. design we give, has thus 6in. advantage in beam, 7in. in length, and is exactly 1 ton larger. There is no doubt that 6in. of beam is a very great advantage, so far as these boats are concerned, when they compete generally by length; so also in sailing under the Y.R.A. rule, in the case of two boats of such proportions as $29\cdot7 \times 9$ and $30\cdot3 \times 9\cdot5$, we should expect to find the 6in. excess beam of more value than the time for 1 ton that would have to be conceded. However, the *Rayonette* is wonderfully stiff under canvas, and indeed would very well bear more. She has 1ft. less length of mast, 1ft. less boom, and 9in. less gaff than given in the table; she has 8cwt.* less weight of lead keel; but her total weight of ballast corresponds with that given in the table.

The *Rayonette* has very fairly figured in the 10-tons class, and in a good breeze is a match for most of the 10-tonners to windward, but fails in running and reaching, as an ordinary 10-tonner has about 9ft. more length. 30ft. is now the fashionable length for a 5-tonner, and when a 10-tonner has only 30ft. in length, it may be assumed that there is a wide difference in the proportion of breadth to length, and that consequently the results of encounters on different points of sailing between a 10-tonner like *Rayonette*, 30ft. long, and one like *Florence*, 39ft. 9in. long, would very much vary. For instance, in a match of the Prince of Wales Yacht Club, sailed in June, 1877, in a good strong breeze, between *Rayonette* (9-tons), *Lily* (10-tons), *Mildred* (10-tons), *Zephyr* (10-tons), *Alouette* (5-tons); the *Rayonette* was the absolutely last reaching down the river to Southend; being 12 minutes astern of *Lily*, which was leading. In the thrash back, with housed topmast, *Rayonette* passed all but *Lily*, and gained 4 minutes on that craft. This probably may be taken as a good example of what a boat like *Rayonette* can do,† and it is evident that what she loses in running and reaching, cannot be made up by what she might gain in beating, if her competitors happened to be any of the crack 10-tonners. Whether an addition of 6in. to the beam, such as given in the design now published, would improve such craft so as to enable them to compete successfully with the best of the 10-tonners is an open question, but at any rate, the extra 9ft. of length will always keep a good 10-tonner ahead when sailing off the wind.

Of course for sailing in the 30ft. class, the 6in. extra beam is certain to tell, supposing all other things to be equal.

* The lead shown in the 30ft. design might be reduced in length aft by 4ft. if the boat were intended more for cruising than racing.

† It also, we believe, bears out the experience on the Mersey when the *Wonderful* sailed against the 10-tonners there.

It will be noted that the length of the design given in the table is 30ft. 4in.; the odd inches would disqualify the boat for the 30ft. class, and in building it would be necessary to bring the sternpost upright from the keel, so that the length on the deck line did not exceed the 30ft. limit.

The 30ft. design and the 27ft. design being identical, we need make no remark about it, further than say that Mr. Shergold in making it was fully impressed with the desire that she was to beat the whole 27ft. class.

The 25ft. (Plate XX.) boat was designed by Mr. Shergold for Mr. Fay, who successfully raced her under the name of *Salus*; she was bought in 1871 by Mr. Beavor Webb, who re-named her *Israfil*. She won ten prizes out of twelve starts whilst in Mr. Webb's hands, and he sold her to Mr. H. Little, who has raced her with varied success, under the name of *Wild Rose*, in the 25ft. class.*

The 21ft. (Plate XXI.) design represents that of the *Centipede*, the most successful fishing boat ever turned out by Mr. D. Hatcher. In the drawing, the design is represented as for a boat of 22ft. 8in. length, but all the sections are exactly as they were in the 21ft. boat, the *spacing* between the sections only having been increased, so as to bring the length up to that necessary to make 5 tons with the same 8ft. beam. The water-lines, with the extra spacing as shown, certainly look very much better, even than they did in the 21ft. design, and no doubt a boat of the extra length would be a very fast and capable craft; and, moreover, would be eligible for the 23ft. class. The *Centipede*, we might say, had very much less weight in her iron keel than given in the table, and the siding of her wood keel was less: the siding of the keel has been increased solely with the object of getting more lead underneath it.

The *Itchen* boats are always carvel built, and are usually decked forward, with a stern sheet aft, and are open amidships with a water way and coaming round. The floor construction is variously contrived, but the most approved plans are those shown in the designs for the 30ft. and 23ft. boat respectively (Plates XIX. and XXI.) In the 30ft. design, a hogging piece, or keelson, of wood, iron, or lead, is worked upon top, the main keel of about half the siding of the latter. A sectional view of this construction is shown at midship section. It will be seen that the heels of the timbers rest on the top of the main keel, and are spiked to the keelson. The whole is secured by iron floor knees, bolted as through frame and plank. Aft a stepping line to take the heels of the timbers has to be cut in the dead wood; in the middle length, the top of the main keel as shown, forms the stepping line. The spaces between the plank floor and keelson are

* As recently as September, 1879, she competed successfully on Southampton Water against all the crack *Itchen* boats,

filled with concrete made with cement and boiler punchings, or cement and lead shot. This is smoothed off level with the top of keelson.

In the 21ft. design (Plate XXI.), no keelson is worked. A stepping line is set off on the keel and dead woods, as shown by *s*. At each station for a frame, a joggle is cut in the keel and dead wood, *b b*, for the heel of the frame to be step-butted in, as at *a, a, a*. A sectional view of this fitting is shown by *A*. The heels of the frames are bolted through the keel, and the whole is secured by iron floor knees (see Fig. 21, page 101.) This plan is to be preferred, unless the keelson is of metal, on account of it having an advantage for ballasting. Any spaces left between the sides of the keel and the plank should be filled with concrete, made as before described. The rabbet (*r*) will be cut as shown, and the garboard strake should be fastened with as long spikes as practicable.

All the Itchen boats have, we believe, what are known as "raking midship sections;" that is, the broadest width of each succeeding water-line is progressively farther forward, from the load water-line downwards. This peculiarity is most apparent in the Centipede. It will be seen that her greatest beam on the L.W.L. is very far aft of the greatest breadth of the lower water-line. The introduction of lead keels and the reduction in the proportion of beam to length, will perhaps cause the rake given to the midship section to be somewhat modified in future, and its advantage under any conditions is at least a debateable point.

With regard to the proportion of beam to length there is evidence that the proportion is gradually getting less; there is no doubt that the lead keels and lead ballast are the cause of this, perhaps assisted by an apprehension that at some time or the other the boats will have to compete under the "tonnage" rule. However, the fishermen still patronise beam, without any such apprehensions, and one of the most successful boats in their class has 9ft. breadth to 21ft. length.*

Until the last four or five years an Itchen boat was never seen with a counter; now counters are becoming common, but, as the regular Itchen boats are square sterned, we have so represented them in the designs.

* There is not much doubt that a heavy lead keel (and a little less beam if thought desirable) is safer than so very much beam and very little outside weight. The fishing boats, as a rule, have very little siding to their keels, and the weight of iron that can be got underneath is consequently very small. It is generally thought, however, among the fishermen, that a foot or so extra beam will more than compensate for the absence of a ton or so weight on the keel. There is a very great mistake about this, and the beamiest of the Itchen boats, as they are necessarily the shallowest, and have, moreover, little or no weight outside and loose ballast inside, are by far the most unsafe, as, although very stiff at first, they lose their righting power as they get near their beam ends (see the chapter on "Stability.") Only recently one of the beamiest of the Itchen boats (19ft. by 9ft.) was capsized in a squall through the loose ballast shifting, and a beamy Itchen boat with no great weight on her keel requires as much looking after in a squall as a *Una*.

A counter would of course give them a more finished appearance, and would help hold the boats a little if much pressed. They however make very little back water wash off the lee quarter, as the transom is so high set. With a counter, the buttock lines would be dropped a little at the transom, according to the length of overhang. The transom would have to be a little wider, too, as otherwise the counter would be very narrow at the arch board.

In rig the Itchen boats have undergone very marked changes. A quarter of a century ago a bowsprit or a bumpkin was quite an innovation; the common rig being foresail with tack fast to stem head, and sheet working on a horse; mainsail without boom, with sheet working on a horse, and very frequently a mizen was added. The mast was long, and the gaff short, and the rig was generally commended because all the sail was in board. However, it would seem that the boats were lacking in head canvas, as "bumpkins" were introduced somewhere about 1851. In 1852, the best boats had what was then considered sharp bows, with a full midship section, a hollow floor, and square stern: the dimensions for a single-handed boat were, length 18ft. 6in., breadth 7ft. 8in., height out of water 1ft. 9in. The stem and sternpost were perpendicular, the fore foot being only slightly rounded off. Some of them had cast iron keels weighing from 2cwt. to 3cwt. The foresail was set on a bumpkin instead of at the stem head as formerly. The dimensions for the sails of a boat of the length given were: hoist of mainsail 17ft. 6in.; boom 13ft.; gaff 10ft.; bumpkin 3ft. 6in.; a bowsprit is also carried.

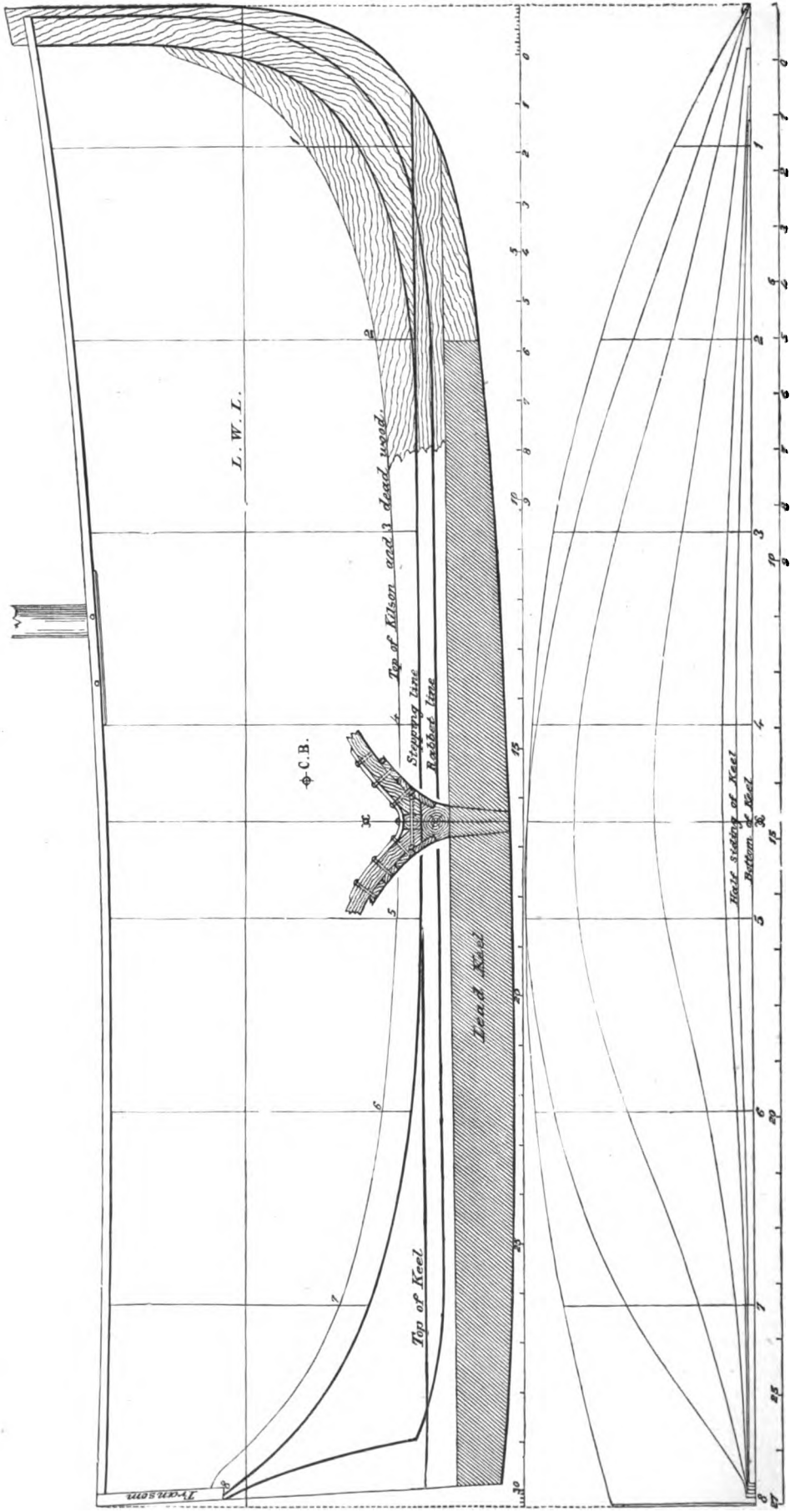
Excepting the length of boom and gaff, these dimensions are pretty much the same as would be given to a similar craft at the present time; in fact the long mast is retained, and the boom and gaff is very much increased in length.

All the Itchen boats still have the bumpkin,* which is a small iron bar (see A, Plate XXII.) fitted to the stem head as shown at *d*; the bumpkin has an iron stay (*s*) welded to it, and bolted to the stem at *k*. The forestay is set up to the bumpkin by a lanyard as shown at *m*. The boats have two shrouds a-side, a pendant and runner, topping lift, topmasts, backstays, preventers, and all the rest of the usual yacht gear, including, of course, purchases.

The dimensions for the sails given are large, and intended for a racing outfit. For a "fisherman's" outfit the mast would be reduced in length about one-ninth, and the boom and gaff about one-seventh. Com-

* The *Rayonette* we believe is the only boat without one, and hers was only discarded when she was lengthened in 1877.

PLATE XIX.



Itchen Boats of 30ft 4in. and 27ft. in length, with scale of feet for each.

pared by length and breadth of water-line, the sail areas are about equal to those of the Windermere yachts, but probably one of the latter would be more than a match for any boat on Southampton Water.

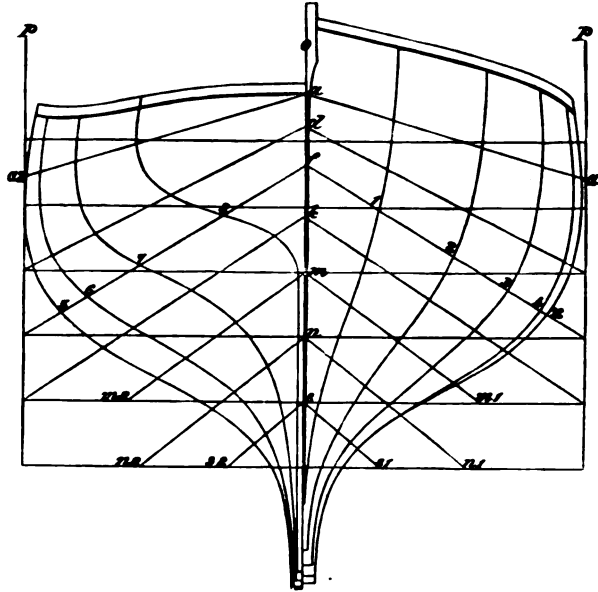


FIG. 97.

LAYING-OFF TABLE FOR 30FT. 4IN. BOAT (SEE PLATE XIX. AND FIG. 97.)

| No. of Section..... | 1 | 2 | 3 | 4 | 5 | 6 | 7 | 8 |
|---|---------|---------|---------|---------|---------|---------|---------|---------|
| | ft. in. | ft. in. | ft. in. | ft. in. | ft. in. | ft. in. | ft. in. | ft. in. |
| Heights above L.W.L. to top timbers | 3 10 | 3 5 | 3 1 | 2 10 | 2 9 | 2 9 | 2 8 | 2 8½ |
| Depths below L.W.L. to stepping line | 2 3 | 3 4 | 3 7 | 3 7 | 3 7 | 3 7 | 3 4 | 2 6 |
| Depths below L.W.L. to under-side of keel | 4 0 | — | — | — | — | — | — | 4 3 |
| Half-breadths at gunwale | 1 5 | 2 11 | 3 11 | 4 5½ | 4 6½ | 4 6 | 4 3 | 3 9 |
| Half-breadths on L.W.L. | 0 10½ | 2 2½ | 3 5½ | 4 3 | 4 5½ | 4 5½ | — | — |
| Half-breadths on diagonal a ... | 1 4½ | 2 11½ | 4 0½ | 4 8 | 4 9½ | 4 9½ | 4 7 | 3 11½ |
| Half-breadths on diagonal d ... | 1 4½ | 2 11½ | 4 1½ | 4 10½ | 5 0½ | 5 0½ | 4 8 | 3 9½ |
| Half-breadths on diagonal f ... | 1 3½ | 2 9½ | 3 11 | 4 7 | 4 9 | 4 8½ | 4 2 | 3 1½ |
| Half-breadths on diagonal k ... | 1 1 | 2 4 | 3 4½ | 3 10½ | 4 0 | 3 11½ | 3 4½ | 2 3½ |
| Half-breadths on diagonal m ... | 0 10 | 1 9½ | 2 6½ | 2 11½ | 3 0 | 2 11 | 2 4½ | 1 4½ |
| Half-breadths on diagonal n ... | 0 5 | 1 1½ | 1 9 | 1 11½ | 1 11½ | 1 10½ | 1 5 | 0 8½ |
| Half-breadths on diagonal s ... | 0 1½ | 0 6½ | 0 11½ | 1 0½ | 1 0½ | 1 0 | 0 8 | 0 3 |

No. 1 section is 3ft. from the extreme fore side of stem. All the other sections are 3ft. 11in. apart, but the aft side of the transom is only 3ft. 10in. abaft No. 7 section. The midship section is midway between No. 4 and No. 5 section.

The water lines are 1ft. 1½in. apart.

Diagonal a is struck 3ft. above the L.W.L., and at a 1 and a 2 cuts the perpendiculars p p 1ft. 6in. above the L.W.L.

Diagonal d is struck 2ft. 6in. above the L.W.L.

Diagonal f is struck 1ft. 10in. above the L.W.L.

Diagonal k is struck 11½in. above the L.W.L.

Diagonal *m*, at *m* 1 and *m* 2, is 2ft. 11in. from the middle vertical line *o*.

Diagonal *n*, at *n* 1 and *n* 2, is 2ft. 9in. from the middle vertical line *o*.

Diagonal *s*, at *s* 1 and *s* 2, is 1ft. 2in. from the middle vertical line *o*.

All the half-breadths are *without* the plank; but in the drawing the boat is represented with the plank on.

The lead keel will be 23ft. 6in. long, 9in. deep at its fore end, 1ft. 3in. amidships, and 11in. aft.

The breadth of the keel on the top at its fore end will be 4in.; amidships, 7in.; aft, 4in.; uniform breadth of the under side, 3in.

LAYING-OFF TABLE FOR 27FT. BOAT (SEE PLATE XIX. AND FIG. 97).*

| No. of Section | 1 | 2 | 3 | 4 | 5 | 6 | 7 | 8 |
|--|---------|---------|---------|---------|---------|---------|---------|---------|
| | ft. in. | ft. in. | ft. in. | ft. in. | ft. in. | ft. in. | ft. in. | ft. in. |
| Heights to top of timbers above L.W.L. | 3 5 | 3 0½ | 2 8½ | 2 6 | 2 5½ | 2 4½ | 2 4 | 2 4½ |
| Depths below L.W.L. to stepping line | 2 1 | 3 0 | 3 2 | 3 2 | 3 2 | 3 2 | 3 0 | 2 3 |
| Depths below L.W.L. to under side of wood keel | 3 7 | — | — | — | — | — | — | 3 10 |
| Half-breadths at gunwale | 1 3 | 2 7 | 3 6 | 4 0 | 4 0½ | 4 0 | 3 10 | 3 4 |
| Half-breadths on L.W.L. | 0 9 | 1 11½ | 3 1½ | 3 9½ | 4 0 | 3 11½ | 3 6 | — |
| Half-breadths on diagonal <i>a</i> ... | 1 3 | 2 7½ | 3 7½ | 4 1½ | 4 3 | 4 2½ | 4 1 | 3 6 |
| Half-breadths on diagonal <i>d</i> ... | 1 3 | 2 7½ | 3 8½ | 4 4 | 4 6½ | 4 5½ | 4 1½ | 3 4½ |
| Half-breadths on diagonal <i>f</i> ... | 1 1½ | 2 5½ | 3 5½ | 4 1 | 4 2½ | 4 2 | 3 9 | 2 9½ |
| Half-breadths on diagonal <i>k</i> ... | 0 11½ | 2 1½ | 2 11½ | 3 5½ | 3 6½ | 3 6 | 3 0 | 2 0 |
| Half-breadths on diagonal <i>m</i> ... | 0 8½ | 1 7 | 2 3 | 2 7½ | 2 7½ | 2 7 | 2 2 | 1 3 |
| Half-breadths on diagonal <i>n</i> ... | 0 4½ | 1 0 | 1 6 | 1 8½ | 1 9 | 1 8 | 1 3 | 0 7 |
| Half-breadths on diagonal <i>s</i> ... | 0 1½ | 0 6 | 0 9½ | 0 11 | 0 11½ | 0 10½ | 0 7½ | 0 3½ |

No. 1 section is 2ft. 8in. from the extreme fore side of stem. All the other stations are 3ft. 6in. apart, but the aft side of transom is only 3ft. 4in. from No. 7 section. The midship section is midway between No. 4 and No. 5 sections.

The water-lines are 1ft. apart.

Diagonal *a* is struck 2ft. 8½in. above the L.W.L., and at *a* 1 and *a* 2 cuts the perpendiculars *p p* 1ft. 5½in. above the L.W.L.

Diagonal *d* is struck 2ft. 2½in. above the L.W.L.

Diagonal *f* is struck 1ft. 7½in. above the L.W.L.

Diagonal *k* is struck 9in. above the L.W.L.

Diagonal *m*, at *m* 1 and *m* 2, is 2ft. 7in. from the middle vertical line *o*.

Diagonal *n*, at *n* 1 and *n* 2, is 2ft. 6in. from the middle vertical line *o*.

Diagonal *s*, at *s* 1 and *s* 2, is 1ft. 1in. from the middle vertical line *o*.

All the half-breadths are *without* the plank, but the drawing represents the boat with the plank on.

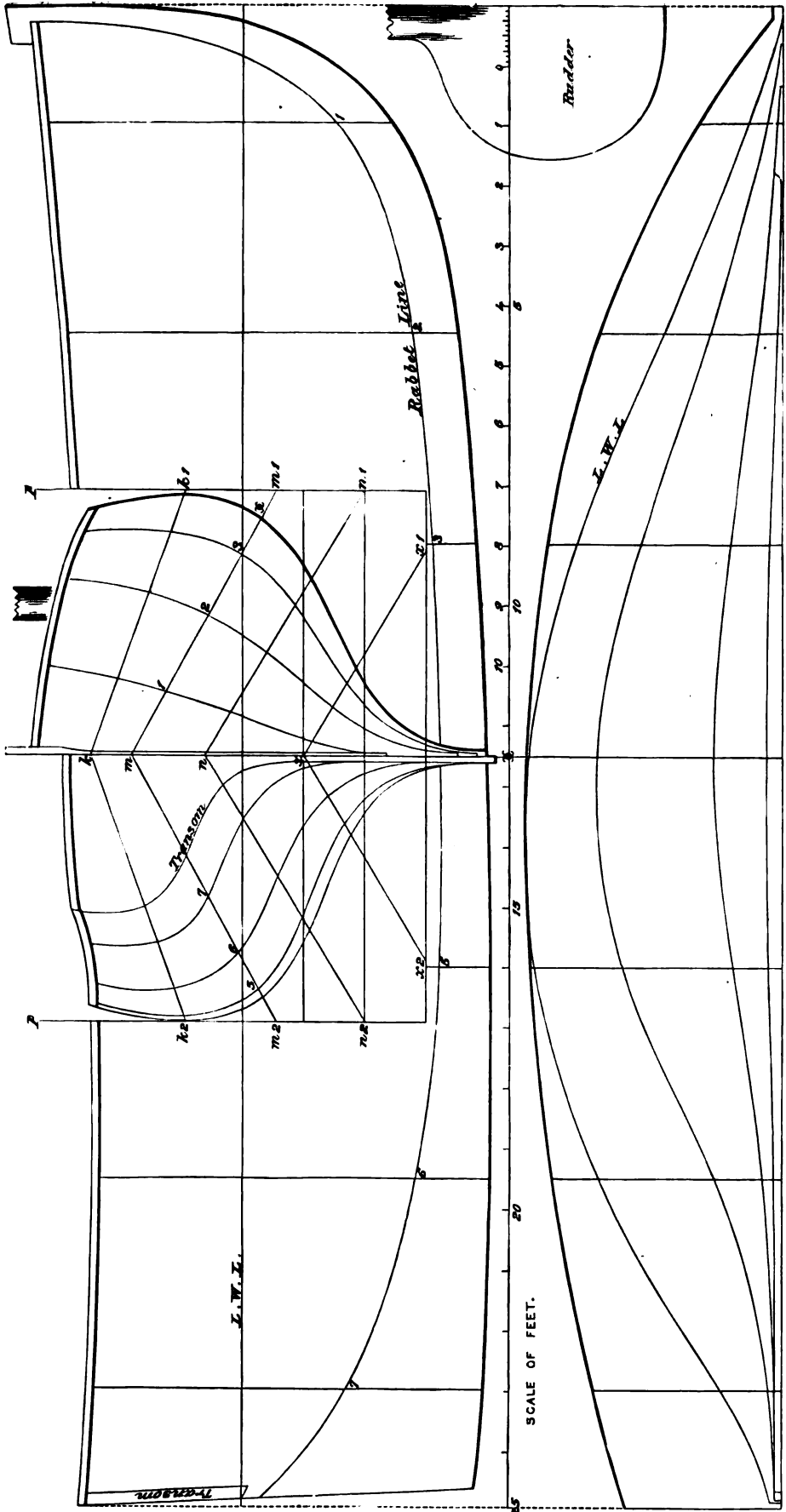
The lead keel will be 21ft. long, 8in. deep at its fore end, 1ft. 1in. at the midship section, 1ft. at No. 7 section, and 9in. at its after end; breadth, 6in. amidships, 3½in. forward, 4in. aft on its upper side; breadth on its under side, 3½in. all through.

LAYING-OFF TABLE FOR 25FT. BOAT (SEE PLATE XX.).

| No. of Section | 1 | 2 | 3 | 4 | 5 | 6 | 7 | Trm. |
|--|---------|---------|---------|---------|---------|---------|---------|---------|
| | ft. in. | ft. in. | ft. in. | ft. in. | ft. in. | ft. in. | ft. in. | ft. in. |
| Heights to top of timbers above L.W.L. | 3 2 | 2 10 | 2 7½ | 2 5½ | 2 4½ | 2 4½ | 2 5½ | 2 7 |
| Depths below L.W.L. to rabbit line... | 1 6 | 2 9 | 3 1 | 3 2½ | 3 2 | 2 10 | 1 8 | — |
| Half-breadths at gunwale | 1 3½ | 2 11 | 3 9 | 4 0½ | 4 0½ | 3 8½ | 3 0 | 2 5 |
| Half-breadths on L.W.L. | 0 6 | 1 11 | 3 3 | 4 0 | 3 11 | 2 10½ | 0 9½ | 0 1½ |
| Half-breadths on diagonal <i>k</i> | 1 2½ | 2 10½ | 3 11½ | 4 6 | 4 5½ | 3 11½ | 3 1 | 2 6 |
| Half-breadths on diagonal <i>m</i> | 1 0½ | 2 7½ | 3 8½ | 4 4½ | 4 3 | 3 6 | 2 4½ | 1 9 |
| Half-breadths on diagonal <i>n</i> | 0 8½ | 1 11 | 2 10 | 3 3½ | 3 0 | 2 2½ | 1 1 | 0 5½ |
| Half-breadths on diagonal <i>s</i> | 0 1½ | 0 10 | 1 3½ | 1 6½ | 1 3½ | 0 8 | 0 1½ | 0 1 |

* This design is the same as the 30ft. 4in. design, the scale only having been altered.

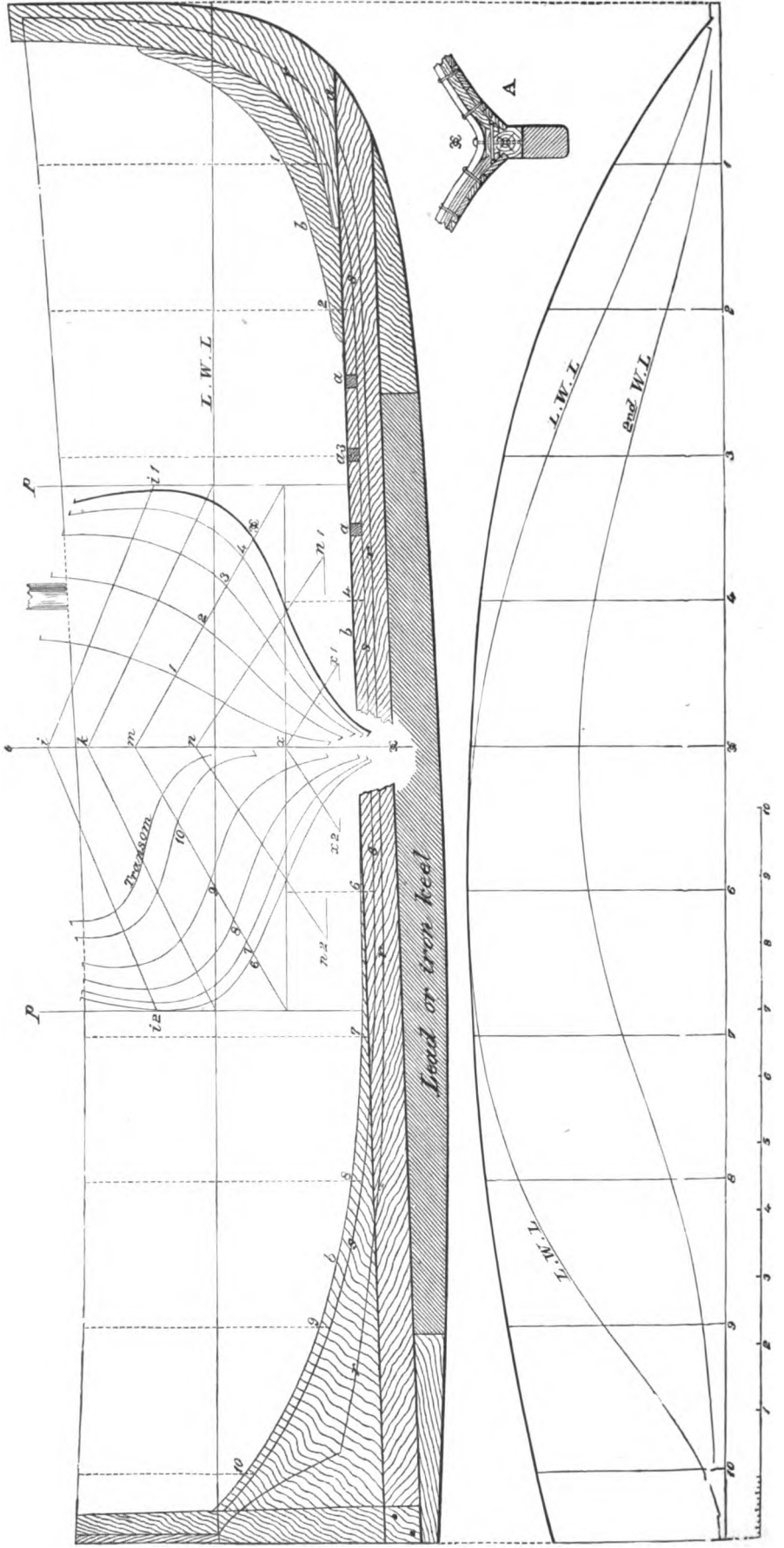
PLATE XX.



Itchen Boat "Wild Rose," 25ft.



PLATE XXI



Itchen Boat "Centipede," 22ft. 8in., and 21ft.

No. 1 section is 2ft. from the extreme fore side of stem ; all the other sections are 3ft. 6in. apart, but the transom is (at the deck) 2ft. from No. 7 section.

The water-lines are 1ft. apart.

Diagonal *k* is struck 2ft. 6in. above the L.W.L., and at *k* 1 and *k* 2 cuts the side perpendiculars *p p* 11½in. above the L.W.L.

Diagonal *m* is struck 1ft. 9in. above the L.W.L., and at *m* 1 and *m* 2 cuts the side perpendiculars *p p* 6½in. below the L.W.L.

Diagonal *n* is struck 7½in. above the L.W.L., and at *n* 1 and *n* 2 cuts the side perpendiculars *p p* at 2ft. below the L.W.L.

Diagonal *z* is struck 1ft. below the L.W.L., and at *z* 1 and *z* 2 is 3ft. 4in. from the middle vertical line of the body plan.

All the half-breadths are *without* the plank just as the others are, in readiness for setting off in the mould loft; but the design is shown with the plank on. The design also shows a keel of only 3in. siding amidships, instead of the thickness we have given in the table.

LAYING-OFF TABLE FOR 22FT. 8IN. BOAT (SEE PLATE XXI.).

| No. of Section | 1 | 2 | 3 | 4 | 5 | 6 | 7 | 8 | 9 | 10 | Trm. |
|---|-------|-------|--------|--------|-------|--------|-------|--------|-------|-------|------|
| Heights to top of timbers above L.W.L. | 2 6½ | 2 5 | 2 3 2 | 1½ 2 | 0½ 1 | 11½ | 1 11 | 1 11½ | 1 11½ | 2 0½ | 2 1 |
| Depths below L.W.L. to stepping line (<i>s</i>) | 1 8 2 | 0½ 2 | 1½ 2 | 2 2 3 | 2 3½ | 2 3 2 | 1 1 8 | 0 6½ | — | | |
| Half-breadths at gunwale ... | 1 6½ | 2 6½ | 3 2½ | 3 6½ | 3 8½ | 3 9 3 | 8½ 3 | 5½ 3 | 2 2 9 | 2 5½ | |
| Half-breadths on L.W.L. ... | 0 8½ | 1 8 2 | 6½ 3 | 3½ 3 | 8 3 | 9 3 6½ | 3 0½ | 1 8½ | 0 8½ | 0 1 | |
| Half-breadths on 2nd W.L. ... | 0 3½ | 0 9 1 | 4½ 1 | 10 2 | 1½ 2 | 0 1 5½ | 0 8½ | 0 3 | 0 1 | — | |
| Half-breadths on diagonal <i>i</i> . | 1 7½ | 2 7½ | 3 4½ | 3 10½ | 4 2 4 | 2½ 4 | 1 3 | 10 3 | 5½ 2 | 10½ 2 | 7 |
| Half-breadths on diagonal <i>k</i> . | 1 5½ | 2 5 3 | 2 3 9½ | 4 1½ | 4 2 4 | 0½ 3 | 8 3 | 1½ 2 | 8½ 1 | 10½ | |
| Half-breadths on diagonal <i>m</i> . | 1 2½ | 2 0½ | 2 8½ | 3 2½ | 3 6½ | 3 6½ | 3 4½ | 2 11 2 | 2½ 1 | 3 0 | 10 |
| Half-breadths on diagonal <i>n</i> . | 0 9 1 | 4½ 1 | 11 2 | 3 2 4½ | 2 4 2 | 1½ 1 | 8½ 1 | 1 0 4 | 0 1½ | | |
| Half-breadths on diagonal <i>z</i> . | 0 2½ | 0 6½ | 0 10 1 | 0½ 1 | 1½ 1 | 0½ 0 | 9½ 0 | 6½ 0 | 3½ | — | — |

No. 1 section is 2ft. 4in. from the extreme fore side of the stem. All the other sections are 2ft. 2in. apart, but the aft side of transom is only 10in. from No. 10 section.

The water-lines are 1ft. apart.

Diagonal *i* is struck 2ft. 5in. above the L.W.L., and at *i* 1 and *i* 2 cuts the perpendiculars *p p* 10in. above the L.W.L.

Diagonal *k* is struck 1ft. 10in. above the L.W.L.

Diagonal *m* is struck 1ft. 1½in. above the L.W.L.

Diagonal *n* is struck 3in. above the L.W.L., and at *n* 1 and *n* 2 is 2ft. 10in. from the middle vertical line *o*, and 1ft. 7in. below the L.W.L.

Diagonal *z* is struck at the 2nd water-line, and at *z* 1 and *z* 2 is 1ft. 3in. out from the middle vertical line *o*, and 1ft. 9½in. below the L.W.L.

The side perpendiculars *p p* are 3ft. 11in. out from the middle vertical line.

All the half-breadths are *without* the plank, and the boat is represented in the drawing *without* the plank.

Depth of lead keel at its fore end, 7in. ; at its amidships, 8½in. ; at its aft end, 5½in.

Width (siding) of lead keel at its fore end, 2½in. ; at its amidships, 5½in. ; at its aft end, 4in.

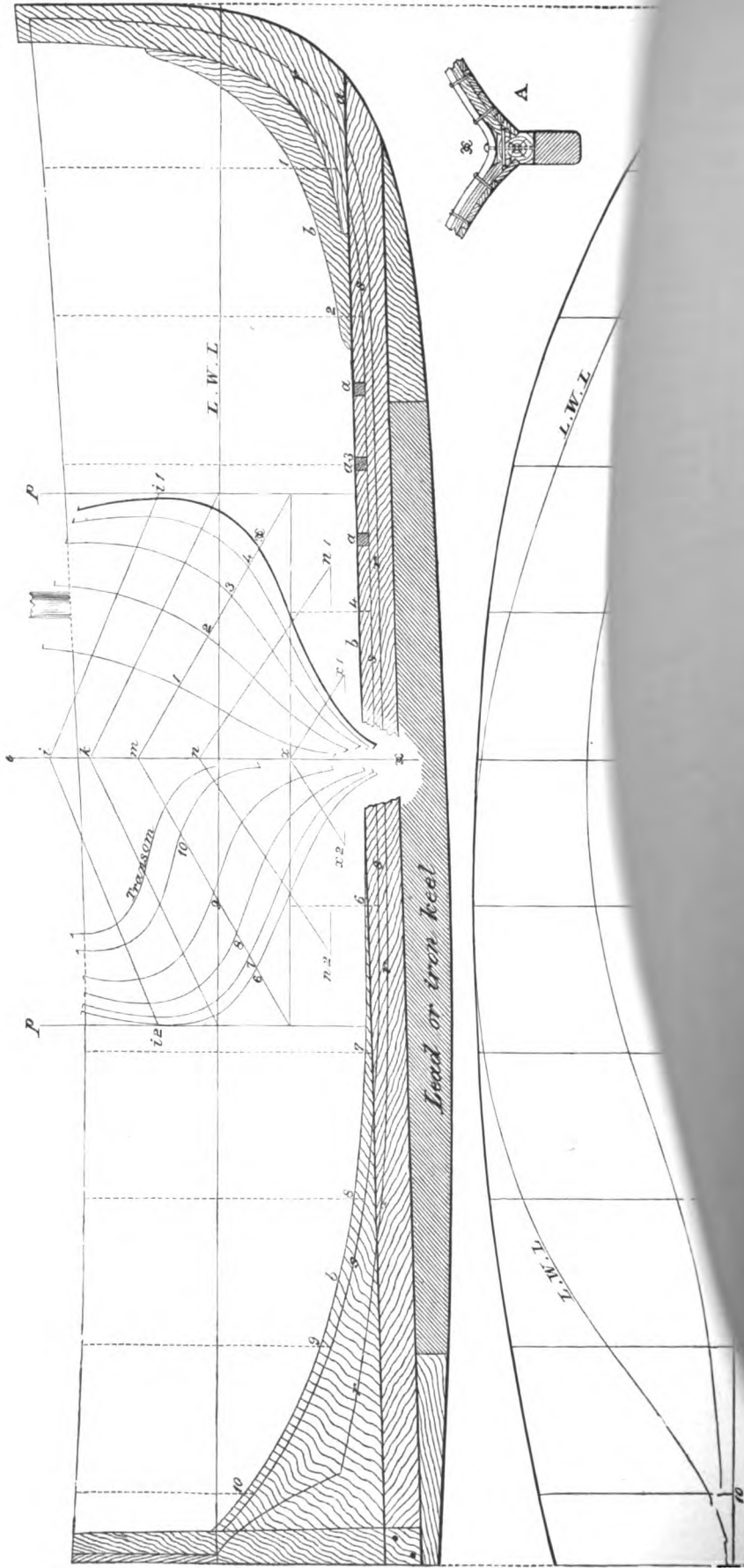
Length of lead keel, 14ft.

21FT. BOAT.

For the 21ft. boat the same laying-off tables will be used, the sections being identical with those of the 22ft. 8in. boat. The spacing between the sections is, however, less.

No. 1 section is 2ft. 2in. from the extreme fore side of the stem ; all the other sections are 2ft. apart, but the transom is only 10in. abaft No. 10 section.

PLATE XXI



No. 1 section is 22 ft. from the extreme fore side of the stem to the other extreme of the keel, but the transom is at the back 22 ft. from the stem.

The water-lines are 12 ft. apart.

Diagonal k is struck 22 ft. above the L.W.L. and at 10 ft. and 20 ft. from the stem perpendiculars p p 1 ft. above the L.W.L.

Diagonal m is struck 18 ft. above the L.W.L. and at 10 ft. and 20 ft. from the stem perpendiculars p p 6 ft. below the L.W.L.

Diagonal n is struck 7 ft. above the L.W.L. and at 10 ft. and 20 ft. from the stem perpendiculars p p at 2 ft. below the L.W.L.

Diagonal o is struck 18 ft. below the L.W.L. and at 10 ft. and 20 ft. from the stem perpendiculars p p at 2 ft. below the L.W.L.

All the half-breasts are without the plank just as the others are, in readiness for cutting of the mould left; but the design is shown with the plank on. The design also shows a list of only 5 in. making mastsheads, instead of the sections we have given in the table.

LAYING-OFF TABLE FOR 21 FT. BOAT (See Plate III.)

| No. of Section | 1 | 2 | 3 | 4 | 5 | 6 | 7 | 8 | 9 | 10 | 11 |
|---|----|----|----|----|----|----|----|----|----|----|----|
| Height to top of timbers above L.W.L. | 12 | 12 | 12 | 12 | 12 | 12 | 12 | 12 | 12 | 12 | 12 |
| Depth below L.W.L. to stepping line (s) | 1 | 1 | 1 | 1 | 1 | 1 | 1 | 1 | 1 | 1 | 1 |
| Half-breasts at gunwale | 1 | 1 | 1 | 1 | 1 | 1 | 1 | 1 | 1 | 1 | 1 |
| Half-breasts on L.W.L. | 0 | 0 | 0 | 0 | 0 | 0 | 0 | 0 | 0 | 0 | 0 |
| Half-breasts on 2nd W.L. | 0 | 0 | 0 | 0 | 0 | 0 | 0 | 0 | 0 | 0 | 0 |
| Half-breasts on diagonal k | 1 | 1 | 1 | 1 | 1 | 1 | 1 | 1 | 1 | 1 | 1 |
| Half-breasts on diagonal l | 1 | 1 | 1 | 1 | 1 | 1 | 1 | 1 | 1 | 1 | 1 |
| Half-breasts on diagonal m | 0 | 0 | 0 | 0 | 0 | 0 | 0 | 0 | 0 | 0 | 0 |
| Half-breasts on diagonal n | 0 | 0 | 0 | 0 | 0 | 0 | 0 | 0 | 0 | 0 | 0 |
| Half-breasts on diagonal o | 0 | 0 | 0 | 0 | 0 | 0 | 0 | 0 | 0 | 0 | 0 |

No. 1 section is 21 ft. 6 in. from the extreme fore side of the stem to the other extreme of the keel, but the aft side of transom is only 18 in. from the stem.

The water-lines are 12 ft. apart.

Diagonal k is struck 21 ft. 6 in. above the L.W.L. and at 10 ft. and 20 ft. from the stem perpendiculars p p 1 ft. above the L.W.L.

Diagonal l is struck 18 ft. 6 in. above the L.W.L.

Diagonal m is struck 12 ft. 6 in. above the L.W.L.

Diagonal n is struck 6 in. above the L.W.L. and at 10 ft. and 20 ft. from the stem perpendiculars p p, and 12 ft. 6 in. below the L.W.L.

Diagonal o is struck on the 2nd water-line, and at 10 ft. and 20 ft. from the stem perpendiculars p p on 2 ft. 6 in. below the L.W.L.

The side perpendiculars p p are 2 ft. 6 in. out from the middle vertical line without the plank.

Depth of lead keel at its fore end, 7 in.; at its mastsheads, 5 ft. 6 in. at its transom, 14 ft.

Witch (width) of lead keel at its fore end, 2 ft.; at its mastsheads, 14 ft.

Length of lead keel, 14 ft.

21 FT. BOAT.

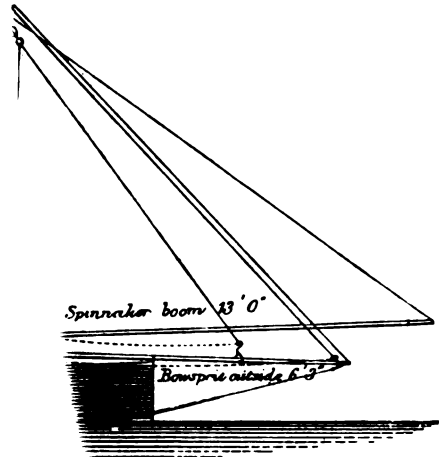
For the 21 ft. boat the same laying-off as for the 22 ft. boat is used, but the sections are, however, less.

No. 1 section is 21 ft. 2 in. from the extreme fore side of the stem to the other sections are 2 ft. apart, but the transom is only 18 in. from the stem.

No. 10 section.

ING PUNTS.

As the boats of this class sailing in England, were little better than ordinary punts on a short bumpkin, and a sprit rig, a club has been formed at Northam, where, through the aid of the Admiralty, very great improvements have been made in the punts, but in their sail plan. They are now built with a sprit rig, hence no time allowance is required, and they carry heavy lead keels, some being 3 1/4 cwt



with slings in them, as shifting punts have shot bags. As will be seen, the rigging is very simple, consisting of a sprit mast and carry a sprit sail, in fact much longer than the mainmast. They set their foresail. This is made as a jib; they have a sprit sail set before the wind. The boats are built in the building yards, ship-

SCANTLINGS.

| | 30ft. | 27ft. | 25ft. | 23ft. | 21ft. |
|------------------------------------|-------------|------------|------------|------------|--------|
| Siding of stem | 3½ in. | 3 in. | 3 in. | 2½ in. | 2½ in. |
| Siding of sternpost | 4 in. | 3½ in. | 3½ in. | 3½ in. | 3 in. |
| Siding of keel amidships | 7 in. | 6 in. | 6 in. | 5½ in. | 5 in. |
| Siding of keel fore end | 3½ in. | 3 in. | 3 in. | 2½ in. | 2½ in. |
| Siding of keel aft end | 4 in. | 3½ in. | 3½ in. | 3½ in. | 3 in. |
| Moulding (depth) of keel | 7 in. | 6½ in. | 6 in. | 5½ in. | 5 in. |
| Siding of timbers | 2 in. | 2 in. | 1½ in. | 1½ in. | 1½ in. |
| Room and space | 1ft. 11 in. | 1ft. 9 in. | 1ft. 9 in. | 1ft. 1 in. | 1ft. |
| Thickness of plank* | 1 in. | 1 in. | 1 in. | ¾ in.* | ¾ in.* |
| Thickness of garboard strake | 1½ in. | 1½ in. | 1½ in. | 1 in. | 1 in. |
| Thickness of top strake | 1½ in. | 1½ in. | 1½ in. | 1 in. | 1 in. |
| Thickness of clamp | 1½ in. | 1½ in. | 1½ in. | 1½ in. | 1½ in. |
| Thickness of transom | 2½ in. | 2½ in. | 2 in. | 2 in. | 2 in. |
| Breadth of rudder | 3ft. | 2ft. 9 in. | 2ft. 6 in. | 2ft. 3 in. | 2ft. |

* An inch strake as a wale should be worked above the water-line at the broadest part of the boat; this will make the boat the required width.

DIMENSIONS, &c.

| | 30ft. 4in. | 27ft. | 25ft. | 22ft. 8in. | 21ft. |
|---|--------------|--------------|-----------|-------------|-------------|
| Length, fore side of stem to aft side transom on deck | 30ft. 4in. | 27ft. | 25ft. | 22ft. 8in. | 21ft. |
| Breadth (moulded) | 9ft. 4in. | 8ft. 4in. | 8ft. 7in. | 7ft. 10in. | 7ft. 10in. |
| Breadth with plank on | 9ft. 6in. | 8ft. 6in. | 8ft. 9in. | 8ft. | 8ft. |
| Draught of water, extreme | 5ft. 4in. | 4ft. 10in. | 4ft. 1in. | 3ft. 4½ in. | 3ft. 4½ in. |
| Displacement | 9 tons | 6½ tons | 5½ tons | 3½ tons | 3½ tons |
| Displacement per inch of immersion at L.W.L. | 9cwt. | 7cwt. | 6cwt. | 5½cwt. | 4½cwt. |
| Weight of ballast inside | 3½ tons | 2½ tons | 2 tons | 1½ tons | 1½ ton |
| Weight of lead keel | 2 tons 8cwt. | 1 ton 16cwt. | 1½ tons | 1 ton | 18cwt. |
| Tonnage Y.R.A. | 9½ | 7½ | 6½ | 4½ | 4½ |

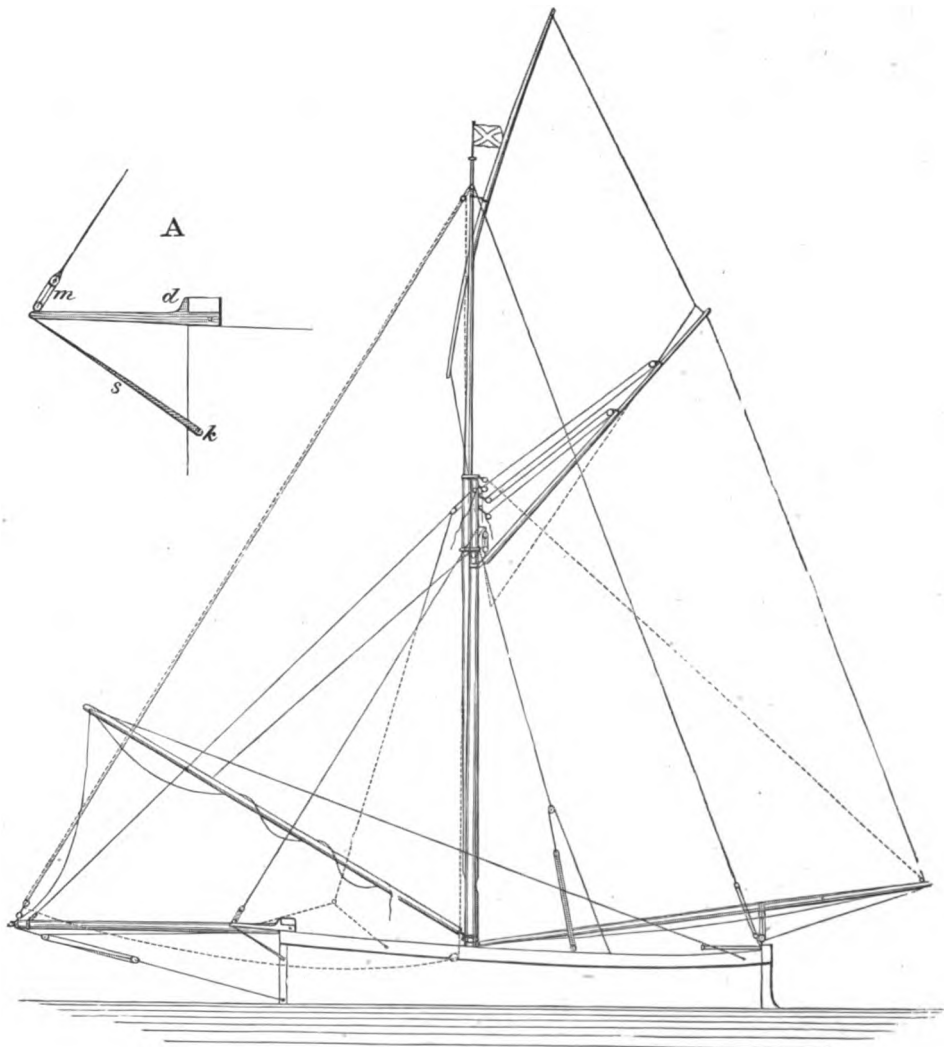
SPARS AND SAILS.

| | 30ft. | 27ft. | 25ft. | 23ft. | 21ft. |
|---|---------|---------|---------|---------|---------|
| | ft. in. | ft. in. | ft. in. | ft. in. | ft. in. |
| Centre of mast from fore side of stem on deck ... | 11 6 | 10 9 | 9 9 | 8 8 | 8 2 |
| Length of mast, deck to hounds | 25 0 | 22 6 | 21 6 | 19 6 | 18 9 |
| Length of mainboom extreme | 27 6 | 26 0 | 24 4 | 21 9 | 19 3 |
| Length of main gaff extreme | 20 6 | 18 6 | 17 9 | 16 3 | 14 3 |
| Length of bumpkin outside | 2 6 | 2 4 | 2 0 | 1 9 | 1 3 |
| Length of bowsprit outside | 16 0 | 14 6 | 12 6 | 12 0 | 11 6 |
| Length of topmast fid to sheave | 20 6 | 19 6 | 18 0 | 17 0 | 16 0 |
| Length of topsail yard | 24 0 | 23 0 | 21 0 | 20 0 | 18 0 |
| Length of topsail yard | 18 0 | 17 0 | 16 0 | 15 0 | 14 0 |
| Length of spinnaker boom* | 27 6 | 25 0 | 23 0 | 21 0 | 19 0 |
| Luff of mainsail | 23 0 | 20 0 | 19 3 | 17 9 | 16 6 |
| Leech of mainsail | 39 0 | 36 0 | 34 0 | 31 0 | 29 6 |
| Foot of mainsail | 27 0 | 25 9 | 24 0 | 21 4 | 18 10 |
| Head of mainsail | 20 2 | 19 0 | 17 6 | 15 8 | 14 0 |
| Tack to peak earing | 41 2 | 38 0 | 36 0 | 32 0 | 30 0 |
| Clew to weather earing (throat) | 32 9 | 31 0 | 29 0 | 27 0 | 24 0 |
| Foot of foresail | 14 6 | 13 0 | 11 6 | 0 0 | 9 0 |
| Luff of foresail | 25 0 | 23 0 | 22 0 | 21 0 | 17 6 |
| Leech of foresail | 23 0 | 21 0 | 20 0 | 18 0 | 15 6 |
| Foot of jib† | 17 0 | 16 0 | 15 0 | 14 0 | 13 0 |
| Luff of jib | 36 0 | 33 0 | 30 6 | 27 0 | 24 0 |
| Leech of jib | 24 0 | 22 0 | 21 0 | 20 0 | 17 0 |

* As they only have one spinnaker, it has to be set on the bowsprit occasionally; hence the length of the spinnaker boom is usually about the length from the mast to the bowsprit end.

† With a reef down the boats are frequently sailed without a jib, the bowsprit being run in and stowed.

PLATE XXII.



ITCHEN BOAT.
SCALE $\frac{1}{2}$ - 1 FOOT.



ITCHEN SAILING PUNTS.

Until within the last three years, the boats of this class sailing in the local match for punts 13ft. long, were little better than ordinary rowing skiffs rigged with a foresail on a short bumpkin, and a sprit mainsail without a boom. Now that a club has been formed at Northam, giving prizes for boats of the above length, very great improvements have been made, not only in the shape of the punts, but in their sail plan. They are all of the same length, viz. : 13ft., hence no time allowance is required, and have for such little craft very heavy lead keels, some being 3½cwt

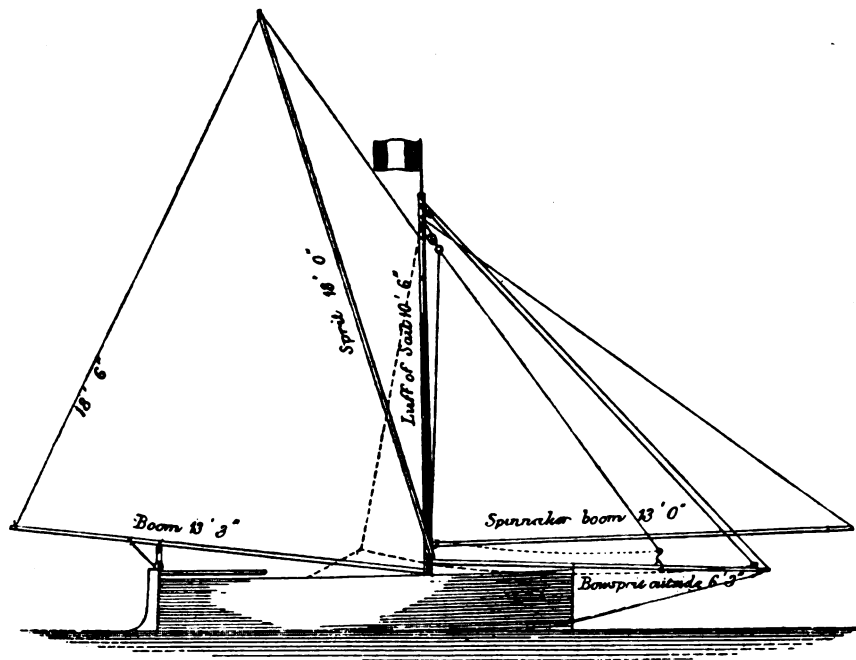


FIG. 98.

The ballast usually consists of iron pigs with slings in them, as shifting is allowed ; however, a few of the new boats have shot bags. As will be seen from the sail plan, they have a long mast and carry a sprit mainsail with a boom, this sprit is very long, in fact much longer than the boat ; they have a bowsprit on which they set their foresail. This bowsprit is made long enough to set the spinnaker as a jib ; they have a small boom also to set the spinnaker on when before the wind. The punts are mostly owned by foremen of the various building yards, ship-

wrights, and masters of racing yachts. The number of races for such boats in Southampton Water must be very numerous, as the two most successful boats in 1878, viz., the *Laura*, owned by Mr. Hatcher's foreman, and the *Tritonia*, owned by one of the Messrs Payne, flew some fourteen winning colours each at the end of the season, after the fashion of racing yachts.

The lead keels, also the pieces of false wood keel fore and abaft this lead, are put on with nuts and screws, and can easily be taken off, leaving the boat a serviceable punt (see Plate XXIII.)

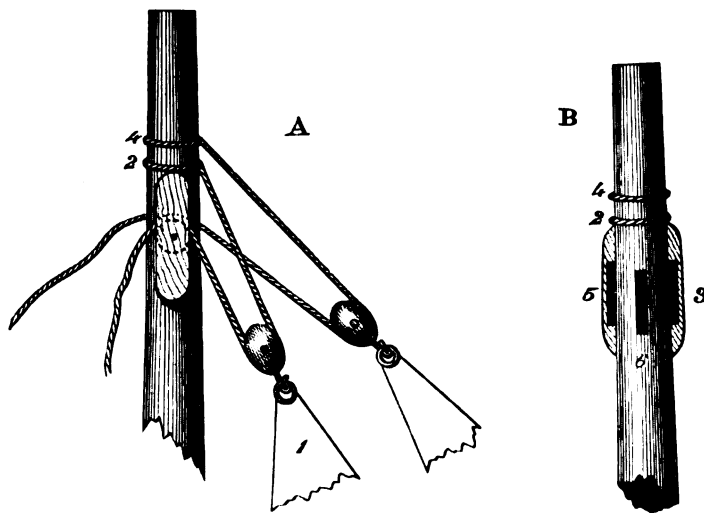
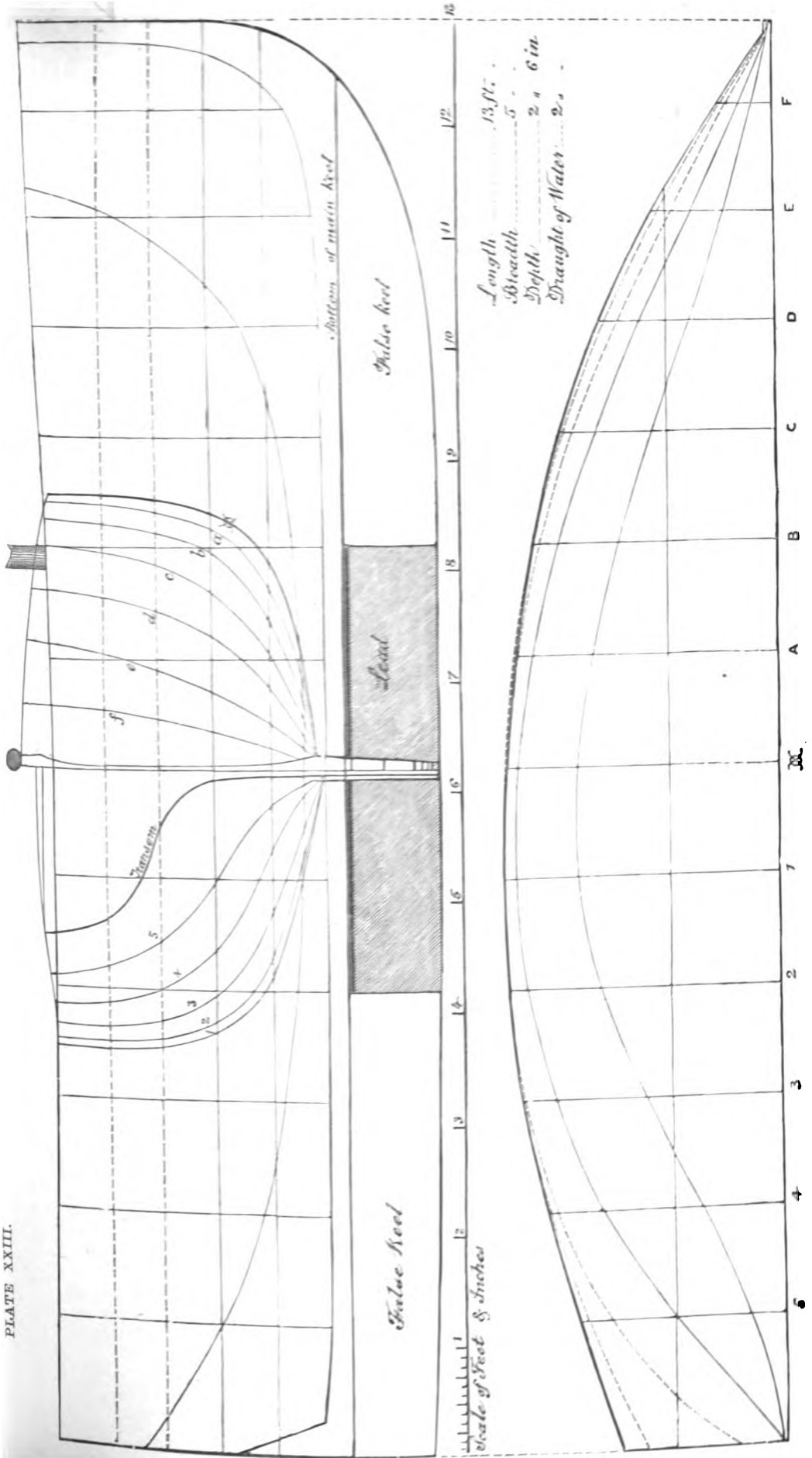


FIG. 99.

The rig of the boats is shown by Fig. 98. The bobstay is a single part set up to the bowsprit by a lanyard.

The halyards are worked as shown by Fig. 99. In A, the head of the foresail is shown by 1; the standing part of the halyard is put over the mast at 2. The hauling part is rove through a cheek block; see 3 on B, which is the mast head viewed from astern. The jib, or spinnaker halyards are similarly fitted; the standing part is at 4 in A, the hauling part is rove through 5 in B. The main halyard is fast to a mast traveller and then passes over a sheave in the mast at 6 in B.

In Ireland, at Kingstown and Queenstown, a sailing boat something like the *Itchen punt* is in use. They are built to compete in a class not exceeding 18ft. in length. A novel feature in these boats is that, when not racing, they have counters screwed on to their transoms. Counters are not allowed whilst they are racing.



The Itchen Punt.



CHAPTER XXIII.

CLYDE SAILING BOATS.

WITHIN the last three or four years, open boat sailing has become wonderfully popular on the Clyde, and this is hardly to be wondered at, as the Firth offers special opportunities for this capital sport. Snug anchorages, fairly smooth water, little or no run of tide, and the facilities given by the railway and steamboat companies for readily getting from the city to the coast, induce most young fellows who are in the least degree nautically inclined to keep a boat of some sort; and during the summer months, in the bright northern evenings, from every coast village may be seen a fleet of little vessels fitting along the shore in the smooth water, and lying over to the land wind, which in good weather, rises as the sun sets. Many of these boats are racing craft, and as each principal waterplace has its local lugsail club, there is no lack of sport on the Saturday afternoons, there being always one, and sometimes two or three events for the little ships. As the prizes are of considerable value, and quite worth winning,* the class of boat has been gradually improved, and while three years ago they were simply ordinary fishing skiffs, ballasted with stone or sand bags, these have given place to such powerful craft as shown in the drawing, with lead keels, spinnakers, and all the modern racing paraphernalia.

The boats are divided for racing purposes into three classes, 17ft., 19ft., and 22ft. The drawing shows a 19ft. boat on a scale of $\frac{1}{4}$ in.=1ft., but tables of offsets and proportional scales are given, so that it can be used for all three sizes; there are also a few 15ft. boats, but the principal racing is among the larger ones. Prior to 1878 the only dimension taken into account was length, that being measured over all, but as this

* The prizes of one 19ft. boat, the Vanguard, amounted in 1877 to £35, while the 22ft. boat, Thisbe, netted over £45.

was thought likely to produce a fleet of "Popohgas," the ordinary Y.R.A. rule was adopted by the Western and Royal Aquatic Clubs, the classes being now fixed at $1\frac{1}{2}$, $2\frac{1}{2}$, and $3\frac{1}{2}$ tons, so as not to disclass existing boats. As far as possible time allowances are discouraged, and no *new* boats are given time, but those built prior to 1878 get time from their larger rivals according to the following scale, which has worked fairly well in practice:

| |
|---|
| For 17ft. boats, 12 seconds per $\frac{1}{2}$ ton per knot. |
| For 19ft. boats, 10 " " " |
| For 22ft. boats, 8 " " " |

Excepting one or two of the earlier boats, all are built with square sterns, the increased power got by this form apparently making up for the unavoidable drag aft, while the over-all measurement, which prevails in most of the clubs, precludes a counter. It is questionable, however, whether a short neat counter could not be made "to pay," at least in heavy weather, and when the boats are necessarily travelling at a high speed; though at small inclinations, and speeds up to three or four miles an hour, this form of after end leaves the water smoothly enough, the stern board being then fairly out of water.

An idea of the advance made in the building of these craft may be gleaned from the following table of particulars of the best boats of their day:

| Date of building | 1878. | 1875. | 1877. | 1878. | 1879. |
|--|-----------|---------|-----------|-----------|--------------------------|
| Name of boat..... | NEVA. | LILY. | VANGUARD. | Building. | Building. |
| Builder | M'Nistan. | Fife. | Paton. | Paton. | — |
| | ft. in. | ft. in. | ft. in. | ft. in. | ft. in. |
| Length | 18 9 | 19 0 | 19 0 | 19 0 | 22 0 |
| Breadth | 5 7 | 5 8 | 5 6 | 6 0 | 5 3 |
| Depth from top of gunwale to top of keel | 2 0 | 2 4 | 2 8 | 3 3 | — |
| Freeboard | 1 3 | 1 5 | 1 8 | 1 10 | 1 9 |
| Draft aft..... | 1 9 | 2 0 | 2 3 | 2 4 | 5 0 |
| Draft forward | 1 4 | 1 4 | 1 6 | 1 6 | 3 0 |
| Mast, extreme length | 20 0 | — | 21 0 | 21 0 | 20ft. deck to hounds. |
| Yard, extreme length | 19 0 | — | 19 6 | 19 6 | |
| Weight of ballast inside | 6cwt. | 10cwt. | 17cwt. | 20cwt. | 8cwt. |
| Weight of ballast on keel | none | none | none | 3cwt. | 40cwt. |
| Displacement (about) | 11cwt. | 16cwt. | 24cwt. | 31cwt. | 80cwt. |

The steady increase of displacement is the most remarkable feature in this table, it presenting indeed but a microcosmic history of yacht-building from the time of "America" to "Vanessa."

The boats are generally entirely open, but the Largs and Western Clubs intend allowing a deck in future, while one or two clubs even

now permit the boat to be covered from the mast forward, the space below forming what is called "the den," where provisions, &c., may be kept dry, and where the luxurious owner and friends sleep when away on a cruise, covering the other four feet of their bodies with a tarpaulin.

There being no inducement (as in the case of the New Brighton boats) to cut down free board, they are given plenty of it, some as much as 24in. the average, as may be seen from the table, being about 22in. for a 19ft. boat, which is not found too much for the heavy sea which a sou'-wester tumbles up between Cumbrae and Porten Cross. Even with this a quantity of water gets aboard, and employs any spare hand baling besides the man at the pump. All the best boats are fitted with large pumps, 2½in. and 3in. in the barrel; they are generally on the aft thwart with discharge to both sides, or through the bottom. An ingenious, albeit expensive kind of pump has been adopted in one or two instances; this is shown in the mid section and general plan (Fig. 101, and Plate XXV.)—the barrel is pivoted at the foot so as to cant over to either side of the boat, the pumper being thus able to sit up in the weather bilge while at work. The discharge of this pump was through the lower part of the stern board, possibly after the idea of Ruthven's jet propeller.

Another pump, made, and we believe patented, by Messrs M'Conechy and Co., Glasgow, attains a like object in a simpler way. It is a lever pump, and by a very simple but effective arrangement, the lever can be shifted to either side, thus securing all the advantages of the other, and being much more easily worked.

The general construction and arrangement of these boats is shown in the drawings (Plate XXV.), and the scantlings are in pretty close accordance with the following tables, but some of the fittings, being as far as we know, peculiar to these boats, deserve particular mention, such as the ballast shelf, mainsheet horse, &c. These are illustrated in the cuts, and their uses further explained by the text.

In the larger boats, and where there is an extra heavy lead keel, a keelson may be advantageously adopted.

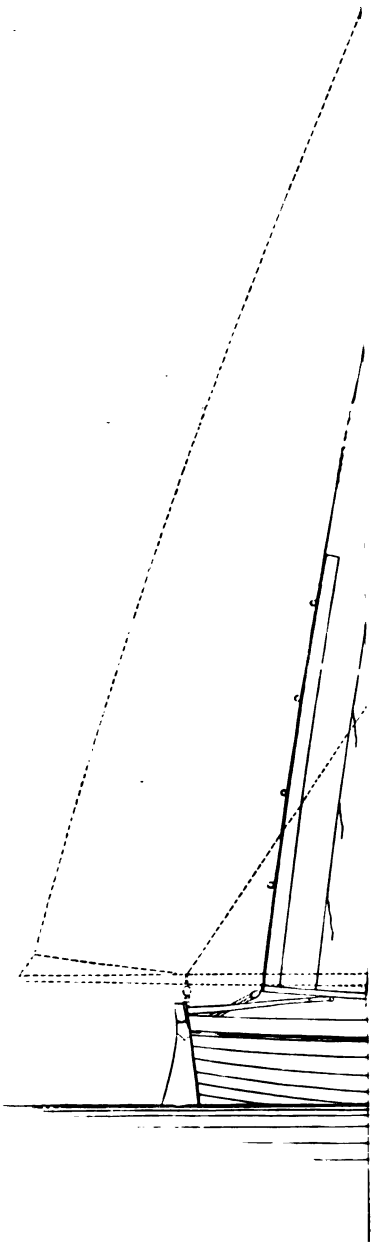
The weight of a 17ft. boat built to these scantlings would be about 5cwt., hulls, spars, sails, &c., complete, of a 19ft. boat 7cwt. to 8cwt., while a 22ft. boat would weigh 15cwt. to 18cwt. The displacements, if built to this drawing, being 22cwt., 31¼cwt., and 49cwt., would leave 17cwt., 23cwt., and 31cwt. for ballast and crew. Of this ballast, one-fourth might advantageously be put on the keel, but, unless lead were used, this amount could not be got in the space at disposal.

TABLE OF SCANTLINGS AND DIMENSIONS OF SPARS.

| | 17ft. boat | 19ft. boat | 22ft. boat |
|--|--|--|--|
| Length of boat | 17ft. boat | 19ft. boat | 22ft. boat |
| Beam, extreme | 5ft. 4 $\frac{1}{2}$ in. | 6ft. | 7ft. |
| Depth from top of gunwale to top of keel amidships... | 3ft. 0 $\frac{1}{2}$ in. | 3ft. 4in. | 3ft. 11 $\frac{1}{2}$ in. |
| Keel, of American elm, sided | 2in. | 2 $\frac{1}{2}$ in. | 2 $\frac{1}{2}$ in. |
| Keel, of American elm, moulded | 6in. | 7in. | 8in. |
| Apron, of American elm | 3 $\frac{1}{2}$ in. \times $\frac{1}{2}$ in. | 3 $\frac{1}{2}$ in. \times 1in. | 4in. \times 1 $\frac{1}{2}$ in. |
| Frames, all bent, sided | 1in. | 1 $\frac{1}{2}$ in. | 1 $\frac{1}{2}$ in. |
| Frames, all bent, moulded..... | $\frac{3}{4}$ in. | $\frac{3}{4}$ in. | 1 $\frac{1}{2}$ in. |
| Frames, spaced centre to centre | 8in. | 9in. | 9 $\frac{1}{2}$ in. |
| Floors, of oak (in every alternate frame space), sided | 1 $\frac{1}{2}$ in. | 1 $\frac{1}{2}$ in. | 2 $\frac{1}{2}$ in. |
| Floors, moulded at throat..... | 3in. | 3 $\frac{1}{2}$ in. | 4 $\frac{1}{2}$ in. |
| Stem, of oak, sided..... | 1 $\frac{1}{2}$ in. | 2in. | 2 $\frac{1}{2}$ in. |
| Stem, of oak, moulded (about) | 6in. | 7in. | 8in. |
| Sternpost, of oak, sided..... | 2in. | 2 $\frac{1}{2}$ in. | 2 $\frac{1}{2}$ in. |
| Sternpost, of oak, moulded at keel | 7in. | 8in. | 9in. |
| Sternboard, of oak, thick | 1in. | 1 $\frac{1}{2}$ in. | 1 $\frac{1}{2}$ in. |
| Gunwale, American elm..... | 1 $\frac{1}{2}$ in. \times 1 $\frac{1}{2}$ in. | 2in. \times 1 $\frac{1}{2}$ in. | 2 $\frac{1}{2}$ in. \times 1 $\frac{1}{2}$ in. |
| Planking, garboard strake, elm | 6in. \times $\frac{1}{4}$ in. | 6in. \times $\frac{1}{2}$ in. | 6in. \times $\frac{1}{2}$ in. |
| Planking, thence to sheer strake, yellow pine | 5in. \times $\frac{1}{4}$ in. | 5in. \times $\frac{1}{2}$ in. | 5 $\frac{1}{2}$ in. \times $\frac{1}{2}$ in. |
| Planking, sheer strake, mahogany | 5 $\frac{1}{2}$ in. \times $\frac{1}{2}$ in. | 5 $\frac{1}{2}$ in. \times $\frac{1}{2}$ in. | 6in. \times $\frac{1}{2}$ in. |
| Thwarts | 7in. \times 1in. | 7in. \times 1 $\frac{1}{2}$ in. | 7in. \times 1 $\frac{1}{2}$ in. |
| Thwarts, mast thwarts | 7in. \times 1 $\frac{1}{2}$ in. | 7in. \times 1 $\frac{1}{2}$ in. | 7in. \times 1 $\frac{1}{2}$ in. |
| Wirings, elm | 3in. \times $\frac{1}{2}$ in. | 3 $\frac{1}{2}$ in. \times 1in. | 3 $\frac{1}{2}$ in. \times 1 $\frac{1}{2}$ in. |
| Mast beam, double-kneed, with lodging knee to wiring | 2in. | 2 $\frac{1}{2}$ in. | 2 $\frac{1}{2}$ in. |
| Mast, deck to hounds | 18ft. | 19ft. 6in. | 20ft. |
| Mast, hounds to truck | — | — | 9ft. |
| Mast, diameter at deck..... | 3 $\frac{1}{2}$ in. | 4in. | 4 $\frac{1}{2}$ in. |
| Yard or gaff, length extreme | 18ft. | 20ft. | 14ft. |
| Yard or gaff, diameter at slings | 2 $\frac{1}{2}$ in. | 2 $\frac{1}{2}$ in. | 2 $\frac{1}{2}$ in. |
| Cruising yard or gaff, length extreme..... | 15ft. | 17ft. | — |
| Cruising yard or gaff, diameter at slings | 2 $\frac{1}{2}$ in. | 2 $\frac{1}{2}$ in. | — |
| Boom, length extreme | 16ft. | 18ft. | 18ft. |
| Boom, diameter at sheet | 2 $\frac{1}{2}$ in. | 2 $\frac{1}{2}$ in. | 2 $\frac{1}{2}$ in. |
| Bowsprit, outboard | 5ft. | 5ft. 6in. | 10ft. |
| Bowsprit, diameter at gamoning iron | 2in. | 2 $\frac{1}{2}$ in. | 2 $\frac{1}{2}$ in. |
| Spinnaker or shadow sail boom, length extreme | 18ft. 6in. | 18ft. 6in. | 21ft. |

The usual rig for boats 19ft. and under is a single standing lug, as shown in the plan (Plate XXIV.), but for cruising, and for racing in some of the clubs, a standing lug, with boom on foot, and short bowsprit with jib, are used; these are shown in the plan by dotted lines. For the single lug the mast is stepped about one-seventh of the boat's length from the stem, for the lug and jib, about 18in. further aft. Most of the boats are fitted for both rigs, and, farther, have several mast steps, so that the rake of the mast may be altered. One of the mast beams is generally bolted to the gunwale, this being strengthened at the part by a heavy clamp piece running two to three feet fore and aft. The mast is further supported by a wire shroud on each side, and a forestay (1 $\frac{1}{4}$ steel). These are shackled to the crane at the masthead, made as shown in Fig. 100, and have a large thimble spliced in at the other end to take the lanyard. Many of the boats are fitted with "channels," to give more spread to the rigging, the mast being so far forward, so lofty, and the boats so fine in the nose, that without these the shrouds would

PLATE XXIV.



as
ars
in
ed
ng
ng
ble
at

nick
be
may
took
sary
ckle
hile

Leng
 Bean
 Dept
 Keel,
 Keel.
 Apro
 Fran
 Fran
 Fran
 Floor
 Floor
 Ster
 Ster
 Ster
 Ster
 Ster
 Gun
 Plan
 Plan
 Plan
 Thw
 Thw
 Wir
 Mas
 Mas
 Mas
 Mas
 Yar
 Yar
 Cru
 Cru
 Boo
 Boo
 Bow
 Bow
 Spi

shc
 of
 jib
 sin
 fro
 bo
 the
 ge:
 by
 me
 (1:
 sh
 to
 gi
 an

give little support; they are of the "skeleton" kind, being made as shown in the sketch. The lengths and diameters of mast and spars are given in the table. A traveller works on the mast, and in construction is identical with that of the New Brighton boats described at page 317, the hook being welded solid on the ring, and hooking into a selvage strop on the yard, the halyard (2in. tarred hemp) being spliced into its eye. But into the other end of the halyard a double block is spliced; and a fall rove through this, and a single block at

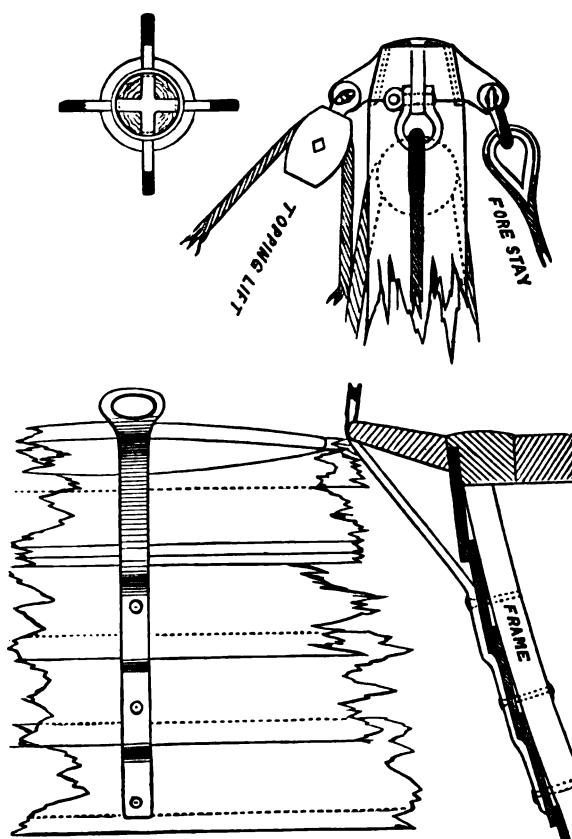


FIG. 100.

the foot, forms a luff tackle purchase for hoisting. The single thick rope is cut a foot or eighteen inches short, so that the yard has to be lifted up and hooked on; this of course is necessary, that the sail may be hoisted "chock-a-block." The tack is simply slipped on to a hook in the mast beam, the tackle on the halyards bringing the necessary strain on the luff to peak the sail. The mainsheet is a gun-tackle purchase, the upper block shackling on to the clew of the sail, while

the lower has a thimble spliced on to its tail, which works on the horse across the stern, as shown in the sketch (Fig. 101). When the boom lugsail is in use, the same sheet is simply shackled into a strop on the boom, thus doing for both. It is evident that by carrying the horse back, say a couple of feet (which might easily enough be done), all the advantages of a boom sail could be retained; there is, therefore, a rule which enacts that "if a horse is used it must be at right angles to the keel."

The spars and sails carried by these boats are enormous; one 19ft. boat, indeed, having a mast 21ft., deck to hounds, or 18in. longer than the five-tonner *Diamond*. She, however, was exceptionally heavily sparred, the general proportions being :

| | Luff. | Head. | Foot. | Leech. |
|-------------------|---------|---------|---------|---------|
| | ft. in. | ft. in. | ft. in. | ft. in. |
| 19ft. boats | 12 6 | 16 0 | 14 6 | 25 6 |
| 17ft. boats | 12 0 | 14 6 | 13 6 | 23 0 |

which dimensions have been kindly given us by Mr. D. M'Kenzie, of Greenock, the local lugsail Laphorne.

With such canvas aloft, the latest improvements in ballasting must be adopted, and the new boats are all fitted with metal keels, 3 cwt. to 5 cwt. in weight. In one or two, all the internal ballast is also lead; but, whether lead or iron, it is neatly cast in blocks, weighing about a hundredweight, which fit close down to the skin, but hang entirely on the keel and floor timbers. As shifting ballast is allowed in the Largs Club, most boats, whether belonging to this club or no, are fitted with a shelf for stowing weather ballast in each bilge, as shown in the arrangement plan and midship section (Plate XXV. and Fig. 101). This shelf also makes a capital seat for the crew, where they are well up to windward and also in shelter. The celebrated Largs boat *Neva* (possibly borrowing the idea from the China clippers, which, when racing, hung water-butts over the weather side) used to get her ballast still farther to windward, by slinging pretty nearly all of it (some 6cwt.) right outside. The Western Yacht Club, however, has most stringent rules against shifting ballast, and rigidly enforces these rules, also limiting the crew to three in the 17ft. and 19ft. boats, and four in the 22ft. boats, so as to prevent, as far as may be, "live ballast."

These boats go out in pretty well any weather, the sail reefing down very snug, and the boats, when not recklessly driven, being most seaworthy little craft. Accidents of any kind are therefore rare, and

we cannot call to mind a fatal one, owing doubtless to the excellent rule enforced in all the clubs, that "every boat shall carry life-saving apparatus sufficient to float every person on board." The modern boats seldom or never miss stays, but in the event of their doing so, it is admissible to use

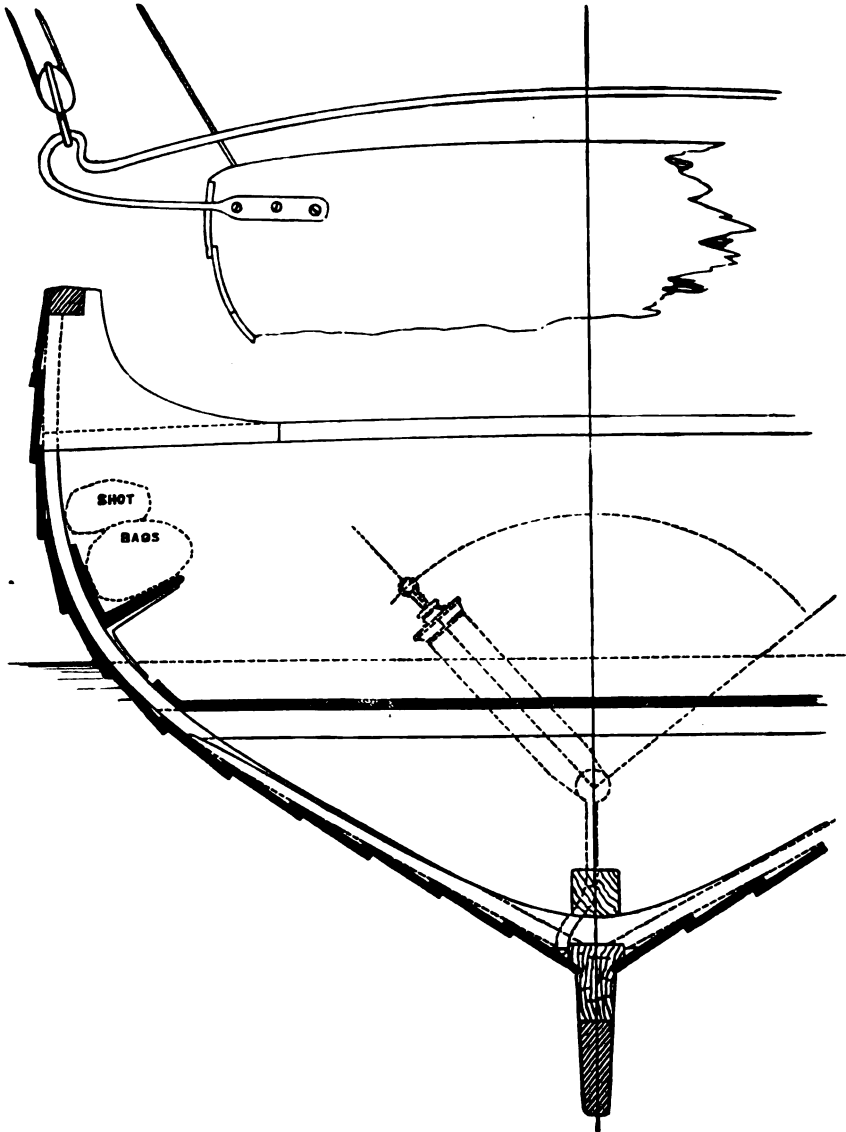


FIG. 101.

an oar to put them round, "but the strokes are to be backward, and in no case to be ahead," a very necessary clause, as before its introduction, a morbid horror of missing stays prevailed, especially in calm weather. At one time in running, the Western Club did not permit extra sails, and

did not even allow "booming out," but the Western now follow the rule of the other clubs and allow spinnakers, or more generally "shadow sails." The shadow sail is generally an old lug sail hoisted opposite the other, and the boom shipped into a snorter on fore side of mast.

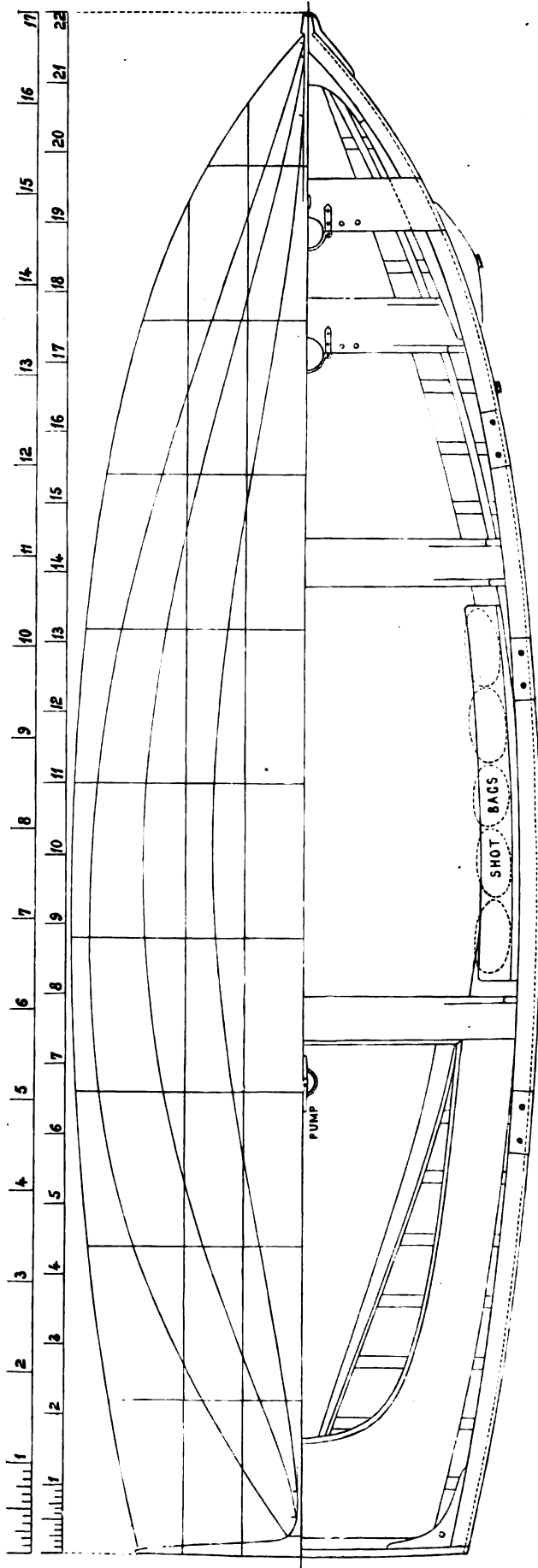
The 22ft. boats are invariably rigged as cutters, with mainsail, foresail, and jib, and small topsail on the pole mast. They carry also the usual balloon canvas for running to leeward, and occasionally indulge even in jib topsails. In the following table we give particulars of the best boats in this class, the "Thisbe," built by McLaren, of Kilcreggan, and owned by Mr. Allan Macintyre, and the "Ayrshire Lass," built by Fife for Mr. Thomas Reid, of Paisley. It is by the courtesy of these gentlemen we are enabled to give the following particulars. Alongside are given those of a 22ft. boat built to our drawing.

| Name | THISBE. | AYRSHIRE LASS. | DESIGN. |
|--------------------------------|--------------|----------------|---------------|
| Length, extreme | 21ft. 11in. | 22ft. | 22ft. |
| Breadth, extreme | 6ft. 11in. | 7ft. | 7ft. |
| Draught of water aft | 3ft. 8in. | 3ft. 6in. | 3ft. 2in. |
| Draught of water forward | 2ft. | 2ft. 6in. | 1ft. 9in. |
| Displacement (about) | 3.15 tons | 2.4 tons | 2.45 tons. |
| Ballast (total) | 2 tons 5cwt. | 1 ton 10cwt. | 1 ton 11cwt. |
| Ballast lead inside | 1 ton 9cwt. | 1 ton 4cwt. | 18cwt. |
| Ballast iron inside | — | 10cwt. | — |
| Ballast on keel | 16cwt. | 6cwt. | 13cwt. |
| Mast, deck to hounds | 20ft. 6in. | 19ft. | 20ft. |
| Boom, extreme | 18ft. | 19ft. | 18ft. |
| Gaff, extreme | 14ft. | 15ft. | 14ft. |
| Bowsprit, outside | 10ft. | 12ft. | 10ft. |
| Area of plain sail | 513 sq. ft. | 520 sq. ft. | 500 sq. feet. |

The Clyde boats are invariably clencher built, so that in the event of anyone building to our drawings it would be necessary to put up a "roof tree" between stem and stern post, then make half moulds for, say, 2, 4, 6, and 8 sections, pivoting these on their centre lines so as to swing round and do for both sides. She may be planked to these moulds, the frames then bent in, and last of all the floors, as if the floors are put on before planking it is unlikely that the bottom will be kept as fair. The sections can be drawn down full size from the following table of offsets.

In all cases the water-lines are named from the load, or first water-line down (see Fig. 102). The diagonals are also named in like manner, the top one being *first* diagonal, and so on. The gunwale heights and breadths explain themselves. The dimensions given are in all cases *moulded*, that is, to the inside of the plank. If it is desired to make





Clyde Sailing Boat—General Plan.

calculations of any elements of these boats, once and a half the thickness of plank must be drawn on.

The stations (see Plate XXV.) are spaced exactly $\frac{1}{10}$ th of the

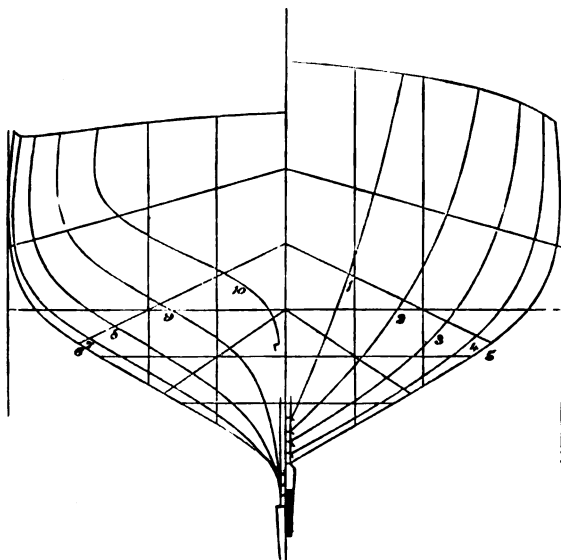


Fig. 102.

extreme length apart, and are at right angles to the water line. The shape of stern-board is shown in projection on the body-plan; in laying it down for building, the rake of post would have to be allowed for to get the *actual* shape.

TABLE OF OFFSETS FOR A 17ft. BOAT-

| No. of Section | 1 | 2 | 3 | 4 | 5 | 6 | 7 | 8 | 9 | 10 |
|--|--------------------|--------------------|--------------------|--------------------|--------------------|--------------------|-------------------|-------------------|-------------------|-------------------|
| Heights above L.W.L. to top of gunwale | 2 2 $\frac{1}{2}$ | 2 1 $\frac{1}{2}$ | 1 11 $\frac{1}{2}$ | 1 10 $\frac{1}{2}$ | 1 9 $\frac{1}{2}$ | 1 8 $\frac{1}{2}$ | 1 7 $\frac{1}{2}$ | 1 7 $\frac{1}{2}$ | 1 8 1 | 8 $\frac{1}{2}$ |
| Depths below L.W.L. to rabbet | 1 0 1 | 1 $\frac{1}{2}$ | 1 2 $\frac{1}{2}$ | 1 4 | 1 5 $\frac{1}{2}$ | 1 6 $\frac{1}{2}$ | 1 7 $\frac{1}{2}$ | 1 8 $\frac{1}{2}$ | 1 8 $\frac{1}{2}$ | — |
| Half-breadths at gunwale | 1 1 $\frac{1}{2}$ | 1 9 $\frac{1}{2}$ | 2 2 $\frac{1}{2}$ | 2 4 $\frac{1}{2}$ | 2 6 | 2 6 $\frac{1}{2}$ | 2 5 $\frac{1}{2}$ | 2 4 $\frac{1}{2}$ | 2 1 $\frac{1}{2}$ | 1 9 |
| Half-breadths at L.W.L. | 0 5 $\frac{1}{2}$ | 1 0 $\frac{1}{2}$ | 1 6 $\frac{1}{2}$ | 2 0 $\frac{1}{2}$ | 2 8 | 2 3 $\frac{1}{2}$ | 2 2 $\frac{1}{2}$ | 1 10 | 1 0 $\frac{1}{2}$ | 0 1 $\frac{1}{2}$ |
| Half-breadths, No. 2 W.L. | 0 3 $\frac{1}{2}$ | 0 8 $\frac{1}{2}$ | 1 1 $\frac{1}{2}$ | 1 6 $\frac{1}{2}$ | 1 8 $\frac{1}{2}$ | 1 8 $\frac{1}{2}$ | 1 6 $\frac{1}{2}$ | 1 0 $\frac{1}{2}$ | 0 5 $\frac{1}{2}$ | 0 0 $\frac{1}{2}$ |
| Half-breadths, No. 3 W.L. | 0 1 0 | 3 $\frac{1}{2}$ | 0 7 $\frac{1}{2}$ | 0 10 | 0 11 $\frac{1}{2}$ | 0 11 $\frac{1}{2}$ | 0 8 $\frac{1}{2}$ | 0 5 $\frac{1}{2}$ | 0 2 0 | 0 $\frac{1}{2}$ |
| Half-breadths on 1st diagonal . | 0 10 $\frac{1}{2}$ | 1 6 $\frac{1}{2}$ | 2 0 $\frac{1}{2}$ | 2 5 | 2 7 $\frac{1}{2}$ | 2 8 $\frac{1}{2}$ | 2 7 $\frac{1}{2}$ | 2 5 $\frac{1}{2}$ | 2 1 $\frac{1}{2}$ | 1 7 $\frac{1}{2}$ |
| Half-breadths on 2nd diagonal . | 0 8 1 | 2 $\frac{1}{2}$ | 1 8 $\frac{1}{2}$ | 1 11 $\frac{1}{2}$ | 2 2 | 2 2 $\frac{1}{2}$ | 2 0 $\frac{1}{2}$ | 1 9 $\frac{1}{2}$ | 1 3 $\frac{1}{2}$ | 0 7 $\frac{1}{2}$ |
| Half-breadths on 3rd diagonal . | 0 5 $\frac{1}{2}$ | 0 10 $\frac{1}{2}$ | 1 1 $\frac{1}{2}$ | 1 3 $\frac{1}{2}$ | 1 4 $\frac{1}{2}$ | 1 4 $\frac{1}{2}$ | 1 3 $\frac{1}{2}$ | 1 0 $\frac{1}{2}$ | 0 7 $\frac{1}{2}$ | 0 1 $\frac{1}{2}$ |

The stations are spaced 1-7ft. apart (1ft. 8 $\frac{1}{2}$ in.), No. 1 station being the same distance from fore-side stem. The water-lines are a bare 5 $\frac{1}{2}$ in. apart; the more exact way to lay them off will be to measure 16in. below the load line, and divide it into three equal parts.

The side lines are parallel to the centre line, and 2ft. 7 $\frac{1}{2}$ in. out.

The first diagonal cuts the centre line 1ft. 3 $\frac{1}{2}$ in. above the load line, and cuts the side line 7in. above the load line.

The second diagonal cuts the centre line 7½in. above the load line, and the side line 7½in. below it.

The third diagonal cuts the centre line at the load line, and cuts the third water line 1ft. 8½in. out.

TABLE OF OFFSETS FOR A 19ft. BOAT.

| No. of Section | 1 | | 2 | | 3 | | 4 | | 5 | | 6 | | 7 | | 8 | | 9 | | 10 | |
|--|-----|-----|-----|-----|-----|-----|-----|-----|-----|-----|-----|-----|-----|-----|-----|-----|-----|-----|-----|-----|
| | ft. | in. | ft. | in. | ft. | in. | ft. | in. | ft. | in. | ft. | in. | ft. | in. | ft. | in. | ft. | in. | ft. | in. |
| Heights above L.W.L. to top of gunwale | 2 | 6 | 2 | 4½ | 2 | 2½ | 2 | 1½ | 1 | 11½ | 1 | 10½ | 1 | 10½ | 1 | 10½ | 1 | 10½ | 1 | 11½ |
| Depths below L.W.L. to rabbet | 1 | 1½ | 1 | 3½ | 1 | 4½ | 1 | 6 | 1 | 7½ | 1 | 8½ | 1 | 10½ | 1 | 11½ | 1 | 11½ | — | — |
| Half-breadths at gunwale | 1 | 2½ | 2 | 0 | 2 | 5½ | 2 | 8½ | 2 | 9½ | 2 | 10 | 2 | 9½ | 2 | 7½ | 2 | 4½ | 2 | 0 |
| Half-breadths at L.W.L. | 0 | 6½ | 1 | 1½ | 1 | 9 | 2 | 3 | 2 | 6½ | 2 | 7½ | 2 | 5½ | 2 | 0½ | 1 | 2½ | 0 | 1½ |
| Half-breadths, No. 2 W.L. | 0 | 3½ | 0 | 9½ | 1 | 3½ | 1 | 8½ | 1 | 11½ | 1 | 11½ | 1 | 8½ | 1 | 2½ | 0 | 5½ | 0 | 0½ |
| Half-breadths, No. 3 W.L. | 0 | 1½ | 0 | 4 | 0 | 7½ | 0 | 11½ | 1 | 1½ | 1 | 0 | 10½ | 0 | 6 | 0 | 2½ | 0 | 0½ | |
| Half-breadths on 1st diagonal ... | 0 | 11½ | 1 | 9 | 2 | 3½ | 2 | 8½ | 2 | 11½ | 3 | 0½ | 2 | 11½ | 2 | 9 | 2 | 4½ | 1 | 9½ |
| Half-breadths on 2nd diagonal ... | 0 | 8½ | 1 | 4½ | 1 | 10½ | 2 | 2½ | 2 | 4½ | 2 | 5½ | 2 | 3½ | 2 | 0 | 1 | 5½ | 0 | 8½ |
| Half-breadths on 3rd diagonal ... | 0 | 6½ | 0 | 11½ | 1 | 3½ | 1 | 5½ | 1 | 6½ | 1 | 6½ | 1 | 5½ | 1 | 2½ | 0 | 8½ | 0 | 2 |

The stations are spaced 19ft. apart (1ft. 10½in.), No. 1 station being the same distance from fore-side stem.

The water-lines are spaced exactly 6in. apart.

The side lines are parallel to the centre line, and 2ft. 11in. out.

The first diagonal cuts the centre line 18in. above the load line, and cuts the side line 8in. above load line.

The second diagonal cuts the centre line 8½in. above the load line, and the side line 8½in. below it.

The third diagonal cuts the centre line at the load line, and cuts the third water-line 1ft. 5½in. out.

TABLE OF OFFSETS FOR A 22ft. BOAT.

| No. of Section..... | 1 | | 2 | | 3 | | 4 | | 5 | | 6 | | 7 | | 8 | | 9 | | 10 | |
|--|-----|-----|-----|-----|-----|-----|-----|-----|-----|-----|-----|-----|-----|-----|-----|-----|-----|-----|-----|-----|
| | ft. | in. | ft. | in. | ft. | in. | ft. | in. | ft. | in. | ft. | in. | ft. | in. | ft. | in. | ft. | in. | ft. | in. |
| Heights above L.W.L. to top of gunwale | 2 | 10½ | 2 | 8½ | 2 | 6½ | 2 | 5 | 2 | 3½ | 2 | 2½ | 2 | 1½ | 2 | 1½ | 2 | 1½ | 2 | 2½ |
| Depths below L.W.L. to rabbet ... | 1 | 3½ | 1 | 5½ | 1 | 7½ | 1 | 8½ | 1 | 10½ | 2 | 0 | 2 | 1½ | 2 | 3½ | 2 | 3½ | — | — |
| Half-breadths at gunwale | 1 | 5 | 2 | 3½ | 2 | 9½ | 3 | 1½ | 3 | 2½ | 3 | 3½ | 3 | 2½ | 3 | 0½ | 2 | 8½ | 2 | 3½ |
| Half-breadths at L.W.L. | 0 | 7½ | 1 | 3½ | 2 | 0½ | 2 | 7½ | 2 | 11½ | 3 | 0½ | 2 | 10½ | 2 | 4½ | 1 | 4½ | 0 | 2½ |
| Half-breadths at 2nd W.L. | 0 | 4½ | 0 | 11½ | 1 | 5½ | 1 | 11½ | 2 | 2½ | 2 | 2½ | 1 | 11½ | 1 | 4½ | 0 | 6½ | 0 | 1 |
| Half-breadths at 3rd W.L. | 0 | 1½ | 0 | 4½ | 0 | 9½ | 1 | 0½ | 1 | 3½ | 1 | 2½ | 0 | 11½ | 0 | 7½ | 0 | 2½ | 0 | 0½ |
| Half-breadths on 1st diagonal ... | 1 | 1½ | 2 | 0½ | 2 | 8½ | 3 | 1½ | 3 | 4½ | 3 | 5½ | 3 | 5 | 3 | 2½ | 2 | 9½ | 2 | 1½ |
| Half-breadths on 2nd diagonal ... | 0 | 10½ | 1 | 7½ | 2 | 2½ | 2 | 7½ | 2 | 9½ | 2 | 10 | 2 | 8 | 2 | 3½ | 1 | 8½ | 0 | 10½ |
| Half-breadths on 3rd diagonal ... | 0 | 7½ | 1 | 1 | 1 | 5½ | 1 | 8½ | 1 | 10 | 1 | 10 | 1 | 8 | 1 | 4½ | 0 | 10½ | 0 | 2½ |

The stations are spaced 22ft. apart (2ft. 2½in.), No. 1 station being the same distance from fore-side stem.

The water lines are spaced exactly 7in. apart.

The side lines are parallel to the centre line, and 3ft. 4½in. out.

The first diagonal cuts the centre line 1ft. 8½in. above the load line, and cuts the side line 9in. above load line.

The second diagonal cuts the centre line 9½in. above the load line, and the side line 10½in. below it.

The third diagonal cuts the centre line at the load line, and cuts the third water line 1ft. 8½in. out.

As to cost, a modern racing 19ft. boat is a pretty expensive toy. About the most successful builder of them, Paton, of Milport, charges

22s. to 23s. per foot, and other builders are pretty much the same; the items, therefore, would tot up about as follows:

| | £ | s. | d. |
|---|-----|----|----|
| Hull and spars, 19ft., at 23s. per foot | 21 | 17 | 0 |
| Plain, pump, and other fittings not supplied by builder ... | 3 | 10 | 0 |
| Lead keel, 6cwt., at 23s. per cwt..... | 6 | 18 | 0 |
| Internal ballast, 10cwt., at 22s. 6d. per cwt. | 11 | 5 | 0 |
| Shot in bags, 4cwt., at 32s. per cwt..... | 6 | 8 | 0 |
| Blocks, running and standing rigging | 8 | 0 | 0 |
| Sails | 15 | 0 | 0 |
| Three life belts, at 15s. | 2 | 5 | 0 |
| Total for boat complete and ready for racing . | £75 | 3 | 0 |

If internal ballast is of iron, deduct £8 10s.

[NOTE.—*August*, 1879.—Since this article was written there has been an enormous stride made in the construction of “Clyde Sailing Boats” through the general adoption by nearly all the clubs of the Y.R.A. rule of measurement. Although this was decided on a year ago, the effects are only seen now, the various builders having launched a number of *miniature yachts* which in no way possess any special features as to hull, sails, or ballasting. They are, indeed, simply models of big yachts; in one or two instances, indeed, they have been built direct off the lines of five or ten tonners, the scale being altered to suit. Three-and-a-half, two-and-a-half, and one-and-a-half ton yachts have therefore been competing in the old 15ft., 19ft., and 22ft. classes, the new boats being one-third to one-half longer, and having half as much displacement again as their rivals, while they have the further advantage of carrying a large proportion of the ballast outside, the result being that the old type of boat is likely to be improved off the face of the water. One or two of the builders, however, stick pretty closely to the old type of boat, simply adding a counter; this year’s build may be somewhat deeper than the vessel shown in the plate, but if a counter be drawn on (the buttock lines will give a good enough guide as to its outline) she will very fairly represent them.

Iron masts were successfully introduced last year in several of the boats, they being found as light as, and much stiffer than the wooden ones. They were made of boiler tube, about 4in. diameter, and $\frac{3}{8}$ th to $\frac{1}{2}$ in. thick, tapered at top by slipping a small piece inside, and then a smaller, somewhat after the fashion of the Chinese bamboo fishing rods.

Lead and everything else being a good deal cheaper, 5*l.* might be deducted from the cost as given above of a 19ft. boat of the old type. The cost of a 2½-tonner (corresponding to the old 19ft. class), with all lead ballast, racing sails, and gear would not fall far short of 150*l.*

In the table (page 348) are given the particulars of a 2½-tonner for better comparison with the old boats.]

CHAPTER XXIV.

YACHTS OF FIVE AND TEN TONS.

THE deeds of these miniature creations of yacht builders which we know as "5-tonners" excite almost as much interest among yachtsmen as do the deeds of larger yachts such as *Formosa*, *Vol-au-vent*, *Kriemhilda*, or *Arrow*; and whilst the merits of the latter four are a moot point among connoisseurs, the merits of such little clippers as *Vril*, *Freda*, *Lorelei*, and *Cyprus* are no less matters of dispute. As in the larger craft, although all are of one type, there is a considerable variation in the model of each, and a glance at the designs of *Freda* and *Lorelei* (Plates XXVII. and XXVIII.) will show this.

The displacement of *Lorelei* and *Freda* is practically the same, and each has much about the same quantity of ballast; but inasmuch as the whole weight of ballast carried by *Lorelei* is on her keel, whilst not half of *Freda's* is so placed, the probability is that *Lorelei* is the stiffer boat.

The design which is given for a 5-tonner has more ballast on the keel than *Freda*, but less than *Lorelei* or *Vril*; but then an increase of displacement has been provided so as to admit of an excess quantity of ballast being carried inside. There is not the smallest doubt that for sailing with the wind before the beam in comparatively smooth water advantages will accrue from having the whole of the lead ballast on the keel; but there are two very serious objections to so much weight being placed outside. In the first place, owing to the major part of the weight of the yacht being concentrated some distance below the bulk of the displacement, an uneasy sea boat will be the consequence, and possibly one that will only perform indifferently well in a sea, from a racing point of view. This is saying nothing more nor less than that great stiffness, with a small weight, is incompatible with good sea going qualities; or that great metacentric height and a small displacement (see Fig. 6, page 9) are antagonistic to certain qualities that are usually sought for in a yacht. It does not matter whether the ballast is inside the hull or outside the hull. There is no special virtue in having the ballast inside the hull; if there was that virtue could be obtained by placing a

casing of wood over the lead on the keel. The relative performances of yachts in a sea way are governed by their metacentric heights and the weight of their displacement, and the forms of their hull and their radii of gyration. In the design the object sought was a metacentric height equal to that of any other 5-tonner, and greater weight, to effect an improvement if possible whilst performing in disturbed water. That a yacht built and ballasted according to the design would be much stiffer than *Freda* there is not the smallest doubt, and would be quite the equal of that famous craft in a disturbed sea. Also it can be concluded that the design would be the equal of *Lorelei* in stiffness, and how the two would fare in a sea way if matched together would be an interesting experiment to see solved.

It might very well be argued that depth and weight of displacement were carried far enough in *Freda*, and that there could be no object in taking more. She has been successful in light weather and heavy weather, and has as much internal room as any one could desire; and, moreover, one or two attempts to build a 5-tonner of heavier displacement did not result in a realisation of expectations. However, the design we give has very considerably larger displacement than *Freda*, is deeper and longer, and has more internal room; yet it is expected that she would be a match for the southern crack. Practically, the design is of the same beam as *Freda*, and the additional length on load water-line was mainly obtained, not by a reduction in beam, but by virtue of the altered manner of obtaining length under the Y.R.A. rule.

The other objection to a yacht carrying a great weight of lead on her keel—equal, perhaps, to nearly two-thirds her total weight—is the enormous lateral strain it causes when the yacht is heeled. It is found almost impossible to keep a yacht tight that has a heavy lead keel; her slight frames are certain to “straighten” a little, and the seams, from the garboards upwards to the bilge, are sure to open a trifle when she is heeled. However, this is regarded as an inevitable defect in a racing yacht, and few will forego the advantages of having a heavy lead keel merely because it may cause a yacht to leak a few gallons an hour in strong winds.

The design was made without any reference to *Freda* or *Lorelei*, and, except in the matter of beam, there is not much resemblance between the three. The midship sections of *Freda* and *Lorelei* are of much smaller area than that of the design, and the difference is entirely due to the hollow they have in the garboards. The ends of the design and those of the *Freda* and *Lorelei* are nearly of the same *relative* fulness, and the difference in the displacement is thus almost entirely due to the greater depth given to the middle body of the design, the extra length being nearly all taken up in drawing out the fore body.

The longitudinal disposition of the displacement of the fore and after body of the design accords exactly with the wave form; but the bow end of both Freda and Lorelei is a trifle fuller than the wave curve form. The displacement of the after body of Lorelei is so disposed as to agree exactly with the wave form.

COMPARATIVE TABLE OF ELEMENTS OF FIVE-TONNERS.

| | Design. | Freda. | Vril. | Lorelei. |
|--|----------------|----------------|----------------|---------------|
| | ft. in. | ft. in. | ft. in. | ft. in. |
| Length on deck stem to sternpost..... | 33 10 | 31 4 | — | 31 6 |
| Length on load water line | 32 0 | 30 4 | 28 4 | 31 6 |
| Rake of sternpost from plumb-line (4ft. in length) | 2 3 | 1 8 | — | 2 5 |
| Breadth moulded | 5 10 | 5 11½ | — | 5 10 |
| Breadth extreme | 6 0 | 6 1½ | 6 7 | 6 0 |
| Extreme draught of water..... | 6 0 | 5 5½ | 5 7 | 5 4 |
| Draught of water 4ft. abaft fore side of stem at L.W.L. | 3 2 | 4 0 | — | 2 11 |
| Mean draught of water | 4 11 | 4 7 | — | 4 3 |
| Area of load water-plane | 132 sq. ft. | 124 sq. ft. | — | 134 sq. ft. |
| Area of midship section | 18·3 sq. ft. | 16 sq. ft. | — | 14·8 sq. ft. |
| Area of vertical longitudinal section..... | 157 sq. ft. | 149 sq. ft. | — | 132 sq. ft. |
| Area of immersed surface | 360 sq. ft. | 353 sq. ft. | — | 318 sq. ft. |
| Area of canvas for square foot of wetted surface | 2·34 sq. ft. | 2·24 sq. ft. | — | 2·47 sq. ft. |
| Displacement in tons | 9·2 tons | 7·7 tons | 6·6 tons | 7·5 tons. |
| Displacement per inch of immersion at L.W.L. | 6½cwt. | 6cwt. | — | 6½cwt. |
| Co-efficient of displacement | ·341 | ·322 | — | ·3294 |
| Midship section abaft centre of length of L.W.L. | 1·5ft. | 1·2ft. | — | 1·9ft. |
| Centre of buoyancy ditto | 1ft. | 0·4ft. | — | 0·8ft. |
| Centre of lateral resistance ditto | 2ft. | 1·1ft. | — | 1·4ft. |
| Centre of effort of lower sails ditto | 1·4ft. | 0·5ft. | — | 0·5ft. |
| Centre of buoyancy below L.W.L. | 1·66ft. | 1·44ft. | — | 1·37ft. |
| Centre of lateral resistance ditto | 2·6ft. | 2·2ft. | — | 2·2ft. |
| Metacentre above centre of buoyancy .. | 0·81ft. | 1ft. | — | 1·1ft. |
| Centre of effort of sails above L.W.L. ... | 15·5ft. | 15·4ft. | — | 14·3ft. |
| Ballast inside | 3 tons 15 cwt. | 2 tons 14 cwt. | 1 ton 19 cwt. | — |
| Ballast outside | 2 tons 5 cwt. | 1 ton 18 cwt. | 2 tons 13 cwt. | 4 tons 3 cwt. |
| Total ballast | 6 tons | 4 tons 12 cwt. | 4 tons 12 cwt. | 4 tons 3 cwt. |
| Tonnage Y.B.A. | 4½ | 4½ | 4½ | 4½ |
| Mast, deck to hounds | 21 0 | 20 6 | 22 0 | 22 0 |
| Masthead | 4 6 | 4 0 | — | 4 0 |
| Diameter at deck | 5½in. | 5½in. | — | 0 5½ |
| Main boom | 29 0 | 28 0 | 24 9 | 27 0 |
| Greatest diameter | 5½in. | 5½in. | — | 0 5½ |
| Gaff | 20 3 | 19 0 | 19 0 | 19 0 |
| Bowsprit outboard | 12 6 | 15 0 | 14 6 | 14 0 |
| Diameter at stem | 4½in. | 5½in. | — | 0 5 |
| Topmast, fid to hounds | 19 6 | 18 6 | 18 6 | 20 0 |
| Topsail yards | 19 0 | 18 0 | — | — |
| Spinnaker boom | 34 0 | 35 0 | — | 33 0 |
| Centre of mast from fore side of stem on deck | 13 3 | 12 4 | — | 12 0 |
| Luff of mainsail | 17 9 | 17 3 | — | 18 0 |
| Leech of mainsail | 35 0 | 34 6 | — | 32 0 |
| Angle of gaff with horizontal..... | 53° | 51° | — | 51° |
| Area of mainsail | 564 sq. ft. | 530 sq. ft. | 500 sq. ft. | 526 sq. ft. |
| Area of foresail | 120 sq. ft. | 110 sq. ft. | — | 104 sq. ft. |
| Area of jib | 150 sq. ft. | 160 sq. ft. | — | 139 sq. ft. |
| Total area lower sail | 834 sq. ft. | 800 sq. ft. | 756 sq. ft. | 769 sq. ft. |

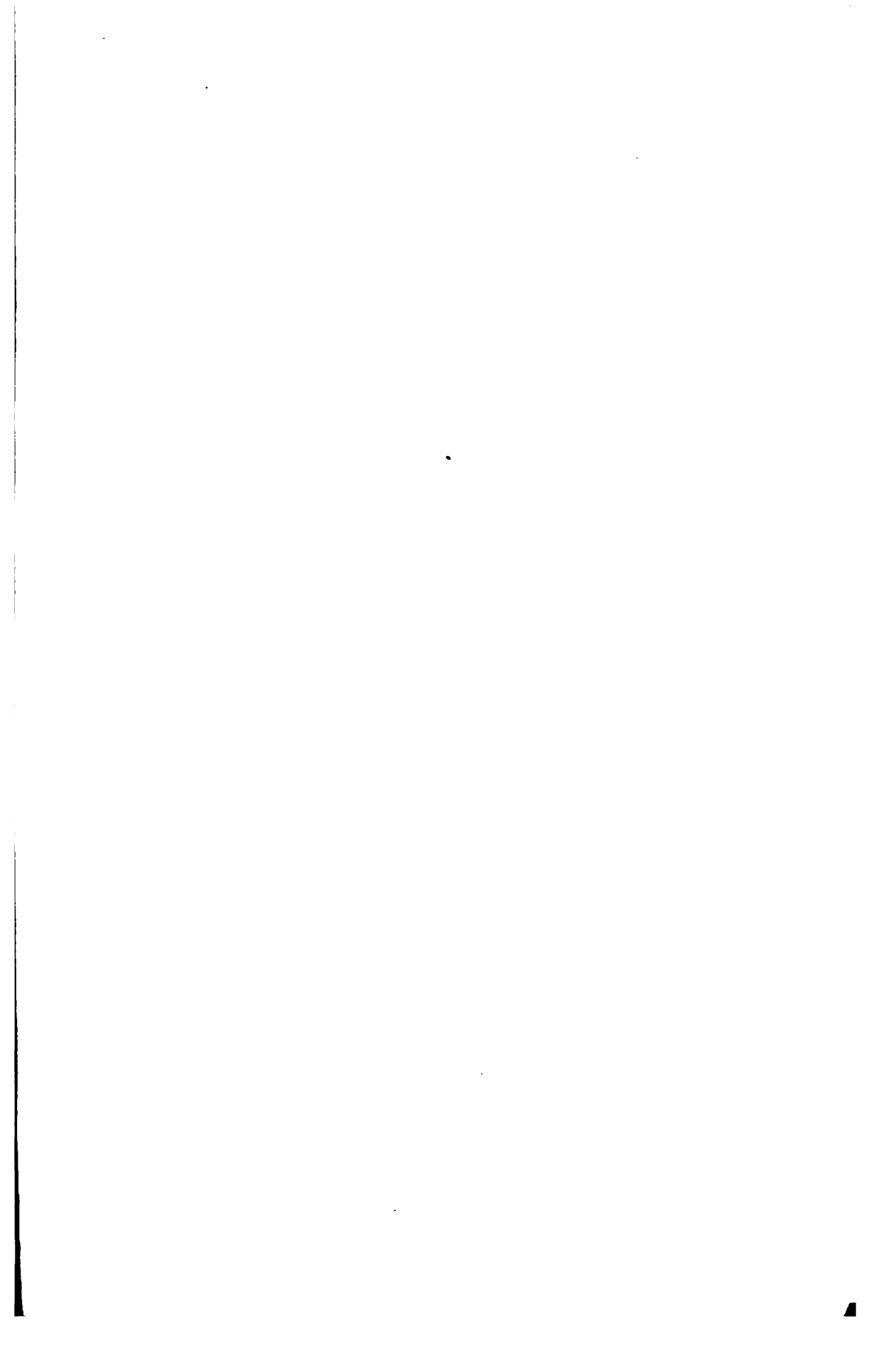
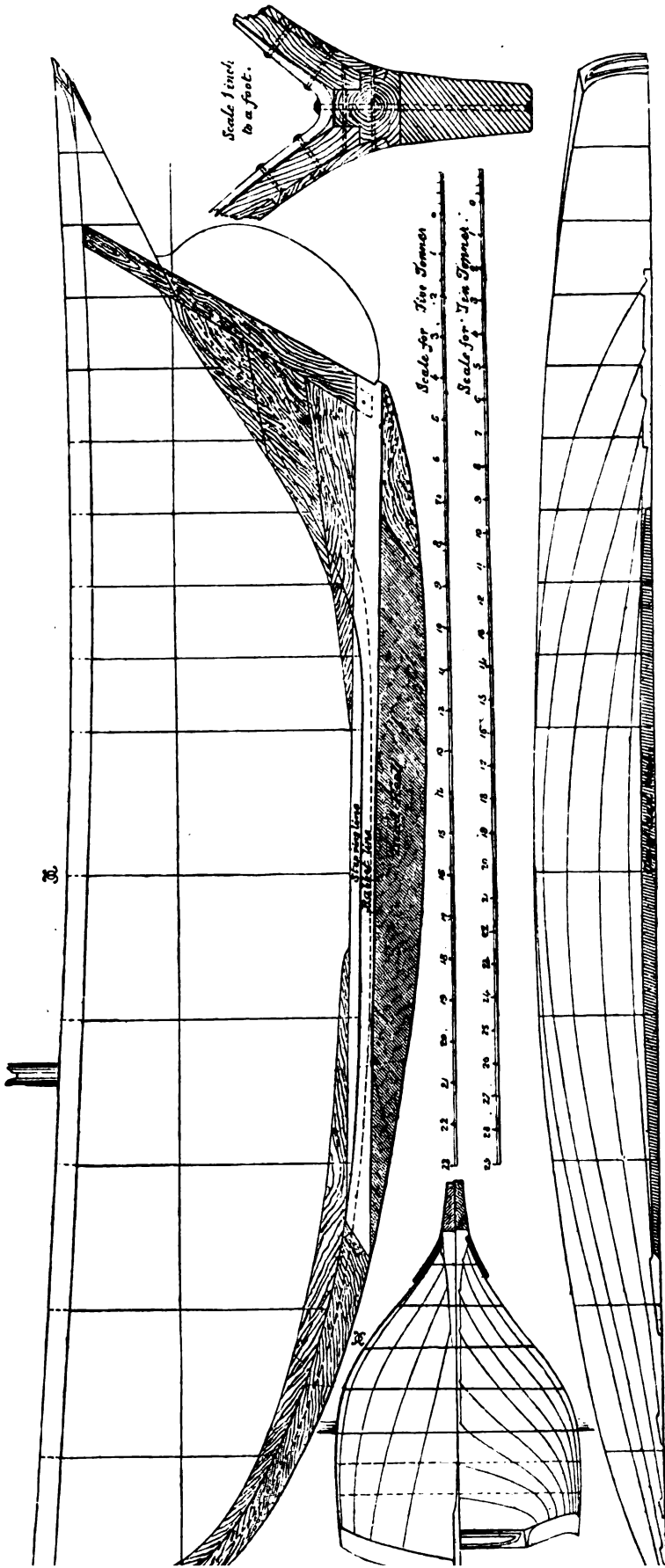


PLATE XXVI.



Cutter Yacht of 5 or 10 Tons.

TABLE OF OFFSETS OF THE DESIGN FOR A FIVE-TONNER (SEE PLATE XXVI.).

| No. of Section | Midship. | | | | | | | | | | | | | |
|--|----------|------|------|------|------|------|------|------|------|------|------|-----|-----|------|
| | 1 | 2 | 3 | 4 | 5 | 6 | 7 | 8 | 9 | 10 | 11 | 12 | 13 | 14 |
| Heights above L.W.L. to covering board | 2 10 | 2 7 | 2 5 | 2 3 | 2 1 | 2 0 | 2 0 | 1 11 | 1 11 | 1 11 | 1 11 | 2 0 | 2 0 | 2 2 |
| Depths below L.W.L. to stepping line | 2 3 | 3 6 | 4 0 | 4 4 | 4 5 | 4 6 | 4 4 | 3 11 | 3 2 | 2 2 | 1 1 | 0 1 | 0 1 | — |
| Half-breadths on deck | 1 4 | 2 1 | 2 6 | 2 9 | 2 10 | 2 10 | 2 10 | 2 9 | 2 8 | 2 7 | 2 6 | 2 3 | 2 1 | 1 10 |
| Half-breadths 1ft. 6in. above L.W.L. | 1 1 | 1 10 | 2 5 | 2 9 | 2 10 | 2 10 | 2 10 | 2 9 | 2 8 | 2 7 | 2 5 | 2 3 | 2 1 | 1 10 |
| Half-breadths 9in. above L.W.L. | 0 11 | 1 9 | 2 4 | 2 9 | 2 11 | 2 10 | 2 9 | 2 9 | 2 7 | 2 4 | 2 0 | 1 4 | 1 4 | — |
| Half-breadths on the L.W.L. | 0 9 | 1 6 | 2 3 | 2 8 | 2 10 | 2 10 | 2 9 | 2 7 | 2 3 | 1 10 | 1 3 | 0 3 | 0 3 | — |
| Half-breadths No. 2 W.L. | 0 5 | 1 2 | 1 11 | 2 5 | 2 8 | 2 6 | 2 3 | 1 11 | 1 6 | 0 11 | 0 3 | — | — | — |
| Half-breadths No. 3 W.L. | 0 2 | 0 9 | 1 5 | 1 11 | 2 1 | 1 10 | 1 7 | 1 2 | 0 9 | 0 3 | — | — | — | — |
| Half-breadths No. 4 W.L. | — | 0 4 | 0 10 | 1 2 | 1 4 | 1 1 | 0 10 | 0 6 | 0 3 | — | — | — | — | — |
| Half-breadths No. 5 W.L. | — | — | 0 3 | 0 6 | 0 7 | 0 6 | 0 5 | 0 3 | 0 1 | — | — | — | — | — |

No. 1 section is 3ft. 6in. from the fore side of the stem at the L.W.L.

Nos. 1, 2, 3, 4, 5, and 6 sections are 8ft. 6in. apart.

Nos. 6, 7, 8, 9, 10, 11, 12, 13, and 14 sections are 1ft. 6in. apart.

The water-lines are 1ft. apart.

All the half breadths are given without the plank.

The heights above the L.W.L. are exclusive of the covering board.

Siding of stem and stern post, 4in.

Siding of keel amidships, 8in.

Moulded depth of keel, 7in.

Timbers, 2in. sided.

Timbers, 3in. moulded at heels, 1 1/2 in. at heads.

Spacing, centre to centre, 1ft. 9in.

Bent timbers, 1 1/2 in. sided, 1 1/2 in. moulded between each out timber.

Garboard strake, 1 1/2 in. American elm.

Plank, 1in.; deck plank, 1 1/2 in.

Deck beams, 2 1/2 in. sided, 2in. moulded.

All the bolts through the keel and frames should be arranged as much out of line as possible; to effect this, it will be well to drive the floor bolts obliquely—that is, if a bolt enters the keel near the edge on the port side, it should come out near the edge on starboard side. The next bolt should enter the keel on starboard side and come out on port side, and so on. Similarly for bolts through the frames.

TABLE OF OFFSETS FOR "LORELEI" (PLATE XXVII.)

| No. of Section | 1 | 2 | 3 | 4 | 5 | 6 | 7 | 8 | 9 | 10 | 11 | 12 | 13 | 14 | 15 | 16 | 17 |
|--|----------|---------|----------|---------|----------|----------|----------|----------|----------|----------|----------|-----------|---------|----------|----------|----------|---------|
| Heights above L.W.L. to covering board | 3 3 | 0 2 | 9 1 | 2 7 1/2 | 2 5 1/2 | 2 3 1/2 | 2 2 | 2 0 1/2 | 1 11 1/2 | 1 10 1/2 | 1 10 | 1 9 1/2 | 1 10 | 1 10 1/2 | 1 11 1/2 | 2 1 | 2 2 1/2 |
| Half-breadths on deck | 0 10 1/2 | 1 6 1/2 | 2 0 1/2 | 2 5 1/2 | 2 7 1/2 | 2 9 1/2 | 2 10 1/2 | 2 10 1/2 | 2 10 1/2 | 2 11 1/2 | 2 10 1/2 | 2 9 1/2 | 2 8 1/2 | 2 6 1/2 | 2 4 | 2 1 1/2 | 2 0 1 |
| Half-breadths 1ft. above L.W.L. | 0 7 1/2 | 1 3 1/2 | 1 10 1/2 | 2 3 | 2 7 1/2 | 2 9 1/2 | 2 10 1/2 | 2 11 1/2 | 2 11 1/2 | 2 11 1/2 | 2 11 1/2 | 2 9 1/2 | 2 8 1/2 | 2 5 1/2 | 2 1 1/2 | 2 1 1/2 | 1 7 1/2 |
| Half-breadths 6in. above L.W.L. | 0 6 1/2 | 1 1 1/2 | 1 8 1/2 | 2 2 | 2 6 1/2 | 2 9 1/2 | 2 11 1/2 | 2 11 1/2 | 2 11 1/2 | 2 11 1/2 | 2 11 1/2 | 2 9 1/2 | 2 7 1/2 | 2 4 | 1 10 1/2 | 0 11 1/2 | |
| Half-breadths on L.W.L. | 0 5 1/2 | 1 0 | 1 8 1/2 | 2 0 1/2 | 2 5 | 2 8 1/2 | 2 10 1/2 | 2 11 1/2 | 2 11 1/2 | 2 11 1/2 | 2 10 1/2 | 2 9 1/2 | 2 7 1/2 | 2 4 | 1 10 1/2 | 0 11 1/2 | |
| Half-breadths No. 2 W.L. | 0 4 1/2 | 0 9 1/2 | 1 4 | 1 9 1/2 | 2 2 1/2 | 2 6 1/2 | 2 9 1/2 | 2 10 1/2 | 2 11 1/2 | 2 11 1/2 | 2 10 1/2 | 2 9 1/2 | 2 7 1/2 | 2 4 | 1 10 1/2 | 0 11 1/2 | |
| Half-breadths No. 3 W.L. | 0 3 1/2 | 0 7 1/2 | 1 1 | 1 6 1/2 | 1 11 1/2 | 2 3 1/2 | 2 7 1/2 | 2 9 1/2 | 2 10 1/2 | 2 11 1/2 | 2 10 1/2 | 2 9 1/2 | 2 7 1/2 | 2 4 | 1 10 1/2 | 0 11 1/2 | |
| Half-breadths No. 4 W.L. | 0 1 1/2 | 0 5 0 | 0 9 1/2 | 1 1 | 1 7 1/2 | 2 1 1/2 | 2 2 1/2 | 2 4 1/2 | 2 5 1/2 | 2 6 1/2 | 2 6 1/2 | 2 4 1/2 | 2 3 1/2 | 1 8 0 | 10 1/2 | 0 11 1/2 | |
| Half-breadths No. 5 W.L. | 0 1 1/2 | 0 3 1/2 | 0 6 1/2 | 0 10 | 1 2 1/2 | 1 5 1/2 | 1 8 1/2 | 1 9 1/2 | 1 10 1/2 | 1 10 1/2 | 1 10 1/2 | 1 8 1/2 | 1 7 1/2 | 1 8 0 | 10 1/2 | 0 11 1/2 | |
| Half-breadths No. 6 W.L. | — | 0 1 1/2 | 0 4 | 0 6 1/2 | 0 9 1/2 | 0 11 1/2 | 1 1 | 1 2 1/2 | 1 3 1/2 | 1 4 1/2 | 1 4 1/2 | 1 0 9 1/2 | 0 5 1/2 | 0 8 1/2 | 0 9 1/2 | 0 11 1/2 | |
| Half-breadths No. 7 W.L. | — | — | 0 2 1/2 | 0 3 1/2 | 0 5 0 | 0 6 0 | 0 6 1/2 | 0 7 1/2 | 0 7 1/2 | 0 6 1/2 | 0 5 1/2 | 0 4 0 | 0 5 1/2 | 0 6 0 | 0 7 1/2 | 0 8 1/2 | |
| Depths below L.W.L. to underside of rabbet | — | — | 2 8 1/2 | 2 9 1/2 | 2 10 1/2 | 2 11 1/2 | 3 1 | 3 2 | 3 3 | 3 4 | 3 5 | 3 6 | 3 7 | 3 7 | 3 6 | 3 5 | 3 4 |

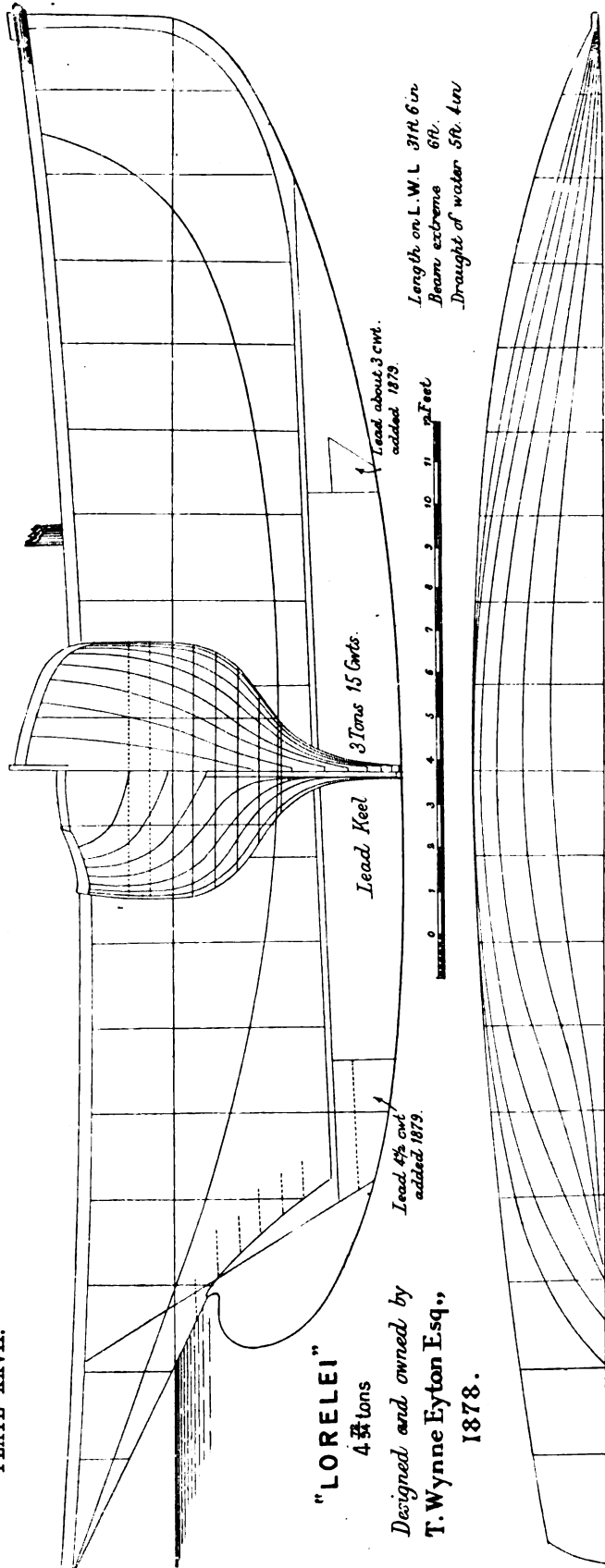
No. 1 section is 1ft. 7in. from the fore side of the stem at the L.W.L. The water-lines are 2ft. apart.
 The sections are 2ft. apart.
 The half-breadths include the thickness of the plank.
 The heights include the covering board.

TABLE OF OFFSETS FOR "FREDA" (PLATE XXVIII.)

| No. of Section | 1 | 2 | 3 | 4 | 5 | 6 | 7 | 8 | 9 | 10 | 11 | 12 |
|--|---------|----------|----------|---------|----------|----------|----------|----------|---------|-----------|----------|---------|
| Heights above L.W.L. to covering board | 3 1 1/2 | 2 10 1/2 | 2 7 1/2 | 2 5 1/2 | 2 3 1/2 | 2 2 | 2 1 | 2 0 | 2 0 1/2 | 2 1 1/2 | 2 2 | 2 3 1/2 |
| Depths below L.W.L. to rabbet | 1 8 1/2 | 3 0 | 3 5 1/2 | 3 8 1/2 | 3 10 1/2 | 3 11 1/2 | 4 0 | 3 11 | 3 6 | 2 1 1/2 | 2 2 | 2 3 1/2 |
| Half-breadths on deck | 0 8 1/2 | 1 8 1/2 | 2 4 | 2 8 1/2 | 2 10 1/2 | 2 11 1/2 | 2 11 1/2 | 2 10 1/2 | 2 8 1/2 | 2 5 | 2 2 | 1 10 |
| Half-breadths 1ft. 6in. above L.W.L. | 0 6 1/2 | 1 5 1/2 | 2 2 1/2 | 2 8 1/2 | 2 11 1/2 | 2 11 1/2 | 2 11 1/2 | 2 10 1/2 | 2 8 1/2 | 2 4 1/2 | 1 10 1/2 | |
| Half-breadths 9in. above L.W.L. | 0 5 1/2 | 1 3 1/2 | 2 0 1/2 | 2 7 1/2 | 2 11 1/2 | 2 11 1/2 | 2 11 1/2 | 2 10 1/2 | 2 8 1/2 | 2 4 1/2 | 0 2 1/2 | |
| Half-breadths on L.W.L. | 0 4 1/2 | 1 1 | 1 10 1/2 | 2 6 1/2 | 2 11 1/2 | 2 11 1/2 | 2 11 1/2 | 2 10 1/2 | 2 8 1/2 | 2 3 0 | 0 8 1/2 | |
| Half-breadths No. 2 W.L. | 0 1 1/2 | 0 9 1/2 | 1 5 1/2 | 2 1 1/2 | 2 7 1/2 | 2 9 1/2 | 2 8 1/2 | 2 10 1/2 | 2 1 1 | 1 0 2 1/2 | | |
| Half-breadths No. 3 W.L. | 0 1 1/2 | 0 5 1/2 | 0 11 1/2 | 1 5 1/2 | 1 10 1/2 | 1 11 1/2 | 1 8 1/2 | 1 0 1/2 | 1 0 1/2 | 0 5 1/2 | 0 2 1/2 | |
| Half-breadths No. 4 W.L. | 0 1 | 0 2 1/2 | 0 5 1/2 | 0 8 1/2 | 0 10 1/2 | 0 11 1/2 | 0 8 1/2 | 0 5 1/2 | 0 2 1/2 | 0 2 1/2 | 0 2 | |

No. 1 section is 1ft. 5in. from the fore side of stem at the L.W.L.
 Nos. 1, 2, 3, 4, 5, 6, 7, 8, 9, and 10 sections are 3ft. apart.
 Nos. 10, 11, and 12 sections are 2ft. apart.
 The water-lines are 1ft. apart.
 All the half-breadths given include the thickness of the plank.
 The heights are exclusive of the covering board.

PLATE XXVII.



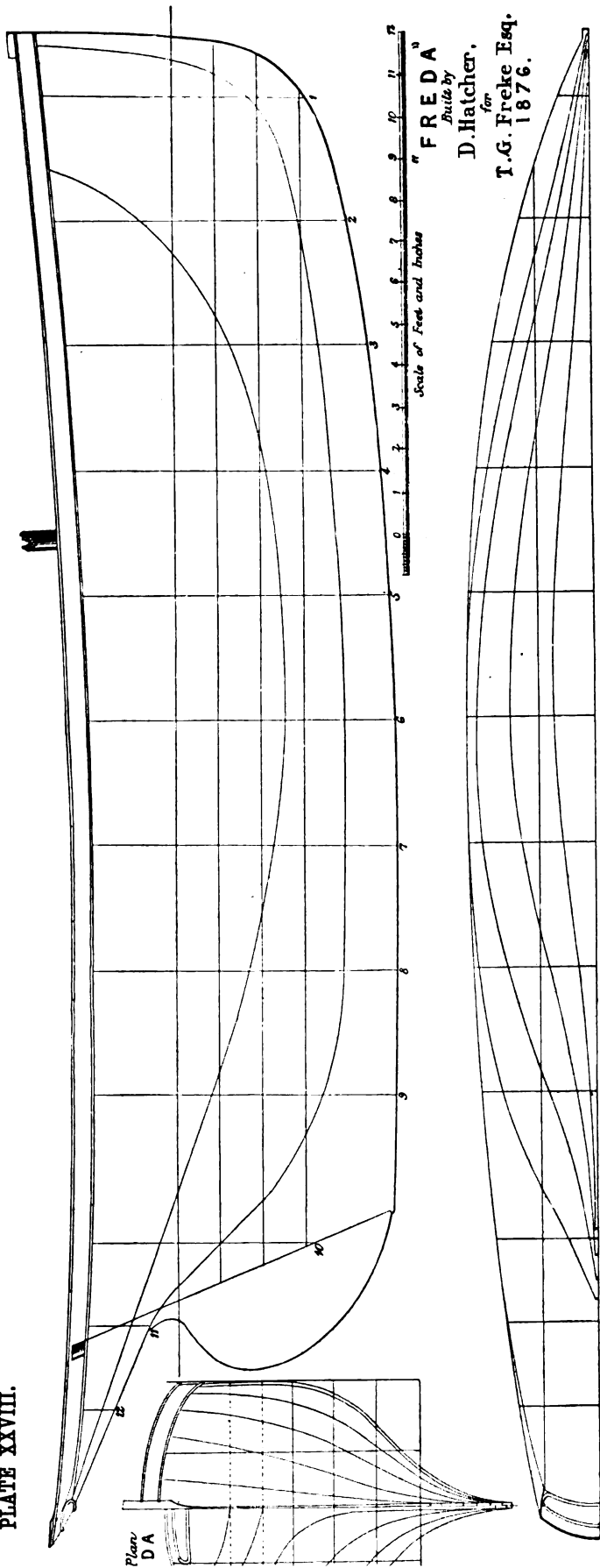
"LORELEI"

4 1/2 tons

Designed and owned by
T. Wynne Eytton Esq.,
1878.

Length on L.W.L. 31 ft 6 in
Beam extreme 6 ft.
Draught of water 5 ft. 4 in

PLATE XXVIII.



TEN-TONNERS.

The design for the yacht of 5 tons can be used for one of 10 tons by multiplying all the *linear* measurements by 1.25; or by dividing the *linear* measurements by 0.8. Thus, take the length on the water-line of the 5-tonner as an example. The length is 32ft., then

$$32 \times 1.25 = 40; \text{ or } \frac{32}{0.8} = 40.$$

The cubic quantities will, of course be doubled, and it might appear to be a rather anomalous condition for a yacht of "10 tons" racing tonnage to have 18 tons actual weight or displacement; but such an apparent anomaly is very likely to occur whilst only two dimensions are used in the Y.R.A. tonnage rule to express nominally a quantity in cubic measure. We apprehend no objection to a "10-ton" yacht having 18 tons displacement, providing so much weight secures some good quality not otherwise obtainable at so small a cost. For instance, say a yacht 40ft. long has to carry 1200 square feet of canvas in her lower sails to obtain a given speed; this sail, we know by experience, a yacht can carry if she has about 9ft. beam, 6ft. 6in. draught of water, and 18 tons displacement. But then such a yacht would be termed by Y.R.A. measurement $13\frac{1}{2}$ tons; and, as Y.R.A. "tons" are a kind of assessment, the object of every yacht designer is to design a craft that can carry the sail and obtain the given speed, and yet be assessed at less than some given value, say $13\frac{1}{2}$ tons. The design we give (Plate XXVI.) has been prepared with a view of obtaining the utmost advantage out of the Y.R.A. rule. It is for a 10-tonner, 40ft. long, and only 7ft. 7in. in breadth; but, by virtue of increased depth, she has the displacement and sail area of a 13-ton craft, 40ft. by 9ft., and in all probability would be the equal of such craft in point of speed. In designing a yacht of such extreme proportions the main things to consider will be a sufficiency of depth, a proper amount of displacement, and as small a frictional surface as possible. The principal dangers of increasing the depth are these: too great displacement may be the result, and too large an area of wetted surface. The inconvenience of too great displacement is that, with any given length, the entrance or the run may be too full, or the middle body may be too full, so that when high speeds are contemplated exaggerated wave-making would be the result. This inconvenience may, however, exist with a comparatively small displacement, but of course will be less pronounced.

The objection to an excessive area of wetted surface is that at low velocities, or in light winds, the frictional resistance will be exaggerated, and the results anticipated from the large sail area may entirely fail.

To avoid a too great displacement, a suitable quantity was determined upon at the outset in making the design for a 5-tonner; and to avoid any unfair fulness, it was disposed of on the wave principle by Mr. Colin Archer's formulæ (see *ante*, page 49). In order that the fore body might be of the wave form, without being unduly lean, it was necessary to cut away the fore foot, or what is usually termed gripe, as much as possible, and this condition necessarily involved that the depth of body amidships should be great. Here two objects were at once secured: a reduction of wetted surface, where it most needs reduction on account of the intensity of the friction on the surface of the fore body; and the practicability of stowing the weights at a great depth to compensate for the reduction in beam. To what extent the objects sought have been attained can only be surmised by a comparison with other yachts of similar pretensions. In point of length and breadth the Florence affords an example, judged through the Y.R.A. rule, that enormous advantage, so far as speed goes, is dependent upon length irrespective of beam. The Florence, however, has, compared with the design, a moderate draught of water and displacement, and she is not conspicuously stiff, although so very fast at reaching. The Lily, on the other hand, whilst not conspicuous for speed, is an example of the influence great stiffness has on weatherliness.

The design has greater length than the Florence, and larger sail area, and yet would be much stiffer. Her wetted surface is probably about the same, and the conclusion is that she should have greater speed in strong winds. The only circumstance to excite doubt about this is the displacement; but, as it has been so carefully disposed, it is unlikely that it will interfere with the anticipated speed qualities.

With regard to the sail area, it will be observed that it is greater than is the sail area of either Florence, Lily, or Quiraing. The lower mast, however, is comparatively short, but the boom is long. The spar plan was purposely planned like this for two good reasons: in the first place, a long heavy mast very seriously interferes with stability; and further, for any given area, a high narrow sail has a much greater heeling moment than a low broad one. However, there is nothing unusual in the length of boom to length of mast, as it is exactly in proportion to the length of boom and mast of Formosa. The bowsprit is comparatively short, but the foresail is large; and it is expected that the sail plan would, on a wind, be found well balanced.

COMPARATIVE TABLE OF ELEMENTS OF TEN-TONNERS.

| | Design. | Lily. | Florence. | Quiraing. |
|--|----------------|----------------|--------------|--------------|
| | ft. in. | ft. in. | ft. in. | ft. in. |
| Length on deck, stem to sternpost | 42 3 | 37 9½ | 39 8½ | — |
| Length on load water-line | 40 0 | 36 6½ | 38 6 | 38 7½ |
| Rake of sternpost from plumb line, 4ft. in length | 2 3 | 2 1 | — | — |
| Breadth moulded | 7 4½ | 7 10½ | — | — |
| Breadth extreme | 7 7½ | 8 1 | 7 9½ | 7 9½ |
| Extreme draught of water | 7 6 | 6 9 | 6 6 | — |
| Mean draught of water | 6 1½ | 5 11 | — | — |
| Area of load water-plane | 209 sq. ft. | 200 sq. ft. | — | — |
| Area of midship section | 29 sq. ft. | 21·2 sq. ft. | — | — |
| Area of vertical longitudinal section ... | 245 sq. ft. | 216 sq. ft. | — | — |
| Area of immersed surface | 550 sq. ft. | 530 sq. ft. | — | — |
| Area of canvas per square foot of wetted surface | 2·33 sq. ft. | 2·06 sq. ft. | — | — |
| Displacement in tons | 18 tons | 18 tons | 12·9 tons | — |
| Midship section abaft centre of length of L.W.L. | 1·9ft. | 1·45ft. | — | — |
| Centre of buoyancy ditto | 1·25ft. | 0·96ft. | — | — |
| Centre of lateral resistance ditto | 2·5ft. | 1·35ft. | — | — |
| Centre of effort of lower sails ditto | 1·7ft. | 1·5ft. | — | — |
| Centre of buoyancy below L.W.L. | 2·07ft. | 1·65ft. | — | — |
| Centre of lateral resistance ditto | 3·25ft. | — | — | — |
| Metacentre above centre of buoyancy ... | 1·1ft. | 1·76ft. | — | — |
| Centre of effort of sails above L.W.L. | 19·4ft. | 18·9ft. | 19·4ft. | 19·5ft. |
| Ballast inside | 6 tons 10 cwt. | 2 tons 12 cwt. | — | — |
| Ballast outside | 4 tons 10 cwt. | 4 tons 3 cwt. | — | — |
| Total ballast | 11 tons | 6 tons 15 cwt. | — | — |
| Tonnage Y.B.A. | 9½ tons | 9½ tons | — | — |
| Mast, deck to hounds | 26 0 | 25 0 | 27 0 | 27 9 |
| Masthead | 5 3 | — | — | — |
| Diameter at deck | 7in. | 6½in. | — | — |
| Main boom | 36 0 | 30 6 | 32 6 | 33 0 |
| Greatest diameter | 6½in. | 5½in. | — | — |
| Gaff | 25 0 | 23 0 | 24 3 | 24 0 |
| Bowsprit outboard | 16 0 | 17 0 | 19 0 | 20 0 |
| Diameter at stem | 5½in. | 6½in. | — | — |
| Topmast, fid to hounds | 24 0 | 24 0 | 22 9 | 25 9 |
| Topsail yard | 24 0 | — | — | — |
| Spinnaker boom | 40 0 | — | — | — |
| Centre of mast from fore side of stem at deck | 16 6 | 15 5 | 15 3 | 15 0 |
| Luff of mainsail | 22 3 | — | 23 6 | 24 6 |
| Leech of mainsail | 43 6 | — | — | 44 6 |
| Angle of gaff with horizontal | 53° | 53° | 53° | 53° |
| Area of mainsail | 890 sq. ft. | 722 sq. ft. | 860 sq. ft. | 870 sq. ft. |
| Area of foresail | 180 sq. ft. | 162 sq. ft. | 170 sq. ft. | 175 sq. ft. |
| Area of jib | 222 sq. ft. | 211 sq. ft. | 240 sq. ft. | 245 sq. ft. |
| Total area of lower sail | 1292 sq. ft. | 1095 sq. ft. | 1270 sq. ft. | 1290 sq. ft. |

TABLE OF OFFSETS FOR TEN-TONNER (SEE PLATE XXVI).

| No. of Section | 1 | 2 | 3 | 4 | 5 | 6 | 7 | 8 | 9 | 10 | 11 | 12 | 13 | 14 |
|---|---------|---------|---------|---------|---------|---------|---------|---------|---------|---------|---------|---------|---------|---------|
| | ft. in. | ft. in. | ft. in. | ft. in. | ft. in. | ft. in. | ft. in. | ft. in. | ft. in. | ft. in. | ft. in. | ft. in. | ft. in. | ft. in. |
| Heights above L. W. L. to plank sheer | 3 7 | 3 3 | 3 0 | 2 9½ | 2 8 | 2 6½ | 2 6 | 2 5½ | 2 5 | 2 5½ | 2 5½ | 2 6½ | 2 7½ | 2 9 |
| Depths below L. W. L. to stepping line | 2 10 | 4 5 | 5 1 | 5 6 | 5 7 | 5 7½ | 5 5 | 4 10½ | 4 0 | 2 9 | 1 4 | 1 0 | — | 2 9 |
| Half-breadths on deck | 1 8 | 2 7 | 3 1½ | 3 5½ | 3 7 | 3 6½ | 3 6 | 3 5½ | 3 4½ | 3 3½ | 3 1½ | 2 10½ | 2 7½ | 2 3½ |
| Half-breadths 1ft. 10in. above L. W. L. | 1 4½ | 2 4½ | 3 1 | 3 6 | 3 8 | 3 6½ | 3 6 | 3 5½ | 3 4½ | 3 3 | 3 0½ | 2 9½ | 2 2 | — |
| Half-breadths 1½in. above L. W. L. | 1 2 | 2 1½ | 2 11½ | 3 5½ | 3 8½ | 3 8 | 3 7 | 3 5½ | 3 5 | 3 3 | 3 0 | 2 6½ | 2 2 | — |
| Half-breadths on the L. W. L. | 0 11 | 1 11 | 2 9½ | 3 5 | 3 7½ | 3 6½ | 3 5 | 3 2½ | 2 10½ | 2 3½ | 1 5½ | 0 8½ | — | — |
| Half-breadths No. 2 W. L. | 0 7 | 1 6 | 2 4½ | 3 1 | 3 4 | 3 2 | 2 10½ | 2 6 | 1 11 | 1 2 | 0 4 | — | — | — |
| Half-breadths No. 3 W. L. | 0 8 | 1 0 | 1 10 | 2 5½ | 2 7½ | 2 4 | 1 11½ | 1 6½ | 0 11½ | 0 4 | — | — | — | — |
| Half-breadths No. 4 W. L. | — | 0 6 | 1 0½ | 1 6½ | 1 8½ | 1 4½ | 1 1 | 0 8½ | 0 4 | — | — | — | — | — |
| Half-breadths No. 5 W. L. | — | — | 0 4 | 0 7½ | 0 9½ | 0 8 | 0 6½ | 0 4 | 0 2 | — | — | — | — | — |

No. 1 section is 4ft. 4½in. from the fore side of the stem at the L. W. L.

Nos. 1, 2, 3, 4, 5, and 6 sections are 4ft. 4½in. apart.

Nos. 6, 7, 8, 9, 10, 11, 12, 13, and 14, are 2ft. 2½in. apart.

The water-lines are 1ft. 3in. apart.

All the half-breadths are given without the plank.

The heights above the L. W. L. are exclusive of the covering board.

Siding of stem and sternpost, 4½in.

Siding of keel amidships, 10½in.

Moulded depth of keel, 8½in.

Timbers, 2½in. sided.

Timbers, 3½in. moulded at heels, 2in. at heads.

Spacing, centre to centre, 2ft. 2½in.

Bent timbers, 1½in. sided, 1½in. moulded between each out timber.

Garboard strake, 1½in. American elm.

Plank, 1½in.; deck plank, 1½in.

Deck beams, 2½in. sided, 2½in. moulded.

NOTE.—It must be understood that in "laying-off" a yacht, either from a drawing or from offsets, some "fairing" will be necessary; and this "fairing" should be very carefully performed before the moulds are made.

CHAPTER XXV.

LOUGH ERNE YACHTS.

THE shallowness of the upper waters of Lough Erne, and the turbulence of the lower, have necessitated a kind of compromise between the shallow American centre-boarder and the deeper-bodied English yacht. A large fleet—some thirty or forty—of these centre-board yachts are on the Lough, and most of them were designed and built by their owners. The Witch (Plate XXIX.) was designed and built by Mr. Edward Saunderson, and is a very capable boat, both on the smooth and narrow water of the Upper Lake, and in strong breezes on the rougher water of the Lower Lake.

The centre-plate or “dipper” is made of $\frac{1}{2}$ in. boiler plate, and is pivoted inside the case. A slot, *a*, is cut inside the case $1\frac{1}{4}$ in. deep, and 2in. wide, the lips of which are protected by iron plates. A short iron bolt or stud projects on either side of the plate, and travels in the slot. The board can be raised bodily by two tackles, as shown; but in sailing it is usual only to raise the after end. The fall *k* leads over the drum of a winch at *w*. At *w* is also a sheave for the pennant part of the tackle, *m*, which lifts the fore end of the board. This sheave is fitted at one end of the barrel of the winch.

The Witch has oak frames 2ft. 6in. apart, with $\frac{1}{2}$ in. wrought iron floor-knees. Between each pair of frames is a steamed timber of American elm.

| | |
|-----------------------------|---------------|
| Length on load-line | 38ft. |
| Beam, extreme | 12ft. 4in. |
| Displacement..... | 12 tons. |
| Lead on keel | 3 tons. |
| Lead inside..... | 3 tons 9 cwt. |
| Iron centre-plate | 11 cwt. |
| Iron floors | 7 tons 3 cwt. |
| Mast, deck to hounds | 38ft. |
| Masthead | 5ft. |
| Main boom..... | 42ft. |
| Main gaff | 26ft. |
| Bowsprit outside stem | 26ft. |
| Topmast..... | 18ft. |
| Luff of mainsail..... | 29ft. |
| Area of mainsail | 1175 sq. ft. |
| „ jib | 575 sq. ft. |
| „ foresail..... | 230 sq. ft. |
| „ topsail | 378 sq. ft. |

TABLE OF OFFSETS FOR LOUGH ERNE YACHTS.

| No. of Section | 1 | | 2 | | 3 | | 4 | | 5 Mid. | | 6 | | 7 | | 8 | | 9 | |
|--|-----|-----|-----|-----|-----|-----|-----|-----|-----------|-----|-----|-----|-----|-----|-----|-----|-----|-----|
| | ft. | in. | ft. | in. | ft. | in. | ft. | in. | ft. | in. | ft. | in. | ft. | in. | ft. | in. | ft. | in. |
| Heights from L.W.L. to covering board. | 3 | 5 | 3 | 0½ | 2 | 7½ | 2 | 3 | 2 | 1 | 1 | 11½ | 2 | 0 | 2 | 3 | 2 | 6 |
| Depths from L.W.L. to lower edge of rabbet of keel | 2 | 1 | 2 | 4 | 2 | 8 | 2 | 11 | 3 | 2 | 3 | 0 | 2 | 1 | 0 | 3 | — | — |
| Half-breadths on deck | 1 | 5 | 3 | 6 | 5 | 0 | 5 | 11 | 6 | 2 | 6 | 0 | 5 | 6 | 4 | 8 | 3 | 7 |
| Half-breadths on L.W.L. | 0 | 9 | 2 | 5 | 4 | 2 | 5 | 8 | 6 | 1 | 5 | 9 | 4 | 4 | 0 | 7 | — | — |
| Half-breadths No. 2 W.L. | 0 | 6 | 1 | 6 | 3 | 10 | 4 | 2 | 4 | 7 | 3 | 8 | 1 | 2 | 0 | 2½ | — | — |
| Half-breadths on diagonal <i>p</i> | 1 | 3 | 3 | 1 | 4 | 7 | 5 | 8½ | 6 | 1½ | 5 | 7 | 4 | 6 | 2 | 10 | 0 | 5 |
| Depths below L.W.L. on buttock line <i>x</i> . | — | — | — | — | 1 | 1½ | 1 | 9 | 1 | 10¼ | 1 | 6 | 0 | 7 | — | — | — | — |
| Heights above L.W.L. on buttock line <i>x</i> | — | 1 | 1½ | — | — | — | — | — | — | — | — | — | — | 0 | 8½ | 2 | 0½ | — |

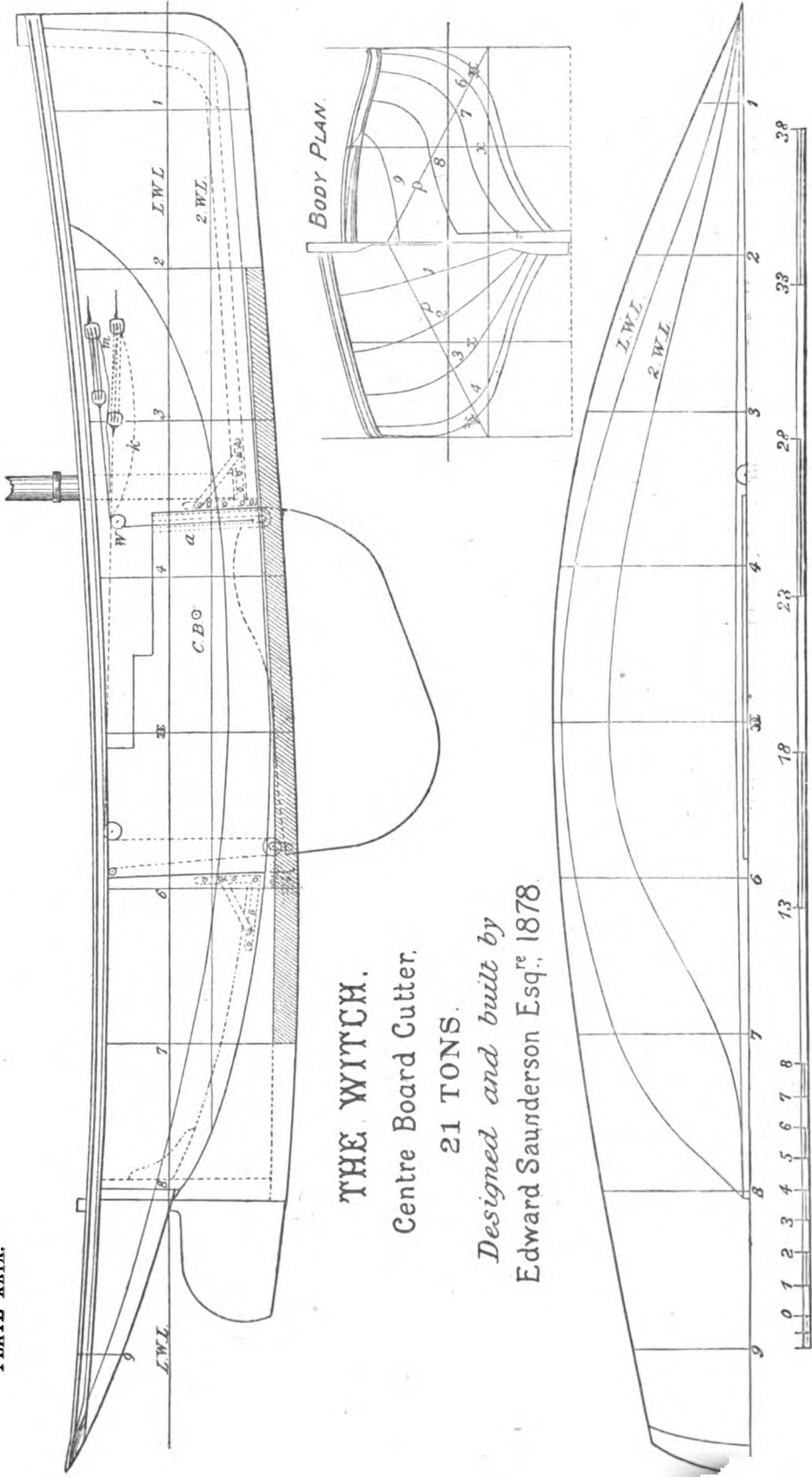
No. 1 section is 3ft. 1in. from fore side of stem. The remaining sections are 5ft. apart. The midship section is shown on both sides of the body plan. Every other section is left out, the frames being 2ft. 6in. centre to centre, with a steamed frame between these, making the actual spacing 1ft. 3in. centre to centre.

No. 2 water-line is 1ft. 3in. below L.W.L.

Diagonal *g g* is struck on middle line 1ft. 11in. above the L.W.L. (See Body Plan.)

The buttock line *x x* is 3ft. out from middle vertical line of body plan. This buttock line is shown in the sheer plan.

Sometimes whilst sailing in shallow water the after end only of the dipper is raised; and at all times with the fore end below the keel the lateral resistance is found to be very effective.



THE WITCH.

Centre Board Cutter.

21 TONS.

*Designed and built by
Edward Saunderson Esq., 1878.*

CHAPTER XXVI.

BOATS OF THE IRISH MODEL YACHT CLUB.

At Kingstown the Irish Model Yacht Club have instituted races for boats of 18ft. length on the load-line, and the contests between these small craft are very keen, and in a breeze some fine examples of boat sailing may often be seen. The rules require that the boats shall not exceed 18ft. length, and that they shall have no counter. The club have also instituted a class for "three tonners," and it occurred to Mr. Ardagh E. Long, one of the many good boat sailers at Kingstown, that an 18ft. boat might also be a three-tonner. With this object in view he designed the exceedingly nice-looking boat *Heathen Chinee*, depicted on Plate XXX.

| | HEATHEN CHINEE. | LANTER. |
|------------------------------|-----------------|-------------------|
| Length | 18ft. | 17ft. 11in. |
| Breadth, extreme | 7ft. | 5ft. 2in. |
| Draught, extreme | 4ft. 3in. | 4ft. |
| Displacement | 3·5 tons. | 3·5 tons (about). |
| Ballast inside (iron) | 12cwt. | 1 ton 16cwt. |
| Ballast on keel (iron) | 1 ton 2cwt. | None. |
| Mast, deck to hounds | 16ft. 6in. | 14ft. 3in. |
| Pole | 8ft. | 9ft. 9in. |
| Boom, extreme | 18ft. | 18ft. |
| Gaff | 14ft. | 13ft. 8in. |
| Bowsprit outboard | 8ft. 3in. | 9ft. |
| Topsail yard | 18ft. | 18ft. |

Generally the proportion of beam to 18ft. length is from 5ft. 6in. to 5ft. 8½in., and two considerations have thus limited the beam. In the first place it has not been anticipated that a three-tonner with only 18ft. length could compete with a three-tonner of 25ft. or upwards, and so the beam of the 18ft. boats has been kept down to that necessary to make two tons, for the sake of time allowance; in the second place, in the 18ft. class time is allowed by a rule of length and beam added together. For these two reasons beam has usually been limited to the proportions named. The boats have, however, not been successful in the three-tons

class, and it is a moot point whether they would not have been better for a little more beam. They have about the same displacement as *Heathen Chinee*, but are a trifle deeper in the body; they are undeniably fast along the wind, but do not carry their canvas quite so well as they might, that is, in comparison with the three-tonners. Whether *Heathen Chinee*, with her greater beam, will be successful against her narrower compeers in the 18ft. class, and in the three-ton class as well, has yet to be put to the proof.

The *Ianthe* is the narrowest boat of the class, and is cutter rigged; but the hitherto most successful boat, *Shrimp*, has a few inches more beam, and is sloop rigged, as will be *Heathen Chinee*. The one headsail is set flying with tack to bowsprit end like a jib, and *Heathen Chinee* will have as many as four jibs to suit different points of sailing, strength of wind, or reduced mainsail. The forestay is set up to the stem by a lanyard, and on going about the clew of the headsail is, of course, hauled round this stay.

The topsails are very peaked, similar to *Alert's* (see Plate XI.), the tack being fast to the heel of the yard. A spinnaker is carried, and the booms for the same are usually longer than the boat—the *Shrimp's* being about 24ft. long.

The boats are actually only half open, as they are decked forward and aft, with a large cockpit amidships. The *Ianthe* had a movable deck (formed with cockpit) so as to be qualified as a real open boat. The deck was a heavy one of 2in. pine, screwed down to a stout gunwale with strips of india-rubber listing between.

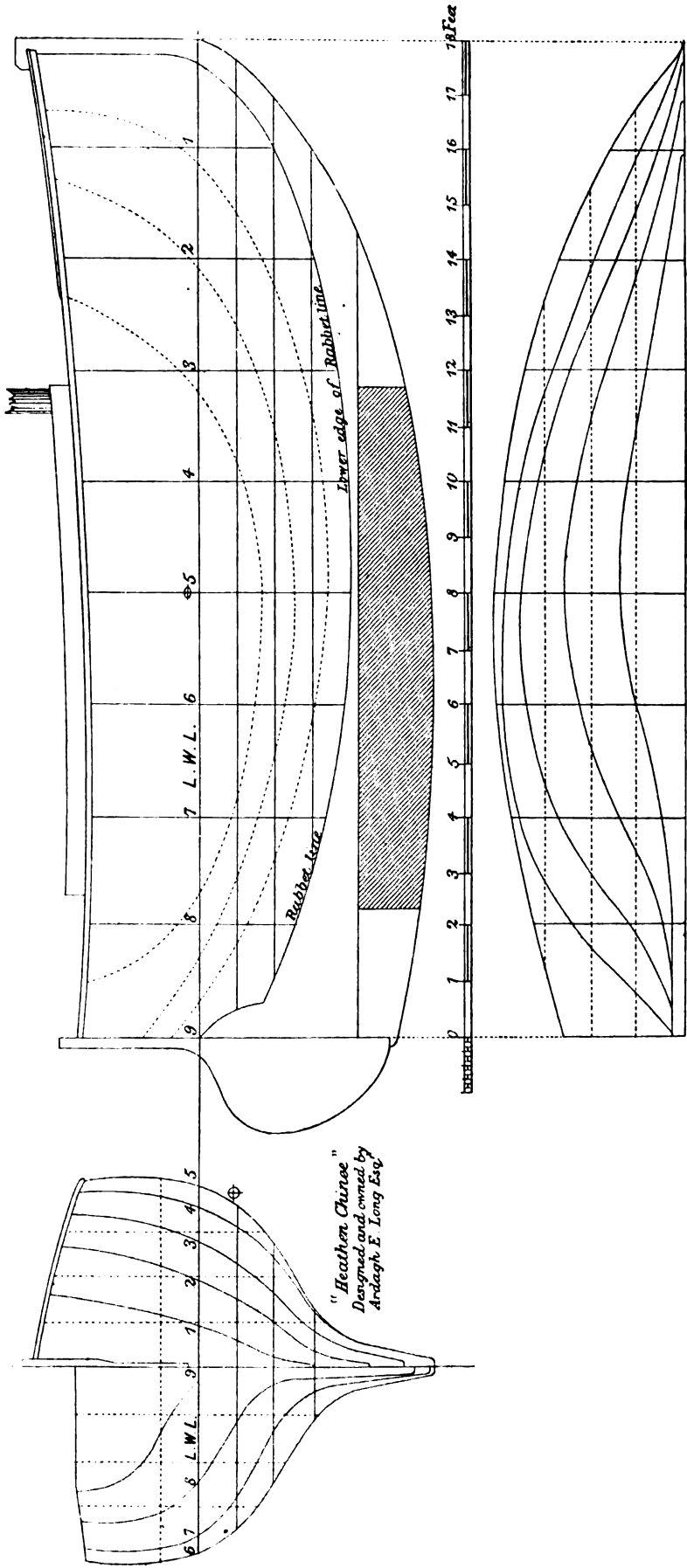
In the 18ft. class counters are not allowed, even though they be included in the 18ft. length; but, nevertheless, counters are found to be of such service to the boats, and so convenient in working the long boom that most of them are fitted with movable counters, which are fixed when it is not *de rigueur* to sail without one.

The counter is usually about 4ft. long, and is framed and planked. The fore end corresponds to the transom, but is fitted with a rudder case or trunk, of which *t* in Fig. 103 is a section. Fig. 104 represents a fore end view of the counter; *a, a, a, a*, are large $\frac{1}{2}$ in. washer plates screwed to the end frame; *b, b, b, b*, are $\frac{3}{4}$ in. bolts with large heads, so as to have a good grip of the washers. On the fore side of the transom frame of the boat similar washers are fitted, and the bolts thereon are screwed up tightly by thumb-screws, as shown by *s s*, Fig. 105. The counters are securely held by this arrangement; but if additional strength were required to meet any unusual strain, a tye rod might be used similar to that recommended for the *Windermere* boats (see Fig. 106).

If accurately and securely fitted these counters look well and answer well, but viewed end on appear rather narrow on account of the "tuck up"



PLATE XXX.



"Heathen Chinese"
Designed and owned by
Ardagh E. Long Esq.

Irish Model Yacht Club Sailing Boat "Heathen Chinese."

and narrowness of the transom, necessary for sailing as a square-sterned boat. (See remarks on this subject in reference to fitting counters to the Itchen boats, p. 340).



FIG. 103.

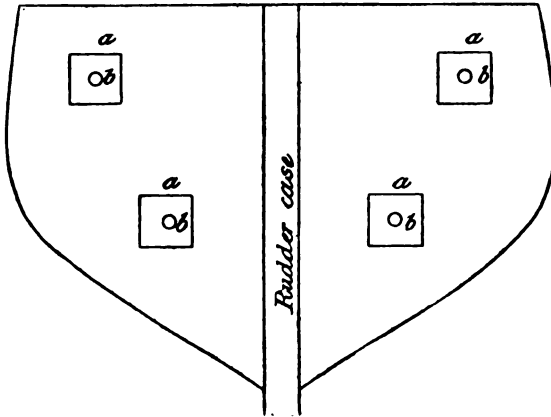


FIG. 104.



FIG. 105.

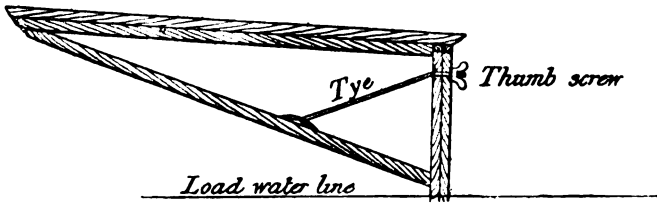


FIG. 106.

The lines of the Heathen Chinee are represented on Plate XXX., but the following table of "offsets" will be referred to in making moulds for building.

| No. of Section | 1 | 2 | 3 | 4 | 5 Midship | 6 | 7 | 8 | 9 Transom. |
|--------------------------------------|-------|-------|------|-------|--------------|-------|------|------|---------------|
| Heights to covering board *..... | 2 8 | 2 5½ | 2 3 | 2 1½ | 2 0½ | 2 0 | 2 0½ | 2 0½ | 2 2 |
| Depths to rabbet † | 1 5 | 2 1 | 2 6 | 2 8 | 2 9 | 2 7½ | 2 3 | 1 8 | — |
| Half-breadths on deck | 1 3½ | 2 2½ | 2 10 | 3 3 | 3 5 | 3 4½ | 3 2½ | 2 9 | 2 2½ |
| Half-breadths 8in. above L.W.L. | 0 11½ | 1 10½ | 2 7½ | 3 2 | 3 5½ | 3 5½ | 3 3½ | 2 7½ | 1 1½ |
| Half-breadths on L.W.L. | 0 9½ | 1 7½ | 2 4½ | 2 11½ | 3 3½ | 3 4½ | 3 0½ | 2 1 | 0 2 |
| Half-breadths W.L. 2 | 0 6 | 1 3 | 2 0 | 2 7 | 2 11½ | 2 10½ | 2 3½ | 0 11 | 0 2 |
| Half-breadths W.L. 3 | 0 2½ | 0 9 | 1 4½ | 1 11 | 2 2 | 1 11½ | 1 2 | 0 3½ | 0 2 |
| Half-breadths W.L. 4 | — | 0 3½ | 0 8½ | 1 0½ | 1 1½ | 0 10½ | 0 4½ | 0 2 | 0 2 |

The water-lines are 8in. apart.

The sections are 2ft. apart.

All the half-breadths include the plank.

* Underside of covering board.

† Lower edge of rabbet.

CHAPTER XXVII.

PENZANCE LUGGERS, GALWAY HOOKER AND POOKHAUN, NORWEGIAN PILOT BOAT, &c.

PENZANCE LUGGERS enjoy a very considerable reputation for weatherliness, and it has even been said that in this quality they exceed the famous cutter yachts of this kingdom. Be this as it may, there is no doubt that with two large and well cut sails, a sharp entrance, and equally sharp run, they are highly adapted for sailing by the wind. They vary in length from 40ft. to 52ft. length of keel, and have a good proportion of beam, usually a little less than one-third the length on deck, or about 0·3 of that length. The greatest beam is on deck, the turn of the bilge is very easy, and the floors nearly straight, with but little dead rise. The displacement of the boats is comparatively small, and although the greatest transverse section is ahead of the centre of length of load line, yet is the centre of buoyancy a little abaft that centre. The displacement of the fore-body and the displacement of the after-body are thus nearly equal, and this is accounted for by the more or less rake given to the mid-section—so that practically the mid-section is not so far forward as the position shown in the drawing—and to the steepness of the buttock lines aft and the lightness of the draught forward. It will be observed that there is little or no dead wood aft, in fact it is “all vessel” there, and the comparative fulness of the buttock lines is compensated for by the fineness of the horizontal or water lines, as shown in the Half Breadth Plan. It is said that the Penzance luggers are wonderfully dry in a head sea, and they are particularly lively. They have long easy lines; an almost perfectly balanced fore and after body; no weight in the ends; no heavy bowsprit, or boom, or rigging; and not a large weight of ballast to carry. The mast, it is true, is stepped rather far forward, but the absence of a bowsprit more than compensates for this, and, whilst it may increase the momentum acquired during pitching and scending, it does not cause them to plunge their bows under. A smaller class of lugger, built on the same lines,

but about 30ft. on the keel, for the Pilchard fishing, are open in the middle, and only decked fore and aft. One of these boats went to Australia in 1848 with five hands for the "diggings." She called off the Cape and took the mails to Melbourne, actually beating the regular Packet, although she had to make a raft or floating anchor of her spars to ride to during a heavy gale.

It is claimed that the Penzance luggers are capable of very high speed, and although they are not asserted to have done such wonderful things as the Yorkshire luggers have, there is no doubt that they are capable of attaining a speed equal to that attained by any other craft of similar length. The design we give (Plate XXXI.) is that of the Colleen Bawn, built at Penzance, by Mr. J. R. Wills, and she is one of the fastest luggers yet built in the west. It will be seen that she has about the length of load line of a racing 20-tonner, but has 5ft. more beam than any such yacht has, and less draught of water. However the "Dewdrop," also built by Mr. Wills, could beat her in a breeze, although she was only 45ft. on the keel and had no counter. The Dewdrop was bought by Mr. T. G. Freke, and fitted up as a yacht. He gave her new spars and a couple of "lugs" which were of unusual size, the bumpkin outrigger for the mizen being 29ft. outboard; still there was not spread enough for the mizen, and a foot-yard was used after the fashion of the foot-yard to a balloon topsail. She had a mizen staysail and was very remarkable for her close-windedness.

The rig it will be seen, upon reference to Fig. 109 (page 377), consists of two lug sails, usually made of cotton and tanned with oak bark and catechu. The fore lug has to be dipped in tacking, but the mizen is a working one and requires no dipping, the tack being made fast at the mast. There is no rigging to either mast, beyond a burton to the foremast and a stay to the mizen. The burton is brought to windward of the mast, and so is the tye-tackle.

The sails are seldom reefed, and they are made with only one reef band. When it is necessary to shorten sail, the mizen is shifted forward and a smaller mizen set; and this shifting goes on until the small "watch" mizen (used when riding to the nets with foremast unshipped) is reached. The boats are usually provided with the large fore lug, and three mizens besides the watch mizen. They cannot very well be hove to, and have to be kept "trying" by the wind or scudding before it; however, it must be a heavy gale that causes them to "up-helm," and then no craft of similar size afloat can excel them in running for the land.

The sail is hoisted by a chain halyard called a tye and a tackle or purchase, consisting of two double blocks, the fall leading from the lower

block. The sheave hole at the masthead for the tye has only a "dead sheave," that is, a half sheave fitted in the hole. The mast traveller is two half hoops jointed together by eyes, and they are said never to jam (see "Traveller" in the Appendix). The tack of the fore lug is hooked to the short bumpkin outside the stem head, but when the other mizen-lugs are shifted forward the tack is hooked to the stem head. The fore sheet tackle is hooked to an outrigger outside on the wales just abreast of the mizen mast.

The mizen stay tackle is hooked to a ring bolt in the centre of the deck.

The mizen sheet is fitted in this way (see Fig. 107): on the bumpkin* is an iron traveller, to the underside of which the chain sheet is fast; the sheet is rove up through a sheave hole at the end of the bumpkin

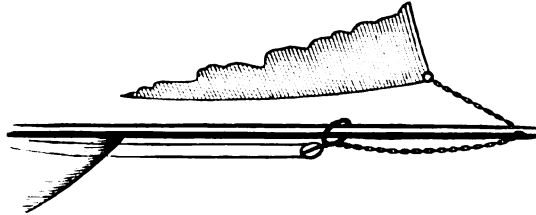


FIG. 107.

and hooked to the clew of the mizen. A block is hooked to the traveller, through which a rope is rove, one end being made fast on board. There are no stays to the bumpkin.

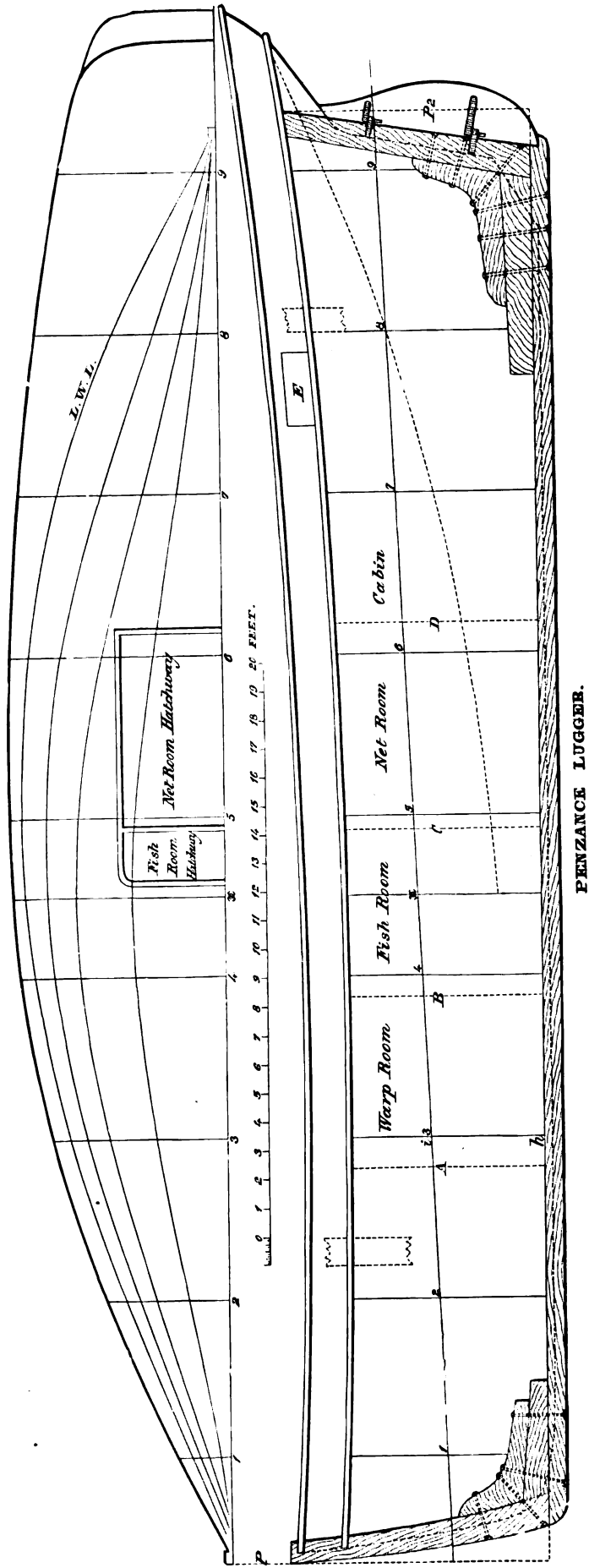
In tacking, the sheet is unhooked from the sail as the helm is put down; as the boat comes head to wind, the halyards are eased up and the after-leach of the sail hauled down upon until the after-end of the yard or peak can be shifted round by the fore-side of the mast; the tack is never started. The sail is gathered in by the foot and leech, and passed round the fore-side of the mast. By not letting go the tack the fore-part of the sail acts as a jib, and assists in paying the boat's head off. If the boat does not pay off readily, the foreyard is kept into the mast so that only the fore-part of the sail can fill, and the mizen sheet is let fly.

In the mackerel season, from February to July, they carry about one and a quarter mile of nets on the S.W. coast of Ireland. In the herring season, from October to January, they carry from half to three-quarters of a mile of nets on the S.W. coast of England.

When hauling or shooting the nets, rollers are fixed on the coamings of the hatchways and on the rail of the bulwarks, to enable the nets

* Called outrigger in the West country

PLATE XXXI.



to run well and to prevent their being damaged. Before the net is shot over the side, a shoot rope is bent to the head of the net by stops. The stops are long enough to allow the shoot rope to lie about half way down the net. The use of this rope is to save the nets, should a vessel sail through and cut them. The boats ride to the nets by this rope.

The boats are usually manned by six men and a boy, who are employed as follows: Two at the capstan getting in the net; one forward to cast off the stops of the shoot rope; two at the net-room hatchway to shake out the fish, and stow the net; one at the helm, and the boy to coil away the shoot rope.

It will be noticed upon reference to the Body Plan and Sheer Plan that the top of the keel, and *not* the load water-line, is the base line from which all heights are measured. All the sections shown in the Sheer Plan are therefore perpendicular to the base line or keel, and not to the load water-line. The curved lines shown in the Body Plan are water-lines; they are set off in this way: in the Sheer Plan (Plate XXXI.) at No. 3 section, measure the distance from *h* to *i*; set off this distance on the middle line (*o*) of the Body Plan as at *j*, measured from the base line; then draw the ticked line *t* at right angles to *o*, and where this line cuts No. 3 section at *v* will be the spot for the water-line on that section. The points in the other sections will be similarly found, and, when complete, a line drawn through the spots will represent the water-line, and will be more or less curved.

| No. of Section | 1 | 2 | 3 | 4 | κ | 5 | 6 | 7 | 8 | 9 |
|---|-------|-------|------|------|------|-------|------|-------|-------|-----|
| SHEER PLAN. | | | | | | | | | | |
| Heights from top of keel to covering board..... | 7 0 | 6 11 | 6 10 | 6 10 | 6 10 | 6 11 | 7 1 | 7 5 | 7 10 | 8 6 |
| Depths from L.W.L. to top of keel | 3 5 | — | — | — | — | — | — | — | — | 5 4 |
| BODY PLAN. | | | | | | | | | | |
| Half-breadths at deck | 1 9½ | 4 2½ | 6 0 | 7 0 | 7 3 | 7 3½ | 7 3 | 6 11 | 6 4½ | 5 6 |
| Half-breadths, <i>a</i> diagonal | — | — | — | — | — | 7 10½ | 7 9 | 7 4½ | 6 4 | 4 4 |
| Half-breadths, <i>g</i> diagonal | 1 9½ | 4 3½ | 6 2½ | 7 3½ | 7 6½ | 7 7½ | 7 4 | 6 6½ | 4 11½ | 2 2 |
| Half-breadths, <i>k</i> diagonal | 1 7¼ | 4 1 5 | 9¼ 6 | 7½ 6 | 9¼ 6 | 9¼ 6 | 1 4 | 10 3 | 2 0 | 9 |
| Half-breadths, <i>m</i> diagonal | 1 5 3 | 5½ 4 | 7½ 5 | 1 5 | 0½ 4 | 9½ 4 | 0¼ 2 | 11½ 1 | 8½ 0 | 4½ |
| Half-breadths, <i>n</i> diagonal | 1 0 2 | 3 2 | 9 2 | 10 2 | 8¼ 2 | 6 2 | 0 1 | 4¾ 0 | 9½ 0 | 3 |

All the half-breadths are without the plank.

No. 1 section is 3ft. 8in. from the fore perpendicular P. The other sections are 5ft. 8in. apart, and No. 9 section is 2ft. from the aft perpendicular P 2.

All the half-breadths given are without the plank.

The water-lines shown in the Half-breadth Plan are 1ft. apart in the Body Plan.

Diagonal *a* is struck 9ft. above the base line, and cuts the perpendicular *p* 6ft. above the base line.

Diagonal *g* is struck 7ft. 4in. above the base line, and cuts *p p* at *g* 1 and *g* 2 at 4ft. 9in. above the base line.

Diagonal *k* is struck 5ft. 11in. above the base line, and cuts *p p* at *k* 1 and *k* 2 at 2ft. 11in. above the base line.

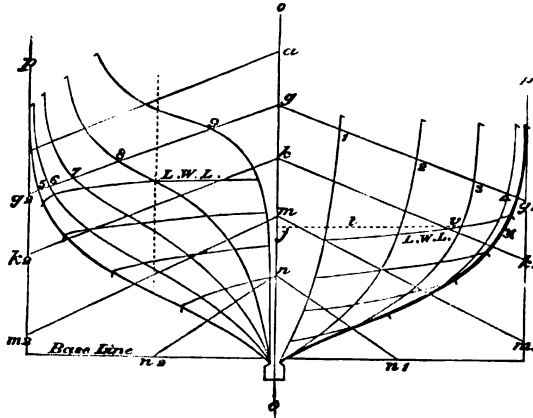
Diagonal *m* is struck 4ft. 2in. above the base line, and cuts *p p* at *m* 1 and *m* 2 at 6in. above the base line.

Diagonal *n* is struck 2ft. 5in. above the base line, and at *n* 1 and *n* 2 is 3ft. 8in. out from the middle vertical line *o*.

The midship section is midway between No. 4 and No. 5 sections.

The fore bulkhead A, forming the warp room (see Sheer Plan), is 13ft. 9in. abaft the fore perpendicular.

The bulkhead B is 6ft. from A, C 6ft. from B, D 7ft. from C; E is the companion entrance to the cabin.



BODY PLAN.

FIG. 108.

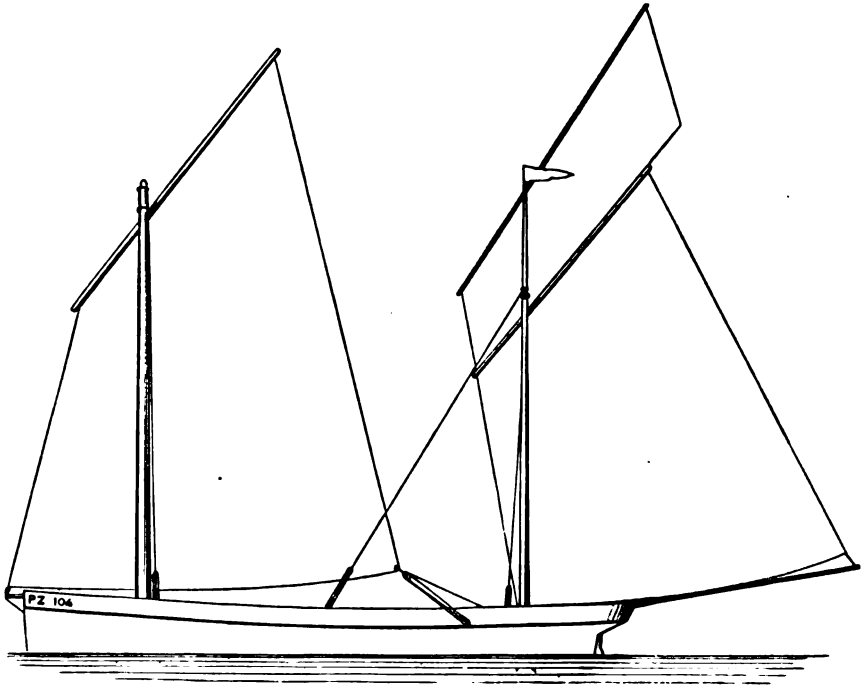
| | |
|---|-------------|
| | ft. in. |
| Length on deck, fore side of stem, aft side of sternpost..... | 51 0 |
| Length on keel | 48 0 |
| Bake of sternpost | 1 4 |
| Breadth, moulded..... | 14 7 |
| Breadth, extreme, with plank on | 14 10 |
| Draught of water, extreme | 6 0 |
| Mid-section ahead of centre of length of load line | 1 8 |
| Centre of buoyancy abaft centre of length of load line | 0 4 |
| Displacement to load water-line | 36 tons |
| Displacement per inch at load line..... | 1 ton 2cwt. |
| Tonnage, B.M. | 41 tons |
| Ballast | 14 tons |

| | |
|---|---------|
| | ft. in. |
| Siding of keel, stem and sternpost..... | 0 6½ |
| Moulding (depth) of keel..... | 0 9 |
| Siding of frames | 0 4 |
| Room and space | 1 5 |

In the drawing only every fourth frame or section is shown.

| | |
|---|---------|
| | ft. in. |
| Fore mast, deck to sheave | 37 6 |
| Mizen mast, deck to sheave | 29 0 |
| Mizen mast, deck to topsail halyard sheave..... | 37 6 |
| Mizen bumpkin, outside | 20 0 |

| | ft. in. |
|---|-------------|
| Foremast, diameter at deck | 0 11 |
| Foremast, diameter at sheave..... | 0 6½ |
| Mizenmast, diameter at deck | 0 10½ |
| Mizenmast, diameter at sheave | 0 6½ |
| Fore tack bumpkin, outside | 1 3 |
| Luff of fore lugsail | 26 0 |
| Leech of fore lugsail | 46 0 |
| Foot of fore lugsail | 34 0 |
| Head of fore lugsail | 28 0 |
| Clew to weather earing of fore lugsail | 36 0 |
| Luff of mizen lugsail | 20 0 |
| Leech of mizen lugsail | 41 0 |
| Foot of mizen lugsail | 29 0 |
| Head of mizen lugsail | 24 0 |
| Clew to weather earing of mizen lugsail | 36 0 |
| Area, fore lugsail | 980 sq. ft. |
| Area, mizen lugsail | 780 sq. ft. |



PENZANCE LUGGER.

FIG. 109.

THE COBLE.

No boat is more distinctive in type than the coble of the north-east coast. Their high, sharp bow and long, flat floor adapt them for rough water and for beaching stern foremost through surf. Their speed and performance in a sea, as compared with the speed and performance of a

well-formed and well-handled yacht of similar length, are, however, no doubt exaggerated. Running before a sea they require clever handling, as, on account of the excessive fore gripe, they evince a tendency to fly up in the wind or broach to. The peculiarly deep rudder checks this tendency somewhat, but the rudders are generally so narrow that they do not keep the boat so straight as they might be kept with some keel "drag." However, "drag" would be inimical to beaching stern first, as the small draught aft (with rudder unshipped) admits of their being landed high on a beach; and the sharp, high, and flaring bow keeps the surf from breaking on board. The coble is very weatherly, and is perhaps seen to greatest advantage when hanging up against a head sea or wind.

The side keels (shown by *k* in the cross sections) overlap the fore keel at *A*. The fore keel sometimes is at least a third shorter than shown.

The boats are measured for length from the heel of the sternpost to the scarp of the stem or fore foot, and this length is called the "ram." The length of the "ram" varies from 15ft. to 40ft., and the extreme breadth is about one-fourth the length over all. The drawing on page 379 was made by Mr. G. Christopher Davies from a typical boat of 20ft. length. The mast of such a boat is stepped 5ft. 6in. from the stem, and rakes aft as shown (Fig. 110). It is about 14ft. above the gunwale, and the only stay is the halyard brought to the weather side. The sail is a square, flat-headed, dipping lug, with tack fast to the weather bow, a little forward of the mast. In moderate weather a jib and mizen are carried. When a jib is carried, the tack of the lug is brought to the mast; but they are not then considered so weatherly as they are when the tack is on the weather bow. The boats are made to carry their canvas a long time, and the only ballast used consists of bags of sand.

The Yorkshire cobbles are generally round-sterned, and have very hollow bows at the load line, and a great deal of shoulder above. The Durham and Northumbrian boats are fuller at the load line. Builders of these boats are Mr. Cambridge, of Filey; Mr. Hopwood, of Flamborough; and Mr. Trotter, of South Shields. The Filey boats are noted for good qualities under canvas.

At Cullerwater there is a squadron of "private" cobbles, of which Sir Hedworth Williamson is commodore. The leading dimensions of the *Lalage*, one of the most noted of this fleet, is as under :

| | | | |
|-----------------------|---------|------------------------|---------|
| | ft. in. | | ft. in. |
| Length over all | 31 8 | Mizen mast | 20 6 |
| Ram | 21 8 | Head of main lug | 15 6 |
| Breadth extreme..... | 7 0 | Foot of main lug | 16 6 |
| Side | 2 5 | Luff of main lug | 21 6 |
| Mast..... | 30 5 | Leach of main lug..... | 23 0 |

THE COBLE.

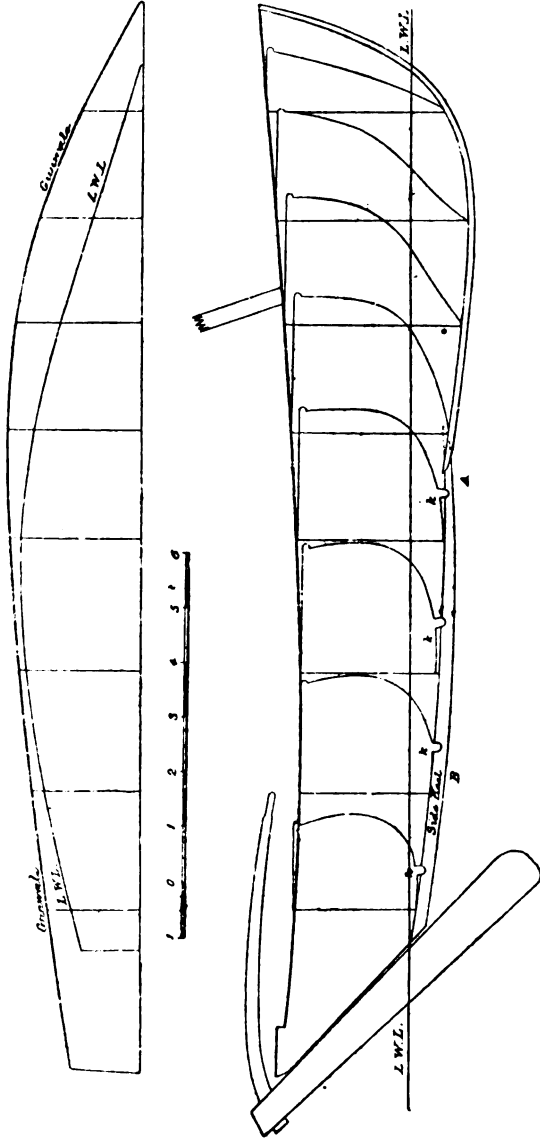


Fig. 110

The big masts must be made of proportionate dimensions. Standing legs would probably be fitted to the mast to support the rigging with the consequent dipping in bearing whatever wind is raised.

THE RACE AT BIRKENHEAD AND BIRKENHEAD.

The Birkenhead race was held in the bay of Ireland for the purpose of testing the speed of the boats and being also a trial for the crew. The boats were started in a line and the race was very exciting. The boats were very fast and the crew were very expert. The race was a great success and the boats were very well liked.

The race was held in the bay of Ireland for the purpose of testing the speed of the boats and being also a trial for the crew. The boats were started in a line and the race was very exciting. The boats were very fast and the crew were very expert. The race was a great success and the boats were very well liked.

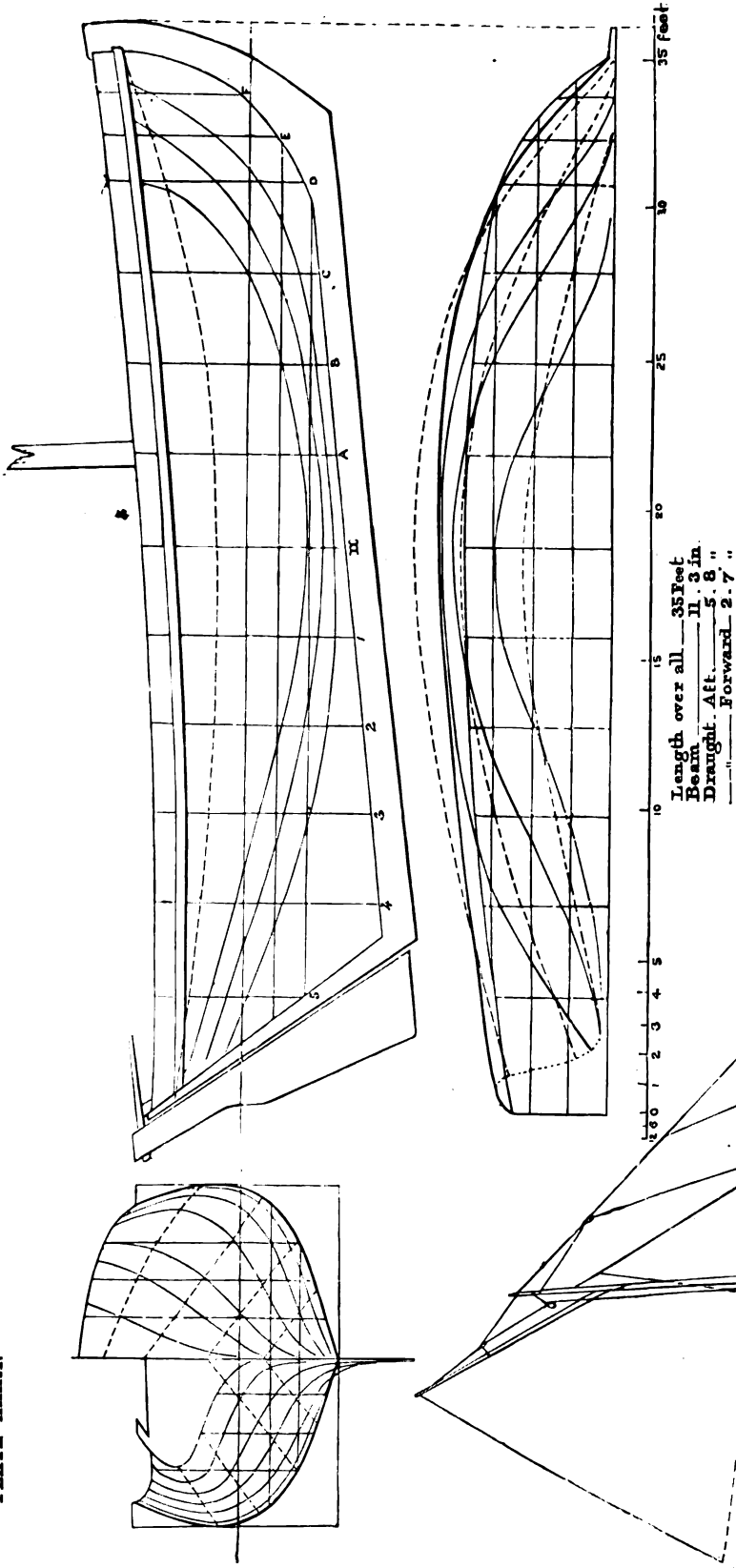
The race was held in the bay of Ireland for the purpose of testing the speed of the boats and being also a trial for the crew. The boats were started in a line and the race was very exciting. The boats were very fast and the crew were very expert. The race was a great success and the boats were very well liked.

The race was held in the bay of Ireland for the purpose of testing the speed of the boats and being also a trial for the crew. The boats were started in a line and the race was very exciting. The boats were very fast and the crew were very expert. The race was a great success and the boats were very well liked.

The race was held in the bay of Ireland for the purpose of testing the speed of the boats and being also a trial for the crew. The boats were started in a line and the race was very exciting. The boats were very fast and the crew were very expert. The race was a great success and the boats were very well liked.

The race was held in the bay of Ireland for the purpose of testing the speed of the boats and being also a trial for the crew. The boats were started in a line and the race was very exciting. The boats were very fast and the crew were very expert. The race was a great success and the boats were very well liked.

PLATE XXXII.



Galway Hooker.

J. H. Loomer
 Commander, U.S.N.

The lug mizen is, mast for mast, of proportionate dimensions. The jib is about 10ft. on the foot. Standing lugs would probably be found much handier for ordinary work, as the constant dipping in beating to windward would be avoided.

THE GALWAY HOOKER AND POOKHAUN.

The Galway hookers are noted on the west coast of Ireland for their weatherly qualities. They average from 11 to 16 tons, and being short, broad boats, with very hollow bows, they are exceedingly lively in a seaway, but seldom ship a sea; perfectly safe in every way except running when deep, when they have sometimes been pooped, owing to their lean hollow runs.

Speaking of these hookers, Commander Horner, R.N., says "they are very bluff above and hollow beneath, and I often tried to persuade them to alter, and at last, after seven years, found one man, Gill, of Arran, who promised to do so, and who a year after sent me word that his new boat, launched just in time for a regatta, couldn't be looked at—beating everything." (See Plate XXXII.)

The sails were made of a coarse stuff called "band linen," saturated with a mixture of tar and butter, which never thoroughly dried.

Horses and travellers are not used for the mainsheet, but when on a wind the sheet is belayed by a single nipping hitch round the timberhead on the quarter, taut down, keeping the mainsail very flat.

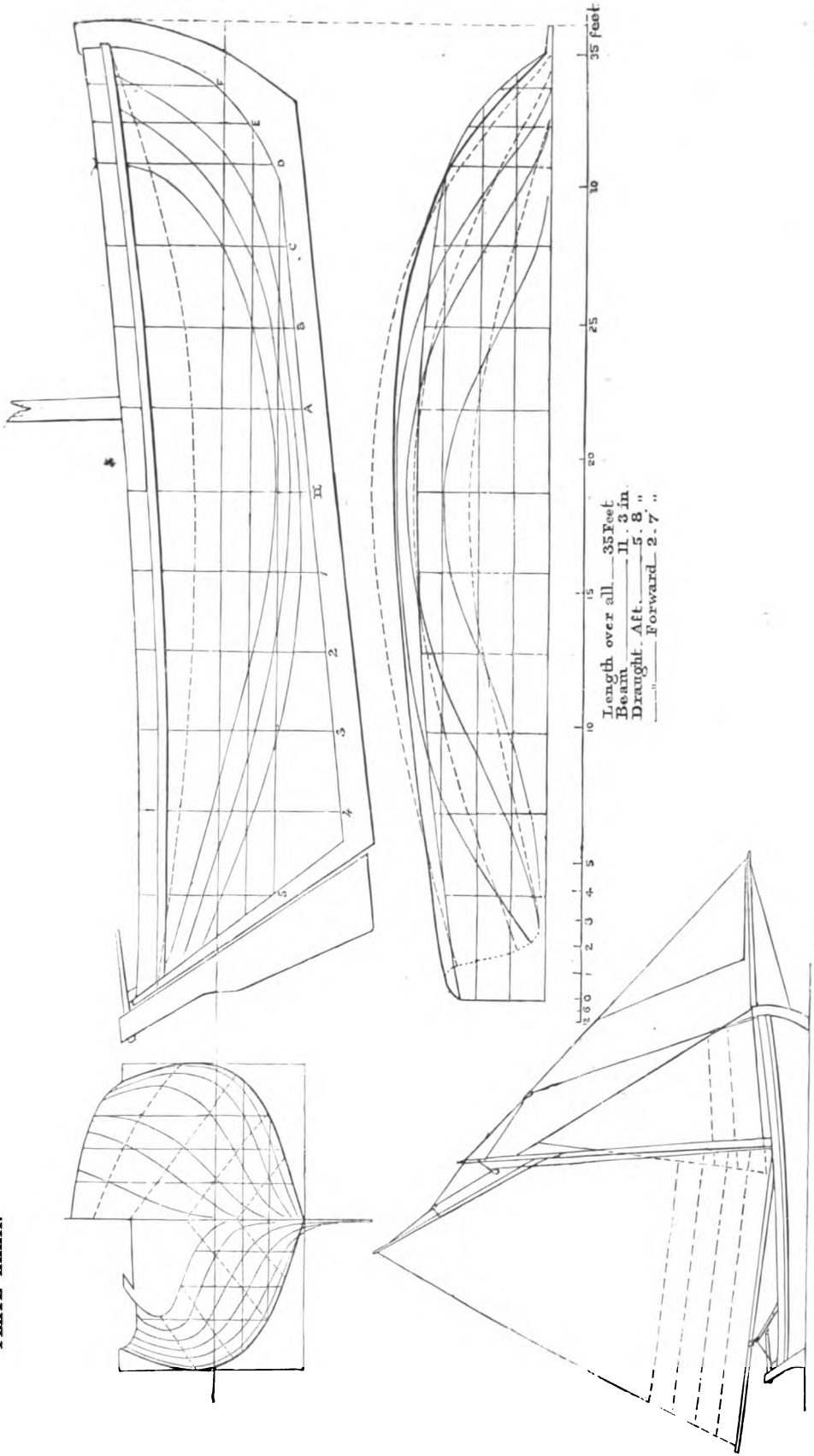
They carried a strong weather helm, and were quick in stays.

They were cleverly handled by the Claddagh fishermen, and few things could be conceived prettier than a fleet of them working out for the fishing ground with the sun shining through their brown and red sails.

The Galway pookhaun (Plate XXXIII.) is a smaller boat than the hooker, and used for both rowing and sailing; but it is built with the same ideas, of great tumble-home of topside to keep the gunwale out of the water when heeling over, and very raking sternpost, for quickness in stays. The sail of the pookhaun is single, cut as a triangle, with a yard on part of fore side, to set as a lug; and when working to windward the fore end of the yard is dipped abaft the mast, and she is brought round very cleverly—often, when blowing fresh, the man at the tack taking a flying swing round the mast with it. They sail exceedingly well, and are very graceful and picturesque boats under sail.

The mainsail in the hooker is laced to the mast, the lacing going

PLATE XXXII.

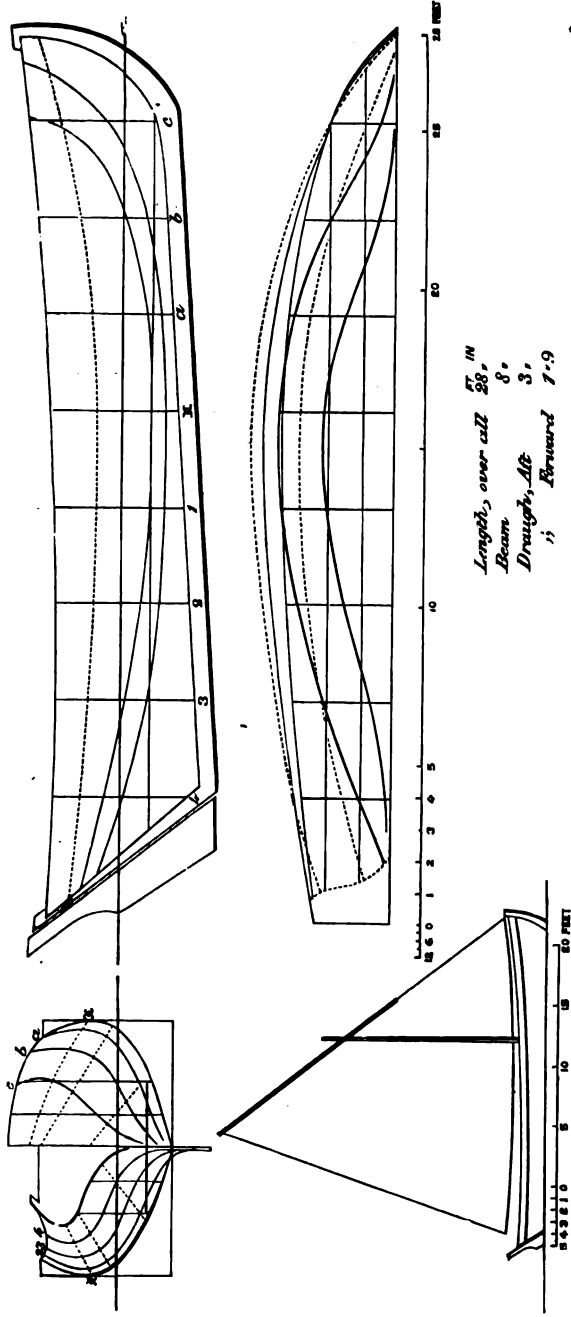


*S. R. Holmes,
Commander, R.N.*

Galway Hooker.

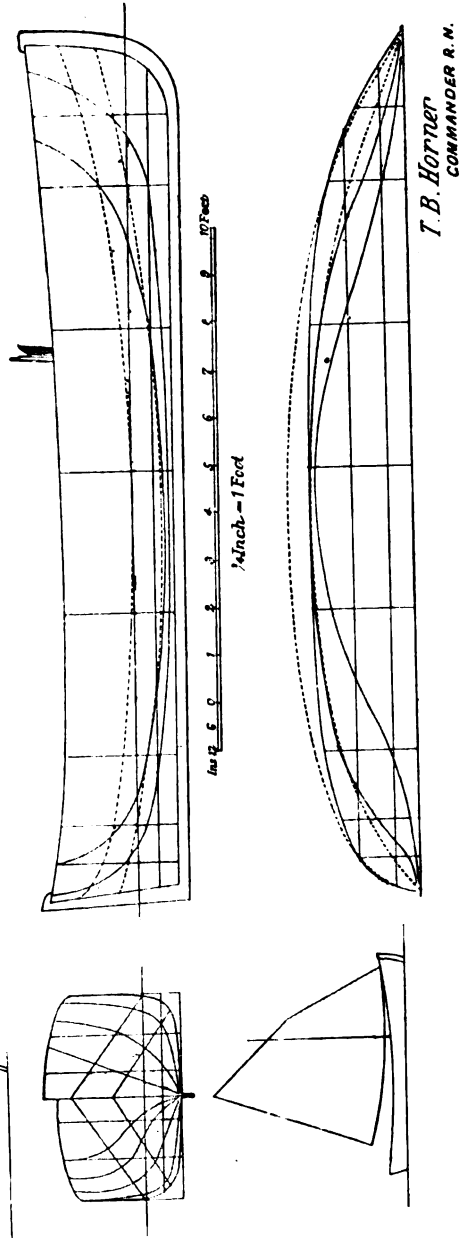
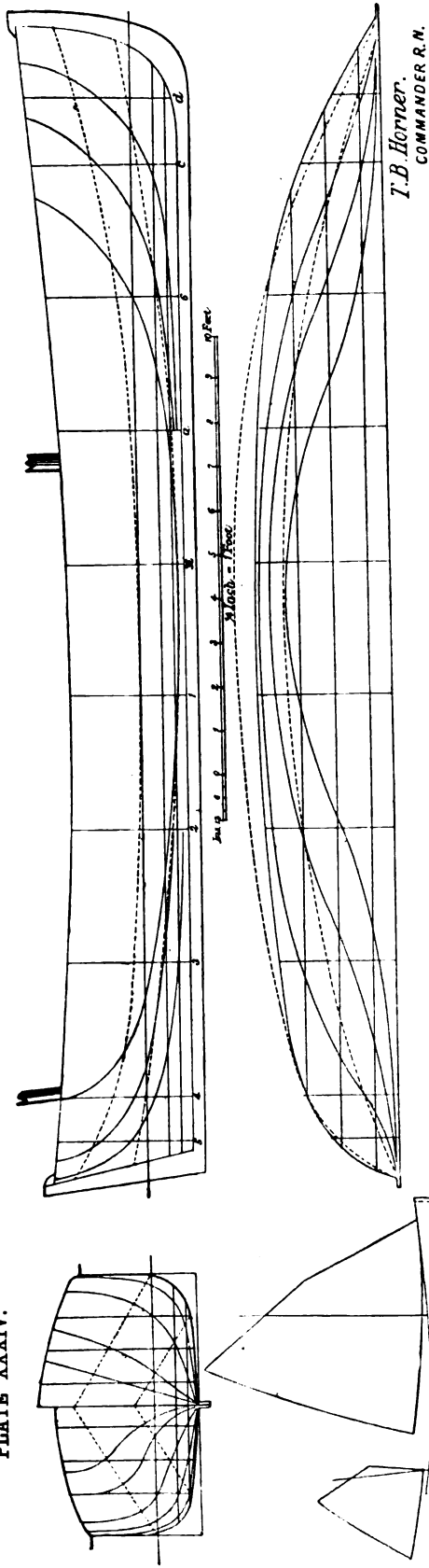


PLATE XXXIII.



Galway Pookhaun.

PLATE XXXIV.



Ship's Boats for Rowing or Sailing.

through the cringle and back again, round before the mast; the sail coming down with the greatest ease when head to wind. The ballast is of stone, built into the bottom of the hooker and making a fire hearth, with a deck above as far aft as the mast.

SHIP'S BOAT FOR ROWING OR SAILING.

Commander T. B. Horner, R.N., in 1858, designed a boat for the Channel Island survey, and she was afterwards fitted for the service. The lines of this boat are shown on Plate XXXIV. She has, it will be seen, a very flat floor, square bilge, and fine, deep ends; she was therefore very buoyant, like a lifeboat. She was reported to be fast, weatherly, dry, and steady under oars or canvas.

Commander Horner subsequently designed another boat of smaller dimensions for general use (see Plate XXXIV.). She is reported to have been a wonderful boat against a head sea with four hands, and generally rowed fast. Under canvas she was equally a success. The transom could of course be made "square," if preferred.

The standing lug, with mizen and head sail, would be a good rig for either of these boats. The mast would remain where shown, and the fore part of the lug would be done away with. The head yard would remain about the same, but the lug would be given greater peak.

Sand bags could be carried for ballast.

BELFAST YAWLS.

This type of whale boat is said to have been imported from Norway, and even the Galway hooker and pookhaun exhibit evidence of Norwegian origin. The Belfast yawls vary in length from 12ft. to 30ft. The larger craft above 20ft. keel have two masts, the shorter one being stepped forward. The mast is stepped in the keelson, and fits into a half circle cut out of the thwart. It is stayed forward, and is kept in position without any mast clamp on the thwart.

The tack of the sail is hooked to a hook on the bow. There are two hooks on each bow, the after one being used when before the wind. The halyard consists of a tye and single whip purchase. The standing part of the purchase is fast to the gunwale, and the fall is also belayed to the gunwale. There is no traveller, and the tye runs over a half sheave at the mast head. This fitting is in great repute among the Belfast men, as there is little chance of the yard jamming in hoisting or lowering.

The main sheet is a single rope rove through a bull's-eye on a swivel on the sternpost. The sail is extended by a boom, the latter having a pin at the outer end, which is put into the clew cringle of the sail. The other end is lashed to the mast. A bowline is sometimes used as represented in the cut (Fig. 111). This bowline is set up to the towing bollard or "Samson," with which these boats are always fitted. The sail is

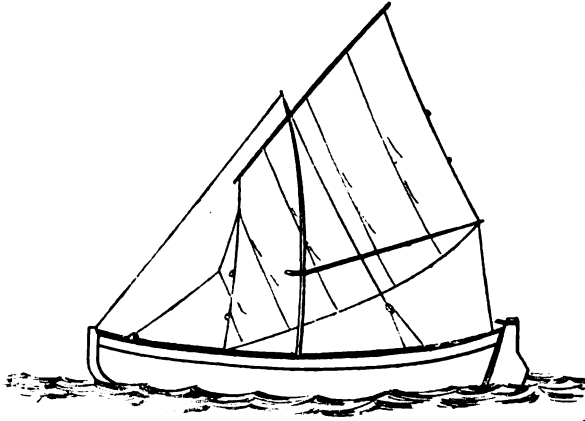


FIG. 111.

cut so high in the clew because it should not get into the water during rolling. The mast is stepped amidships. In squalls the sheet or halyard is let go. In running, if the bows dive, the halyard is eased a little.

The boat is steered by a yoke and long lines, all the crew sitting amidships. Stones are used as ballast. The rig is a very rude one, and it could not be expected that such craft would do much to windward where short tacking would of necessity be frequent.

NORWEGIAN PILOT BOATS.

The lines of a Norwegian pilot boat on page 384 were drawn by Mr. Colin Archer, of Laurvig, Norway. It is not often that prettier or cleaner water lines will be met with; and if the flare of the bow were reduced, the fore-foot rounded up a little, a lead keel added, and a suitable sail plan, we think that a very fast and weatherly yacht could be built from the lines. Mr. Archer thus describes the boats:

"I doubt if English boats of the same size are as handy with a small crew in all kinds of weather. A pilot and his 'boy' (technically so called—he may be an 'old boy') will go to sea in one of these boats and stay there (perhaps for a week) till he finds a vessel. When this

happens, perhaps somewhere between the Naze and the Skaw, the boat goes close alongside, the pilot jumps on board, and the 'boy' is left to bring the boat home the best way he can. The sail is a sprit, and, notwithstanding the formidable dimensions, one man is supposed to be equal to all contingencies.

| | |
|----------------------------------|-------|
| Whole length of mast about | 33ft. |
| Diameter at deck | 11in. |
| Diameter at top | 4½in. |

“There are no shrouds—only the forestay. They balance on a wind with the foresail and mainsail, but generally carry a jib or two for sailing free, and often a jib-headed topsail hoisted on a long pole.”

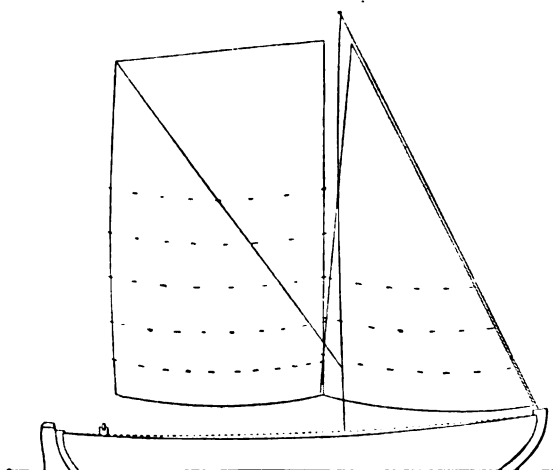


FIG. 112.

The mackerel fishing-boat is the same model; they carry about 600 fathoms of nets, three to four hands. These boats will live a long time in a seaway and keep pretty dry (they are decked); but their great "forte" is their extreme quickness in answering their helm, a necessary quality when ships have to be boarded from them in a gale of wind; and they will work to windward through surprisingly narrow places, and at a good rate too. These boats are all oak except the timbers—thirteen to fourteen strakes 1½in. boards—clinker-built, with juniper treenails with heads, placed about 4½in. apart. They look clumsy, chiefly from their upper works spreading so much. If this feature—which, however, gives them an enormous reserve of buoyancy—were altered, they might be made to look well enough, though peculiar. The boats carry about one-third to one-fourth of their total weight in ballast,

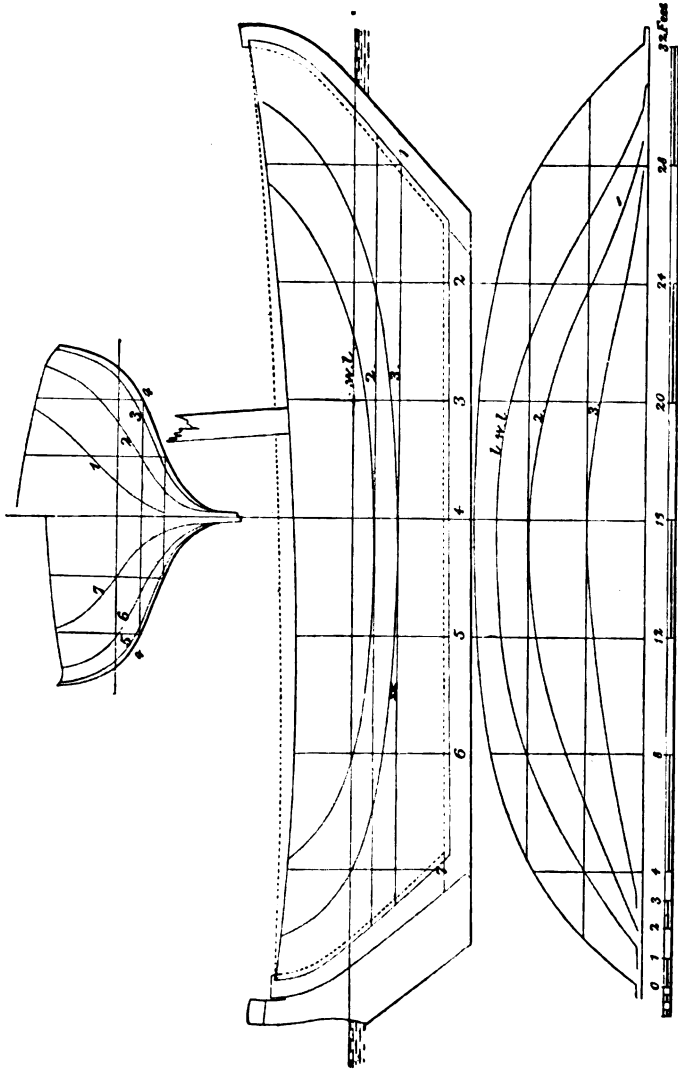


FIG. 118.

generally consisting of iron ore, which is plentiful in the neighbourhood of Laurvig.

| | |
|---|-------------|
| Length extreme | 33ft. |
| Length on L.W.L. | 30·2ft. |
| Breadth extreme | 11·6ft. |
| Breadth on L.W.L. | 10·0ft. |
| Draught of water | 4·2ft. |
| Displacement | 7·5 tons. |
| Area midship section..... | 15 sq. ft. |
| Area load water-plane | 198 sq. ft. |
| Meta-centre height. | 4·46ft. |
| Centre of buoyancy aft, centre of length of L.W.L..... | 5ft. |
| Midship section forward of centre of length of L.W.L. ... | 0·4ft. |
| Area of mainsail | 500 sq. ft. |
| Luff of mainsail | 24ft. |
| Leech of mainsail | 22ft. |
| Head of mainsail | 14ft. |
| Foot of mainsail..... | 14ft. |

CHAPTER XXVIII.

THE JULLANAR.

THE Jullanar in contour is different from most other vessels, and some peculiarities in her design, if not of much value, are at least original. For instance, her sternpost is upright and built very far in the vessel, so that a large portion of her counter is immersed; and her keel is raked so much that her draught of water at the sternpost is about twelve times what it is at the stem. But setting aside the fact that the *America*, built in 1851 by Mr. George Steers, and the *Kitten*, built by Mr John Harvey in 1852, varied in their draught of water fore and aft in much the same way, there is no doubt that the long immersion of counter abaft the sternpost were not the novelties they were first thought to be.

In 1852 and 1853 there was a great discussion as to the desirability of altering the manner of taking length for tonnage. Length was taken along the keel to a plumb-line dropped from the fore side of the stem at the deck. This measurement was mainly objectionable because it tempted a man to make a vessel very short on the keel and long on the water-line, and by tripping a vessel the position of the plumb-line could be greatly altered. To meet the difficulty and obtain fixed points, it was proposed to alter the manner of arriving at the length by taking the distance on deck from stem to sternpost. In April, 1853, Mr. William Cooper, under the *nom de plume* of "Vanderdecken," published a letter in *Hunt's Yachting Magazine*, in which he showed how easy it would be to evade such a rule. He said:

"My plan is as follows: To contract the length between stem and sternpost, by placing the sternpost as near the midship section as the form of the midship section will admit of [nearer, we presume, in proportion as the section approached the V form], consistent with giving power to the operation of the rudder; to project the main body of the vessel considerably beyond the main sternpost, without any keel, false sternpost, or dead wood whatsoever, but with a strong, secure frame of timbe:

laid upon a keelson. This projection of the main body thus assumes the form of one immense counter, but, being below the load water-line, enables the preservation, despite the trammels of measurement, of a powerful floating vessel with lengthy water-lines.

“Unless some positive advantage, other than that of cheating the measurement for tonnage, may be found to exist upon actual experiment, I should be very sorry to see it introduced; if, however, such may turn out to be the case, then our ‘fixed points’ for measurement become exploded. My present object is to call the attention of yachtsmen to the probability that such an evasion of measurement as I have stated is practicable, and that yacht club sailing committees should be prepared for it.”

Mr. Cooper no doubt here gave a very faithful description of the existing Jullanar; however, in the next number of the magazine (May, 1853) appeared a letter stating that, in consequence of the deck measurement for length having been in use *some years* on one of the Irish lakes, Mr. Marshall, of Dublin, had built a vessel named Banshie, of 10 tons, long before “Vanderdecken” made his proposal. She is said to have had a perpendicular sternpost, with a very long counter, fine water-lines, rudder out of sight, and the immersed counter was said to help the vessel a very great deal.

Thus, so far as we can at present trace, Mr. Marshall, of Dublin, “many years” before 1853, invented the Jullanar; but what is odd is the fact that a kind of Banshie was quoted twenty years later by Mr. C. E. Strong as a tonnage-cheater. The accompanying sketch (Fig. 114) is

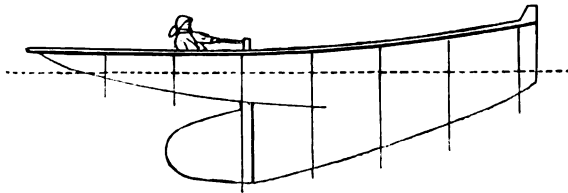


FIG. 114.

an exact representation of the sheer drawing of the vessel Mr. Strong published in *Hunt's Magazine*, in February, 1873, as a “tonnage-cheater.”

Two years later, in 1875, the Jullanar was laid down, and, whilst she was building, extraordinary stories were current about the wonderful position of her sternpost, and the effect it would have upon her tonnage. However, Mr. Bentall informs us that he had no idea or thought of evading a tonnage rule in designing Jullanar, and that she was the produce of many years' study.

Jullanar exemplifies up to a certain point what may be considered a

true principle in ship designing, so far as the development of speed goes. The design, taken broadly, shows in an eminent degree how three leading principles in the design of a sailing ship, although primarily antagonistic, can be so reconciled as to assist each other. We have length, the wave form, and a minimum of immersed surface which form the principle of small resistance; an effective plane for lateral resistance, which is the principle of weatherliness; and great stability, which is the principle upon which depends the magnitude of the propulsive force. It cannot be supposed that the apt combination of these fundamental principles was the result of mere chance, and it becomes necessary to here state how Jullanar was designed. Mr. Bentall, writing in February, 1877, said:

“The object I had in building Jullanar was not to avoid any rule, but to carry out a principle to its legitimate results—that is, ‘the longest water-line, the smallest frictional surface, and the shortest keel.’ I could carry it no further and keep her centres right.”

The latter sentence refers to the “theoretical assistance” Mr. Bentall received from Mr. John Harvey. The original design of Jullanar in its crude state as it came from Mr. Bentall resembled, so far as the contour of the sheer plan goes, the design now published of the actual Jullanar, but in reality the general design was a very different affair. The midship section was of smaller area, and had much more hollow near the garboards; the displacement to the designed load-line was lighter (about 143 tons, so far as we recollect); and the area of immersed vertical longitudinal section (sheer draught) was greater, and differently disposed. So also was the disposition longitudinally of the displacement. Mr. John Harvey altered the design, taking away here and adding there, until he got the centres of gravity of various equidistant water planes, and the fore-and-aft position of the centre of buoyancy corresponding to those water planes, into such positions as accorded with a certain theory formed by Mr. Harvey.

Jullanar was built from Mr. Harvey’s modified drawing, and Mr. Bentall has acknowledged that Mr. Harvey gave him “efficient assistance.”

The craft was afloat in 1875, and was soon reported to be a wonder to windward, and fast along the wind; whilst her qualities as a sea-boat were pronounced unparalleled. In 1877 Jullanar (having been bought by Mr. A. D. Macleay) made her *début* as a racing craft, and her performance fully justified all Mr. Harvey had predicted concerning her.

It would be interesting and instructive to know what process Mr. Bentall employed in designing Jullanar; but the probability is that

no system was pursued farther than that sketched out by himself, as just now quoted. The fact is, one arbitrary and unusual condition led up to certain modifications of the common type, and Mr. Bentall could not very well have had his short keel without the other conditions as well.

For instance, by placing the sternpost upright and in such an unusual position, great depth under the load line was necessary at the heel of the keel, and very little depth forward under the load line. In fact, in spite of the great difference in the draught of water fore and aft, as Mr. Bentall designed it to be, Mr. Harvey found it necessary to cut a large piece away from the fore foot, and add a little to the draught aft. By cutting away so much of the dead wood, of course the area of immersed surface was largely reduced, and thus Mr. Harvey was able to attain one of the objects Mr. Bentall had in view. With the keel so much raked upwards, it became almost impossible to have anything like hollow lines forward, and the displacement would have been seriously reduced—in fact, the *Jullanar* would have been in the condition familiarly known as “all ends and no middle.” The consequence is that the lines which bound horizontal planes in *Jullanar*’s fore body are convex, and do not resemble wave lines. This was another condition favourable for reducing the immersed surface, inasmuch as a smaller displacement would have been the cause of an increase in the immersed surface. Another important condition depended upon the abstraction of dead wood from the fore body and upon the parabolic character of the horizontal lines (water lines); and that was, that the displacement of the fore body is so disposed as to be a pure wave form.

We are not aware if Mr. Bentall or Mr. Harvey had any particular object in making *Jullanar*’s water lines convex, beyond that of keeping a certain amount of displacement in the fore body, and the area for surface friction small; but Mr. Colin Archer, in 1877, when he made known his theory as to the true form of wave bow, pointed out that such a bow could exist without the presence of a single line with a contrary flexure in the vessel. This is undoubtedly true; and, supposing that all we need have in a vessel is the wave-form bow, independent of the form of any particular horizontal curve, to obtain the best results, then the *Jullanar*, so far as her fore body is concerned, exactly fulfils the condition.

What we consider the weak point about *Jullanar* is her attenuated after body. In fact, the displacement of the after body is disposed almost similarly to that of the fore body—that is, the curve of displacement of the after body more nearly resembles a curve of versed sines

than a trochoid. Whether or not Jullanar would have been a better vessel if the displacement of the after body had been greater, so as to correspond with the trochoidal curve, is more or less a matter of conjecture; we are inclined to think that she would. No doubt the fineness of the after body of Jullanar is to a great extent dependent upon the place where her sternpost is fixed; and if her sternpost had been raked aft from the heel of keel to the end of her water line (50°), *à la Kitten*,* no doubt she would have had fuller lines aft, and thus have had a heavier after body.

Jullanar has not a large area of lateral resistance, but it is a most effective one (see page 15). Here again we find the fortuitous combination of conditions, which we have before spoken of, operating to render the surface effective for its purpose. Mr. Harvey, to get the centre of gravity of the vertical longitudinal plane sufficiently far aft, cut away more of the gripe than even Mr. Bentall had designed for, and by so doing the keel obtained the excessive upward rake.

We next come to consider the stability, or sail-carrying power, of Jullanar. Here again it is interesting to note that the fortuitous combination of conditions rendered the condition on which Jullanar's stability mainly depends a possible one. Hitherto all attempts to evade the effects of the Y. R. A. tonnage rule, by increasing the proportion of length to beam, had been limited by the fact that a consequent increase in depth involved an excessive area of immersed surface. But Jullanar, like a well designed yacht with a much rockered keel, has great depth of middle body as well as length, and consequently carries her ballast low. At the same time the area of her immersed surface is small, for the reason which has been sufficiently pointed out.

The stability of Jullanar is of a satisfactory character; but it is not of so potent a nature as it might have been with a little more beam. Mr. Bentall, in his letter heretofore quoted from, does not say why he gave Jullanar so little beam. He says his object was to get the longest vessel on the load-line with the smallest area of immersed surface. Lengths and areas are not directly comparable, and possibly Mr. Bentall meant that his object was to get the longest vessel on the load-line in ratio to length of keel. At any rate, the proportions of the linear dimensions of length, breadth, and depth of Jullanar exemplify in a certain manner the truth of what those who have made yacht naval architecture a study have long contended, that the best sea-going craft is one of

* The Kitten was 43ft. on the load line, and had 55° rake of stern post. By putting her sternpost upright from heel of keel, she would have had 8ft. of immersed counter. Her draught of water at heel of sternpost was 6ft. 3in.; forward, 2ft. in from stem, about 2ft. 6in.

long body in proportion to her breadth of body, accompanied with great depth of body and small initial stability. A vessel with a faint bilge, small initial stability, and great depth will not have violent lateral motion among waved water, such as rolling, lurching, and lifting of the whole mass; and one that is long and deep will have, compared with short vessels, no violent fore-and-aft motions, especially if her displacement is so apportioned that her weights are necessarily concentrated in the middle of the vessel. The disadvantage of small initial stability is that, even with low wind pressures, the vessel will take an excessive heel; her deck will be a difficult one to walk upon, and so will be her cabin floor. However, the discomfort of a steep platform may be considered compensated by the fine behaviour of the vessel that has it among disturbed water. [The stability of Jullanar compared with some other yachts will be found referred to on page 46.]

It is beyond doubt that speed is proportional to length, other things being equal; and Jullanar affords a striking example of the deficiency of length alone for speed purposes where no equality in other essential qualities exists. For instance, Florinda is 14ft. shorter on the load-line than Jullanar, yet is her speed, under what may be considered as the most favourable circumstances for developing the same, equal to the speed of Jullanar. We have not far to look for the reason of this. The initial stability of Florinda is much greater than that of Jullanar, and consequently, in moderate whole sail breezes and smooth water, she can carry her canvas much more effectively—or, in other words, she then commands a greater propelling force. This will be easily understood by reference to the diagram showing the curves of stability of the yachts (page 47).

Florinda, like Jullanar, has a small area of immersed surface; but she has comparatively little draught of water, and her keel has but a moderate upward rake. Now Jullanar's excellence in a good whole sail breeze depends on her weatherliness, and speed. Florinda has equal, perhaps superior, speed under such conditions; but she compares unfavourably for weatherliness. In the first place, her form—she having very little depth of body, and an expanded ∇ form of section—is not so suitable as Jullanar's for lateral resistance; and, secondly, her small rake of keel renders her dead wood less effective than it would be if she had the same area differently disposed. If her sternpost were given more rake—without increasing her length of load line—and if the piece removed were placed along and under her keel aft, and if some of the dead wood forward were removed, there is not much doubt that her weatherly qualities would be improved.

COMPARATIVE TABLE OF DIMENSIONS.

| | Florinda. | Jullanar. |
|---|----------------|----------------|
| Length on load line | 85ft. 9in. | 100ft. |
| Breadth, extreme | 19ft. 4in. | 16ft. 10in. |
| Breadth on load line..... | 19ft. lin. | 16ft. 8in. |
| Draught forward 5ft. from stem..... | 7ft. 3in. | 2ft. 9in. |
| Extreme draught | 11ft. 9in. | 13ft. 8in. |
| Mean draught | 10ft. lin. | 9ft. 4in. |
| Least height of freeboard | 3ft. lin. | 3ft. 10in. |
| Area of load water plane | 1100 sq. ft. | 1085 sq. ft. |
| Displacement in cubic feet | 5250 cubic ft. | 5540 cubic ft. |
| Displacement in tons | 150 | 158 |
| Displacement per inch of immersion at L.W.L. | 2·62 tons. | 2·6 tons. |
| Area of immersed vertical longitudinal section | 901 sq. ft. | 934 sq. ft. |
| Area of midship section | 106 sq. ft. | 106 sq. ft. |
| * Midship section abaft middle of length of L.W.L. | 3ft. | 1ft. 6in. |
| Centre of buoyancy abaft middle of length of L.W.L. | 1·3ft. | 0·4ft. |
| Centre of buoyancy below L.W.L..... | 2·75ft. | 3·44ft. |
| Centre of lateral resistance abaft middle of length of L.W.L. | 3·6ft. | 3·3ft. |
| Centre effort sails ditto | 4ft. | 1·5ft. |
| Meta-centre above centre of buoyancy | 4·75ft. | 3·13ft. |
| Meta-centre above centre of gravity | 3·7ft. | 3·3ft. |
| Area of immersed surface | 2200 sq. ft. | 2178 sq. ft. |
| † Co-efficient of displacement | ·311 | ·359 |
| Ballast | 54 tons. | 79·5 tons. |
| Portion of this ballast on keel | 8 tons. | 6 tons. |
| Area of mainsail | 2762 sq. ft. | 2737 sq. ft. |
| Area of foresail | 778 sq. ft. | 650 sq. ft. |
| Area of jib | 1045 sq. ft. | 875 sq. ft. |
| Area of mizen | 672 sq. ft. | 726 sq. ft. |
| Total area lower sail | 5257 sq. ft. | 4988 sq. ft. |
| Mainmast, deck to hounds | 54ft. 6in. | 53ft. |
| Mizenmast | 33ft. 6in. | 36ft. |
| Mainboom | 56ft. 6in. | 56ft. 6in. |
| Maingaff..... | 42ft. 6in. | 42ft. |
| Bowsprit outside | 36ft. | 24ft. 6in. |

* The Jullanar has a rake to the midship section, and the position given is at the point where the greatest section was found.

$$\dagger \left(\frac{\text{Displacement in cubic feet.}}{\text{Length} \times \text{breadth} \times \text{mean draught.}} \right) = \text{Co-efficient.}$$

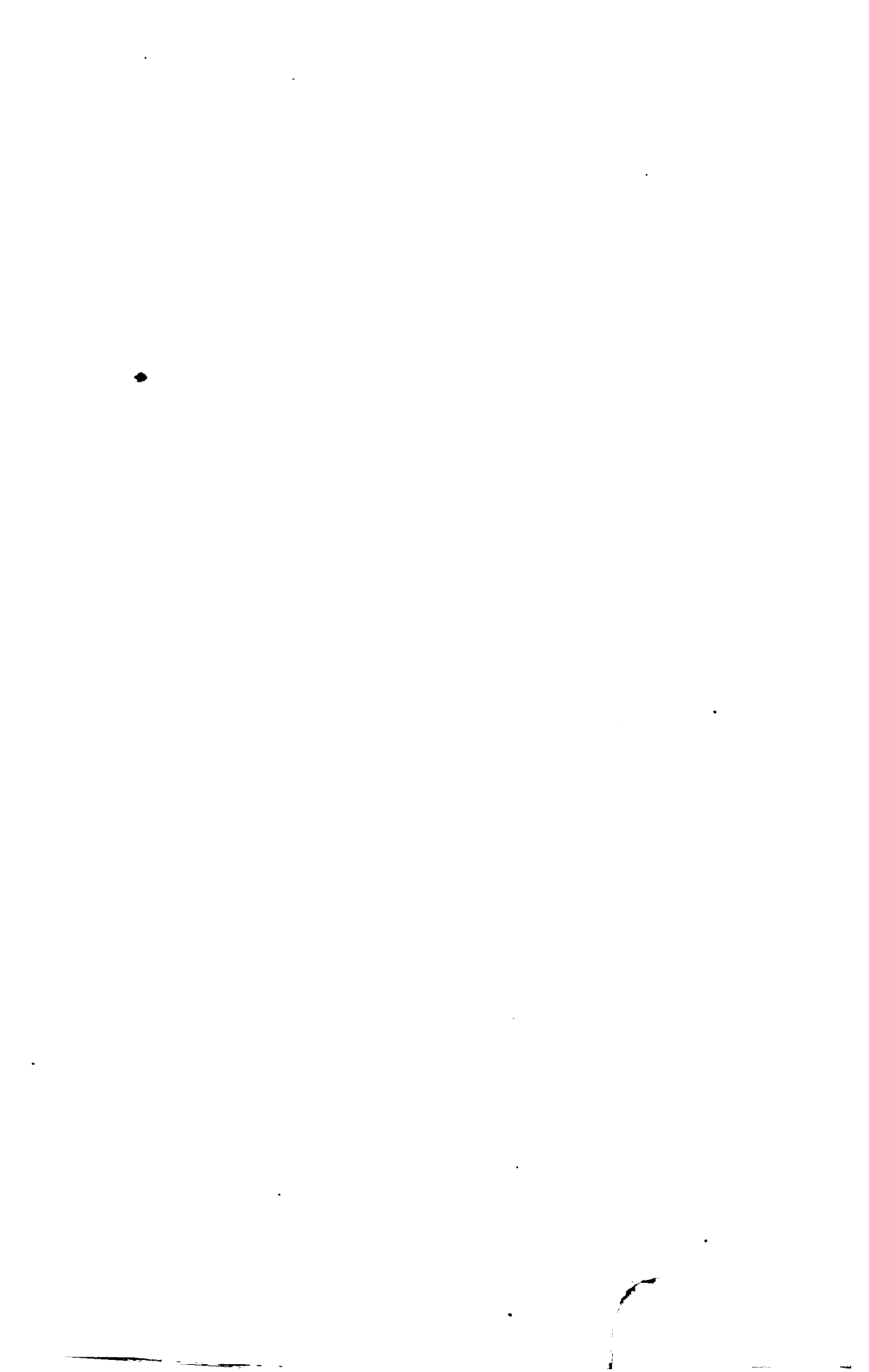
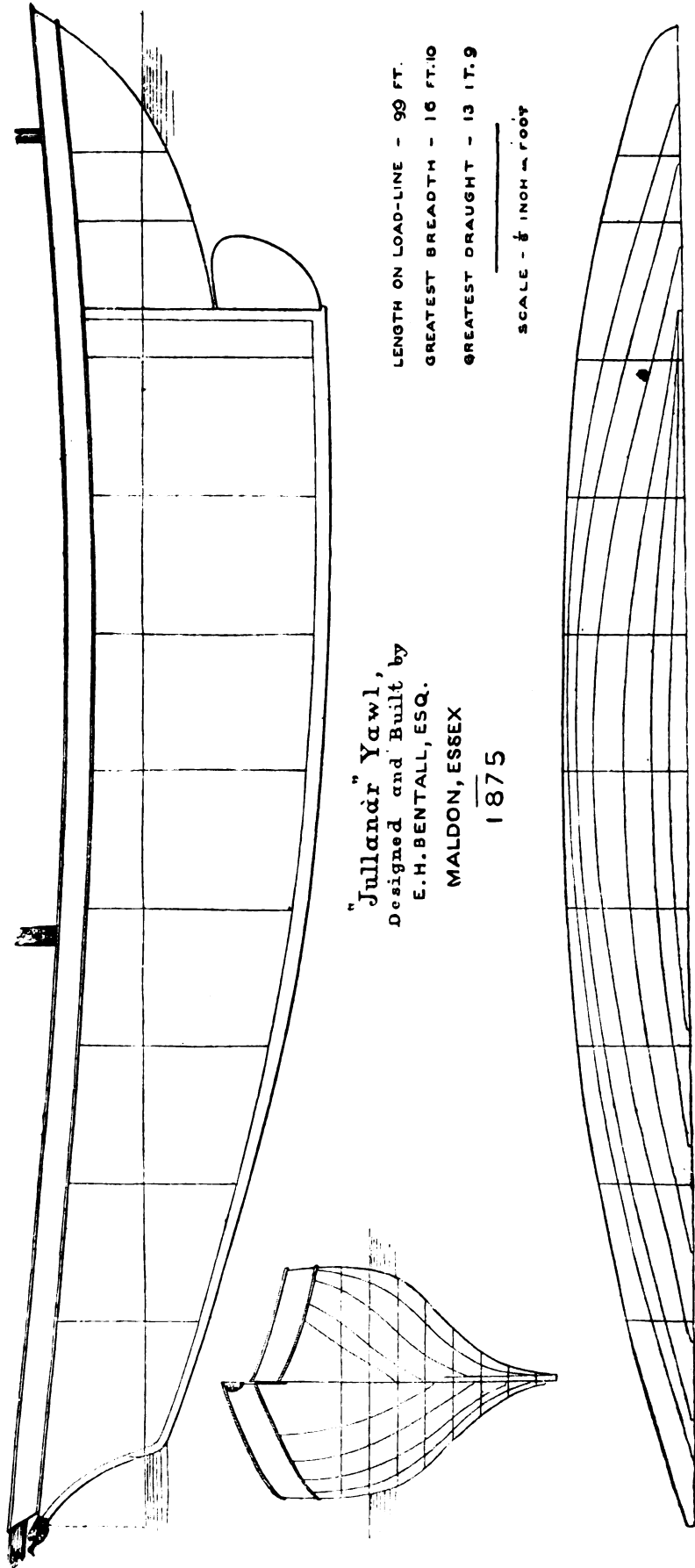


PLATE XXXV.



"Julland" Yawl,
Designed and Built by
E. H. BENTALL, ESQ.
MALDON, ESSEX

1875

LENGTH ON LOAD-LINE - 90 FT.
GREATEST BREADTH - 16 FT. 10
GREATEST DRAUGHT - 13 FT. 9

SCALE - $\frac{1}{8}$ INCH = FOOT

JULLANAR.—TABLE OF HALF BREADTHS AND DEPTHS.

| No. of Sections | 1 | 2 | 3 | 4 | 5 | 6 | 7 | 8 | 9 | 10 | 11 | 12 | 13 | 14 | 15 | 16 | 17 | 18 | 19 | 20 | 21 | |
|--|-----|-----|-----|-----|-----|-----|-----|------|------|------|------|------|------|------|------|------|------|------|------|------|------|---|
| ft. | 13 | 29 | 41 | 51 | 60 | 67 | 72 | 78 | 81 | 83 | 84 | 85 | 86 | 84 | 83 | 81 | 76 | 68 | 60 | 48 | 32 | |
| Half breadth on deck..... | 0.8 | 2.0 | 3.2 | 4.3 | 5.3 | 6.1 | 6.9 | 7.4 | 8.0 | 8.3 | 8.3 | 8.5 | 8.4 | 8.3 | 8.2 | 7.6 | 6.8 | 5.7 | 4.8 | 2.6 | 0.5 | |
| Half breadth, 2ft. above L.W.L. | 0.3 | 1.3 | 2.5 | 3.7 | 4.7 | 5.6 | 6.3 | 7.1 | 7.6 | 8.0 | 8.3 | 8.4 | 8.3 | 8.0 | 7.5 | 6.8 | 5.6 | 4.3 | 2.8 | 1.3 | — | |
| " at L.W.L. | — | 0.7 | 1.7 | 2.7 | 3.8 | 4.7 | 5.6 | 6.3 | 7.0 | 7.5 | 7.7 | 7.8 | 7.5 | 7.0 | 6.3 | 5.3 | 4.0 | 2.7 | 1.3 | 0.2 | — | |
| " at No. 2 W.L. | — | — | 0.5 | 1.4 | 2.4 | 3.4 | 4.3 | 5.1 | 5.8 | 6.2 | 6.4 | 6.3 | 6.0 | 5.3 | 4.3 | 3.3 | 2.2 | 1.0 | — | — | — | |
| " at No. 3 W.L. | — | — | — | 0.4 | 1.0 | 1.9 | 2.6 | 3.3 | 3.8 | 4.1 | 4.3 | 4.1 | 3.8 | 3.3 | 2.6 | 1.8 | 0.8 | — | — | — | — | |
| " at No. 4 W.L. | — | — | — | — | — | 0.6 | 1.1 | 1.6 | 2.0 | 2.3 | 2.3 | 2.3 | 2.2 | 1.8 | 1.4 | 1.0 | 0.4 | — | — | — | — | |
| " at No. 5 W.L. | — | — | — | — | — | — | 0.4 | 0.5 | 0.8 | 1.0 | 1.2 | 1.2 | 1.1 | 1.0 | 0.6 | 0.5 | 0.3 | — | — | — | — | |
| " at No. 6 W.L. | — | — | — | — | — | — | — | — | 0.4 | 0.4 | 0.4 | 0.4 | 0.4 | 0.4 | 0.4 | — | 0.3 | — | — | — | — | |
| " at No. 7 W.L. | 7.6 | 7.1 | 6.6 | 6.0 | 5.6 | 5.1 | 4.9 | 4.5 | 4.2 | 4.1 | 4.0 | 3.9 | 3.8 | 3.9 | 4.0 | 4.1 | 4.3 | 4.6 | 5.0 | 5.4 | 5.9 | |
| Height above L.W.L. | 0.0 | 2.8 | 4.4 | 6.6 | 7.8 | 8.6 | 9.8 | 10.8 | 11.7 | 12.5 | 13.0 | 13.2 | 13.3 | 13.4 | 13.5 | 13.7 | 13.5 | 13.5 | 13.5 | 13.6 | 13.0 | — |
| Depth below L.W.L. to underside of keel..... | | | | | | | | | | | | | | | | | | | | | | |

The sections are 5ft. apart, No. 1 commencing from the fore-side of the stem. Every other section is omitted in the drawing.

The water-lines are 2ft. apart.

All the measurements are given in feet, and decimal parts or 1/2 of a foot, with plank on.

CHAPTER XXIX.

DOUBLE BOATS.

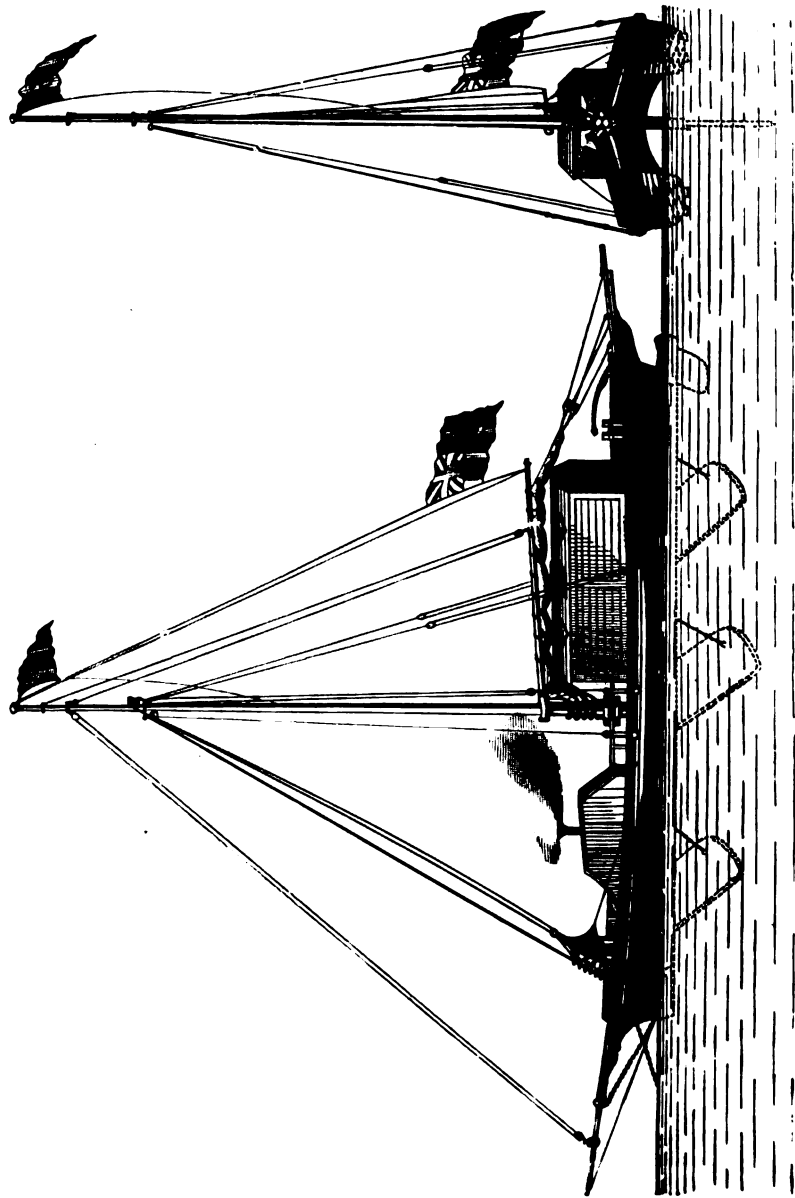
DOUBLE boats, in some form or the other, are met with all over the world, and the principle is adopted with the main object of acquiring great stability. But, although double boats may have in this way great stability, it must not be supposed that they are uncapsizable. They could be capsized by carrying a heavy press of canvas, or they might be thrown over by a sea, just as a lifeboat is sometimes.

In 1873, the late Mr. H. Melling, of Liverpool, had what he termed a safety yacht constructed on the double hull principle, as shown on the opposite page (Plate XXXVI.). Mr. Melling thus described his boat: "Happen what may, she cannot sink, for even if scuttled she will remain as a strongly-put-together life-raft. She can accommodate herself to draw only one foot of water, although of the size of 15 tons. She can be beached at pleasure without risk of straining. She can be anchored and put into places out of the way of harm or being run down or afoul of, and ride to her anchor in a roadstead, light and buoyant, with little strain on her cable. All is of pine wood, light and buoyant, having no ballast whatever. She has comfortable cabin accommodation on deck, affording a good 'look-out' fore and aft. Galley and stowage berths are in the forecastle, and by a system of casks stowed away in the pontoons and on deck she could carry stores, provisions, water, &c., for a voyage, which as they are emptied and bunged up will add materially to her safety. She made very good weather of it in turning down the Dee and along the Welsh coast over shallows against a strong wind. In running back off the wind she attained extraordinary speed.

"The use of the boards are as follows: if the fore board is down, or part down, it makes her stay in a sea way; if the aft one be down it holds her steady in scudding, and prevents broaching to; if they be all down, she holds a good wind and makes no lee way. They can be let down partially



PLATE XXXVI.



Melling's Safety Yacht.

or wholly as required by a chain, and can be hauled up by hand. They are weighted to sink by themselves, and house themselves as soon as she touches the ground. Her pontoons are 30ft. long, and 2ft. 6in. in diameter, representing enormous floating power; and, as it is almost unnecessary to say, water-tight pontoons or air chambers are the most powerful principle of buoyancy known. In the drawing her broadside view is given, with the submerged portion shown by dotted lines. The 'end-on' view more clearly shows the power of the vessel, and the peculiarity of her construction."

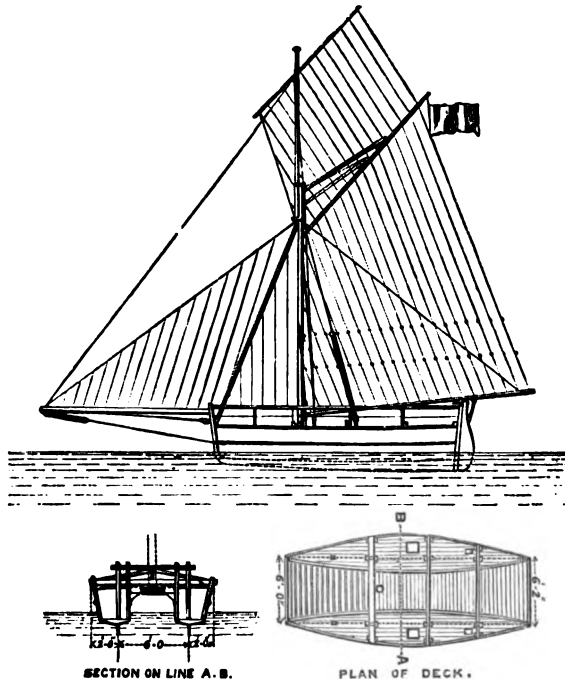


FIG. 115.

In the spring of 1868 Mr. John Mackenzie, of Belfast, constructed a double boat, but without dropping keels. He thus described her: "There are two boats of equal size, each 21ft. keel, 3ft. beam, and 3ft. deep. Each boat is divided by bulkheads into four compartments, two of these being 6ft. 6in. long, so as to be used for sleeping purposes; a hatch is in one compartment and a movable skylight in another, which is also adapted for ventilation; these hatches are screwed down on indiarubber, and can be made quite air-tight. A keel is provided on each boat, 15in. deep at the stern or heel, diminishing forward to 6in. Bolted to the keel by strong iron knees are stanchions which rise through the deck, on which the rail is fixed; to these stanchions the cross-beams connecting

the boats are fixed, the timbers or ribs also rising through the deck for a similar purpose, where the cross-beams are placed. The skin is lin. thick, being in one board on either side of the keel; the sides are in two, each 18in. deep, the seams being covered by a continuous strip of wood. By this method there are only four seams in each boat which require caulking, so that leakage is rendered nearly impossible. The boats are connected by five trussed beams, the one at which the mast is stepped being double trussed. A platform rests on these beams, a space of 3in. being left at either side to allow air compressed by a cross-sea to escape from underneath; from the mast forward this platform is formed of open-work. Immediately under the platform is a chest, 2ft. broad and 6in. deep, capable of carrying 6cwt. of water to serve as ballast in heavy weather. It is provided with brass valves in bottom, which in light weather or in case of accident can be opened, and the water discharged in a few minutes; when the box is emptied, by closing the valves a third chamber or boat is formed, capable of carrying 7cwt. or 8cwt., in case the other two got waterlogged. It may seem strange to place the ballast in the position described; but this extra weight—which is absolutely required to enable the boat to beat up in a strong sea—makes her also stay with certainty and speed by its central position. A boat of this description, no doubt, will carry her sail without ballast; but no craft with a very light draught will stay in a heavy sea without an additional weight to that of the hull and spars. A helm is attached to each boat, and these, being coupled together by a connecting rod, are worked by a tiller in the centre, so that both are moved in the same direction.

“It might be supposed that a boat so constructed would wet those on board very much; but this is not the case, as the buoyancy is so great that very few waves break over the platform. Those that do come on board, being principally in front of the mast, disappear through the open-work before mentioned. When on a cruise and lying at anchor, a waterproof tent can be rigged up on deck, in which there will be a clear inside space of 8ft. by 6ft., sleeping berths being provided for four persons in the boats as before mentioned. A permanent cabin on deck is in my opinion very objectionable, as it interferes with the working of the sails, and is a serious hindrance to beating to windward. I had various opportunities during the last two summers of testing the qualities of this boat. The best opportunity was afforded during last summer by a cruise along the Antrim coast, and by frequent sailing in the Irish Channel, sometimes in half a gale of wind. I always found her to stay well, and go to windward in a very satisfactory manner. The greatest speed attained was ten knots an hour. During the summers of 1868 and 1869 she was moored in the centre

of Bangor Harbour (which is a tidal one), without any trouble. When the tide ebbs the boats sit down on an even keel, and I consider it a great advantage to be able to run into harbour at nearly any state of the tide, as it takes away the risk of mooring in an exposed bay; or if running for shelter, you are much more likely to be able to enter a harbour than with an ordinary boat."

In America a double boat has recently been introduced called a catamaran. The boats are connected by iron stays working in ball and socket joints so that the weather boat would not be likely to be lifted out of water under strong wind pressures. One of these boats has been imported to this country by Mr. H. N. Custance. She is called Duplex. Her dimensions are—Length, 30ft. ; breadth of each hull, 2ft. ; depth, 1ft. 6in. ; distance between the hulls, 12ft. Each hull is fitted with centre-board and rudder. These catamarans are quite unfit to be sailed in wave water, as the lee boat is almost certain to go bow under, and then the whole construction would be torn all to pieces if the sail were not instantly lowered. Off the wind they have attained a speed of sixteen miles.

CHAPTER XXX.

ICE YACHTING.

FASCINATING pastimes like yacht and boat sailing ought to sink into insignificance when compared with the fascinations of ice yachting, if speed alone be the cause of excitement. It is, however, difficult for a Briton to realise the extraordinary enthusiasm ice-boat racing or sailing gives rise to in Canada, the United States, and some parts of Europe. The mere idea of being conveyed through the air in a boat at a rate equal to the speed of the fastest express train repels rather than fascinates; however, those who have experienced the extraordinary velocity of an ice yacht say that when the first dread of the lightning-like flight is overcome, the longing for the fast travelling of an ice yacht becomes quite a fascination.

Ice boating in England has been attempted on many occasions, and in Folkard's "Sailing Boat" are numerous plans for making such contrivances; however, none of these agree with the American plan of making ice boats, but, as the Americans have had more experience of ice-boat sailing than any other people in the world, we may take it for granted that their plan is in every way better adapted than any other for the attainment of high speed and safety. A winter seldom occurs in America when no ice-boat sailing is possible; and on the Hudson and smaller lakes of Canada the sport is as much a winter amusement as cat-boat sailing is at the watering-places during the summer months. In the British Isles we do not often get a long enough duration of frost to render ice boating possible; but ice boats have been constructed and sailed, and the frequent inquiry for information concerning them would lead one to think that, with suitable opportunities, ice-boat sailing would become as popular here as it is in North America; and, as the boats are very simple and inexpensive in construction, there is no reason why the amusement should not be taken up by anyone who knows anything at

all about boat sailing or boat steering. The engraving which we give of the American ice yacht, Haze (owned by Mr. Aaron Innes, of Poughkeepsie, U.S.), is, we presume, a fair example of Transatlantic ice yachts, although they are not all exactly alike in every detail. The different parts of the yacht and the mode of construction can be readily understood from the engraving, and all we need do is to describe these parts, and

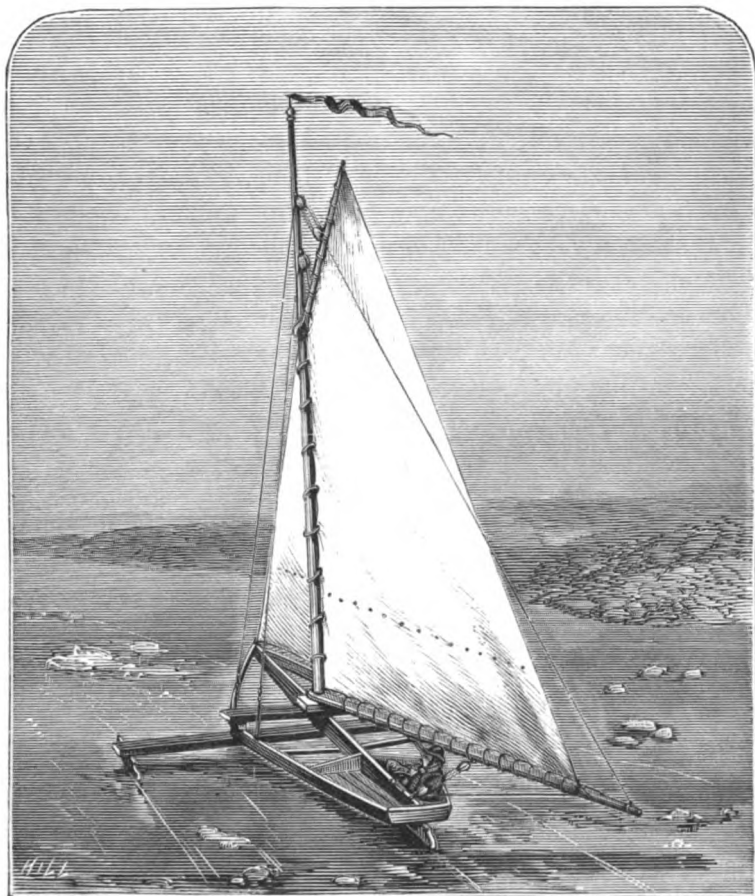


FIG. 116. THE AMERICAN ICE YACHT "HAZE."

give the sizes of the material, such as used in the construction of the Haze.*

The keel, or centre timber, is 24ft. 6in. long, 3in. wide, and 9in. deep (an ordinary "deal"). The side frames are 2½in. thick and 4in. deep.

At the mast a timber, 1ft. wide, by 3in. deep and 7ft. 6in. long, is fitted on top across the side frames. Underneath the mast timber is the

* The engraving is copied from the *Scientific American*.

"runner" plank, of 1ft. width, 8in. depth, and about 16ft. long, the side frames, mast plank, and "runner" plank being all bolted together. Sometimes the side framing is continued forward of the mast timber round to the bowsprit, and thus makes the construction look more boat-like.

The after part of the frame is bottom-planked with inch boards to form the deck.

The "runners" are three in number, one fixed to either end of the runner plank (which crosses the keel at right angles), and the third is fitted aft to the keel timber and rudder post, and is used as a rudder, the pintles being "upside down." This rudder-runner is usually somewhat smaller than the other two, and is fitted with a tiller.

The runners are securely fitted, in a line parallel with the keel, to the ends of the runner plank. They are 6in. deep, 2in. thick, and 2ft. 6in. or 3ft. long. Each runner is shod with steel, and rounded up at the fore end. The shoe is solid, and is 1½in. deep. One inch of this depth is ground to an angle of 90° V; the remaining ½in. forms the upper part of the shod, and is square with the top, which is 2in. wide. The steel is "tapped" on the upper side about an inch deep. Into these taps ½in. bolts are screwed, and are long enough to pass through the runner and runner plank; their heads are then secured with counter-sunk nuts before the runner is fitted to the "runner plank."*

As a rule, nothing but the two sails are carried, and the ice yachts of Toronto have but one lateen sail. These lateen sails are similar to the sail described on page 296, and reproduced in Fig. 117. The dimensions of the spars of the Haze are as follows:

| | |
|-----------------------------------|------------|
| Mast, step to cap..... | 20ft. |
| Mast, diameter at heel | 5in. |
| Mast, diameter at cap | 3½in. |
| Bowsprit, beyond mast | 16ft. 6in. |
| Bowsprit, depth at mast..... | 6in. |
| Bowsprit, depth at outer end..... | 3in. |
| Bowsprit, width† | 3½in. |

* In the Naval Museum, South Kensington, there is the model of a Finland ice boat. The runners of this boat are large skates, 7in. or 8in. deep, about 2ft. long, and about 1in. thick. They are very much rounded up at the fore end, like a Dutch skate. They are fastened by transverse bolts to the sides of pieces of timber of the same length as the skates. The cross timber, or "runner plank," is sunk into the top of the pieces of timber to which the two side skates are bolted. The after centre skate (there are three skates in all, including the rudder skate) is of similar pattern, and is fixed as a rudder. The keel of this boat is 24ft. The breadth across the runners is 12ft. The Finland model is also said to represent a "Canadian" ice boat. It is of the Γ form, with timbers fitted to it in an X form for strength. An ice boat constructed in 1878 for Lake Windermere had the "skates" pivoted to the runners, so as to have a fore and aft motion. The idea was to ease jolting in coming upon irregularities in the ice, but it is difficult to understand that the jolting could be relieved by such a method.

† The bowsprit is fitted to the keel by a clamp iron ½in. by ½in., and by a through-bolt abaft the iron. The bowsprit can be a mere continuation of the keel timber.

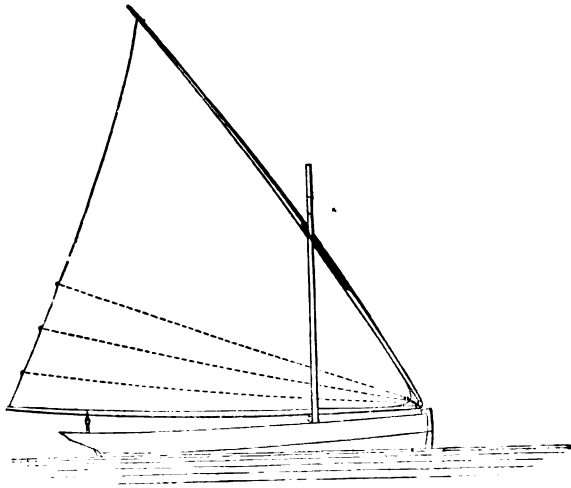


FIG. 117.

| | ft. | in. |
|--|-----|-----|
| Jibboom, length (when one is fitted) | 15 | 3 |
| Jibboom, diameter at centre | 0 | 2½ |
| Jibboom, diameter at ends | 0 | 2 |
| Mainboom, length | 29 | 4 |
| Mainboom, diameter at centre | 0 | 4½ |
| Mainboom, diameter at ends | 0 | 2⅞ |
| Gaff, length | 8 | 9 |
| Gaff, diameter | 0 | 2 |
| Mainsail, luff | 14 | 6 |
| Mainsail, foot | 28 | 0 |
| Mainsail, head | 8 | 0 |
| Foresail, leech | 15 | 0 |
| Foresail, luff | 22 | 0 |
| Foresail, foot | 14 | 6 |

The ice boats are usually of about the dimensions given; but one, the *Icicle*, owned by Mr. J. A. Roosevelt, has a framework 32ft. long, is 26ft. between the runners, and the runners are 7ft. 6in. These appear to be extreme dimensions. An ice boat built for a gentleman in the North of England in 1879 was 12ft. long, and the runner plank was about 7ft. long, the sizes of the timber being proportionately small. The weight, however, is of use when sailing with a beam wind, to keep the boat from excessive heeling, it being a not uncommon circumstance for the weather runner to be lifted four or five feet off the ice; and in such an event the yacht is luffed sharp up.

The favourite points of sailing are with the wind a point or so before the beam, right abeam, or a point abaft the beam. With such a wind, a straight course over perfectly smooth ice, free from hummocks and cracks, and a gale of wind, it is claimed that these yachts can and do travel at the rate of sixty or more miles an hour. Every winter we see

numerous records of such time made, and they are apparently well authenticated; at any rate, it seems incredible that, year after year, American gentlemen should enter into a conspiracy to deliberately publish false times. There is not the shadow of a reason for believing that the time given for making a mile (a statute mile is understood) is persistently exaggerated.*

An elucidation of the phenomenon of a vessel sailing faster than the wind has frequently been attempted, but, so far as we know, with no clear conception of the mechanical principles involved. In the first place, it must be distinctly understood that a boat's speed before a wind which blows with a constant velocity cannot equal the speed of the wind; under different conditions it is conceivable, and in accordance with mechanical principles, that the speed of a boat may equal, and greatly exceed, that of the wind. If the boat were before a wind which is travelling at the rate of 30 sea miles an hour, the direct impulse of the wind on the sails, if *fixtures*, would be equal to 6lb. per square foot. But the sails are not fixtures, and move before, or away from, the wind; the pressure is thereby gradually diminished until it is balanced by the resistance met with by the boat on the ice. As the resistance of an ice boat is very small, a high speed—nearly equal to that of the wind—is reached before the resistance and the wind pressure become uniform. Thus, say the velocity of the wind were 30 miles an hour, and the speed of the boat 20 miles an hour, the resultant pressure of the wind would be only of that due to a wind speed of 10 miles, or about $\frac{2}{3}$ lb. per square foot (see page 19). But if the wind makes a more or less acute angle with the line of advance, the conditions are entirely altered; the pressure of the

* The following extract from a letter, copied from the *Spirit of the Times*, March 1, 1879, whilst it gives a denial to the fictitious speed attributed to some ice yachts, confirms the report of the amazing speed an ice yacht is capable of: "As to the speed of ice yachts much has been said, and a great deal has been said devoid of truth. A wind on the beam—what we call three-quarters free—is the wind for speed, and there are times that a yacht attains a speed of sixty-five to seventy miles per hour (in fact, there is no limit to their speed, conditions of ice and wind favourable); but the yacht is not able to maintain this high speed long, as the helmsman is continually obliged to deviate from a straight course, on account of hummocks, cracks, or rough ice, and the course of a yacht is always zigzag instead of straight. I have often, in company with Commodore Grinnell, of the N.H.I.B. Club, raced with the express trains on the Hudson River Railroad. We would beat down on a train with a good west wind, and often run side and side with the train over a mile; then the wind would light up, and the train would draw ahead. At other times we would pass a train like a rocket, and run a mile and a half ahead, when we would be compelled to tack across the river and bear away again. Meantime the train would crawl up, only to be beaten again for a mile or two. The fastest time between Poughkeepsie and New Hamburg that I know of was made this winter. The distance is nine and three-quarter miles, and the run was made by the yacht *Zephyr*, of the N.H.I.B.C., in ten minutes. The *Phantom* made the same run, some years ago, in twelve minutes. The yacht *Whiz* was reported, and has a record of the same course of nine and three-quarter miles in seven minutes. This is another mistake as she never made the time, but it went the round of the papers all the same."

wind does not diminish with the advance of the boat, and its effective impulse is determinable on mechanical principles, which will admit as possible a speed of the boat much greater than the actual speed of the wind. However, it is scarcely possible that any water-borne boat propelled by sails could ever be made to exceed the speed of the wind which impelled it, on account of the enormous growth of the resistance due to wave-making; but "ice boats" may be regarded as having almost no head-resistance; the slightest force will give them motion, and keep them in motion. The only friction is from the lee runner, as when sailing the weather runner seldom touches the ice, and the lee runner, cutting into the ice, prevents excessive leeway.

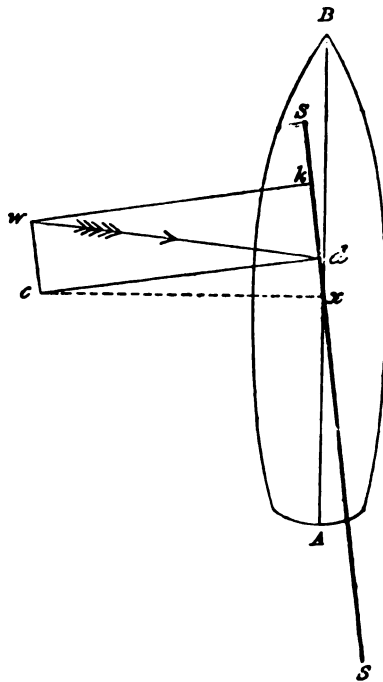


FIG. 118.

To illustrate the principles involved, it will be assumed as a fact that ice boats in America have been timed to sail at the rate of one mile in a minute by the aid of a force due to a velocity of thirty sea miles an hour of the wind. Such a wind force is termed a "fresh gale" by sailors, and a ship would be under reefed topsails, reefed courses, or possibly fore and mizen topsails furled. In Fig. 118 we will suppose A B to be a boat fixed so that it cannot move. The line $w d$ represents on a scale the direction and force or speed of the wind equal to 30 miles an hour. The line $s s$ represents the balance lug sail of an ice boat. It

is obvious that the wind, blowing on the sail from the direction shown, would tend to drive the boat in the direction of its own motion. But the force $w d$ is made up of two components—one, $c d$, is acting at right angles to the sail, and the other, $d k$, acting along the plane of the sail without any potent effect. The component $c d$ can be further regarded

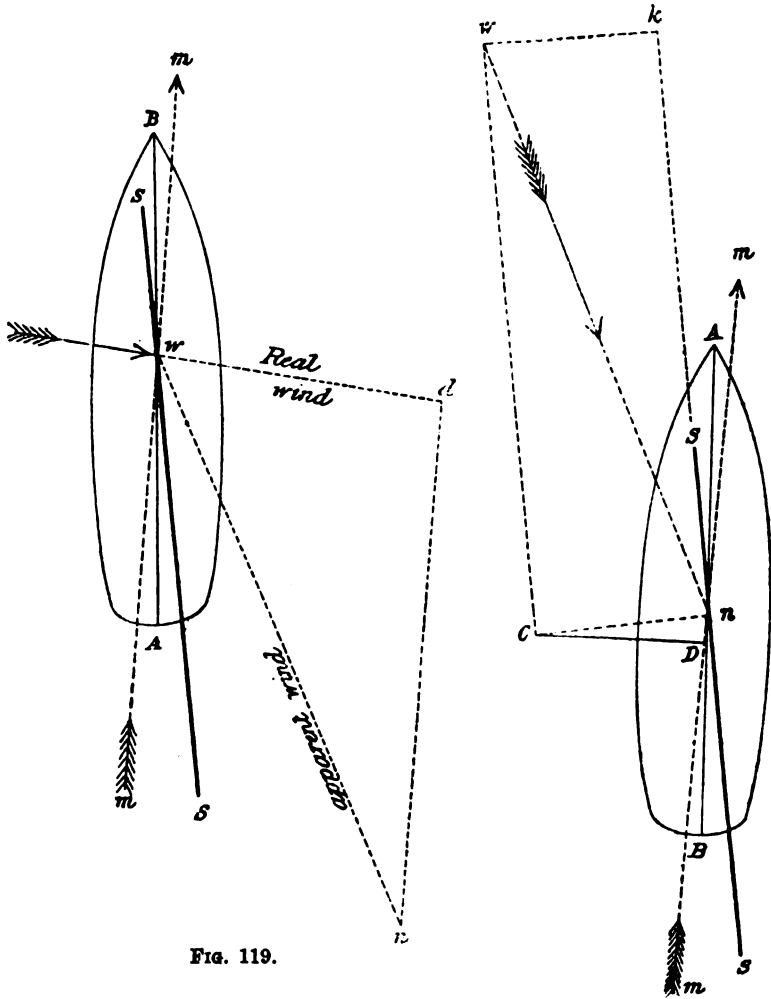


FIG. 119.

FIG. 120.

as a force made up of three other components—one, $c x$, acting at right angles to the keel of the vessel, and tending to drive her to leeward; another, $x d$, acts in a line with the vessel's keel, and tending to drive her ahead. The third force is resolved vertically in a downward direction, and need not be considered.

Hitherto we have only dealt with the "real wind," and we have now to consider what takes place when a boat, under the influence of αd , gathers way, or commences to move in a direction to meet the wind at a more or less acute angle. In Fig. 119 A B is the boat set in motion* by the component of the wind αd , and is proceeding in the direction of the arrow $m m$; the difference between the arrow and the keel line represents the angle of leeway, or amount of leeway made. The dotted line $w d$ represents the direction and velocity of the real wind, as in Fig. 118; but the wind *apparently* will now be blowing more ahead, and it is the *apparent wind* with which we have to deal. The apparent wind is thus determined: On a line parallel to $m m$ set off a distance (see $d n$, Fig. 119) by scale (same as the wind scale) to represent an opposing motion equal to the speed of the boat (assumed in this case to be sixty miles an hour, or double the velocity of the wind). Join $n w$, and the dotted line $n w$ will represent the force and direction of the *apparent wind*.

This apparent wind must now be regarded as the propelling force, and not the real wind as shown in Fig. 118. In Fig. 120 let the dotted line $w n$ represent the direction and force of the *apparent wind*; by a parallelogram of forces the line of force $w n$ has two components, one acting in the direction $w c$, or $k n$, and the other in the direction $c n$. The component $c n$ is farther resolved into three components, as before shown by Fig. 118, represented by $c D$ and $D n$ in Fig. 120, and another acting vertically, not shown. It is the component $D n$ which impels the boat forward. It will be seen that the force $D n$ is very small, or only about one-seventh of the force $c D$, which is striving to drive the boat to leeward; but the resistance to leeway is very great, whilst the resistance to headway is very small. Consequently the boat moves a scarcely perceptible distance in a broadside direction, but gathers speed in the direction of her keel, or rather in the direction of the line $m m$, which includes the broadside motion or leeway. The boat continues to gather way or increase in speed from the rest position shown in Fig. 118 until the resistance she meets with, from friction of the skates on the ice and resistance to the rigging, &c., equals the force shown by $D n$. The speed of the boat then remains uniform so long as the wind is constant.

If the speed, *with the same wind force*, could be increased by diminishing the resistance, beyond sixty miles an hour, the apparent wind would draw more ahead, and then obviously the effective impulse, $D n$, would be further diminished, until the apparent wind were brought right ahead,

* The sail is represented as hauled flat in. In practice the sail would be well off at the moment of starting, and would be gradually hauled aboard as the speed increased and the apparent wind drew more ahead.

when Dn would disappear altogether; the sails would "lift," and a fresh start would have to be made.

From what has been said it will be concluded that on any point of sailing between a quarterly wind and a wind on the bow, if any great speed is realised, the boom must be hauled close aboard, the exact angle with the keel being determined by the speed of the boat or by the direction of the apparent wind, and not by the direction of the real wind. When a point dead to leeward has to be made, it is thought that the point is reached more quickly by hauling up to 45° from the course, and then, when half-way, gybing or tacking, and making for the point to be reached, thus traversing a right angle.

Sailing for a point dead to windward is not such rapid work, and we believe ice boats do not make a course nearer than $3\frac{1}{4}$ points of the real wind, and their speed over the ice is not one-half of what it is with a beam wind, but it is believed to just about equal the speed of the wind.

The usual mode of coming to rest from a high speed is by running off to dead before the wind, and then luffing to sharply until head to wind. The boat is "anchored" by turning the "rudder runner" right across the keel.

CHAPTER XXXI.

CANOEES.

NAUTILUS CANOES.

BRITISH canoeing includes such various branches of work, and so many forms of canoes, each adapted particularly to its own branch and generally to all the others, that a consideration of canoe designs can hardly be successfully entered upon without first glancing at the rules and practices which at present guide the members of the Royal Canoe Club, who form the majority of British canoeists.

To construct a concise definition to comprehend a "canoe" is not an easy matter. No doubt the rules of the Royal Canoe Club do in a measure dictate what is and what is not a canoe; but there are still many loopholes left by which a canoe can be invested with qualities which strictly do not belong to the "canoe" proper. The disintegrated materials from which a concise definition might be abstracted are, among others, some of the following: A canoe is a vessel propelled with a paddle or with sail by a person or persons facing forward; she is a vessel capable of navigating shallow water as well as open rough water; and she is a vessel not too large or heavy for land portage by two men when her ballast and stores have been removed. Therefore, a vessel propelled by oars or machinery, which, either by bulk of hull or weight of fixed ballast cannot be lifted by two men, is not adapted to the requirements, nor entitled to the appellation, of a "British canoe."

The cruising work, for which a British canoe is mainly constructed, demands that she shall be as small and as light as possible compatible with sea-going qualities and carrying capacity; but the occasional sailing matches in which such a craft may compete, suggest an increase of power by size and weight for sail-carrying purposes; and, therefore, in order to protect the majority and to foster craft of the cruising type, it has been found necessary to check by club rules the introduction of

mere racing machines, which, by lead, beam, and sail-area, might desert the canoe definition and become miniature yachts.

The Royal Canoe Club, however, does not attempt to define or limit the size, design, construction, or crew of canoes, except as regards sailing and paddling matches; and, therefore, provided the canoeist does not intend to compete in the club matches, he may build his craft in any manner his experience or fancy may dictate. But there can be no question that under the club rules a most serviceable type of canoe for general cruising, and also a very perfect class of sea-going sailing canoes have been produced; and as the canoes we are about now to consider are to conform strictly to the club rule, it may be advisable to set the rule out in full.

“Canoes eligible for these races shall not be over the following dimensions, viz.: first class, any material and build; greatest length over all, from stem to sternpost, not more than 20ft., with a limit of beam of 2ft.; but the beam may be increased by $1\frac{1}{2}$ in. for each whole foot of length decreased; greatest depth at fore end of well under the centre of the deck to the garboards, not more than 16in. Fixed keel of wood not more than 2in. deep, including metal band, which must not exceed one-half of an inch deep.”

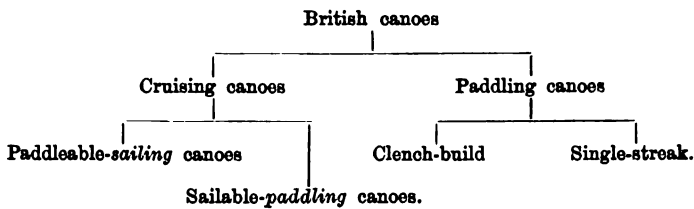
“NOTE.—A competitor is allowed to use either a drop or deep keel. The greatest depth allowed in drop or deep keels is 18in. beyond the fixed keel; but when hauled up they must be completely housed within the canoe. The greatest depth allowed in keels more than half the canoe's length is 6in. beyond the fixed keel. All ballast, except centre boards, but including anchor and other metal weights, shall be carried inside the canoe when sailing. Ballast may be started or shifted during a match. There is no restriction as to material or mode of building, or as to ballast, sails, or rudder. Each canoe shall contain one man only.”

Having thus far glanced at the general features of canoeing, the next step will be to attempt a practical classification. Hitherto a canoe has generally been classed under one or other of the original type classes, namely, Rob Roy, Ringleader, or Nautilus. Such a classification would only be useful so long as the original model remained unaltered, and succeeding canoes were exact copies of the originals. Even then it is an unsatisfactory attempt at classification; but it will be patent to all canoeists that succeeding Rob Roy and Nautilus canoes have been built widely differing from their predecessors, and also that many craft, taking points from each, have sprung into existence, and claimed a type title of their own.

The Rob Roy was a small, short, strong, and straight-floored canoe, chiefly intended for paddling, and was built without sheer. The Ringleader was a craft similar to the Rob Roy, but of great length, and very

light build—in fact, a river canoe. The Nautilus was a short beamy craft, chiefly intended for sailing and cruising in open waters, and was built with considerable sheer, a rockered keel, and rising floor. Therefore, it may be taken that, under this classification, all canoes built with sheer and rockered keels must belong to the Nautilus class, and canoes built without sheer belong to the Ringleader type if long and light, or to the Rob Roy if short, strong, and flat; of course variations must result from such a classification, unless simply “sheer” or “no sheer” is to determine the question of type.

The following is submitted as a more practical classification :—



NAUTILUS PADDLEABLE-SAILING CANOE.

The paddleable-*sailing* canoe is a vessel designed for cruising on navigable rivers, lakes, and seas, and for sailing matches—a craft in which sailing is the chief mode of propulsion. The sailable-*paddling* canoe is intended for navigating inland lakes, rivers, and canals, and in her paddling is the chief mode of propulsion.

A universal feature of British canoes is that they are “decked,” and, with the exception of a few river craft, the decks are of wood permanently and substantially built to the canoe. An equally prominent, but not so universal, feature is that, with the exception of the club “fours” and a few two-handed canoes, each canoe is manned by one man only; but, when considering the subject of sailable-paddling canoes as regards their adaptability to extensive foreign cruising and exploration, we shall endeavour to point out the advantages, if not superiority, of double-handed canoes for touring purposes.

The design and construction of a paddleable-*sailing* canoe will first be considered. The design represented by Plate XXXVII. has stood the test of existence, and has originated several craft highly successful both as cruisers and racers; but the design has been slightly altered from the one recently built to—as will be duly pointed out—in order to rectify such weaknesses as were made apparent by practical tests; the centres of “lateral resistance” and “effort of sails,” have been placed conformably to the dictates of actual trial; and the various

fittings and equipments as to sizes, shapes, and positions, are not speculative, but the tried results of the experience of many good canoeists.

Under the sliding scale of the club rules canoes have crowded into the lengths between and inclusive of 12ft. and 15ft., and of these perhaps 14ft. canoes are the most numerous. The most generally serviceable sailing canoe (which may be paddled) will be found under the dimensions of 13ft. length, by 2ft. 10½in. beam. Another club rule is that the depth at the fore end of the "well," from under the centre of deck to garboards, shall not exceed 16in.; keel outside not more than 2in.; centre-board not more than 18in. deep.

On these leading dimensions the design has been constructed :

The "sheer plan" is that from which all the heights, depths, and lengths are taken, and is shown at the scale of ¼in. to 1ft.

The "body plan" gives the measurements from which the building moulds are to be made. The body plan is shown on the scale of ¼in. to a foot.

The deck plan is inserted to show the well coamings and locker and the foot-steering gear. Scale ¼in. to 1ft.

All the plans are drawn to the outside edge of the plank, so that in making building moulds, &c., allowance must be made for the thickness of plank, and also a piece must be cut out of the moulds to fit over the inboard portion of the keel to the upper edge of the rabbet. The moulds need only be "half moulds," *i.e.*, representing the shape of one side only to the middle vertical line, and will then be worked for both sides, fixing a fore-and-aft cord as the centre line. If, however, there is any doubt as to the capabilities of the workman (even if with a good man, great accuracy is required), then whole solid moulds fixed in position, form the only safe plan, as with half moulds the sides of the boat may, by carelessness, vary very considerably.

Canoes and other small boats are usually built up from a straight-edge building block, and therefore the rocker, or upward curve of the keel from that straight-edge is given; the heights of stem and sternposts, and their "set" or "rake," will be taken from the drawing, and they will be fixed in position to the keel before the latter is fixed to the building block. The other heights, whereby the correct sheer is obtained, will be taken from the sheer plan table, page 414, and transferred to the building moulds; and, to insure these moulds being in position, the load water-line should be marked on both stem piece and stern post and on each mould; and a hole should be bored through each mould at the cutting of the water-line with the middle line; or, if the whole mould be not solid a batten should be nailed across each, the top edge of which

batten should be level with the load water-line; then a tightly-stretched chalk line, nailed to marks on stem and stern posts, should cut the aforesaid water-line points or battens on the moulds. Without this precaution moulds and "lines" are useless, and one might as well build according to the rule-of-thumb plan of allowing the plank to take its own form.

In the sheer plan (see Plate XXXVII.) the vertical positions for timbers are placed one foot apart. No. 1 is one foot from vertical of fore side of stem. The heights are measured from the load water-line to the upper side of the deck at gunwale; and the depths are measured from the load water-line to the lower edge of the rabbet on the keel. The back rabbet, or inside position, of keel will be seen in the longitudinal section plan.

The rocker or upward curve of the keel above the straight edge is at the sternpost lin., and at the fore end (at 6in. in from perpendicular of stem) the rocker is $4\frac{1}{2}$ in.; at No. 1 station it is 3in., at No. 2 it is $1\frac{1}{2}$ in., at No. 3 it is $\frac{3}{4}$ in.; fore edge of stem at load water-line is $1\frac{1}{2}$ in. in from perpendicular of stem; sternpost at L.W.L. from aft perpendicular is $1\frac{1}{2}$ in.

The keel, from No. 3 to No. 7 sections—*i.e.*, in the wake of the centre-board slot—is sided at rabbet line 2in., and is $1\frac{1}{2}$ in. at lower edge; the siding—*i.e.*, thickness—at rabbet line forward and aft of this should not be less than $1\frac{1}{2}$ in. The cutwater of stem should be reduced on the fore edge to about $\frac{3}{4}$ in.

Selecting the wood for the keel will be a matter of choice. For hard work teak is recommended; for great strength and weight greenheart; but red pine (not pitch) has been found quite strong enough for all ordinary work.

The next point of importance is the skin, or plank, and the mode of putting it on. Except for the roughest coast-bumping or for home lake sailing, oak is uselessly strong and heavy. A combination of mahogany and cedar, well seasoned and properly fastened, forms for a sailing canoe as strong and light a build as can be desired—that is to say, the canoe should be built with the three lower strakes, mahogany (the garboard very wide), and the three upper strakes of cedar, ranging from about a quarter to three-eighths of an inch thickness.

Various modes of planking have been tried with the object of obtaining a smooth outer surface, and a light but strong skin; of these the most successful are the "clincher," the "ribband carvel," and the "double skin." The ordinary carvel build requires sufficient thickness of plank to allow of caulking, but this increases the weight beyond what is advisable for a canoe. The "double skin" plan is as follows: When the stem and stern posts have been set up and fastened off, and the building moulds—say one foot apart—carefully and strongly fixed in position, and firmly battened round at their heads by a kind of temporary gunwale,

and the centre-board case or cases fitted and fixed, this framework is turned upside down, and again fixed in position. Thin, well-steamed planks of cedar, about "wager boat" thickness, are tacked in position edge to edge, over the moulds, as if for carvel-planking; over this is then laid, plank by plank, a somewhat thicker skin of steamed cedar, the edges of which come over the centres of the planks of the inner skin. The two skins are then fastened off as if one, along the rabbet line, with brass screws; the edges of the outer skin are then pierced along and copper nailed as in ordinary building. The craft is then turned up and the nails are clenched off on the inside. It will also be found necessary on some strakes to nail along the inner skin edges also. In such case the holes will be bored from inside and nails driven from outside. Very few timbers will be needed, and the double skin will be found to possess great strength. A good coat of varnish or strips of varnished calico between the skins would no doubt add greatly to the strength and watertightness of the structure.

In the ribband-carvel build (see Fig. 121), the planks of, say $\frac{1}{4}$ in. to $\frac{3}{8}$ in. stuff, are tacked on to the building moulds edge to edge. Ribbands



FIG. 121.

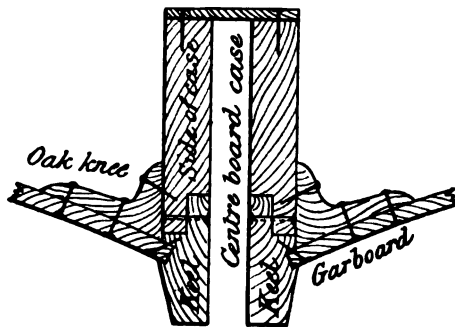


FIG. 122.

of clean-grained oak, about $1\frac{1}{4}$ in. wide and $\frac{1}{4}$ in. or $\frac{3}{8}$ in. thick, are laid along on the inside of the joints of the plank between the timbers which are placed in the vertical positions shown in the sheer plan; the edges of the planks are then pierced and nailed through the ribbands, and clenched on the inside, or they may be screwed into the ribbands. A stronger plan is to work a $\frac{1}{4}$ in. ribband in whole lengths, cutting out notches in the backs of the timbers and moulds to take each ribband. In all cases a strip of varnished linen should be laid over the joints of the plank before the batten is fitted, and the linen should be continuous from end to end. The timbers are about $\frac{3}{8}$ in. sided by $\frac{3}{8}$ in. moulded. No doubt this mode, and that of the double skin, give a very fine outer surface; but the number of nails required is nearly double that employed

in a clincher-built boat, and with neat workmanship a clincher boat can be built with next to no "lands" showing on the outside, and yet be of sufficient strength.

The garboard plank will be 6in. or 8in. wide at the broadest part, and the other planks will be as broad as the shape of the canoe will admit of being worked, and will of course vary in breadth and shape.

The construction of the section of slot in the keel and centre-board case is shown by Fig. 122.

The most convenient mode of "laying off" a canoe for building will be obtained by working in the following manner: Take a sheet of common wall paper of 14ft. length, and on the reverse side draw in, with a straight edge, a strongly marked and straight "load water-line;" then, by measurements from the scale drawing and from the table (page 414) draw the "sheer plan" at full size. On similar paper, and in like manner, draw the "body plan," and from the body plan cut out moulds of stiff brown paper from which to make the wooden building moulds, *taking off* a margin from the paper or from the wood mould to allow for the thickness of the planking. As before said, the *load water-line* must be carefully marked across each mould; or, better still, a batten should be nailed across the mould to represent the load water-line. (See "Boat Building" in the Appendix.)

The mast steps, centre-board case, bulkheads, coamings, rudder, and centre-board can all be laid off on the sheer plan; and provided the points of measurement are correctly placed—no matter how rough the drawing—the builder will have a clear eye to his work, and the trouble of laying her off on a mould floor will be avoided.

PADDLEABLE SAILING CANOE.—TABLE OF DIMENSIONS.

| | ft. | in. |
|---|-----|-----|
| Length over all, stem to sternpost | 13 | 0 |
| Beam, extreme | 2 | 10½ |
| Depth from deck to garboard, fore end of well..... | 1 | 3½ |
| Sheer, forward, from midships | 0 | 9 |
| Sheer, aft | 0 | 5 |
| Freeboard at midship (No. 7) | 0 | 7 |
| Draught at midship (No. 7)..... | 0 | 8 |
| Rake of sternpost, 7° | | |
| Centre of mainmast from fore side of stem | 2 | 4 |
| Centre of mizenmast from aft side of sternpost | 1 | 2 |
| Mid-length, from perpendicular at fore side of stem | 6 | 6 |
| After bulkhead from mid-length | 2 | 8 |
| Length of centre-board slot..... | 3 | 8 |
| Fore end of centre-board slot from mid-length..... | 3 | 4 |
| Fore end of well, forward of midships | 1 | 0 |
| Length of fore end of well | 1 | 6 |
| Length of middle, or flap piece of well | 1 | 6 |
| Length of after piece of well | 0 | 8 |

TABLE OF DIMENSIONS—*continued.*

| | ft. in. |
|---|---------|
| Length of locker opening..... | 1 3 |
| Height of well coamings | 0 2 |
| Foot yoke for a 5ft. 8in. man forward of midships | 1 6 |
| Centre of lateral resistance aft of midships | 0 9 |
| Rudder : depth of fore side, 1ft. 7in. ; extreme length, 1ft. 7in. ; length at head, 3in. ; length at 6in. down from head, 3in. ; length at load line, 10in. ; depth below load line at centre of rudder, 11in. | |

TABLE OF HEIGHTS AND DEPTHS. (See PLATE XXXVII.)

| Number of Section | 1 | 2 | 3 | 4 | 5 | 6 | 7 | 8 | 9 | 10 | 11 | 12 |
|--|-----|-----|-----|-----|-----|-----|-----|-----|-----|-----|-----|-----|
| SHEER PLAN.—FIG. 1. | | | | | | | | | | | | |
| Height of gunwale, including deck above load line | 14½ | 12¾ | 11 | 9½ | 8¾ | 7½ | 7 | 7 | 7¼ | 8 | 9 | 10¾ |
| Height of gunwale at stem above load water-line = 16 inches. | | | | | | | | | | | | |
| Ditto at sternpost = 12 inches. | | | | | | | | | | | | |
| Depths—Lower edge of rabbet below load line..... | 3½ | 5 | 5½ | 5¾ | 6 | 6 | 6 | 6 | 6 | 6 | 6 | 4½ |
| Depth of top streak | 2½ | — | 2½ | — | 2½ | — | 2¼ | — | 2¼ | 2 | 1¾ | *1¼ |
| Rocker of keel above straight edge . | 3 | 1½ | ¾ | ¾ | — | — | — | — | — | — | — | ¾ |
| BODY PLAN.—FIG. 2. | | | | | | | | | | | | |
| Diagonals A is started on middle line at 12in. above L.W.L. | 5¾ | 10½ | 14¼ | 16¾ | 19 | 20 | 20½ | 20¾ | 19¼ | 17¼ | 14 | 8½ |
| Diagonal B 6in. above L.W.L. | 4½ | 8½ | 11¾ | 13¾ | 14¾ | 15½ | 16 | 15¾ | 15 | 13¼ | 10¾ | 6 |
| Diagonal C, at L.W.L..... | 2¼ | 4¾ | 6 | 7 | 7¾ | 8 | 8¼ | 7¾ | 7¼ | 6¼ | 4½ | 2½ |
| Half-siding (width) of keel at rabbet | ½ | ¾ | ¾ | 1 | 1 | 1 | 1 | 1 | 1 | ¾ | ¾ | ¾ |

The diagonals form an angle of 55° to the middle line ; or diagonal A cuts the L.W.L. at 1ft. 5¼in. from the middle line measured on the water-line ; diagonals B and C are each parallel to A, and 5in. apart.

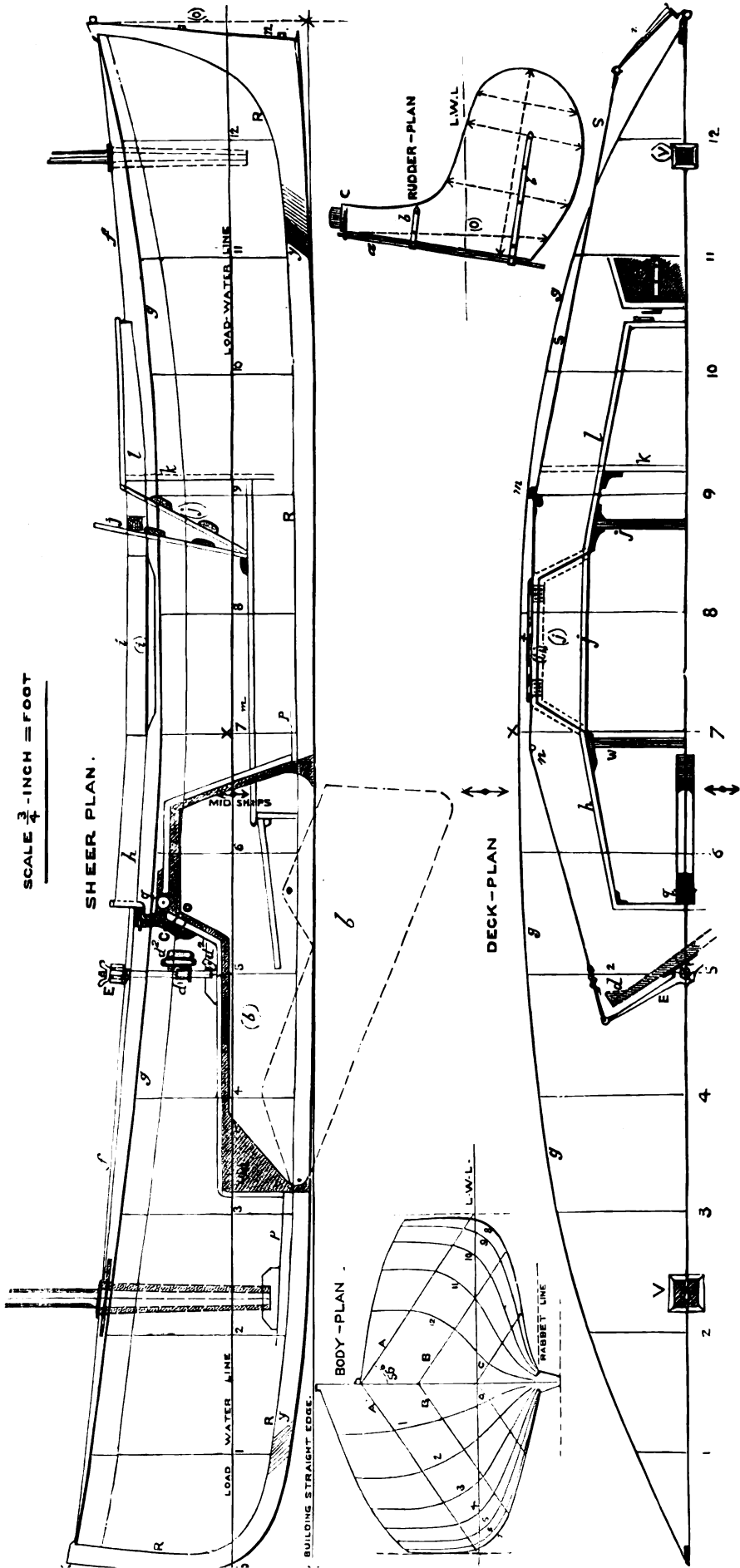
It may be again mentioned that all the body plan measurements are to the *outside edge*, so that plank, deck, &c., must be *allowed* for in making the building moulds.

SHEER PLAN.—PLATE XXXVII.

| | |
|--|--|
| o, the perpendicular at the fore end of load water line. | h, forward side-coaming of well. |
| (o), the perpendicular at the aft end of load water-line. | i, coaming of sailing flap, or opening in side deck. |
| a, the centre-board slot and case. | (i), flap, side deck. |
| b, centre-board, lowered for sailing. | j, back-board and shifting beam, used for paddling. |
| (b), centre-board, hoisted in the case. | (j), back-board in sailing position. |
| c, knee, which steadies the centre board case at point of greatest pressure. | k, water-tight bulkhead. |
| d, foot steering yoke of wood, and d 2 is a side chock to prevent the foot slipping off. | l, locker side-coaming. |
| E, foot-steering gear deck-yoke. | m, floor boards. |
| R, rabbet line, lower edge. | n, sternpost and metal gudgeons. |
| f, upper side of deck at middle line. | p, a line showing upper side of keel. |
| g, upper side of deck at sides. | X, position of greatest beam. |
| | q, centre-board sheave hole. |
| | y, keel scarping. |

* Taper to ½in. at stern.

PLATE XXXVII.



"Nautilus" Paddleable-Sailing Canoe, designed by W. Baden Powell, Esq.

DECK PLAN.

| | | |
|--|--|---------------------------------|
| (i i), supports for flap deck. | | u, locker lid and hinge. |
| s, wire steering-lines, passing round brass buttons at m. | | v, mainmast hole and case. |
| t, beading to keep flap, when open, from jamming the steering wires. | | (v), mizenmast hole and case. |
| | | w, apron beam for "well" cover. |
| | | x, rudder-yoke. |

RUDDER.

| | | |
|---------------------------------------|--|---|
| (o), aft or sternpost, perpendicular. | | b, gudgeon metals. |
| a, rudder pin or rod. | | c, (shaded part) is brass cap for yoke to fit over. |

The general features of the design may now be reviewed. In the first place, in the design just described, *sailing* requirements were given the chief attention; secondly, it will be well to bear in mind that the word "design" includes both "model" and "fittings," and the same model can be fitted either for pleasure sailing or for sailing cruises by arranging such fittings as centre-boards, bulkheads, mast cases, &c., conformably to the use the boat is to be put to. Sleeping accommodation, for instance, does not demand that the model shall be altered, but requires a 6ft. space in the centre of the canoe; therefore two small centre-boards, having a joint area equal to the larger single board, become a necessity, and by this means an effective lateral resistance is maintained; still, a considerable amount of weatherliness is sacrificed unless the after-board is constantly and carefully worked.

Limited by the club rules, the leading dimensions of the model have been fixed upon, viz.: length, 13ft.; beam, 2ft. 10½in. A model 12ft. by 3ft. would give greater sail-carrying power, and would be more adapted for quick turning and eating to windward; but the "floor" would be considerably shortened, and the boat generally cramped as to the fore-and-aft arrangement of her fittings; 14ft. and 15ft. length give better results as to speed in running and reaching, and, to some extent, as to speed and ease in rough water; but the necessary reduction of beam to 2ft. 7½in. for 15ft. length takes away a considerable amount of initial stability, which, on account of the existing club rules, cannot be compensated for by increasing the depth of hull, and thereby lowering the weights; the increased length also comparatively retards the vessel's turning, unless her keel and floor line are considerably rockered.

The dimensions given provide good beam for stability, sufficient length for fine lines with good length of floor, and not too great a length for quick turning.

The fore-and-aft positions of the various fittings have been settled in compliance with the following requirements: The weights must be crowded as near midships as possible, so as to give easy performance in

rough water; consequently the after end of the centre-board and the fore side of the man must be brought as close together as possible, allowing, however, sufficient room between them for the shifting ballast to cross the floor. The centre-board must not come much abaft amidships, because the centre of lateral resistance would thereby be thrown so far aft that a large unhandy mizen would have to be carried to properly balance the centre of effort of the sails with the centre of lateral resistance of the hull. The man must not sit too far aft, as that would necessitate very full lines aft; at the same time the weights would be separated, and being nearer the ends, bad performance in a seaway would be the result. The performance, governed by the longitudinal position of the centre of buoyancy and the distribution of the weights, is not that of power to carry sail, nor even sailing or steering performance in smooth water, provided the normal trim has not been altered; but it is the performance of the canoe in a sea—whether she takes kindly and dryly to a head sea or a following sea without plunging and diving violently. The masts, in order to get spread for the sails, have to be placed far forward and aft; but their weight is small compared with that of the man, centre-board, and ballast.

CENTRE-BOARDS.

The foot steering gear requires the centre-board case to be sufficiently low at the locality of the foot yoke—*i. e.*, 3ft. 9in. forward of the man's back—to allow the foot yoke to swing at eight inches above the foot boards. This, combined with reducing fore-and-aft weight, has suggested the form of centre-plate shown in Plate XXXVII. The centre-board case is thus fitted to the keel (see Fig. 122, page 412). The sides of the case are rabbetted into the keel as shown, and fastened by screws which go clean through the keel, the ends being subsequently filed down in the slot.

The centre-board should be made of $\frac{3}{8}$ in. iron "boiler plate," and should be galvanised; the measurement should be taken from the drawing, and laid off full size on paper; the paper mould, having the pin hole and chain hole marked on it, should be sent to the foundry, and great care should be taken in seeing that the plate is perfectly straight. Cast-iron centre-boards are often used, but they are bad, in that sudden breakage is the common result of a hard lateral bump on the ground, and also that, to obtain the same weight as "boiler plate," a thicker plate must be carried.

On the position, forms, and areas of the centre-board or boards and rudder depends, to a very great extent, the successful sailing (apart from actual speed) of the canoe. As, has been already pointed out, the position

of the centre-board is determined by the requirements of space for the man and the stepping of the masts; two or three canoes, noted for their sailing qualities, have been ingeniously fitted with "fan" centre-boards, which collapse into a case which does not come above the floor boards. Such centre-boards can, of course, be placed regardless of the well seat and steering gear; and, provided they are of a pattern and make which gives sufficient rigidity when in the sailing position, they are undoubtedly of service.

But the position of the sails in a canoe does not admit of much variation. Leaving out of the question extraordinary rigs, the centre of effort of the mainsail-and-mizen rig (which is the most popular in canoes) will be generally found to be at the mid-length, or not more than eight inches abaft it; then, the canoe being of shallow draught, the rudder, to be effective, has to be somewhat large in area, and, being at the extreme end of the vessel, naturally carries the centre of lateral resistance considerably aft; then, to bring the centre of lateral resistance forward and near to the vertical of the centre of effort of the sails, the centre-board has to be placed slightly forward of midships; therefore, it is evident that the position and area of the centre-board is of the first importance, and its mechanism merely a matter of convenience.

Two square feet area of centre-board has in practice been found amply sufficient, even in match sailing; and whether this area be given in one large plate or two small ones is practically immaterial as far as lateral resistance is concerned, but in relation to turning and manœuvring there is a great deal to be said on both sides. In the first place, the single board and the double board are equally efficient in counteracting leeway, that the single board is the more delicate and perfect for eating to windward; and the double is more perfect than the single for reaching and running, and is undoubtedly the more powerful weapon for manœuvring when skilfully handled. With the single board the canoe on a wind will answer the least touch of her helm or alteration of her sheets; and, except for shoal water, the board need not be touched from start to finish. It is often asserted that a single centre-board (of course in relation to other centre-boards) is not so good for beating in rough water, for the reason that her head is easily knocked off the wind by every sea; but it should be remembered that a boat does not eat to windward by virtue of gripe or forefoot; she works on her common centre of lateral resistance, and, though the bow may be knocked off the wind by the seas, a like facility of movement exists for bringing her to, and, further, the single-plate boat is able to take advantage of smooths or free puffs for getting a screw up and a rapid fill away again. It is the crest of the wave that will knock the bow off the wind, but this is almost

an advantage, and it places the vessel in the best position—"three corner ways on"—for dropping gently down the back of the sea, off the wind, and, consequently, "all full," and gathering way for a neat luff up the face of the next sea. (See page 18.)

No doubt the double centre-boarder, in the hands of a skilful canoeist, has many advantages over the single-plate craft; but, to utilise these advantages to their full, a judgment and quickness are needed, which can only be obtained by long and constant practice. The experienced hand in a double centre-boarder will use his boards, by alternate lifting and dropping, when on a wind or reaching, almost in preference to his rudder; in fact, the working of the boards will be attended to before working the sheets. The ease with which the centre of lateral resistance can be thus shifted forward or aft of the centre of effort of the sails places within his grasp a power of turning which in match sailing is of the first importance. If from any accident the mizen is lost or has to be stowed, the canoe will be handy under mainsail if the after board be hauled up; and if caught in a squall, the mainsail can be stowed and the canoe hove to under mizen and fore centre board—the aft one being of course hauled up. Without going into details of intricate manœuvres, it may be stated that when the canoe is sailing, say, close-hauled, if the afterboard be suddenly hauled up, the craft will fly up into the wind's eye. Of course this can be augmented by easing the fore sheet, and also by putting the helm down—*i.e.*, bringing the rudder to windward. In like manner, for quick bearing away, the after-board would be kept down, the fore-board lifted, the mizen-sheet eased off, and the helm put up.

Beyond these qualities, the double board permits of space for the owner to sleep on board, and this, in some waters, is no small advantage; for the greatest genius at tidal calculations, when cruising in navigable tidal waters, may more than once find himself benighted and tide-bound far away from his anticipated night post, and with a considerable strip of soft black mud between the edge of the water and *terra firma*. In such a predicament, a canoe of the dimensions we have been considering will, if fitted so as to allow of sleeping space, prove a safe, if not comfortable, miniature hotel for the night.

The leading measurements for fitting a canoe of the dimensions shown in the design (Plate XXXVII.) will, with two centre boards, be as follows: The fore end of the slot for the foremost plate will be 3ft. 10in. forward of midships; the length of the slot, measured on the lower edge of the keel, will be 2ft. 4in.; length of lower edge of plate, 2ft., and drop, 1ft. 3in.; the forward end of the after slot will be 3ft. 3in. abaft midships, and the length of the slot will be 1ft. 8in.; length

lower side of plate, 1ft. 6in., and drop, 1ft., giving a joint area of 2.5 sq. ft.

The inboard shape of the fore plate, *i.e.*, that portion which remains in the keel and case when the plate is lowered for sailing—should be as small, especially at the fore-end, as is consistent with keeping the plate rigid laterally; many canoes are fitted with the centre-board case extending up to the deck and open along its top; in such cases the plate is usually hung by its fore-end from a bolt at the deck, and at its after-end by its hauling-up gear, the advantage being that a plate so fitted (instead of being bolted at its fore-end through the keel) can be lifted out of the canoe through the deck, and thus be speedily removed when requisite without having to lift the craft herself out of the water.

The after-plate should be inclosed in as small a case as possible, so as to give stowage space in the locker; a case of triangular form, the after end of which comes up to the deck, will be found to act well. Such a case gains support from the deck, and permits the hauling-up gear to be worked above deck; the after-board should be light, and may be made of zinc, as lateral resistance only is required, and weight should be avoided.

The after-end of all centre-board cases should be raked forward at its upper end in order to prevent the water heaping up and overflowing at the chain-hole when the boat is moving rapidly, or when in lumpy water.

A very heavy centre-board is by no means an unmixed good in a canoe. In smooth-water sailing it doubtless adds considerably to the canoe's stiffness; but in lumpy water its thumping leverage will soon be felt by the boat, and, sooner or later, something will start unless the craft and centre-board case are built and fastened with unusual strength.

The hauling-up gear in the single-plate fitting (Sheer Plan, Plate XXXVII.) would be a small galvanised iron chain, shackled to the hole in the forward upper corner, and cut to the exact length between that hole, when the centre-board is down, and the upper edge of the sheave (*g*) in the top of the centre-board case; to this end of the chain a small single block, metal stropped, should be shackled, with a thick india-rubber ring placed on over the shackle to act as a buffer; the standing part of the hauling line is then spliced into an eye-bolt at the after-end of the top of the centre-board case, and the hauling-part having been rove through the block, is finished off by having a wooden toggle spliced in its end at such length that when the board is down the toggle is at the block, and when the board is up a turn is taken on the hauling-part round a patent tumbler cleat, fitted on the after end of the upper side of the centre-board case.

For a light plate, a split-ring handle may be put into the last link of the chain, the buffer, however, being placed over the chain first.

STEERING GEAR.

There are many ways of fitting the steering gear; in fact, so many, that it would only be confusing to attempt to describe and consider each kind. The two most common modes are where, in the one case, the yoke lines are led direct to a foot-yoke; or, in the other, to a deck-yoke, which is connected to the foot-yoke. The most serviceable of these is undoubtedly the deck-yoke gear; this gear is shown in the sheer plan, and is marked *d*, *d*², and *E*, and in the deck plan *d*², *E m* and *z*, *s*.

The rudder-yoke fits over the brass-capped rudder-head, and should be 14in. wide, with an eye at each end. The foot-yoke is made of hard wood, 16in. wide, and of sufficient strength to act as a stretcher for both feet, for it will be thus used when the canoe is being paddled; the yoke rod should be a round brass tube inclosing an iron or a steel rod, the heel of the rod steps in a block on the top of the centre-board case, the upper end having been pushed up through a brass-bound hole in the deck; a shoulder of brass, with a squaring above it of about 1½in., is soldered on to the rod, and to this the foot-yoke is tightly clamped; it should be at such a distance from the lower end of the rod as to bring the foot-yoke, when in position, about 8in. above the surface on which the skipper's heels are to rest; the head of the rod should project about 1½in. above the deck. At ¼in. above deck the rod is filed square, for the deck-yoke to ship on to, and the squaring is carried up about ¾in., that being about the thickness of the boss of the yoke; then the last half an inch of the rod is formed into a screw, on to which a thumb nut (*E*) is screwed to keep the deck-yoke in its place. The deck-yoke requires an eye at each end; and the yoke should be of iron, as neither copper nor brass is strong enough for fittings 18in. or 20in. long.

The yoke lines should be made either of solid brass or copper wire, and must be stout, and may be fitted thus: Having fitted a copper or brass thimble into each of the four eyes of the rudder and deck yokes, with powerful nippers, simply take the ends of the two wires, and, having passed them round the thimbles in the rudder-yoke, twist the ends round their own standing parts; then at the fore end fit in like manner to two thimbles, making the wires of such length as will place these two thimbles at about one foot from the eyes of the deck-yoke when it and the rudder are shipped in position. A small lashing line is now spliced to each of the fore ends of wire, and, being rove

through the yoke thimbles and the wire thimbles, say three turns, makes a powerful but easily workable gear.

The wires would naturally thus lay along near the middle of the canoe; but to keep them clear of the canoeist, and also of the deck flaps, locker, &c., little brass studs are screwed into the deck, as shown at *m* and *n* in the deck plan, a single one opposite the fore end of well, and two diagonally placed, are put in abreast of the after end of the well.

One great advantage of this plan is that, for unrigging, simply the rudder-yoke and deck-yoke are taken off, and the wires folded round them. The lines do not lead down below through the deck, coaming, or bulkhead, and are not in the way when stowing or unstowing spars under the side deck. The yoke on deck is very handy for hand steering whilst kneeling up working at the mast gear.

In the case of foot-yoke only, the wires are fitted much in the same way as above; but they have (before being fitted at the second end) to be passed through perhaps both coaming and bulkhead, in order to get a fair lead to the stretcher-yoke; and the rudder-yoke ends should be fitted with snap swivels, so as to be detachable from the yoke.

The rudder-pin (*a*, Rudder Plan, Plate XXXVII.) should be, as shown, of the whole length of the sternpost; the gudgeon metals (*b*) are so placed as to allow the rudder to travel up the pin when it strikes the ground. These rudder fittings—and indeed all the metal fittings of a canoe, should be of copper, or gun metal, or brass.

DECK FLAPS.

The flap side deck was contrived for the "Rob Roy" by Mr. Macgregor in 1868; it is to allow the skipper to sit to windward, and should have an easy opening and shutting, and yet be water-tight. The flap being just abreast of the body, the hands are often placed heavily upon it in getting in or out of the canoe; this demands good supports under the main deck (marked *i i* in the deck plan, Plate XXXVII.), and for water-tightness washers should line the edges.

APRONS, &c.

The apron of the Nautilus racing canoe is thus fitted: A piece of macintosh of suitable size is fixed by nails to two battens (see Fig. 123). The battens are of the length of the fore end of the well, and are kept in position by two fillets, which are nailed to the deck, near to and parallel to the coaming. The macintosh is nailed about an inch or an inch and a quarter from the edge of the batten, and a flap is left to go over the fillet

as shown. The macintosh is also secured to the top edge of the batten by a nail, and half round fillet. The side battens being fitted to the exact span of the coamings, stretch the macintosh tightly across the well. The fore end of the macintosh is a loose drop piece over the coaming, and tucked under an india-rubber band across the deck.

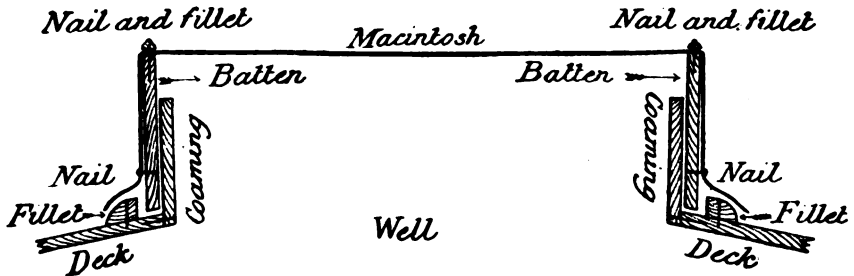


FIG. 123.

The parts of the sides of the macintosh which come from the flap deck aft have no battens, but have an indiarubber cord in the bottom edge, and a button-hole at each corner to button on to a small stud screw at the aft end of the flap piece (a small brass drawer handle will do for a stud). When sailing the apron has to be unbuttoned on the weather side.

Across the well is a shiftable beam, which supports the apron if heavy water comes on it. The whole thing comes away immediately if a capsize takes place, or any sudden "jump up" is required. When not in use the whole apron can be rolled up into a very small space.

For canoe travelling a macintosh coat is required, such as used in the Nautilus canoe of 1870. The coat is long, and closed like a petticoat from the bottom to the breast, where there is a neck opening with three buttons. Fixed by waterproof glue close under the arms is a macintosh flounce; run through the bottom hem of which is an elastic cord. The hem of the flounce is placed over the hatch and hatchway coaming, and abaft the backboard, thus forming a kind of tent. The flounce should be full behind to allow stooping forward without detaching its hold on the coaming. Elastic bands round the cuffs of the coat will prevent water running up the sleeves. The object of having a long inside coat is that it will then do duty as a macintosh for shore walking.

MAST FITTING AND TABERNACLE.

The tabernacle for lowering the mainmast is a matter of importance. The ordinary method is to cut a well through the deck for the mast heel to travel in (as described for the Nautilus racing canoe, page 425); but, as the bow of a canoe is very frequently immersed when working

in rough water, it is undesirable to have any opening in the deck. The tabernacle is thus fitted: Two pieces of oak placed in the ordinary form of a tabernacle, *c* (Fig. 124), secured at the heels by a block (G), and passing up through a blocking piece under the deck *a* (Fig. 124), and through the deck *b*. The two heads are each $3\frac{1}{2}$ in. high by $2\frac{1}{2}$ in. wide fore and aft, and half an inch thick, the heels being considerably tapered off for lightness; (*c*) in the sketch is a blocking piece, firmly bolted in between the uprights, and let through the deck and deck block. Against this the mast heel lodges. The mast heel should be $1\frac{1}{2}$ in. square, from heel to half an inch above the tabernacle; then round and taper to 1in.

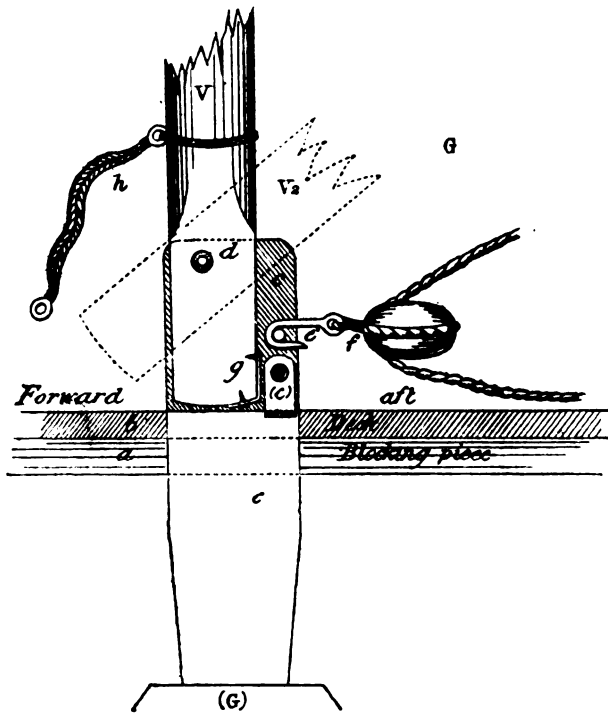


FIG. 124.

at head. The mast is bolted between the tabernacle heads, at three-eighths of an inch from the top of the heads at *d*. At *e* is a through bolt, on to which, between the heads, the halyard blocks hook. The mast heel and the outer sides of the tabernacle heads should be brass plated, and there should be a small piece of indiarubber screwed on the heel as a buffer (G). The mast is set up by a forestay, which should be small galvanised wire about one-tenth of an inch in diameter, from the swivel clip (clipped to a thimble in the masthead block strop) down to a small single block, which, when the mast is up, comes about four inches above

the stem-head. The fall is fast to stem-head, and then leads through the stay block and through the stem block or cheek sheave, and into a cleat near the well. So long as the mast is set up, the halyard blocks *f* cannot be unshipped from the bolt *e*, but when the mast is lowered as far as shown by the dotted line, the halyard blocks can be unhooked.

The mast is fitted with a ferrule joint at 4ft. 6in. above the tabernacle pin, and then the upper portion, 4ft., including a 6in. ferrule to ship *over* lower mast, makes a total of 8ft. 6in. pin to truck. With the exception of unclipping the forestay, all the gear remains on the masthead, and the sail is kept on the upper part of the mast, with its halyards bent on and parrels in sailing position.

THE NAUTILUS TENT.

The Nautilus tent for camping on shore is of the "Alpine" form, but divided into two pieces by a joint of buttons and holes along one side of the ridge rope, and this junction is protected above by a flounce or bonnet stitched on the opposite side of the ridge rope, and buttoned to small buttons on the joint side of the tent; four slight poles are embedded in a hem at each corner, their lower ends sticking into the ground, and their upper ends are held in strongly stitched pockets; only one rope, the ridge rope, is needed, and is set up either to a couple of pegs driven into the ground, or to tree stumps; two pegs are used on each side in windy weather. The poles should be jointed, and need only be slight in diameter; the Nautilus had ash, but bamboo would be equally good and much lighter. The ground space is 6ft. by 6ft., and the height under the ridge is 7ft. The ends join down the middle, and are double flap jointed, with button and hole as a fixer. A kind of curtain 1ft. deep goes round the lower part of inside, stitched on about 6in. above the edge, and is used for tucking under the ground sheet.

THE "NAUTILUS" RACING CANOE OF 1879.

The Nautilus of 1879 (Plate XXXVIII.) was designed for "special racing service,"* and not for general work, and consequently, both in form and fittings, differs considerably from the type of canoe previously described. The Royal Canoe Club measurement rule, as already shown, limits length and beam by a sliding scale of relative proportions. The fixed keel of wood is not to be more than 2in. deep outside, including the metal keel

* The Nautilus won the Royal Canoe Club Challenge Cup at Hendon, 1879, beating Pearl, the winner in 1878, and several others.

band, which must not exceed half an inch in depth; the depth of the canoe at the fore end of the well, from underside of deck to the upper side of the garboards, must not exceed 16in.; all ballast and metal weights, except centre-board and keel band, must be carried *inside* the canoe; ballast may be shifted; and there is no limit beyond these as to ballast or rig or mode of building.

Bearing these limitations in mind, the idea was to create a craft which, without being of excessive displacement, thereby requiring a heavy equipment of ballast, should have sufficient area of lateral resistance of hull to perform well "on a wind" without being dependent on a centre-board, and at the same time by this greater draught of water to obtain a low centre of gravity of ballast. The next point of importance was to obtain a long light bow, with little or no "gripe;" a deep drag aft, with a raking post and powerful rudder; the sail plan being that of a "Ketch" without head sails, the latter being incompatible with such a sheer plan.

The draught of water and weight of ballast are the only drawbacks the 1879 Nautilus has for inland cruising. At sea, however, and in lake and navigable water, the depth and weight are advantages.

A freeboard permitting a 25° list, coupled with a flat deck at fore end of the well, determined the draught of water at that station in the length, owing to the club limitations of depth and keel; from this point the keel is raked so as to allow a great draught aft to be taken. Between the well and the mast is placed a centre-board, which is used solely in manœuvring, though at first trial it was anticipated that it might be necessary for beating to windward. Experience, however, has shown that the canoe goes to windward equally well without it, and it might be replaced for manœuvring purposes by a very much smaller and lighter board.

A watertight bulkhead is placed at each end of the well, so that water shipped is confined to the well space, and therefore comparatively harmless. The well and deck fittings and steering gear are exactly as described for Plate XXXVII., excepting that the centre-board, as already mentioned, is forward of the well altogether.

The mainmast is stepped in a tabernacle, to admit of its being lowered when passing under bridges, and in cruising is worked and set up by a fore stay and tackle; but for racing the mast heel is bolted to the keelson block by a long perpendicular slide bolt screwed on the fore side of the mast heel, which is worked by hand from the deck. This bolt is an ordinary slide bolt, such as is fitted to doors, shutters, &c.

The ballast consists of two kinds: firstly, 70lb. of shot in three bags, for shifting to windward; and, secondly, lead blocks cast to fit close down on her garboards, weighing 190lb., and a centre-board of boiler plate,

weight about 65lb. The lead lies in four blocks equally dispersed between the two bulkheads, and the shot bags are about at the midship section. (The sail plan will be described further on.)

TABLE OF OFF-SETS. (See PLATE XXXVIII.)

| Number of Section | 1 | 2 | 3 | 4 | 5 | 6 | 7 | 8 | 9 | 10 | 11 | 12 | 13 |
|--|-----|-----|-----|-----|-----|-----|-----|-----|-----|-----|-----|-----|-----|
| | in. | in. | in. | in. | in. | in. | in. | in. | in. | in. | in. | in. | in. |
| Heights above L.W.L. to top of plank sheer | 12½ | 10¾ | 9½ | 8½ | 7½ | 7¼ | 7 | 6½ | 7 | 7½ | 8½ | 9½ | 10½ |
| Depths below L.W.L. to rabbet line | 4 | 5½ | 7 | 7¾ | 8½ | 9½ | 10½ | 11 | 11½ | 12½ | 13½ | 13½ | 8½ |
| Depths below L.W.L. to under-side of keel | 4½ | 6½ | 8½ | 9¾ | 10½ | 11½ | 12½ | 13½ | 13½ | 14½ | 15½ | 15½ | 16 |
| HALF-BREADTHS. | | | | | | | | | | | | | |
| Half-breadths at deck | 6½ | 10½ | 13 | 14½ | 15½ | 16 | 16½ | 16½ | 16 | 15½ | 14½ | 12½ | 8½ |
| Half-breadths 6in. above L.W.L. | 5 | 9 | 12½ | 14½ | 15½ | 16 | 16½ | 16½ | 16 | 15½ | 14½ | 12 | 7½ |
| Half-breadths 3in. above L.W.L. | 4 | 7½ | 11½ | 13½ | 14½ | 16 | 16½ | 16½ | 16½ | 15½ | 14 | 11 | 6½ |
| Half-breadths on L.W.L. | 2½ | 5½ | 9½ | 12 | 14½ | 15½ | 16½ | 16½ | 16 | 15 | 13 | 9 | 3½ |
| Half-breadths No. 2 water line | 0½ | 2½ | 5½ | 8½ | 11½ | 13½ | 15 | 15½ | 14½ | 13 | 9½ | 5 | 1½ |
| Half-breadths No. 3 water line | — | 0½ | 1½ | 3½ | 5½ | 7½ | 9½ | 9½ | 8½ | 6½ | 3½ | 1½ | 0½ |

Length on L.W.L., 13ft. 8in. Beam, 2ft. 9in.

The sections are 1ft. apart. No. 1 section is 1ft. from the fore end of the load water line (L.W.L.), and 1ft. 1½in. from the plumb line. The stem tumbles home 1½in. at the deck.

The water lines are 3in. apart.

SHEER PLAN.

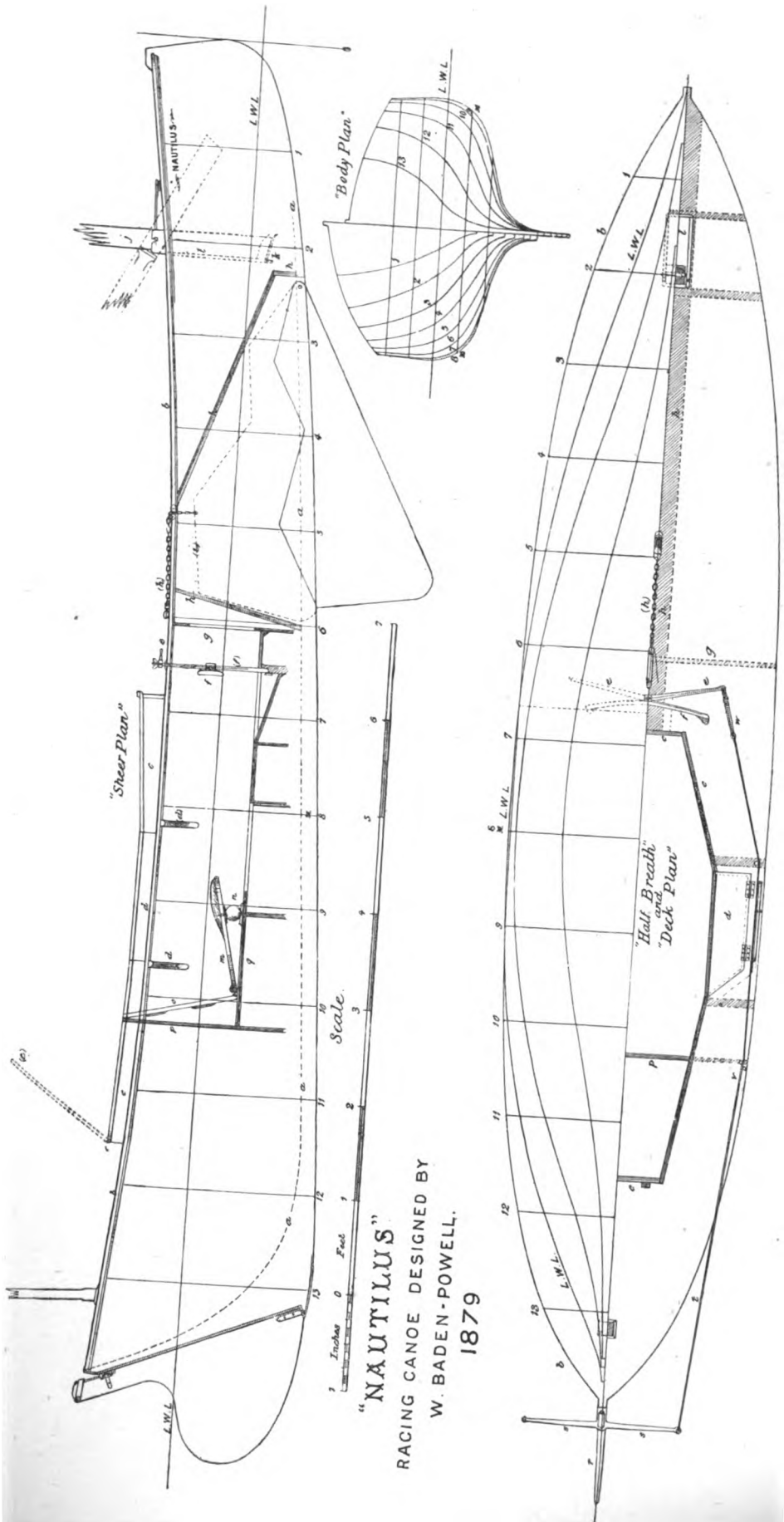
| | |
|--|---|
| a, rabbet line. | (h), chain and tackle for lifting centre-board. |
| b, plank sheer of deck. | i, centre-board when lowered. |
| c, coaming of well. | (i), centre-board when hoisted. |
| (c), lid of locker. | j, mast. |
| (d), knees to support side deck where the opening is made. | k, step of mast. |
| d, movable part to make opening in coaming. | l, tabernacle. |
| e, deck yoke. | m, seat. |
| f, yoke for the feet. | n, ball support of seat |
| g, bulkhead, watertight. | o, backboard. |
| h, centre-board case. | p, bulkhead, watertight. |
| | q, platform over ballast. |

HALF-DECK PLAN.

| | |
|---|--|
| b, gunwale or plank sheer line. | (h), chain and tackle. |
| c, coaming of well. | j, mast. |
| d, flap opening in coaming and in the deck water-ways. | l, tabernacle and opening in deck for working mast bolt. |
| e, deck yoke. | p, bulkhead. |
| f, yoke for the feet. | r, rudder. |
| g, bulkhead. | s, yoke on rudder. |
| h, centre-board case. This shaded part also represents a fore and aft carline to which the fore deck is screwed. A similar carline is fitted aft. | t, wire yoke lines. |
| | v, stud guides for yoke lines. |
| | w, lanyard for setting yoke lines taut. |

"NAUTILUS" CRUISING CANOES.

The "Nautilus" canoe depicted on Plate XXXVII. is intended chiefly for cruising on navigable rivers, lakes, and seas, and also for sailing matches. In such a craft compactness of dimensions, lightness of hull



"NAUTILUS"
RACING CANOE DESIGNED BY
W. BADEN-POWELL,
1879



and fittings, and other requisites for ease of transportation, were considered of secondary importance to seaworthiness and sail-carrying power; and the canoe was intended more for pleasure *cruising* in ordinarily frequented navigable waters than as a *travelling* craft for navigating inland lakes, rivers, and canals in thinly-populated districts.

The canoe we are now about to consider is designed to perform the latter work, of travelling. The term *cruising* is distinguishable from a voyage in that the cruise extends from port to port, with the intention of returning to the home port; whereas the *voyage* would be a journey to some distant place, and intermediate ports would only be visited for stores and necessaries. It will therefore simplify matters to assume that cruising consists of short trips in home waters, whereas travelling includes journeys to distant places and to places in foreign lands.

To arrive at a suitable design for a travelling canoe, the starting point should be that *sailing and paddling are equal in value as modes of propulsion*; and then the nature of the particular travelling the proposed canoe is most commonly to perform must be considered before preponderance is given to the one quality or the other. It is on this preponderance of sailing or paddling requirements that the leading details of construction and equipment are dependent for their proportions and position. For instance, where the work is chiefly to be the navigation of rivers and canals, paddling will be of more value than sailing, and consequently the craft should have small beam and good length; and as transport on land and “carrying over” will be constantly occurring, lightness of structure and fittings will be most desirable. A low freeboard and a well-rounded deck also will make paddling easy, and yet allow sufficient room inside. On the other hand, if the canoeist is bent on a rough tour, in which he will probably have to cross large open lakes and arms of the sea, and yet often have to work his way down rivers and through canals, sailing will, or should, undoubtedly play as important a part as paddling; hence good freeboard and beam, coupled with a flat floor, are necessary for this work.

To go any further on this side of the balance would simply be towards making a craft which would be useless as a general travelling canoe, and inferior as a sailing canoe; and on the other side one would be nearing the details of ordinary river or “hack” canoes, whose form and fittings are easy of design and application.

The travelling canoe *par excellence* is that in which paddling and sailing are considered as of equal value as means of propulsion—a craft that paddles “light off the hands,” that sails and “goes full and by” without making much leeway, has good freeboard and moderately

rounded deck, is built lightly but strongly, and is fitted with a watertight compartment for safety, and in which stores and clothes may be kept dry—at the same time be the conveyance or the camp of her master.

The drawings on Plate XXXIX. show: Firstly, a "one-man canoe," Fig. A; and, secondly, a "two-man canoe," Fig. B. Either or both these canoes can be built from the body plan D, from which the building mould plan E is taken; bearing in mind, however, that for the "one-man" or Fig. A canoe the sections 1, 2, 3, 4, &c., are 1ft. apart, where in Fig. B they are 1ft. 2in. apart; otherwise the same heights and breadths are common to both.

As to the drawings, the sheer plan (Figs. A and B) is that from which all heights, depths, and lengths are taken, and also shows the position, longitudinally and the sectional shape, of various fittings.

SHEER PLAN A. (PLATE XXXIX.)

| | |
|--|---|
| a Centre-board case. | m Burdens, or floor boards. |
| b Centre-board lowered. | (m) Heel boards. |
| (b) Centre-board housed. | n Stern post and stern band, with gudgeons. |
| c Tabernacle. | o The two rudder bands and gudgeons. |
| (c) Chock for ditto on keel, with mast-heel chock on deck. | (t) The pin passing through these gudgeons. |
| d Foot steering yoke. | P Top side of keel. |
| e Deck yoke for rudder lines. | q Centre-board up-haul. |
| f Middle line of deck. | R Rabbet line. |
| g Beading, covering top of top streak and edge of deck. | t Rudder up-haul sheave. |
| h Coaming of fore side of well. | u Locker lid. |
| (i) Side deck. | V Mainmast standing. |
| i Side coaming of well. | V ² Ditto in paddling position. |
| j Backboard and shifting beam. | (V) Mizzenmast and case. |
| k Watertight bulkhead. | w Fore hatch. |
| l Coaming of locker hatchway. | (w) After hatch. |
| | y Scarp of keel, with stem and post. |
| | z Rudder yoke. |

IN FIG. C.

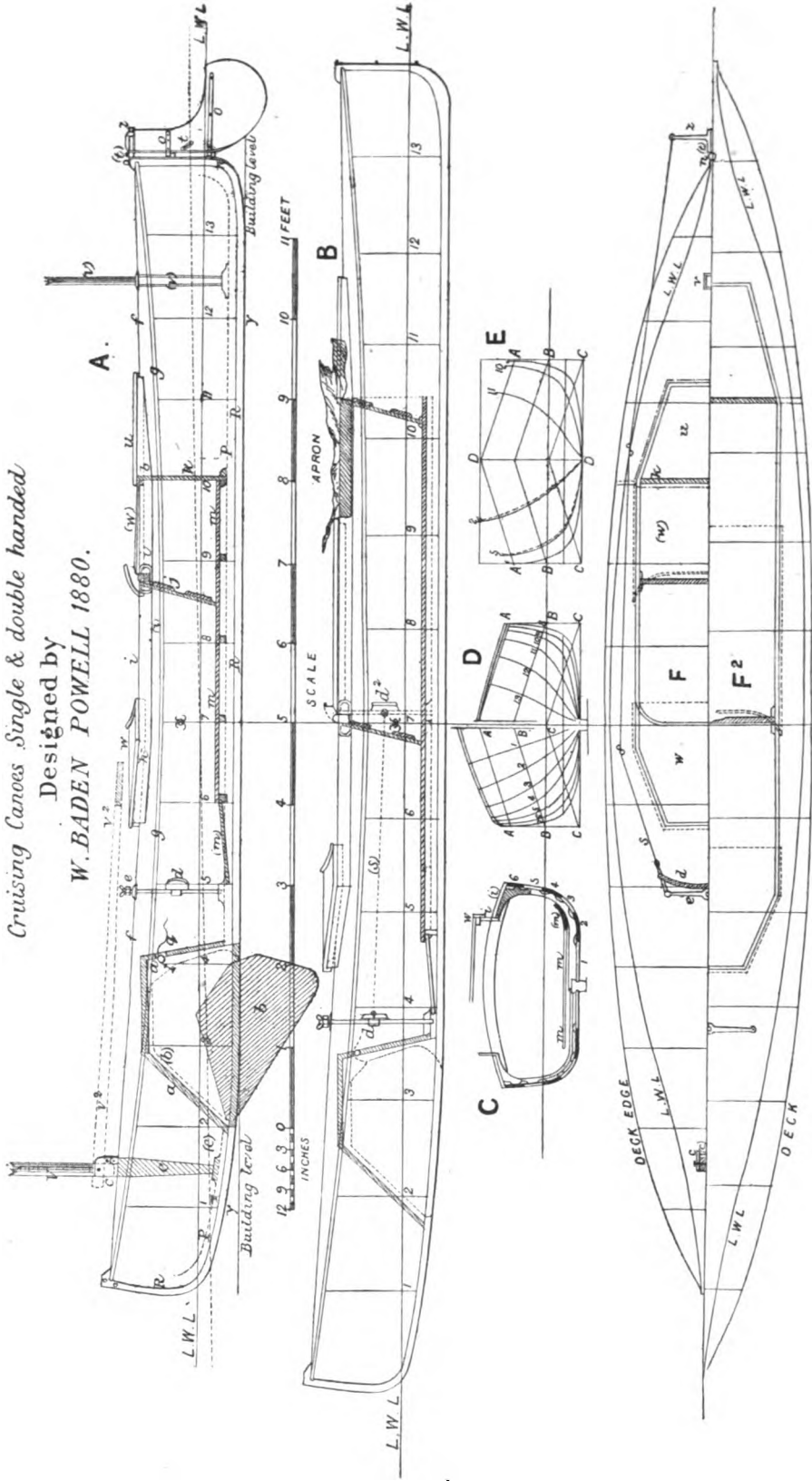
| | |
|--|---------------------------------------|
| 1, 2, 3, 4, 5, and 6 represent the planks. | I Coaming of well; and (i) side deck. |
| M The floor boards. | w Hatch, covering the well. |
| (m) Bilge burdens. | |

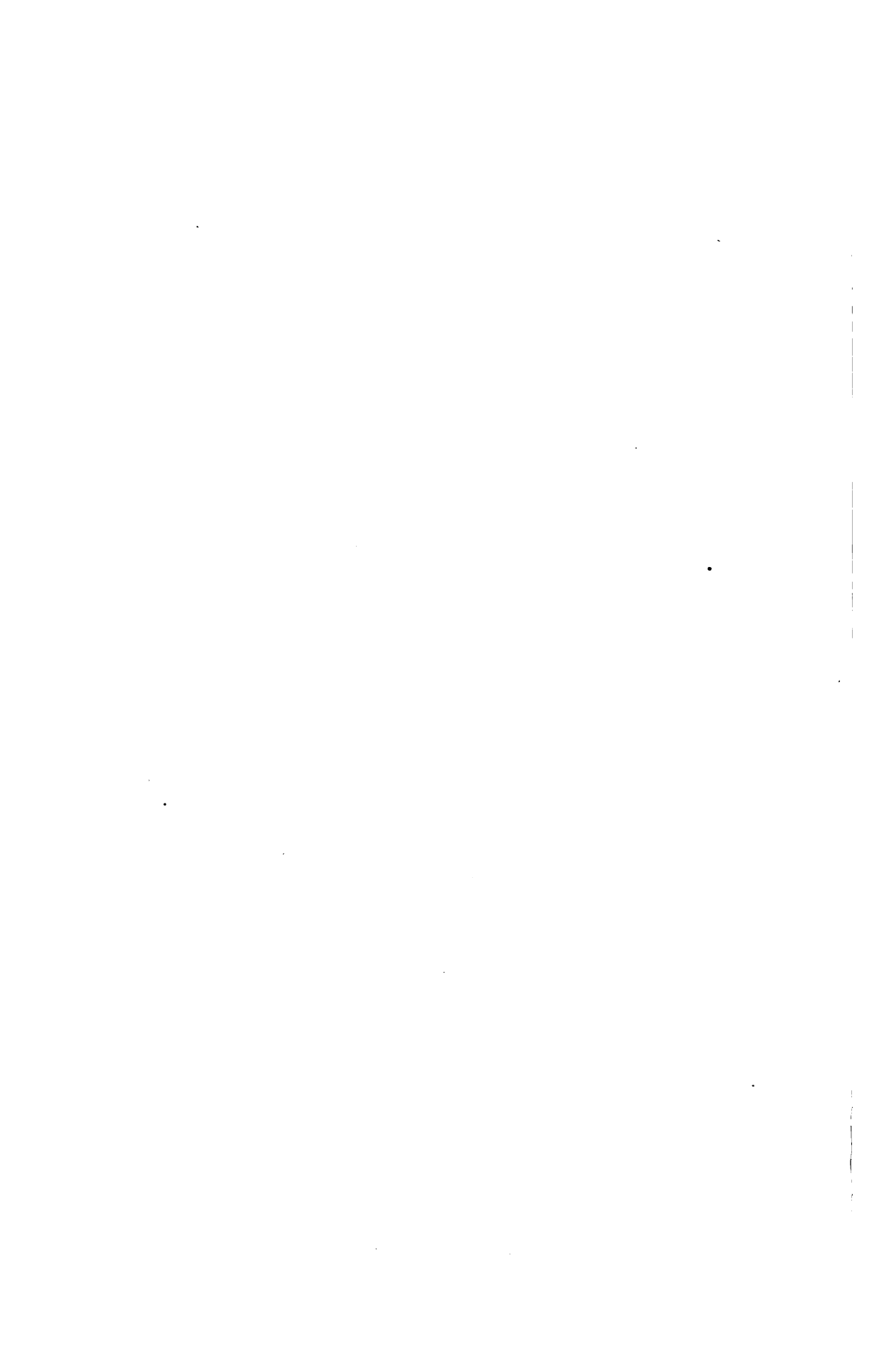
TABLE OF DIMENSIONS.—FIG. A.

| | ft. | in. |
|--|-----|-----|
| Length over all, stem to sternpost | 14 | 0 |
| Beam, extreme..... | 2 | 6 |
| Depth, underside deck to garboards, taken at the fore end of the well..... | 1 | 1 |
| Sheer forward, above gunwale at X..... | 0 | 7 |
| Sheer aft, ditto | 0 | 4 |
| Freeboard at midship section (No. 7) | 0 | 6 |
| Draught at ditto | 0 | 6 |
| Centre of mainmast from fore side stem | 1 | 6 |
| Centre of mizenmast from stern post | 2 | 0* |
| Midship mark <i>x</i> from perpendicular of fore side of stem head | 7 | 0 |

* Shown as 1ft. 6in. in the drawing.

N A U T I L U S
Cruising Canoes Single & double handed
Designed by
W. BADEN POWELL 1880.





| | ft. in. |
|---|---------|
| Water-tight bulkhead aft of mark | 3 0 |
| Centre-board slot, fore end from fore perpendicular | 2 0 |
| Centre-board slot, length on underside of keel | 2 4 |
| Fore end of well from midships..... | 1 3 |
| Length of fore end of well, on middle line | 1 0 |
| Length of main well, to bulkhead..... | 3 3 |
| Length of locker hatchway, on middle line | 1 3 |
| Height of well coaming | 0 2 |
| Foot yoke rod from midship mark (for a man about 5ft. 8in. in height) | 2 9 |
| Fore side of backboard beam aft of midships | 1 9 |
| Heel of backboard, ditto..... | 1 6 |

TABLE OF HEIGHTS, DEPTHS, AND BREADTHS (PLATE XXXIX.)

| No. of Sections | 0 | 1 | 2 | 3 | 4 | 5 | 6 | 7 | 8 | 9 | 10 | 11 | 12 | 13 | Stn. |
|---|----|-----|----|----|-----|-----|-----|-----|-----|-----|-----|-----|-----|----|------|
| Height of gunwale, including deck, above load line | 13 | 11½ | 9½ | 8½ | 7½ | 6½ | 6½ | 6 | 6 | 6½ | 6½ | 6½ | 7½ | 8½ | 10 |
| Depths, lower edge of rabbet below the load line | — | 3 | 4½ | 4½ | 5 | 5 | 5 | 5 | 5 | 5 | 5 | 5 | 5 | 4½ | — |
| Booker of keel above building straight edge | 7 | 2½ | 1 | ½ | — | — | — | — | — | — | — | — | — | — | 5 |
| Half-breadths of gunwale, g, from mid-line, without beading | ½ | 5½ | 9½ | 12 | 13½ | 14 | 14½ | 14½ | 14½ | 14½ | 14 | 12½ | 10 | 6 | ½ |
| Half-breadths on diagonals. Fig. E A | — | — | 9½ | — | — | 14½ | — | 15½ | — | — | 14½ | — | 10½ | — | — |
| B | — | — | 6½ | — | — | 13½ | — | 15½ | — | — | 14 | — | 9 | — | — |
| C | — | — | 3½ | — | — | 9½ | — | 9½ | — | — | 9½ | — | 5 | — | — |
| L.W.L. widths at 2, 5, 7, 10, 12 | — | — | 4½ | — | — | 12½ | — | 14½ | — | — | 13 | — | 7 | — | — |

The diagonals are placed (Fig. D): A at 10in. above the load line on the *middle line* (marked DD in Fig. E), and 5in. above the load line on the side perpendiculars; B starts from a height of 5in. on the middle line, and cuts side perpendiculars at load line; C starts from middle line at load line, and cuts side perpendicular 5in. below load line.

The whole of the half breadths are to the outside edge of plank, so that, in building from them, allowance should be made for the thickness of the plank at every section (see dotted lines (2), (5), Fig. E); thickness of deck in the heights is included; therefore, in making the building moulds 2, 5, 7, 10, 12, the thickness of deck should be deducted from the heights above water-line.

We next come to the internal arrangements and disposition of the weights; here the starting point must be the man and his luggage. The backboard has been placed at 1ft. 9in. abaft the centre of length; a space has then been left, for reasons which will appear in due course, and the fore end of the luggage compartment is found at 3ft. aft of midships; forward is placed a small light centre-board, which should be of sheet steel or thin galvanised iron; and with the mainmast at 2ft. in from the stem, and the mizen at 2ft. from the stern, a good balance will be found to exist with sails of 32.5 and 19.5 square feet. Either

a tent may be carried, or the owner may sleep on board, the foot steering rod of course being unshipped for such work; the tent, with cooking gear "made up" inside, can be stowed under the after hatch (*w*).

When sailing, the backboard beam *j* is removed, and the after hatch is slewed round, and its after end is tucked under the after end of the fore hatch, or it is shipped over the locker lid; the canoeist then reclines at full length, with the tent roll for a pillow. This alters the trim and puts the canoe down by the stern about 2in., which brings the centre of lateral resistance aft, and gives a good balance for sailing, and the deeply immersed rudder holds a powerful sway over the movements of the craft. The rudder is fitted with two gudgeons, which when it is down rests on top of the two lower gudgeons on the sternpost band; a pin passes through these four gudgeons, and is held by a gudgeon at the head of the stern band, of larger bore; in this gudgeon, which is wormed, the head of the pin, which is also wormed for about a quarter of an inch, is screwed. A hauling line, which is fast to an eyebolt at one side of stern head, is rove through the sheave (*t*), and through a block or sheave fastened on the other side of the stern head, and then leads in to hand. The rudder is then liftable, and in the case of grounding, fouling weeds, backing astern, carrying over, going down rapids, and the like, the rudder should be hauled up until the upper rudder gudgeon comes in contact with the stern head gudgeon; in carrying over, or in any work out of water, it will be better to take the rudder off entirely.

The following mode of building is recommended: East India teak or pitch pine for the keel, mahogany for stem and stern posts, mahogany or oak planking for Nos. 1, 2, and 3 planks (Fig. C), and cedar for Nos. 4, 5, and 6; red pine shelf (under deck edge inside, Fig. C); sawn oak timbers cut from "crooked" pieces, with grain following round—cross grain being worthless—at stations 2, 4, 6, 10, and 12, and at 4in. and 1ft. 8in. abaft α section (Fig. A), and intermediate timbers, at 8in. apart, of steamed bent American elm; deck in six pieces—viz.: two half fore decks from forward to fore end of well, and aft two half decks coming from aft to bulkhead, of cedar; the two side decks (*i*) of mahogany; the seams of deck at middle line (*f*) and at ends covered by a $\frac{1}{4}$ in. beading.

The most successful mode of planking is the "ribband carvel," details of which were given on page 412. The ribband, however, in the present canoe may be even smaller, and be either of oak, American elm, or even cedar; the planking should be not less than $\frac{1}{4}$ in. in any part, and the garboards should be *screwed* to the keel with brass screws at most 4in. apart, and the hood ends or plank at stem rabbet should all be screwed.

The building moulds must have notches cut in them as the planking goes on, to admit the ribbands; the sawn timbers are fitted and notched so as to fit close over the ribbands and on to the plank, and should be about $\frac{1}{2}$ in. sided, and $\frac{3}{4}$ in. moulded depth, with the inboard edges rounded away. The steamed American elm ribs are $\frac{1}{2}$ in. by $\frac{3}{4}$ in., and may be screwed to the ribbons or through-fastened.

The centre-board case should be of light construction, and should, with the slot in the keel, be no wider than is necessary for the centre place. No trouble should be spared to ensure the case being water-tight.

The bulkhead *k* should be of mahogany $\frac{3}{4}$ in., or cedar $\frac{1}{2}$ in., and be well bedded against the timber at No. 10 station with marine glue or white lead. It should be tested and made water-tight *before* the deck is put on; so also the centre-board case.

The coamings, for all but very rough work, may be of cedar, and so also the hatches *w* (*w*) and *u*.

The rudder should be of mahogany, and bound all round with a copper band. A bilge stringer of American elm $\frac{3}{4}$ in. by $\frac{1}{2}$ in., or even larger, would add very little to the weight of the canoe, and would greatly strengthen it. Such a stringer might be fitted between *m* and (*m*), Fig. C, or on the side above (*m*), and should go from the bulkhead to the stem, and be screwed to the timbers, with chocks under it where it fastens to a bent timber if necessary.

The keel band should be light, and either of copper or galvanised iron; the stem and stern to be of copper; the deck and rudder yokes of copper. The arms of the rudder yoke should be on the after end, as even a fore-and-aft pull is with such yokes still turning the rudder; the foot-yoke is of wood, and its rod should be a steel rod, covered with brass. The foot-yoke is *fixed* to the rod, and the deck-yoke fits on to a square head, the upper part of which is wormed; and a thumbscrew nut keeps the yoke on firmly. The deck should be bushed with brass where the yoke rod comes through. The yoke lines should be solid stout copper wire, with thimbles twisted in at each end, and lashed to the rudder yoke, and set up with a lanyard to the deck yoke and abreast of the “well.” They should pass between brass deck studs, to keep them set in working position.

The design in its leading features differs considerably from existing canoes, and it may be well to give the chief reasons which dictated the design. First of all, the canoe is to be as small as will comfortably carry a 12-stone man and about 60lb. of luggage in a draught of water of about six inches; she must be of sufficient freeboard and beam to cross large open lakes in ordinary weather; she is not intended to carry

ballast, but is intended to carry sail, therefore the floor must be kept flat. Freeboard is of far more importance, coupled with a flaring bow and quarters, in getting over rough water, than is any amount of rounding of deck—indeed, were it not for requisite strength, it would be preferable to take 2in. of rounding from the deck and put it into the freeboard; but then in steps paddling, which demands a low freeboard when the beam is wide; however, in the design the freeboard is as low as it comfortably and safely can be, and the deck is kept at a sufficient rounding for strength. It will doubtless be noticed that considerable flare is given to the sections at the bow and stern above water. In a racing canoe this would be an error. But for a travelling canoe the flaring bow forms a great help towards a dry passage in broken water.

The double-handed canoe (drawing B) is a craft which is becoming exceedingly popular, not only as the "married members' canoe," but as a travelling craft; there is a good deal to be said in favour of a craft which will carry two men on a cruise, and yet be not too large for one to manage in the absence of the rest of the crew. In the first place the original cost is for *one* canoe, and though she is some 2ft. or 3ft. longer, and has a few more fittings, yet her cost should not be more than about 3*l.* over that of a "single;" secondly, her "keep" or "housing" by the year is for *one* canoe; so also her cartage, railway, steamboat, and such portage charges, are for one canoe; and many similar points might be invoked to show that her working expenses are not much over those of a "single," and very considerably under those of two canoes.

Two good hands could, in travelling, work the double-handed canoe nearly twice the distance in a day that two single-handed canoes could be worked in the same circumstances. At sailing in a reaching wind she would be faster than the short single, in lumpy water she would have more weight to carry her way on; in a calm or head wind both can pound away with the paddle, and work can be continued "watch and watch" if need be; so that literally the double-handed canoe could be kept going on her course day and night with scarcely more hardship to the crew than is entailed in working a 5-ton yacht down Channel.

The design is arranged for two moderate weights, such as twelve stone and nine stone, which we may take as average for a "married member's" canoe; in that craft the "better half," *i.e.*, the heaviest weight, should be in the forward seat, and then the "light weight" and the baggage in the locker will bring about the correct balance. When it becomes necessary to jump out and shove off from the ground when running a rapid, it is the "heavy weight" who should do

so, and should do so from the fore end, so as to prevent her swinging broadside to the stream. When the canoe is being towed, and the after sitter remains on board to steer her, the foot yoke forward is connected by two wires, (s) Fig. B, to another foot yoke which is fitted into a step on the keel and into a notch or chock on the afterside of the back-board beam of the fore compartment; the after well is covered by a macintosh apron abaft the half hatch. When the canoe is to be worked by one man only, he would sit in the after place and put the luggage under the fore hatch and join the two hatch covers together.

The canoe shown is for about twenty-one stone of crew; for two men of twelve stone the sections from No. 7 each way should be 1ft. 3in. apart, *i.e.*, length 17ft. 8in. The placement of the masts and centre-board should be the same, measuring from the ends, as in the “single” canoe; a slight advantage might be found, where much lake work is contemplated, in having a small centre-board aft in addition to the one forward, but as its case takes up valuable space in the locker, and as centre-board cases are apt to get out of order on long rough journeys, and leak, on the whole, it will be better to omit the after centre-board where rough work is anticipated.

The same rig and sails should be given to the “double” as to the “single,” for though longer and more heavily weighted, she may often have to go single-handed, and even when double-handed sufficient speed will be got out of the suggested rig and area.

Where the chief work is to be lake sailing slide flaps will be very useful, but where much hauling about, and jumping in and out are anticipated, side flaps are utterly out of place. If fitted to the travelling canoe the after end of the flap should be just forward of the backboard beam, and it should be strongly hinged at the outer edge, and, in short, strongly fitted in every way, as it is just about in the place that one’s hands lay hold of to raise the body in case of a sudden jump up or out. A broken, and perhaps lost overboard, flap would be a dangerous mishap to a canoe in rough water.

The hatches by which the well is covered may be seen in the drawings, and it will be noticed that on the after end of the fore hatch, and on the fore end of the after hatch, are small coamings, with a beading on them; these coamings are for the purpose of holding the “coat apron” flounce (see page 422).

One side under the fore deck, forward of the foot yoke, should be as nearly as possible filled up by a macintosh air bag or air bed. Such a bag is of little weight, and makes it impossible for the canoe to sink. If sleeping in the canoe, or indeed any camping out is contemplated, an

air bed will be found a great comfort. It should be specially made, having one end smaller than the other, so that when folded lengthways and blown out it just fills the space on one side under the fore deck. If a bed, it should be wrapped up in a macintosh sheet, which for sleeping in the canoe will form the tent between the masts, or ashore acts as ground sheet. The canoe should be fitted with a strong pair of slings, ready for hoisting her on to steamers or quays, &c. For each end of the canoe a strong webbing band, with an eye at each end, is passed under the keel, the eyes meeting over the middle of the deck, at about 3ft. in from the end; a piece of lin. or $1\frac{1}{2}$ in. manilla is spliced into the two eyes, and is of such length as, when fitted at its other end with a pair of clip-hooks, to reach the mid-length of the canoe; here a large-sized galvanized iron ring, having the after sling rope spliced to it, and also coming to the mid-length, hooks on to the fore sling, and the steamer's crane hook hooks into the ring. The sling thus fitted can be shipped or unshipped in a very short time, even when afloat in rough water.

Sails for the cruising, or travelling, canoes will be found described further on under the head of "Canoe Sails."

SAIL CARRYING POWER OF CANOES.

Paddling demands an upright position of the man's body, but sailing equally demands a lowering of the weights, and consequently a reclining position; and further, when running dead before a strong wind under a press of sail, even though a spinnaker be set, the head of the lug will get forward of the right angle, and cause violent, if not dangerous, rolling. Comfort, combined with safety, will be obtained under these circumstances by lying back, and firmly wedging one's shoulders between the two sides of the after well-coamings. To obtain this the bulkhead is placed six inches further aft than it would be for the ordinary back board, and the back board is supported for paddling by a shiftable beam, which can be removed when sailing, and then the back board is inclined against the bulkhead.

A British sailing canoe, of racing build and equipment, is undoubtedly the most delicate of all sailing craft in the world to handle. Her sail-carrying power almost entirely depends on the artificial shifting of her centre of gravity to windward by moving her ballast and crew. She is the craft *par excellence*, in which "crew" and "craft" are linked together, and form one working machine. The small depth of body and keel allowed by the club rules, coupled with the necessary large proportion and weight of crew, spars and sails, to the small hull, cause a far higher

position of centre of gravity in a canoe than would be found in any other class of vessel.

The beam allowed by the club being very trifling for sailing purposes, it will be readily understood that the "righting couple" (see page 9) must be very short at any angle of heel, unless the weights are moved rapidly over to windward as the vessel heels; consequently, righting force or stability will be limited to comparatively small angles of heel, and there will be a point at which stability will vanish and the craft capsizes.

As soon as the canoe begins to heel, the weather bilge is lifted out of water, and a large bulk of body is immersed on the lee side, and

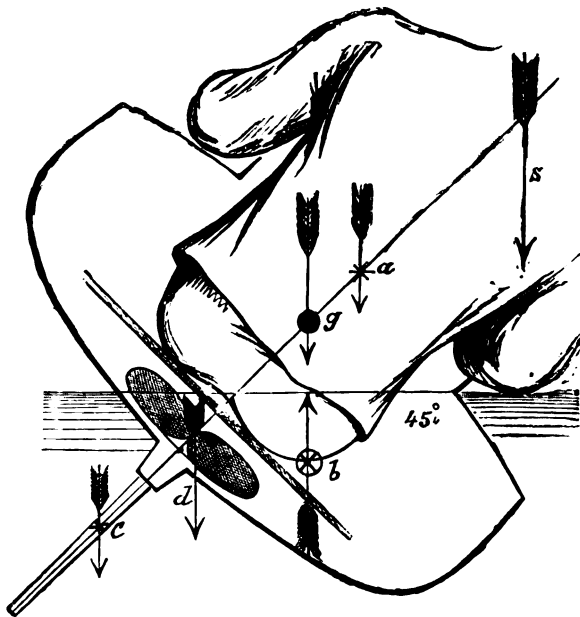


FIG. 125.

consequently the centre of buoyancy is rapidly shifted out to leeward. Supposing, then, that her weights remain in midships (Fig. 125), there would be a considerable and gradually increasing righting power, till, practically, the deck is awash, or about at a heel of 25° ; but the centre of gravity is now being lifted, as it were, and some of the weights, such as that of the man's body, is coming into the vertical in which is the centre of buoyancy, and that of the spars and sails is shifting out to leeward. This is rapidly shortening the righting lever, and therefore the vessel is nearing the capsizing point, and at 45° she has brought them into the same vertical, and then a capsize must follow. But before

this point is reached the man's balancing power, aided by that of ballast trimmed to windward, comes into play, and the craft receives a new lease of righting life, as in Fig. 126; the only danger then remaining is that of the lee well-coaming getting under water, or of the ballast or man suddenly falling to leeward.

In Figs. 125 and 126 the positions of the centres are slightly exaggerated, in order to show the movements more clearly: *b* in each drawing represents the centre of buoyancy (through which a force is always acting upwards at right angles to the surface of the water); *g*, the centre of gravity, is the mean centre of gravity of all the weights, such as ballast, man, spars, sails, centre-board, and weight of hull; a force is always acting downwards, in a vertical direction through *g*. Each of these two forces is equal to the exact weight of the canoe and all she contains. The horizontal distance between the verticals of *g* and *b* is the "righting couple," and, so long as *g* has any horizontal distance to windward of *b*, there is stability; but in Fig. 125, *g* and *b* have been brought into the same vertical line, the meta-centre (*m*, in Fig. 126) has been brought to coincide with the centre of gravity, and consequently the vessel is in equilibrium, and a cockroach walking across the deck might settle the question of "capsize" or "right."

The centre of gravity of the separate parts of the canoe may be considered individually: *a* is the centre of gravity of the canoeist; *d* the centre of gravity of the ballast; *c* the centre of gravity of the centre-board. The arrow *s* reminds the reader that spars and sails are heavy, and have a centre of gravity.

The curve of stability of a canoe, in which the ballast is not shifted, and the man's position is not altered more than an attempt at a perpendicular balance, made whilst retaining a midship seat, would show considerable stability at small angles of heel, say 10° to 25° ; thence, however, it would rapidly decline, and arrive at a vanishing point at about 45° ; but, if the ballast and man both shift up to windward, the curve will be a far more powerful one, and the canoe would be safe, even though a puff put her over suddenly to 45° .

Suppose a canoe to be sailing, and heeled over to an angle of about 20° , and working short tacks where there is no time to trim ballast over, and where the wind is coming in sudden puffs, it will often be found necessary to do a multitude of things at the same moment; such as to sit over to windward, to luff sharply before steerage way has been lost in consequence of the sails banging about, to ease off the head sheet and flatten in the mizen, and, perhaps, to lift the centre-board for shoal water, and then have to go about suddenly, and perform much the

same thing on the other tack, with perhaps the addition of taking in or shaking out a reef or two.

The necessity of performing the operations quickly in a canoe suggest and somewhat dictate the various fittings and arrangements; for instance, sitting up to windward can best be performed when the craft has been fitted with side deck flaps; to luff or bear away at the same moment that one's hands are engaged about the sheets and halyards, pointedly suggests the advisability of steering with one's feet. To work the sails smartly, and keep the canoe bottom downwards, it is essential

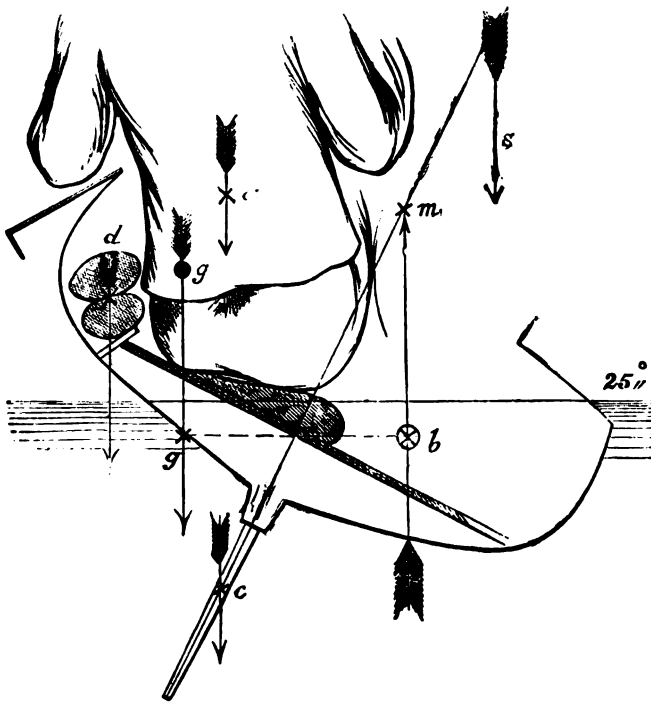


FIG. 126.

that the chief sail should be, with its gear, forward of the man, and the various ropes and centre-board lifting gear must all be close at hand, so as to be readily worked by the man without leaving his sitting position.

The canoe, limited in its dimensions by the club rules, is essentially a craft of small displacement—a craft, in fact, in which balancing the crew and a little ballast out to windward has more to do with, and is more successful at, sail carrying than any weight of ballast stowed below; the ballast cannot be got low enough to act as does the lead mine in a 5-ton yacht, and it is becoming more and more acknowledged that,

for canoe sailing, a pound of shifted ballast is more effectual than ten pounds of weight stowed beneath the floor boards.

To allow a good and sufficient margin for heeling over and for rough water, freeboard in sailing canoes is very seldom less than 6in., and much more often will be found to be 8in. Taking this as a fair margin, the depth of the canoe's body, from water-line to garboards, will be 6in.; weight of boat, gear, and man will not put the foregoing size of canoe down to this depth of immersion; consequently, ballast must be taken in until she has come near to, or down to, her marks. The arrangement of this ballast will be a question of how best it can be handled in working the boat; the heavy man will possibly require no more ballast to put his boat down to her designed load-line than he can conveniently handle as shifting ballast; whereas the light weight may have much more than he could possibly shift, and, consequently, must stow some below the floor.

Having arrived at the correct weights, and the most useful way of stowing them, the next question will be as to how much sail the canoe, so weighted and balanced, will stand; it is a point that can scarcely be found out by calculation, but can be most surely ascertained by experiment. A suit of sails will never be wasted, for in making them and trying them much experience will have been gained, even if the sails are never used again; the same masts and rigging will, or should, be available for each and every suit of sails the canoe is fitted with; and in making them for a new canoe it should be kept in mind that once a spar is cut no amount of watering will make it grow longer; so it will be well to have all spars and ropes longer than actually necessary at first; then, when the craft has been carefully tried, the owner will know how much may be cut off.

The rigging scheme should be this—give the craft sails of the *full length she can use*, and in hoist stop them at the area it is anticipated she will be able to carry to a moderate breeze; leave the masts long enough for larger sails, then the same spars and gear will do throughout. If she is found to be over-stiff for the first rig, either ballast can be taken out or more sail added, and in such case it is only a matter of increasing the hoist, taking care, however, that the relative sizes are kept up so as not to disturb the position of the centre of effort.

CANOE SAILS.

Almost every conceivable rig and sail has been tried on canoes—cutter, sloop, schooner, yawl, dandy, and even top-sail schooner have appeared; gaff sails, Chinese lugs, standing lugs, dipping lugs, balance lugs, sprit sails, settee sails, lateen sails, sliding gunters, sliding sprits,

split lugs, and leg-of-mutton sails have all been tested. Now, for racing, the balance lug main-and-mizen rig is the common favourite.

These two working sails and a spinnaker for running appear to give the best all-round results. Topsails and jibs are often used, but they are difficult to handle—not of much value as drivers, and they require a considerable amount of extra gear.

It has been pointed out that the peculiarities of a canoe considerably dictate the forms and positions of her fittings; but the position of her masts depends to a great extent on the situation of her centre-board or boards, and that the proportions and positions of her sails must be agreeable to the centre of lateral resistance. We now come to the consideration of the various rigs and rigging adaptable to the requirements of the canoe; and, whilst considering the subject of sails, it will be well to bear in mind that the particular cut or shape—such, for instance, as a high-peaked head *versus* a low or square head—can be indulged in in accordance with individual ideas of beauty, to any extent, so long as the relative areas and position of the centre of effort are not disturbed in relation to the centre of lateral resistance.

It has often been contended, on paper, that the most perfect rig for going to windward is that which has two sails, the large or driving-sail aft, and the small or balancing sail forward. This plan is not always the best for canoes, even apart from the peculiar requirements of the canoe.

In a cutter yacht, where the main sheet is never started, and the vessel can be allowed to lie over till the wind passes over her sails, the mainsail is properly the after sail; but in boats and canoes which cannot be safely permitted to lie down and drag through a squall, the chief sail should undoubtedly have its centre forward of midships, and should be supplemented by a balancing sail the shape of a mizen.

A jib in canoes is a troublesome snare, its driving power is comparatively small, and it is only in play when the wind is abeam or forward of the beam; yet it entails a lot of extra gear, requires constant watching, and in a really bad squall is suicidal to the boat.

The two-sail rig is, however, handy and effective on all points of sailing and manœuvring, “before the wind” both main and mizen are “drawing well,” and in a squall when on-a-wind the mizen luffs the boat, and the pressure is taken off her by spilling or reducing the big sail; the centre of gravity of the mainsail is forward of the centre of lateral resistance, consequently by spilling the mainsail the centre of effort of sail is thrown aft, and the boat luffs sharply; or, for bearing away, the main sheet is kept flat in and the mizen eased up, the centre of effort thereby being thrown forward, and the canoe goes off the wind; both manœuvres

being a more general definition by the judicious use of helm and
 sails. The usual rig supplemented, of course, by efficient
 handling and sailing gear should not be lightly be cast aside in favour
 of a more radical system until it is a really bad and lasting squall
 in such cases the presence of the above qualities will decide whether
 the change will be brought about.

SAIL PLAN OF A PROPELLER-SAILING CANOE.

In the Sail Plan, Plate XL, the main-and-mizen rig is shown
 formed by two masts. The sails, however, need not necessarily be
 square sails, but a gaff or sprit sail may substituted the masts have
 to be situated forward, which is undesirable, as the weights should be
 kept as much as-ward as possible. It may be objected that the rig
 shown in the drawing has too much gear to be handy for cruising
 purposes, but the rig is not put forward as a rig admitting of rapid
 sailing, but as a moderately well-proportioned sailing rig.

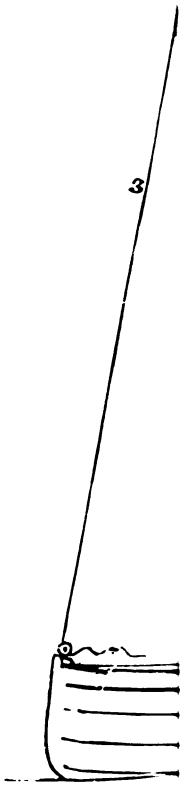
It is always easier to do away with parts of gear than to invent
 them, consequently a full design must be more satisfactory than a bald
 one, as in such case each owner can adopt, alter, or discard details
 according to his fancy. There is always something to learn in the matter
 of rigging, even by the oldest hands; and slight alterations in the arrange-
 ment of the gear can often be made to add greatly to the ease and enjoy-
 ment of the canoe sailor.

In Plate XL, Sail Plan I, G is the centre of gravity of the sail; A,
 the tack of the sail; B, the throat; C, the peak; D, the clew; e, reef or
 hawser bands; f, the ends of the battens; g, fairlead bands for reef ear-
 ings; h, strengthening pieces at all corners and cringles.

The numbers refer to the ropes and blocks, and some are reproduced
 on a larger scale in diagram II., Plate XL.: 1, the tack; 2, main halyard;
 (2), main halyard snotton; 3, peak halyard, acting also as forestay; 4,
 peak halyard span; 5, double topping lift; 6, main sheet; 7, reef earings;
 (7), ends of reef earing and cleat for belaying them on; 8, spinnaker
 halyard block; (6), main sheet gear. Fig. (6), main sheet gear; 5,
 topping lift; 6, main sheet, showing block and snap hook. Fig. 2, mast-
 head and slinging plan, in which the ropes are numbered as above.

| | Mainsail. | | Mizen. | |
|----------------------|-----------|-----|--------|-----|
| | ft. | in. | ft. | in. |
| Tack to peak | 14 | 10 | 7 | 3 |
| Clew to throat | 11 | 0 | 4 | 11 |
| Foot | 9 | 4 | 4 | 5 |
| Luff | 6 | 4 | 3 | 0 |
| Head | 8 | 9 | 4 | 4 |
| Head rounding | 0 | 2½ | 0 | 1 |
| Leech | 15 | 4 | 7 | 4 |

PLAT



being, of course, greatly facilitated by the judicious use of helm and centre-board. The two-sail rig, supplemented, of course, by efficient handling and reefing gear, should not too lightly be cast aside in favour of some, perhaps, prettier fancy rig, for in a really bad and lasting squall in open water, the presence of the above qualities will decide whether the canoe will live through it or not.

SAIL PLAN FOR PADDLEABLE-SAILING CANOE.

In the Sail Plan (Plate XL.) the main-and-mizen rig is shown formed by two balance lugs. The sails, however, need not necessarily be balance lugs; but if gaff or sprit sails are substituted the masts have to be shifted forward, which is undesirable, as the weights should be kept as much in-board as possible. It may be objected that the rig shown in the drawing has too much gear to be handy for cruising purposes, but the rig is not put forward as a rig admitting of rapid shifting, but as a moderately well-proportioned sailing rig.

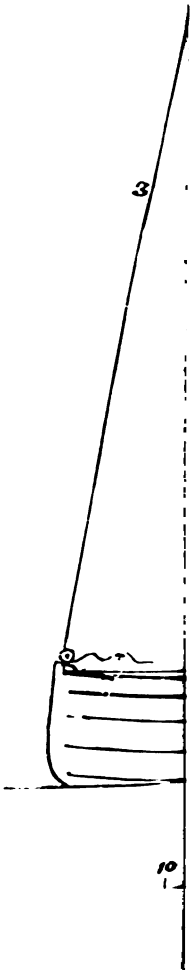
It is always easier to do away with parts of gear than to invent them, consequently a full design must be more satisfactory than a bald one, as in such case each owner can adopt, alter, or discard details according to his fancy. There is always something to learn in the matter of rigging, even by the oldest hands; and slight alterations in the arrangement of the gear can often be made to add greatly to the ease and enjoyment of the canoe sailor.

In Plate XL. (Sail Plan I.) G is the centre of gravity of the sail; A, the tack of the sail; B, the throat; C, the peak; D, the clew; *e*, reef or batten bands; *f*, the ends of the battens; *g*, fairlead bands for reef earings; *h*, strengthening pieces at all corners and cringles.

The numbers refer to the ropes and blocks, and some are reproduced on a larger scale in diagram II., Plate XL.: 1, the tack; 2, main halyard; (2), main halyard snotter; 3, peak halyard, acting also as forestay; 4, peak halyard span; 5, double topping lift; 6, main sheet; 7, reef earings; (7), ends of reef earing and cleat for belaying them on; 8, spinnaker halyard block; (6), main sheet gear. Fig. (6), main sheet gear; 5, topping lift; 6, main sheet, showing block and snap hook. Fig. 2, mast-head and slinging plan, in which the ropes are numbered as above.

| | Mainsail. | | Mizen. | |
|----------------------|-----------|-----|--------|-----|
| | ft. | in. | ft. | in. |
| Tack to peak | 14 | 10 | 7 | 3 |
| Clew to throat | 11 | 0 | 4 | 11 |
| Foot | 9 | 4 | 4 | 5 |
| Luff | 6 | 4 | 3 | 0 |
| Head | 8 | 9 | 4 | 4 |
| Head rounding | 0 | 2½ | 0 | 1 |
| Leech | 15 | 4 | 7 | 4 |

PLAT





Centre of effort of whole main and mizen is 4in. aft of midships ;
 centre of effort of first-reefed main and whole mizen 9in. aft midships.

| | Area. |
|-----------------|-------|
| Mainsail | 76·2 |
| Mizen | 16·5 |
| Total Area..... | 92·7 |

The total area here shown as 93 square feet will be found as much as the canoe can well carry on a wind in from light to moderate breezes. She could, of course, carry more in light airs and calms, but that would entail the use of longer and heavier spars, which would tell heavily against her in any other weather. The plan, however, is drawn so that the first reef taken in the mainsail leaves a total area of 71·5 square feet, 55 in mainsail, and 16·5 in mizen, with centre of effort in same vertical as centre of lateral resistance. The proper principle for making a sail plan for canoe is—give her (correctly balanced) as much sail as she can stand in a good steady sailing wind, and a reef extra for fine weather.

For running in light-weather racing, a spinnaker may be set. Such a sail requires only one extra spar, a boom of about 7ft. to 8ft. length, and a halyard and outhaul. It is by no means an easy sail to handle, and should not be set in a breeze until considerable practice have been gone through in light airs ; for the above rig the luff would be 12ft. and the foot 7ft.—36 square feet.

The mizen shown in the sail plan is an ordinary balance lug, fitted with an ordinary “standing” tack and a “standing” topping lift ; the lower part of the topping lift branches into two parts so as to gather in the sail when lowered, and thus save the trouble of tying reef points or furlings. The reef earings are fitted thus : the standing part of each is fast to the boom, the earing is then rove up through rings on luff of, and after one through rings on, the sail, passing through a thimble on the upper side of the batten and down the other side of sail, through rings to and through a thimble on the boom, both parts are brought to the after side of a thimble, lashed on the boom abreast of the mast, and at that point where the sail is hoisted are spliced into one another, the single part is then brought through the thimble and leads to a cleat at the well ; on lowering the halyard this reef line is hauled on and the reef comes snugly down as the sail is lowered.

The mizen halyard may be fitted thus : a wooden toggle is fitted to the end of the halyard, two grummet eyes of rope are fitted on to the yard, one at the fore end and the other at middle, the halyard is passed through the upper eye and passed round the opposite side of the mast to that on which the yard is, and then toggled to the eye at fore end

of yard; the tauter the halyard is set up the closer the yard is jammed to the mast. The batten, which is contained within a broad band of tape stitched on to the sail, keeps the sail set flat, and avoids the necessity of tying the reef points.

The mainsail should be made of fine calico sheeting in one width, and the stuff should be nailed out on a floor, and the sail shape marked off in pencil or coloured chalk, taking the selvedge for the leech. Narrow stay-binding tape should then be stitched on all round, except the leech, and the stuff cut outside the tape, allowing sufficient for turning in. Eyelet holes must be sewn where required for lacings, &c., and the sail should be strongly roped on the luff and slightly on the head-corner patches, for strength should not be forgotten. Next the sail may be lightly set on its yard and boom and hoisted, and then well wetted all over and left to dry. After this the reef bands and batten bands may be put on.

For spars yellow pine is generally preferred. Many use bamboo; but, except for a flying topsail, or other light sail, bamboo offers no advantage. Well-picked yellow pine spars look well and stand well.

The main tack can be fitted in many ways. A good plan is that in which a snotted, or short piece of stout rope, or flat sennit is fitted to the boom abaft where the mast will be. It is taken round the opposite side of the mast to that on which the boom lies, and is then rove through a thimble on the under side of the boom, and finishes with an eye. The tack pennant is toggled to this eye, and then leads through a block or eyebolt in the deck under the boom at foreside of mast, and may be used either in single part to a cleat at the well, or fitted with a block and whip. (See also page 447.)

In reefing, the tack-earring should always be hauled down first, then the after-earring, and the points can be tied whilst sailing.

The drawing shows the yard as slung with main and peak halyards. In this rig, when the peak halyard is let go, the main being fast, the sail spills just as a gaff sail does. This is very handy in a squall; and the sail can be better set than is the case where one halyard only is used. The gearing for these halyards is shown in the masthead plan II. in Plate XL.; (2) is the mast snotted, made either of rope or flat sennet. It is lashed to the yard on the mast side, and leads round the mast to and through a thimble at the fore end of the yard, and is then finished off in an eye to which the main halyard toggles. The reason for having these snotters is, on the one hand, that they receive the chief wear and tear and can be renewed, thus saving the halyards and tack pennant from being cut and shortened; on the other, that, if of flat sennit, greased, they travel on the mast more freely, and do not cut into the spar as rope

does. No. 4, the peak span, is best made of copper or brass wire cord. It divides the strain on the spar, and permits the peak halyard to shift upwards when the sail is reefed. A metal thimble, with a grommet of rope on it forming an eye, travels on the span, and the peak halyard is toggled to the eye.

The topping lift (5), a most useful piece of gear, is fitted by having its standing part—a running eye—round the masthead; the end is taken down one side of the sail to and rove through the thimble, in the sheet-block strop, then up on the other side of the sail to reeve through its block on side of masthead, and down to block at side of mast at deck, and into hand at the well.

The peak halyards may be taken down to a block on stem head or at side of mast, and lead into the well.

With the large sails now in use a forestay will be found almost necessary to hold the masthead from coming aft when close hauled by the wind. Another very useful piece of gear is a mast jackstay, fast at both ends to the mast, one at the masthead, and the other having passed down outside the sail on the opposite side to the mast, comes under the boom and up, and belays round the mast, some 6in. above the level of the boom; when the sail is lowered, it is snugly gathered in by this jackstay and the topping-lift, and all the gear can be unbent from the yard and boom, and then the sail, rolled round, can be slipped out from the gear, and all the ropes neatly frapped up and down the mast.

The mainsheet is fitted at one end with a large eye, the splice ends of which are formed into a good-sized knot, sufficient to prevent it unreeving; the sheet is used single when running or reaching, and, when close hauled, the eye is slipped over a hook on deck aft of the well, and the sheet becomes doubled thereby.

The battens, which cross the sail at the reef-bands, are usually made of yellow pine or bamboo, and should be stoutest at about one-third from the fore end, and be parreled to the mast by a snotter, with toggle and eye, or by a lacing; and, thus fitted, the sail stands without any shifting, as well on one tack as on the other.

The sail, as shown, is rigged on the port side of the mast; the jackstay is not marked, as it might be confusing to the inexperienced reader; it, however, comes down on the port side of the sail.

It will be found a great convenience to fit the main mast so as to be lowered as already described; in such case the mast will be pivoted to a tabernacle an inch or two above the deck, and a small hatchway will be necessary on the fore side of the mast in the deck to allow the heel to come up; the mast will be held upright either by a forestay or a heel

tackle. There are many ways of fitting the heel and lowering gear; the chief point, however, is to remember that with a long heavy mast there is considerable leverage about its heel, and therefore the deck and mast case fittings must be strong.

The mainmast should be a "grown" fir spar, straight and tapering, if possible, with little more than the bark taken off. Length, from deck to masthead shoulder, 12ft., cut square at and below deck, $2\frac{1}{4}$ in. diameter at deck, and tapering below to $1\frac{1}{4}$ in. rounding, commencing 3in. above deck, taper to $1\frac{1}{4}$ in. at head. The mast should be cut rather longer, say 13ft. or 14ft. deck to hounds at first, it can then, after trial, be reduced to the length suitable to the sail. The boom should be cut 10ft. long, and reduced at the after end when the sail has settled into shape. Yellow pine, $1\frac{1}{4}$ in. diameter in centre, taper to 1in. at fore end, and $\frac{3}{4}$ in. at after end. The yard should be of yellow pine, cut 9ft. 6in. long, same size at boom, or a little less, or it may be a slight spar, with a fish batten of elm seized on its upper side.

A double $1\frac{1}{4}$ in. or 2in. block and a single block should be stropped with strop and thimble, and lashed firmly to the mast just above the deck; the double block at the after side and the single one on the starboard side of the mast, and on the port side a stout brass ring, lashed on by the same lashing, will serve as a leader for the topping lift. At the masthead there should be a good-sized sheave hole and sheave for main halyards, three single blocks, $1\frac{1}{4}$ in., stropped with strop and thimble, lashed on above the mast shoulder, so that one hangs each side, and one on the fore side—these take the peak and spinnaker halyards and the topping lift; a truck above and a neat brass flag rod gives a finished look to the masthead.

All spars, blocks, and lashings should be varnished, the mast being afterwards glass papered and oiled.

Blocks should be of boxwood, and have metal sheaves.

The mizen sheet may lead to a boomkin, but it will be better led to the rudder. The standing part fast to back edge of rudder just above water, then led through a block on mizen boom and in to hand at the "well."

SAILS OF "NAUTILUS" RACING CANOE, 1879.

The sail plan and its fittings of the 1879 Nautilus are shown, except as to dimensions, on p. 440, Plate XL., the chief difference being that the mizen in the 1879 rig is, in proportion to the mainsail, very much larger, *i.e.*, about half instead of about a quarter the size of the mainsail. The sails are five in number, viz.: a racing mainsail, No. 1 mizen, No. 2

mizen, No. 1 spinnaker, No. 2 spinnaker. The mainsail is 100 square feet area, with bamboo yard, and three bamboo battens and a pine boom; boom 11ft., yard 9ft., spinnaker boom 11ft. The reefing gear is simple and effective; the stuff used is woven cord lightly dressed with boiled linseed oil (to prevent shrinking or swelling when wet). The after earing is rove thus (see Fig. 127): make one end fast on the boom at *a*, plumb from under the reef cringle, then lead up through small brass rings sewn on to the sail, and lead through a block at the after end of the batten (*b*), thence, in a line parallel with the batten, through a stout brass ring lashed on the batten; then through one of two blocks (stropped and seized head to head as a sister block), and back through a block seized to the stout ring and down through small rings (*c*) on the sail, and fast to boom at *d*. The fore earing is made fast at tack end of boom (*e*),

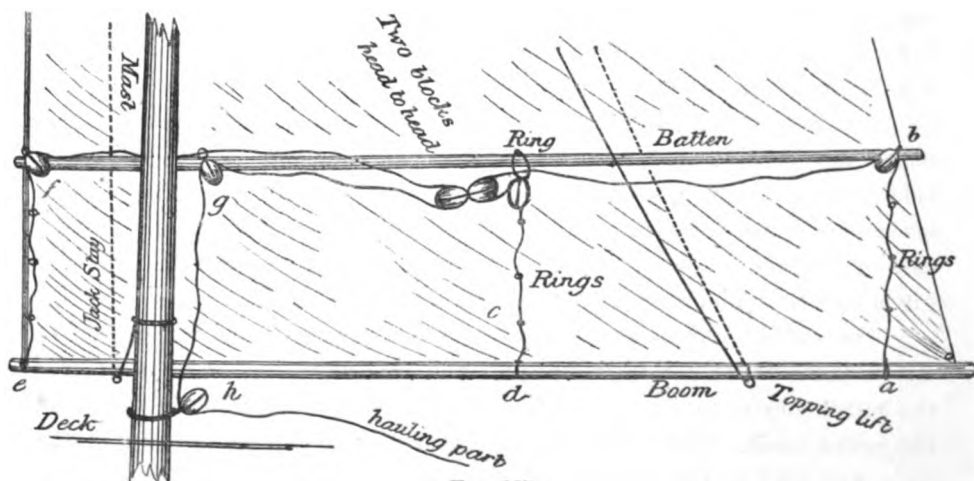


FIG. 127

and leads up, through sail rings, to and through a block at fore end of batten (*f*), thence along batten to and through the other of the two blocks already mentioned as being stropped together, and back to a block lashed on batten abreast of mast at *g*; thence down to a fair-lead block (*h*) at heel of mast on deck, and belay the hauling part to a cleat. This gear can be fitted to each reef, but is in practice only necessary for first and second. When a reef is hauled down it may be further secured by ordinary points. The boom being held up by the mast jackstay and the double topping lift, a reef is taken in by simply easing away the halyard till the batten is down; and when the reef is down, the sister block is close up to the batten block at mast.

The No. 1 mizen is 50 square feet area, and is fitted with one batten only; No. 2 mizen is 25 square feet, and fitted also with one batten reef.

The mizen reefing gear is of the same pattern as that of the mainsail. The large mizen makes a good bad-weather mainsail with No. 2 mizen set aft.

No. 1 spinnaker is set on a long boom, which has a ferule joint about $\frac{1}{2}$ in., so as to be shortenable for stowage, and also for using with No. 2 spinnaker; the spinnaker is 60 square feet area.

The mainmast is a "grown stick" of white pine, and is 15ft. 6in. from deck to head, and 2 $\frac{1}{2}$ in. diameter at deck, tapering to 1 $\frac{1}{2}$ in. at head.

The mizen is 8ft. deck to head, 1 $\frac{1}{2}$ in. diameter at deck.

Rigged in this way, the canoe works perfectly, and so long as an air of wind is going the paddle keeps the "watch below."

SAILS FOR CRUISING CANOES (PLATES XLI. AND XLII.)

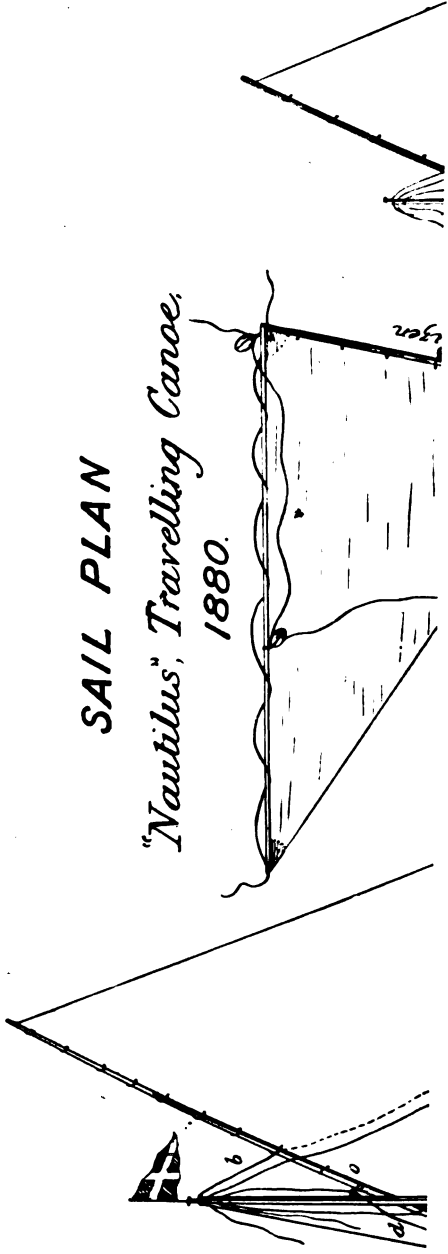
One of the first principles in planning the sails for a canoe is to keep the centre of effort as low as possible, and where a large sail area is wanted, it should rather be obtained by long boom and yard than by a lofty mast and narrow sail. Now stowage of spars demands that they be kept as short as may be, and also it will be found that where the masts are considerably towards the ends of the craft a mizen of considerable size will have to be carried; if a fair sail balance is to be made combining these requisites—a good sail area, a low centre of effort, ease of stowage of spars, and a good working balance—the sail plan here given will be found an efficient one for all-round work.

The outline idea is that the main and mizen lugs are to be used in all weathers up to a "fresh breeze," and that then for stronger breezes the mizen lug is to be set on the main mast, and the storm mizen on the mizen mast. The total lug area is 52 square feet—i. e., 32.5 in the main, and 19.5 in the mizen; and the storm mizen is a sail of 9.5 sq. ft. The rig itself and the various fittings have been amply tested in practice afloat, except as to the proposed mode of mast tabernacle, contrived to avoid a hole in the fore deck. The following letters denote the chief fittings :

| | |
|--|--|
| <i>a</i> Main halyards. | <i>l</i> Stay tackle. |
| <i>a</i> 2 Hauling part of ditto. | <i>m</i> Mast parrel on batten. |
| <i>b</i> Main topping lift. | <i>n</i> Cleat on boom for hand reef line. |
| <i>b</i> 2 Main topping lift hauling part. | <i>o</i> Yard grommets. |
| <i>c</i> Tack parrel. | <i>p</i> Main sheet grommet. |
| <i>c</i> 2 Main tack. | <i>q</i> Main jack stay (dotted). |
| <i>d</i> Reef batten of bamboo. | <i>R</i> Main blocks. |
| <i>e</i> Reef earing. | <i>s</i> Mizen sheet. |
| <i>e</i> 2 Hauling part of reef earing. | <i>t</i> Mizen tack. |
| <i>f</i> Reef earing blocks and fairleads. | <i>u</i> Mizen halyards. |
| <i>g</i> Reef sister blocks. | <i>v</i> Mizen topping lift. |
| <i>h</i> Hand reef line. | <i>w</i> Mizen jack stay (dotted). |
| <i>i</i> Main sheet. | <i>x</i> Main and mizen reef bands. |
| <i>j</i> Mast joint ferrule. | <i>y</i> Buttonhole slit in band |
| <i>k</i> Forestay. | <i>z</i> Patches on sails for rings. |

SAIL PLAN

"Nautilus", Travelling Canoe,
1880.



—
The
larg

in
spit

dec

of 1

kee
is v
a l
be
ma
sid
ma
east
givi

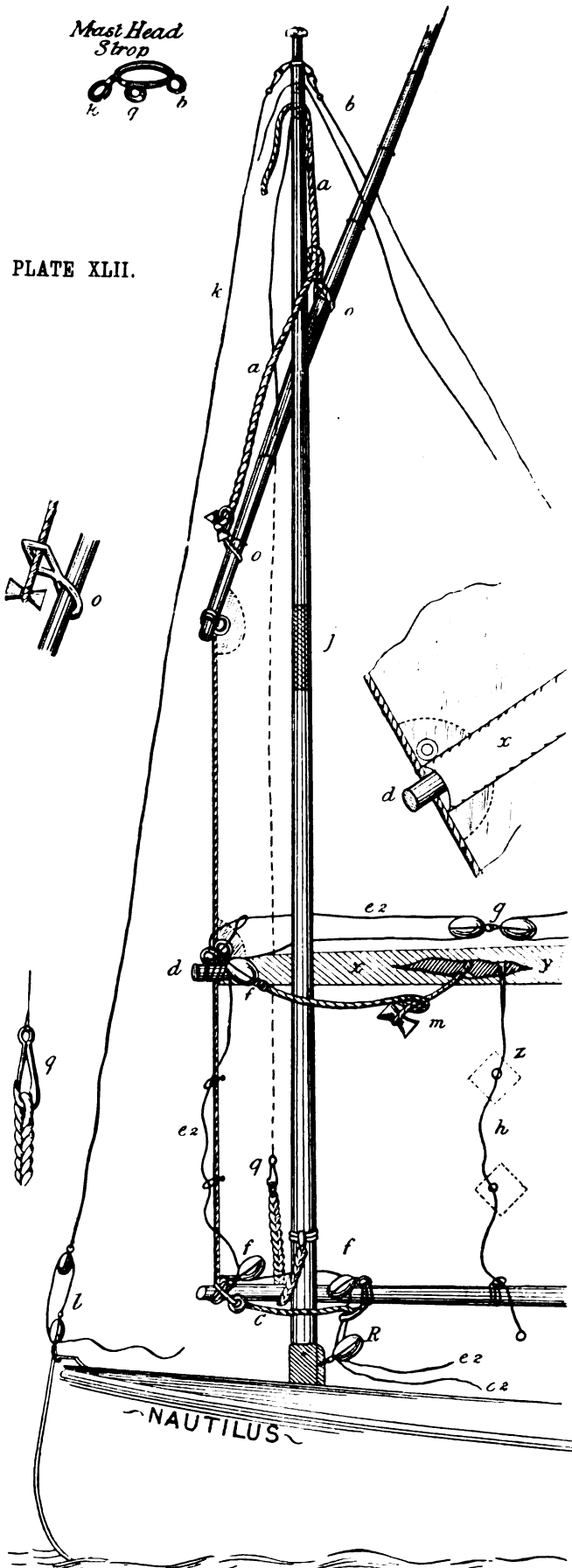
all
the
the
mai
The
aflo
a h

a
a:
b
b:
c
c:
d
e
e:
f
g
h
i
j
k

Mast Head
Strop



PLATE XLII.



In the accompanying sail and gear plans there will be found only such gear and fittings as have a pronounced value in the working of the craft and the sails. Not a single thing can be omitted; each has its use, and has been introduced under the light of experience.

The drawings (Plates XLI. and XLII.), are intended to show the position, form, and make of the sails, and are drawn to scale; the gear, however, is put in the drawing in a pronounced manner, in order to make the details clear to those who may desire to rig in the same manner. The blocks, for instance, are shown much larger than scale drawing would show them; the ropes are shown thick and slack, so that their “lead” and use may be easily picked out.

The gear at the mast head is either toggled or snap-hooked to a mast-head strop, *k q b*, so as to be easily taken off for the various shifts of sail. The main halyard are rove from the deck block, *R*, up to the sheaves in mast head, and rove through from forward aft and *a* rove through a grommet (seized on to yard at 2ft. in from fore end), and then taken on opposite side of the mast to that on which the yard is, and toggled to a grommet which is seized on to the yard at 6in. from the fore end. Another plan is to have a flat sennit parrel from the fore end of the yard rove through the inner grommet, and ending in an eye just above the grommet, and to this toggle the halyard; fitted thus the sail is held tightly in to the mast.

A jackstay toggled at masthead leads down on the starboard side of the sail, and snap hooks to a sennit band, which passes under the boom and up on the port side, and is seized to the mast about a foot above deck; this jackstay is most useful in keeping the sail steady when being lowered or hoisted. The batten parrel, *m*, is either made of flat sennit or four strand line; the fore end of fore part is either seized or spliced into the reef block strop, *f*, and the end finished off with an eye; the after part toggles to this eye, and the after end is seized to the reef batten, so that when toggled the parrel binds the batten into the mast. The main tack parrel, *c*, is also flat sennit with an eye at each end, the fore end is seized on to the boom about 3in. in from fore end of boom, and it then passes on opposite side of mast to that on which the boom lies, and is rove through a grummet or ring, which is seized on to the boom about 9in. from fore end, to the after eye of the parrel the tack hauling part *c 2* is toggled and rove through the deck block *R*. The stay is snap-hooked or toggled to the mast head strop at *k*, and its tackle is shown at *l*. The topping lift—without which no sail is either safe or handy—is fitted by toggling the standing part to the masthead strop at *b*; then passing down the starboard side of the sail, it is rove through the main sheet thimble, where the main sheet is spliced into a snap-hook, which hooks to the grommet at *p* on

the boom; it then leads up the port side of the sail, and is rove either through a block toggled to a fourth eye (not shown in the sketch) in the mast strop, or through a sheave in the mast head above the halyards, and down to and through block R and into hand.

The reefing gear is much the same as that for the "Nautilus" racing canoe; but the block *g*, Fig. 127, has been dispensed with by doubling the parts of the ropes and making one end fast at *d* (Plate XLI.). It has been used constantly, not only in canoes but in boats and is a most successful and sure working plan. The reef-line, in the first place, is woven cord (see page 444). The after part of the earing is fastened to the boom by a "clench," or by forming an eye by sewing the end back to the standing part, and then seizing the eye to the boom. Then lead the reef earing up through brass rings, which are firmly stitched on the sail on the patches (*z* in Plate XLII.), and through the block *f* (Plate XLI.) at after end of the batten *d*; then through a thimble or ring stropped in above the next *f* block in on the batten; then through the sister block *g*, and back to and through the last-mentioned *f* block, and down through the rings *e*, and fasten to the boom. When the sail is fully hoisted the sister block *g* should rest nearly against *f* block, about an inch off. Next reeve the fore part of the reef earing. Make the standing part, *e* 2, fast by clenching it through the cringle or eyelet hole on the luff of the sail at *d* (as shown in the rigging plan, Plate XLII.); then take it away aft in line with the batten, and reeve it through the block *g*; lead forward again to and through *f* at fore end of batten; then down through the rings to and through block *f* at fore end of boom; then along the boom to and through fair lead block *f* abaft the mast, and then through R and into hand. The reef blocks for this rig should be not less than 1in. blocks, and should have brass sheaves. The blocks at R should be two double blocks, 1½in. or 1¾in. blocks, with brass sheaves strongly stropped. Copper wire grommets, if neatly made and seized, will be found to make most durable strops for blocks; but where much twisting and working occurs rope only should be used.

The hand reef line *h* is fast to the batten *d*, and leads down through rings on the sail and a ring on the boom, and is finished off by having a ring spliced into its own end. This line is used for snugging that part of the sail where the reef gear does not come, and the ring at the end of *h* is in such case taken hold of by means of a boathook till brought into hand, and is hitched to the cleat *n* on the boom (Plate XLI.). The hand reef line may also be used when the sail has to be shortened quickly for a short passing squall, and then shaken out again.

The gear on the mizen is fitted in the same way, except as to the topping lift. It has been found in practice that a kind of crow's-foot form of topping lift is best to keep the sail and reef gear clear of the rudder yoke when the sail is lowered; but as the mizen lug is to be shiftable, so as to set as a mainsail and give place to the storm mizen, it is necessary to be able to detach the topping lift; therefore the standing part is fast to the masthead on the starboard side, and the lift leads down that side of the sail, and at about two feet above the boom it divides into two parts by splicing a part to it. These two branches then go under the boom, reeving through two thimbles (seized on to the boom in a fore-and-aft direction), and then going up on the port side of the sail to about two feet above the boom, and there ending each in an eye splice. The hauling part, which is rove through a sheave or block at the mast head, comes down to and toggles into these two eyes (*v*). The sheet is a single line toggled to the boom at *s*, and reeving through an eye-bolt in the sternpost head, leads in to hand.

When the lug mizen is used as a mainsail, the storm mizen is rigged by gathering the lacing together in clear turns, and dropping them over the mizen mast head; then hitch the end of the tack below the halyard block, leaving sufficient play for gybing, &c.; then hitch the head earing through the mast head sheave hole, and toggle the sheet on to the strop. The brail is kept on the sail, as shown in the drawing, a line fast to the clue then leading up to and through a ring on the leech at 2ft. 4in. up, then to a block on the luff at 5ft. 8in. up, and down to a block at the tack. This sail should be roped all round, and a light bamboo boom laced on foot.

The area of mainsail, 32·5 square feet, and of mizen lug, 19·5—52·0 square feet, will be found ample for travelling in moderate winds, and then when it blows fresh the mizen lug is set forward, and the storm mizen of 9·5 feet is set aft—equal to 29·0 square feet—a nice snug suit.

The reef band (*x*) is made of wide tape, stitched on slack—*i.e.*, the tape won't stretch, but the sail will when new, so the band has to be put on slack to avoid girting the sail. The batten bamboo (*d*) is passed into this pocket formed by the sail and tape band, and is seized to the sail cringles at each end. At the stations on the batten where the reef blocks are to be lashed, the band is slit and button-hole stitched (*y*). The slits must be long enough to allow the lashing of the blocks when the sail has been slacked in along the batten.

The yard and boom should be of bamboo, which, if possible, should have a “knot” at each end when cut to the right length. The mast

may be of yellow pine; a "grown stick" is best, though apt to buckle and kink.

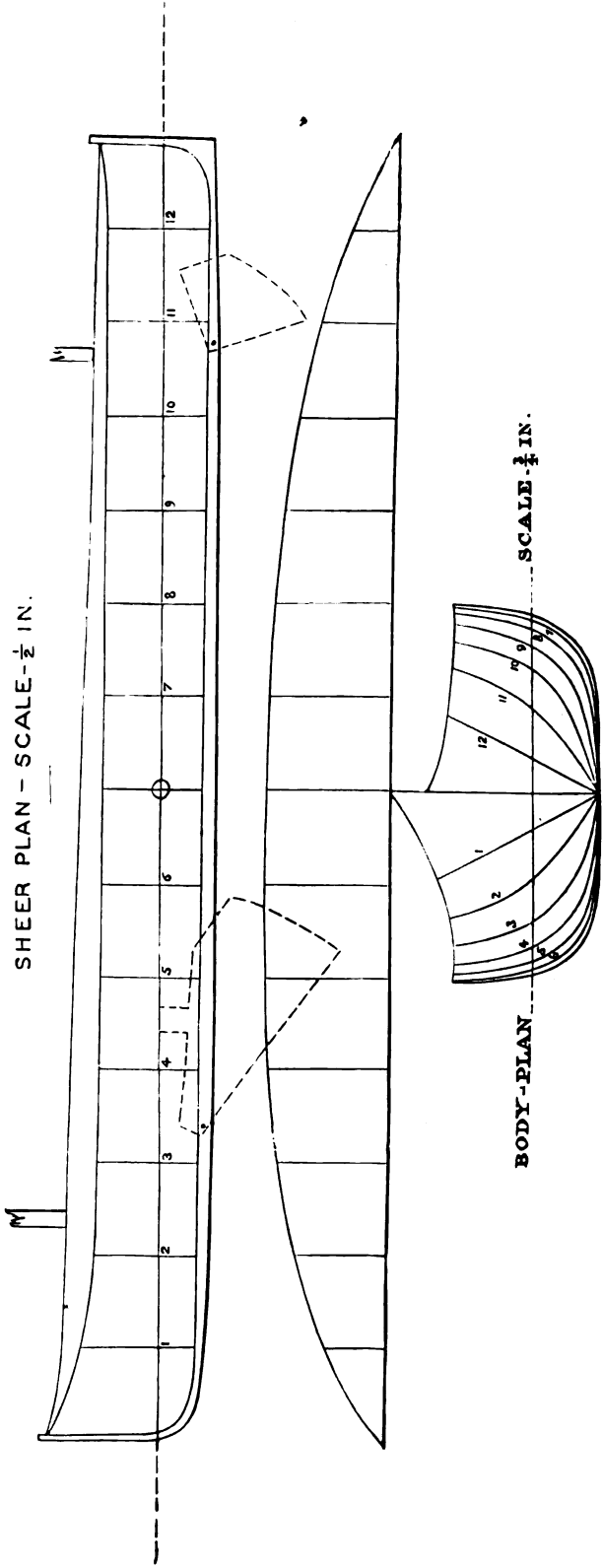
With regard to the mainsail, where complete stowage is desired the sail may be kept on the upper mast—that is, keeping the halyards fast, let go the tack (*c*), and pull close up on the topping lift (*b*), and lower away the mast by slacking up *l* till the sail comes to hand, then unhook main blocks R either by hand or by boat hook, and roll them and all rope bights and ends into the sail, keeping tack and batten parrels on the mast above the mast joint. Then unclip the fore stay at masthead, and the jack stay at lower end, and unship the upper mast, frap the sheet round all, and stow below. Or, if only to be stowed for a short time, when the sail is set, let go the tack, haul down the reef, lowering halyards at the same time, tie the sail by gaskets (like reef points on the yard), and pull the sail "up and down" by the topping lift and halyard, and lower the mast half down. After a little experience and practice, it will be found that there are many other modes of dealing with this sail in setting, stowing, reefing, or shifting it.

THE "PEARL" CANOE.

Canoeists are by no means agreed as to the best form for canoes, and Mr. E. B. Tredwen, one of the most successful canoe sailers of the R. C. C. has taken a great departure from the Nautilus racing type in building the "Pearl" canoes. Mr. Tredwen contends that a flat floor rather than a rising floor is better for canoes. With a flat floor the canoeist sits lower, and can sit farther to windward when the canoe is heeled, and consequently assist the stiffness of the canoe; and, moreover, the flat-floored canoe will draw less water, and so is to be preferred for cruising in shallows. Mr. Tredwen has done a great deal of cruising in open water in the Pearl, and no doubt the design shows a very buoyant and good "all round" canoe. Mr. Tredwen says, "As to the various modes of building, the double skin is the least satisfactory, for the water gets between the planks, and the boat soon rots out, while leaks are frequent and very difficult to stop. I prefer the ribband carvel, but used brass screws throughout instead of copper nails."

The lines shown on Plate XLIII. are those of a very successful canoe Mr. Tredwen built in 1878. So far as the shape of the water-lines go, both ends are alike, and this peculiarity will be found in the "Pearl" canoe for 1880 (Plate XLIV.) Mr. Tredwen says he adopted this design in consequence of an experiment he made in building two canoes on sections or moulds of the same shape, but differently placed,

PLATE XLIII.

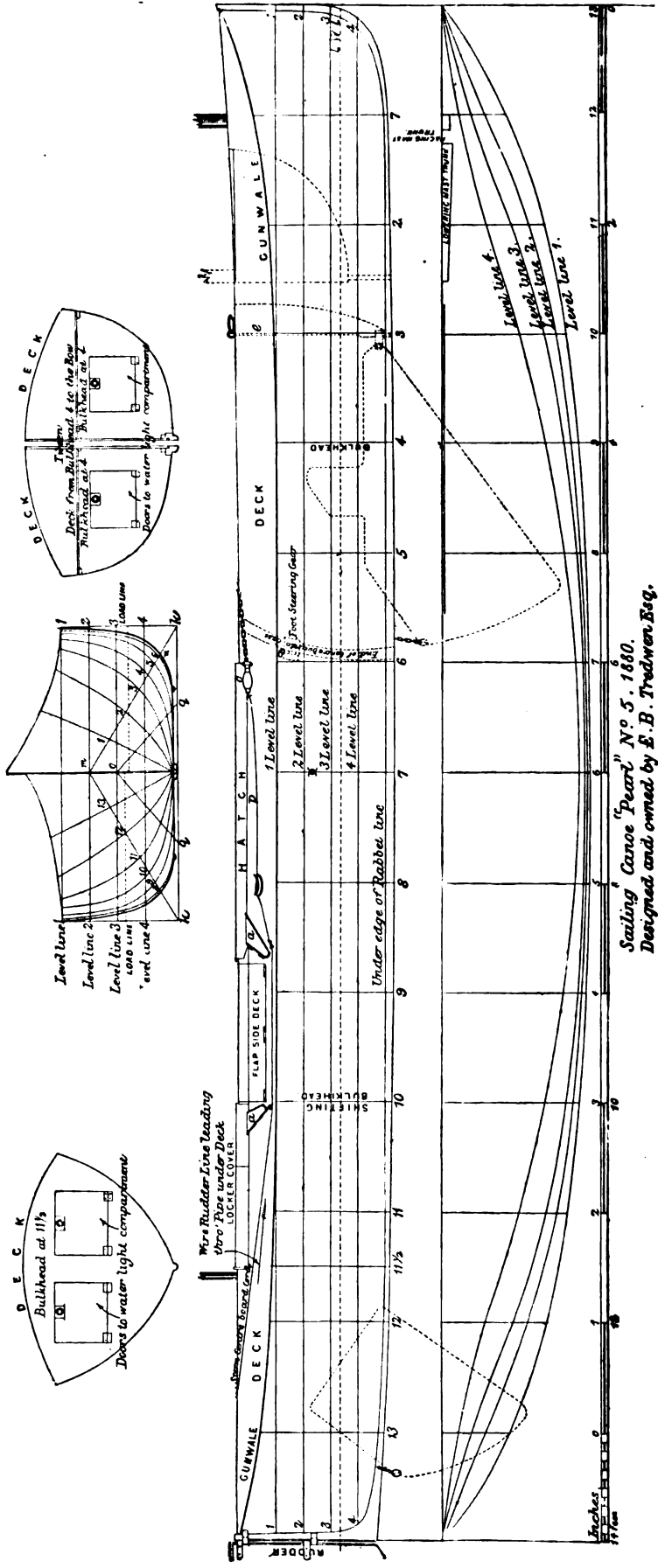


"Pearl" Canoe. E. B. Tredwen, Esq. (Winner Royal Canoe Club Challenge Cup, 1878.)

.



PLATE XLIV.



Sailing Canoe "Pearl" No 5, 1880.
Designed and owned by E. B. Fredwen Esq.

so that one had a short bow and long stern, the other a long bow and short stern, the displacement of both being about equal; in fact, the water-lines in the fore-body of one were nearly the same as those in the after-body of the other. These two canoes, rigged and ballasted alike, have been sailed against one another in every variety of weather, and the results obtained are that the long-bowed canoe performs the better in light winds, or when heavily loaded with ballast; but the short-bowed canoe always comes to the fore in a strong wind, or when carrying only a small quantity of ballast, or sailed entirely without ballast. Mr. Tredwen says that the Pearl of 1880 is a "compromise between the two, and should have a fair proportion of the good qualities of both, and therefore make a good all-round performer."

TABLE OF OFFSETS OF "PEARL" CANOE FOR 1880. (PLATE XLIV.)

| No. of Section | 1 | | 2 | | 3 | | 4 | | 5 | | 6 | | Mid 7 | 8 | | 9 | | 10 | | 11 | | 12 | | 13 | | | |
|--------------------------------------|-----|-----|-----|-----|-----|-----|-----|-----|-----|-----|-----|-----|----------|-----|-----|-----|-----|-----|-----|-----|-----|-----|-----|-----|-----|-----|---|
| | in. | ft. | in. | ft. | in. | ft. | in. | ft. | in. | ft. | in. | ft. | in. | ft. | in. | ft. | in. | ft. | in. | ft. | in. | ft. | in. | ft. | in. | ft. | |
| Depths * | 2½ | 0 | 3 | 0 | 3 | 0 | 3 | 0 | 3 | 0 | 3 | 0 | 3 | 0 | 3 | 0 | 3 | 0 | 3 | 0 | 3 | 0 | 3 | 0 | 3 | 0 | 3 |
| Half-breadths No. 1 level line | 6 | 0 | 11 | 1 | 1½ | 1 | 2½ | 1 | 3½ | 1 | 4 | 1 | 3½ | 1 | 3½ | 1 | 2½ | 1 | 1½ | 11 | 6½ | | | | | | |
| Half-breadths No. 2 level line | 4½ | 0 | 9½ | 1 | 0½ | 1 | 2½ | 1 | 3½ | 1 | 3½ | 1 | 3½ | 1 | 3½ | 1 | 2 | 1 | 0½ | 9½ | 4½ | | | | | | |
| Half-breadths No. 3 level line | 3½ | 0 | 7½ | 0 | 11½ | 1 | 1½ | 1 | 2½ | 1 | 3 | 1 | 3½ | 1 | 3 | 1 | 2½ | 1 | 1½ | 0 | 11½ | 7½ | 3 | | | | |
| Half-breadths No. 4 level line | 1½ | 0 | 4½ | 0 | 8½ | 0 | 10½ | 1 | 1 | 1 | 2 | 1 | 2½ | 1 | 1½ | 1 | 1 | 0 | 11½ | 0 | 8½ | 4½ | 1½ | | | | |
| Half-breadths on diagonal k m ... | 4½ | 0 | 7½ | 0 | 10½ | 1 | 0½ | 1 | 1½ | 1 | 2½ | 1 | 3 | 1 | 2½ | 1 | 1½ | 1 | 0½ | 0 | 10½ | 7½ | 4½ | | | | |
| Half-breadths on diagonal o q | 3 | 0 | 5½ | 0 | 7 | 0 | 8 | 0 | 8½ | 0 | 9 | 0 | 9 | 0 | 9 | 0 | 8½ | 0 | 8 | 0 | 7 | 5½ | 3 | | | | |

The level lines are 3in. apart.
 The sections are 1ft. apart.
 The half-breadths on the diagonals are measured from m towards k, and from o towards q.
 The base line q k, k k, is 1ft. 0½in. below No. 1 level line.

Mr. Tredwen designed all the fittings for the Pearl, and some of them are remarkable for the ingenuity of contrivance. These fittings are shown in the drawing (Plate XLIV.), but a more detailed account of their arrangement and uses will be necessary.

CENTRE BOARD.

The strength requisite to resist the strain of a heavy centre-board in lumpy water can be given to the case without much addition of weight. The sides of the case should be rabbeted into the keel, and fastened by dowels (a, Fig. 128) two inches apart. A piece of wood about one inch

* The depths are measured from No. 4 level line to the under edge of rabbet line.
 G G 2

square is then screwed with alternate vertical and horizontal fastenings into the keel and into the side of the centre-board case, as represented in Fig. 128. The slot through the keel is cut about two inches longer than the inside dimensions of the case, so that the cross ends of the case go down through the keel, and are through fastened to the keel. Each side of the case is bound with a strip of brass from the deck to the keel at the part where the greatest friction takes place, in order to protect the wood. This brass is marked T in Fig. 128, and is about 1 in. wide and $\frac{1}{4}$ in. thick.

In order that the canoe may be easily moved about in general cruising and travelling, it is necessary that the ballast and centre-plate shall be readily removable; 60 lb. is quite heavy enough for a plate for convenient handling, and three square feet of wrought iron plate, $\frac{1}{4}$ in. thick, gives about this weight. (See "Weight of Boiler Plate" in the Appendix.)

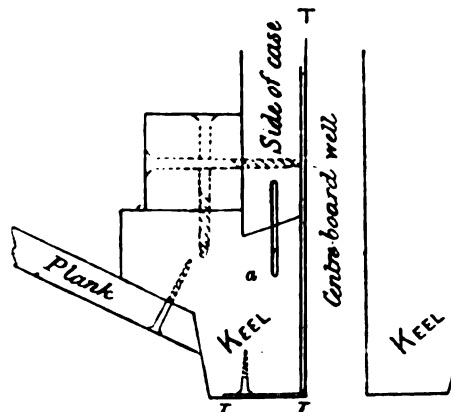


FIG. 128.

The plate, after being cut into the shape and fitted to the case, should be galvanised to prevent rust, and to thus keep it smoother, so as to cause less frictional resistance in the water. The cost of galvanising should not exceed 1½ d. per pound. The plate is slightly increased in weight and thickness by galvanising, a fact which must not be lost sight of in fitting the case.

A heavy centre-board plays an important part in making a canoe self-righting, and a rough-water cruiser with a 60 lb. centre-board should still have good righting power when she is heeled till the water flows over the lee coamings. The Pearl, in the Challenge Cup Race 1879, thrown on her beam ends, and shipped a large quantity of water, aided by the weight of her centre-board she was righted as soon as the pressure of wind was shaken out of her sails, and she was able to continue

the race.* In the event of a complete capsize, the weight of the centre-board assists the canoe to right, steadies her while her skipper gets in again, and when running in a cross sea prevents her rolling gunwale under, and shipping water faster than he can bale out.

The shape of the plate should be designed so as to place the weight as low as possible, and give a large surface for lateral resistance, but at the same time there should be plenty of grip in the trunk when the plate is lowered to the full extent. The ordinary triangular shape is not the best for a heavy plate, the part left in the trunk being so narrow as to throw an undue amount of strain on the sides of the case. The annexed diagram (Fig. 129) A, B, C, D, is a very good shape, its length being 2ft. 9in., and breadth 1ft. 4in. The dotted outline shows the part of the plate remaining in the case when it is lowered 18in. below the keel band, the limit of drop allowed by the Royal Canoe Club rules.

The corners A and B are reduced in thickness about $\frac{1}{4}$ in. on each side, to allow room for the fittings, and a $\frac{1}{4}$ in. hole is drilled through each.

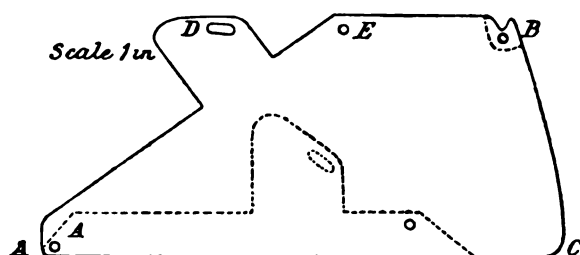


FIG. 129.

The projecting arm is of the full thickness, and has a hole through its upper edge, D, which forms a handle by which to lift the plate in or out of position, and a small hole at E takes a pin above the deck, to support the centre-board while the chain is being placed in position for hoisting or lowering. The edges of the plate, from A to C and C to B, are sharpened to reduce resistance in the water, and the angle C is rounded off to prevent its catching in the ground when the canoe is being hauled astern with the centre-board not quite housed in the trunk. If a small area of canvas only is carried, or if no intention exists of sailing in strong winds, it may be better to use a lighter centre-board, of say $\frac{1}{4}$ in. plate, and then the projecting arm, D, is doubled or trebled by pieces riveted on, so as to make it $\frac{1}{4}$ in. thick, to fill the trunk and prevent undue play. The after-end

* The Lurline in one of the races at Hendon, in 1879, capsized and filled with water when under full racing sail (120 square feet), but was, nevertheless, able to continue the race, and come in third in a fleet of eleven. This element of safety is far more important in cruising, where the canoeist's life depends on the canoe, unaided by any extraneous assistance.

of the centre-board is raised or lowered by a galvanised short link chain; the end link is longer than the others, and is shackled to the plate by two brass lugs (B) and two bolts, as represented in Fig. 130.

The fore-end, A, in the case of a fixed centre-board, is bolted to the keel by a pin through the hole in the corner; but a rather more compli-

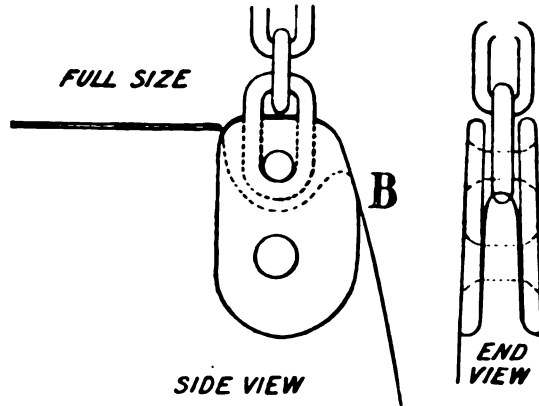


FIG. 130.

cated arrangement is necessary in order that the plate may be lifted out of the canoe easily when afloat or aground. See Fig. 131.

L in Fig. 131 is the fore-end of the centre-board case sloping forward in the arc of a circle, with centre at B radius B A (Fig. 129). The iron pipe, E (Fig. 131), is bolted through the keel at three-quarters of an inch from

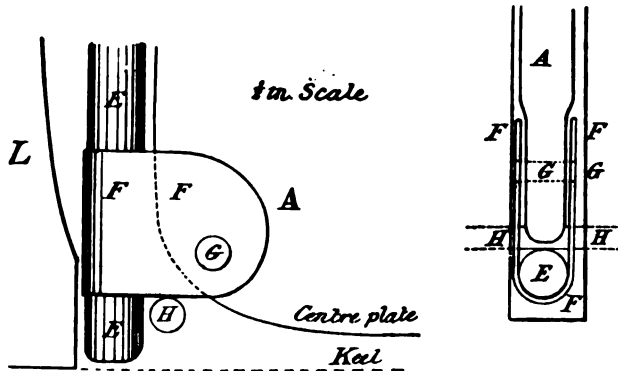


FIG. 131.

the fore-end of the slot. A brass-bound iron pipe, E (half-inch diameter outside), in length equal to the depth from top of deck to bottom of l is bound round, half an inch from one end, by a piece of sheet brass 3 in. by 1 1/4 in., which is securely brazed on. The fore-end of the centre board, A, is bolted by the rivet, G, to both sides of the brass plate

The other end of the rod, E, on deck is fitted with a brass ring to serve as handle. The bolt, H, prevents the rod, E, from shifting aft, or dropping below the level of the keel. The chain at the after-end of the centre-board is about a yard long, and leads over a pulley, M (Fig. 132), and through a snatch block, N, both with chain sheaves turned to the shape, R, which gives a bird's-eye view of the deck. The snatch block, N, is so constructed that the side can be opened so as to slip the chain into the block, and it can then be closed, so that when the centre-board is lowered, the fore-end of the buffer, O, brings up against the block. The buffer, O, is an india-rubber cylinder, $1\frac{1}{4}$ in. diameter outside, with $\frac{1}{2}$ in. hole through it, brass capped at each end. The chain runs through this buffer, which eases the

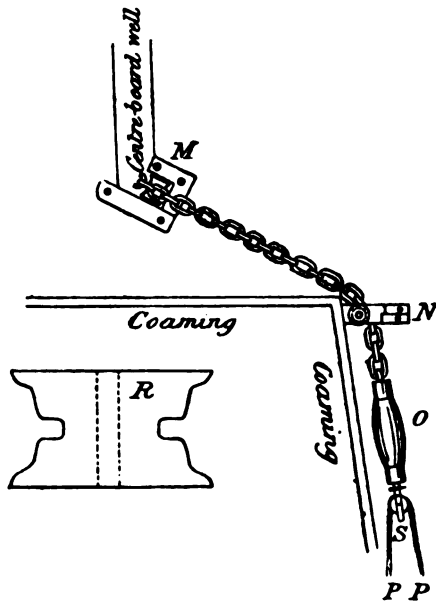


FIG. 132.

shock when the centre-board is let go by the run. Without this check the momentum of 60lb. dropping 18in. would carry away the block, N. The line, P, is made fast to an eye-bolt in the side deck near the hand, and leads through a brass-bound block at S, and is the tackle by which the plate is hauled up, the line being fastened to a cleat on deck.

It is easy enough to take out the centre-board when the canoe is lying on the shore; but on a cruise it is often necessary to lighten the boat while she lies afloat alongside a rock or jetty, over which she has to be dragged. In this case the centre-board is hauled up by its tackle nearly as far as it will go. The skipper then goes forward, and, with one foot on the fore-deck alongside the centre-board trunk, lays hold of the handle

or ring in the top of the rod, E, and pulls it up until its foot is clear of the trunk. It is then swung forward a little, and allowed to rest on the deck at the fore-end of the trunk. A pin is then passed through the hole, E (Fig. 129), to prevent the after-end of the centre-board dropping while the line P is cast off, and overhauled from the block S. The snatch block, N, is then opened, the chain is free, and the centre-board can be lifted ashore by the handle D, or by a hand each to the rod E and the chain. The after centre-board, being quite in the stern, should not be too heavy, but must have weight enough to ensure its dropping freely when let go.

The tackle for working the centre-boards is kept on deck, so as to be available in rough-water sailing when the hatches are battened down, and the well is inaccessible except at the expense of a good drenching.

WELL AND DECK FLAPS.

Mr. Tredwen says that whilst deck flaps are of much use to ensure safety by allowing the canoe sailer to sit well to windward, yet a contrivance is necessary to keep seas out of the well in rough water. The contrivance consists of four weather-boards hinged to the deck, represented by A in different aspects by the three diagrams annexed. Fig. 133 is a

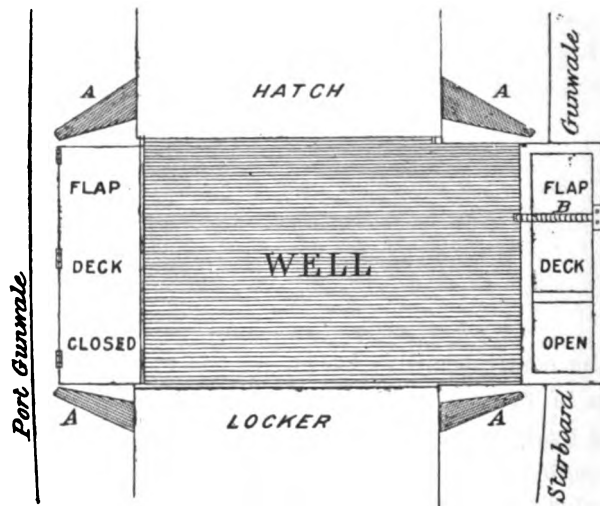


FIG. 133.

bird's-eye view of the deck ; Fig. 134 shows the canoe in section, the port flap closed, the starboard open ; the port weather-board A 1 lying flat on deck, the starboard (A) standing up ; Fig. 135 is a view of the starboard side, the fore weather-board raised, the after one folded down on deck. These weather-boards when standing up act as coamings round

the flap deck openings, and project above the hatch cover and locker cover about half an inch.

In rough water the skipper wears a macintosh coat, the body or skirt of which is 2ft. long from under the arm, and 8ft. in circumference at the bottom. In the seam around the bottom is an indiarubber cord, which gathers it together and makes it fit tightly round the four weather-boards and across the hatch and locker covers. A small

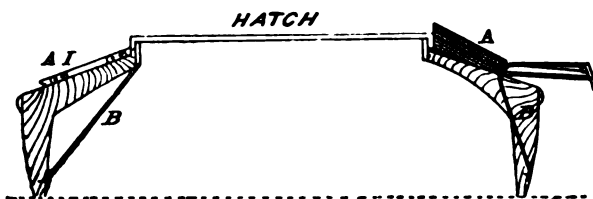
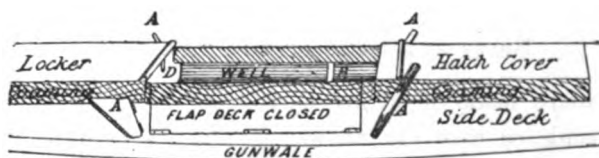


FIG. 134.

beading across each of these prevents any leakage under the macintosh, so that no water can find its way into the well. Each deck flap is provided with an indiarubber spring, marked B in Figs. 133 and 134; this is made of square indiarubber cord (obtainable at any waterproofer's), its ends fastened to the woodwork of the bilge, and the flap by screw plates. The springs keep the flaps closed tight, and also keep them open when folded back to the full extent, but close the flaps when they are raised a little further than is shown in Fig. 134.



Load Water Line

FIG. 135.

The flaps can be opened or closed under the canoeist's macintosh without any difficulty.* All the hinges to these fittings should have brass pins, otherwise they soon get broken or jammed, especially in salt-water cruising. The flaps should be strengthened by a framework of hard wood, as they often get hard knocks; and they should be hinged so as to lie

* The coat opens from the neck down the breast for only six inches, and is fastened by a double fold and two rows of buttons, so that no water can find its way through, except in over the collar. The ends of the aleeves have inner cuffs, gathered round the wrist with indiarubber cord, so as to clasp the wrist tightly and prevent any water running up the arms.

½ in. above the deck when open, otherwise they are liable to be wrenched off over the cords leading from the mizen or the after centre-board.

In the event of a capsize, with the macintosh coat fitted round the weather-boards, it would at once come loose, their hold not being sufficient to resist a strong upward pull.

A canoe is so small, and the height of freeboard so little, that it is impossible to keep the seas off the deck, if sailing in rough water. It is therefore much better for the sake of comfort, safety, and speed, to recognise this fact, and fit the canoe to sail through, as well as over, the combers; and this is successfully accomplished by the macintosh fitting around the weather-boards. There are many occasions when it would be quite impossible to lay a course across a tideway with a beam wind and lumpy sea without this arrangement, for the waves will break clean across the canoe, which will lurch, occasionally coaming under, and would be swamped in a very short time if the well were not completely battened down.

The hatch cover underneath is fitted round the sides with ledges which fit outside the well-coamings snug down to the deck, and so prevent any water getting into the fore part of the well.

REFERENCES TO "PEARL" FOR 1880.—PLATE XLIV.

IN SHEER PLAN.

a, Weather boards. (See Fig. 133.)
e, Rod. (See Fig. 131.)

o, Spring. (See Fig. 132.)
p, Centre-board tackle. (See Fig. 132.)

SPARS AND SAILS OF THE "PEARL."

Mr. Tredwen's mode of fitting a lowering mast is to have a quadrant-shaped trunk or case (as shown by K, Fig. 136), in which the mast is stepped. The trunk is lined with zinc, or copper, to prevent any water finding its way into the canoe through this opening, and a brass pipe (H), from the bottom of the case out through the keel, empties the water in the same way as the valves in the bottom of a lifeboat. The mast is encircled, at the level of the deck, with a brass ferrule, to the aft side of which there is secured a crossbar (F), on which the mast pivots when being raised or lowered. The crossbar turns in two hooks or crutches (G), securely screwed to the deck. The mast can be raised and maintained in position either by a forestay leading from the masthead through a block at the stem head, or by a heel rope, as represented in the diagram. When a forestay is employed the mast must be well back in the boat, or else a bumpkin will be required to take the stay clear of the luff of the sail, unless the latter is cut with a great deal of peak, and a very small part of the sail

on the foreside of the mast. The flat-headed sail has a shorter yard, and when slung so as to have a good breadth top and bottom on the fore side of the mast, it sits very well. The mast, fitted with a heel rope, can be placed well forward in the canoe, and the sail does not then interfere with the paddle, when both modes of propulsion are used simultaneously. In the diagram, A is the sheave in the heel of the mast; B, a sheave fitted on a ferrule around the mast, 6in. above the deck; C, a sheave on deck; D, heel rope made fast to an eye at E; F, crossbar on which the mast pivots; G, pair of crutches for F to pivot in. On slacking the rope D the mast falls aft, the heel of the mast A coming up to the deck towards C.

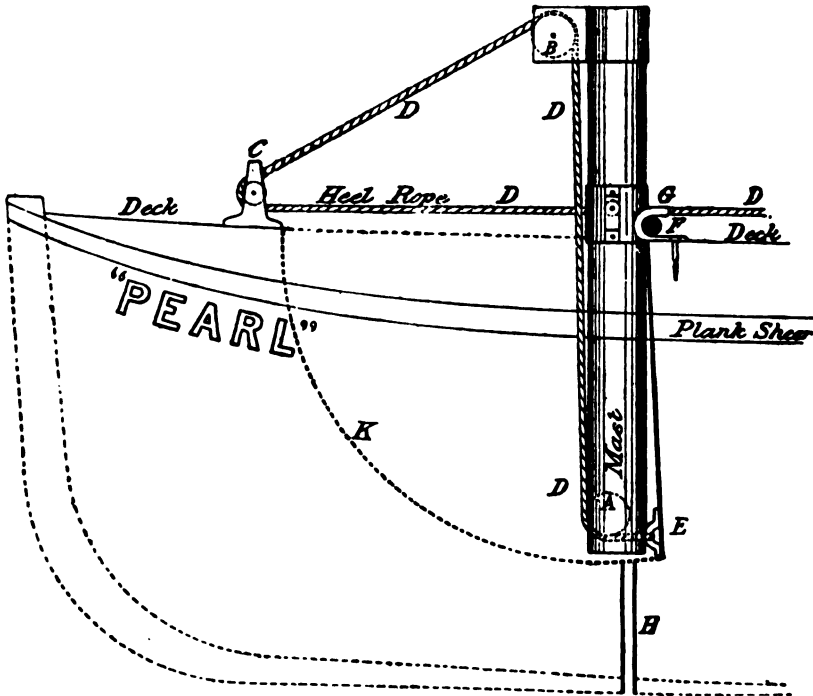


FIG. 136.

The sail (represented by Fig. 137, on $\frac{1}{4}$ in. scale) is a cruising sail with one reef hauled down, and the dotted outline shows the sail fully set. The total area of the sail is about 55 square feet, reducible by three reefs, each reef containing 14ft., 13ft., and 12ft. respectively. The close-reef, or third reef size of the sail, will therefore be 16 square feet.

The material of the Pearl's sails is "washed longcloth," one-yard widths joined together by seaming the selvages. The leach of the sail, from the peak (I) to the upper batten (J¹), is a selvage edge, to which the other seams run parallel, the first seam taking very nearly the line of the topping

lift. The sail is bound all round with strong tape, the luff with a double thickness. There are three battens (indicated by dotted lines) across the sail, one at each reef. A piece of tape is stitched along each edge to the sail, thus making a pocket for the battens. Instead of the tape seamed pockets, the Pearl has long bags or pockets made to fit the battens, and stitched to the sail across the side next the mast. The extra thickness prevents the sail pressing against the mast when closehauled, with the mast to leeward. Two openings are cut out of each pocket, at K and L, in order to make fast a block to the batten. These blocks are made fast by a seizing of fine waxed twine. At each of the points J and M other blocks must be made fast. Across the sail, up and down from K to K and L to L, strips of tape are stitched, great care being taken to keep the tape slack, so as not to *draw* the sail and spoil its sit. Along these tapes, and also on the luff and the leach, are rows of fishing-rod rings ($\frac{1}{4}$ in. outside diameter) sewn on at intervals of 2 in. The running gear for each reef is in three parts. The first is secured to the after end of the boom, and leads up through the rings on the leech and the block at J, and along the batten to N, where it turns into a bight to form a strop round the block N, and is securely seized, and then the line turns back through the block K, and forward along the batten, through the block M and the row of rings on the luff, down to the boom, where it is made fast. The second line is a short one; B, its end, is fastened to the strop of block N, and it leads through block K down the row of rings, and is made fast to the boom. There are thus two lines leading through the block at K; but, as both run simultaneously, the working is quite smooth. Two single blocks or a double block can be used at this point K, but the double block seems to give most friction to the line from M, and two single blocks give the best result. The third line, stouter than the others, is made fast to the fore end of the batten at M or L, and, being rove through the blocks N and L, down through the row of rings at L L through the threefold block on the port side of the mast, and back to the hand, becomes the tackle, by pulling which the reef is gathered together at the leech, luff, and the points K K and L L. All three reefs are fitted in the same manner, the ends of the lines in the second and third reefs being attached to the *battens* instead of to the boom, as in the first reef. The arrangement of the ropes and blocks will be more clearly understood by referring to diagram (Fig. 138). The regular conventional reef points (*x*) are also tied to the battens at intervals, as a reserve in case of the reef tackle getting carried away.*

* Care must be taken in cutting this gear, or there will be a difficulty in keeping the numerous lines of the exact lengths required for its successful working.

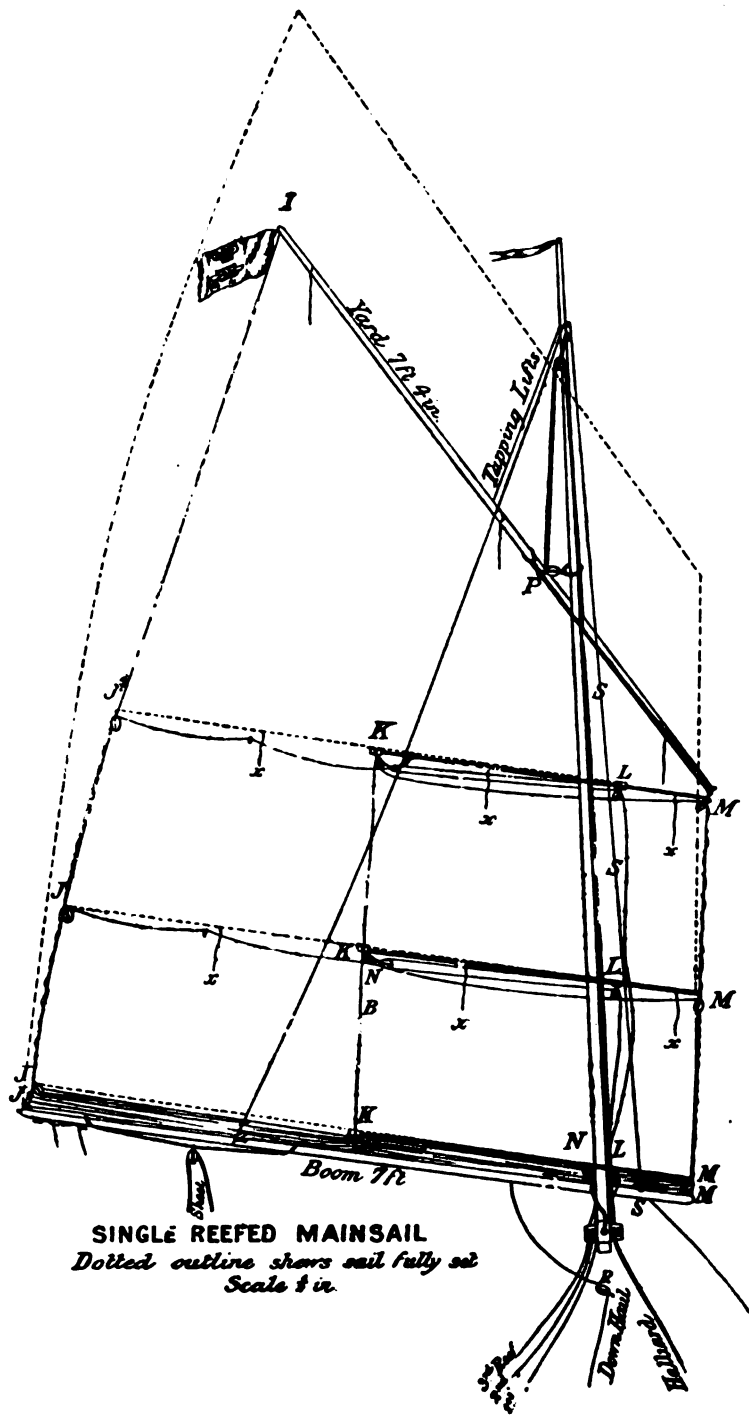


FIG. 137.

Plaited cords should be used for this work, as laid cord would kink and twist up, especially where three lines join into one at the block N. The best cord for the purpose is the "white Albert blind cord," No. 2 size, for the first line (J J M M), and No. 1½ for the second line (K K). The third line which leads to the hand should be "No. 1½ extra super flax-sash line." The blocks required for each reef are two ½in. at M and J, and three ¾in. blocks (or ½in.) at K, N, and L. Thimbles may be substituted for blocks at the expense of increased friction to the running gear. All these cords and blocks can be obtained of W. Good and Sons, Arthur-street East, London Bridge.

A parrel of strong cord leads from P to M on the yard, around the mast, and a similar parrel on each batten goes around the mast from

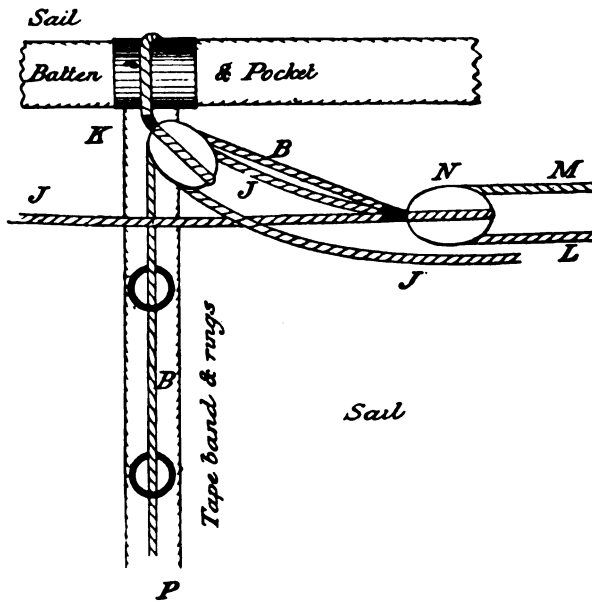


FIG. 198.

M to K. The weight of the sail is thus divided, and spread fairly over the length of the mast when the sail is to leeward, and a great amount of strain is thus removed from the masthead.

The downhaul, for pulling down the whole sail, is made fast to the yard at P, and leads down through a block on the deck at R. The three reef tackles, and this downhaul, lead along the deck through four eye-bolts (screwed into the deck) within easy reach of the hand, and the ends are knotted, so that they cannot go astray, but must always be ready to hand when wanted. This arrangement is convenient on a dark night when everything is invisible, and prevents accidents happening

from mistaken identity of the various cords. The downhaul is important for getting down sails in sudden emergency; also in case of an upset the downhaul becomes essential to gather in the sail after the halyard is let go, otherwise the canoe cannot be righted without great difficulty.

The halyard is made fast to a hollow brass curtain ring running on the mast, and then passed through a block stopped and seized to the yard before passing through the masthead block. This arrangement always keeps the yard well set up to the mast, and yet allows the yard to lower down easily.

The double topping lift leads through an eyebolt screw just above the halyard block, and the ends, having passed through a thimble on the boom at Z, are knotted together and fastened to a small cleat on the boom end, and by letting go from this cleat the sail can be dropped on deck. Another line (S), which leads from the masthead through a thimble on the boom, is fastened to the other small cleat on the after end of the boom, and this line prevents the fore end of the boom from dropping while a reef is being hauled down. The tack is made fast to an eye on the aft side of the ferrule around the mast at the deck, and to this ferrule are riveted the brass treble blocks for the reef tackles and the double blocks for the main and spinnaker halyards. For the yard there are at intervals three or four ties with which to make up the sail when lowered down.

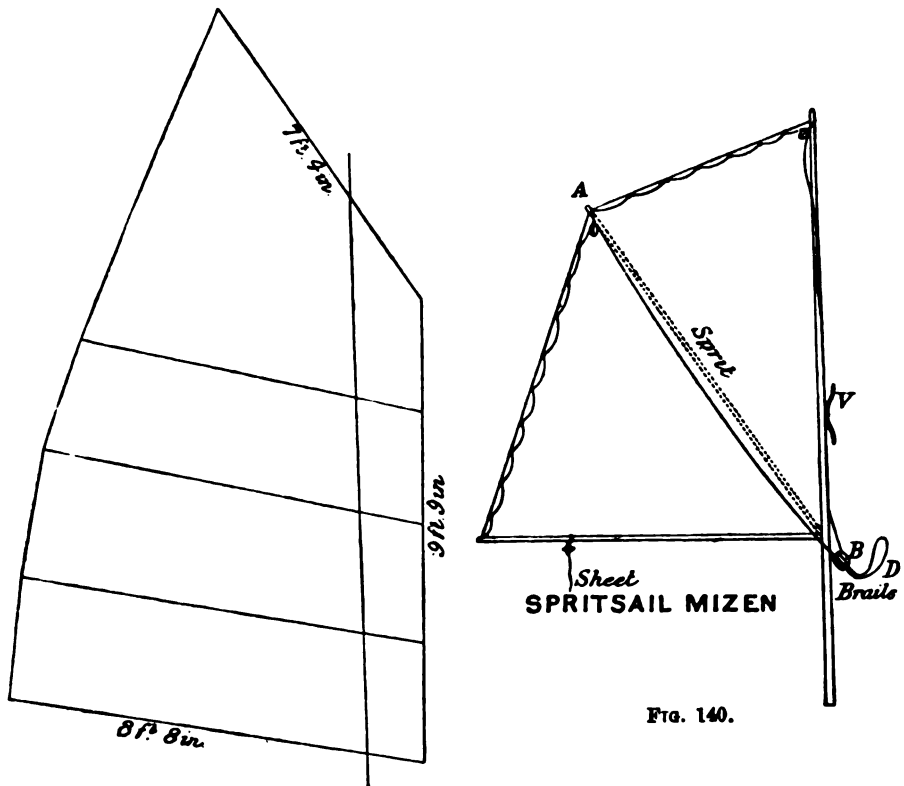
The racing sail is represented on a smaller scale, $\frac{1}{4}$ in. to the foot (Fig. 139). Its area is about ninety square feet, and it is fitted with the same gear as the cruising sail.

Mr. Tredwen says "objection may be taken to the appearance of these sails; that the foot is too narrow, the leech being rounded in too much; but this much can be said in favour of a short boom and narrow sail: the sail is less in the way of the paddle, and it is safer in squally weather than a wide sail, as in a sudden puff a long boom dips into the water, and acts as a paddle backing on the lee side to prevent the canoe luffing up, while the water holds the sail aft like a belayed mainsheet, and keeps it full of wind. If the squall lasts a minute, the canoe is almost certain to upset under these conditions. A small sacrifice of beauty is certainly repaid by the safety acquired in a narrow sail." Of course Mr. Tredwen must mean "height for height," as a low and wide sail is safer, so far as its heeling effects go, than a high and narrow one, the areas being equal.

In squally weather the sail would be of course reduced, and the boom would be well topped clear of the combers.

The spritsail mizen (Fig. 140) is fitted with a brail, running from the

boom end through a row of rings up the leech, and through a block at the sprit head (A), then down the sprit through a double block at the foot of the mast at B, and then (leaving about a foot or so of slack in a bight) it passes over the other sheave of the double block to the masthead, and along the top of the sail through rings to the sprit end, where it is made fast. A finger being put into the bight (D) of the brail, one pull furls the whole sail (the sheet being overhauled); or, by pulling one line only, the sail can be reefed into a jib-header. A line is always kept fast to the masthead long enough to wind two or three times round the sail



RACING MAINSAIL. $\frac{1}{8}$ INCH SCALE.

FIG. 139.

FIG. 140.

when brailed up, and this being fastened to the cleat on the mast at V, the sheet can be untoggled and the sail stowed away, ready to be re-set at a minute's notice, there being no halyards, tack, &c., to adjust. This kind of sail has been found to work well up to 40 square feet, and, although rather unsightly, it is handy as a mainsail in a Rob Roy, where the sail is set low. The canoeist can look under his boom, by a pull on the brail, to see what is under his lee. The sprit is run through a tape pocket to ensure a good sit of the sail when reefed to a jib-header.

The Pearl is fitted with a "roller mizen," and Mr. Tredwen says it has these advantages: "It can be reefed down to any size required to establish a proper balance of effort with the mainsail, and no sail can be reefed so easily and rapidly, for there are no halyards and tacks to be cast off or hauled in, and the operation can be performed without taking the skipper's eyes off his course ahead."

This sail has two booms; the upper one is round, on which the sail is rolled; the lower one is oval, so as to give great strength in the direction required, with a minimum of weight. A ferrule, J (Fig. 141), with an arm brazed on, is fitted to each end of the oval boom, and in the top of each arm is a hole, in which the spiles or axle pins of the upper boom revolve. Riveted on the ferrule at J¹ (Fig. 142) at the fore end of the boom, there is a brass cheek block, through which the cord A runs. The upper boom or roller is of equal diameter throughout its length. Two discs of brass (A on the upper boom), 3in. diameter, are brazed to a ferrule 1½in. long,



Fig. 141.

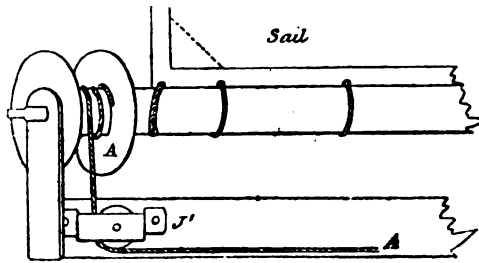


Fig. 142

and make a reel, which is driven on to one end of the roller, the other end being lightly ferruled; two pins are screwed into these ends through the holes in J, and the roller is thus hung so as to revolve freely.

In cutting the sail, the angle of the luff and foot must be rather less than a right angle, otherwise the sail in rolling down will wind over the reel and get jammed. The sail is bound round its edges with strong thin tape, and two bags or pockets, open at the fore end but closed at the leech, are stitched across the sail, to take bamboo* battens about ½in. or 1in. diameter. These pockets are applied as in the cruising sail already described, so that the whole thickness of the battens is interposed between the sail and the mast. The battens are of "South Cane," greenish-yellow in colour, very light weight, and tapering very slightly. The ends of these canes are ferruled lightly and plugged with wood, and the after end is neatly rounded off to prevent it cutting a hole through

* Bamboos can be obtained of Farley (fishing-rod maker), in the Strand, near Temple Bar.

the tack. A parrel around the mast is fixed to the yard from L to M, and a similar one to the boom from K to N; and a block, S, is lashed to the boom at K. Some preparation must now be made for the halyard and downhaul on deck. A screw eye-bolt must be fixed in the deck at B², for a double block to hook on to; or, better still, a brass double cheek block, delineated in the diagram (Fig. 144), is slipped into a couple of catches, C¹ and C², which are firmly screwed to the deck at B¹ and B² (Fig. 143). Another screw eye-bolt (E, Fig. 144) is then securely fixed in the side deck, about two or three feet forward of the skipper's seat, to which a single block (I) is hooked. A line (F) is made fast to E, and rove through the brass eye of a very powerful indiarubber doorspring D, back through the block I, and then to a cleat within easy reach of the skipper's hand. A single block (H) is then seized on to the other end of the spring, and everything is ready for the running gear. The line A, which is halyard and downhaul in one (a piece of No. 1½ extra super flax sash line), is made fast to the yard near M (Fig. 143), and is led

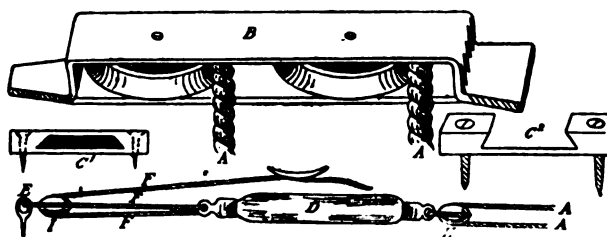


FIG. 144.

through the blocks at the head and heel of the mast, around one sheave of B block, through the block H, and then back around the other sheave of B, through the block S, along the boom, and through the cheek block at J¹ up to the reel A. The line is then cut to the right length, and the end passed through a hole in the disc which forms the aft side of the reel, and tied in a knot.

For hoisting (having toggled on the sheet and cast off the tyers P), a good pull on the line F is given; the line is then fastened to the cleat, which sets the peak of the sail as shown by the dotted diagonal lines in Fig. 143. The line A now bears the same relation to the sail as the cord to a window blind; pulling one side of the bight on deck hoists the sail, and pulling the other side of the bight lowers it. The door-spring, which must be a very powerful one, is necessary to keep the tension right, for the bight of A A sometimes lengthens or shortens as the sail is hoisted or lowered. When the sail goes up, the slack of the halyard A is rolled round on the reel, and is payed out again as the sail comes down. The battens can remain in their pockets, when the sail is

furled, or may be withdrawn in a moment after unhooking the rings from the spiles on their fore ends.

When it is necessary to take the sail off the boat entirely, it is first rolled down as far as it will go, the peak remaining set (as shown by the dotted outline in Fig. 143); the line F is then cast off from its cleat, and the yards drop on to the boom in the bight of the topping lift. The sail is then made up by being lashed round with the tyers P, the tackle on deck is unhooked from the eye E, the block B is slid out of its catches, the mast unshipped, sheet untoggled, and everything can be stowed below, ready to be reset at three minutes' notice.

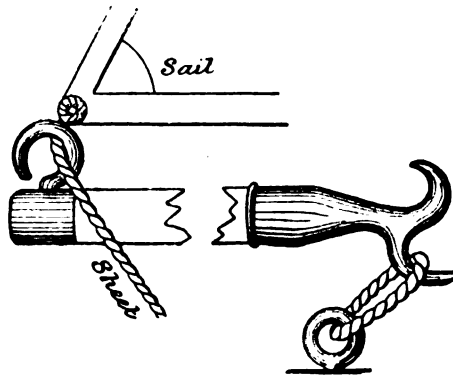
Mr. Tredwen says: "All this rigging may appear very complicated; but when it has once been fitted there is far less trouble in working the sails than when they are rigged in the more primitive fashion."

The roller mizen is suited for sails of from 30 to 40 square feet. The Pearl and Lurline both race with sails of this kind, 6ft. in the luff and 6ft. in the foot, giving an area of about thirty-six square feet fully set.

A spinnaker ought to be set without the canoeist leaving his seat and Mr. Tredwen's plan to achieve this is as follows: The material should be fine in texture, so as to hold a minimum of water, dry rapidly, and stow away in a small compass when not set. The Pearl's cruising spinnaker is as follows: foot, 6ft.; hoist, 7ft. by 9ft. 3in. The edges are bound round with light tape. To each corner is attached a swivel to prevent any twisting of the sail, and the halyard and tack both fastened on by clip-hooks. When the sail is not set the spinnaker halyard is hooked to the thimble on the main boom, through which the topping lift lead, and the other end is led through an eye-bolt on deck within easy reach of the hand. The tack leads through an eye-bolt in the deck, about a foot from the fore side of the mast, and both ends are made fast to an eye in the side deck within reach of the hand. The sail when stowed away is rolled up, the three corners outside in readiness for the halyard and tack to be hooked on. The spinnaker boom of the Pearl is 10ft. long, made with a fishing-rod joint in the centre for convenience of stowage. The outer end has a hook (see Fig. 145), almost a complete circle, which travels out along the sheet to the corner of the sail as the sheet is hauled taut. The inner end of the boom is fitted with a brass boathook head, which hooks on to a loop of cord split to an eye on the lee-half deck. If the mainsail gybes on to the spinnaker the inner end of the boom is unhooked from this loop, the sheet is allowed to slip clear of the hook in the outer end, and is passed around the mast by means of the boathook, and hauled in on the other side. The sheet is then again slipped into the hook on the boom end, with

is run forward till it reaches the corner of the sail. The boathook end is then looped down to the deck, and the sheet hauled aft till the sail is set to the best advantage.

When the wind hauls more abeam, the spinnaker can be made to sit well by means of a guy made fast to the boom, and led through an eye on



*Outer & Inner Ends
SPINNAKER BOOM'*

FIG. 145.

the weather gunwale to a cleat aft and, being bowsed down taut, prevents the boom from lifting.

In the Pearl, when before the wind, the spinnaker is always pulled up and hauled down on the starboard side, and there is no difficulty in booming it out on either side as the mainsail is gybed. This sail is indispensable in racing.

CLYDE CRUISING CANOES.

Prior to the establishment of the Clyde Canoe Club in 1874, there was no settled class of canoe on the northern waters, and Rob Roys were the only craft in which any cruising was done. In 1874 the Rambler was built from the drawings in Mr. Baden Powell's "Canoe Travelling," and Mopoon and Bothnia succeeded; and the Lark (now Wren) which is accepted as the Clyde canoe. Unlike the Rob Roy or Nautilus, she might be called a cross between a birchbark and kaiak, and, as will be seen from the drawing (Plate XLV.), she is built with very hollow lines, and the ends, perhaps, are too fine to accord with an English canoeist's idea of a cruising canoe, and are, indeed, finer than the ends of many Clyde canoes.

One of the most important things in the build of a canoe is to have

her built so as to keep the inside as dry as possible. For that purpose the idea of building canoes with sheer was adopted first in the Nautilus. The Clyde canoes have a similar sheer, which commences from the bow, and rises in a gentle curve to the requisite height necessary to keep her nose out of the waves, and, with the assistance of a slight flum, the advancing waves are gently thrown aside, when otherwise they might have been on deck.

The principal dimensions of the Wren are: Length over all, 14ft. 6in.; beam, 2ft. 5½in.; depth, 10in., measured from under side of garboards to top of sheer strake amidships. The planking (five planks on each side, top strake being teak), is white pine, ¼in. thick, clincher-built. The deck is, by preference, mahogany, ¼in. thick, and is put on in four pieces, fastened with brass screw nails to strong deck beams, and carlines running fore and aft on port and starboard side of canoe. By doing so, one portion of the deck can be lifted for internal repairs without disturbing the rest of the deck work. Bow and stern posts are of mahogany, and keel of American elm; watertight bulkheads forward and aft, with one sliding bulkhead at aft end of well. The mainmast is stepped 2ft. 6in. from perpendicular of bow, and mizen 3ft. 6in. from perpendicular of stern.

The greatest beam is parallel for 18in. at centre of canoe, and the after end of the well is 20in. aft of centre of canoe.

At aft end of well, behind sliding bulkhead, there is a hinged hatch giving access when afloat to a commodious locker; and on aft watertight compartment there is a small hatch, usually made from 7in. to 8in. square giving access to locker, where lamps and other such like articles can be stowed when afloat. From the foot steering gear to the mainmast step there is also good stowage room for tent, meat tins, bread box, and whatever else of that description may be required.

By keeping the mainmast well forward the canoe is supposed to be better to the wind than if it were, say, 1ft. or 18in. further aft. With keel of 1½in. in depth, she goes well to windward, and, having 2in. camber fore and aft, can be put about like a boat without using the paddle.

The masts are stepped into square sheet-brass sockets from 9in. to 10in. in depth, 1½in. square at the deck, and tapering to 1in. square at the bottom. These sockets are watertight, so no danger arises from their being full of water. Watertight bulkheads are made a close and tight fit to their respective sections, and are bedded down with red or white lead. They are cut out of half-inch pine; if made much thinner they are liable to get stove in when spars are stowed below, or when baggage is too energetically shoved fore and aft. The sliding bulkhead is the width of the well, and made to slide into a tapered groove, and

PLATE XLV.

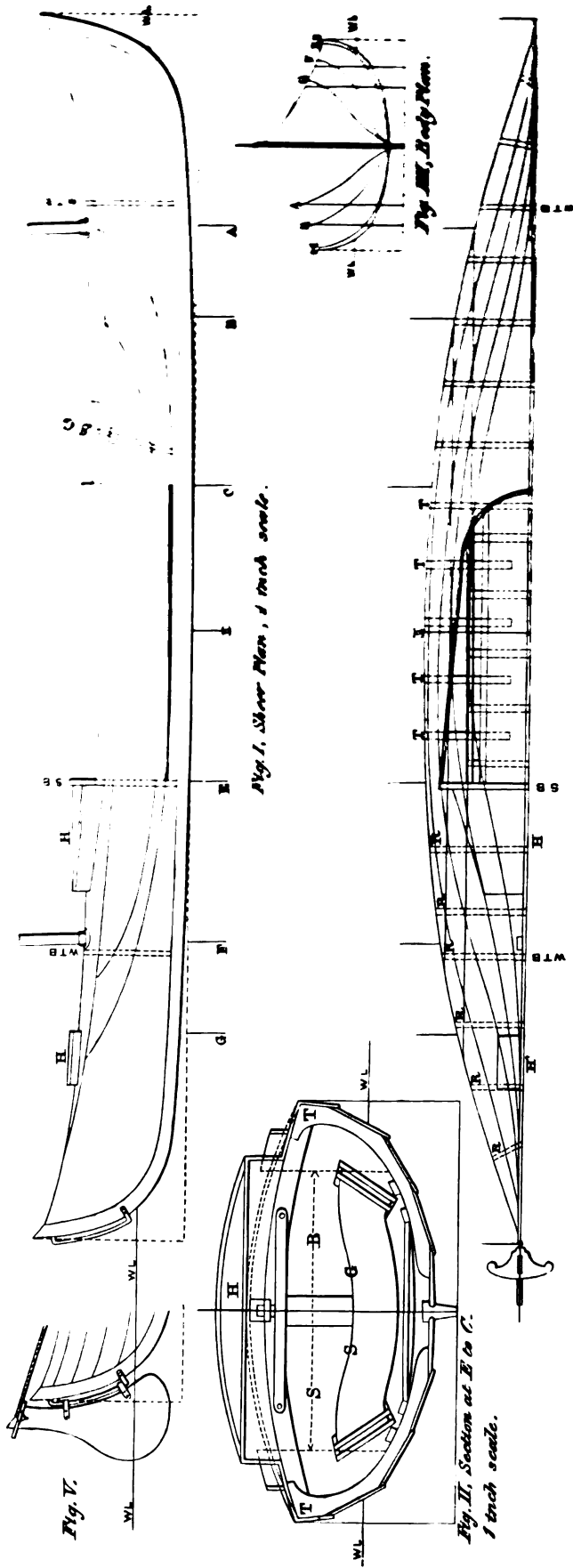


Fig. III, Deck Plan, & track scale.

Clyde Canoe, designed by C. G. Y. King, Esq.

like the other bulkheads, is made of half-inch wood, but by preference mahogany. The ribs (which are $\frac{3}{8}$ in. by $\frac{1}{4}$ in.) and timbers are pitched 8 in. apart, and, with the exception of those within the well, are made of American elm steamed and bent to position. The "well" timbers and knees are of good oak bends, and cut to fit the cross sections. If cut from natural bends they will be all the stronger. The coaming round the well is made of $\frac{1}{4}$ in. elm. This wood is by far the best where the front part of the well is curved, otherwise oak, mahogany, or cedar have been used. On one side of the well, under the deck, is a chart locker about 2 ft. long, and occupying the full width from the coaming to the gunwale. The formation of this locker tends to strengthen the well amidships, as it is impracticable to have short beams joined to a carline. On the other side (starboard) is fitted a slight shelf or open locker, likewise giving extra strength to the deck. This is useful to hold pipe, handkerchief, and other light and often-needed articles.

REFERENCES TO PLATE XLV., "WREN" CANOE.

FIG. I.—SHEER PLAN.

- M M, mainmast.
- M, mizenmast.
- H H', hatches.
- W T B, water-tight bulkheads.
- S B, sliding bulkheads.
- S G, steering gear.

FIG. II.—SECTION AT E. TO C.

- T, timbers in well.
- H, top of hatch,
- S to B, sliding bulkhead.
- S G, stretcher and foot steering gear combined.

FIG. III.—DECK PLAN.

- H H', hatches.
- W T B, water-tight bulkheads.
- S B, sliding bulkhead.

- E R R, ribs.
- T T T, timbers in well.

FIG. IIII.—BODY PLAN.

FIG. V.—RUDDER PLAN.

PRINCIPAL DIMENSIONS.

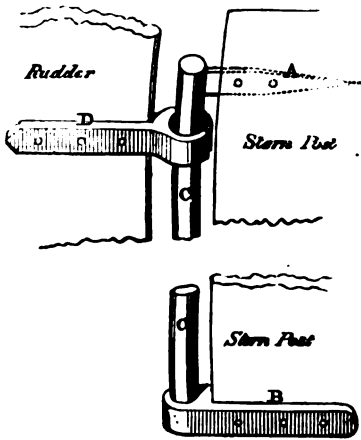
| | ft. in. |
|---|-------------------|
| Length over all | 14 6 |
| Beam | 2 5 $\frac{1}{2}$ |
| Depth, centre of well deck to garboards..... | 0 10 |
| Sheer fore from gunwale at amidships | 0 8 |
| Centre of mainmast to perpendicular of stem | 2 6 |
| Centre of mizenmast to perpendicular of stern | 3 6 |
| Aft end of well from centre of canoe | 1 8 |
| Length of canoe well | 3 6 |
| Width of well aft | 2 1 |
| Diameter of circle of well at fore-end..... | 0 9 $\frac{1}{2}$ |
| Width of hatch at after-end of well | 1 10 |
| Width at after-end of hatch..... | 0 11 |
| Height above deck of hatch..... | 0 1 $\frac{1}{2}$ |
| Width of hatch on after-locker | 0 7 |
| Length of hatch on after-locker | 0 7 |
| Height of well coamings | 0 1 $\frac{1}{2}$ |

CLYDE CANOE FITTINGS.

The diagrams in Plate XLV. to a great extent explain themselves.

Fig. 146 shows details of the rudder arrangement, half full size.

The rudder mountings are all brass. The rod C is $\frac{1}{4}$ in. diameter, and is shaped to the curve of the stern, and is made fast to the sternpost by means of the flat and tapered pin A and the clamp B.



$\frac{1}{2}$ Full Size
FIG. 146.

Two clips similar to D are fastened on the rudder top and bottom. These clips have a $\frac{3}{8}$ in. hole bored in them, and a slot cut out to clear the flat pin A when the rudder is being shipped. The pin A is $\frac{1}{2}$ in. full thick, and when shipped the clamp B keeps the rudder in the position required. This is the simplest and neatest way in which rudders can be fitted on curved sternposts.

Figs. 147 and 148 show two very common methods of rudder connections.

In Fig. 147, A is a brass rod, which is dropped through the brass eyes B B, the eyes on the rudder being at a shorter distance apart than those on the sternpost, so as to prevent the rudder being lifted out of position by the waves.

Fig. 148 shows the common pintle arrangement.

Fig. 149 shows the Wren's stern squared. The false sternpost is shown by A, made fast to the stern by means of square pintles in

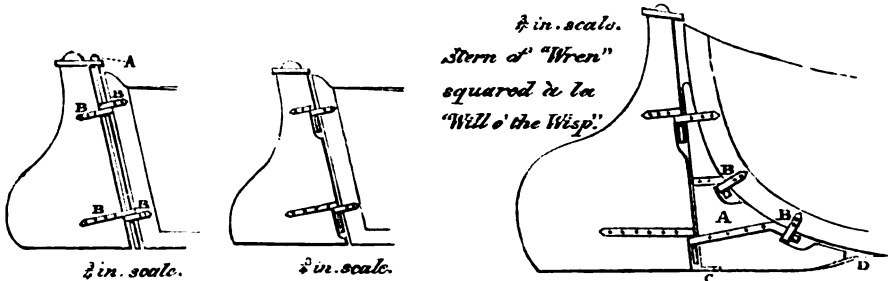


FIG. 147.

FIG. 148.

FIG. 149.

square sockets at B B. The rudder can then be fastened to A, either according to Figs. 147 or 148. C and D are guards of sheet brass,

placed so as to keep weeds from catching and entangling the rudder or false sternpost.

The rudder is worked by the foot steering gear, copper wire, brass wire cord, and brass chain having been tried in succession. At present brass chain is in use between the rudder and foot yoke. It answers well, never kinks, and takes up little room when gathered up. The chain leads to the foot yoke under the deck, so as not to hamper the deck with extra gear lying exposed and in the way of often-used ropes.

The hatch or well covering was originally of wood, similar to those still in use on the Clyde. It was not fastened in any way to the well coaming, but had simply a counter coaming of elm, fitting over well coaming. This hatch is made in two pieces, which are joined by leather hinges, so that the whole well need not be covered in. If wanted, the whole hatch could be removed and placed either forward of the well on deck, or on top of locker aft. At present the hatch or apron in use is that used by the Mersey Canoe Club, and similar to that described on page 422. It is of waterproof cloth. This cloth is fastened to battens, in length equal to length of well; and to keep the battens in position a strip of mahogany is nailed to the deck along both sides of the well, and the battens are jammed between these strips and the coaming. At the fore end of the well is an indiarubber cord $\frac{3}{8}$ in. to $\frac{1}{2}$ in. thick, which keeps the front portion of the apron close to the coaming at deck.

CLYDE CANOE PADDLE.

For the propulsion and guidance of canoes the use of the paddle was, and is, the primary method. The paddle is 8ft. long, and is of the kind known on the Clyde as the "split paddle," in consequence of it being split or divided into two lengths at its centre. The advantage gained by one blade being feathered is that, in paddling against a head wind, one blade cuts the wind while the other does the work. A slight movement of the wrist is all that is necessary to perform the feathering operation; it does not tire the arm, and, when once acquired, is easily kept up all day. The paddle shaft is $1\frac{1}{8}$ in. in diameter, and the blades are 15in. long by 8in. wide; an indiarubber ring close to each blade serves to keep off trickling water.

CLYDE CANOE SAILS.

With the improvement in canoe design, sails for canoes have improved very much lately; their use at first being auxiliary to the paddle, it is only within a few years that much attention has been paid to their utility for cruising and racing purposes, and consequently beating to windward.

On the Clyde the art of sails and their gear has not reached the perfection and complication as used by Nautilus and Pearl, but is, instead, of the simplest description possible.

Plate XLVI. gives a view of the Wren's sail plan, to the scale of $\frac{1}{4}$ in. = 1 ft., and in design of rig is simple and easily handled. The masts, main and mizen, are good strong yellow pine sticks, 1 $\frac{1}{2}$ in. diameter at deck, square in the step, and tapering to 1 in. square at the foot; diameter at masthead, $\frac{3}{4}$ in.; height above deck, 8 ft. for main mast and 5 ft. for mizen. The mizen mast is thus stouter in proportion to length than the main, and the advantage gained in having both

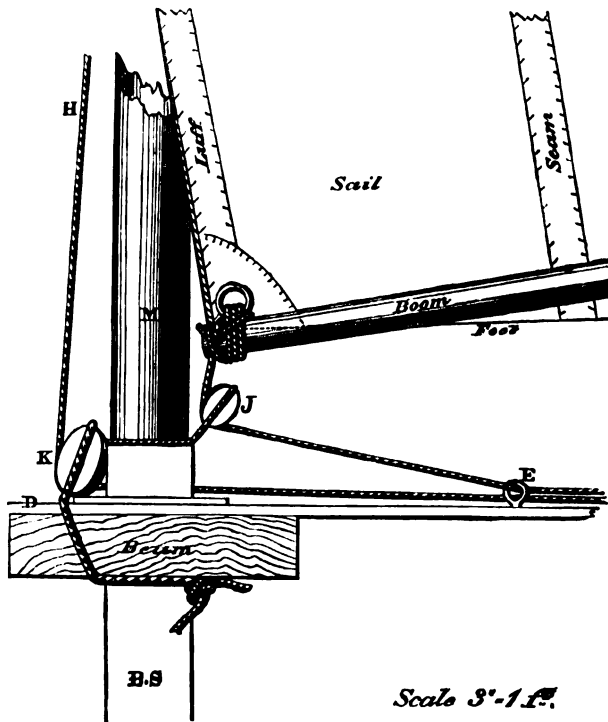
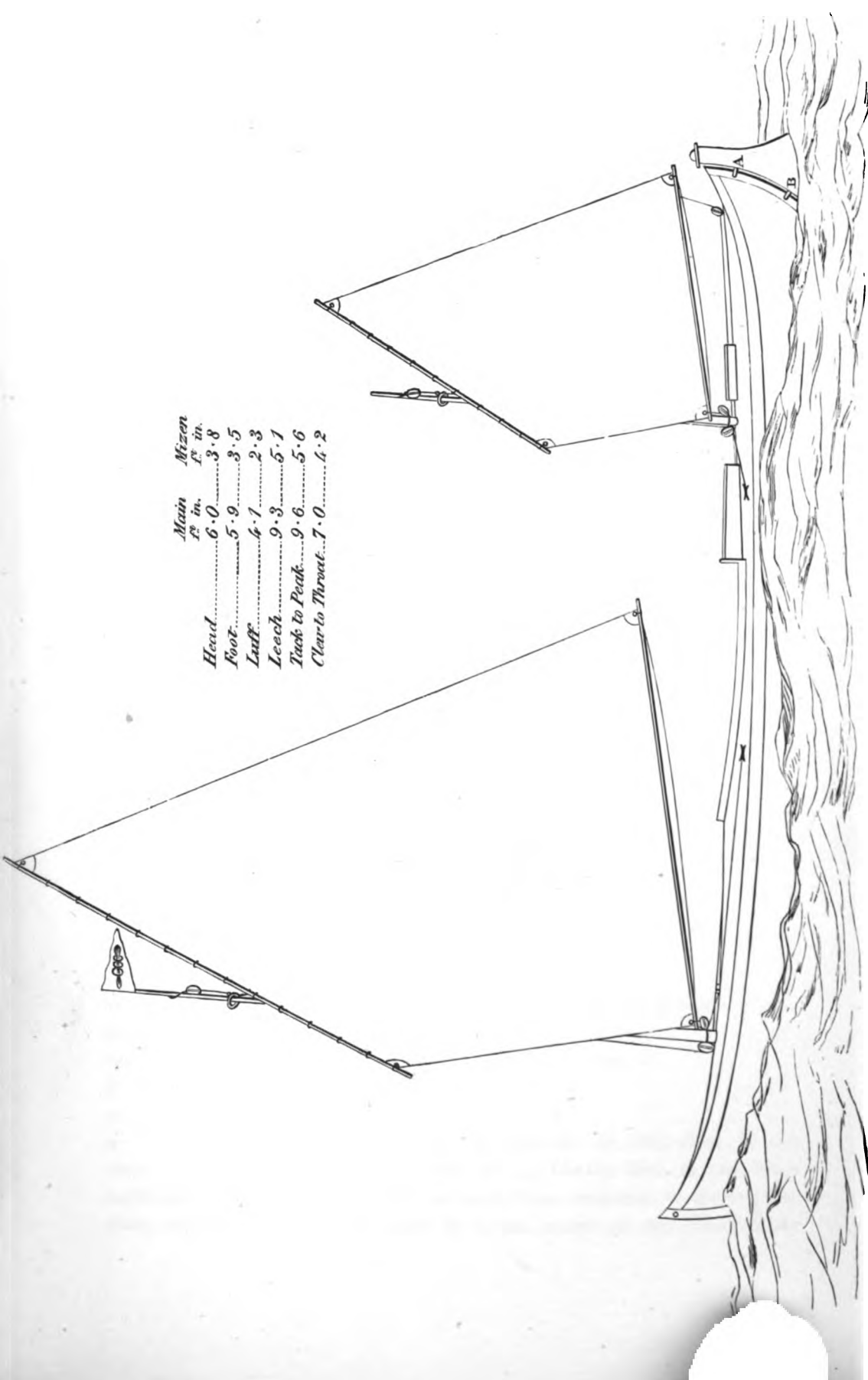


FIG. 150.

masts alike at the step is evident, when the mizen mast and sail can be set forward instead of the main in almost any weather. To each sail (main and mizen) there are the following ropes—halyard, tack, and sheet; and, as both sails are rigged alike, the sketches Figs. 150 and 151 may do for each.

In Fig. 150, K is the halyard block at deck; J, tack block at foot of mast; M, mast; D, deck; E, eyebolt through which tack is passed to its cleat; H, halyard; B S, brass socket for mast, made watertight; Beam, an extra strong beam athwartship at each mast, to strengthen



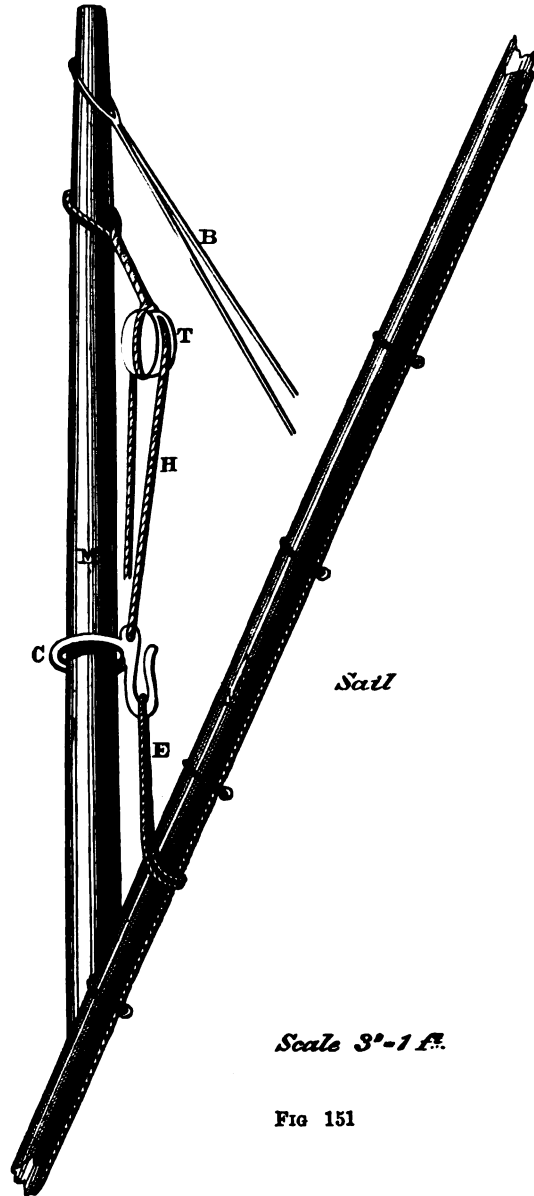
| | Main ft in. | Mizzen ft in. |
|----------------------|----------------|------------------|
| Head..... | 6.0 | 3.8 |
| Foot..... | 5.9 | 3.5 |
| Luff..... | 4.1 | 2.3 |
| Leech..... | 9.3 | 5.1 |
| Tack to Peak..... | 9.6 | 5.6 |
| Clear to Throat..... | 7.0 | 4.2 |

Fig. V, Scale 1/2" = 1 foot.
Sail Plan of Clyde Canoe.



deck. The tack block is made fast round the foot of the mast, close to the top of brass step socket, and the halyard block fastening is passed through a hole in the deck and beam on the fore starboard side of the mast, then the two ends of the lashing are tied under the beam round the mast step.

In Fig. 151 is shown the masthead gear, where B represents the brails, C, the traveller, with hook, on which the strop E is hung with running eye round the yard; T, halyard block; H, halyard; M, mast. Brails are seldom used on the Clyde canoes, the folds of the sail being usually gathered in as sail is lowered. Also few canoes are fitted with a downhaul, which, although not on the Wren, is of the greatest benefit when the sail requires to be lowered suddenly in heavy winds. The ropes are of woven linen. Woven cord is very suitable, as it does not unravel, although some never use it, as it cannot be spliced. For a mainsail sheet a good length of 1in. Manilla rope is very suitable, as it is not so thin as to cut the hands when holding it in in a strong breeze. The mizen sheet is rove through



Scale 3"-1 ft.

FIG 151

a block at the stern, thence along the deck to its cleat close to the well. Paget's patent rocking cleats are by far the best, as one hitch holds anything. Sails are made of stout linen material, in cloths from 10in. to 12in. wide, and if made by a sail maker all the better. At

each corner are strengthening gores, of the same material as the sail. The leech is as usual the selvage, and the head, foot, and luff are corded, instead of being, as some sails are, bound with tape.

It must be remarked that centre-boards are but little used on the Clyde; perhaps the reason is that their increased weight makes hauling canoes above high water mark when cruising and camping a nuisance.

For cruising, the Wren has a special mainsail of 25 sq. ft., and the mizen is left at home.

When being raced, little or no ballast is carried in the Wren, except about 10lb. of lead, placed well aft; and as the well is extra wide at its after end, the canoeist is enabled to sit well to windward.

CLYDE CANOE CRUISING.

For clothes, the canoeist may be advised to take an every-day suit for wearing ashore, as well as his usual knickerbockers, stockings, shoes, jersey, and cap for wearing afloat. For provisions, should the cruise be intended to extend over a couple of weeks, in localities where shops are never heard of, an extra supply of everything should be taken, but not so much as to have a superfluity of any one thing. Tea, coffee, or cocoa, according to choice, can be taken; preserved milk, bread, butter, tins of meat, soup, and fruit; matches should be kept in an empty pickle bottle; corkscrew, and many other little articles which suggest themselves to the requirements of the would-be *voyageur*; but it is a well-known fact that the oftener one goes cruising, the fewer unecessaries are taken.

Sleeping costume is perhaps the most variable of all costumes, and the novice to a great extent has to please himself. Some put on a complete suit of clothes, roll a thick muffler round the throat, and put on a double supply of stockings. Others, again, envelope themselves in a Highland cloak, having on a spare boating suit; others, who carry railway rugs, Scotch plaids, or the common household blanket, don a nightshirt; while some sleep in sacks, with only their heads visible.

In almost every instance, each member while afloat is seated on a cushion about 2in. thick, 20in. wide, and from 2ft. 6in. to 3ft. long. These cushions are covered with American cloth (waterproof) and stuffed with hair, and in the evening, when the tent is pitched, make admirable couches for repose.

THE CLYDE TENT.

Some canoeists who indulge in river cruising prefer to sleep on board their craft, sometimes afloat, and sometimes on shore. Truly the

simplest style of camping out alone is sleeping in the canoe. Sleeping on board, afloat or on shore, is, however, a thankless job, and there is not the comfort or satisfaction that arises from the use of a tent. The canoe is, for sea cruising, too unstable for such use afloat, and is seldom designed for such use ashore, although it may have the recommendation that dryness of couch is thereby obtainable. For general comfort and satisfaction, a tent is truly the *sine qua non* for sleeping in, and there can always be found a plot of ground beside a running stream where the canvas walls can be erected.

A tent must have many qualities; it must be light to carry, simple in its erection, free from draughts, strong enough to stand up in a gale of wind, and, above all, perfectly watertight. The members of the Clyde Canoe Club claim that the Clyde tent combines these qualifications, and no true canoeist who has once slept in a Clyde tent cares to try any other design. Its most essential item is dryness internally, in the heaviest rainfall. One great feature is the simplicity of its construction, in that the floor, walls, and roof are in one length of cloth, sewn together at the floor edge.

The tent shown in the drawing is made suitable for the accommodation of two canoeists.

Fig. 152 is a drawing of the floor or ground sheet, walls, and roof, extended or unrolled before setting up.

Fig. 153 is a view in elevation of one side of tent.

Fig. 154 is a view in elevation of the back of tent.

Fig. 155 is a view in elevation of tent door, shown closed.

Fig. 156 is a detail from Figs. 153 and 154.

Fig. 157 enlarged view of A galvanised tent pin in Fig. 153.

Fig. 158 an enlarged view of R, Fig. 153.

Fig. 159 is a detail of tent pole.

Fig. 160, canoe lamp.

These illustrations will now be considered in detail, so that the construction may be better understood.

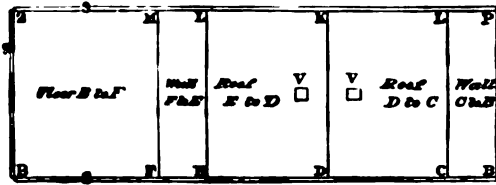
The corner letters in each view of tent are all intended to correspond with each other.

In Fig. 152 B to F, or the rectangular piece B F M Z, is the floor of ground sheet; E F L M and L C B P, walls; L E D K, and D K C L the roof, K to D being the ridge; V is a ventilator. The strip marked S is for hemming or counter-hemming the back and front ends of tent to floor, walls, and roof.

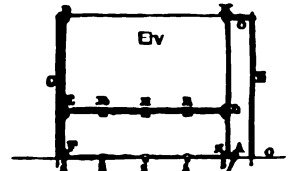
In Fig. 153 D K is the ridge; D E L K, one side of roof; E F N L, wall; F N, edge of ground sheet; O, ridge pole (horizontal); G, tent

pole (perpendicular) and back of tent, placed close to the tent ; H, tent pole at door, sometimes 12in. or 18in. from front of tent, to allow free ingress or egress to tent ; V, ventilator ; R R R, guy rings ; S S S S and A, tent pins.

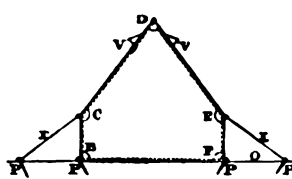
Fig. 154, D, ridge ; C D and D E, roof ; C B and E F, walls ; B F,



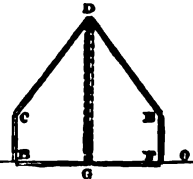
Plan of Tent extended. Scale 1"=1ft
FIG. 152.



Side Elevation Scale 1"=1ft
FIG. 153.



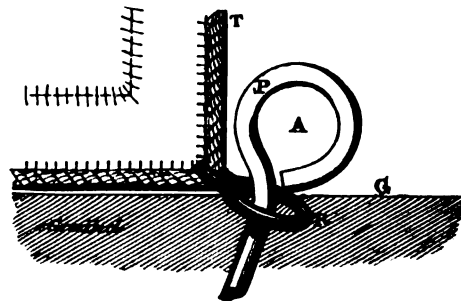
Back Elevation. Scale 1"=1ft.
FIG. 154.



Front Elevation. Scale 1"=1ft
FIG. 155.

ground sheet ; I, guy ropes ; P, tent pins ; V, ventilator shown open—when required to be shut, a cord leading to the inside closes it.

Fig. 155, D, ridge ; C D and D E, roof ; C B and E F, walls ; B F, floor ; D G, door shown shut, with eyelets for lacing same ; when open, a space equal to a triangle B D F is formed by tying the two corners G to the angles C and E.



Full Size.
FIG. 156.

Fig. 156 shows the corner tent pin A in Fig. 153, or any other tent pin full size.

Fig. 157 shows tent pin to scale of 3in. = 1ft.

Fig. 159, O, ridge pole ; G H, front and back tent poles ; A and B,

iron or brass pins, B being thrust into the ground to steady the pole, while A on each pole keeps the ridge pole O steady.

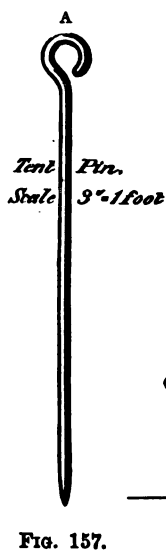


FIG. 157.

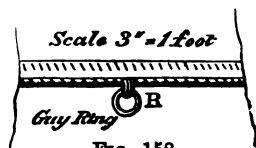


FIG. 158.

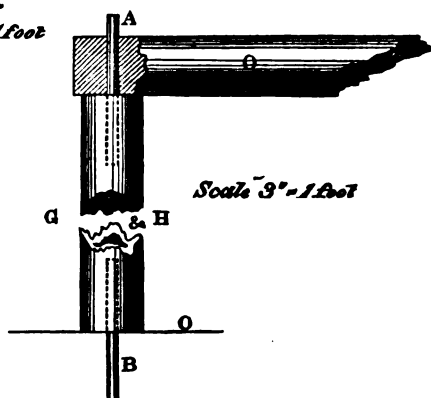


FIG. 159.

Fig. 158 is an enlarged view of R in Fig. 153, showing the ring R, to which stout woven cord guy ropes, like I in Fig. 154 are fastened.

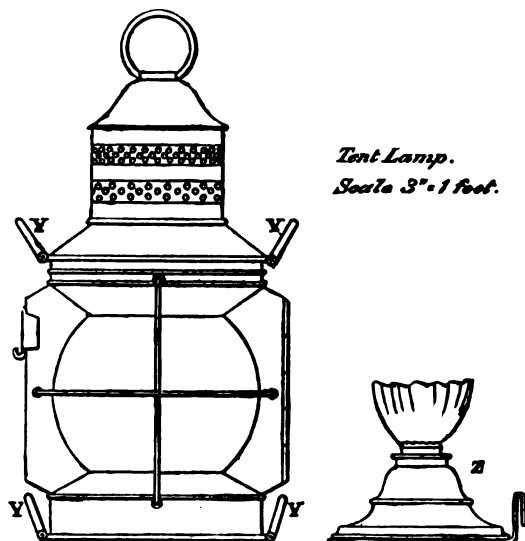


FIG. 160.

Fig. 160 shows a copper lamp, which is hung up to the ridge pole inside the tent at night. The glass globe is of thick glass, and is

protected by two cross copper wires. The lamp divides in the centre, thereby enabling the oil receiver and lamp proper Z to be removed for cleaning or renewing oil or wick. Y Y Y Y are rings through which a rope is rove to steady the lamp while at the masthead when paddling at night after dark.

In the construction, having cut out in one length sufficient cloth to make the floor, walls, and roof, and sewn the edges Z B and P B (Fig. 152) together, the back end, Fig. 154, can now be sewn in, as also can the door end, Fig. 155, care being taken that the corners B F E D and C take their right places. The door is sewn along all its outside edges, except from B to F, and, after being laced, is kept close down by means of the lacing cord being made fast to the tent pin at G.

Figs. 153 and 154 show outside finished dimensions, and the dotted lines correspond to the strip S in Fig. 152, which, being a double seam, gives extra strength. Along all the edges, such as F M, E L, C L, B P in Fig. 152, and B C D E F in Figs. 154 and 155, there is a stout cord sewn, and on each edge F M, E L, C L, and B P, and B F front and back, and at suitable intervals, there are brass rings sewn; those along the ground lines, to receive the tent pins to hold ground sheet down; and along E L and C L, are similar rings as R in Fig. 153 and R in Fig. 158, to which gny ropes are attached, and at the ground end of gny rope is a loop in which is clipped round the tent pin when same is being driven home.

Those who object to the use of iron tent pins possibly do so because they have always used wooden ones. The Clyde tent pin is of $\frac{1}{4}$ in. galvanised iron, 10in. long, with a ring at top end (A in Figs. 156 and 157) large enough to admit the finger, thus enabling them to be easily withdrawn from the ground and fastened together in a bundle.

The inserting of a wooden peg necessitates the use of a mallet or any stone lying about handy; their wear and tear necessitates frequent renewal, and their insertion is difficult in stony ground. The use of iron obviates all difficulties of these kinds. The tent poles G and H are each in one length, according to height of tent at ridge pole. They are of $1\frac{1}{4}$ in. yellow pine. The ridge pole varies in length according to length of tent. It is likewise of $1\frac{1}{4}$ in. pine, and is jointed like a fishing rod at its centre, so as to be handily stowed below. This joint is made of a strong brass tube 10in. long, one half of the ridge pole being inserted for five inches, and fastened to the brass tube by a couple of screws, while the other half of the pole fits exactly into the remaining five inches.

To erect the tent, stretch the ground sheet flat on the ground and

fasten it close down by means of the pins, and let them be angled inwards, as in Fig. 154. The roof and walls will now be lying in a heap. Next pass the ridge pole through the hole specially prepared for it at D in Figs. 154 and 155, then insert tent-pole pins through the holes at each end of ridge pole, and keep back end pole close to the end of tent, leaving front pole 12in. or 18in. clear from the door (see Fig. 153). Then commence at either end, and stretch guy ropes, and press pins closely down to the ground, the pins being angled inwards. If properly set and strained, the roof and wall will sit as flat as a board. The material used is either bleached or unbleached calico, and, to render it waterproof, it should be coated over, when erected, with two coats of boiled oil and terebin (extract of turpentine tree), one gill of the latter to two quarts of the former being a good proportion of mixture. The tent as shown by drawings was actually designed to accommodate two canoeists, and is of the smallest suitable size which it is advisable to make. Similar though larger ones are in use, in which four can sleep comfortably, with baggage inside.

One very good and general plan is, when several canoeists are camping together, to carry a small tent, like the one described, specially for holding baggage, and to be used as the kitchen of the camp.

Novices in camping have often great difficulty in selecting a suitable and simple cuisine. The best known is the Russian lamp, or Rob Roy cuisine. In the north it is accredited with the euphonious name of the "Devil," on account of the roaring propensities of the blast when burning. The Clyde Canoe Club have no speciality in cuisines.* One simple arrangement is to have a copper pot with frying-pan lid, which can hold inside it a five-wick lamp, handle, and legs for pot to stand on. For cooking purposes it is seldom used, except in wet weather, as there is always sufficient dry drift wood to be found along the shores above high-water mark to make a fire large enough to cook for the camp. A half-gallon tin of methylated spirit is carried; and as such a commodity is seldom procurable among the western isles, it is used as little as possible. The tent, with poles and pins, weighs about 18lb.; it can be erected in three minutes, by two canoeists, and, for a cost complete of 2*l.* 2*s.*, is within reach of all canoeists who care to order it from any sailmaker, or cheaper still if they make it themselves.

Some tents are made with roof sloping down to where the ground sheeting should be, and have no walls, no floor beyond a separate waterproof ground sheet. These tents are never dry, and, not being waterproofed, they secrete the rain, and are thus objectionable companions when packing up in a hurry in the morning. The rain possibly does not penetrate as

* King and Brown, 93, Wigmore-street, keep most excellent cooking stoves.

it falls, but when touching the inside it at once trickles on the hand. The majority of special canoes are designed to suit the waters they are intended to be used on, but the same can never be said of tents, which are suitable anywhere.

MERSEY SAILING CANOES.

A class of boat is rapidly getting into favour on the Mersey, which, in some respects, is better adapted for the combined recreation of "paddling and sailing" in the open sea than are any of the canoes hitherto described. We are indebted to Mr. C. Arthur Inman for a description and drawing of the Mersey craft (Plate XLVII.); and it would be strange indeed if that home of "canvas-backs" did not turn out something specially serviceable in the way of boats. Although these Mersey sailing boats are termed "canoes" and "canoe yawls," it is quite plain that they are as much "sailing boats" as the Surbiton gigs are. It is true that they have grown out of the Rob Roy canoe; but a vessel 17ft. long, 4ft. 6in. broad, and 2ft. deep, that carries "passengers," 1cwt. of ballast, has a large sail area, and is, moreover, rowed and not "paddled," is better described by the word "boat" than "canoe."

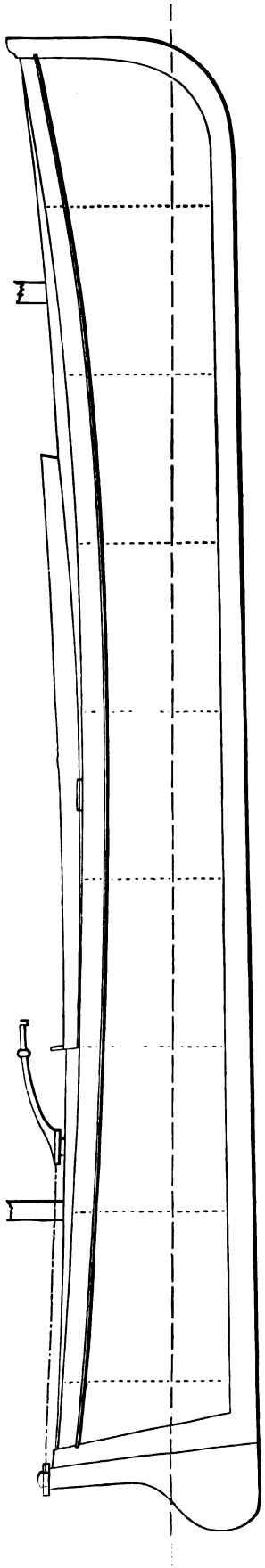
The boats are usually of one length, 17ft.; and a breadth of 4ft. 6in. is found to answer well. The depth from gunwale to under side of keel is 2ft., and the keel is 4in. deep. They are decked all over, excepting the well, which has 1½in. coaming all round, and is usually of the form shown in the drawing. The well is carried so far forward to enable the crew to reach the mast, or anything forward of it, without getting on the deck. The canoes are clench built, of white or yellow pine ¾in. thickness when worked up. The stem and sternpost are alike, 1½in sided, with 2½in. outside rabbet, and about 3in. inside, enough to take the plank fastenings and serve as apron.

The steering arrangement is very capitally contrived with yokes coupled by rods or chains as a tiller, as shown. Strengthening pieces (running fore and aft) are worked above and below the deck, through which a bolt with collar passes, and is secured with nut and washer underneath. On the upper part of the bolt, above the collar, the yoke and tiller (all in one) are shipped on the bolt, and kept from unshipping by a pin. In case the tiller and yoke be of wood, a brass socket is fitted in the hole to prevent the collar of the boat wearing away the wood.

Generally about 1cwt. of ballast is carried, in flat lead or iron bricks. The boats carry three passengers; two sitting aft on the stern sheets, and one on the fore seat.

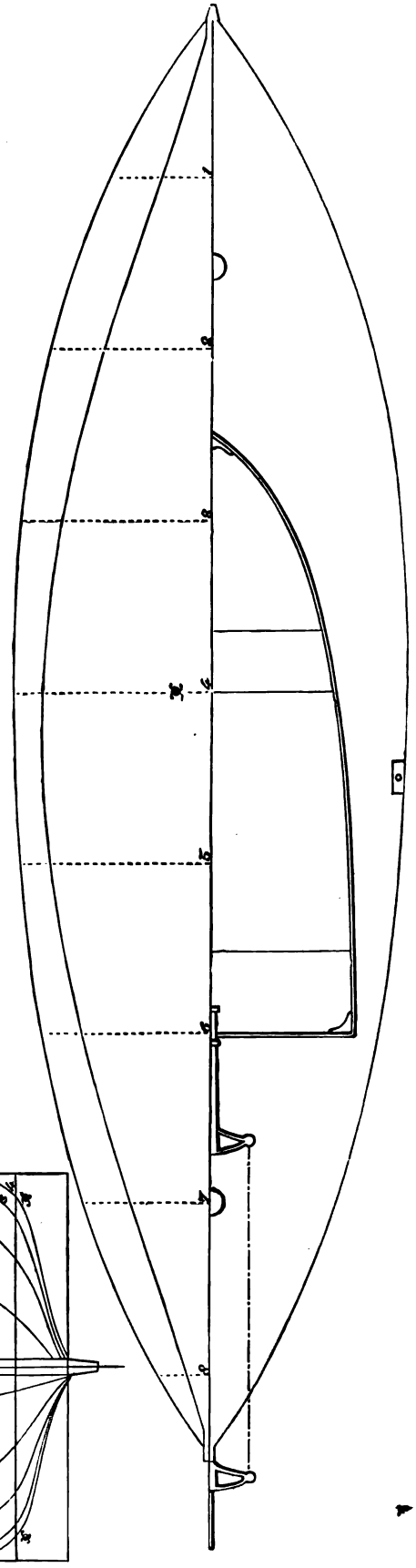
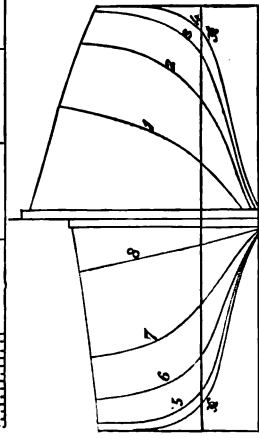


PLATE XLVII.



0 1 2 3 4 5 6 7 8 9 10 11 12 13 14 15 16 17

SCALE $\frac{1}{4}$ IN. TO 1 FOOT.



MERSEY SAILING CANOE.

The rig, it will be seen, is the main and mizen; and in strong winds, with small mainsail and small storm mizen, they sail fast, and are dry. As they are decked in, these little boats may be seen out in all weather, and are considered as dry and safe as the New Brighton boats; but, of course, could not compete with them.

In form the boats are comparatively full forward, and have a long clean after-body; compared with the usual run of sailing boats, they are longer in proportion to their breadth, but if cut off at No. 7 section they would not much differ from the ordinary sailing boat.

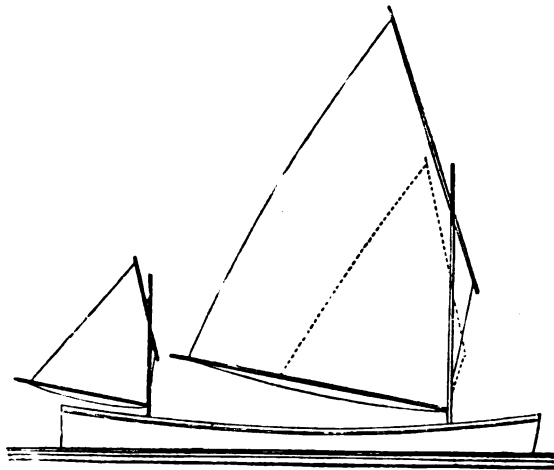


FIG. 161.

The 4in. keel is found quite sufficient, in the way of dead wood, to check lee-way; but, with a comparatively small sail area (only 100 square feet), such boats could hardly be expected to compete with the beamy Surbiton craft.

The main and mizen rig is found to answer well, and the boats stay well under it in smooth water. In rough water they require to be handled with more care in tacking; and if a boat seems likely to miss stays, the rowlock is close by the helmsman, and he can help her round with a stroke of an oar. However, generally they are backed round by hauling the foot of the mainsail to windward if they hang in stays; but the oar, if used, has this advantage—it keeps the boat going.

| | ft. | in. |
|---------------------------------------|-----|-----|
| Mainsail, foot..... | 10 | 0 |
| Mainsail, head..... | 10 | 0 |
| Mainsail, luff..... | 5 | 0 |
| Mainsail, leech..... | 14 | 6 |
| Mainsail, tack to peak earing..... | 14 | 8 |
| Mainsail, clew to weather earing..... | 10 | 9 |
| Small mainsail, foot..... | 6 | 6 |

| | ft. | in. |
|---|-----|-----|
| Small mainsail, head..... | 7 | 6 |
| Small mainsail, luff..... | 2 | 6 |
| Small mainsail, tack to peak earing..... | 9 | 0 |
| Small mainsail, clew to weather earing..... | 7 | 0 |
| Mizen, foot..... | 4 | 6 |
| Mizen, head..... | 2 | 6 |
| Mizen, luff..... | 2 | 4 |
| Mizen, leech..... | 6 | 0 |
| Mizen, tack to peak earing..... | 5 | 9 |
| Mizen, clew to weather earing..... | 4 | 9 |

It will be seen that the sails are not laced. The boom is fitted with goose-neck or jaws to the mast, and the tack is bowsed down by a rope which leads through a block on the aft side of mast on the deck.

The builder of the Mersey canoes is Mr. Samuel Bond, Mersey-street, Birkenhead. Sailmaker, Mr. J. E. Jarvis, 8, Tabley-street, Liverpool.

A good material for the sails would be “ $\frac{3}{4}$ Bleached Linen Drill,” made by Messrs. Foster, Conner, and Son, Linen Hall, Belfast. This material has been used by Mr. Arthur Hill Coates for the balance lu of a centre-board gig with excellent results.

The Mersey tent is recommended for its lightness and portability. The strength is adjusted to meet all strains, and in roughest weather, on an exposed coast, they have been snug and safe. The material is not waterproofed, as waterproofing adds considerably to the weight. On the other hand, if the tent is not waterproofed, it takes a considerable time to dry after rain or heavy dew if no opportunity exists for drying it. The gable form of the roof has a sufficient angle to shed the water; there is never any drip; but then no seam in the roof is allowed, and this is an important point. When planning a tent for extreme portability, floor space is of more value than standing height. These gable tents are about 12 ft. square, and 4ft. 6in. high to the ridge—ample height for sitting in; the dimensions make a roomy tent for two men and their luggage, and the space is not too small for three men. The weight of tent, with poles, poles, and ropes, is under 12lb.; this does not include waterproof floor sheet which may be either of macintosh or oiled grey sheeting; the latter is less expensive, but is more difficult to procure in a short time, because of the slow drying of the oil. Mr. Samuel Bond can give all further particulars as to costs, &c., of the tent.

THE MANAGEMENT OF CANOES.

Sail can be carried in almost any breeze so long as the water keeps moderately smooth, but beware of sailing a *light* canoe in rough water. “Big seas” are not here referred to; these will be referred to hereafter. Rough water throws a light canoe about in sudden

unavoidable jerks, and a puff into the sails at a wrong moment, or perhaps a lump of water, may just give the canoe a finishing touch to a capsize; at the best her pace will be slow, and her working uncertain under sail, as soon as the water gets a rise of a couple of feet or more; then out with the paddle and in with the mainsail; the mizen, however, may be of use if paddling to windward.

With regard to heavy seas, the canoeist should bear in mind that there is a great difference between a "sea" and a "swell." With a fresh breeze "white horses" begin to show on a comparatively smooth sea, but if there is at the same time a steep swell on, then the ruffled swells appear somewhat in the form of "huge seas." Canoes and boats can easily, with fair management, live in such water, and have often done so, hence the stories of sails being becalmed in the hollows between the waves, &c. But a "sea" is a vastly different thing to look at and to put a boat at; a broken sea not only has way on, but generally has weight on in its angry top, which, if not cleverly negotiated, would crush a canoe up like a steam roller going over an egg shell. It is not often that a canoe is worked in a "high" sea; but what is not uncommon is for a canoe to be caught out away from port and get into a nasty sea, a savage sea, before she can get into shelter. For an old hand to work safely through it is merely a question of whether he possesses the requisite amount, in equal parts, of pluck and caution, and sufficient physical strength to avoid a collapse from exhaustion. He knows from practice how best to handle his craft as the various forms of water approach him; he knows, too, when to carry on and when to ease her, and how to put her at a hollow breaker. But to the man who is not an old hand at the work, such work is no mere inconvenience; it soon becomes a struggle for life, and a flurried twitching of the rudder and a dip or two of the paddle the wrong way may end that struggle in a few short moments.

There are one or two short maxims on which the handling of a canoe in a sea are founded, and, being very simple, they can easily be called to mind by beginners when trying their craft against a "steamer's swell." Unless in a well-ballasted sailing canoe, never keep sail on when the seas begin to break and come aboard, because by the time they get to breaking aboard you will probably be unable to get the sails in, and a sea into the sail might be a finisher; or, if you have to leave your seat to get hold of the sail, a sea is pretty sure just to board the canoe, and, once waterlogged, it is hard work for even a practised hand to get rid of the water. Never allow the canoe for one moment, except of course in the act of turning, to be broadside on to the sea; it

may be all very well in a little popple or tide overfall to treat the crests with indifference, and let them "break across the deck;" but if you intend a safe return to land don't try any such duck-pond pranks with a heavy sea. To work safely through really heavy water a zig-zag course *must* be steered; the seas should, when possible, be dodged; but where it becomes necessary to "take" a sea put her at it nearly end on, with plenty of way on (the weight in the boat rather forward than aft); then, as soon as she passes the head of the sea, drop her down sideways on the back of it; if, on the contrary, you attempted to let it break athwartship over the deck, you would probably find yourself suddenly caught up and hurled broadside along before the sea for a few moments, then a thundering roar, a cold weight of water all over you, crackling of planks, a greenish glimmer, and a want of air would proclaim to you that somehow your canoe, or the wreck of it, was above you instead of under you.

When about to reef in rough water do not put the canoe end on to the sea; on the contrary, keep some way on her; lower away the halyards, and haul the boom in, and with the reefing gear little or no difficulty will be found; reef the mainsail first, then shift the mizen, and so be prepared to shift mainsail if necessary.

When running before a sea keep the weight aft in the canoe removing the backboard beam and lying down, haul down the mizen and when a breaker is coming along stop the canoe's way by back stroke with the paddle, else she may be overended or broached to. If the canoe runs her bow under a sea, let go the halyards promptly, and ease down the sail till the bow lifts again. In running for shore, before getting into the breakers, turn her round head upon sea, and back in when the smooths, and paddle ahead to meet each heavy breaking sea.

The paddle should always be ready for use in a sea way, and the most useful mode is to have the ordinary double-bladed paddle jointed in the middle, and a piece of bamboo 3ft. long, brass tipped, fitted into the ferrule, and so make a long-handled single paddle a help to steering and working in a sea way.

Never go to sea, even for an hour's sail, without a compass; if you turn up even in the summer. Before going on a long cruise test the fittings and gear carefully, and certainly have an experimental cap to test, above mere calculation, that the air bag and compartment are sufficient to support canoe and skipper when swamped; after the canoe righting practice getting on board by striding the bow or stern, or over the side amidships; *finally, have a life-belt on whenever there is risk of an upset.*

APPENDIX.

DICTIONARY OF GENERAL INFORMATION.

A.

A.B.—Able seaman, who must be able to hand-reef and steer, splice, knot, turn in rigging, &c. — able-bodied seaman, as distinguished from a youth or ordinary seaman.

Aback.—A sail is said to be aback when the wind strikes it from ahead and tends to force a vessel astern; generally applied to square-rigged ships. In a fore-and-aft vessel the sails would be said to be aback if their clews were hauled up to windward, or if the vessel came up head to wind, and went off on the opposite tack without the head sheets being handed over; or if the wind headed the vessel and struck her from the opposite side to that which it had been blowing so as to cause the sails to lift. (See also "All Aback For'ard!")

Abaft.—A relative term used to denote the situation of an object or point that is astern of another, and begins from the stem head, or from the fore part of any spar or other object; generally the term means towards the stern, or in the direction of the stern.

Abandon.—To leave a ship and take to the boats.

Abeam.—At right angles to a vessel's broadside or keel; opposite to the vessel's centre of length.

Aboard.—Inside a ship or on the deck of a ship. "Come aboard, sir," is a sailor's way of reporting himself on board after leave or absence. To run or fall aboard a vessel is for one vessel to come into collision with another. A sail is said to fall aboard when, from the lightness of the wind or other causes, it ceases to blow out. To haul the boom aboard is to haul the boom in by the main-sheet from off the lee quarter.

About.—To tack. "Ready about" is the signal given for the men to prepare to tack the ship.

About Ship.—"Bout ship!" The order given to tack, that is to put the vessel on the opposite tack to the one she is on when the order is given to tack.

Abreast.—Synonymous with "Abeam." Side by side. *To Breast.*—To come abreast.

Accommodation.—The cabins of a vessel.

Acker.—A tide coming upon the top of another tide.

Ackers' Scale.—A graduated time allowance computed by the late Mr. G. Holland Ackers, now superseded by the Y.B.A. scale.

A Cock Bill.—An anchor hanging by its ring to the cat head. The situation of yards when one arm is topped up.

Across Tide.—Crossing the stream of the tide so that it comes broadside on. If a vessel in beating to windward crosses a tide fairly at right angles on one tack, she will stem it on the next, or have it stern on, according to whether the tide be lee-going or weather-going. (See "Weather-tide.")

Admeasurement.—An old-fashioned way of expressing the builder's tonnage of a ship calculated by length and breadth.

Admiral.—The highest rank in the Navy. Formerly there were admirals of the red, white, and blue, with the intermediate ranks of vice and rear of the red, white, and blue. When the white ensign was taken exclusively for the Royal Navy about twenty years ago, the red, white, and blue divisions were done away with. Admirals now fly a St. George's Jack, which is a white square flag with red St. George cross in it at the main, fore or mizen, according to their rank. A vice-admiral has a red ball in the upper (hoist) canton of the flag; a rear-admiral two balls.

Admiral of the Fleet.—An honorary distinction bestowed on admirals for long service, &c. If an admiral of the fleet has a command, he hoists the "union" at the main.

Admiralty Flag.—A red flag with fouled anchor (horizontal) in it, flown by the Sovereign and Lords of the Admiralty.

Admiralty Warrants.—Warrants granted to clubs and the members thereof, granting permission to fly the white ensign, or the blue ensign, or the red ensign with device on it. The Admiralty have recently issued a regulation to clubs that a warrant will only be granted to yachts which are registered according to the provisions of the Merchant Shipping Act. An Admiralty warrant also enables the owner to ship excisable goods, such as wines, spirits, tobacco, tea, &c., direct from bond without payment of duty; and to enter ports without paying harbour dues (this does not include dock charges), and to make fast to mooring

- buoys laid down by the Admiralty, if such buoys be not required by ships of H.M. fleet. An Admiralty warrant is also useful in foreign ports, as it at once establishes the nationality of a yacht; and the port authorities usually show great civility to yachts carrying an Admiralty warrant, securely berthing them and frequently foregoing harbour dues (not dock charges). When a yacht changes hands her warrant must be returned through the club secretary to the Admiralty. (See "Ensign.")
- Adrift.**—Floating with the tide. Generally driving about without control. Also a vessel is said to be adrift when she breaks away from her moorings, warps, &c. The term is also applied to loose spars rolling about the deck; sheets or ropes which are not belayed, &c.
- Afloat.**—The state of being waterborne after being aground. To be on board ship.
- Aft.**—The contrary of abaft. Towards the forward end of anything.
- Aft.**—An abbreviation of abaft, generally applied to the stern. To go aft is to walk towards the stern; to launch aft is to move a spar or anything else towards the stern. To haul aft the sheets is to bring the clew of the sail more aboard by hauling on the sheets.
- After.**—The state of being aft, as after-sail, after-leech, after-side, &c.
- After Body.**—The part of a vessel abaft her mid-ship section.
- After End.**—The stern end of a vessel or anything else.
- After Guard.**—Men stationed aft to work sheets, &c. In racing yachts, if there be any amateurs on board, they are generally made use of as an after-guard. In merchant ships the ordinary seamen or landsmen enjoy the distinction.
- After-most.**—A thing or point situated the most aft of all.
- Afternoon Watch.**—The watch between noon and four o'clock.
- After Part.**—The stern extremities of a vessel or anything else.
- After Peak.**—The hold of a vessel near the run. A small cuddy or locker made in the run of a boat aft.
- After Rake.**—Contrary to fore rake. The rake or overhang the stern post has abaft the heel of the keel. To incline sternwards.
- Aftward.**—Towards the stern; contrary to forward.
- Against the Sun.**—An expression used to show how a rope is coiled: from right to left is against the sun, from left to right is with the sun. The wind is said to blow against the sun when it comes from the westward.
- Agreement.**—The document executed, when a vessel is built, by the builder and the person for whom the vessel is being built. The following is a form of agreement recently used:
- An Agreement between Messrs. _____, of _____, yacht builders, hereinafter called the builder, of the one part, and _____, Esquire, hereinafter called the owner, of the other part.

_____ , Esquire, hereinafter called the owner, of the other part.

The builders shall build and equip a yacht according to the specification and drawings marked A, B, C, and signed by the parties hereto. The yacht shall be built and completed in all particulars according to the requirements of the said specification, and the whole of the workmanship and material shall be such as shall be required by Lloyd's Rules, and such as will entitle the yacht to be classed at Lloyd's as a yacht A 1 for a term of fifteen years. The whole of the work shall be executed under the special survey of Lloyd's surveyor, and to the satisfaction of Lloyd's committee; and also to the satisfaction of _____, marine architect, hereafter called the architect. The yacht shall be delivered to the owner complete as aforesaid, safely moored in _____.

In consideration of these premises, the builder shall be entitled to be paid by the owner as follows:— _____ pounds on the signing of this agreement; _____ a further sum of _____ pounds when the said yacht shall be in frame, and the architect shall have given a certificate in writing under his hand that the yacht is in frame, and all the work up to that stage has been done to the satisfaction of Lloyd's surveyor and to the satisfaction of the architect; _____ a further sum of _____ pounds when the yacht shall be completely timbered and planked, and the deck laid, the coamings fixed, and the architect shall have given a certificate in writing under his hand that the yacht is completely timbered and planked, and the deck laid, and the coamings fixed, and that all the work up to that stage has been done to the satisfaction of Lloyd's surveyor and to the satisfaction of the architect.

When the vessel shall have been duly launched and classed at Lloyd's 15 A 1, and when the said architect shall have given a certificate under his hand that the vessel has been completed in all respects to his satisfaction, according to the said plans and specification, and the vessel has been delivered afloat, and complete in all respects for sea, and moored in safety in _____, the owner shall pay to the builder the further sum of _____ pounds.

The yacht from and after the payment of the said sum of _____ pounds, to be paid on the signing of this agreement, shall be, and continue to be, the property of the owner; and all the materials intended for, or appropriated to the said yacht, shall be deemed to be the property of the owner.

If at any time the builder shall become bankrupt, or enter into any arrangement with his creditors under the Bankruptcy Acts, or shall fail or be unable to complete the said vessel in accordance with this agreement, or shall in the opinion of the architect be guilty of any unreasonable delay in the execution of the work agreed to be done, then it shall be lawful for the owner to enter upon the builder's yard and take possession of the said yacht, and to cause the work included in this agreement to be completed by any person

or persons whom he shall see fit. All damage that shall happen to the said yacht agreed to be built as aforesaid, or to the materials intended to be used in her construction, by fire or otherwise, previous to her being delivered to the owner complete as aforesaid, shall be forthwith made good by and at the expense of the builder.

The architect and the owner shall at all times be permitted to have access to the said yacht during the progress of the works.

The builder shall deliver the said yacht complete for sea, according to the said plans and specification, afloat at and classed at Lloyd's as aforesaid, on or before the first day of _____, one thousand eight hundred and eighty, and in default he shall pay for each and every day after the said first day of _____ during which the said yacht remains undelivered or unclassed as aforesaid, the sum of _____ pounds a day as and for liquidated damages; and the said sum of _____ pounds a day may be deducted by the owner from any money payable, or to become payable, by him to the builder.

The builder shall not be entitled to make any claim or demand upon the owner for work done upon the said yacht, or in connection with the building or equipment thereof, or for any alterations or extras beyond the remuneration hereinbefore mentioned, except in respect of work for which written certificates, describing the work as extra work, shall be given under the hand of the architect and countersigned by the owner.

No work done on the said yacht without a written order signed by the architect, and countersigned by the owner, shall be deemed to be extra work. The builder shall not be entitled to an extension of the said time by reason of any extra work or alteration being ordered unless a written order for such extra work be signed by the architect and countersigned by the owner, and unless the architect shall think fit at the time such written order is given by written certificate under his hand to extend the time fixed for completion, and then the time shall be extended only so far as the architect by the said certificate shall determine.

Any dispute arising between the builder and the owner respecting anything contained in this agreement, or in the specification and plans above referred to, or in any way relating to the building, equipping, or delivery of the yacht, shall be referred to the said architect, whose decision shall be final, or, him failing, to some other arbitrator to be agreed upon between the parties, or to be nominated, in case of difference, by the registrar of the Admiralty Division. The costs of any such reference to be in the discretion of the arbitrator. This agreement may be made a rule of the High Court of Justice if the court shall so think fit.

Specification. — Design and Dimensions: The yacht to be built according to drawings and plans furnished by _____, and to be of

the following dimensions:—The length on deck from the fore side of the stem to the aft side of the stern post to be 50ft.; and the length between perpendiculars, measured along the rabbet of the keel from the after side of the stern post, to a perpendicular dropped from the fore side of the stem at the deck to be 46ft.; and the breadth, from outside to outside of the planking in the broadest part of the yacht, to be 11ft.; and the least height of freeboard to be 2ft. 7in., the dimensions shown in the drawings. **Keel:** The keel to be of sound English or American elm, 8in. sided, and not less than 8in. deep, to taper fore and aft to stem and stern post. If the keel be in two pieces, the scarf to be not less than 6ft. long, butted and bolted with $\frac{1}{2}$ in. metal bolts, six in number. A solid iron keel to be cast and fitted underneath the main keel amidships, as shown in plan, 26ft. in length; the builder to make the moulds for and find the iron. **Stem:** To be a sound piece of English oak, with a grown crook, 5in., sided and 14in. moulded, properly butted and scarphed into keel, and bolted with $\frac{1}{2}$ in. copper bolts. **Stern Post:** The stern post to be of English oak, 7in., sided at top, and 9in. moulded. **Knightheads and Apron:** The knightheads and apron to be of English oak. **Deadwoods:** The upper deadwoods of English oak, and of sufficient depth to receive the timbers, and to be bolted with $\frac{1}{2}$ in. metal bolts. **Futtocks and Timbers:** The futtocks and timbers to be of English oak, with room and space centre to centre of 18in., and to be 4in. sided and 4in. moulded, each to be step-butted and bolted to the keel, deadwoods or hogging piece. The heels of first futtocks to be securely fastened to keel with wrought-iron knee floors, through-bolted to keel and futtocks with $\frac{1}{2}$ in. metal bolts. Iron floor plates $\frac{1}{2}$ in. thick, to be fitted to sufficiently connect the heels of the futtock frames. The double timbers to be bolted together with $\frac{1}{2}$ in. square iron, galvanised, and the heels and heads to fit closely and neatly. **Garboards:** The garboard strakes to be of sound American rock elm, not less than 9in. wide and 2in. thick. **Planking:** Six strakes below the water line to be of English oak, the sheerstrake and six topside strakes of teak, and the remainder of the planks to be of pitch pine, the whole to be wrought in parallel strakes 2in. thick, and not more than 5in. deep (the sheerstrake to be 7in. wide), and in long lengths to have a $\frac{1}{2}$ in. copper bolt clinched through every other frame, and to have a cast metal $\frac{1}{2}$ in. dump in the remaining timbers. The butts of the planks to be well fitted and caulked, and to have not less than 5ft. shift unless a whole stake intervenes between two butts, and each butt to have $\frac{1}{2}$ in. wrought copper bolt through the centre of the plank, and the timber next thereto. All fastenings to be punched home $\frac{1}{2}$ in. deep to receive putty stops. **Shelf:** The shelf to be of English oak, 5in. thick by 6in. deep, as shown in the drawing C, showing the midship section, through-fastened to top and second

strake with $\frac{1}{2}$ in. metal bolts at every timber, and to have a strong galvanised iron breast-hook forward, and galvanised iron knees aft. Beams to be dovetailed to the shelf, and well bolted with metal bolts. The clamp to be 3 in. thick. *Bilge Strakes*: Two bilge strakes of English oak 6 in. by 2 in., running fore and aft to be worked on each side, and to be through-fastened with $\frac{1}{2}$ in. copper bolts, and to have a galvanised iron breast-hook forward, and to be bolted into transom frame with metal bolts aft. *Deck Beams*: The deck beams to be of English oak, 4 in. sided and 4 in. moulded, and to have about 4 in. rise at centre; to have galvanised iron knees where required, carefully fitted and bolted through the top timbers and top strake with $\frac{1}{2}$ in. metal bolts; the bitt and mast beams, and the other beams, to have a galvanised iron hanging knee at each end, with three $\frac{1}{2}$ in. metal bolts through each arm. English oak lodging knees to be fitted between the beams in wake of the mast, and where required. *Covering Board*: The covering board to be of teak, 7 in. wide and 2 in. thick, properly secured to top strake and clamp, and to project about $\frac{1}{2}$ in. outside of the plank. *Deck Plank*: The deck plank to be of picked, well-seasoned Quebec yellow pine, free from knots and defects, in long lengths, tapered as required; no feather edges to be left at endings of planks, forward or aft, the ends to butt $\frac{1}{2}$ in. into covering board; the plank to be 2 in. thick, and to be doweled and nailed diagonally, with yellow metal nails at the sides, so that no nail heads show. *Bulwarks*: The bulwark stanchions to be of oak, 3 in. moulded and $3\frac{1}{2}$ in. sided at deck. The bulwark skirting to be of teak. *Rail*: The top rail to be of American elm, $3\frac{1}{2}$ in. by 2 in., free of defects, and fitted fair. *Rudder*: The main piece of rudder to be of one solid piece of English oak, and to have a carefully fitted water-tight rudder trunk; to have strong copper braces, fitted with a rule joint, let in flush with stern post; also a strong brass or gun metal bearing at heel, to have an iron strap round the rudder head, and the rudder head to fit, and work in a metal collar, sunk into the deck with chock of teak; to have a neat brass cap, with name of yacht, if required, engraved thereon, to have two neat carved oak or mahogany tillers, with brass fittings. *Caulking*: The outside planking to be thoroughly and carefully caulked, and the seams carefully payed and puttied, and the deck to be very neatly and carefully caulked and payed with marine glue, the whole of the seams of hull and deck planking to be made tight; the outside planking to be painted with three coats of paint; two coats of composition to be laid on the bottom, and at the end of the season, or when required by the owner, the hull to be sheathed with copper sheets carefully laid on, 18oz. below the water-line and 20oz. at and above the water-line. *Ballast*: The builder to supply and carefully stow a sufficient quantity of pig-iron ballast (besides

iron keel) to put the yacht to the designed load-line; the ballast to be painted with one coat of red lead paint. The builder to supply lead ballast if so required by the owner, allowing for the difference between the prices of pig-iron ballast and lead. *Bits*: The bowsprit bits to be of sound English oak fitted and fastened in the usual way, mast bits of English oak to be fitted on the fore-side and aft-side of mast, with usual cross pieces and all other necessary belaying bits, pin racks, cleats, cavels, loading sheaves, eye bolts, and other usual deck fittings to be found and fitted as required. *Pump*: A properly-constructed lead pump to be fitted, 4 in. in diameter, with lead tail pipe, and rose at bottom, and the discharge pipe to lead under the gunwale. *Water-closet*: To have a patent water-closet of the most approved construction, with mahogany seat and fittings complete. *Deck Fittings*: All the usual hawse pipes and chain pipes to be properly and carefully fitted; channels and chain plates, bolts, and dead eyes as required; bowsprit gammon iron at stem to be covered with leather. *Bobstay Shackle and Rod*: To have strong bobstay shackle cast in copper to fit the stem, and to let in flush with the wood so far as may be prudent, and riveted through, the bobstay chain to be of galvanised iron, and fitted to bobstay shackle. *Davits*: To have boat's davits fitted to ship on one side, also one small anchor davit to ship on either bow. *Ridge Rope Stanchions*: To have six brass stanchions for ridge ropes on either side of the same, to be hand-burnished in the best manner and fitted into square sockets in rail and lower part of bulwarks stanchions. *Iron Cleats*: To have two well-furnished cleats on taffrail, and two galvanised iron cleats on bow, and to have, if required, a neat elm grating extending from taffrail to mizzen mast. To have iron roller in sheave fitter for hawse pipe to take chain cable. *Hatches*: The companion to be of teak fitted with brass slides as required, and to shut in with shifting panel or doors at after side, and secured with brass hasp and padlock. The fore hatch to be of teak, to be very carefully fitted as required by owner. The sail room hatch to be of tea of convenient diameter, to be securely fitted with coamings on deck, and fastened with brass lock on the aft side, and brass hasp and padlock on the fore side. *Skylight*: The main cabin and other skylights to be teak, fitted on teak coamings, and made ship and unship in the usual way, and to have proper brass fastenings inside, and to be thoroughly water-tight in every way, and the glass panes to be protected by neat brass guards, or by galvanised iron or teak bars as required by the owners. A curtain slide on brass rods to be fitted to the skylight the main. After-cabin skylight coatings to be provided. *Companion Ladder*: The companion ladder to be fitted as required, with glass windows, if required, at back of ladder opening into after cabin. *Ceiling*: The yacht to be ceiled throughout, down to the ball-

line, with 1½ in. pitch pine, carefully planned and fitted on the timbers; below ballast line to be coated with red lead, gas tar, or varnish. *Platform*: The platform and platform beams to be of fir, and laid as required; the floor to be secured to beams with brass screws. The floor at the foot of companion to be formed of a neat American elm grating, carefully fitted. *Main Cabin*: The main cabin to be fitted according to the plans supplied by owner, with hard wood panelled bulkheads, doors, sofas or bed berths, with lee boards. The cabin to be fitted with polished pitch pine panels, and mahogany styles. One mahogany upboard or sideboard to be fitted at the after end or both ends of each sofa, and a mahogany shelf with small open rail extending the whole length of the cabin to be fitted above each sofa. A small mahogany bookcase to be fitted against one of the bulkheads. All locks, bolts, hinges, hasps, or other fastenings, and all keys in the main cabin, and in every other part of the vessel to be made of brass. *Stove*: An approved stove to be fitted in forward bulkhead of the main cabin, with fender and irons complete; brass screw coamings for funnel, and length of copper chimney to lead clear of rail. *Forecastle*: The forecabin to be bulkheaded, as required, and fitted with lockers, shelves, cupboards, locks, door, rack, table, seats with lockers underneath, and to have the usual lockers, and the lockers for chain and coke, closely ceiled to prevent dirt or dust from the same getting into the hold; also similar lockers to be fitted below the pantry, and fore state room floor. To have a neat iron ladder from floor to deck, fitted to ship and unship; a portable commode to be fitted, if required, in the forecabin, and one in after cabin. *Sheet Lead Coverings*: The floor underneath the cooking stove, and all the wood work near the stove, to be neatly covered with sheet lead, nailed with copper tacks. *Water Tank*: A properly constructed galvanised iron water tank, with manhole, to be provided, and fitted below the floor with pump and supply pipe attached, with brass deck plate, and screw cover for the same. *Cooking Stove*: A patent cooking apparatus (No. 3), of Atkey's make, to be fitted complete with Atkey's patent ventilation coamings; length of copper piping to funnel sufficient to lead clear of rail. *Hammocks*: Three hammocks, with bedding complete, to be fitted. *Mops, Brooms, &c.*: All the usual mops, brooms, brushes, buckets, squeegee, and other forecabin articles to be supplied. *Pantry*: The pantry to be fitted up as required, with dresser, shelves, liquor holes, racks, hooks, drawers, lockers, &c., and mahogany door opening into main cabin. *Fore State Room*: The fore state room to be fitted with bed berth of mahogany, with drawers underneath, mahogany washstand, and a folding mahogany slab to form a writing table; cupboard, underneath shelves, racks, &c., mahogany door, &c. The space on port side of companion way to be fitted

with seats or lockers, as required. *Ladies' Cabin*: The ladies' cabin to be fitted with polished wood panels, same as main cabin, with mahogany bed berths and washstands, cupboards and drawers, as required, and the sofas to be fitted with lockers underneath, and the doors to be fitted as required. *Lavatory*: The lavatory to be fitted with patent washstand, with tap and water; a tank for water supply, and a patent water closet of the best construction, to be fitted with mahogany seat, the lavatory to be bulkheaded or doored, as required. *Spars*: To be supplied with a complete set of spars, as required for a yawl of 25 tons, the whole to be carefully made, and all the ironwork to be of the finest quality, and galvanised, the dimensions of the spars to be according to plans supplied by the owner. *Mainmast*: The mainmast to be a picked spar, as free from knots as may be, of Oregon or Baltic red pine, fitted complete in every respect as required. *Mast Step*: The mast to be stepped into a solid iron mast step to be furnished by the builder. *Hoops*: The usual mast hoops properly riveted to be fitted to mast. *Crosstrees*: The crosstrees to be carefully fitted as required. *Bowsprit*: The bowsprit to have a galvanised iron rack plate on the upper side from the heel to the stem, and a stout galvanised iron pinion where fitted to the bits, with handle for the same, and a lignum-vitæ roller between the bits with a score round the centre to allow for the passage of the rack plate; also a plain stout lignum-vitæ roller between the bits on the under side of the heel of the bowsprit. A small, square, iron fid as required, sheave at outer end, traveller leather covered. *Whiskers*: Galvanised iron whiskers, fitted with preventer rods and all the other usual fittings for the bowsprit as required, to be carefully fitted. *Main-boom*: The main-boom to be fitted to mast with iron band and universal joint, and all other fittings, including reef cleats, to be neatly fitted as required. *Gaff*: The gaff to be fitted with strong iron jaws, and the other fittings as required. *Trysail Gaff*: The try-sail gaff to be similarly fitted so that the jaws may be used with either gaff. *Topmast*: The topmast to be fitted with galvanised iron self-acting fid and a brass-bound sheave in heel for mast rope; all the other fittings to be carefully made as required. *Topsail Yard*: The topsail yard to be supplied of such dimensions as may be required. *Squaresail Yard and Boom*: A squaresail yard and boom to be fitted in the usual way as required. *Mizen-mast*: The mizen-mast, boom, boom-kin, yard, &c., to be fitted as required, and the mast to be stepped securely. *Rigging and Blocks*: The standing and running rigging of wire, hemp, and manilla of suitable sizes, to be most carefully fitted, and the patent blocks for the same to be all of the best make, the whole standing and running rigging, blocks, tackle, &c., to be fitted complete in every detail. The main and gaff halyards to be of the best Russian hemp, the jib halyards of

chain. *Sails*: A complete suit of sails fit for a yawl of 25 tons, to be found by the builder, and made by Laphorn, and to consist of mainsail, two mixins, foresail, four jibs, two topsails, squaresail, trysail, and a complete set of sail covers, properly painted, to be supplied, and bags for the smaller sails. *Anchors*: One Trotman anchor of 1½cwt., one Wastney Smith's anchor of 1½cwt., and one kedge anchor, to be supplied. *Chain Cable*: Ninety fathoms of 9-16 chain cable, galvanised, to be supplied. *Hawsers*: Two hawsers of 60 fathoms each, suitable for the yacht, to be supplied. *Windlass*: An improved ratchet windlass with double lever to be fitted. *Painting*: The outside of the vessel to be made as smooth as possible, and to have the usual number of coats of the best oil paint. A gilt strake. *Varnish*: Bulwarks and all woodwork fittings on deck to have three coats of the best varnish. *Inside Paint*: The underside of the deck, and such other parts of the vessel as may require it, to have three coats of the best zinc white. *Upholstery*: The upholstery work to be complete, and to consist of Brussels carpet for the main cabin, ladies' cabin, and state room, hard-seasoned oilcloth for the lavatory. *Sofas*: The sofa mattresses, backs, and pillows to be of hair, and covered with rep, Utrecht velvet, or leather, as required. *Cabin Tables, Chairs, &c.*: A mahogany swing table to be fitted in main cabin, with cloth cover complete, also three folding chairs, Atkey's Osborne swing lamp, and the stove before mentioned. *State Room Beds*: The berths in the state room and ladies' cabin to be fitted with hair mattresses, down feather bolsters and pillows of the best quality, and three blankets of the finest quality, to be supplied for each bed. *Toilet China*: The usual toilet china to be supplied to each berth, but to be selected by owner. *Lamps*: A suitable bronze swing lamp to be supplied to each berth. *State Room Sofas*: The sofas or seats in the after state room or ladies' cabin to be fitted with hair mattresses covered in rep or Utrecht velvet. *Boats*: A suitable gig, to be supplied with oars, brass rowlocks and yoke, mahogany back board, and elm grating, and boat hooks, complete in every respect; also a dinghey, with brass rowlocks and oars. *Binnacle*: A binnacle of teak, with brass lamp and fittings, suitable for one of Sir William Thompson's patent compasses, to be supplied by builder. The compass to be supplied by owner, the builder to allow the difference between the cost of the patent compass and an ordinary compass. *Winch*: A lever ratchet winch to be fitted on the mainmast. *Side Lamps, &c.*: Side lamps (dioptric) to be supplied, together with screens and galvanised iron stanchions, made to fit into the rail or into fastenings fixed on the rail. The lower part of the stanchions to be made to fit into the covering board, or into fastenings on the lower part of the bulwark stanchions. The side light screen to be made with brass hinges, so as

to fall flat when out of use. An anchor lamp (dioptric) to be supplied. A rack to be fitted in the fore-castle to receive the screens and lamps. *Lead Line*: A hand lead and properly marked line to be supplied. *Bell*: A ship's bell of the size required by the Board of Trade to be supplied, and to be fitted on deck if required. *Legs*: Galvanised iron legs to be provided, with fittings complete. *Finally*: The whole of the workmanship and materials to be of the very best quality; and notwithstanding any omission from this specification, the builder is at his own expense to complete the vessel in every detail, in what is understood as hull, masts, spars, ironwork, and deck and cabin fittings as usual in first-class yachts, with all joiner's, cabinet maker's, painter's, and plumber's, and upholsterer's work appertaining thereto.

Aground.—A vessel is said to be aground when her keel or bottom rests on the ground.

Ahead.—Forward; in advance of.

Ahoy.—An interjection used to attract attention in hailing a vessel, as "Galatea Ahoy!"

A-Hull.—A ship under bare poles, with her helm lashed a-lee. An abandoned ship.

Air-Tight Cases for Small Boats.—By air-tight cases is meant cases that will keep out water. The most general form of case is made of zinc, copper, or Muntz metal. Macintosh bags have been used; and are put inside wood lockers, and then inflated, the object of inflation being of course to keep the bags from collapsing, thus practically making the wood lockers impervious to the influx of water. As any kind of bag is liable to be punctured or otherwise damaged, metal cases are to be preferred—they should be fitted inside wood lockers. To render a boat un-submergable she must be provided with cases which will displace a quantity of water equal to the weight of the boat. A ton of salt water is equal to 35 cubic feet of the same: now suppose a boat 16ft. long and 6ft. broad weighed 15cwt. (¾ton) with all passengers, gear, air-tight cases, &c., on board, then she would require air-tight cases equal in bulk to 26½ cubic feet, as there are 26½ cubic feet of water to ¾ton weight. But it may be taken that the wood material used in the construction of the boat, the spars, and wood cases, would be self-supporting. Say that these weighed 5cwt., then 10cwt. (¼ ton) would remain to be supported, ¼ a ton is equal to 17½ cubic feet. A locker 6ft. long, 2ft. broad, and 1ft. 6in. deep would contain 18 cubic feet, and so would support the boat with her passengers on board, or prevent her sinking if filled to the gunwale with water. Of course it would be rather awkward to have such a large locker as this in so small a boat, and the air-tight spaces are usually contrived by having a number of lockers, some under the thwarts in the bow end and stern end of the boat, and sometimes above the thwarts under the gunwales.

Some boats are made un-submergable by a cork belting fixed outside below the gunwale.

One ton of cork is equal to 150 cubic feet of the same, and will support $3\frac{1}{2}$ tons in water. Thus, roughly, cork will support three times its own weight in water. Supposing it is sought to support a boat equal to 10cwt., as stated above; then a belting of cork will have to be used equal to $17\frac{1}{2}$ cubic feet, plus a quantity equal to the weight of the bulk of the cork. Say the boat is 16ft. long, and the measurement round the gunwales will be 32ft. A tube 32ft. long to contain $17\frac{1}{2}$ cubic feet would require to be $10\frac{1}{4}$ inches in diameter. [The contents of a tube are found by multiplying its length by the area of one end. This area is found by taking the square of the diameter and multiplying it by .78 (see "Areas of Circles").] The $17\frac{1}{2}$ cubic feet of cork would weigh $(17.5 \times 15) 262\frac{1}{2}$ lb. equal to 4 cubic feet of salt water, and so an addition would have to be made to the tubing to that extent. Thus, in round numbers, 22 cubic feet of cork would be required to support 10cwt. net. A tube 32ft. long and 11in. in diameter would contain 22.0 cubic feet. The tubes that contain the cork are usually made of canvas and painted. The weight of the canvas tube would have to be added to the general weight to be supported. Solid cork should be used, and not cork shavings, for filling the tubes; cork shavings get more or less saturated, and lose their buoyancy, and generally have less buoyancy than solid cork, in consequence of the multitude of spaces between the shavings which would admit water.

The accompanying sketch shows a small boat with a cork belting round under her gunwales.

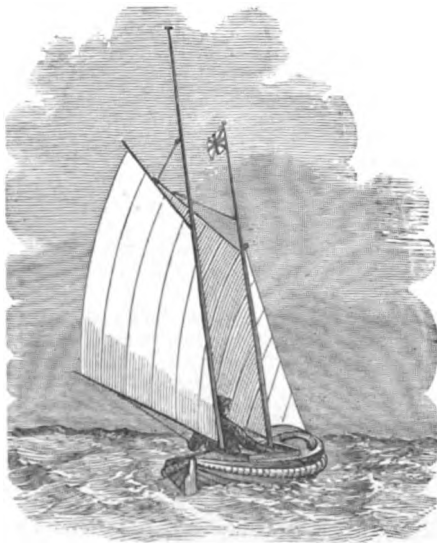


FIG. 162.

A-Lee.—To leeward. The helm is a-lee when it is put down to leeward. Hard a-lee means that the helm must be put as far to leeward as it can be got. (See "Helm's a-lee.")

All.—A prefix put to many words to show that the whole is included, as "all aback," meaning all the sails are aback; "all-a-taunto," meaning that the ship is fully rigged and fitted out, with everything in its place; "all hands," the whole ship's company; "all standing," with everything in its place—nothing being shifted, &c.

All Aback For'ard.—A cry raised when a vessel is sailed so near to wind that the head sails lift or shake.

Alley.—The channel made in the after part of a steamship for the propeller shaft is termed the shaft alley.

Aloft.—Up the mast; overhead. "Aloft there!" is a manner of hailing seamen who may be aloft on the mast tops, yards, &c.

Along the Wind.—Sailing along the wind means to sail with the wind from a point to four points free, or with the wind abeam.

Along the Land.—To lay along the land is when a vessel can hug or keep close to the land without tacking.

Along Shore.—Close to the shore, by the shore, or on the shore.

Alongside.—By the side of the ship. "The rig is alongside, sir," is a common way of informing the owner, master, or other officers that the boat is manned and by the gangway, in readiness to take people off; also said when a boat is brought to the gangway so that passengers can embark.

Amateur.—See "Corinthian."

Amidships.—The middle part of a ship. The middle part of anything. To put the helm amidships is to bring it in a line with the keel. Generally the word has reference to the middle fore-and-aft line of the ship, and to a middle athwartship part of a ship.

Anchor for Small Boats.—For small open boats the anchor should weigh 1lb. for every foot of length up to 20ft. length; but if the boat be ballasted another $\frac{1}{2}$ lb. per foot of length should be added. Anchors for small boats should be long in the shank, and of the old-fashioned pattern.

Anchor Shackle.—A shackle which connects the chain with the anchor.

Anchor, Tripping an.—If an anchor is let go on very firm holding-ground, or on ground where the anchor is likely to get foul, a tripping line is made fast to the crown of the anchor; to the other end of the line a buoy is made fast, and when the anchor is "wanted" it can be broken out of the ground by hauling on the tripping line if it cannot be got by hauling on the cable.

Another plan is to "scow" the anchor by bending the end of the cable to the crown instead of to the ring or shackle. The cable is then "stopped" to the ring by a yarn. When the cable is hauled upon the stop breaks, and, of course, the cable being fast to the crown, the anchor is readily broken out of the ground. A boat should not be left moored with her anchor "scowed," as, if any

unusual strain came upon the cable, the stop would break, and the boat would probably go adrift. The trip line should be used in such cases. (See "Scowling.")

Anchor Watch.—A watch kept constantly on deck when a ship is at anchor, to be ready to veer out or take in chain, or to slip, make sail, give warning to the hands below, &c., if the vessel be in danger of collision or other mishap. One hand may keep an anchor watch, and call up the officers and crew if necessary.

Anchor, Winch for Raising a Boat's.—Very neat and small winches are now made for almost any sized boat that has a deck forward, but a winch is not readily fitted to an open boat, and fishermen have a very simple contrivance to obtain the necessary power. Get a short piece of hard wood about 4 in. in diameter, and of a length equal to the width of the boat at the gunwale, where it is to be fitted to serve as the barrel of a winch (termed a "wink" by the fishermen). In either end drive an iron pin to form an axle, and to keep the wood from opening fit an iron band on either end (all the iron should be galvanised). On each gunwale fit an iron band on either end (all the iron should be galvanised). On each gunwale fit an iron plate—a round hole in one plate and a hole and slot (opening aft) in the other. A hole must be bored through the wood to receive a short bar of tough wood or iron three or four feet long, to serve as a lever, or three or four pegs can be inserted, as is shown in the

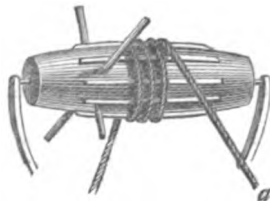


FIG. 163.

sketch. The end of the cable will be fast to the wink, and as the latter is hove round the cable will be wound up. If there be two hands in the boat the cable need not be fast to the wink, but one hand can heave whilst the other holds on to the cable and coils away. A ratchet and pawl are sometimes fitted to the wink. Messrs. Pascal Atkey and Son, Cowes, manufacture a suitable ratchet windlass for small yachts.

Anchor (Cole's).—This is an anchor something like the "old bay." It has a very long shank and sharp clean flukes. The crown is fitted to the shank and kept in its place by a pin. The advantage of this anchor is its great holding power, and the quickness with which it gets a hold even in hard ground. In letting go very little chain is required to bring a vessel up, but if the vessel has much way on a good scope should be given, as the anchor

is a dangerous one to snub. The parts of the anchor are very light, and generally the weight required is 25 per cent. less than the weight of other anchors.

Anchor (Smith's Stockless).—This curious anchor is recommended by the patentees for the following reasons: It takes immediate hold; cannot foul; requires no stock; can be 20 per cent. lighter than other anchors;

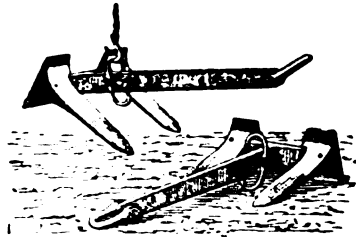


FIG. 164.

always cants properly; great strength; easily worked; lies flat on deck; stows in small space; easily tripped. The anchor is shown in the annexed cut, Fig. 164.

The sizes recommended for yachts are, for

| SAILING YACHTS. | | STREAM YACHTS. | |
|-----------------|---------|----------------|---------|
| 250 tons | 6½ cwt. | 250 tons | 4½ cwt. |
| 200 " | 5½ " | 200 " | 4 " |
| 150 " | 4½ " | 150 " | 2½ " |
| 125 " | 3½ " | 100 " | 2½ " |
| 100 " | 3 " | 75 " | 2 " |
| 75 " | 2½ " | 50 " | 1½ " |
| 50 " | 2 " | 25 " | 1 " |
| 40 " | 1½ " | 12 " | ½ " |
| 30 " | 1½ " | | |
| 20 " | 1 " | | |
| 10 " | ½ " | | |
| 5 " | ½ " | | |

Answer.—To repeat an order after an officer; thus, if the order be to the helmsman, "No more away," he will repeat, "No more away, sir;" or to the jib-sheetsman, "Check the jib-sheet," he will answer, "Check the jib-sheet, sir." Thus the crew should always "answer" every order to show that they comprehend.

Answer Her Helm.—A vessel is said to answer her helm when she moves quickly in obedience to a movement of the rudder. Long, deep vessels are slow to answer their helm. A vessel cannot "answer her helm" if she has not steerage way.

A 1.—The highest class obtainable at Lloyd's. Formerly (from about 1760) all new ships were classed "A" with a term of years according to their Port of building; after this term expired the ship was degraded to the E or I class, and so frequently it happened that a bad ship got a long term and a good one a short term; and perhaps the short-termed ship when repaired for the class E was better than the long-termed one was when first built. Such an absurd way of classing formed no useful guide for underwriters or insurance brokers, and in 1824 the present well-known committee of "Lloyd's Register" was established, by which ships are classed and given a term, according as they are built, in compliance with certain rules. A 1 is the highest class.

"A" denotes that the hull is built of good materials, in accordance with certain rules, "1" is the symbol that the rigging and general equipment of the ship are in every way perfect. The number of years assigned to a ship as her term depends upon the quality of the materials used and the mode of construction, and may vary from eight to eighteen years. A well-built ship upon being restored may be retained in the A class. "A in red" are ships that have passed their term, or ships that were not classed when built. Class *Æ* applies to ships fit only for short voyages. Class E and I are similar to *Æ*, but denote that the ships are not fit to carry perishable goods on any voyage. It is seldom that any number is assigned but 1, and generally the classes will be found distinguished by A 1 15 years, A 1 (in red) 7 years, *Æ* 1; the classes *Æ*, E and I, are subject to annual inspection (see Lloyd's Yacht Register).

A-Peak or Peak.—An anchor is said to be a-peak when the cable has been so much hove in as to form a line with the forestay; "hove short" so that the vessel is over her anchor. Yards are a-peak when topped by opposite lifts.

Apostles.—Seaman's slang for knightheads, bol-lards, &c., for belaying warps to.

Apron.—A piece of timber fitted at the fore end of the keel at its intersection with the stem.

Arch Board.—The formation of the counter at its extreme aft end, being a continuation of the covering board, and covers the heads of the counter frames.

Ardent.—A vessel is said to be ardent when she grips or shows a tendency to come to against a weather helm.

Areas of Circles.—The area of a circle is found by multiplying the square of the diameter by the fraction 0.7854. The areas of small circles in decimals of a foot are given in the following table :

| Diameter in inches. | Equivalent diameter in decimals of a linear foot of 12 inches. | Area of circle in decimals of a square foot. | Circumference of the circle in inches. |
|---------------------|--|--|--|
| 1½ | 0.1 | 0.0078 | 3.92 |
| 2½ | 0.2 | 0.0314 | 7.46 |
| 3½ | 0.3 | 0.0706 | 11.38 |
| 4½ | 0.4 | 0.1256 | 14.92 |
| 5½ | 0.5 | 0.1963 | 18.84 |
| 6½ | 0.6 | 0.2827 | 23.27 |
| 7½ | 0.7 | 0.3848 | 28.31 |
| 8½ | 0.8 | 0.5028 | 33.93 |
| 9½ | 0.9 | 0.6363 | 39.77 |
| 10½ | 1.0 | 0.7840 | 45.99 |

The contents of a tube or cylinder can be found by the above table.

Thus, say a tube 30ft. long be 3½ in. (equal to 0.3 of a foot) in diameter, then the area of one end of the tube will be .0706 sq. ft. The contents of the tube will be found by multiplying its length by the fraction .0706 (30 × .0706 = 2.118 cubic feet). If the tube were 6in. in diameter, then its contents would be 30 × .5 = 15 cubic feet.

Arms.—The extremities of anything, as yard arms.

Ashore.—A vessel is said to be ashore when she is aground. To go ashore is to leave the ship for the land.

A-stay.—Synonymous with a-peak.

Astbury's Tanning for Sails.—This is a composition for tanning sails without altering their colour: it is said to preserve the canvas and render it waterproof. Messrs. Astbury's address is 48, King-street, Manchester.

Astern.—Towards the stern. To move astern; to launch astern; to drop astern. An object or vessel that is behind another vessel or object.

A-taunto.—With all the masts on end, and rigging completely fitted. (See "All-a-taunto.")

Athwart.—Transversely, at right angles to fore and aft; across the keel. Athwart-ship is thus across the ship from one side to the other. Athwart hawse is when one vessel gets across the stem of another.

A-trip.—When the anchor is broken out of the ground or is a-weigh. A topmast is said to be a-trip when it has been launched and unfitted.

Avast.—Stop, cease, hold, discontinue. As avast heaving (stop heaving), avast hauling (stop hauling), &c.

Awash.—Level with the surface of the water.

Away.—A general order to go, as "away aloft," for men to go into the rigging; "away aft," for the men to move aft, &c. "Gig's away there," a "cutter's away there," or "dinghy's away there," is the common way of giving the order to get the boats ready and manned. "Away with it," to run away with the fall of a tackle when hauling upon it. "Away she goes," said of a vessel when first she moves in launching. "Away to leeward," "away to windward."

A-Weather.—The situation of the helm when it is hauled to windward. To haul a sail a-weather is to haul the sheet in to windward instead of to leeward, to form a back sail, to box a vessel's head off the wind or put stern way on her. Generally to windward.

A-Weigh.—Said of the anchor when it is a-trip or broken out of the ground. The anchor is weighed when hove up to the hawse pipe.

Axioms for Yachtsmen by an American.—Don't stand up in a boat; don't sit on the rail of a boat; don't let your garments trail overboard; don't step into a boat except in her middle; don't stand up in a boat before you are alongside; don't pull under the bows of a ship—it looks green, and the consequences might be fatal; don't forget to "in fenders" every time you shove off; don't forget that a loaded boat keeps headway longer than a light one; don't make fast with a hitch that will jam; don't lower away with the plug out; keep the plug on hand by a small lanyard to it, so that it cannot be "lod astray" and have to be hunted up when needed. Do.—Do hoist your flags chock up—nothing betokens the landsman more than slovenly colours; do haul taut all your gear; do see that no "Irish

pennants" are flying adrift aloft; do have a long scope out in a gale; do see that your crew keeps in its place and does not boss the quarter deck; do keep your men tidy and looking sailor-like; do keep to leeward of competing yachts when you are not in the match yourself.

Aye Aye, Sir.—The response made by seamen when an order or direction is given them, to show that they understand and will obey.

B.

Back.—To back a sail, is to haul the sheet to windward.

Back and fill.—To luff up in the wind, and then fill off again. Often a vessel is worked up a narrow channel with a weather tide by backing and filling: that is, the helm is put down slowly, and the vessel kept moving until she is nearly head to wind; the helm is then put smartly up, and the vessel filled again. Care must be always taken to fill before the vessel loses way. Figuratively, to back and fill is to blow hot and cold, or assent and dissent, or to go backwards and forwards with opinions.

Backing.—Timber fitted at the back of other timbers.

Backstays.—The stays that support the topmast with a beam or stern wind. The topmast shrouds or rigging (See "Shifting Backstay, and Preventer.")

Backwater.—The water thrown back when waves strike a wall or other solid object. The water that appears to follow under the stern of a ship. To back water is to move the oars of a boat, so that the boat moves astern instead of ahead.

Baffling Wind.—A wind that is continually shifting its direction, so that it is difficult to keep the sails full or steady.

Bag.—Sails are said to bag when they do not sit flatly.

Bagpipe.—To bring the sheet of an after-sail, such as the mizen, forward to the weather rigging, so that the sail forms a bag, or back sail: useful to put stern way on a vessel.

Balance Lug.—(See page 271.)

Balance Reef.—In gaff sails a band with reef points or eyelet holes for lacing, sewn from the throat to the clew. The reef is taken in by lowering the jaws down to the boom and lacing the sail along the reef band to the boom. Sometimes the gaff end is lowered down to the boom end; in which case the reef band is laced along the gaff.

Bale.—To throw water out of a vessel or boat by buckets or balers.

Balk.—A hewn tree; a piece of timber for masts, &c.

Ballast.—A ship is said to be in ballast when she has no merchandise on board, but only sand, gravel, mud, or rubbish as ballast. A yacht in marine parlance is always "in ballast."

Ballast, To Keep Clean or Sweeten.—The ballast of an old vessel should be removed every other season, scrubbed, and whitewashed with hot lime, or coated with black varnish or red lead. The hold of the yacht should at the same time be thoroughly cleansed and black varnished or red leaded. A mixture of two-thirds Stockholm tar and one-third coal tar boiled together will make a good composition for the ballast and the inside of a vessel below the floor. Some vessels are now regularly hauled up every year, and of course their ballast is taken out and stored. (See "Laying up" and "Limber Boards").

Ballast, Run, into a Vessel.—Several racing yachts built with floors as shown by Fig. 20, page 100, have had ballast run into them, but the plan has fallen into disuse owing to the great labour of cutting the lead out again in case alterations became necessary; and moreover with a little trouble ballast can be moulded to fit into every cavity, however small, between the floors and keel. Before the lead is run into a vessel the timbers and plank should be cemented or smeared with wet clay; the vessel should be caulked before the lead is run in.

Ballast, To Shift from Inside to the Keel.—The quantity of ballast that can be removed from inside the hull whilst the same stability is maintained by placing a certain amount of metal on the keel, can be ascertained as follows: before the vessel is hauled up to have the metal keel fixed, perform the following experiment: take a quantity of ballast (say 10cwt. for a 20 tonner) from the hull and place it on one side of the deck; mark on the vessel's side the line to which she is heeled; after the metal keel has been fixed and the vessel launched, put exactly the same weight of ballast (taken from the hull) as before on the side of the deck in exactly the same place; then remove ballast from the inside until the vessel heels to the line she did before the metal keel was fixed. This experiment should always be made before sailing a vessel to a lighter load-line after fixing a metal keel or adding to one. The experiment should be performed in perfectly smooth water. (The result can be arrived at by calculation, as explained in "Yacht Designing," but the process requires too many figures to introduce here.)

Ballast, Shifting.—To put ballast in the weather side of a vessel during sailing. This practice is now strictly forbidden in yacht racing, and if a man were known to practise it he would be shunned as a thoroughly dishonest person.

Balloon Sails.—Balloon canvas is a term applied to sails of large dimensions, made of light canvas, and generally only used in yacht matches. A balloon jib fills up the whole space from the bowsprit end, mast-head, and mast at deck; a balloon foresail is hanked to the forestay, but the foot reaches some distance abaft the mast; a balloon topsail has a yard nearly as long as

- the yacht is long over all, and the foot extends beyond the gaff on a jack yard; a balloon maintopmast staysail, has an up and down weather leech extending below the lower corner of the sail, which is hanked to the maintopmast stay (see Fig. 23, page 93). A jib topsail is sometimes termed a balloon sail, but now it is generally considered a "working sail." Balloon jibs are going out of fashion, as "bowsprit spinnakers" are now more generally used, and are more easily handled. In cutters, jack yards for balloon topsails are generally dispensed with, but are still used in yawls and schooners; but the latter seldom now have a jack yard for fore topsail.
- Bare Poles.**—With no sail set. With all the sails furled or stowed at sea for sou'nding before a heavy gale, or sometimes for lying to.
- Bargee.**—A seaman employed on board a barge.
- Bar Harbour.**—A harbour that has a bank or bar of sand or gravel at its mouth, so that it can only be entered at certain hours of the tide.
- Barque.**—A ship without yards on her mizen mast.
- Barquentine.**—A vessel square rigged on her foremast, and fore-and-aft rigged on her two other masts.
- Barra Boats.**—Vessels common to the Western Isles of Scotland, with almost perfect V section.
- Barrel.**—The part of a capstan, windlass, or winch round which the cable or rope is wound whilst heaving. Sometimes termed the drum.
- Base Line.**—In naval architecture a level line near the keel, from which all heights are measured perpendicularly to it. Generally in yacht designs the load water-line is made the base line, and all depths and heights are measured perpendicularly or at right angles to the load water-line, as shown in the Sheer Plan.
- Batten.**—A long piece of wood used to lash to yards or booms to strengthen them. Thin pieces of hard wood fitted to spars to prevent their being chafed or out. Thin splines of wood used by draughtsmen to make curved lines. Generally a thin strip of wood.
- Batten Down.**—Putting tarpaulins over hatches or skylights, and securing them by iron bars or battens.
- Beach.**—A Shore. To beach is to lay ashore, to strand.
- Beach Boats.**—Flat floored boats that can be readily beached. (See page 299.)
- Beacon.**—A stake, boom, or post put on a sand-bank or shoal as a warning for vessels.
- Beacon Buoy.**—A buoy with a kind of cross upon top of it.
- Beadon's Safety Reel.**—Used for belaying the main sheet. This was a contrivance invented in 1833 described in "Folkard's Sailing Boat." This reel is said to have been contrived without oogs or catches, and released the main sheet upon the boat being held to a certain angle (See "Cruikshank's Patent Cleats".)
- Beam.**—A timber that crosses a vessel transversely to support the deck. The breadth of a vessel. "Before the beam" is forward of the middle part of a ship. The wind is said to be before the beam when the ship makes a less angle than 90° with the wind. A beam wind is a wind that blows at right angles to a vessel's keel. "Abaft the beam" is towards the stern.
- Beam and Length.**—The proportion a vessel's beam bears to her length. A quarter of a century ago, it was considered that this proportion had a great deal to do with speed, hence many builders set great store on the particular amount of beam to length they gave a vessel. A yacht was seldom made more than four times her beam in length, but now a common proportion is five times the beam. It is generally contended that the builders' rule and Thames rule for ascertaining tonnage have a great deal to do with the diminishing of breadth in its proportion to length, and so no doubt it has, inasmuch as an owner finds that, if he builds, say, a yacht of 100ft. in length, he gets practically no more room in her, if he makes her 22ft. in breadth, than he would if she were only 21ft. It would of course be an advantage to the builder to make the yacht 22ft. in breadth, as her tonnage would be 189 tons, instead of 185; so he would be paid about 200l. more for the foot extra beam, and practically there would be nothing to show for it. In sailing yachts it is not found prudent to make the length much exceed five times the beam, and hitherto results seem to show that a better proportion is four and a half times the beam. A yacht that has a beam of only four times her length need be rather shallow, or she would have a very large displacement and would be slow; on the other hand, shallow vessels are not good sea boats. The comparatively deep and long-bodied vessels make the best sea boats. They are of a good weight, which tends to lessen the influence of the waves on their motions, and they are easier in their motions with a beam sea. (See the chapters on "Resistance and Speed," page 49; "Ballast," page 63; "Spars," page 68.)
- Beam Ends.**—A vessel is said to be on her beam ends when she is hove down on her side by the wind or other force, so that the ends of her deck beams are on the water, or her deck beams perpendicular to the water.
- Bear To.**—The direction an object takes from a ship expressed in compass points or by points in the vessel; as in reference to another vessel she bears S.E. or W.S.W., &c., or on the port bow, or weather bow, port beam or weather beam, port quarter or weather quarter, &c.; or two points on the weather bow or port bow, &c.
- Bear a Hand There.**—An admonition to hurry.
- Bear Away or Bear Up.**—To put the helm up and keep the vessel more off the wind.

Generally used in close-hauled sailing when a vessel begins to alter her course by sailing off the wind. (See "Wear.")

Bearings.—The direction between one object and another; generally the direction of an object on land to a ship.—The widest part of a vessel which may either be above or below water. A vessel is said to be on her bearings when she is heeled over, so that her greatest breadth is in the water.

Bearings by Compass.—An object is said to bear so many points on the port or starboard bow, or port or starboard quarter, or port or starboard beam as the case may be; or an object may be said to bear E.N.E. or E. or W., &c., from the point of observation. The usual plan of taking a bearing is to stand directly over the binnacle, and notice which point on the compass card directly points to the object. A more accurate way of taking bearings may be followed thus: on each quarter-rail abreast of the binnacle, have a half compass plate of brass fixed, or mark two compass points on rail, and let two opposite points (say north and south) be in direct line or parallel with the keel. A pointer or hand, eight or nine inches long, must be fitted to the plate, to ship and unship on a pivot; move the pointer until it points directly to the object, then read off the number of points it is from the direction of the ship's head. Next observe the direction of the ship's head by the binnacle compass; if the ship's head points N., and the pointer showed the object to be, say, four points away westerly from the direction of the ship's head, then the object will bear N.W., and so on. If very great accuracy be required, and if the ship be yawing about, one hand should watch the binnacle compass, whilst another makes the observations with the pointer.

An object is said to bear "on the bow" if its direction in relation to the ship does not make a greater angle with the keel of the vessel than 45°. If the direction of the object makes a greater angle than that it would be said to bear "before the beam;" next on the beam, then abaft the beam, on the quarter, right astern.

Beat.—To beat to windward is to make way against the wind by a zigzag course, and frequent tacking. (See "Thrashing" and "Turning to Windward.")

Beating to Windward.—(See "Beat.")

Becalm.—To deprive a vessel of wind, as by one vessel passing to windward of another.

Becalmed.—In a calm; without wind.

Becket.—A piece of rope used to confine or secure spars, ropes, or tackles. Generally an eye is at one end; sometimes an eye at either end; or a knot at one end and an eye at the other.

Beef.—Strength; generally the weight of the men hauling on a rope. "More beef here" is a request for help when hauling.

Before the Beam.—Towards the bow or stem of a vessel.

Before the Mast.—A term used to describe the station of seamen as distinguished from officers. Thus a man before the mast near a common sailor, and not an officer. The term owes its origin to the fact that the seamen were berthed in the forecabin, which is usually "before the mast."

Before the Wind.—Running with the wind astern.

Behaviour.—The performance of a ship in a seaway or under canvas is generally termed the sailors her "behaviour."

Belay That.—An order given whilst men are hauling on a rope, &c. Also slang for ceasing talking or fooling.

Belay, To.—To make fast a rope or fall of tackle. In hauling upon a rope the signal ceases is usually, "Belay!" or "Belay there Belay that, or "Avast hauling! Belay!"

To belay the mainsheet in small boats where the sheet travels on a horse through a block the block will travel on the horse by a thimble eye strop; the sheet will be spliced to clew cringle in the sail and rove through block. Bring the fall of the sheet down the pin under the stern seat, round which take a single turn; then take a bight and it between the sheet and the seat, and a slight pull will release the sheet. The sheet can be belayed in the same fashion by a turn to under a thole pin in the gunwale; or a bight of the fall can be taken and made fast to the sheet above the block by a slippery hitch.

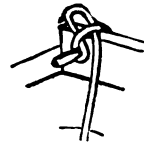


FIG. 165.

A plan for belaying a single sheet is shown in the accompanying sketch. A pin is fitted to the transom as shown. The fall of the sheet is brought round the pin outside the transom, then round the pin inside the transom, a bight jammed in between the transom and sheet.

Belaying Pins.—Pins in racks, in coveys, and hoops, &c., to make fast ropes to.

Belaying the Binnacle.—A slang term applied to a greenhorn who uses unseamanlike tactics or who does not know the duties of a seaman.

Bell Buoy.—A buoy with an iron cage upon it, with a bell which is struck by a hammer moved by the heave of the sea.

Bells.—The manner of keeping time on a ship by striking a bell every half hour. Thus one bell is a half hour, as half twelve; two bells one o'clock; three half-past one, and so on until eight bells struck, which would be four o'clock. The bell would then be begun again and pro-

up to eight o'clock. Thus eight bells are struck every four hours, the duration of a watch (see "Watch"). (See page 196.)

Below.—A general term for the under-deck space. To go below is to descend from the deck to the cabin, or to under the deck. A seaman always goes "below," and never "downstairs." It is considered very green and landsman-like to hear a person on board a vessel speak of going "downstairs" for below, or upstairs for "on deck."

Below, or Below There!—A mode of hailing or attracting the attention of the crew below by those on deck.

Bend.—To fasten a rope to another; to fasten a rope to a spar; to bend a sail to a yard, &c. A knot, a mode of fastening a rope to a spar, &c.

Bends.—The wales of a ship. Stout planks on the side of a ship.

Beneaped.—Aground for want of water, owing to neap tides.

Bermudian Rig.—The mast of a Bermuda rigged boat is very long, and is placed far into the bow, which is usually very bluff. The mast rakes aft, and the sail set upon it is of the well-known sliding gunter shape. The objection to the rig is the long heavy mast placed in the eyes of the boat, and although the sail stands well when hauled in on a wind, yet off the wind it causes some trouble, as it is almost impossible—except in very strong breezes—to keep the sail from falling on board.

Berth.—The situation of a ship when at anchor. A place to sleep in; a cabin. Employment.

Berthon's Collapsible Boats.—These boats were invented by the Rev. E. Berthon in 1851. They are made upon longitudinal frames with a double skin of stout canvas. When collapsed the gunwales fold outwards, back

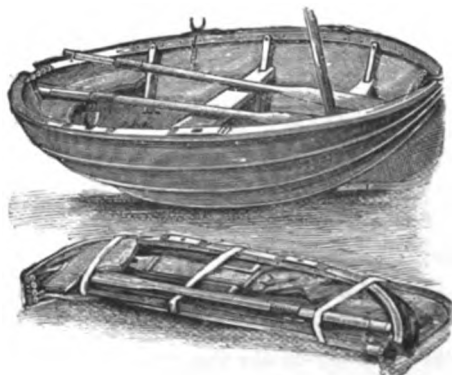


FIG. 166.

flat on the keel. A 7ft. dinghy which might suit a 5-ton yacht, will have 8ft. beam, and when folded only require space of 7ft. x 2ft. x 6in. The weight of such a boat is about 40lb.

A small boat 10ft. long weighs, with all the gear, about 80lb. A yacht's gig 26ft. long, 50wt. The price of a boat 10ft. long is

14 guineas. The preceding sketch shows the boats open and collapsed. (See Water-proofing.)

From experiments made by the Admiralty (1878) with a 20ft. boat, intended for the use of troopships, a Berthon is not adapted to carry a great weight (60 "blue jackets" formed the weight), as after being rowed some distance the shores showed signs of straining, and it was anticipated that in a seaway the boat would have collapsed.

Berthon's Logs, or Speed Indicators.—A log invented by the Rev. E. Berthon. A tube passes through the keel, and the water rises in this tube in proportion to the speed of the vessel through the water. A simple mechanical contrivance of weight, line, and pulley serves to indicate the speed on a dial.

Bevel.—In shipbuilding, the departure from the square a timber is made to take to suit the inclination of a plank. An oblique edge of a piece of timber or plank.

Beveling Board.—A piece of wood used by ship builders on which the angle of the bevels for timbers are to take are marked in lines.

Bibs.—Pieces of timbers fastened to the hounds of ships' masts to support the trestle trees.

Bight.—A loop or part of a rope doubled so as to form a loop, thus ∩.—The deepest part of a bay.

Bilge.—The round in a vessel's timbers where they begin to approach a vertical direction. (See page 116.)

Bilged.—A vessel is said to be bilged when her framing is broken in, or damaged along her bilge by grounding, or falling down when shored up by the side of a wharf.

Bilge Keels.—Pieces of timber fitted longitudinally on a vessel's bottom, so that she may take the ground readily and not damage her bottom. Bilge keels, however, now fulfil different offices and are fitted to large ships to assist in checking their rolling. The Brighton beach boats are fitted with bilge keels, and it has been argued that they prevent a boat making lee way; of course only the lee bilge keel can so operate, and the effectiveness of this one would be interfered with by the disturbed state of the water near it. Bilge keels, if very deep, would affect very greatly a boat's handiness in tacking; also the lee one would assist in heeling the boat to an extent dependent upon the force of the lee way, and the area of the bilge keel; on the other hand, bilge keels will tend to check the sudden heeling of a boat, for the same reason that they cause the process of rolling to be more slowly performed.

Bilge Kelsons.—Stout pieces of timber fitted inside a vessel in a fore-and-aft direction along the bilge to strengthen her.

Bilge Strakes.—Thick plank worked longitudinally in the ceiling of a vessel inside along the bilge to strengthen her—used instead of bilge kelsons.

Bilge Water.—The water inside a vessel, which in flat-floored crafts may rest in the bilge.

Bill.—A point of land; also the extreme points of the flukes of an anchor.

Bill Boards.—Pieces of wood fitted to the bow of a vessel to protect the plank from the fluke of the anchor.

Bill of Health.—A document wherein it is certified that the condition of the crew is healthy or otherwise. Hence a clean bill of health means that all the crew are free from disorders, and a foul bill of health the contrary.

Bill of Lading.—A document setting forth the cargo of a ship, certified by the master.

Bill of Sale.—A document by which a vessel is transferred from one owner to another. A "Bill of Sale" must be produced before a register can be transferred. Forms of Bill of Sale can be procured from Waterlow and Sons, printers and stationers, London.

Billy Buoy.—A bluff bowed vessel, common in the north, rigged with one mast, and commonly with a square topsail.

Binnacle.—A case wherein the compass is contained.

Bird's Nest.—(See "Crow's Nest.")

Birlin.—A rowing and sailing boat of the Hebrides.

Bitter End.—The end of a cable inside the bitts. The extreme end of a rope.

Bitts.—Stout pieces of timber fitted in the deck to receive the bowsprit; also stout pieces of timber fitted in the deck by the side of the mast, to which the halyards are usually belayed.

Black Book.—A book kept at the Admiralty, or said to be, wherein is recorded the offences of seamen. Several yacht clubs have kept "black books," but they have been of little use, as owners showed a disinclination to insist that no man should be engaged in his yacht who was on the "black book."

Black Paint.—A good mixture for the outside of a boat is thus made: to 6lb. of best black paint add half pint of good varnish and $\frac{1}{2}$ lb. of blue paint.

Black 9lb.; raw linseed oil 1 quart; boiled linseed oil 1 quart; dryers $\frac{1}{2}$ lb.

For an iron yacht: 10wt. of Astbury's oxide of paint; 6 gallons of boiled linseed oil; 1 gallon of turpentine; 3 gallons of varnish; 21lb. dryers. (Messrs Astbury's, King-street, Manchester.)



FIG. 167.

Blacking.—An American plan for bleaching sails is as follows:—Scrub with soap and fresh water on both sides, rinse

well, then sprinkle with the following solution: slacked lime, 2 bushels; draw off lime water and mix with 120 gallons water and $\frac{1}{2}$ lb. vitriol. This also preserves the sails. ("Mildew.")

Blind Harbour.—A harbour whose entrance not readily be made out from a distance.

Blisters.—Unsightly blisters on paint are generally caused by putting new paint upon the top of or using very thick paint. The old paint should be burnt or scraped off.

Block.—A pulley. A single block has one sheave; double, two; three-fold or treble, three; so on. (See "Fiddle block.")

Block and Block.—Chock-a-block. When blocks of a tackle are hauled close together a vessel is said to take her main sheet block and block, when the boom is hauled so aboard that the two blocks come close together.


Blow, A.—A gale of wind.

Blue Jackets.—Sailors.

Blue Peter.—A blue flag with a white square in the centre; hoisted at the fore truck as a signal that the vessel is about to go to sea. Sometimes for brevity called Peter.

Blue Water.—The open sea or ocean.

Bluff.—A wall-like headland.

Bluff-bowed.—Very full bowed, thus .

Board.—In beating to windward a board is a time a vessel is on one tack and the distance she makes on that tack. Thus it may be on a long board or a short board. Working to windward by a long board and a short board is when a vessel can more nearly lie on her course on one tack than on another. To suppose the wind be S.W., and the vessel's course from headland to headland S.S.W. the vessel can lie four points from the wind on the starboard tack the vessel's head S., or two points off her course; on port tack she will lie W., or six points off her course. The long board will be the one on the starboard tack. A vessel is said to make a good board when the wind free on one tack; a bad board when it heads the stern board is to get stern way on working.—To board a ship is to enter her deck, generally supposed to mean without invitation.—"By the board" to fall close to the deck.—A mast is said to go by the board when it breaks by the deck and falls overboard.

Board and Board.—Vessels are said to board and board when they keep in company and tack simultaneously.

Boat Building.—In the first place lay out the sections, keel and sternpost, and sternpost as described page 253 (see also the chapter on Canoes). [If the keel has a straight edge, top and bottom, it will not require to be laid off.] When the sections are laid off, proceed to make moulds to fit the curves; these moulds will be made of $\frac{1}{2}$ inch or $\frac{3}{4}$ inch deal or elm, any odd pieces of wood will do, and there can be as many joints

mould as may be found convenient: (See Fig. 168.) The cross piece A should be stout enough to keep the mould rigid. The diagonal braces D need not be used if the mould can be made rigid without them; in such case the joints in the mould should be secured by a doubling piece. The bar W.L.

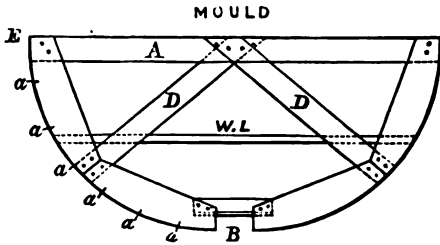


FIG. 168.

represents the load-water-line. B is the part that fits on the keel and represents the "joggle" in the floor-timber. The cross piece here should be securely attached and fixed so that the joggle is of the proper depth. A nail on each side of the mould, or a couple of pieces of wood nailed to the keel, will keep the mould in position on the keel.

The outer edges of the mould must be planed up to fit the curve of the section as drawn on the mould loft. When floors or timbers have to be sawn out, and not steamed, the mould is laid over the timber and its shape marked on it by pencil or chalk.

The stem and sternpost are tenoned into mortices in the keel; but if the keel be not thick enough to take a tenon, the keel and stem, and keel and sternpost are box-scarped together by halves: that is, half the thickness of each is cut away.

In all the drawings of small boats given in the body of the book, the load-water-line is made the base-line, and therefore everything must be plumb to that.

Having got the stem, sternpost, and keel shaped and put together, proceed to fix them to the stocks. [A deal firmly fixed edgewise at a convenient distance from the floor—high enough to enable the builder to drive the nails up through the bottom of the boat—will make the stocks.] A straight edge or line must be fitted from stem to stern-post to represent the load-water-line as shown on the Sheer Plan: (See Plate IV.)

Also a stout bar of wood must be nailed to stem-head and stern-post-head, above the one marking the L.W.L., to firmly connect the two; this bar will be found useful for nailing the mould stays to.

In fixing the keel stem and stern post frame on the stocks it must be wedged up forward until the line or straight edge representing the load-water-line is perfectly level or horizontal. A spirit level or plumb level can be used for this adjustment.

Fit the dead wood knee aft, and the stem knee and apron forward. Bore the holes for

the through bolts with a long augur or gimlet. The heads of the bolts will be inside, and clenched outside over a ring: (See Plate III.)

Next the transom must be cut out from a mould and let into the sternpost and through bolted, as shown Plates III. and IV. The edges of the transom will require to be bevelled to suit the fore-and-aft curve of the boat.

When the keel, stem and sternpost are on the stocks and in position (the stem and sternpost must be plumed to see that they neither cant to port nor starboard), they must be secured by stays; the stays will be bars of wood and reach from the stemhead and head of sternpost to the floor or ceiling of the building-shed, and they must be securely nailed. The keel can be kept in its position by similar stays; or if the keel be quite straight on its underside it can be kept in its position by thumb cleats nailed to the deal forming the stocks.

The lower edge and upper edge of the rabbet in the keel, stem, and stern dead woods must be next set off, and cut out with a chisel. The aft dead wood will probably require some adzing away back to the rabbet.

The moulds must be next put into their proper places. Care must be taken that they are "square" to the keel (i.e., cross it at right-angles) that they are plumb (perpendicular) to the load-water-line, and that the bar W.L. (Fig. 168) is at the level of the line stretched between stem and stern-post to represent the load-water-line. The moulds must be kept in position by wood stays. A temporary gunwale can also be fixed round the moulds to assist in keeping them in position. Sometimes all the moulds are not fixed; but if there are no more than shown in Plate IV., they should be all fixed.

The planking will next be proceeded with. The width of the strakes will be in the widest part about $4\frac{1}{2}$ or 5 inches. Measure the half-girth of the midship mould (Fig. 168) from B to E by passing a tape or line round the outside curved edge. Divide this length into a number of equal intervals to represent the breadth of the strakes as *a a*, &c. (see Fig. 168). Allowance must be made for about $\frac{1}{4}$ in. overlap of each plank which forms the lands.

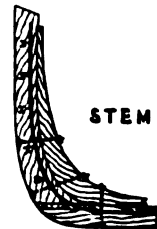


FIG. 169.

Count the number of intervals or strakes of plank, and set off the same number in equal intervals on the rabbet of the stem (see *s s*, Fig. 169) and on the transom. These intervals will be much closer together than on the

moulds, and will therefore show that the plank must taper towards the ends. The same number of intervals can also be set off on the intermediate moulds.

The garboard strake will be first fitted. This will be a strake quite straight on its upper edge before it is bent round the moulds from stem to stern post. The under edge will be cut to fit the rabbet in keel, and stem, and dead wood aft. When this plank has been fitted into the garboard and nailed at intervals of two or three inches to the keel, the next plank must be fitted. Take the board (out of which the plank is to be sawn) and hold it along as closely as possible outside the upper edge of the garboard strake. Mark a line along it to correspond with the top edge of the garboard. Remove the board and it will be found that the line is more or less curved. Saw down this curved line. Then fit the board to the garboard again, making it overlap (by its curved edge) the garboard by about $\frac{1}{2}$ of an inch. Now mark by spots on the upper edge of the board the next interval, representing the breadth of the plank (see *a a*, Fig. 169) for each mould, including stem and dead wood or transom aft. Remove the board and run a line in through the spots representing the intersections *a a* on with the moulds; this will show the shape, or the curve of the upper edge, and the curve of the lower edge of the next strake. The plank may possibly be shaped like the sketch (Fig. 170), but the greatest curvature will be



PLANK

FIG. 170.

found as the bilge is reached. It is not absolutely necessary that the plank should accord with the spots *a a* at every mould, as the intervals are more as a guide to get the curve of the strake than to show the shape of the curve arbitrarily.

When the strake has been cut out it will be planed and then fitted to overlap the garboard; whilst it is being nailed it will be held in position by a number of clamps (at intervals of two or three feet.)

The clamps are made of two pieces of hard wood loosely connected by a screw bolt (see Fig. 171) and has a wedge. The bolt must



PLANK

FIG. 171.

be allowed plenty of play, so that when the clamp grips the strakes it can be wedged up tightly as shewn.

The plank will be nailed together at intervals of 3 inches. The nails will be of copper, and will be rooved and clinched inside. At the stem and transom, the upper part of each strake is thinned away in order that the hood ends may fit into the rabbet flush.

To get the strakes round the bilge in a fair curve the upper outer edge of each strake is bevelled off (see Fig. 101, page 353), and sometimes the inner lower edge of the overlapping strake is also bevelled.

Holes should be bored for the copper nails by a sharp bradawl a little smaller than the nails. The roove having been put over the nail, the latter will be cut off by a pair of nippers, leaving about $\frac{1}{4}$ of an inch projecting above the roove. A "holder on" will be held to the head of the nail outside the boat, and the nail will then be clinched down over the roove inside the boat.

The boat being now planked up to the top strake, the floors and timbers must be put in. If the boat is a large one, such as the Brighton Beach boats (not the New Brighton boats, which are carvel built), the floors will be sawn out of timber of a suitable size (see



FIG. 172.

page 299) and joggled (see Fig. 172) to fit in the lands of the plank; but joggles are objectionable as they weaken the floors. The floors should extend across the keel and into the turn of the bilge; they will be fastened through the keel with a Muntz-metal, or copper, or galvanised iron bolt, and, if thought necessary, clinched with ring. A copper nail will be driven through the plank (where two strakes overlap), and be clinched on the top of the floor; frequently rooves are not used for these fastenings. A fastening is put through every overlap.

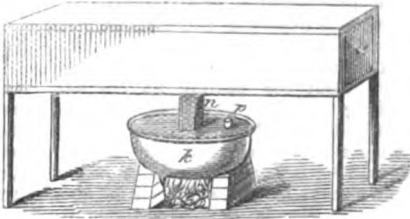
The timbers should be sawn out of a straight-grained piece of American elm, but sometimes English oak or ash is used; oak is generally preferred for the floors, and American elm for the timbers.

The timbers, having been sawn out, must be planed up, and will then require steaming to get them into their places. The timbers should extend from one gunwale across the keel to the other gunwale, but frequently, where stout floors are inserted, the timbers are not worked across the keel, and do not reach within 6in. of the keel; in such cases the timbers are in "halves."

A steam chest or kiln will have to be constructed (see Fig. 173). In length it should be a foot or so longer than the longest timber, and be a foot deep and a foot broad. It should be made of 1 $\frac{1}{2}$ in. deal. The end, *a*, is a door. Inside on the bottom should be nailed three or four cross pieces of wood, 2in. deep, for the timbers to rest upon, forming a kind of rack.

Steam can be generated in a common three-legged pot set up on bricks (see *k*). The pot should contain three or four gallons of water. The cover will be made of wood, cemented

round with clay or mortar. *n* is a steampipe (made of inch deal, inside size 3½ in. by 3½ in.); *p* is a plug for the water supply. The door, *a*, should fit inside the steam chest, and fillets



STEAM KILN

FIG. 172.

of inch deal must be nailed inside for the door to rest against. Before putting the door in its place, clay or mortar should be smeared round the fillets to keep the door from leaking. The door need not be hinged, but can be kept in its place by a cross-bar of wood working through two staples driven into the ends of the chest.

The timbers will require steaming three or four hours before they are sufficiently pliable. They must be taken from the steam chest and fitted into the boat one by one; the first fastening to put in will be the one through or in the keel (a Muntz-metal dump is best for this). Press with the foot or hands the timber into the bilge, and put a fastening through it here (from the outside). The stations for the timbers should be previously marked across each plank strake, and the holes through the overlaps should be bored before putting the timber in.

If the timber has to be joggled to receive the inside edges of each strake (see Fig. 172), the fastenings must not be clinched as the timber will have to be removed for the joggles to be cut. The timbers, however, should not be removed until they are perfectly cool and rigid; they should be allowed to stay in the boat a day and night before removing. (If strength rather than neatness be required, the timbers should not be joggled.)

The gunwale must now be fitted (this is more properly termed the "in-wale," as it is the piece of timber which is fitted inside the top strake; it answers the purpose of the "clamp" used in larger boats). Having decided upon the size of the wale—its depth and thickness—it must be fitted. In the first place, the timber heads are cut down inside the top strake to the depth of the wale [one plan is not to cut the timbers so low as this by half an inch, and make joggles in the wale to receive the head of each timber; when this is done, however, the wale or clamp should be somewhat stouter, as it will be weakened by the joggles]. Usually the wale is flush with the top strake; but a better plan is to cut a rabbet in the wale (see Fig. 101, page 353) to fit over the top strake.

A nail is put through the top strake and wale (from the outside), and rooved or clinched without a roove, inside. A nail is put through about every 4, 5, or 6 inches. Forward, the wale top strake, stem, and apron are kept together by a breast-hook or >-shaped knee (see sketch A, Plate III., page 255). Aft, the wale and top strake are secured to the transom by a knee (see *m*, Half-breadth Plan, Plate III.). The thwarts will rest on the stringers (which are fastened through timbers and plank), as shown by *a a* and *b b*, Sheer Plan, Plate III. The thwarts are secured by knees, as shown Fig. 101, page 353. The knee is fastened through and out the wale and top strake, and with a long fastening through the overlap of strakes, and clenched with ring on the knee; there will also be fastenings through the thwart and knee.

In buying copper nails care must be taken that "land nails" are obtained for the plank fastenings, and "timber nails" for the timber fastenings. The rooves must match the nails. A rooving iron (which is simply a kind of punch with a hole in its end) will be required to drive the rooves on whilst a hammer is held to the head of the nail. The sizes of the plank nails will depend upon the double thickness of the plank; about one-sixth of the double thickness should be added to the length of the nails for rooving and clenching.

If the boat is to be decked, a clamp or kind of shelf must be fitted to the timbers, and thoroughly fastened at each timber. The clamp will be fitted low enough for the beams to come flush with the top strake. The beams will be arched as required, and fastened through the shelf, much in the same way as shown by Fig. 25, page 105. The top strake should be of sufficient thickness to take the fastenings of the covering board. The covering board should be of hard wood, such as oak, and must be cut to fit the curve of the deck, as shown in the Half-breadth Plan.

The deck plank will be nailed to the beams by galvanised nails; not *through* the plank from the top downwards, but diagonally through the side edges of the plank into the beams.

The under edges of the plank will meet closely on the beams; but the upper edges will "gape," as shown, in an exaggerated way, by *a a*, Fig. 174; this is for the caulking. An eighth of an inch will give a wide enough



FIG. 174.

seam. The oakum or cotton thread (a couple of threads will be enough for inch plank) must be driven in tightly by the caulking chisel, and then payed with marine glue or stopped with putty (see articles on these subjects). Generally the arch of the beams will give the seam opening enough, as at *a a*; but, where it will not, the plank should be bevelled

to the extent of a shaving or two. The seam round the covering board should be well caulked and payed.

A hanging knee should be fitted on each side under the beam abreast of the mast or rigging (see n, Fig. 25, page 105). If the boat is wholly decked, three pairs of such hanging knees should be fitted.

If the boat is half-deck, waterways should be fitted. Short beams will be worked for these, and their inner ends will be butted into a fore-and-aft piece, which fore-and-aft piece will in turn be butted into the full beams at either end. Two or three pairs of hanging knees (made of oak) will support the waterways.

Chain-plates for the rigging will be fitted as shown by Fig. 100, page 351.

The following are suitable sizes of timber or plank for a boat of these dimensions:—

Extreme length, 14ft. 2in.; beam, 5ft. 1in.; depth, 2ft.; elm plank, $\frac{1}{2}$ in. thickness; American elm timbers, steamed, $\frac{1}{2}$ in. by $\frac{1}{2}$ in.; all copper fastened, with copper stem-band, and rudder hangings; gunwales, American elm, $1\frac{1}{2}$ in. by 1in.; keel, elm, 2 $\frac{1}{2}$ in. wide, 4in. deep below the garboard strake; false keel, 4in. aft, running to 3in. forward; three thwarts, the first from the stem 3ft., second 5ft. 11in., third, 8ft. 10in.; seats round the stern, width 1ft., thickness all in, 1in.; ballast, when single-handed, three bags of beach gravel, length, 1ft. 11in., width, 1ft. 5in., weighing each about a hundredweight; with three hands on board one bag can be dispensed with, with four hands only one bag is in ordinary weather requisite; sails, sprit mizen, lug foresail, and jib. The following are the dimensions of the sails:—Jib, on the luff, 10ft. 6in.; hoist or leach, 8ft.; foot, 8ft. 6in.; standing lug-mainsail, 5ft. 4in. on the luff; head 9ft. 6in., leach 14ft. 6in., foot 9ft. 4in.; a sprit mizen, measuring on the luff 5ft., on leach 8ft., on the foot 4ft.; length of sprit, 8ft. 1in.; length of bowsprit, 7ft. 10in.; diameter at outer end, 2in.; at heel, 2 $\frac{1}{2}$ in. Mast as long as can conveniently stow inside the boat on the thwarts; diameter at top, 2 $\frac{1}{2}$ in.; at level of the thwarts, 3in.; distance of mast from the stem, 1ft. 9in., and stepped through a fore and aft thwart, fitted to the front thwart and extending forward until it butts against the apron piece at the back of the stem. The lug has a little boom, 2in. diameter at the mast, and 1 $\frac{1}{2}$ in. at the after end. In lieu of jaws or gooseneck a hole is bored through the end where the jaws would be, to receive the tack of the lugsail, which is knotted below the boom, and thus keeps the boom in its place close to the mast; a hole is bored also through the thwart to receive the tack, one inch abaft the mast hole. The arrangement of the main sheet is as follows:—On the foreside of the after-thwart two wedge-shaped cleats are nailed amidship against the edge, which form a notch an inch deep. The mainsheet has a small thimble in it, 18in. from one end, which is secured round the thwart and in the notch,

hence it cannot slide from its position. Another thimble is seized by a grommet to the boom. The mainsheet is first rove through the boom thimble, and then through the first-named thimble, just above the level of the afterthwart. The mainsail thus works from side to side in going about, without the usual trouble of shifting the sheet from gunwale to gunwale. This arrangement is convenient for beating up channels, river sailing, or at sea when fishing, where a constant change of course is necessary every few minutes. For a freshwater lake or river it would be better to use fir or oak plank, as elm decays at the water-line in about three years. Elm is especially liable to decay, "between wind and water," but if entirely submerged will endure for ages.

Boat Chocks.—Pieces of wood with a score in them to take the keel of boats when they are lifted in upon deck.

Boat Hook.—A wood pole with a metal hook and prong at one end; sometimes with two hooks. A yacht's gig has two boat hooks—one for the use of the bowman, another for the stroke; by these means a boat is held alongside the steps of a jetty or by the gangway of a vessel, &c.

Boat Keeper.—The man left in charge of a boat when the other part of her crew go on shore.

Boat's Crew.—Men told off to always man a particular boat, such as the gig, cutter, or dinghy of a yacht.

Boatswain.—An officer who takes charge of a yacht's gear, and it is his duty to superintend all work done upon the spars, rigging, or sails. He also takes charge of all spare gear and sails, and sees that everything on deck and above deck is neat, clean, and ship-shape. He must in every sense of the word be a thorough seaman, and must know how all work upon rigging and sails should be done. As he has constantly to handle the sails and rigging, he necessarily has a knowledge of their condition, and it is his duty to report all defects in the same.

Boatswain's Call.—A whistle consisting of a hollow ball and a tube leading to a hole in it. By varying the sounds the men are "piped" to their work just the same as soldiers are ordered by the sound of a bugle. The pipe is seldom met with in English yachts, not even in those of large size, and the boatswain has little to do with giving orders.

Bobstay.—The bowsprit stay. (See page 115.)

Body.—Part of a vessel's hull, as fore-body, middle-body, and after-body. A vessel is said to be long-bodied when the tapering of the fore-and-aft lines are very gradual; short-bodied when the fore-and-aft lines taper very suddenly; a long-body thus means a great parallel length of middle-body. (See "Straight of Breadth.")

Body Plan.—A plan which contains the cross sections of a vessel. The midship section or largest section is generally shown on the

right-hand side of the middle line of the body plan; sometimes on both sides.

Bollard.—A stout timber to fasten ropes and warps to.

Bollard Timbers.—The bollard timbers of a vessel are the same as the knightheads; originally the knightheads were carved figures of knights (fitted near the foremast to receive the windlass), hence the name knightheads. (See "Knightheads.")

Bolsters.—Pieces of hard wood bolted to the yoke or lower cap on the mast for the rigging to rest upon. They are sometimes covered with leather or sheepskin with the hair on, or raw hide, to prevent the rigging chafing. (See page 119.)

Bolt.—A fastening of metal. An eye bolt is a bolt with an eye in it used to hook blocks, &c., to. A ring bolt is a bolt with an eye and a ring in the eye. An ear bolt or lug bolt is a bolt with a kind of slot in it to receive the part of another bolt, a pin keeping the two together and forming a kind of joint (see C, Fig. 31, page 124). Bay bolts are bolts with jagged edges to prevent their drawing.

Bolt Rope.—The rope sewn round the edges of sails. It is made of the very best Riga Rhine hemp, dressed with Stockholm tar. A fore-and-aft sail is roped on port side, a square-sail on aft side. There is the weather (luff) rope, leech rope, foot rope, and head rope.

Booby Hatch.—A hatch on coamings used to give greater height in the cabin of small yachts, and which can be removed.

Boom.—A spar used to extend the foot of sails. To top the boom is to make sail and away. To boom off is to shove off a wharf, bank, &c., by the aid of spars. Stakes of wood used to denote a channel through shoal water are termed booms.

Boom Irons.—Iron bands on booms, with eyes, to which blocks or ropes may be hitched.

Boomkin.—A short boom of great strength, usually written "bumpkin."

Bonnet.—An addition to a sail by lacing a short piece to its foot; common in America, not often seen in British yachts.

Bore.—A sudden tide wave, which rolls along rapidly at certain times on some rivers, and makes a great noise.

Boreas.—The north wind. An old sailor's saying is, "as cold as Boreas with an iceberg in each pocket." Popularly the god that rules the wind, as Æolus is supposed to do.

Bore Away.—Did bear away. Said of a vessel that alters her course in a leewardly direction "as she bore away."

Bore by the Head.—A vessel is said to bore by the head when she, whilst passing through the water, is depressed by the head. (See pp. 28 and 329.)

Boring.—When a vessel by bearing away or luffing forces another vessel to bear away or luff to avoid a collision.

Boss.—A slang American term for sailing master, or chief in command.

Both Sheets Aft.—When a square-rigged ship has the wind dead aft, so that the sheets lead aft alike.

Bottom.—Usually understood as the part of a vessel below the bilge.

Bottomry.—The hull or bottom of a ship pledged as security for a loan. If the ship be lost the money is lost unless the lender has covered himself by other means.

Bound.—Encased with metal bands. Also referring to the destination of a vessel. Wind-bound means that a vessel is in a port or at an anchorage because the wind is unfavourable for her to proceed. Formerly square-rigged ships were everlastingly wind-bound, i.e., waiting in port because the wind was adverse; now they go out and look for a fair wind, and generally can sail so well on a wind that waiting for a fair wind would be considered an unpardonable piece of folly.

Bow.—The fore part of a vessel; forward of the greatest transverse section. In taking bearings an object is said to be on the bow if its direction does not make more than an angle of 45° with the line of the keel.

Bower Anchor.—The anchor in constant use.

Bow Fast.—A warp for holding the vessel by the bow.

Bowing the Sea.—Meeting the sea bow on or end on, or nearly end on, as in close-hauled sailing. When the sea runs true with the wind.

Bowline Haul.—The foremost man in hauling on a bowline sings out, "One! two!! three!!! haul!!!!" the weight of all the men being thrown on the rope when the "haul" is shouted out. This chant is sometimes varied, thus:

Heave on the bowlin'
When the ship's a rollin'—
One! two!! three!!! haul!

The origin of this probably is from the fact that when the ship takes her weather roll the sails lift and so some of the bowlines slack can be got in.

Bowline knot.—Formed thus: (Fig. 175.)

Bowlines.—Ropes made fast to cringles in the weather leech of squaresails, to pull them taut and steady when sailing on a wind. The bowlines usually lead into a bridle. Sailing on a bowline means sailing on a wind when the bowlines would be hauled taut; hence the phrase "sailing on a taut bowline." Sailing on an easy bowline means sailing with the sails well full, and the bowlines eased up a little, so that the vessel is not quite "on a wind" or close hauled.

Bow-lines.—Continuation of buttock lines, showing the outline of vertical fore-and-aft sections in the fore-body. (See "Buttock-lines.")

Bowse.—Hauling with a will upon a rope.



FIG. 175.

- Bowsprit.**—A spar projecting from the bow of a vessel. A running bowsprit is one that can easily be reefed in like a cutter's. A standing bowsprit is one fitted in a bed and generally prolonged by a jibboom.
- Bowsprit Bitts.**—See page 118.
- Bowsprit Cranse.**—The iron cap at the bowsprit end, to which the gear is hooked; in the case of the vessel having a jibboom the cap is a double one to take the jibboom.
- Bowsprit Shrouds.**—See pp. 115 and 118.
- Boehauling.**—In tacking a ship to make her turn on her heel by hauling the head sheets a-weather, and getting stern-way on. Practised by square-rigged ships, sometimes in working narrow channels.
- Boeing off.**—Assisting to pay a vessel's head off the wind by hauling the head sheets a-weather.
- Boe the Compass.**—To call over all the points of a compass in regular order. To understand the compass points and subdivisions. (See "Compass.")
- Braces.**—Gunmetal or brass straps with eyes, fastened to the sternpost to receive the pintles of the rudder.
Strengthening pieces of iron or wood to bind together weak places in a vessel.
Ropes used in working the yards of a ship.
- Braced Sharp Up.**—Said of a square-rigged ship when the weather braces are slacked up and the lee ones hauled in taut so as to trim the sails as close to wind as possible.
- Brace-up and Haul aft!**—The order to trim sails after a vessel has been hove to with sails slack.
- Brails.** Ropes fast to the leeches of fore-and-aft sails and leading through blocks on the mast hoops; used to haul or truss the sail up to the mast instead of lowering it and stowing it.
- Breach.**—A breaking in of the sea. A clean breach is when a wave boards a vessel in solid form, and sometimes makes a clean sweep of the deck, taking crew, boats, and everything else overboard. To make a clean breach over a vessel is when the sea enters one side and pours out the other.
- Break Aboard.**—When the crest of a wave falls aboard on the deck of a vessel.
- Breakers.**—Caaks for containing water. Also the disturbed water over reefs, rocks, shoals, &c.
- Break Off.**—In close-hauled sailing, when the wind comes more from ahead so as to cause the vessel's head to break to leeward of the course she had been sailing. Not to be confused with "fall off," which means that the vessel's head goes off farther away from the wind.
- Break tacks.**—When a vessel goes from one tack to the other.
- Breaming.**—Cleaning off a ship's bottom by burning the excrescences thereon. Sometimes when a vessel is not coppered small worms will eat into the plank. It is usual then to scrape her bottom, coal tar her, and then bream her off by fire in breaming irons.
- Breast Fast.**—A warp fastened to a vessel amidships to hold her.
- Breasthook.**—A strong >-shaped wood knee used forward to bind the stem, shelf, and frame of a vessel together. Breasthooks are also used in other parts of a vessel. They are now frequently made of wrought iron.
- Breeze, A.**—In sailor's parlance, a strong blow of wind; but generally a wind of no particular strength, as light breeze, gentle breeze, moderate breeze, strong breeze, &c. (See "Wind.")
- Breeze-up.**—The wind is said to "breeze-up" when it increases fast in strength from a light wind.
- Bridles.**—The parts of moorings to hold on by many ropes gathered into one.
- Brig.**—A two-masted vessel, square-rigged both masts.
- Brigantine.**—A two-masted vessel, differing from a brig by being only square-rigged forward.
- Bring To, or Bring Her To.**—To luff or to close to wind. To anchor. (See "Come To")
- Bring to Wind.**—To luff a vessel close to wind after she has been sailing off the wire.
- Bring Up.**—To come to anchor.
- Bring Up all Standing.**—To come to anchor to a stop suddenly without notice, or with any sail being lowered. To anchor with lowering sail.
- Bristol Fashion.**—In the best manner possible Bristol shipbuilding and seamen form having a great reputation for excellence.
- Broach To.**—To come to against the wind helm. (See page 180.)
- Broad Pennant.**—The swallow-tail flag of a commodore. (See "Burgee.")
- Broadside On.**—When a vessel moves sideward or when she is approached by an object at right angles to her broadside.
- Broken Water.**—When waves lose their form breaking over reefs, rocks, or shallows, counter meeting waves from another direction, then a cross sea.
- Broom at the Masthead.**—A signal that a boat or vessel is for sale. The origin of the custom appears to be unknown; but it is ingeniously argued that brooms were hoisted as a signal that a man wanted to make a clean sweep of his vessel.
- Brought To.**—After a vessel has been sailing to wind when she is brought to wind, or close to wind. Anchored.
- Brought Up.**—At anchor.
- Bucklers.**—Blocks of wood used to stop the lead pipes.
- Builder's Certificate.**—A document given by the builder of a vessel to the owner when handed over, setting forth the builder's name, the name of the ship, place of building, method of building, rig, dimensions, tonnage, and concluding with the following declaration:—"This is to certify that [I or we] have at _____, in the county of _____, year _____, the vessel _____." The master

ment, tonnage, and description of which are given above.

As witness my hand, this day of _____
Signed,

This document must be produced when application is made for registration.

Builder's Measurement, or B. M.—(See "Tonnage.")

Bulk.—(See p. 3.)

Bulkheads.—The athwartship partitions which separate a vessel into compartments, cabins, &c. Fore and aft partitions are also termed bulkheads.

Bull's Eye.—A block without a sheave, and with one hole in it.

Bulwark.—The side of a vessel above the deck.

Bumboat.—A boat used by shore people to carry provisions on sale to ships.

Bumpkin.—(See "Boomkin.")

Bunk.—A bed or place to sleep in in a cabin.

Bunt.—The middle part of a sail. To gather up the bunt is take hold of the middle part of a sail and gather it up.

Bunting.—Woolen stuff of which flags are made.

Bunter.—A kind of tackle.

Bunt Lines.—Ropes attached to sails to haul them up by.

Buoy.—A floating mark.

Buoyancy.—(See page 4.)

Burden or Burthen.—Supposed to mean the quantity in tons of dead weight that a vessel will carry. The quantity would be the difference between the displacement of the ship when light and the displacement of the ship when she was laden as deeply as prudent. (See page 3.)

Burgee.—A triangular flag flown at the truck as a kind of pennant. A commodore's pennant is a "swallow-tail" burgee. A vice-commodore's burgee has one white ball in the upper corner or canton of the hoist; a rear-commodore's, two balls.

Burgee, Etiquette of.—It is considered etiquette, if a yacht is on a station where there is a club established, and her owner is a member of the club, that the flag of that particular club should be hoisted as the yacht arrives on the station, although the owner may be the commodore, or vice, or rear-commodore of another club. Frequently, however, in such a case the burgee is merely run up on arrival and then lowered and the commodore pennant re-hoisted. If the yacht is a schooner, a flag-officer can fly his pennant at the main, and the club burgee at the fore. If several yachts are lying at an anchorage where there is no club, the yachts will fly the burgee of the senior flag-officer present; but if there be two flag-officers of equal rank present, then the flag of the one whose club is senior by virtue of the date of its Admiralty warrant will be flown. In the Royal Navy, if two or three ships are cruising in company, the title of commodore is given by courtesy to the senior captain present; but the rank does not seem very well defined, as, although an "appointed"

commodore is said to rank next to a rear-admiral, yet he cannot fly his broad pennant in the presence of a "superior captain" without permission. In the case of the Yacht Navy, the senior officer would mean the one of highest rank; and where, in the case of a club, the rank of the flag-officer is equal, seniority depends upon the date of the Admiralty warrant of the club which conferred the rank, and not upon the length of service of the officer; but a vice-commodore of a senior club does not take precedence of a commodore of a junior club. By the same rule, when several yachts are present belonging to clubs that have no Admiralty warrants, the date of the establishment of the several clubs would decide the seniority of flag-officers of equal rank, but clubs with Admiralty warrants always rank before those without. (See "Saluting," "Recognised Clubs," "Royal Clubs," "Admiralty Warrants," and "Ensigns.")

When the Royal Yacht Squadron was first established, members flew private signal flags, containing their crest or other device, at the truck. Owners of schooners in America fly such a flag at the fore when the owner is on board, club burgee always at the main. During meals American yachtsmen sometimes hoist a "dinner napkin," i.e., a square white flag at the fore. The *Cambria* in the Atlantic race flew her racing flag at the main, and the Royal Harwich Yacht Club burgee at the fore.

Burton.—A tackle composed of two single blocks; a double Spanish burton consists of two single and one double block.

Butcher's Cleaver Plate.—This plate has been devised to get a greater area of board immersed without increasing its extreme dimensions, and thereby necessarily increasing the size of the case inside the boat. The plate, instead of being pivoted at its fore end as usual, had an iron bar some two or three feet long riveted thereon; and the plate was then pivoted on this bar.

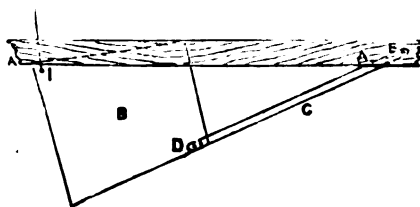


FIG. 176.

A is a portion of the keel of a boat 15ft. long.

B is the plate made of $\frac{1}{2}$ in. boiler iron 3ft. 6in. long, and 1ft. 4in. deep.

C is an iron bar $1\frac{1}{2}$ in. by $\frac{1}{2}$ in. riveted to the plate at D, and pivoted in the keel at E. The bar at D has "ears" or jaws, into which the plate is fitted and riveted.

The plate is lifted by a jointed bar bolted at I.

When the board is lifted the bar C fits into a groove made in the keel to receive it.

The probability is, as nearly half of the plate would be moving in disturbed water, that equally good results would be obtained from a triangular plate of half the area. It was pointed out on page 16 that the effective lateral resistance for any given plane would be considerably increased if one edge of the plane made a large angle with the direction of its motion; and for this reason a square plate of 3 square feet area would be not much more effective than a triangular one of $1\frac{1}{2}$ square feet area.

Butt.—The joining or meeting of two pieces of wood end-ways. Butt and butt means that two planks meet end to end, but do not overlap.

Butt End.—The biggest end of a spar.

Buttock.—The after-part of a vessel from her run upwards.

Buttock Lines.—Planes in a fore-and-aft direction, showing the outline of vertical fore-and-aft sections in the after-body.

By and Large.—Backing and filling, which see. (See also "Large.")

By the Head.—When the vessel is trimmed or depressed by the head so that her proper line of flotation is departed from.

By the Lee.—To bring a vessel by the lee is when nearly before the wind she falls off so much as to bring the wind on the other quarter; or the wind may shift from one quarter of the vessel to the other without the vessel altering her course ("See Lee"). (See page 180.)

By the Stern.—The contrary to being by the head.

By the Wind.—Close hauled; hauled by the wind.

By the Board.—Going or falling overboard.

C.

Cable.—A rope or chain by which a vessel is held at anchor.


Cable's Length.—A measure of one-tenth of a sea mile, 608 feet, or 101 fathoms, or 203 yards.

Caboose.—The cooking room or kitchen of a merchantman. Also the "galley fire" or cooking stove of a yacht or other vessel.

Cage Buoy.—A buoy with an iron framework upon the top. Formerly "cages" were put on poles in intricate channels, and for two hours about the time of high water at night fires were lighted in them.

Call.—(See "Boatswain.")

Callipers.—An instrument consisting of a "straight edge" beam with two legs, used for measuring the breadth of yachts, packages of merchandise, &c. Metal bow-legged compasses called callipers are used for measuring the diameter of spars.

Cambered.—When the keel of a vessel has its ends lower than its middle, thus . Opposed to rockered. (See pp. 17 and 18.)

Canoe Hatch.—The double lines *c* are carlines, supposed to be seen through the hatch which

is screwed to the two dotted ones; the ends of the latter are made to slide in a groove in the coamings. The middle carline is fastened to the deck and prevents the latter sliding too far, and stops the water getting into the well

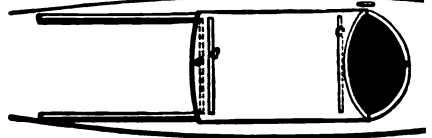


FIG. 177.

should any find its way under the hatch on line. A channel should be made round the rim of the well so that the person sitting therein could fit an apron or waterproof in it after the fashion of the Esquimaux.

A preferable plan is to have the hatch as the frame on which it slides separate, so that it will fit over the rabbets round the coamings; then if the canoe upsets, the hatch will float off and free the canoeist.

Cant Frames.—The frame in the bow a quarter of a vessel that are not square to the keel.

Canvas-back Duck.—A wild duck common in America, and highly esteemed for the table.

Canvas Boats.—These are boats made of canvas and used by the Galway fishermen, particularly at Dingle. The ribs of the boats are made of wood hoop, such as may be got casks; outside the ribs battens are nailed a fore-and-aft direction; a keel to which the ribs are also nailed is rounded up at the ends to form stem and stern post. The canvas is about two feet wide, and runs fore-and-aft. There is an inwale and gunwale as usual. At the top of the ribs, the canvas goes between the two. These boats are usually 20ft. by 10ft. They are very light, one man carrying them easily. They are manned by a crew of five each man using a pair of oars. A lug sail is carried off the wind. These boats get through a great deal of rough water by aid of eight oars they are propelled by.

The following directions for making canvas boats appeared in the *Field*:—

"For the keel get a piece of larch 12ft. long, 2½in. wide, and 2in. deep; the stem and stern posts, with rake according to fashion may be mortised into the keel; these pieces must be bevelled off from the width of the keel, so as to have a outwater of about 1½in. an inch, which will be sharp enough. I get three good heavy blocks of wood, and set them four feet apart in the place where they are going to build your boat; then take the keel with the stem and stern posts already fixed and fix it perfectly true on the said blocks using a spirit level for the purpose. The easiest temporary way of fastening the keel down is to nail short pieces of wood fit to the blocks, just wide enough apart for the keel to jam between them, and drive a nail through these pieces into the keel on each side; this will keep all firm, and pre-

the keel from moving or twisting as you proceed with other work; it is an important point, and must not be omitted. This done, the next thing is to get a good stout spar, about 2in. or 3in. square, and longer than the boat; tack this on the top of the stem and stern posts; as it is necessary that this fore-and-aft piece should be stayed stiffly in its position, this can easily be done by tacking some rough pieces to it here and there, and nailing the other ends to the rafters of your shed. The uses of this spar are many and obvious. You will thus get your stem and stern posts true, and it will be useful afterwards to keep the moulds in their places, and for shoring out the timbers and ribbands or battens so as to keep them shapely to the eye as the work proceeds. Your next business is to make what shipwrights call "the moulds," which is to give the shape, beam, and depth. To make the moulds, first strike it out full size with a piece of chalk on the floor of some room. For a boat 15ft. in length, the width ought to be at least 4ft., the depth not less than 2ft. Do not let the curve of the sides be too sharp, but give her a good round side and a flattish bottom. Having made your moulds to the exact shape of the pattern chalked on the floor, nail a thin strip of wood across the upper (gunwale) ends, which will keep them stiff and true; next take the moulds and nail them on the keel in their proper places, fastening it above to the fore-and-aft piece. The moulds being now firmly fixed in their places, you may proceed to what in other boats would be called the planking. Saw out some thin strips of larch, about 20ft. long, 1in. wide, and a quarter of an inch thick. Six of these on each side would be sufficient. Having chamfered off a little from one of the ends to make it fit the stem of the boat, fasten it with two small copper nails; carry the ribband in your hand, and humour it gently round the moulds tacking it slightly there, and bring it on to the stempost. You will probably find your piece too long; mark the required length, cut, and nail it in its place. In laying on these ribbands you must begin at the bottom of the boat, and work up. Having fixed your ribband both sides, get two long pieces the same width, only double the thickness, for gunwales, and fix them; fit a breast hook stem and stern, and rivet the gunwales securely to them. Saw out a lot of thin stuff for ribs, half an inch wide, and about the eighth of an inch thick; they will bend easily, and will not require steaming. Put these on about six inches apart, and rivet them to the battens. Next put in your thwarts, fixing them well down in the bottom of the boat, which will make her safer, the weight being near the keel. Get some copper, galvanised iron, or oak knees, with one leg long enough to reach from the gunwale down to the seat; rivet this well to the battens and gunwale, and nail the other part on the seat; there should be four to each thwart, as they help to strengthen the boat immensely. You may now take your

boat off the stocks, and she will be ready for the next operation. Get some good new sail canvas, not too stout, and cover one side at a time; tack the edge of the canvas all along the bottom of the keel and pull it to the shape of the boat, tacking it neatly to the sides of the stem and stern posts. Where you find it does not sit well, you may sometimes avoid cutting by folding the spare stuff, and, with a sailor's needle and palm, sew it to the main body of the canvas. Do this on a warm day, as the canvas will then be quite supple, and more easy to handle. Nail a strip of wood half an inch thick on the bottom of the keel to keep all snug, and as an extra security drive a row of tacks through the canvas on each side of the keel. You must be careful to nail over the canvas some narrow strips of wood, as 'bilge pieces,' where you see she would take the ground when lying on her side, otherwise the pulling and dragging over the sand in launching, &c., would quickly wear the canvas through. With care, and with an extra coat of paint now and then, a boat of this sort will last nine or ten years.

"The following suggestions will be found effective to prevent the puckering of the canvas skin of the proposed boat. A framework of 4ft. beam will require about three breadths of canvas on each side, and waste should be avoided by preparing paper patterns by which to cut out the canvas. To do this cut some old newspapers to the width of the canvas, and paste sufficient pieces together end to end to give the required length of the boat. Turn the frame of the boat upside down, and stay it in a horizontal position and upright. Lay the edge of the paper on the flat keel along the middle, place weights upon it, and measure off the distances from the middle line across the paper on the ribs, so as to keep the breadths horizontal from the middle to the stern and bow of the boat. Towards the bow and stern the breadths will be of course materially reduced. Remove the paper on to the floor, and draw a line from point to point marked on the paper at the crossings of the timbers. From this pattern you can easily cut out the two canvas strakes, one for each side of the boat against the keel, which are called the garboards. Replace the pattern; but, before doing so, mark the lower edge for the second breadth of paper, and, setting off the distances along the ribs to the width of the first pattern, you will be able to mark it out and cut it as the previous one. A double seam will be better than a single, as it will give great additional strength to the canvas, and the width of an inch and an eighth should be allowed for it. The lower edge of the third breadth can now be marked and cut out by the upper edge of the second, and if found to reach the gunwale, the top edge may be left uncut until the canvas is drawn over the framework. In applying the canvas to the keel, put plenty of thick paint on the inside to half the breadth of the keel, and nail the selvage with copper tacks along

the middle line; then screw on with brass screws, at 6-inch intervals, a piece of elm plank $\frac{1}{2}$ th of an inch thick, and exactly the same width and length as the keel. Between the 6-inch intervals drive copper tacks. A small strip of copper at the fore foot and heel will prevent this shoeing, as it is called, from catching in anything. To make a good finish at stem and stern, cut out the thickness of the stem and sternpost to the eighth of an inch from top to bottom, as in an ordinary boat, which will form a groove or rabbet, and when you come to this part fold the end of the canvas back. This will give additional strength for the nails, and at the same time make a very snug finish."

"A diagonal-framed canvas boat was built as long ago as 1844, and is still in existence. The canvas was stout, and it was very thickly painted when dry, and not wetted, as is frequently the case, to prevent the absorption of paint. The boat was built on three moulds, the transom or stern board (for she is not canoe-formed at the stern) being one mould, the midship mould the second, and a third equi-distant between it and the bow. An inner keel or kelson having been connected with the stem and sternposts by mortices, this kelson was let into the moulds its own thickness, 1in., and secured. The moulds were steadied in their positions by the gunwales, of $\frac{1}{2}$ in. by 2in. yellow pine, nailed to the stern and transom board. The frame of yellow pine, $\frac{1}{2}$ in. by $\frac{1}{2}$ in., was then nailed on diagonally, leaving openings of 2 $\frac{1}{2}$ in. wide where crossing each other. The canvas, put on lengthways, was cut so as to run along the framework parallel with the kelson on each side; and the seams were sewn double, as sails are ordinarily made by sailmakers. There is one bottom and two side breadths, and, therefore, no join along the kelson. The canvas turns in over the gunwale, and is secured by a strip of the same wood. The framework is nailed with copper tacks. The canvas, being so well supported, is perfectly rigid, and the boat appears likely to last a number of years."

A canvas "coracle" (Fig. 178) was built by Capt. J. Richards, E.N., in 1878, for the river Avon, 12ft. long, 3ft. wide, and 15in. in depth. She has a frame of American elm, fastened with rove and clench copper nails and wire; her floor is nearly flat, formed of $\frac{1}{2}$ in. white pine wood, lined inside with sheets of cork to fill up the spaces between the timbers, and form a level and solid platform within. Above the floor and outside the timbers (which are 6in. apart, and twenty-three in number), instead of the planking of an ordinary boat, there are stout fore-and-aft stringers of American elm three inches apart, outside all of which is stretched the thick No. 1 canvas skin of the outer boat. The principal materials required are keel of 1in.

square ash; gunwale, 1in. square ash; cross-pieces of gunwales, 1in. square ash; keel chafing pieces, $\frac{1}{2}$ in. by $\frac{1}{2}$ in. ash; fore-and-aft stringers, $\frac{1}{2}$ in. by $\frac{1}{2}$ in.; bilge stringers, $\frac{1}{2}$ in. by $\frac{1}{2}$ in.; twenty-three timbers, $\frac{1}{2}$ in. square.

Within this structure and securely attached

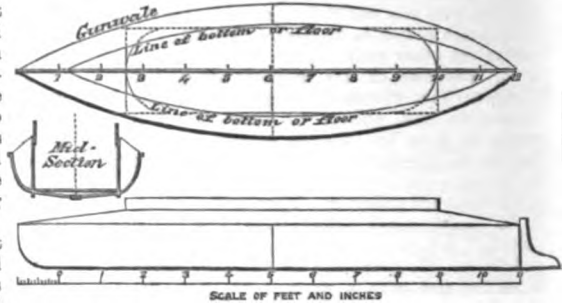


FIG. 178.

to it, although quite distinct from it, there is an inner canvas boat, 8ft. long and 2ft. wide (having a separate gunwale), in which the crew sit on the floor.

The deck space between the gunwale and coaming is entirely covered in by canvas supported on a strong framework of wood and cane; and, being under ordinary circumstances quite secure from wet, was intended by Capt. Richards for the stowage of bedding, clothes, and provisions of the crew.

The gunwale and the coaming are strongly braced together, and the ends of the gunwale are additionally secured to the stem or sternpost by strong iron plates, with eye bolts above, in which are rove stout rope to moor the boat with when afloat, or suspend her to trees like a hammock when ever her crew may desire to sleep in the position.

The coracle is fitted with a couple of small light wheels and iron axle (weighing on about 12lb, and movable at pleasure about a couple of minutes), which when attached to her keel afford her the locomotive advantages of a porter's truck.

The twelve-foot coracle weighs about 90lb and draws three inches water when light but, with her crew of two men and her gear on board, at her late trial she drew five inches forward and seven aft. An inch of the however, is due to her false keel, which, with bilge pieces, give ample lateral resistance when under sail in a seaway.

The entire structure was well saturated with boiled linseed oil, and then painted.

The inner boat can be disengaged at the gunwale, and removed altogether in about four minutes.

One of the principal advantages claimed for this "double-shell boat" consists in the fact that the outer boat may be stove in without rendering her unserviceable or wetting the crew; and so long as the outer boat is intact a sea may be accidentally shipped in the in-

boat without dangerously affecting the stability of the vessel; and should both the outer and inner boats be swamped with water, the cork floor and cushions will, nevertheless, still afford her the properties of a life buoy sufficient for her crew.

The builders of these boats are Messrs. Hill, Canon's Marsh, Bristol. Price £6 10s. Carriage by rail 1d. per mile.

Cap.—A figure of 8 iron band fitted to the mast-head, bowsprit end, &c. Sometimes the yoke is termed the lower cap. (See page 115 to 119.)

Capful of Wind.—A puff of wind soon passing away.

Capstan.—A mechanical contrivance for raising the anchor. Capstans very compact in form are now made for yachts instead of the cumbersome windlass. The one most generally in use is manufactured by Harfield and Co., Mansion House Buildings, E.C. Cantelo, of Southampton, manufactures a capstan that can be used without capstan bars.

Capstan Bar.—Bars of wood by which the capstan is turned, and so made to wind up the anchor or raise any weight.

Capstan for a Trawl.—A capstan for a trawl for a yacht of twenty or more tons is made at the Mount's Bay Foundry, Cornwall.

Card.—The dial of a compass upon which the points are marked.

Cardinal Points.—The compass points, E., W., N., and S.

Caroon.—To heel, to list, to lean over.

Carlines.—Pieces of timber fitted between the deck beams in a fore-and-aft direction.

Carry Away.—The breakage of a spar, rope, &c.

Carry Canvas. A vessel is said to carry her canvas well if she does not heel much in strong breezes.

Carvel Built.—Built with the plank flush edge to edge, and the seams canked and payed.

Cast.—Said of a ship when she fills on one tack or the other after being head to wind. Used generally in getting under way, as cast to port, &c. The word is variously used, as to cast anchor, to cast off a rope.

Catamaran.—A small raft common in the East Indies. A double boat in use in America.

Cat Block.—The block used in catting the anchor.

Cat Boat.—A boat with one sail, like a Una boat.

Catch a Turn.—To take a turn quickly with a rope round a belaying pin, or bitt, or oavel.

Cathead.—Timber or iron projection from the bow of a vessel by which the anchor is hoisted up to the rail, after it has been weighed to the hawse pipe.

Catpaws.—In calms, when the water is rippled here and there with passing airs of wind, it is said to be scratched by catpaws. A "catpaw" is also a bight in a rope.

Caulking.—Driving oakum into the seams of a vessel. (See "Marine Glue.")

Caulking Iron.—A kind of blunt chisel used for driving oakum into the seams.

Caustic Soda.—A mixture of three-parts of soda to two of unslacked lime. The soda is boiled in the water, and then the lime added. The mixture should be applied hot. In applying it great care should be exercised so as not to allow it to touch the hands. A brush of vegetable fibre should be used, as the composition will destroy hair. Caustic soda is used for cleaning off old paint or varnish; the mixture should be put on nine or ten hours before it is scraped off if a very clean job is desired. If it is a deck that has to be cleaned it is desirable to damp it with fresh water before an application of the mixture; hence it is a good plan to apply it on a dewy morning. Mahogany should be scraped, and not cleaned with caustic soda. A mixture of two parts soda and one part soap, simmered together and applied hot, is sometimes used.

Cavel (sometimes spelt "kavel" or "keval").—Stout pieces of timber fixed horizontally to the stanchions on bitts for belaying ropes to.

Ceiling.—The inside planking of a vessel.

Centre-board (a Temporary).—Make a board of the shape of either of those in the sketch (Fig. 179) about one-third of the length of the boat. Three bolts will be on the upper edge of the board; the centre bolt will have a

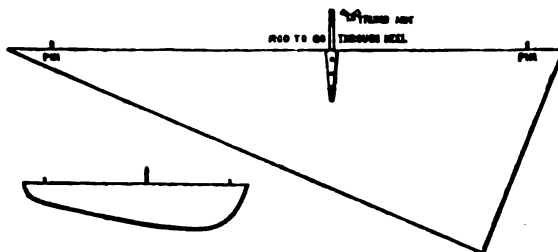


FIG. 179.

thread longer than the other two, and protrude through the keel. When the board is fitted under the keel, it will be held tight to the keel by a thumb nut on the centre bolt. To unship the board when afloat unscrew the thumb nut, push the board down, and it will float up alongside. A cork will be put into the bolt hole. Of course the board cannot be shifted when the boat is afloat. It would be unsafe to sail about in shallow water with such a contrivance; nor should the boat under any circumstances be allowed to take the ground with the board fixed.

Another form of temporary board (Fig. 180) has been fitted to an ordinary boat, 18ft. long. It consists of a board, to which are affixed iron clamps on either side, which admit of the main keel being inserted between them; through these are passed bolts with nuts, which firmly hold the two keels together.

The dimensions of a board for an 18ft.

boat are 6ft. long, 1ft. 10in. deep, and 1½in. thick. The board is to be about 1ft. 6in. shorter on its under side than on its top side, the fore end sloping aft, and the aft end

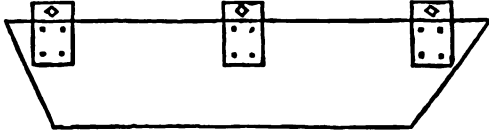


FIG. 180.

sloping forward; but the slope at the fore end is nearly double that at the aft end.

Place the centre of the board a trifle in advance of the centre of the main keel; it can be fixed in five minutes when the boat is in the davits; only one word of caution is necessary, that is, not to tow her with the keel on behind the yacht when sailing, or in all probability she will take a sheer out and capsize.

This plan was introduced by Mr. G. H. Harrison, of the *Siesta* schooner; but it is not quite so good as the American plan on the other page, because it cannot be unfitted or released whilst the boat is afloat; and, moreover, a triangular shape is to be preferred.

Chain Pipe.—Iron pipe on the deck through which the cables pass into the lockers.

Chain Plates.—Iron braces on the side of a ship which sustain the rigging.

Channel Plates.—(See "Chain Plates.")

Channels.—Strong pieces of timber fixed on the side of a ship inside the chain plates to give greater spread to the rigging.

Check, To.—To check a sheet is to ease it a little. To check a vessel's way as by a warp, or by backing a sail. To check a tide is to keep a vessel from her course, in order to allow for the influence or drift of a tide. A vessel is said to check the tide when it throws her to windward. To check a vessel with the helm is to prevent her altering her course. (See "To Meet.")

Cheek Blocks.—A sheave fitted on a spar inside a sort of cleat, as the cheek block for top-sail sheet on the end of a gaff. (See page 90).

Cheeks of the Mast.—The hounds.

Cheering.—The "hip, hip, hurrahs!" that the crew of a vanquished yacht greets the victrix with. A custom much honoured. (See "Man Ship.")

Chill.—In very light winds, if a cloud passes overhead and a puff comes out of it, it is called a chill—probably on account of its coldness.

Chinese Lug.—A lug sail with battens. (See page 279.)

Chips.—A nickname for a ship's carpenter.

Chock.—A block or wedge of wood.

Chock a Block.—Said of two blocks when, in hoisting or hauling, the two blocks of a tackle are brought close together. Generally when two things are brought so close together that they cannot be got closer.

Chock Full.—Full to the brim. Frequently used in close-hauled sailing to let the helmsman know that the sails are full enough, and he need keep her no more off the wind.

Chock Home.—Close up.

Chopping Sea.—A short, steep sea, which makes a vessel continuously pitch and 'soend.

Chuckle-headed.—Full or bluff in the bow; thickheaded.

Chuck to Windward.—A weather-going tide is said to chuck a vessel to windward, and the contrary a lee-going tide.

Circumference of a Circle.—The diameter multiplied by 3·14159; in algebra denoted by the Greek letter π .

Clamp.—A thick strake of wood worked inside a vessel under the shelf. (See p. 105.)

Clamps.—A kind of wedge vice, used in boat-building to hold the plank together. (See "Boat Building.")

Clamps.—Various contrivances of wood or metal used in fitting up a vessel or in fixing parts in her construction.

Clap on Canvas.—To put on more canvas. "Clap on here" is a request frequently made to idlers to assist in hauling on a rope.

Claw.—To hang well to windward, as to "claw off a lee shore."

Claw to Windward.—To beat to windward under difficulties. To claw off a lee shore is to beat off and avoid getting stranded.

Clean Full.—Barely close-hauled; when all the sails are full.

Clear for Going About.—A question often asked when work is being done on deck, and the vessel has to be put about: "Are ye all clear there for going about?"

Cleats.—Pieces of wood with one or more arms fastened to spars, &c., for belaying to, or to prevent ropes slipping, &c. (See "Thumb Cleats" and Cruickshanks' Patent Safety Cleats.)

Clench Work (spelt also "clencher," "climcher," and sometimes "clinker.")—In boat building when the edges of the plank overlap, forming lands.

Clew.—The lower corners of a square sail; in fore-and-aft sails only the lower after corner is called the clew.

Clew Lines.—Clew garnets. Ropes used for hauling up the clews of sails. (See page 115.)

Clew Up.—To haul up a sail by the clew lines for furling, &c. Also used as a slang term for shut up or cease.

Clinch.—To fasten a rope by a half hitch, and seize the end back to the other part; a method adopted with very large ropes or hawsers after they have to be bent to rings, &c., in a hurry. To clinch is also to beat the end of a bolt or rivet until it forms a head; or to turn the end of a nail in so that it will not draw.

Clinometer.—An instrument for measuring the angle of inclination or the extent of heel a ship has under canvas or whilst rolling.

Clip Hook.—A double hook (hinged to the eye) whose parts overlap when attached to a ring,



FIG. 181.

&c. A hook not much in favour, as it so frequently breaks or gets half detached.

Clipper.—A fine ship; first applied to the sharp-bowed ships that sailed out of Baltimore, U.S.

Clock Calm.—So calm and still that the ticking of a clock could be heard.

Close Aboard.—Near to, as the land is said to be close aboard when a vessel has approached it very closely.

Close-hauled.—With all the sheets trimmed flat aft, and every rope that helps extend the sails hauled taut. Hauled as close to the wind as the sails will admit without shaking their luffs. When a square-rigged ship is close-hauled she is about from five to six points off the wind. A fore-and-aft schooner, with everything nicely trimmed for racing, will lie within four and a half points of the wind; a cutter within four and a quarter points. This, of course, supposes the water to be smooth and the wind of what is known as "wholesail strength." In rough water a vessel cannot be sailed so close; in the Atlantic race between the Cambria and Dauntless, the former, although she had head winds for a large part of the time, for two reasons was never hauled up closer than six points: generally there was too much sea to admit of it without being half hove to, and in such long passages it was thought better to sail her along hard on the chance of the wind freeing; or if it headed her she could have been put on the other tack. (See "Wind.")

Close Reefed.—When the last reef is taken in, generally the fourth reef; but some modern schooners with laced mainsails have only three reef bands, and it is thought that when the fourth reef is wanted that it is time to set the trysail.

Close to Wind.—Close hauled. As close to the wind as the sails will bear without lifting.

Clothes.—The outfit given to a yacht's crew by the owner, consisting of trousers, frocks, caps, shoes, and neckerchief. When the yacht is paid off the men take the clothes with them, but if a man is discharged for misconduct, he is made leave his clothes behind. Under any circumstances the men have no legal right to the clothes if the owner chose to retain them, as it is only a kind of livery.

Clothes Lines.—A sail is said to be across a clothes line when it is girted by a rope. Lines used on board men-of-war for drying the sailors' clothes on washing days.

Cloth in the Wind, A.—When the foremost cloth or luff of a sail is shaking through the vessel being brought too near the wind. A man is said to be three cloths in the wind when intoxicated.

Clove Hitch.—(See "Scowing an Anchor.")

Club Hauling.—(See page 164.)

Coal, Consumption of.—With engines of the old type a steamer consumed from 4lb. to 6lb. of coal per indicated horse-power per hour. With compound engines the consumption is from 2lb. to 3lb. per horse-power per hour.

Coamings.—A raised frame fitted to and above the deck for the hatches, skylights, &c., to rest upon.

Coats.—Painted canvas used to cover sails when they are stowed.

Coated.—Sails stowed and covered up by the coats.

Coble.—A boat common on the Yorkshire coast. Said to run over a sea very dry. The pecu-



FIG. 182.

liar deep rudder makes them steer well in a sea. (See page 377.)

Cockpit.—In a man-of-war, part of the ship below water where the middies were berthed, and where the wounded were attended in time of action. A kind of well in the deck aft, common in American yachts and in some small ones in this country.

Coil.—Ropes packed up in rings one over the other. To coil away.

Cole's Anchors.—(See "Anchors.")

Collar.—An eye or bight of a shroud, stay or rope to go over the masthead as the collar of the forestay. Also a rim on a bolt.

Collier.—A vessel employed to carry coal.

Collision.—When one vessel comes into contact with another.

Colours.—Flags denoting nationality, ownership, or other identity.

Comb.—The crest part of a wave.

Comber.—A big surf-like wave.

Combings.—(See "Coamings.")

Come no Nearer.—An order to the helmsman not to bring the vessel nearer the wind.

Come on Board, Sir.—A seaman's laconic speech when he reports his arrival on board to an officer in charge after leave.

Come To.—To fly up in the wind; to come nearer or closer to the wind; to luff. Generally used when a vessel comes nearer the wind after having falling off the wind.

Come Up.—Generally to slack up. Whilst hauling on the fall of a tackle and the order comes, "Avast hauling there," the hand that has to belay sings out, "Come up behind;" all hands instantly release the fall, so that the one who has to belay may catch the turn round the belaying pin or caval without "losing any." (See "Hold on the Fore Side" and "Belay.") In slang an admonition to cease fooling.

Come Up, To.—A vessel is said to come up when the wind frees her so that she can head nearer her course, or look, or point her course. In beating, a helmsman in reporting the progress made by the vessel may say, "She has come up two points this tack, sir," according to the extent of the wind freeing; if the wind came more ahead, he might say she has broken off or fallen off two points, &c.

Come up With.—To overtake.

Commodore.—A rank conferred by clubs upon members; and there are Commodores, Vice-Commodores, and Rear-Commodores. Their duties are to see that the laws of the club, especially those that apply to matters afloat, are properly carried out. Commodores fly the broad pennant or swallow-tail burgee. (See "Burgee.")

Companion.—The entrance from the deck to the below cabins.

Compass Bowl.—The bowl within the binnacle containing the compass.

Compass Card.—A circle divided into 32 parts, called points; and each part is again divided into 4 parts, and the whole is divided into 360 degrees.

| Courses. | Degrees. | Points. | Back Bearings. |
|-----------------|----------|----------|-----------------|
| N. | 0 0 0 | 0 point | S. |
| N. † E. | 3 48 45 | " | S. † W. |
| N. † E. | 5 37 30 | " | S. † W. |
| N. † E. | 8 26 15 | " | S. † W. |
| N. by E. | 11 15 0 | 1 point | S. by W. |
| N. by E. † E. | 14 3 45 | " | S. by W. † W. |
| N. by E. † E. | 16 53 30 | " | S. by W. † W. |
| N. by E. † E. | 19 41 15 | " | S. by W. † W. |
| N.N.E. | 22 30 0 | 2 points | S.S.W. |
| N.E. by N. † N. | 25 18 45 | " | S.W. by S. † S. |
| N.E. by N. † N. | 28 7 30 | " | S.W. by S. † S. |
| N.E. by N. † N. | 30 56 15 | " | S.W. by S. † S. |
| N.E. by N. | 33 45 0 | 3 points | S.W. by S. |
| N.E. † N. | 36 33 45 | " | S.W. † S. |
| N.E. † N. | 39 22 30 | " | S.W. † S. |
| N.E. † N. | 42 11 15 | " | S.W. † S. |
| N.E. | 45 0 0 | 4 points | S.W. |
| N.E. † E. | 47 49 45 | " | S.W. † W. |
| N.E. † E. | 50 37 30 | " | S.W. † W. |
| N.E. † E. | 53 26 15 | " | S.W. † W. |
| N.E. by E. | 56 15 0 | 5 points | S.W. by W. |
| N.E. by E. † E. | 59 3 45 | " | S.W. by W. † W. |
| N.E. by E. † E. | 61 52 30 | " | S.W. by W. † W. |
| N.E. by E. † E. | 64 41 15 | " | S.W. by W. † W. |
| N.N.E. | 67 30 0 | 6 points | W.S.W. |
| E. by N. † N. | 70 18 45 | " | W. by S. † S. |
| E. by N. † N. | 73 7 30 | " | W. by S. † S. |
| E. by N. † N. | 75 56 15 | " | W. by S. † S. |
| E. by N. | 78 45 0 | 7 points | W. by S. |
| E. † N. | 81 33 45 | " | W. † S. |
| E. † N. | 84 22 30 | " | W. † S. |
| E. † N. | 87 11 15 | " | W. † S. |
| E. | 90 0 0 | 8 points | W. |
| E. by S. | 92 48 45 | " | W. by N. |
| and so on. | | | |

* It is customary in the Royal Navy to call this N.N.E. † E.; N.N.E. † E.; N.N.E. † E., then N.E. by N. Either way is correct. Sometimes also E. by N. † N. is called E.N.E. † E.; or N.E. by E. † E. is called for shortness E.N.E. † N. The table, however, gives the more correct way. In calling off the points avoid such "lubberisms" as N.E. by E. † N. for N.E. † E., or S. by W. † S. for S. † W., &c.

It is commonly believed that the mariner's compass was introduced into Europe in the fifteenth century, but it seems to have been

well known in a primitive form in the twelfth and thirteenth centuries. In one of the popular songs written in the time of King John, it is related that the sailors who went on long voyages to Friesland and the East, knew their way by observing the polar star, but, when the sky was covered with clouds, and they could no longer see the stars of heaven, they had a contrivance which consisted of a needle of iron put through a piece of cork so that one end remained out. This they rubbed with the loadstone, and then placed it in a vessel of water, and the needle pointed without error to the polar star. This formed a primitive but fairly perfect mariner's compass. If an ordinary needle be rubbed on a magnet and gently dropped into a glass of water it will float and point to the north.

Compass Point.—The 32nd part of 360 degrees, or practically 11 1/4 degrees.

Complement.—The full number; the whole ship's crew.

Composition for a Boat's Bottom.—Day's composition has been much used for coating the bottom of boats. It is said to prevent the growth of weeds, barnacles, &c. The boat should have a coat of common varnish first, and the composition should be applied before the varnish is quite dry. Only a part of the boat should be varnished at a time, or the varnish will dry before the composition can be put on. One gallon carefully put on will cover about 400 square feet or the immersed surface of a 10-tonner. The composition should be kept well stirred whilst being used, as the ingredients are heavy, and soon settle to the bottom. Day's address is Forest Hill, London. (See "Jesty's Composition.")

Peacock's composition has been used on iron ships with good effect. The composition can be obtained of Messrs. Peacock and Buchanan, Southampton. This composition should be applied in the same manner as Jesty's. Two, three, or four coats of black varnish, or coal tar, should be first put on. The plates of an iron yacht should be thoroughly cleaned of rust, &c., before applying the varnish. (See "Coal Tar or Black Varnish.")

The Protector Fluid Company, 8, Leadenhall-street, E.C., have a poisonous composition, said to very effectually prevent the growth of barnacles.

The following composition was patented by Mr. A. C. A. Holzappel, 15th March, 1879. The composition consists of:—(1) 5 parts coal tar or black varnish; (2) 25 parts methylated spirit; (3) 10 parts rosin; (4) 5 parts shellac; (5) 3 parts pine oil; (6) 32 parts colouring matter, amber, brown, and oxide of iron; (7) 2 parts chloride or oxide of mercury; (8) 12 parts sulphide of antimony; (9) 6 parts arsenic. Substances 3 and 4 are dissolved in 2; then 1, 5, and 6 added, and afterwards 7, 8, and 9, the mixture being allowed to stand twenty-four hours before filling into caaks. We have not heard of this composition having been used, and unless

- anyone desired to make experiments, either *Jesty's* or *Peacock's* compositions can be recommended as fairly answering the purpose for which they are used.
- Compressor.**—A contrivance to prevent the chain cable being veered too quickly, or to stop its veering altogether.
- Conduct Money.**—Money kept back from a seaman's wages, but given up in whole at the end of an engagement if the seaman's conduct has been good; generally the amount kept back is 2s. per week, and a fine to that amount is levied for an offence.
- Contrary Wind.**—A wind that blows adversely down a vessel's course.
- Copper Bottomed.**—The bottom of a ship sheathed with copper. (See "Sheathing.")
- Copper Fastened.**—Fastened with copper bolts and nails.
- Coracle.**—A small boat used by the ancient Britons. (See "Canvas Boats.")
- Cordage.**—A general term used to denote the rope used in the rigging of a ship.
- Corinthian.**—A term in yacht parlance synonymous with amateur. The term Corinthian half a century ago was commonly applied to the aristocratic patrons of sports, some of which, such as pugilism, are not now the fashion. No doubt the name originated with the supposed similarity between the fast young men of the Greek Empire who emulated the feats of athletes, &c., and their modern prototypes.
- A "Corinthian" sailor has never been defined. The Royal Alfred Yacht Club enjoins that in all matches the amateur element shall consist of "members of the club, their sons, or members of a royal, foreign, or recognised yacht club, or naval officers." Anyone not being a mechanic or menial is generally regarded as a qualified amateur. Some clubs only allow yachts of 15 tons and under one paid hand, who is not permitted to touch the tiller. A later and more suitable plan is to have paid hands in the proportion set forth in the table, page 207. In all cases an amateur must steer.
- Corinthian Rule of Measurement.**—A tonnage measurement adopted by the Corinthian Yacht Club on the builder's rule for roughly estimating the register tonnage of a vessel, thus $\frac{L \times B \times D}{300}$, where L length, B breadth, and D depth, amidships from deck to under-side of keel. This rule was also adopted by the New Thames Yacht Club in 1875, but after a trial of two years it was abandoned, as the general opinion appeared to be that the rule would have an injurious influence on yacht designing.
- Cot.**—(See "Wexford Flat-bottomed Boats.")
- Counter.**—The projecting part of a vessel abaft the sternpost.
- Course.**—Direction; the direction in which a vessel moves; the direction from one point to another point which a vessel has to reach.
- The distance yachts have to sail in a match at a regatta.
- Courses.**—The lower squaresails of a ship.
- Covering Board.**—The outside deck plank fitted over the timber heads. See "Plank sheer."
- Cosswain.**—The man who steers and has charge of a boat and her crew. Pronounced "oor'n."
- Crabbing.**—When a vessel tumbles down under a heavy press of canvas, or when she sags to leeward badly.
- Cracking on.**—Carrying a large quantity of sail.
- Cracks in a Mast or other Spars, To Stop.**—When the spar is quite dry run in marine glue; when the glue is hard, scrape out some of it, and stop with putty, coloured to imitate the colour of the wood.
- Craft.**—A vessel; also used in the plural, thus a number of craft, or a lot of craft, means a number of vessels.
- Crank.**—Not stiff under canvas; a boat that can be heeled or listed very easily; generally a dangerous boat.
- Cranse.**—An iron hoop band, with eyes fitted to bowsprit ends or the ends of other spars. (See Fig. 100, page 350 and 351.)
- Creek.**—An inlet of the sea.
- Crests.**—The top edges of waves.
- Crew.**—A ship's complement, and including every man employed on board in any capacity whatsoever, distinct from passengers.
- Crimps.**—Agents for engaging seaman: a vocation not in high repute.
- Cringle.**—A metal thimble worked into the corners and leeches of sails.
- Cripple, A.**—A vessel that does not carry her canvas stiffly.
- Cross Chocks.**—Pieces of wood used for filling in between lower futtocks where their heels do not meet on the top of the keel.
- Cross-jack.**—Cross-jack-yard is the lowest yard on the mizen mast. Pronounced "cro'-jack."
- Cross Sea.**—Waves that come from divers directions, usually caused by sudden shifts of wind when it is blowing heavily.
- Cross-trees.**—See p. 115, &c.
- Crow-foot.**—A number of lines attached to one line, and spreading out something like a bird's claw.
- Crown of an Anchor.**—The part of an anchor where the arms are joined to the shank.
- Crow's Nest.**—A place of shelter at the top-gallant mast-head for a look out man, used by whalers in Northern latitudes.
- Cruickshank's Patent Cleats.**—This is a contrivance for jamming the mainsheet without any turns or bights, so that when a certain pressure is put on the sail the sheet unreeves. The cleat was invented with a view of preventing boats being capsized when struck by sudden squalls. The objection to such cleats is that they may

possibly foul, and moreover the pressure which if applied steadily would just cause the sheet to unreeve, might if applied suddenly capsize the boat long before the sheet would run through the jammers. (See page 187.) With a "breeze of wind" there is generally some sea, and then it is not so frequently a sudden accession of wind or squall that causes the boat to capsize as her position among the waves. If she gets so placed as to lurch or roll to leeward from the effect of a wave crest passing underneath her, she may upset without any increase in the pressure of wind; that is to say, if her safe angle of heel under canvas is 20 degrees, and she be permanently heeled by the wind pressure to that angle, then, if the action of the waves caused her to heel further—say 10 degrees—she would capsize unless skilfully handled by the steersman. As there need be no increase of wind pressure to bring about such a catastrophe, the "safety cleat" would be of no avail under such circumstances. In smooth water it would never be prudent or safe to wait for a squall to strike a boat, as, if the squall were heavy enough to cause the boat to heel to the capsizing point, the safety cleat could not relieve the sheet fast enough to prevent such heeling. The squall must be "met," the boat thrown head to wind, and the sheet released, before the squall strikes. Sometimes in small boats, with the wind abeam or abaft the beam, it may be more prudent to run them off the wind; but scarcely in any case, either in a sea or in smooth water, could the safety cleat save a boat from being capsized if the helmsman or crew carelessly handled her when she is in danger of such a catastrophe. Mr. Cruickshank's cleat is provided with a releasing line, which is to be held in the hand, and if the break does not allow the sheet to be released fast enough, the line is to be pulled. Manifestly it would be safer and give less trouble to hold the sheet itself in the hand. (See "Beadon's Safety Reel.")

Crutch.—An iron support for a boom when the sail is stowed something in this form Y; the upright part fits into a socket on the taffrail. Crutches are sometimes made of two cross pieces of wood, thus X; in schooners the crutch for the fore boom is generally so formed; also a similar crutch is used to put the tiller in when the vessel is moored to keep it from flying about, and when by lashing the tiller lines across the vessel to either rail the passage fore and aft would be inconveniently obstructed. An X crutch is used to support the middle of the boom when the sail is stowed and not slung by the peak halyards. A crutch is also the metal fork used instead of tholes in a row boat.

Cubic Measure of Water.—One gallon contains 277.274 cubic inches, or 0.16 of a cubic foot. One cubic foot contains 1728 cubic inches, or 6.233 gallons. One ton of salt water contains 35 cubic feet. One ton of fresh water contains 35.9 cubic feet. A ton weight is equal

to 2240lb. See "Decimal Equivalents." (See "Water.")

Cuddy.—A small cabin, a deck house, the space under the half deck of a boat.

Cunt-line.—The space between four caeks when they are stowed bilge to bilge.

Cutter.—A boat heavier than a gig, and used in bad weather when the lighter boat might get swamped.

Cutter.—A vessel with one mast rigged with mainsail, foresail, jib and topsail, as shown in the accompanying sketch, known as the national rig.

A cutter's sails are termed "fore-and-aft" sails, because they are tacked and sheeted in

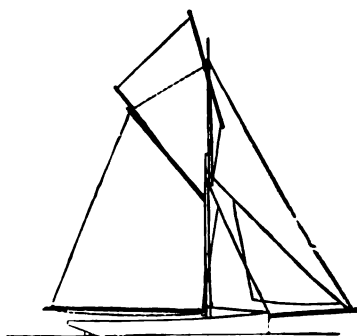


FIG. 183.

a fore-and-aft direction in contradistinction to sails which are tacked and sheeted as squaresails are.

D.

Dagger knee.—A piece of timber crossing the frames diagonally.

Dandy.—A cutter rigged vessel with lug mizen aft set on a jigger-mast.

Darning the Water.—When a vessel keeps sailing backwards and forwards, as before a bar harbour or pier, waiting for water or orders, &c.

Davit Guys.—The stays or ropes used to keep the davits steady.

Davits.—Strong iron arms used for hoisting boats, &c.

Day's Paint.—(See "Composition.")

Dead Calm.—Without a breath of wind.

Deaden-her-way.—To stop a vessel's way by backing and filling, or by hauling a sail aback, or by yawing her about with the helm, &c.

Dead Eye.—A circular block, with three holes in it (crow-foot fashion) without sheaves, used to reeve the lanyards through for setting up the rigging. (See page 115, &c.)

Dead Flat.—The midship section. The term is applied to the middle flat of a ship, where she

gets ne broader and no narrower ; that is, where the cross sections for some distance amidships are of the same size and form : thus the side will present a "dead flat" for some distance. (See "Straight of breadth.")

Dead Lights.—Strong shutters made to fit the outside of cabin windows—closed in bad weather. In yachts small circular lights are generally fitted, and without the shutters.

Dead on end.—Said of the wind, when it blows straight down the course a vessel wishes to make. (See "Nose-ender," "Muzzle.")

Dead Reckoning.—The calculation of a ship's position by the log, the courses she has made, lee way, set of currents, &c., without an observation.

Dead Rise.—The approach the floor timbers of a vessel makes to a perpendicular. In the case of ships, the frames in the after body are called the dead-risings, because they only rise from the keel at a sharp angle, all the middle frames starting nearly horizontally from the keel. A yacht is said to have considerable dead rise on a very rising floor, when she is more or less of the V form, but really vessels of the T form have the greatest dead rise, as the heels of the floors forming the framing to take the garboards, do rise nearly perpendicularly to the keel.

Dead water.—The water in a vessel's wake, close to her rudder, that does not appear to move with such rapidity as the water along a ship's side.

Dead weight.—Concentrated weight in a vessel's bottom, such as a heavy cargo of ore or ballast.

Dead wood.—The solid wood worked on top of the keel forward and aft (See page 115)

Decimal Equivalents—

| In. | OF A FOOT. | | | | OF A TON | | | |
|-----|------------|-------|-------|-------|----------|------|------|------|
| | — | ‡ | ‡ | ‡ | Cwt. | Ton. | Cwt. | Ton. |
| 0 | .000 | .021 | .042 | .063 | 1 | .05 | 11 | .55 |
| 1 | .083 | .104 | .125 | .146 | 2 | .10 | 12 | .60 |
| 2 | .167 | .187 | .208 | .229 | 3 | .15 | 13 | .65 |
| 3 | .250 | .271 | .292 | .312 | 4 | .20 | 14 | .70 |
| 4 | .333 | .354 | .375 | .396 | 5 | .25 | 15 | .75 |
| 5 | .417 | .437 | .458 | .479 | 6 | .30 | 16 | .80 |
| 6 | .500 | .521 | .542 | .562 | 7 | .35 | 17 | .85 |
| 7 | .583 | .604 | .625 | .646 | 8 | .40 | 18 | .90 |
| 8 | .667 | .687 | .708 | .729 | 9 | .45 | 19 | .95 |
| 9 | .750 | .771 | .792 | .812 | 10 | .50 | 20 | 1.00 |
| 10 | .833 | .854 | .875 | .896 | | | | |
| 11 | .916 | .937 | .958 | .979 | | | | |
| 12 | 1.000 | 1.021 | 1.042 | 1.063 | | | | |

Deck.—The platforms supported on the beams of ships. The old three deckers had upper deck main deck, middle deck, lower deck, and orlop deck, no guns being carried on the latter. Below the orlop deck were the hold platforms, or decks. Yachts usually are said to have only one deck, i.e. the upper deck open to the sky ; some large yachts, however, have a lower deck, laid and caulked. Smaller yachts have platform beams upon which the platform rests. The platform is the cabin floor.

Deck Caulking and Stopping.—(See "Marine Glue.")

Deck, to Whiten.—Make a mixture of 1lb. oxalic acid to 1 gallon of water. Damp the deck with this and wash off.

Deep sea lead (pronounced "dipsey lead").—A lead of 28lb. weight attached to a line of 200 fathoms. Now, automatically recording machines are generally used for deep sea soundings. (See "Lead.")

Delivery.—The quarter wash of a vessel. A yacht is said to have a good delivery if on passing through the water no waves are raised at and about the quarters ; she is then said to leave the water clean, to have a clean wake, clean delivery, or to run the water very clean aft.

Demurrage.—Compensation paid to the owner of a ship when she has been detained longer than reasonable by a freighter at a port.

Depth of a Yacht, to measure.—Very frequently it is necessary to know accurately the external depth of a yacht from rail to keel, or her draught from load line to keel. The following simple plan is a ready means of obtaining such depth and draught: To obtain the depth take a straight-edged bar of wood (see *s e*, Fig. 184) will be placed across the rail, at right angles to the keel. A small chain, *f f*, will be passed under the bottom of the yacht, and one end will be made fast on the bar at *g*, so that the chain

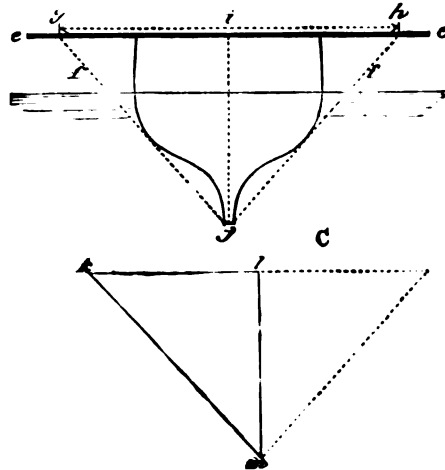


FIG 184.

just touches the bilge ; the chain will be drawn tight, and the other end made fast to bar at *h*. The distance *g h* must be accurately measured on the bar, as also, when removed, must the length of the chain which passed from *g* under the yacht to *h*. (To obtain the points for the measurement of the chain, it would be found convenient to fasten a small piece of cord or yarn at the points *g* and *h*, immediately under the bar, before the chain is cast off.)

Having obtained these measurements, it will be an easy matter to find the depth ϵj . The distance $g h$ can be laid off to scale, divided in the centre by a perpendicular, $i j$: half the length of the chain will then be laid off from g and h to intersect the perpendicular, $a a$ at j ; the distance from i to j on the bar, measured by the scale, will be the depth required.

The draught of water of the yacht will of course be found by subtracting her height out of water, from load line to rail, at the points where the depth was taken.

If no scale be at hand, the depth can readily be found by calculation. Take half the length $g h$, which call $k l$ (Fig. 184), and half the length of the chain, which call $k m$; subtract $k l$ from $k m$; multiply the remainder by the sum of $k m$ and $k l$ added together; the square root of the product will be the required depth. Expressed in algebraic language:

$$\sqrt{(k m + k l) \times (k m - k l)}$$

Say $k m$ is 10ft., added to $k l$ 7ft., make 17ft.; next 7 subtracted from 10 leave 3, and 3 multiplied by 17 make 51. The square root of 51 is 7.1, which would be the required depth.

The mean draught would be found by taking the actual draught at several (say 4) equidistant intervals, commencing at the heel of the sternpost and ending at the stem; add these draughts together, and divide the sum by the number of measurements taken, including those at stem and sternpost. If the fore foot is very much rounded away, the measurement at the stem will be 0, but in counting the number of measurements, that for the stem must be included.

The Barrow Corinthian Yacht Club formerly included mean depth in their tonnage rule, and adopted, on the suggestion of Mr. R. S. White, the following plan for obtaining depth at any point without calculation. (See Fig. 185.)

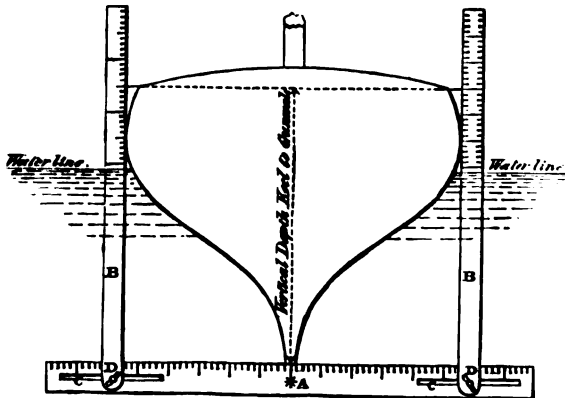


FIG. 185.

A is the keel batten, graduated from centre, in feet and tenths, with slots marked C, at each end, to slide the side or depth battens to the exact beam of yacht.

BB. Side or depth battens, graduated at upper part in feet and tenths from top of keel batten, and secured to keel batten with thumb-screws marked D.

Modus operandi: Having obtained exact beam of yacht, set the depth battens BB at this distance apart on keel batten A, by means of thumb-screws D tightly screwed up. Dip the keel batten under keel until opposite marks on gunwale, where depth is required to be taken; then bring it close up to keel, and take readings off depth battens BB, until they correspond on each side—this being depth of yacht, keel to gunwale, in vertical line, as shown in sketch.

If the measurements have to be taken in a tideway, the batten A must be kept close up to keel to prevent its driving aft.

Depth of Hold.—In a single-deck vessel, the height between the keelson and deck.

Derelict.—A vessel abandoned at sea. It is said that an owner's rights are not also abandoned if any live animal be left and found on board.

Derrick.—A kind of crane.

Deviation.—A movement of the compass needle due to local attraction, principally met with in iron or composite ships, and distinct from variation.

Dhow.—A large Arab vessel, usually lateen-rigged.

Diagonal Braces.—Strengthening straps of iron that cross the frames of a vessel diagonally.

Diagonal Lines.—Lines which cross the sections of a vessel shown in the body plan, in a diagonal direction with the middle vertical line.

Diameter of Circle.—Circumference multiplied by 0.31831.

Diminishing Strakes.—The strakes immediately above and below wales being the thickness of the wale on one edge, and diminishing to the thickness of the plank on the other.

Dinghy.—A small boat of Bombay, with a settee sail. Also a small skiff, or punt, carried by yachts. (See "Portable Dinghy.")

Dinghy-man.—The man who has charge of the dinghy of a yacht, whose duty it is to go on shore on errands, &c.

Dip.—The inclination the compass needle makes towards the earth in high latitudes.

Dip the Ensign, To.—To lower the ensign as a salute, or token of respect. (See "Dipping the Ensign.")

Dipping Lug Sail.—A sail hoisted by a halyard and mast hoop traveller. The sail is set to leeward of the mast, and the tack is usually fast to the stem or on the weather bow. In tacking or gybing the sail has to be lowered and the yard shifted to the other side of the mast. A plan has been proposed to perform this dipping by the aid of a topping and

tripping line instead of by lowering the sail (see the sketch, Fig. 186); but the balance lug, which requires no dipping what-

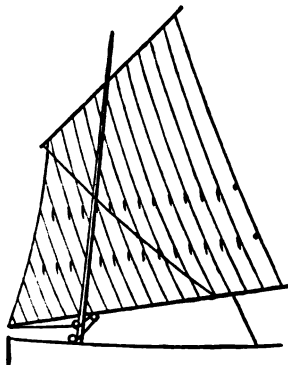


FIG. 186.

soever in tacking, is to be preferred to the best dipping arrangement. (See "Penzance Luggers.")

Dipping the Ensign.—The ensign is lowered or dipped as a means of saluting a commodore, &c., or member of a club. The junior member should be the first to dip. Sometimes, if no ensign is flying, the burgee is dipped. It is usual to "dip" on passing a man-of-war or royal yacht. A royal yacht never answers the salute by dipping her ensign. Strictly it is etiquette for the blue ensign to dip to the white, and red to the blue and white.

Discharge Ticket.—A formal document given to seamen when they are discharged.

Dismantled.—Unrigged: without sails or spars.

Dismasted.—When a vessel loses her mast by violence, or accident.

Displacement.—The quantity of water a vessel displaces, which, in weight, is always equal to her own weight.

Displacement per inch of immersion.—It is often necessary to know how much weight would have to be put into a yacht to sink her an inch or more deeper in the water or lighten her to a similar extent. Roughly, this can be ascertained by the following rule:—Multiply the length on the load line by the breadth on the load line and divide the product by 600. $(\frac{L \times B}{600})$. The quotient will be the weight in tons or fractions of a ton. This rule would not hold good if the yacht were lightened more than three or four inches or deepened to that extent. The rule is based on the assumption that the area of the load line is $\cdot 7$ of the circumscribing parallelogram. That is to say, the length and breadth multiplied together and again multiplied by $\cdot 7$ will (approximately) give the area of load line. Divide this product by 12, and the area is reduced to cubic feet, and divide again by 35 and the answer will be given in tons or

fractions of a ton. By this rough rule the displacement per inch at any part of the hull of the vessel (if the measurements are taken at the part) can be found approximately $(\frac{L \times B \times 7}{12 \times 35}) = (\frac{L \times B}{600})$

Divisions.—The portions of a fleet; as the star-board, port, and centre divisions, the admiral in command always occupying the centre division. Prior to 1856, there were red, white and blue divisions, but now, as only the white or St. George's ensign is recognised, the divisions by colour have been done away with. (See "Admiral.")

Dock.—A basin into which a ship is floated and the gates closed upon her; the water is then pumped out and the ship left dry, supported on a framework and by shores. These are called dry docks.—A general name for a place to receive ships for repair or cleaning. A ship is said to dock herself when placed in a soft tidal bed of mud she buries herself in it more or less.

Dockyards.—Places where ships are built; usually, however, confined to government naval works.

Dog Shores.—Pieces of timber used in launching ships.

Dog Vane.—A light vane made of bunting or feathers, to show the direction of the wind, and sometimes put on the weather rail.

Dog Watches.—The divided watch between four and eight in the evening; thus the first dog watch is from four to six, and the second from six to eight. (See "Watches.")

Doldrums.—The state of being becalmed. Parts of the ocean where calms are prevalent.

Dolphins.—Stout timbers or stone pillars placed on wharfs to make fast warps to.

Dolphin Striker.—The perpendicular spar under the bowsprit end by which more spread is given to the stay of the jib-boom.

Double-banked.—When men sit on the same thwart to row oars from different sides of a boat. Double-banked frigates were two deckers, with the upper deck ports disguised.

Double Block.—A block with two sheaves.

Double Gimbals.—See "Gimbals."

Doubling Plank.—To put one thickness of plank over the other.

Douse or Dowse.—To lower away suddenly, to take in a sail suddenly. "Dowse the glim;" to put out a light.

Dove-tail Plates.—Plates in form like a dove's tail.

Dowell.—A hard wood or metal pin used for connecting timber or the edges of plank.

Downhaul.—A rope used for hauling sails down.

Down Helm.—An order to put the helm to leeward and cause the vessel to luff.

Down Oars.—The order given for the crew of a boat to let fall their oars after having them on end in the boat.

- Down Wind.**—Sailing in the direction of or with the wind; before the wind; with the wind astern.
- Down Wind, Down Sea.**—The sea will subside when the wind does.
- Drag.**—The increased draught of water aft compared with the draught forward.
- Drag, To.**—To scrape the bottom; to search the bottom with grapnels.
- Draught of Water.**—The depth of a vessel to the extreme underside of the keel measured from the load water line.
- Draw.**—A sail is said to draw when it is filled by the wind. To let draw is to ease up the weather sheet of a sail after it has been hauled to windward, and trim the lee sheet aft.
- Draw Her to.**—An order to bring a vessel closer to wind.
- Dress.**—To dress ship is to hoist flags from deck to truck; or from bowsprit end to truck and taffrail.
To dress copper is to lay or smooth down wrinkles by going over it with a flat piece of hard wood and a hammer.
- Drift.**—To float about with the tide or current.
- Drift.**—The distance between two blocks of a tackle; the distance two parts of a thing are apart.
- Drive.**—To move to leeward by the force of the wind, or drive without control.
- Dry-rot.**—The decay timber is subject to, often through imperfect ventilation.
- Duck.**—Light canvas of which boat sails and balloon sails are made. To duck is to dive under water.
- Ducks.**—A sailor's white suit of duck.
- Dumb Cleat.**—A thumb cleat.
- Dump.**—A nail used in fastening plank to the timbers, as distinguished from a through-bolt.
- Dungaree or Dongaree.**—A blue linen or cotton cloth in use in India, now much used for the rough or working suits given to yacht sailors.
- Dunnage.**—Loose material such as cork, bamboo, shavings, ferns, coir, &c., used to jam in between a heavy cargo such as casks, iron, &c.
- Dynamometer.**—An instrument to measure forces.

E.

- Earings.**—Ropes used to fasten the corners of the heads of sails to the yards, by the cringles. The upper corners of sails are frequently termed earings. (See "Reef Earings.")
- Ears of a Bolt.**—The lugs or upper projections of a bolt with a score in it, into which another part is fitted and held by a through pin so as to form a joint like that of a gooseneck.
- Ease Away.**—The order to slacken a rope, &c.; to ease off a sheet, to ease up a sheet, are synonymous terms, and mean to slacken. (See "Check.")
- Ease the Helm.**—The order given when sailing against a head sea to ease the weather helm, and by luffing meet the sea bow on, and at the same time deaden the ship's way so that the sea and ship meet less violently. Generally to put the helm amidship, or more amidship after it has been put to port or starboard.
- Eating a Vessel out of the Wind.**—When two vessels are sailing in company, and if one soaks or settles out to windward of the other she is said to eat her out of the wind. In reality, to make less leeway than another vessel.
- Eating to Windward.**—A vessel is said to eat to windward when she apparently soaks out to windward of her wake.
- Ebb.**—The receding of the tide.
- Eddy.**—Water or currents of air apparently moving in circles.
- Edge Away.**—To gradually keep a vessel more off a wind after sailing close hauled.
- Edge Down on a Vessel.**—To bear away towards a vessel to leeward, so as to approach her in an oblique direction.
- End for End.**—To shift a spar, rope, &c., by reversing the direction of the ends.
- End On.**—Said of vessel when she has an object bearing in a line with the keel, directly ahead of the bow. On approaching a mark or buoy it is said to be end on if it is directly ahead of the vessel, the bowsprit will then point to the object, hence it is sometimes said that an object is "right on for the bowsprit end."
- Ensign.**—A flag flown as a distinguishing mark of nationality. The red ensign, with "Union Jack" in the upper corner of the hoist, is the English national flag; but the ensign of the Royal Navy is white with red St. George's cross in it besides the Jack in the corner; this is called "St. George's ensign." Prior to 1856 the red (highest in rank) white and blue ensigns were used in the Royal Navy, and there were Admirals of the Red, Admirals of the White, and Admirals of the Blue; and there were Vice and Rear Admirals of the red, white, and blue. A fleet was divided into red, white, and blue divisions, according to the rank of the Admirals who commanded. In 1855 the red ensign was allotted to the British Mercantile Marine, the blue ensign to the Royal Naval Reserve, and the white ensign to the Royal Navy. However, the white and blue ensign had always been reserved for the exclusive use of H.M.'s navy, and other vessels could not use either without an Admiralty warrant.
- In the Royal Navy it was etiquette, when an Admiral was on board his ship, to fly the white ensign from the main truck, Vice-Admiral from the fore truck, and Rear-Admiral mizen truck. Admirals now fly St. George's Jack (which see) from the main, fore, or mizen, according to rank. A Union Jack is carried at the stem head or bowsprit end (all ships of the Royal Navy now so carry a Jack). When a council of war is being held on board

a flag-ship, the white ensign is displayed in the main, fore, or mizen shrouds, according to the rank of the Admiral. If there is to be an execution after a Court Martial, the white ensign is hoisted on the main, fore, or mizen yard arm. Ships of the Royal Navy at the approach of Royalty, or whilst saluting, "dress" ship, by hoisting St. George's ensign at the fore, main, and mizen trucks.

If an ensign other than the red be flown by any vessel without a warrant from the Admiralty, a penalty of 500*l.* may be inflicted, and any Custom House or Consular officer or other officer in H.M.S. on full pay may board the vessel and seize the flag. Although the red ensign has been assigned to the mercantile marine, no device can be put in it other than the Jack without the permission of the Admiralty.

The jurisdiction of the Admiralty only extends to flags flown afloat, and any ensign can be hoisted on flagstuffs on shore.

When a warrant is granted to a club to fly the white, blue, or the red ensign with a device, this warrant does not of itself entitle a member of the club to fly either ensign on board his yacht; before he can legally do so he must also obtain a warrant from the Admiralty through the club secretary. As many warrants must be obtained as he belongs to clubs if he desires to fly the flag of each club. When the yacht is disposed of, the warrants must be returned through the club secretary to the Admiralty, and if the owner obtains a new yacht he must get fresh warrants.

Prior to 1858 the Royal Western Yacht Club of Ireland flew the white ensign with a wreath of shamrock in it. In 1847, the privilege of flying the white ensign was accorded to the Royal St. George's Yacht Club, Kingstown, but was afterwards rescinded upon a representation by the Royal Yacht Squadron that that club by its warrant of 1829—(prior to 1829, the R.Y.S. flew the red ensign)—had the exclusive privilege of flying the white ensign. In 1853 an application was made in Parliament to know if the R.Y.S. had that exclusive privilege. The first Lord of the Admiralty said it had not, inasmuch as the privilege had also been extended to the Royal Western of Ireland in 1832, and was still enjoyed by that club. (But it does not appear that the Royal Western ever applied for a separate warrant for a yacht to fly the white ensign. In 1858 the Royal St. George's Yacht Club (also the Holyhead) again applied for permission to fly the white ensign; the permission was not granted, and the Admiralty informed the Royal Western that they were no longer to use it; on making search at the Admiralty, it was found that in 1842 a decision was come to restricting the white ensign to the Royal Yacht Squadron; and the clubs affected by the decision were informed of it accordingly, but the Royal Western of Ireland was not interfered with, because up to that time no application for separate warrants from the club for yachts to fly the ensign had been received; and further

in 1853, the Royal Western obtained permission to continue to use the ensign. However, in 1858, the Admiralty revoked that permission, and since that date no club excepting the R.Y.S. has been permitted to fly the St. George's ensign. It would be much better if the Admiralty only issued warrants to fly the blue ensign without device, and cancelled all existing warrants that gave permission to put devices in the red ensign. (See "Admiralty Warrants," "Royal and Recognised Clubs," "Burgees.")

Ensign for Hired Transports.—The blue ensign with admiralty anchor (yellow) in the fly.

Ensign, Hoisting of.—Ensigns and burgees are hoisted every morning at eight o'clock (9 a.m. from September 30 to March 31), and hauled down at sunset. It is a slovenly habit to hoist and haul down colours at irregular hours. At sea it is only usual to hoist colours when passing another vessel.

Ensign of the Colonies.—The blue ensign with arms or badge of colony in it.

Ensign of Naval Reserve.—The blue ensign.

Entrance.—The fore part of a vessel, the bow. A good entrance into the water means a long well-formed bow.

Entrance Money.—The money demanded by clubs from yacht owners, who enter their vessels for match sailing at regattas.

Entry.—The record that a yacht is engaged for a particular match.

Equipment.—The complete outfit of a vessel including everything used in her handling, working, and accommodation. The inventory comprises the equipment.

Even Keel.—Said of a vessel when she is not heeled either to port or starboard, also when her keel is horizontal, that is when she is so trimmed that her draught forward is the same as aft.

Every Stitch of Canvas Set.—When all available canvas that will draw is set.

Extreme Breadth.—The greatest breadth of a vessel from the outside of the plank on one side to the outside of the plank on the other side, wales and doubling planks being included and measured in the breadth.

Eye Bolt.—(See "Bolts.")

Eyelet Holes.—Small holes worked in sails for lacing, &c., to be rove through.

Eyes of Her.—The extreme fore end of the ship near the hawse pipes, which are the "eyes of her."

Eyes of the Rigging.—The loops spliced into the ends of shrouds to go over the mast, and dead eyes.

Eye Splice.—The end of a rope turned in so as to form an eye.

F.

Fag End. When there is "nothing left of the rope but the end." The frayed-out end of a rope.

Fairing a Drawing.—A process by which the intersections of curved lines with other lines

- in the body plan, half-breadth plan, and sheer plan are made to correspond. A fair curve is a curved line which has no abrupt or unfair inflexions in it.
- Fair Lead.**—When the fall of a rope leads fairly, without obstruction, from the sheave hole. Also a "lead" made for a rope through a sheave hole or through any other hole.
- Fair Leaders.**—Holes in plank, &c., for ropes to lead through, so that they lead fairly and are not nipped or formed into a bight.
- Fairway.**—The ships' course in a channel. The navigable channel of a harbour as distinct from an anchorage in a harbour. A harbour master's duty is to see that the fairway is kept clear, and that no vessels improperly anchor in it. A fair way is generally buoyed.
- Fair Wind.**—A wind by which a vessel can proceed on her course without tacking; it may range from close-hauled point to dead aft.
- Fake, A.**—One of the rings formed in coiling a rope. The folds of a cable when ranged on deck. To fake is to arrange in folds.
- Fall.**—The loose end of the rope of a tackle, the hauling part of a tackle; also applied generally to the tackle of the bobstay and the topmast backstays.
- Fall Aboard.**—One ship sailing or driving into another. A sail is said to fall aboard when the wind is so light that it will not stay blown out.
- Fall Astern.**—The same as drop astern. When two vessels are sailing together, if one falls to keep company with the other by not sailing so fast.
- Fall Off.**—To drop away from the wind; when a vessel is hove to she is said to fall off if her head falls to leeward, in opposition to coming to; also when a vessel yaws to windward of her course and then falls off to her course or to leeward of it. Not used in the sense of breaking off, which means when the wind comes more ahead and causes an alteration in the direction of a vessel's head to leeward of a course she had previously been sailing.
- Fall To.**—To join in hauling, to commence work.
- Falling Tide.**—The ebbing tide.
- False Keel.**—A piece of timber fitted under the main keel to deepen it or protect it when taking the ground.
- False Tack.**—A trick sometimes practised in yacht racing when two vessels are working close hauled together, and one has been "weather bowing" the other every time they went about. To be rid of this attention the crew of the vessel under the lee quarter of the other makes a sudden move as if about to tack; the helm is put down and the vessel shot up in wind; the other vessel does the same and probably goes on the opposite tack; if she does so the former vessel falls off on her original tack, and the two part company. To shoot up in the wind and fall off on the same tack again.
- Fashion Timbers.**—The timbers which form the shape or fashion of the stern.
- Fast.**—Made fast by belaying. (See "Branst Fast," "Bow Fast," "Quarter Fast.")
- Fastenings.**—The bolts, nails, &c., by which the framing and planking of a vessel are held together.
- Fathom.**—A sea measure of six feet. To fathom a thing is to arrive at the bottom of it, to understand it.
- Fay, To.**—To join pieces of timber together very closely. Plank is said to fay the timbers when it fits closely to it.
- Feather Edge.**—When a plank or timber tapers to a very thin edge, "tapering to nothing."
- Feathering.**—Turning an oar over on its blade as it comes out of the water.
- Feeling her Way.**—Proceeding by sounding with the hand lead.
- Feel the Helm.**—In close hauled sailing when a vessel begins to gripe or carry weather helm. Also, generally, when a vessel begins to gather head way, so that she can be steered, or "feel her helm."
- Feint.**—To pretend to tack. (See "False Tack.")
- Fender.**—A sort of buffer made of rope, wood, matting, or other material to hang over the side of a vessel when she is about to come into contact with another vessel or object.
- Fend Off.**—To ward off the effects of a collision by placing a fender between the vessel and the object which is going to be struck.
- Fetch Away.**—To slip or move without intention. To fetch sternway or headway is when a vessel begins to move ahead or astern.
- Fetch.**—In close hauled sailing when a vessel arrives at or to windward of any point or object, as "she will fetch that buoy in two more boards," or "she will fetch the mark this tack," &c.
- Fid.**—A bar of wood or iron used to keep topmasts and bowsprits in their places. (See pp. 131 and 132.)

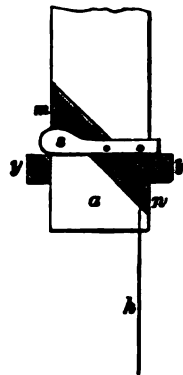


FIG. 137.

A plan of fid is used by the south coast fishermen as shown in the annexed sketch:

a is the topmast; *y y* the yoke or lower cap; *s* is an iron fid, one end being loaded as shown. The fid is pivoted nearly in the centre, the shorter arm being the lighter. *m* and *n* are slots cut in the topmast. *k* is a small line passing up through a hole in the heel of the topmast, and attached to the heel rope until, by pulling on the line *k* the fid is brought into an oblique position in the slots *m* and *n*; the topmast can then be lowered through the cap. In sending the topmast up the line *k* must of course be kept taut.

The plan recommended on page 132, and illustrated thereon by Fig. 36, is to be preferred; as if anything happened to this line *k* some one would have to go aloft to unfid. As the advantage of such contrivances depends almost entirely on being able to unfid without going aloft, the plan referred to on page 132 is to be recommended in preference to the one here given.

Fidded.—When the fid has secured the topmast or bowsprit in its proper place.

Fiddle Block—A long block with one sheave above another.

Fiddle Head.—The curved part of the knee at the upper fore part of the stem in schooners, turned upwards aft like the curly part of a fiddle head. A scroll head turns downwards.

Fill, To.—When a vessel has been sailed so close to wind that the sails have shaken, and the helm being put up the sails are "filled" with wind. In getting underway after being hove to a vessel is said to fill, or to have been "filled upon."

Fillings or Filling Timbers.—Pieces of wood or timbers used to fill various spaces that may occur in ship building.

Fine.—To sail a vessel "fine" is to keep her so close to the wind that her sails are on the point of shaking; considered sometimes good sailing if done with great watchfulness. Too fine means too near the wind.

Fire Escape.—A term applied to chaplains by sailors. (See "Sky Pilot.")

Fish, To.—To strengthen or repair a damaged spar by lashing a batten or another spar to it.

Fisherman's Bend.—(See "Knots.")

Fisherman's Walk.—When there is very little deck room, "Three steps and overboard."

Fishing Tackle.—The lines, hooks, sinkers, &c., used by fishermen. Messrs. Hearder and Son, of 195, Union-street, Plymouth, publish a book giving a full description of all the lines, nets, &c., necessary for a yacht, with instructions for using the same. The book can be had on application to Messrs. Hearder.

Fitting Out.—Getting a ship's rigging, sails, &c. into place after she has been dismantled.

Fitted Out.—When a vessel is "all-a-taunto," which see. A vessel ready to proceed to sea.

Flag Officer.—An Admiral, Vice-Admiral, or Rear-Admiral; also the Commodore, Vice-Commodore, or Rear-Commodore of a club.

Flags.—Pieces of bunting of various forms, colours, and devices, such as ensigns, jacks, burgees, &c.

Flags, the size of.—The size of the racing flags usually carried is as under:

| Tons. | ft. in. | ft. in. | Tons. | ft. in. | ft. in. |
|-------|---------|---------|-------|---------|---------|
| 5 | 1 6 | by 1 0 | 60 | 3 0 | by 2 3 |
| 10 | 1 9 | by 1 2 | 100 | 3 6 | by 2 9 |
| 20 | 2 3 | by 1 9 | 150 | 4 0 | by 3 3 |
| 40 | 2 9 | by 2 0 | 200 | 4 6 | by 3 9 |

and above 200 tons the same.

Flare.—To project outwards, contrary to tumbling home.

Flat Aback.—In square rigged ships when all the yards are trimmed across the ship, with the wind ahead so as to produce sternway.

Flat Aft.—When sheets are trimmed in as close as the vessel will bear for close hauled sailing.

Flat Floored.—When the bottom timbers or floors of a vessel project from the keel in a more or less horizontal direction.

Flatten in Sheets.—To haul in the sheets.

Fleet, To.—To overhaul a tackle or separate the blocks after they have been hauled close together.

Float.—To rest on the surface of the water, contrary to sinking.

Floating Anchor.—Although floating anchors are continually referred to in old writings as a means whereby many ships have been enabled to ride out very heavy gales in comparative ease, we seldom hear of their being used now. No doubt many a ship has been lost through getting broadside on to the sea, whereas they might have kept bowing the sea by such a simple contrivance as a floating anchor. However, masters, it would seem, prefer to heave-to, as they like to keep their vessels under command. In a very heavy sea and gale a floating anchor may be of very great service, and no doubt if a vessel can be kept bow to the sea, she will feel the violence of it in a much less degree than she would if hove-to when she might be continually flying-to against the sea after falling off.

Many plans for floating anchors have been used, the simplest being thus made; three spars, in length about two-thirds the beam of the vessel, were lashed together by their ends in the form of a triangle; over this triangle a jib made of stout canvas was lashed. Then to each corner of the triangle a rope was made fast; the ends of these ropes were then bent to a hawser, and thus formed a kind of bridle. A weight was attached to one corner of the triangle to keep it in a vertical position; veer out the hawser and ride to 30, 50, or 70 fathoms, according to the sea.

The most approved plan of making a floating anchor is shown by the diagram; *k, m, n, o*, are the ends of two iron bars formed into a cross, and connected by a stout bolt, nut, and pin at their intersections *s*. At each end of the bars is a hole through which a strong rope is rove, hauled taut, and well secured. Thus a square is formed, and over the square a piece of stout canvas is laced to the roping. Four

stout ropes are made fast to the iron bars, and make a sort of bridle or orow foot, the other ends being bent to a ring α . The ends should be well seized or "clinched." The hawser is bent to this ring to ride by. To

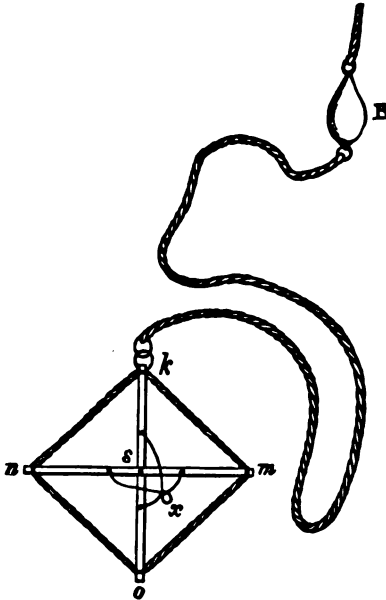


FIG. 188.

prevent the anchor sinking a buoy, B, is made fast attached to one corner with 6 or 7 fathoms of drift; this buoy will also prevent the anchor "diving" (as it would, like a kite flies into the air) when a strain is

line p ; this will bring the anchor edgeways, and it can then be readily hauled in.

Floating Dock.—Upon lakes, where there are no tides, and no convenience for hauling a yacht up, a floating dock may be of service to get at a yacht's bottom. The dock would be rectangular in form, of which [] might be a transverse section, and its size would depend upon the weight of the yacht that had to be docked. The weight of the yacht can roughly be arrived at thus: length on load line, multiplied by beam on load line, multiplied by draught of water to rabbet of keel; the product in turn being multiplied by the fraction 0.3. The decimal .3 is used, as that fairly allows for the quantity cut away from the cube in modelling. Say the yacht is 40ft. long, 8ft. broad, and 6ft. deep to the rabbet in the keel, then $40 \times 8 \times 6$, equal to 1920 cubic feet. 1920 multiplied by 0.3 is equal to 576 cubic feet. There are 35 cubic feet of salt water to one ton, and 576 divided by 35 is equal to 16.4 tons. (There are 36 cubic feet of fresh water to one ton.) A dock 50ft. long, 16ft. broad, and immersed 2ft., would (omitting of course the reduction by the factor .3, as the dock would be a cube) be equal to 45 tons; the weight of the dock made of 4-inch deal, would be, if the sides were 10ft. deep, about 20 tons; this would leave a margin of 25 tons for floating at 2ft. draught. A false bottom and sides 2ft. deep would have to be made in the dock; also a door at one end hinged from its lower edge, level with the top of the false bottom, and rabbeted at the sides. To get the yacht in the dock lower the door and fill the false bottom and sides with water until the dock sank low enough to be hauled under the keel of the yacht; then close the valve which lets the water in,

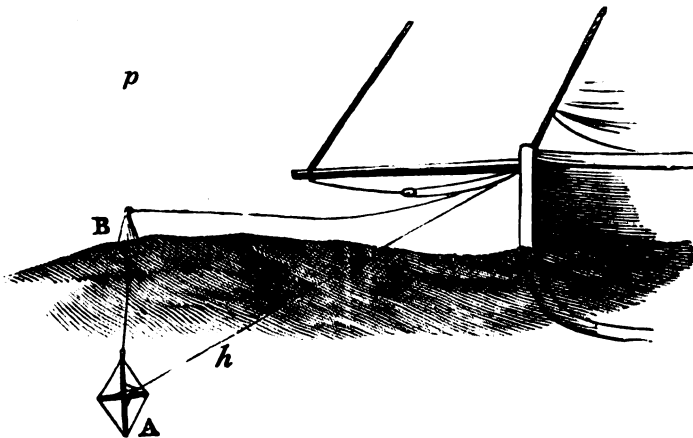


FIG. 189.

brought upon it. The buoy rope p should lead on board; h is the hawser to which the vessel is riding, A is the anchor, and B the buoy.

To get the anchor on board haul in on the

shut the door and pump the water out of the false bottom and sides (a hose for the pump should be used in case the dock sank). The yacht should be shored up from the sides of the dock before she took any list. With

caution such a contrivance could be used for floating a deep draught yacht over shallows from one lake to another, or through canals; in such cases, if the draught of water for going over the shallows were not limited to 2ft., it would be well to keep the false bottom full or partially full of water.

Flood Tide.—The rising tide, contrary to ebb.

Floors.—The bottom timbers of a vessel.

Flotsam.—The cargo of a wreck that may be floating about or liberated from the wreck.

Flowing sheet.—In sailing free, when the sheets are eased up or slackened off.

Flowing tide.—The rising tide, the flood tide.

Fluid compass.—A compass card in a basin of fluid, usually spirit, used in rough weather because the card should not jump about. In a small yacht a good and steady compass is an essential part of the outfit, and if there be any sea on the usual compass card and bowl are perfectly useless to steer by. The fluid compass then becomes necessary, and frequently a "life boat" compass, which costs about 5*l.*, is used. A more yacht-like looking liquid compass, however, is one sold by Mr.



FIG. 190.

C. Wilson, 157, Leadenhall-street, price 6*l.* 6*s.*, shown by Fig. 190. The extreme height is only 1ft. 2in., and the card remains steady under the most trying circumstances of pitching and rolling.

Flukes.—(Pronounced "fines" by seamen). The barb-shaped extremities of the arms of an anchor.

Flush deck.—When the deck has no raised or sunken part.

Fly.—The part of a flag which blows out; the opposite side to the hoist; the halyards are bent to the hoist.

Flying jib.—A jib set in vessels on the flying jib-boom. There is then the jib, the outer jib and flying jib or inner jib, jib and flying jib; probably called flying jib because unlike the others it is not set on a stay.

Flying light.—Said of a vessel when she has been lightened in ballast so as to float with her proper load-line out of water.

Flying start.—In match sailing a start made underway. (See page 214.)

Flying to.—When a vessel in sailing free, luffs suddenly, or comes to suddenly; also after tacking, if a vessel's head is kept much off the wind, and the helm be put amidships, the vessel will fly to, *i.e.* fly to the wind quickly. A vessel that carries a hard weather helm will fly to directly the tiller is released.

Fly up in the Wind.—When a vessel is allowed to come head to wind suddenly.

Foot.—The lower edge of a sail.

Fore.—Front; the contrary of aft; the forward part.

Fore-and-aft.—Running from forward aft, in a line with the keel.

Fore-and-aft rig.—Like a cutter or schooner without yards, with all the sails tacked and sheeted in a line with the keel.

Fore-body.—The fore part of a ship which is forward of the greatest transverse section.

Forecastle.—The space under deck before the mast allotted to the seamen.

Fore Deck.—The deck before the mast.

Fore Foot.—The foremost part of the keel at its intersection with the stem under water.

Fore Guy.—The stay of a squaresail boom or spinnaker boom which leads forward.

Foremast.—The mast which occupies the most forward position in a vessel.

Fore Peak.—The fore-castle, a space decked over forward in a small boat to stow gear in.

Fore-rake.—The rake the stem has forward beyond a perpendicular dropped to the fore end of the keel.

Fore-reach.—When one vessel reaches past or sails past another; generally applied in close-hauled sailing. Thus it is frequently said that one vessel "fore-reaches but does not hold so good a wind as the other;" meaning that she passes through the water faster but does not or cannot keep so close to the wind. A vessel is said to fore-reach or head-reach fast that is noted for great speed when sailing by the wind. (See "Head Reach.")

Foresail.—In square rigged ships the large lower-sail set on the foremast; in cutters the triangular sail or jib foresail set on the fore-stay; in fore-and-aft schooners the gaff sail set abaft the foremast.

Fore-staysail.—The jib foresail set on the fore-stay of schooners; properly "stay-foresail."

Foresheet.—The sheet of the foresail.

Foresheet horse.—An iron bar for the foresheet to work upon.

Fore-topman.—In a schooner yacht a man stationed aloft to work the fore-topsail tack and sheet in going about.

Fore-topmast.—The topmast over the foremast.

Foreyard.—The yard on the foremast for setting the foresail in square-rigged ships.

Forge ahead.—When a vessel that is hove to gathers way; generally when a vessel moves past another.

Foul.—Entangled, not clear.

Foul Anchor.—When an anchor gets a turn of the cable round its arms or stock; when imbedded among rocks, &c., so that it cannot be readily recovered.

Foul Berth.—When two vessels that are anchored or moored have not room to swing without fouling each other. If a vessel is properly moored and another comes and fouls her berth she is held liable for any damage which may ensue.

Foul bottom.—A rocky bottom; also the bottom of a ship when it is covered with weeds, &c.

Frames.—The timbers or ribs of a vessel.

Frapping.—A rope put round the parts of a tackle to draw them together and prevent them overhauling. Frequently a frapping is put on the parts of the head sheets of a yacht to draw them down to the sail, and thus bring a strain on the leech and foot.

Free.—Not close hauled. When a vessel is sailing with a point or two to come and go upon. The wind is said to free a vessel when it enables her to check sheets so as to be no longer close hauled. Also when it enables a vessel that is close hauled to lie nearer her course.

Freeboard.—The side of a vessel which is above water.

French Nautical Terms—

| | |
|----------------|-------------|
| Keel..... | Quille. |
| Stem..... | Étrave. |
| Sternpost..... | Etambot. |
| Budder..... | Gouvernail. |
| Bulwarks..... | Pavois. |

| SPARS. | ESPARS. |
|--------------------------------|---|
| Mainmast..... | Grand mât. |
| Topmast..... | Mât de fûche. |
| Bowprit..... | Beaupré. |
| Mizen mast..... | Mât de tapecul. |
| Main boom..... | Bôme ou guy. |
| Gaff peak..... | Corne ou pic. |
| Mains yard $\frac{1}{2}$ | Vergue de tapecul. |
| Bumpkin..... | Bout dehors de tapecul. |
| Topmast yard..... | Vergue de fûche. |
| Spinnaker boom..... | Tangon de spinnaker ou de vent-arrière. |

| STANDING RIGGING. | MANGUÈVES DORMANTES. |
|----------------------|--------------------------------|
| Forestay..... | Grand étai. |
| Topmast stay..... | Étai de mât de fûche. |
| Shrouds..... | Haubans. |
| Topmast shrouds..... | Galhaubans. |
| Bunner tackle..... | Bastaque. |
| Bobstay..... | Sous-barbe. |
| Backstay..... | Patacas ou galhaubans volants. |

| RUNNING RIGGING. | MANGUÈVES COURANTES. |
|-----------------------------------|----------------------|
| Boom topping lifts..... | Balancines. |
| Sheets..... | Écoutes. |
| Main or throat halyards..... | Drisse de mât. |
| Peak halyards..... | Drisse de pic. |
| Spinnaker boom brace..... | Braç du tangon. |
| Spinnaker boom guy..... | Retenue du tangon. |
| Spinnaker boom topping lifts..... | Balancine du tangon. |
| Davits..... | Pistoleta. |

| SAIJS. | VOILES. |
|--------------------------------|--------------|
| Mainmast..... | Grand voile. |
| Gaff topsail..... | Fûche. |
| Jib topsail or flying jib..... | Clin-Foc. |
| Jib..... | Foc. |
| Foremast..... | Trinquette. |
| Mizen..... | Tapecul. |

| MAINSAIL. | GRAND VOILE. |
|----------------------------|--------------|
| Mainmast..... | Mât. |
| Gaff..... | Corne. |
| Boom..... | Bôme ou guy. |
| Luff or weather leech..... | Guindant. |

| | |
|--|--|
| Head..... | Tête. |
| Leach or after leach..... | Chute arrière. |
| Foot or roach of sail..... | Bordant. |
| Tack..... | Point d'amure. |
| Clew or clus..... | Point d'écoute. |
| Throat..... | Empointure du mât. |
| Peak earing..... | Empointure du pic. |
| First, second, third, and close reef cringles..... | Cosses d'empointures des 1 ^{re} , 2 ^e , 3 ^e , 4 ^e ris. |
| Reef knittles or points..... | Hanets ou garcettes de ris. |

| GAFF TOPSAIL. | FLECHE POINTU. |
|------------------------|--------------------|
| Leach..... | Chute. |
| Halyards..... | Drisse. |
| Gaff topsail boom..... | Balestron. |
| Clew..... | Point d'écoute. |
| Tack..... | Point d'amure. |
| Truss..... | Collier de racage. |
| Weather leach..... | Guindant. |
| Yard..... | Vergue. |
| Backstay..... | Étai de fûche. |
| Foot..... | Bordant. |

| SQUARE TOPSAIL. | FLECHE CARRE. |
|---------------------|------------------------------------|
| Yard and head..... | Vergue de fûche et ratine de tête. |
| Leach..... | Chute arrière. |
| Luff..... | Chute avant. |
| Foot..... | Bordant. |
| Tack..... | Point d'amure. |
| Clew..... | Point d'écoute. |
| Head..... | Point de ris. |
| Tack pendant..... | Pantoire d'amure. |
| Sheet pendant..... | Pantoire d'écoute. |
| Clew-line..... | Cargue. |
| Traveller..... | Rocambeau. |
| Bowline bridle..... | Patte de bouline. |
| Bowline..... | Bouline. |

HULL.

| COQUE D'UN BATEAU. | |
|-------------------------|--------------------|
| Keel..... | Quille. |
| Keelson..... | Carlingue. |
| Stem..... | Étrave. |
| Forefoot..... | Bron. |
| Sternpost..... | Etambot. |
| Arch board..... | Barre d'hourdi. |
| Long stern timbers..... | Allonges de voûte. |
| Budder..... | de tableau. |

| | |
|----------------------|-------------------|
| " Afterpiece..... | Safran. |
| " Spindle..... | Mèche. |
| " Helm..... | Barre. |
| Helm-port..... | Trou de jannière. |
| Beam..... | Barrots ou banc. |
| Deck..... | Pont. |
| Bits..... | Bittes. |
| Windlass..... | Guindeau. |
| Partners..... | Etambrai. |
| Strep..... | Emplanture. |
| Frame..... | Des membres. |
| " Floor timbers..... | Varangue. |
| " Timbers..... | Genou. |
| " Futtock..... | Allonge. |

| | |
|----------------------|-----------------------|
| Stanchions..... | Jambette. |
| Rail..... | Lisse. |
| Knees..... | Courbe. |
| Gunwale..... | Plat-bord. |
| Scuppers..... | Dalots. |
| Planking..... | Bordage. |
| Wales or bends..... | Précointe ou carreau. |
| Channel..... | Porte-hauban. |
| Chain plates..... | Cadène de hauban. |
| Garboard strake..... | Gabard. |
| Rabbit..... | Rabure. |
| Inboard plank..... | Valgrage. |
| Clamp..... | Banquière. |
| Bulwarks..... | Pavois. |
| Flooring..... | Plancher. |
| Bending strake..... | Hilote. |
| Skylight..... | Claire-voie. |

| JIBS. | FOCS. |
|--------------------------------|--------------------------------|
| Jib..... | Foc. |
| Foremast..... | Trinquette. |
| Flying jib or topsail jib..... | Foc volant ou foc en l'air. |
| Spinnaker..... | Spinnaker. |
| Halyards..... | Drisses. |
| Head..... | Points de drisse. |
| Clew or clus..... | Points d'écoute. |
| Tack..... | Points d'amure. |
| Sheet pennant and blocks..... | Pantoires et poulies d'écoute. |
| Jib purchase..... | Etarque de foc. |

Flying jib tack Amure de foc volant.
 Sheets Ecoutes.
 Main stay and hanks Grand étai, servant de
 draille, et bagnes.
 Topmast stay..... Étai du mât de flèche.
 Foresail bowline Bouline de trinquette.
 Inhaul of the traveller ... Hâle-à-bord.
 Foresail downhaul Hâle—bas de trinquette.
 Bobstay and tackle Sous-barbe et son palan.
 Bowsprit shrouds Haubans de beaupré.
 Foresail tack tackle Palan d'amure de trin-
 quette.

MAINMAST.
 Iron cap
 Top rope sheave
 Eye-bolt
 Jib halyard clamp
 Galloways bitt
 Yoke
 Crossrees
 Tressle trees
 Cheeks
 Topping lift clamp
 Spider hoop
 Mast coat.....
 Masthead.....

BOOM.
 Boom
 Boom iron
 Main tack
 Main tack cleat.....
 Reef tackle cleat
 Main sheet strop
 Topping lift strop.....
 Reef earing bee blocks ...
 Clew traveller on the boom
 Main sheet clamp

TOPMAST.
 Heel
 Fid
 Top rope sheave
 Traveller
 Halyard sheaves
 Top rigging
 Pole
 Truck

BOWSPRIT.
 Bowsprit heel
 Fidd
 Traveller
 Ironwork
 Jib tack

GAFF OR PEAK.
 Throat.....
 Truss
 Sheet sheave
 Peak halyard strop

MISCELLANEOUS.
 Forward
 Aft
 Fore and aft
 Athwart
 Starboard
 Port
 Below
 Aloft
 Avas
 Crew
 Boatwain
 Sailmaker
 Carpenter
 Steward
 Cook.....
 Seaman
 Boy
 Belay!
 Let go!
 Hoist away!
 Lower away!
 Haul!
 Handsomely
 Hold on
 Heave away
 Slack
 Bear a hand
 Foul.....

BAS-MAT.
 Blin
 Clan de guinderesse.
 Pitons de pouilles (pic).
 Laitte de drisse de foc.
 Potence.
 Chouque.
 Bare de hune.
 Elongia.
 Jottereaux.
 Galoche de balancine.
 Cercle du mât.
 Braie.
 Ton.

BOMME OU GUL.
 Bôme.
 Ferrure.
 Amure de grand-voile.
 Taquet d'amure de grand
 voile.
 Taquets d'Itagnes de ris.
 Estrope de grande écoute,
 ou d'écoute de guy.
 Estrope de balancines.
 Violons de ris.
 Bocombeau d'écoute.
 Clan d'écoute de grand-
 voile.

MAT DE FLECHE.
 Caisse.
 Clef.
 Clan de guinderesse.
 Bocombeau.
 Clans de drisses.
 Capelages.
 Fusée.
 Pomme.

BOUT DEHORS OU BEAUPRE.
 Talon.
 Clef.
 Bocombeau
 Frette.
 Clan d'amure de foc.
CORNE OU PIC.
 Mâchoire.
 Collier de racage.
 Clan d'écoute de flèche.
 Estropes de drisse de pic.

De l'avant.
 De l'arrière.
 De l'avant à l'arrière.
 Par le travers.
 Tribord.
 Babord.
 En bas.
 En haut.
 Tenez bon.
 Equipage.
 Maître d'équipage.
 Voller.
 Charpentier.
 Commis aux vivres.
 Cuisinier.
 Matelot.
 Mousse.
 Amarrés!
 Larguez!
 Hissez!
 Amenez!
 Hales!
 Docement
 Tenez.
 Vires.
 Filer.
 Vite.
 Embrouillé.

Weather gage Dessus le vent.
 Windward Au vent.
 Leeward Sous le vent.
 Catch hold Aitrappez.
 Look out Être en Vigie.
 All right Tout droit.
 Ready about Pare à virer.
 Hard up the helm! La barre au vent.
 Steady the helm! Comme cela!
 Let go the anchor Mouillez.
 Pay out the cable Filer de la chaîne.
 Right the helm Dresser la barre.

Fresh Breeze.—(See "Wind.")
Freshen.—To alter the strain upon a rope.
Freshen Hawse.—To veer out or heave cable, so
 that a different part will take the chafe of the
 hawse pipe.
Freshen the Nip.—To shift a rope, &c., so that
 its nip, or short turn, or bight, may come in
 another part. In slang, to quench a desire
 for drink.
Full.—When all the sails are filled with the wind
 and quite steady.
Full Aft.—When a vessel is said not to taper
 sufficiently aft.
Full and Bye.—Sailing by the wind or close
 hauled, yet at the same time keeping all the
 sails full so that they do not shake through
 being too close to wind. Generally a vessel does
 better to windward when kept a "good full and
 bye" than when nipped or starved of wind.
Full and Change.—(See "High Water.")
Full bowed.—The same as bluff bowed.
Furl.—To roll a sail up on a yard, &c.
Futtocks.—The timbers which abut above the
 floors called first, second, and third futtocks.
 This should properly be written foothooks.

G.

Gaff.—The yard to which the head of a fore-and-
 aft sail is bent. (See "Jaws.")
Gaff Topsail.—The topsail set over a gaff sail,
 such as the topsail set over a cutter's main-
 sail. Sometimes the sail has a head yard, and
 sometimes not. (See "Jib-Headed Topsail.")
Galley.—A long narrow rowing boat propelled by
 six or eight oars. A boat a little longer and
 heavier than a yacht's gig.
Galley or Galley Fire.—The caboose, or kitchen
 of a vessel.
Gammoning.—The lashings which secure the
 bowsprit to the stem piece, and are passed
 backward and forwards in the form of an X,
 over the bowsprit. Now, generally chainis used.
 In yachts, an iron band or hoop, called the
 gammoning iron or span-shackle, is fitted to
 the stem, through which the bowsprit passes.
Gammon Iron.—An iron hoop fitted to the side
 of the stem, or on top of the stem, as a span-
 shackle, to receive and hold the bowsprit.
Gangway.—The opening in the bulwarks, or side,
 through which persons enter or leave a vessel.
 Generally a passage, or thoroughfare of any
 kind. "Don't block up the gangway," is a
 common admonition to thoughtless people
 who stand about in passages or thoroughfares,
 to the impediment of passers.

Gangway Ladder.—The steps hung from the gangway outside the vessel. Sometimes there is also a board, or kind of platform, called the "Gangway Board."

Gant-line.—A whip purchase; a single block with a rope rove through it. A Gant-line is used to hoist the rigging to the masthead on beginning to fit out.

Garboard.—The strake of plank next above the keel into which it is rabbeted and bolted.

Garland.—A strop put round spars when they are hoisted on board.

Garnet.—A kind of tackle used for hoisting things out of the hold of vessels; also used for clueing up squaresails.

Gaskets.—Pieces of rope, sometimes plaited, by which sails when furled are kept to the yards. The pieces of rope by which sails are secured when furled, such as the tyers of the mainsail, by which that sail when rolled up on the boom, is secured. (See "Tyers.")

Gather Way.—When a vessel begins to move through the water, under the influence of the wind on her sails, or under the influence of steam. (See "Steerage Way.")

Gawlor.—An open boat which can either be rowed or sailed, common to Portsmouth watermen. They are very skilfully handled by the watermen, and go backwards and forwards to Spithead and elsewhere in all kinds of weather, and seldom meet with mishaps. They are sharp sterned, like the bow, and are rigged with sprit, main, and mizen, and jib-foresail. They have no boom to the mainsail.

Get a Pull.—To haul on a sheet or tack or fall of a tackle.

Getting Soundings Aboard.—Running aground.

Gig.—A long boat of four or six oars kept for the owner of a yacht. In gig races a boat should not be considered a gig if she has less than 1ft. of breadth for every 7ft. of length, and $\frac{1}{2}$ in. depth amidships for every foot of length. At the regatta held at Itchen-ferry by yacht-masters a "gig must not exceed 28ft. in length, and be in the proportions of 28ft. long, 4ft. broad, and 1ft. 8in. deep." A boat could be shorter if these proportions were maintained.

Gilling.—To gill a vessel along is to sail her very near the wind, so that very little of the weight of the wind is felt by the sails. The sails are kept lifting, and only bare steerage way kept on the vessel. A vessel is generally "gilled" through heavy squalls or through very broken water.

Gimbals.—The cross axles by which compasses, lamps, &c., are swung on board ship. Generally called "double gimbals." In Fig. 191 *a a* are the axles of the outer ring B, and *x x* of the inner ring M.

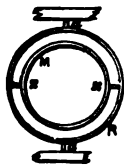


FIG. 191.

Girt.—To moor a vessel so that she cannot swing by tide or wind. To draw a sail into puckers; to divide the belly of a sail into bags as by a rope, such as the topping lift of boom.

Girt-line.—(See "Gant-line.")

Give Her.—A general prefix to an order, as "Give her sheet;" "Give her the jib-headed topsail;" "Give her chain," &c.

Give her the weight of it.—An admonition to a helmsman to sail a vessel a good heavy full when close-hauled.

Give Way.—The order to a boat's crew to commence rowing or to pull with more force or more quickly.

Giving the Keel.—Heeling over suddenly and bringing the keel near the surface; vessels that are not very stiff under canvas are said to "give the keel."

Glass.—The term by which a sailor knows the barometer. Also a telescope, and the sand glass used to denote half-hours on board ship, or the half-minute or quarter-minute glass used when heaving the log.

Glass Calm.—When it is so calm that the sea looks like a sheet of glass.

Glue for Paper.—For joining paper, cardboard, or model work, or similar articles, a good glue can be made thus: dissolve 2oz. of the best transparent glue in $\frac{1}{2}$ pt. of strong cider vinegar. Let it simmer slowly by placing the dish containing it in a dish of boiling water. When it has become liquid, add 1oz. of highest proof alcohol, and keep it tightly corked. If cold, heat in hot water when needed for use.

Go About.—To tack.

Go Ahead!—The order to the engineer of a steam vessel. Also "Go astern;" "Easy ahead;" "Easy astern;" "Stop her!"

Go Down.—To sink. To go down below.

Going Large.—The same as sailing with the wind free. (See "Large.")

Going Through Her Lee.—When one vessel overtakes and passes another vessel to leeward; considered to be a very smart thing for a vessel to do if they are close together and of equal size.

Good Conduct Money.—A donceur of one shilling or more a week given to men at the end of a season for good behaviour, and withheld for the week in which any offence or offences were committed. (See "Conduct Money.")

Good Full.—Same as "Clean Full," or little fuller than "Full and By."

Gooseneck.—An iron jointed bolt used to fix the end of booms to the mast, &c. (See Fig. 43, p. 154.)

Goose Wing.—A schooner "goose wings" when dead before the wind by booming out the gaff foresail on the opposite side to the mainsail. A practice not now in much use in racing, as the introduction of large squaresails and subsequently of spinnakers have made it unnecessary, but in America, where such sails are not allowed in matches, "goose-winging" is always resorted to. To goose-wing is to gybe the gaff foresail of a schooner to the opposite side to the mainsail. (See "Wing and Wing.")

Graduated Sail.—A sail whose cloths taper towards the head from the foot upwards; so

that a whole cloth forms the luff as well as the leech. Manufactured by Gordon, of Southampton, and Summers and Hewitt, of Cowes.

Granny Knot.—An insecure knot which a seaman never ties, but which a landsman is sometimes seen to do when trying his hand at reef knots. (See "Knots.")

Grapnel.—A grappling iron with four claws used to moor small boats by or to reach the bed of the sea.

Gratings.—Open woodwork put in the bottom of boats, in gangways, &c.

Graving.—Cleaning a vessel's bottom.

Graving Dock.—A dock which can be emptied of water by opening the gates as the tide falls, and its return prevented as the tide rises by closing the gates. Used for clearing the bottoms of vessels, repairing the same, &c.

Gravity.—Weight. For centre of gravity see page 6.

Great Guns.—A heavy wind is said to "blow great guns."

Green Hand.—A landsman shipped on board a vessel, and who has yet to learn his duties.

Green Horn.—A conceited simpleton, incapable of learning the duties of a seaman.

Green Sea.—The unbroken mass of water that will sometimes break on board a vessel as distinct from the mere buckets full of water or spray that may fly over her. Such bodies of water always have a green appearance, while smaller quantities look grey, hence we suppose the term.

Gridiron.—A large cross framing over which a vessel is placed at high water in order that her bottom may be examined as the tide falls.

Grin.—A vessel is said to grin when she dives head and shoulders into a sea and comes up streaming with water.

Gripe.—The forepart of the dead wood of a vessel; the fore foot.

Gripe, To.—A vessel is said to gripe when she has a tendency to fly up in the wind, and requires weather helm to check or "pay off" the tendency. (See "Weather helm.")

Grommet or Grummet.—A ring formed of a single

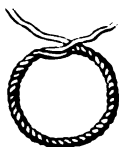


FIG. 192.

strand of rope laid over three times. Used for strops, &c.

Grounding.—The act of getting aground or taking the ground as the tide falls.

Ground Sea, Ground Swell.—The swell that may be seen along shore sometimes, whilst in the offing the sea is calm.

Ground Tackle.—The moorings, anchors, chains, &c., used in securing a vessel.

Ground Ways.—The blocks on which a vessel is supported whilst she is being built.

Gudgeons.—Metal eye bolts fitted to the stern post to receive the pintles of the rudder. (See "Braes.")

Gunwale.—In small boats the timber which fits over the timber heads, and is fastened to the top strake. (See "Inwale.")

Gunwale Under.—Heeling until the lee gunwale is in the water.

Guy.—A rope used to steady a spar or keep it in its position.

Gybing (also spelt jibing and jib-bing).—To keep a vessel so much off the wind that at last it blows on the opposite quarter and causes the sails to shift over. The opposite of tacking, which is to come to the wind until it blows on the opposite bow of the vessel to the one on which it has been blowing.

H.

Hail.—To speak to a ship at sea by signals or otherwise. To attract the attention of a ship by singing out "Ship ahoy!" or "Neptune ahoy." To "hail from" a locality is to belong to a particular place by birthright.

Half-breadth Plan.—A drawing showing the horizontal sections or water-lines of a vessel by halves.

Half-breadths.—The width of horizontal sections at particular points.

Half-mast High.—Hoisting a burgee or ensign only halfway up as a mark of respect to a person who has recently died.

Halyards or Halliards, or Haulyards.—Ropes or tackles for hauling up sails, yards, &c., by.

Hammock.—A canvas bed swung underneath the deck beams.

Hand.—To hand a sail is to stow, furl, or take in; hence a sail is said to be "handed" when either of these operations has been performed upon it.

Hand.—A man. A member of a ship's crew.

Hand Lead.—(See "Lead.")

Handle Her.—An admonition to the crew to be smart in working the sheets in tacking or gybing. Also a steamboat master is said to "handle" his vessel in bringing her alongside a wharf, pier, &c.

Hand over Hand.—Hauling on a rope by one hand at a time and passing one hand rapidly over the other to haul. A very rapid way of hauling, hence anything done rapidly is said to be done "hand over hand."

Hand over Fist.—(See "Hand over Hand.")

Hand Sail.—(See "Sailing on Skates.")

Handsomely.—Steadily; with care. Not too fast nor yet too slow, but with great care; cleverly. As "Lower away handsomely." In easing up a sheet, if the man is likely to let it fly, the master or mate will sing out, "Handsomely there!" meaning that the man is to ease up the sheet carefully, not letting too much run out nor yet letting it come up with a jerk nor yet allowing it to run away with him.

- Handspike.**—A bar of wood, usually of ash, used as a lever.
- Hand Taut.**—As tight or taut as a rope can be got by the hand without swigging upon it.
- Handy.**—A vessel is said to be handy when she answers her helm quickly, and will turn in a small circle, or go from one tack to the other quickly.
- Handy Billy.**—A watch tackle kept on deck for general use to get a pull on whatever is required, such as sheets, tacks, or halyards.
- Hang.**—To lean towards. To hang to windward is to make but little leeway. "Hang on here!" an order for men to assist in hauling on a rope.
- Hanging Compass.**—A compass suspended under the beams so that it hangs with the face of the card downwards; termed also a "Tell-tale Compass."
- Hanging Knees.**—Knees that help keep the beams and frame together; one arm is bolted to the under side of a beam, the other to the frame.
- Hank for Hank.**—Slang for "tack for tack."
- Hanks.**—Rings or hooks made of rope, wood, or iron for fastening the luff of sails to stays. Iron rings are usually used for the stay foresail; iron hooks for the balloon foresail and jib topsail.
- Harbour Master.**—An officer whose duty it is to see that vessels are properly berthed and moored in harbours. His authority cannot be disputed with impunity, as, in nine cases out of ten, if a dispute with a harbour master gets into court the decision will be for the harbour master.
- Harbour Watch.**—The watch kept on board a vessel at night when she is riding to an anchor in harbour; the anchor watch.
- Hard.**—A landing place usually made of gravel, piles, &c., across mud, as the "Common Hard," Portsea, where the small boats land and take in passengers.
- Hard Down.**—The order to put the helm hard-alee. Hard-a-port; hard-a-starboard; hard-a-weather; hard up.
- Hard Up.**—The tiller as far to windward as it can be got for bearing away.
- Hard In.**—Sheets are said to be hard in when a vessel is close-hauled.
- Harpings.**—Pieces of timber or battens that are fitted around the frames of a vessel in an unbroken line to keep the frames in their places before the plank is put on.
- Hatches.**—The coverings for hatchways or openings in the deck.
- Hatchway Coamings.**—The raised frame above the deck upon which the hatches rest.
- Haul.**—To pull on a rope.
- Haul Aboard the Boom!**—An order to get the main boom hauled in on the quarter for close-hauled sailing.
- Haul Aft the Sheets.**—The order to haul in the sheets for close-hauled sailing.
- Haul Her Wind.**—To become close-hauled after sailing free. Generally to sail closer to the wind when sailing free. Haul to the wind. Haul on the wind.
- Haul Round a Mark, Point, &c.**—When a vessel in sailing free has to come closer to the wind as her course alters round a point, buoy, &c. By hauling in the sheets the vessel will sometimes luff sufficiently without any help from the helm.
- Haul Up.**—To hoist a sail. A vessel is said to "haul up" when she comes, or is brought nearer the wind or nearer her course if she has been sailing to leeward of it. Haul up a point, haul up to windward of that buoy, &c.
- Hawse Pipe.**—The pipes in the hawseholes in the bow of a vessel through which the cables pass.
- Hawser.**—A large rope laid up with the sun or right-handed.
- Hawse Timbers.**—The large timbers in the bow of ships in which the hawseholes are cut.
- Head.**—The fore part of a vessel. The upper part of a sail. "By the head" means pressed or trimmed down by the head, in contradistinction of "by the stern." To head is to pass ahead of another vessel.
- Head Earings.**—The earings of the upper part of a squaresail, &c.
- Heading.**—The direction of a vessel's head when sailing. Generally used when sailing close hauled, as "she headed S.E. on port tack, and N.E. on starboard tack." In such cases it is never said she "steered S.E.," &c., as practically the vessel is not steered, but her course alters with the wind. A vessel "steers" such and such a course when she is sailing large.
- Headland.**—A high cliff or point.
- Headmost.**—The first in order.
- Head Reach.**—In sailing by the wind when a vessel passes another either to windward or to leeward. A vessel is said to "head-reach" when she is hove to, but forges ahead a knot or two an hour. (See "Fore-reach.")
- Head Rope.**—The rope to which the head of a sail is sewn.
- Head Sails.**—A general name for all sails set forward of the foremost mast.
- Head Sea.**—The sea met when sailing close-hauled. In the case of a steamship she may meet the sea stem on.
- Head Sheets.**—The sheets of the head sails.
- Head to Wind.**—When a vessel is so situated that the wind blows no more on one bow than the other; when her head is directly pointed to the wind.
- Head Way.**—When a vessel moves ahead through the water.
- Head Wind.**—A wind that blows directly down the course a vessel is desired to sail. A foul wind. To be headed by the wind is when the wind shifts so that a vessel cannot lie her course, or puts her head off to leeward of the course she had been heading.
- Heave.**—To bring a strain or drag upon a capstan bar, purchase, &c. To throw as "heave over-board."

Heave About.—To go into stays to tack.

Heave Ahead.—To draw a vessel ahead by heaving on her cable, warp, &c.

Heave-and-Away.—The last heave of the capstan that breaks the anchor out.

Heave in Stays.—The same as heave about.

Heave Short.—To heave on the cable until the vessel is over the anchor, or the cable taut in a line with the forestay, so that with another heave, or by the action of the sails, the anchor will be broken out of the ground.

Heave To.—To so trim a vessel's sails aback that she does not move ahead. The same as "lie to" or "lay to" as sailors call it.

Heave the Lead.—The order to cast the lead for sounding.

Heave the Log.—The order to throw the log ship overboard to test the rate of sailing.

Heel.—The lower after end of anything, as heel of the keel, heel of the mast (the fore part of the lower end of a mast is called the toe), heel of a yard, heel of the bowprit. The amount of list a vessel has.

Heeler.—A heavy puff that makes a boat heel.

Heel Rope.—The rope by which a running bowsprit is launched out.

Heel, To.—To incline, to careen, to list over, to depart from the upright.

Height.—A distance measured in a vertical direction, as height of freeboard, &c.

Helm.—The apparatus for steering a vessel, but usually applied only to the tiller. The word is derived from *helma* or *healma*, a rudder; German *helm*, a handle and a rudder.

Helm's A-lee.—The usual call made in tacking or in going about, as a signal for the crew to work the sheets, &c. The helm is a-lee when the tiller is "put down" or to leeward. (See "Lee Helm" and "Weather Helm.")

Helm Port.—The rudder trunk in the counter of a vessel.

Helm, to Port the.—To put the helm or tiller to the port side, and thereby bring the vessel's head round to starboard. If a wheel is used besides a tiller the action of turning the wheel to port brings the vessel's head round to port, as the tiller is moved by the chains to starboard. Thus with a wheel, when the order is given to port the wheel is turned to starboard. The rule observed in French war ships and merchant ships, since 1876, is this: The order to "port" means to turn the vessel's head to port; and the order to "starboard" to turn the vessel's head to starboard.

Helm, to Put Down the.—To put the tiller to leeward, and thereby bring the vessel to the wind, or luff; the contrary action to putting up the helm.

Helm, to Put Up the.—To bring the tiller to windward, so that the rudder is turned to leeward, and consequently the head of the vessel goes off to leeward or "off the wind."

Helm, to Starboard the.—To put the tiller the way opposite to port.

Helm, to Steady the.—To bring the helm or tiller amidships after it has been moved to port or starboard, as the case may be.

Helmsman.—The man who steers a vessel. If a man can sail a vessel well on a wind he is generally termed a good "helmsman," and not steersman.

Hermaphrodite Brig.—A two-masted vessel, square-rigged forward, and fore-and-aft canvas only on mainmast.

High and Dry.—The situation of a vessel that is ashore when the ebb tide leaves her dry.


High Water: Full and Change.—On all coast charts the time of high water at the full moon and new moon is set down, the time of high water at the full moon and new moon always occurring at the same hour throughout the year; therefore, if the time of high water at full and change (new moon) is known, and the age of the moon, the time of high water for any particular day can be roughly calculated, about twenty-five minutes being allowed for each tide.

Hipping.—To make a vessel broader on the beam about the water-line. It is an American term, and became generally known in England in connection with the celebrated American yacht *Sappho*. After her defeat by the English yacht *Cambria*, in the match round the Isle of Wight in 1868, she was taken to New York and hipped; that is, her planking was stripped off amidships, and each frame backed with timber, so that the vessel might be made to have more beam about the water-line. The backing is "faired" to the frames and then planked over. Sometimes, if it is not sought to give the vessel more than five or six inches more beam, the hipping is accomplished by a doubling of plank; in such cases a rabbet is cut for the edges of the new plank in the old plank; the seam is then caulked and payed. If the new planks were worked to a feather edge water would get underneath, and it might soon bring about decay.

Hire of a Yacht.—The hire of yachts varies from 30s. per ton per month to 40s. per ton. Usually the owner pays all wages, excepting those of the steward and cook; also often provides for the mess of the master and mate. The crew always provision themselves; the owner clothes the crew. The hirer pays insurance, and contributes to laying-up expenses. The exact details of hiring are usually a matter of special arrangement. Sometimes at the end of a season, if a yacht is already fitted out, she may be hired for a less price per month. When a yacht is wanted on hire, the best plan is to advertise.

Hitch.—A mode of fastening a rope. There are many kind of "hitches," such as Blackwall hitch, timber hitch, clove hitch, rolling hitch, &c. A hitch is also a short tack or board made in close-hauled sailing.

Hogged.—The situation of a vessel when she rises higher in the middle part than at the ends; the opposite of sagged.

- Hogging Piece.**—A piece of timber worked upon top of the keel to prevent its hogging or rising in the middle. (Fig. 20, page 100.)
- Hoist.**—The length of the luff of a fore-and-aft sail, or the space it requires for hoisting. The hoist of a flag is the edge to which the roping is stitched.
- Hoist, To.**—To raise anything by halyards or tackles, &c.
- Hoisting the Pennant.**—A commodore is said to hoist his pennant when he goes on board the first time, as his pennant is then hoisted.
- Hold.**—The interior of a ship; generally understood to mean the space in which cargo, &c., is stowed away.
- Hold-a-wind.**—To sail close to the wind.
- Hold her Head Up.**—A vessel is said to "hold her head up" well that does not show a tendency to fall off.
- Holding On.**—To continue sailing without altering a course or shifting sail.
- Holding On to the Land.**—To keep the land aboard in sailing; not departing from the land.
- Holding Water.**—Resting with the blades of the oars in water to check a boat's way or stop her.
- Hold On.**—The order given after hauling on a rope not to slack any up, as "Hold on all that."
- Hold On the Fore Side.**—If, when hauling on the fall of a tackle, some of the hands have hold of it on the tackle side of the belaying pin, the hand that has to belay sings out, "Hold on the fore side" to those in front of him, and "Come up behind" to those behind. The hands on the fore side thus hold the fall and keep it from running through the blocks whilst it is being belayed. (See "Come Up.")
- Hollow Lines.**—The horizontal lines of a vessel that have inflections.
- Hollow Sea.**—When the waves have a short, steep, and deep trough.
- Home.**—Any operation that is completely performed, as "sheeted home" when the clew of a sail is hauled out to the last inch, &c. An anchor is said to come home when it breaks out of the ground.
- Hood.**—A covering for skylights, sails, &c.
- Hood Ends.**—The ends of the plank which are fitted into the rabbet of the stem or stern post; termed also the hooded ends, meaning probably that they are "housed" or covered in by the rabbet.
- Hooker.**—A small coasting craft.
- Hoop.**—(See "Mast Hoop" and "Spider Hoop.")
- Horizontal Lines.**—The curved lines on the Half-breadth Plan which show the water sections, the plane of each section being parallel to the horizon.
- Horizontal Keel.**—A plate of iron fitted to the underside of a boat's keel, a fore-and-aft view showing thus . The plate should be made of iron plate of from $\frac{1}{2}$ in. to $\frac{3}{4}$ in. in thickness. For a boat 12ft. long the plate should be 8in. wide at the middle (so as to project about 3in. on either side of the keel), and 8ft. long, tapering each end to the width of the wood keel, to the underside of which it is screwed. The wood keel should extend at least 3in. below the garboards to render the plate effective. It is necessary that the plate should be kept horizontal, or in other words, in the same plane as the horizon; inasmuch as if the keel dips forward or aft the tendency of the plate will be to draw the boat either by the head or stern. A horizontal keel will increase a boat's weatherliness, but not to the extent of a centre board. The deeper the wood keel of the boat is the more effective the horizontal plate will be, as it will clear the eddy water along the garboards, and prevent the possibility of the bilge of the boat as she heels over being lower than the keel. However, if a very deep keel is necessary to make the horizontal plate effective, it may be as well to have another inch or so, and dispense with the plate altogether. The plan does not appear to have met with much favour.
- Horns.**—The projections which form the jaws of gaffs or booms. The outer ends of the cross-trees are sometimes termed horns.
- Horse.**—A bar of iron or wood, or a rope for some part of a vessel's rigging to travel upon.
- Hounds.**—The projections on a mast which support the lower cap and rigging. (See pages 117 and 119.)
- House.**—To lower a topmast down within the cap. A snug house is when very little of the topmast shows above the upper cap.
- Housing of a Mast.**—The part under the deck.
- Hove Down.**—Said of a vessel that is very much careened or heeled by the wind or other cause.
- Hove her Keel Out.**—Said of a vessel that heels over, so as to show her keel. (Generally used only as a figure of speech.)
- Hove in Sight.**—To come into view; said of a sail that appears above the horizon or round a headland; also of the anchor when it comes above water.
- Hove in Stays.**—Said of a vessel when she tacks, often meaning that a vessel tacks suddenly.
- Hove Short.**—When the cable is hove in so that there is but little more length out than the depth of water.
- Hove-to.**—The condition of a vessel with her head sails abaok, so as to deprive her of way. Vessels hove-to on port tack should fill or get way on, if approached by a vessel on the starboard tack; but if the vessel on port tack can, by hailing or otherwise, make the other vessel understand the situation, the latter should give way; this is the custom of the sea, but there is no statutory regulations concerning the point.

Hoy.—A small vessel. An abbreviation of "Ahoj."

Hug the Land.—To sail along as close to a weather shore as possible.

Hug the Wind.—To keep very close, or too close to the wind.

Hulk.—A vessel whose seagoing days are over, but is still useful as a store ship, &c.

I.

Ice Yachts.—A description of the ice yachts used by the Americans is given in the body of the book, and the following account of similar craft to be met with in Russia has been supplied by Mr. John Yeames, of Taganrog. Mr. Yeames thinks that the American ice boats are not built sufficiently strong for the rough

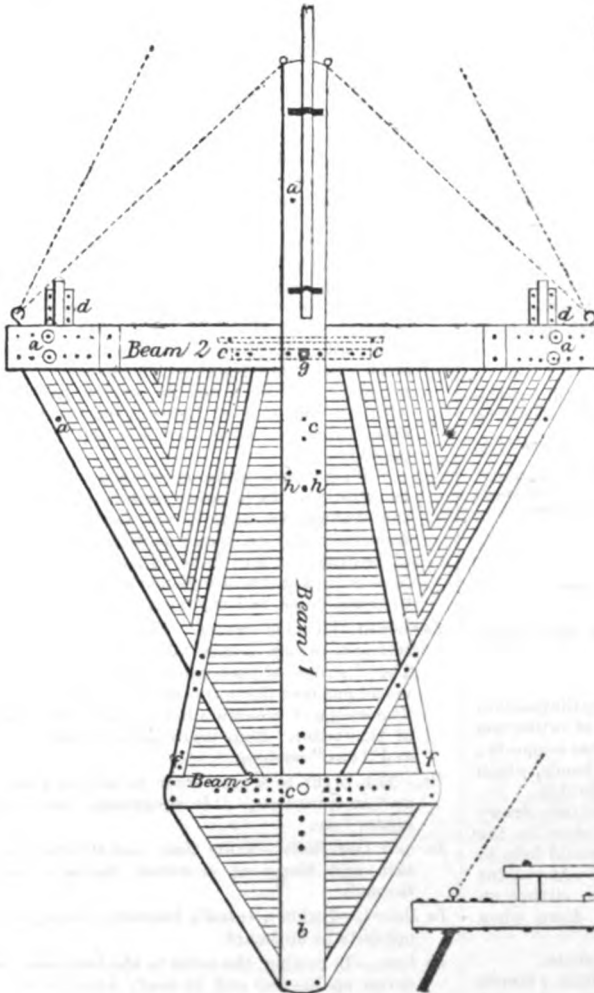
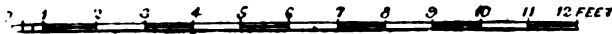


FIG. 193.

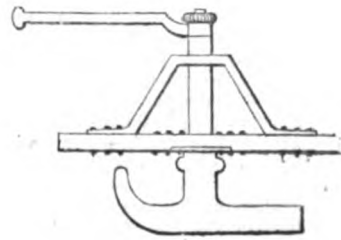


FIG. 195.



FIG. 196.



FIG. 197.

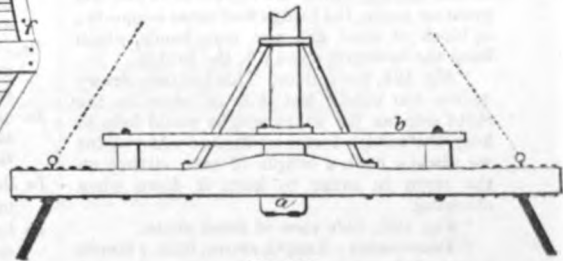


FIG. 194.

Hull.—The ship, as distinct from her masts and rigging.

Hull, To.—To strike the hull with shot, &c.

Hull Down.—On the sea when only a vessel's spars appear above the horizon.

Hull-to, or A-hull.—With all sails furled and the helm lashed to leeward, leaving the waves to do their worst.

ice of the sea of Azoff, where ice-yacht sailing is practised. He says:

"The Azoff Sea naturally has not such a smooth frozen surface as a river, for, until the ice is of great thickness, it is continually split into big floes by the variations in the level of the water, caused by changes of wind. There is no tide in the Azoff, but N. and S.

winds cause the water to rise with a S. wind and fall with a N., with a difference of 12ft. to 15ft. between the two extremes. The floes get knocked together, and the broken ice of the edges is forced down to the bottom of the sea—which is not very deep—and piece piled upon piece until the pile rises to about 1ft. to 3ft. above the level of the floes, which then freeze to these piles, which stretch for great distances, and, in fact, form a network in all directions. They are most numerous in shallow water, where the rise and fall of the water has the greatest effect. In parts where great forces have been at work the ice is piled in bergs of 30ft. to 60ft. in height.

"With my present yacht we charge over broken ice which is not higher than 18in., and of course the breadth which we can rush at depends upon the force of the wind. Above 18in. and up to 3ft. we dare charge a narrow line, but above that height we are obliged to circumvent it. However, I do not think any boat could charge a greater height than one built on the plan of my present one.

"Fig. 193. General bird's-eye view of yacht. The three main beams are of oak, and the remainder of the framework of ash. The lattice work is of deal, made much lighter in the stern than forwards.

GENERAL DIMENSIONS.

Beam 1—Bowsprit, 6ft.; mast to rudder, 10ft.; rudder to stern, 4ft. = length, 20ft.; breadth, 10½in.; thickness, ¾in.

Beam 2—Length, 12ft.; breadth, 10½in.; thickness, ¾in., thickening to 7in. in centre.

Beam 3—Length, 6ft.; breadth, 5½in.; thickness, ¾in. The remaining beams are all—breadth, 3in.; thickness, ¾in.; but the two stern ones might be made lighter.

EXPLANATIONS.

- a Bolts with rings for rigging.
- b Bolt with rings for mainsail sheet.
- c Strong bolts fastening iron supports of mast.
- d Two main skates.
- e Rudder hole.
- f Supports for steersman's bench, about 1ft. above deck.
- g Mast.
- h Bolts to fasten iron bands.
- i Chains to stiffen bowsprit.

"Fig. 194 is a front view, showing the position of the skates, which are drawn at rather too great an angle, the bridge and mast supports; a, block of wood and two iron bands, which keep the bowsprit down; b, the bridge.

"Fig. 195, the rudder. This has been drawn rather too thick; but it is an error on the right side, as the extra weight would help to keep the rudder firmer on the ice. At present we always have a couple of men sitting on the stern in order to keep it down when charging.

"Fig. 196. Side view of front skate.

"Dimensions: Length above, 32in.; length below, 24in.; breadth on top, 7in.; breadth of fluted part, ½in.; height of skate from ice, 1ft. 3in.

"Fig. 197. Bird's-eye view of front skate; a, two strong holdfasts going right through beam 2, with rings for stays to mast.

"As will be seen from the plans, both the skates and the rudder supports, as well as those of the mast, have been firmly fastened with iron bands and bolts, and all mortices

and joints have been strengthened in the same manner. Any boat built according to this plan ought to stand anything; but she weighs probably more than a ton herself, and when sailing, what with the pressure of the wind and the weight of ten or twelve persons—which is our usual number—her weight will be greatly increased. We have found that, as a rule, seven inches of ice are sufficient. The rudder must be entirely of iron, edged with steel, and fluted. The fore skates should also be of iron, if charging has to be resorted to. I have a very fine pair of wrought-iron ones, fluted and edged with steel. The greatest difficulty was that the main beam split from the strain of the mast when charging; but the plan of stepping the mast upon an ash bridge is a perfect success. This is well shown in Fig. 194. Of course she could be constructed much lighter, if not required for very rough ice.

"She is cutter rig, and the following are the length of her spars: Height of mast to gaff, 16ft. 6in.; length of boom, 20ft.; length of gaff, 13ft. 6in.; length of jibboom, 16ft. The boom swings 3ft. above the deck, to give room to move; but perhaps it could be lowered. (See Plate XLVIII.) She is quite open all round, not planked round the stern, as the American ones are. We generally sail with ten to twelve persons, with all but one or two on the windward side, so as to keep the boat as level as possible.

"With regard to the speed on good smooth ice, with only six or seven persons for ballast, the Russian ice boat is not far behind the American, and on rough ice would take a lot of beating, for they have run across several lines of broken ice, a distance of twenty-eight to thirty miles, in forty minutes."

Immersed.—Under water. The opposite of emerged, which means taken out of water. The "wedge of immersion" is the part of a vessel put into the water when she heels over. The wedge of emersion is the part taken out of the water. Sometimes termed the "in" and "out" wedges.

In.—The prefix to a curt order to take in a sail, as "In spinnaker," "In squaresail," or "In boats," &c.

In and Out Bolts.—Bolts that pass through the skin and frame of a vessel through and through.

In Board.—Inside a vessel's bulwarks, being the opposite to outboard.

In Bow.—In rowing, the order to the bow man to throw up his oar and be ready with the boat hook, to help bring the boat alongside.

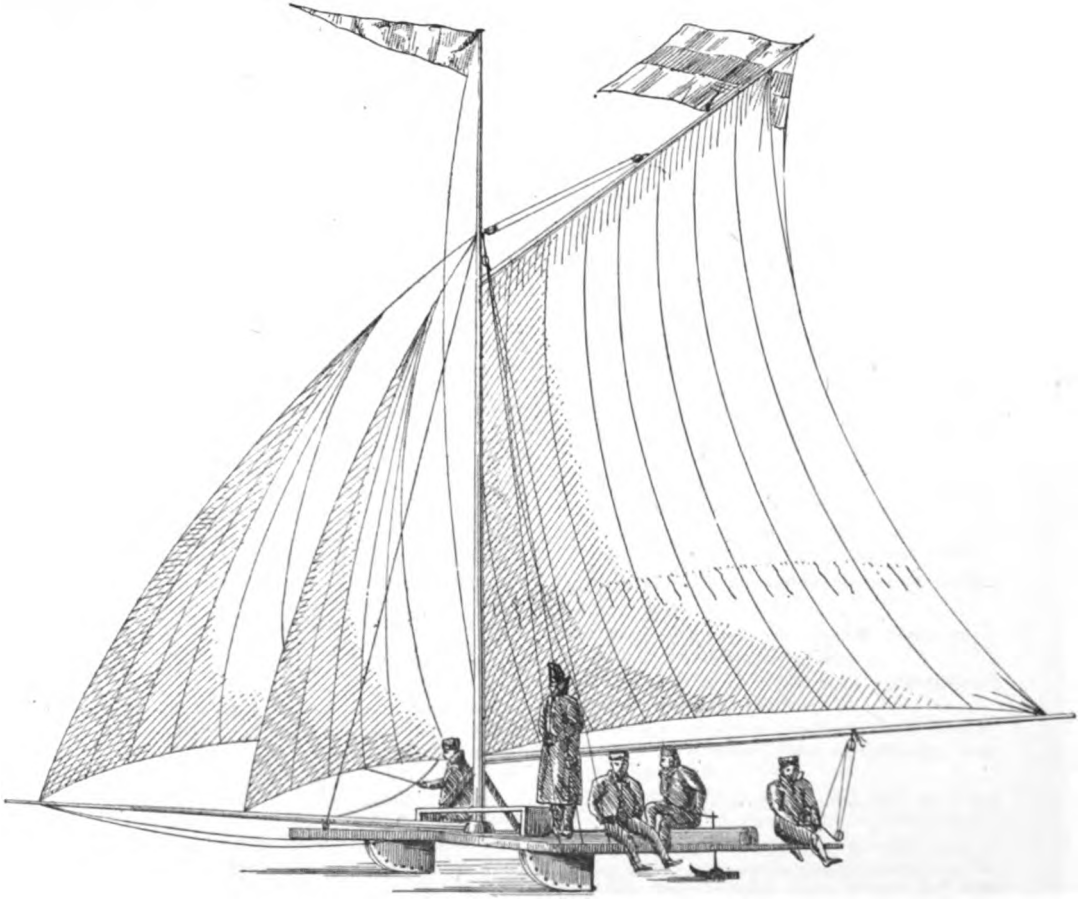
Inclination.—Heeling from an upright position. Synonymous with careening and listing.

Inner Jib.—The jib next the forestay sail in schooners where two jibs are carried.

Inner Post.—A piece of timber sometimes worked inside the sternpost.

In Haul.—A rope used to haul sails on board, as the inhaul of a jib or spinnaker.

PLATE XLVIII.



Ice Boat of the Sea of Azoff.



In Irons.—A vessel is said to be in irons when she is brought head to wind, and, having lost her way, will not fall off on one tack or the other.

Initial Stability.—The resistance a vessel at the first moment offers to being heeled from the upright position, as distinct from the resistance she may offer to being further heeled when inclined to considerable angles. Thus beamy boats are said to have great initial stability, because they resist powerfully, being heeled to small angles; narrow vessels, on the other hand, are readily heeled at first, but may offer greater resistance, as they are farther heeled, whereas a beamy boat's resistance may rapidly decrease as she gets over to large angles of say 30°.

Inlet.—A creek. A pipe to admit water to the hold.

Inshore.—Close to the shore.

In the Wind.—When sailing close hauled, if a vessel comes to nearly head to wind she is said to be "all in the wind."

In wale.—The clamp or strake of timber inside the top strake of a small boat, generally termed the gunwale.

Irish Pennants.—Loose ends of ropes, &c., hanging about a vessel's rigging or sails.

Iron Moulds.—Diluted oxalic acid will remove iron moulds from sails; but the instant the iron mould is removed the part should be well rinsed or soaked in fresh water, or it will be rendered rotten.

J.

Jack.—The Union Jack. The typical British flag that has "braved a thousand years, the battle and the breeze." It originally only had the red St. George's cross on a white field. Upon the accession of the Scotch King James to the English throne, St. Andrew's cross on a blue ground was added, and the flag was thereupon termed the "Union Jack" and National Flag, "For the Protestant religion and liberty." The red cross of St. Patrick was added (over the white St. Andrew's cross) upon the union with Ireland 1801. (See St. George's Jack.)

Jack in the Basket.—A boom or pole with a cage on the top used to mark a shoal or bank.

Jack Screw.—A powerful screw used for moving heavy weights.

Jack Stay.—A rod of iron, or rope, usually wire rope, for sails or yards to travel on. Also the wire rope stay on the boom of laced sails, round which the lacing is passed.

Jack Yard.—The small yard on the foot of balloon topsails to extend them beyond the gaff. Termed also jenny yards and foot yards.

Jam.—In belaying or making fast a rope to close up or jam the turns together. To clinch the hitch of a rope by passing the end through a bight.

Jaws of a Gaff.—The horns at the end of the gaff which half encircle the mast. A rope

called a "jaw rope," or jaw parrel, is fitted to the ends of the horns, and, passing round the mast, keeps the gaff in its place. Wood beads are rove on the rope to make it slide easily on the mast.

Jenny Yard.—(See "Jack Yard.")

Jesty's Composition.—This is a composition in great request for coating the bottoms of iron and wooden ships. Before applying it give the vessels one or two coats of coal tar thinned with turpentine; when this has dried on apply a couple of coats of the composition; a priming of red lead is sometimes used instead of coal tar. The composition should be kept well stirred in the pot whilst it is being applied, as some of its ingredients are very heavy. The Jesty manufactory is at Gosport, Hants. (See "Composition.")

Jelson.—Goods thrown overboard in heavy weather to lighten the ship. (See "Flotsam.")

Jib.—The outer triangular sail set on the bowsprit. A cutter usually carries six jibs—balloon jib, No. 1, 2, 3, 4, and 5 jib, the latter being the storm or spitfire jib.

Jibb or Jibe.—(See "Gybe.")

Jib-boom.—The spar beyond the bowsprit in schooners upon which the outer jib is set.

Jib Foresail.—In schooners the stay-foresail. (See "Fore-staysail.")

Jib Stay.—In schooners the stay to which jibs are hanked.

Jib Topsail.—A triangular sail made of duck set upon the topmast stay.

Jib Traveller.—The iron hook-hoop on the bowsprit to which the jib tack oringle is hooked.

Jigger Mast.—The misen mast of yawl or dandy.

Joggles.—Notches cut in timber.

Join Ship.—To come on board a vessel, or to enter as a seaman on board.

Jolly Boat.—A boat larger than a dinghy, and not so large as a cutter.

Jumpers.—A short frock made of duck worn by sailors. The triatic stays of schooners when they are double.

Junk.—Old rope. Also old salt beef as tough and hard as old rope. Also a Chinese ship.

Jury.—A makeshift or temporary contrivance, as jury-mast, jury rudder, jury bowsprit, &c., which may be fitted when either has been lost or carried away.

K.

Kamsin.—A south-westerly wind which is said to blow on the Nile for fifty days during March and April. The simoom.

Kedge.—The smallest anchor a yacht carries, used for anchoring temporarily by a hawser or warp. To kedge is to anchor by the kedge, or to carry the kedge anchor out in a boat and warp ahead by it.

Key.—A small oak, or breaker.

Keel.—The fore-and-aft timber in a vessel to which the frames and garboard strake are fastened.

Keel.—An awkward-looking north-country boat with one lug-sail forward.

Keel Haul.—A mode of punishment formerly in use in the Royal Navy. A rope, passed underneath the bottom of the ship, was made fast to each yard-arm. A man with a weight fast to his feet was made fast to one part of the rope and hauled from one yard-arm to the other, passing underneath the bottom of ship. Keel hauling now, in punning language, means "undergoing a great hardship" of some kind.

Keelson or Kelson.—An inside keel fitted over the throats of the floors.

Keep her Full.—When close hauled, an admonition not to keep too close to the wind.

Keep her Off.—An order to sail more off the wind; to put the helm up. To keep off is to keep away from the wind.

Keep your Luff.—An admonition to keep close to the wind. In match sailing, an order given when a vessel is being overtaken by one coming up from astern not to give way and allow the vessel to pass to windward. It is an old maxim in close-hauled sailing, "keep your luff and never look astern," meaning that if you sail as close to the wind as possible the overtaking vessel must take her passage to leeward or risk a collision by trying to force a passage to windward.

Kentledge.—Pig iron used as ballast.


Ketch.—A two-masted vessel, something like a yawl, but with the mizen stepped ahead of the stern post, and not abaft it as a yawl has it. Ketches were formerly common in the Royal Navy for yachts and bomb boats. A rig now seldom used except by coasters; it has all the disadvantages of the schooner or yawl rig, and none of the advantages.

Kevel or Cavel.—Large pieces of timber used for belaying ropes to such as the horizontal piece which is bolted to the stanchions aft to belay the main sheet to.

Key Model.—A model made by horizontal layers or vertical blocks, showing either the water lines or vertical sections of a vessel.

Kit.—A sailor's belongings in the way of clothes, &c., which he carries in his bag or keeps in his locker.

Kittiwake.—A kind of seagull.

Knees.—Pieces of timber or iron shaped thus  used to strengthen particular parts of a ship. A hanging knee is the one fitted under the beams (see *n* in Fig. 25, page 105); a lodging knee is a knee fitted horizontally to the beams and shelf, or to the mast partners or deck beams. Floor knees are V-shaped, like breast-hooks. (See *n*, Fig. 20, page 100.)

Knight Heads.—Strong pieces of timber fitted inside and close to the stem to bear the strain of the bowsprit. Called also "bollard timbers." The name is said to be derived from the windlass bitts, the heads of which formerly were carved to represent the heads of knights.

Knot.—A geographical mile, or sixtieth part of a degree, termed also a sea mile or nautical mile. The Admiralty knot or mile is 6080ft., a statute mile is 5280ft. A sea mile = 1.1515 statute mile; a statute mile = .86842 sea mile.

KNOTS PER HOUR CONVERTED INTO FEET PER SECOND.

| Knots per hour. | Feet per second. | Knots per hour. | Feet per second. | Knots per hour. | Feet per second. |
|-----------------|------------------|-----------------|------------------|-----------------|------------------|
| 1 | 1-688 | 11 | 18-67 | 21 | 35-45 |
| 2 | 3-876 | 12 | 20-26 | 22 | 37-14 |
| 3 | 5-064 | 13 | 21-94 | 23 | 38-82 |
| 4 | 6-752 | 14 | 23-63 | 24 | 40-51 |
| 5 | 8-44 | 15 | 25-32 | 25 | 42-20 |
| 6 | 10-13 | 16 | 27-01 | 26 | 43-89 |
| 7 | 11-82 | 17 | 28-70 | 27 | 45-58 |
| 8 | 13-50 | 18 | 30-38 | 28 | 47-26 |
| 9 | 15-19 | 19 | 32-07 | 29 | 48-95 |
| 10 | 16-88 | 20 | 33-76 | 30 | 50-64 |

Knots and Splices.—A Short Splice: Unlay the strands to an equal distance from each end of the rope. Intertwine the ends as shown in Fig. 198, and draw all close up together.



FIG. 198.

Take one end of the rope in the left hand close up to the unlay strands, and with it the unlay strands of the other end of the rope; grasp these firmly, or, if more convenient, stop them with a piece of yarn. Take one of the strands (which are free), pass it over the strand (belonging to the other end of the rope) next to it, under the next strand and out, and haul taut. Pass each of the three strands in the same way, and then the three other strands, and the splice will be made as shown in Fig. 199. The



FIG. 199.



FIG. 200.



FIG. 201.

operation can be repeated, or the ends can be seized with spun yarn round the rope. If the ends are stuck again, it is usual to taper each strand so as to make a neater job of it.

An Eye Splice: Unlay the strands of the rope and bring a part of the rope between the strands so as to form an eye (see Fig. 200). Put one end through the unlay strand of the

rope next to it; the succeeding end passes in an opposite direction over the strand and through under the next strand. The remaining end goes under the strand on the other side. Taper the ends and work them through the strands again, and serve.

Single Wall Knot (Fig. 201): Unlay the end of a rope, hold it in the left hand, take a strand A, and form into a bight, holding it tight in the left hand to the standing part of the rope. Pass B round A, C round B, and up through the bight of A; haul taut. To crown, lay one end over the top of the knot, lay the second over that, the third over the second, and then under the bight of the first.

Sheet Bend, or Common Bend (see Fig. 202): Useful for bending two ropes together, or

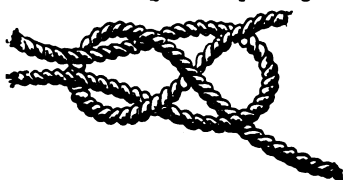


FIG. 202.

bending a rope to a cringle (see also Fig. 41, page 151).

Bend for Hawser (Fig. 203).



FIG. 203.

Magnus Hitch (see Fig. 204).—Useful for bending ropes to spars, &c.

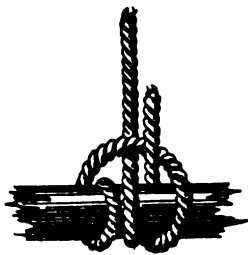


FIG. 204.

Bowline Knot (Fig. 205): Take a convenient



FIG. 205.

part of the end of a rope and form the bight A, then the large bight; pass the end through the

bight A, then round the standing part E, and down through the bight A, and haul taut.

Running Bowline Knot (Fig. 206): After the bight A is made, take the bight B round E (which is the standing part), then up through

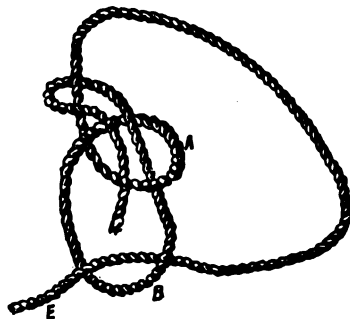


FIG. 206

A, round the standing part, and down through A as before (see also "Clove Hitch," "Fisherman's Bend," "Timber Hitch," and "Black-wall Hitch").

L.

Labour.—A ship is said to labour when she pitches and rolls heavily, causing her frame to work.

Lace.—To pass a rope in and out.

Laid.—The make of a rope, as cable laid, hawser laid, single laid, laid with the sun, &c.

Land.—To go from a vessel to the shore; also to place anything. The outer edge of the plank of a clincher-built boat.

Land Fall.—The point or part of a coast a vessel first sights after being at sea. To make a good land-fall is to sight the land at the point calculated.

Land Lubber.—A person unacquainted with the duties of a seaman, and one never likely to learn them.

Landsman.—Men who have just joined a ship to train as seamen.

Lane.—A lane of wind is a current of air that travels in a narrow space and does not spread. On board ship the order to "Make a lane there," when a lot of men are standing together, is for them to stand on one side so that others can pass. Steamship lane is a track usually taken by steamships in crossing an ocean.

Lanyards or Laniards.—Ropes rove through dead eyes, &c., by which shrouds and stays are set up.

Larboard.—The left side. In consequence of frequent blunders occurring through "larboard" being misunderstood for "starboard" or vice versa, "port," as a distinctive sound, was introduced instead of larboard.

Larbolins.—The men composing the port watch. (See "Starbolins.")

Large.—With the wind abeam or abaft the beam. "She is sailing along large" means that the

ship has the wind abeam or between the beam and the quarter.

Lash.—To lace, to bind together with a rope.

Lashing.—A lacing or rope to bind two spars together, &c.

Lateen Sail.—A large triangular sail, with the luff bent to a yard. It really has no head.

Lateral Resistance.—The resistance a vessel offers to being pressed broadside on through the water. This resistance is assumed to be governed by the area of the plane bounded by the stem, keel, and rudder.

Launch.—The largest boat carried by a ship. To launch is to move an object, as "launch a spar forward," to launch a ship.

Launching a Boat Across a Flat Shore.—In making a truck to launch or beach a boat on a sandy or loose gravelly shore, the truck should run on rollers in preference to wheels, as the latter will sink into the sand or gravel, and render the transit very laboursome.

Lay.—Used by sailors instead of the neuter verb "to lie;" as "lay to" for lie to, "lay her course" for lie her course, "lay up" for lie up, &c., or "she lays S.W." for lies S.W. This use of the active verb is sometimes justified by an appeal to the well-known naval song—

'Twas in Trafalgar's Bay
We saw the Frenchmen lay.

But, whether right or wrong, a sailor will never be brought to say, "there she lies" for "there she lays, or "she's going to lie up" for "she's going to lay up."

Lay along the Land.—When a vessel can just keep along a weather shore close-hauled.

Lay her Course.—A vessel is said to lay her course when sailing close-hauled, if her head points nothing to leeward of it.

Lay in Oars.—An order given to a boat's crew to toss their oars aboard; generally curtly spoken "Oars." To "lie on your oars" is an order for the men to cease rowing, but not to toss their oars up; to rest on their oars.

Lay of a Rope.—The way the strands of a rope are laid up.

Lay Off.—To transfer the design of a vessel to the mould loft full size. This is never written or spoken "lie off."

Lay Out.—To move, as to lay out on a yard-arm.

Laying Up.—Dismantling a yacht after a cruise has been brought to a termination. It is always much the best plan to have a mud dock dug for the yacht to lie in, as then the bottom will not foul, and if the vessel be coppered, she will haul out quite clean; on the other hand, if she lies afloat, weeds and barnacles will accumulate on the bottom. It is much the practice now to haul vessels up high and dry during the winter months; this is an excellent plan, and greatly assists in preserving the hull. The ballast is removed, and the inside of the hull below the platform coated with red lead, black varnish, or a mixture of two-thirds Stockholm tar to one-third of coal tar; black varnish or red lead

is, however, to be preferred. The mast should be taken out before the vessel is hauled up, and with the other spars housed. In case the mast be not removed, all the rigging should be lifted over the mast, and the yoke taken off as well, so that no accumulation of damp may rot the masthead. (See "Limber Boards.")

Lazy Guy.—The guy used to prevent the main boom falling aboard when a vessel is rolling.

Lazy Tack.—A running bight put on the tack cringle of a sail, and round a stay to keep the sail from blowing away whilst it is hoisted.

Lead.—A long weight or "sinker," of 7lb., 14lb., or 28lb. The line is "marked" thus:

| Fathoms. | |
|----------|-----------------------------------|
| 2 | a piece of leather in two strips. |
| 3 | " leather three strips. |
| 4 | " white calico. |
| 5 | " red bunting. |
| 6 | " leather with a hole in it. |
| 10 | " blue serge. |
| 13 | " white calico. |
| 15 | " red bunting. |
| 17 | " |
| 20 | two knots. |

There are usually 5 fathoms beyond this unmarked. In heaving the lead, if the vessel has headway, the lead must be cast ahead, so that when it touches the bottom the vessel is directly over it. If the first white mark is just awash when the lead is on the bottom, the leadsman sings out, "By the mark five." If it is less than five, say $4\frac{1}{2}$, he sings out "Quarter less five," And not $4\frac{1}{2}$. If $\frac{1}{2}$ or $\frac{3}{4}$ more than five, he sings out "and a quarter five," &c. There are no marks for 1, 4, 6, 8, 9, 11, 12, 14, 16, 18, and 19 fathoms, and these numbers are called "deeps;" in sounding, the leadsman has to estimate the depth, as, for instance, between 5 and 7 marks, and will sing out, "By the deep 6." The deep-sea lead, pronounced "dipseey lead," weighs from 28lb. to 35lb., and has a much longer line. Up to 20 fathoms it is marked the same as the hand lead—at 30 fathoms 3 knots, at 40 fathoms 4 knots, and so on; the intermediate "fives" being marked by a piece of leather or a small strand with a knot in it; 100 fathoms is marked by a piece of bunting, and then commence the knots again—1 knot 10 fathoms, and so on. In sounding with the deep-sea lead the vessel is usually hove to.

Lead Ballast.—Bricks of lead cast from moulds to fit inside the frames of a vessel without resting on the plank. Sometimes lead has been run into a vessel hot. When this has been done, the frame and plank have been first smeared with wet clay in order that the wood might not be injured. The objection to running lead into a vessel is the extreme difficulty of getting it out again. The vessel should be well caulked before the lead is run in. In casting a lead or iron keel, $\frac{1}{2}$ in. per foot is allowed each way for shrinking.

Lee.—The opposite side to that from which the wind blows.

Lee Board.—A very old-fashioned contrivance to check leeway. The board is usually tra-

peziform, and hung from the gunwale on either side. The board in length should be about one-fifth the length of the boat, and at its broadest part two-thirds its own length in breadth, and its narrowest one-third its own length. If the board is fixed to an open boat, the gunwale should be strengthened at the point of attachment by a piece of timber worked inside at the back of the boat's timbers. For a boat 17ft. long this strengthening piece should be at least 5ft. in length by 6in. in depth, and be of 1½in. thickness. The board will be pivoted at its narrow end by an inch bolt; the neck of the bolt which passes through the board should be square, and a square iron plate should be fitted each side of the board, through which plates the bolt will pass. The round part of the bolt will pass through the gunwale and strengthening piece; the bolt will be tightened up by a thumb nut, and, to prevent the latter working into the strengthening piece, it will be best to have an iron plate inside over the hole in the gunwale. The board should be made of inch stuff, with two through bolts of ½in. galvanised iron rod.

A very good plan for a lee board was recommended in the *Field* a short time ago. It consists of a board about 16in. by 2ft., suspended over the side of the boat (the top

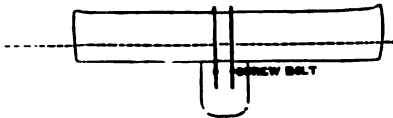


FIG. 207.

of the board being level with the keel) by two irons, which reach up the side over the gunwale, and are turned up along the midship thwart, to which they are fastened by means

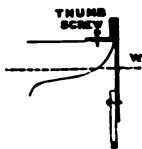


FIG. 208.

of two thumb screws; at the lower end two screw bolts connect the irons with the board; if necessary, one might be fitted on each side of the boat.

The advantages over the ordinary lee-board are that it is not unsightly, is always held parallel to the keel without straining the side, and two turns of the thumb screws will disconnect it in a moment from the boat. By unscrowing the irons, they, with the board, take up no room in the bottom of the boat. If these irons be fixed to different thwarts, a long board might be fitted in the same way; but most men would prefer a deep to a long one for going to windward.

Lee, By the.—In running nearly before the wind, when a vessel runs off her helm so much as to bring the wind on the quarter over which the boom is; a very dangerous proceeding, as if there be no boom guy a sudden gybe, or a gybe "all standing," may be the result. For safety, the helm should be put down the instant a vessel begins to run off. In match sailing, in running for a mark, yachts are often brought by the lee through a shift of wind, and frequently they are kept so, if a spinnaker or squaresail be set, and if near the mark, to save a gybe, every precaution being of course taken to prevent the main boom coming over, by hauling on the guy or pressing against the boom; this risk, however, should only be run in very light winds.

Lee-going Tide.—The tide that is running to leeward in the direction of the wind. The opposite to weather-going tide, which see.

Lee Helm.—The helm put to leeward to keep a vessel to or by the wind. Synonymous with slack helm. If the centre of effort of the sails is much forward of the centre of lateral resistance, the vessel will have a tendency to fall off, and will require the helm to be put to leeward to keep her close to wind. The tendency can be checked by reducing the head sail, or by hardening in the sheets of the after sail and easing the sheets of the head sail. A vessel that requires lee helm will be an awkward one, and in a heavy sea a dangerous one to work to windward. The contrary to "weather helm," which see.

Lee Scuppers.—Inside the lee bulwarks by the scupper holes. To be always in the lee scuppers is to be always in disgrace.

Lend a Hand Here.—An order to a person to assist.

Let go and Haul.—In tacking a square rigged vessel the order given to let go the lee braces and haul in on the others.

Let Her Feel the Weight of It.—An order to keep a vessel more off the wind, and not allow her sails to shake.

Life Belts.—Appliances for support in the water. The cork life belts of the National Lifeboat Institution (6s. each), John-street, Adelphi, are the most highly recommended.

Lights.—The lights which all vessels must exhibit between sundown and sunrise. (See "Side Light.")

Limber Boards.—Plank covering the floors of a vessel near the keelson. These should be removed when a yacht is laid up, so that the hold may be thoroughly cleansed of all bilge water accumulations. In yachts built with iron knee floors as shown on page 78 and 79, it is a common practice to fill up all cavities along the keel or hogging piece, fore dead-wood and apron, and dead-wood aft, with cement, first carefully coating the wood with Stockholm tar.

Limber Clearer.—A small chain which is kept rove through the limber holes in the floors at the side of the keelson, to allow the bilge

water to flow freely to the pumps; occasionally the chain is worked backwards and forwards to clear the holes. This contrivance is seldom met with in yachts.

Line.—A general name for a rope, or cordage.

Liner.—A line-of-battle ship. An old name for ships of the first and second rate, as three deckers and two deckers. We believe the term is not applied to fighting ships of the present day.

Lines.—A general term applied to the drawing or design of a vessel as depicted by fore-and-aft lines. A vessel is said to have "fine lines" when she is very sharp fore-and-aft.

List.—A vessel is said to list when from some cause—shifting of ballast or cargo or weights—she heels over.

Listing.—A narrow strip of plank, usually 4 in. in width, cut out of the plank in ship throughout her whole length, in order that the condition of her frames or timbers may be examined.

Lizard.—A piece of rope with a thimble eye spliced in one end, used in setting squaresails; sometimes the lizard is of two or more parts with a thimble in each, the whole being spliced into one tail.

Lloyd's Register.—The committee appointed in 1824 by "Lloyd's Society of Underwriters for the insurance of ships," to classify and regulate the building of, and keep a registry of all ships. (See "Underwriter.")

Lloyd's Yacht Register.—A register of yachts founded by Lloyd's, 1878, in which the build, age, condition, &c., of each yacht is set forth. The published register also contains rules and tables of scantling for the building of yachts. The offices are White Lion Court, Cornhill.

Load-water-line.—The line of flotation when a vessel is properly laden or ballasted.

Load-water section.—The horizontal plane at the line of flotation.

Loft Sided.—Larger or heavier on one side than on the other.

Locker.—A small cabin, or cupboard, or cavity to stow articles in.

Log Board or Log Slate.—The slate on which the hourly occurrences in navigating a ship—her speed, canvas, courses, the strength of wind, direction of wind, and general condition of weather—are set down.

Log Line and Ship.—An ancient contrivance for testing the speed of a ship by throwing a line overboard with a piece of board called "the ship," at one end, and then by noting the time (usually done by a sand glass) it takes to run so much line out. Massey's or Walker's log are now constantly towed, but the log line and ship are regularly used on board large steamers.

Log Official.—See "Official Log."

Long Boat.—A ship's launch; usually carvel built.

Long Leg and a Short One.—In beating to windward, when a vessel can sail nearer her intended course on one tack than another. Thus, say her course is E. and the wind



FIG. 209.

S. E. by E. she would lie E. by N. one tack, which would be the long leg, and S. by E. on the other, which would be the short leg.

Long Shore.—A contraction of along shore.

Long Tackle Blocks.—A double block with one sheave above the other, as a fiddle block, which see.

Look-out, The.—The men stationed on the bow, &c., to watch the approach of other ships or to seek the land, &c.

Lose her Way.—Said of a vessel when she loses motion or gradually comes to a stop.

Lose His Number at Mess.—(See Number.)

Lower.—To cause a thing to descend—as to "lower the topsail," &c. An order given to ease up halyards, as "lower," "lower away!"

Lower Masts.—The masts that are next the deck.

Lubber's Hole.—The opening in a masthead cap, by which seamen get into the top instead of by the futtock shrouds.

Lubber's Point.—The black line or stroke in the front part of a compass basin, by which the direction of a vessel's head is told. The lubber's point is always in a direct line with the vessel's keel, or stem and sternpost.

Lucky Puff.—A puff that "frees" a vessel in close hauled sailing.

Luff.—To come nearer the wind. To "spring your luff" is to luff all the ship is capable of, without making her sails shake.

Luff and Touch Her.—To bring the vessel so near the wind that the head sails begin to shake a little.

Luff of a Sail.—The weather cloth in a sail. (See "Weather Cloth.")

Luff Tackle.—A tackle composed of a single and double block, the standing part of the rope being fast to the single block.

Luff upon Luff.—One luff tackle hitched to the fall of another so as to make a double purchase.

Lugger.—A vessel rigged with lug sails like the fishing boats of this country and France.

Lug-Sail.—A sail set on a yard. (See "Dipping Lug.")

Lurch.—When a vessel is left unsupported at the bow, stern, or amidships, so that she makes a sudden dive forward, or by the stern, or a heavy weather or lee roll.

Lutings.—Stoppings of white lead, putty, tar, &c. for seams and joins in planks, &c.

Lying To.—The condition of a ship when hove to.

M.

Mackerel Sky.—A sky streaked with fine clouds, something in the manner of the stripes on the back of a mackerel.

Mackerel Tailed.—A boat with a very sharp or fine after body. "Cod's head and mackerel's tail" or "full forward and fine aft," once supposed to represent the solid of least resistance; now the order is reversed.

Made.—Built, as built mast, &c., meaning that the mast is not made of one piece of timber, but by several pieces bound together.

Main.—The open ocean. The principal, as main mast, main boom, main stay, main sail, &c.

Main Breadth.—The extreme breadth of a vessel.

Main Course.—The main sail of a square rigged ship.

Main Keel.—The keel proper, and not the keelson or false keel.

Mainsheet.—The rope or tackle which holds the aft clew of the mainsail. A good arrangement of mainsheet for a small boat with boom to the sail is to make fast one end of the sheet to one end of the after thwart, or near thereto (so that the sheet is clear of the helmsman) take the other end through a thimble eye in a strop round the boom and down through another thimble eye strop at the other end of the thwart; the hauling part can be made fast by a turn and bight above the latter thimble. This arrangement would do for a 10ft. or 12ft. boat, but in one of the larger size a block should be stropped to the boom and thwart instead of the thimbles. (See "Belay.")

Mainsheet Horse.—A mainsheet horse is frequently used in small boats, and in America in large yachts as well. Less mainsheet is required on a wind when the lower block travels on a horse, and therefore the boom cannot lift so much and assist in throwing the sail in a bag. In a seaway, however, there is some advantage in having more drift between the blocks than would be very likely given if a horse were used. For small boats to obviate the shifting of the mainsheet from side to side in tacking the horse is of advantage. The foresheet can also be made to travel on a horse if the boat be decked or half decked.

Mainmast.—The man whose duty it is to go to the mainmast head of a schooner to pass the lacing of a topsail, keep the topsail yard clear, &c.

Makes Fast.—To securely belay a rope or join two ropes.

Make Ready There.—An order sometimes given to prepare to tack or lower a sail, as "Make ready for going about there," the "there" referring to the crew.

Make Sail.—To set sails. To add to sails already set. To shake out reefs.

Make Stern Way.—To drive astern as a vessel sometimes will in tacking by getting in irons or through the head sails being thrown aback.

Make the Land.—After losing sight of the land to approach and sight it.

Making Water.—Leaking. A vessel is said to make no water if she is so tight that none ever gets through her seams, &c., into the hold.

Man.—To apply manual power to anything, as "Man the capstan," "Man the boat," &c.

Man Overboard.—A shout of alarm made on board ship when a man gets overboard by accident. In such cases it is not usual to wait for orders, but everyone joins in if he sees he can be of service in throwing a life-buoy, helping to launch a boat, jumping overboard, &c.

Mansard.—An American term for a booby hatch.

Man Ship.—An old-fashioned custom in the Navy of mustering the crew along the bulwarks to cheer upon parting company or meeting another ship. Losing yachts generally man the bulwarks and cheer a victorious yacht, a custom probably derived from the practice in "fighting days" of one war ship cheering another that was an enemy.

Marine Glue.—This composition is now usually employed to stop the seams of decks after they are caulked. The old fashioned plan was to use white lead putty for the stopping and indeed it is at this present time occasionally used; the objection to it is that it dries as hard as a cement and cracks, the result being that water gets into the caulking, rots it, and then leaky decks are the consequence. Moreover, hard putty is very difficult to get out of the seams without damaging the edges of the plank, and then in re-stopping ragged ugly seams are the result. Marine glue, on the other hand, if it does dry and crack can easily be renewed, and the edges of the plank remain uninjured.

In using marine glue the following practice should be observed: In driving the oakum or cotton thread (the latter is sometimes preferred as it can be laid in finer strands, a matter of consideration, if the plank is closely laid) into the seams, the caulking iron should be dipped in naphtha, and not in oil, as, if the sides of the plank are touched with the latter the glue will not adhere; naphtha on the other hand dissolves the glue and assists in closely cementing the seams. The plank should be quite dry when the glue is applied, or it will not adhere to the sides of the seams. The glue should be dissolved in a pot, and applied by lip ladles used for paying, two being kept going; or the glue can be melted in the lip ladles. The glue should not be melted over too fierce a fire, as if it burns or ignites it will be spoilt. A little of the liquid glue can be usefully mixed with the other as it assists in keeping it dissolved. The glue that runs over the sides of the seams should be cleaned off with a broad sharp chisel and remelted. It is not advisable to scrape the surplus glue off the seams, as it cannot be so removed without leaving a ragged unsightly surface.

- Mariner.**—A sailor. Two hundred years ago it was spelt "maryner," and appears to have only been applied to men who were perfect as seamen. Thus, from a muster roll made in the seventeenth century, we find so many men set down as "maryners" and so many as "seafaring men."
- Marks.**—The pieces of leather, &c., on a lead-line (see "Lead.") In sounding it is usual to say, "By the mark," &c., if the depth of water accords to a mark; if there be no "mark," as between three and five fathoms, the leadsman says, "By the deep four," &c. (See "Lead.")
- Marle.**—To wind spun yarn round a rope to secure its parts, or round a hank of yarn to secure it.
- Marline Spike.**—An iron implement tapering to a sharp point used to open the strands of rope for splicing, to turn eye-bolts, &c.
- Martingale.**—A stay spread by a "dolphin striker" to help secure the jibboom, the same as a bobstay does the bowsprit.
- Mast Carlines or Carlings.**—Pieces of timber fitted fore and aft between the beams to support the mast.
- Master.**—The chief officer of a ship.
- Master Mariner.**—A master of a vessel who has a master's certificate of competency. An old-fashioned term. A "master mariner" is popularly known as a "captain" among yacht sailors, but a master is only a self-dubbed captain. Master is the correct term, and the only recognised one in law. A few yacht masters have obtained the Board of Trade certificate of competency, and are skilled navigators; the majority, however, barely understand the use of charts and the methods of keeping a dead reckoning.
- Masthead.**—The part of a mast above the hounds.
- Masthead Light.**—The white light which steam vessels are required to exhibit at the masthead when under way. (See "Side Lights.")
- Masthead Pendants.**—The pendants and runners which help support the mast.
- Mast Hoops.**—The hoops to which the luff of fore and aft sails are seized to keep the sail to the mast.
- Mast Rops.**—The heel rope by which a topmast is sent up and lowered; not, however, termed heel rope.
- Match.**—In competition as yachts in a race. Formerly all contests between yachts were termed matches. Of late years the term race has been more generally applied to such encounters.
- Mate.**—The officer next in command to the master.
- Maul.**—A heavy hammer used by shipwrights.
- Meaking Iron.**—An implement used to extract old caulking from seams.
- Measurement.**—Generally written admeasurement. The computation of a vessel's tonnage by certain rules. (See "Tonnage.")
- Meet Her.**—When a vessel begins to fly to or run off the wind, to stop her doing so by the helm. Generally to check a vessel's tendency to yaw by aid of the helm.
- Meet, To.**—To meet a vessel with the helm is after the helm has been put one way to alter her course to put it the other way to stop the course being altered any further. This is also called "checking with the helm."
- Mess.**—The number of officers or men who eat together. Disorder; entanglement.
- Middle Body.**—The middle third of a vessel's length.
- Middle Watch.**—The watch between midnight and 4 a.m. (See page 196.)
- Mildew.**—Sails if rolled up when they are damp frequently mildew, and it is almost impossible to get the stains out entirely. New sails suffer most in this respect, as the "dressing" not being entirely washed or worked out of them will ferment and cause the mildew. The stains can be partly removed by scrubbing the sail with fresh water and soap; then rub the sail with soap and sprinkle or rub whitening over it; leave the sail to dry and bleach in the sun, and repeat the process more than once if necessary. Both sides of the sail should be scrubbed. Chloride of lime and other caustics and acids would remove mildew, but would almost certainly make the canvas rotten. If chloride of lime be used only the clear liquor should be allowed to touch the sail, and the latter should be well rinsed in fresh water afterwards (see "Bleaching"). If sails are stowed whilst damp or wet, they should be hoisted again as soon as possible for drying or airing.
- Mile.**—(See "Knot.")
- Missing Stays.**—To fail in an attempt to tack. (See page 163.)
- Mizen Bumpkin.**—A short spar that extends from the taffrail aft for the lower block of the mizen sheet to be hooked to. East country yachts have this bumpkin generally crooked downwards, the reason given being that the downward crook shows up the sheer of the yacht. A more practical reason, however, can be given, and that is, if a bobstay is used, a more effective purchase is obtained.
- Mizenmast.**—In a ship the after mast. So also in a yawl or ketch.
- Mizen Staysail.**—A sail set "flying" from a yawl's mizenmast head to an eye bolt on deck forward of the mizenmast. Generally set with a quarterly wind.
- Moment.**—A weight or force multiplied by the length of the lever upon which it acts. Sail moment generally means the area of sails and the pressure of wind upon them multiplied by the distance the centre of effort is above the centre of lateral resistance, which represents the length of lever. (See pp. 22 and 42.)
- Momentum.**—A force represented by a weight and the velocity with which it is moved.

Moon.—Sailors say there will be a moon at such and such a date, meaning that there will be a new moon or full moon, from which the time of high water is calculated.

Moor.—To anchor by two cables.

Mooring Rings.—The rings by which the chain is attached to large stones used for moorings. Sometimes the bolts that hold these rings pass clean through the stone, and are secured underneath, but a more secure plan than this is that known as a "Lewis." In the engraving *a* is the ring or shackle, *b* a bolt with a

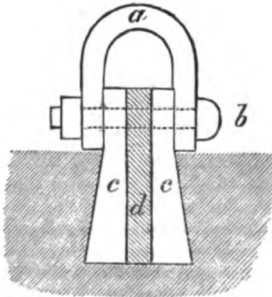


FIG. 210.

screw nut and linch pin; *c c* movable parts of the bolt; *d* the key or wedge. When the key is in its place the cavities, if any, can be filled with lead or sulphur.

Morning Watch.—The watch from 4 a.m. to 8 a.m.

Moulded.—The depth a timber is made between its curved surfaces as distinct from its siding, which is the thickness between its flat surfaces.

Moulded Breadth.—The greatest breadth of a vessel without the plank.

Moulds.—Curves used by draughtsmen. The skeleton frames made by shipwrights to cut the frames by.

Mourning Ribbon.—A blue ribbon or stripe run round a yacht's side, instead of a gold or white one, to denote mourning. Mourning is also denoted by flying an ensign or burgee half-mast.

Mousings.—Yarns wound round hooks to prevent them becoming detached. Indiarubber rings were in use a few years ago as mousings for cliphooks, but are never met with now.

Mudian Rig.—A contraction of "Bermudian rig."

Mulin.—A slang term given to the sails: generally applied to balloon sails.

Muster.—A strong wind that blows directly down a vessel's intended course. Synonymous with "nose ender."

N.

Nail-rick Clench-built Boat.—This is when the nail fastenings have become loose in a boat so that she leaks. Mr. J. C. Wilcocks recommends that the boat should have the

whole of her ballast taken out; let her then be thoroughly cleaned out and laid on her sides, with sufficient weight to keep her so until the water begins to come over the gunwale. A man should be inside with some chalk or white paint, and mark every leak which becomes visible, first on one side, then on the other; or the boat can be hauled up and filled with water and marked outside. If the boat be decked, any recesses behind bulkheads or in the counter must be carefully examined, and marked in the same manner. After all the leaks have been discovered, let her be dried, and every nail examined; the lands or joinings of the planks should also be tried with the blade of a very thin knife. Any rivets which have worked very loose must be cut out, and replaced with nails and rooves of a larger size, and through the chief parts of the bottom it will probably be necessary to put an additional nail between every two originally driven. Many of the old nails which are only a little slack should again be hardened by a few taps on the inside, a boy holding on against the head of the nail on the outside. After this work has been thus gone through, melt a pound of pitch in a gallon of boiling Stockholm tar, and give her a good coat inside up to the level of the inside of the lockers—that is to say, as high as it can be done not to interfere with the paint. The garboard strake fastenings, and also those of the hood ends, must also be examined, and will be certain to require careful caulking. In tarring the boat inside, the ledges or lands should be quite filled up with the boiling stuff.

Neaped.—The situation of a vessel that gets ashore during high water at spring tides, and as the tides get shorter every day towards the neap tides she cannot be floated off till the next spring tides. Generally termed be-neaped.

Neap Tides.—The tides which occur between new and full moon; spring tides being at or near the new and full moon.

Near.—Very close to the wind, so that the sails shake or lift.

Near the Wind.—Close to wind; generally used in a sense to convey the meaning that the vessel is too near the wind, as "She's near forward," meaning that the head sails are shaking or lifting. (See "Nip.")

Nettles.—Small lines or ropes used to support hammocks when they are slung under the beams. Also reef points are sometimes termed nettles.

News.—The intimation conveyed sternly to the watch below to turn up when they do not obey the first summons, as "Do you hear the news there, sleepers?"

Niggling.—Sailing close to the wind or too close.

Nip.—A short bight in a rope, such as the part that goes round a sheave, &c. To nip a vessel is to sail her very close, or too close, to the wind.

Nippering.—Joining a rope by cross turns.

No Nearer.—An order given to a steersman not to luff any more, or not to bring the vessel any closer to wind. When sailing free a course is frequently given to the steersman thus, W.S.W. and no nearer, or S.E. and no nearer, which may be varied "Nothing to windward of W.S.W.," or whatever the compass course may be.

Nosebag.—A name given to a jib, generally meaning a jib that is too big for the after sail; or a jib that bellies out into a bag.

Nose-ender.—Dead on end. A wind which blows directly down a vessel's intended course, involving a dead beat. (See "Muzzler.")

Noose.—A slip knot or running bight in a rope.

Number.—The number of a ship in the registry kept by the Registrar-General of Shipping; hence when a ship "makes her number" she hoists the signal flag denoting her number so that her name may be read. Also the number of a seaman on a ship's book. "To lose the number of the mess" is to fail to appear at mess through drowning or sudden death.

O.

Oars!—An order given to cease rowing and toss up the oars. (See "Lay in Oars;" and page 193.)

Off.—The opposite to near (which see), as "Off the wind." "Nothing off" is an order given to a helmsman to steer nothing to leeward of a particular course, or to sail nothing off the wind, but to keep the vessel full and bye. (See "No Nearer.")

Off and On.—Beating along a shore by a board off and then a board on.

Official Log.—The record of a voyage containing all matters relating to the crew, &c., which the law requires to be kept.

Offing.—Away from the land, seaward. To make an offing is to sail away clear of the land.

"Off She Goes!"—The shout raised when a vessel begins to move at launching.

On.—In the direction of, as "on the bow," "on the beam," "on the quarter," "on for that buoy," &c.

On a Bowline.—Close-hauled. Generally applied to the square rig when a ship has her bowlines hauled taut to keep the leeches of the sails from shaking when she is close-hauled.

On End.—A mast is said to be on end when in its place; literally, standing on its end. Generally applied to topmasts.

On a Wind.—Close-hauled; not off the wind.

On an Easy Bowline.—Not quite close-hauled; a good full.

One, Two, Three, Haul!—A cry raised by the foremost hand in hauling on a tackle. All hands throw their whole weight and strength on the rope or fall at the word "Haul!"

Open.—Upon sailing round a point or headland when an object comes into view.

Opposite Tacks.—When of two vessels one is on the port tack and the other on starboard tack. Cross tacks.

Ordinary Seaman.—On board a man-of-war a young sailor not yet efficient in his duties so as to entitle him to the rank of A.B.

Outer and Inner Turns.—In bending a sail to a yard, the outer turns haul the sail out taut along the yard, the inner turns secure the sail.

Outhaul.—A rope or tackle by which a sail is hauled out on a spar, as distinct from an inhaul by which it is hauled inboard.

Outrigger.—A contrivance of some sort for extending a sail or stay outboard. A name for a kind of row-boat which has the rowlocks extended beyond the boat's side.

Over-canvassed.—Too much canvas.

Overfalls.—The rough water caused by the tide pouring over a rough or precipitous bottom.

Overhang.—The "knee of the head" or the curved piece of wood fitted to the stem to form a graceful or ornamental curve. Also the inclination the stem has outwards from the end of the water-line forward; also the overhanging part of the counter aft. Anything that projects beyond the base.

Overhaul.—To overtake another vessel; to loosen the parts of a tackle; to ease up, to slacken, or free the fall of a tackle; to slacken or "lighten up" a rope.

Overlap.—When any part, spars and sails included, of one vessel covers or overlaps any part of another vessel. Generally when anything partly covers another thing.

Over-masted.—Masts that are too large or long for a vessel.

Over-rigged.—Generally more rigging, spars, and canvas than a vessel will properly bear.

Over-set.—To cause a capsiz.

Overshoot a Mark.—To go up to a mark with too much way on so that the vessel shoots past it.

Over-reach.—To stand so long on a reach that upon tacking the vessel can fetch much farther to windward of a mark than was necessary or desirable.

Over-stand.—In beating to windward to stand on a reach so long that the yacht is able to clear a mark farther to windward than desired. (See "Over-reach.")

Overtake.—To approach a vessel that is sailing ahead. The "rule of the road" is that an overtaking vessel must keep clear of the vessel she overtakes; the vessel so overtaken must, however, keep her course steadily. In competitive yacht sailing this rule is somewhat different, as it allows the vessel that is overtaken to alter her course to windward to prevent the other passing her to windward; she must not, however, alter her course to leeward to prevent the overtaking vessel passing.

P.

Paint.—(See "Black Paint.")

Painter.—A rope spliced to a ring bolt in the bow of a boat to make fast by. "To let go the painter" is figuratively to depart.

Palm.—The guard and thimble used by sail makers. Also the fluke of an anchor.

Paltry.—A wind is said to be paltry that is light and varies a great deal in direction; baffing.

Parbuckle.—To roll a spar, cask, &c., by placing it in the bight of a rope, one end of which is fast, the other hauled upon. (See page 181.)

Parcel.—To cover a rope with strips of canvas painted or otherwise. The canvas is wound round the rope and "served" with spun yarn.

Parrel or Parral.—Ropes or irons used to secure yards at the slings to the mast; rope parrels are commonly rove through balls of wood, so that they hoist easily on the mast. Parrels are used on the jaws of a gaff. An eye is usually spliced in either end of a parrel.

Partners.—A strong frame of timber fixed between the deck beams to receive and support the mast.

Pass.—To receive. Also to hand a thing one from another.

Passage.—A voyage. To carry a person from one place to another is to give a passage.

Paul or Pawl.—An iron bar used to prevent the back recoil of the barrel of a windlass, &c.

Pay.—To run hot pitch and tar, or marine glue, &c., into seams after they are caulked.

Pay Off.—When a vessel's head goes off to leeward by virtue of the head sails being put aback or the helm being put up.

Pay Out.—To veer or slack out chain or rope.

Peak.—The upper after corner of gaff sails, gaff topsails, lugsails, &c. A sail is said to have a great deal of peak when the gaff or yard makes a small angle with a vertical. A low peak means a flat-headed sail.

Peak Downhaul.—A rope rove through a single block at the gaff end to haul upon when lowering the mainsail.

Peak Halyards.—(See p. 115.)

Peak Purchase.—(See p. 115.)

Pendant.—A stout rope to which tackles are attached. (See p. 115.)

Pennant.—A long white streamer with a St. George's cross at the hoist, used only by ships of the Royal Navy. It is said to owe its origin to the following incident: a Dutch Admiral hoisted a broom at his masthead as a symbol that he would sweep the English from the sea; the English Admiral retorted by hoisting a long streamer to denote that he would whip the Dutch off the sea; the English Admiral more nearly succeeded in his object than the Dutchman did. A Commodore has a broad pennant or swallow tail flag. (See "Burgee" and "Hoisting Pennant.")

Peter.—(See "Blue Peter.")

Peter Boat.—A small fishing boat, sharp at both end, common at the mouth of the Thames and Medway.

Petticoat Trousers.—An ancient garment worn by sailors, now only used by fishermen; a kind of kilt.

Pig.—A heavy mass of iron or lead.

Pile Driving.—Pitching heavily and frequently in a short steep sea.

Pilot.—A person who takes charge of a ship in narrow or dangerous channels, and, who from his local knowledge of the same can, or ought to avoid the dangers of stranding.

Pintles.—The metal hooks by which rudders are attached to the braces.

Pipe.—To summons men to duty by a whistle from the boatswain's call.

Pipe up.—The wind is said to pipe up when it increases in strength suddenly.

Pitching.—The plunging motion of a vessel when she dives by the head; the opposite motion to ascending, which is rising by the head and sinking by the stern.

Planking.—The outside skin of a vessel; plank laid on the frames or beams of a vessel whether inside or outside.

Plank Sheer.—The outside plank at the deck edge which covers in the timber heads, and shows the sheer of the vessel. The same as covering board.

Platform.—The floor of a cabin. (See "Deck.")

Ply to Windward.—Plying to windward is synonymous with beating to windward.

Points.—(See "Reef Points.")

Pole.—The part of a topmast about the shoulders.

Pole Mast.—A long mast without a topmast, but with a long "pole" or piece above the hounds.

Poop.—The raised part of a vessel at her extreme after end. To be pooped is when running before the wind a sea breaks in over the stern.

Poor John.—Dried hake, a coarse fish caught on the west coast.

Port.—The left hand side, the opposite to starboard. Formerly termed larboard, which see. To port the helm is to put the tiller to port so that the vessel's head goes to starboard.

Portable Dinghies.—Numerous plans have been suggested for the construction of portable dinghies for small yachts, the best known perhaps being one adopted by Biffen, the well-known boat builder, in 1858. The boat was divided longitudinally into halves, each half being a complete boat, the longitudinal bulk heads coming as high as the thwarts; three iron clamps were fitted to one half of the keel, into which the other half of the keel was fitted. The top part of the bulkheads were kept together by thumb-screws inserted above the water line. The boat was 9ft. long, and 4ft. broad; in shape she did not differ from an ordinary dinghy when put together. She was used in a 6 tonner, and when not in use one half was stowed on either side of the cabin below. It was said that this boat could be put together in half a minute. In 1862 Biffen built a

similar boat which was not so well recommended, on account of the multiplicity of fastenings. The obvious objection to such contrivances is of course the trouble of putting the parts together when the boat has to be used. (See "Berthon's Collapsible Boats.")

Ports and Portholes.—Square holes in the side of a ship for the guns, &c.

Port Sills.—The bottom framing of a port hole to which the lower half-port or shutter is hinged, also the frame to which the upper half-port is attached.

Preserving a Boat.—All small boats, if possible, should be hauled out of water or beached when not in use. Varnish preserves the wood from water absorption better than paint. Whenever the varnish becomes worn, the boat should be re-coated.

Press of Sail.—All the sail a vessel dare carry.

Preventers.—Additional ropes, stays, tackles, &c., used to prevent spars being carried away if their proper stays give out, as preventer backstays for the topmast (see page 115), preventer bobstay, &c. A preventer is also any rope or lashing used to prevent something giving way.

Preventive Man.—An old fashioned name for a coastguard man, whose duty it is to prevent or detect the landing of smuggled goods.

Protest.—A declaration that a yacht has not conformed to sailing rules.

Puff.—A gust of wind. A free puff is when it enables a vessel to luff; a foul puff when it breaks her off.

Punt.—A small boat or dinghy.

Punt Building.—The following directions for building a fishing punt were given in the *Field* some time since:—Take for the sides two 1in. planks 16in. wide and 14ft. long; for the ends

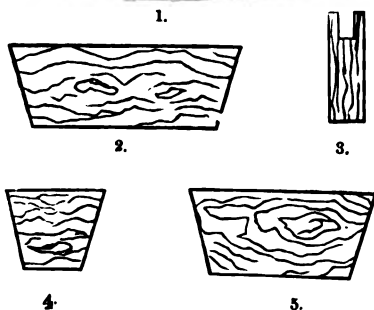
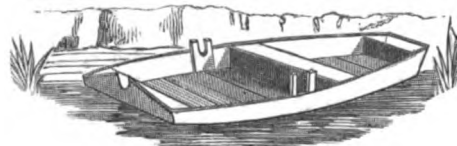


FIG. 211.

use 2in. plank. Cut the stern-piece 30in. long at bottom, and 40in. at top; cut the bow piece 12in. long at bottom, and 20in. at top; then cut a centre-piece 12in. wide, 40in. long

at bottom, and 50in. long at top; put these pieces in position, and securely nail the sides to them; this can be readily done by bringing the planks into place by means of a rope, twisted by a short lever. After the sides are thus secured true up the bottom edges, and plank crosswise with three-quarter inch plank one-eighth of an inch apart; caulk these seams with oakum or cotton, and pitch the whole bottom, and 2in. or 3in. up the sides. A keel lin., 2in., or 3in. deep can then be nailed on, depending on the depth of the water where the boat is to be used. For seats nail a plank across each end, and one for the rower over the middle piece; two rowlocks, about 6in. above the sides of the boat, complete the job. These can be made of plank, set up on end, and fastened to the inside of the boat. A common carpenter can make such a boat in about two days, and, if planed and painted, it looks well. The ends ought to incline outwards about 3in. to the foot. No. 1 shows the skiff completed, but with a stern piece adapted for steering with an oar; No. 5 is a diagram of the stern piece; No. 4 the bow piece; No. 2 the middle piece, and No. 3 the rowlock. By putting in two pieces in the middle the required distance apart, and perforating the cross planking between them, a well would be readily formed.

Purchase.—A tackle; any contrivance for increasing mechanical power.

Put About.—To tack.

Put In.—To call at a port or harbour.

Put Off.—To leave, as to leave a ship's side or the shore.

Pykar.—An ancient English boat used for fishing.

Q.

Quarter Deck.—The deck abaft the main mast where the crew are never seen unless duty calls them there.

Quarter Fast.—A warp or rope made fast to the quarter; a quarter spring.

Quarter Master.—An officer who sees that the orders of the mate or master are properly executed, &c.

Quarter Timbers.—Large pieces of timber secured to the transom frame, which support the counter.

Quarter Watch.—When the two watches are subdivided into four watches, so that only one quarter of the crew is on deck at one time; sometimes observed in light weather.

Quarter Wind.—The wind that blows on the quarter, or four or more points abaft the beam, but not dead aft. (See "Compass.")

Quarters.—That part of a yacht or ship nearest the stern.

R.

Rabbit or Rebate.—An angular channel or groove out in the keel, stem, or sternpost, &c., to receive the edges or ends of the plank.

Race—A competition between yachts. A strong current or tide running over a pit-like bottom producing overfalls. (See "Overfalls.")

Racing Flags—The size of racing flags will be found under the head of "Flags."

Racking.—A rope or seizing used to lash the parts of a tackle together, by taking several turns, so as to keep them from running through the blocks, whilst the fall is cast off for some purpose, or whilst one hand belays the fall made fast to some fixture by one end and then passed round and round a rope to hold the latter by.

Raflee.—The square topsail set flying on the fore-topmast of schooners, and formerly often set on cutters and ketches above the squaresail. Sometimes this topsail is triangular in shape, like a scraper.

Rail.—The timber fitted on to the head of the bulwark stanchions. Called also "top rail."

Raising a Boat's Anchor.—(See "Anchor.")

Raising Iron.—A sort of chisel for removing the paying and caulking from seams.

Raising Tacks and Sheets.—To lift the clews of lower squaresails previous to tacking or wearing.

Rake.—To lean forward or aft from the vertical, as raking masts, raking sternposts, raking stem, &c.

Rakish.—A vessel that has a look of speed about her, probably originating from the fast schooners of former days that had raking masts.

Ramp.—In close-hauled sailing, to sail a vessel along a heavy full without easing up the sheets.

Ramping Full.—Barely close-hauled.

Range.—Scope. To range is to arrange: to range the cable, to place a lot on deck in fakes ready for veering out.—To give a range of cable is to veer out enough in letting go the anchor to bring the vessel up without causing much strain to come on the bitta.—To sail near to, as to range up to windward, to range up alongside, to range along the coast, &c.

Rap Full.—The same as ramping full. By no means near the wind.

Rate of a Chronometer.—The daily loss or gain of a chronometer in relation to mean time.

Ratlines.—The small lines which cross the shrouds horizontally, and form the rungs of a ladder. Not generally used in yachts of 40 tons and under.

Rattle Down.—To fix ratlines to the shrouds.

Reaching.—Sailing by the wind. A "reach" is the distance sailed between tacks, and means the same as board. To "reach" another vessel is to pass her. In reaching a schooner of 150 tons, say, will pass a cutter of 100 tons; that is, will "fore-reach" her, but the cutter holding a better wind will generally keep the weather gauge. A "reach" is a distance a yacht can sail from point to point without tacking, and often such a reach does not require the yacht to be quite close-hauled.

A reach is also the distance from bend to bend in a river or channel. (See "Head Reach," and "Fore Reach.")

Ready About!—The order given to prepare for tacking.

Ready, All.—Everybody make ready.

Rear Commodore.—The third flag officer of a yacht club, who has no duties in the presence of the Commodore or Vice-Commodore. He has two white balls in the upper corner of his pennant.

Rear Guard.—(See "After Guard.")

Recognised Yacht Club.—A term very frequently used in yacht rules; formerly it was a general condition that "a member of a Royal or recognised yacht club shall be on board" each yacht competing in a match, who is responsible for the due observance of the sailing rules. Often the rule required that a member of the particular club under whose auspices the match was being sailed should be on board. Of late years, since the establishment of the Yacht Racing Association, this rule has been modified to mean a member of a recognised yacht club. No one seems to know exactly what "recognised" means; strictly it should mean a club with an Admiralty warrant, but any "yacht club" is considered "recognised" which is organised for the promotion of properly conducted yacht matches. (See "Admiralty Warrant," "Royal Yacht Club," "Burgee," and "Ensign.")

Reef.—To shorten sail by reefing. Also to shorten a spar, as to take a reef in the bowsprit. The topmasts of some yachts are made with one reef in them. In such cases a thimble eye is seized to the backstays for the blocks of the falls to be hooked to when the reef is taken in. The depth of such a reef is usually about one-sixth the length of topmast from first fid to sheave hole. When the topmast is lowered to second fid it is called reefing, not housing.

Reef Band.—A strip of canvas sewn across the sail in which the eyelet holes are worked to receive the reef points. Not always met with in yacht sails.

Reef Cringles.—The large cringles in the leeches of sails through which the reef pendants are rove and tacks or sheets hooked. (See p. 114.)

Reef Earing.—(See "Reef Pendant.")

Reef Knot.—(See Fig. 40, p. 147.)

Reef Pendant (called also "reef earing").—A short and strong rope (with a Matthew Walker knot in one end) which is passed through the reef cringle leech of a fore-and-aft mainsail, and then through a sheave hole formed by the cleats or cheeks on the side of the boom end. One end of the pendant is passed up through a hole in the cheek on one side of the boom and stopped by the knot in the end. The other end is then passed through the reef cringle in the sail and down through the sheave hole on the other side of the boom. (See page 114.) Reef pendants are rove on opposite sides.

Reef Points.—Short pieces of rope attached to sails to secure the folds rolled up when reefing. (See page 114.)

Reef Tackle.—The tackle hooked to the reef pendants.

Register.—A certificate of ownership granted by the Registrar-General of Shipping.

Registry.—A register of all British ships kept by the Registrar-General of Shipping. When a ship is registered, the following documents must be produced: (1) Certificate of Custom House measuring officer. (2) Certificate of Board of Trade Surveyor; in the case of yachts this certificate is not required. (3) Builder's certificate, or if the builder's certificate cannot be obtained, a document setting forth all that is known of the vessel. (4) Declaration of ownership. All vessels, yachts, or otherwise of 15 tons N.M. and over must be registered. It is advisable to have even smaller vessels registered for the sake of holding the register, and being able to prove nationality when visiting foreign parts. The name of a vessel once registered cannot be altered except with the sanction of the Board of Trade. A quantity of useful information on the registry of ships will be found in a little book by Mr. Miles Stapylton, published by Oliver, St. Dunstan's Hill, E.C., and called the "Imperial Guide to Registry of British Shipping."

Render.—To slacken or ease up. A rope is said to render when it slackens without warning.

Reeve.—To put a rope through a hole of any kind.

Resistance.—According to Beaufoy, a plane moved normally at a rate of 10ft. per second meets with a resistance of 112·5lb. per square foot. The resistance varies as the square of the velocity. Generally understood to mean the resistance a vessel meets with from the friction of the water on her copper and the waves she makes. (See "Salt and Fresh Water," and also page 48.)

Ribbands.—Long pieces of plank or timber, usually three-sided, and sometimes called harpings, secured to the frames of a vessel in a fore-and-aft direction, when she is building, and representing the dividing lines or geodetic lines.

Ribs.—The frames or timbers of a ship or boat.

Ride.—To rest at anchor, or to be held by an anchor.

Ridge Ropes.—The ropes rove through the eyes of metal stanchions fitted in the top rail.

Riding Down.—When men go aloft and hang on the halyards and assist by their weight in hoisting sails.

Riding Light.—The white globular lantern hung on the forestay of vessels when riding at anchor.

Rig.—The arrangement of a vessel's spars, rigging, and sails, as schooner rig, cutter rig, lugger rig, &c. To rig is to fit the spars with rigging, &c. To rig out is to fit out.

Right Away.—In the direction of. An American term for quickly out of land, or move ahead.

Right Hand Rope.—Rope laid up or twisted with the sun.

Ring Bolt.—A bolt with an eye and a ring through the eye.

Ring Tail.—The studding sail of a gaff sail. (See page 157.)


Rings.—Rooves for bolt or nail clinching.

Rising Floor.—Distinct from flat floored, or flat bottomed; Sharp bottomed. (See "Dead Rise.")

Risings.—Stringers fitted inside small boats to strengthen them and support the thwarts.

Roach.—The curved part of the foot of a sail.

Roadstead.—An open anchorage.

Rockered Keel.—A keel whose ends curve upwards thus . (See "Cambered.")

Rolling.—The transverse motions of a ship when amongst waves.

Rolling Hitch.—A way of fastening a rope to a spar.

Room and Space.—The distance from the centre of one frame to the centre of another.

Roove.—(See "Ruff.")

Rope.—Ropes are of three kinds; three-strand, four-strand, and cable-laid. A number of yarns twisted together forms a strand. Three-strand rope (see Fig. 212) is laid right-handed, or with the sun (sometimes termed hawser-laid). Four-strand rope (see Fig. 213) is also laid with the sun (sometimes termed strand-laid). Four-strand rope is usually used for sheets and shrouds, pennants, and

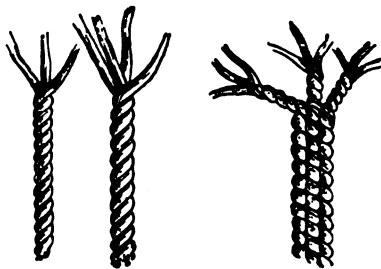


FIG. 212. FIG. 213.

FIG. 214.

generally for standing rigging. All rope comes under the general term of cordage. Cable-laid rope (see Fig. 214) consists of three "three-strand" right-hand laid ropes laid up together into one; these ropes are laid left-handed against the sun. Right-hand laid rope must be coiled with the sun; cable-laid rope is coiled against the sun.

Rough-tree Rail.—The top rail fitted to the stanchions.

Round In.—To haul in on a rope.

Round To.—To bring by the wind. To come up head to wind. A vessel is said to "go round" when she goes about.

Round Turn.—To pass a rope twice round a pin or cleat so as to make a complete circle.

Rope.—The condition of a rope that has been passed through a sheave hole or through any aperture.

Rowlocks.—The fittings on the gunwale to receive the tholes or crutches for the oars.

Royal.—The sail next above the topgallant sail.

Royal Standard.—The flag of the Sovereign and Royal family. It is always flown at the main. When the Sovereign is on board, the standard is flown at the main, and the Admiralty flag (a red ground with fouled anchor) at the fore, and Union Jack at the mizen.

Royal Yacht Club.—A club that has obtained permission from the Home Office to use the prefix "royal." An Admiralty warrant obtained from the Admiralty does not confer the title; but a royal yacht club that has not also the Admiralty warrant can only fly the red ensign, and this can have no device. A club with an Admiralty warrant takes precedence of a club that has only a Royal warrant. (See "Recognised Club.")

Rudder Trunk.—The trunk fitted in the counter to receive the rudder post into which the tiller is fitted.

Ruff or Roove.—A small ring or square plate placed over copper nails before clinching in boat building.

Rules of the Road.—Certain rules framed under the provisions of the Merchant Shipping Act, 1854, to enable ships to better keep clear of each other. They are as follows:

Art. 11. If two sailing ships are meeting end on or nearly end on so as to involve risk of collision, the helms of both shall be put to port, so that each may pass on the port side of the other.

Art. 12. When two sailing ships are crossing so as to involve risk of collision, then, if they have the wind on different sides, the ship with the wind on the port side shall keep out of the way of the ship with the wind on the starboard side; except in the case in which the ship with the wind on the port side is close hauled and the other ship free, in which case the latter ship shall keep out of the way; but if they have the wind on the same side, or if one of them has the wind aft, the ship which is to windward shall keep out of the way of the ship which is to leeward.

Art. 13. If two ships under steam are meeting end on or nearly end on so as to involve risk of collision, the helms of both shall be put to port, so that each may pass on the port side of the other.

Art. 14. If two ships under steam are crossing so as to involve risk of collision, the ship which has the other on her own starboard side shall keep out of the way of the other.

Art. 15. If two ships, one of which is a sailing ship, and the other a steam ship, are proceeding in such directions as to involve risk of collision, the steam ship shall keep out of the way of the sailing ship.

Art. 16. Every steam ship, when approaching another ship so as to involve risk of collision, shall slacken her speed, or, if necessary, stop and reverse; and every steam ship shall, when in a fog, go at a moderate speed.

Art. 17. Every vessel overtaking any other vessel shall keep out of the way of the said last-mentioned vessel.

Art. 18. Where by the above rules one of two ships is to keep out of the way, the other shall keep her course, subject to the qualifications contained in the following article.

Art. 19. In obeying and construing these rules, due regard must be had to all dangers of navigation; and due regard must also be had to any special circumstances which may exist in any particular case rendering a departure from the above rules necessary in order to avoid immediate danger.

Art. 20. Nothing in these rules shall exonerate any ship from the consequences of any neglect, &c.

[NOTE.—These rules will only remain in force until Aug. 31, 1880; after which date the rules given at the end of this Appendix come into force.]

Run.—The under part of a vessel aft defined by the buttock lines and water lines.

Run.—To sail before the wind. To come down by the run is to lower or overhaul without warning, or suddenly. To run away with a rope is to take hold of a fall and haul on it by running along the deck.

Run Down.—To foul a vessel or other object wrongfully or by accident.

Run Foul Of.—To get into collision with a vessel or other object.

Run Out.—To veer out a warp or cable.

Run Over.—The same as run down. Generally denoting carelessness in bringing about a collision.

Runners.—(See pages 115.)

Running Bowsprit.—A bowsprit that is fitted to run in and out and "reef" like a cutter's. Since 1856 most schooners have their bowsprits fitted in this way.

Running by the Lee.—To run with the boom on one quarter when the wind is blowing on the other quarter. A dangerous proceeding. (See "By the Lee.")

Running Off her Helm.—Said of a vessel if, when sailing, her stern flies up to windward (her head apparently going off to leeward) and giving her lee helm does not readily bring her to.

S.

Saddle.—A projection on a spar to support another spar, as the saddle on the mast for the jaws of the boom to rest upon.

Safety Cleats.—(See "Crucikshank's Cleats.")

Sagging.—Bending or curved downwards; the opposite of hogging. Sagging to leeward is to make a great deal of leeway.

Sail Her Along.—In close-hauled sailing, an order given to the helmsman when he is keeping the vessel too close to wind, meaning that he is to keep her a little off; sail her fuller or harder or "give her the whole weight of it," meaning the wind, and keep her passing through the water as fast as possible.

Sail Her.—When lying to if way has to be got on again, the order is to "Sail her;" or, "Let the head sheets draw and sail her!" Also "Sail her" is a general admonition to a helmsman to be very careful in his steering.

Sailing Directions—Books of pilotage which accompany charts.

Sailing on Skates.—In 1879 a gentleman, under the signature of "Glacianant," published in *The Field* a description of a sail he had contrived for sailing on skates on ice. The sail is made of a piece of unbleached calico, with slightly rounded ends; each end is attached (either by a lacing, as in the case of a cutter's topsail, or by a wide hem, such as is common in window blinds) to a light stick or yard, of sufficient length to stretch the ends of the sail. The sail is spread by a central mainyard, long enough to project 9 in. beyond the sail at each end; this must be strong, stiff, and light, and must be fitted at each extremity with two stout eyes, smooth on the inside. A piece of stout line as a "lanyard" is made fast to the centre of each of the small yards, and rove through the eyes at the ends of the mainyard, then round the small yard, and

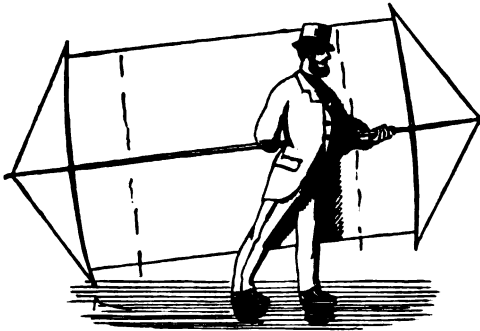


FIG. 215.

through the eye again, finishing up with a "figure of eight seizing" round the main and small yards at the points where they cross one another. One lanyard is first rove and made fast, the other is then used as a purchase to strain the sail taut. The use of the rounded ends to the sail is now seen, as the small yards buckle when the strain of the purchase comes on them. To prevent the leaches of the sail from flapping, and to relieve the small yards, a light stay is led from each end of them to the extremity of the mainyard, and made fast to the second pair of eyes already mentioned. The size of sail for a gale is 6ft. by 3ft., 9ft. by 6ft. for light wind; 7ft. 6in. by 5ft. is a good size for one skater to handle in ordinary wind.

Two people can manage a sail together great comfort. The 9ft. by 6ft. sail is too large, and tall men could manage a large one. Two rows of reef points would be a great addition, and might very easily be arranged. The sail must stand perfectly and the yards and gear must be stout enough to bear the strain of setting everything taut. In sailing alone, the skater should hold the greater part of his sail behind him; or, if wise he will infallibly be taken aback if wind is before the beam. Running before wind needs no comment, but to work to windward satisfactorily and tack smoothly require some practice.

When two go together, the sail is under perfect control. The front skater steers, the hinder one, who is in command, trims the canvas correctly by the wind. It is equally easy to gybe or tack, and one can always stop immediately by coming head to wind.

Tacking may be accomplished in two different ways:—When close hauled, say, the starboard tack, the sail being on the lee side of the man, the right or weather foot will be in front, the other in a line behind the left hand will be forward, and the right (which answers to main sheet) holding the yard behind his back. When it becomes necessary to go about, by a slight inclination of his skates the skater luffs sharply, the skates shake, the feet are changed, the harness remaining in the same position as before; the sail rapidly fills on the other side, and the skater shoots away smoothly on the port tack with his sail to windward of him. In moderate weather, the more smartly this is done the better. When blowing hard, it is necessary to take a wide sweep and shoot farth to windward in stays, running a little off the wind for a moment after filling away on the fresh tack. When tacking in this manner the yard will be alternately to windward and to leeward of the sail. In the former of these positions, the strain on it becomes very great and for this, as well as other reasons, it may be desirable to tack in the other way, as follows:

When close hauled with the sail to windward of the man, and desiring to go about without bringing the wind on the other side of the sail, the skater, instead of luffing, turns his skates to leeward, keeping the sail spread behind his back, and running for a moment right before the wind. While in this position he rapidly shifts his hands along the yard until he reaches the point at which the balance of his head and after canvas becomes correct (this is a most important consideration). What was the after hand on the other tack becomes the fore hand now, and what was the leach now becomes the luff of the sail. With a slight turning of his skates to windward, and trimming his canvas accordingly, the skater hauls his wind in a moment, and shoots away on the fresh tack with unhindered velocity, and, if the manoeuvre has been skilfully performed, with a loss of only a yard or two to leeward. This plan is recommended

for sailing single-handed, and the former when two people are going together.

Changing feet is perfectly easy; one foot can be slid in front of the other at any time.

Any skates that are sure not to come off (as Acme often do) will answer equally well.

When close hauled, the skater keeps by far the greater portion of the sail behind him; when reaching, he pushes it more forward. This answers to setting a big jib; and when running, he stands right in the middle.

Sails.—Sails in this country are usually made of flax in the form of canvas. In America nothing but cotton canvas is used. Cotton stretches less than flax; but the objection to it is that in case of rain it takes up so much water as to become exceedingly heavy and so hard as to be almost unmanageable with the hands. Information on the cutting out and making of yacht and boat sails will be found in Kipping's treatise on "Sail Making," 2s. 6d., Weale's Series.

St. Andrew's Flag.—A blue flag with white diagonal cross, thus X

St. George's Jack.—A white square flag with red St. George's cross (right angled, thus +), used by admirals in the Royal Navy. A vice-admiral's flag has one red ball, and rear-admiral's two. An admiral flies his flag from the main, vice from the fore, rear from mizen. St. George's Jack was the English flag before the union with Scotland and Ireland. (See "Jack.")

St. Patrick's Cross.—A red diagonal cross, X

Salt and Fresh Water.—A cubic foot of salt water weighs 64lb.; a ton contains 35 cubic feet. A cubic foot of fresh water weighs 62.5lb.; a ton contains 36 cubic feet: hence salt water bulk for bulk will sustain a greater weight. When a vessel goes from salt water to fresh she is sometimes lightened in ballast, in order that she may present the same surface for friction. There will be a loss of stability, and on the whole the practice is of doubtful utility. Regarding the case inversely, if a vessel be loaded down in salt water to the same depth that she has been floating at in fresh water, and driven at the same speed, the resistance will increase in ratio to the superior density of salt water. No exact experiments have been made to ascertain whether a vessel, by floating somewhat lighter in salt than in fresh water, meets with a decrease of resistance. The comparison would be always attended with difficulty, as, if there were a difference in the resistance, it would be a very complicated matter unravelling it, as it would be necessary to know how much of the resistance depended on skin friction, and how much on wave making. We are inclined to think that the resistance (taking weight for weight) is a trifle less in salt water than in fresh. By removing weight, so as to float at the same load line as in salt water, the resistance in fresh water would be less, but the question of diminished stability, which removing weight involves, is such a serious

matter that removing weight for river sailing cannot be advised. (See "Yacht Designing," page 93.)

Salute.—A salvo of cannon fired as a mark of respect and honour to a royal personage, commodore, vice or rear commodore, flag, &c. A Royal Salute is twenty-one guns. Among yacht clubs it is usual to salute a flag officer on his first hoisting his flag (swallow-tail burgee) on a club station at the beginning of a season, and when he hauls it down at the end of a season, by eleven guns for a commodore, nine for a vice-commodore, and seven for a rear-commodore respectively. It is etiquette for a flag officer of a club to return a salute, but a royal personage does not do so. The practice used to be for a yacht to "salute the flag" on arriving at a station; this practice is still in vogue in America, a junior always saluting first. (See "Dipping the Ensign.")

Save All.—A water sail; a sail set underneath booms in light weather.

Scant.—When the wind is very bare; when the wind comes so that a vessel will barely lie her course.

Scanlings.—The dimensions of all kinds of timber used in the construction of a vessel.

Scarp or Scarf, or Scarve.—A method of joining pieces of wood by tapering their ends. A box scarp is when the ends are not tapered, but a half thickness cut out of each part so that when put together the parts form only one thickness.

Schooner.—A fore-and-aft rigged vessel. A top-sail schooner has yards on her foremast, and sometimes on her mainmast, but no courses.

Scope.—Length or drift of rope or cable.

Score.—A groove to receive a rope or strop, &c.

Scowing an Anchor.—When small boats have to anchor on ground known or suspected to be foul, it will always be prudent to scow the anchor. Unbend the cable from the ring, and make the end fast round the crown, shank, and flukes with a clove hitch, and bring the end a

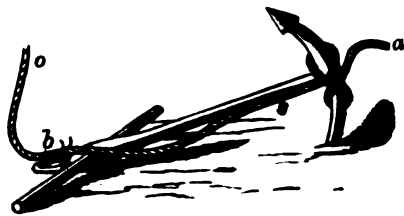


FIG. 116.

back to *a*, and stop it round the cable with spun yarn or hitches; take the cable back to the shackle and stop it as at *b*; when the cable is hauled upon by the part *c* the stop at *b* will break, and the fluke of the anchor can be readily lifted out of its bed. Sometimes, instead of scowing the anchor a trip line is bent to the crown and buoyed. (See "Anchor.")

Screens.—The wood shelves and screens painted red for port side, and green for starboard, in which a vessel's side lights are carried. (See Side lights.)

Scroll Head.—The outward curved part of the knees at the upper fore part of the stem, called volute.

Scud.—To run before a gale of wind with very little canvas set, or "under bare poles."

Scul.—An oar. To scull is to propel a boat by working an oar over the centre of the transom on the principle of the scull.

Scuppers.—Apertures out in the bulwarks or waterways to clear the deck of water.

Sea, A.—A wave. A heavy sea is when the waves are large and steep. When a quantity of water falls aboard a vessel it is said that "she shipped a sea."

Sea Boat.—A vessel fit to go to sea. A good sea boat is a relative term, and means a vessel that does not pitch badly or labour in a sea, or does not ship much water, and is, above all things, handy in a sea.

Seam.—The line formed by the meeting of two planks; overlapping parts of canvas in a sail.

Sea Mile.—The sixtieth part of a degree; the same as a geographical mile or nautical mile. (See "Knot.")

Sea Pie.—A dish made up of all sorts in layers.

Sea Way.—Generally used in the sense of waves in an open sea, meaning a disturbed sea.

Seaworthy.—In every respect fit to go to sea. In chartering a ship it is insisted that she must be "tight, staunch and strong, and well equipped, manned with an adequate crew, provisions, &c."

Second Topsail.—A gaff topsail between the largest (the latter not being a ballooner) and the jib-headed topsail.

Selwagee Strop.—A strop made of spun yarn laid up in coils and marled.

Serve.—To cover a rope with spun yarn called "service."

Serving Mallet.—The mallet which riggers use to wind service round ropes and bind it up tightly together.

Set.—To hoist or make sail. This word is sometimes improperly confused with "sit" in reference to the way a sail stands.

Set Flying.—Not set on a stay or bent by a lacing; a jib in a cutter is set flying.

Set of the Tide.—Direction of the current.

Setting Up.—Purchasing up or hauling rigging taut.

Sewed or Sued.—The condition of a vessel that grounds and on the return of the tide is not floated. If the tide does not lift her by 2ft. she is said to be "sewed" 2ft. If the tide on falling does not leave her quite dry, she is said to "sew" 1ft., 2ft., 3ft., or more, as the case may be.

Shackle.—A U-shaped crook with an eye in each end, through which a screw bolt is passed. Various used, and are often preferred to hooks.

(Fig. 217.) There is a shackle at every five fathoms of cable, so that by unshackling



FIG. 217.

the cable can be divided into many parts. Useful if the cable has to be slipped.

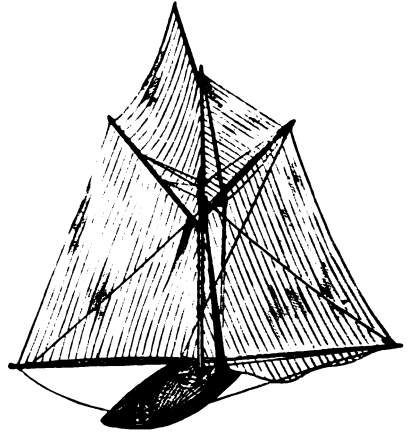


FIG. 218.

Shadow Sail.—This was a contrivance patented by Messrs. Harvey and Fryer, of Wivenhoe



FIG. 219.

in 1874, as an improvement on the spinnaker. It consisted of a gaff, goose-necked to the fore

side of the masthead, and a boom to the fore side of the mast at deck. When the spars were in their places (the gaff being set up by halyards similar to the peak halyards of the mainsail), the sail was hoisted by its peak earing and throat, and hauled out by its clew to the boom end. Above the gaff a jib-headed topsail was hoisted. There were an after-brace for the gaff, an aft and a fore guy and topping lift for the boom. The sails were nearly of the dimensions of the main sails. (See Fig. 117.) Practically it was found that there was too much gear for the sail to be got out in a hurry, and in a strong wind the spars and gear would not have borne the strain of such large sails; and so the spinnaker remains in use. We believe Messrs. Harvey and Fryer's patent has only been fitted to one vessel, the *Seabelle*, and she only tried it once in a match.

The plan appears to have been invented by Mr. N. M. Cummins, as that gentleman had a "shadow" fitted to his yacht *Electra* in 1869. Fig. 118 is a sketch of the *Electra* under the shadow or "cloud," as Mr. Cummins termed it.

Shake, To.—To sail a vessel so close to wind that the weather cloths of the sails shake; the head sails generally are the first to shake, and if the helmsman does not notice it someone who does sings out, "All shaking forward;" or "Near forward."

Shake Out a Reef.—To untie the reef points and unroll a reef.

Shallow Bodied.—With a very limited depth of hold.

Shape a Course.—To steer a particular course.

Sharp Bottomed or Sharp Floored.—A vessel with V-shaped sections.

Sharp Bowed.—With a very fine entrance or a bow whose two sides form a very acute angle.

Sharp Sterned.—A stern shaped something like the fore end or bow, thus <.

Sheathing.—The copper sheets put on the bottom of a vessel. 16oz. and 20oz. copper is generally used for yachts. Sometimes 20oz. copper at the load line, and 16oz. below. The sizes and weight of sheathing are usually as follows:—48in. by 20in., and more commonly for yachts 48in. by 14in. The weight per sheet of the 48in. by 20in. is 7.5lb., there being 18oz. to the square foot. The weight per sheet of the 48in. by 14in. is as under:

| | | | |
|-------|---------|-------|----------|
| 16oz. | 4.67lb. | 28oz. | 11.67lb. |
| 20 | 5.83 | 32 | 12.33 |

160 nails to a sheet, or 10wt. nails to every 100 sheets. The allowance made for old copper is generally one-eighth less the price paid for new. That is, if the price of new copper be 80l. per ton, the price of old will be 70l. per ton. This price is subject to another deduction of 5lb. per cwt. for dross, &c. Copper is usually put on so that the edges overlap, but in the case of a few yachts the edges of the copper have been butted: that is, the edges were laid edge to edge and the nails were counter sunk and scoured down. Of course

this plan entails enormous trouble, but the superior surface it presents can be considered as a compensation. Many yacht builders obtain the copper sheathing of Messrs. Neville, Druce, and Co., 13, Sherborne-lane, E.C.

Sheave.—The wheel within a block or in the sheave hole of a spar over which ropes pass.

Sheepshank.—A plan of shortening a rope by taking up a part and folding it into two loops



FIG. 220.

or bights, and then putting a half hitch of each standing part over a bight.

Sheer.—The fore-and-aft curve of a vessel's deck or bulwarks.

To sheer is to put the rudder over when a vessel is at anchor, so as to cause her to move laterally and ride clear of her anchor. A vessel is said to break her sheer when she departs from the sheer that has been given her.

Sheer Hulk.—An old vessel fitted with sheers, whereby masts are lifted into other vessels. Sometimes used in the sense that nothing but the hulk remains.

Sheer Mast.—Two masts fitted in the form of a triangle, termed sheers.

Sheer Plan or Sheer Draught.—A drawing showing a longitudinal vertical section or profile of a vessel. (See Plate III.)

Sheers.—Two spars erected in the form of a triangle (apex uppermost), to raise or lift heavy spars by.

Shelf.—A strong piece of timber running the whole length of the vessel inside the timber heads, binding the timbers together; the deck beams rest on and are fastened to the shelf. (See page 105.)

Sheet.—A rope or chain by which the lower after corners of sails are secured.

Sheet Home.—To strain or haul on a sheet until the foot of a sail is as straight or taut as it can be got. When the clew of a gaff topsail is hauled close out to the check block on the gaff. In square-rigged vessels a sail is said to be sheeted home when the after clews are hauled close out to the sheet blocks or sheave holes in the yard. This no doubt is the origin of the term.

Shifting Backstays.—The backstays that are only temporarily set up and shifted every time a vessel is put about or gybed. (See "Preventer.")

Shifting Ballast.—Ballast carried for shifting to windward to add to stiffness. A practice severely condemned in yacht racing. (See page 48.)

Shifting her Berth.—When a vessel removes from an anchorage, &c.

Shift of Plank.—The distance one plank overlaps another.

Shift Ports, To.—To proceed from one port to another.

- Shift Tacks, To.**—To go from one tack to the other.
- Shift the Helm.**—To move the tiller from one side to the other; thus, if it is put to port, an order to shift the helm means put it to starboard.
- Shift of Wind.**—A change of wind.
- Shin Up.**—To climb up the shrouds by the hands and shins, when they are not rattled down.
- Ship, To.**—To put anything in position. To engage as one of the crew of a vessel. To ship a sea, to ship a crutch, to ship a seaman, &c.
- Ship Shape.**—Done in a proper and unimpeachable manner.
- Ships' Papers.**—These include builders' certificate, register (in case of not being an original owner, bill of sale as well), bill of lading, bill of health, &c. Also in the case of a yacht her Admiralty warrant.
- Shiver.**—To luff up and cause the sails to shiver or lift.
- Shiver the Mizen.**—To luff up until the mizen lifts or shivers.
- Shoe or Shod.**—Iron plates rivetted to the ends of wire rigging to receive shackle bolts.
- Shore.**—The land. A support of wood or iron, a prop.
- Short Tacks or Short Boards.**—Beating or working to windward by frequent tacking.
- Shorten.**—The wind is said to shorten when it comes more ahead. To shorten sail, to take in sail.
- Shoot.**—To move through the water after the means of propulsion is withdrawn.
- Shy.**—The wind is said to shy when it comes from ahead or breaks a vessel off.
- Side Keelsons.**—Stout pieces of timber fitted fore and aft on either side of the keel.
- Side Lights.**—The red (port) and green (starboard) lights carried by vessels when under way. Small yachts during bad weather are not required to have their side lights fixed, but must always have them ready on deck on their proper sides ready to show. Open boats must carry lights, and if the usual side lights are not used they must have lanterns fitted with green and red slides, to show when required. Steam yachts and steam launches, in addition to the usual side lights, must carry a white light at the masthead. Steam vessels when towing must carry two white lights (vertically) at the masthead. All vessels when at anchor are required to exhibit after sundown a white light at a height not exceeding 20ft. above the hull. This light must be visible one mile, and show all round the horizon. It is usual to put this light on the forestay. Pilot vessels carry a white masthead light, and exhibit a "flare up" every fifteen minutes. Fishing vessels and open boats, when riding to nets, carry a white light and show a flare up occasionally. If drift netting, a fishing boat must carry two red lights vertically. A ship which is being overtaken by another ship must show a white light or flare up over her stern. Previous to 1847 had been no regulation as to the color of lights; the custom being for ships to exhibit a light over their sides when approaching each other at night; but in the Admiralty were empowered to regulations respecting lights, and steamships were ordered to exhibit a white light at the masthead, a green light to starboard, a red light to port, and vessels at anchor a white light. And sailing ships were ordered to show, when required, a green light on starboard side and a red to port. As between steamships and sailing vessels, the latter required to present a light to the former where there was any danger of collision. The Admiralty Court acted upon the Admiralty Regulations, The Order in Council issued in pursuance of the Act, and dated June 29, 1848, and the 1852, re-affirmed the former regulations for steamers, and recommended all sailing vessels to be provided with red and green side lights, and lights to be shown on the port and starboard bow, according to the side a vessel might be approaching. Section 295 of the Merchant Shipping Act, 1854, confirmed the powers of the Admiralty to the same extent as before. The Merchant Shipping Act, 1861, did not alter the law with respect to steamships but made it compulsory on sailing ships to keep their side lights fixed instead of playing red or green lights by hand lanterns. (See "Lights.")
- Siding or Sided.**—The size of a timber, between its two-plane sides. (See "Molding.")
- Sight the Anchor.**—To heave up the anchor.
- Signal of Distress.**—An ensign hoisted jack downwards.
- Sit.**—Sails are said to "sit" well when they do not girt, pucker, belly, or shake. This verb is sometimes wrongly written "set."
- Skeet.**—An instrument (usually a horn on a staff) for wetting sails. In old yacht club racing, skeeting to windward only was allowed, and it was thought the skeet might be used as a means of propulsion.
- Skids.**—Pieces of timber put under a boat's bottom for resting her on deck, or when launched off.
- Skiff.**—A small boat used by coast watermen for the conveyance of passengers.
- Skin.**—The outside or inside planking of a vessel.
- Skin Resistance.**—The resistance a vessel meets with owing to the friction of the water on the plank or sheathing. (See "Resistance.")
- Skipper.**—A slang term for the master of a yacht or other vessel.
- Skysail.**—A square sail set above the royals.
- Sky Scraper.**—A triangular sail set above the skysail. Sometimes the sail next above the skysail is a square sail; then it is termed moonsail, and the sail above that a stager.
- Sky Pilot.**—A term applied by sailors to chaplains.

- Slab Reef.**—A kind of half-reef in a mainsail below the first reef, it takes up the foot or slab of the sail.
- Slack.**—Not taut. To slack up a rope or fall of a tackle is to ease it.
- Slack Helm.**—When a vessel carries very little, if any, weather helm.
- Slack Tide.**—The tide between the two streams when it runs neither one way nor the other. There is high-water slack, and low-water slack.
- Slack in Stays.**—Slow in coming head to wind, and still slower in paying off.
- Slant of Wind.**—A favouring wind. A wind that frees a vessel when close-hauled.
- Sleep, or All Asleep.**—When the sails are full and do not flap or shiver.
- Sliding Keel.**—(See page 244.)
- Slings.**—Ropes or strops used to support or sling yards, &c.
- Slip.**—To let go, as to slip the cable.
- Sloop.**—A fore-and-aft rigged vessel something like a cutter, but usually has a standing bowsprit. Small sloops have only one head sail set on a stay. (See pp. 246 and 333.)
- Slot.**—An aperture generally for a pin or bolt to travel in.
- Smack.**—A small trading vessel usually cutter rigged. A fishing cutter.
- Small Helm.**—Said of a vessel when she carries weather helm.
- Snatch Block.**—A block with an opening in the



FIG. 221.

shell so that a rope can be put over the sheave without reeving it. (See Fig. 221.)

- Sneak Boat.**—A shallow and beamy boat in use on the Ohio and Mississippi.
- Snotter.**—An eye strop used to support the heel of a sprit.
- Snub.**—To bring a vessel up suddenly when she has way on and only a short range of cable to veer out. Sometimes necessary if the vessel must be stopped at all costs, but a practice likely to break the fluke of an anchor if it is a good and quick holder.
- Sawg.**—Comfortably canvassed to suit the weather. Anything made neat, or stowed compactly.
- So!**—An order to cease, often given instead of "belay" when men are hauling on a rope.
- Soldiers' Wind.**—A wind so that a vessel can lie her course all through to her destination without tacking or any display of seamanship.
- Sounding.**—(See "Lead.")

- Soundings.**—To be near enough to land for the deep sea lead to find a bottom.
- Spales.**—Cross shores used to keep the frame of a vessel in position whilst building.
- Span.**—A rope made fast by either end to a spar or stay, usually for the purpose of hooking a tackle to. Spans are now commonly fitted to gaffs to hook the peak halyards to. (See page 139.)
- Spanish Burton.**—A purchase composed of three single blocks. A double Spanish Burton consists of one double and two single blocks.
- Spanish Reef.**—A knot tied in the head of a jib-headed sail to shorten the hoist or reduce the area of the sail.
- Spanker.**—The fore-and-aft sail set with boom and gaff on the mizen of a square-rigged ship; termed also the driver.
- Span Shackle.**—A bolt with a triangular shackle. The gammon iron that encircles the bowsprit at the stem. When it is directly over the stem the forestay is shackled to it.
- Spars.**—The masts, booms, gaffs, yards, bowsprit, &c., of a vessel.
- Spars, Mensuration of.**—Cubical contents of a spar can thus be found. Find the area of each end (see "Area of Circles"); add the areas of the circles together and halve the sum. Multiply the half by the length of the spar. If the spar tapers towards each end, the area of each end and the middle area should be taken, added together and divided by 3. And the plan is as follows: take the girth (see circumference "Areas of Circles") of the spar at each end and halve it. Find the square of the half, and multiply it by the length of the spar. If the spar tapers at both ends, find the girths at three places, halve and divide by 3; find the square of the quotient, and multiply it by the length of the spar. The weight of spars can be found by multiplying their solid contents by the weight in pounds of a cubic foot of the wood the spar is made of. Thus a cubic foot of red pine will weigh from 32 to 40lb., and a cubic foot of oak from 53 to 60lb. (See "Weight and Bulk of Substances.")
- Speed Indicators.**—The log-line, log-ship, and sand-glass have done service to test the rate of speed for more than two hundred years; but they make at the best a clumsy contrivance, and it is not surprising that many attempts have been made to supersede it. Of these perhaps Masey's and Walker's logs are the best known, and, with certain limitations, the most reliable; but one objection to these has been that they do not show at a glance the rate of sailing, and, if anything fouls the log, the record of the distance sailed through the water is imperfect. Another disadvantage—although, it must be confessed, it is a small one—is that, before the distance run can be ascertained, the log has to be hauled in. Some eight years ago we recollect witnessing some experiments in America with a fantail log attached to a small wire, which necessarily turned with the log. The wire was attached

to some clock-like machinery on the poop, and a dial recorded the number of miles sailed. This instrument was said to have kept a true record of distances in a voyage to the West Indies and back; but, as it does not appear to have come into general use, it may be presumed that it was subject to mishaps. Reynolds's "pendent log" is similar to the American contrivance, inasmuch as it registers on board the miles run.

The speed indicators which most resemble the line and log-ship in its results are those which only show the rate of sailing per hour, and do not record the distance traversed. Of these perhaps Berthon's log, or adaptation of it, is the most in favour, and if properly adjusted, marks very accurately the speed per hour at any moment. Berthon's log consists of a tube, which passes through the keel, or any immersed part of the hull, and, as the water will rise in this tube in accordance with the speed through the water, it was not a difficult matter to adjust a speed indicator in connection with the tube. Another kind of log, on the dynamic principle, is one invented by the late Mr. Joseph Maudslay. This was a very simple contrivance, and consisted of an ordinary Salter's spring balance, a line, and small weight.

The line was 25 fathoms long, and 1 inch in circumference. The lead weight was 6 inches long, $1\frac{1}{4}$ inches in diameter, and weighed about $2\frac{1}{4}$ lb. The ends of the lead were rounded off. A hole was made through the lead from end to end, through which the line was passed and secured by a knot. With 12 fathoms of this line and lead immersed the resistance at two knots per hour was found to be 1 lb., and for other speeds the resistance increased nearly as the square of the speed; thus at two knots the resistance is 1 lb.; at ten knots, or five times greater speed, the resistance is 25 lb., as $5 \times 5 = 25$. We some years ago tested this log with Berthon's, and on different occasions on the measured mile, and found the speed pretty accurately indicated so long as the water was smooth; but when it came to rough water, the lead jumped about so that it was impossible to arrive at the exact speed.

The lead weight can be dispensed with; without it the line will not jump out of the water, and so a constant or steady pull can be obtained. We tried an experiment by towing a rope astern of a steam launch, and found the resistance at various speeds as set forth in the middle column. The rope forming the "log" was 13 fathoms long, the whole of which was permanently immersed. The rope was four stranded, "water-laid," and one inch and a quarter ($1\frac{1}{4}$ inch) in circumference. A smaller line was spliced to the other as a tow line, as much of this being payed out as was sufficient to keep the larger rope immersed, or to prevent any part of the thirteen fathoms being towed out of water. At the splice, and on the larger piece of rope, was a piece of lead pipe about a foot long (with an inside diameter equal to the diameter of the rope).

This served the double purpose of showing a glance if the whole of the larger rope not immersed, and helped to maintain immersion. The after end of the larger should be whipped. The log patented by Clark Russell is similar to this arrangement.

On the face of the spring balance numbers of the knots should be engraved opposite the resistance in pounds as set in the table.

In all cases speed indicators or logs only the speed through the water; and to calculate the distance made to the good over the ground the tide must be eliminated.

| Knots. | Resistance of Proposed Log in lbs. | Resistance of Maudslay's Log in lbs. |
|--------|------------------------------------|--------------------------------------|
| 2 | $1\frac{1}{4}$ | 1 |
| 3 | $2\frac{1}{4}$ | $2\frac{1}{4}$ |
| 4 | $4\frac{1}{4}$ | 4 |
| 5 | $7\frac{1}{4}$ | $6\frac{1}{4}$ |
| 6 | 11 | 9 |
| 7 | 15 | $12\frac{1}{4}$ |
| 8 | $19\frac{1}{4}$ | 16-2oz. |
| 9 | $24\frac{1}{4}$ | $20\frac{1}{4}$ |
| 10 | $30\frac{1}{4}$ | 25 |
| 11 | 37 | $30\frac{1}{4}$ |
| 12 | 44 | 36 |
| 13 | $51\frac{1}{4}$ | $42\frac{1}{4}$ |
| 14 | 60 | 49 |
| 15 | 69 | $56\frac{1}{4}$ |

Speed of Yachts.—No doubt very exaggerated opinions prevail as to the speed an English yacht is capable of. Very frequently the mistake made about the distance sailed certain time; no allowance has been made for tide, or the speed has been inaccurately judged. So far as our experience goes following table gives the extreme speeds of sailing yachts of certain length and tonnage have attained:

| Length. | Equivalent Tonnage. | Knots per hour. | Time per mile |
|---------|---------------------|-----------------|---------------|
| ft. | | | Min. sec. |
| 9 | 0 $\frac{1}{2}$ | 3-75 | 16 0 |
| 16 | $1\frac{1}{4}$ | 5-00 | 12 0 |
| 25 | $4\frac{1}{4}$ | 6-25 | 9 36 |
| 36 | 6 | 7-50 | 8 0 |
| 41 | 10 | 8- | 7 30 |
| 49 | 20 | 8-75 | 6 51 |
| 64 | 40 | 10- | 6 0 |
| 81 | 100 | 11-25 | 5 20 |
| 100 | 190 | 12-50 | 4 48 |
| 121 | 320 | 13-75 | 4 21 |
| 144 | 400 | 15-00 | 4 0 |

These observed speeds correspond with theory that speed varies as the square root of the length on load water-line. But there are some apparently well-authenticated reports that yachts of 121 ft. on the load have reached a speed of 16 knots per hour. The American yacht, Sappho, is said to have made such a speed; and as doubts have various times been thrown upon the statement, it will be well to re-publish the following extract from her log, taken while crossing the Atlantic in 1869. The Sappho left Sandy Hook Lightship 7 a.m. July

and arrived Queenstown Harbour 9 p.m. Aug. 9, Queenstown time, making the run in 12 days 9 hours 36 min. (two hours less to the Old Head of Kinsale).

It will be seen that the strong wind was on the quarter the whole way, and as the sea was exceptionally smooth, more favourable conditions for attaining high speed could not have been had. As a rule, with a strong wind, there is a great deal of sea, and this, of course, is an unfavourable condition for the attainment of high speeds.

comes to be relieved and the one who has to take his place lags, the former sings out "Spell O!" (See "Trick.")

Spencer.—A fore-and-aft sail set with gaffs in square-rigged ships, as trysails on the fore and main mast.

Spider Hoop or Spider Band.—An iron band encircling the mast with iron belaying pins in it.

Spiling.—Marking on a bar of wood the distances that a curved line (say that of a frame) is from a straight line.

| | LAT. N. | | | LONG. W. | | | MILES. | COURSE. | WIND. | REMARKS. |
|-------------------|---------|----|----|----------|----|----|--------|-----------------------------|------------|--|
| | D. | M. | S. | D. | M. | S. | | | | |
| July 28 | 40 | 29 | 32 | 73 | 21 | 00 | 27 | E. $\frac{1}{2}$ S. | S.W. | Fine breeze. |
| " 29 | 40 | 32 | 38 | 67 | 27 | 0 | 279 | E. $\frac{1}{2}$ S. | S. | { Fresh breeze, making 9 to 14 knots thick fog; ran 47 miles in 3 hours. |
| " 30 | 41 | 23 | 38 | 61 | 32 | 0 | 273 | E. $\frac{1}{2}$ S. | S. by W. | { Making 16 knots, wind died out to calm, foggy. |
| " 31 | 43 | 32 | 00 | 56 | 55 | 0 | 229 | E. | W.S.W. | { Light breeze and fog; got a glimpse of sun for latitude. |
| Aug. 1 | 44 | 41 | 39 | 54 | 26 | 15 | 112 | E. by S. $\frac{1}{2}$ S. | W.N.W. | { Light breeze; dense fog 8 p.m., nearly calm. |
| " 2 | 45 | 20 | 23 | 51 | 25 | 15 | 134 | E. by S. | W. by S. | { Nearly calm, only going 1 knot sometimes; dense fog. |
| " 3 | 46 | 25 | 17 | 47 | 10 | 15 | 192 | E. by S. | W.S.W. | { Dense fog; moderate breeze; fog lifted 6 p.m. |
| " 4 | 47 | 36 | 49 | 41 | 52 | 45 | 238 | E. by S. | S. | { Fine breeze, clear weather. |
| " 5 | 49 | 31 | 18 | 35 | 21 | 15 | 315* | E. by S. | S.S.W. | { Fresh breeze; very smooth, sea like a lake. |
| " 6 | 50 | 53 | 56 | 29 | 33 | 15 | 244 | E.S.E. | S.W. | { Fog and rain; moderate breeze. |
| " 7 | 50 | 56 | 49 | 24 | 14 | 30 | 192 | S.E. by E. | W.S.W. | { Fresh breeze, with swell. |
| " 8 | 51 | 07 | 30 | 17 | 06 | 00 | 271 | S.E. by E. $\frac{1}{2}$ E. | N.W. by N. | { Fine breeze. |
| " 9 | 50 | 42 | 25 | 10 | 12 | 15 | 255 | S.E. by E. $\frac{1}{2}$ E. | N.W. by N. | { Overcast; fresh breeze, increasing to fresh gale; sighted land 4.15 p.m. |
| | | | | | | | 96 | E. by N. $\frac{1}{2}$ N. | N. by E. | |
| Total miles | | | | | | | 2857 | | | |

* The run of 315 miles on Aug. 5 was an average of 13.1 knots an hour.

It is equally well authenticated that the American yacht Meteor (which was lost in the Mediterranean in 1869), in a passage from Cowes to Lisbon, logged 319 miles in 24 hours, with a strong quarterly double-reef wind. During some portion of the 24 hours the Meteor logged 16 knots. The Cambria, in the Atlantic yacht race 1870 only attained a speed of 11 $\frac{1}{2}$ knots, but there was a heavy quarter sea whenever she had a strong fair wind. The greatest sustained speed that we have ever been witnesses to in a match was in a race between the Livonia (106ft.) and Columbia (98ft.) in America. The Livonia did the distance between the S.W. Spit buoy and Sandy Hook Lightship, 8 $\frac{1}{2}$ nautical miles, in 40 minutes, or at the rate of 13 knots an hour; and no doubt that some part of the time she was going 13 $\frac{1}{2}$ knots. The tide was not strong, and abeam. We do not think this speed has been much exceeded by English yachts, but Mr. Thellusson states that the Guinevere has logged 14 knots. It is recorded that the American clipper ship Sovereign of the Seas in 1852 averaged 300 miles a day for eleven consecutive days, and 333 miles for four consecutive days. Her greatest distance any day, noon to noon, was 362 miles. Every one will agree that this was most extraordinary sailing. (See "Time Allowance by Length.")

Spell.—The term of work allotted to any of the men in a watch. Thus there is the spell at the helm termed "trick;" spell at the mast-head to look out, &c. When a man's time

Spinnaker.—A jib-headed sail reaching from the topmast head to the deck, first introduced in yacht racing in 1865 by Mr. William Gordon in the Niobe, and hence for some time termed a "Niobe." The term "spinnaker" appears to have been applied to it as a kind of nickname, without "rhyme or reason." In 1866 Mr. Herbert Maudslay had a similar sail made for his yacht Sphinx, and it was first used in a match of the Royal Victoria Yacht Club at Ryde. The men called the yacht "Spinks," and hence it is said that the sail became known as a spinker, the spinniker, or, as now written, "spinnaker." Mr. MacMullen in his "Down Channel" says that he had a similar sail in 1852.

Spindle Model.—A name given to a cylindrical model tapering at the ends.

Spirketting.—Timber worked inside a vessel under the shelf in a fore-and-aft direction.

Spitfire.—The smallest storm jib.

Splice.—To join the ends of rope together by interweaving the untwisted strands. An eye splice is formed by interweaving the untwisted end of a rope in the lay of the strands.

Split Lug.—A lugsail in two parts (Fig. 119); the fore part is sheeted like a foresail, and in going about the tack is never cast off, nor is the tack of the after part of the sail. The up and down lines on the sail show where it is divided, and where the mast comes. To heave to, the clew (after oringle) of the fore part of the lug would be hauled up to the mast or to windward of it, easing the main-

sheet as required. The split lug is not in much favour. The standing lug (or even balance lug) and foresail rig has all the advantages of the split lug without so much

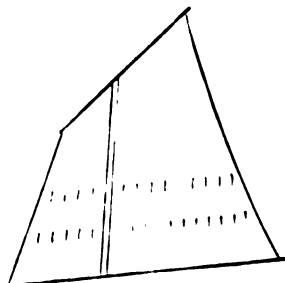


FIG. 221.

yard forward of the mast and without the disadvantage of not being able to lower the fore part or foresail.

Spoken.—Said when one ship has spoken to another by signal.

Spokes.—The bars of the wheel of a ship radiating from the boss. "To give her a spoke" is to move the wheel to the extent of the distance between spoke and spoke.

Sponson.—The platform ahead and abaft paddle wheels, usually outside the bulwarks, but sometimes inclosed.

Spoon Drift.—Spray blown from the crests of waves.

Spring.—A warp or hawser or rope.

Spring a Mast.—To crack or splinter a mast.

Spring her Luff.—To ease the weather tiller lines so that a vessel will luff to a free puff.

Sprit Sail.—A four-sided sail stretched by a pole termed a sprit. This is a time-honoured con-

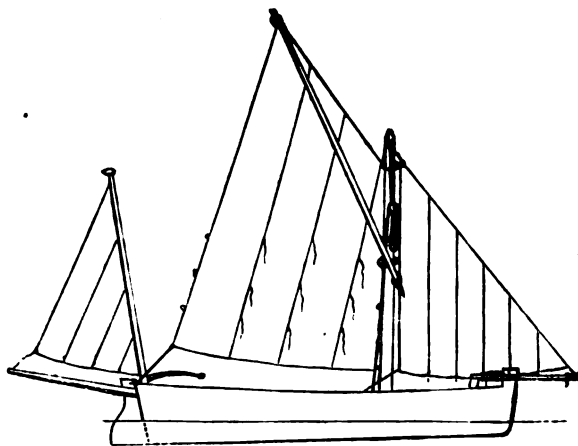


FIG. 222.

trivance for setting a sail that has no boom, but a gaff is preferred if the sail has a boom. (See page 285.)

Spring.—Damaged by cracking or splitting. (See "Spring a Mast.")

Spun Yarn.—Small rope or cord used for &c.

Square.—Said of sails when they are true right angles to the keel. A ship is said to have square yards when there is little difference between the lengths of upper and lower yards when her yards are very long.

Square the Yards.—To brace them across right angles to the keel. Square the boom and haul it out at right angles to the keel.

Squeeze.—A vessel is said to be squeezed when she is sailed very close to the wind in such a manner that she may weather some point or other.

Stains on Deck.—Iron moulds, &c., removed from a deck by a solution of oxymuriatic acid, three parts water.

Stand.—A term variously employed; as to stand on the shore, to stand E.S.E., and to stand on without tacking. A sail is said to stand when it does not lift or shake.

Standard.—(See "Royal Standard.")

Stand By.—The order to make ready. "Stand by to lower the topsail."

Standing Part.—The part permanently made to something, and not hauled upon.

Standing Rigging.—The rigging that is permanently in its place. (See pages 112-122.)

Stand Up.—A vessel is said to stand up when she carries her canvas without heeling much.

Starboard.—The right hand side. The opposite to port.

Starbolins.—The men and "Watches" who compose the starboard watch. (See "Larboard.")

Start, To.—To move, as to slacken a sheet or to start a butt is to cause a plank to start at its butt or end.

Started neither Tack nor Starboard.—Said when a vessel sails a course without a shift of course so that there is no occasion for her to alter the trim of sails.

Starved of Wind.—When a vessel is sailed so near the wind that she does not have enough of it to feel the weight of it.

Stay, To.—To tack.

Stay Rope.—The luff or weather bolt rope of a jib or other sail.

Stays.—Ropes for supporting the masts and other spars. A vessel is said to be in stays when she is tacked through the operation of tacking. To stay is to tack. (See "Tacking Stays.")

Steady!—An order to put the vessel about, or not to move about.

Steerage.—In a yacht the space between the athwartship bulkhead of the main cabin and the athwartship bulkhead of the after cabin.

(The latter is generally known as the ladies' cabin.) Usually the term *steerage* is limited to the fore and aft passage and berths therein.

Steerage Way.—When a vessel moves through the water so that she can be steered. In simply drifting or moving with the tide a vessel has no steerage way on, and cannot be steered; therefore *steerage way* means that a vessel relatively to the water moves ahead and passes the water.

Steersman.—A helmsman.

Steeve.—The upward inclination or rake which a bowsprit has, or which the plank sheer has forward. The running bowsprit has usually a steeve corresponding with the sheer forward; a standing bowsprit has generally considerably more.

Stem.—The timber at the fore end of a vessel into which the ends of the plank are butted. To stem is to make headway, as against a current.

Stemson.—A piece of timber worked inside the stem.

Step.—A piece of timber or metal to receive a vessel's mast, &c. To step is to put a thing into its step.

Stern-board.—The name given to the three-cornered board aft in an open boat. (See "Stern Sheets.")

Stern Board.—A movement of a vessel sternwards.

Stern Way.—Moving astern: to make a stern-board.

Stern Post.—The strong timber to which the rudder is hung.

Stern Sheets.—The seat in the aft end of a boat. Sometimes the three-cornered bottom board is termed the stern sheet. This board in a yacht's gig is usually a wood grating. In small fishing boats the stern sheet is the platform on which the fisherman coils away his nets, lines, &c.

Stiff.—Not easily heeled; having great stability.

Stock of an Anchor.—The crossbar near the shackle.

Stocks.—The framework upon which a vessel rests whilst she is being built.

Stopper.—A rope or lashing used to prevent a rope or chain surging or slipping, as cable stopper, rigging stoppers, &c. The latter is usually a short piece of rope put on as a kind of racking to prevent the rigging or its tackles rendering. (See "Racking.")

Stops.—Yarns or short pieces of rope by which sails are secured when rolled up or stowed. Also the short lines by which sails are tied to yards when they are not laced.

Storm Sails.—The storm jib and storm trysail set in bad weather.

Stove in.—Broken in.

Stow.—To roll up. To pack away.

Straight of Breadth.—The distance where the breadth of a ship is equal amidships; now generally termed parallel length of middle

body, because the two sides of a ship may be for some distance parallel to each other. A straight of breadth is seldom found in a yacht excepting in some long steam yachts; these frequently are of the same breadth for some distance amidships. (See "Body" and "Dead Flat.")

Strake.—A breadth of plank.

Strand.—Yarns twisted together and they then make the parts or strands of a rope.

Stranded.—Said of a rope when one or more of its strands have burst. Cast ashore.

Strands.—Yarns when unlaid and used as "stops" are sometimes called strands.

Strap.—(See "Strop.")

Stream.—The direction of the flood tide and ebb tide. The tides in the channel are usually referred to as the eastern stream for the flood and western stream for the ebb.

Stretch.—A course sailed. Also the elasticity of canvas or rope.

Strike.—To lower, as to strike the topmast, &c. Also to strike the bottom, &c.

Stringers.—Strengthening strakes of plank or iron inside a vessel's frame.

Strop or Strap.—A sort of hoop made of rope yarn, wire, or iron, used to put round spars, rigging, &c., to hook tackles to.

Studding Sails.—Sails set outside the courses, topsail, &c., in square-rigged ships; called by sailors "stu'n's'ls."

Stuff.—Slang for sails, as, "Give her the stuff," meaning more sail. Also small rope, and picked hemp or cotton waste.

Surge.—When a rope renders round a belaying pin, &c.

Swansea Pilot Boats.—A very snugly rigged kind of schooner met with in the Bristol channel. The rig comprises mainmast, foremast, and running bowsprit; the mainmast is stepped exactly in the middle of the boat, and has a great rake aft, so that the head of the

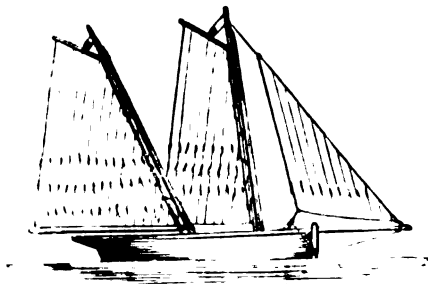


FIG. 294.

mast plumbs over the after part of the cockpit, two sheaves are out in it, through which the halyards are rove. The foremast is upright, with sheaves like the mainmast, and a block on the fore part under the sheave holes for the jib halyards. These masts require no rigging or stays, and are pole masts without

any topmasts. The gaffs are short, being for a boat of 25 to 30 tons only about 6ft. long, and only require one halyard. One end of the halyard is spliced to a single block; the other end being passed over the first sheave in the mast, then through a single block, which is hooked on to the gaff, and finally through the upper sheave in the mast. This end is belayed. A purchase is formed by a rope passed through the block on the halyard and through a block on deck. The fore halyards are rigged the same way, and the jib halyards are of the ordinary kind. The sails consist of mainsail, foresail, and jib; the two former being laced round the mast. These sails can be taken in in about one minute and a half, and set in about two and a half. The outhaul of the jib is passed under a sheave on the stem, and acts as a bobstay; there are no shrouds to bowsprit. The advantages of this rig are said to be that one man can handle a boat of 25 tons himself, and the boats are equally as handy with the foresail as without it, likewise the mainsail. They will stay or do anything either way, and with only the foresail and jib a boat can be sailed on a wind.

Swell.—Long waves with unbroken crests, usually met with after heavy winds have subsided.

Sweep.—A long bend. To sweep is to impel by sweeps or large oars; formerly, vessels as large as 300 tons used sweeps, and by hard work could make three knots an hour. Sweeps are not permitted in yacht racing.

Sweeps.—Large oars.

Swig, To.—The fall of a tackle is put under a cleat or pin, and is held firmly by one or more of the crew; another man or men then takes hold of the part of the fall between the cleat and the block and throws his whole weight on it; as he comes up the other hand takes in the slack. By swigging on a tackle a couple of hands can often get in all that is required, where by steady hauling they might not have moved the blocks an inch.—To drink.

Swimming.—If a person who cannot swim falls overboard, he should turn his face towards the sky, and press his chest forward; he cannot then sink. He should keep the legs down as much as possible. He should keep composed, and strike out slowly with the hands. A person could soon learn to swim by walking into the water breast high, and then striking out, holding the face well up towards the sky.

Swivel Hook.—A hook that revolves by a pivot inserted in a socket and clinched.

T.

Tabernacle.—A strong trunk used in barges to step the mast in on deck so that the mast can be lowered for going under bridges. It is in fact a lengthening of the mast, the trunk being the housed part with a hinge or joint on deck. In small boats that have no deck the mast is generally stepped at the bottom of the tabernacle, and not on the top. (See pages 281, 423, 459, &c.)

Tabling.—The strengthening pieces of canvas sewn to the edges of sails where the rope goes on.

Tack.—The lower fore-corner of a sail. To tack is to go about or shift from one tack to another. The side on which the wind blows on the sails, as starboard tack or port tack. This term probably originated with the square rig, as "port tacks" aboard means that lower port corners of the sail are now haul in-board, whereas when the wind was on the other side these corners had been hauled out-board by the sheets.

Tackle.—An arrangement of ropes and pulleys for increasing power; a purchase. (Pronounced "tay-kle" by sailors.)

Tackle-fall.—The hauling part of the rope of a tackle.

Tack Tackles.—The tackles employed to set down the tacks of sails.

Taffrail.—The continuation of the top rail round the aft side of the counter.

Tail Block.—A block with a tail or piece of rope stropped to it for making fast the block instead of a hook.

Tail on.—An order to take hold of a rope to help haul.

Tail Tackle.—A watch tackle; that is, a double and single block. The single block has a hook; the double block a rope tail.

Take In or Take Off.—To haul or furl a sail.

Take, To.—A jib is said to take when a vessel bears head to wind and the jib fills on one side or the other.

Take Up.—To shrink; to tighten up.

Tanning a Sail.—No tanning will entirely prevent mildew, if the canvas is left unopened and unaired an unlimited time. For a 20ft. boat boil in a furnace of 15 gallons 28lb. catechu, until thoroughly dissolved; put such sails as convenient, and let them steep a night; then spread and mop them over both sides with the mixture. If required very dark indeed, double the amount of catechu. Sails too large for a furnace or vat should be mopped only on a floor of asphalt, or cement with the mixture. Sails are sometimes "tanned" in a tan yard.

Taunt.—Tall, high, towering. (See "A-taunt")

Taut.—Tight; stretched as tightly as possible.

Taut Bowline.—A ship is said to be on taut bowline when the bowlines on both sides of the sail are hauled as tight as possible for sailing near the wind. With everything stretched as flat as possible for close-hauled sailing.

Tend.—To attend to a sheet and watch it to see if it requires hauling in or slacking out generally to attend to any work on board ship.

Tenon.—A sort of tongue cut at the end of a piece of timber to fit into a mortise.

Thimble.—A ring, pear shaped or circular, with a groove outside for ropes to fit in.

Thimble Eyes.—Eyes spliced in rigging round a thimble. A thimble seized in a strop. (See page 317, *c* and *d*, Fig. 90.)

Tholes.—Pins fitted into the holes in rowlocks for oars to work in.

Thread.—A vessel is said to thread her way when she weaves in and out among other vessels, or through a narrow channel.

Throat.—The deepest part of the hollow of the jaws of a gaff, or the hollow of a ∇ shaped knee, or the hollow of a floor. The throat halyards are those which are attached to the throat of a gaff. The upper weather corner of a gaff-sail is often called the throat, because it is attached to the throat of the gaff.

Through Bolt, or Through Fastening.—A bolt that passes through timber and plank.

Thumb Cleat.—Pieces of wood put on spars, &c., to prevent ropes or strops from slipping.

Thwarts.—The transverse seats in a boat. (See "Athwartships.")

Tidal Harbour.—A harbour that can only be entered on certain stages of the tide.

Tides.—Usually the rise and fall or flow and ebb of the sea around the coast. The highest tides occur at the new moon and full moon. Tides in estuaries, harbours, and bays vary a great deal.

Tight.—Impervious to water; well caulked; not leaky. Never applied to the tension of ropes, &c., which are always "taut." (See "Taut.")

Tiller.—The piece of timber inserted in the rudder head for steering; usually termed the helm.

Tiller Lines.—The lines attached to the tiller to move it by. Generally in yachts of 40 tons and over, a tackle is used. In large yachts a second tackle is sometimes used, if the yacht carries much weather helm or is hard to steer: these second tackles are usually termed relieving tackles.

Timber-heads.—The heads or upper ends of the frames.

Timber Hitch.—A quick way of bending a rope to a spar. A loop or bight is formed by twisting the end of a rope round its standing part, thus:



FIG. 225.

The end of the rope is shown on the right, and the standing part passing through the bight on the left.

Timbers.—The frames or ribs of a vessel.

Time Allowance.—The allowance made by one yacht to another in competitive sailing, proportional to the size of the yachts and the distance sailed. The Y.R.A. Scale founded on that of the Royal Alfred Club, which in turn was adapted from a scale prepared for the Royal Yacht Squadron, is the one in use in match sailing.—In small boat sailing, an allowance of 1sec. per inch for every excess inch of length for every mile sailed, is a good allowance. Where length and breadth are multiplied together, 1sec. per square foot for

every mile makes a good allowance. Where length and breadth are added together, the allowance might be $1\frac{1}{2}$ second per inch per mile. These allowances are only adapted for boats that do not differ much in length. Where the difference in length much exceeds a foot, the boats should be classed as a 20ft. class, 25ft. class, &c., unless the graduated table of allowance for length given on page 564 be used.

The principles assumed in computing the Y.R.A. time tables are that the allowance of time given by a larger to a smaller vessel should be *directly* proportional to the distance sailed, and *inversely* proportional to the size of the vessels; that is to say,

If a larger can allow a smaller vessel one minute on a particular length of course, she can allow her two minutes on a course of twice the length.

And with respect to the element of size, the assumption is that if a vessel, of say 50 tons, can allow a smaller one any given time per ton of difference, a vessel of twice the size, or 100 tons, can only allow half the time, or the same for two tons that the vessel of 50 tons allows for one ton.

The allowance of time for each ton will consequently be obtained from the relation $t = \frac{k l}{T}$ where t is the allowance of time per ton in seconds, k a number, whose value in the table is taken as 30, on the supposition that a vessel of 30 tons can allow one of 29 tons one second per mile, l the length of the course in miles, and T the tonnage of the vessel.

For a course of 50 miles the formula therefore is $t = \frac{30 \times 50}{T}$

The Y.R.A. time scales have been computed for courses of 50, 10, and 8 nautical miles. For 50 miles, the time per ton is $\frac{30 \times 50}{31} = 49$ seconds, and between 31 tons and 32 tons $\frac{30 \times 50}{32} = 47$ seconds, which, added together, is equal to 96 seconds, the time 32 tons allows 30 tons. The formula only gives the time per ton between any two vessels which are of one ton difference for fifty miles; the time allowed between any two, say between a yacht of 40 tons and 30 tons, is the sum of the time the intermediate yachts would allow each other in regular succession, or $(\frac{30 \times 50}{31}) + (\frac{30 \times 50}{32}) + (\frac{30 \times 50}{33}) + (\frac{30 \times 50}{34}) + (\frac{30 \times 50}{35})$, and so on.

[The New Thames Yacht Club scale was calculated on the assumption that on a fifty miles course a yacht should receive fifteen minutes from one of double tonnage, and so the allowance per ton is always the ratio 1 : 2 where the tonnage is in that ratio, and the allowance per ton for other tonnages is in proportion.]

The Y.R.A. scale for ten miles is given on the next page.

To use the table, take the times placed

opposite to the tonnages of any two vessels; the difference between these times will be the time the larger vessel is to allow the smaller one over a course of ten miles.

If the course be twenty miles, the time allowance would be double; if thirty miles, treble, and so on.

If the course be an odd number of miles, like twenty-seven, the time can be found between any two yachts by a simple proportion sum.

Thus, it can be assumed that one yacht is 78 tons, and the other 42 tons. The time opposite these tonnages are

| | |
|-------------------------------|-----------|
| 78 tons | m. a. |
| 42 tons | 13 17 |
| Allowance for ten miles | 5 4 |
| Multiply by | 27 miles. |
| Divide by 10 miles..... | 10)87 48 |
| | 8 16.8 |

That is, if the time between the two yachts were 8 min. 4 secs. for ten miles, it would be 8 min. 16 secs. (or taking in the fraction '8 it would be more correctly 8 min. 17 sec.) for twenty-seven miles.

TIME FOR A COURSE OF TEN NAUTICAL MILES.

| Ton. | Min. | Sec. | Ton. | Min. | Sec. | Ton. | Min. | Sec. |
|------|------|------|------|------|------|------|------|------|
| 5 | 0 | 0 | 59 | 11 | 54.0 | 113 | 15 | 7.6 |
| 6 | 0 | 50.0 | 60 | 11 | 59.0 | 114 | 15 | 10.4 |
| 7 | 1 | 32.8 | 61 | 12 | 3.8 | 115 | 15 | 13.0 |
| 8 | 2 | 10.4 | 62 | 12 | 8.6 | 116 | 15 | 15.6 |
| 9 | 2 | 43.6 | 63 | 12 | 13.4 | 117 | 15 | 18.0 |
| 10 | 3 | 13.6 | 64 | 12 | 18.2 | 118 | 15 | 20.6 |
| 11 | 3 | 41.0 | 65 | 12 | 22.8 | 119 | 15 | 23.2 |
| 12 | 4 | 6.0 | 66 | 12 | 27.4 | 120 | 15 | 25.6 |
| 13 | 4 | 29.0 | 67 | 12 | 31.8 | 121 | 15 | 28.2 |
| 14 | 4 | 50.4 | 68 | 12 | 36.2 | 122 | 15 | 30.6 |
| 15 | 5 | 10.4 | 69 | 12 | 40.6 | 123 | 15 | 33.0 |
| 16 | 5 | 29.2 | 70 | 12 | 44.8 | 124 | 15 | 35.4 |
| 17 | 5 | 46.8 | 71 | 12 | 49.0 | 125 | 15 | 37.8 |
| 18 | 6 | 3.6 | 72 | 12 | 53.2 | 126 | 15 | 40.2 |
| 19 | 6 | 19.4 | 73 | 12 | 57.4 | 127 | 15 | 42.6 |
| 20 | 6 | 34.4 | 74 | 13 | 1.4 | 128 | 15 | 45.0 |
| 21 | 6 | 48.6 | 75 | 13 | 5.4 | 129 | 15 | 47.2 |
| 22 | 7 | 2.2 | 76 | 13 | 9.4 | 130 | 15 | 49.6 |
| 23 | 7 | 15.2 | 77 | 13 | 13.2 | 131 | 15 | 51.8 |
| 24 | 7 | 27.8 | 78 | 13 | 17.0 | 132 | 15 | 54.2 |
| 25 | 7 | 39.8 | 79 | 13 | 20.8 | 133 | 15 | 56.4 |
| 26 | 7 | 51.4 | 80 | 13 | 24.6 | 134 | 15 | 58.6 |
| 27 | 8 | 2.4 | 81 | 13 | 28.4 | 135 | 15 | 60.8 |
| 28 | 8 | 13.2 | 82 | 13 | 32.0 | 136 | 16 | 3.0 |
| 29 | 8 | 23.4 | 83 | 13 | 35.6 | 137 | 16 | 5.2 |
| 30 | 8 | 33.4 | 84 | 13 | 39.2 | 138 | 16 | 7.4 |
| 31 | 8 | 43.2 | 85 | 13 | 42.8 | 139 | 16 | 9.6 |
| 32 | 8 | 52.6 | 86 | 13 | 46.2 | 140 | 16 | 11.8 |
| 33 | 9 | 1.6 | 87 | 13 | 49.6 | 141 | 16 | 13.8 |
| 34 | 9 | 10.4 | 88 | 13 | 53.0 | 142 | 16 | 16.0 |
| 35 | 9 | 19.0 | 89 | 13 | 56.4 | 143 | 16 | 18.0 |
| 36 | 9 | 27.4 | 90 | 13 | 59.8 | 144 | 16 | 20.2 |
| 37 | 9 | 35.4 | 91 | 14 | 3.0 | 145 | 16 | 22.4 |
| 38 | 9 | 43.4 | 92 | 14 | 6.4 | 146 | 16 | 24.2 |
| 39 | 9 | 51.0 | 93 | 14 | 9.6 | 147 | 16 | 26.2 |
| 40 | 9 | 58.6 | 94 | 14 | 12.8 | 148 | 16 | 28.4 |
| 41 | 10 | 5.8 | 95 | 14 | 15.8 | 149 | 16 | 30.4 |
| 42 | 10 | 13.0 | 96 | 14 | 19.0 | 150 | 16 | 32.4 |
| 43 | 10 | 20.0 | 97 | 14 | 22.2 | 151 | 16 | 34.4 |
| 44 | 10 | 26.8 | 98 | 14 | 25.2 | 152 | 16 | 36.2 |
| 45 | 10 | 33.4 | 99 | 14 | 28.2 | 153 | 16 | 38.2 |
| 46 | 10 | 40.0 | 100 | 14 | 31.2 | 154 | 16 | 40.2 |
| 47 | 10 | 46.4 | 101 | 14 | 34.2 | 155 | 16 | 42.2 |
| 48 | 10 | 52.6 | 102 | 14 | 37.2 | 156 | 16 | 44.0 |
| 49 | 10 | 58.8 | 103 | 14 | 40.0 | 157 | 16 | 46.0 |
| 50 | 11 | 4.8 | 104 | 14 | 43.0 | 158 | 16 | 47.8 |
| 51 | 11 | 10.6 | 105 | 14 | 45.8 | 159 | 16 | 49.8 |
| 52 | 11 | 16.4 | 106 | 14 | 48.6 | 160 | 16 | 51.6 |
| 53 | 11 | 22.0 | 107 | 14 | 51.4 | 161 | 16 | 53.4 |
| 54 | 11 | 27.6 | 108 | 14 | 54.2 | 162 | 16 | 55.4 |
| 55 | 11 | 33.0 | 109 | 14 | 57.0 | 163 | 16 | 57.2 |
| 56 | 11 | 38.4 | 110 | 14 | 59.6 | 164 | 16 | 59.0 |
| 57 | 11 | 43.8 | 111 | 15 | 2.4 | 165 | 17 | 0.8 |
| 58 | 11 | 48.8 | 112 | 15 | 5.0 | 166 | 17 | 2.6 |

TIME FOR TEN MILES—continued.

| Ton. | Min. | Sec. | Ton. | Min. | Sec. | Ton. | Min. | Sec. |
|------|------|------|------|------|------|------|------|------|
| 167 | 17 | 4.4 | 245 | 18 | 50.2 | 323 | 20 | 21.0 |
| 168 | 17 | 6.2 | 246 | 19 | 0.4 | 324 | 20 | 22.0 |
| 169 | 17 | 8.0 | 247 | 19 | 1.6 | 325 | 20 | 23.0 |
| 170 | 17 | 9.8 | 248 | 19 | 2.8 | 326 | 20 | 24.0 |
| 171 | 17 | 11.6 | 249 | 19 | 4.0 | 327 | 20 | 25.0 |
| 172 | 17 | 13.2 | 250 | 19 | 5.2 | 328 | 20 | 26.0 |
| 173 | 17 | 15.0 | 251 | 19 | 6.4 | 329 | 20 | 27.0 |
| 174 | 17 | 16.8 | 252 | 19 | 7.6 | 330 | 20 | 28.0 |
| 175 | 17 | 18.4 | 253 | 19 | 8.8 | 331 | 20 | 29.0 |
| 176 | 17 | 20.2 | 254 | 19 | 10.0 | 332 | 20 | 30.0 |
| 177 | 17 | 21.8 | 255 | 19 | 11.2 | 333 | 20 | 31.0 |
| 178 | 17 | 23.6 | 256 | 19 | 12.2 | 334 | 20 | 32.0 |
| 179 | 17 | 25.2 | 257 | 19 | 13.4 | 335 | 20 | 33.0 |
| 180 | 17 | 26.8 | 258 | 19 | 14.6 | 336 | 20 | 34.0 |
| 181 | 17 | 28.6 | 259 | 19 | 15.6 | 337 | 20 | 35.0 |
| 182 | 17 | 30.2 | 260 | 19 | 17.0 | 338 | 20 | 36.0 |
| 183 | 17 | 31.8 | 261 | 19 | 18.0 | 339 | 20 | 37.0 |
| 184 | 17 | 33.4 | 262 | 19 | 19.2 | 340 | 20 | 38.0 |
| 185 | 17 | 35.0 | 263 | 19 | 20.4 | 341 | 20 | 39.0 |
| 186 | 17 | 36.6 | 264 | 19 | 21.4 | 342 | 20 | 39.0 |
| 187 | 17 | 38.2 | 265 | 19 | 22.6 | 343 | 20 | 39.0 |
| 188 | 17 | 39.8 | 266 | 19 | 23.8 | 344 | 20 | 40.0 |
| 189 | 17 | 41.4 | 267 | 19 | 24.8 | 345 | 20 | 41.0 |
| 190 | 17 | 43.0 | 268 | 19 | 26.0 | 346 | 20 | 42.0 |
| 191 | 17 | 44.6 | 269 | 19 | 27.2 | 347 | 20 | 43.0 |
| 192 | 17 | 46.2 | 270 | 19 | 28.2 | 348 | 20 | 44.0 |
| 193 | 17 | 47.8 | 271 | 19 | 29.4 | 349 | 20 | 45.0 |
| 194 | 17 | 49.2 | 272 | 19 | 30.4 | 350 | 20 | 46.0 |
| 195 | 17 | 50.8 | 273 | 19 | 31.6 | 351 | 20 | 46.0 |
| 196 | 17 | 52.4 | 274 | 19 | 32.6 | 352 | 20 | 47.0 |
| 197 | 17 | 53.8 | 275 | 19 | 33.8 | 353 | 20 | 48.0 |
| 198 | 17 | 55.4 | 276 | 19 | 34.8 | 354 | 20 | 49.0 |
| 199 | 17 | 56.8 | 277 | 19 | 35.8 | 355 | 20 | 50.0 |
| 200 | 17 | 58.4 | 278 | 19 | 37.0 | 356 | 20 | 51.0 |
| 201 | 17 | 59.8 | 279 | 19 | 38.0 | 357 | 20 | 51.0 |
| 202 | 18 | 1.4 | 280 | 19 | 39.2 | 358 | 20 | 52.0 |
| 203 | 18 | 2.8 | 281 | 19 | 40.2 | 359 | 20 | 53.0 |
| 204 | 18 | 4.4 | 282 | 19 | 41.2 | 360 | 20 | 54.0 |
| 205 | 18 | 5.8 | 283 | 19 | 42.4 | 361 | 20 | 55.0 |
| 206 | 18 | 7.2 | 284 | 19 | 43.4 | 362 | 20 | 56.0 |
| 207 | 18 | 8.6 | 285 | 19 | 44.4 | 363 | 20 | 56.0 |
| 208 | 18 | 10.2 | 286 | 19 | 45.4 | 364 | 20 | 57.0 |
| 209 | 18 | 11.6 | 287 | 19 | 46.6 | 365 | 20 | 58.0 |
| 210 | 18 | 13.0 | 288 | 19 | 47.6 | 366 | 20 | 59.0 |
| 211 | 18 | 14.4 | 289 | 19 | 48.6 | 367 | 21 | 0.0 |
| 212 | 18 | 15.8 | 290 | 19 | 49.6 | 368 | 21 | 1.0 |
| 213 | 18 | 17.2 | 291 | 19 | 50.6 | 369 | 21 | 1.0 |
| 214 | 18 | 18.6 | 292 | 19 | 51.6 | 370 | 21 | 2.0 |
| 215 | 18 | 20.0 | 293 | 19 | 52.8 | 371 | 21 | 3.0 |
| 216 | 18 | 21.4 | 294 | 19 | 53.8 | 372 | 21 | 4.0 |
| 217 | 18 | 22.8 | 295 | 19 | 54.8 | 373 | 21 | 5.0 |
| 218 | 18 | 24.2 | 296 | 19 | 55.8 | 374 | 21 | 5.0 |
| 219 | 18 | 25.6 | 297 | 19 | 56.8 | 375 | 21 | 6.0 |
| 220 | 18 | 27.0 | 298 | 19 | 57.8 | 376 | 21 | 7.0 |
| 221 | 18 | 28.2 | 299 | 19 | 58.8 | 377 | 21 | 8.0 |
| 222 | 18 | 29.6 | 300 | 19 | 59.8 | 378 | 21 | 9.0 |
| 223 | 18 | 31.0 | 301 | 20 | 0.8 | 379 | 21 | 9.0 |
| 224 | 18 | 32.4 | 302 | 20 | 1.8 | 380 | 21 | 10.0 |
| 225 | 18 | 33.6 | 303 | 20 | 2.8 | 381 | 21 | 11.0 |
| 226 | 18 | 35.0 | 304 | 20 | 3.8 | 382 | 21 | 12.0 |
| 227 | 18 | 36.2 | 305 | 20 | 4.8 | 383 | 21 | 13.0 |
| 228 | 18 | 37.6 | 306 | 20 | 5.8 | 384 | 21 | 14.0 |
| 229 | 18 | 39.0 | 307 | 20 | 6.6 | 385 | 21 | 15.0 |
| 230 | 18 | 40.2 | 308 | 20 | 7.6 | 386 | 21 | 15.0 |
| 231 | 18 | 41.6 | 309 | 20 | 8.6 | 387 | 21 | 16.0 |
| 232 | 18 | 42.8 | 310 | 20 | 9.6 | 388 | 21 | 16.0 |
| 233 | 18 | 44.0 | 311 | 20 | 10.6 | 389 | 21 | 17.0 |
| 234 | 18 | 45.4 | 312 | 20 | 11.6 | 390 | 21 | 18.0 |
| 235 | 18 | 46.6 | 313 | 20 | 12.4 | 391 | 21 | 19.0 |
| 236 | 18 | 48.0 | 314 | 20 | 13.4 | 392 | 21 | 19.0 |
| 237 | 18 | 49.2 | 315 | 20 | 14.4 | 393 | 21 | 20.0 |
| 238 | 18 | 50.4 | 316 | 20 | 15.4 | 394 | 21 | 21.0 |
| 239 | 18 | 51.8 | 317 | 20 | 16.2 | 395 | 21 | 22.0 |
| 240 | 18 | 53.0 | 318 | 20 | 17.2 | 396 | 21 | 23.0 |
| 241 | 18 | 54.2 | 319 | 20 | 18.2 | 397 | 21 | 23.0 |
| 242 | 18 | 55.4 | 320 | 20 | 19.2 | 398 | 21 | 24.0 |
| 243 | 18 | 56.6 | 321 | 20 | 20.0 | 399 | 21 | 25.0 |
| 244 | 18 | 58.0 | 322 | 20 | 21.0 | 400 | 21 | 26.0 |

The Thames Sailing Club, to meet the conditions of up-river sailing, makes the allowance per mile five seconds instead of one second between any two vessels, one of which is one-thirtieth smaller than the other, and further applies the rule to Statute instead of to Nautical miles.

The table is constructed by separately

calculating the allowance which each size of boat should give to the size immediately below it, the steps being by tons and tenths of tons.

For the purpose of the Thames Sailing Club Table, *l* was left out of the formula, being 1 (the table applies to one mile only), and the result was multiplied by 5; the formula will then be $t = \frac{30}{T} \times 5$, where *T* is the tonnage in tenths of tons.

As an example, a boat of 2 tons (20-tenths) allows a boat of 1.9 tons (19-tenths) 7.5 seconds per mile, because

$$t = \frac{30}{T} \times 5 = \frac{30}{20} \times 5 = 7.5$$

—as appears by the Table.

TABLE SHOWING, IN SECONDS, THE ALLOWANCE PER STATUTE MILE OF THE COURSE, TO BE MADE BY BOATS OF ALL SIZES UP TO 5 TONS, TO A BOAT MEASURING HALF-A-TON.

| Tonnage. | Allowance per Statute Mile of the course, to a boat measuring 5-10ths of a ton. | Tonnage. | Allowance per Statute Mile of the course, to a boat measuring 5-10ths of a ton. |
|----------|---|----------|---|
| | Seconds. | | Seconds. |
| .5 | 0 | 2.8 | 246.6 |
| .6 | 25 | 2.9 | 251.7 |
| .7 | 46.4 | 3 | 256.7 |
| .8 | 65.2 | 3.1 | 261.6 |
| .9 | 81.8 | 3.2 | 266.3 |
| 1 | 96.8 | 3.3 | 270.8 |
| 1.1 | 110.5 | 3.4 | 275.2 |
| 1.2 | 123 | 3.5 | 279.5 |
| 1.3 | 134.5 | 3.6 | 283.7 |
| 1.4 | 145.2 | 3.7 | 287.7 |
| 1.5 | 155.2 | 3.8 | 291.7 |
| 1.6 | 164.6 | 3.9 | 295.5 |
| 1.7 | 173.4 | 4 | 299.3 |
| 1.8 | 181.8 | 4.1 | 302.9 |
| 1.9 | 189.7 | 4.2 | 306.5 |
| 2 | 197.2 | 4.3 | 310 |
| 2.1 | 204.3 | 4.4 | 313.4 |
| 2.2 | 211.1 | 4.5 | 316.7 |
| 2.3 | 217.6 | 4.6 | 320 |
| 2.4 | 223.9 | 4.7 | 323.2 |
| 2.5 | 229.9 | 4.8 | 326.3 |
| 2.6 | 235.7 | 4.9 | 329.4 |
| 2.7 | 241.2 | 5 | 332.4 |

The allowance to be made by any boat to a smaller boat, *per statute mile of the course*, is ascertained by deducting the allowance given in the above table opposite to the tonnage of the smaller boat, from that placed opposite to the tonnage of the larger boat. The remainder is the required allowance.

TIME ALLOWANCE BY LENGTH.

Rating yachts by length, in competitive sailing, has been practised since the early days of yacht racing, so far at least as small yachts are concerned; but the practice has not become general, for the principal reason that one yacht, say of 40ft. length, owing to greater beam, might be capable of carrying a larger quantity of sail than another yacht of 40ft. length, and so have greater speed. If sails were not the means of propulsion this would be of little consequence, as, length for length, vessels of varied proportions of beam might, if well modelled, be of equal speed; and the speed of vessels of different lengths will be found to vary nearly as the square

roots of their lengths, unless there be some extraordinary variance in their general form. It is not, therefore, surprising to find that the roots of the linear dimensions of yachts have been many times suggested as a proper basis for a time allowance; and, indeed, the Boston Yacht (U.S.) Club, some twelve years ago, had a time scale founded on the assumption that the greatest speed of a yacht is equal to 2½ times the cube root of her length;

thus $2\frac{1}{2} \left(\frac{S}{\sqrt[3]{L}} \right) = \left(\frac{S \times 0.4}{\sqrt[3]{L}} \right)$ where *S* is the number (3600) of seconds in an hour, and *L* the length on the load water-line. 3600 seconds multiplied by .4 yield 1440 seconds, and so

the formula can be simplified to $\left(\frac{1440}{\sqrt[3]{L}} \right)$ and the time per mile allowed by one yacht to some other would be expressed in seconds—

$\left(\frac{1440}{\sqrt[3]{L}} \right)$ minus $\left(\frac{1440}{\sqrt[3]{L_2}} \right)$ (*L*₂ of course means some other yacht); or, say the length of one yacht is 27ft., and that of the other 64ft. The cube root of 27 is 3, and the cube root of 64 is 4; the time per mile between these two would be $\left(\frac{1440}{3} \right) - \left(\frac{1440}{4} \right) = 120$ secs.

The allowance would be 72 seconds per mile under the Y.E.A. time scale between yachts of the lengths given. And it would be difficult to say which would be the fairer allowance, taking into consideration the very different circumstances under which matches are sailed.

But the speed of yachts varies more nearly as the square roots of their length than as the cube roots, other things being equal. On this assumption, and, in order that a properly graduated scale should be available instead of the clumsy contrivance of "so much a foot," we have computed a scale for yachts of all lengths from 9ft. to 200ft.

A common practice for allowing time over courses of any given distance is to make the allowance 1 min. per foot. This works very well so long as the boats are arranged in classes of say from 20ft. to 22ft., 22ft. to 25ft., and so on; but the rule would be misleading if there was as much difference of say 5ft. in the length of the boats.

So far as our experience goes, the speed of yachts of different sizes accords with those set out in the table below; and these speeds also agree with the assumption that the speed varies as the square root of the length.

| Length. | Equivalent Tonnage. | Knots per hour. | Time per mile. |
|---------|---------------------|-----------------|----------------|
| ft. | | | Min. sec. |
| 9 | 0½ | 3.75 | 16 0 |
| 12 | 1½ | 5.00 | 12 0 |
| 25 | 4½ | 6.25 | 9 36 |
| 36 | 6 | 7.50 | 8 0 |
| 41 | 10 | 8 | 7 30 |
| 49 | 20 | 8.75 | 6 51 |
| 64 | 40 | 10 | 6 0 |
| 81 | 100 | 11.25 | 5 30 |
| 100 | 190 | 12.50 | 4 48 |
| 121 | 330 | 13.75 | 4 21 |
| 144 | 400 | 15.00 | 4 0 |

Thus, in the table it has been assumed that a yacht 64ft. long can sail one mile in six minutes; and that the time of other yachts per mile will vary as the square root of their respective lengths. Therefore, on this assumption, a yacht 9ft. long will sail a mile in sixteen minutes (or 960 seconds), and the time between a yacht 9ft. long and any other larger yacht will, therefore be found by the equation

$$960 - \left(\frac{980 \times \sqrt{9}}{\sqrt{L}} \right)$$

The letter L in the equation is, of course, some other yacht.

This allowance assumes that the full speed of the yachts would be maintained; but in yacht racing we know that full speed is seldom kept up; and practice teaches us that an allowance based on the assumption that full speed would be maintained from start to finish, would be nearly always double what the larger yacht is capable of giving the smaller. Consequently, in the table which follows, only half the full-speed allowance has been given.

The table has been computed for a course of five miles; for ten miles the time would be doubled; and for fifteen miles trebled; and so on. Or the time can be found for any number of miles by a simple proportion sum. Say one yacht is 49ft. long and the other 64ft. The times opposite these lengths are as under :

| | |
|-----------|-----------|
| | Min. sec. |
| 64ft..... | 25 0 |
| 49ft..... | 22 51 |

2 9 = Time for five miles.

That is, 64ft. allows 49ft. 2min. 9sec. (or 129 seconds) for five miles. The time for any other length, of course (say twenty-three-miles), can be found thus :

| | |
|---------|--------------|
| 129 | ... seconds. |
| 22 | ... miles. |
| — | |
| 887 | |
| 258 | |
| — | |
| 5) 2967 | |

598 = Time for twenty-three miles.

That is, the time for twenty-three miles would be 593 seconds, or 9min. 53sec.

TIME SCALE FOR LENGTH FOR A COURSE OF FIVE MILES.

| ft. | in. | min. | sec. | ft. | in. | min. | sec. | ft. | in. | min. | sec. |
|-----|-----|------|------|-----|-----|------|------|-----|-----|------|------|
| 9 | 0 | 0 | 0 | 18 | 6 | 12 | 6 | 28 | 0 | 17 | 21 |
| 9 | 6 | 1 | 3 | 19 | 0 | 12 | 29 | 28 | 6 | 17 | 33 |
| 10 | 0 | 2 | 2 | 19 | 6 | 12 | 50 | 29 | 0 | 17 | 45 |
| 10 | 6 | 2 | 58 | 20 | 0 | 13 | 10 | 29 | 6 | 17 | 57 |
| 11 | 0 | 3 | 38 | 20 | 6 | 13 | 29 | 30 | 0 | 18 | 8 |
| 11 | 6 | 4 | 36 | 21 | 0 | 13 | 48 | 30 | 6 | 18 | 18 |
| 12 | 0 | 5 | 30 | 21 | 6 | 14 | 7 | 31 | 0 | 18 | 28 |
| 12 | 6 | 6 | 3 | 22 | 0 | 14 | 25 | 31 | 6 | 18 | 38 |
| 13 | 0 | 6 | 40 | 22 | 6 | 14 | 42 | 32 | 0 | 18 | 48 |
| 13 | 6 | 7 | 21 | 23 | 0 | 14 | 58 | 32 | 6 | 19 | 58 |
| 14 | 0 | 7 | 55 | 23 | 6 | 15 | 14 | 33 | 0 | 19 | 7 |
| 14 | 6 | 8 | 35 | 24 | 0 | 15 | 30 | 33 | 6 | 19 | 16 |
| 15 | 0 | 9 | 2 | 24 | 6 | 15 | 45 | 34 | 0 | 19 | 25 |
| 15 | 6 | 9 | 52 | 25 | 0 | 16 | 0 | 34 | 6 | 19 | 34 |
| 16 | 0 | 10 | 0 | 25 | 6 | 16 | 14 | 35 | 0 | 19 | 43 |
| 16 | 6 | 10 | 28 | 26 | 0 | 16 | 28 | 35 | 6 | 19 | 52 |
| 17 | 0 | 10 | 54 | 26 | 6 | 16 | 42 | 36 | 0 | 20 | 0 |
| 17 | 6 | 11 | 19 | 27 | 0 | 16 | 55 | 36 | 6 | 20 | 8 |
| 18 | 0 | 11 | 48 | 27 | 6 | 17 | 8 | 37 | 0 | 20 | 16 |

TIME SCALE FOR A COURSE OF FIVE MILES—continued.

| ft. | in. | min. | sec. | ft. | in. | min. | sec. | ft. | in. | min. | sec. |
|-----|-----|------|------|-----|-----|------|------|-----|-----|------|------|
| 81 | 0 | 26 | 44 | 81 | 6 | 26 | 47 | 185 | 6 | 29 | 25 |
| 82 | 0 | 26 | 47 | 82 | 0 | 26 | 50 | 186 | 0 | 29 | 24 |
| 83 | 0 | 26 | 50 | 83 | 6 | 26 | 53 | 187 | 0 | 29 | 23 |
| 84 | 0 | 26 | 53 | 84 | 0 | 26 | 56 | 187 | 6 | 29 | 22 |
| 85 | 0 | 26 | 56 | 85 | 6 | 26 | 58 | 188 | 0 | 29 | 21 |
| 86 | 0 | 26 | 58 | 86 | 0 | 27 | 0 | 188 | 6 | 29 | 20 |
| 87 | 0 | 27 | 0 | 87 | 6 | 27 | 2 | 189 | 0 | 29 | 19 |
| 88 | 0 | 27 | 2 | 88 | 0 | 27 | 4 | 189 | 6 | 29 | 18 |
| 89 | 0 | 27 | 4 | 89 | 6 | 27 | 6 | 190 | 0 | 29 | 17 |
| 90 | 0 | 27 | 6 | 90 | 0 | 27 | 8 | 190 | 6 | 29 | 16 |
| 91 | 0 | 27 | 8 | 91 | 6 | 27 | 10 | 191 | 0 | 29 | 15 |
| 92 | 0 | 27 | 10 | 92 | 0 | 27 | 12 | 191 | 6 | 29 | 14 |
| 93 | 0 | 27 | 12 | 93 | 6 | 27 | 14 | 192 | 0 | 29 | 13 |
| 94 | 0 | 27 | 14 | 94 | 0 | 27 | 16 | 192 | 6 | 29 | 12 |
| 95 | 0 | 27 | 16 | 95 | 6 | 27 | 18 | 193 | 0 | 29 | 11 |
| 96 | 0 | 27 | 18 | 96 | 0 | 27 | 20 | 193 | 6 | 29 | 10 |
| 97 | 0 | 27 | 20 | 97 | 6 | 27 | 22 | 194 | 0 | 29 | 9 |
| 98 | 0 | 27 | 22 | 98 | 0 | 27 | 24 | 194 | 6 | 29 | 8 |
| 99 | 0 | 27 | 24 | 99 | 6 | 27 | 26 | 195 | 0 | 29 | 7 |
| 100 | 0 | 27 | 26 | 100 | 0 | 27 | 28 | 195 | 6 | 29 | 6 |
| 101 | 0 | 27 | 28 | 101 | 6 | 27 | 30 | 196 | 0 | 29 | 5 |
| 102 | 0 | 27 | 30 | 102 | 0 | 27 | 32 | 196 | 6 | 29 | 4 |
| 103 | 0 | 27 | 32 | 103 | 6 | 27 | 34 | 197 | 0 | 29 | 3 |
| 104 | 0 | 27 | 34 | 104 | 0 | 27 | 36 | 197 | 6 | 29 | 2 |
| 105 | 0 | 27 | 36 | 105 | 6 | 27 | 38 | 198 | 0 | 29 | 1 |
| 106 | 0 | 27 | 38 | 106 | 0 | 27 | 40 | 198 | 6 | 29 | 0 |
| 107 | 0 | 27 | 40 | 107 | 6 | 27 | 42 | 199 | 0 | 29 | 0 |
| 108 | 0 | 27 | 42 | 108 | 0 | 27 | 44 | 199 | 6 | 29 | 0 |
| 109 | 0 | 27 | 44 | 109 | 6 | 27 | 46 | 200 | 0 | 29 | 0 |
| 110 | 0 | 27 | 46 | 110 | 0 | 27 | 48 | 200 | 6 | 29 | 0 |
| 111 | 0 | 27 | 48 | 111 | 6 | 27 | 50 | 201 | 0 | 29 | 0 |
| 112 | 0 | 27 | 50 | 112 | 0 | 27 | 52 | 201 | 6 | 29 | 0 |
| 113 | 0 | 27 | 52 | 113 | 6 | 27 | 54 | 202 | 0 | 29 | 0 |
| 114 | 0 | 27 | 54 | 114 | 0 | 27 | 56 | 202 | 6 | 29 | 0 |
| 115 | 0 | 27 | 56 | 115 | 6 | 27 | 58 | 203 | 0 | 29 | 0 |
| 116 | 0 | 27 | 58 | 116 | 0 | 27 | 60 | 203 | 6 | 29 | 0 |
| 117 | 0 | 27 | 60 | 117 | 6 | 27 | 62 | 204 | 0 | 29 | 0 |
| 118 | 0 | 27 | 62 | 118 | 0 | 27 | 64 | 204 | 6 | 29 | 0 |
| 119 | 0 | 27 | 64 | 119 | 6 | 27 | 66 | 205 | 0 | 29 | 0 |
| 120 | 0 | 27 | 66 | 120 | 0 | 27 | 68 | 205 | 6 | 29 | 0 |
| 121 | 0 | 27 | 68 | 121 | 6 | 27 | 70 | 206 | 0 | 29 | 0 |
| 122 | 0 | 27 | 70 | 122 | 0 | 27 | 72 | 206 | 6 | 29 | 0 |
| 123 | 0 | 27 | 72 | 123 | 6 | 27 | 74 | 207 | 0 | 29 | 0 |
| 124 | 0 | 27 | 74 | 124 | 0 | 27 | 76 | 207 | 6 | 29 | 0 |
| 125 | 0 | 27 | 76 | 125 | 6 | 27 | 78 | 208 | 0 | 29 | 0 |
| 126 | 0 | 27 | 78 | 126 | 0 | 27 | 80 | 208 | 6 | 29 | 0 |
| 127 | 0 | 27 | 80 | 127 | 6 | 27 | 82 | 209 | 0 | 29 | 0 |
| 128 | 0 | 27 | 82 | 128 | 0 | 27 | 84 | 209 | 6 | 29 | 0 |
| 129 | 0 | 27 | 84 | 129 | 6 | 27 | 86 | 210 | 0 | 29 | 0 |
| 130 | 0 | 27 | 86 | 130 | 0 | 27 | 88 | 210 | 6 | 29 | 0 |
| 131 | 0 | 27 | 88 | 131 | 6 | 27 | 90 | 211 | 0 | 29 | 0 |
| 132 | 0 | 27 | 90 | 132 | 0 | 27 | 92 | 211 | 6 | 29 | 0 |
| 133 | 0 | 27 | 92 | 133 | 6 | 27 | 94 | 212 | 0 | 29 | 0 |
| 134 | 0 | 27 | 94 | 134 | 0 | 27 | 96 | 212 | 6 | 29 | 0 |
| 135 | 0 | 27 | 96 | 135 | 6 | 27 | 98 | 213 | 0 | 29 | 0 |
| 136 | 0 | 27 | 98 | 136 | 0 | 27 | 100 | 213 | 6 | 29 | 0 |
| 137 | 0 | 27 | 100 | 137 | 6 | 27 | 102 | 214 | 0 | 29 | 0 |
| 138 | 0 | 27 | 102 | 138 | 0 | 27 | 104 | 214 | 6 | 29 | 0 |
| 139 | 0 | 27 | 104 | 139 | 6 | 27 | 106 | 215 | 0 | 29 | 0 |
| 140 | 0 | 27 | 106 | 140 | 0 | 27 | 108 | 215 | 6 | 29 | 0 |
| 141 | 0 | 27 | 108 | 141 | 6 | 27 | 110 | 216 | 0 | 29 | 0 |
| 142 | 0 | 27 | 110 | 142 | 0 | 27 | 112 | 216 | 6 | 29 | 0 |
| 143 | 0 | 27 | 112 | 143 | 6 | 27 | 114 | 217 | 0 | 29 | 0 |
| 144 | 0 | 27 | 114 | 144 | 0 | 27 | 116 | 217 | 6 | 29 | 0 |
| 145 | 0 | 27 | 116 | 145 | 6 | 27 | 118 | 218 | 0 | 29 | 0 |
| 146 | 0 | 27 | 118 | 146 | 0 | 27 | 120 | 218 | 6 | 29 | 0 |
| 147 | 0 | 27 | 120 | 147 | 6 | 27 | 122 | 219 | 0 | 29 | 0 |
| 148 | 0 | 27 | 122 | 148 | 0 | 27 | 124 | 219 | 6 | 29 | 0 |
| 149 | 0 | 27 | 124 | 149 | 6 | 27 | 126 | 220 | 0 | 29 | 0 |
| 150 | 0 | 27 | 126 | 150 | 0 | 27 | 128 | 220 | 6 | 29 | 0 |
| 151 | 0 | 27 | 128 | 151 | 6 | 27 | 130 | 221 | 0 | 29 | 0 |
| 152 | 0 | 27 | 130 | 152 | 0 | 27 | 132 | 221 | 6 | 29 | 0 |
| 153 | 0 | 27 | 132 | 153 | 6 | 27 | 134 | 222 | 0 | 29 | 0 |
| 154 | 0 | 27 | 134 | 154 | 0 | 27 | 136 | 222 | 6 | 29 | 0 |
| 155 | 0 | 27 | 136 | 155 | 6 | 27 | 138 | 223 | 0 | 29 | 0 |
| 156 | 0 | 27 | 138 | 156 | 0 | 27 | 140 | 223 | 6 | 29 | 0 |
| 157 | 0 | 27 | 140 | 157 | 6 | 27 | 142 | 224 | 0 | 29 | 0 |
| 158 | 0 | 27 | 142 | 158 | 0 | 27 | 144 | 224 | 6 | 29 | 0 |
| 159 | 0 | 27 | 144 | 159 | 6 | 27 | 146 | 225 | 0 | 29 | 0 |
| 160 | 0 | 27 | 146 | 160 | 0 | 27 | 148 | 225 | 6 | 29 | 0 |
| 161 | 0 | 27 | 148 | 161 | 6 | 27 | 150 | 226 | 0 | 29 | 0 |
| 162 | 0 | 27 | 150 | 162 | 0 | 27 | 152 | 226 | 6 | 29 | 0 |
| 163 | 0 | 27 | 152 | 163 | 6 | 27 | 154 | 227 | 0 | 29 | 0 |
| 164 | 0 | 27 | 154 | 164 | 0 | 27 | 156 | 227 | 6 | 29 | 0 |
| 165 | 0 | 27 | 156 | 165 | 6 | 27 | 158 | 228 | 0 | 29 | 0 |
| 166 | 0 | 27 | 158 | 166 | 0 | 27 | 160 | 228 | 6 | 29 | 0 |
| 167 | 0 | 27 | 160 | 167 | 6 | 27 | 162 | 229 | 0 | 29 | 0 |
| 168 | 0 | 27 | 162 | 168 | 0 | 27 | 164 | 229 | 6 | 29 | 0 |
| 169 | 0 | 27 | 164 | 169 | 6 | 27 | 166 | 230 | 0 | 29 | 0 |
| 170 | 0 | 27 | 166 | 170 | 0 | 27 | 168 | 230 | 6 | 29 | 0 |
| 171 | 0 | 27 | 168 | 171 | 6 | 27 | 170 | 231 | 0 | 29 | 0 |
| 172 | 0 | 27 | 170 | 172 | 0 | 27 | 172 | 231 | 6 | 29 | 0 |
| 173 | 0 | 27 | 172 | 173 | 6 | 27 | 174 | 232 | 0 | 29 | 0 |
| 174 | 0 | 27 | 174 | 174 | 0 | 27 | 176 | 232 | 6 | 29 | 0 |
| 175 | 0 | 27 | 176 | 175 | 6 | 27 | 178 | 233 | 0 | 29 | 0 |
| 176 | 0 | 27 | 178 | 176 | 0 | 27 | 180 | 233 | 6 | 29 | 0 |
| 177 | 0 | 27 | 180 | 177 | 6 | 27 | 182 | 234 | 0 | 29 | 0 |
| 178 | 0 | 27 | 182 | 178 | 0 | 27 | 184 | 234 | 6 | 29 | 0 |
| 179 | 0 | 27 | 184 | 179 | 6 | 27 | 186 | 235 | 0 | 29 | 0 |
| 180 | 0 | 27 | 186 | 180 | 0 | 27 | 188 | 235 | 6 | 29 | 0 |
| 181 | 0 | 27 | 188 | 181 | 6 | 27 | 190 | 236 | 0 | 29 | 0 |
| 182 | 0 | 27 | 190 | 182 | 0 | 27 | 192 | 236 | 6 | 29 | 0 |
| 183 | 0 | 27 | 192 | 183 | 6 | 27 | 194 | 237 | 0 | 29 | 0 |
| 184 | 0 | 27 | 194 | 184 | 0 | 27 | 196 | 237 | 6 | 29 | 0 |
| 185 | 0 | 27 | 196 | 185 | 6 | 27 | 1 | | | | |

TIME SCALE FOR A COURSE OF FIVE MILES—continued.

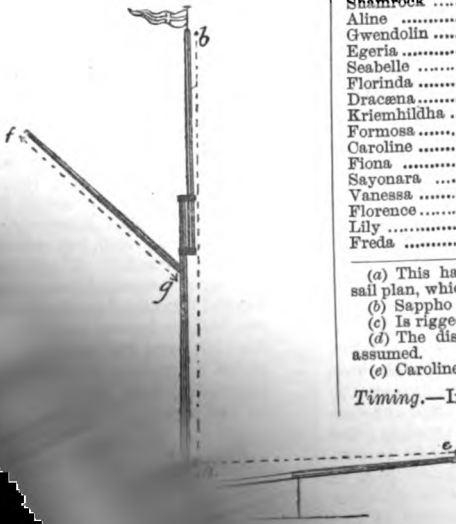
| ft. | in. | min. | sec. | ft. | in. | min. | sec. | ft. | in. | min. | sec. |
|-----|-----|------|------|-----|-----|------|------|-----|-----|------|------|
| 169 | 6 | 30 | 51 | 176 | 0 | 31 | 5 | 188 | 0 | 31 | 19 |
| 170 | 0 | 30 | 52 | 176 | 6 | 31 | 6 | 188 | 0 | 31 | 20 |
| 170 | 6 | 30 | 53 | 177 | 0 | 31 | 7 | 189 | 0 | 31 | 21 |
| 171 | 0 | 30 | 54 | 177 | 6 | 31 | 8 | 191 | 0 | 31 | 22 |
| 171 | 6 | 30 | 56 | 178 | 0 | 31 | 9 | 192 | 0 | 31 | 23 |
| 172 | 0 | 30 | 57 | 179 | 0 | 31 | 10 | 193 | 0 | 31 | 24 |
| 172 | 6 | 30 | 58 | 180 | 0 | 31 | 11 | 194 | 0 | 31 | 25 |
| 173 | 0 | 30 | 59 | 181 | 0 | 31 | 12 | 195 | 0 | 31 | 26 |
| 173 | 6 | 31 | 0 | 182 | 0 | 31 | 13 | 196 | 0 | 31 | 27 |
| 174 | 0 | 31 | 1 | 183 | 0 | 31 | 14 | 197 | 0 | 31 | 28 |
| 174 | 6 | 31 | 2 | 184 | 0 | 31 | 15 | 198 | 0 | 31 | 29 |
| 175 | 0 | 31 | 3 | 185 | 0 | 31 | 16 | 199 | 0 | 31 | 30 |
| 175 | 6 | 31 | 4 | 186 | 0 | 31 | 17 | 200 | 0 | 31 | 31 |
| | | | | 187 | 0 | 31 | 18 | | | | |

TIME ALLOWANCE BY SAIL AREA AND LENGTH.

In Fig. 226 measure the length from *a* to *c* and the height from *a* to *b*. Multiply the height by the length, and divide by two, and the quotient will be the quantity of sail in square feet that can be set as head sail. Next measure the length of the main boom *d e* and gaff *f g*, and multiply two-fifths of these lengths by the height *a b*. The product will pretty accurately give the quantity in square feet of canvas that can be set abaft the mast, including topsail. But a rougher rule than this can be used, with very little variation in the result.

Take the extreme length from bowsprit end to boom end; to this length add the length of the gaffs. Multiply the sum by the height from deck to hounds of topmast, and divide the product by two. The quotient will be the sail area.

In the case of a schooner, the extreme length from bowsprit end or jibboom end to



lated. Add the boom and yard together and multiply by half the height, deck to hounds.

Rule.—Multiply the sail area by the length of the yacht on the load water-line, and divide the product by 7000. The quotient will be the sail tonnage.

By cancelling the three right-hand figures the divisor becomes 7 instead of 7000.

Applying the rule to Egeria, the following is the sum :

| | |
|---------------------------------------|-----------------|
| Length, bowsprit end to boom end..... | 158ft. |
| Length of main gaff | 37 |
| Length of fore gaff | 28 |
| | 223 |
| Mean height..... | 89 |
| Main height... 94.5 | 2007 |
| Fore height... 83.5 | 1784 |
| | 2)1780 |
| | 2)19647 |
| Mean height... 89 | 9923 |
| Length on load-line | 94 |
| | 89692 |
| | 89807 |
| | 7)989762 |
| | Sail-tons 133.0 |

By this rule fewer figures will be required than by the Y.E.A. rule, and anyone acquainted with the four rules of arithmetic could apply it. The effect of the rule on yachts of various sizes will be found in the table which here follows (Y.E.A. Time Scale) :

| Yacht. | Y.E.A. Tons. | Sail-Tons. |
|-------------------|--------------|------------|
| Boadicea | 364 | 388 (a) |
| Sappho | 366 | 271 (b) |
| Shamrock | 280 | 176 (c) |
| Aline | 200 | 168 |
| Gwendolin | 186 | 162 |
| Egeria | 147 | 133 |
| Seabelle | 136 | 123 |
| Florinda | 124 | 114 |
| Dracæna | 110 | 80 (d) |
| Kriemhildha | 104 | 82 |
| Formosa | 101 | 95 |
| Caroline | 81 | 65 (e) |
| Fiona | 77 | 70 |
| Sayonara | 70 | 22 |
| Vanessa | 19 | 30 |
| Florence | 10 | 13 |
| Lily | 10 | 11 |
| Freda | 5 | 5½ |

- (a) This has been calculated from Boadicea's original sail plan, which has been much reduced.
- (b) Sappho has very short topmasts.
- (c) Is rigged for cruising.
- (d) The distance between Dracæna's masts has been assumed.
- (e) Caroline is rigged for cruising.

Timing.—In timing vessels passing marks to finish a race or otherwise, the fairest plan is to take the time as each vessel's stem reaches the mark. In timing yachts that have to gybe or tack round marks, time must be taken when in the opinion of the time keeper the yacht is fairly at or round the mark; this especially in the case of gybing.

Toggle.—A short rope with an eye at one end and a small piece of wood at the other, to insert in the eye and form a kind of strop or becket.

Ton.—A weight of 2240lb. avoirdupois. In hydraulics 35 cubic feet of sea water, represent a ton or 36ft. of fresh water. In the merchant navy 100 cubic feet of space represent a ton. In yacht tonnage the product of length, breadth, and half-breadth divided by 94 represents the number of tons. (See "Tonnage.")

Tonnage.—The nominal size or capacity of a ship, variously estimated. The tonnage of a merchant ship is her internal space or cubical contents expressed in 100 cubic feet to the ton, after making deductions for engine room and crew space. This is termed new measurement (N.M.) Builder's measurement (B.M.) or as it is sometimes termed old measurement (O.M.) is thus expressed.

$$\frac{(L - \frac{1}{2} B) \times (\frac{B^2}{2})}{94}$$

94

where L is length, and B breadth.

According to builders' measurement, length is taken along the keel from the sternpost to a perpendicular or plumb line dropped from the stem-head on deck. By raking the sternpost the length of keel was shortened, and in order to prevent evasions in this way, the Royal London Yacht Club in 1854 passed a rule that the length should be taken on deck instead of along the keel. The tonnage of the vessels with very raking sternposts was, of course, much increased, and in order to let them off a little more easily, the whole beam was ordered to be subtracted from the length instead of $\frac{1}{2}$ ths of the beam. The rule then read

$$\frac{(\text{Length} - \text{Breadth}) \times (\frac{\text{Breadth}^2}{2})}{94}$$

94

or

(Multiplying by beam, then by half beam, is the same as multiplying by the half square of the beam.)

$$\frac{(L - B) \times (B \times \frac{1}{2} B)}{94}$$

94

This is the rule known as the "Thames Rule," and was the rule adopted by the Yacht Racing Association.

In 1879 the Yacht Racing Association altered the rule to length on load line.

The following is the Y.R.A. rule in text. The length shall be taken in a straight line from the fore end to the after end of the load water-line; from which length deduct the breadth, and the remainder shall be esteemed the length to find the tonnage; the breadth shall be taken from outside to outside of the planking, in the broadest part of the yacht, and no allowance shall be made for wales, doubling planks, or mouldings of any kind: then multiplying the length by the breadth, and the product by half the breadth, and dividing the result by 94, the quotient shall be deemed the true tonnage; provided always that if any part of the stem or sternpost, or other part of the vessel at or below

the load water-line project beyond the length taken as above-mentioned, such projection or projections shall, for the purposes of finding the tonnage, be added to the length taken as stated. Any fraction of a ton shall count as a ton. If, from any peculiarity in the construction of a yacht, or other cause, the measurer shall be of opinion that this rule does not measure a yacht fairly, he shall report the circumstances to the Council who may order the yacht to be measured as they may consider fair.

Top.—In square rigged ships, the stage at the lower mast heads to give additional spread to the topmast rigging, and to form a kind of gallery for riflemen in war ships. There is a fore top, main top, and mizen top. To top is to raise one end of a boom or yard by the topping lifts. (See Plate I., and page 115.)

Top Gallant Bulwarks.—Bulwarks fitted above the top rail to afford additional shelter on deck.

Topgallant Mast.—The mast next above the topmast in square-rigged ships.

Top Hamper.—Any real or supposed unnecessary weight carried on deck or on the masts.

Topmast Hoops.—Occasionally hoops are used for jib-headed topsails. The hoops when in use rest on the masthead. In hoisting the topsail the lacing is passed through an eye-hole in the luff of the sail and through the hoop, and so on. When the sail is hoisted chock-a-block the lacing is hauled taut; when lowering the lacing is slackened. Hoops facilitate the hoisting and lowering of the sail and admit of its being lowered with ease during a squall, and hoisted without a man going aloft.

Topping Lifts.—Ropes or tackles used to raise or support booms or yards. (See page 115, also Plate I.)

Top Rail.—The rail fitted on the stanchions to give a finish to the bulwarks.

Topsails.—Racing yachts usually are supplied with various topsails, viz., balloon topsail No. 1 topsail, No. 2 topsail, jib-headed topsail and jib topsail. Formerly a square topsail was carried as well, but spinnakers have superseded squaresails. A cruising yacht usually carries one square-headed topsail and one jib-headed topsail. American yachts usually carry one balloon topsail (called a club topsail—see Fig. 56, page 245) and one jib-headed topsail called a working topsail, and a jib topsail. Schooners, both British and American, carry as well a main topmast staysail.

Topmast Schooner.—(See "Square Topsail Schooner.")

Topside.—That part of a vessel above the wales now in yachts sometimes understood as the part between the water-line and deck, or the freeboard.

Top Timbers.—The upper parts of the framing of a vessel.

Top Your Boom and Sail Large.—To leave in hurry.

Toss the Oars.—To throw them out of the rowlocks and rest them perpendicularly, blades uppermost.

Toss up the Boom.—To raise the boom by the lifts.

Touching the Wind.—Luffing into the wind so that the sails shake. (See "Luff and Touch Her.")

To Whip.—To bind the ends of rope with twine to prevent their fraying.

Tow Rope or Tow Line.—The rope or hawser used in towing.

Track.—The course sailed by a ship. Her wake.

Trade Wind.—Winds that blow in one direction a considerable time, admitting of traders making expeditious voyages.

Trail Boards.—Carved boards formerly fitted on the bow and stem of schooners.

Transom.—The frame at the sternpost of a vessel. In boats the transverse board at the stern, which gives shape to the quarters and forms the stern end of the boat.

Transverse.—Athwartships. At right-angles to the line of the keel.

Trapesium.—A four-sided figure with two sides parallel, as a ship's square sail.

Trapesoid.—A four-sided figure whose sides do not form parallel lines, such as a cutter's mainsail.

Traveller.—An iron ring, thimble, or strop which travels on a spar, bar, or rope.

Traveller, Jointed.—The fishermen on the S.W. coast use a jointed mast traveller. The iron hoop is in two half moons, each end has an eye turned in; the two halves are connected by

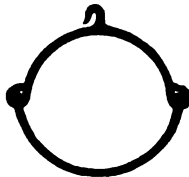


FIG. 327.

these eyes. The object in having a jointed traveller is to facilitate lowering. (See "Penance Luggers.")

Trenails.—Bolts or plugs of wood used to fasten plank to the timbers of vessels. Originally spelt treenail. (See page 107.) Pronounced "trennel."

Trestle Trees.—In ships long pieces of timber fitted at the masthead in a fore-and-aft direction to support the cross trees.

Triatic Stay.—(See page 118 and 133.)

Trick.—The time a man is stationed at the helm. (See "Spell" and page 198.)

Trim.—The position of a ship in the water in a fore-and-aft direction. To trim a vessel is to set her in a particular position, by the head or stern. The term is sometimes erroneously

used to represent the shifting of ballast transversely. To trim the sails is to sheet and tack them so that they are disposed in the best manner possible, in relation to the force of the wind.

Trip.—A passage. Sometimes used to denote a board made in beating to windward. To trip a spar is to cant it. To trip an anchor is to break it out of the ground; an anchor is a-trip when one of its flukes is on, but not in, the ground. (See "Anchor" and "Soowing.")

Trip or Tripping Line.—A rope used to cant a spar, as trip halyards for a topsail, or the line bent to the crown of an anchor to trip it or break it out of the ground.

Trough.—The hollow between wave-crest and wave-crest.

Trucks.—The wooden caps fitted on the upper mastheads to reeve the signal halyards through.

True Wind.—A wind that does not vary; the prevailing wind in contradistinction to eddies or baffling puffs.

Trying.—To "try" is when a vessel is hove to, if her sails are so trimmed that she may gather headway and make something to the good.

Trysail.—A small sort of gaff sail set in heavy weather. The sail set on the fore and main mast of square rigged ships similar to the spanker on the misen. The meaning of try-sail is probably that under it in heavy weather a vessel can try to sail.

Tuck.—The form of the hollow in the quarter by the transom or stern-post.

Tug.—A towing boat. To tug is to tow.

Tumble In or Tumble Home.—When the sides of a ship near the deck incline inwards; the opposite to flaring.

Tumbler.—A piece of wood pivoted in the jaws of a gaff which is always in the plane of the mast.

Tumbler-rod.—(See page 131 and 132.)

Turk's-head.—A knot made to finish off the end of a rope.

Turn.—A circle made by a rope round a pin, &c. "Turn O!" is an order to belay. To catch a turn is to put the fall of a tackle or part of any rope round a belaying pin, stanchion, &c.

Turn in.—To secure the end of a rope by seising.

Turning to Windward.—Working or beating for a point or object by short boards. Generally beating to windward. To turn is to tack.

Turn of the Tide.—When the tide changes from flood to ebb, or the contrary.

'Tween Decks.—Under a deck.

Twice Laid Rope.—Rope re-made from old rope.

Twiddling Stick.—The tiller, hence "twiddling lines" are the tiller lines.

Two-blocks.—Said when a tackle has been used so that its two blocks come close together. (See Chock-a-block.)

Tye.—A runner to which a tackle is hooked, used for hoisting lug-sails and squaresails.

Tyers.—Ropes or gaskets used to secure the mainsail of a fore-and-aft vessel when furled or stowed to the boom. The tyer that takes up the middle of the sail is termed the bunt tyer. (See "Gasket and Buntline.")

U.

Una Boat.—This is a centre-board boat with one sail introduced from America, where they are known as "cat boats." The mast is stepped close to the stem (sometimes with a rake aft), and the sail is laced to a boom and gaff. The name Una was given them because the first boat introduced at Cowes, from America, was so named. These boats vary from twice to three times their beam in length, and are very shallow. If handled with care, they are safe enough, very fast, and in smooth water very weatherly and handy. In squalls they should always be luffed up in good time, or they might be blown over. (See page 308.)

Unbend.—To cast loose a sail from its gaff, yard, &c. The opposite of bend.

Under Bowing the Sea.—When a vessel is close-hauled sailing in a cross sea, and gets the worst of it on the lee bow.

Under Canvas.—Proceeding by means of sail. With sail set.

Under Deck.—Below.

Under Hatches.—Below deck.

Under Run.—To follow up a rope, chain hawser, or cable, by hauling it in from a boat which moves in the direction that the cable, &c., is laid out.

Under Sail.—(See "Under Canvas.")

Under Shore.—Close to the shore or land.

Under the Lee.—Sheltered from the wind by the sails of another vessel. Under the lee of the land, sheltered from the full force of the wind by the land.

Under-way.—Moving through the water under the influence of the wind, steam, or oars. Sometimes wrongly written under-weigh. A vessel may be said to be under-weigh, when she is getting her anchor; but even then it would be the anchor, and not the vessel, that would be under-weigh.

In Admiral Smyth's "Sailor's Word Book," (edition revised by Admiral Sir E. Belcher, 1867), is the following:—"UNDERWAY.—A ship beginning to move under canvas after her anchor is started, some have written this *underweigh*; but improperly. A ship is underweigh when she has weighed her anchor; she may be with or without canvas, or hove to. As soon as she gathers way she is *underway*. This is a moot point with old seamen."

The obvious objections to using *underweigh* in this limited sense is that a man might find himself saying, "We got *underweigh* at noon, but were not *underway* until two hours later." The fact is, underweigh is never written by seamen except through careless-

ness; but the odd thing is that greenhorns take to the word more kindly than they do to *underway*, probably because they have enough knowledge to know that to get *underway* the anchor must be weighed. The best naval writers never describe the operation of getting the anchor as getting *underweigh*; but always write "she weighed," or "she weighed anchor," or we weighed," &c. To get *underway* is by them used in the sense of making preparation to get way on; and when the anchor is aweigh the ship may have way on or not. Dana (who may be taken as an unimpeachable authority) does not admit the word *underweigh* in his Seaman's Manual (revised edition by the Registrar-General British Shipping); but in the instructions for making sail, &c., *underway* is always used thus: "Getting *underway* from a single anchor," "getting *underway*, riding head to wind," &c.

In Falconer's Marine Dictionary (revised edition 1815, by Dr. Burney, Master of the Naval Academy, Gosport), is the following section:—"UNDERWAY.—If it be in a tide way and with a leading wind, so that the ship can stem the tide, let it be a rule when the tide serves to get *underway* and sail against the flood, which gives time to clear a ship of her moorings, and affords a more powerful effect to the helm to clear of other ships, &c.

Underwriter.—A person who attaches his name to a policy of insurance by the side of the amount he will share of the risk. The under part of some policies may have two or three hundred names attached, as the principle of underwriting is to have very little at stake on any one ship. To become an underwriter at Lloyd's a deposit of 5000*l.* is required by the committee, for which a percentage of interest is paid annually. This deposit must be in cash, or in property (sureties will not do.) The entrance fee is 100*l.*, and the subscription is 12*l.* 12*s.* per year, together with 5*s.* for a seat in the rooms—total subscription annually, 17 guineas. Fifteen hundred or two thousand might be profitably employed if a person has a good knowledge of underwriting, &c., or it might not. Underwriting to some is very profitable, to others just the reverse.

Union Down.—An ensign with the jack downwards, hoisted as a signal of distress.

Union Jack.—A flag composed of St. George's, St. Andrew's, and St. Patrick's crosses. (See "Jack.")

Unmoored.—With anchors a-weigh. A vessel is also said to be "unmoored" when she is riding to a single anchor, as to be moored, two anchors must be down. (See page 185.)

Unreeve.—To haul out a rope from a hole, &c.

Unrig.—To dismantle a ship or any part of her, as to unrig a spinnaker boom, to unrig a bowsprit, &c.

Unship.—To remove a thing from its lodgment. The opposite of "to ship."

Up and down.—Vertically. The wind is sometimes said to be up and down the mast, when there is none at all, like Paddy's hurricane.

Upper Mast—*Upper Stick*.—A topmast, a topgallant mast, &c.

Upper Strake.—The top strake running round a vessel at the deck edge under the covering board, usually stouter than the general planking, and almost always of hard wood to better hold fastenings.

Usages of the Sea.—Customs of the sea in relation to commercial pursuits, which are held in law to be binding.

V.

Van.—The advanced part of a fleet.

Vane.—(See "Dog Vane.")

Vang.—A rope used to keep in the gaff of a schooner's foresail. The foresail of a schooner has usually very little peak, and consequently the halyards will not keep it from going off to leeward. A block is lashed to the mainmast head, through which the vang is rove and made fast to the fore gaff end; the fall of the rope leads to the deck. In square-rigged ships vangs are generally used on the spanker gaff. Sprit sail barges also use vangs.

Variation of the Compass.—The departure the compass needle shows from true North at certain parts of the globe. The difference between magnetic and true North usually expressed in degrees on charts. The variation widely differs, thus: in the English Channel it is about 23°, at New York only 5°. The deviation of the compass is due to local attraction. A chart called a "Variation Chart," shows by curved lines the changing variations of the compass needle for different parts of the globe. Variation must not be confused with the deviation due to local attraction in iron and composite ships.

Varnish.—Black Japan: 1oz. lamp black, 2oz. bitumen, ½oz. acetate lead, ½oz. Turkey umber, ½oz. Venice turpentine, 12oz. boiled oil. Dissolve the oil in turpentine; powder the other ingredients, and stir in gradually. Simmer on slow fire ten minutes.

Copal Varnish: Copal 30oz., drying linseed oil 18oz., spirits of turpentine 50oz. Briskly fuse the copal; heat the oil to close on boiling point, and pour it hot on the copal; mix thoroughly; allow the mixture to cool a little and add the turpentine, mix thoroughly. Allow the mixture to further cool, and strain for use.

Quick-drying Varnish: 7lb. copal (fused), hot linseed ½gall., hot turpentine 1½gall. Carefully stir and boil together.

Oak Varnish: 7lb. pale resin dissolved in 2gall. oil of turpentine.

Varnish for Metals: Powder 1lb. of copal and dissolve in 2lb. of strongest alcohol. A very quick-drying varnish.

Varnish for Iron: Mastic (clear grains)

10lb., camphor 5lb., sandarach 15lb., elemi 5lb. Dissolve in sufficient alcohol.

Black Varnish or Polish for Iron: Resin 4oz., lamp black 2oz., beeswax 3oz., shellac 2oz., linseed oil 1qt. Boil together one hour, and then stir in ½pt. turpentine.

Tar Varnish for Iron: Coal tar 1pt., lamp black 1oz., heel ball ½oz., spirits turpentine ½pt., beeswax 1oz. Dissolve the heel ball and beeswax in the turpentine, add the lamp black and tar, warm and mix it thoroughly. This mixture should be applied hot.

Tar Varnish for Wood or Iron: 1gall. coal tar, 2oz. oil of vitrol; mix thoroughly, and add ½pt. of turpentine; mix, and apply immediately. This dries very quickly, and only small quantities sufficient for use should be made.

Varnishing a bright Boat.—Oil the planks, &c., and when the oil is dried in put on two coats of copal varnish. If size is used instead of oil, the varnish will peel off. To clean off varnish: take a mixture of soda (2lb.), soap (1lb.), boiled together, it will remove varnish from spars, &c. It should be applied hot. (See also "Caustic Soda.")

Veer.—To pay out chain. Veer is also used in the sense of wearing or gybing. The wind is said to veer when it changes in direction with the sun; to back when it changes against the sun. On board a ship, the wind is said to veer when it draws more aft. To haul when it comes more ahead.

Veer and Haul.—To slacken up a rope, and then haul on it suddenly, in order that those who are hauling on it may acquire a momentum. Pulling by jerks.

Veer away the Cable.—The order to pay or slack out cable.

Veering a Buoy in a Vessel's Wake.—Throwing overboard a buoy in the wake of a ship when a man has fallen overboard, in the hope that he may get to it, and pick it up.

Vertical.—At right angles to the horizon, or perpendicular to the horizon.

Vessel.—A name for all kinds of craft, from a canoe to a three-decker.

Vice Commodore.—(See "Commodore.")

Victual.—To supply with provisions for a voyage, &c.

Voyage.—The passage of a vessel by sea. A short voyage is called a trip or a cast.

W.

Waist.—The middle part of a vessel 'tween decks.

Wake.—The peculiar eddying water that appears after a ship has passed. Vessels are said to leave a clean wake that do not cause waves to form astern.

Wales.—Thick strakes of plank.

Walk Away with It.—(See "Run Away.")

Wall Knot.—A knot formed at the end of a rope by unlaying the strands, and weaving them in and out.

Wall Sided.—Up and down sides of a vessel that neither tumble home nor flare out.

Wallow.—To lie in the trough of a sea and roll heavily; to roll under the sea.

Warrants.—See "Admiralty Warrants.")

Wash Strake.—A movable strake of plank fitted to the gunwale of an open boat to increase her height out of water whilst sailing or otherwise.

Watch and Watch.—The arrangement whereby one half of the crew is on deck for four hours, then the other half for four hours. (See "Watches.")

Watch.—An anchor buoy or mooring buoy is said to watch when it keeps above water.

Watches.—The divisions of time for work on board a vessel. The crew of a ship is divided for this work into two watches, port and starboard, each watch being alternately on deck, excepting in emergencies, when both watches may be called on deck. Watches are thus divided: From 8 p.m. to midnight is the "First Watch." From midnight to 4 a.m. is the "Middle Watch." From 4 a.m. to 8 a.m. is the "Morning Watch." From 8 a.m. to noon is the "Fore-noon Watch." From noon to 4 p.m. the "Afternoon Watch." From 4 p.m. to 8 p.m. the two "Dog Watches." (See p. 196.)

Watching for a Smooth.—In a sea way looking out for a time when the waves are smaller to tack in, &c. (See page 160 and 166.)

Watch Tackle.—A tackle consisting of single and double block; the single block has a hook, the double a tail.

Water.—One cubic foot fresh water '0279 ton or 62'39lbs.; one gallon '0045 ton. A ton fresh water equal to 223'76 gallons. One cubic foot salt water '0286 ton or 64'05lbs.; one gallon '0046 ton; ton 217'95 gallons. A ton of fresh water is usually taken as 36 cubic feet; a ton of salt water as 35 cubic feet. (See "Cubic Measure of Water.")

Water Ballast.—Water carried in tanks or breakers as ballast. The tanks or breakers if intended to act as ballast should be kept full.

Water Borne.—Not resting on the ground, but being in the condition of floating.

Water Line.—A horizontal plane passing through a vessel longitudinally. A line shown in the half-breadth plan of a ship drawing. Length on load water-line means the length in a straight line from the fore side of the stem to the aft side of the stern-post at the water level.

Water Logged.—The condition of a vessel, that although her hold is full of water, she does not sink, owing to the buoyant nature of her cargo, or from other causes.

Waterproofing.—Boil 12oz. of beeswax in 1gall. of oil for two hours; paint the cloth with this mixture twice or thrice. If black is required, add the necessary quantity of black for the second and third coat.

Waterproofing Sail Cloth.—The recipe used by Mr. Berthon to render the canvas of his col-

lapsing boats airproof and waterproof, is believed to be similar to that used in H. dockyards for hammock cloths, is as follow: To 6oz. of hard yellow soap add 1½ pint water, and when boiling, add 5lb. of green spruce ochre, ½lb. patent driers, and 5lb. boiled linseed oil. For waterproofing sheet the ochre should be omitted, as it adds to weight, lessens the flexibility, and is unnecessary. Existing coverings are made temporarily airproof and waterproof by preparation of indiarubber, oil, paint, &c. Fabric coated with preparations of indiarubber: not proof against the effects of climate rough usage, are not easily repaired, as compared with those coated with the Chinese and other preparations, are very heavy, and the same dimensions, expensive. The recipe for "waterproofing" stout calico used by the Chinese, is given by the late Mr P. Le Ne Foster, in his recent report on life-saving apparatus in the "Journal" of the Society of Arts. He states that it is perfectly efficacious alike in the hottest and coldest climates, believed to be composed of boiled oil (1 quart, soft soap 1oz., and beeswax 1oz.; 1 whole boiled until reduced to three-quarters of its previous quantity; but experiments are required satisfactorily to test the above proportions.

The following plan is recommended in America: To waterproof cotton drilling take a mixture of 6oz. hard yellow soap, 1½ pint water, ½lb. patent driers, 5lb. boiled linseed oil.

Waves.—The formation of waves is a subject which has received much attention of late, but no completely satisfactory theory as to their genesis has yet been evolved. The general theory is, that the smooth sea is acted upon the impact and friction of the moving air wind, and that the waves increase in size and speed, until the wind force is incapable of further developing them. Deep sea waves vary much in length, even under similar influences of wind pressure, and its continuation. Captain Motter of the French Navy measured a wave in the North Atlantic 2720ft., or half a mile from crest to crest, and Sir James Ross, one 1920ft. long. In the Bay of Biscay, where the sea is usually turbulent, waves have been seen of 1300ft. length. Such waves however, are seldom met with, and Dr. Scoresby, who measured the lengths of some Atlantic storm waves observed, had lengths of from 500ft. to 600ft. Measuring the heights of waves is a more difficult matter than measuring their length and there has been much exaggeration under this head. The late Sir E. Belcher, at the Institute of Naval Architects in 1866 mentioned a wave he had observed rise to 100ft. Professor Rankine in his work on Naval Architecture, speaks of waves on rocky coasts rising to 150ft., and waves have been known to fly over the Eddystone Lighthouse. However, the greatest height of deep sea waves as measured by Dr. Scoresby, and other accurate observers, have

been 48ft., but it is rare to meet with waves exceeding 30ft. in height. Ordinary storm waves such as met with in the Atlantic of about 200ft. in length, have a height of about one-twentieth of their length, but the ratio becomes lower as the length of the waves increase, and waves of 1000ft. in length have been observed with but a height of 10ft. On the other hand, waves of 600ft. in length have been observed of unusual steepness, and with heights one-eighth of their lengths. A long series of observations made by M. Bertin on the heights and lengths of waves, would seem to prove that the average height of deep sea waves is as 1 to 25 of their length. This of course is applied to single waves only. In what is termed a "confused sea," where a long wave may overtake and pass through a short one, the general height becomes increased, almost to the extent of the combined heights of both waves, and the wave form under such circumstances, is more or less "confused." In the English channel, superposed waves are common, and the waves generally being short and steep, heights are met with of about one eighth the length of the waves. (A wave length is the length from crest to crest, and wave height, the height from hollow to crest.)

The speed of waves are generally proportional to their length. Thus a wave 20ft. long, will travel 6 miles an hour, and one 50ft. long, 9 miles; 120ft., 15 miles; 200ft., 19 miles; 400ft., 27 miles; 600ft., 32 miles; 1000ft., 42 miles. It must be understood that it is only the *wave motion*, and not the water that travels, and no substance resting on the water is carried forward by the advance of waves further than the force of gravity may give a substance an alternate forward and backward motion, as it became differently situated on the sides of waves. Thus a ship will simply rise and fall with the waves and not be carried forward by them, and an unbroken wave would do a ship no harm in the sense of an impact due to the wave striking her. The danger from waves arises when they break over a ship, or when a ship by intercepting a wave causes it to break. (The best article in a popular form on Waves, and oscillations of ships among them is in Mr. W. H. White's "Manual of Naval Architecture.")

Ways.—Balks of timber arranged in a kind of shute to haul vessels upon or to launch them off.

Wear.—To bring the wind on the other side of a vessel by putting the helm up so that the vessel's head goes round away from the wind instead of towards the wind as in tacking. (See "Gybe.")

Weather.—The windward or "breezy" side of an object. The side on which the "weather" is felt; not to leeward. To weather is to pass on the windward side of an object. In cross tacking the vessel "weathers" another that crosses ahead of her. To weather on another vessel is to gain on her in a windward direction by holding a better wind than she does—to eat her out of the wind.

Weather Board.—On the weather side of a vessel. Sometimes in working to windward by a long board and a short one the short one is called "weather board."

Weather Boards.—Pieces of boards fitted over open ports to turn water or rain off.

Weather Cloth.—The cloth in a sail next the luff. The "weather" of a sail is the luff.

Weather Cloths.—Pieces of canvas fitted on ridge ropes and stanchions of yachts above the bulwarks; also the tarpaulins used to cover the hammocks when stowed in the nettings.

Weather Gauge.—The condition of a vessel that is to windward of another one. In slang, to possess an advantage.

Weather Helm.—The helm or tiller hauled to windward when a vessel owing to too much after sail has an inclination to fly up in the wind. If the centre of effort of the sails is much abaft the centre of lateral resistance, a vessel will require weather helm to keep her out of the wind. The tendency to fly up in the wind can be remedied by reducing the after sail, or setting more head sail, or by easing the main sheet. However, all vessels should carry a little weather helm. (The contrary to "Lee Helm," which see.) It has been frequently argued that the effect of the water pressure on the rudder when the helm is to windward (that is the rudder to leeward), is to press the vessel bodily to windward, and no doubt there is some truth in this, although the influence of the rudder in this respect could be only small.

Weathering.—A relative term used in sailing to define the action of one vessel that is eating to windward of another, thus, if a vessel is said to be weathering on another she is eating her out of the wind, or closing up to her from the leeward, or departing from her in a windward direction. Weathering an object is passing on its windward side.

Weather Lurch.—A weather roll or a roll to windward. In running with the main boom well off, it should be always secured with a guy, or it may fall to the opposite side during a weather roll, and cause some damage.

Weather Tide, or Weather-going Tide.—The tide that makes to windward or against the wind. (See "Lee-going tide.")

Wedges of Immersion and Emersion.—(See Immersed.)

Wedging Up.—Lifting a vessel by driving wedges under her keel to take her weight off the building blocks before launching.

Weepings.—The exudations of damp or water through the seams or cracks of planks, &c.

Weigh.—To raise a thing, as weighing the anchor.

Weight (of Wire Rope).—The weight, elasticity, and strength of iron and steel wire rope and hemp rope vary very considerably, according to the quality of the iron, steel, or hemp used in its manufacture. The following table of the weight of different sizes rope of iron, hemp, &c., was compiled by the well-known civil engineer Mr. G. L. Molesworth:

| Hemp. | | Iron Wire. | | Steel Wire. | | Equivalent Strength. | |
|----------------|---------------------------|----------------|---------------------------|----------------|---------------------------|-----------------------|--------------------------|
| Circumference. | Pounds weight per Fathom. | Circumference. | Pounds weight per Fathom. | Circumference. | Pounds weight per Fathom. | Working Load in Cwts. | Breaking strain in Tons. |
| 2½ | 3 | 1 | 1 | ... | ... | 6 | 3 |
| 3 | 4 | 1½ | 1½ | 1 | 1 | 9 | 4 |
| 3½ | 5 | 2 | 2 | 1½ | 1½ | 12 | 5 |
| 4 | 6 | 2½ | 2½ | 2 | 2 | 15 | 6 |
| 4½ | 7 | 3 | 3 | 2½ | 2½ | 18 | 7 |
| 5 | 8 | 3½ | 3½ | 3 | 3 | 21 | 8 |
| 5½ | 9 | 4 | 4 | 3½ | 3½ | 24 | 9 |
| 6 | 10 | 4½ | 4½ | 4 | 4 | 27 | 10 |
| 6½ | 11 | 5 | 5 | 4½ | 4½ | 30 | 11 |
| 7 | 12 | 5½ | 5½ | 5 | 5 | 33 | 12 |
| 7½ | 13 | 6 | 6 | 5½ | 5½ | 36 | 13 |
| 8 | 14 | 6½ | 6½ | 6 | 6 | 39 | 14 |
| 8½ | 15 | 7 | 7 | 6½ | 6½ | 42 | 15 |
| 9 | 16 | 7½ | 7½ | 7 | 7 | 45 | 16 |
| 9½ | 17 | 8 | 8 | 7½ | 7½ | 48 | 17 |
| 10 | 18 | 8½ | 8½ | 8 | 8 | 51 | 18 |
| 10½ | 19 | 9 | 9 | 8½ | 8½ | 54 | 19 |
| 11 | 20 | 9½ | 9½ | 9 | 9 | 57 | 20 |
| 11½ | 21 | 10 | 10 | 9½ | 9½ | 60 | 21 |
| 12 | 22 | 10½ | 10½ | 10 | 10 | 63 | 22 |
| 12½ | 23 | 11 | 11 | 10½ | 10½ | 66 | 23 |
| 13 | 24 | 11½ | 11½ | 11 | 11 | 69 | 24 |
| 13½ | 25 | 12 | 12 | 11½ | 11½ | 72 | 25 |
| 14 | 26 | 12½ | 12½ | 12 | 12 | 75 | 26 |
| 14½ | 27 | 13 | 13 | 12½ | 12½ | 78 | 27 |
| 15 | 28 | 13½ | 13½ | 13 | 13 | 81 | 28 |
| 15½ | 29 | 14 | 14 | 13½ | 13½ | 84 | 29 |
| 16 | 30 | 14½ | 14½ | 14 | 14 | 87 | 30 |
| 16½ | 31 | 15 | 15 | 14½ | 14½ | 90 | 31 |
| 17 | 32 | 15½ | 15½ | 15 | 15 | 93 | 32 |
| 17½ | 33 | 16 | 16 | 15½ | 15½ | 96 | 33 |
| 18 | 34 | 16½ | 16½ | 16 | 16 | 99 | 34 |
| 18½ | 35 | 17 | 17 | 16½ | 16½ | 102 | 35 |
| 19 | 36 | 17½ | 17½ | 17 | 17 | 105 | 36 |
| 19½ | 37 | 18 | 18 | 17½ | 17½ | 108 | 37 |
| 20 | 38 | 18½ | 18½ | 18 | 18 | 111 | 38 |
| 20½ | 39 | 19 | 19 | 18½ | 18½ | 114 | 39 |
| 21 | 40 | 19½ | 19½ | 19 | 19 | 117 | 40 |

Manilla rope, if not dried up and chafed, is slightly stronger size for size than hemp.

WEIGHT OF A SUPERFICIAL FOOT OF PLATES, OF DIFFERENT METALS, IN LBS.

| Thickness. | Iron. | | | | | | Steel. | | | | | | Brass. | | | | | | Copper. | | | | | | Lead. | | | | | | Zinc. | | | | | | | | | | | | | | | | | | | | | | | | | | | | | | | | | | | | | | | | | | | | | | | | | | | | | | | | | | | | | | | | | | | | | | | | | | | | | | | | | | | | | | | | | | | | | | | | | | | | | | | | | | | | | | | | | | | | | | | | | | | | | | | | | | | | | | | | | | | | | | | | | | | | | | | | | | | | | | | | | | | | | | | | | | | | | | | | | | | | | | | | | | | | | | | | | | | | | | | | | | | | | | | | | | | | | | | | | | | | | | | | | | | | | | | | | | | | | | | | | | | | | | | | | | | | | | | | | | | | | | | | | | | | | | | | | | | | | | | | | | | | | | | | | | | | | | | | | | | | | | | | | | | | | | | | | | | | | | | | | | | | | | | | | | | | | | | | | | | | | | | | | | | | | | | | | | | | | | | | | | | | | | | | | | | | | | | | | | | | | | | | | | | | | | | | | | | | | | | | | | | | | | | | | | | | | | | | | | | | | | | | | | | | | | | | | | | | | | | | | | | | | | | | | | | | | | | | | | | | | | | | | | | | | | | | | | | | | | | | | | | | | | | | | | | | | | | | | | | | | | | | | | | | | | | | | | | | | | | | | | | | | | | | | | | | | | | | | | | | | |
|------------|-------|------|------|------|------|------|--------|------|------|------|------|------|--------|------|------|------|------|------|---------|------|------|------|------|------|-------|------|------|------|------|------|-------|------|------|------|------|------|------|------|------|------|------|------|-------|-------|-------|------|-------|-------|-------|-------|-------|-------|-------|-------|-------|-----|-------|-------|-------|-------|-------|-------|-------|-------|-------|-----|-------|-------|-------|-------|-------|-------|-------|-------|-------|-----|-------|-------|-------|-------|-------|-------|-------|-------|-------|-----|-------|-------|-------|-------|-------|-------|-------|-------|-------|-----|-------|-------|-------|-------|-------|-------|-------|-------|-------|-----|-------|-------|-------|-------|-------|-------|-------|-------|-------|-----|-------|-------|-------|-------|-------|-------|-------|-------|-------|-----|-------|-------|-------|-------|-------|-------|-------|-------|-------|-----|-------|-------|-------|-------|-------|-------|-------|-------|-------|-----|-------|-------|-------|-------|-------|-------|-------|-------|-------|-----|-------|-------|-------|-------|-------|-------|-------|-------|-------|-----|-------|-------|-------|-------|-------|-------|-------|-------|-------|-----|-------|-------|-------|-------|-------|-------|-------|-------|-------|-----|-------|-------|-------|-------|-------|-------|-------|-------|-------|-----|-------|-------|-------|-------|-------|-------|-------|-------|-------|-----|-------|-------|-------|-------|-------|-------|-------|-------|-------|-----|-------|-------|-------|-------|-------|-------|-------|-------|-------|-----|-------|-------|-------|-------|-------|-------|-------|-------|-------|-----|-------|-------|-------|-------|-------|-------|-------|-------|-------|-----|-------|-------|-------|-------|-------|-------|-------|-------|-------|-----|-------|-------|-------|-------|-------|-------|-------|-------|-------|-----|-------|-------|-------|-------|-------|-------|-------|-------|-------|-----|-------|-------|-------|-------|-------|-------|-------|-------|-------|-----|-------|-------|-------|-------|-------|-------|-------|-------|-------|-----|-------|-------|-------|-------|-------|-------|-------|-------|-------|-----|-------|-------|-------|-------|-------|-------|-------|-------|-------|-----|-------|-------|-------|-------|-------|-------|-------|-------|-------|-----|-------|-------|-------|-------|-------|-------|-------|-------|-------|-----|-------|-------|-------|-------|-------|-------|-------|-------|-------|-----|-------|-------|-------|-------|-------|-------|-------|-------|-------|-----|-------|-------|-------|-------|-------|-------|-------|-------|-------|-----|-------|-------|-------|-------|-------|-------|-------|-------|-------|-----|-------|-------|-------|-------|-------|-------|-------|-------|-------|-----|-------|-------|-------|-------|-------|-------|-------|-------|-------|-----|-------|-------|-------|-------|-------|-------|-------|-------|-------|-----|-------|-------|-------|-------|-------|-------|-------|-------|-------|-----|-------|-------|-------|-------|-------|-------|-------|-------|-------|-----|-------|-------|-------|-------|-------|-------|-------|-------|-------|-----|-------|-------|-------|-------|-------|-------|-------|-------|-------|-----|-------|-------|-------|-------|-------|-------|-------|-------|-------|-----|-------|-------|-------|-------|-------|-------|-------|-------|-------|-----|-------|-------|-------|-------|-------|-------|-------|-------|-------|-----|-------|-------|-------|-------|-------|-------|-------|-------|-------|-----|-------|-------|-------|-------|-------|-------|-------|-------|-------|-----|-------|-------|-------|-------|-------|-------|-------|-------|-------|-----|-------|-------|-------|-------|-------|-------|-------|-------|-------|-----|-------|-------|-------|-------|-------|-------|-------|-------|-------|-----|-------|-------|-------|-------|-------|-------|-------|-------|-------|-----|-------|-------|-------|-------|-------|-------|-------|-------|-------|-----|-------|-------|-------|-------|-------|-------|-------|-------|-------|-----|-------|-------|-------|-------|-------|-------|-------|-------|-------|-----|-------|-------|-------|-------|-------|----|
| | lb. | lb. | lb. | lb. | lb. | lb. | lb. | lb. | lb. | lb. | lb. | lb. | lb. | lb. | lb. | lb. | lb. | lb. | lb. | lb. | lb. | lb. | lb. | lb. | lb. | lb. | lb. | lb. | lb. | lb. | | | | | | | | | | | | | | | | | | | | | | | | | | | | | | | | | | | | | | | | | | | | | | | | | | | | | | | | | | | | | | | | | | | | | | | | | | | | | | | | | | | | | | | | | | | | | | | | | | | | | | | | | | | | | | | | | | | | | | | | | | | | | | | | | | | | | | | | | | | | | | | | | | | | | | | | | | | | | | | | | | | | | | | | | | | | | | | | | | | | | | | | | | | | | | | | | | | | | | | | | | | | | | | | | | | | | | | | | | | | | | | | | | | | | | | | | | | | | | | | | | | | | | | | | | | | | | | | | | | | | | | | | | | | | | | | | | | | | | | | | | | | | | | | | | | | | | | | | | | | | | | | | | | | | | | | | | | | | | | | | | | | | | | | | | | | | | | | | | | | | | | | | | | | | | | | | | | | | | | | | | | | | | | | | | | | | | | | | | | | | | | | | | | | | | | | | | | | | | | | | | | | | | | | | | | | | | | | | | | | | | | | | | | | | | | | | | | | | | | | | | | | | | | | | | | | | | | | | | | | | | | | | | | | | | | | | | | | | | | | | | | | | | | | | | | | | | | | | | | | | | | | | | | | | | | | | | | | | | | | | | | | | | | | | | | | | | | | | | | | | | |
| 1/8 | 2.5 | 2.6 | 2.7 | 2.8 | 2.9 | 3.0 | 3.1 | 3.2 | 3.3 | 3.4 | 3.5 | 3.6 | 3.7 | 3.8 | 3.9 | 4.0 | 4.1 | 4.2 | 4.3 | 4.4 | 4.5 | 4.6 | 4.7 | 4.8 | 4.9 | 5.0 | 5.1 | 5.2 | 5.3 | 5.4 | 5.5 | 5.6 | 5.7 | 5.8 | 5.9 | 6.0 | | | | | | | | | | | | | | | | | | | | | | | | | | | | | | | | | | | | | | | | | | | | | | | | | | | | | | | | | | | | | | | | | | | | | | | | | | | | | | | | | | | | | | | | | | | | | | | | | | | | | | | | | | | | | | | | | | | | | | | | | | | | | | | | | | | | | | | | | | | | | | | | | | | | | | | | | | | | | | | | | | | | | | | | | | | | | | | | | | | | | | | | | | | | | | | | | | | | | | | | | | | | | | | | | | | | | | | | | | | | | | | | | | | | | | | | | | | | | | | | | | | | | | | | | | | | | | | | | | | | | | | | | | | | | | | | | | | | | | | | | | | | | | | | | | | | | | | | | | | | | | | | | | | | | | | | | | | | | | | | | | | | | | | | | | | | | | | | | | | | | | | | | | | | | | | | | | | | | | | | | | | | | | | | | | | | | | | | | | | | | | | | | | | | | | | | | | | | | | | | | | | | | | | | | | | | | | | | | | | | | | | | | | | | | | | | | | | | | | | | | | | | | | | | | | | | | | | | | | | | | | | | | | | | | | | | | | | | | | | | | | | | | | | | | | | | | | | | | | | | | | | | | | | | | | | | | | | | | | | | | | | | | | | | | | | | | | | | |
| 1/4 | 5 | 5.2 | 5.4 | 5.6 | 5.8 | 6.0 | 6.2 | 6.4 | 6.6 | 6.8 | 7.0 | 7.2 | 7.4 | 7.6 | 7.8 | 8.0 | 8.2 | 8.4 | 8.6 | 8.8 | 9.0 | 9.2 | 9.4 | 9.6 | 9.8 | 10.0 | 10.2 | 10.4 | 10.6 | 10.8 | 11.0 | 11.2 | 11.4 | 11.6 | 11.8 | 12.0 | | | | | | | | | | | | | | | | | | | | | | | | | | | | | | | | | | | | | | | | | | | | | | | | | | | | | | | | | | | | | | | | | | | | | | | | | | | | | | | | | | | | | | | | | | | | | | | | | | | | | | | | | | | | | | | | | | | | | | | | | | | | | | | | | | | | | | | | | | | | | | | | | | | | | | | | | | | | | | | | | | | | | | | | | | | | | | | | | | | | | | | | | | | | | | | | | | | | | | | | | | | | | | | | | | | | | | | | | | | | | | | | | | | | | | | | | | | | | | | | | | | | | | | | | | | | | | | | | | | | | | | | | | | | | | | | | | | | | | | | | | | | | | | | | | | | | | | | | | | | | | | | | | | | | | | | | | | | | | | | | | | | | | | | | | | | | | | | | | | | | | | | | | | | | | | | | | | | | | | | | | | | | | | | | | | | | | | | | | | | | | | | | | | | | | | | | | | | | | | | | | | | | | | | | | | | | | | | | | | | | | | | | | | | | | | | | | | | | | | | | | | | | | | | | | | | | | | | | | | | | | | | | | | | | | | | | | | | | | | | | | | | | | | | | | | | | | | | | | | | | | | | | | | | | | | | | | | | | | | | | | | | | | | | | | | | | | | | |
| 3/8 | 7.5 | 7.8 | 8.1 | 8.4 | 8.7 | 9.0 | 9.3 | 9.6 | 9.9 | 10.2 | 10.5 | 10.8 | 11.1 | 11.4 | 11.7 | 12.0 | 12.3 | 12.6 | 12.9 | 13.2 | 13.5 | 13.8 | 14.1 | 14.4 | 14.7 | 15.0 | 15.3 | 15.6 | 15.9 | 16.2 | 16.5 | 16.8 | 17.1 | 17.4 | 17.7 | 18.0 | | | | | | | | | | | | | | | | | | | | | | | | | | | | | | | | | | | | | | | | | | | | | | | | | | | | | | | | | | | | | | | | | | | | | | | | | | | | | | | | | | | | | | | | | | | | | | | | | | | | | | | | | | | | | | | | | | | | | | | | | | | | | | | | | | | | | | | | | | | | | | | | | | | | | | | | | | | | | | | | | | | | | | | | | | | | | | | | | | | | | | | | | | | | | | | | | | | | | | | | | | | | | | | | | | | | | | | | | | | | | | | | | | | | | | | | | | | | | | | | | | | | | | | | | | | | | | | | | | | | | | | | | | | | | | | | | | | | | | | | | | | | | | | | | | | | | | | | | | | | | | | | | | | | | | | | | | | | | | | | | | | | | | | | | | | | | | | | | | | | | | | | | | | | | | | | | | | | | | | | | | | | | | | | | | | | | | | | | | | | | | | | | | | | | | | | | | | | | | | | | | | | | | | | | | | | | | | | | | | | | | | | | | | | | | | | | | | | | | | | | | | | | | | | | | | | | | | | | | | | | | | | | | | | | | | | | | | | | | | | | | | | | | | | | | | | | | | | | | | | | | | | | | | | | | | | | | | | | | | | | | | | | | | | | | | | | | | | |
| 1/2 | 10 | 10.4 | 10.8 | 11.2 | 11.6 | 12.0 | 12.4 | 12.8 | 13.2 | 13.6 | 14.0 | 14.4 | 14.8 | 15.2 | 15.6 | 16.0 | 16.4 | 16.8 | 17.2 | 17.6 | 18.0 | 18.4 | 18.8 | 19.2 | 19.6 | 20.0 | 20.4 | 20.8 | 21.2 | 21.6 | 22.0 | 22.4 | 22.8 | 23.2 | 23.6 | 24.0 | | | | | | | | | | | | | | | | | | | | | | | | | | | | | | | | | | | | | | | | | | | | | | | | | | | | | | | | | | | | | | | | | | | | | | | | | | | | | | | | | | | | | | | | | | | | | | | | | | | | | | | | | | | | | | | | | | | | | | | | | | | | | | | | | | | | | | | | | | | | | | | | | | | | | | | | | | | | | | | | | | | | | | | | | | | | | | | | | | | | | | | | | | | | | | | | | | | | | | | | | | | | | | | | | | | | | | | | | | | | | | | | | | | | | | | | | | | | | | | | | | | | | | | | | | | | | | | | | | | | | | | | | | | | | | | | | | | | | | | | | | | | | | | | | | | | | | | | | | | | | | | | | | | | | | | | | | | | | | | | | | | | | | | | | | | | | | | | | | | | | | | | | | | | | | | | | | | | | | | | | | | | | | | | | | | | | | | | | | | | | | | | | | | | | | | | | | | | | | | | | | | | | | | | | | | | | | | | | | | | | | | | | | | | | | | | | | | | | | | | | | | | | | | | | | | | | | | | | | | | | | | | | | | | | | | | | | | | | | | | | | | | | | | | | | | | | | | | | | | | | | | | | | | | | | | | | | | | | | | | | | | | | | | | | | | | | | | | |
| 5/8 | 12.5 | 13 | 13.5 | 14 | 14.5 | 15 | 15.5 | 16 | 16.5 | 17 | 17.5 | 18 | 18.5 | 19 | 19.5 | 20 | 20.5 | 21 | 21.5 | 22 | 22.5 | 23 | 23.5 | 24 | 24.5 | 25 | 25.5 | 26 | 26.5 | 27 | 27.5 | 28 | 28.5 | 29 | 29.5 | 30 | | | | | | | | | | | | | | | | | | | | | | | | | | | | | | | | | | | | | | | | | | | | | | | | | | | | | | | | | | | | | | | | | | | | | | | | | | | | | | | | | | | | | | | | | | | | | | | | | | | | | | | | | | | | | | | | | | | | | | | | | | | | | | | | | | | | | | | | | | | | | | | | | | | | | | | | | | | | | | | | | | | | | | | | | | | | | | | | | | | | | | | | | | | | | | | | | | | | | | | | | | | | | | | | | | | | | | | | | | | | | | | | | | | | | | | | | | | | | | | | | | | | | | | | | | | | | | | | | | | | | | | | | | | | | | | | | | | | | | | | | | | | | | | | | | | | | | | | | | | | | | | | | | | | | | | | | | | | | | | | | | | | | | | | | | | | | | | | | | | | | | | | | | | | | | | | | | | | | | | | | | | | | | | | | | | | | | | | | | | | | | | | | | | | | | | | | | | | | | | | | | | | | | | | | | | | | | | | | | | | | | | | | | | | | | | | | | | | | | | | | | | | | | | | | | | | | | | | | | | | | | | | | | | | | | | | | | | | | | | | | | | | | | | | | | | | | | | | | | | | | | | | | | | | | | | | | | | | | | | | | | | | | | | | | | | | | | | | |
| 3/4 | 15 | 15.6 | 16.4 | 17.2 | 18 | 18.8 | 19.6 | 20.4 | 21.2 | 22 | 22.8 | 23.6 | 24.4 | 25.2 | 26 | 26.8 | 27.6 | 28.4 | 29.2 | 30 | 30.8 | 31.6 | 32.4 | 33.2 | 34 | 34.8 | 35.6 | 36.4 | 37.2 | 38 | 38.8 | 39.6 | 40.4 | 41.2 | 42 | 42.8 | 43.6 | 44.4 | | | | | | | | | | | | | | | | | | | | | | | | | | | | | | | | | | | | | | | | | | | | | | | | | | | | | | | | | | | | | | | | | | | | | | | | | | | | | | | | | | | | | | | | | | | | | | | | | | | | | | | | | | | | | | | | | | | | | | | | | | | | | | | | | | | | | | | | | | | | | | | | | | | | | | | | | | | | | | | | | | | | | | | | | | | | | | | | | | | | | | | | | | | | | | | | | | | | | | | | | | | | | | | | | | | | | | | | | | | | | | | | | | | | | | | | | | | | | | | | | | | | | | | | | | | | | | | | | | | | | | | | | | | | | | | | | | | | | | | | | | | | | | | | | | | | | | | | | | | | | | | | | | | | | | | | | | | | | | | | | | | | | | | | | | | | | | | | | | | | | | | | | | | | | | | | | | | | | | | | | | | | | | | | | | | | | | | | | | | | | | | | | | | | | | | | | | | | | | | | | | | | | | | | | | | | | | | | | | | | | | | | | | | | | | | | | | | | | | | | | | | | | | | | | | | | | | | | | | | | | | | | | | | | | | | | | | | | | | | | | | | | | | | | | | | | | | | | | | | | | | | | | | | | | | | | | | | | | | | | | | | | | | | | | | | | | | |
| 7/8 | 17.5 | 18.2 | 19.2 | 20 | 20.8 | 21.6 | 22.4 | 23.2 | 24 | 24.8 | 25.6 | 26.4 | 27.2 | 28 | 28.8 | 29.6 | 30.4 | 31.2 | 32 | 32.8 | 33.6 | 34.4 | 35.2 | 36 | 36.8 | 37.6 | 38.4 | 39.2 | 40 | 40.8 | 41.6 | 42.4 | 43.2 | 44 | 44.8 | 45.6 | 46.4 | 47.2 | | | | | | | | | | | | | | | | | | | | | | | | | | | | | | | | | | | | | | | | | | | | | | | | | | | | | | | | | | | | | | | | | | | | | | | | | | | | | | | | | | | | | | | | | | | | | | | | | | | | | | | | | | | | | | | | | | | | | | | | | | | | | | | | | | | | | | | | | | | | | | | | | | | | | | | | | | | | | | | | | | | | | | | | | | | | | | | | | | | | | | | | | | | | | | | | | | | | | | | | | | | | | | | | | | | | | | | | | | | | | | | | | | | | | | | | | | | | | | | | | | | | | | | | | | | | | | | | | | | | | | | | | | | | | | | | | | | | | | | | | | | | | | | | | | | | | | | | | | | | | | | | | | | | | | | | | | | | | | | | | | | | | | | | | | | | | | | | | | | | | | | | | | | | | | | | | | | | | | | | | | | | | | | | | | | | | | | | | | | | | | | | | | | | | | | | | | | | | | | | | | | | | | | | | | | | | | | | | | | | | | | | | | | | | | | | | | | | | | | | | | | | | | | | | | | | | | | | | | | | | | | | | | | | | | | | | | | | | | | | | | | | | | | | | | | | | | | | | | | | | | | | | | | | | | | | | | | | | | | | | | | | | | | | | | | | | | |
| 1 | 20 | 20.8 | 21.8 | 22.8 | 23.8 | 24.8 | 25.8 | 26.8 | 27.8 | 28.8 | 29.8 | 30.8 | 31.8 | 32.8 | 33.8 | 34.8 | 35.8 | 36.8 | 37.8 | 38.8 | 39.8 | 40.8 | 41.8 | 42.8 | 43.8 | 44.8 | 45.8 | 46.8 | 47.8 | 48.8 | 49.8 | 50.8 | 51.8 | 52.8 | 53.8 | 54.8 | 55.8 | 56.8 | | | | | | | | | | | | | | | | | | | | | | | | | | | | | | | | | | | | | | | | | | | | | | | | | | | | | | | | | | | | | | | | | | | | | | | | | | | | | | | | | | | | | | | | | | | | | | | | | | | | | | | | | | | | | | | | | | | | | | | | | | | | | | | | | | | | | | | | | | | | | | | | | | | | | | | | | | | | | | | | | | | | | | | | | | | | | | | | | | | | | | | | | | | | | | | | | | | | | | | | | | | | | | | | | | | | | | | | | | | | | | | | | | | | | | | | | | | | | | | | | | | | | | | | | | | | | | | | | | | | | | | | | | | | | | | | | | | | | | | | | | | | | | | | | | | | | | | | | | | | | | | | | | | | | | | | | | | | | | | | | | | | | | | | | | | | | | | | | | | | | | | | | | | | | | | | | | | | | | | | | | | | | | | | | | | | | | | | | | | | | | | | | | | | | | | | | | | | | | | | | | | | | | | | | | | | | | | | | | | | | | | | | | | | | | | | | | | | | | | | | | | | | | | | | | | | | | | | | | | | | | | | | | | | | | | | | | | | | | | | | | | | | | | | | | | | | | | | | | | | | | | | | | | | | | | | | | | | | | | | | | | | | | | | | | | | | | |
| 1 1/8 | 22.5 | 23.4 | 24.6 | 25.8 | 27 | 28.2 | 29.4 | 30.6 | 31.8 | 33 | 34.2 | 35.4 | 36.6 | 37.8 | 39 | 40.2 | 41.4 | 42.6 | 43.8 | 45 | 46.2 | 47.4 | 48.6 | 49.8 | 51 | 52.2 | 53.4 | 54.6 | 55.8 | 57 | 58.2 | 59.4 | 60.6 | 61.8 | 63 | 64.2 | 65.4 | 66.6 | 67.8 | | | | | | | | | | | | | | | | | | | | | | | | | | | | | | | | | | | | | | | | | | | | | | | | | | | | | | | | | | | | | | | | | | | | | | | | | | | | | | | | | | | | | | | | | | | | | | | | | | | | | | | | | | | | | | | | | | | | | | | | | | | | | | | | | | | | | | | | | | | | | | | | | | | | | | | | | | | | | | | | | | | | | | | | | | | | | | | | | | | | | | | | | | | | | | | | | | | | | | | | | | | | | | | | | | | | | | | | | | | | | | | | | | | | | | | | | | | | | | | | | | | | | | | | | | | | | | | | | | | | | | | | | | | | | | | | | | | | | | | | | | | | | | | | | | | | | | | | | | | | | | | | | | | | | | | | | | | | | | | | | | | | | | | | | | | | | | | | | | | | | | | | | | | | | | | | | | | | | | | | | | | | | | | | | | | | | | | | | | | | | | | | | | | | | | | | | | | | | | | | | | | | | | | | | | | | | | | | | | | | | | | | | | | | | | | | | | | | | | | | | | | | | | | | | | | | | | | | | | | | | | | | | | | | | | | | | | | | | | | | | | | | | | | | | | | | | | | | | | | | | | | | | | | | | | | | | | | | | | | | | | | | | | | | | | | | | |
| 1 1/4 | 25 | 26 | 27.4 | 28.8 | 30.2 | 31.6 | 33 | 34.4 | 35.8 | 37.2 | 38.6 | 40 | 41.4 | 42.8 | 44.2 | 45.6 | 47 | 48.4 | 49.8 | 51.2 | 52.6 | 54 | 55.4 | 56.8 | 58.2 | 59.6 | 61 | 62.4 | 63.8 | 65.2 | 66.6 | 68 | 69.4 | 70.8 | 72.2 | 73.6 | 75 | 76.4 | 77.8 | 79.2 | 80.6 | | | | | | | | | | | | | | | | | | | | | | | | | | | | | | | | | | | | | | | | | | | | | | | | | | | | | | | | | | | | | | | | | | | | | | | | | | | | | | | | | | | | | | | | | | | | | | | | | | | | | | | | | | | | | | | | | | | | | | | | | | | | | | | | | | | | | | | | | | | | | | | | | | | | | | | | | | | | | | | | | | | | | | | | | | | | | | | | | | | | | | | | | | | | | | | | | | | | | | | | | | | | | | | | | | | | | | | | | | | | | | | | | | | | | | | | | | | | | | | | | | | | | | | | | | | | | | | | | | | | | | | | | | | | | | | | | | | | | | | | | | | | | | | | | | | | | | | | | | | | | | | | | | | | | | | | | | | | | | | | | | | | | | | | | | | | | | | | | | | | | | | | | | | | | | | | | | | | | | | | | | | | | | | | | | | | | | | | | | | | | | | | | | | | | | | | | | | | | | | | | | | | | | | | | | | | | | | | | | | | | | | | | | | | | | | | | | | | | | | | | | | | | | | | | | | | | | | | | | | | | | | | | | | | | | | | | | | | | | | | | | | | | | | | | | | | | | | | | | | | | | | | | | | | | | | | | | | | | | | | | | | | | | | | | | | |
| 1 1/2 | 27.5 | 28.6 | 30.1 | 31.6 | 33.1 | 34.6 | 36.1 | 37.6 | 39.1 | 40.6 | 42.1 | 43.6 | 45.1 | 46.6 | 48.1 | 49.6 | 51.1 | 52.6 | 54.1 | 55.6 | 57.1 | 58.6 | 60.1 | 61.6 | 63.1 | 64.6 | 66.1 | 67.6 | 69.1 | 70.6 | 72.1 | 73.6 | 75.1 | 76.6 | 78.1 | 79.6 | 81.1 | 82.6 | 84.1 | 85.6 | 87.1 | 88.6 | 90.1 | 91.6 | 93.1 | 94.6 | 96.1 | 97.6 | 99.1 | 100.6 | | | | | | | | | | | | | | | | | | | | | | | | | | | | | | | | | | | | | | | | | | | | | | | | | | | | | | | | | | | | | | | | | | | | | | | | | | | | | | | | | | | | | | | | | | | | | | | | | | | | | | | | | | | | | | | | | | | | | | | | | | | | | | | | | | | | | | | | | | | | | | | | | | | | | | | | | | | | | | | | | | | | | | | | | | | | | | | | | | | | | | | | | | | | | | | | | | | | | | | | | | | | | | | | | | | | | | | | | | | | | | | | | | | | | | | | | | | | | | | | | | | | | | | | | | | | | | | | | | | | | | | | | | | | | | | | | | | | | | | | | | | | | | | | | | | | | | | | | | | | | | | | | | | | | | | | | | | | | | | | | | | | | | | | | | | | | | | | | | | | | | | | | | | | | | | | | | | | | | | | | | | | | | | | | | | | | | | | | | | | | | | | | | | | | | | | | | | | | | | | | | | | | | | | | | | | | | | | | | | | | | | | | | | | | | | | | | | | | | | | | | | | | | | | | | | | | | | | | | | | | | | | | | | | | | | | | | | | | | | | | | | | | | | | | | | | | | | | | | | | | | | | | | | | | | | | | | | | | | | | | | |
| 1 3/8 | 30 | 31.2 | 32.9 | 34.6 | 36.3 | 38 | 39.7 | 41.4 | 43.1 | 44.8 | 46.5 | 48.2 | 49.9 | 51.6 | 53.3 | 55 | 56.7 | 58.4 | 60.1 | 61.8 | 63.5 | 65.2 | 66.9 | 68.6 | 70.3 | 72 | 73.7 | 75.4 | 77.1 | 78.8 | 80.5 | 82.2 | 83.9 | 85.6 | 87.3 | 89 | 90.7 | 92.4 | 94.1 | 95.8 | 97.5 | 99.2 | 100.9 | 102.6 | 104.3 | 106 | 107.7 | 109.4 | 111.1 | 112.8 | 114.5 | 116.2 | 117.9 | 119.6 | 121.3 | 123 | 124.7 | 126.4 | 128.1 | 129.8 | 131.5 | 133.2 | 134.9 | 136.6 | 138.3 | 140 | 141.7 | 143.4 | 145.1 | 146.8 | 148.5 | 150.2 | 151.9 | 153.6 | 155.3 | 157 | 158.7 | 160.4 | 162.1 | 163.8 | 165.5 | 167.2 | 168.9 | 170.6 | 172.3 | 174 | 175.7 | 177.4 | 179.1 | 180.8 | 182.5 | 184.2 | 185.9 | 187.6 | 189.3 | 191 | 192.7 | 194.4 | 196.1 | 197.8 | 199.5 | 201.2 | 202.9 | 204.6 | 206.3 | 208 | 209.7 | 211.4 | 213.1 | 214.8 | 216.5 | 218.2 | 219.9 | 221.6 | 223.3 | 225 | 226.7 | 228.4 | 230.1 | 231.8 | 233.5 | 235.2 | 236.9 | 238.6 | 240.3 | 242 | 243.7 | 245.4 | 247.1 | 248.8 | 250.5 | 252.2 | 253.9 | 255.6 | 257.3 | 259 | 260.7 | 262.4 | 264.1 | 265.8 | 267.5 | 269.2 | 270.9 | 272.6 | 274.3 | 276 | 277.7 | 279.4 | 281.1 | 282.8 | 284.5 | 286.2 | 287.9 | 289.6 | 291.3 | 293 | 294.7 | 296.4 | 298.1 | 299.8 | 301.5 | 303.2 | 304.9 | 306.6 | 308.3 | 310 | 311.7 | 313.4 | 315.1 | 316.8 | 318.5 | 320.2 | 321.9 | 323.6 | 325.3 | 327 | 328.7 | 330.4 | 332.1 | 333.8 | 335.5 | 337.2 | 338.9 | 340.6 | 342.3 | 344 | 345.7 | 347.4 | 349.1 | 350.8 | 352.5 | 354.2 | 355.9 | 357.6 | 359.3 | 361 | 362.7 | 364.4 | 366.1 | 367.8 | 369.5 | 371.2 | 372.9 | 374.6 | 376.3 | 378 | 379.7 | 381.4 | 383.1 | 384.8 | 386.5 | 388.2 | 389.9 | 391.6 | 393.3 | 395 | 396.7 | 398.4 | 400.1 | 401.8 | 403.5 | 405.2 | 406.9 | 408.6 | 410.3 | 412 | 413.7 | 415.4 | 417.1 | 418.8 | 420.5 | 422.2 | 423.9 | 425.6 | 427.3 | 429 | 430.7 | 432.4 | 434.1 | 435.8 | 437.5 | 439.2 | 440.9 | 442.6 | 444.3 | 446 | 447.7 | 449.4 | 451.1 | 452.8 | 454.5 | 456.2 | 457.9 | 459.6 | 461.3 | 463 | 464.7 | 466.4 | 468.1 | 469.8 | 471.5 | 473.2 | 474.9 | 476.6 | 478.3 | 480 | 481.7 | 483.4 | 485.1 | 486.8 | 488.5 | 490.2 | 491.9 | 493.6 | 495.3 | 497 | 498.7 | 500.4 | 502.1 | 503.8 | 505.5 | 507.2 | 508.9 | 510.6 | 512.3 | 514 | 515.7 | 517.4 | 519.1 | 520.8 | 522.5 | 524.2 | 525.9 | 527.6 | 529.3 | 531 | 532.7 | 534.4 | 536.1 | 537.8 | 539.5 | 541.2 | 542.9 | 544.6 | 546.3 | 548 | 549.7 | 551.4 | 553.1 | 554.8 | 556.5 | 558.2 | 559.9 | 561.6 | 563.3 | 565 | 566.7 | 568.4 | 570.1 | 571.8 | 573.5 | 575.2 | 576.9 | 578.6 | 580.3 | 582 | 583.7 | 585.4 | 587.1 | 588.8 | 590.5 | 592.2 | 593.9 | 595.6 | 597.3 | 599 | 600.7 | 602.4 | 604.1 | 605.8 | 607.5 | 609.2 | 610.9 | 612.6 | 614.3 | 616 | 617.7 | 619.4 | 621.1 | 622.8 | 624.5 | 626.2 | 627.9 | 629.6 | 631.3 | 633 | 634.7 | 636.4 | 638.1 | 639.8 | 641.5 | 643.2 | 644.9 | 646.6 | 648.3 | 650 | 651.7 | 653.4 | 655.1 | 656.8 | 658.5 | 660.2 | 661.9 | 663.6 | 665.3 | 667 | 668.7 | 670.4 | 672.1 | 673.8 | 675.5 | 677.2 | 678.9 | 680.6 | 682.3 | 684 | 685.7 | 687.4 | 689.1 | 690.8 | 692.5 | 694.2 | 695.9 | 697.6 | 699.3 | 701 | 702.7 | 704.4 | 706.1 | 707.8 | 709.5 | 711.2 | 712.9 | 714.6 | 716.3 | 718 | 719.7 | 721.4 | 723.1 | 724.8 | 726.5 | 728.2 | 729.9 | 731.6 | 733.3 | 735 | 736.7 | 738.4 | 740.1 | 741.8 | 743.5 | 745.2 | 746.9 | 748.6 | 750.3 | 752 | 753.7 | 755.4 | 757.1 | 758.8 | 760.5 | 762.2 | 763.9 | 765.6 | 767.3 | 769 | 770.7 | 772.4 | 774.1 | 775.8 | 777.5 | 779.2 | 780.9 | 782.6 | 784.3 | 786 | 787.7 | 789.4 | 791.1 | 792.8 | 794.5 | 796.2 | 797.9 | 799.6 | 801.3 | 803 | 804.7 | 806.4 | 808.1 | 809.8 | 811.5 | 813.2 | 814.9 | 816.6 | 818.3 | 820 | 821.7 | 823.4 | 825.1 | 826.8 | 828.5 | 830.2 | 831.9 | 833.6 | 835.3 | 837 | 838.7 | 840.4 | 842.1 | 843.8 | 845.5 | 847.2 | 848.9 | 850.6 | 852.3 | 854 | 855.7 | 857.4 | 859.1 | 860.8 | 862.5 | 864.2 | 865.9 | 867.6 | 869.3 | 871 | 872.7 | 874.4 | 876.1 | 877.8 | 879.5 | 881.2 | 882.9 | 884.6 | 886.3 | 888 | 889.7 | 891.4 | 893.1 | 894.8 | 896.5 | 898.2 | 899.9 | 901.6 | 903.3 | 905 | 906.7 | 908.4 | 910.1 | 911.8 | 913.5 | 915.2 | 916.9 | 918.6 | 920.3 | 922 | 923.7 | 925.4 | 927.1 | 928.8 | 930.5 | 932.2 | 933.9 | 935.6 | 937.3 | 939 | 940.7 | 942.4 | 944.1 | 945.8 | 947.5 | 949.2 | 950.9 | 952.6 | 954.3 | 956 | 957.7 | 959.4 | 961.1 | 962.8 | 964.5 | 966.2 | 967.9 | 969.6 | 971.3 | 973 | 974.7 | 976.4 | 978.1 | 979.8 | 981.5 | 983.2 | 984.9 | 986.6 | 988.3 | 990 | 991.7 | 993.4 | 995.1 | 996.8 | 998.5 | 10 |

down on heavy pieces of squared wood, and the elm timbers, which are sawn out of wood having the necessary bend, so as to reach from a few inches beyond the centre of the bottom to the top of the gunwale, are about two inches square—they cross one another; the bottom boards are then pegged to these timbers by driving pegs three-quarters of an inch thick and some eight in length through the timbers and boards; the ends are left to be cut off after the boat has been finished and turned over. These pegs are secured by cutting out a wedge from the lower end with a chisel, and then driving the wedge into the place from which it has been cut, thus filling the peg-hole more tightly. No nails are used for the bottom except to attach the short piece of keel at the stern, say four feet; and the heads of these nails are sunk in the keel. These wooden pegs never move, and wear even with the bottom; breadth at bottom, 4½ft. The stem and stern are alike, no transom being required. The end of a short keel extends some two inches beyond the bottom of the sternpost to protect the rudder. The stem and stern posts are then morticed for the ends of the bottom boards, and, as it is well to have them strong, there is a good lot of dead wood.

The first strake is three-quarters of an inch thick, and often an inch; but before fastening this on the beam of wood under the centre of the boat is either removed or sunk in the ground, say, three inches, and heavy weights of stones usually are placed on the bottom, near the centre, to bend the bottom boards, as it is considered that they do not row or sail so well on quite an even bottom.

The rest of the strakes are half an inch thick, and fastened on both to the timbers and themselves with iron nails, galvanised if procurable. Twelve-pennies are used to fix to the bottom boards and timbers, and six-penny nails to the strakes. Of course these boats are all clincher built, and are rather heavy, weighing three and a half or four hundredweight. They require four men generally to run them down and haul them up upon rollers. These are some 6in. in diameter if the sand is heavy. They place long boards or the sprits under the rollers. The sails are usually two or three sprit sails (see sketch), and sometimes a foresail. No



FIG. 229.

keel boats are ever used, owing to the great advantage of a flat bottom when they ground.

Accidents seldom take place with these boats, but, like all shallow boats, they require very skilful handling.

The centre-board now remains to be described. It runs in a frame or sheath formed for it in the centre of the boat. These, when let down, draw about 3ft. below the bottom of the boat, and are about 2ft. broad. The board is about 1in. thick; no iron is used for them. When they near the shore they are hauled up. They are not required when the sails are not used. The depth of these boats is about 2ft. to the top of the gunwale, and they generally pull four oars. They are too broad for one man to scull. Of course they will not carry so much sail as a keeled boat, nor will they sail so near the wind.

The ballast used consists of large stones. The fishermen hereabouts are a bold and hardy race, and they need be, for herring fishing on a December night is desperately cold work; but it is their harvest of the sea, and when four men can take from twelve to twenty mace of herrings in the night (the mace is 500, and worth from 15s. to 20s.), it pays them well. It is a pretty sight to see forty or fifty boats out of a night; but it is very cold work, and none but those brought up to it could stand it.

Wheel.—Used to give motion to the rudder by chains which pass over a barrel and lead through blocks to the tiller. When the tiller points forward the chain is put over the barrel first; when the tiller points aft the chain is put under the barrel first.

Where Away?—When an object is sighted, a question as to its bearing.

Wherry.—A small boat for rowing and sailing, usual rig a spritsail, main, and mizen, and foresail. (French "Honari.")

Whip.—A purchase consisting of one single block, a pennant vane.

Whip, To.—To bind the ends of rope with twine to prevent their fraying.

Whiskers.—(See p 118.)

Whistling for Wind.—In calms or light winds sailors sometimes amuse themselves by whistling in the hope that it will bring a breeze. They also scratch the boom for a breeze, or to make the vessel go faster. During heavy weather the superstition is all the other way, and no whistling or boom scratching is permitted.

Whole Sail Strength.—A wind of such strength so that a yacht can just carry all her canvas, including her "best" (not balloon) gaff topsail, to windward.

Winch.—A drum with crank handles, pawl, &c., fitted to the mast to get in the topsail sheet, &c.

Wind Bound.—(See "Bound.")

Windfall.—An unexpected advantage or acquisition of treasure.

Windlass.—A horizontal barrel revolved by cranks or handspikes, used for getting the anchor. In yachts a small neat capstan is now generally used.

Winds.—Winds have been arranged according to the following table.

| Velocity of wind in knots. | Pressure in lbs. per sq. ft. | No. of force 0 to 12 | Description of wind. | Sail Carried. |
|----------------------------|------------------------------|----------------------|---|---|
| 1. | 0.087 | 1. | Light air | All balloon canvas. |
| 2. | 0.27 | | | |
| 3. | 1.0 | | | |
| 4. | 1.97 | 2. | Light wind | " |
| 5. | 1.67 | | | |
| 6. | 2.40 | 3. | Light breeze | " |
| 7. | 3.27 | | | |
| 8. | 4.27 | 4. | Moderate breeze. Whole sail, including first topsail. | " |
| 9. | 5.40 | | | |
| 10. | 6.67 | | | |
| 11. | 8.07 | 5. | Fresh breeze ... Jib headed top-sail. | " |
| 12. | 9.60 | | | |
| 13. | 1.13 | | | |
| 14. | 1.31 | | | |
| 15. | 1.50 | | Lower sail. | " |
| 16. | 1.71 | | | |
| 17. | 1.93 | 6. | Strong breeze ... One reef. | " |
| 18. | 2.16 | | | |
| 19. | 2.41 | | | |
| 20. | 2.67 | 7. | Moderate gale ... Three reefs, or close reefs. | " |
| 22. | 3.23 | | | |
| 24. | 3.84 | | | |
| 26. | 4.51 | | | |
| 28. | 5.23 | 8. | Fresh gale | Trysail. |
| 30. | 6.00 | | | |
| 32. | 6.83 | 9. | Strong gale | Reefed try-sail. |
| 34. | 7.71 | | | |
| 36. | 8.64 | | | |
| 38. | 9.63 | 10. | Heavy gale | Storm try-sail. |
| 40. | 10.7 | | | |
| 50. | 16.7 | 11. | Storm | Whatever small sail could be got to hold together. |
| 60. | 24.0 | | | |
| 70. | 32.7 | 12. | Hurricane | No canvas made strong enough to stand such a force. |
| 80. | 42.7 | | | |
| 90. | 54.0 | | | |
| 100. | 66.7 | | | |

Wing and Wing.—A schooner before the wind with the main sail off the lee quarter, and the foresail boomed out to windward. Sometimes termed goose winged. (See "Goose Wing.")

Wings of a Ship.—That part of a ship below water near the load line.

Wink.—A west country term for a kind of winch used in the bow of a boat by fishermen to raise the anchor. (See "Anchor.")

Winning Flag.—The racing flag which is hoisted after a race to denote that a yacht has won a prize. It is hoisted immediately below and on the same halyards as the burgee. When a regatta is concluded a yacht hoists under her burgee as many racing flags as she has won prizes. On arriving at a port fresh from a regatta where she has been successful, she, in a like manner, hoists as many racing flags as she has won prizes. When she has sailed her last match she hoists as many racing flags as she has won prizes during the season. These are also hoisted when she returns to her own port. If a yacht has won more prizes than she has racing flags, it is usual to make up the deficiency with code signal flags.

Wiring.—A stringer or ledge running fore and aft in a boat to support the thwarts. (See the table, page 350.)

Wisby Laws.—A code of maritime laws which, with the rules of Oleron, for many centuries

formed the basis of all regulations relating to seamen and ships. Wisby is a seaport of Gothland in the Baltic, and a port famous so long back as the 13th century.

Woof.—The threads or texture of any kind of cloth or canvas, &c.

Work.—A vessel is said to work when the different parts of her frame, planking, &c., are not securely bound together so that the various parts relative to each other alter their positions.

Working to Windward.—Proceeding by short tacks. Beating to windward. To work up to a vessel is to get nearer to her or catch her whilst beating to windward.

Wrinkle.—Something worth knowing; a piece of valuable experience.

Wrinkles in copper are generally a sign of severe strains in vessels, or that the vessel "works," or that her frame and plank shifts when she is underway in a sea.

Y.

Yacht.—Generally any kind of vessel that is permanently fitted out and used by her owner for pleasure. This is a word said to be of Dutch origin. In the time of Elizabeth a "yacht" was kept for the use of the Sovereign, and since that date every succeeding monarch has had more than one yacht. The "Rat of Wight" was built at Cowes in 1588, and Cowes appears from that early date to have been the head-quarters of yachting. But the Thames was early associated with yachting; in 1661, Charles II. sailed in a yacht on the Thames from Greenwich to Gravesend against a yacht in which sailed his brother the Duke of York. Pepys says "the King lost it going, the wind being contrary, but saved stakes in returning, his majesty sometimes steering himself." This probably is the first record of a yacht match, and likewise the first record of an amateur helmsman. Various yachts were built at Cowes during the eighteenth century, but to Cork apparently belongs the honour of originating yachting as a national pastime. In 1720 the "Cork Harbour Water Club" was established; but the yachts were small; and not until about 1783 did any private person build a yacht of any considerable size. This yacht was built at Itchen for the Duke of Richmond, and between that date and 1812 various yachts were built at Cowes, Fishbourne, and Southampton. In 1810 a club was started at Cowes (the club seal of the Royal Yacht Squadron bears date 1812), and thenceforward yachting made very rapid strides. In 1812 there were probably fifty yachts afloat, and these belonged exclusively to noblemen or to country gentlemen. In 1850 the number of yachts reached 500, and the pastime of cruising and racing had taken a firm hold of all branches of the community. From this time forward the growth in the number of yachts became very rapid, as will be gleaned from the table which follows. The rigs are separated, and

it will be seen that yawls have only become an important class during the last fourteen years. This has not been at the expense of cutters, as the numbers in that rig have increased in a steady ratio. The schooners have been the sufferers; and, as the labour of racing a schooner is so very much greater and so much more expensive than racing a cutter or yawl, there is small hope of the schooners coming into favour again.

NUMBER OF YACHTS.

| | 1850. | 1864. | 1878. |
|----------------------------------|------------|------------|-------------|
| Under 5 tons | 4 | 52 | 160 |
| 5 tons, and not exceeding 9 tons | 50 | 137 | 300 |
| 10 " " | 19 | 127 | 408 |
| 20 " " | 29 | 85 | 118 |
| 30 " " | 39 | 59 | 69 |
| 40 " " | 50 | 41 | 44 |
| 50 " " | 60 | 27 | 47 |
| 60 " " | 80 | 40 | 59 |
| 80 " " | 100 | 15 | 36 |
| 100 " " | 150 | 33 | 63 |
| 150 " " | 200 | 9 | 30 |
| Above | 200 | 10 | 15 |
| Steam Yachts | 8 | 33 | 282 |
| Total | 503 | 895 | 1883 |

RIGS.

| | 1850. | 1864. | 1878. |
|------------|-------|-------|-------|
| Cutters | 372 | 574 | 754 |
| Schooners | 76 | 207 | 328 |
| Yawls | 45 | 54 | 328 |
| Other Rigs | 7 | 27 | 25 |
| Steamers | 3 | 33 | 282 |

TONNAGE.

| | 1850. | 1864. | 1878. |
|-----------------|--------|--------|--------|
| Average Tonnage | 44 | 44 | 47 |
| Gross Tonnage | 22,141 | 39,485 | 89,420 |

Yacht Club.—A club formed with the ostensible object of associating yacht owners, and promoting a fondness for the sea.

Yacht Racing Association.—An association of yachtsmen founded in 1875 in order to provide one code of sailing rules for use in all matches, and to decide such disputes as might be referred to the Council of the Association. The Association and Council are constituted similarly to the Jockey Club. The following are the Y.E.A. sailing rules, as sanctioned for 1879:—

1. **Management of Races.**—All races, and all yachts sailing therein, shall be under the direction of the flag officers or Sailing Committee of the club under whose auspices the races are being sailed. All matters shall be subject to their approval and control; and all doubts, questions, and disputes which may arise shall be subject to their decision. Their decisions shall be based upon these rules so far as they will apply, but as no rules can be devised capable of meeting every incident and accident of sailing, the Sailing Committee should keep in view the ordinary customs of the sea, and discourage all attempts to win a race by other means than fair sailing and superior speed and skill. The decisions of the Sailing Committee shall be final, unless they think fit, on the application of the parties interested, or otherwise, to

refer the questions at issue for the decision of the Council of the Yacht Racing Association. No member of the Sailing Committee or Council shall take part in the decision upon any disputed question in which he is directly interested. The Sailing Committee, or any officer appointed to take charge for the day, shall award the prizes, subject to rule 30. If any yacht be disqualified, the next in order shall be awarded the prize.

2. **Postponement of Races.**—The Sailing Committee, or officer in charge for the day, shall have power to postpone any race, should unfavourable weather render such a course desirable.

3. **Measurement for Tonnage.**—(See "Tonnage.")

4. **Time allowance.**—Time shall be allowed on arrival for difference in tonnage, according to a scale, increased or decreased in proportion to the length of different courses.

If it is necessary during a race to shorten the course, the signal flag denoting the race hoisted under the white Peter, or in case of fog or darkness two guns fired shall show that the race is to finish with the round about to be completed, and the time allowance shall be reduced in proportion. (See "Time Allowance.")

5. **Entries.**—Entries shall be made with the Secretary at least forty-eight hours previous to noon of the day appointed for starting each race. In case of a Sunday intervening, twenty-four hours shall be added. Entries may be made by telegram, and it shall be deemed sufficient that the same shall have been dispatched before noon of the day on which the entries close, subject to the provision as to Sundays.

Form of Entry.—Form of entry to be signed by the owner, or his representative, previous to the race:—

Please to enter the Yacht for the race at _____ on the _____ Her distinguishing flag is _____; her rig is _____; and her tonnage, in accordance with Rule 3, is _____ tons. I undertake that while sailing under this entry she shall not have on board any bags of shot; that all her ballast shall be properly stowed under the platform or in lockers, and shall not be shifted or trimmed in any way whatsoever; and that I will obey and be bound by the Sailing Rules of the Yacht Racing Association.

Signed this _____ day of _____.

Should any yacht duly entered for a race not start, or having started should she give up, or be disabled during the race, such yacht shall, in the event of the race being resailed, be entitled to start; but no new entries shall be received under any circumstances whatsoever for a postponed race.

6. **Ownership.**—Each yacht entered for a race must be *bond fide* the property of the person or persons in whose name or names she is entered, who must be a member or members of a recognised yacht club.

7. *Ownership.*—No owner shall be allowed to enter more than one yacht in a race, except in cases in which a prize is given for each rig, when one yacht of each rig may be entered, nor shall he be entitled to enter the same yacht under different rigs for any race.

8. *One Yacht Entitled to Sail Over.*—When a prize has been offered for competition, any yacht, duly entered, may claim to sail over the course, and shall be entitled to the prize; subject, however, to Rule 2.

9. *Sliding Keels.*—No yacht which is fitted to shift keels, or to otherwise alter her form, shall be permitted to enter.

10. *Member on Board, and Declaration.*—Every yacht sailing in a race shall have on board a member of a recognised yacht club, who, before the prize is awarded, shall sign a declaration that the yacht under his charge has strictly conformed to all the sailing regulations, as follows:—

I hereby declare that the _____ yacht whilst sailing in the _____ race this day, has strictly observed the sailing rules and regulations.

(Signed) _____

Date _____

11. *Flags.*—Each yacht must carry, at her main topmast head, a rectangular distinguishing flag of a suitable size, which must not be hauled down unless she gives up the race. If the topmast be lowered on deck or carried away, the flag must be rehoisted in a conspicuous place as soon as possible.

12. *Instructions.*—Every yacht entered for a race shall, at the time of entry, or as soon after as possible, be supplied with written or printed instructions as to the conditions of the race, the course to be sailed, marks, &c. Nothing shall be considered as a mark in the course unless specially named as such in these instructions.

13. *Sails.*—There shall be no restrictions as to sails, or the manner of setting and working them; but steam power must not be used for hoisting sails.

14. *Crew and Friends.*—There shall be no limit as to the number of paid hands, and no restrictions as to the number of friends, or to their working. No paid hand shall join or leave a yacht after the signal to start. [This rule is not intended to apply to Corinthian matches.]

15. *Fittings and Ballast.*—All yachts exceeding five tons shall be fitted below deck with the ordinary fittings of a yacht, including two transverse bulkheads of wood, and their platforms shall be kept down, and bulkheads standing. No water shall be started from or taken into the tanks after the signal to start has been made. No more than the usual anchors and chains shall be carried during a race, which must not be used as shifting ballast, or for altering the trim of the yacht. No bags of shot shall be on board, and all ballast shall be properly stowed under the platform or in lockers, and shall not be

shifted or trimmed in any way whatsoever during a race. No ballast shall be shipped or unshipped after nine p.m. of the day previous to the race. A race resailed shall, so far as regards this rule, be considered a new race.

16. *Boats and Life Buoys.*—Every yacht exceeding thirty and under sixty tons, shall carry a boat on deck not less than ten feet in length and three feet six inches beam, and every yacht of seventy tons and over, one of not less than twelve feet in length, and three feet six inches beam, with oars lashed in them, ready for immediate use. Each yacht shall carry a life buoy on deck ready for use.

17. *Starting.*—The yachts shall start from moorings, anchors, or underway, as directed by the Sailing Committee. Half-an-hour before the time of starting one of the following flags of the Commercial Code shall be hoisted as a preparative flag for the yachts of each successive race; in case of a start from anchors or moorings to take up their stations for the start with headsails down, or all sails down, as the Sailing Committee may direct; or in case the start be a flying one, to approach the starting line, viz:—

| | |
|------------------------------|-----------|
| B of Commercial Code for the | |
| Yachts of the..... | 1st Race. |
| C | 2nd " |
| D | 3rd " |
| F | 4th " |

and so on.

Five minutes before the start the preparative flag shall be lowered and a blue peter hoisted, and a gun fired; after which, the yachts in the race shall be amenable to the rules. At the expiration of five minutes *exactly* the blue peter shall be hauled down and a second gun fired as a signal to start. If the start is to be made from anchors or moorings, lots shall be drawn for stations, and springs shall be allowed on the same bridle or anchor chain or warp as the bowfasts, but are not to be carried to a buoy, pier, other vessel, or fixed object. If any yacht lets go or parts her bridle before the signal to start, or if she drags any moorings or anchor to which she is made fast for the purpose of starting, she shall be liable to be disqualified, unless such parting or dragging be explained to the satisfaction of the Committee, or unless she has returned, after the signal to start within the line of buoys, so as not to obtain any advantage by the accident. In a flying start if any yacht or any part of her hull or spars be on, or across the line before the signal to start is made, she must return and recross the line; a yacht so returning or coming working into position from the wrong side of the line after the signal to start has been made, must keep clear of all competing yachts which are crossing, or have crossed the line properly. Should the gun miss fire, the lowering of the blue peter to be the signal to start.

18. *Meeting End On.*—If two yachts are meeting end on, or nearly end on, so as to

involve risk of collision, the helms of both shall be put to port, so that each may pass on the port side of the other.

19. *Two Yachts Crossing, &c.*—When two yachts are crossing so as to involve risk of collision, then if they have the wind on different sides, the yacht with the wind on the port side shall keep out of the way of the yacht with the wind on the starboard side, except in the case in which the yacht with the wind on the port side is close hauled and the other yacht free, in which case the latter yacht shall keep out of the way; but if they have the wind on the same side, or if one of them has the wind aft, then the yacht which is to windward shall keep out of the way of the yacht which is to leeward.

20. *Overtaking, Rounding Marks, &c.*—A yacht overtaking another yacht shall keep out of the way of the last mentioned yacht, but when rounding any buoy or vessel used to mark out the course, if two yachts are not clear of each other at the time the leading yacht is close to, and actually rounding the mark, the outside yacht must give the other room to pass clear of it, whether it be the lee or weather yacht which is in danger of fouling the mark. No yacht shall be considered clear of another yacht, unless so much ahead as to give a free choice to the other on which side she will pass. An overtaking yacht shall not, however, be justified in attempting to establish an overlap, and thus force a passage between the leading yacht and the mark after the latter yacht has altered her helm for the purpose of rounding.

21. *Obstructions to Sea Room.*—When passing a pier, shoal, rock, vessel or other obstruction to sea room, should yachts not be clear of each other, the outside yacht or yachts must give room to the yacht in danger of fouling such obstruction, whether she be the weather or the leeward yacht; provided always that an overlap has been established before an obstruction is actually reached.

22. *Luffing and Bearing Away.*—A yacht may luff as she pleases to prevent another yacht passing to windward, but must never bear away out of her course to hinder the other passing to leeward—the lee side to be considered that on which the leading yacht of the two carries her main boom. The overtaking vessel, if to leeward, must not luff so as to interfere with the yacht she has overtaken until she has drawn clear ahead.

23. *Close-hauled Approaching Shore.*—If two yachts are standing towards a shore or shoal, or towards any buoy, boat, or vessel, and the yacht to leeward is likely to run aground, or foul of such buoy, boat, or vessel (a mark vessel excepted), and is not able to tack without coming into collision with the yacht to windward, the latter shall at once tack on being hailed to do so by the owner of the leeward yacht, or the person acting as his representative, who shall be bound to see that his own vessel tacks at the same time.

24. *Running Aground, &c.*—Any yacht running on shore, or foul of a buoy, vessel, or other obstruction, may use her own anchors, boats, warps, &c., to get off, but may not receive any assistance except from the crew of a vessel she has fouled. Any anchor, boat, or warp used must be taken on board again before she continues the race.

25. *Fouling Yachts, Marks, &c.*—Each yacht must go fairly round the course; and must not touch any buoy, boat, or vessel used to mark it out, but shall not be disqualified if wrongfully compelled to do so by another yacht. Any yacht causing a mark vessel to in any way shift her position to avoid being fouled by such yacht, shall be disqualified. If a yacht, in consequence of her neglect of any of these rules, shall foul another yacht, or compel other yachts to foul, she shall forfeit all claim to the prize, and shall pay all damages.

26. *Means of Propulsion.*—No towing, sweeping, poling, or pushing, or any mode of propulsion except sails, shall be allowed.

27. *Anchoring.*—A yacht may anchor during a race, but must weigh her anchor again, and not slip. No yacht shall during a race make fast to any buoy, stage, or pier, or send an anchor out in a boat, except for the purpose of rule 24.

28. *Soundings.*—No other means of sounding than the lead and line allowed.

29. *Side Lights.*—All yachts sailing in a race at night shall observe the Board of Trade rule as to the carrying of side lights.

30. *Man Overboard.*—In case of a man falling overboard from a competing yacht, all other yachts in a position to do so shall use their utmost endeavours to render assistance; and if it should appear that any yacht was thereby prevented winning the race, the committee shall have power to order it to be resailed between any yacht or yachts so prevented and the actual winner.

31. *Protests.*—Should the owner of any yacht, or the person acting as his representative, consider that he has a fair ground of complaint against another for foul sailing, or any violation of these rules, he must, if it arise during the race, signify the same on first passing the committee vessel, by showing an ensign conspicuously in the main rigging. The protest shall be made in writing, and under such regulations (if any) as the sailing committee may have determined, within twelve hours of the arrival of the protesting yacht, and shall be heard by the sailing committee and decided, after such inquiries as they may consider necessary. They shall also, without a protest, disqualify any yacht, should it come to their knowledge that she has committed a breach of the rules.

32. *Removal of Flag Boat.*—Should any flag vessel, buoy, or other mark boat be removed from its proper position, either by accident or design, the race shall be sailed over again, or not, at the option of the sailing committee.

33. Penalty for Disobeying Rules.—Any yacht disobeying or infringing any of these rules, which shall apply to all yachts whether sailing in the same or different races, shall be disqualified from receiving any prize she would otherwise have won, and her owner shall be liable for all damages arising.

Should a flagrant breach of these rules be proved against any yacht, her sailing master may be disqualified by the council for one season from sailing in any race held under the rules of the Yacht Racing Association.

34. Cruising Trim.—When yachts are ordered to sail in cruising trim, the following rules are to be strictly observed:—

1. No doors, tables, cabin skylights, or other cabin or deck fittings (davits excepted) shall be removed from their places before or during the race.
2. No sails or other gear shall be put into the main cabin in yachts exceeding forty tons.
3. Anchors and chains suitable to the size of the yacht shall be carried, one at the cathead (or in yachts of forty tons and under, at the usual place on the bow), which anchor shall not be unshackled from the chain before or during the race.
4. Every yacht exceeding thirty and under seventy tons, shall carry a boat on deck not less than ten feet in length and three feet six inches beam—a yacht of seventy tons and over, her usual cutter and dinghy.
5. No extra hands, except a pilot, beyond the regular crew of the yacht shall be allowed.

In the Appendix the Yacht Racing Association further recommend for the consideration of Sailing Committees:—

1. Allowance to Schooners and Yawls.—That as mixed races are no satisfactory test of the relative speed of yachts, the different rigs should, whenever practicable, be kept separate; but when mixed races are unavoidable, the following rule shall be observed:—

The tonnage of schooners and yawls to be reckoned for time allowance as follows, viz., schooners at three-fifths, and yawls at four-fifths of their actual tonnage; provided that in case of a yawl, her main boom when in its place and parallel to the deck, does not extend more than two-fifths her extreme beam abaft the stern end of her load water-line. In calculating the deduction for difference of rig, the tonnage by certificate to the exact fraction to be used. The time allowances to be calculated from each vessel's reduced tonnage. Schooners and yawls shall not be allowed to enter in classes of forty tons and under at the reduced tonnage.

2. Flying Starts.—That flying starts should be adopted when practicable, but no time should be allowed for delay in starting.

3. No Limit to Race.—That any limit to the time for concluding a race should be avoided as far as possible.

4. Classification.—That the classification of yachts should, when possible, be as follows:—

| | |
|--------------------------------------|---------|
| Not exceeding | 5 Tons. |
| Above 5 tons and not exceeding 10 .. | 10 " |
| " 10 " " " " " | 15 " |
| " 15 " " " " " | 20 " |
| " 20 " " " " " | 40 " |
| " 40 " " " " " | 80 " |
| " 80 " " " " " | " " |

5. Courses.—That as distance is an important element in the calculation of time allowance, the marks and flag boats should be placed so as to mark as accurately as possible the length of the course, for which time is allowed.

6. Rounding Marks.—That in heavy weather it should be arranged, if practicable, for yachts to stay instead of gybe round marks.

7. Room at Starting.—Sailing Committees should be particularly careful to provide ample room between the points marking the starting line.

Yacht Register.—A book compiled by the well known committee of Lloyd's Society, at the request of yacht owners. Hitherto difficulty was experienced in arriving at the age and condition of a yacht, but the Register contains all the particulars an intending purchaser need know. Owners will derive benefit from having their yachts surveyed and classed at Lloyd's, and special facilities now exist for making such surveys and assigning characters. The Register contains the following particulars: Names of yachts; official number, number in the Register; signal letters; rig; sailmaker's name; registered tonnage, N.M.; Thames tonnage; dimensions (length, breadth, and depth); repairs to yacht, and date thereof; nature of repairs; class; materials used in her construction; builder's name; date of building; port; port of survey; fastenings; sheathing; description of engines; builders of engines, &c. The first part of the Register contains the rules and regulations for building for classification. These rules and regulations relate to wood, iron, and composite yachts; and tables of scantlings, fastenings, &c., are given for each, together with a table for anchors, chains, &c., for sailing yachts and steam yachts. This part of the book is most valuable, and will be a large help to builders who have little experience of the particular work required in a yacht, and will as well be found of great use to the more experienced builders. A yacht can be built of any material and fastened in almost any way an owner or builder may desire, and still she can be admitted with a grade into the book. Existing yachts can be surveyed, and if approved, assigned the A 1 class for four teen years, or any other grade, according to their construction, condition, and age. The Register also contains full information as to the manner of having a survey effected; list of surveyors and their addresses; list of owners and their addresses; list of subscribers and their addresses. The offices are Lloyd

Register of British and Foreign Shipping, White Lion Court, Cornhill, E.C. (See Lloyd's.)

Yard.—A spar used to extend a sail.

Yard Arm.—The extremities of yards.

Yarn.—A yarn is generally understood to mean one of the parts of a strand of a rope. The strands of old rope are separated and used as stops for temporarily securing sails when rolled up, &c. A narrative, a tale, a long story, or discourse. (See "Strands.")

Yaw.—When a vessel's head flies from one direction to another; generally when a vessel does not steer a straight or steady course.

Yawl.—A cutter-rigged vessel with a mizen mast stepped in her counter.

Yellow Flag.—The quarantine or fever flag.

Yoke.—The lower cap on the masthead. It is cut out of solid wood, and either strengthened by an iron plate over the whole of its top, or an iron band round its entire edge. The cross trees are fitted on the yoke. (See page 119.) A yoke is also the crossbar put on the rudder-head of small boats, to which lines, termed yoke lines, are attached for steering.

Z.

Zig-Zag.—Working to windward.

APPENDIX II.

STEERING AND SAILING RULES.

On Sept. 1, 1880, the following rules (by Order in Council, held at Osborne, Aug. 14, 1879), will come into force, instead of the rules given on page 549 :

Art. 14. When two sailing ships are approaching one another so as to involve risk of collision, one of them shall keep out of the way of the other as follows, viz. :—

- (a.) A ship which is running free shall keep out of the way of a ship which is close-hauled.
- (b.) A ship which is close-hauled on the port tack shall keep out of the way of a ship which is close-hauled on the starboard tack.
- (c.) When both are running free with the wind on different sides, the ship which has the wind on the port side shall keep out of the way of the other.
- (d.) When both are running free with the wind on the same side, the ship which is to windward shall keep out of the way of the ship which is to leeward.
- (e.) A ship which has the wind aft shall keep out of the way of the other ship.

Art. 15. If two ships under steam are meeting end on, or nearly end on, so as to involve risk of collision, each shall alter her course to starboard, so that each may pass on the port side of the other.

This Article only applies to cases where ships are meeting end on, or nearly end on, in such a manner as to involve risk of collision, and does not apply to two ships which must, if both keep on their respective courses, pass clear of each other.

The only cases to which it does apply are, when each of the two ships is end on, or nearly end on, to the other; in other words, the cases in which, by day, each ship sees the masts of the other in a line, or nearly in a line, with her own; and by night, in cases in which each ship is in such a position as to see both the side lights of the other.

It does not apply by day to cases in which a ship sees another ahead crossing her own course; or by night, to cases where the red light of one ship is opposed to the red light

of the other, or where the green light of one ship is opposed to the green light of the other, or where a red light without a green light, or a green light without a red light, is seen ahead, or where both green and red lights are seen anywhere but ahead.

Art. 16. If two ships under steam are crossing so as to involve risk of collision, the ship which has the other on her own starboard side shall keep out of the way of the other.

Art. 17. If two ships, one of which is a sailing ship and the other a steamship, are proceeding in such directions as to involve risk of collision, the steamship shall keep out of the way of the sailing ship.

Art. 18. Every steamship, when approaching another ship so as to involve risk of collision, shall slacken her speed or stop and reverse if necessary.

Art. 19. In taking any course authorised or required by these regulations, a steamship underway may indicate that course to any other ship which she has in sight by the following signals on her steam whistle, viz. :—

One short blast to mean "I am directing my course to starboard."

Two short blasts to mean "I am directing my course to port."

Three short blasts to mean "I am going full speed astern."

The use of these signals is optional; but if they are used, the course of the ship must be in accordance with the signal made.

Art. 20. Notwithstanding anything contained in a preceding Article, every ship, whether a sailing ship or a steamship, overtaking any other shall keep out of the way of the overtaken ship.

Art. 21. In narrow channels every steamship shall, when it is safe and practicable, keep to that side of the fairway or mid-channel which lies on the starboard side of such ship.

Art. 22. Where by the above rules one or two ships is to keep out of the way, the other shall keep her course.

Art. 23. In obeying and construing these rules due regard shall be had to all dangers of navigation; and to any special circumstances which

may render a departure from the above rules necessary in order to avoid immediate danger.

**NO SHIP, UNDER ANY CIRCUMSTANCES, TO
NEGLECT PROPER PRECAUTIONS.**

Art. 24. Nothing in these rules shall exonerate a ship, or the owner, or master, or crew thereof, from the consequences of any neglect to carry lights or signals, or of any neglect to keep a proper look-out, or of the neglect of any pre-

caution which may be required by the ordinary practice of seamen, or by the special circumstances of the case.

**RESERVATION OF RULES FOR HARBOURS AND
INLAND NAVIGATION.**

Art. 25. Nothing in these rules shall interfere with the operation of a special rule, duly made by local authority, relative to the navigation of any harbour, river, or inland navigation.

INDEX.

| A. | |
|---|----------|
| Ackers, Mr. G. H., his opinion as to port and starboard tack..... | 223 |
| African oak, weight of a cubic foot..... | 3 |
| Admiralty, experiments of, with rudders ... | 33 |
| Admiralty and centre-boards | 244 |
| Algoa Bay, lateen rig..... | 294 |
| Alert, centre-board yacht | 305 |
| Amenable to Y.R.A. rules..... | 242 |
| Anchoring | 184 |
| Y.R.A. rules | 240 |
| Anchors for yachts..... | 110 |
| Angle for sails on different points of sailing | 23 |
| Apparent wind | 19 |
| Approaching shore close hauled | 232 |
| Archer, M. Colin, his wave form theory (Foot note)..... | 49 |
| and Norwegian pilot boats | 382 |
| Arrow and Vol-au-Vent, &c..... | 56 |
| Artificial and natural stability | 12 |
| B. | |
| Balance lug rig | 271 |
| Ballast, and a vessel's performance in a sea-way | 65, 359 |
| centre of gravity of | 65 |
| distribution of | 65 |
| in relation to a yacht's displacement ... | 63 |
| iron and lead floors | 66 |
| shifting | 64 |
| shifting in small boats, danger of | 267 |
| slinging of | 66 |
| stowing | 66 |
| table showing amount of ballast different yachts carry | 62 |
| Ballasting, Harvey and Pryers..... | 66 |
| Beam and length | 51 |
| penalty on | 56 |
| Bearing away | 225 |
| Before the wind | 233 |
| Belfast yawls | 381 |
| Bells..... | 196 |
| Bentall, M., designer of Jullanar..... | 387 |
| Blocks, sizes of for yachts | 120 |
| Boats, beaching of | 193 |
| capsizing of | 187 |
| for rowing and sailing designed by Capt. Horner..... | 381 |
| general cautions in the management of management of open under sail | 191 |
| reefing the sails of | 185 |
| reefing the sails of | 192 |
| Boatswain, duties of | 196 |
| Bobstay, fitting of | 135 |
| Bombay yacht..... | 283 |
| Booms, weight of | page 73 |
| Bowprit, carrying away a | 181 |
| shrouds, fitting of | 134 |
| to parbuokle | 181 |
| Bowprits, weight of | 73 |
| Brighton beach boats..... | 298 |
| Bring up, to..... | 184 |
| Buoyancy, explanation of | 4 |
| Buoyancy, centre of | 5 |
| Butler, Mr. T., his topmast funnel | 129 |
| C. | |
| Cables for yachts | 110 |
| Cambered keels | 18 |
| Cambria, her hollow masts | 76 |
| Canoes, aprons | 421 |
| building of, for cruising..... | 430 |
| cause of hanging to windward..... | 417 |
| centre-boards | 416 |
| classified | 409 |
| construction of | 411 |
| deck flaps..... | 421 |
| defined | 407 |
| fitting double centre boards and areas of the same..... | 418 |
| fitting single centre-board..... | 419 |
| for cruising | 426 |
| for paddling and sailing, description of mast and tabernacle | 422 |
| Nautilus racing canoe of 1879..... | 424 |
| relative advantages of single and double centre-boards | 417 |
| sail-carrying power of canoes | 434 |
| sails for..... | 438, 444 |
| steering gear | 420 |
| tent of the Nautilus | 424 |
| Carrying away spars and rigging..... | 181 |
| Catsamarans (American)..... | 397 |
| Centipede, Itchen boat | 338 |
| Centre-boards | 18 |
| use of, in steering (double) | 32 |
| and stability | 259 |
| construction of case | 257 |
| for canoes | 416 |
| fan shaped | 250 |
| shoe | 251 |
| double | 246, 417 |
| boats | 243 |
| designs for boats of various sizes..... | 262 |
| boat for rowing and sailing | 253 |
| boats, sails for | 267 |
| sloops | 303 |
| yacht Charm | 284 |
| yacht (French) | 276 |
| yachts, slow in stays (Foot note)..... | 32 |

| | | | |
|--|----------|--|----------|
| Centre of buoyancy | page 5 | Equipment of yacht | page 115 |
| effort of sails | 22 | Examination, general, of a yacht..... | 88 |
| effort of sails and centre of lateral | | Expenses of yachting..... | 201 |
| resistance..... | 27 | of yacht racing | 208 |
| gravity explained | 6 | | |
| gravity of ballast | 65 | F. | |
| lateral resistance..... | 14 | Falling off and coming to | 18 |
| Chain cables for yachts | 110 | Falmouth luggers, Mr. Wilcock's descrip- | |
| Charm, centre-board yacht | 284 | tion of | 292 |
| Clayton, Mr. C. P., designer of New Brighton | | False tacking | 226 |
| Sailing Boats | 314 | Fids | 131 |
| Close-hauled approaching mark or shore..... | 232 | self-acting | 131, 132 |
| and sailing free | 237 | Fifteen tonners | 87 |
| sailing | 167 | Five and 10-tonners | 359 |
| Clothes of crew | 201 | Flags of racing yachts | 212 |
| Clyde sailing boats..... | 347 | Florence and other 10-tonners | 365 |
| canoes | 469 | Florinda's curve of stability..... | 47 |
| canoe sails | 473 | Florida and Jullanar compared | 46 |
| canoe tent | 476 | speed of, compared..... | 391 |
| Columbia, speed and sail spread of | 45 | Floor construction of yachts..... | 98 |
| Columbia and Seabelle | 45 | Forestay, fitting of..... | 183 |
| their speed compared..... | 60 | Fore halyards, fore tacks, and foresheets, | |
| Coble | 377 | fitting of | 187 |
| Composite yachts | 111 | Fore reaching | 218 |
| Composition for yachts' bottom | 111 | Forbes, Mr. E. B., his rigs for small boats... 279 | |
| Cooper, Mr. W. ("Vanderdecken") | 386 | Forwood, Mr. W. B., his remarks on Winder- | |
| Copper sheathing | 91 | mere yachts | 328 |
| Council of Y.R.A., duties of..... | 211 | Freda's sail spread..... | 57 |
| Crew, clothes of | 201 | Freda and Lorelei | 358 |
| character of | 200, 206 | Freeboard | 52 |
| discipline of | 196 | rule for determining height of | 53 |
| liberty of and discipline | 199 | Friction of skin surface..... | 48 |
| management of | 194 | at great depths | 50 |
| for racing yachts..... | 206 | Froude, Mr., experiments of, with rudders... 38 | |
| wages of | 291 | his experiments with steering of screw | |
| Cross-tacking | 220 | yachts | 38 |
| Curves of stability | 42 | his resistance experiments..... | 48 |
| of Jullanar, Florinda, Seabelle, and Rose | | his resistance experiments in relation to | |
| of Devon | 47 | form | 49 |
| Cutter rig, incomparable | 83 | his report on friction at great depths of | |
| | | immersion | 50 |
| D. | | his experiments on beam in relation to | |
| Decks, difficulty of to keep tight..... | 93 | resistance..... | 55 |
| Density of water at great depths..... | 50 | | |
| Depth, rule for determining the depth of | | G. | |
| yachts | 54 | Galway Hooker | 380 |
| Discipline | 199 | Pookhaun | 380 |
| Displacement, explanation of | 3 | Gooseneck | 154 |
| rough rule for finding the | 261 | Gripping | 168 |
| as a basis for time allowance | 59 | Guinevere, weight of, compared with weight | |
| of models in relation to real yachts..... | 5 | of Sappho | 68 |
| Double boats; Mr. Melling's and Mr. | | her form | 56 |
| Mackenzie's | 395 | Gunter sprit rig, Mr. Baden-Powell's | 291 |
| centre-boards, use of, in steering..... | 32 | Gybing | 163 |
| advantages of..... | 247, 417 | Gyration, radius of..... | 65 |
| keels..... | 251 | | |
| Drag..... | 18 | H. | |
| Draught of water, rule for determining | 54 | Halyards, fitting of..... | 136 |
| Duplex double boat | 397 | to bend..... | 151 |
| | | Harvey, Mr. John, and Jullanar | 388 |
| E. | | and Pryer's mode of ballasting..... | 66 |
| Effort of wind | 19 | Head reaching | 218 |
| of sails tending to depress the bow | 28 | Helm and crew | 198 |
| centre of | 22 | Heathen Chinese, Irish Modal Yacht Club boat 369 | |
| Elaine, New Brighton sailing boat | 315 | Heaving to | 164 |
| Entries and post entries | 212 | Heavy sea, sailing a yacht in | 175 |

- Horner, Capt. (E.N.), lateen rigpage 296
 and Galway Hookers and Pookhaan ... 380
 Hookers of Galway 380
 Hove-to on port tack..... 241
- I.
- Ianthe, Irish Model Yacht Club boat 369
 Ice yachting..... 398
 Ice yachts, best points of sailing 401
 excessive heeling of 401
 mode of bringing them to rest 406
 sailing faster than the wind, principles
 of, explained 402
 speed of authenticated 402
 speed of, beating to windward 406
 Icicle, ice yacht, dimensions of 401
 Instructions for yacht matches 214
 Irish Model Yacht Club boats 369
 Israfel, Itohen boat 338
 Itchen boats 336
 capsizing of..... 339
 sailing punts 345
- J.
- Jabberwock, New Brighton sailing boat..... 322
 Jeans, Mr. W., his double centre-board yacht 246
 Jib-sheet outriggers 169
 tack, jib halyards, and jib sheets, fitting of 186
 John, Mr. W., his remarks on wire and hemp
 rigging 125
 Jullanar (see Footnote) 17
 account of her building, &c. 386
 curve of stability 47
 and Florida compared 46
- K.
- Keane's, Capt., screw lanyards..... 124
 Ketch rig, inconvenience of 71
 compared with that of yawl 82
 Kriemhilda, Arrow, and Vol-au-Vent compared 56
- L.
- Laying off 253
 Lane, Mr. A. J., and double centre-boards... 247
 Lateen rig, Algoa Bay 294
 Capt. Horner's 296
 Lowestoft 294
 topsails 245, 305
 Lateral resistance 14
 illustrated 16
 and centre of effort 27
 Lead ballast 63
 Leaving a yacht during a match; Y.R.A. rule 241
 Length and beam 51
 breadth, and depth of different yachts... 72
 Le Lison, French centre-board yacht 276
 Liberty of crews..... 199
 Lily and other 10-tonners 365
 Livonia, her speed 60
 Lloyd's Yacht Register 88
 rules for building..... 97, 107
 classification 107
 rules for anchors and chains..... 110
 Long, Mr. Ardagh, designer of Heathen
 Chinese 369
- Long bodypage 50
 Lorelei and Freda 358
 Lough Erne yachts..... 367
 Lowestoft lateen sail 294
 Luffing and bearing away..... 219, 234
 to free puffs..... 173
 Luggers, Falmouth 292
 Lug sail, balance 271
 standing 274
 Chinese 279
- M.
- Maggie, cutter yacht 87
 Main and peak halyard fitting 138
 Management of open boats under sail..... 185
 of matches 211
 Marks, rounding of 227
 Markboat; causing one to shift her position 231
 Mast; carrying away a, and rigging jury
 mast 183
 Masthead described 119
 pendants, fitting of..... 132
 Master of yacht 194
 Mate, duties of 195
 Measurement, builder's 50
 by displacement 59
 New Brighton Sailing Club rule 314
 and sail spread 57
 Thames..... 56
 Y.R.A. 56
 of New York Yacht Club 45
 Measurements. Table showing the length,
 breadth, sail spread, &c., of yachts 59
 Meeting, end on 237
 Missing stays 163
 Misen rig for small boats, advantages of..... 269
 of a yawl explained 117
 Mohawk, capsizing of 43
 Moor, to 185
- N.
- Naval architects and yacht building 112
 New Brighton sailing boats, management of 322
 Sailing Club measurement rule..... 314
 sailing boats 314
 York Yacht Club measurement..... 45
 Norwegian pilot boats 382
- O.
- Oimara; her bowsprit 80
 Outhauls 140
 Outriggers for jib sheets 169
 Opposite tacks at marks 227
 Over-reaching 225
 Overtaking yachts 234
 on a weather shore..... 236
 Owner of yacht 194
- P.
- Parbuckling bowsprit..... 181
 Pearl canoe 450
 canoe centre board 452
 sails of 453
 Pendants 182

- Penzance luggerspage 373
 Percy, Earl of, and centre boards..... 243
 Pookhaun, of Galway..... 380
 Port tack, hove to a 241
 Port and starboard tack 220
 Powell, Mr. Baden, his Chinese lug rig 279
 his topmast funnel 128
 Post entries 212
 Postponement of races 212
 Professional skippers 173
 Puffs, free 172
- Q.
- Quiraing and other 10-tonners 365
- R.
- Racing flags..... 212
 expenses 208
 money 209
 yachts, crews for 206
 Rayonette and 10-tonners 337
 Reefing..... 147
 small boat sails 192
 Reef knot..... 147
 Resistance and speed..... 48
 and wave making 50
 Mr W. H. White's remarks on..... 55
 Ribband carvel build described..... 412
 Rigs for small boats considered 268
 Rig, gunter sprit..... 291
 New Brighton 320
 sliding gunter 290
 sloop 245, 305
 sprit sail 285
 Una 310
 Rigging and sails of old yachts..... 94
 fitting of 122
 standing 122
 of schooner explained 118
 sizes of, for yachts 121
 spars and sails of yachts explained 115
 for topmasts 127
 Rockered keels 18
 Roosevelt, Mr. J. A., owner of the *Ice-ber*
 yacht 401
 Rose of Devon's curve of stability 46
 Rounding marks..... 228
 Rudders, breadth of 33
 action of 29
 action of, in tacking 36
 action of, in screw steam yachts 38
 Admiralty experiments 33
 pressure on 34
 sculling, Y.R.A. rule 240
 Runners of rigging, fitting of 132
 Ryde wherries..... 285
- S.
- Sailing, boat, management of 322
 along a weather shore 236
 free 237, 239
 off the wind..... 178
 by the wind..... 167
 a yacht in a heavy sea 175
- Sail carrying power and speedpage 41
 spread; table of for different yachts ... 72
 Sails, centre of effort of..... 22
 oblique pressure of wind on 25
 areas of Surbiton gigs 270
 balance..... 168
 and rigging of old yachts 94
 rough rule for finding the area of..... 270
 for centre-board boats 267
 for canoes 434, 438, 444
 of yachts explained..... 115
 setting and taking 145
 to shift..... 149
 Sappho, weight of 63
 Sanderson, Mr Edward, designer of the
 " Witch "..... 367
 Scandalise, to, a mainsail 167
 Scantling, table of 108
 Schank, Capt., his invention of centre-boards 243
 Sculling with rudder, Y.R.A. rule..... 240
 Seabelle, her form 56
 curve of stability 47
 speed and spread of canvas 45
 and Columbia's speed compared 60
 Seamanship 145
 Self-acting fids 181
 Selecting a yacht 77
 Shallow yachts, instability of 44
 Sheets, to bend 151
 Shergold, Mr., designer of *Itchen* boats 336
 Shifting ballast 64
 ballast in boats, danger of 267
 sail 149
 Ship boats designed by Capt. Horner 381
 Shoe centre-board 251
 Shrouds (bowsprit), fitting of 134
 screw lanyards 124
 Side lights, Y.R.A. rule..... 239
 Sliding gunter rig 290
 American 277
 French rig 275
 Sloop, centre board 303, 305
 rig 245, 305
 Mr. Forwood's remarks on 328
 Smoking by crew 199
 Spinnaker halyards 140
 booms 142
 to set 154
 Sounding, Y.R.A. rule 241
 Spars 68
 effect of, on stability 68
 rules for determining the length of..... 69
 rule for lengths of schooners 69
 for cutters 70
 for yawls and ketches 71
 table of lengths of different yachts 72
 rules for placing the same in cutters,
 schooners, yawls, and ketches 74
 rules for determining the diameter of... 75
 hollow and built..... 76
 and rigging of yachts explained 115
 Speed on different points of sailing..... 24
 and sail spread 58
 of Columbia and Seabelle compared ... 60
 of Jullanar and Florida 391
 " Spell O " 198
 Sprit sails 285
 American..... 287
 Squalls..... 166

