

# Canoeing, sailing and motor boating

Warren Hastings  
Miller

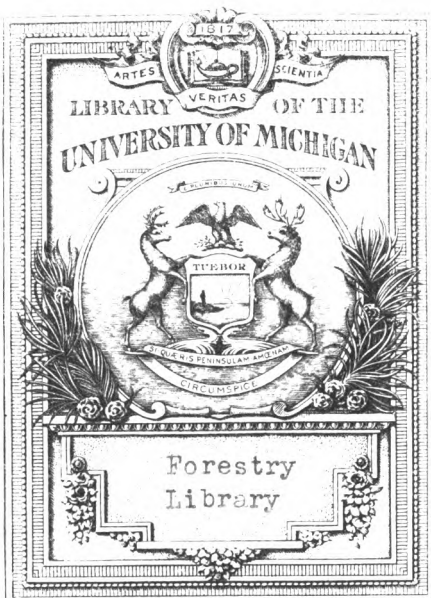

THE GIFT OF  
Maurice W. Senstius



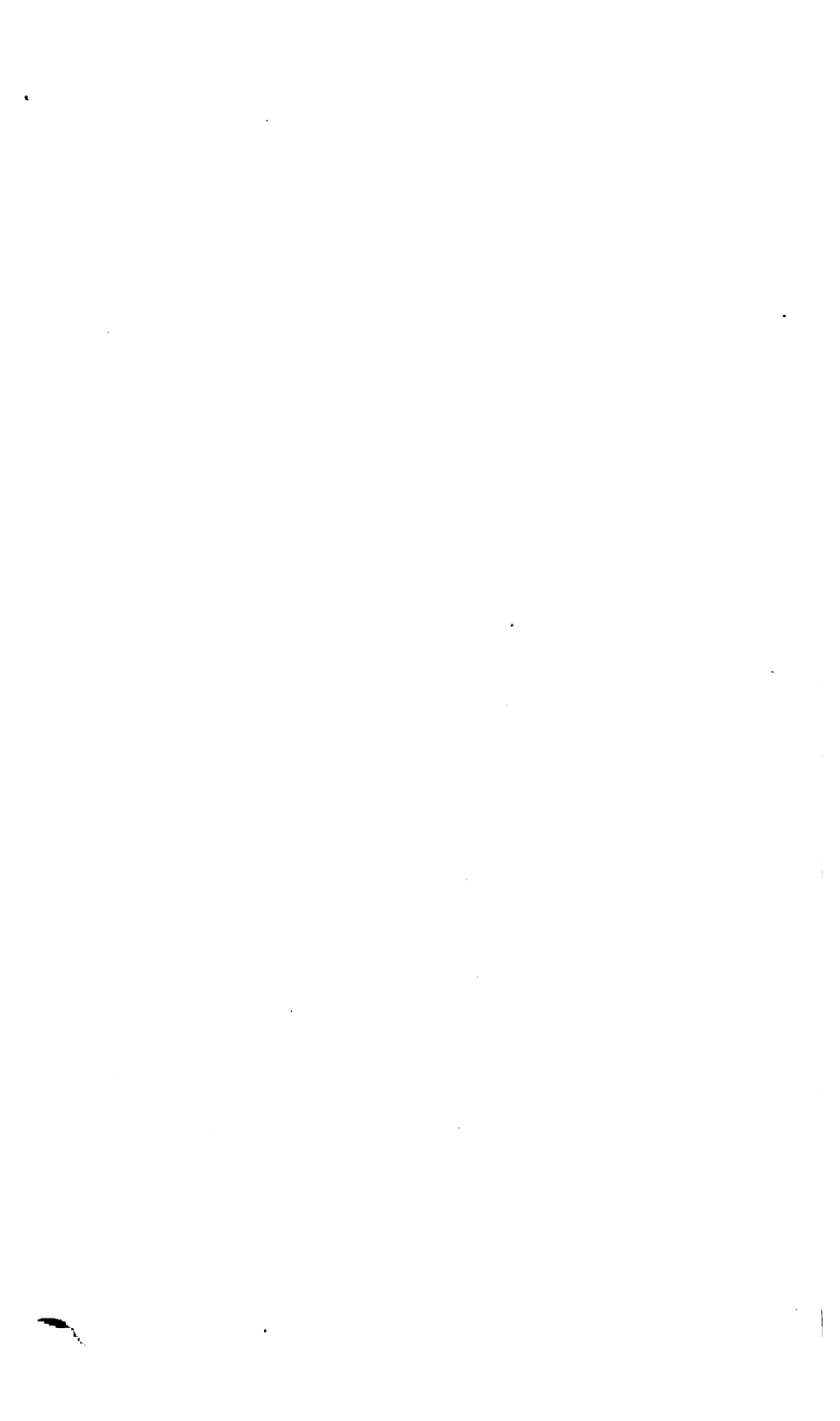



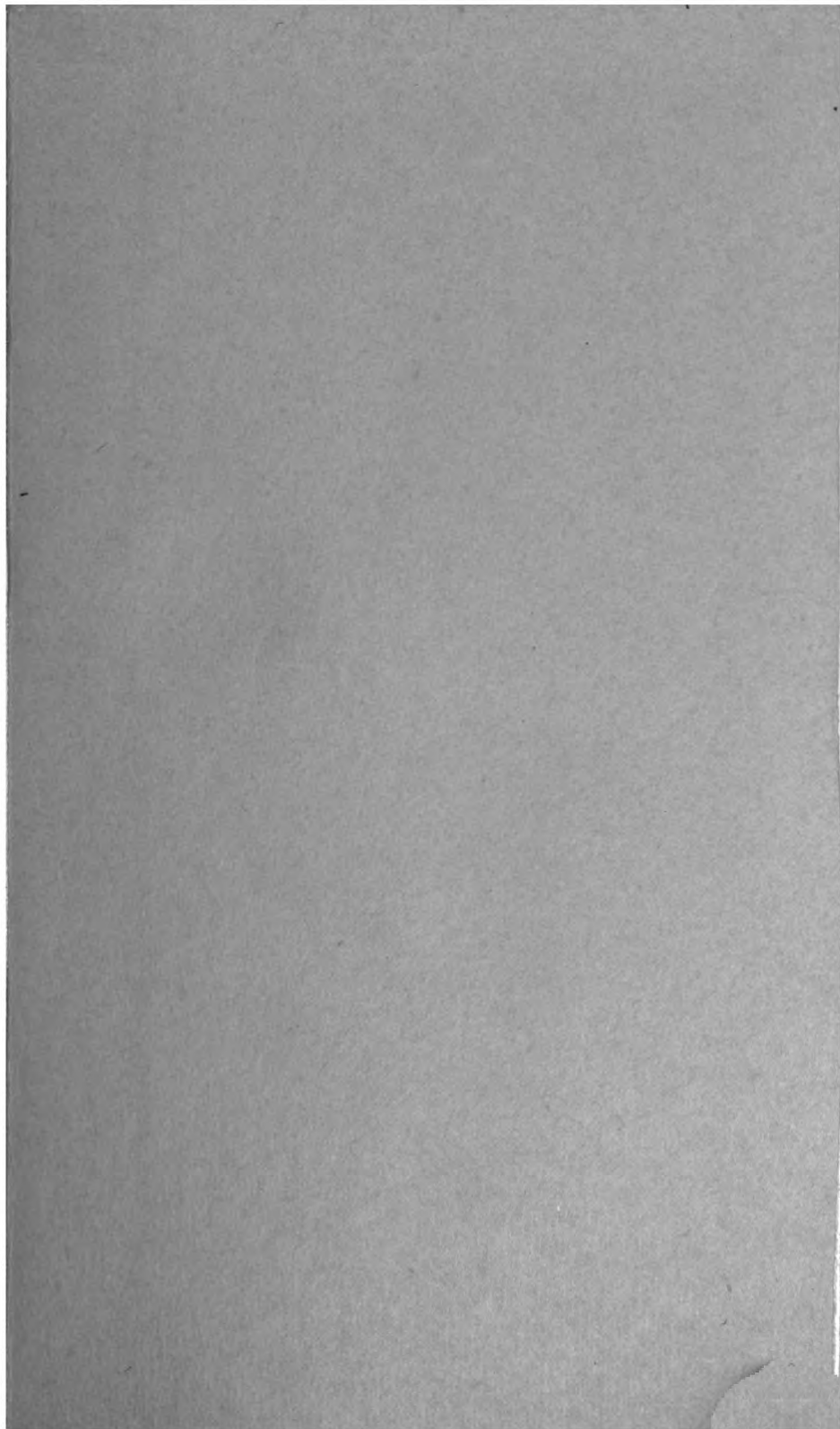



**CANOEING, SAILING  
AND MOTOR BOATING**

---

**WARREN H. MILLER**

1576





A SAILING SKIPJACK RACE, ROUNDING THE MARK

*Courtesy "Rudder"*

# CANOEING, SAILING AND MOTOR BOATING

PRACTICAL BOAT BUILDING  
AND HANDLING

BY  
*auting*  
LIEUT. WARREN H. MILLER  
U.S.N.R.

AUTHOR OF "RIFLES AND SHOTGUNS," "CAMPING OUT,"  
"THE AMERICAN HUNTING DOG," ETC., ETC.



NEW  YORK

GEORGE H. DORAN COMPANY

**COPYRIGHT, 1917, 1919,  
BY GEORGE H. DORAN COMPANY**



**COPYRIGHT, 1911, BY THE FIELD AND STREAM PUB. CO.**

**COPYRIGHT, 1911, BY OUTING PUBLISHING CO.**

**PRINTED IN THE UNITED STATES OF AMERICA.**



Forestry  
Gt.  
Maurice W. Sennius  
6-3-40

Forestry Lib.  
GV  
775  
M65

## PREFACE

WITH most men whose homes are beside salt water, river or lake, the desire to get afloat and navigate their own craft is ineradicable. Beginning with the boyhood batteau, we grow to the youth's catboat or dory, and then to manhood's yacht or motor boat. The sea-faring blood seems well distributed throughout the country, as witness the army of inland bluejackets trained at the Great Lakes and other stations far from our sea-coasts.

Once a sailorman, always a sailorman,—even if the craft is of the most modest pretensions. And we do not outgrow our old loves. At forty we get as much fun out of the tiny canoe as from the expensive power cruiser, and to those of us whose purse (and we are many) does not permit anything resembling a fancy yacht, the craving to venture forth on the waters is well satisfied by a cruising canoe, a small sailboat, or a twenty-foot power boat, home-built, perhaps from knockdown frames.

It is to this great class that I write. It is not needful to be even moderately wealthy to enjoy

your own craft. Boys, youths, workmen of modest means, all find the way, in one fashion or another, to satisfy the craving to cruise, each in his own choice of craft. To help such a one to select, manage or build the boat of his heart's desire is the purpose of this volume. The author has never been well blessed with this world's goods, yet, from earliest boyhood, has managed to own his fill of pleasure craft, and to this day gets as much enjoyment out of the least as from the most pretentious of them—with always still another boat looming in the future, on paper! His experiences afloat have given him golden memories, with future ones in store, and the knowledge and self-reliance that years of boat handling have brought have been useful to his country on two occasions in time of war. For, after two years in the Naval Reserve as a youth, it was the author's privilege to serve in the Navy as Ensign during the Spanish War; and, after twenty years' retirement from naval affairs in the Fleet Reserve, he was again called to duty as Senior Lieutenant in the German War now happily terminated.

As the knowledge of nautical terms is one of those things that stamp the sailorman as true blue aboard ship, a yacht design, with many of the proper names of the various parts of rig and hull

## PREFACE

vii

marked on it, has been included in this preface. A study of it is recommended, as being the easiest way for the tyro to become familiar with the seaman's names for things aboard a yacht.

It is believed that the book will have wide appeal, not only to the boy making his first ventures on blue water and to the youth learning to become an able yachtsman, but to the man who would still keep to his love for adventures afloat, yet whose pocketbook may prevent him from becoming a yachtowner in the accepted meaning of the term. To the Poor Man, therefore, let this volume be dedicated. May its perusal steer him clear of expensive pitfalls, show him the way to enjoy his days afloat, and keep alive in him that love of the sea which lies at the root of this nation's sea power.

WARREN H. MILLER

INTERLAKEN, N. J., 1919.

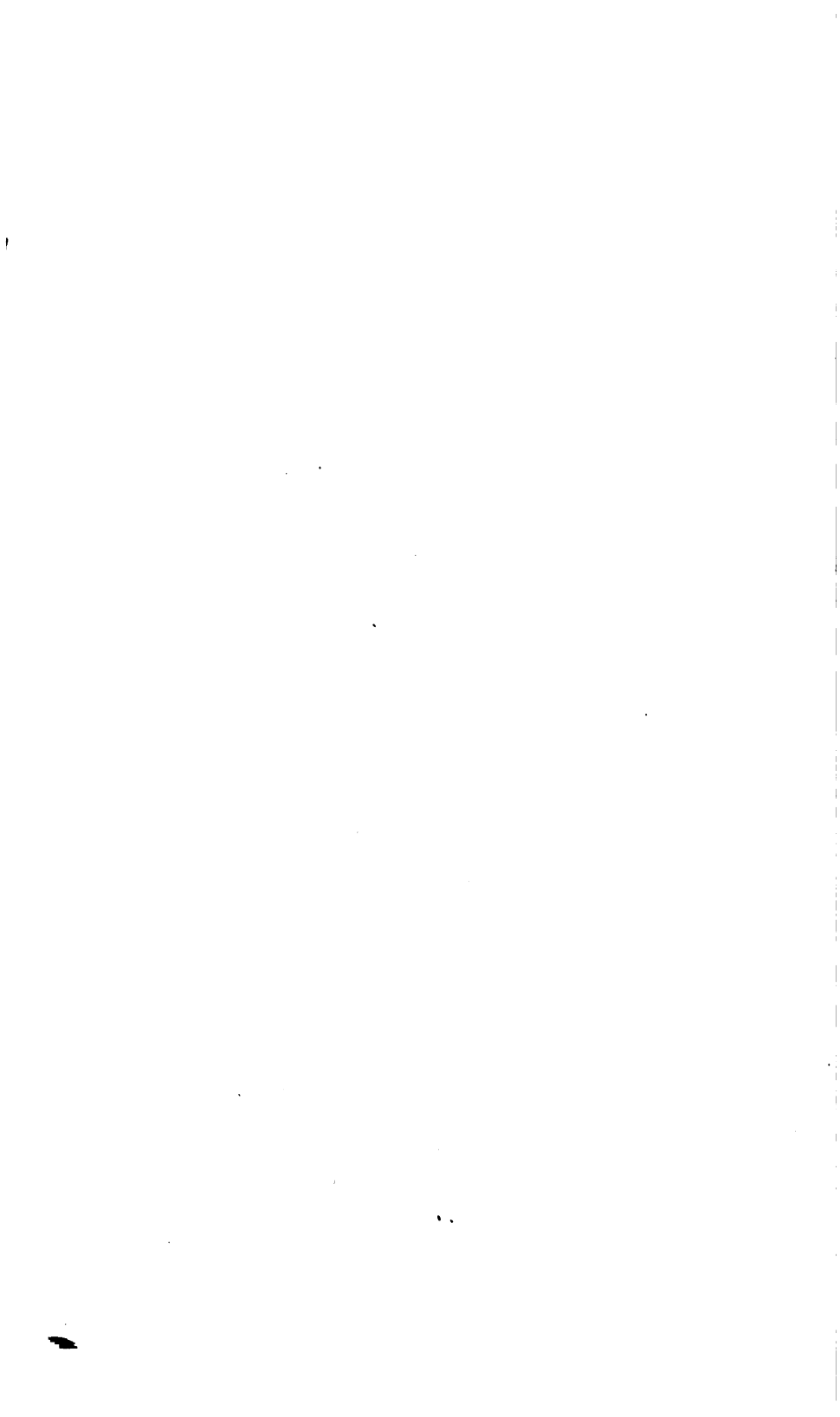

## CONTENTS

### PART ONE: SAILING AND BOAT BUILDING

CHAPTER	PAGE
I THE SAILING BATTEAU . . . . .	17
II SAIL DORY, DUCKBOAT AND SKIFF . . . . .	41
III CATBOATS AND KNOCKABOUTS . . . . .	63
IV BOAT BUILDING . . . . .	89

### PART TWO: CANOEING AND CRUISING

I HOW TO RIG AND HANDLE AN OPEN CANOE	119
II CANOE CRUISING . . . . .	138
III HOW TO BUILD A DECKED CANVAS CRUISING CANOE . . . . .	160
IV CANOE FITTINGS . . . . .	177

### PART THREE: MOTOR BOAT MANAGEMENT AND CONSTRUCTION

I CHOOSING YOUR MOTOR BOAT . . . . .	189
II MOTOR BOAT FITTINGS . . . . .	206
III CABIN AND INTERIOR FURNISHINGS . . . . .	226
IV YACHT PLUMBING . . . . .	241
V ALL ABOUT YOUR ENGINE . . . . .	253

**CONTENTS**

<b>VI</b>	<b>ENGINE TROUBLES . . . . .</b>	<b>266</b>
<b>VII</b>	<b>THE GALLEY OF THE POWER CRUISER . .</b>	<b>286</b>
<b>VIII</b>	<b>GOING INTO COMMISSION . . . . .</b>	<b>303</b>
<b>IX</b>	<b>HAULING OUT FOR THE WINTER . . . .</b>	<b>318</b>
<b>X</b>	<b>BUILDING A POWER CRUISER FROM KNOCK- DOWN FRAMES . . . . .</b>	<b>331</b>

## LIST OF ILLUSTRATIONS

A SAILING SKIPJACK RACE . . . . .	<i>Frontispiece</i>
	PAGE
PART I: CHAPTER I . . . . .	32
NAUTICAL NAMES ABOUT A BOAT	
KEEL BOARD FOR 15-FT. SAILING BATTEAU	
UNDER FULL SAIL	
WHISTLING FOR A BREEZE	
THE 13-FT. L. W. L. SAILING BATTEAU <i>Margaret</i>	
PART I: CHAPTER II . . . . .	48
SAIL AND DECK PLANS OF THE 17-FT. WHITEHALL	
BOAT <i>W. B.</i>	
THE BARNEGAT DUCK BOAT	
THE 17-FT. CLUB SAILING DORY <i>Bee</i>	
18-FT. DECKED RACING DORIES	
PART I: CHAPTER III . . . . .	72
A 16-FT. LAP STRAKE CATBOAT FOR BOYS	
FRAME PLAN AND DECK PLAN OF 16-FT. LAP	
STRAKE CATBOAT	
A KNOCKABOUT RIG FOR A 22-FT. DECKED SKIFF	
THE POPULAR 15-RATER KNOCKABOUT	
SAIL PLAN OF A 26-FT. O. A. KNOCKABOUT	
A 16-FT. RACING CATBOAT	

	PAGE
FRAMING PLANS AND DECK PLAN OF 16-FT. CAT-BOAT . . . . .	
KNOTS AND BENDS USED IN SEAMANSHIP	
BOAT CONSTRUCTION DETAILS	
PART I: CHAPTER IV . . . . .	96
SHEER PLAN AND BODY PLAN OF 19-FT. SAIL DORY	
FRAMING DESIGNS FOR A 19-FT. SAIL DORY	
PART II: CHAPTERS I, II . . . . .	132
TO SWING CANOE OVERHEAD	
PADDLES LASHED IN POSITION	
CARRYING SINGLE	
FRAME PLAN AND SAIL PLAN <i>Waterat IV</i>	
GETTING BREAKFAST IN THE CANOE TARP CAMP	
DAN BEARD OR CAMP-FIRE TENT	
THE FORESTER TENT	
THE PERFECT SHELTER TENT	
PART II: CHAPTER II . . . . .	144
THE CANOE TARP CAMP	
IN CAMP IN A CRUISING DECKED CANOE	
THE SIDE-OPENING GRUB BAG	
READY TO GO OVERBOARD AGAIN	
THE <i>Varmint</i> UNDER FULL SAIL	
THE <i>Waterat IV</i> WITH SAILS AND COCKPIT TENT	
DETAILS OF STEM AND STERN CONSTRUCTION	
<i>Waterat IV</i>	
PART II: CHAPTER III . . . . .	168
DECK FRAMING OF THE <i>Waterat IV</i>	
AFTER STRETCHING CANVAS	



# ILLUSTRATIONS

xiii  
PAGE

BODY VIEW

RIBBANDS OF *Waterat IV*

ROUNDING THE MARK

THE *Varmint* UNDER AN ASH BREEZE

PART III: CHAPTERS I, II . . . . . 192

A HUSKY LAUNCH FOR BAYS OR LARGE LAKES

THE HUNTING CABIN LAUNCH

A DEEP-SEA MOTOR CRUISER

THE AUTHOR'S DEEP-SEA CRUISER *Go-Sum*

THE AUTHOR'S LAKE LAUNCH *Adelaide*

SOME FITTINGS THE MARINE LAW REQUIRES

A GOOD DESIGN OF YACHT COMPASS

THE VIKING TYPE OF ANCHOR WINDLASS

OPEN 25-FT. LAUNCH WITH HUNTING CABIN ADDED

CABIN AND DECK SECTION OF THE *Go-Sum*

BENDING THE PLANK FOR THE HUNTING CABIN

PART III: CHAPTERS III, IV . . . . . 228

CABIN PLAN AND ELEVATION OF THE *Go-Sum*

CABIN PLAN OF A LARGE OCEAN-GOING CRUISER

ELEVATION OF GALLEY AND TOILET ROOM OF THE  
*Go-Sum*

DETAILS OF CABIN CONSTRUCTION ON THE *Go-Sum*

A HOME-MADE FORCE PUMP

ELECTRICAL CONNECTIONS FOR JUMP-SPARK IGNI-  
TION

PART IV: CHAPTERS V, VI, VII, VIII . . . . . 288

CRANK PISTON AND ENGINE BED

A FOUR-HORSE GRAY 2-CYCLE

	PAGE
COMPRESSION IN 2-CYCLE ENGINE	
3½ H. P. FERRO 2-CYCLE ENGINE	
GALLEY AND TOILET ROOM PLAN OF THE <i>Go-Sum</i>	
CAN, CORK AND BARREL BUOYS	
ANCHOR BITT AND CAPSTAN, COMBINED	
MUSHROOM MOORING ANCHOR	
MOORING TACKLE	
PART IV: CHAPTERS IX, X . . . . .	320
OVERBOARD WITH A PAIR OF SHEARS	
CRADLE AND WAYS FOR HAULING OUT	
DETAILS OF HAULING-OUT WAYS	
THE FIRST DAY'S WORK ON THE <i>Go-Sum</i>	
FINISHING THE PLANKING	
PLANKING THE <i>Go-Sum</i>	

**PART ONE: SAILING AND BOAT  
BUILDING**



# CANOEING, SAILING AND MOTOR-BOATING

## PART ONE: SAILING AND BOAT BUILDING

### CHAPTER I

#### THE SAILING BATTEAU

MY boyhood town was located on a point of land commanding a beautiful blue harbor, an arm of the salt sea whence came in daily stately ships, standing in from the open roadstead and sweeping majestically through the crowds of small sail craft, until the grizzled port pilots gave the signal to let go anchor, or a puffing tug took charge and nosed them into the wharves. That was before the U. S. Government dredged out our harbor to admit steamers. We were a great sail ship port, and our people dealt in commodities that are carried from far distant lands. Later it all gave way to huge smoky steamers, laden with prosaic iron and coal, and the town became a big manufacturing center.

But we boys were of the sail period of the Re-

## 18 SAILING AND BOAT BUILDING

public; the salt sea was in our breath all day, and to be "Cap'n" of even a ten-foot sail dory was the ambition of every one of us when but six years old. By the age of ten we had usually learned to swim well and then had the parental permission to own a boat, a sail boat of course, usually rigged from bowsprit withe to topping lift cleat entirely by ourselves. There were plenty of fish to be caught, and the bay abounded in wild fowl, so that from April to Hauling-out-time in November we lived in or on the water. I carry the weatherbeaten tan of those days to this hour, and no amount of city living can eradicate it!

We usually began with a flat-bottomed batteau, fitted first with a sprit sail and centerboard or keel board, and later added the glory of bow deck, wash boards and standing rigging; sold the precious frigate at about the age of fifteen and acquired a round-bottomed sharpie; sold her and got a catboat; and, before we were nineteen years old, had graduated into the full glory of the racing 18-rater knockabout. And, as the port had a flourishing yacht club, we boys were much in demand for crews, both for racing and cruising. Our own particular crowd of five boys were the crew of the *Ocean Spray*, a forty-foot racing sloop, whose owner we were only too glad to help at over-

hauling time, in return for being taken on a cruise or two in the summer and allowed to help man the yacht in a race. It was a thorough school of seamanship—I think every boy of our squad is to-day a yacht owner and a naval reservist—and, though the motor boat with its general air of land-lubberliness seems to have come to stay, the ancient sport of sailing is more than holding its own in dozens of ports along our sea-coast.

My first cruiser was a thirteen-foot flat-bottomed batteau, four and a half foot beam, that cost me ten dollars just as she lay, a common row-boat, in Capt. Milham's slip. I bought her with the money of my eleventh Christmas, having convinced Pater the summer before that I could out-swim *him* by challenging him to catch me. We were all in swimming off the end of Parker's pier, in about two fathoms of water, and Pater, after a vain chase of maybe twenty minutes, nearly got me; but I dived under him, and, coming up about where his heels were, I made fast and ducked him properly! And so that Christmas I received permission to buy my first boat. She was a staunch, light batteau; two strakes, cedar planking; an able boat in the seaway that got up in every easterly blow that hit our harbor. I bought her in March (it seemed that January and February would

## 20 SAILING AND BOAT BUILDING

*never* pass), and my first work was to paint her and put her overboard. That meant a can of copper paint for her bottom, a can of white lead for her outside, and a can of buff for the inside coating. These were all quart cans, as two coats each were needed, so the bill was \$1.95 that stared me in the face. A whole lot for a boy of eleven years, but I raised it somehow. Her seams lay wide open, but the calking was in good shape, so all she needed was putty in the seams and then the paint. Meanwhile, my chum Eber, who owned a similar boat, fifteen feet on the waterline, was happily working over his craft nearby in the warm spring sunshine, and we combined forces when it came to getting the boats overboard. Both promptly filled to the water's edge, as is the way with all flat-bottomed craft until the planks swell shut, but in a week they were ready to bail out and were tight as drums the rest of the summer.

My first problem was one that troubles many a boy,—how to overcome leeway and how to make a rig for her. A flat-bottomed boat will skid over the water like a leaf if she has no centerboard. Leeboards are a clumsy and landlubberly contraption for a regular boat, though well enough on canoes, and a centerboard is rather expensive—\$2.75 was the best price I could get from the



“Cap’ns” alongshore, who all did a bit of boat carpentry in the winter. My first scheme was a hinged centerboard. A piece of twelve-inch-wide yellow pine three feet long was secured for ten cents from the local wheelwright, and two stout galvanized iron hinges with brass pins were screwed to it, about eight inches from either end. The *Margaret* was then hauled up on the beach and turned on her side, while I attached this centerboard to the keel strip by its hinges. Two stout galvanized iron screw eyes were next screwed in the lower edge of the board, and from them was led out two pieces of flexible copper rope a yard long each and costing ten cents a foot. These fastened in cleats on opposite sides of the gunwale, and the board was then ready for use.

This board worked rather well. A knot in the copper rope told me when she was perpendicular to the keel, when both ropes would be belayed on their cleats, and she held up well, making little leeway. When the boat began to heel down and move right along under a smart breeze the ropes thrummed as they cut through the water, making the whole boat vibrate and of course reducing her speed, so she was beaten by nearly every craft in the harbor that carried a sail.

My chum, who was a Florida boy and hated to

## 22 SAILING AND BOAT BUILDING

be beaten, devised a *keel board* for his boat, preferring beaching troubles to going slow. He used a  $\frac{7}{8}$  x 12-in. yellow pine plank five feet long, cut on a long slant at both ends. This was spiked securely to a strip of 2 x 4-in. dressed pine running the full length of the keel board, and this in its turn was screwed to the bottom of his batteau. A second strip was screwed along the other side of his keel board and toenailed to it. The whole thing was then copper painted and it made a strong job, a deep, permanent keel in fact, and he lost no speed from copper ropes thrumming underneath. Of course his troubles came when he got into shallow waters or wanted to beach her, when that tender keel would strike and had to be nursed to prevent it going adrift. The photo shows how we made the latter type of board; they both cost about the same, \$1.00, as we both were mighty short on the coin of the realm!

My first rig was a six-foot by six-foot leg-o'-mutton, made of two yards of unbleached muslin, the upper corner of which being cut off and added on below made the whole sail. It looked huge, in the house, and my mother was very much frightened at my carrying all that canvas (!) but on the boat it looked like a pocket handkerchief and just about gave her steerage way. The mast was

a piece of bamboo picked up on the beach and the boom a *square* strip of yellow pine—can you beat it for landlubberliness! However, in a hard blow the sail drew well enough to let me learn the simple arts of tacking, running free and running dead before a blow, and it was a much safer rig in the last case than one with a peak. This sail got dirty and mildewy, and, at the height of its disreputableness my father and old Cap'n Tom Little, the port pilot, decided that I had progressed far enough in sailing to carry a bit more canvas, and so I received permission to add a peak. This was done, a snowy triangle of unbleached muslin added to the filthy leg-o'-mutton, and with that and a light sprit spar to hold it out, I scandalized the harbor! This in its turn got muddy and dirty from numerous shipwrecks and cruises up muddy salt-water creeks after snipe, and then I found another boom and a longer spar for a sprit and so added about two feet more to the leach of the sail, making it eight feet along the boom, six feet hoist and six feet head. This is about as small canvas as I would advise any boy starting out with, for a thirteen-foot boat; it gives her good speed and she is not set back so much on a tack by the tide drift. My sail now resembled Joseph's coat of many colors, but I did not care—wasn't I

## 24 SAILING AND BOAT BUILDING

the eleven-year-old "Cap'n" of a sail boat myself! And presently November came around and the hunting season was in full blast, so I spent more time in the forest with my air rifle than on the water in the *Margaret*, and soon she was hauled out and turned over, bottom up, on a pair of skids and left to the snows of winter.

But her skipper was not idle; far from it. My twelfth Christmas, word having gone throughout the family that I was going to rig *the* boat and put in a centerboard, and that cash would be *very* acceptable in lieu of presents, resulted in about \$12 in my stocking. I needed a powder rifle and a tomahawk very badly but, oh, gee! I did need *everything* imaginable for that boat! A new main sail, a jib, spars, centerboard, bow deck, washboards, standing rigging, running rigging, anchor, paint—what not! I spent all January planning, and resisting the temptation to sell her and add the money to my \$12 to buy a round-bottomed boat, but I wisely stuck to the able little *Margaret*, for the other boat would need complete rigging too, and I did not propose to worry through another season half found. During February conferences with Cap'n John Milham, who was very busy building boats for the men at the yacht club, brought me his promise to put in a centerboard,

put on washboards, bow deck and bowsprit all for five dollars, so this amount was set away until it would be needed in the spring. The remaining seven had to buy canvas for the sails, rope, blocks, spars, etc., and it required careful planning to make it cover all the necessities, while the rifle and tomahawk were relegated to another time. Mr. Kearney, owner of the sloop *Hitty Maginn* at the yacht club, coached me on the rig that was to be her final "grown-up" outfit. Eleven-foot boom, eight-foot gaff, eight-foot hoist and sixteen-foot leach were settled on for the mainsail, and thirteen-foot hoist, ten-foot six-inch luff and six-foot six-inch foot were the dimensions of the jib. My school arithmetic was taxed to the utmost to find out how many yards of canvas this called for, but we made it eighteen yards, and this was bought in American drilling at ten cents a yard (now about fourteen cents). Then, one sunny Saturday in March, we pegged out the dimensions of mainsail and jib on the lawn, running a cord from peg to peg so as to give us a full-sized outline of the mainsail. We gave the foot a one-foot rise, which brought us a tall, sassy peak. The canvas was then unrolled, the first strip being laid along the leach line, and this was cut to the string along head and foot. Each gore was then added to this,

## 26 SAILING AND BOAT BUILDING

overlapping to the blue line on the canvas edge, and pinning every foot, cutting off along the sail outlines until both mainsail and jib lay rough finished on the lawn and there was but a small bit left of my roll of drilling.

With these sails I went home and cajoled mother into hemming them all around, sewing down the gore seams and finishing the sails for grommets, etc. With this light canvas, an ordinary house sewing machine with forty cotton thread and heavy needle is amply strong enough.

Before the next Saturday came around, oh, joy—I had the mumps! No school for two weeks and only two days of misery—that is what it means to a boy! No wonder that that disease (and measles) are considered by boys blessings in disguise, no matter what parents think of them! Two bad days in a darkened room, and then, still confined to my room, I was up and about. I had stored the closet full of salty paraphernalia: manila rope, sail needle and beeswax, a ball of sail-maker's twine, some smelly, tarry marline, of brass grommets a box, galvanized pulley blocks—a sailor's paradise forsooth! At the end of every seam I put in a  $\frac{3}{8}$ -in. No. 1 brass grommet. These little brass rings come in two parts, a "thimble" and a ring, costing 30 cents a gross box. You cut

a hole with your scissors, insert the thimble through one side, slip over the ring on the other, and turn over the edges of the hat with a marlin-spike or fid, or even a stout wire nail will answer. Finish with a blow of the hammer and there you are! Along head and foot these grommets go, not only at the end of every seam, but along the hem midway between the seams also, giving you one about every foot. Through them is rove the head rope and foot rope which secure the sail to gaff and boom respectively. Simply pass it round and round the spar taking in a grommet hole at every turn and securing with a double half hitch at the end of the spar.

I got in the grommets for both mainsail and jib and then went at sewing on the bolt rope. An ordinary hem will not do for a boat sail; it stretches too much and soon pulls the sail all out of shape so she will not draw well and you lose speed. You simply must have a bolt rope, a stout manila rope, sewed to the hem with sailmaker's twine. For a sail such as the *Margaret's*  $\frac{3}{8}$ -in. hemp rope is ample. Your twine should follow the lay of the rope, fitting neatly in the bottom of the twist and nowhere exposed to the rough usage that it will surely get if it goes round the bolt rope at any old angle. I had about a hundred feet of bolt rope

## 28 SAILING AND BOAT BUILDING

to sew around the two sails, and it took two days to do it. Wax your twine religiously if you expect it to last.

With the bolt rope on, the sails began to take on a real seamanlike appearance, and my next job was to lay them out on the floor of the room and mark out the reef points. One must go in every seam, but do not put them in the plain body of the sail unless you reinforce the spot with a little square of canvas. As I did not have but a few gores in my sail I had to put in these little squares, every one of them hand stitched. The reef point hole itself can either have a small  $\frac{1}{4}$ -inch grommet or a worked eyelet. The latter take longer but are stronger, and, as I had all the time in the world, I eyeletted them all, two rows of reef points, two feet apart vertically for the mainsail, and one row for the jib. To put in the reef points you cut pieces of white cotton rope (the  $\frac{1}{8}$ -inch size for this small sail) two feet long. Stick it through the eyelet hole a foot, and tie a knot. Put another knot on the other side of the sail and your reef point is secure. Both ends of it are next to be lashed with waxed twine, for no seaman would tolerate a knot or a crown on the end of a reef point.

By this time I was allowed at large, as the



mumps were about over, but had not returned to school, and my first excursion was to the ship-yards where the incessant clicking of the calking mallets had been calling to me through the open windows of my room. It was late in March, and the tall-sparred three-masted schooners were riding high in the drydocks, their bulging sides covered with busy men driving in the oakum that was to make them tight and sound for the season. Oh, the Time of the Calking Mallets! It comes along about Lent (and tops and marbles for the small boys), but for us sea-faring youths it meant boat work in the balmy spring sunshine and good times to come! I headed for a soaking pool filled with spruce spars of every conceivable length, all with the bark on and all as straight as so many lances. They are sold at twenty-five cents an inch across the butt, and I was not long in picking out a  $2\frac{1}{4}$ -inch stick 14 ft. 6 in. long that was to be my future main mast. Back to the house, where with plane and spokeshave the bark was peeled off and the mast got ready for slushing with beef tallow. This is rubbed in by hand—a seaman's delight—three or four times until enough is absorbed by the spruce to make the mast rings slide freely.

My friend the wheelwright supplied the boom and gaff—two  $1\frac{1}{2}$ -inch square spruce strips, en-

## 80 SAILING AND BOAT BUILDING

tirely free from knots,—and these I worked down to a round with plane, spokeshave and sandpaper, tapering them to an inch for the gaff and  $1\frac{1}{4}$  inch for the boom. The stock cost 30 cents in the rough. Any lumber mill nowadays can furnish you these spruce sticks already round and only requiring tapering, any diameter you prefer, so all three spars can now be had anywhere just as easily as if a shipyard were handy.

And now to bend on the sails! First the galvanized mast rings, six of them, were lashed to the luff of the sail at each point where a brass grommet marked the end of a seam. Next the mast was erected alongside the back porch, and the rings with sail attached slipped over it. Then gaff and boom were tapered with a sharp flat cut where the jaws were to go and the latter sawn out of inch oak and whittled and sandpapered smooth. Most boys get these jaws too wide and clumsy so that when put on they do not hug the mast closely. The way to cut them is with the back of the jaw along the grain and a quarter circle of the radius of the mast struck, after allowing not over an inch for the thickness of the horn of the jaw. Then a taper is struck from the heel of the jaw to its aft end and you have a narrow, thin, strong

jaw of oak, which, when bolted to boom and gaff, will lie close to the mast.

These went on as described, also a hole bored through the boom and gaff near the meeting point of the jaws, through which was rove the  $\frac{1}{8}$ -inch cotton rope which was to lash head and foot of sail to the spars. A double crown knot of this rope stopped it from pulling through the hole, and then the foot of the sail was lashed to the boom by running this rope around and around the boom, taking in a grommet along the foot at each turn. The two lower corners of the sail are called the tack and clew; the clew being the corner at the aft end of boom. To secure the tack, the lash rope must take one turn through the tack grommet before running out along the boom. To secure the clew the sail is pulled out tight, seeing that all lashing is taken up snug, and then she is belayed with a turn through clew grommet and a double half hitch around the boom. The boom ought to be about a foot longer than the sail, to allow for stretching, also the lash rope must be about three feet longer because when you come to reef you will need the end of this rope to belay the cringle, which is the last grommet at the end of the line of reef points, in the hem of the leach. All of which I attended to in a seamanlike man-

## 32 SAILING AND BOAT BUILDING

ner and did the same by the gaff. The two upper corners of the sail along the gaff are called the throat and peak.

The next thing was to bend on the running rigging. The throat halliard for so small a sail as this is simply tied to a screw eye driven into the gaff near the meeting point of the jaws. The peak halliard requires a block, and the location of this block on the gaff takes some experiment. If too far in it will tend to draw too hard on the throat of the sail, if too far out will hoist the peak too hard. A little trial will give about the right place. The mast needs a galvanized iron withe with four rings standing out from it. To the aft ring is lashed the galvanized double pulley block which takes throat and peak halliards; to the forward ring the wire rope jib stay; and to the two side rings the wire rope shrouds. I whittled a shallow collar on the mast-head and fitted the withe over it tight. Then I had a perfectly *lovely* tarry half hour "serving" the ends of those wire ropes with marline. This is a tarry hemp cord which fairly reeks of ships and shipping, and to this day I keep a wad of it in my pocket so that if I see too many gardens I can take a sniff of it and feel all right again! Wire rope cannot be tied without making a landlubberly

job of it, so the end is passed through the ring on your mast withe, bent over in an eye and the end lashed to the standing part with marline. This is called serving it, and you have a little serving mallet over which a couple of turns of the marline are taken and then this is passed around and around the wire by its handle. The pressure exerted by it is so great that it makes the marline lie flat and sweat tar so as to make a neat smooth job of your lashing. The wire rope for my boat was the smallest obtainable, 3/16-inch diameter.

Finally the peak and throat halliards were rove, and up went my new sail for the first time! She set nice and flat after taking up here and there, and the next thing to do was to put a draw in it. The "set" of sails explains all the reason why one boat will beat another with identically the same hull and rig and sailed equally well. Too flat a sail means a slow boat; too loose, a poor pointer. The ideal shape is a sail, nice and flat aft, and full along the luff, the shape of an aeroplane wing or bird's wing. The wind shoots into such a sail, expends its energy and is slid out along the flat leach. If the latter is baggy, the wind will get trapped in it and hold back the boat, hence, for large sails, the necessity for battens in the leach. My sail

## 34 SAILING AND BOAT BUILDING

was too small for that. By setting up hard on the peak so as to throw a quantity of wrinkles into the luff, the fullness desired is in a way attained. I helped it by letting out a trifle of lashing rope along head and foot just aft of throat and tack.

Then I went down to the shore where I found Cap'n Jack already started on my boat. He had gotten out a centerboard log of  $1\frac{1}{2}$  x 5-inch clear white pine and had slotted it for a 24-inch board. Maybe I didn't camp out on a saw horse for the rest of the afternoon and watch him make that board! First went in two 2 x 1-inch uprights a foot high and were securely spiked with galvanized nails into each end of the slot. To these were nailed the two trunk sides of  $\frac{7}{8}$  x 14-inch clear white pine stock, 28 inches long. These were calked where they abutted on the log and were white leaded along the uprights and log before nailing fast up through the bottom of the latter. Next, the board itself was made, of a single  $\frac{7}{8}$ -inch plank of hard yellow pine, with a couple of iron rods driven through it to prevent warping. These were upset at the ends and then the board was put in the trunk in position and an inch hole drilled through both sides of the trunk and the board down in the for'd lower corner where the pivot pin was to go. This was next put in, a sim-

ple pin whittled of white pine and driven through.

Then Cap'n Jack laid out, on the keel of my precious boat, a centerboard slot, drilled an inch hole through keel, bottom boards and keelson at each end of the slot and joined the holes by two long saw cuts. The bottom boards were then calked and painted where they crossed the keelson and finally some wicking soaked in white lead was laid around the edges of the slot and the centerboard trunk screwed fast. At last I had a board!

Next day he began with the washboards and bow deck. Two white pine planks we held in the position they were to go, along the sides, and the line of the gunwale was scribed on the plank from below. A line parallel to this and six inches inside was next struck, and the Cap'n labored with his rip saw until he had the two washboards cut out and ready to fit. They were then nailed down through the top into the gunwales and an inch half-round strip run along the gunwale to cover the crack. Along the inner edge went the coaming, a piece of  $\frac{3}{4}$ -inch by 3-inch yellow pine board, with a strip of cove molding in the corners. The coaming ended with a square fit about six inches aft of the mast. Next Cap'n Jack put in oak deck carlines every foot, sawed to give about two inches crown to the deck, and then ran the mast plank

## 86 SAILING AND BOAT BUILDING

from coaming forward over the stem. This plank was six inches wide and the ends of the washboards or "plank sheer" as they are called in boat building, butted against it. The space left was then filled with small deck strips, two inches wide, so accurately laid together that not a crack between them could be discerned. But of course this would never do for sea service, they would leak—all these deck cracks—with the first sea that came over the bows, so the Cap'n began calking all these seams just as if they were in the bottom of the boat! Even I was not prepared for such thoroughness as that, but, let me tell you, that is what you have to have in an able sea boat! Then the seams were all payed with paint and puttied, and then the first coat of paint went on.

The Cap'n next began pottering about with a stick of spruce, carrying the while a quizzical smile on his grizzled features, and suddenly I realized with a jump of joy that he was making my *bowsprit*! A husky stick it was, six feet long, 2 inches square at the butt, and fined to an octagon after it stood out over the stem. He bolted it through the deck carlines, put on a two-ring withe and ran an iron rod down to her stem from the bowsprit end.

"Thar, sonny, ye kin set up on yer jib stay till



ye bend the mast out'n her before ever the bowsprit will lift!" Indeed you could pick up the whole boat by her bowsprit, as I did many times afterward.

The Cap'n still had a little time left in his day, and so he examined my rudder with a sardonic grin.

"Looks like a potato paddle, and is hung like a barn door!" vouchsafed he. A little rummaging in the shop brought forth some more white pine and soon he had sawn the rudder as shown in our drawings, reinforced with a strip along the bottom to prevent it warping, and then the Cap'n made me put on the rudder irons and *do it right*. My carpentry was of the let-it-go-at-that kind, but the Cap'n soon made me realize that sea carpentry is "do it right or don't do it at all!"

Next day I brought down the sails and put in a joyful day rigging her, while all the weather-beaten Cap'ns alongshore hee-hawed and admired the diminutive yacht. I first tried to hold the shrouds with screw eyes but they pulled right out, so I dug up 60 cents and bought the smallest galvanized iron chain plates, 5 inches long, and these were screwed to the sides of the boat about eight inches aft of the mast step. An eye was next put in the shroud wire and the shrouds hove up tight,

## 38 SAILING AND BOAT BUILDING

with three or four turns of marline running from the chain plate eye to the shroud eye. Then the jib stay was run from the masthead with a set of iron rings for the jib luff grommets to tie to. In a larger boat you would use jib hanks, which can be snapped over the stay, but they do not come small enough for a diminutive yacht of 13 feet L. W. L., so I used inch galvanized iron rings instead. This jib stay up, the double block for throat and peak halliard was next secured to the after masthead with eye with a few turns of marline and the same was done to the jib halliard block at the forward eye. Then a jib downhaul block at the bowsprit tip, and I was ready for the running rigging. This was all  $\frac{1}{4}$ -inch white cotton rope, and after being rove through the proper blocks and secured to the spars I put on the cleats to which each was attached. You want these in galvanized iron, about the six-inch size, one each, for throat and peak mainsail halliards, jib halliard, jib downhaul, port and starboard jib sheets, and one for the main sheet on the stern transom under the tiller. For a sail of this size the main sheet can be just a  $\frac{1}{4}$ -inch hemp rope, single, no blocks being needed. A topping lift for the main boom will also be wanted to prevent the boom dropping in the water, when the sail is let

down and the boom happens to be outboard, and this I put on next, securing at the aft masthead eye and tying with a double half hitch at the aft boom end to give the right topping of the boom, about two feet above the deck.

She was now ready to spread her wings. I ran the boat ashore on a convenient sand beach where she could face the wind, for it is better to make the first try with your rigging when the boat is on something solid or she will go all over the lot and maybe upset while you are tuning up this and that. Next I hauled away on throat and peak mainsail halliards and up went the snowy white sail! Aye, but that was a joyful sight! Then the jib, and now they were both flapping in the wind, everything drawing well and it was time to be off for a trial spin. I shoved her off, let down the board and gathered in the main sheet, and presently she filled and was away! Speed!—you bet! She made all her previous time look like racing a dock. And now for the first time I had to hike well over the side in the puffs, and now and then had to spill wind when it drove her lee washboards under and water came over the side. But I was satisfied—she made the lighthouse a mile down the harbor in a little less than no time, it seemed to me! Mainsail was a bit too flat, but I soon

## 40 SAILING AND BOAT BUILDING

remedied that by heaving to and hauling on the peak halliard so as to throw a mass of wrinkles in along the luff. At first the jib got away with me, as I had never had so large a jib to manage. Never have the jib up without the mainsail first, for its tendency is to haul the bow of the boat away from the wind and you have no steering control over her at all. In coming up into the wind the jib is a great help in going about quickly if you hold the weather sheet fast until the wind has had a chance to get on the other side of the jib thus throwing her bow around. But all these points of handling sails must be left for another chapter; suffice to conclude with the reflection that I now had a fine, fast, able little racer and cruiser that I could go anywhere in, sleep in at night, sail ten miles or fifty, or just knock about the bay in, and the whole cost of changing her from a plain batteau to practically a small skipjack yacht was not over fourteen dollars. How I handled her, raced her and cruised her, and how to build such a batteau from the planks up will be told in succeeding chapters.

## CHAPTER II

### SAIL DOBY, DUCKBOAT AND SKIFF

WHAT first awoke me to the sailing possibilities of the round-bottomed boat, or skiff, was when on a lazy summer afternoon, when we boys were loafing on the porch of the Yacht Club, we noted a *girl* rowing a 16-foot Whitehall boat with a speed and ease that would make any boy envy her. There was a nice easterly blow on, with the usual choppy sea, and most of the yachts of the fleet were out in it, knocking about the bay. The tide was on strong, as usual, yet that girl was pulling her skiff in the teeth of it, across the choppy seas, in long, sure strokes that jumped the boat ahead twenty feet to the stroke. It showed easy work on the face of it, and of course, being a girl, she couldn't have had much strength anyway!

A brilliant idea struck me. "Say, mates, if a good sharpie rig were stepped in that Whitehall boat, just *wouldn't* she go right along like a scared cat!" said I.

The idea was received with tumultuous approval. One of us owned a seventeen-foot St.

## 42 SAILING AND BOAT BUILDING

Lawrence skiff, which is built on the lines of the Whitehall rowboat, only she is clinker built, with lapstrakes, instead of carvel built with smooth planking. This boy, Harry, had a rich father who gave him everything he wanted, but his mother was as timid as a mouse and wouldn't let him do anything with all his possessions, and, while all the rest of us had our sail batteaux, sail dories and sneak boats or sail ducking craft, poor Harry had to content himself with rowing, and so was "out of it" most of the time, for we went so fast and covered so many miles of distance that he hadn't a chance.

But here was a way to let him in on the fleet. "Buy a sail boat for Harry—Never!" was the verdict of his family, but, to step a rig in his skiff, —well, as Harry had been "mate" on nearly all our sail boats and was a good sailorman, we *might* get a rig for his boat across!

We spent the afternoon discussing the best way to make the change. The first thing wanted would be a keel and keel board, for these long, fine, round-bottomed boats have too narrow a keel to think of putting in a centerboard, and if they have no keel at all will make leeway like a balloon. We decided on a four-inch keel, running the entire length of the bottom and rockered two inches in

## DORY, DUCKBOAT AND SKIFF 48

a long slant towards bow and stern. This rocker-ing process is hard carpentering, but necessary or the boat will be too slow in coming about to get around without the help of oars. The wood for this keel was to be a piece of 3-inch by 1½-inch hard yellow pine, and, to fasten it to the bottom of the boat, we would use five brass  $\frac{3}{8}$  x 7-inch through bolts with their heads sunk flush with the bottom of the keel and augur bit holes drilled through the built keel and keelson of the skiff. The threads of the bolts stick through about an inch, and when the nuts are screwed down tight it makes a strong job. To make it water-tight around the bolts we simply tie around each bolt a couple of turns of wicking soaked in white lead, and when the new keel is drawn up tight this wicking is clamped in firmly between the new keel and the built-in keel of the boat.

For the rig we chose the sharpie leg-o'-mutton, with the leach cut full to destroy that distressing bag-and-nigger-heel combination that usually afflicts this type of sail. The mainsail had 15-foot hoist, 11-foot boom rising one foot aft, and 18-foot leach. The mizzen had 10-foot hoist, 6-foot boom, rising about 14 inches, and 12-foot leach. This pair of sails were made of American drilling and staked out on the floor of the big dock where we

## 44 SAILING AND BOAT BUILDING

boys kept all our boats. A twine run around nails driven in the floor at the corners of these sail areas gave us something to cut to, and to get fullness in the leach we cut the gores of the sail *perpendicular* to the leach, instead of parallel to it as you would do with an ordinary mainsail. We allowed 4 inches of outcurve to the leach, bending a thin batten over a nail from peak to clew so as to get a fair curve. The sails were cut to these limits and then sewed up and hemmed all around, for a leg-o'-mutton sail of this size does not need a bolt rope. Brass  $\frac{3}{8}$ -inch grommets were next put in at the end of every gore and midway between each, and the sails were ready to bend on the spars.

To make these latter we discovered that the planing mill carried round spruce in stock, in 14- and 16-foot lengths, thus doing away with the necessity to work them up from square stock as I had done with my sailing batteau. All this round stock needed was a little tapering at gaff and boom ends and mast tops and you were ready for the spar varnish. The mainmast was of  $2\frac{1}{2}$ -inch round spruce, main boom and mizzen mast of  $1\frac{3}{4}$ -inch stock, and mizzen boom of  $1\frac{1}{4}$ -inch. The rig was all made ready down at the club in three days of work, after the daily swim, and we all pitched in



## DORY, DUCKBOAT AND SKIFF 45

and helped Harry out, as we wanted him along on a big consort cruise down the bay. Both sails were lashed to boom and mast by a running white cotton rope around the spar and through the grommets, as no halliards are wanted on this rig; they are a nuisance except on large sail dories. To step the mainmast all that was needed was a  $2\frac{3}{4}$ -inch hole in the bow sheets, a stout oak mast step bolted to ribs and keelson, and a  $\frac{3}{8}$ -inch iron rod run through the ribs at the bow sheets clear through the boat and upset on the outside. This is essential, to brace the boat to withstand the strain of the rig, or the pressure of the sail on the bow sheets will strain the planking and make her leak forward. We had the village blacksmith cut this rod for us and upset it over wide iron washers, using an axe at one end as anvil and an ordinary hammer to upset the other end.

The mizzen mast was stepped by simply screwing a galvanized iron U-clamp to the aft rowing thwart and putting a mast step in the grating below this thwart. This U-clamp can be bought at any pipe fitter's, of the size to go around a  $1\frac{1}{4}$ -inch iron pipe. Around the mizzen mast we also put the yoke for managing the rudder, for, of course, you should not sit 'way back in the extreme stern to handle a two-sail rig. The mast went through

## 46 SAILING AND BOAT BUILDING

a hole in the yoke, and two wire cords led back to the yoke on the rudder, so that a boy sitting amidships could steer nicely.

This boat went like a racehorse. I took the first spin in her, a leg out to sea and a leg back again, while the rest were in swimming near shore. I got back so fast that I nearly ran down two of them! The mizzen sheet was simply cleated fast and took care of itself on either tack, as it was led down to a pulley block on the stern transom and thence for'd to its cleat. My principal attention was on the mainsail, the sheet of which was held in the hand and never cleated, for this boat was nearly as lively as a sail canoe. And fast! She beat most of the *power* boats that we met going our way, when I shipped Harry and Raymond, my old mate of the *Margaret*, for a crew and "beef to windward."

In bringing a sharpie about you use your mizzen to help out the rudder. Get a good full on her, and then put the helm down hard. This will throw her in stays where she will most likely hang, so at this point back the mizzen, that is, push its boom out to windward by hand, when the wind will fill it and shove her stern around so that the mainsail will fill off on the other tack. With our 3-inch rockered keel she still made a good

## DORY, DUCKBOAT AND SKIFF 47

deal of leeway, and was so slow in stays that we could generally beat the *W. B.* ("world-beater") as Harry called her, in tacking to windward, so later we added a keel board. To make the rocker (I should have told you before), you strike a long curve from one end to the other of your keel plank, making it 3 inches deep for about 5 feet amidships and then tapering gradually to 1½ inches at bow and stern, and this is easiest carpentered by dubbing down with a hatchet and finishing with a jack plane. To add a 5-foot keel board, we got a piece of 7/8-inch dressed oak board 8 inches wide, sawed a slant at each end of it and put in three carriage bolts through the top of this board, so that by putting the ends of these bolts through three corresponding holes in the keel we could screw it fast with galvanized iron wing nuts by hand. To put it on, of course, you had to beach the *W. B.* and turn her over on her side, but, with a light boat like the *St. Lawrence* skiff, this was easy for a couple of boys to do when you were off for a long sail. With the keel board added she was less lively, made less leeway and stood up much stiffer in a blow. In all, I do not know of a better rig than this leg-o'-mutton sharpie for a long, fine round-bottomed rowboat, such as one

## 48 SAILING AND BOAT BUILDING

finds in thousands on all our lakes and the salt water bays and sounds of the Atlantic Coast.

Another exceedingly popular small sail boat with us boys was the Barnegat duckboat. As you will note from the plans herewith of a typical boat of this type, she is built something like a wide, shallow slipper, a "punkin' seed" as she is called in many localities. The bottom is round, with a shallow dish curve, and the deck is almost a duplicate of the bottom. There is a small cockpit amidships, a mast hole a short distance for'd of this, and a centerboard trunk for a dagger type centerboard is generally built in at the same time the boat is made. As a cruiser, a ducking craft, and a fast racer in blows that would put many a larger craft under three reefs, it is hard to beat the Barnegat duckboat. With their high, rounded decks they are a most easy craft for a boy to slide overboard out of, so the stern deck is generally enclosed by a high board frame, secured to the decks with hooks and eyes, and inside this frame go also the two wooden, folding oarlocks.

We boys knew these boats well, and sailed them in all kinds of weather. I had an aunt down at Barnegat Bay, and whenever I visited her she knew just what to do with me, and that was to give me the exclusive possession of a small duck-

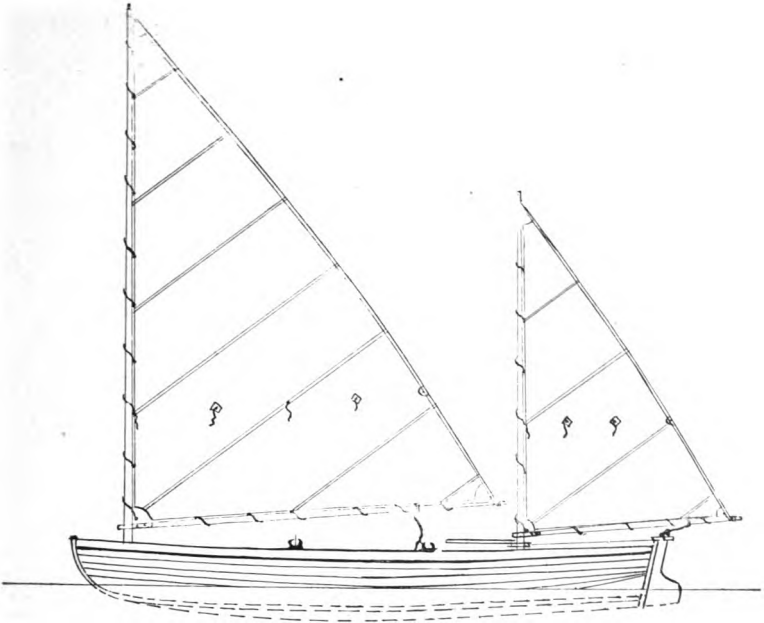

**SAIL PLAN OF THE 17-FT. WHITEHALL BOAT, "W.B."**  
 Lower dotted lines show the yellow pine keel we bolted below her built keel.

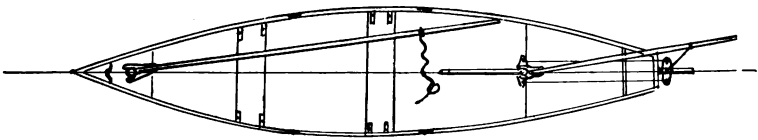

**DECK PLAN OF THE "W.B."**  
 Showing arrangement of tiller and yoke.

W. H. M. 41

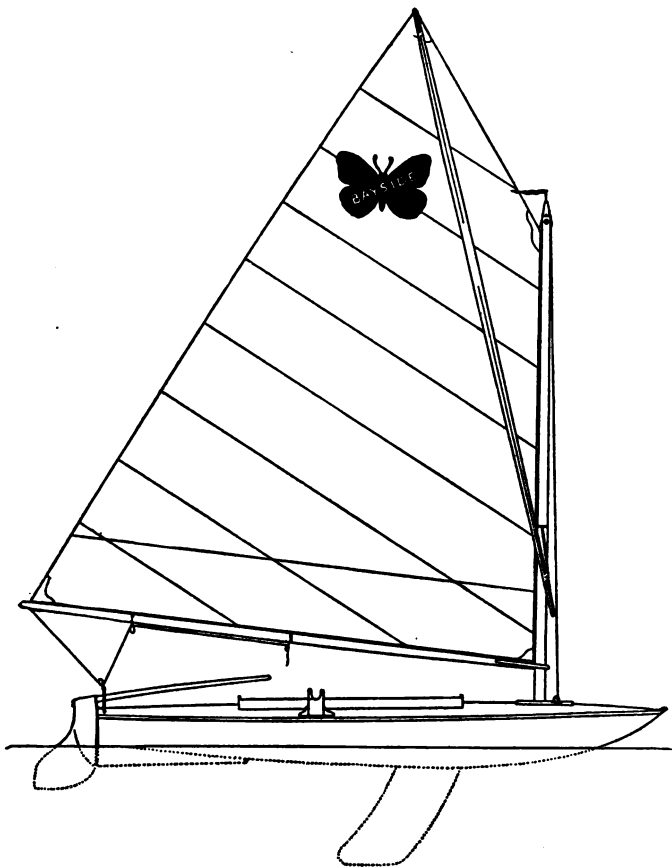

Sail plan

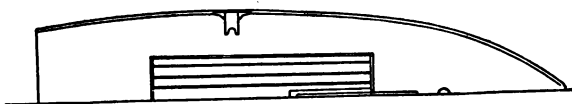

Deck plan

**THE BARNEGAT DUCK BOAT**

Showing spritsail rig and dagger centerboard; a splendid sailboat for bay waters.

*Courtesy "Yachting"*

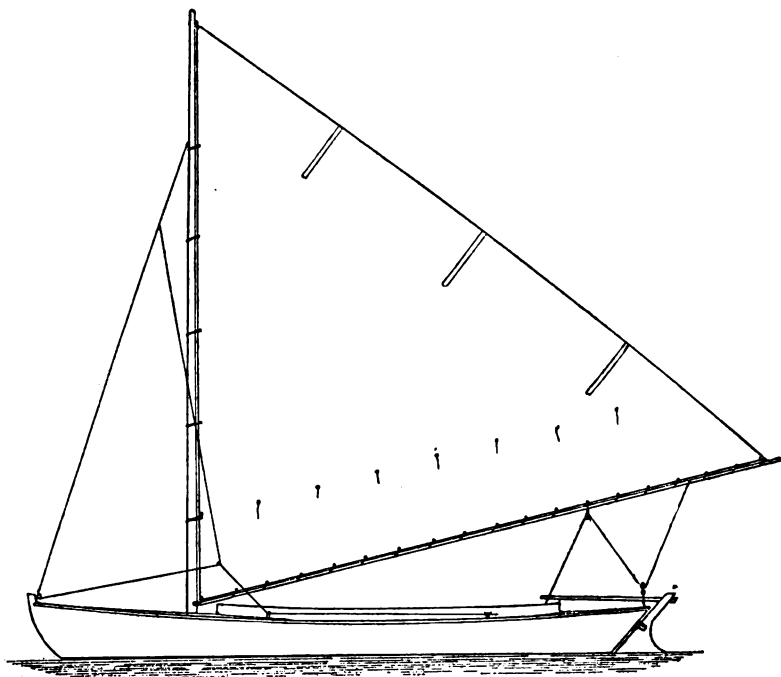

SAIL PLAN

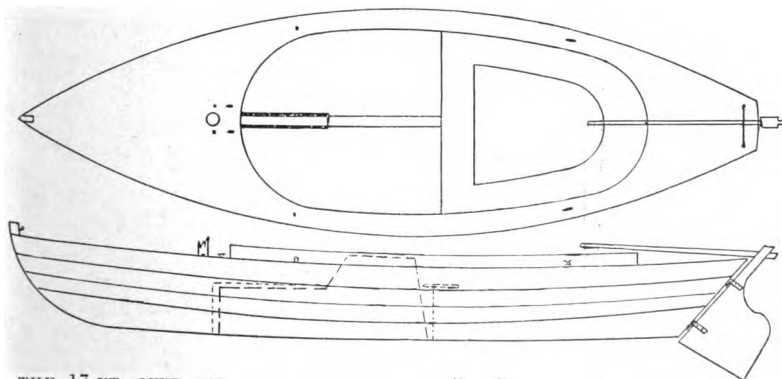

THE 17-FT. OVER ALL CLUB SAILING DORY, "BEE"

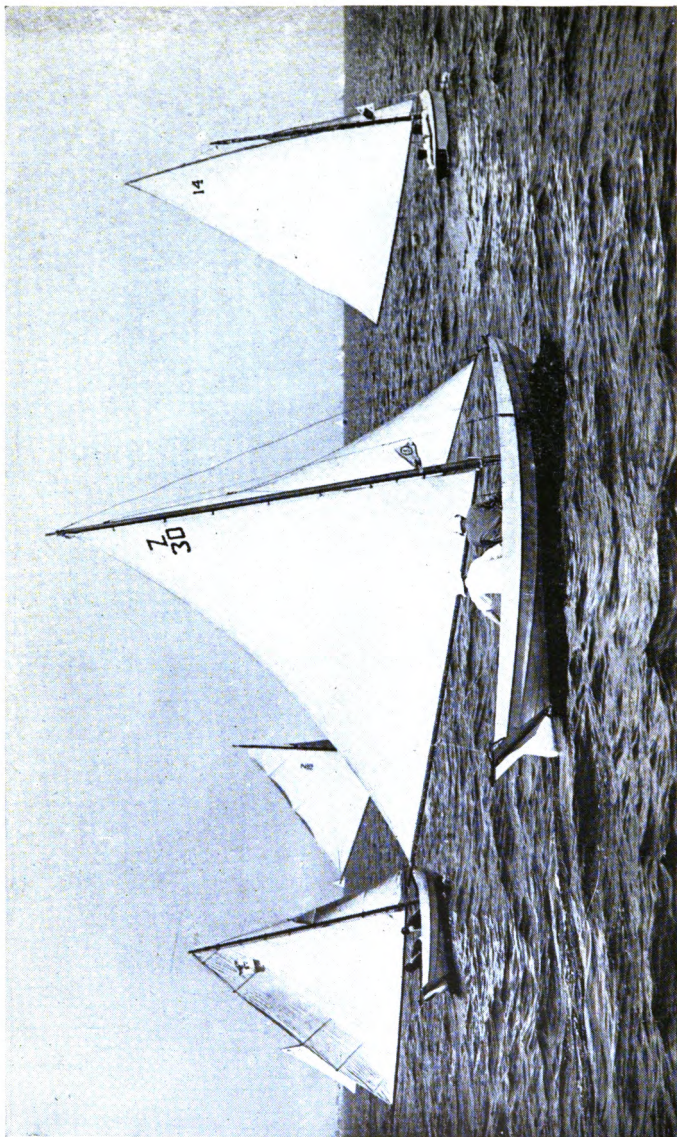

18-FT. DECKED RACING DORIES



## DORY, DUCKBOAT AND SKIFF 49

boat and sail and turn me loose! It was just a little sprit sail, of some seven feet hoist and eight-foot boom, say, ten feet to the peak, and I was in a perennial condition of wet feet with her, for she sailed with her whole lee rail awash and I was a regular Roll-Down Joe—I never spilled wind unless she was positively *going* to upset! These small duckboats were steered with an oar out astern through the sculling chock, and were simple and primitive to handle, but how they could go! With a gun, some snipe stools, a wad of fishing tackle and some bait, a boy could be so happy for week on end at Barnegat that Heaven itself would have to go some to beat it! Inside the cockpit coaming the baymen always put a sort of wooden rack in which sedge grass could be stuck so that the boat herself, by covering her decks with seaweed and anchoring her off a point, would be an excellent duck and snipe blind. Although wet in a heavy sea practically no water gets over the cockpit coaming, and, as a boy's boat, they are one of the safest types imaginable.

Naturally the fame of such a boat would extend far and wide from its birthplace in Barnegat Bay, and soon the "punkin' seed" was developed into an able, fast racer, culminating in the Butterfly Class of the Bayside (L. I.) Yacht Club, where a

## 50 SAILING AND BOAT BUILDING

fleet of 21 of these boats were ordered built at Barnegat, N. J., and raced every Saturday on Long Island Sound. These were 14 feet long by 4 feet 6 inches beam and usually had a crew of two to three boys, or one man. The sail area was increased to 106 square feet, that is, boom, 12 feet, rising 14 inches; hoist, 9 feet 6 inches; head, six feet; leach, 16 feet, with about 3 inches fullness. The sprit was retained for simplicity and made rather long, 14 feet, stepped low down so as to throw plenty of draft into the sail. All sprits are stepped alike, a slip noose around the mast and an eye for the foot of the sprit to rest in. To set the sail, the sprit is slipped into a pocket in the peak (or an eye in the bolt rope at the peak usually), and the peak is then raised until the foot of the sprit rests in the "slippery Jim," as we called the sliding sprit rope. Then, to tauten the sail and throw wrinkles into the luff, you just raised the noose up along the mast and it would stay fast wherever put. A simple rig, and the best for small boats, of twelve to fourteen feet L. W. L.

Charley Hall was the only one of us boys that owned a sailing duckboat. She was sixteen-feet by five-feet beam and had a standing rigging, that is, the mast was stepped in her and held so by wire shrouds, the sail raised with throat and

## DORY, DUCKBOAT AND SKIFF 51

peak halliards, and she had a traveler over the tiller so that the main sheet block could cross the boat on either tack, the sheet pulling so hard as to require a block instead of being held by hand or over a cleat as with the smaller duckboats. She was an able, fast boat; could beat the *Margaret*, hands down, and no weather was bad enough to make her stay in if Charley could get in reefs enough. But the smaller 14-foot boat, with its simpler rig, we found the handiest type. She could do anything the big boat could do, and then some, for you were not handicapped by standing and running rigging, could leave the sails at home when the wind was wrong or in working up a crooked salt creek, and you could pick the whole boat up by the bow and camp under her, as she was so light.

As this boat is so easy to build I will outline here the plans of her construction. All the ribs are steam bent over the same mold, both bottom and deck, usually of  $\frac{3}{8}$ -inch by 1-inch oak stock. The keel is simply a broad plank, 1-inch stock, a quarter inch heavier than the  $\frac{3}{4}$ -inch cedar or white pine planking of which the rest of the boat is built. The keel plank is tapered from about 8 inches amidships to 3 at the bow, and 5 at the stern, in long easy lines, and is then bent up for-

## 52 SAILING AND BOAT BUILDING

ward and aft to fit the sheer. The frames are then screwed onto the keel in pairs, riveted together at their ends, the transom secured to the keel with a knee and a yellow pine chime is bent around inside the frame joints, securing them all together longitudinally and taking the place of the sheer strakes of the batteau construction. The planks are next gotten out, three on a side, and planed to an easy taper bow and stern, so that they lie side by side over the ribs. They are riveted to the ribs, or secured with galvanized iron clout nails, and where deck and bottom meet, are finished with smooth joint, and usually a low molding or gunwale is run around the deck at this point. The cockpit coaming, and cockpit ceiling, screwed to the frames, is next put in and the boat is done and ready to calk and let swell tight. She needs a skeg, sawed out of pine board, and a center board trunk if you are going to sail her. The centerboard trunk should of course be built before the planking goes on while the boat is still in the keel and frame stage. A slot is cut in the keel between the ribs just for'd of the cockpit, two posts let in and the trunk sides screwed to these posts and screwed to the bottom from the under side of the keel. The top of the board ends in a corresponding slot in the deck planking, and

## DORY, DUCKBOAT AND SKIFF 53

a dagger centerboard, 12 inches by 3 feet long with a stop head, is shoved down through the trunk, and it is removed entirely and stowed below when not in use. The mast hole is cut in the deck partner plank and the mast step screwed securely to the keel plank. Some boys of my acquaintance, not feeling expert enough in their carpentry to plank this duckboat, have built her as above described, fitting the planks as closely as they could, and then put a canvas deck and bottom on her just like a canoe, painting it to get her water-tight. Such a boat will do nicely anywhere but in rocky waters.

Down Boston way, where one sails a good deal on the open ocean for pleasure and the heavy ocean swells run right into the harbors in an easterly blow, the demand for an able, deep sea boat has brought another favorite boy's sail craft into existence—the sail dory. The Barnegat duckboat is too low and shovel-nosed to live in a heavy ocean sea. The choppy and comparatively low seas that get up on inland waters and such wide bays as Barnegat and Great South Bay she manages very well, albeit somewhat wet. But, suppose one end of her is held up on a comber six feet high, while her nose is rammed into the breast of another of the same height,—you can readily

## 54 SAILING AND BOAT BUILDING

see her whole for'd deck going under and the boat swamped. What is wanted is a high, lifting bow, and high sides, a deep, narrow boat, non-capsizable because of her depth, and non-swampable because of her high sides and bow,—in a word the deep-sea Viking type of boat. Such a craft is the sail dory, such as you will see on Long Island Sound and Down East from Buzzard Bay to Maine. In addition to this the dory is light enough and flat-bottomed enough to be easily beached, another fine feature for a boy's boat, as going ashore on a strange coast is half the fun! In general, the dory construction consists in a somewhat narrow, flat bottom board, usually in three planks, a natural-bend stem piece secured to this bottom board at one end, and a deep, narrow transom stern secured to the other end of the bottom plank with a bent knee. Four frames, sawn out of natural-bend rib stock, give you the ribs and around these are wrapped the side planking, four planks on a side. You will see that she is rather an easy boat to build, not as simple as a batteau but considerably easier than a narrow-planked round-bottomed rowboat which only an expert ship carpenter can put together. The original Swampscott Dory was 18 feet long by 4 feet 6 inches beam, 30 inches deep forward and 28 inches

## DORY, DUCKBOAT AND SKIFF 55

aft. It carried a rig, as shown in the illustrations, of a wide shallow leg-o'-mutton, 13-foot 6-inch foot, 11-foot hoist, 16-foot leach, and a jib of 8-foot hoist, 6-foot foot and 7-foot leach. A centerboard was let in between the first and second frames for'd, giving you room enough for a 3-foot board. About two hundred pounds of ballast in sand bags ought to go on her bottom, and so rigged and ballasted she makes a very able, fast boat for a boy of twelve to fourteen years.

It seemed to me that a sail dory would be a splendid proposition for cruising in Barnegat Bay down near the Inlet where the ocean rollers come into the bay and the distances are so great that a very neat sea gets up in the bay itself. Such a boat could live in weather that would either send the duckboat to port or else make a very wet boat of her, and so I ordered the largest and best of the sail dories, the decked 17-footer, as made by the Toppan or Cape Cod Dory Companies. This boat was wider than the regular dory, being 5 feet 6 inches beam for 17 feet of length. She was about the same depth fore and aft, but was decked over, with a 10-foot cockpit about 4 feet wide, and a traveler astern to lift the main sheet block over the tiller.

This boat, the *Bee* by name, carries much more

## 56 SAILING AND BOAT BUILDING

sail than the smaller and narrower type of dory. She has 17-foot hoist, 18-foot boom rising two feet, and 14-foot hoist by 8-foot foot for the jib. The rig is standing, that is, there is main halliard, jib halliard, jib downhaul and wire rope shrouds for the mast. She will take four to six people easily, and for a cruiser for four boys is unsurpassed. Seaside Park is the furthest point by rail to the hunting and fishing grounds of Barnegat, and from there down to Cedar Creek is six miles further before the shooting gets good, and ten miles to the Inlet where you get channel bass in the surf, also weaks and croakers and bluefish, small weakfish in the bay, and snipe and ducks in their season. Further on, down towards Great Bay and Little Egg Inlet, the water is still rougher and the shooting and fishing splendid. To reach those places requires a long roundabout trip by rail, and we have also tried rowboat and sand tramping with a camp on the beach for several days to get to it. Sand camping is the hardest of all sorts of outdoor camping; the sand blows into everything, the mosquitoes and flies are a pest, and the wind blows so hard that even your fire gets blown out! The big sail dory changed all that. Now we take the train for Seaside Park, hoist our sail and are away for the delights of a



## DORY, DUCKBOAT AND SKIFF 57

cruise in those waters. Decoys, provisions and a cockpit tent are kept aboard under the bow deck, so that all we have to bring is the rods, guns, ammunition and bait. A water butt takes care of the all-important water problem, and we go ashore to fish and shoot wherever we please, as you can beach her anywhere. At night, we top up the boom and tie the ridge of the cockpit tent underneath the boom, fastening the sides down to staples outside the cockpit coaming. A scrim front and rear curtain keep out the mosquitoes, and we have four ticking bags which we fill with dry seagrass on the beach and put one on each side of the centerboard and two up in the stern sheets. The grating is taken up out of the bottom and hung just below the cockpit seats, with turn-out cleats for the purpose, and so you get two stories, so to speak, for our tent, and there is plenty of room for four to sleep aboard. In the morning the little alcohol yacht stove is pulled out in its tin galley box, and a breakfast of coffee, bacon, eggs, fried fish and creamed potatoes is furnished by the cook—which is me! Then a lunch is put up and we have the whole day ashore fishing or in the snipe blinds. Returning at nightfall, a big feed is cooked up aboard the boat, and a little later we are ready to turn in, for “early

## 58 SAILING AND BOAT BUILDING

to rise" is the only rule to get good fishing and shooting. No sand, no mosquitoes, no wind blowing everything to kingdom come—it's a great improvement over our old camping days on the beach, and now we can go forty miles, when ten used to be our outmost limit.

The smallest sail dory is the 14-foot open sailing boat, virtually the Gloucester fishing dory with a sail stepped in her. The hoist for this would be 10 feet, boom 13 feet, rising 12 inches. The simplest possible spar rig would be a horizontal sprit, running from a slippery Jim on the mast to a pocket in the clew. The mainsheet is bent to a ring in the clew bolt rope and there you are! This makes a very nice boat for young boys, but rather too small for youths of sixteen and up. If you live in a town where there are shipyards, especially in New England, it will not be so very hard to build yourself a sail dory of the 17-foot or 18-foot size. Dory side planks have so very much sheer to them that the plain lumber mill board will cut to a lot of waste, so regular white pine dory stock is kept on hand by most Down East shipyards. This is natural-bent tree, sawed into  $\frac{5}{8}$ - or  $\frac{3}{4}$ -inch stock. Then the ribs, which are of tamarack (or, as it is often called, hackmatack), are sawed out of natural crooks, which are kept in

## DORY, DUCKBOAT AND SKIFF 59

stock at the shipyard. Enlarge the frame patterns I give you in the illustrations to fit the size you want on big sheets of brown paper, cut out and take to the shipyard where you can try them on the stock and pick out what you will need and have it sawed out on the band saw at the yard. In the same way the stem is gotten out of a 5-foot piece of 2-inch oak, natural curve, and with it the stern knee. For bottom board you will want  $\frac{7}{8}$ -inch white pine stock, 6 or 8 inches wide, in the 14-foot merchant length, ordinary dressed lumber boards, and, for side planks, dressed white pine,  $\frac{5}{8}$ -inch stock, 20 feet long, about 10 inches wide, for the six side planks, and 14 for the two garboards. These will be natural sweep stock.

Enlarge your bottom plan to full size, and get out the three bottom planks to make up, the center plank being full width, as in it you must cut the centerboard slot and so do not want the centerline to be a crack. Now clamp together and tack with a few cross pieces, and then set up your four frames, screwing through the bottom with No. 10 brass screws, allowing three feet for the centerboard frame and the rest spacing about even, some 2 feet 10 inches apart. Plumb and set up the stem and stern knee, and secure to bottom board with three or four galvanized iron screws

## 60 SAILING AND BOAT BUILDING

each. The frames and stern transom are then beveled to fit the planking, the angles being gotten by running strips of light stuff around, touching all the frames. The stem knee has of course been rabbeted to receive the planking before setting up.

You are now ready for the garboard planks, the spiling of which will be shown from the frame flats. Bend your wide garboard plank around and mark the pattern points on it direct. The bottom line can be scribed with a pencil and the upper points marked and joined with a long flexible sweep strip. Saw it and its mate out with the rip saw and nail on with galvanized iron clout nails, about 10 d. is right, clinched on the inside of each rib. Bore holes in the plank and rib before driving the nails, to prevent splitting, and do not nail *anything* until the garboard is a perfect fit everywhere. The bottom planking wants about 1¼-inch rocker on it before scribing the bottom line of the garboard. Note that the bow and stern of the garboard are much wider than the midships, about 12 inches for'd and aft and 6 inches amidships is about right. Also note that the first two planks come in line on the stem and stern, there being no knuckle, and are almost carvel fitted at the center frames. The next two lap and are beveled to a fit and clinch-nailed together. The planks can

## DORY, DUCKBOAT AND SKIFF 61

be wrapped and marked in place or a spiling taken from a straight strip, either way you prefer. After the garboards are on, the craft will be strong enough to turn over and build upside down, as that is much the easiest way to plank her.

After the planking is finished you will want a 2 x 7/8-inch oak gunwale wrapped around outside, and a 2 x 7/8-inch pine riser secured around inside about 8 inches below gunwale to rest the thwarts on. The centerboard trunk is made of two oak posts of 2 x 7/8-inch stock (same stock as gunwale) and two wide 17- or 18-inch white pine boards, 3 feet long, are screwed to each side of the posts over a white lead and wicking filler, making a tight trunk, with about an inch of the posts sticking down below the trunk. The posts are then notched half an inch to give the ends of the trunk something to bite on when in place, and a 3/4-inch by 3-foot slot is then cut in the center bottom board of the dory. (See construction drawings in Part One, Chapter IV.) Drive in the posts, with a turn of lamp wicking, soaked in white lead paste completely around the slot, and secure with galvanized iron screws driven up through the bottom of the dory into the bottom board of the trunk. This job should be tight enough to squeeze out paint all around. The center board is next gotten

## 62 SAILING AND BOAT BUILDING

out of  $\frac{5}{8}$ -inch dressed oak and hung by a white pine pinion driven through the side of the trunk in the lower for'd corner and the dory is ready for sails. Brace the mast step thwart by knees to the planking and put in the step with the grain running *across* the boat. The mast will be two to three inches for the 14-foot and 18-foot dories, and the other dimensions I leave to you. I would suggest 14 feet by 3 feet 10 inches for the 14-foot size, 18 feet by 4 feet 6 inches for the 18-foot open dory and 17 feet by 5 feet 6 inches for the decked sailing dory. Scaling in proportion on the frame plans, etc., given here without dimensions, you can make up your patterns and build the boat any size you prefer. These drawings were taken by Mr. Victor Slocum from the original Swampscott dory and we are indebted to him and the *Yachting Magazine* for their use.

## CHAPTER III

### CATBOATS AND KNOCKABOUTS

WHILE the smaller sail craft, dories, duckboats and sailing batteaux answer very well for the boy of from ten to fifteen years of age, the youth of sixteen to twenty will be more satisfied with a larger craft; one that can enter the regular races of the Yacht Club—and right here enters a great sport, one of the finest—yacht racing—a sport that brings out to the full all the skill, seamanship, sportsmanship and gentlemanliness that is in the youth. No sport is more real—less savoring of a mere game—and no sport is a keener test of character. There are times when it is essential to hold your way,—to have your rights; when giving way is not generosity but mawkishness; and there are other times in this great sport when a really unfair advantage *can* be taken, and then the promptings of generous sportsmanship may take full sway; and, as these situations occur again and again in the great game of life, there is no better training for the youth than yachting, if he is to be a whole man in later years.

## 64 SAILING AND BOAT BUILDING

The cat rig has the great merit of simplicity. There is only one sail to manage, and that means a good deal for an inexperienced skipper in a heavy blow. The disadvantages of the cat are its hard helm, its slowness in proportion to its sail speed, and—to me—its simplicity! By that I mean the lack of finesse in sailing which is otherwise made possible in the sloop rig by the jib. I graduated from the cat rig at the age of eleven, and never returned to it in any of my own boats. The jib, with its infinite possibilities in expert seamanship, in balance of the helm, in nicety of judgment, has always been to me a fascinating sail, and of course jib and mainsail, foot for foot area, are always faster than mainsail alone, partly because the balance of the sail takes the hard helm off her, eliminating that back rudder pressure so retarding to the speed of the boat, and partly because the sloop lines are finer, the cat requiring a tubby model to withstand the big pressure of her mainsail. Of late years designers have gotten somewhat finer lines by using the sliding gunter rig for small cats and topping up the gaff as high as can be swung, thus putting the bulk of the sail pressure low down. This is an important idea, boys, and I want you to get it. If you look at any of the older



## CATBOATS AND KNOCKABOUTS 65

cat models you will find the gaff nearly as long as the boom, the sail, when hoisted, very square, with a great peak towering aloft and well out from the mast. Now, the wind pressure is always heavier up above the water than right on it—that is the reason your small boat's sail will often hang slack, while the big fellow bowls right ahead; he has a puff of wind that has raised off the water and passed over your head. Now this big accumulation of wind pressure up in the peak gives a heavy capsizing effect on the boat, and to withstand it you have to use the tubby cat model, more than half as wide as she is long. Compensating for this by making it very shallow and dish-like, you get considerable speed on a flat keel, but as soon as she heels she digs her bilge into the briny and you have an awkward shape to drive through the water.

But if you top up that peak nearly straight, you get the bulk of the sail area down low, almost like a leg-o'-mutton, as shown in the illustration of a handsome little 16-foot catboat for boys, and the rig becomes safe and the lines of the boat fine and fast.

Let us look at that model a little more, for she is a fine boy's boat, and, by building her with a skipjack dead-rise bottom, she can be built by any

## 66 SAILING AND BOAT BUILDING

boy from 16 years up in age. The lap strake shown in the designs is too complicated for ordinary carpentry, so I suggest instead a skipjack mid-ship section, taking but three wide boards on a side, and using the same keel, stem, transom and skeg shown. You will note that the skipjack rib is in two straight pieces joined by a knee brace, and a chine is bent around the outside of the frames at this joint, and against this chine the upper and lower planks can swell shut. If you tried to join them direct, as is often done with motor boats, it is hard to keep the joint tight, as there is nothing for the planks to swell against when the boat goes overboard. However, working out a set of five frames, you can design yourself a skipjack cat that will be as fast and sassy as the boat shown in our plans. I would suggest  $\frac{7}{8}$ -inch white cedar planking, and chine and frames, also keel board, of 1-inch white oak. The keel board had best be of 1 x 12-inch dressed oak plank, rockered as in plans, transom of the same stock, stem and stern knee of 2-inch stock. The deck I would make of  $\frac{3}{4}$ -inch white pine boards covered with 10-ounce duck canvas, and the board would be preferably of straight posts as shown.

A word on the sliding gunter rig. If you top

## CATBOATS AND KNOCKABOUTS 67

up the gaff until you get it almost perpendicular it is almost impossible to make the jaws stay around the mast. They cannot be made of wood and get enough bend, but they can be made of brass rodding or heavy galvanized wire for canoe rigs, and are held to the mast by the topmost mast ring. This is essentially a weak construction, and, while well enough for canoes and small boats, when your sail pressures get large the best plan is to discard it altogether and use a sliding gunter. This, as you will note from the drawing, is a metal gaff collar, a standard boat fitting, sliding up and down the mast, and to it is bolted the end of the gaff. A single halliard raises the latter, and it is shown rigged with a bridle to distribute the strain on the gaff, which ought to be as light a spar as possible to save overhead weight. The sail has 115 square feet of surface and is 14-foot boom, 12-foot gaff, and 19-foot 6-inch leach, with hoist about 5 feet. The mast should be 2-inch, 10 feet long.

A great advantage of all cats, as cruisers, is that the mast is stepped well for'd, giving one a big, open cockpit. This permits a cabin on even a 20-foot cat, and a cabin is a tremendous convenience. It need not necessarily be high enough to stand up in—never spoil the looks of your boat

## 68 SAILING AND BOAT BUILDING

for cabin height; but it does afford a refuge in case of thunder squalls, a place for the galley and a sleeping place at night, eked out by a tent over the cockpit, hung from the boom. With such a catboat a couple of fellows can cruise anywhere there is fishing, shooting or racing to be had, living aboard the boat for a week and having a high old time at it, infinitely preferable to going ashore and setting up a tent on the sand.

Closely allied to the sail cat shown is the jib-and-mainsail sailing skiff, a popular design for youths being included in these chapters. You can convert any oyster skiff to this rig with very little work. The dimensions of the average skiff are 21 feet by about 6 feet 6 inches beam, and they can be picked up alongshore for from \$50 used to \$100 new. They have a centerboard, and usually the oystermen rig them with a large sprit sail and removable mast. The so-called one-design racing dory class, recently built for the Panama Yacht Club, is practically just what you can do by stepping a standing rig in an oyster "skiff" as the longshoremen call them. The boat is simply decked over fore and aft, with washboards and a traveler over the tiller (or, in the design shown, the rudder is underhung and worked through a post coming up just aft of the cockpit but the old

## CATBOATS AND KNOCKABOUTS 69

skiff rudder is just as good and easier to handle). The dimensions are 22 feet long by 6 feet 4 inches beam, and she carries 228 square feet of sail. The mainsail is 15 feet 6 inches boom, 12 feet 9 inches hoist, 9 feet 7 inches gaff, and 22 feet 4 inches leach. The jib is 15 feet 6 inches hoist, 13 feet 8 inches luff, and 6 feet 6 inches foot. A spinnaker with 10-foot 6-inch spar is provided for racing.

But the best small racing craft of all for boys is the knockabout. In the old days designers used to build a yacht with sharp vertical bow and a long bowsprit that overhung like a spar. Such a boat always slowed up in a head sea, and, when running before the wind, was apt to dig her nose into a wave and "broach to," that is, slew around on her nose until broadside to the wind, when she would generally capsize. These were bad points, and the short body of the yacht made good sharp entrance lines impossible. So, why not have the bowsprit part of the boat hull itself, so that it would lift her up in a heavy sea and make it easy also for the designer to give her long, easy entrance lines? In a word, the knockabout model of to-day. Another thing: most boats sail on their sides, not on their bottoms, and the formula for speed says that, other things being equal, a boat is faster in proportion to her length. Now a

## 70 SAILING AND BOAT BUILDING

knockabout on an even keel will draw only, say, 15 to 25 feet of waterline, but when she heels down on her side she puts all of her shell into the water for its full length, 25 to 40 feet respectively, and thereby increases her speed, besides giving her good lifting power when her nose hits a wave. And so the knockabout came to stay, and, as it beat the older models all to pieces and was much safer to sail, the latter went out of existence entirely. In general the knockabouts are built with rather shallow sections and a deep fin keel; the overhang fore and aft when on an even keel is very large, taking the place of the bowsprit and stern outrigger of early days; the jib is entirely inboard so you do not have to crawl out over the pickle and get soused with salt spray in furling it (as I had to when a boy); the mainsail is of the modern shape, with gaff cocked well up and center of effort kept low—and how she can sail! I've seen the large Class Q knockabouts raced against the famous Sandy Hook boats and give them quite an argument before they dropped astern, and the little ones can beat anything in cats, sloops or dories that carry sail. Our illustrations show the smallest of the knockabouts, the 16 feet L. W. L., 26 feet over all. The beam is 7 feet 5 inches, so you see she is not so narrow; the draft, in-

## CATBOATS AND KNOCKABOUTS 71

cluding fin, is 4 feet 6 inches or about three feet to the bottom of the boat measured from the traff-rail. They carry about 1,700 pounds of lead ballast in the keel, and of course are too complicated for youthful carpenters to attempt. The best way to acquire one is to buy them second hand in the fall, when their rich owners are willing to part with them for a few hundred dollars, having usually built the boat solely to enter some one-design races. The sail area of the boat shown is 330 square feet, which is a good deal more than double that of the 16-foot catboat just described, and a third larger than that of the sail skiff. The boom is 19 feet 6 inches; gaff, 18 feet 4 inches; hoist, 10 feet; and leach, 32 feet. Jib has 18-ft. hoist; 14-ft. luff and 7 ft. 10 in. foot. A spinnaker with 18-foot pole, completes the sail set. A little house or cabin aids in making her a good weather boat, besides providing a cruising shelter, of sorts. This boat is primarily for racing, but modern designers have worked up cruising knockabouts that are better cruisers than any of the older designs of cats and sloops.

In the design you will note that the matter of strength in mounting and staying the mast has received especial attention. The two weak points in any boat are the mast step and the shroud an-

## 72 SAILING AND BOAT BUILDING

chorges. These, with the mast itself, constitute a triangular truss that must withstand the enormous sail pressures. No ordinary mast step will do; note that the step used in knockabouts is a heavy oak timber, secured to half a dozen ribs as well as to the stem for'd. The ribs and mast partners are braced at the mast sections with knees, and doubled ribs are put in here to give a stout anchorage to the chain plates. Note also a new rope in the rigging that you have not seen before. It runs from the masthead back to a cleat about amidships on each side, and is called the backstay preventer (or rather preventers as there are two of them, to port and starboard). One or the other of them is in use when broad reaching or going dead before the wind with spinnaker set in both cases. The ordinary drive of the mainsail is taken care of by the aft pitch of the main shrouds, but, with the spinnaker added, the pressure would pull the mast over forward if it were not for the preventer backstay. The lee preventer is slacked off its cleat and the weather one belayed as the boat comes about so there is always one of them working.

While the design of a knockabout *looks* hard, I believe that a simplified model, with centerboard (as many of them are designed), and the planking



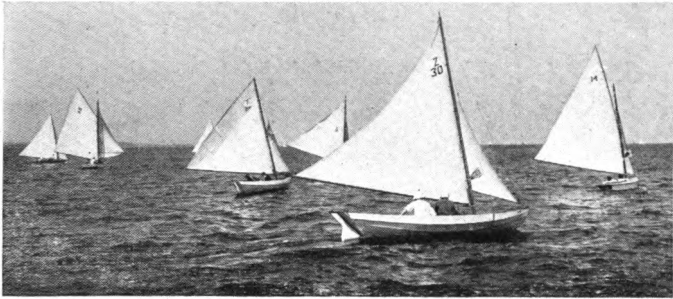

RACING WITH SAIL DORIES

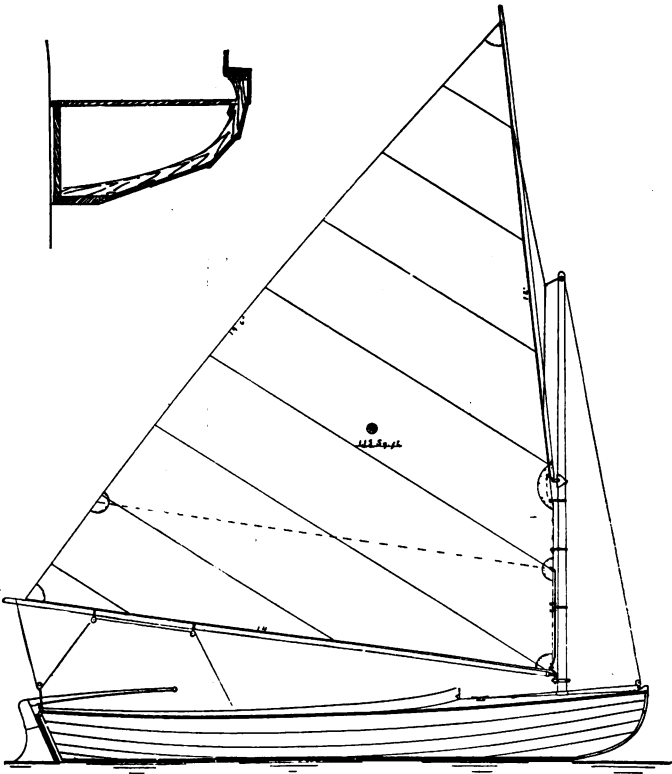

A 16-FT. LAP STRAKE CATBOAT

*Courtesy "Yachting"*

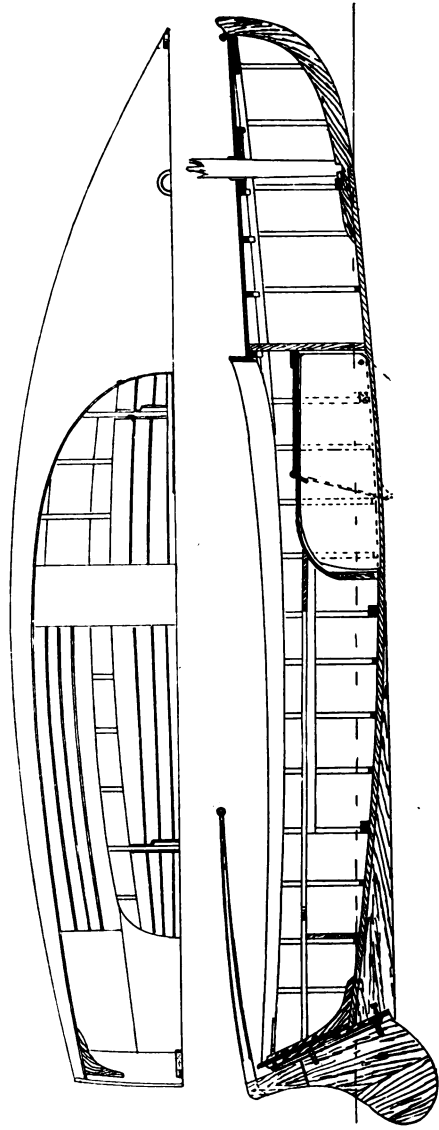

FRAME PLAN AND DECK PLAN OF 16 FT. LAP STRAKE CATBOAT

*Courtesy "Yachting"*

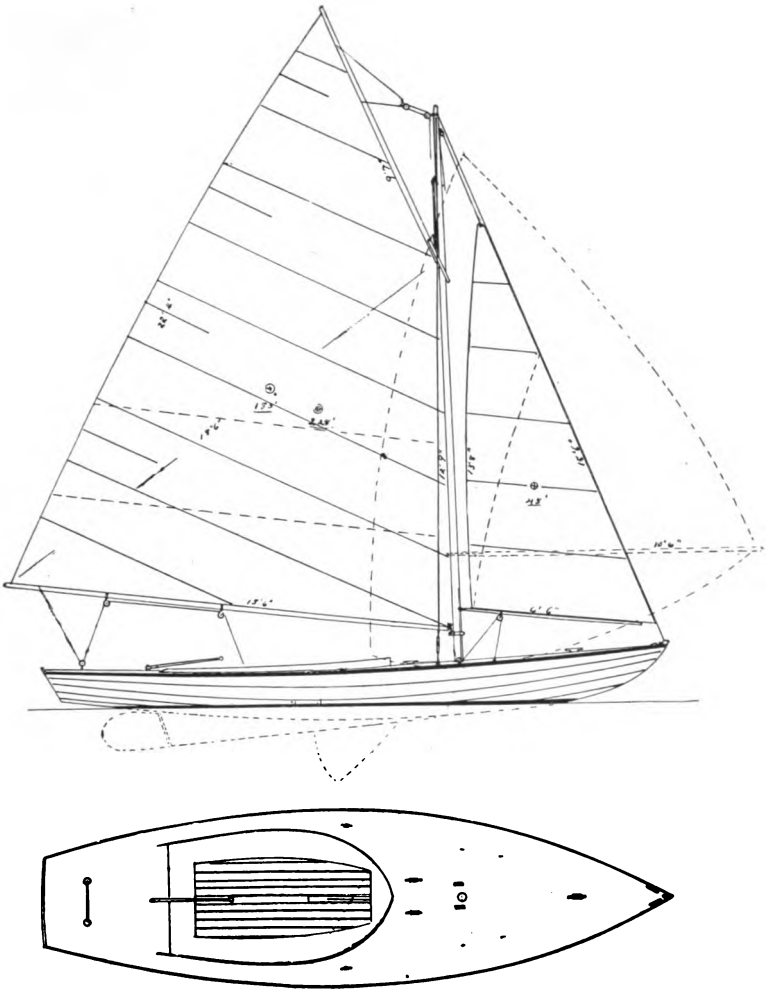

**A KNOCKABOUT RIG FOR A 22-FT. DECKED SKIFF**

An ordinary oyster skiff can be rigged on this model at small expense, making a splendid cruiser of her.

*Courtesy "Yachting"*



THE POPULAR 15-RATER KNOCKABOUT

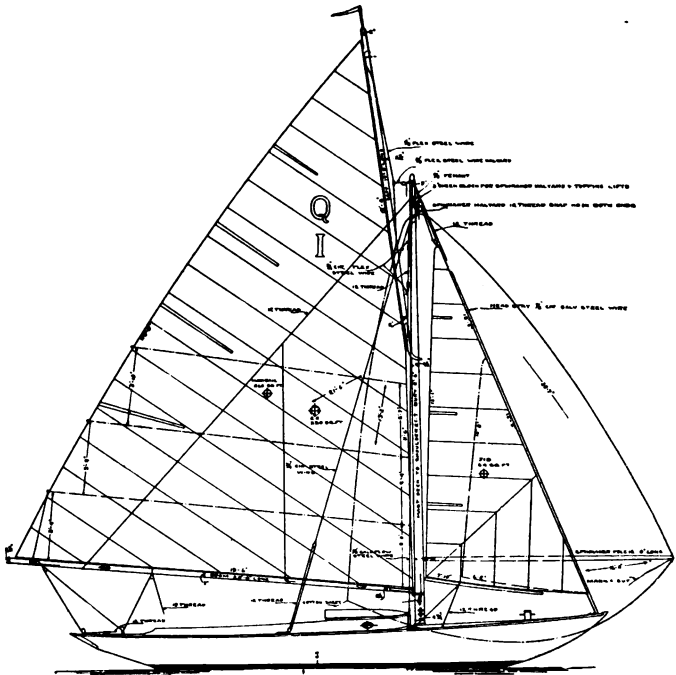

SAIL PLAN OF A 26-FT. O.A. KNOCKABOUT

*Courtesy "Yachting"*

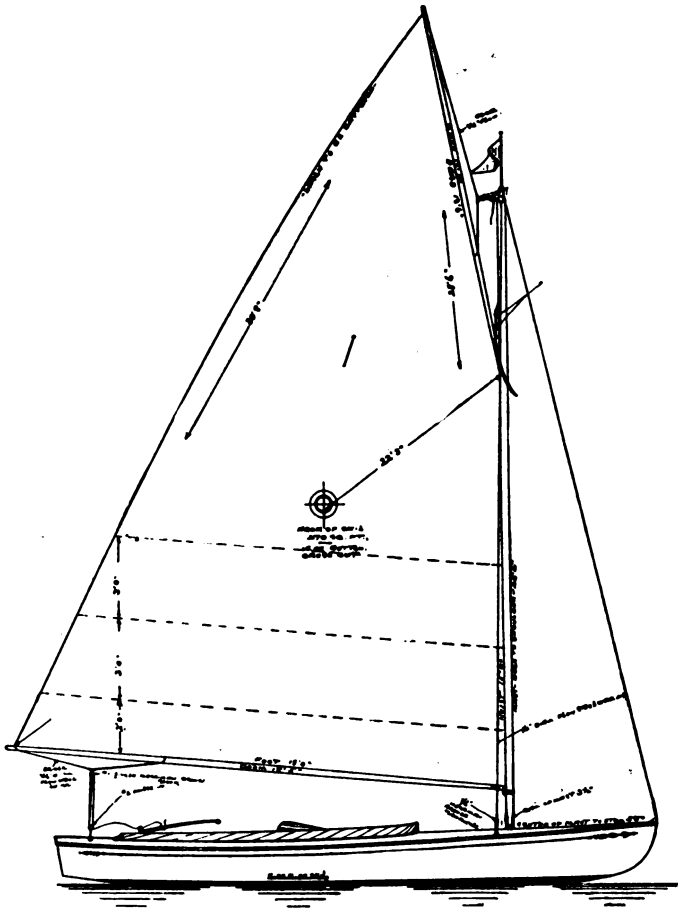

A 16-FT. RACING CATBOAT

Courtesy "Yachting"

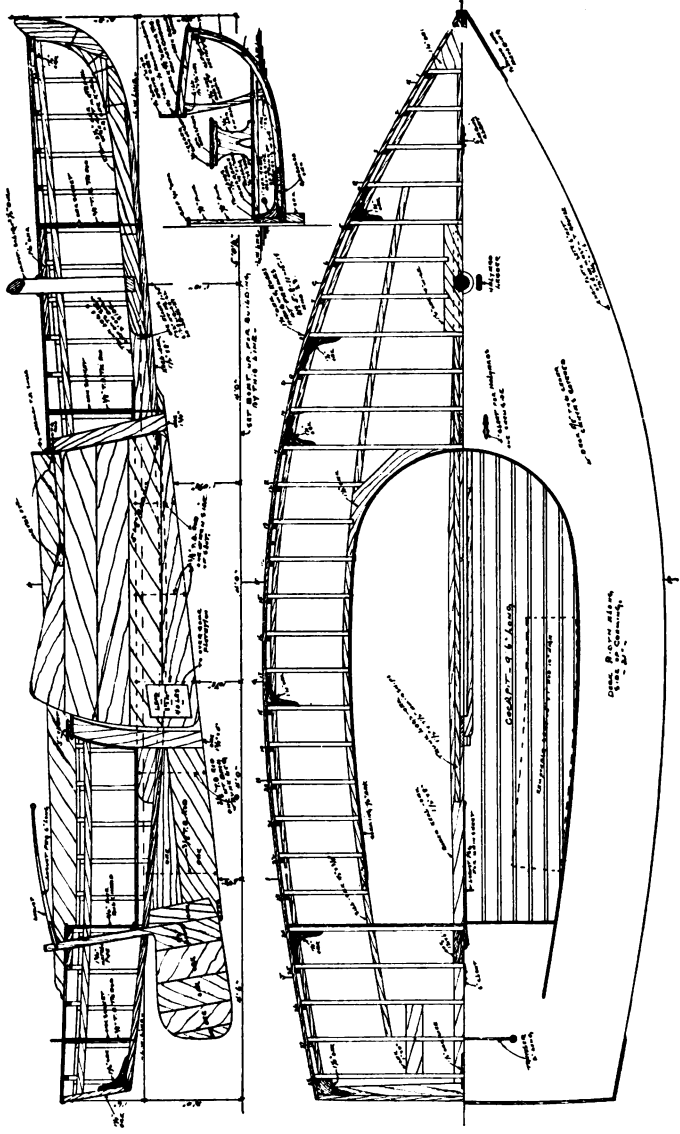

FRAMING PLANS AND DECK PLAN OF 16-FT. CATBOAT

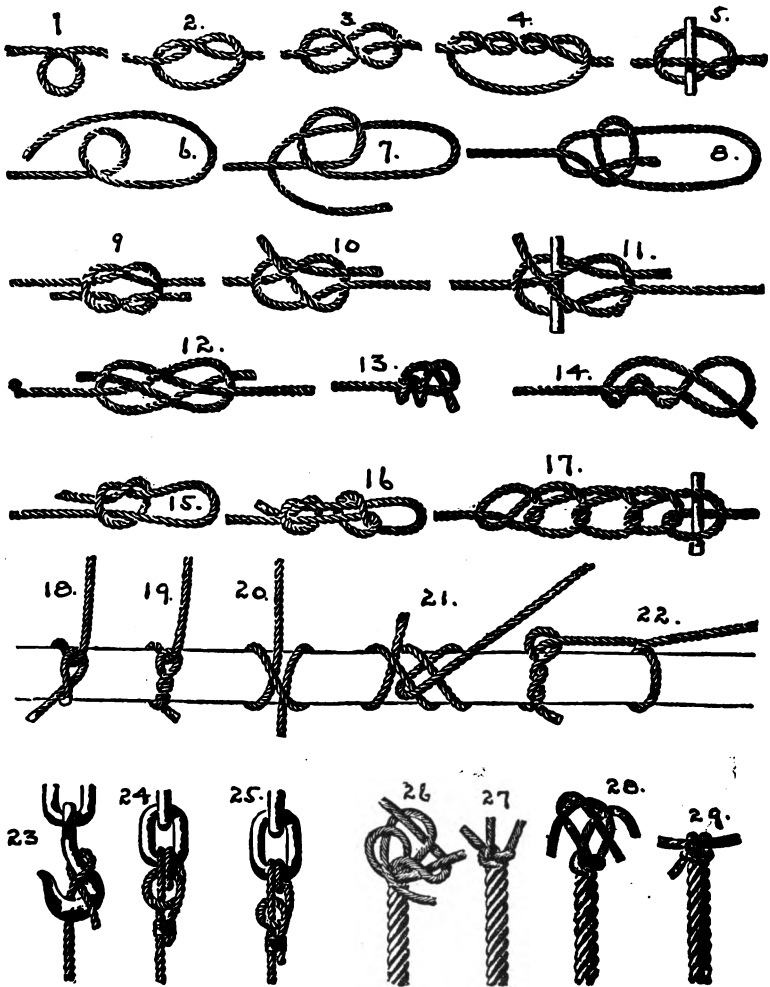

KNOTS AND BENDS USED IN SEAMANSHIP

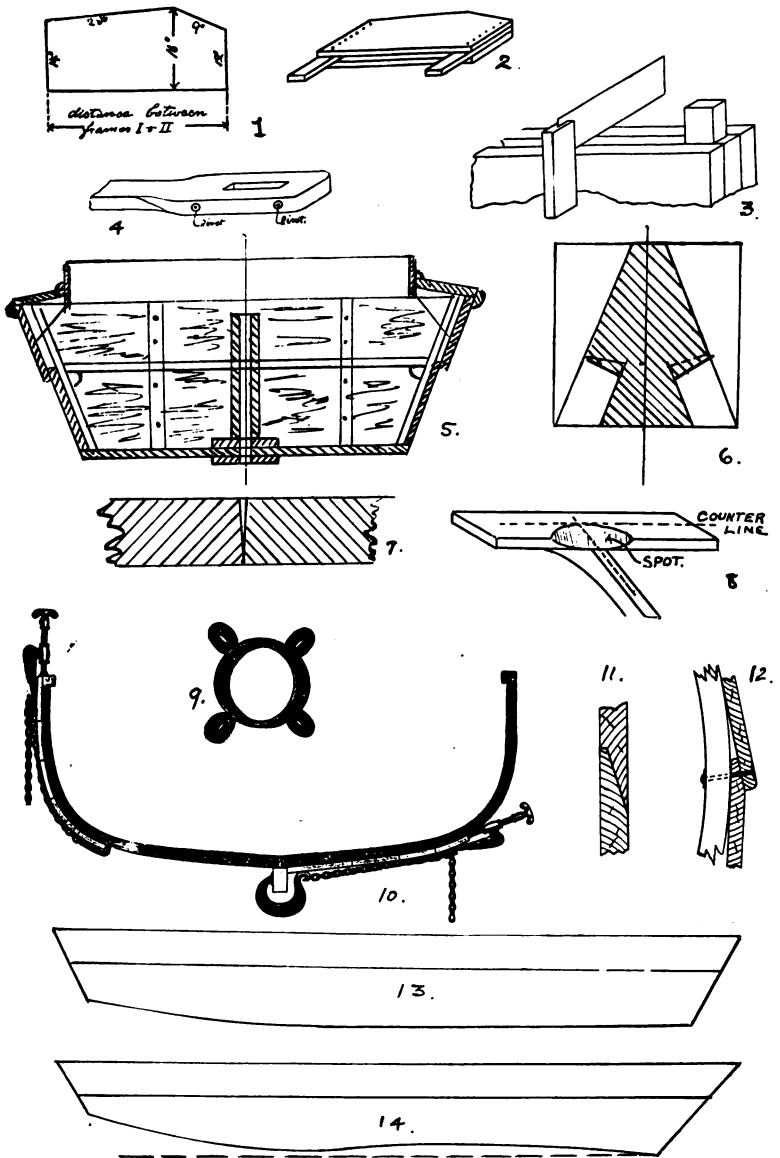

BOAT CONSTRUCTION DETAILS

W.H.M. del.



## CATBOATS AND KNOCKABOUTS 73

covered with canvas, would not be out of the question for four youths of 18 to 20 years of age to build. I would suggest a 2 x 12-inch oak keel, steam bent to fit the lines shown and take the place of the stern hook on the usual three-piece keel of larger craft. A natural bent 3 x 6-inch oak stem and a stern knee of 3-inch stock serve for your main members. Oak stern transom of 1½-inch stock; planking of 7⁄8-inch white pine with No. 00 duck canvas skin. An 8-foot board will be plenty for this boat, and the bottom of centerboard trunk logs are rockered to fit the sweep of the keel. The logs would be of 2 x 12-inch hard pine; upper boards of 1½-inch yellow pine; centerboard of 17⁄8-inch willow oak. Both board and trunk are through-bolted with half-inch iron rods. You would need a skeg and rudder post, and the boat itself ought to be a foot wider beam than the dimensions of the one shown with keel, and the ballast, about 800 pounds of it, in sand bags in each bilge behind the cockpit seats, making 1,600 pounds in all. Ribs of 1 x 7⁄8-inch oak stock, steam bent. A heavy sawed frame every third rib, gotten out of 2-inch stock, makes a stiffer boat of her, leaving the work of pinning the planks firmly together to the thinner steam-bent ribs. Our chapter on boat construction in general will give

## 74 SAILING AND BOAT BUILDING

you details of construction of all minor parts of a boat of this size, so that it will not be hard to design in the rest of the boat yourself.

The fine points of boat sailing really deserve a chapter to themselves but our space in this book is limited. Indeed whole books have been written on the sole subject of handling a racing yacht under all conditions that are likely to occur during the adventures of the racing skipper. However, for the youthful beginner, I believe that I will get in here about all you will need to make a good all-around skipper, leaving the rest for you to learn in the big school of experience in actual cruising and racing.

To begin with the cat rig. She carries necessarily a hard weather helm, due to the immense driving power of the mainsail which is unbalanced by any jib. This necessitates the rudder being always a considerable bit out of true with the keel and retards her speed, as you may have often noted in your motor boat in turning a curve and observing her engine slowing down and the boat losing headway. There is no help for this with the cat rig, and she pulls your arm off, nearly, particularly when you are a boy of only fourteen years, as I was when I sailed the famous cat *Peggy* owned by my uncle. To relieve this pull

## CATBOATS AND KNOCKABOUTS 75

on your arm we used the ropes for securing the boom in the lazy tongs when in port. These are short half-inch hemp bent through rings on the deck, and a turn of the weather rope around the tiller took the strain off your arm yet gave you entire control by keeping a hand on the tail of it. A good hunch, for a cat rig of 18-foot boom and over.

In handling a cat, tacking, all beginners learn as a first instruction to keep her just rap full, that is, just enough off the wind to prevent the sail luffing or shivering up near the mast. A good skipper will follow his wind closely, eating up into it in strong puffs instead of spilling it by letting go sheet, yet not sending her up so smart as to kill her headway. When the wind slackens do not keep her broad away but hold her reasonably on the course and do your gaining in the puffs or "catpaws." You can see these come over the water in black prickles over the waves. Your only danger when "on the wind," or tacking, is in getting such a knockdown puff that you cannot let out sheet because the boom is already fouled in the water. This causes more upsets than any other thing that besets amateur sailors. If in such a fix, loose the peak halliard instantly. Throwing her sharp up into the wind will help

## 76 SAILING AND BOAT BUILDING

some, but you really can not do much with either helm or sheet, and had best use the time you have left, which is a few seconds, in spilling the peak, which will save her every time. For this reason always have the halliards belayed with a single turn, crossing over the cleat once and then under it, the free end of the halliard in a short loop. The rest of the halliard is neatly coiled down on deck in a tight rope spiral, and a pull on the loop frees the halliard and she runs out without a moment's loss of time in lifting a coil off the cleat or anything else. It is best to anticipate what appears to be a knockdown catspaw coming by shoving her up into the wind and spilling some by starting the sheet, when you will only get a furious luffing instead of your boom being driven under water.

Another cause of upset on the wind is main sheet made fast. Only sheer carelessness would tolerate this in a small boat, and in a larger one the sheet is belayed like a halliard so it can instantly be started. For a sail canoe the sheet is held always in the hand, as she is so lively that she responds heavily to the least change of wind and at no time is the pull of the sheet very heavy. In small sail batteaux, duckboats, sail dories and cats, the sheet has a single turn under the aft horn

## CATBOATS AND KNOCKABOUTS 77

of the cleat, so it can be easily shifted to spill wind, yet half of its pull is taken by the cleat. This also prevents the sail "skying" under the lifting power of the peak and prevents the peak itself bagging off to leeward when it lifts the boom. In cats and knockabouts of 18 to 30 feet over all the main sheet is rove through one or more boom blocks and the traveler block and then finally secured on the main cleat with a loop under the turn. Our various sail craft drawings each show different ways of rigging the main sheet.

A final point in sailing on the wind is to know when you have the right of way and to hold it at all costs, only yielding to the road hog when it is absolutely necessary to save *your* boat—not his! Warn him by the hail, "Right of Way!" and then hold your course. Nowadays, particularly among the newly rich, one encounters skippers ignorant of the Rules of the Road at sea, and, as these gentry have an idea that they own the earth anyway because of their lately acquired wealth, they are apt to pay small attention to the rights of others when sailing. You have the right of way when on the starboard tack; that is, when the wind is blowing on your face when you look to starboard. Hold your course; it is up to the other fellow to keep clear, and if you do not hold your

## 78 SAILING AND BOAT BUILDING

course he does not know what to do himself. Another way to remember it is, "When your boom is out to port, you're on the starboard tack" and *vice versa*, so when you are tacking out to a mark and are reaching it on the starboard tack, and your rival is swooping down on it on the port tack, keep on your way and round the mark. If he crosses ahead of you he is taking chances of being run down, and if he runs into you to port he must stand all damages to your boat. His best scheme is to crowd down on you as close as he dares and then luff up hard, filling in on you to windward when you come around the mark and lay over on the port tack. You still have the right of way, as the windward boat must keep clear of the one on his lee.

In broad and close reaching, that is, running across the wind either with it somewhat astern (broad) or somewhat ahead (close) you have a fast point of sailing and little danger, and the sail is let out until it shows a trifle of quiver in the luff. Do not try to follow the wind too much, as she is apt to yaw and broach in the seas, particularly if long and heavy ones, and the continual drag of the rudder in rectifying her course will slow her down a lot. It is much better to anticipate,—“feel your boat,” as it is called—a mere

## CATBOATS AND KNOCKABOUTS 79

flip of the tiller, taken at the right moment before she begins to yaw and slew, stopping the tendency without any undue drag. If she gets away from you, let her go and ease her back to the course gradually. Always aim to land to weather of your mark, so as to have something to come and go on. If it is before the wind on the homeward stretch, have the spinnaker ready to let go, for every second counts with it after you round the mark. Cut it close and let go the pole.

Before the wind is, to my mind, the most dangerous point of sailing to the tyro skipper, particularly in handling a cat. There are two things to look out for, jibing and broaching to, also ballooning of the mainsail. The peak tries to raise the sail up more than ever, and, as the sheet cannot now hold it down, it may throw the boom up so that the wind catches under it. The result is a folding up or ballooning of the mainsail, a tremendous jibe as the boom falls over on the other side of the mast, and, most likely, an upset or a cracked mast. The prevention for such condition is to slack off the peak halliards quite a bit, enough to drop a big, inactive bag in the peak, and, in a high wind, drop the gaff down altogether, letting it hang behind the mast. These precautions are necessary with the old-design, broad cat sails

## 80 SAILING AND BOAT BUILDING

whenever you have a heavy wind astern and high rolling seas. The modern cat sail, with nearly vertical boom and battened leach has much less of this tendency to balloon, as the lifting of the gaff is impossible—it is cocked up already as high as it can go!

“Broaching to” occurs when a boat is being driven hard before the wind in a heavy sea and catches the wave ahead. She at once buries her nose in it, and, as the rear wave lifts her stern, she slews around broadside on, with main boom dragging in the water, and likely, upsets. The old models, with sharp, straight stems and hard lines for’d, were particularly apt to this sin, and the cure for it was to carry less sail, put in a reef, so as to still get the benefit of the lift of the peak. Another way was to sail slightly off dead before the wind. Modern boats, with long overhanging bows lift over such waves when they catch them, and are far less likely to broach to.

Jibing is a part of the regular game of sailing, and, if done right is no great storm on a small craft. When you are dead before the wind the boom has but little preference as to which side it will go from your mast, and if you let her yaw or sheer much from dead before the wind *towards* the side where your boom is, the wind will get



## CATBOATS AND KNOCKABOUTS 81

behind it and throw it around suddenly and violently, sweeping everything before it, and, if the wind is strong and the boom large, the craft will most likely capsize with her own momentum. Yet if this same jibe is performed intentionally, and the boom hauled close aboard before throwing her around with the helm so as to get the wind on the other side of the sail, it can be done without much danger and is often done so, in cruising and racing, when the course changes from dead before the wind to a broad reach. Many a time we had to "wear ship" with the old square-rigged sloop of war *Portsmouth*, on which I spent many of my youthful days! When wind and tide together make it impossible to tack the ship, the alternative is to let her fall off until dead before the wind, and then come up on the other tack, "wear ship" it is called by seafaring men. It means all hands on the braces, four of them in a bundle in your hands, and all the crew pulling and hauling on them together as the ship wears. In jibing a small boat, if taken unawares and you find the boom starting in on her, it can often be headed off and the effects much diminished by throwing the helm smartly down, that is, the tiller towards the sail, thus putting her on a broad reach. If she comes over in spite of you, throw

## 82 SAILING AND BOAT BUILDING

your weight across the boat so as to lift the boom high when it gets over on the other side, and grab the main sheet so as to ease her over. The thing to prevent is the boat dipping so violently as to bury the boom in the water, when you no longer have control over it and are due for a capsize.

With jib and mainsail the young skipper's problems are much increased, but his rewards are greater in a perfectly balanced rig. The tendency of the jib is to pull the bow *away* from the wind; that of the mainsail to drive her *up into* the wind. The latter should always have the greater force; too big a jib is very dangerous, for, in a hard catspaw, it will not let her come up when you spill wind out of the mainsail but sets her further abeam all the time. The only salvation then is to let fly the jib sheet quick. But, with the jib and mainsail properly balanced, if you spill your wind and shove the helm down she will come up into the wind and luff the jib also, and you are perfectly safe. Ballast also has a great deal to do with it, so that if you find your jib giving her a lee helm, shift the ballast further forward until you get her well balanced with a slight weather helm, that is, a slight tendency to come up into the wind, when both mainsail and jib are sheeted home close hauled. My boat, the *Margaret*, was

## CATBOATS AND KNOCKABOUTS 83

so perfectly balanced that she would sail with the skipper's shinbone against the tiller, a mere turn of the leg correcting the helm. Moreover, in a light wind she would *sail herself*, with jib and mainsail properly set. She would come up, hang in stays, fall off, come up again and this time go about on the other tack, and keep this up indefinitely, with her skipper lying indolently in the bottom of the boat. I was once boarded by some anxious fishermen who thought the boat gone adrift and sailing herself, with her youthful skipper drowned somewhere!

In coming about with a sloop rig, after the familiar hail, "Hard a-lee!" is given by the skipper, the helm is put down hard and jib sheet slacked off. The boat goes in stays with both jib and mainsail luffing, and the jib sheet is still held on cleat while the jib fills on the other side, thus throwing the bow around. As soon as the mainsail fills and is sheeted home, the weather jib sheet is slacked off and the lee sheet snugged home and cleated, and you are "all standing" on the other tack. A good sloop ought to get about in seven seconds. Always remember that the jib is the last sail set and the first sail down, for, if the mainsail comes down first, the jib will play "Charley Horse" with you until you get it down

## 84 SAILING AND BOAT BUILDING

and furled, for with it up alone you have no control of the boat whatever. Get the driving power of the mainsail on her first, and then up with your jib. The only time this rule is broken is when running dead before the wind in such a heavy blow that not even a rag of the mainsail can be set. Sometimes I have scudded before a storm with only the jib set, and made excellent time at it too!

In going dead before the wind the jib might just as well come down, as the mainsail and spinnaker rob it of all the wind. The boy's simplest rig for a spinnaker that I can suggest would be: spinnaker boom rigged with slippery jim like a sprit, put on the mast just above the first mast ring. Boom has spinnaker sheet block on outer end. Use topping lift for spinnaker halliard and start out in the race with the spinnaker up and in fine twine stops along the mast, and spinnaker sheet already rove through pole block. The pole is carried lashed alongside of mast, upright. Now then; when you round that outer buoy, every second counts in getting the spinnaker set, for she will jump ahead as soon as she feels it, and if the other fellow gets *his* set first he will catch you. A boy at the spinnaker boom sets its end in the slippery jim, with guy led aft and sheet led

## CATBOATS AND KNOCKABOUTS 85

around mast to leeward, and at the hail "Let go spinnaker!" he drops pole out, yanks on spinnaker sheet to break the stop threads, and hauls it out flat on the boom, while the skipper is belaying the spinnaker guy on a cleat at the stern. Set it flat or ballooned out, according to the wind, by hauling in or paying out on the spinnaker sheet. If you have a balloon jib set also, it will pay to balloon the spinnaker out a bit, so that the wind spilled from the spinnaker will tumble into the balloon jib, giving that sail a little pull also.

Finally, the art of setting sails. A sail set dead flat will not be worth much. Shakespeare proved himself an able seaman when he made the line, "The wind sits in the *shoulder* of your sail." The ideal sail set is the curve of a bird's wing, or an aeroplane plane. It needs a full bag up near the luff, and then a nice flat plane aft, so that the wind, having done its work in the shoulder of your sail, can be passed out aft, dead, without any bags or pockets to retain it. For this reason a "nigger heel" jib and ditto clew and peak for the mainsail are always slow. The wind gets in that pointed bag in the sail and stays there, and that much of the sail might just as well be cut off with the scissors, for all the good it does! A slight out-curve or fullness to the leach of the

## 86 SAILING AND BOAT BUILDING

mainsail corrects the "nigger heel" tendency, and the same thing on the jib is done by cutting the foot, not on a straight line, but with a downward curve as you will notice in all the jibs shown in these illustrations. To get that desirable fullness in the luff, the young skipper will be careful to set up his gaff so high as to throw some wrinkles in the luff before starting, and also the lacing around the boom and gaff are eased off up near the luff and drawn taut aft. Finally, see that the peak halliard has a good grip, far out towards the upper end of the gaff. Otherwise it will sag off to leeward and you lose a lot of driving power.

In two-sail craft like sharpies and decked sailing canoes, a certain balance is again obtained by the proportions of the two sails. In this case the small sail astern, the mizzen, becomes the driver and is your "safety sail." It should go up *first* instead of the mainsail, for the tendency of the mizzen is always to drive the bow of the boat or canoe *up into the wind*—the point of safety. Every time you spill wind from the mainsail, your mizzen drives her up into the wind; without it you would most likely fall off the wind, as the mainsail is stepped so far forward, and you would be in a bad way indeed! So, set the mizzen and keep it trimmed a trifle closer than you are han-

## CATBOATS AND KNOCKABOUTS 87

dling the mainsail, thus giving her a weather helm. In this way your rudder has a better hold on her, aided by the sails, and she will come about nicely, even though the boat is long and narrow with a long, rather deep, keel. In coming about, throw her up into the wind and, after going in stays, back the mizzen, that is, reach around and hold its boom up to windward, thus using it to slew the stern quickly around and allowing the mainsail to fill off on the other tack.

And, do not douse the mizzen in a canoe when paddling with the double blade paddle. Theoretically leaving the mizzen up would drag you astern because of the constant luffing; practically, the wind is constantly shifting a trifle, filling the mizzen first on one side and then the other, and you can actually *feel* the drive of it. And, all the time, it is holding her head up into the wind so that you are not continually paddling on one side or another to bring her back into the wind, as you have to when having no sail up and paddling into a head wind.

While you will use but three knots constantly, the clove hitch (double half hitch), bowline knot and square (or reef) knot, there are about 20 others that you occasionally have use for aboard ship. The list of them is given below and the

## 88 SAILING AND BOAT BUILDING

drawings for which I am indebted to Messrs. Chas. Durkee are given, loose-tied, on the page opposite this.

1. Bight of a rope.
2. Simple or overhand knot.
3. Figure 8 knot.
4. Double knot.
5. Boat knot.
6. Bowline, first step.
7. Bowline, second step.
8. Bowline, completed.
9. Square or reef knot.
10. Sheet bend or weaver's knot.
11. Sheet bend with toggle.
12. Carrick bend.
13. Stevedore knot complete.
14. Stevedore knot commenced.
15. Slip knot.
16. Flemish loop.
17. Chain knot with toggle.
18. Half-hitch.
19. Timber-hitch.
20. Clove-hitch.
21. Rolling-hitch.
22. Timber-hitch and half-hitch.
23. Blackwall-hitch.
24. Fisherman's bend.
25. Round turn and half-hitch.
26. Wall knot commenced.
27. Wall knot completed.
28. Wall knot crown commenced.
29. Wall knot crown completed.



## CHAPTER IV

### BOAT BUILDING

Boat building is quite a step away from chicken house and woodland shack construction, in that it requires two qualities that are not essential in ordinary building—thoroughness and exactitude. Things that will “get by” in building a hen coop, like a crack not tightly made up, or a corner not exactly plumb, will never do in boat building; but when a boy gets to sixteen years and older he begins to take pleasure in honest, exact work, and will not be satisfied with rough and ready constructions, and it is at just about this age that he takes great interest in boat building, boat overhauling, boat rigging and all the aquatic sports that go with the ownership of a boat.

As most youths are much shorter in coin than in ambition, and as a boat costs but a third as much when you build it yourself, the way to own a really fine, large craft is to build it yourself, during the winter months. To do this you need a few tools, but these of the best; for no five-and-ten-

## 90 SAILING AND BOAT BUILDING

cent store articles will do for boat building. You need a *good* cross-cut saw, and ditto rip saw, each of them costing not less than \$1.65; a good jack plane, costing \$2.00; a good hammer, of real steel, costing a quarter; a ratchet brace, costing a dollar; four bits of the twenty-five cent kind; a breast drill with small twist drills for boring holes for nails (for no real boat carpenter would dream of driving a nail without first boring for it—it's the way they so marvellously avoid splitting things); a spoke-shave, costing 40 cents; and one chain boat clamp, costing \$1.50. This latter you can hardly get along without, unless you can borrow something of the kind from a carpenter, for the strains on boat planking are tremendous, and far beyond your strength to bend. You often read, in boys' books, of bending twenty-foot planks 14 inches wide by hand, the writer slurring over the details of *how* you're going to do it because he either does not know himself, or else does not realize what he is asking the boy to do. As a matter of fact your whole weight on such a plank will hardly bend it six inches, while it must bend some *two feet* to fit the curves of a boat, and this can only be done with a screw clamp. This clamp (Fig. 10) has a piece of chain attached, and two interchangeable hooks, the keel hook and plank hook;

and you use it either to squeeze the planks edge-wise against each other before nailing fast, as in planking a boat, or use it to draw the planks to the frame in wrapping them around the molds.

Going at it gradually, you can soon accumulate this set of tools, and are now ready for lumber. The best planking is white cedar, costing about 7 cents a board foot for clear stock free from knots. Next after it comes white pine; and last, cypress, which latter, though it will never rot, is prone to split, and is heavier than the other two woods. For stem, knees, deadwoods, frames, keel, etc., the best wood is sound white oak. There is no use considering anything else, as you can always get it.

My own boy is now building a 12-foot sailing batteau for cruising in Barnegat Bay, and as she is almost an exact duplicate of my boat, the *Margaret* (described in Part One, Chapter I), that I had when a boy of his age, we will start by telling how to build her. You want, first of all, a good oak stem, made from a piece of 4 x 4-inch white oak not less than 26 inches long. Most boys make the mistake of getting the stem too small, so that when they come to cut the rabbet for the  $\frac{7}{8}$ -inch side planks there is not enough wood left in the stem to nail securely to, and the boat is weak

## 92 SAILING AND BOAT BUILDING

where she ought to be strongest. And you want length enough to allow for the forward sheer and cutting across the stem at an angle, top and bottom, to match the sheer. Having gotten your stem piece, scribe a center line down one side and lay out from it two lines,  $\frac{3}{4}$  inch apart, which are to be the front edge of your bow. Do not get this any sharper, for when you have trimmed it round (or maybe put on an iron stem band) you will find it not any too wide. Lay off the shape of the stem and rabbet on top and bottom of your block of oak, as shown in the drawing (Fig. 6), and saw off the superfluous wood, or trim it off first with a sharp hatchet and finally smoothing flat with your plane. Then saw out the rabbet for the planks. It is easier to saw this than to chisel it out, as, once you get your rip-saw started right she will cut you a neat, plane surface that simply needs smoothing with the plane. The saw, of course, will slot the full length of your stem, cutting a deeper and deeper kerf until you get down to the bottom of the rabbet. Do not get these rabbet angles the wrong way (as shown by the dotted lines). Most amateurs make this mistake and the stem is ruined, for you then have a great hole in behind the side planks that will never calk tight in the world!

You are now ready for the side planks, the lower or garboard pair. Too often boys' books waste the poor boy's money by telling him to use these planks just as they come from the mill (Fig. 13, how not to cut), yet a little experiment with a cardboard miniature plank will show you that the only way those planks can bend around the middle mold with both edges straight is bolt upright, a most unseaworthy and landlubberly way for the sides of your boat to be. No; you must have out-board flare to the planks, and to get this flare like a regular boat and yet not have her bottom curve up so much as to spin around like a wash tub and have no grip on the water, you must cut the bottom edge of the garboard planks with a long in-curve of some three inches rise, as shown in the drawing (Fig. 14). The upper edge can stay straight, as that will give her just about the right sheer. Cut, also, the stem end of the plank at the slant shown and cut up the curve for the counter astern as shown, also lay off but do not cut the angle for the stern transom. Do not bevel the lower plank edge as yet. Both garboards are to be finished alike with square edges and sawed out with your ripsaw. When finished, paint the inside of the rabbet and the forward edges of both garboards with thick

## 94 SAILING AND BOAT BUILDING

white lead paste and then tack both planks to the stem with wire nails. They will lie out astern at a long angle, and, when satisfied that they lie true to the rabbet angle, bore four holes in each plank with your breast drill and drive in 2-inch 10-penny galvanized iron clout nails, setting them in below the surface of the planks to allow for putty above the nail heads.

You are now ready for the center mold. Suppose you have chosen fourteen feet for the length of your boat. Planks come in merchant sizes of 10, 12, 14, 16 and 18 feet, with rarely some 20-foot sizes to be picked up. You will then choose fourteen-foot planks for the garboard and sheer strake 12 and 8 inches wide respectively, one each for each side. Tack the sheer strake to the stem, lapping the garboard one inch, and then lay out on the planks the angle of the stern transom, measuring down from near the upper corner of the sheer strake (about an inch from the end of the plank to allow something over for the bend of the plank), and you will then have the right *length* for the garboard plank, and this should be done before sawing it. If the boat is to be about fourteen feet long (she will come a little less when the planks are bent) the right beam will be 4 feet 6 inches, and the flare on each side to throw back

the waves will be 6 inches, making the bottom 3 feet 6 inches wide.

Now for the height amidships; the garboard plank as it came from the lumber yard was 12 inches wide, of which 3 inches was taken out amidships by the rise of the bottom curve. This leaves 9 inches for the garboard width amidships. The top or sheer strake will be an 8-inch board, and will lap the garboard one inch, so that the total depth of the side amidships will be 16 inches. Get a rough 10-inch board and saw from it two pieces about 4 feet 8 inches long, cleat them together, making one wide mold some 18 inches high by 4 feet 8 inches long, and lay out on this the lines of the center mold as shown in Fig. 5, with a 3-foot 6-inch bottom, 6-inch flare, 16-inch sides and 4-foot 6-inch top. Cut out a  $\frac{7}{8}$  x 9-inch notch on each side for the garboard, making the actual width of the mold bottom 3 feet  $4\frac{1}{4}$  inches inside, allowing  $\frac{7}{8}$  inch for the lap of sheer strake on garboard strake.

Now you are ready to put in the mold and bend the garboard planks around it. The mold does not go in the center, but, to get a pretty sailing shape, it is put 6 feet from the bow and a little less than 8 feet from the stern. Now to bend the planks: Put on your chain clamp, with the

## 96 SAILING AND BOAT BUILDING

plank hook bearing against a cleat tacked on outside the after edge of the strake and its screw foot bearing on a similar cleat on the opposite after edge. By main strength you can bring the planks together maybe a foot or more around the central mold as brace, and then you catch the chain in the right link to hold what you have gotten. Next, screw in on the clamp, drawing the plank ends together until they are the right width to fit in the stern transom. This is made of oak,  $\frac{7}{8}$  by 12 inches wide and is cut, shaped very like the central mold, with the same flare angles but narrower. For a fourteen-foot batteau your stern seat would need to be about 3 feet wide at the top and 2 feet 3 inches at the bottom; allowing for a  $\frac{7}{8}$ -inch notch on each side for the garboard plank, it makes the actual bottom dimension of the transom 2 feet  $1\frac{1}{4}$  inches, and, as the sheer strakes will take 7 inches of the transom, this notch for the garboards will only be 5 inches high. (The actual distance you take off the transom cut of the garboard planks.) This gives very little to nail to, and certainly not enough to hold the planks if you take off the clamp. However, bore for two clout nails and drive them home through the garboard strakes into the ends of the transom, and tack a board across the bottom with nails driven into the



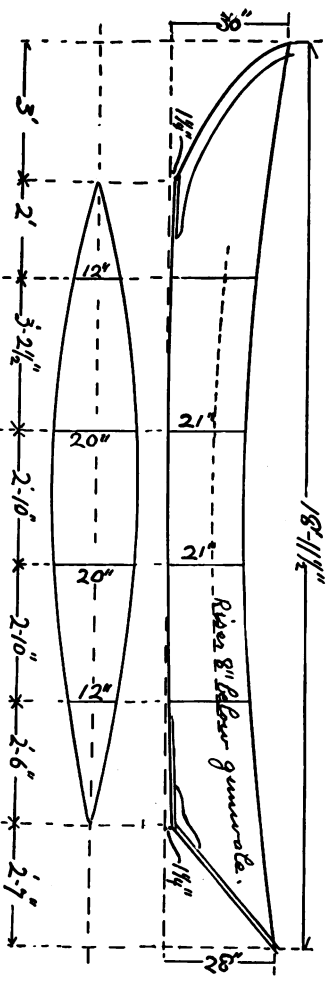
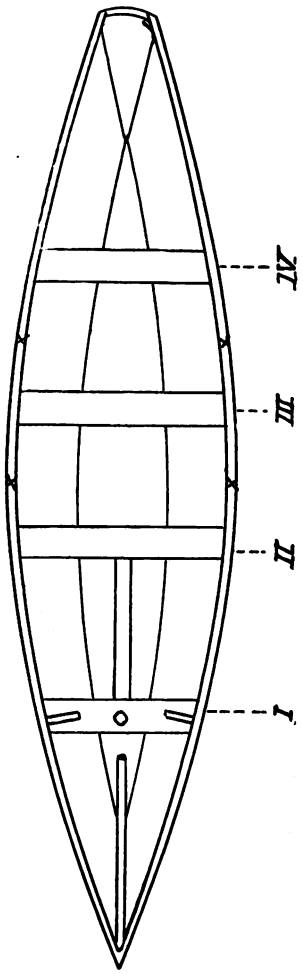

Fig 2.—Construction plan, with all necessary measurements from which to cut paper patterns

SHEER PLAN AND BODY PLAN OF 19-FT. SAIL DORY

Courtesy "Yachting"

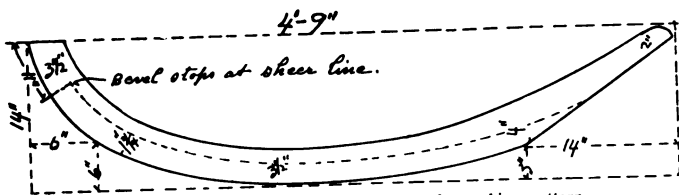
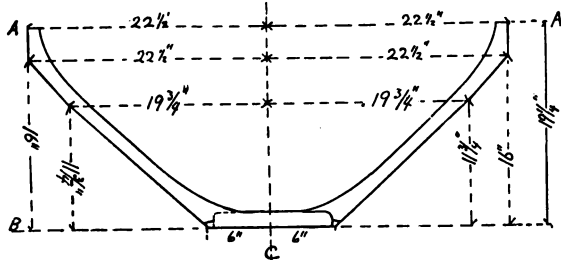
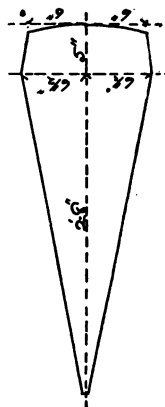
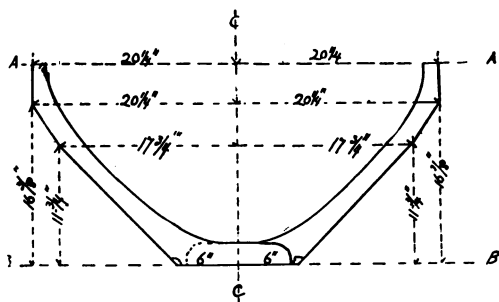
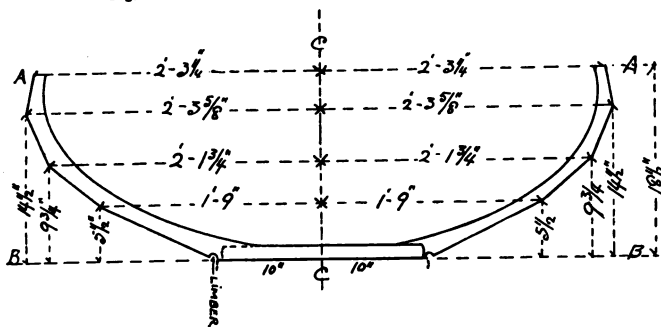

Fig. 8.—Stem piece, with measurements for making pattern



FRAMING DESIGNS FOR AN 18-FT. SAIL DORY

Courtesy "Yachting"

garboards on the turn of the counter. Then work in two oak corner knees, 6 inches on a side, to fit snugly in the corners between the inside of the garboards and the inside of the transom. These are secured by two No. 14 brass screws  $2\frac{1}{2}$  inches long, driven through the outside of the garboard, and two more driven through the outside of the transom. These knees are very important, for strength in securing the garboards to the transom. Even now you dare not take off the clamp, but must first secure the garboards by nailing on all the bottom planking, with the clamp still on the transom.

Turn the boat over and "spot" the garboard plank edges for bevelling (Fig. 8). To do this, take a strip of wood 2 x 1 inches, perfectly true and straight, and lay it across the bottom of the boat at various places, marking down from it the *outside* of the garboard the correct distance that its *inside* edge is below the under surface of your strip. Run a thin batten through all these points, and scribe a line, which will be the bevel line to plane to. Finish smooth and true with your plane, and then put on your bottom planks, beginning at the transom. The plank furthest aft overlaps the transom and nails to it, so the latter must be bevelled to match. When you get forward to the

## 98 SAILING AND BOAT BUILDING

small planks up at the bow, it is time to stop and put in the keelson, in which I am a great believer, for the additional strength it gives, besides keeping the bottom planks from springing (though plenty of small rowboats *have* been built without keel or keelson). However, we will put one in our boat, as she is to be an able deep-sea cruiser. Get it out of  $\frac{7}{8}$ -inch yellow pine, dressed, 6 inches wide and 14 feet long; and the cheapest thing to do is to pick out a nice 12-inch board at the mill and have them rip it in half for you, getting thus keel and keelson at the same time. The keelson goes inside the boat, from stem to transom, and is bent to fit snug along the bottom. Each plank is nailed to it with four 8-penny galvanized clout nails, driven through from the bottom and clinched (first boring for them with the breast drill) and setting the heads in to take putty. The keelson will bend up the counter easily if you begin nailing at the bow end first and cross-cut it half through every inch where the turn of the counter begins to get bad. An oak knee is worked in from keelson to transom, thus strengthening the latter.

All the bottom plank nails are 10-penny galvanized, driven down into the garboard edges, three to the plank and set to take putty. When all

of the plank ends have been trimmed off with the cross-cut saw and the rough ends planed smooth, you are ready for the sheer strake planks, which are now to be nailed to the stem the same as the garboards. But, as they must come in flush, to fit into the rabbet, so you must first cut a bevel on the tops of garboards, beginning about 16 inches back from the stem; and cut a corresponding bevel on the bottoms of the sheer strakes. In order not to get a thin shim edge that will not calk well, cut this bevel with a notch, as shown in Fig. 11. Having fitted them, nail fast to the stem and wrap the planks around the mold, overlapping the garboards an inch. Nail with 8-penny galvanized iron clout nails every three inches, boring for each to avoid splitting the edges of your planks, driving the nails from outside and clinching inside on the garboard. It takes two boys to do this, one holding an axehead against the spot where the nail will come through.

When you get aft nearly to the transom it will be time to take off the clamp (which was on the garboards all this time) and you had best secure them by tacking a few strips across the top of the boat, here and there, and wrapping a rope around the boat near the stern, tightening it by driving a wedge in between the boat bottom and

## 100 SAILING AND BOAT BUILDING

the rope. I once ruined a nearly finished batteau by taking the clamps off at this time without proper security. It was a single-plank, ten-foot dinghy, and the strains in bending the planks were very severe. After nailing on the bottom boards and transom, I took off the clamps without putting in the corner knees, and while working at them there was a sudden rending crash, and the whole boat flew apart in a second. The side planks tore loose from transom and bottom planks, great strips of wood being torn off the bottom of the side planks, and the only thing to do was to cut up those side planks until I got to good sound wood again, a loss of about two inches in depth of the sides. It is a classic accident; one that will happen to all youthful boat builders unless warned.

However, we have got to get off our clamp from the garboards, to wrap in the sheer strakes, so we will do it now, putting the clamp on as soon as possible and drawing the sheer strake planks in until they lie flat against the garboards and are snug to the transom. Then drive and clinch the lap nails aft to the stern, drive in nails through sheer strake into the transom, and work in two more oak corner knees flush with the gunwale. Then trim off with a saw any overhang of the

sheer strakes (which should be left long enough for the purpose).

Next, put in the sill for the stern seat. It is a piece of  $\frac{7}{8}$  x 4-inch oak, and is fitted in on edge about 24 inches forward of the transom, securing with two screws, one each side, driven through from the outside. It should come about six inches below the gunwale and should notch to fit over the tops of the garboard strakes. When this is in you can safely take off the clamp for good, and can handle the boat without fear. Turn her over and put on the keel, first trimming off the surplus stem true with the top sheer and bottom rocker. The keel is to go under the stem and have a large screw driven through it up into the stem. But, before this is done, all the bottom planks must be calked or you will not be able to get at the seams *under* the keel. Calking takes three operations: (1) opening the seam with a calking tool (the No. 0 is right for small boats); (2) calking the seam with cotton, sold for the purpose in balls of wicking; (3) "paying" the seam, as painting over the cotton is called, and puttying over the paint. It is quite a job, but when done the keel can go on and is best secured to the bottom with No. 12 brass flat-head screws, countersunk to take putty over their heads. Slot the keel back four feet

## 102 SAILING AND BOAT BUILDING

from the stern, with two saw cuts an inch apart, leaving a central tongue which you will spring up over the skeg. Now screw fast these two keel sides under the counter, trimming off at the transom. Next, fit the skeg. It will be about eight inches deep, as you can find out exactly by bending the tongue of the keel until it comes in true line with the bottom. Hold an eight-inch board with its edge touching the bottom of the boat, the board being exactly in the line of the keel. Now scribe from the bottom with a stick 8 inches long and having a pencil on the end of it, making a curve on the board parallel to the curve of the bottom, or "counter" as it is called at this point. Saw out with your rip, and you have the skeg, which can then be driven in snug under the keel tongue, fitting tight in the slot between the keel strips up under the counter. Trim off at the transom and put on the stern post, made of 2 x  $\frac{7}{8}$ -inch oak, screwed to the back of the transom with 2-inch brass No. 14 screws, also driving them through the post into the skeg. Finish the job by driving screws down through the keel strip into the skeg and also from the inside of the boat through the bottom planks into the skeg.

We are now ready to take out the central mold. Before doing it, its place must be taken with some-



thing equally strong, and that is the central rowing thwart. This goes in just aft of the mold, and you first get out two side braces of  $\frac{7}{8}$  x 8-inch yellow pine, 16 inches long, and tack to each of them a block 8 x 8 x  $\frac{7}{8}$  inches to take care of the lap of garboard and sheer strake planks. These side boards are secured by brass screws driven through from the outside, and then the thwart is cut, of 8 x  $\frac{7}{8}$ -inch yellow pine, and set in to come about 8 inches above the bottom of the boat. It should drive snug, so as to spread the boat a trifle and free the central mold. Take this out, and the boat is nearly done. Get two yellow pine 1½-inch half-round pieces of molding, 14 feet long, to be bent later around the gunwale over the wash board cracks for fenderwales. Work in an oak breast-hook in the bow, just aft of the stem and fitting snugly to it. Two oak knees to the rowing thwart, and the boat is done, as a row-boat, barring the stern seat, which can be fitted in, in white pine, left-over, bottom planks.

But we want a sail batteau of her, with deck, washboards and centerboard. Put in the centerboard first. The construction I have shown in Figs. 1, 2 and 3 is the easiest to make and put in. The sides of the trunk are 12 x  $\frac{7}{8}$ -inch white pine, 30 inches long, and are secured to the posts with

## 104 SAILING AND BOAT BUILDING

brass screws, some lamp wicking and white lead paste being run along between the posts and trunk boards, not only to make it tight but to make it a trifle wider, so that a  $\frac{7}{8}$ -inch yellow pine center-board can swing freely inside. Saw this center-board out, building it up of 4 x  $\frac{7}{8}$ -inch yellow pine strips, strung on two  $\frac{3}{8}$ -inch iron rods by drilling holes for the purpose, and finally planing the whole thing flat and true. About 26 inches long, 12 inches deep at forward end and 16 inches aft is about right for this board. Swing with a white pine plug, driven through both sides of the center-board trunk and passing through an inch hole in the lower forward corner of the board. The posts must be long enough to go through keelson, bottom boards and keel "and then some"; say,  $3\frac{1}{2}$  inches longer than the height of the trunk. Slot through the keel, keelson and bottom boards with compass and rip-saw, calk all the seams inside with a hook calking iron, and then lay lamp-wicking soaked in white lead paste around the slot, set in the posts and trunk and draw down tight with long, 4-inch No. 16 brass screws, driven up through keel, bottom boards and keelson, into the bottom of the centerboard trunk planks.

To put on the deck you first want a set of deck carlines, spaced about eight inches. These are of

2 x  $\frac{7}{8}$ -inch oak, and are planed with a slight crown on the tops. Secure by toe-nailing to the sides on top of a "riser" strip, run around two inches below the gunwales, inside on the sheer strake. The first thing to go on these carlines is the plank-sheer, which continues aft to form the washboards. Four inches wide is plenty, and it must be gotten out in two pieces to a side. By stretching a string across, from the stem to a point on the gunwale about 6 feet 6 inches aft from the stem, you will find a place where the height of the curve from stem to this point and from inside corner of transom and sheer strake to the same point will be the same height, 4 inches. As you want the plank-sheer to be four inches wide, it is obvious that such a curved plank can be cut from a board eight inches wide, but six feet long for the plank-sheer and eight feet for the washboard. Lay one of the 6-foot boards down on the deck with its outer edge just touching the gunwale about 3 feet 3 inches from the bow. Then scribe the outline of the gunwale on the under side of the plank, and batten a parallel line four inches away from it, which second line will just end inside your plank corners. Do the same thing with the 8-foot plank, laying it on the gunwale just touching at a point 4 feet from the stern, and scribe your line. Run

## 106 SAILING AND BOAT BUILDING

a second parallel line four inches from it, and saw out both planks. They will meet end to end over a block placed a foot aft of the carline which forms the nail strip for the front cockpit coaming, which latter crosses the boat five feet aft of the bow. Make the port side plank-sheer and washboard precisely as described for the starboard side, and meet the two plank-sheers on the breast-hook, laying one on top of the other and sawing a neat cut down the centerline of the boat to bring them snugly together. Nail them to breasthook, carlines and gunwales. The washboards will need little triangular blocks under them at intervals of about 18 inches along the inside of the gunwale, these blocks being 4 x 4-inch triangles, gotten out of  $\frac{7}{8}$ -inch pine, and fitted snug to sheer strake and under side of washboards.

The cockpit coaming goes on next. About twenty feet of 4 x  $\frac{3}{4}$ -inch oak will do, and it should be molded half-round on the upper edge. Run this across the front of your cockpit, nailing to the carline, and around the inside of your washboards, letting it hang down maybe  $\frac{1}{2}$  inch below the under side of the washboards.

They are called by this peculiar name, you will find out as soon as you begin to sail, because these

boards are awash most of the time when tacking. Without them you cannot sail much in a stiff breeze, because the water will always be coming over the gunwale, but with them you can "roll her down good."

The next thing to go on is the king plank, or "mast partner," as it is called in larger boats, because there are two of them for large masts, each cut out half-round to pass a big mast. With a small boat like ours a single 6-inch yellow pine  $\frac{7}{8}$ -inch dressed plank, five feet long, suffices, and you nail it fore and aft, fitting snugly into the angle between the plank-sheers, resting on the breast-hook, and fitting snug against the cockpit coaming aft. It is nailed to all the carlines, and you then have left two triangles to fill on the deck, in between the plank-sheers, the king plank, and the forward edge of the cockpit coaming. Fill these with narrow 2-inch strips of  $\frac{7}{8}$ -inch white pine, nailing each strip to the carlines, and then calk the whole thing, every seam in the deck, for it is just as important to have your deck tight as your bottom. Next wrap around your half-round fenderwales, covering the crack between washboards and gunwales, and then make your bowsprit, working it out of a piece of 2-inch square spruce, six feet long, and let it stick out three feet beyond

## 108 SAILING AND BOAT BUILDING

the bow. Bolt to king plank with  $\frac{3}{8}$ -inch galvanized iron through bolts. Add a wire bobstay and a galvanized iron, two-ring withe (Fig. 9), over the end of the bowsprit; put your oarlocks in their proper places on the washboards; put in rudder gudgeons; main and peak halliard cleats on the cockpit for'd coaming; two jib sheet cleats on the inside of the sheer strake, aft, just in front of the stern seat; a main sheet cleat on the inside of the transom; jib downhaul and halliard cleats on the for'd cockpit coaming; centerboard cleat on the centerboard trunk; a chain plate to port and starboard, six inches aft of the mast hole on the outside of the sheer strakes; and you are ready to rig her, for details of which see Part One, Chapter I. A word about the lower mast step. This is one of the most strained blocks in the boat and must be put on with four heavy screws, well sunk into the keelson. Two screws will not do, as the mast will surely split the step in half. To get the position of the step wait until your mast is in, when you can find it by eye. The mast should rake back about 6 inches, coming forward maybe three inches when you set taut on the wire rope jib stay.

A more complicated boat to build than the batteau is the dory. Except that it has a set of frames, around which the strakes are wrapped,

its details of construction are much the same as with the batteau. You have the flat bottom to begin with, only this time the planks run fore and aft, and on these the frames, stem and transom are first set up, after which the planks are wrapped as described in Part One, Chapter II. When we come to the clinker built boats we are getting into real fine work and you have hard garboard planks to fit to a rabbet in both keel and stem. The planking is beveled and secured to the ribs as shown in Fig. 12. To build such a boat as the various skiffs shown in our chapter on catboats and knockabouts, you first set up keel or bottom plank and then on them the stem and stern transom, secured by deadwoods and the stern knee. Molds taken from the designer's lines are next set up at equal stations along the keel or bottom plank, and the garboard and upper strakes are put on around these molds, usually working both ways from garboard up and from sheerstrake down, so as not to come out with a lumpy, uneven sheerstrake. After this the ribs are steamed and shoved down inside the boat until they touch the planks equally all around. These ribs are very small and numerous, about  $\frac{3}{4} \times 1\frac{1}{4}$  inches wide being right for quite a large skiff. When all are in place and secured, the keelson is bolted over the ribs where they cross

## 110 SAILING AND BOAT BUILDING

and all the thwarts are put in and kneed to the ribs, and the clamp (as the oak strip that runs along inside the gunwale is called) is riveted through all the rib heads to the sheer strake. The molds are then knocked out and the boat is ready for paint. In still larger boats, carvel built, that is, with planks nailed to the ribs and abutting against each other so that the skin is a flush surface, the keel, stem, stern hook and transom are first set up and spiked to all the deadwoods with drift bolts. Next the rabbet is cut, and, as the angle of it constantly changes, the "bearding line" or inner line of the rabbet must be found from the plans and the rabbet chiselled true at various spots, when it can be cleaned out fair and true joining these spots, and it will then fit the garboards when they are put on. Next all the ribs or "frames" are bent to agree more or less with the set of molds taken from the plans. These molds are spaced from two to three feet along the keel and battens are run around them from stem to stern to get the fair lines of the model. The ribs are then put in and faired up, also bevelled to lie flat against the future planks, fore and aft, and then their floor timbers are nailed to both ribs and keel. This holds them firm in their shape, in addition to which battens are tacked across each



pair of ribs and across the bend of each rib, so that it will hold its shape until the planks are on. In large boats every third rib is sawed out true to the next mold, which is taken from the lines. This gives additional stiffness, as this third rib is always of much larger stock, say 2 x 3 inches for a 30-foot boat, and they further hold the model true, since they agree with the molds. The two most important planks are then put on—the garboards and sheer strakes. To fit the garboards a spiling is taken of the line it must make to fit into the stem and keel rabbet. This is always a peculiar wavy line, when the plank is out flat, and, as it must fit snugly, the only way to find it is to tack on a flat batten, called the spiling, which roughly fits the line of the rabbet. The exact fit is then scribed on it by a marker and pencil, the marker always touching the edge of the rabbet line and thus transferring its contour to the spiling batten. Cutting this line out on the batten and laying it on the garboard planks you mark the bottom lines of each of them. To get the top lines, each rib is divided into as many divisions as there are to be planks, the narrower planks being at the round turn of the bilge, and these distances are laid off on the garboard plank up from the rabbet line along each rib line as drawn out on the gar-

## 112 SAILING AND BOAT BUILDING

board plank. A batten is run through these points and getting at this line with your rip-saw you have the outline of the most important plank and the hardest to fit. Take time and get it on right, for a leaky garboard means a leaky boat for the whole of her life. To get these carvel-built planks on snugly, the chain clamp is brought into play, sometimes hooked over the keel to draw a plank snug against its lower neighbor, sometimes hooked over the sheer strake (or taffrail if same is already on) to hold a plank tight against its upper neighbor while the holes are being drilled for the nails or the rivets driven through planks and ribs. Each plank, where it passes a rib, should be hollowed out slightly with an adze, and the edges of the planks are not cut square but bevelled slightly to open about  $1/16$  inch on the outer seam (Fig. 7), so that you can calk the wedge-shaped crack thus formed, and when she swells shut she will crush the inner edges of the planks tight. A boat perfectly planked, with edges meeting square, would simply burst herself when she went overboard, for there would be no room for all the planks to move in when they swelled under the influence of the water.

In order not to add up any errors in building up a planked boat edge to edge, ship carpenters

always stop planking at about the fifth plank up from the garboard and begin planking down from the sheer strakes. The final plank is apt to be very irregular in shape, but is not noticeable if it occurs on the side of the ship, while it would be painful to see if up just under the sheer strake. Further and more elaborate details of how to plank a large carvel-built boat are given in our chapter on building a power cruiser.

You will note that making molds or frames from plans is an essential feature of boat building. The "lines," as they are called, of many of the boats in this book are given in the illustrations, and you can build the boat from them. Enlarge to the size you have selected. This is best done with an architect's rule giving you choice of scales from  $\frac{3}{32}$  inch = 1 foot up to 3 inches = 1 foot. Lay off the lines on coarse building paper, full size, *both* body plan and sheer plan. The reason for this is that your lines as enlarged from the body plan will never agree with the lines as enlarged from the sheer plan, but will be out from  $\frac{1}{4}$  to  $\frac{1}{2}$  inch, due to errors in enlargement, and you must correct these errors until both sets of lines agree, and yet sweep fair curves with no wriggles or dog's-tails in them. Then, when you make molds from your enlarged and corrected full-size body

## 114 SAILING AND BOAT BUILDING

plans, they will be true and the planks when put on them will run in fair sweeps, with no flats and hollows.

For boys around eighteen to twenty years old it is not hard to lay out a knockabout from our plans and build her complete. None of the timbers are very large, and the construction is, in general, simple. A centerboard modification of the accepted deep-keel type is more agreeable to the youth's pocketbook, for a lead or even an iron keel is not to be thought of for persons of ordinary means. But sand or gravel ballast is cheap, and simply requires the manufacture of a dozen 10-ounce duck canvas bags, about 30 inches long by 18 inches wide, which will each hold a hundred pounds of beach stones, to be picked up for nothing on any beach along our shores. These are stowed in the bilges, and you then have a ballast that will insure stability. The rest is a matter of a few hundred dollars for lumber and hardware, and you have a racing boat which would cost some \$2,000 at the shipyards.

And, in all boat construction, do not overlook the knockdown frame idea. It saves a mountain of hard labor and insures a hull that will be true to design. Buy the frame, knocked down but fitted, and buy the plank patterns. Lay out the

latter on your plank stock and have your planking sawed at a band saw, and the whole job will cost but a couple of dollars, whereas if you rip them yourself, not only is it a back-breaking job, but you are sure to spoil more than two dollars' worth of planks in mistakes and slips. Calking, paying and puttying seams, fitting the planks, nailing them fast and countersinking and upsetting rivets, planing the skin of your ship to a fine smooth surface that will take paint without showing tool marks, sandpapering the whole thing to a fine polish,—all these are long-winded jobs, and quite enough for a gang of youths to undertake with a large boat. With a small one all these are but details and the main building operations are not overlong in time. Even a couple of twelve-year-olds can make a good job of a batteau; and older boys around fifteen years of age can make a sharpie which is a batteau some twenty feet in length with flat or else skipjack dead-rise bottom; or they can tackle a 17-foot sail dory. Around seventeen years a boy has proficiency and honesty enough to try a lap-strake skiff or catboat. By honesty I mean intolerance of any faulty work, and nerve enough to scrap spoiled work instead of trying to make it go in the boat, where it will worry you from that time on. A boy that is hon-

## 116 SAILING AND BOAT BUILDING

est enough with himself to take the consequences of his mistakes in measurements and carpentry and not try to foist them off on his boat, has learned one of the great lessons of life. He'll do to trust with a man's job, as soon as he knows enough!

## **PART TWO: CANOEING AND CRUISING**

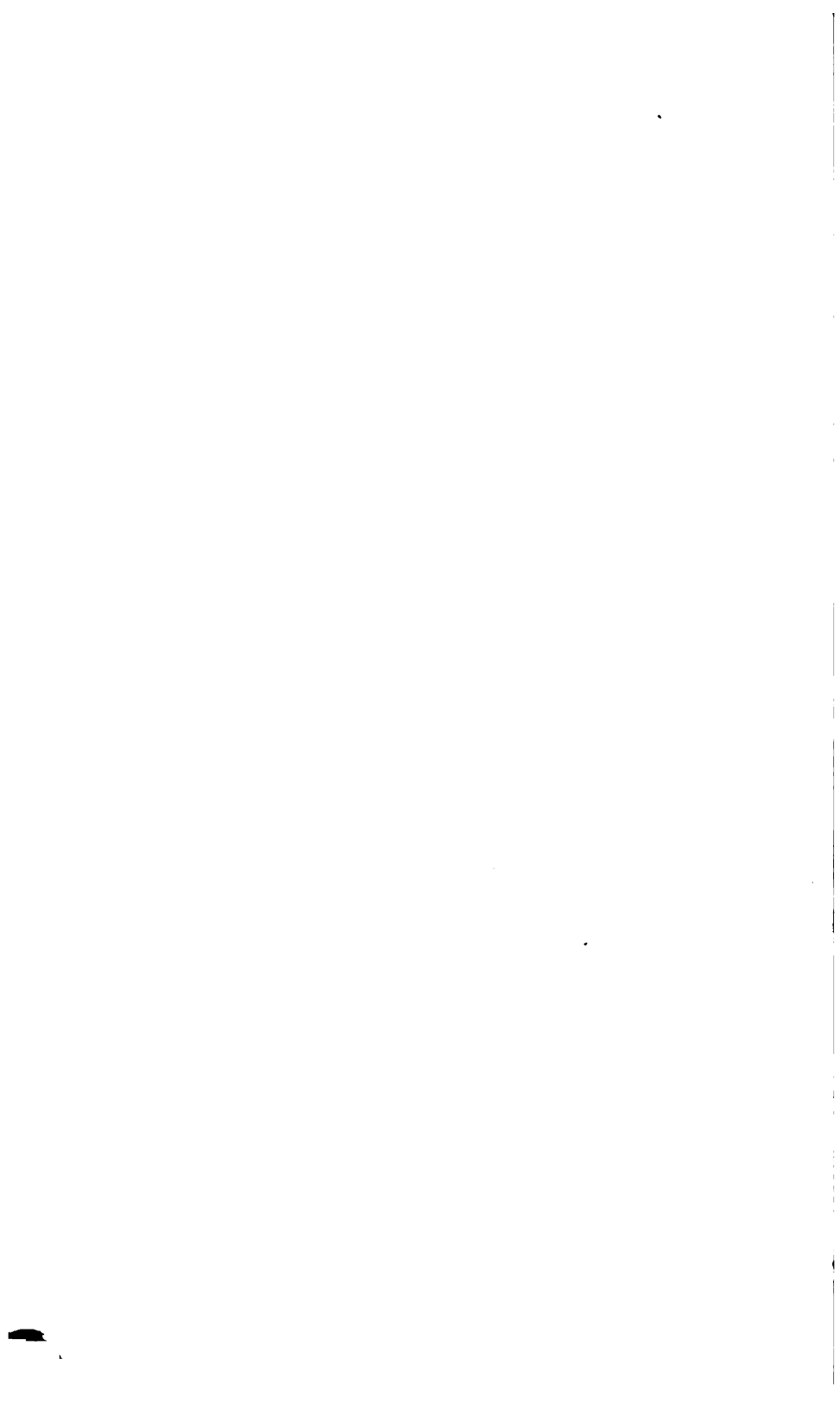



## PART TWO: CANOEING AND CRUISING

### CHAPTER I

#### HOW TO RIG AND HANDLE AN OPEN CANOE

PROBABLY of all craft the open paddling canoe gives the most sport, the greatest change of scene, and the most ease of woods travel with the least effort. Compared with rowing a boat, riding horseback or back packing through the forest trails, the canoe is paradise, as the work of paddling is so divided among the muscles of the whole body as to make none of them ache, and one sits down comfortably, not with bumping seat and strained knees as on horseback. A down-stream canoe trip, particularly on a wild river where there is plenty of fish and game and one camps nightly along the banks, is one of the most enjoyable outings a boy can take, and none of it is too hard work for the unformed muscles of youth.

Wherefore, owning a canoe is the ambition of every man living within reach of lake, stream or bay. Nowadays they are very cheap—as boats go—a good canvas canoe, staunchly built, canvas

## 120 CANOEING AND CRUISING

covered over wooden sheathing, being had from such a concern as the Detroit Boat Co. for as little as \$20. One of the best canoes in the world, the White guide's model, is only \$28, and the extra-well-built canoes of the Morris company cost around \$40, so the youth from twelve to twenty has a wide range of choice in the quality purchasable.

I should not advise trying to build such a canoe. Later on in these chapters I will tell you how to build a decked sailing canvas canoe over a spruce and ash frame. I have built four of these canoes, my first offense being at the age of twelve, and they all cost about \$7 for material alone, so that the material for the much-ribbed and sheathed open canvas canoe would run at least \$14 and one will get a better boat for \$20 than could possibly be built by an amateur.

In choosing a canoe the first question comes up, shall we have a keel or not? This has been argued pro and con by many an experienced woods voyager. The keel adds staunchness but increases her draft at least an inch, so that she may stick in getting over a ledge or a down tree while the other would slip over. On the other hand the keelless canoe will get her canvas badly scraped if the ledge is sharp and she touches, and, in lifting over

trees when heavily loaded, she is apt to buckle or "hog-back" amidships. My own Morris, which has done over a thousand miles of wilderness river travel, has a keel an inch deep, and she bears few scars on her bottom, most of them being on the turn over the bilge, yet going over dams and down trees is her specialty,—I should say at least a thousand of the latter have passed under her keel first and last! A compromise measure, adopted by recent canoeists and suggested by the writer, has been to put on a flat strip keel of hard maple about  $\frac{3}{8}$  inch thick and three inches wide, which will protect her from scraping yet only increase her draft a tiny bit.

In picking a canoe, the safest and fastest model has a quite flat bottom, with a sharp, round turn to the bilge. The tippy ones are those deep and round on the bottom with no bilge, having no more stability than a barrel. The flat bottom draws but little water, slides over the stream like a duck, and it makes her a prime sailer because she is so staunch. The dimensions of my own canoe, a faster canoe by hours than many another model which she has raced down stream, are: length, 16 feet; beam, 33 inches; depth amidships, 12 inches; depth bow and stern, 24 inches; width of comparatively flat bottom, 24 inches. The cheaper type

## 122 CANOEING AND CRUISING

\$20 canoe, one of which is owned by my boys, has the following dimensions: length, 15 feet 6 inches; beam, 31 inches; depth amidships, 12½ inches; depth, bow and stern, 22 inches; width of comparatively flat bottom, 16 inches. This latter canoe is much more tottly than mine, hard to sail and nowhere near so staunchly built. Both canoes weigh about 60 pounds.

Having purchased the canoe, the first thing to learn is how to paddle her. The sign of the novice is his reaching far ahead for his water. Do not let yourself do that; you have no leverage there, most of your strength is to be put in as the left wrist passes your left hip, the while your right hand is sweeping the top of the paddle forward. This will put your shoulder and body into it and the motion can be kept up all day without fatigue. If paddling with another fellow in the bow, the stern man is always captain, and he is to correct with a turn of his paddle any deviation from the true course during each stroke. Your mate may be weaker than you, and the canoe then tends to swing towards his paddle side, which is generally opposite to yours. In that case, correct him at the end of each of your strokes with a turn of the paddle. If paddling alone it makes a vast difference where you sit as to how the canoe be-

haves. Abandon the rear seat and find a place kneeling somewhere just forward of the rear cross brace. Here you can paddle on one side indefinitely, holding the paddle blade at a slight angle inwards from straight across. If you find that the canoe tends to sheer away from course opposite from the side where you are paddling, move a bit further forward and alter the angle of your paddle slightly until you get her balanced just right. It is the only way to win a race, for the time lost in correcting your course at each stroke, as you would have to do sitting in the rear seat, will lose you out every time.

River paddling, especially in rapid white water, is full of kinks which you have to know and use instantly. If the bow man, never embarrass the stern man by striking at rocks, etc., with your paddle. You will do no good whatever, and may upset the canoe. The water always takes care of the bow, the stern is the thing to be swung clear with the paddle. You report "Rock ahead!" and be sure that he sees it, and then leave it to him. His stunt is to back paddle the stern of the canoe *away* from the position of the obstruction when the current will swing the bow, as it is flowing faster than the canoe is going. The bow man's hard work comes going around bends. The river

## 124 CANOEING AND CRUISING

tends to swing the canoe into the main eddies and your aim is to keep out of them, cutting across in the still water. If you want hard work going down stream just let the canoe stay indefinitely in the deepest and fiercest waters! And so the bow man must anticipate the river each time and get his bow headed out of the eddies and into the quiet part of the bends, as here the stern man can aid but little. As soon as the bow is right the stern man puts in his strength and shoves her ahead across the head of the bend. Never back paddle at these times, you lose all your steerage way and put yourself at the mercy of the current.

Down trees and shallows require instant decision as to where to take them and agreement at the same time between bow and stern as to what they are going to do. Don't argue or fight when the river is bearing you swiftly on the obstacle! All other things being equal, the stern paddle has the say. There is usually a hole around one end or the other of the tree through which the canoe can be snaked. Occasionally it is advisable to cross the stream without going either up or down, and to do this, bow back-paddles lightly and stern paddles forward heavily, which will have the effect of holding the canoe stationary at a slant upward

to the stream. The current will then take her across.

In approaching a down tree which cannot be gotten around, back her and let her swing about gently until broadside to the stream alongside the log. Pull out the heaviest duffle and set on log. One man stands on the log on either side of the canoe, and between them she is slid over. Most of the duffle can be left aboard. In rocky waters, go ahead and look over the rapids before venturing out, for once started there is no turning back. More than once you will need to have the courage to be a coward,—for it takes a brave man to say “No!” when an inexperienced crowd want to run a rapids that better men than any of them have portaged around. If there is a portage trail it is a pretty fair sign that most canoeists go around instead of shooting the rapids. Look for a landing, apparently much used, or a blazed tree, or tin can on a sapling. If you have decided to run, see that all duffle is lashed securely and go to it, the stern man being the responsible one. As the current splits over rocks it forms a cushion which will float your bow away if the stern man but guides it in the current and takes care to keep his stern clear. Keep where there is plenty of current and water, but avoid the main bend, if pos-

## 126 CANOEING AND CRUISING

sible, particularly if there are many rocks. Back paddle and let her come down easy at all points of danger.

The stern paddle should be heavy, of hard maple and copper shod, five feet long, 28-inch blade, 6½ inches wide. ~~The bow paddle is lighter,~~ of spruce, five feet long, 26-inch blade, 5½ inches wide. If upset in a rapids, hang to the canoe and let the paddles go; you can find them somewhere in an eddy down stream later, but to swim after them in rough water is folly. One man takes the bow and the other the stern, and you work her ashore as soon as possible, build a conflagration and dry out everything. In traversing, i.e., crossing, a lake or bay, look carefully at your whitecaps first, or indications of wind if the water is calm. A canoe lightly loaded will live in an incredible sea; heavily loaded she becomes logy and a death trap. Once in November I came spinning down the Metedeconk River with seven miles of white water behind me in which even a heavy 25-foot launch made desperate weather. I had my boy and a chum along and all our duffle, but one look at the whitecaps made me decide on a back-packing expedition for them along shore, while I took the canoe alone. I left 50 pounds of duffle in her and started down wind for a point three miles



away. It was sure a wild ride! The seas were three to four feet high, white-capped, and the wind so strong that it blew the canoe bodily across the waters. Gradually I worked the canoe out abreast of the point, but I blew down on it so fast that I suddenly realized that I would clear it, if at all, only by the most desperate paddling. As it was, I ran into the big combers off the point, the second one of which picked up the canoe broadside and curled her over as if to dash her bottom up on the shoals.

“No you don’t!” I gasped, and, shoving hard down on the weather gunwale with my elbow, I righted her and took the sea aboard. It filled her a third full of water, but, before the next comber could pour in its cap, I had flown around the point and was in the still water under its lee, where the boys soon joined me. So, if you must traverse, and the seas are high and choppy, better make it in two trips lightly loaded than try to do it in one and get swamped. When you see a sea about to curl aboard, give the canoe a flip so she shows her bottom to the wave, when it will go under you and all will be well. If any come in and there are likely to be more, lay to, and one boy (bow) starts bailing. Always have your paddle tied to the crossbar by about eight feet of small cotton rope

## 128 CANOEING AND CRUISING

in making a traverse and have the duffle loose. If swamped or upset, hang to your paddle and regain the canoe, for it's a drowning matter if she gets away from you.

In reasonably still waters one boy alone can bail out an upset canoe. There are two good methods, rocking it out and shoving it out. In the first, swim around to the stern of the canoe and get the water inside rocking from side to side so that it flops out at each reverse. As soon as enough is out to give her a few inches of freeboard get aboard over her stern and dash out the rest with your hands. "Shoving" the water out also depends on the momentum of a body of water. Swim astern, and, grasping the stern breasthook, give her a smart pull towards you. The water will slop out in a torrent over her bows. Then shove away from you with all your strength and the water will come rushing aft and slop out over her stern. Keep this up until about half emptied, when get aboard over her stern and dash out the rest with your hands. No boy under sixteen years is strong enough to be successful with either of these methods, but by lying down in her when she is awash the water can be dashed out if you are patient and do not try to move about. I do not believe that a single man or boy can bail out a

swamped canoe in a heavy blow. Stick to her, for she is your only hope, and get overboard all the heavy duffle. If the water is not too cold, take time to get out some twine or fish line and buoy-mark rifles, axes, etc., by lowering them to the bottom and tying a floating duffle bag at the surface anchored by the gun. This leaves the canoe free; right her and get into her still awash. Watch your chance to get water out and do so at every opportunity. Sooner or later she will drift ashore, and, if you feel yourself getting numb, rest your head on bow or stern cross brace and keep quiet. If the water is cold, act quickly; heave out all duffle, right the canoe, get in and bail steadily with your hat or any container. You may beat out the waves, and at least will keep exercising while you drift to the shore.

But upsets and the like seldom happen more than a few times in a lifetime with a staunch canoe, most of which are more able than a row-boat of the same size. The portage is the surest preventative of disasters, and how to do it right is worth knowing. Two men, each carrying an end of a canoe under their arms, will work much harder than one man alone carrying it properly. Even carrying it upside down, with an end over each man's head is preferable, but the time-hon-

## 130 CANOEING AND CRUISING

ored Hudson Bay method is to lash the paddles to the middle and forward thwart braces, the blades of the paddles resting on the middle thwart. Then, when you turn the canoe over, your head will go between the two paddles and the blades rest on your shoulders. With a coat or sweater bunched up on each shoulder you can carry an ordinary 60-pound canoe with ease while the other boy packs the duffie. Keep your baggage low in weight if you are going to have many portages, for double tripping it means three times the time and work lost. Suppose you have a two-mile portage from one lake to the other. With a single trip that is two miles to the lake, launch the canoe and on your way; with a double trip you have two miles there loaded, two miles back empty, and two miles there again loaded—six miles! Ever hike six miles along a woods trail, with no load at all? I'd rather do that two miles in one lap if I had to stop and rest every five minutes!

### CANOE SAILING

If one has but a moiety of the real Indian spirit in him he will have a pronounced aversion to anything even in a remote degree resembling work. Paddling a canoe comes under this head; you don't realize this until once under sail in the same

canoe, where she goes right along like a greased eel with no more effort on your part than the exercise of a little skill and judgment. And, if you give her all the sail power she is really capable of, you will get such exciting hikes, such breathless speed, such a glory of existence out of that canoe as you never dreamed of. A full-powered sail canoe is in the same class as regards thrills and sport as a game fish or carnivorous big game,—any of these will keep your hands full mastering their tricks with all the resourcefulness at your command. Far be it from me to utter a word counter to the delicious memories of day-long paddles in the open Indian canoe, down green-arched rivers, across long whitecapped lakes and down rushing streams. But I have other memories;—of the open ocean and the green-sedged marsh; of wide estuaries and hill-rimmed bays, where the decked canvas canoe, heeled down to the cockpit coaming under the stress of her great white sails, tore and raced over and through the long ocean swells,—when every black catspaw put you out over the pickle with your toes hooked under the opposite coaming and that little witch lay down and shot through the whitecaps like a flying fish! And these breathless memories far eclipsed the best

## 182 CANOEING AND CRUISING

sport that the Indian canoe affords,—taken strictly and solely as canoeing. If you have no portaging to do and your river or chain of lakes affords reasonable sea-room, I prefer a single sail and a pair of lee-boards for the open model canoe. Take along a leg-o'-mutton sail, eight feet hoist by nine feet along the foot, of American drilling, hemmed and provided with grommets every foot along the luff. This takes but little space in your kit and can be bent to a spruce sapling as a mast with plenty good enough results. Spread it with a sprit of light spruce or birch which you can cut in the woods. She will go right along with such a rig, but will make leeway like a floating leaf if you have no lee-boards. For canoe voyaging I prefer these of the folding, collapsible type.

The sail for my Morris, which I have used for over four years in lake and bay cruises, has a 2-inch diameter mast, 6 feet 9 inches long; and a lateen rig, 10-foot 2-inch head, and 11-foot 2-inch foot, with 10-foot 6-inch leach. The jaw is attached to bring the mast 19 inches from the fore peak of the sail. The sail is made of light 4-ounce duck canvas and with it she is very fast. The mast is stepped with a cross brace, attachable with brass hooks and wingnuts, and the foot step is screwed stoutly to three ribs, giving the mast



**TO SWING CANOE OVERHEAD**

The canoe is the famous Peterboro wooden canoe used in the Hudson Bay country.

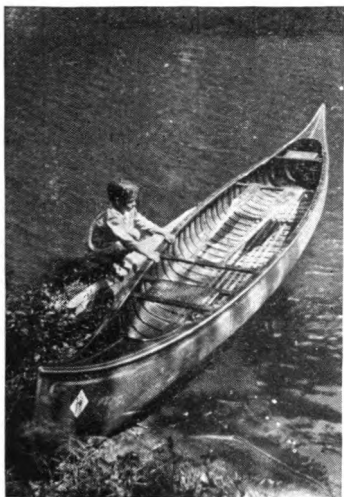

**PADDLES LASHED IN POSITION**

Lashed to rear and forward thwarts the blades form a yoke which rests on the shoulders.



**CARRYING SINGLE**

A yoke makes this much easier; cannot be done in a strong wind.

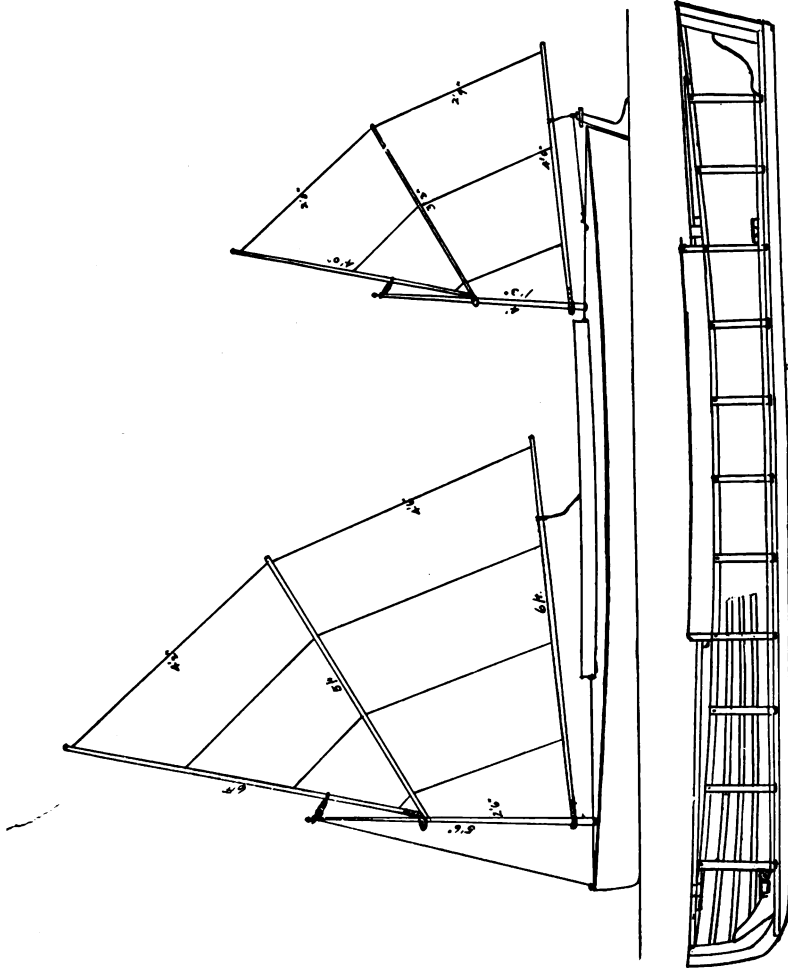

FRAME PLAN AND SAIL PLAN, DECKED SAILING CANOE "WATERAT IV"





**GETTING BREAKFAST IN THE CANOE TARP. CAMP**

After bedding is cleared away, breakfast can be served on a camp table under the tarp.



**DAN BEARD OR CAMPFIRE TENT**

A roomy model for a party of four canoe voyagers.



THE FORESTER TENT. WEIGHT  $4\frac{3}{4}$  LBS.

Designed by the author for canoeing and hiking in cold weather. With an open fire in front, the walls are at such an angle as to reflect all the heat down on the bedding.



THE PERFECT SHELTER TENT. WEIGHT  $3\frac{1}{2}$  LBS.

Designed by the author for summer cruising and hiking. Sides and front are of mosquito bar, with a changeable side piece to go on windward side.

a very slight rake backwards. The lee-boards for this rig are gotten out of inch spruce and are 30 inches long with a 12 x 20-inch blade. They are secured to stout shoes on the ends of the cross piece by brass wing nuts passing through holes in the shank of the lee-boards. The cross piece is 1 x 5 x 38 inches long.

To make your own lee-boards whittle out of clear spruce two blades about the size and shape of your broad double paddle-blade with square stocks 3 by  $\frac{7}{8}$  inches. Get a pair of brass 3-inch hinges and cut a length of clear spruce 3 by 1 inches, a foot longer than the canoe is wide. Lay it across the gunwale of your canoe and mark where the two shanks of the lee-boards will come to fit snug up to the gunwale. Screw on the hinges, facing inward so that the lee-boards will fold toward each other. The length of the lee-board does not need to exceed 24 inches, all told, and should fine off to a thin edge much as does a broad-blade canoe paddle. Having screwed the hinges fast, erect the two lee-boards so that they stand upright bringing up hard-and-fast on the ends of their own shanks. They should then stand a little outward. Get two heavy brass hooks, such as are used aboard ship for doors and skylight hatches, and screw the eye of these hooks onto the back of the pad-

## 184 CANOEING AND CRUISING

dle, and the shackle of the book onto your spruce cross-rail, letting the hooks come over at about 45 degrees and planting them so that when each hook is snapped into its eye it will hold its lee-board upright, firm and solid. To use the board set the cross-rail across the canoe with the lee-boards in the water on each side of the canoe. The cross-rail is lashed to the cockpit coaming by a couple of turns of marlin around two cleats screwed to either side of the coaming inside, below where the rail will cross, i.e., a little forward of amidships. Twelve inches wide by 24 inches long is plenty lee-board enough for an ordinary 16-foot canoe.

For canvas-decked canoe I have used a number of different sails, including leg-o'-mutton and lateen, but have finally come to prefer the Canadian Club canoe sail, with short stubby mast and long gaff cocked up almost vertically. This sail has less spar weight than the lateen, practically the same weight as the leg-o'-mutton, and has not the bad leach of the latter, because the batten keeps it flat and well spread. It is a wonder for quick reefing as one can lower the gaff, tie the batten to the boom at both ends and the middle, and hoist away again in less than three minutes. In making it, avoid too heavy spars. For a 12-foot

canoe, the boom and gaff of the mainsail should be six feet long, each of  $1\frac{1}{4}$ -inch clear spruce, tapering to  $\frac{3}{4}$  inch at each end. Batten,  $1\frac{1}{4} \times \frac{3}{8}$  inch 4 feet 10 inches long and mainmast 5 feet 6 inches long, of  $1\frac{1}{2}$ -inch spruce, tapering to  $\frac{3}{4}$  inch; material of sail, American drilling. Mizzen sail boom and gaff 4 feet each, of 1-inch spruce, tapering to  $\frac{1}{2}$  inch, batten  $1 \times \frac{3}{8}$  inch 3 feet 6 inches long. Hoist of mainsail, 2 feet 6 inches, of mizzen, 1 foot 6 inches. You will note from this that only two mast rings are needed on the mainmast and one on the mizzen. To cut out sails the easiest scheme is to stake out the dimensions, either on a lawn or in a large empty room, and run a string around the stakes or tacks, giving the outline of the sail. Lay the canvas parallel to the leach (rear outer edge of sail), and cut as many gores as will be needed, allowing an inch of hem. Leave  $1\frac{1}{2}$  inches overlap along the line of the batten, and when the two parts of the sail are done, turn under and sew the overlap, forming a sort of pocket  $1\frac{1}{2}$  inch wide into which the batten can be slipped. Along the head, foot, and luff of the sail will be wanted brass  $\frac{3}{8}$ -inch grommets, which are little brass eyeholes through which the lashing rope is run. These grommets space about 9 inches, and are easily put in by punching a hole

## 186 CANOEING AND CRUISING

in the hem, slipping in the male half of the grommet, putting on the ring and turning over with a fid, or, in lieu of any such nautical implement a large 20-penny wire nail. To make the spars buy the stock from a door-and-sash mill in the rough square or rounded if they keep it. They will rip it off a clear plank for you for a few cents more than the cost of the plank. Work the spars round with a jack-plane and a spoke-shave, finish to a nice taper each way from the middle (except the mast, which tapers from the foot), sandpaper and varnish with marine spar varnish. Whittle the jaws for the gaff out of natural bend maple forks giving them the proper twist so as to seize the mast when the gaff is cocked up taut. All the running rigging, lashings, reef-points, etc., should be of white  $\frac{1}{8}$ -inch cotton rope and the blocks (pulleys) of  $\frac{1}{8}$ -inch galvanized iron. The main sheet (rope) is single and is held in the hand while sailing (it pulls about as hard as a large dog). The mizzen sheet is made fast on a cleat on the rear deck after trimming true to the wind. It should pass through a brass screw-eye on the rudder-head, so as to sway clear at each tack. The rudder is best managed by a yoke on the head of it, with steer lines running flat over the rear deck and through screw-eyes along the inside of

the cockpit. The steer rope is endless and taut throughout its length. To steer you can grab it anywhere, and wherever you leave it the rudder will stay. Most of canoe steering is done by sails alone. A centerboard can be done without in a canvas canoe, as the 3-inch fin keel gives her plenty of grip on the water, but an 8 in. x 36 in. keel board fastened to the keel with carriage bolts and ring nuts as described in Part Two, Chapter III, is a great aid.

A word to the inexperienced as to the value of the mizzen or dandy. With it a canoe is far safer than with the mainsail alone, because the tendency of the dandy is always to shove you up into the wind. The minute you spill the wind out of the mainsail (too strong a catspaw) the dandy shoves you safely up into the wind unless checked by the rudder. Without it the canoe would simply knock down and probably fall off the wind, thus filling the mainsail again just when you don't want it, and, unless you check her immediately with the rudder, you are in for very serious trouble indeed. With the dandy astern she will be much faster, safer and quicker to mind her helm, and the only reason I do not advocate it for the open Indian canoe is because of the high curling stern of the latter.

## CHAPTER II

### CANOE CRUISING

**THERE** are two kinds of canoe cruises, both of them splendid outdoor recreations for boys, the lake and river cruise in the open canoe, with the paddle as motive power, and the decked sailing canoe where the paddle is of secondary importance and a pair of bat wing sails eats up the miles of distance between you and your destination. Both are fine sport, and both constitute the easiest form of travel in the open. Do not take sails on a canoe cruise unless you are going to have plenty of use for them, as they are heavy and much in the way in stowing duffle; and do not take an ounce more weight in any case than is positively necessary.

I would set a limit of fifty pounds of belongings to every man on the trip. Even if there are only trifling portages, such as lifting over down trees, around obstructions on the banks or over dam sites, too much duffle becomes a burden, and when afloat its weight brings the canoe dangerously low down in the water and puts a lot of work



in paddling on the voyageur's shoulders. The same canoe that will fly along like a fairy when properly loaded, will act like a submerged turtle when just a wee bit overloaded. And it is so easy to take too much! One of my first canoe trips was nearly spoilt by just this duffle trouble. We both swore ourselves black in the face that not a pound extra would be taken, but this is what we actually did take:—For guns we took the shotguns as a matter of course, and, as if that was not enough, the rifles also, in case any long range shots might offer, and then, piled on that, a revolver each for snakes and turtles, ammunition in generous quantities for the three,—let's see, that makes 26 pounds of extra useless weight, not counting the shotguns, which are doubtful commodities in a summer trip and apt to get you into trouble with game wardens, as snipe are the only game birds shootable in September when we went; then, as we *might* have a few miles sailing, we took along the sails, 25 pounds more, mostly in the way, and only used once, for we had head winds on all the other open stretches; then we took along a sack of potatoes when we knew well we would pass lots of farms, another useless 20 pounds of weight—the wonder to me is that she floated at all when we set forth! As it was she had just three inches of

## 140 CANOEING AND CRUISING

freeboard, and was as logy as a water-soaked tree trunk. Well, we had a strong northwest wind to face the first thing; five miles of it. Did we hoist the sails and tack? We tried it, but made as much leeway as headway and finally ended by paddling the whole distance, arriving by nightfall where we had allowed to reach in but three hours on the schedule. All the blankets, etc., were soaking wet, from water shipped aboard off the white-caps, and we were half the night drying them out so that we could get off to sleep.

Our first portage was a hummer! Only around a dam, a few hundred feet, but it took five trips to do it—fire-arms, bedding, grub, cook outfit, tent and sails (now soaking wet, and all weighing twice what they would dry). Again tribulation camped on our trail when we struck long reaches of shallow water. She drew so much that we both had to get out and wade, towing her up stream. The end of the second day saw eleven miles of progress and 150 miles to go. On the third day we passed under a railroad bridge, went into camp and shipped back home by express the sails, guns, ammunition and spuds, and kept only the fishing tackle, tent, bedding and cook outfit, with a few provisions. Then we made easy

progress, but our bad start had cost us two days' fishing at the lake which we were headed for.

This little sketch of how not to do it brings to mind several points taught us by hard experience. In the first place everything in a canoe that water can hurt *must* go in a waterproof duffle bag, either side-opening or end-opening. For clothing, blankets, tent, etc., the 11 x 24-inch brown waterproof end-opening duffle bag costing a dollar is the thing. It will take folded blankets and tents easily and they can be pulled out without trouble. For food the side-opening bag 8 x 22 inches, with rows of pockets inside, is the thing. When you go ashore for the night campment, drive in two upright stakes to windward of your cook fire and hang up this bag by the grommet holes in the lip, put there for that purpose. All your main food sacks are now in plain sight, in rows along the bottom of the kitchen bag, where each can be chucked back as used; and in the pockets are small bags of salt, tea, baking powder, soup powders, etc., while the knives, forks, spoons, chain pot-hooks and the like are handy in the top pockets. This duffle bag has a stout maple rod sewed into one lip, and to fasten it up you roll the other lip around this rod until the bag is rolled tight and then secure with rope around the bag or a pair

## 142 CANOEING AND CRUISING

of school book straps.' As these side-opening bags are rather expensive to buy I will give you the way to make them yourself. Get a yard of ten-ounce brown paraffined duck canvas at a ship chandler's or awning maker's. It costs forty cents a yard, and comes 28 inches wide. Cut off an eight-inch strip along one edge and out of this strip make two circular ends for your bag, 8 inches in diameter. Get a  $\frac{1}{2}$ -inch maple dowel from a pattern shop or department store or hardware store, and cut it 20 inches long. Sew a hem along both lips of your bag, and slip the rod into one lip and secure by sewing over the end of the hem. Now sew the circular ends half around to the side of your bag and fill in the rest of the space with a khaki end-cloth as shown in the pattern, finishing the whole thing with an edging of gray tape. Sew inside two khaki strips 8 inches wide by 30 inches long, to make two rows of three pockets each. Each pocket is 8 inches wide and will take ten inches of your cloth, the back of the pocket being the wall of the bag. Put two school straps around the bag, about a foot apart, and join with a strap riveted around each of the two straps to make a carrying handle, or else just get a ten-cent shawl strap at the five-and-ten-cent store and use it in lieu of the school-book straps. Total cost:

canvas, 40 cents, khaki, 20 cents, shawl straps, 10 cents; all together, 70 cents. One bag will hold all the food four men will need on a week's canoe trip, and keep it dry and handy to use. For food sacks the standard sack for bulk food is 8 inch diameter by 10 inch depth, and they cost fifteen cents each. To make them yourself get from a sporting-goods store two yards of paraffined muslin, cut out eight-inch round bottoms, and 10 inch high by 24 inch circumference sides, sewing the sides around the bottoms and turning inside out. It can all be done on a domestic sewing machine, using a heavy needle and number 40 cotton. Finish the food sacks with a foot of white tape, sewed up near the top of the bag for a tie-string. You will also need three plain rectangular 4 inch by 9 inch bags, and four small 3 inch by 6 inch bags of the same paraffined muslin. To make paraffined muslin yourself, buy the ordinary unbleached muslin and steep in a mixture of a pint of turpentine with two bricks of paraffine dissolved in it. It will not dissolve cold, but if your tin can of turpentine is warmed in a kettle of hot water it will dissolve the paraffine readily. Hang the muslin out to dry after soaking in the solution.

The large food bags are to be marked RICE, FLOUR, SUGAR, OATMEAL; the 9 x 4's, CORN MEAL,

## 144 CANOEING AND CRUISING

PRUNES, COFFEE, PANCAKE FLOUR; and the small 3 by 6's, TEA, COCOA, SALT, RAISINS. Milk goes in its own cans of evaporated cream; eggs, in a 3 by 5 inch tin can with friction top (holds 14 fresh eggs broken into it); potatoes and onions in an ordinary muslin flour sack; meat, bacon, butter, etc., in 8-inch friction top tin cans, costing 25 cents each, two will be plenty. All these provision sacks except the spud sack will go in the side opening grub bag; will weigh, all told, for a week's cruise, about thirty pounds and will make about 150 pounds of cooked food. Rain and spray, upsets and hard knocks will then make no difference to the grub pile; it is the only way to stow and carry food in a canoe.

The cook kit to be taken along may be any of the well-known outfits, such as the nesting aluminum set for four, the Forester, Stopple, Boy Scout, etc., or it may be plain set of nesting tin pails, three of them one inside the other, a couple of fry pans and some 7 by 2 inch tin mixing and baking pans. Each man has his individual table set, of knife, fork, and spoon, cup, and nine-inch tin or aluminum plate, and you will want a wire grate and a folding reflector baker or an aluminum one with cover on which a fire can be built like a Dutch oven. The wire grate should have a cloth

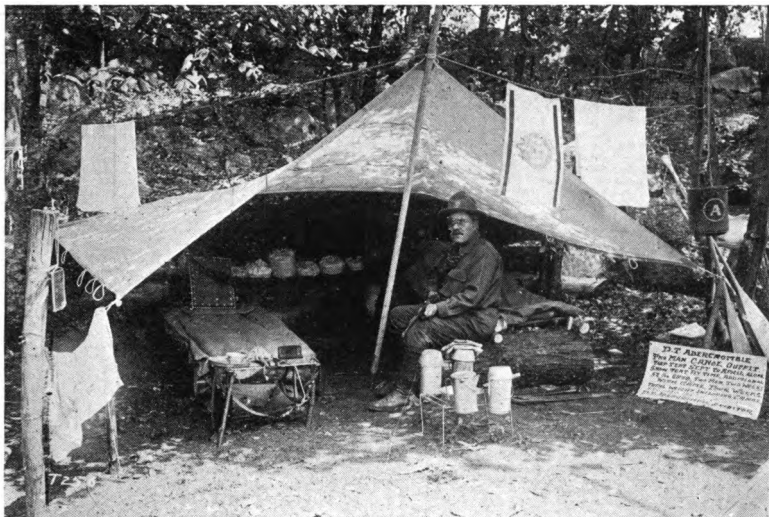

#### THE CANOE TARP. CAMP

An old canoeist's dodge. Canoe is turned on its side with all duffie on shelf made by lower rim and tarpaulin stretched as shown. A light, roomy canoe encampment.



#### IN CAMP IN A CRUISING DECKED CANOE

The author is just putting his head out from under the mosquito bar of the canoe cockpit tent. His chum is sleeping out under one of the canoe sails as shelter, the sleeping bag being rainproof.



**THE SIDE-OPENING GRUB BAG (opened and closed)**

**On a canoe trip the food is best carried in paraffined muslin food bags inside a stout, side-opening, waterproof grub bag.**



**READY TO GO OVERBOARD AGAIN**

**The author putting in reefs before hitting the lake. A whitecap breeze is blowing outside. The night was spent under this tree, hauled up.**



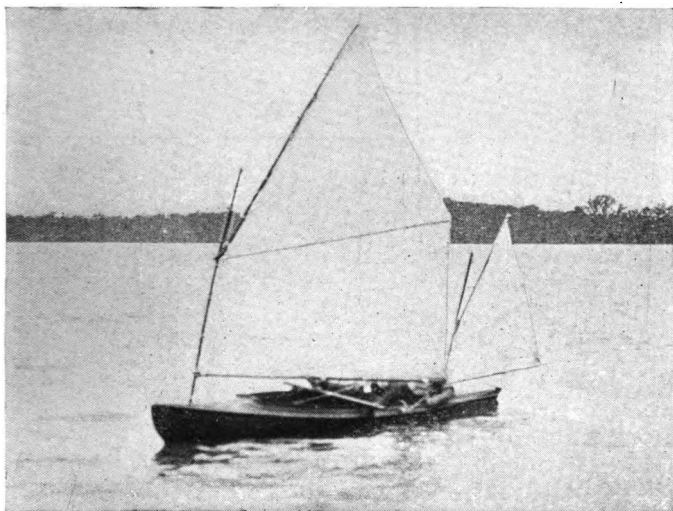

**THE "VARMINT" UNDER FULL SAIL**

This canoe was built by a "Field and Stream" subscriber from the plans and directions given in this chapter, when published in the "Field and Stream" magazine.

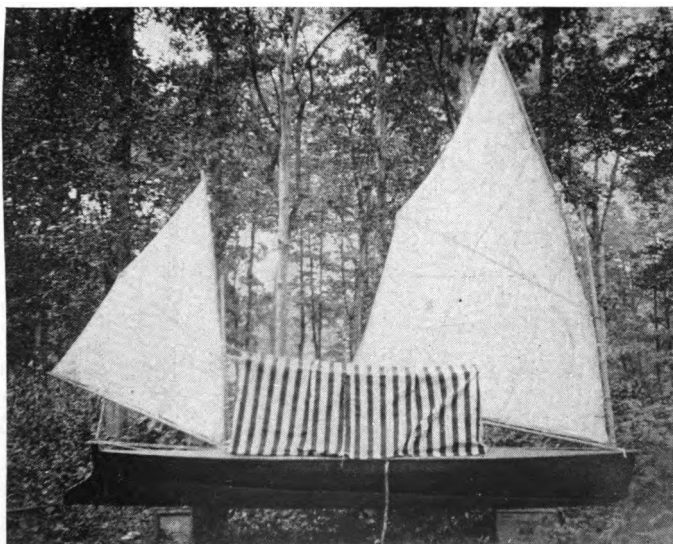

**THE "WATERAT IV" WITH FULL SAIL SET AND COCKPIT TENT**

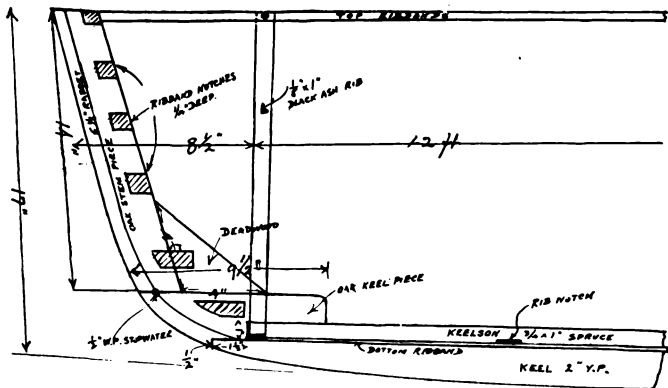

DETAILS OF STEM CONSTRUCTION, DECKED SAILING CANOE.  
"WATERAT IV"

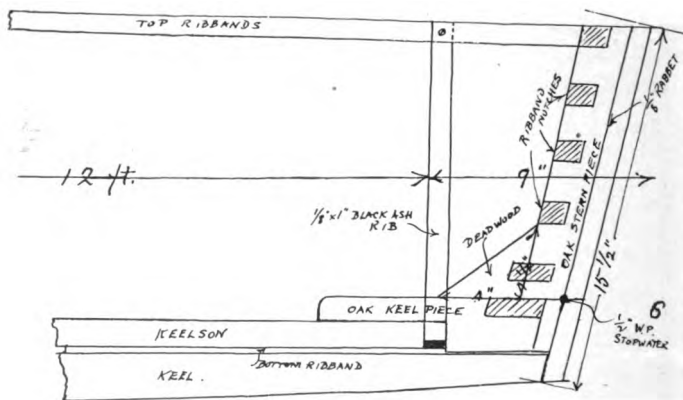

DETAILS OF STERN CONSTRUCTION, DECKED SAILING CANOE  
"WATERAT IV"

bag to pack in as it gets very sooty and will soon get the rest of the things in the canoe dirty if uncovered.

For a tent there are several special canoe types on the market, the Hudson Bay, Dan Beard, Canoe Tent, and Forester being four types that have made good on long canoe trips where each night a new camp is made. You want something quickly and easily put up, with a few pegs and few poles. Canoe-cruise regulations call for a heavy meal at breakfast, an all-day paddle with a bite of lunch eaten in the canoe at midday, and a rousing feed at night. One usually looks out for a good site and a spring along about four o'clock, as camping and cooking after dark is a nuisance and takes away the pleasure of the cruise. Wherefore you want a tent that can be quickly put up, almost anywhere. The Hudson Bay tent calls for a handy tree and a pair of shears in front (for it is too much to ask, to expect *two* trees to grow just the right distance apart at the right place, with a level bit of ground in between them!). The Canoe tent needs one short pole and two long rear stakes; and the Forester, three ten-foot saplings. These are easy to find in any thicket along a lake or stream bank. All three tents take eight to ten short pegs, and are put up in ten to fifteen min-

## 146 CANOEING AND CRUISING

utes time. Never pitch on a sloping ground site unless the slope runs from head to foot of the tent, a side slope is very uncomfortable to sleep on and the boy furthest uphill will be continually rolling down on the others in his sleep. One man can put up the tent, while the others get night wood, water for the cookee and browse for the tent bottoms.

The man elected cook sets about preparing the evening meal. He will need about 45 minutes to do a good job, and will want good hot woods to do it with, so see that he has plenty of dry, hard maple, blackjack oak, white oak, pignut hickory and white birch to do with. The surest way to have a slow meal that is forever cooking, is to give the cook any old dry trash wood, such as balsam and pine. There is little heat in them, they are "out" most of the time, and the pot is forever boiling. But blackjack and maple will not only start the pots up in no time but their coals will keep them going after the flames have subsided. Get the boiled things going first, the pots over the fire amid the flames, and the potatoes and onions peeled into the "mulligan," a handful of rice added and some salt, and you can put the cover on and let her simmer. Add soup meat if you have it, or grouse breasts, chunks of

deer meat, cut up rabbit, any old meat component; add a bouillon cube for each man when the stew is nearly done, thirty-five minutes later, and she will taste fine and keep you in good health. Fry your fish dipped in egg and rolled in corn meal and set some one to tending the fry pan over a bed of coals while you make up the corn bread batter, squaw bread dough, or doughnuts. These require for a hot *high* fire a couple of blazing logs lifted up off the main fire and set on the edge of the wire grate, and the baking tin is then put under them on top of some coals, or the reflector baker, with its pan full of biscuits, is set in front of them. Boil rice in the other pot, and tea in the pail. For breakfast use your flap-jack flour for pancakes, and have coffee, fish fried in bacon grease with bacon on the side, and potatoes cubed and creamed. Plenty of these, with lots of fruit, will run you all day long. Aim to get the canoes in the water by eight o'clock, stop paddling about noon for an hour to serve a cold lunch of ham or sardines with chocolate, cheese, raisins, nuts, and some Graham crackers, and be on your way again in an hour. At four the definite stop for the day is made. Pick a good site, on a point if possible to get away from flies and mosquitoes, and be sure to pitch somewhere near a spring.

## 148 CANOEING AND CRUISING

Any river that is inhabited,—that is, has farms and small towns on its banks,—is unsafe to use for drinking or cooking water. My twelve-year-old boy got a case of typhoid fever from one of our canoe cruises, where there was but *one* town on the river bank. The rest of us were badly physicked and just missed typhoid, but he had a severe case which nearly cost him his life. Since then I have always insisted on a spring for water or else boiled it before using. And, by the same token, refrain from dipping up the river water in a cup and drinking it, unless the river is wholly wild, like the Allagash in Maine, or the Lumbee in North Carolina, or Wading River in New Jersey, all of which streams give fine canoe trips.

In lieu of a sail, a good thing to take along is a tarp for a floor cloth made of some light water-proof tent textile. If you have a mast step screwed to several ribs of your canoe, and a detachable cross bar, with a two-inch hole in it for a mast hole, and two brass hooks with wing nuts to secure the cross rail to the gunwale, you can easily cut spars at the lake bank and rig the "tarp" as a sail when you have a long down-wind traverse to make. Without the step and bar it is rather awkward to rig anything that will stand wind pressure and not become dangerous from coming

adrift and upsetting the canoe in a gust. In making any traverse, study your weather and white caps before venturing out, for it is braver to say "No!" and stay ashore windbound than to be foolhardy and go out and get swamped. If you *must* make the traverse and the waves are high, do it with canoe lightly loaded in two trips, as a logy, heavily loaded canoe is a dangerous thing in choppy seas.

In river work, haul her over logs, down trees and the like by getting out on the log, one on each side, and sliding the canoe over between you with the duffle aboard. In navigating rivers keep cutting across the heads of bends, the bow man anticipating the river at each bend and getting the canoe headed for the shallows, when the stern man can then exert his strength and shove her ahead. Keep out of the full force of the current in the bends; it only makes you paddle twice as far and hard, and the force of the current is always throwing your canoe broadside onto alders and rocks in the elbow of the bends. In running a rapids, be first sure that they are safe, as they change almost daily with the height of water. Look for a portage trail if you know nothing about the rapids and if there is a landing above the rapids, with a clearly defined trail through the

## 150 CANOEING AND CRUISING

forest, it is a safe bet that the rapids are dangerous and have been portaged by better men than you. In running white water the stern man has the say and the bow man should not embarrass him by attempting to fend off with the paddle, etc. Only do this when it is clearly evident that the stern man has not control enough to prevent her ramming. As a rule, the water parting around a rock will carry her bow clear if the stern man guides her and sees that the stern follows clear.

In general, back paddle so that the current flows faster than the canoe is going, and let her down easy at the difficult spots. In any event, keep out of the main force of the current if there is an easier passage, and always go along a rapids on foot ashore before running it. In many rivers and broad creeks there is plenty of white water not dangerous, only exciting. Follow the current where it is clearest of rocks, and, in passing one, back the stern of the canoe away from the rock, letting the current carry the bow clear. In all rapids running the duffle should be lashed in by your tracking line; in traversing a lake everything should be free and clear, as you may need to empty her in a hurry. In both cases stick to the canoe in case of upset, get her ashore in the rapids, and dump the water out



of her in the lake, letting the duffle float where it will until the canoe is ready again. In both cases the paddles should be lashed to the canoe with about six feet of cotton rope, as they may be your only hold on the canoe, and if she once drifts away from you in a lake you are lost. Two men treading water can lift a canoe clear enough to turn out most of the water, and then can get aboard from bow and stern simultaneously, being careful to jump at the same moment so as to balance the weight. One man alone can hardly empty a canoe unless over sixteen years of age and husky. If strong enough you can rock it out, or "shove" it out, either by swashing it from side to side, letting it slop out, or by giving it smart shoves to and from you, when the momentum of the water will slop it out over bow and stern alternately. A boy of twelve is not strong enough to do this and had best get inside the canoe and lie down in her awash. She will not sink, but will lie with about an inch of gunwale exposed. Keeping her on an even keel, the water can be dashed out of her if reasonably calm, but with a sea on the best way is to go astern and kick her ashore, climbing in and lying down in her when tired. Sooner or later she will drift ashore. Keep cool, play safe and do not start anything rash that you may not

## 152 CANOEING AND CRUISING

be able to finish. The canoe will always float herself and you, and if not too cold you will arrive safely in time, even if you have a mile or so to drift.

In river travel the banks are near, and if you stick to the canoe no eddy can pull you under. As a matter of fact upsets are extremely infrequent in canoe travel. I have yet to have my first one in over thirty years of canoeing in river trips, and in my sailing canoes have but three upsets in all that time to record.

The second great branch of canoeing is that of canoe sailing in the great open bays and lakes, where the wind is too strong and the seas too heavy for an open type canoe to live. The wooden-decked sailing canoe has always been a popular "poor man's yacht," but for boys she is so heavy to paddle that until you get sixteen years or over it is too hard work to be fun. However, we boys did not let that worry us. We built decked *canvas-covered* sailing canoes that weighed about forty pounds, and had two sails, mainsail and jigger, and they could beat anything of their inches that carried canvas, and live in a sea that sent big catboats into harbor with three reefs in their sails. These craft I built four of; my chums two or three apiece, and, for long cruises down the great salt-

water bays of the Atlantic Coast, sleeping in the canoe every night, they were simply Jim Dandy! Thirteen feet long by 32 inches beam and a foot deep was the preferred size, with a six-foot cockpit in which you could sleep when the canoe was hauled out on the beach and the sand banked up around her. Contrary to the general impression spread by writers who do not know, the canvas-covered canoe is not "limp and logy"; instead she is fast and lively; she will not sink when capsized, but will keep herself afloat and you, too. And she paddles like a bird with the double-blade paddle, which the wooden sailing canoe would never do on a boy's strength.

We cruised in ours for weeks at a time. Sometimes it would be but a day's expedition up some big salt marsh creek after railbirds and snipe; others, it would be a fishing trip down the bay to some favorite bank, where the canoe would be moored to an oyster stake while its crew attended to the fish market; again it would be an extended consort cruise of two or more of these canoes, when both of them would be hauled out on the beach and the cockpit tents set up, while a board running from one canoe to the other would make the eating table. Many a night have I dozed off to sleep with the strong salt breeze strumming

## 154 CANOEING AND CRUISING

through the guy ropes of my canoe cockpit tent, the mosquitoes humming a lively tune outside, while within there would be solid comfort from the muslin mattress filled with fragrant sage and making the round contours of the canoe as comfortable as your bed at home. I have paddled out into a roaring sea that even a large sloop would respect, in those able little decked canvas canoes, setting up a rag of sail and beating to windward like a flying fish, and only once in hundreds of miles of such canoeing have I been upset. It was during a squally northwest blow and I was snipe shooting on Marsh Point on the Baritan. I got thirsty and so set sails for the opposite shore a mile away where I knew there was a spring of iron water, highly prized by us boys because we believed that drinking it would make us strong! As the tide was running out strongly it took several tacks to make up for the drift in getting across, and in one of them my rudder jammed. Its regular pin had been lost and it was therefore hung with a couple of makeshift copper lashings to the screw eyes. At every other gust the canoe was knocked down to her cockpit coaming, but that was nothing unusual,—one simply jammed one's toes under the lee rail and hiked out over the pickle! But this rudder jamming was an-

other matter; I couldn't steer now, except with a paddle blade, which is "nix" in a decked canoe, as it will not let you hang out to windward when the gusts come. Several times I was nearly unbalanced by the knockdown puffs, and finally one got me and I was pitched bodily overboard to leeward, taking the canoe with me. I remember leaping headlong into my own mainsail, and then a smother of salt water. When I came up, the first thing I noticed was my precious moccasins wavering down through the water. They had come off my feet while doing the dive into the mainsail. I dove for them with both eyes open, and got them both by great good luck. Next I felt inside the canoe for my gun; it was lashed in securely, thank goodness! Then I loosened both main and mizzen halliards and unstepped the masts, which released the canoe so I could right her. The next stunt was to roll up the two sails and stow them inboard, and then go swimming after the paddles. I was a great little retriever, and soon had all the canoe belongings back in the cockpit, which was awash in the whitecaps. I was half a mile from shore, and so I went astern and turned myself into a human propellor, so that, helped by the strong wind and sea, I had soon kicked her where I could touch bottom and begin

## 156 CANOEING AND CRUISING

to wade with her. A fish hawk had been following me interestedly, and now he swooped down and flew off with a white package left behind in my wake. I suddenly realized that that was *my package of lunch* he was making off with, with all my sandwiches in it! A frantic grab for the gun was futile, as he was already out of range—I owe that fish hawk a grudge to this day! However, there were two hard-boiled eggs and a couple of boiled crabs in the canoe, and so, taking off all my clothes and spreading them abroad in the marsh, I sat down on the paddles to a lunch of egg and crab while the clothes dried out. About four o'clock the snipe came up the marsh in great flocks of fifty or a hundred apiece and I had some royal shooting. It was too dark to see the gun sights and the shells all shot before I was ready to go home. Outside the draw-bridge to the open sea, the waves were high, as I could tell by the big, smooth swells in the river, but she shot through the draw in great shape under paddle alone and made the two-mile trip in the dark, open sea without incident, hurdling the big whitecaps like a huntsman. A great little boat!—I use the mate to her now, and in one of these chapters will tell you how to build one for yourself at a cost of \$7.50, complete. In paddling against a head wind

with such a craft you had best leave the dandy up, as it not only keeps her head staunch to the wind, but every side puff fills the dandy and you can just *feel* her shoving you along!

In the paddling canoe with sail I have had two upsets in thirty years, one of which was in a howling southeast gale when we ran aground on a point and she turned a summersault over her own leeboards; and the other was in a squally northwest wind when I was navigating a narrow, crooked lake under sail. While the canoe was "in stays,"—that is, luffing and coming about on another tack,—a sudden gust blew out of the wall of forest, broadside on, and knocked her over as if you had struck her with a giant hand! No amount of seamanship could have avoided this, as the sail was perfectly loose and free, but a broadside gust from an entirely different point of the compass from that in which the wind is blowing is likely to hit you unexpectedly in narrow waters surrounded by high banks of forest, and so it is always much safer to use paddle only in such places. As to the other upset, the leeboards were straight down, and you should always avoid a point likely to have a shoal on it when tacking in a high wind for, if she strikes bottom with the leeboards, you

## 158 CANOEING AND CRUISING

will have the ignominy of upsetting in a foot and a half of water!

As to rigs for canoes, I have tried them all; leg-o'-mutton, bat wing, lateen and Canadian Club or battened leg-o'-mutton; and have settled on the latter for all my later canoes. Leg-o'-mutton is a slow sail, because of its bad leach, and its spars are so long as to be unstowable in a canoe with six-foot cockpit. Bat wing is too complicated a sail for most men to make, and easily gets out of gear. Lateen has not only too long spars, but is unreefable, and is a dangerous sail before the wind in a heavy blow. The Canadian Club, shown in our illustrations, has comparatively short spars, a good flat leach, and is easy to reef and stow. The dimensions given are right for a twelve-foot canoe, a larger sail can be carried, but you will have to reef it most of the time. A single set of reef points in mizzen and mainsail gives you canvas for a heavy blow, while reefing her down to her battens will give you a rag that you can navigate a gale in, like the time last summer when I crossed Greenwood Lake in ten minutes in *Waterat IV*, the present representative of the canvas-covered decked sailing canoe in which I navigate.

Taken all in all, canoeing is a great sport, and



one that appeals particularly to men and youths who have the adventurous exploring spirit in them. I have sailed everything from a full-rigged ship to a canoe, and, to this day I still keep three canoes in my fleet of pleasure craft, one of which, *Waterat IV*, is still the unbeaten crack of this section!

## CHAPTER III

### HOW TO BUILD A DECKED CANVAS CRUISING CANOE

ANY man in the least acquainted with tools can build this canoe. I made my first one when I was twelve and two more when I was sixteen and nineteen respectively. The first one had no sails and only a little cockpit three feet long, so that, while she was good for day cruises and paddling up creeks after snipe and rail birds, you could neither sleep in her nor sail her. The second had a six-foot cockpit and leg-o'-mutton mainsail and jigger. Also a gaudy awning-canvas tent which went over the cockpit, and I had many a glorious cruise in her, sleeping at night in the canoe after hauling her out on the beach and banking sand around her to keep her steady. She had one defect which you should be warned against—she had a kyak bow and stern, little low six-inch oak blocks screwed to the keel at each end, just high enough to take the six ribbands of the frame. Easy to make, but, gee! she was a wet boat in heavy weather! That kyak bow would shoot through every wave like a dagger, and in spite of an eight-

## DECKED CRUISING CANOES 161

een-inch hood over the cockpit for'd, a deluge of sea water would come aft and most of it would stay in the canoe. But she would go like a streak, and when I was seventeen I sailed her across Prince's Bay in a bird of a southeast blow, soaked to the ears with salt spray but cheerful as a clam at high tide. It was some hike, believe me!

I stung another boy with her for \$5 and built No. 3, which had a 14-inch bow and 12-inch stern, was fourteen feet long by 32 inches beam. She had lateen-rigged mainsail and jigger, weighed 42 pounds, and was a corking little boat. I had her for ten years and cruised in her for weeks at a time. She finally died of numerous broken ribs, a bunch of kids using her holy bottom as a jumping stand one winter when she was left out in the yard.

Number Four is shown in the accompanying illustrations. She is 16 inches deep at the bow and 14 at the stern, 10 inches amidship, fourteen feet long, 33 inches beam and weighs just 40 pounds, exclusive of her sails. She will cost you \$7.00 to build, not including her sails, and for an all-around cruiser is hard to beat, as she will live in water that would drown an open canoe, is a dry, rain-proof and mosquito-proof home to sleep in at

## 162 CANOEING AND CRUISING

night, and will sail dozens of miles where you would paddle one.

Most of our writers of boys' books advise building a canvas canoe of barrel hoops. That is conclusive evidence that they never built a canoe in their lives, for of all the material to give you a cranky, unsafe, tippy canoe the barrel hoop is king. The reason is because it is round—just the shape to roll over—and can't be made to hold any other shape. Look at any good Indian model canoe (Morris, White, etc.) and you will see that it is flat-bottomed with a fair round bilge or turn-up from bottom to sides and it is hard to upset because you must submerge one side before the other can come up. Now any kind of a barrel hoop has been steamed round, there is not a flat spot in it anywhere, and to make a canoe even passably steady you want at least 20 inches of flat bottom before curving up over the bilge.

The ideal rib stick is one that will tend to keep flat and yet permit a sharp bend upward at the bilge. There is no wood better for this purpose than black ash, though white will do. Go to any wagonmaker's shop and ask him for a board of black ash about five feet long, an inch thick and five inches wide. He will charge you fifteen cents for it. Take it to the nearest wood-working mill

## DECKED CRUISING CANOES 163

and get them to rip it up for you into strips one-eighth inch thick. You will get some twenty canoe ribs out of the board. While at the mill ask to see their No. 1 spruce stock. Tell them you want one board, planed both sides, sixteen feet long, free from knots. Have this ripped up into strips a quarter-inch thick until you have sixteen of them. You will have half your board still left and from it you will have two  $\frac{3}{4}$ -inch pieces ripped off and two 2-inch. Next, you want a piece of 2-inch by 3-inch white oak six feet long, two pieces of  $\frac{7}{8}$ -inch half-round yellow pine moulding sixteen feet long, two pieces  $\frac{1}{2}$ -inch quarter-round ditto and one piece  $2\frac{1}{2} \times \frac{1}{2}$ -inch beaded white pine for a cockpit coaming. Have them all wrapped up into a bundle, pay your mill bill, which should be about two dollars, and march home with the entire material for your canoe frame on your shoulder. The bundle will weigh thirty pounds.

Arrived home the first thing to do is to set to work at that stick of 2 by 3-inch white oak, for out of it you make the stem and stern knees. From the drawings herewith you will get the angles for bow and stern pieces. Saw across the top of the stick at this angle and again a parallel cut 14 inches from the top. Saw it straight across 9 inches further on and take the two pieces so

## 164 CANOEING AND CRUISING

obtained and stand the 14-inch piece up on the other. You will at once see that you have, roughly, the bow knee. Draw the curve of the bow on both pieces of wood and saw off the superfluous wood beyond the curve. You now must work both pieces into triangular shape and the best tool to do it with is a camp axe. Your stem should be half an inch thick at the extreme front so as to give room to screw on a brass stem-band, so draw two lines  $\frac{1}{2}$ -inch apart down the center of the front face of the blocks. Hew from these lines back to the rear corners with your axe until you have dubbed the stem and keel-piece roughly triangular in cross section and finish smooth with a plane. Now nail the stem to the keel-piece and you are ready to fit the deadwood, the triangular piece which holds both of them together. Take off the angle for this on a piece of paper from your already assembled stem and keel-piece and transfer the angle to your piece of oak stick, being careful to saw out the block with true cuts square across.

If well done the deadwood block will fit snugly and you can screw it home with  $2\frac{1}{2}$ -inch, No. 14 iron screws into stem and keel-piece. Work over the deadwood block until you get a true fit, as this is what takes the shock if you ram anything (and

## DECKED CRUISING CANOES 165

you're always ramming things on a canoe cruise). Drill screw-holes in the deadwood a little larger than the screws and just a little smaller than these in the back of stem and keel-piece. The bow knee is now done and the stern is made the same way. The next job will be to cut a shallow  $\frac{1}{8}$ -inch rabbet on stem and stern and keel-piece to take the canvas, and six notches on a side for the ends of the ribbands. The top notches must be deep enough to take two ribbands one on top of the other,  $\frac{1}{2}$  inch deep. Now saw out the places in both stem and stern keel blocks to take keelson and keel, as shown in the working drawings, and the long job on stem and stern knees is done.

The canoe will go ahead with a rush from now on. Take one of your  $\frac{3}{4}$ -inch strips and cut it 13 feet long for a keelson. Cut a shallow notch in the center  $\frac{1}{8}$ -inch by 1 inch and cut one like it at every foot each way to within one foot from each end. Turn the notches down and screw on the stern and stem knees at each end of the keelson. Follow with a ribband nailed along under the keelson and of the same length, and then fit the keel, rockering it  $1\frac{1}{2}$  inches each way and screwing from underneath to the keelson with long 3-inch screws or bolts. By rockering is meant tapering along the under side of the keel, which is

## 166 CANOEING AND CRUISING

made out of one of your 2-inch spruce strips and should taper down to ½-inch deep at each end, beginning five feet from the end. The job is best done with a hatchet and finished to a line with the plane.

Now you are ready for the center mould. Make it of box boards as shown in the illustrations and set up over the middle notch in the keelson. Now take the first of your ash ribs, slip it through the middle notch and bend it snugly around the mould board, tying together across the top with a piece of string so that the rib cannot fly out straight again. Now take four ribbands, slip them in pairs over the ends of the mid-rib, bend them in at bow and stern and nail them temporarily over their notches with thin brads. Do not cut them off until everything else is done, as there will be a lot of taking up and letting out before the bottom is even and smooth. Put on all the other ribbands, five on a side, spacing them evenly along the mid-rib and tacking them in place by brads driven through ribband and rib into the edge of the mould board. Tack them temporarily over their notches at stem and stern, letting each ribband take its natural curve.

You are now ready for the ribs, only the last two of which at each end will have to be steamed.



## DECKED CRUISING CANOES 167

Beginning each side of the mid-rib, shove in a rib down between the two ribbands of the gunwale, through the notch under the keelson and up between the opposite pair of gunwale ribbands. Tack it with a brad half-driven through the keelson and rib and then push down the ends of the rib on each side until you get a true flat, almost like that of the mid-rib with almost as sharp a bend at the bilge. Lash tight with twine around the gunwale. You will also have to lash the mould-board down, as the tendency of the ash rib is to raise it and make your bottom not flat and safe but round and cranky. Put in the other ribs the same way, working in pairs towards bow and stern, always trying to have each curve a little less than the one before it and keeping them as flat across the keelson as possible. The last two will have to be steamed, easily done by simply wrapping a soaking towel of scalding water about the rib and letting it stand ten minutes while you drip on more steaming water from the tea kettle.

The ribs just behind the stem and stern bend up from the keel so sharply that they simply *must* break, so, to put them in, whittle a block to shape and screw it down on the keelson, cut the rib in two and screw the lower ends of it to the block.

## 168 CANOEING AND CRUISING

Tie the ribs to the ribbands wherever they cross and then turn the canoe frame over. You will find it all hills and valleys—flat spot here, a bulge there, two halves of the same rib uneven, a lopsided place somewhere else. What it needs is patient adjustment, shoving down the end of a rib in one place to give her more bilge, letting it up somewhere else, pulling a ribband in a little flatter or letting it out a bit, but finally the whole bottom will come out smooth and fair and is ready to rivet.

Whether to use copper rivets or clinched copper nails I leave to you. All my canoes except this last one were done with 2d copper nails clinched inside and all were staunch and strong. In this one I used rivets (No. 1— $\frac{7}{8}$ -inch long) but it was a tedious job as they all had to have holes drilled for them, a shallow countersink made to sink the rivet-head flush with the ribband, and the little burrs are most exasperating to keep on while you are hammering over the rivet head. With copper nails it is just a drill hole with the brad awl, insert the nail and clinch over. However, do them all but the gunwale, which will be all out of shape from the pressure of the rib ends, and then untie your twine and adjust the gunwale to get a fair and pretty sheer. Secure with brass screws

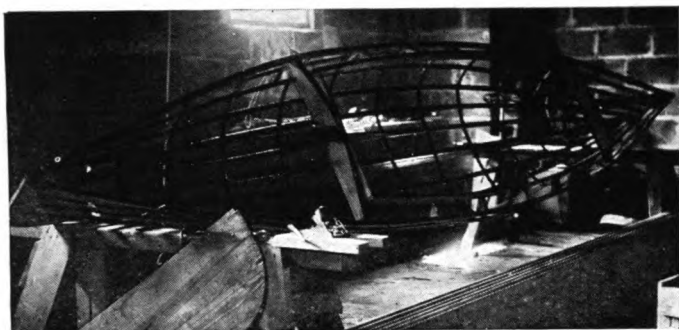

DECK FRAMING OF THE "WATERAT IV"  
Note center mould to left.

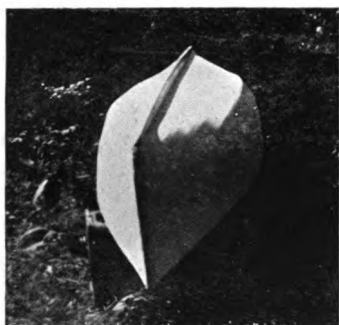

AFTER STRETCHING CANVAS

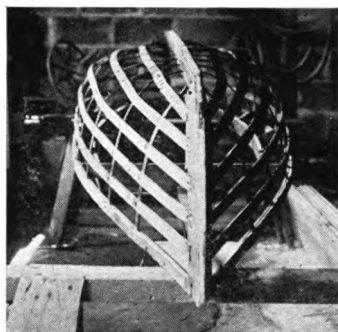

BODY VIEW

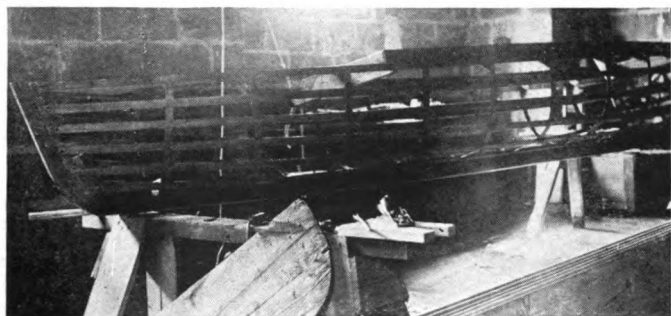

RIB-BANDS OF THE "WATERAT IV"  
Note center mould to left.

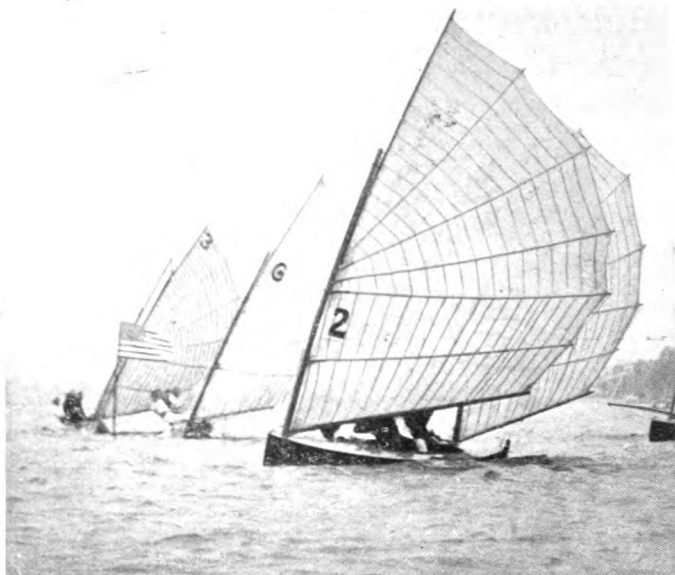

**ROUNDING THE MARK**

**An exciting moment in a race of deeked sailing canoes with bat-wing rigs.**



**THE "VARMINT" UNDER AN ASH BREEZE**

## DECKED CRUISING CANOES 169

and cut off the rib ends flush with the gunwale. You will find that the strain of the ribs on the ribbands has pulled both your stem and stern knee out of shape so that ugly cracks show around the deadwood block. You now pull out all those temporary brads in the ribband ends and free the stem and stern. Close up the cracks snugly with a few taps of the hammer and then put back the ribbands, beginning with the gunwales and cutting each off to exactly fit in its notch. Secure with  $\frac{3}{4}$ -inch brass screws, two to the notch.

The frame is now done and should weigh 24 pounds. Next you go in for the deck framing. At bow and stern insert the triangular white pine boards called breasthooks. Cut a  $1\frac{1}{2}$ -inch hole for the mainmast step and cut out an oak block with a 1-inch round cup drilled in it for a footstep for the mainmast and secure it to the bow deadwood, giving the mainmast a pretty "rake" or lean aft. Now for the cockpit. If you are going to sleep in her it ought to be six feet long, so the cross-braces must go at the third rib each way from mid-rib. Make these cross-pieces out of your 2-inch spruce strip, sawing them so as to pitch an inch each way from the center. Cut a notch for the deck ridge piece and then put in your braces with  $1\frac{1}{2}$ -inch brass screws driven into their

## 170 CANOEING AND CRUISING

ends through the gunwale. At the same time take out the mould board as you no longer need it. Next get out your ridge pieces of the 2-inch spruce strip, planing them to the ridge along the top surface and fitting them into notches in the cross-braces and breasthooks at bow and stern. The rear ridge piece wants a 1½-inch hole cut in it for the jigger mast step, so you had better nail reinforcing strips on each side where this hole goes through. The cockpit coaming should go about three inches from the gunwale, parallel to it, so lay off the three inches on each side on the cross-braces. Then cut from your 2½-inch white pine beaded cockpit coaming two pieces of the same length as between the marks and screw them to the cross-braces, allowing the beading to just project above the cross-brace. To fit the coaming sides, measure off two lengths a little longer than you need, cut a spreader six inches shorter than the inside measurement from gunwale at the mid-rib and bend the two coaming sides around this spreader, held fast with a loop of rope at each end. Pick up this frame and put it on the canoe and saw off the coaming ends so that they will exactly fit between the cross-braces, slip them into place and secure with blocks, besides nailing with brads to the cockpit end pieces. At each rib you

## DECKED CRUISING CANOES 171

will now need a small block between gunwale and cockpit coaming secured by 1½-inch brass screws through the gunwale and 1-inch screws through the coaming. When all are in, the spreader can be knocked out and the canoe frame is ready for the canvas and will weigh 28 pounds.

To make the canvas lie smoothly a last job will be to plane the edges of the ribbands round and smooth so that sharp rib edges will not make the canoe look like the ribs of a starved dog. Get ten yards of 10-oz. duck canvas (20 cents a yard). It will weigh 100 oz. or a little over 6 lbs. Cut it in half and have the two 5-yard pieces sewed together on the sewing machine along the blue line overlap mark. Now take off the keel and lay this seam along the keelson ribband, tacking it here and there with 4-oz. copper tacks. Fold the canvas up over bow and stern and tack here and there to the gunwale. Cut off the surplus all around and save all of it, for there is enough for both bow and stern deck and the strips of deck outside the coaming. Now stretch and tack on the canvas, working each way from the center, but do not drive the tacks home nor use more than one every four inches. At the point where the stem and stern rabbet crosses the crack in the bow and stern knee, drill a half-inch hole and drive

## 172 CANOEING AND CRUISING

in a soft white pine plug called a stopwater. Next daub the whole rabbet over with white lead paste and stretch the canvas tight into the rabbet, tacking close together. Now work back along the gunwale towards the mid-rib, stretching the canvas as tight as you can, tacking every two inches and being sure to work on opposite sides of the canoe alternately. In spite of all your care there will probably be a gather or pucker in the canvas amidships, but do not let this worry you, simply slit it four inches down from the gunwale and sew up the overlap. Take your left-over canvas and get out the bow and stern decks, tacking them over the side of the gunwales. You will also find that the original pieces of canvas cut off along the side when reversed will exactly fit along the coaming. Tack them to it, stretch taut over the gunwale and trim off all the hangover.

The canoe is now ready for paint and weighs 34 pounds. I have tried all kinds of ways to reduce the paint weight and also its cost. On this last canoe I tried one coat of shellac and two of Sherwin-Williams willow green canoe varnish. Total paint bill \$3.00, total weight 6 pounds. On the whole the cheapest and best was that on *Waterat III*, two coats of white lead paint and a finish of any color preferred. Avoid varnishes



## DECKED CRUISING CANOES 173

and shellacs and save expense. You ought to come out under \$2.00 cost and 8 pounds weight. After the paint is on, put your  $\frac{7}{8}$ -inch yellow pine half-round moulding along your gunwales, and the  $\frac{1}{2}$ -inch quarter-round beading around the cockpit. Give these two coats of varnish and you are ready to go at your rigging.

I have tried leg-o'-mutton, lateen, and battened leg-o'-mutton or Canadian Club, and on the whole I prefer the latter. The leg-o'-mutton is the simplest, but it has long spars impossible to stow in the canoe, and its baggy leach makes it slow sailing. The lateen also has long spars, but the draft is excellent and fast. It is, however, hard to reef. *Waterat IV*, my latest canoe, has the battened leg-o'-mutton shown in the illustrations. It is a top-heavy, dangerous rig in large sizes for any but first-class canoe sailors, and the amount of canvas shown in the photographs is "man's sized." Sailing the little witch in a squally breeze is some busy occupation! However, by making the boom of the mainsail two feet shorter and all the rest of the measurements in like proportion (the actual dimensions as given in the sail plan drawing) a very good safe rig is had. The best sailcloth is American Drilling, 14 cents a yard, and you will want about eight yards. To lay

## 174 CANOEING AND CRUISING

out a sail, choose a level spot on the lawn and stake out the sail according to the dimensions given, cocking the boom up 18 inches above a right angle and setting the gaff up nearly straight, allowing just room for a block between it and the mast head. Join the stakes with twine and spread out the canvas under the twine outline, always laying it parallel to the leach or after-edge of the sail. Hem it all around and put in grommets every foot along the boom, gaff and luff. To put in the batten, fold over a pocket in the sail just large enough to pass a  $\frac{1}{4}$ -inch by 1-inch strip of spruce ribband and sew a seam along both edges of the pocket on the sewing machine. To make the spars you can buy  $1\frac{1}{2}$ -inch and  $1\frac{1}{4}$ -inch round spruce sticks 14 feet long at any sash-and-door mill for about 25 cents apiece and they will save you much weary planing as all they need is tapering at the ends. The masts are of  $1\frac{1}{2}$ -inch stock, booms and gaffs  $1\frac{1}{4}$ -inch. For gaff jaws you can buy a regular brass canoe gaff jaw and bend it over at the right angle to grip the mast when the gaff is up. You will need 5 two-inch mast rings for the luffs of mainsail and mizzen, and don't forget to grease the mast with tallow candle or slush. Four brass cleats and four pulley blocks complete your running rigging. Two pulley blocks

## DECKED CRUISING CANOES 175

are for the halliards at main and mizzen mast heads, one on the deck for a main halliard fair-leader and one on the rudder-head for the mizzen sheet.

For extras, first of all, a bottom grid. Cut up what you have left of the ribband stock into 6-foot lengths and tie them to the ribs in the cockpit along between the ribbands. Otherwise your toes will be digging into the canvas bottom all the time, making unsightly dents in it. Another way is to tie in a sheet of oilcloth or heavy canvas, which will serve to keep your feet off the bottom. You want two canoe paddles, a big double blade with drip cups, and a little single-blade pudding-stick for working in narrow creeks, frogging, etc. The latter may be 30 inches long by 5 inches wide and you saw and whittle it out of a white pine board. Then you want a cockpit tent to have the best fun in a canoe. Get six yards of 8-ounce duck canvas. Make a rope frame with two spreaders the same size as your cockpit and stretch the rope frame between main and mizzen masts 30 inches above the cockpit. Over this spread your canvas, cutting and pinning until you have a little rectangular house over the cockpit, and have it sewed up on the machine. Cut a door in one side and fill with mosquito netting. Put in staples in the cock-

## 176 CANOEING AND CRUISING

pit leading along the sides and grommets in the bottom hem of the tent to match the staples. Take along a browse bag and fill it with leaves or sage at night, and, my word for it, you will sleep in that mosquito-proof, rain-proof and damp-proof canoe-house like a major!

## CHAPTER IV

### CANOE FITTINGS

THE day of sail canoeing seems to have gone out of vogue of late, giving place to the light, open Indian type of canoe. Time was when one could go to the far ends of the earth in the canvas-covered cruising canoe or its heavier wooden counterpart, though I always preferred the former. I see no good reason for this change, and hope that these chapters on the canvas cruiser will do something to revive a most interesting type of long-distance canoeing. As a matter of fact you can build a very serviceable canvas canoe with spruce and ash framing and ten-ounce duck skin which will not weigh over thirty-five pounds. Nes-smuk, who navigated in the lightest wooden canoes in the world, weighing but 11 lbs., seemed to think that canvas canoes gained in weight with age and were limp, logy, and non-floating when awash. As a matter of fact he spoke from hearsay on this matter and never gave the canvas canoe a chance. Far from being logy it is as taut and spruce a craft as floats, lively and safe in sea-

## 178 CANOEING AND CRUISING

ways that would have held Nessmuk's ten-foot open canoe helplessly wind-bound, and, if you upset, which may happen if some accident like a jamming rudder befalls you, she will fill to the brim and yet carry your weight nicely, while you kick her ashore, or, if the seas are not too choppy, you can bail her out from the water alongside, crawl in over the stern and go your ways rejoicing. I have done both and I *know*. And she is the only solution of the mosquito problem in a cruise along the great Atlantic bays, such as the one to Currituck Sound and back via inside route from New York. For the canvas cruising canoe is the one impervious sleeping resort—where marsh mosquitoes abound. Its tent is virtually a little rectangular house over the cockpit, and is provided with a mosquito blind inside the flap. When you retire for the night, not only is the tent buttoned firmly to the cockpit all around, but the bottom edge of the mosquito bar is also. You gather a few armfuls of sage for bedding, strew them in the bottom of the canoe, pile sand around her as she lies up the beach, step in the two masts and guy the tent between them, leading out to pegs on the beach,—and the ravenous horde of stingers outside can sample the tent or the canvas deck, or the canoe bottom, to their heart's content

for all you care. In making a canoe tent, ordinary sober whites and drabs seem out of keeping with such a gay bird as the canoe has been proving herself to be all day long. I always prefer something loud in awning effects, broad, noisy stripes that are blatantly aggressive on the color-scheme of the surrounding scenery. These stripes should go vertically, and four feet high is plenty. The tent should be just the length and width of your cockpit, which will be about 2 feet wide by 6 feet long. To make it, sew two strips of yard-wide awning duck together, hemming across the ends. This piece will give you both sides and the top. Get out two more strips a little over two feet wide and five inches longer than the height of the tent. Hem at the bottom and sew to the other piece of canvas, making the ends of the tent. Each of these ends will now have two five-inch flaps sticking up above the tent top. Get two spreaders (stout sticks, like broom handles) and sew these flaps around them, sewing the leftover edge inside the top of the tent at the ends with a double seam. Run in two bolt ropes of  $\frac{1}{8}$ -inch white cotton rope inside the tent from one stick to the other, and sew it to the canvas every foot, or overstitch it to it all along its length. Bend on a bridle to each of the sticks and put in grommets every foot

## 180 CANOEING AND CRUISING

along the bottom of the tent. To set up:—Run the canoe up on the beach, pile sand around her, step the main and mizzen masts furled, lead out guy-ropes for bridles of the fore and aft spreader-sticks of the tent and guy to pegs in the sand. Use the main and mizzen sheets for side guys. Along the outside of your cockpit should be a row of brass awning buttons or hooks, which you can get from any ship chandlery, and you now snap the grommets over these hooks and the tent is up. For doors you simply leave about three feet of the middle seam on each side unsewed, and sew to the edges of the flap thus formed a loose fold of green mosquito netting of the strong linen kind, that they use for salt water mosquito bars. This arrangement allows you to pin back one flap and get the air, the opening being covered by the mosquito bar. As the rest of the canoe is mosquito proof this bar will ensure you a good night's sleep, no matter how mosquitoey the country, and in the day time along its Atlantic marshes the mosquitoes are generally at peace with the world. The canoe tent is good and comfortable for mid-summer camping, and is insect and snake-proof, besides giving the maximum of comfort with the least browse, since its circular shape goes in very well with the contours of one's body. I have slept



in them for weeks, and have even tried it off shore at anchor, but this is apt to end rather moistly as you never know, when you drift off to sleep, what the weather is going to do during the night.

Nessmuk's "pudding stick" or auxiliary paddle I have tried and found good. Get a piece of  $\frac{7}{8}$ -inch by 4-inch clear spruce about two feet long, and whittle from it a miniature paddle with a seven-inch blade 4 inches wide. Tie it to a rib of the canoe with a bit of twine so you can drop it any time.

It is very useful when working up salt creeks after rail, snipe or reed birds. Hold the shotgun in one hand and maneuver her along with the pudding-stick in the other. If a shot offers, drop the stick alongside while you attend to fresh fowl for the larder.

A  $3\frac{1}{2}$ - or 4-pound folding galvanized anchor, costing about \$1.50, is a necessity; also a small bow chock on each side of the stem, as there will come times when you will simply *have* to lie to, when paddling is impossible against head seas. You can't do anything with her without the bow chocks unless you perform the delicate maneuver of crawling out and tying your anchor-line to the stem ring. The anchor is also handy for fishing

## 182 CANOEING AND CRUISING

or resting for lunch in the middle of a long traverse.

I do not advise a folding centerboard for a canvas canoe. They are a necessity on the larger wooden cruising canoes, but the little fellow is easy to keep on a level keel and is in fact a boy's paradise in all kinds of blows, so that a good 2½-inch or 3-inch yellow pine keel the entire length of the canoe will keep her from making leeway quite as well as anything of a folding nature. Besides, the smallest of these made is 24 inches long and requires about three inches of flat keel to screw to. A good brass drop rudder is, however, a luxury not to be despised. You can buy these at more or less fancy prices, compared to the cost of building the canoe (about the same money), but you can make one for less than a dollar. Get a piece of half-inch brass pipe 16 inches long and slot its lower end with a hack-saw. Spread the slot to pass a 1-16-inch brass rudder plate. Cut this out, of the conventional round-end rudder shape, 8 inches long by approximately six inches broad. Pin near bottom with ¼-inch brass bolt. Drill two 3/16-inch holes in the back of the pipe to receive the rudder hangers, which are stout brass awning hooks screwed into the stern-post and left upside down. They have just the right slope to

allow the rudder to be easily shipped. Finish the rudder by filing a flat at the top to receive the yoke, which should have an eye in the bottom to pass the twine for lowering and raising the rudder. The only other hardware you will need is a jam cleat for the rudder line, two for the main sheet inside the cockpit, and one on the bow deck for the anchor. Halliard cleats are best on deck screwed to the main deck carline. So equipped you will find a canvas canoe trip one of the most enjoyable cruises you ever undertook.

I propose to add here a foot-note on centerboards which has been several years in the making. Leeboards are objectionable as being clumsy and landlubberly; I have always preferred a fixed keel. This latter will, however, not do much towards minimizing your leeward drift when sailing closehauled, so I have schemed much for some sort of canoe centerboard for canvas sail canoes.

Of course the first thing to be investigated was the folding metal fan centerboard, used on wooden sailing canoes. These run from 24 to 40 inches long and, even in galvanized iron cost \$8, or more than the cost of the canoe; but that is not its worst defect. The width of three or more inches required by the base of the folding centerboard trunk puts it out of the question for attaching to

## 184 CANOEING AND CRUISING

a  $\frac{7}{8}$ -inch keelson. If I were building a larger *Waterat* of, say, 17 feet L. W. L., intended mainly for sailing purposes, I would make the keel of 5-inch stock, fining down to 1 inch at stem and stern and riveting my ribs across it inside. With this keel there would be plenty of room to screw down the trunk of the folding board, and I am sure that such a cruiser for two men in salt water or lake country would be nearly ideal, for she could carry a lot of sail, would be much lighter than the wooden cruising canoe, and therefore paddle more easily, and it was the bugbear of this tedious and laborious paddling that eventually led to the downfall of the popularity of the wooden sailing canoe.

My cogitations on centerboards for the *Waterats*, as built, led to the design of a thin wooden trunk of shape to take a 12 x 36 x  $\frac{1}{8}$ -inch brass dagger centerboard. This board was to be lined inside with canvas, the lips of which were to be brought out and tacked over the canvas on the keel, thus making a watertight canvas surface inside the trunk, for it is obvious that a plain wooden trunk would surely leak because of the joint between keelson and keel which cannot be got at to calk. By lining the trunk with canvas this difficulty is obviated. To construct such a board, cut a slot through keel, keelson and ridge timber of

upper forward deck  $\frac{3}{8}$  x 12 inches. Let in two uprights of  $\frac{1}{2}$  x 1-inch oak, necked down to  $\frac{3}{8}$  inch where they pass through keel and upper ridge timber, and screw these into place at each end of the slots, setting the joint in white lead paste. Now screw to each side of these uprights the sideboards of the trunk, with their canvas inside facings already stuck fast on them by painting down with several coats of paint. These facings should have about three inches of free canvas along their lower edges, which canvas is pulled down through the slot in keel and keelson and brought around outside the canoe, where they are pulled smooth and flat and tacked outside the main canvas skin of the canoe with copper tacks set close together and liberally doped with white lead paste. This construction will give you a watertight, canvas-lined centerboard trunk suitable for a narrow dagger-type centerboard of  $\frac{1}{8}$ -inch brass with a wooden stop or top, which board is to be shoved down through the slot in the upper forward deck, which is the upper end of your trunk.

The above design is easily put in while building the canoe, and, even for a built one, simply involves taking off the forward upper deck so as to get at the work. As *Waterat IV* was wanted

## 186 CANOEING AND CRUISING

up at the June encampment of the Camp Fire Club and I was too busy to attempt any extensive work on the canoe that year, I built on her a detachable keelboard, put on and taken off with wing nuts like a set of leeboards as we used to do with keel rowboats. All you needed was a piece of  $8 \times \frac{7}{8}$ -inch yellow pine about three feet long, and two  $\frac{1}{4}$ -inch carriage bolts  $2\frac{1}{2}$  inches long with wing nuts. It did not take half an hour to put this scheme into execution. I sawed a slant fore and aft on the keelboard, so that in running aground or striking anything submerged I would not be brought up all standing and have something ripped loose. Two carriage bolts were driven through, about eight inches from either end of the keelboard; the holes for them were marked on the  $2\frac{1}{2}$ -inch keel (which, you will remember, is permanently secured to the bottom of the *Waterat* models), and, before putting her overboard, the carriage bolts of the keelboard were shoved through these holes in my keel and secured fast with the two wing nuts. Other sailors had leeboards; I had a keelboard! and, for a long time, they were mystified as to what kept the *Waterat* so well up into the eye of the wind with no visible lee-board gear.

**PART THREE: MOTOR BOAT MANAGE-  
MENT AND CONSTRUCTION**

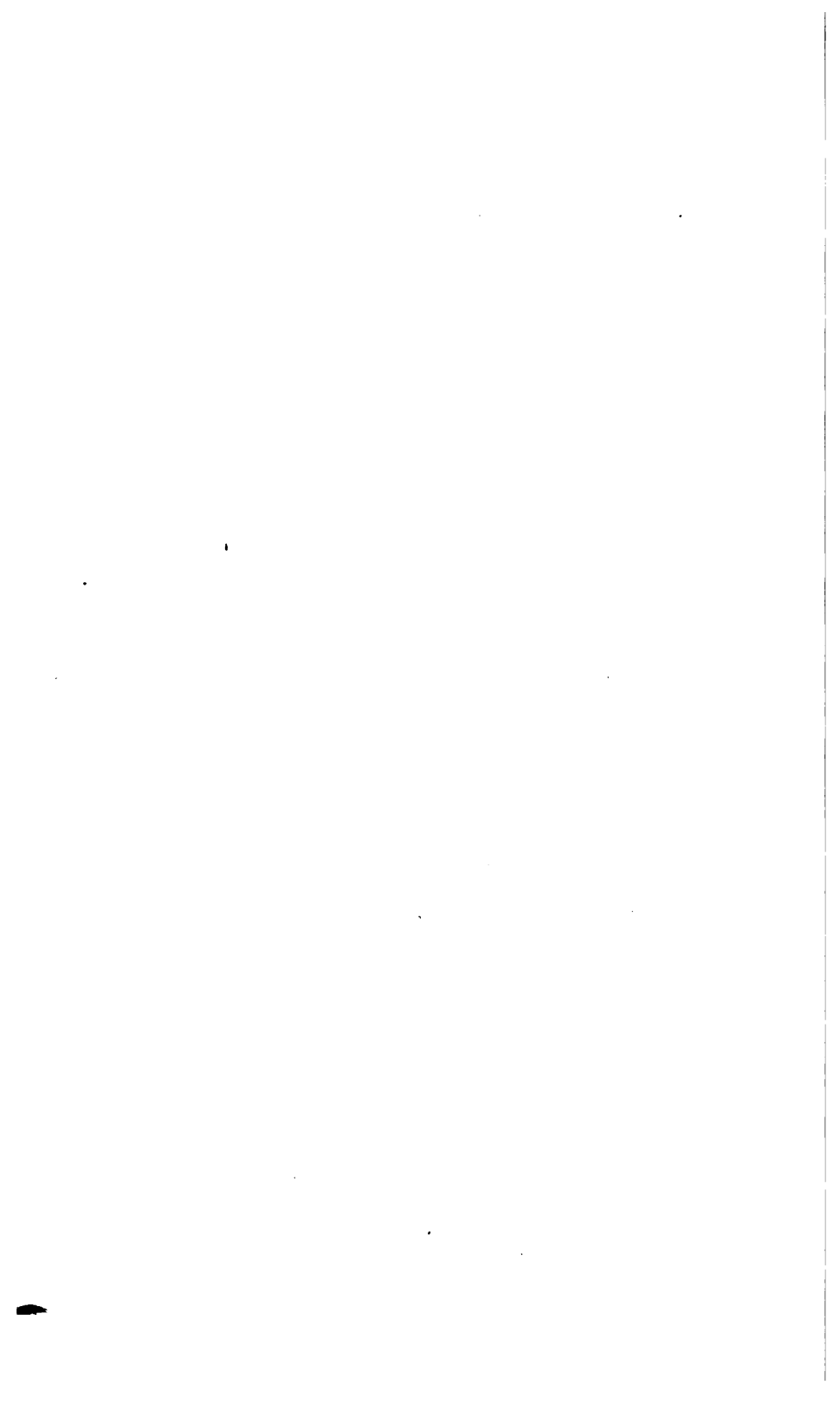



## PART THREE: MOTOR BOAT MANAGEMENT AND CONSTRUCTION

### CHAPTER I

#### CHOOSING YOUR MOTOR BOAT

BECAUSE of its engine, a motor boat is an expensive thing for a man or youth to buy, yet by picking up a second-hand one in good condition or building one from knockdown frames and patterns a very successful launch can be had for as little as \$50 to \$75. For one reason or another, owners are entirely willing to part with a perfectly good motor boat for a price far below its original cost. I have seen many a good one sold for \$75 that cost \$250 new, and cheaper boats in proportion. Then, with the knockdown-boat proposition, the whole cost of the hull is as low as \$25, and the engine can be picked up second hand for \$15 up, or bought new on some partial payment plan.

Finally, any good rowboat may be made a motor boat by the mere addition of an outboard motor, of which no less than ten good models are

now in the market and the older types of which can be picked up very cheaply.

If you are mechanically inclined and not much of a sailor, or your waters are poor for sailing, you will make up your mind to own a motor boat, and the first thing to decide is what type to have it. The hulls are roughly divided into two general classes, the long and narrow speedy boats, not very able in a seaway; and the tubbier models, able to get along on the open ocean and fine for big bays and lakes. Taking first the case where you have not much open water, say a river or long narrow lake, naturally you want all the speed you can get out of the horsepower of your engine, and this is had by a long narrow model, a tubby boat being out of place in such waters. Where I live, on Deal Lake, we have ten miles of long, narrow arms and bays and the waves are never over a foot high. Consequently our motor boat *Adelaide* is a speedy craft, one of the fastest on the lake, 20 feet long by 38-inch beam, with a 3½ horse Ferro engine giving her about ten miles speed. She is timbered for a six horse, double-cylinder Palmer engine, guaranteeing her thirteen miles an hour, but I used the smaller engine to save gasoline and because ten miles was all the speed we could reasonably handle. We have used her

## CHOOSING YOUR MOTOR BOAT 191

four years on the lake, and the engineer and captain is my 12-year-old son, who starts and runs her himself, and I seldom have to bother with it except to get him out of trouble when the engine misbehaves. This is generally not the engine's fault; once he fed her oil so much and so fast that she got oil bound, with the spark plug all sooted up and the engine trailing a cloud of white smoke from the burning oil; once he lost his pump suction and nearly burned the engine up before he stopped her; and once he got the timer all out of adjustment so she could not make any speed, but these things were easily remedied and you cannot catch him on those particular tricks again!

It seemed to us that that boat would be ideal for Barnegat Bay. Towing a couple of sail canoes as tenders, loaded with duffle and tents, what a time we could have with her fishing, shooting and camping on the dunes down the lower bay! What a time, indeed! She looked good to us, so we hired an automobile truck and shipped her down there. In the upper bay she did well and I started the first cruise with six boys, our tents, grub, duffle and what-not, with the canoes towing astern. We had a week's camp up on the Metedeconk River, a tributary of Barnegat, and the boat was fine for transportation as there was plenty of good

water. Later we started down to the lower bay and our troubles began. The bay is some six miles wide there, and generally has a neat sea on, and through those waves the *Adelaide* cut like a knife, drenching us and the duffle with salt spray. All right; we used the boat cover for a tarp, and managed to keep the engine dry so she would run, but that was not the worst. All along the shores of the lower bay the sea grass beds extend out for miles; there is no good water except in the buoyed channels, so, as soon as we spied a good camp site in the dunes and turned the boat towards shore, she promptly wound a wad of weeds around the propeller and gummed the works. The engine just spun around, and the boat stood still. We were miles from shore, and it was up to me to go overboard with a hunting knife and cut away those weeds. A cold job, at dusk of a brisk September day, with the keen northwest wind cutting across the waters! No sooner done and the engine started again, when she wadded up a second time! This time I cut her clear and there was nothing else to do but paddle that motor boat back to the channel with the canoe paddles! Darkness came on, and we were homeless in an open motor boat with a thunderstorm brewing and no chance to get ashore except where civilization had cleared



**A HUSKY OPEN LAUNCH FOR OPEN WATER OR LARGE LAKES**



**THE HUNTING CABIN LAUNCH**  
Engine is under the lazarette astern.

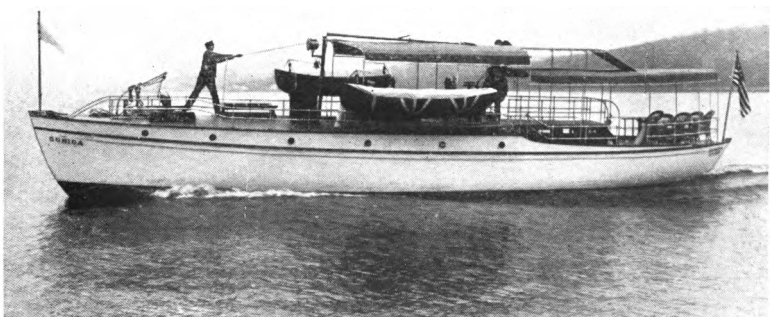

**A DEEP SEA MOTOR CRUISER**  
This type can cross the ocean and is exceedingly seaworthy.



**THE AUTHOR'S DEEP SEA CRUISER "GO-SUM"**

Built by himself on knock-down frames, this cruiser has been three hundred miles out on the Atlantic.



**THE AUTHOR'S LAKE LAUNCH "ADELAIDE"**

A narrow speed launch, good for lake service but too wet in a choppy sea.

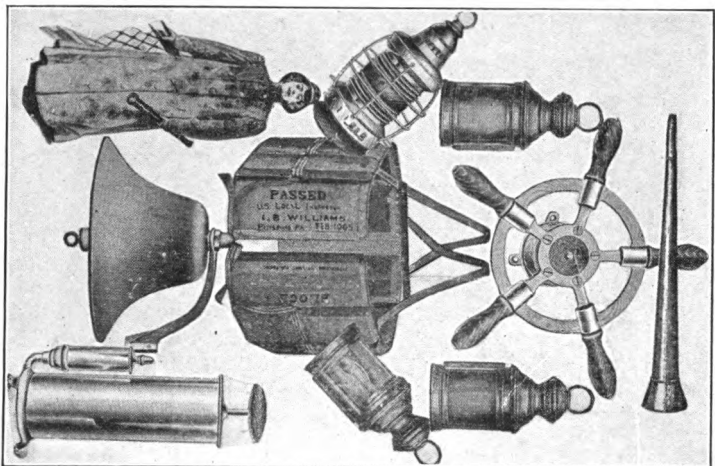

SOME FITTINGS THAT THE MARINE LAW  
REQUIRES YOU TO HAVE

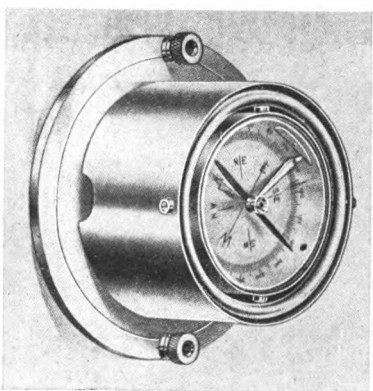

A GOOD DESIGN OF YACHT COMPASS

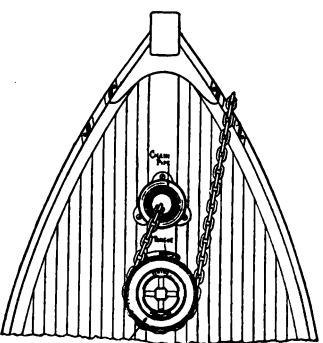

THE VIKING TYPE OF ANCHOR WINDLASS  
Can be operated with one hand.

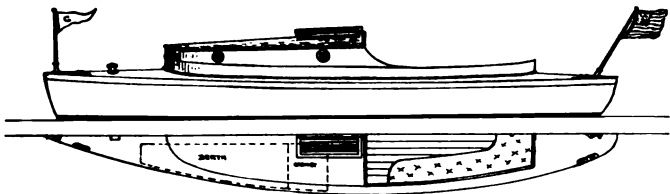

OPEN 25-FT. LAUNCH WITH HUNTING CABIN ADDED

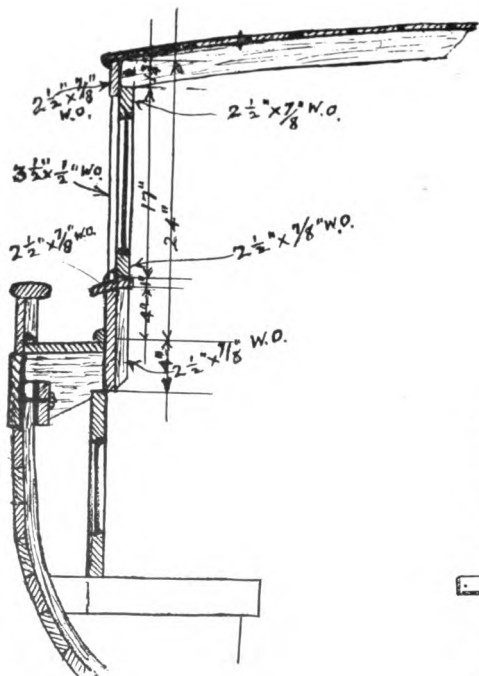

CABIN AND DECK SECTION OF THE "GO-SUM"

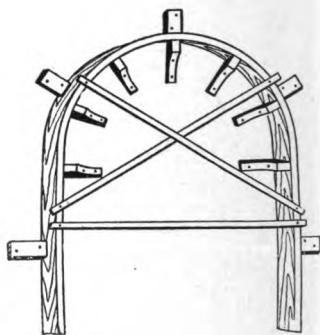

BENDING THE PLANK FOR THE HUNTING CABIN



## CHOOSING YOUR MOTOR BOAT 193

the way of weeds to a harbor. We nosed along at half speed through the darkness, feeling our way down channel, and every now and then getting into weeds again,—when me for over the side with chattering teeth and hacking knife! Finally we put into the harbor of Lavalette and we all camped out in the cockpit of a sloop, anchored the farthest out; the hardest sleeping I ever experienced, for that sloop was a racer and her cockpit floor was ribbed with hard oak foot-braces for the helmsman!

Next morning, after a long search, we found a beach where we could get in, but it wasn't just where we would liked to have camped, and it involved a long pack trip over the dunes. We had several days of snipe shooting and surf and bay fishing, but we never took the motor boat down there again.

So, if you have weeds or shallow water you must allow for a tunnel stern boat and put a square small-mesh chicken wire screen over the propeller well to keep the weeds out of the propeller. Reversing the engine helps somewhat in clearing weeds, but not much, particularly if they are thick.

This brings us to the question of sterns in general. The old type of fan-tail stern used in sail

boats was designed to give an overhang which could make a foundation for the main sheet traveller, main cleat, etc., and it was in no danger of being submerged by following waves because the lift of the sail pulled upon it strongly, so she had no tendency to squat. But, with a propeller underneath, sucking out all the water under the stern and driving it aft, the fan-tail stern squatted down flat to the water until it got a bearing surface, and that put it so low that a following sea would climb right over the stern and swamp the boat. And so grew the box-end, stubby, motor-boat stern, made in a number of ways, but all with the idea of providing a buoyant, lifting stern that would slide right over the water and that a following sea would simply lift up, not swamp. These motor-boat sterns are classed as flat transom, Norman V, sloping transom, sloping V, compromise, and canoe sterns. Of these the flat vertical transom is the easiest to build, but requires an outboard rudder, hung on gudgeons; the Norman V is good to look at, and not hard to build, in fact it is easier in some ways than the flat transom, for one large, wide oak board is not required, two smaller ones doing the service just as well, jointed at the point of the V. The forward-sloping flat transom or V both look well, and

## CHOOSING YOUR MOTOR BOAT 195

give a maximum of lifting power to the stern, and both require under-hung rudders. The compromise and canoe sterns are both hard to build for amateur carpenters, as the planks have so much strain on them that, unless they are steamed, they will likely split when the nails are driven home and I would warn boy carpenters off from such difficulties. My big 35-foot cruiser the *Go Sum* was built with a canoe stern, and what a time we did have bending those cypress planks and getting them to stay nailed without splitting!

For a seagoing motor boat or one used in wide open waters the bow also must receive consideration. The plain, straight-sided bow, with no flare will make a wet boat of her, as there is nothing to catch the waves and hurl them back, instead they wash up and over the bow deck, slewing aft and wetting down everything, particularly the engine spark plugs, thereby stopping the motor. The ideal bow would rake forward somewhat and the sides would flare outward in a V shape, fining down to the stem along and below the water line, and rounding in to the stem up at the deck level. Such a bow will ride many a wave without shipping water, while the straight stem would let it come aboard.

A third point is protection for the engine. No

matter what the water, you will need some sort of housing over the engine to keep off spray, rain, etc. Even with the patent waterproof spark plugs you will not want your high tension wiring wetted down, nor the flywheel flinging up rain in pinwheels all over the boat. The covering for sea-going motor boats is generally a box hatch, with hooked sides and top so that it can be taken apart to get at the engine if it misbehaves. All you really need to get at most of the time are the carburetor throttle, the timer handle, and the main oil cup, and a box that nearly fits the engine will enable you to reach these through the top. The flywheel should project through the for'd end of the box to get at in cranking. With an engine mounted well forward, like the *Adelaide's*, a pair of hatches, with hinges on the coaming so that they can be raised when starting the engine, is the most convenient rig. In both cases the box or hatch confines the noise of the engine, and all of them are more or less noisy, a nuisance in the long run! The advantage of an engine mounted well forward is that you can have more available room in your boat and a long easy slant to the shaft, getting the most of your thrust instead of losing a fraction of it as you do with an engine mounted aft with the shaft at a sharp slant. The disad-

## CHOOSING YOUR MOTOR BOAT 197

vantage of mounting the engine forward is of course the difficulty of getting at the flywheel to crank her, and most of them are so rigged as to start with a rear starting device, simply a sprocket and chain with starting pawls on the sprocket which engage notches on the engine coupling plate when you are cranking the starting shaft. This turns the engine over, and, with the timer set a trifle back, you get a kick out of her, and, quickly advancing the timer, she gets up speed, after which the clutch can be thrown in. Another advantage of the forward-mounted engine is that you can buy a brass shaft log and screw it directly to your keel plank, with a long slot cut to pass the shaft. This construction is much easier for the amateur builder than to make a shaft log, get it fitted right to the deadwoods and calk and stopwater it properly.

The next things to look at in a motor boat are the engine timbers. These take the whole thrust of the engine, and should be anchored to at least three ribs and their floor timbers to get a good hold on the boat. At no point should they touch the planking, for if they do the vibration of the engine will be transmitted to the planking and start it leaking. Good notches, with a reasonable bite over the floor timbers, are ample. On the

timbers go the engine and clutch. The best foundation bolts for both are screws that are lag-screw threaded in the wood and machine-threaded for the nuts. Two of these machine nuts are first put on and jammed, and by them the lag-screw is driven home, after which the nuts can be backed off, one at a time, and the bolt studs are ready for the engine. When the latter has to be taken out of the boat for the winter, all you have to do is to unscrew the nuts and lift the engine off, a much better job than backing out a set of solid head lag-screws from the oak, where they have probably "frozen" fast!

As to having a clutch, most two-cylinder engines can be reversed with the timer and switch, if you know your engine. Even a single cylinder one can be so reversed by any boy who takes the time to learn the trick. You must know by the sound, or a mark on the flywheel, just when she is going over center, and the stunt is to throw off the switch, reverse the timer, and catch her with the switch again just when the upstroke begins, thus driving her backwards, when the timer will keep her going that way without further reversal. On a crowded lake, however, a reverse clutch is necessary, and generally required by police regulations. They cost from \$20 up, according to the

## CHOOSING YOUR MOTOR BOAT 199

size of the shaft, and for small boats one of the patent reversing propellers answers as well.

In buying a second-hand boat, the thing needed is to find out how old the hull and motor are, and what abuse they have been through. If the hull has been left for a winter, submerged and at the mercy of ice and thaw, she will show it in leaky bottom, strained ribs and floor timbers, and half rotten condition of the bilge. Dig in here with your knife, trying garboard strakes, ribs, floor timbers and deadwoods for soundness. If rotten, the knife will go in easily; if sound, a cut of the knife will turn up a clean shaving. Try the seams; they should not be open more than a sixteenth inch at the end of a winter out of water, and should be uniform in the width of crack. Look out for wide spots, plugged with wads of calking and wooden splines, these are always leak points. Don't buy an old, logy boat at any price; she isn't worth fixing up; better spend the money on a knockdown frame and build one yourself.

As to the engine, insist on seeing it opened to get some idea of the condition of the cylinder walls. A try at the crank, with priming cock closed, will give you some idea, for if the rings are tight you will get good compression and have to use a lot of force in getting her over center.

Hold her nearly at center and note if she loses any compression; if the rings are leaky it will all soon "evaporate." Well-oiled rings may fool you in turning over fast, but take your time and if the compression is not good it will soon fade away. The cylinder walls should show a bright, hard polish; beware of an old engine with the lathe marks still showing on the cylinder walls—she has been rebored and most likely the walls are now too thin for safety. When the engine is running, listen for any knocks in the piston and crank connecting rod pins, and don't take any engine that shows any such knock. The seller might as well get these out of her before turning her over to you—the engine has been abused at some earlier time in its history, or she would not have them; most likely has been allowed to run out of oil, with the result of melting out the babbitt in the bearings or burning them so that she now has a knock. It will get worse, so let him take up the wear himself and turn her over to you in perfect condition.

Take a good long run in her before you accept the boat, and note if any bad features develop. In the succeeding chapters we will tell you how to overhaul and take care of "Maud" (as the engine of the motor boat is usually called because



## CHOOSING YOUR MOTOR BOAT 201

of her likeness in character to a mule). Most engines get on without much trouble if you only feed them oil and gasoline properly and see that your electric current is on the job.

Get a motor boat with fore and aft deck, and high coaming around the cockpit, or, if your purchase is an open launch, deck it yourself with a canvas deck. In a later chapter I will show you how to build a hunting cabin for it, and even on a twenty-foot boat such a cabin changes her from a mere day launch into a cruiser for boys that one can live a week in. And that's where the fun comes in in a motor boat—getting somewhere! Without doubt you can go a great deal further than with a sail boat, partly because of having no necessity to tack, partly because of the boat being faster, but principally because calms and head storms impede you not!

As I said once before, the cheapest way to own a really fine motor boat at a low price is to build it yourself, from knockdown frames and patterns. This sort of work is well within the ability of any enterprising youth from sixteen years up, and as one's Saturdays out of school and numerous holidays throughout the winter give plenty of time, it will be a fine winter's work and a good use for the Christmas money and other

savings. Roughly the cost of a motor boat built this way is one-third the price of the same boat as put out by any reputable manufacturer. I built a 35-foot power cruiser, that went 300 miles out on the broad Atlantic, from knockdown frames for \$700 complete, including engine, yet any boat of her class and size, manufactured by any good company, would cost not less than \$2,200. There are several good makers of knockdown boats, and, as they all advertise freely, it is no trouble to get their catalogues and pick out the boat you want. Find out by correspondence whether your frames will come to you already set up and all beveled to fit the planking and then knocked down again and if not reject any proposal that will not guarantee this. Some of them simply furnish rough-sawn stem, stern and keel, and a lot of ribs steam bent over one or two moulds, but not fitted or beveled, and these make you so much work and so much danger of getting a poor job, full of flats and out of true, that they will not pay to bother with. Other concerns set up the frame complete, bevel all the ribs true to fit the planking and then knock down and send to you, so all you have to do is to assemble it again, put in the bolts, drifts and stopwaters, and you are ready for the planking. This insures a true hull, with no bad spots,

## CHOOSING YOUR MOTOR BOAT 208

no poorly fitted main timbers, and a boat that will be as good in her foundations as any that ever left a shipyard. Such a frame was that of my *Go Sum*. In one single day two other fellows and myself assembled that frame complete and were measuring for the garboard planks, and that for a 35-foot boat, the one described in the last chapter of this book. All the stern timbers, shaft log, etc., came assembled in one piece, and the stem ditto, with its scarf joints and deadwood already pinned together with heavy bolts, so all we had to do was to assemble the keel, bolt on stem and stern timbers, set up the frames (each of which came with a lath tacked across it so that it *had* to stay true) and put on the keelson. Then the holes were drilled for the through bolts, through keel, floor timbers and keelson, and, when the nuts for these were set up, our hull skeleton stood finished. The patterns came in long rolls like wall paper, and you cut them out and pasted on the boards (a fine lot of clear cypress that I picked up at 7 cents a square foot), and the planks were all sawed out at the mill in an hour and a half by a bandsaw man, a boy to feed the planks, and a nigger to carry away the finished work. I advise you to get yours sawn that way, for the job cost only a couple of dollars and saved many an hour of weary ripsaw-

ing. We had work enough as it was, fitting those planks! It took eleven days of work to fit them all, put in the butt joints, calk the whole job, pay with white lead, and plane the skin smooth all over. Of course a boat of that size is a big job, as big as a small house, but on a smaller scale boats from fifteen to twenty-five feet have been successfully built by youths all over the country from frames and patterns on the knockdown system. Most of the cost of a boat is in the time spent by expert carpenters in fine finishing all over it, and much of this is equally staunchly (if not so finely) done by amateurs whose time is charged in as recreation—for it is fun puttering around a motor boat, believe me! And this is at the bottom of the success of the business of selling knockdown frames and patterns—your boat is a sure success, and not a “lemon” as she will most probably be if you attempt to design as well as build her yourself. When I was a boy we had no knockdown frames to start with, and some of the most fearful tubs ever conceived in the mind of man came right out of amateur shipyards in my home harbor town. They looked well to the eye; but as sailers they were nix!—any craft designed by a regular naval architect could sail circles around them!

## CHOOSING YOUR MOTOR BOAT 205

A final word on the selection of your craft. If for deep-sea work, avoid the flat-bottomed type, whether round or skipjack; select the ancient standby of the men of the sea, a deep V-bottomed craft that will have plenty of grip on the water and will ride upright with plenty of ballast in her bottom. For lakes and bays, the flat-bottomed shoal-draft type will suit you better, will go faster, and, as there are no really big waves about, will not pound herself to pieces in a seaway. Low freeboard and small sheer, bow and stern, will answer for her; for the ocean type, plenty of freeboard and plenty of sheer. In the knockdowns you will find both types well represented.

## CHAPTER II

### MOTOR BOAT FITTINGS

“Souse my swashbuckets, but there’s a lot of fittin’s about a boat!” You won’t say this, you’ll *groan* it, before they’re all bought; and most of them have to be before she ever leaves the dock. Otherwise, next time you’re down Quarantine way you’re liable to run afoul of a fast launch with a queer flag full of vertical red and white stripes, and before you can manage to disappear she’ll give you the four toots, which signal you will do well to obey, for it says: “Heave to! We’re coming alongside to take out your works and see what makes you act so. This means YOU!” Presently two leathery officials in navy blue come over the side and begin to look around. “Let’s see ye’re running lights? Hev ye *got* any?”

“Er,—no; but we’ve a cook for’d with one flaming red nose and two green eyes. Wouldn’t he do for a combination headlight if we stand him up in the bow and let him shut his port eye——”

“One hundred, please. Got any life-preservers?”

“Stacks of it—in the ice-box; it’s all yours——”

The inspector shakes his head and tries your whistle. “One-second squeak,” he mutters. “Got a fog horn?”

“Sure thing! Jim, here, can beller like an Alabama coon when he——”

“One hundred bucks——”

“*What!!*”

“I said ‘One hundred dollars’ *fine!*’ young man, for being at large without side lights, life-preservers, a fog horn, and I don’t know what all besides.”

(Long, panic-stricken pause.)

“Here, officer—take my boat. She’s all I have in the world (sob), and as much as ten dollars couldn’t buy her——”

Oh, it’s harrowing, but it’s much safer, to have all the fittin’s the law requires, besides a whole lot that the far sterner laws of the Sea insist upon—with your life as the penalty of being without them. It’s the most joyful thing in the world to be minus a compass in a thick fog, out of sight of land; it’s screamingly funny to have a canary-bird’s-claw anchor, with a roaring reef under your lee; it’s the height of hilarity to be under way in a nor’easter with no oil-skins and a four-hour

watch ahead—but one can be still happier *with* all these “fittin’s.”

The principal trouble with fittin’s is,—your pocket-book. By the time the boat is built or bought, you’re busted; so you venture out, shy a raft of commodities that you’ll get nabbed for not having, or else the Sea will want to know where they are in that curiously urgent way the Sea has of reminding you that your boat is ill-found.

First, the anchor. I shouldn’t advise anything less than 1½ pounds per foot of length of your boat, and 2 pounds, if she has high sides with extension trunk cabin. Such a boat will usually gambol all around the anchor—playful to look at, but nervous business for the owner unless he *knows* the bower hook is big enough. If you are over 35 feet you need at least a 70-pound sheet anchor and a 50-pound stream anchor, the latter for ordinary cruising, as it is easy to heave, and the former for business purposes, when the real goods are blowing. And be sure you get a forged wrought iron anchor, not a malleable one; that is, for the regulation fluke-and-stock anchor. The stockless variety with swinging blades are of cast steel, but I do not care for them, preferring the old-fashioned kedge hook that was good enough



for Noah and Nelson and all those other primitive navigators. The forged anchor is easily recognized by the hammer marks where the shank joins the crown and by the clean appearance of the flukes. If she is suspiciously smooth along the crown and the edges of the flukes are a little ragged and fringy, she's a *malleable*, and old Nep will grin up his sleeve to see you buy her. I once rode out a bird of a nor'easter on a malleable anchor and it got the hook so deep in the sand that nothing but the engine would pull it up. When she came up on the bill-board the shank was trying to bite the ear of the port fluke, so bent was it, and, on attempting to straighten it, it parted just under the crown at the first tap of the blacksmith's sledge. As we had had a neat, rocky shore under our lee all night, this scribe would have been by now playing jewsharps to the mermaids if that shank had parted down there in the sand.

And, when you bend on your anchor rope, don't forget to make fast the cotterpin which holds the anchor stock in place when set. It wants a short piece of galvanized chain closed around the stock so that the cotter will not plunk overboard the first time you take it out to fold in the stock of the anchor.

Attached to the anchor is—rope. Have a chain if you prefer, but good manila for mine. Nothing less than  $2\frac{1}{2}$ -inch (circumference) for any boat from 22 to 40 feet, and chain for the sheet anchor of the latter size. Secure it to the anchor ring with a fisherman's bend, which is simply two turns around the ring, across in front of the standing part of the rope, and under inside the turns around the ring. Pull taut and seize the end to the standing part with a bit of marlin. You will need not less than 150 feet of anchor cable, as you may have to anchor in a 30-foot channel with a six-knot tide some day, and your scope should never be less than five times the depth. Then you want a stout  $\frac{3}{4}$ -inch eyebolt in the anchor post or windlass head to bend the bitter end of the cable to. If she once starts to go, nothing but that eyebolt will save the rope and anchor for you, for if you dare touch it you'll go overboard like a skyrocket. A little windlass is necessary for any anchor over 75 pounds, but the usual 40 to 60-pound anchor can be hoisted on deck by hand, and, to break it out, simply snub up short and start the engine, tripping the anchor, whereat you can easily gather it in. The cost of a good anchor is about twelve cents a pound.

Both for'd and astern you need chocks for the

anchor cable. I used to get these in polished brass, but now, galvanized iron is plenty good enough, with a perennial coat of paint. The polished brass chock is too much workful to keep looking like anything. Besides, these chocks will cost you about \$4 for bow and stern sets in polished brass. Before leaving the subject of anchors in general I want to put in a word for the sea anchor. Some day you may need it; off soundings. Be sure that there is *something* in your boat like a grating, a stern sheet or what-not, that can be rigged as a sea-anchor in emergency. Make a bridle, attaching to three corners of this invention and weight one of the corners so it will float upright, while the bridle drags it vertically, broadside to, in the water. Bend the anchor cable to this bridle and get her over if the weather is thickening to wind'ard and the motor promises to be in for a three-hour balk. It will keep her head to the seas; and it *may* save something worse than an ugly rolling. Use the dink submerged if your power boat is large and the power minus for the nonce.

The next "fittin's" to look to are the running lights. The old rules used to taboo the combination light. Even a green-eyed citizen, with a red nose was disallowed, but now motor boats under

26 feet overall may carry them, provided that the former white light that used to be in the middle of the combination does not show. Boats of this size are also required to show a clear white light a foot higher than the green and red combination for'd, so that your boat must have a flag-pole socket astern and a pole with halliards for the lantern by night, and presumably your ensign by day. For motorboats from 26 up to 40 feet overall (deck measurement) four lights are required; green and red starboard and port side lights, in light screens, so fixed as to show the light from dead ahead to two points abaft the beam; a white light, placed as far for'd as possible, throwing an unbroken light ten points on each side of the vessel (dead ahead to two points abaft the beam on either side); a white light aft to show all around the horizon. This is also your anchor light, which must be shown from sunset to sunrise unless you happen to be an inner boat in an anchorage whose limits are already clearly lighted. If you get run down while at anchor without a light you are liable for all damages to the other fellow, besides the Government fine. All these lanterns must have fresnel glass lenses, which are fluted, with prisms inside, so that the flame appears as a long, bright bar of light when looking at it

## MOTOR BOAT FITTINGS 213

from the water alongside. In the spitkit class under 26 feet, plain glass is allowed, but it makes a poor, discouraging, *dangerous* light to carry. A set of fresnel glass lanterns in polished brass will cost you about \$12 for the four. Screens for side lights of motorboats above 26 feet must be 18 inches long and above 60 feet, 24 inches long. The screens are usually painted red and green inside, though the law does not expressly require it.

The running rules on which the navigation laws are based have been made into rhymes by some forgotten poetical genius, and are well worth committing to memory, for it is impossible to get them wrong, once learned that way; the meter will not jibe if you attempt to get port and starboard mixed up.

### RULE I.

Meeting steamers do not dread  
If you see three lights ahead.  
Green to green, or red to red,  
Perfect safety, go ahead!

Pretty and soothing, isn't it? Especially the third line. Rule II covers the only dangerous situations afloat, and so it has quite a poem:

### RULE II.

If to starboard red appear,  
'Tis your duty to keep clear;  
Port or starboard, back or stop her,

Act as judgment says is proper.  
But if on your port is seen  
A vessel with a light of green  
There's not so much for you to do,  
The green light must keep clear of you.

The poet who wrote that was a genius. Take it apart, and I defy you to get any of it in wrong again and yet come out all right in your meter. These two rules cover about the whole subject of maneuvering at night except when overtaking another craft, in which case you must keep clear of him. Sail boats carry no white light, wherefore keep clear a single red or green light as all sail-boats have the right of way. Tugs carry two white lights hanging from the top of the flag pole for ordinary tows, three for tows 600 feet long or more. You can perceive by the above that "by their lights ye shall know them"—not only what the stranger is, but which way she is going.

By day the rules of the road prescribe a corresponding set of navigation signals; wherefore you will find the law requiring you to possess in good working order: a whistle or blast of two seconds' duration; a fog bell; and a fog horn. (They used to call for four seconds' blast, but even the 18-inch hand-whistle would peter out in about three seconds unless blown by an expert.) As sold, you get the hand-pump in polished brass

for \$1.75 in the 12-inch length, and \$3.50 in the 18-inch, with the whistle stuck on an elbow at the bottom of the pump. This will not do, since the whistle has to be above the cabin roof to be both ornamental and useful; so the handiest place for the pump is to screw it to the cockpit floor just under the steering wheel with a brass  $\frac{3}{8}$ -inch pipe, running up the cabin panel to the roof, on which is screwed the whistle. This sailorman has no use for a chime, for the reason that three small whistles use up a good deal more air than one larger one. One bright spirit of my acquaintance has an air cylinder reservoir 2 feet long by 12 inches diameter, with a check valve on it, through which his pump fills the reservoir with compressed air. A very respectable deep-voiced tugboat whistle connects to the reservoir and every one gives him a wide berth in a fog, not guessing by the whistles that it only belongs to an 18-foot motorboat instead of an ocean-going tug. The foghorn may be an ordinary tin fish-horn from 2 to 3 feet long. Don't blow it under way in a fog, unless your regular whistle is rusty or out of whack, for the other boats will take you for a sail craft, and it isn't fair to give wrong impressions at sea. Your fog bell may be 6 inches across the mouth for motorboats up to 40 feet, but the 8-inch

bell in polished brass is only \$1.85, so by all means get it, no matter how small your craft. You'll *appreciate* it some day in a thick fog! And don't blow your horn and ring your bell at the same time, as Kipling makes his fishermen do in "Captains Courageous." The two signals mean two different things, under way and anchored, and are sure to get you into trouble if you sound them both at once. When under way at half speed in a fog blow a "prolonged" blast (say, three seconds if the pump will let you) every minute. If anchored, ring the bell for five seconds once every minute; not oftener, as that would tell the other fellow that there are two of you, but right on the dot, timing it with your watch.

In navigating by day, one blast of your whistle means, "I'm turning to starboard," or "Will pass you on your port." Two blasts:—"I'm turning to port," or "Will pass you on your starboard." Meeting obliquely, if you have the other fellow on your port you have the right of way. He should then give one blast saying that he is turning to starboard and will pass you to port. You answer with a single blast showing that you understand. If he wishes to cross your bow he will give two blasts, meaning he will turn to port. If you assent, two blasts give him the permission; if not,



do not attempt to cross-signal or contradict—blow four short toots and slow your motor until both of you come to some agreement. He should at once slow down on hearing your alarm signal. Most harbor tugs will cross your bows even when you have the right of way, and few of them ask your permission. They feel that “business is business” and you are out for pleasure, so it is not worth while getting stuffy about it. If in a dangerous predicament and you have reversed engines, give three blasts to let the other fellow know you have done so, and if you see any of his lights out at night give him the “double-two,” or two short blasts, a pause, and then two more. It is not merely a courtesy, it is your duty. And if you hear the double-two, don’t gape around like a man paralyzed, but look to both your screens, your bow light and stern lantern, *at once*. It may mean you!

All boats are required to carry life preservers, two sets of the harbor rules, and means for putting out gasoline fires. While the law regarding life preservers reads only for the hired launch, it worked backwards to the bonafide owner, as every hired launch immediately became “the owner and his friends,” so that in many harbors the inspectors were forced to require one life preserver to

each person on *all* boats so as to reach the commercial launches. The sets of harbor rules are printed both in pamphlet form and as a framed document. For small boats up to 40 feet the pamphlet form, kept in the chart drawer, will answer, but larger boats must frame and post up the harbor rules in some conspicuous place in the chart room. As for a good gasoline extinguisher, you can get a dandy little tin sand squirt-can loaded with chemicals for a dollar, and there is no excuse for being without one.

So much for the legal "fittin's"—now for the equally important things that the Sea requires. First, good steering gear. There will come times when you will have to snake that boat around on her own tail with the seas driving you ashore and a rock-ribbed dock on either side of you, so don't be niggardly about the size of the rudder. There is nothing more comfortable to a sailorman than a ship quick to mind her helm, one that will go the limit as regards turning on her own heel when she *has* to. About one square foot of rudder to every ten feet of length of your motorboat isn't a bad rule of thumb. Have a good stout shoe running out from the skeg to the heel of the rudder. The kind that are swung free look pretty, but you lose interest in them if some one backs the boat

against a bunch of rocks and jams the rudder forthwith. The tiller rope is best of red cord with steel wire insertion, for boats up to 35 feet. Beyond this, chain or steel wire rope only. The red rope costs 6 to 8 cents a foot. Lead it through flat iron sheave blocks under the washboards, being sure that the sheaves are somewhat bigger than the rope and avoiding sharp bends out of the general plane of the sheaves. The steer wheel drum wants enough port and starboard turns of your rope on it to swing the rudder full each way without over-running the securing staple which anchors the rope on the drum. A good five-spoke polished brass wheel large enough for any boat up to 35 feet can be had for \$1.75. It has a brass shoe which carries the axle and drum, and this shoe should be bolted to some stout panel where it will not pull out, no matter if you put on strain enough to nearly part the steering rope. You *will*, you know, some one of these days, so you might as well be prepared for it.

The steering wheel should go on the port side of the cockpit. To me the wheel invariably suggests a compass, as one seldom sees the one without the other just in front of it, in a stout binnacle, screwed to the deck. For motor boats the best rig, to my mind, is a permanent compass mounted

on one of the aft panels inside of the cabin, with a pane of glass so that the skipper at the wheel outside can see it day and night by simply glancing through his binnacle pane. This is also the cheapest rig, and one which you can feel reasonably certain will stay well lighted and be protected from the weather, which the small brass binnacle, with its dinky lamp, will *not* stay or be. Assuming that you elect to locate your compass in a permanent box on the aft port cabin panel, set the rhumb line true fore and aft and screw the fixture in place just under the panel window pane. The rhumb line is a fixed black line which you will find inside the bowl of the compass and represents the fore and aft center-line of the ship with respect to the rotating compass card. By the rhumb line you lay your course in degrees and minutes on the card as taken off your chart bearing. Simply keep your rhumb line on the point on the card which represents your bearing and you will "arrive."

In almost any cruise you will need a set of charts covering the various landfalls you will make, giving all buoys, lights, soundings, etc. By writing to the U. S. Coast and Geodetic Survey you can get a book giving all the charts for the Atlantic, Pacific and Gulf coast lines. These are numbered and you order the ones you want from

the diagram maps in the book. The charts cost about 50 cents apiece and are very complete and up to date. If your boat draws any water at all, do not attempt to go beyond the limits of your chart without picking up the course on another. We once tried that on a river showing only five miles back from the harbor chart. Fifteen years before I had often navigated that river so I followed the old bend regardless of the fact that many a large schooner was now sailing down some new channel cut through the marsh. I didn't know where the new channel went, but I was sure of the bend, so I followed the familiar old course. Suddenly there was a crash for'd and our cruiser hurdled up into the air. Something solid drummed along our keel and out astern, and we found ourselves afloat in that new channel with our rudder jammed fast. We had hurdled clear over a sheet piling breakwater, two feet below water at mean low tide, with our 35-foot cruiser going ten knots an hour. A tap on the rudder with a machinist's hammer freed it and we got under way again, but it was a ticklish business thereafter without any chart!

As stated before, the chart gives soundings at mean low-tide, in fathoms in white waters and in feet in stippled shoals and shore beaches. Where-

fore, in picking out your anchorings in a cruise be very sure to take the tide into account and allow at least four feet under your keel at dead low tide. This is because if any sea gets up you will touch at the trough of every wave and pound the skeg off her unless you have at least a few feet clear below it in still water at low tide. To get your depth you need an exceedingly important little item of equipment, the "dipsey lead" which is "tar" for the deep sea sounding plummet. A seven-pound billet will do for any motor boat. Bend on it a length of stout braided "banks" line and let it be at least fifty feet long, as there will come times when you have got to put down the hook in mid-channel and hence will be curious about the depth. For taking anchorage or "feeling your way" soundings, stand up on the starboard bow and swing the lead out into the pickle, about twenty feet ahead, using an underhand swing. Don't attempt to whirl the lead in grand circles as you've seen them do on big ships going seven or eight knots in five fathoms of water. You'll only hang the plummet on some innocent bystander's ear, and will make a landlubberly exhibition of yourself in general. It isn't easy to heave the lead like an old salt. No trouble about the other stunt!

Mark your lead line in feet, with a brass clip at two feet below your boat's draught, a red flannel rag at 10 feet, a white bunting rag at 15 feet, a leather tag at 20 feet, etc. There is no use adopting the regulation nautical markings of the lead line as they are far too coarse and too deep to be of much use for a motor boat. The different tags, however, are good to adopt as they show the depth as well by night as by day. You can easily feel the difference in the tags and measure the exact point on the line from the nearest tag with your arm even on dark nights.

A highly important but not much appreciated "fittin'" (before launching) is the bilge pump. First, when your boat is being built, see that the lead holes ("limbers") under the ribs fore and aft are all clear and have not gotten choked up with chips and sawdust. Choose a handy point for the bilge well and have a permanent bilge pump put in near it with a permanent suction to the well and a discharge overboard. No well-built motor boat should leak much, but as they gradually grow old they leak a little more every year; and the stern gland of the screw shaft lets in more or less water throughout the season, since its packing *will* get worn and hard. It is well worth while, to simply have to work a handle whenever a peep at the

bilge well tells you that she has made a few inches of water. The little brass bilge pumps sold for motorboats throw a wonderfully voluminous jet of water,—out of a clear, clean pailful of it. But handling dirty bilge-water is another matter, and these pumps usually stick before the first ten strokes are made. Then there is nothing for it but unscrew the pump and get the chip or grit out from under the ball check-valve, or else free the ball itself, which often sticks on its seat. Put it together again, and observe how nicely it will stick once more in the next three strokes. Besides which, some one has to hold the rubber hose over the side or else it is sure to squirt on the boat cushions, and another boy will have to put in time holding down your temper for you while you struggle with the pump.

Under the head of fixtures and fittin's comes the signal mast and the awning. The signal mast is a very natty and handy addition to any motor boat, but nothing will make you look more like a landlubber, a gardener, and a cabbage-planter than a signal-mast badly stepped, badly raked, or improperly stayed. Wherefore make a scale drawing of your boat and experiment with a pencil and rubber as to height and step of your signal-mast before cutting any holes for it. It wants a



neat yard arm hung in a rope bridle above the shroud withe, and the permanent halliard pulley-blocks are at either end of the yard. Your club flag may fly from the starboard block on the yard-arm, with blue peter on bow pole and yacht ensign astern; or else the house flag takes the yard arm, the club flag, the bow pole, and the ensign the stern. The port pulley-block is for signalling.

As regards the awning, let it come forward over the extension trunk cabin by all means, as even a foot of cool shade under the awning will keep the cabin from becoming a sweatbox. All the awning rail equipment should be stout and securely bolted to the deck, as it is the very thing which collides most frequently with dock string pieces, sail craft's bow-sprits, steam-yacht boat-booms, etc. A good rig is of one-half-inch galvanized piping, forming a hand-rail clear around the awning with short 16-inch stanchions to the cabin deck and long ones to the main deck around the cockpit. The awning is a few inches short of this rail all around, so that it can be stretched taut by a lashing around the rail. This latter should stop a foot back from the edge of the cabin eaves, so as to provide a runway for'd and should leave at least seven feet of clear deck for'd to give room for handling the anchor gear.

## CHAPTER III

### CABIN AND INTERIOR FURNISHINGS

PEOPLE seem to think that you shouldn't have a cabin on a boat unless you can stand up in it. It isn't so. I've seen the time in a thunderstorm in an open boat when I would have been glad to have had a stove-pipe to crawl into, let alone a standing cabin. You want shelter and you want it cosy, so you can sleep in it if you wish to cruise for a few days. It is no privation not to be able to stand up in it, as your living-room on a small boat is the open cockpit. You go into the cabin to sleep or get in out of the moist, or, maybe, shake up a light meal on a small yacht stove for'd under the bow deck. But the rest of the time you are taking it easy, or steering her, or fishing—*out in the cockpit.*

Wherefore, do not make the cabin a monstrosity for the sake of height. You need at least 5 feet 8 inches to stand upright, but such a cabin on a 25-foot boat will make a first-cousin to Noah's ark out of her, and it will spoil her looks if the crown of the roof goes over 4 feet 6 inches from

the floor. But, in good proportions the boat simply looks like a miniature power cruiser and is a cute little trick in spite of her infinitesimal size.

The easiest way to put on a cabin is to follow the lines of the cockpit coaming already on the boat. This usually runs about three to six inches clear above the deck and will stand a single ten-inch oak or ash plank on top of it. Don't attempt to bend this in place. Get out nine neat oak risers of  $\frac{7}{8}$ -inch dressed stock,  $2\frac{1}{2}$  inches wide by 18 inches long, and screw them to the inside of the coaming, first bevelling the latter with a plane so that its top edge slants down outwards all around. The uprights will later have to be notched to receive the ends of the roof carlines. The ash plank should not be over half an inch thick,—they will dress it down at the mill for you,—and should be bevelled on the bottom edge to fit the coaming before bending. The plank itself must be sawed to match the shear of the coaming. Take a light batten and run it around the tops of your uprights, tying in with marline and adjusting until you get a pretty profile to the eave of the cabin roof. It will be found that this line looks best about parallel to the waterline or sloping a couple of inches up at the after end. Lay the heights out on the

plank, as taken on the uprights from the batten down to the coaming top. If you have not enough to get a good curve with this spiling batten, put up a few extra sticks temporarily, thus getting the distance from your eave batten down to the coaming top and transferring to the plank. When all is done you will have a symmetrical curve shading off each way from the center of the plank from about two inches above the bottom edge in the middle to nothing at the ends. Rip this line with the saw and bevel to fit the coaming, and you are ready to bend. The plank may have to be steamed, especially if there is much shear to the cockpit coaming. Bend with the straight edge of the plank down, and around a set of chocks laid out as in the illustration around the circle of the coaming chalked on a level floor. Two men and a boy can persuade the plank around these chocks, and, once in place, hold her with diagonal and cross braces with small outside cleats on them. These take the outward thrust of the plank, while a light nail driven down into the edge of the plank will keep it from getting away. Don't attempt to hold the plank in place with nails driven into the edge of the plank alone or they will surely rip out and ruin the plank. Better also tie the business ends of the plank with a rope, passing clear around





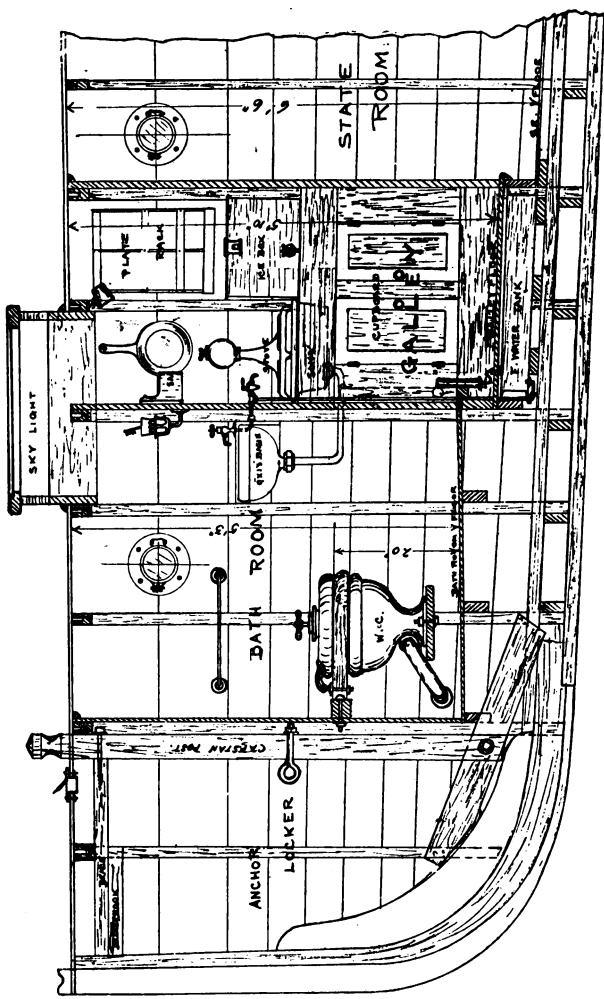

ELEVATION OF GALLEY AND TOILET ROOM OF THE "GO-SUM"



**DETAILS OF CABIN CONSTRUCTION ON THE "GO-SUM"**

After completing the planking at the shop she was hauled to the shipyard, where all the cabin work, fittings, and engine installation was performed. She went down the ways from this site.

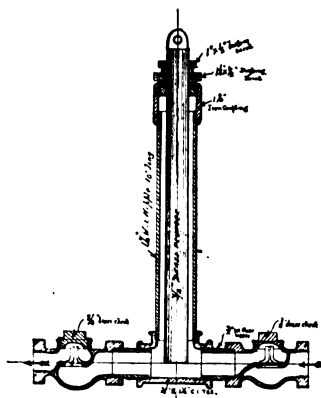

**A HOME-MADE FORCE PUMP  
FROM PIPE-FITTINGS**

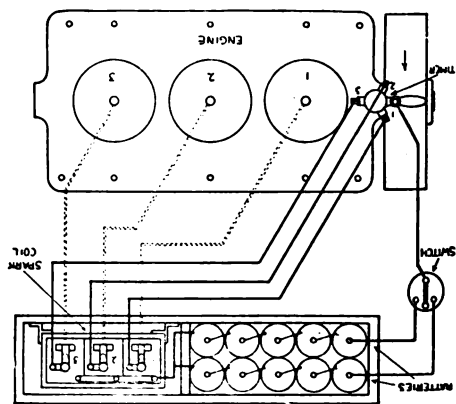

**ELECTRICAL CONNECTIONS FOR JUMP-SPARK  
IGNITION, 3-CYLINDER ENGINE**



both ends, as there is forty mule-power stored in that bent plank, and she will spread the whole family over a ten-acre lot if she once gets away from the braces. This done you can transfer it to the coaming and screw fast to all the uprights, taking off one brace at a time and beginning with the for'd uprights. Run in some white lead putty all around the bevel before setting on the cabin sides, and have a couple of carpenter's adjustable clamps handy to draw it down snug at each upright before screwing fast.

The plank will come about eighteen feet long, and as eight feet nine inches is about right for total length of a hunting cabin for a 24-foot boat over all, you will need about two feet added to each end of it on the sides. This joint ought to come in the center of an upright butting the plank and the addition on it. Clean and varnish the plank before the weather gets at it and you are then ready for the roof. On a boat of this size, about four feet six inches clear across the coaming inside is all the room you will have if the craft is at all speedy. Therefore, a six-inch crown to the roof carlines will be plenty. You need one every two feet, or five in all, and the best way to get them is to have the mill saw them out for you from a 1½ x 12-inch white oak plank. The lower

faces should be planed and an ornamental bead put on with a beading plane. The carline ends are tenoned to fit the mortise in your uprights and are snapped into place, securing with a brass pin passing through mortise and tenon. The best roof is half-inch yellow pine tongue-and-groove wainscoting, about four inches wide, with a false bead in the center of each strip. Begin with the middle plank, working each way to the outside, and leave considerable overlap on the last carline astern, as there is a good deal of trim and door fitting to go there. Trim the job carefully with a saw and you are then ready for the roof canvas. This is 10-ounce duck, which should be sewed on the machine before tacking down. Do not attempt to tack the seams to the deck instead of sewing. It will surely shrink in bows between the tacks if you do. Use four-ounce copper tacks and lap the canvas three-quarters of an inch over onto the sides of the cabin all around, driving the tacks into the edges of the ceiling planks. The copper tacks have a provoking way of turning and curling over under the canvas if they do not happen to start in just right. It will save time, tacks and troubles with the recording angel to keep a bradawl handy, slung to your wrist, and start each tack with a preliminary jab of the bradawl. Be sure and tack the aft end

## CABIN FURNISHINGS 281

of the roof canvas over the ends of the ceiling plank, even though you know very well that you are going to take it up later. When that roof paint goes on, the canvas will shrink faster and farther than Hiram's sheenie shirt, and woe unto you if the aft end of it is free!

"Nor all your piety nor wit  
Can lure it back to gain  
A single inch of IT!"

The canvas will need three coats of paint. Don't paint it sky blue,—it won't match the brand overhead; nor sea-green, for there's some of that also in a pail over the side. And don't try contrasty effects in hot-time-in-the-old-town reds, or passionate purples. The Sea don't like it and won't stand for it. There are plenty of other colors, so I leave it to you.

Cover the lap of the canvas with a trim of 1½-inch oak half round beading along the eave of the cabin. Have this beading good and thick, and not flat, so that the run-off from your roof will drip out on the washboards and not run down the cabin sides and streak them. It should also be puttied and varnished as soon as on, for the way that even galvanized nails have of staining oak in the weather is really marvelous.

To close in the aft end of the cabin, let in a

filler of  $\frac{7}{8}$ -inch oak about 6 inches wide under the washboards so as to bring down the line of the sides plumb to the floor of the boat. A 20-inch door is wide enough, so that two 16-inch panels, of 4-inch frames and 8-inch panel, will answer for sides with a jamb of  $2\frac{1}{2}$ -inch by  $\frac{7}{8}$ -inch double-rounded moulding running up each side from floor to carline for the doorway. You can make up the side and door panels yourself, with dowelled or mortised oak frames and panel boards screwed to back, or, better, have a door-and-sash mill run them out for you. After screwing the side panels to carline and floor, and dowelling them into the fillers under the washboards, you are ready for the door sill and eave trim of the after end of the cabin. The trim should be a piece of heavy OG moulding, bent and screwed to the side panels and to a filler on the carline at the door. It should lie flat under the ceiling planks. These can now be cut off short enough to stop back of the turn of the OG, sufficiently to permit a quarter-round beading to be let in. Pull up the canvas and nail the ceiling boards to the OG trim, then tack the canvas over the ends of the ceiling boards, cover with the beading and finish with plane, sandpaper and varnish.

You will note that there is no cabin hatch. I can't see the use of such an expensive thing, unless

you have a high, self-bailing cockpit and a ladder, as on a sail sloop. But, in a small motor boat with cockpit and cabin floor, practically the same thing, the reason for the companion-way hatch vanishes. Better put on a low skylight from which you can get light and ventilation. A doorsill about three inches high will be needed, however, to have the door swing free, and this should next be put on in 3-inch by 1½-inch oak, mortised into the door jambs. The doors are then swung with concealed hinges, a bolt on one door, top and bottom, and an inside lock with keyhole; an Act for the Discouragement of River-Pirates, so to speak. With such a cabin you can cruise over night at pleasure, and, when thunderstorms fret the landscape, you will not be out in the wet looking for that dear old lady with a small fortune, an umbrella and no life-preserver.

The first thing in the way of furnishings will be port lights. Don't be inveigled into building them in, in hermetically sealed glass, or the cabin will have about the same temperature as a hen-incubator, which is 103 or thereabouts. You can get five-inch portholes of plain brass for \$2 apiece at any motor boat supply house in New York. They cost about five dollars each in polished brass, but will quickly get rusty and green unless you keep after

them continuously. Somehow, polishing portholes lying flat on the cabin roof with the blood rushing to one's head doesn't compare with the peaceful joys of camping out beside a bross chock or cleat with your putz box and polishing rags. Don't get the portholes too big, or your boat will look like a battery of sea-serpent's eyes, and don't *think* of making them yourself. Some of the most fearful things seen on the sea are the home-made portholes now and then encountered on motor boats.

For a cabin nine feet long, five portholes are plenty,—two on each side and one amidship for'd. There are two ways to put them on,—either cut neat round holes with carefully rounded edges (if you can do it I'll give you a ship's biscuit), and screw the porthole flange on the inside; or else cut a round hole with a compass saw and cut in notches for the hinge and screw fastener, putting the porthole plate on outside. If you elect the latter be careful about cutting notches too freely, as there is little to spare for the flange to cover the corners of the hinge notch especially. Each porthole needs a little ball-fringe curtain. While a certain amount of individual taste is permissible about a yacht, there is no place where form and precedents in things nautical count for so much. Every object of utility aboard a yacht *must* go in

just such a place, and will look queer if an inch out of it. Ball fringes on yacht curtains seem to be one of these nautical fetishes in small things, so by all means let's have 'em, even if the curtain be smaller than a pocket handkerchief! As a matter of fact two green silk porthole curtains *are* just about the size of a small pocket handkerchief, but they are a necessity for a' that. Run them in pairs on light brass rods with square hooks and knobs at the rod ends. Some yachts have single porthole curtains, but they look better and are less in the way of the portlight if divided.

Having a nine-foot cabin, what shall we do with the interior? The unthinking will at once run a wood seat along each side and put cushions thereon,—but not you. Consider your feet, how they grow. Is there any reason why *they* should be permitted to occupy the precious cabin space during your slumbers? Shove 'em up under the bow deck. In other words run the berth under the forward deck at least two feet. As the total length of the berth will be about six feet eight inches, the end of it will come only four feet eight inches into the cabin, leaving a clear space in front of four feet. This room is more valuable than it looks. For instance, you can use twenty inches on each side to put in low cabinets about two feet

high, with paneled sides and hinged, polished tops. In one is the yacht toilet, and the other carries a yacht basin under the hinged top, while the galley stove and "kittles" are kept in the lower part. The wall space behind is available for a mirror, a shaving case or what-not. You still have two feet four inches left of clear floor space near the door, and I don't know of any better use to put it to than to locate there a couple of comfortable folding campchairs with side arms; shallow lockers, built in here under the coaming, will give you a flush wall surface.

As to the all-important matter of berths, the writer has investigated and tried a rich selection of patent devices, from folding mattresses to pipe berths. It is hard to beat, for comfort or cheapness, a permanent berth built right into the boat with a heavy canvas bottom. It may also be a good scheme to plant a colony of bed-springs under the canvas to make it bulge upward, instead of stretching it taut, but an ordinary excelsior mattress with cotton top is cheaper and don't need any springs under the canvas bottom. You can get the 24-inch mattress for \$2.50 single-faced, or double with cotton on each face so as to be reversible for about \$4, or all wool felt in green cloth for \$2.75. Get the "wimmin folks" to put a



cover of green velveteen on the mattress,—or turkey red if you like that better,—and put in the buttons yourself with an upholstering needle.

Now as to the building of the berths. You really don't need but 23-inch width for a comfortable berth and you will find that the boat fines away for'd so that there will be less than eighteen inches where your pedal ends come. It's more than enough however,—your feet aren't your shoulders,—and the 24-inch mattress will go in that berth as nice as a cotton hat, as it will be just about right at the 23-inch ends and will easily thicken up to fit in the 18-inch end without any persuasion at all. This disposition of berths will give you a foot and a half of runway between the berths,—plenty,—“thousandths!” as my mechanical friends would say. To make the berths, get out a plank of  $\frac{7}{8}$ -inch red oak eight inches wide, nail on a trim  $\frac{7}{8}$  x  $2\frac{1}{2}$ -inch round-edge oak moulding, projecting an inch above the top of the board, and also a bottom trim of 3 x  $\frac{7}{8}$ -inch beaded or coved oak. Mitre and join to make the aft corner of the berth, and trim to fit snug against the skin of the ship in behind a rib. Make two of these berth sides and ends, and screw them in place to cleats in the floor, running the sides parallel to the centerline of the ship and leaving

about eighteen inches between them. The front ends under the bow deck can be closed in with any old pieces of board. Now run in a strip of  $\frac{7}{8}$ -inch by  $1\frac{1}{2}$ -inch red oak along the ribs inside the berth, and it is ready for the canvas bottom. Tack this on with double folded hem and 20-ounce galvanized tacks spaced not over three inches. Varnish the sides and ends and you are ready for the cushions. It makes a very comfortable berth, and if you elect to have the galley and toilet cabinets you can dispense with the berth ends and run the sides into the cabinets. As they project about a foot above the berth they make a good corner for the pillow, or, maybe, for that sofa-cushion that your best girl has contributed to "the boat."

For larger boats, running from 30 to 40 feet, the amount of room usually wasted by the average builder is astonishing. Arrangements that would be obvious to the intelligence of a frog are sacrificed to make a little foolish alleyway or to box in the "stateroom"; they hide the engine in some cubby-hole where only an eel can work at it, and put the toilet most anywhere but up in the bow where it belongs. Yet out of a 35-foot boat with extension trunk cabin you can get the following "improvements": From for'd aft,—anchor locker, 4 ft. 6 in.; toilet, with skylights and two

portholes, 4 ft.; galley, 3 ft.; stateroom, 6 ft. 6 in.; engine-room and launch cabin, 7 ft. 8 in.; cockpit, 5 ft.; stern deck, 4 ft. 4 in. Yet this type of boat is generally found with a long row of peek-hole port lights on each side, and nothing inside but two long wooden seats with bullet-proof cushions on them, which are only a little softer than a moss-grown boulder. The thing has more berth-room than she really needs; it's too hot to stay in there except some time after midnight; and the engine is boxed off from the main cabin with the laudable intention of keeping it from roasting out the rest of the boat. Is she beyond redemption to let a little coolth and some elbowroom into her? Not exactly. The engine will not get the boat hot if you put on a skylight over it, and provide good portholes. The room around it is worth going after. To the woods with the adamant seats and the engine-room rabbit-hutch. Set off six feet six inches from your forward cabin partition and put in a couple of panels, making a stateroom of this space with a 20-inch door. See that this room gets two portholes on a side, and build in permanent berths on each side with clothes-drawers under them. You have left a large main saloon aft, with the engine in the middle of it, and can run hard or soft seats along the sides as you prefer. If to

change the portholes here to larger size would spoil the looks of the boat, change them to the oval shape to get more ventilation. The cockpit floor in these boats is generally higher than the main floor, so as to be above the water-line, and self-bailing. For this reason a small roof hatch is generally necessary, though if there is not too great difference between the two floors it can be dispensed with, as in the smaller boats.

For interior furnishings of the main saloon you want ball-fringe curtains on brass poles, in pairs, at each large porthole or window, and one in the stateroom door. A nine-foot runner rug in the stateroom, extending out as far as the engine in the main saloon, will also add to cosiness and comfort. The best floor for the main saloon is plain green 12-ounce duck canvas, tape bordered. Both carpets should be easily taken up, as they will occasionally get "some" damp, and need a sun bath, or else the boat will get damp and mouldy. Two brass yacht lamps in swinging gimbals with smoke-guards overhead should be screwed to the aft panels of the cabin. A ship's clock and an aneroid put on the corresponding panels at the for'd end of the cabin lend a nautical air to the cabin which ought to make a pickled herring out of the greenest tyro on his very first trip!

## CHAPTER IV

### YACHT PLUMBING

**THERE** are six rules for doing plumbing aboard a yacht, the first of which is: Don't do it yourself. Forget the rest. If you can hire a yacht plumber to put it in for you, by all means do so. Otherwise—better take a course of contortionist and angleworm exercises to get in training for the job. Also cultivate the fine arts of manipulating an eighteen-inch pipe wrench with your left hand and no room to work it in; of wiping a red-hot lead joint without leaving most of the skin of your fingers adhering thereto; and of fitting three ells into a space too small for a one-inch nipple. All connections to plumbers' fittings are of lead pipe and brass nipple, and each calls for a wiped joint, made with a hot-blast torch, a pound of lead and four tons of hard feelings. You are lucky if the torch doesn't start something in some cranny of the boat where you can't get at it to put the fire out.

Nor can you take these things out into a vacant

lot so as to make them up and *then* put them into the boat—for a variety of reasons. It isn't done, that's all. For instance: the toilet requires two connections to the skin of the ship, both below waterline (so get them in before launching as you love your pocket-book). The first is to the syphon check-valve and is a piece of two-inch D-weight lead pipe. Cut a hole for it in the skin of the ship about three inches below waterline and bell the end of the pipe, passing it from outside after crooking it properly to meet the brass toilet connection. This latter can be unscrewed and set either one of two ways, so you are not tied down to starboard or port, but in general it is best to come out of the connection with a bend and cross to the opposite side of the boat so as to get a manageable length of pipe. If too short you will have endless trouble with it. After bending it so it fits, punch holes all around the edge of the bell outside and nail it temporarily in place with a couple of copper nails. You are now ready to "wipe" the joint, and before I get very far with the directions you will be ready to fade away and let a yacht plumber get at it. The "wiper," from which the joint gets its name, is a thick pad of drilling cotton or bed-ticking about four inches square. You now stand on your ear and hold the

pad against the side of the joint, while your helper lets a pile of hot solder drop on it until you have quite a cake of it in a more or less mushy state resting between the pad and the joint. Then the joint is given a painting with acid and you plaster this mushy mass of hot solder around it with the wiper. It will chill instantly so you will have to go after it with the torch, and here's where your judgment and experience comes in, for if you give it too much heat the whole cake will drop into the bilge and set it afire, and if too little heat the cake will not be plastic enough and will break away from the joint when you attempt to mould it into a smooth job, fitting all around. However, with patience, persistence and much wiping with the pad, you will have a fairly presentable job—maybe. But the chances are that, being a greenhorn at it, you will have gone black in the face with rush of blood to the head, the boat will be afire, and you will have dropped dead into the solder-pot. After the joint is wiped, if you are still alive, go around outside and finish nailing the bell of the pipe to the rind of the boat, using 1-d copper nails with heads almost touching and a liberal smear of white lead putty in under the bell. The water-pump connection to the toilet is similar to the waste-pipe connection, except that it is

made with three-quarters inch lead pipe, and its inlet should be protected with a copper strainer and located not less than seven inches below the waterline. As to layout of the yacht toilet and galley plumbing, if you are fortunate enough to be able to plan the interior arrangements of your own cruiser, or can specify what you want, when she is building, the first requirement would be to cut down the room allotted to the galley a great deal more than what is usually thought necessary. You don't want too much room; and it is far better spent on the toilet room, which is usually so crowded as to be little more than a coop. If the cruiser is about thirty feet long, the toilet is best put just aft of the anchor-locker, and the space allotted to it is often hardly larger than a mere seat. Aft of this comes the galley, which is sometimes made as long as five feet. Now, every inch of length of the cruiser must count for the most possible,—here are two whole feet of length which are much better added to the cockpit, or to the bathroom. This latter should not be much less than 3 feet 10 inches long, should have two port-holes and a skylight of its own; a white enamel corner wash-basin; and a complete nickel-plated set of bathroom fixtures, besides the toilet. The last has a hand-pump, and must be of the "yacht"



type, or you will get flooded out through seas coming in through the siphon. It should have an oak or mahogany seat with a cover, so that one can sit on it with cover down when shaving, washing face and hands and such details of personal cleanliness. The corner basin, right at one's hand, with soap-fixture, towel-rack and mirror fastened to the opposite panel, gives one all the comforts and conveniences that such matters should have, and the abundant light from portholes and skylight is just what you need so as to start the day with precisely such a general overhauling of your face and scalplock as you would have in your own home. In my boat the bathroom is enameled throughout with white furniture enamel, and the skipper begins each day with a plunge overboard, followed by a shave, scrub, combing out the hurrahs-nest, and holystoning all teeth in the bright, sunny bathroom, breezy and glorious with the reflections of the rising sun.

The skylight over the bathroom should extend to cover about ten inches of the galley, which latter has no portholes and is only three feet long all told. Its floor will be four inches higher than the stateroom, because the boat fines so much forward, and the floor of the bathroom is still six inches higher than this, so that one must sit down

in the latter or else have one's head poked up into the skylight hatch. In the galley one will have to stoop a trifle, but it is never a noticeable hardship. The absence of portholes in the galley is principally because of the unshipshape appearance outside if there are too many portholes crowded closely together. By omitting them a symmetrical arrangement of portholes along the sides of the ship is attained, and it *must* be so; for if there is any place where things simply have to be precisely according to regulations it is aboard anything calling itself a yacht. In actual practice the skylight gives all the ventilation and light needed, especially when aided it by pulling back the curtain of the bathroom door. In passing, it may be well to note that doors anywhere aboard a small power cruiser are a snare and a nuisance. Always use curtains on brass poles, with brass rings and yacht ball-fringe edging.

In the galley you need, first of all, a good oil-cloth or rubberoid imitation parquetry floor. It wants scrubbing after every meal, just as you would scrub the kitchen table, and a wooden floor soon gets hopelessly bespotted with grease spots and general dirt, no matter how nicely matched and varnished it may have been originally. A cheerful white and light-green checker-board pat-

tern, with squares about two inches on the side, gives a neat and cleanly appearance; and it will look fresh after each rub-down, no matter how sloppy and niggery the chef may have been when in action. Next you need a sink, and the smallest that comes is 8 inches by 16 inches in plain cast-iron or enameled, the former costing \$1.10. Neither kind will have the right sort of stopper for the waste pipe, for, on land, the sink is not meant to get full of water, and only has a rose sieve. But, in your cruiser, the sink is the washpan for dishes, and so order with it a rubber and brass fixture. After you are through mopping the crockery, pull the chain and there you are. The sink connection to the lead waste pipe is by our old friend the brass nipple and requires another wiped joint. As it is obvious that dishwashing operations are not continuous, and also that every cubic inch of room is valuable, the sink should have a neat oak cover, fitting down flush into it, and onto this cover is screwed the stove. I have done very fair meals with a two-hole kerosene affair; but they are landlubbery contraptions, with a patent device to warn one when the lamp is full, which device is a lovely spiller of kerosene when the swash of some passing steamboat rolls you mightily; and I have come to prefer the stand-

ard denatured alcohol yacht stove, with two burners and a small globular reservoir, to any form of kerosene device. Whatever it is, be very sure that it is screwed fast, or you will have a curious mixture of dinner and blazing combustibles eating the heart out of your ship, some fine calm day,—when a passing tug gives you her wash abeam.

The sink being rectangular, and the ship being anything but that, you will need about eighteen inches of room to mount it in. This leaves you eighteen inches remaining out of your three feet of galley. The next thing wanted will be an icebox; and plans of yachts usually show them built in cunningly into the general architectural effect. You are lucky if the carpenters do not get away with ten dollars' worth of time in doing it, and *then* they will take up a lot of room better used for something else. And, all the time, the very thing you want is waiting for you in any department store. It is a little tin baby refrigerator, painted to imitate oak closely, 16 inches long by 12 inches deep and 10 inches high. It is double-lined with insulation inside the walls; galvanized heavily inside; has an ice compartment which just holds a five-cent cake of ice; a sliding shelf in the interior; and a nickel-plated faucet connected to the ice-compartment, whereby pure ice-

water can be drawn off to drink. Take this away from that department store, for it is good; and they can have your \$2.75 and welcome. You will find that it will just fill the space left over in the galley by butting it against the edge of the sink. To mount the two of them in the galley, you put in a piece of 6 x  $\frac{7}{8}$ -inch oak, set edgewise, and running parallel to the skin of the ship. The drawings show just how the sink and ice-box are mounted on this. A similar piece of oak, let in along the floor below it, suggests completing the frame in oak and giving it two little doors, so that all the space under the sink and ice-box is enclosed and can be provided with shelves. What shall we put in there? The novice would at once fill half of it with pots and pans; but,—every inch aboard ship is valuable! The pots and pans do very much better on brass hooks, judiciously planted around the stove above the sink; cups are best hung in rows from tiny brass hooks screwed into the ceiling; and the plates are better nested and slipped into light racks behind the cover of the ice-box. So that practically all the shelf-room below is available for staple groceries, and you'll appreciate this if you stay out half a week in her.

All this equipment should be put on the same side of the boat as the wash-basin in the bathroom,

so that the same plumbing line can supply both. Under the galley floor is room for a very respectable fresh-water tank; and a reserve one can be put in the lower part of the anchor locker, as all that space will not be needed for rope. To get the water out, one can use a hand force-pump, made as in the sketch, with two brass check-valves and pipe fittings, or you can mount an ordinary bicycle-tire pump at any convenient point in the galley, connecting to a small riser from the top of the tank. Pumping on this puts air-pressure on the tank, and makes the water ascend in the pipe leading out of the bottom of the tank and branching to the sink and wash-basin faucets. It is a very clean, handy system, and cheap to install. The drain-pipe branches to both the bottom of the sink and the wash-basin in the bathroom, and will be installed by the yacht plumber at the same time he puts in the toilet,—an you be wise! The joints have to be soldered or “wiped” as described before and the whole installation *must* be impervious to leaks, which it certainly will not if put in by amateur efforts.

On the opposite side of the galley you have the whole space available for something new. You don't need any more cooking equipment, but you *do* need a long locker in which coats can be hung,

guns and fishing rods stored, brooms put away, and the set of storm oilskins kept. Here is just the place for such a locker, reaching from floor to ceiling, say 5 feet 8 inches, 16 inches deep and 3 feet long. Frame around it with 6 x 7/8-inch oak, and put in a door with a long pier-glass mirror.

Still another layout of yacht plumbing is to abolish the bathroom entirely, putting the galley and engine furthest forward in a large room about five feet long. In such case you screw to the forward panel of your stateroom a folding lavatory as shown in the illustration with the pump and waste lines coming in from the galley through the back of the panel. The pump connection should have no branches but go direct to the skin of the ship five or six inches below water line. All one's shaving and washing articles go in racks and holders inside this lavatory, which closes up with a mirror on the back precisely as in the stateroom lavatories of ocean steamers. In this plan practically the only disposal that can be made of the w.c. is under an oak seat in the extreme forward end of the galley. It is, moreover, a rather expensive arrangement as these lavatories run from \$35 up, against \$7 for a white enameled covered basin complete with nickel faucet.

As to the cost of the yacht toilet, a well-made

plain one can be had with oak seat for \$30, installed complete by any yacht plumber. He gets enough rake-off on buying it to pay for putting it in at the same price it will cost you to buy it.



## CHAPTER V

### ALL ABOUT YOUR ENGINE

THERE is no shadow of doubt but that Maud is of all creation the animal most complicated. Blown hither and yonder by the gusty winds of her temperament, Maud is willful and wayward—and complex. Excepting the hen, most creatures move about with some fixed purpose, a few settled convictions, in life that cause them to arrive somewhere from some definite starting point. But Maud has obstinacy to a degree, and also a poor memory as to starting points, so she is apt to act upon a set of convictions belonging to entirely the wrong starting points and thus arrive far off the reservation. It is merely a case of over-complexity. Any animal that tries to take along a whole load of last week's impressions and mix them in on to-day's doings is sure to become complicated and hard to understand. Wherefore Maud is more than apt to arrive on a thistle top instead of over the finish line if she attempts anything so direct and single minded as a "mewl" race.

Most animals have their counterparts in the

world of machinery, and I have had more than once to point out the beautiful parallel that exists between Maud and the gasoline engine of the motor boat. The basic reason for the resemblance is the same—complexity. For the gas engine is complex, the four-cycle only a little more so than the two. As turned over to you by the manufacturer a whole lot of things have been made to jibe in order that the engine shall run smoothly. Failure of any one of these to act at the right time will bring Maud's heels up into the air and leave you blissfully unaware which particular flea is troubling her. Wherefore, as Maud is afflicted with a tempestuous disposition, has a population of 172 censused fleas and, further, possesses a quantity of gouty joints, it behooves you to know her not only well but thoroughly. If flea No. 123 is troubling her, for heaven's sake don't strike in the dark and stir up Nos. 100 to 150 inclusive, but flag that disorderly No. 123 and no other. Don't try to carry a "trouble chart" around in your brain or in your pocket. The best thing to do with a trouble chart is to spend an afternoon with one in company with your engine. You will know so much about Maud and why she works at all before you get through that you could write an au-

## ALL ABOUT YOUR ENGINE 255

thoritative volume entitled "A Wild Animal I Have Met," with fluency and feeling.

Let us go over the various sources from which Maud draws her sinews of war and see if we can't construct an automatic trouble chart based on knowing just why Maud is good enough to run—when she does run. I assume at the outset that you know how a gas engine works, both the two-cycle and four-cycle species. If you don't it will not have been the fault of the engine catalogues, for, after reading a few of them you can say the dope over in your sleep or sing it backward. I always like to begin with the carburetor. It's full of gasoline and trouble, oftentimes also replete with sea-water, lubricating oil, galvanized iron chips, mud, and other species of grit in Maud's hay. Now to be really fool-proof and valuable the carburetor must be automatic in its action. In large power house gas-engines its place is taken by a mixing valve, adjustable by hand for changes of speed and load and pressure of gas. But in a boat you are frequently changing the speed of your engine and the pressure of gasoline is constantly changing as the tank empties. If you had to run around and adjust the spray needle or alter the air intake every time you changed the speed of your engine, the carburetor would be an intoler-

able nuisance. So it must be made automatic. To keep the spray always the same no matter how much gasoline there is in the tank, there is a little reservoir in the carburetor feeding the spray direct, and the main tank fills the reservoir through a float feed-valve. This automatically shuts when the level in the reservoir reaches the right height to give a proper spray. And right here some one opens the bag and a whole colony of fleas camp out on Maud's body politic. Suppose there is grit in your gasoline or a little free acid which eats off some of the lining of the tank. Forthwith enters a large section of the trouble-chart, because a tiny piece of this grit gets under the needle of the automatic float feed-valve so that it cannot close, thus allowing the reservoir to fill up and bringing the full pressure of the tank upon the spray valve. You can appreciate how that spray will turn into a geyser forthwith, but the first indication you have that another flea is at large is a mysterious stoppage of the engine. The trouble is that you are "flooded," but like as not you will begin monkeying with the ignition after a few futile crankings of the flywheel. However, your nose soon apprises you that gasoline is abroad in the air; and you investigate to discover it dripping steadily from the air intake of the car-

## ALL ABOUT YOUR ENGINE 257

buretor. A few energetic workings back and forth of the float feed-valve spindle which sticks up out of the carburetor will usually dislodge the piece of grit and the dribbling of gasoline will cease.

Now to get rid of the flooding. When the mixture of air and gasoline gets either too rich or too poor, it will first fire slowly with loss of power, and finally cease to explode altogether. If too poor, you will know it by backfiring through the carburetor, of which more later, but if too rich she will slow down and stop, while the exhaust will be black and smoky. Close the spray needle and crank her over a dozen times until she starts to run again. Let her run until Maud lets out with both heels through the carburetor which is a sign that her fodder is running low; open up the spray needle gradually about one-fourth turn, and observe events. If she goes right along and is up to full speed everything is O. K. If not, give her just a mite more gas. Understand that a small drip of gasoline when the engine is standing still, particularly when cold, is entirely normal. It simply means that your spray, not having any air to gasify, is dripping out through the air intake instead of going into the engine. It should disappear soon after starting up; if not, either your spray needle is too far open or there is grit under

the float valve needle and the pressure of the tank is coming on the spray instead of only the pressure of the carburetor reservoir.

Backfiring through the carburetor in a two-cycle engine is always due to just one cause, too slow ignition of the charge. Remember that there is always a charge in the crank case ready to pop into the cylinder the instant the inlet port opens. Now if the mixture in the cylinder is too lean, it will fire very slowly. It will still be burning at the end of the stroke as the inlet port opens, when it rushes the crank case mixture, instantly takes fire, and whang! out goes the whole business through the carburetor intake which is open to the air. It can also ignite too slowly because of poor spark or late timing, but these are other fleas which we will come to later.

The second feature in which the carburetor must be automatic is in the amount of air which it admits to the cylinder as the speed varies. You will admit that there is a minimum amount of air needed, corresponding to slow speed. Suppose we make the fixed inlet opening of the carburetor the right size to admit this amount of air. Then when she gains speed she will begin to pump and suck for more air, and the way to get it automatically is to have a second intake, closed by a disc-valve

## ALL ABOUT YOUR ENGINE 259

with a light spring. The more the engine speeds the more this valve opens. Its tension is adjusted by a fine screw with locknut, and this you are to *leave alone* no matter what else you monkey with. How do you know how much air is proper for the mixtures at different speeds? The tension of that spring was adjusted at the factory, where they know just how much air it will allow. Knowing the air to be right, all you have to do is to adjust the gasoline spray; but if you get both of them out of kilter you are lost in a sea of unknown quantities.

In general, all makes of carburetors aim to automatically proportion the quantity of air and gas mixture to suit the speed of the motor. Nearly all use the float feed to control the spray, the excellence of the mechanism depending on the size of the float, its leverage and the workmanship put on the needle valve. Nearly all use a spring-controlled auxiliary air intake valve in addition to the constant air opening. One famous carburetor uses a set of five bronze ball valves to replace the spring auxiliary. As the motor speeds up the five balls, one after the other, float above their seats, held up by the inrush of air sucked in by the engine. The weight of the balls is always the same, so that the apparatus cannot be put out of ad-

justment by some fool who likes to tamper with the tension spring of his carburetor. Nor does the pressure due to the weight of the balls ever change, whereas a spring is apt to get fatigued or break.

Finally, nearly all carburetors have some sort of an arrangement to thoroughly mix the incoming air with the gasoline spray. It is usually done with some sort of nozzle on the injector principle.

The carburetor is not only the source of Maud's hay supply, but a good place to introduce lubrication for her interior joints. The piston, cylinder walls and connecting rod pin have three ways to get lubrication: (1) by splash from the case (not to be depended upon). (2) Through a port in the side of the cylinder always covered by the piston. This is usually excellent for the connecting-rod pin, as it gets a drop as it passes the oil duct. (3) General lubrication of the cylinder through the carburetor. This is the main reliance, for the oil is drawn in with the mixture as a sort of partially dissolved spray. To this end about sixteen drops a minute, one every four seconds, should be fed to the carburetor for a ten to fifteen-horse sized engine. If too much the surplus will burn and you get a white smoky exhaust.

The carburetor feeds direct to the crank case in



## ALL ABOUT YOUR ENGINE 261

two-cycle engines and to the inlet valve manifold in four cycles. For four-cylinder and six-cylinder engines it is better to have two smaller carburetors, each feeding a group of two or three cylinders than one large one, because the end cylinders rarely get their share of the mixture if one long manifold is fed by a single carburetor. There should always be two stop valves between the tank and the carburetor. Gasoline is like steam—when you want it shut off you want it so a whole lot. Wherefore if your single valve leaks, gasoline will drip into the boat all the time you have the carburetor off for repairs. You cannot even fix the float valve. The reason for preferring a second stop valve, right at the tank, is that it then commands the whole line of gasoline piping in case you need to take it apart. All joints for all gasoline piping are best made up with ordinary brown kitchen soap rubbed on the threads. They will be far tighter than any form of lead paint used in steam fitting.

This Maud person is a highly nervous critter. She has electric nerve centers which cause her to kick at the right psychological moment—and, more than often, at the wrong. You might as well know your ignition from the ground up as it is Maud's nervous system and is one of the

things that keeps her from relapsing into chronic coma. It takes a certain appreciable moment of time for a charge to ignite and develop explosive pressure. This is the reason why you can touch her off before the compression stroke is completed, as the engine utilizes the short time in going over the center and starting down again in igniting the charge and getting up pressure in it. The ideal point of timing, then, is when the pressure catches the piston just after it starts downwards. Any point earlier than this will lose speed and power for you, besides causing a slight thump or knock in the connecting rod pin which can be heard and felt as you advance the spark. Every point later than the ideal causes a falling off of speed until finally the charge ignites so late as to be still burning when the stroke is ended, and, in a two-cycle engine, the crank case charge will ignite and fire back through the carburetor. The ignition system harbors the largest colony of fleas in Maud's make up. All the high-tension apparatus is more or less liable to be bitten as it is very susceptible to shorts and breakdowns from moisture. Formerly the jump spark plugs in a small open boat were a prolonged terror in a choppy sea, but now, with the top of the plug properly enclosed, this trouble has been chased.

## ALL ABOUT YOUR ENGINE 268

There is still, however, the likelihood of the plugs becoming cracked when very hot explosions are being used and the engine running at maximum power with spark advanced a trifle too much. Porcelain plugs are prone to this evil, and the minute they crack, oil soaks into the cracks and "grounds" the plug on the case. Maud at once becomes vicious and balky for, when the timer comes around to that plug, instead of a spark passing, the current simply travels through the oily crack to the engine body, side-tracking the spark-gap entirely. The charge is therefore not ignited, and, if the other cylinder is still going, its hot exhaust is quite likely to touch off the unexploded charge of the first cylinder as soon as it gets into the muffler.

Another promiscuous flea which causes Maud to rear up at the wrong time or not at all, is found in the vibrators of the spark coil. The fatness of the spark crossing the air gap of the plug inside of the cylinder is due to two things: (1) the strength of the battery current, (2) the amplitude of vibration of the vibrators. All the best makes of coil have platinum tips on both needle and spring of the vibrators, and some of them use silver, which is not as good. In either case in due course of time the surface of both

spring and point becomes oxidized so that the current cannot pass and the vibrator will not work. Remember that inside of your spark coil is the primary circuit with its bundle of iron wires as a core. This primary circuit is under no heavier voltage than that given by the batteries of the magneto, somewhere around six to nine volts. Very little oxidization of the platinum will make the resistance at this point of the primary circuit so great that the current cannot start and will miss. Each time it misses a corresponding miss takes place in the secondary circuit as no spark was induced, so that your charge passes out unexploded into the exhaust. Generally it gets away into the air without further trouble, but if there happens to be a shining spark of hot carbon dust in the muffler or a spark of carbon is shot out with the next exhaust into the muffler, it will touch off this and explode the charge and you will have a rumpus in the muffler.

On the other hand, if the screw of the vibrator is turned back so far that the spring must travel relatively quite a large distance to make a connection, you will get very much slower vibrations and the resulting spark will be thin and of very high tension so that it is quite likely to break down the insulation of the spark plug somewhere,

## ALL ABOUT YOUR ENGINE 265

and "short" the circuit into the engine ground. The ideal to be looked for is a short fat spark in the plug, which can be gotten by a medium amplitude of vibration.

## CHAPTER VI

### ENGINE TROUBLES

THE title of this chapter ought to be "The Care and Feeding of the Mule," as, if you have a really good one—one with a pedigree—it should not require much overhauling before going into commission again. That is, if you have treated it right and fed it the proper amounts of oil and gasoline during the previous season. In other words, a little advice on taking care of the mule, if religiously followed, should make any subsequent remarks on overhauling for the next season superfluous. While a steam engine may be likened to a horse and be measured in horsepower, the gasoline engine, particularly the breeds sold for motorboats, may be more appropriately symbolized by the mule, and *ad seq.* measured in mule power, I presume. A well-bred one, of Christian antecedents, will turn faithfully away at the propeller, hour after hour, with no more trouble than there is between a kitten and a warm brick; when, presto!—her name is Maud, and you can start in on a two-hour guessing-match while she will give

an exhibition of mulish obstinacy in the matter of responding to urgent crankings that will leave her animal counterpart shamed into the booby-hatch. The reason is simple enough. Not that the mule is by nature any more complicated in its working parts than the steam engine, but because so many different things enter into the successful running of a gasoline engine. In the steam engine the same cylinder and piston and connecting rod constitute the mechanical features which turn the crank, but all it has to do is to let in steam first at one end and then at the other. But, a gas engine has first to mix air and gasoline vapor to form an explosive gas of the right proportions; then it has to fill the cylinder with this gas, compress it, touch it off at the right moment and finally sweep the burnt gases out; and in a two-cycle engine it has to both do this latter and fill the cylinder with fresh mixture at the same time. When we think how many things go into just making that spark to touch off the mule at the right moment, it is no wonder that when she balks there are any one of two hundred different possible causes for the walkout.

My advice to all and sundry is to leave Maud alone, unless she is knocking or squeaking or raising some other Cain that ordinary oiling or over-

hauling the ignition cannot remedy. You wouldn't take her animal equivalent apart and expect to get her blithely together again; nor can a mere mortal do the same thing with the gasoline variety. It takes a machinist. Consider how the beast is made. You have a crank case, split mathematically in half at the bearings, and a combined engine-frame and cylinder which bolts down onto this lower half. Between is a gasket which you destroy if you take it apart. The gasket is gastight, so as to hold the compression, yet not so tight as to press down on the bearings and seize the shaft. Nor is it so loose as to allow any pound in the main bearings. The thickness of a sheet of paper is more than the difference between these two, and yet you are supposed to get on a new gasket of exactly the right thickness (eked out with the proper number of liners) to get your bearing-caps exactly right upon tightening the casenuts hard down, and yet leave no possible leak for air to get in and spoil your compression and vitiate your mixture. A good, patient machinist, used to this kind of work, will usually hit it off the first time—but not you. You will cut and try and make mistakes until you are black in the face—but woe to you if you start the mule up again until everything is exactly right; not nearly right, but ex-



actly so to the thousandth of an inch. I am merely giving out this warning to discourage the cheerful optimist who lays hands on the crank case and gets everything apart whenever a wire gets loose somewhere in his ignition outfit. Such an enthusiast is usually in hot water with his engine most of the time. It is on record that one of these cheerful idiots took his engine apart on a case of ignition switch plug jarring loose. He labored over the piston and interior works for two hours, got her together again, cranked for ten minutes without drawing a single snort—and then some one handed him a spiral spring eighteen inches long which had been just picked up out of the bilge. As it wasn't in the boat before they took the engine apart, it must have sneaked out of her *somewhere*, but, as it beat them all where that spring could possibly belong, they hailed a tug and bought a tow home.

Usually if the mule kicks there is something wrong with the ignition, or the mixture, or the jacket water, or the gasoline supply. For instance, she will suddenly, without warning, back-fire through the carburetor, filling the boat with smoke. Now what caused that? The engineer looks wise and grins. Pretty soon she does the same trick again—and the engineer looks sheep-

ish. He knows that it is due to any one of five causes, but which one he is not prepared to say, offhand. Now, the action itself is simply ignition of the fresh, incoming charge by left-over burning gas in the cylinder. If the mixture was too weak it will burn slowly and some of it will still be afire when the engine reaches the end of its stroke and uncovers the inlet port to take in the fresh charge. If the "scrutineer" is a wise lobster he first takes a feel of the tank valves to be sure that neither of them has been left shut in the excitement of starting off. Next, he tries the carburetor to see that it is feeding properly, and if so, opens its spray needle a trifle to strengthen the mixture. If everything quiets down forthwith he thanks his stars and throws out his chest, but if again one of those disconcerting back-fires butts in to shame-face him he tries the timer, as the spark may be too late, so that it does not start the mixture burning soon enough to get it all burnt up before the end of the stroke. If the engine is four-cycle, his trouble may be in the inlet valve being leaky, in which case, if it does not soon quiet down and the valve seat properly, he gives the carburetor intake a little extra oil and hopes for results. If not—*good-night*—down with the hook and grind in that valve!

Another joy of the motorboatist is to hear the regular drumming of his exhaust interrupted with a sickening miss now and then, accompanied with an occasional backfire of the engine. This is an ignition trouble. Batteries too weak; switch over onto the other set and if it stops—"there's our man," to quote Sherlocko. If she continues to drop a stitch now and then, you for the vibrators. Shut off the gasoline, run the carburetor out, and when the mule comes to a stop turn the flywheel over some, listening intently to the song of your vibrators. If both are about the same as usual, try taking out the spark plugs and see if they are sooted or not. Everything O.K. with them? Well, then, run over all the electric connections; there is probably a loose wire in either the primary or secondary circuit. Try the switch and see that both it and its plug are in good firm contact. An engine with weak batteries will both miss and backfire, varying these antics with an occasional complete stoppage, starting off backwards and wrenching your wrists out of joint as soon as you get a firm grip on the flywheel and start to turn it. If it is two-cylinder, and one of them is firing all right, while the other is missing, it will make half a dozen revolutions and then come to a stop, usually with a back-fire thrown in, just to show

that there is no hard feeling at all. The very next ignition will start her off violently backwards, and, as you are usually on the other end of the flywheel rim about that time, she is liable to hurt your feelings. Cracked spark plugs are a prolific source of this evil. Some galoot, who never navigated anything bigger than an Iowa duck pond in his life, will open the throttle to the limit and give her all the gasoline through the carburetor spray that she will stand, "just to see her go." She does. Into a trance. The mule has balked for keeps. She throws about unceremoniously any one who dares lay hands on her flywheel. If it is dark you can easily locate the trouble, as you will note sparks coming down *outside* the plugs and entering the top of the cylinder head. By day you will easily perceive that the plug is getting oily and has fine dark lines in it. Take out the porcelain center-pieces and throw them overboard, as they are worthless and ruined. New ones will cost you 50 cents per each, and, on putting them in, Maud will become tractable once more.

Pounding is another disease to which your mule is liable, particularly from the timer or propeller shaft, as it is contagious. If the shaft is not in line, and never was, you will hear from it sooner

or later, and if you have habitually kept the spark too advanced it will develop into a pound. You touched her off too soon, and before the piston has gotten to the top of its stroke the full force of the explosion had already developed, and so the flywheel had to drive it over, thus introducing heavy strains on the bearings at the top of the stroke. Listen carefully at your engine as you advance the spark. She will gain in speed and improve up to a certain point, when she begins to develop a faint thump and on still advancing she will begin to slow down. This shows you where you are at, and you can easily judge about how far back of this point to set the spark and still get good speed with the engine running easily.

Every good skipper keeps his eye peeled over the side to know all the time how his water and exhaust are getting on. The ideal exhaust has but a faint wisp of bluish white smoke trailing astern. If it is yellow and smoky you are too generous with your oil, and if you do not take a reef in the oil feed to the carburetor you will soon soot up the interior of the engine. If the smoke is blackish you have the needle-valve of the spray nozzle of the carburetor too far open, and are getting flooded. Close it and shut off the tank valve until

the engine begins to backfire, by which time she ought to be ready for gasoline again and everything in good shape. If the exhaust shows clouds of white smoke which do not disappear no matter what you do with the carburetor needle, you have more or less water in the gasoline, which got into the tank somehow (probably in the last can you bought). It all collects in the bottom of the tank and gets into the feed-pipe at once if same is properly located. It will soon disappear, however, and you can usually look for it after a long storm, as the damp air and condensed moisture combined make a lot of steam in the exhaust.

The mule should be felt all over about once every fifteen minutes when under way. Even when entirely alone in a large cruiser it is no trick at all to dash below, leaving her to her own helm for a minute, and run your hand over all the main bearings, cylinder walls, etc. Below the jacket the cylinder walls should not be hotter than your hand can bear. If so, give her a drop or so more oil per minute until it cools down again. The main bearings for a ten-horse engine get about four drops a minute of good gas-engine oil; the cylinders ten drops each, and the carburetor fourteen. Any mule will labor away faithfully and indefinitely if all its journals and its cylinder

walls get enough and not too much oil fed to it regularly. Eternal vigilance is the price of peace. If you have been mindful of Maud and her infirmities during your season's cruises, and have caught and headed off every attempt to heat up, there should be no necessity to open up the case and break the gasket joints for an overhauling before going into commission again next season.

But usually the reverse has been the case. You have had carouses wherein the mule was left to its own devices, and your first intimation that it was still alive was a pungent odor of frying oil, a slowing down of the mill, or a loud shriek from some forgotten shaft-bearing. You stopped and ran her slowly, while fresh oil cleared the bearing and got her cooled down again,—but Maud was never the same animal again. Or, worse, you may have been bowling merrily across the pickle, when suddenly there was a tremendous hubbub inside the case and you find that the babbitt has left the connecting rod bearing for parts unknown and you are running on bronze and steel alone,—a hot combination. Off comes the cylinder case and you extemporize a brass liner or put in a spare babbitt bearing,—or get towed home. In any event the mule is not feeling very well thereafter, and so, by the end of the season, she has a number of

ailments which require overhauling—to say nothing of the entire ignition system. The proper way to pour a new babbitt bearing is to get it done in a machine shop for you, and pay the machinist for his time; but if you elect to do it yourself do not pour it in place on the crank shaft, but disconnect the connecting rod and pour it around a steel billet the same size as the crank-shaft pin, and then scrape it to a true bearing all over, testing it with red lead and scraping down the high spots until it really has a true bearing and does not merely touch on the high spots alone. Now that you have her apart, look at all the piston rings carefully and see that none of them are gummed fast or cracked. Get new ones made or sent from the manufacturers if there are any broken ones discovered. They should all float loose and free in their grooves. Clean out all soot deposits from the piston top and combustion chamber while you are at it, and take a look at the water ports to see that they have no deposits of mud or pebbles or eel-grass in any of the ports or pockets. In making up journals they should be free to move easily, but without the slightest play. If you can wiggle it the least bit, rest assured that that bearing will knock when the power is on. The safest way is to take out liners until she just seizes and then put



under a single thin paper one, just freeing the journal enough to permit a film of oil. Note carefully the material of the gasket and get the same, of the same thickness, no matter what it costs. It is not every gasket material which is oil-proof, air-proof and heat-proof combined. If you take any old gasket material you find in the hardware store, there is going to be a squall ahead coming to you. Cut the gasket to size by laying it on the crank case and peining it with the hammer along the edges and bolt holes. You are now ready to assemble the engine. Ten to one, when you have screwed down the capscrew nuts, she will seize or else you will detect a slight hiss when you crank her over. Besides which, the main journals will all grip fast as soon as you screw down their bolts. Don't compromise matters by leaving the nuts slacked back, as this simply invites a knock. It is now time to show what you can do in the exercise of patience and finesse in the handling of paper liners. Any good heavy paper will do, as it at once soaks with oil and becomes air-proof. Work at your liners until everything is free—and just free. By that I don't mean that it runs hard, as a few such handicaps will rob your engine of half its power, besides running hot in time, but I do mean that the journal should be free enough to

spin around without having play enough to let a knock get started. Since you are overhauling for the entire season, don't be satisfied with anything but the real goods, and, if you detect a suspicion of a pound with the power on, get after it and take out a hair's breadth of liner until the engine runs like a lamb. The chances are she will continue to do so throughout the season if you do your share as regards oiling her and watching for hot spots.

Having gotten the engine to rights, the ignition system is the next peck of trouble to go after. Throughout the season previous it was the most prolific source of trouble in connection with the mule and if you test it now you will probably find it still doing business at the old stand. I always prefer to make the ignition system as compact and moisture-proof as possible. If the cruiser is a large one with cabin I prefer a table over the engine with the spark coils and batteries mounted under the table. This gives the least possible wiring, as only a single piece of duplex rubber-covered wire will have to be led out to the control switch on the cabin panel in the cockpit. It is also about the most moisture-proof spot to be found in the boat, besides which the heat from the engine gives everything a periodical drying out. If

such a scheme cannot be worked in connection with the engine, the best thing to do is to make a battery box of the right size to hold six dry-cells; wire them up and then pour melted paraffin over and around them until the box is filled to the brim. Put two screw terminals on the cover of the box, and lead the plus and minus wires to them inside. Now screw down the cover and paint the whole box over outside with black tar paint. Such a battery will hold up about twice as long as if the cells are laid loose in some shelf under a berth or seat. The batteries should give at least twenty amperes each when new, and when the amperage falls as low as twelve open the box and set in six new cells.

Probably the most abundant cause of obstinate periods on the part of Maud is the wiring system, particularly the low-tension side. This is generally due to the quality of the wires. People think that almost any old bell wiring will do for the low-tension side, forgetting that the engine is "ground" and that any leak in the wire anywhere to "ground" completes the circuit and allows the batteries to bleed themselves to death, giving a slow but feeble current night and day, month after month, until you suddenly realize that they are run down without having been on more than a

few cruises with the boat. The best wire to use is duplex white-core rubber-covered double-braid No. 14 wire, such as is standard for conduit work throughout the big city buildings. This wire is not at all affected by the prevalent dampness always present about a boat at night, nor will it ever "ground." As the two wires are in one flat strip side by side, it makes a neat, compact lead. To branch it you can cut the double-braid covering back as far as you like, thus separating the two rubber-covered leads which can be led off wherever you want. In wiring I split the duplex at the two negatives of both sets of batteries to the switch in the cockpit, thus leading the negatives of both sets of batteries to the switch. I then come back to the handle of the timer with a single ground line of ordinary weatherproof. If the engine is two-cylinder I come over to the spark coils from the two sides of the timer with another lead of duplex, and wind up with a single rubber-covered positive from the spark coils to the batteries. The best way to tack up the duplex is by "milonite" telephone nails, which are insulated with a bushing and two washers.

In overhauling the engine, the oil system should receive a thorough cleaning throughout, especially if you are using grease cups. Keep a squirt-can

of gasoline handy and sluice out all ducts that may be drilled through the crank shaft arms to lead oil from the main bearings to the crank pin. Clean out all ducts fed by grease in compression cups and sluice out the drips of all sight-feed oil cups. If you have an oil manifold, clean out all the drips and small brass leads from it. If these things are palpably clean and have given no trouble before, leave them alone, but if you have had to re-use your oil or have had to put in dirty oil into the reservoir, most of this dirt will be found in the leads and ducts.

The best way to avoid having extensive overhauling troubles each season is to know your mule thoroughly enough to keep a sort of automatic "trouble chart" in your head. You get to know most of her tricks as the seasons go by, but just when you think you have her she will spring a new one and fool you again. Then is the time you can think clearly if you have the whole "innard" workings of the mule clear in your mind's eye. The three illustrations opposite page 282 will explain the whole action of a two-cycle engine. Fig. 1 shows her sucking in the mixture from the carburetor. If the engine is two-cylinder, here is the first chance for trouble, for the other cylinder will be in the position of Fig. 2, where the inlet port is

uncovered, allowing the charge to blow into the cylinder. If the burnt gases are not all through combustion (late spark, weak mixture, etc.), the incoming charge will take fire and everything in the crank case will blow back through the carburetor filling the boat with smoke. However, if nothing like that occurs, the piston of No. 1 will descend until it uncovers the exhaust port, thus allowing its burnt gases to escape and almost at the same time it uncovers the inlet port, allowing the charge in the case which was compressed by the piston coming down, to blow into the cylinder. It strikes the baffle-plate on the piston top which deflects it up into the combustion chamber and prevents it blowing straight across and out through the exhaust port. The piston then ascends, instantly shutting off the inlet port and compressing the mixture in the combustion chamber. Somewhere up near the top of the stroke it is touched off by a spark from the plug, and here is where judgment must be exercised. It takes a teeny instant of time for that mixture to burn and develop the complete force of the explosion, and you must set your timer so that this occurs just as the piston has reached the top of the stroke and has started to descend. Your ear will tell you this. If too soon she will pound a little and

slow down; if too late she loses speed with the throttle of the carburetor remaining the same.

This is all there is to the action of the mule; wherefore if she balks the trouble will be in the ignition, carburetor, lubrication, compression or water in the order named. Feel her all over. If nothing is hot you presumably have no mechanical troubles. Turn the flywheel; that will tell you about the compression; a glance over the side will put you wise as to the water-works; and a look-see will tell you by the buzz of vibrators or absence of it if the spark-coil is on the job. This much can be ascertained in twenty seconds. If there is still a nigger somewhere in the wood pile, begin with the ignition. The investigation will usually end there, or in the carburetor. If you get a loud squeal and the engine slows down you don't have to go any farther than the propeller shaft, as only brass seized in a journal will let out such a yell. Steel is more quiet, but deadly. If the trouble is in the gasoline supply and you have to take apart any of the tank line connections, remember that ordinary brown kitchen soap is the best smear to put on the threads before screwing up again.

One can go on all day gassing about engine troubles. Your cause for stoppage may be due to any one of 172 different possible troubles,

ninety per cent. of which are trivial but effective, and must be ferreted out before further progress is to be made. A mule with a good pedigree and well installed, however, will give you but mighty few real balks in a season, as she is bound to go if everything is right and kept so.

A word as to propellers. Many owners are dissatisfied with the speed of their boats and blame it on the propeller after due cogitation. If it is the screw the manufacturer recommended for that particular engine and boat you had better hunt elsewhere for your lack of speed; but if you selected the propeller yourself, quite likely the trouble is right there. The horsepower of your mule is dependent entirely upon how fast she can turn up. The explosion cannot be made any stronger than the volume of your cylinder with a fat spark and good mixture. Beyond that you cannot go. To get more "power" out of her by putting on a propeller too big for the engine to turn at the maximum speed she has, is simply to take that much off your available horsepower. If the engine is, say ten horse, and goes about 800 revolutions, a small 18-inch three-bladed wheel will develop the maximum power of the mill. But if your engine is a large single-cylinder slow-speed at five hundred revolutions, you will



develop its power better with a large propeller of 22 inches diameter. In general I prefer the high-speed three-blade screw with compact multi-cylinder engine, and have had excellent success with them installed even in raised-deck cabin cruisers.

## CHAPTER VII

### THE GALLEY OF THE POWER CRUISER

It is surprising how little room you really need for the culinary department aboard ship. The smallest specimens I have seen consisted of a zinc-lined box opening top and front and containing a two-burner kerosene oil stove. This had assorted pots, pans and spiders hung around its interior and was kept under the deck for'ard. Upon it the skipper would perform mysterious ceremonies and diabolical incantations and bring forth therefrom the most remarkable meals you ever threw your lip over. In most large power cruisers the galley forms part of the engine-room and the crew's quarters, which is well enough in its way, but not in my way, as I prefer to be my own crew and have, therefore, no use for a boat much over 35 feet. In such a boat every cubic inch of room is precious, as you simply must have a stateroom, a living-room and a bathroom, besides a reasonable sky-parlor out in the cockpit, so the galley proposition boils down to three feet of the length of the boat, which is ample. In point of fact you only

need one side of the boat at that, and can devote the other to a much-needed clothes-locker of sufficient height to accommodate fishing rods, scap nets, guns and other such long duffle. As this galley section is preferably well up for'd, the boat will fine away so fast that at the floor there will be a scant thirty inches of width, all of which you will need for standing room so that the front of the clothes-locker will rise from the floor at the point where the latter joins the skin of the ship. On the opposite side you will have the same condition, and it is not until the galley front is about waist high that there will be really room enough for a sink and icebox. The lower space is best used for a storage cupboard for staple groceries.

Your galley requires just three essentials to be self-sufficient,—a 12-inch by 16-inch by 6-inch iron sink with a rubber stopper in it and a countersunk oak cover, a yacht stove screwed on the sink cover, and an icebox. In furnishing the boat one is often led into building an icebox into the boat by insulating the space included between the skin of the ship, the stateroom panel and the galley front, converting it into a refrigerator,—in all \$10 to \$15 worth of carpenter work at the lowest estimate, and the thing will melt ice like a hot-box. But if you really want a satisfactory

equipment just go and buy one of those metal baby refrigerators costing less than \$3. The smallest is 12 inches wide by 12 inches high by 16 inches long and will just fit in the galley as shown in the plan and elevation illustrated. It is metal lined, with a packing of some kind of felt hermetically soldered in between the inner and outer walls, and at one end has a tank compartment which just holds a five-cent cake of ice. The tank connects with a little faucet so that the melting ice water can be drawn off to drink. The balance of the icebox has a sliding galvanized iron tray and holds enough perishables for quite a bunch of hungry mortals. The writer's party is always four, and our little refrigerator keeps all our meat, milk, butter and green vegetables in good shape. As to the stove, a plain kerosene oil stove will answer, provided it has a screw cap to the filler. Some of the strictly landlubber ones have a contraption for automatically registering the height of the oil but this diabolical contrivance will spill an unholy sprinkling of good kerosene out of place all over the galley whenever a beam sea puts a moderate roll on the cruiser. The wickless blue flame kerosene stoves are less apt to smut the bottom of all your pots and pans, but they are too high and chimnified for use about a

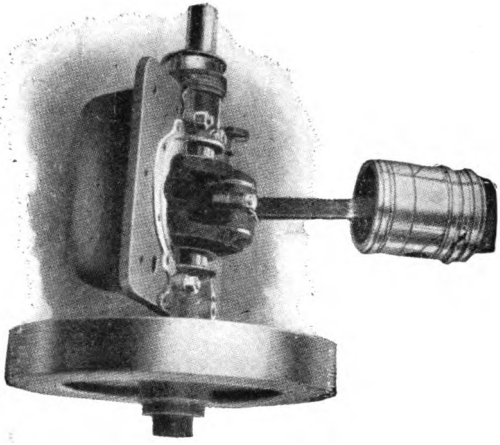

CRANK PISTON AND ENGINE BED

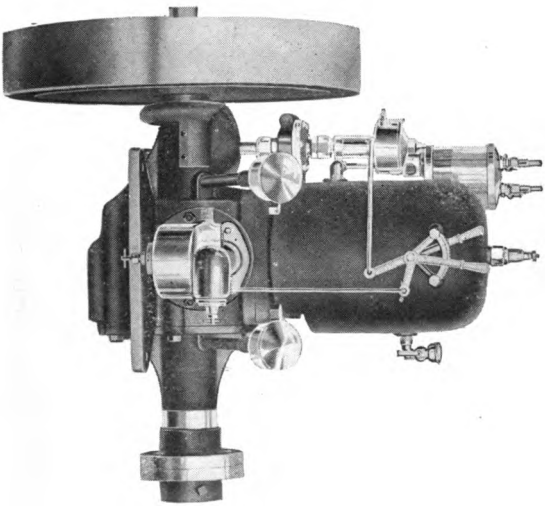

A FOUR HORSE GRAY 2-CYCLE

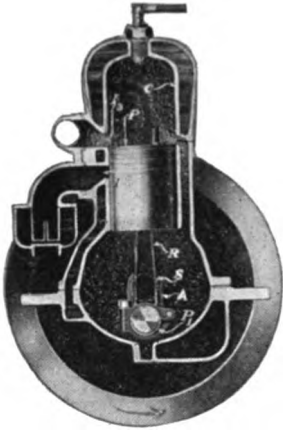

EXHAUST AND INTAKE

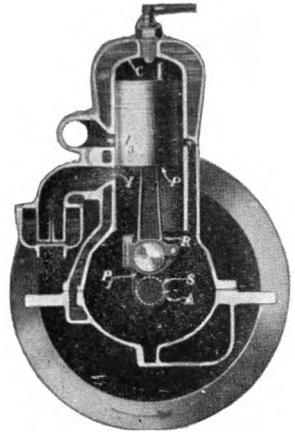

IGNITION

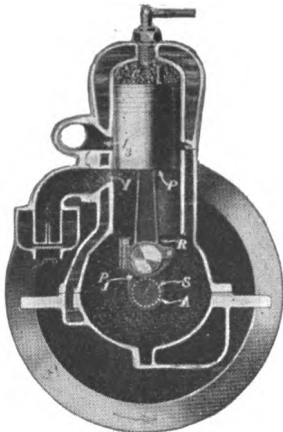

COMPRESSION

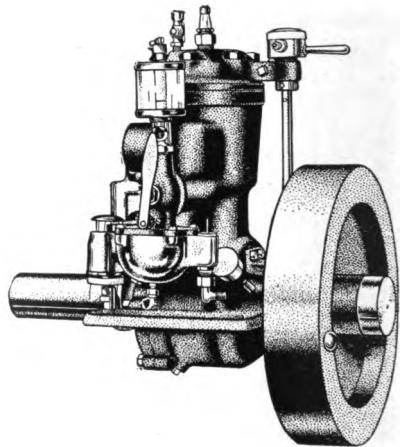

3 1/2 H. P. FERRO 2-CYCLE ENGINE

GALLEY AND TOILET ROOM PLAN OF THE "GO-SUCK"

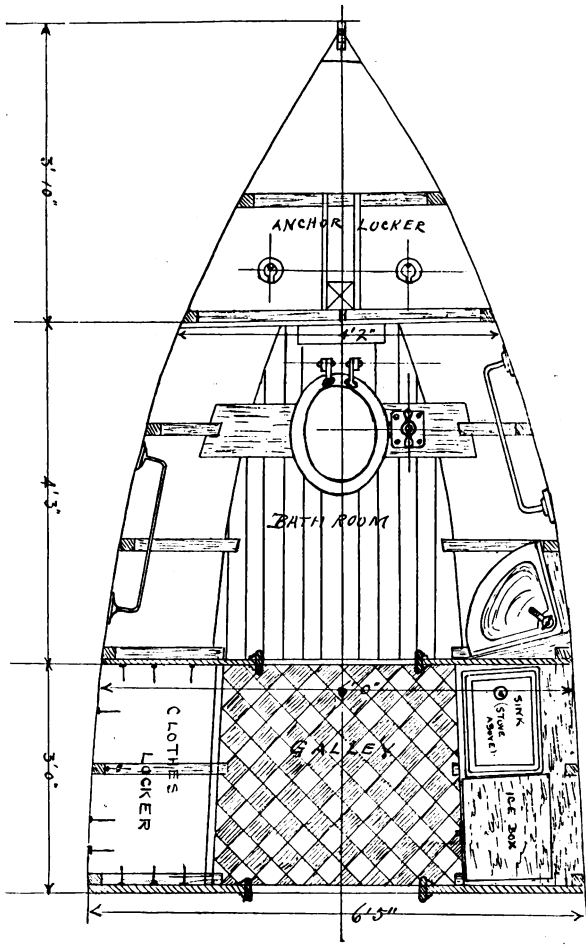

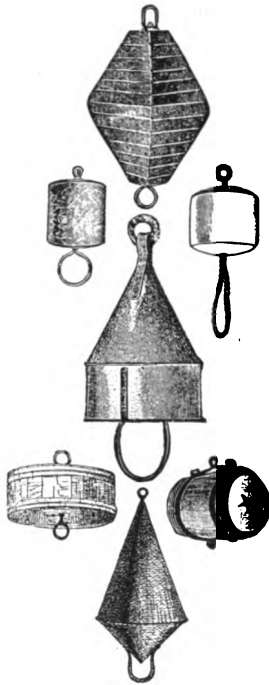

CAN, CORK AND BARREL  
BUOYS

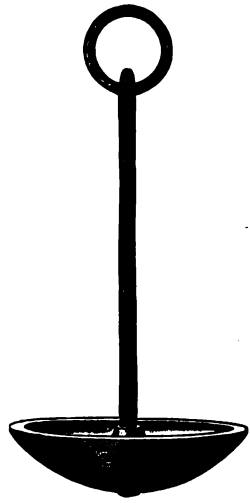

MUSHROOM MOORING ANCHOR

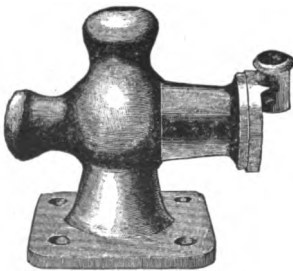

ANCHOR BITT AND CAPSTAN,  
COMBINED

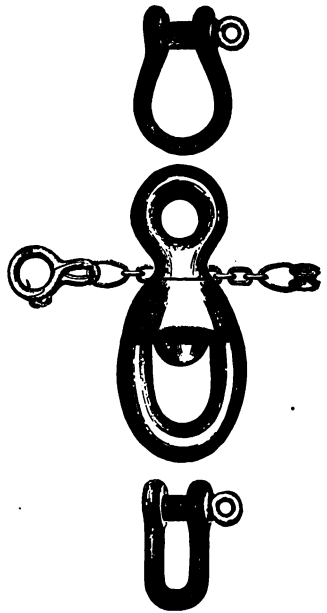

MOORING TACKLE



lively and wallowing power boat. The yacht stove with the burners down low and the reservoir of denatured alcohol perched aloft at the end of a cast iron arm is the candy infant to this tar's fancy. Both this and the kerosene contrivances have regulatable flame, which is the most important point of all in cooking, as your true finnegan trims his flame to suit the shorn lamb in the pot as carefully as a skipper trims his canvas.

As regards dopping out advice in the matter of pots and pans,—suit yourself, and the fewer of them the better. Cruising in summer time is the place of all places for the chef to do masterpieces in cold lunches, salads and iced lemonade fests, and as a general rule the less of anything cooked besides tea and soup for the evening meal the better. The same is true for breakfast,—the frying-pan, coffee-pot and a single container for cereals is all you need on the fire. At dinner in the middle of the day a vegetable and a pail of spuds should be on the job, after which a quick fry of some finny specimen yanked over the ship's side completes the culinary endeavors. For a party of four you want one twelve-inch frying pan, four pails all nesting, a coffee pot of ample proportions and a tea pot ditto. The four pails should hang from an appropriate hook over the

stove end of the galley. The fry pan and broiling spider hang on another hook, on the for'd galley bulkhead, and the two pots are stowed away under the deck, hanging from big brass hooks on the roof carlines. All the ship's plates go in a rack behind the icebox and all the cups hang from rows of hooks on the carlines over the icebox. Knives, forks, spoons, napkins and glasses are kept in the sink, which is normally clean and empty and covered with its oak top, upon which sits the stove. These dispositions are economical of space and leave the pantry, below the sink and icebox, free for staple groceries. Here you keep your ham, fitch of bacon, side of codfish, wursts of various species, canned goods, cereals, murphs and staple vegetables. Also assorted dessert bases, such as jellos, prunes, dried apricots, etc. It pays to have all these things kept in those large light tin cans that you can get at that general Army and Navy Stores, the five-and-ten-cent store. Otherwise the chef is liable to set the sugar bag down on the keroseney decks of the stove base, or leave the flour on top of the icebox in a paper bag, whence it will be neatly tossed onto the floor by the first roller, being promptly joined by the maple syrup in the obvious purpose of smearing the ship with a paste of unequalled richness. So

if I were stocking the pantry for a week's cruise I would see the top shelf filled with a shiny row of big cans filled with sugar, pancake flour, coffee, oatmeal, force and the cured meats. The next lower shelf, being narrower, would contain smaller cans of tea, macaroni, rice, salt, jello and white flour. Also as many cans of fruits and vegetables as there was room for. The lowest compartment of the pantry has more or less of a wedge shape and here is the place for bags of spuds, beets, onions, carrots, prunes and other long-winded vegetables.

Through your little icebox will ebb and flow a continuous stream of milk bottles, fresh meats, fish out of the ship's garden, lettuce, cantaloupes, sweet corn and fresh green vegetables. The only fixed thing will be your three-pound crock of butter which ought to last a week. A good place for eggs is in a flat cardboard egg box, stuck in behind the refrigerator where they can neither be thrown promiscuously about by the jocular white caps nor reduce each other to sorrowful messes from the weight of other edibles which is more than likely to happen in the icebox.

The meal régime is determined by two kinds of cruise which dictate in the matter more or less. There is the cruise where you have a definite

schedule and propose to arrive somewhere sometime, and for this I generally prefer breakfast and supper on board and the heavy meal at mid-day on shore at some town or yacht club, managing to arrive at some such haven about time for the meal ticket. The other is for a cruise in more or less uninhabited waters where the towns look like flyspecks on the chart and still more so when you come to hunt for them with the naked eye. Such cruises can be had anywhere down the Atlantic Coast in our big sounds and bays behind the line of beaches and keys. If properly conducted no one has any idea of going anywhere in particular at any specified time. The party are usually out to fish, shoot shore birds, tread clams, catch crabs and indulge in piratical raids on the rural co'hn fields and melon patches. For these cruises three straight meals a day on board are the only time-table for the chef to live up to, and, as everyone is always hungry, it takes a large fat man with a calm eye and a clear conscience to keep them all full and happy.

While the latter form of cruise is up and away the most fun, let me first recall a few menus taken from personally conducted tours of our big waterways where could always be made a large town with an opulent yacht club to take care of all our

noon meals for us. For breakfasts: The cruiser would have been anchored about five o'clock the evening before in some little well-sheltered bay and after a cool and calm night the mob would usually begin the day with general stampede over the side, diving to early religious ceremonies in the rathskeller below. That would put an edge on already keen appetites and cook would proceed to construct a monstrous feed, assisted by the supe for the day, while the rest scrubbed bright work or any other job the skipper saw fit to order. The chef always set a handsome table with silver and napkin at each man's plate around the tiny folding table in the saloon. During thundering hot spells our breakfasts were fruit, force, coffee, omelettes and one vegetable. Here are a few of the menus: (1) Iced cantaloupe, force, coffee, toasted hardtack, plain omelettes, French fried potatoes. (2) Strawberries and cream, force, coffee, bacon, creamed potatoes. (3) Blackberries, baker's rolls, oatmeal, coffee, fried ham, hominy. (4) Yellow harvest apples, cream of wheat, coffee, fried eggs, rice. (5) Sliced oranges, rice and cream, coffee, Varginny pancakes, country sausages, maple syrup, creamed potatoes. (6) Peaches and cream, force, coffee, toast, fried porgies, hominy. None of these meals required the

chef to do more than boil coffee, fry one meat and work up one staple vegetable. The scarab, as the assistant chef and scullion for the day was dubbed, prepared the fruit, set the table, got out the glasses and filled them with ice water and generally made himself useful until the chef himself called all hands to mess, not having been over twenty minutes since first lighting the burners. And what meals they were in the cool and breezy cabin, with the morning sun shining in through every porthole and the early seas just lapping against the ship's sides!

To prepare most of the above commodities is nearly as easy as the Esquimos' idea of cooking musk-ox,—just add the hot water and serve. Coffee, for instance: Ladle a cupful of water into the pot for each nose at the table and dump in a palmful of coffee grounds for each cup. Stick over the burner while you get your rice or oatmeal on to boil. Presently the coffee comes to a violent head, boils over and nearly puts out the burner. Rescue by turning down the burner forthwith until it merely simmers, which it should do for ten minutes more. Rice will need the biggest of your pails with half a cupful of rice in the bottom, and plenty of water, and should boil furiously for half an hour, at the end of which time

turn down the burners and let her steam dry. Early in the process give the pot a swipe with the cook spoon so as to dislodge any particles of rice that may have gotten stuck to the bottom as they will surely scorch and spoil the mess. Oatmeal requires two things to be *parfait*: judgment in proportioning water to oats so as not to get it too sloppy and five to ten minutes of real fire heat with assiduous stirring to prevent scorching. A handful of oats to each person in a pot of salted water just deep enough to cover the oats will do to start with. If she gets too thick it is easy to add more water, but if too thin it's a long slow job boiling down to a proper thickness. Frying jobs require also much judgment in handling the flame. Bacon wants a quick hot flame, fishing out the slices the minute they are done and putting a couple on each man's plate. Fish need ten minutes' slow frying in bacon fat after rolling in egg and corn meal. Allow five minutes to each side and then turn up the burner and brown quickly. When done the flesh is firm and white. To make your omelettes, break two eggs to each man into a pail and beat vigorously with a fork, add half a cup of water if there are eight eggs in the game, the function of the water being to make the omelette fluffy. Wipe the frying pan with a rind of

bacon and pour in enough of the beaten eggs to cover the bottom of the pan a quarter of an inch deep. Run a knife under her, now and then, to keep from scorching. Flop over one half on the other when top of the egg mixture begins to dry and turn light yellow. You can run them off one every three minutes.

For evening meals on these "civilized" cruises, so to speak, we served "tea," which is to say that commodity was about the only thing cooked. However, the chef usually got out the frying pan and gave us French fried potatoes, fried mush or fried rice cakes to go with our cold sliced meat, lettuce salad, bread and butter, cake, lemonade and cheese.

But crowded with still more joyful recollections than these were the uncivilized cruises where a fleet of canoes was towed astern and the cruiser was sufficient unto herself, never anchoring except in some woods-bordered uninhabited bay, and spending often days together on some good shooting or fishing ground. Those were the days when a dollar was worth nothing except to waylay some passing iceboat or to buy eggs and milk at some shore farmhouse. The ship's garden produced abundant fish, clams, oysters, crabs and shore birds, or, if on fresh water, we had pickerel, bass,



sunfish and perch, there was water-cress salad with mayonnaise dressing, and frogs legs *à la* mushroom, *à la* terrapin and *à la* backwoods,—which is plain fried frogs legs.

A solemn responsibility devolves upon the chef in such a cruise,—that of providing three square meals a day of such heroic proportions as to make eight ordinary domestic feeds. For every one is active and full of exercise on such a trip, as the problem of filling the larder keeps every one on the hustle. Bathing, paddling, fishing, foraging for crustaceans and mollusks, and marsh shooting are all strong-arm games, and all engender wolfish appetites. Going on fresh water is quite as strenuous; there are side trips for trout, bait castings from the canoes for bass, catfish yanked over the side with a white frog's-leg for bait in the stilly night, and frogging expeditions in the dark of the moon with a jack-lantern and a shepherd's crook made out of four feet of arrow wood and a stout pickerel hook. Our usual plan on such cruises is to have a reasonably heavy breakfast, say a quart of berries apiece, a bowl of cereal, four cups of coffee, thirteen flap jacks, two whole fish and a bucket of creamed spuds per man. Then a fried steak spread at midday with biscuits and crisp fried potatoes on the side, and finally a grand

French wash-out for supper, comprising a bucket of soup per hand, tea, toast, salad, and, say, a watermelon apiece for a finisher. If the chef lives up to this scale of things the crew will not come running in at seven bells for a smack. Heavy gumbo soups are one of the most hearty, healthy and economical articles for the final meal of the day. They generally clean out the icebox, as everything is grist to the soup mill, and are not only appetising, but plumb easy to do. Cut up potatoes, onions, carrots, greens of all kinds into small pieces and set them to bubbling in the largest pail you have, an hour before supper. Put in all meat bones, left-over pieces of steak, bird ghosts, etc., and just before serving add in a couple of beef concentrated capsules. Season sparingly, as the capsules will add considerable salt of their own. Long before supper time the whiffs of aroma from that soup will have the whole crew waiting around the hatchway with their tongues hanging down to their knees!

I have already given some hints on fish. To do crabs heave them into a pail of boiling water, throw in a couple of sage leaves to give them a tone and fish them out in twenty minutes. The best recipe for soft clams that I know of is for the crew to flourish around on some sandy bar at

low tide until twenty-five of them to each man are apprehended, clean out sand, put them in the swash bucket, clap on the big broiling spider, and invert them over the frying pan. Start them heavenwards with a little water in the frying pan. As the steam ascends the clams will loosen up, dropping their liquor into the pan. Steam until the last clam gives up his inside information and serve with a cup of the liquor on the side, to which has been added a spoon of butter and a dash of pepper. Believe me, it's a swell feed!

Shore birds simply need gentling flat with an axe and broiling in the spider. Butter and pepper all over. Fresh water fish are all fried in corn meal and bacon fat, fresh out of the water if small and split open and broiled in the spider if large. Almost all the fresh water ducks and upland birds are first parboiled fifteen minutes and then roasted on a spit over the burner with little pieces of bacon skewered into them. Salt water ducks are the better for being roasted with a peeled lemon inside which condiment removes the fishy flavor. All birds should hang at least a day before using, but for cat's sake don't hang them near the state-room or a colony of old settlers will sample you the following night and you'll spend the silent hours looking for trouble.

Frogs are not noisy except when overburdened with sentimental emotions concerning the stars and the moon, but when these latter draw forth the distressing sounds that some old he-one scrapes out, down there in the marsh, it's time to go and get him and have frog's legs for breakfast. You light the jack-lantern, pull the canoe alongside and silently step in. Noiselessly you slip across the lily pads, pausing now and then to allow the batrachian to unburden a little more sentiment. Now you are quite close, and you shoot out the lantern ray. There he is, just behind those cat tails. The gaff is stretched stealthily over his back; there is a quick yank and a surprised squeal,—and frog's-legs for breakfast for one. Repeat until the entire ship's crew is mustered. Next morning parboil the legs fifteen minutes, dip in a beaten egg, roll in flour or corn meal, fry to a crisp brown and serve with a squeeze of lemon and a dash of cress. On either fresh or salt water you can come pretty nearly living off the land if the waters are fit to cruise in, *provided* that no one has the travel mania and that no member of the company wants to sacrifice the sports of the hour to any infernal get-somewhere-else schedule.

There is a mineral commodity at the basis of ali

these culinary operations, viz. : common or garden water,  $H_2O$ , which will cause you more worry than all the rest of the edibles and drinkables put together. You can't carry it in a pail because the next wave is sure to invert that container all over the Brussels carpeting in the stateroom and slop it gently into the beans, causing the latter to swell and spread mightily. You can't carry it in a tank on the roof, such tank being in the way of everybody's head besides making the cruiser top heavy. If you put it under the floor of the galley then you need some sort of a pump to get it out again. I described in the chapter on yacht plumbing a home-made force-pump which was very efficient in persuading the water in the tank under the floor to betake itself somewhere else. In the elevation shown herewith is another tank scheme, which consists of putting air pressure on the tank with an ordinary bicycle pump and a check valve in the air pipe. The tank should not be filled more than two-thirds full, and, with the bicycle pump located in almost any handy place in the galley, a few strokes on it will put a fine-and-dandy pressure on the tank which will make both the faucets in bathroom and galley operative for some little time. The tank itself should have solid wooden blocks both on top and

bottom covers, not only to prevent getting adrift in a seaway, but to guard against some vigorous brother pumping air into the tank with all *élan* of a man filling a bicycle tire—and bulging the tank! As both the top and bottom of the tank are flat they would immediately swell out and spring leaks around the edges unless braced by outside blocks. The tank should have a filler pipe with 1-inch screw cap flush with the galley floor.

## CHAPTER VIII

### GOING INTO COMMISSION

SPRING, to my mind, is always associated with two phenomena of Nature,—the click of calking hammers and the smell of fresh tar, and oakum. One might also mention Lent and the small boy playing marbles along the village street in the warm afternoon sun, as you can always see this also at the season of the Calking Mauls. And at the end of every street leading down to the bay will be the huge bowsprit and tall spars of some big three-master whose sides are being stuffed with oakum as she rides high out of water on the marine railway. In a stroll among the various yards along the shore you will come across, here and there, beaches which have been a refuge for motor boats during the winter, and now is the season when every one of them will be inhabited by their happy owners, blissfully overhauling the beloved craft, opening up cabins and berths to dry out the winter damp, scraping spars for a new coat of varnish, and generally playing with everything in sight. It is indeed time to get off the

winter tarpaulin and go over the hull with a critical eye. You will find that she has swelled open so that you can throw a dog through the cracks, but by the same token she will swell shut again, so there is not much to worry about in that. Pay the seams with paint and give them a good rub-in with white lead putty and you will be ready for operation No. 2 of the going into commission, which will be to go over all the hard, ridgy edges of last year's seams with a scraper and smooth her down fine preparatory to a rough coat of sandpapering. If the paint is very old, consisting of several years' layers, it will have begun to curl and peel and you are in for a torch-and-scraper job. Use a gasoline hot-blast torch with 76 test gasoline and a three-cornered steel scraper. It takes two men to do the job, as one man needs to apply full-power elbow grease to the scraper and he should follow up the man with the torch as fast as he softens the paint with his heat. It takes all the torch man's energy and attention to soften the paint without burning the vessel likewise.

As a general thing, your motorboat will not need this heroic treatment but once in a considerable span of years—if you own her that long. After your rough coat of sandpapering, followed by a smooth coat, she is ready for the paint. As



I never use any other color than white for the outside of a boat, I shall simply give here the best mixtures to get a real *white* finish on her. I give her first two coats of house-painter's "Inside White," which you can mix yourself or, better, buy it mixed from any first-class paint-manufacturing concern. After these coats have dried I put on one coat of "Yacht White." This is a quick-drying mineral paint, much like the common copper paint used on the bottom. The cans of it come 62 cents a quart can, with the paint all in a heap at the bottom of the can and the liquor above. This liquor is precisely the same essential quick-drying oil as is used in the copper paint, and it will not stir and hold the paint as does linseed oil. As a consequence, the novice will usually stir until he is tired and then proceed to paint. The application will be nearly transparent. He will see every dirt mark and blemish on the house white underneath and, in fact, this new "Yacht White" makes the color distinctly dirtier than before. This keeps up to a disgusting degree, until more than half the liquor is gone, when presently, in response to repeated stirrings, the paint is a fine heavy white, making the house-paint look yellow by contrast. You once more get that motor-boaty smile that won't rub off, but it soon

fades as you discover that there is now not enough liquor and you are shortly reduced to painting out thick gobs of white mud which require infinite labor with the brush to spread. All this misery can be circumnavigated by simply using *two* paint pails, one the can containing the "Yacht White" in its state of original sin, and the other a can in which you pour off the liquor and add as wanted to keep the paint of the right and Christian consistency. You will find that there is just the right amount of each to use every bit of it in a fine, heavy, snowy white.

The next job is the below waterline work. Scrape all last season's mud and barnacles off, rub white lead putty in the seams, smooth her off with a scraper and then you are ready for the waterline. Get enough stout mason's twine to go entirely around the boat and nail a lath across the stern. Set her bow exactly plumb, and level up the lath across the stern so that it comes exactly square with the stem of the boat. Nail a second lath across the stem and set it exactly square, or, if the stem has a brass guard, set the horizontal lath on a couple of thin uprights. This lath, or rather straight edge, should be long enough so that you can see all around the side of the boat as you go out along it. To snap the

waterline pull the twine taut from bow to stern, while you go out and sight across the for'd and aft straight edges. The string should always lie just above your line of sight and the other man must pull it up or lower it if it sags below or raises out of your line of sight. Tack the line here and there and paint from it down. You can use either green or brown copper paint, using two pails, as for yacht white. It will dry in a few hours; in fact, you can go overboard just about as soon as the last bit of it is on.

The next job of painting is the varnish work. All of last year's will be black and furry, besides which, with all your care, there will be some smears of this year's white, to say nothing of the specks which have flown off the brush bristles. Get a few broken panes of glass and break them artistically to give you long curved glass daggers (sit down on the pane to get the really finest effects), and use these on fenderwales, taffrails, spars, cabin-eaves, etc., until you have the clean oak once more. Follow with rough and smooth sandpapering, and then immediately with first-class spar varnish. For inside work any good marine or floor varnish will do. To get a good mahogany stain use cherry and varnish over it on red oak. For stateroom, bathroom, etc., good

white enamel is best in the long run. It is easy to clean and stays so, so that an inadvertent greasy thumb will not leave an irrevocable blemish, as it will on plain white lead finish. And if you want to trim up the corners of carlines, etc., with gold paint, why go ahead!—I don't care—only the less of it the better, and none at all looks fine.

The details of getting overboard are neither many nor lengthy. In order to avoid a general wetting down of the boat and everything in her by a prolonged soaking during the swelling of the planks, it is well to throw six or seven pailfuls aboard of her for several days before launching and let these swell up the garboard and second and third strakes. To get her into the water you can run her down at low tide on skids with rollers under her cradle, and let the tide come up and get her, or if there is no tide, put on seven-league boots and set a couple of skidways by nailing side spikes to 2 x 10 planks and then securing them to the mud bottom by putting your weight on the skid until the spikes are home in the mud. Use iron pipe rollers with lengths of marlin tied to them so that they can be hauled up as fast as they pass out at the bow.

Once overboard the all-important point of a

berth and a mooring for her must be settled—if you are wise this has already been done. Almost everywhere on salt water you have both tide and the prevailing lee-shore gale to look out for. Along the Atlantic seaboard the worst thing we have is the nor'easter, which usually blows viciously for three or four days and will make any sheet of water over a mile wide a proposition to be regarded with respect. The tide is equally important as the two of them together will surely put you ashore if by any possible means the anchor can be started or anything in your whole mooring gear broken. Study your proposed berth carefully, particularly at full rush of ebb and spring tides, before choosing it. Also, look out for your neighbors and keep out of the probable drift of other boats larger than yourself. If your boat is any size at all moor her out where there is some sea room, the more the better, and keep away from all docks and floats.

Better put down a two-hundred pound mushroom anchor with a chain and buoy, and let her ride to it out where she can't possibly foul anything. There is not a gale that blows that any good motor boat cannot weather if she can hold her head to it. And there is a good deal more *to* this mooring equipment than appears on the sur-

face. To begin with the mushroom anchor. The plain ones run nine cents a pound black iron, and twelve cents galvanized, and you *must* have the latter for salt water. There is a fancy variety with a bulb at the end of the handle shank, a cast eye on the back of the mushroom for a tripping rope, and a shackle pinned directly to the shank. All of which I do not like. As the mush is to remain in the mud all the season the tripping rope would rot long before you will need to use it; the bulb in the shank may help her ride at first, but any proper mushroom knows that its first duty in life is to dig into the mud and pile a cubic yard of bottom in front of itself, out of which sticks the shank, as rigid as a crow-bar, so of what use is the bulb? As for the shackle pin there is sure to be a great deal of rotary motion to it during the season as she rides, which will wear the pin more than if the shackle is in the chain where it should be. Of what use is a stout one-and-a-half-inch shank on the mushroom if it is only backed up by a thin one-half-inch shackle-pin at the end of the shank? The simple mushroom with a large ring forged in the end of the shank is less apt to have fatal weak spots to develop during storms and let you get ashore. Into the forged anchor ring goes the anchor chain shackle, and its pin

passes through the eye of a mooring swivel which should be of wrought iron galvanized—malleable will not do. The swivel takes the last link in the chain, which you should have the blacksmith forge together or else use a pin chain shackle with the ends of the pin burred over.

The chain should be one-fourth inch for boats 30 feet and under, five-sixteenths inch for 40-foot, and three-eighths inch for 60-foot craft. Under the ring of the buoy goes a second pin shackle, a swivel, and a screw shackle. The screw shackles have an eye in the pin, not only for unscrewing with a fid or a large nail, but for securing against coming unscrewed by running a couple of turns of galvanized iron wire through the eye and around one leg of the shackle. They should be of wrought iron galvanized.

As to size and choice of mooring buoys you have as wide a range as in the styles of female hats ashore. There are three breeds of can buoys, running from \$2.50 up to \$4 in galvanized iron, in 10 x 12 and 12 x 15 for the plain can buoy, and 13 x 22 for the conical buoy. The latter have stirrups riveted to the shell, and the plain can buoy has a pipe passing through the center soldered to the can, while a rod passing through the pipe has the mooring ring above and the swivel on the

lower end, thus needing only a screw shackle for attaching the chain.

The cork buoys run from \$3 up to \$10 and come in lozenge, cylinder and tub shapes. There are two styles of barrel buoys, one with rope bridle and mooring bend, and the other with galvanized iron straps with an eye at top and bottom. They cost from \$1.50 up. Finally there is the new cedar spar buoy painted in red and white stripes and provided with large wrought iron shackle riveted to the buoy, with burred-over iron through-bolts. This buoy cannot be stolen and stands high out of water so that it is easy to "pick up."

A good many motorboatists have, by right of plain purchase, become possessed of a beer keg, and, as here is a grand chance to put it to work once more, a few directions will not be out of place. A rope bridle for it is open to the objection that it will not stay on the keg with any certainty, besides which it can be cut and your buoy stolen, giving you the dickens' own time finding your chain and mush at the bottom of the pickle. A better plan is to take a bit and brace and cut two-inch holes in opposite sides of the keg, and drive into it a length of  $\frac{3}{4}$ -inch gas pipe, guiding it straight to the opposite hole with an iron rod. This pipe should be an inch longer than the diame-



ter of the keg and you should cut an inch of thread on it at each end. After driving in, with half an inch sticking out of each side, run down a washer and a locknut with a turn of cotton soaked in white lead putty under the washer. Tighten up the nuts and thus make the keg waterproof. Don't cut your holes so that one of them is in the bung. She will get full of water some day, and then you will want to start the bung. The next move is to get a piece of  $\frac{3}{4}$ -inch iron and have the blacksmith turn and forge a 4-inch mooring ring in one end of it and cut a thread on the other. Slip this rod through the buoy, run the thread into an empty turnbuckle stirrup, put on a nut inside the turnbuckle and jam it fast. Your chain shackle takes the other end of the turnbuckle.

On the boat end of the mooring we find a 42-inch mooring chain to which is usually bent the end of the riding rope, so as to be able to veer out all you want in emergency, etc.

In crowded waters, such as are most of our harbors along the Atlantic Coast, there is, however, a fair chance of your boat being stolen, so that it pays to have a long mooring chain, say seven feet, pin-shackles to the mooring ring and a pair of gaff topsail sisterhooks at the inboard end. These can be closed around a ring on the anchor

post and a small padlock run in the eye, which locks both sisterhooks. Such a rig is not apt to be tampered with by any ordinary river thief. If they are really after your boat of course no chain will amount to much, as they will bring along a cold chisel and cut it on their own anchor shank.

In getting up either chain or rope ground tackle, there are two handy little rigs especially adaptable to motor boats of 35 feet and over. There is the combined windlass and bitt for rope, which is made in five sizes, from \$9 up, in galvanized iron; and there is the vertical chain windlass lately put on the market. The first of these screws to the deck by four stout bolts passing through its base, and has two niggerheads to the left and on top, and the right-hand side is the windlass drum, which is  $2\frac{3}{8}$  inches diameter in the smallest size. It can be worked with the right hand while the left takes up slack and belays around the bitts when the anchor is away. The vertical chain windlass, which goes under the trade name of the "Viking," is a compact little thing, 10 inches in diameter by  $3\frac{1}{2}$  inches high in the size for  $\frac{5}{16}$ -inch chain, or 7-inch x  $2\frac{3}{4}$ -inch for  $\frac{1}{4}$ -inch chain. It costs about \$9 and \$18 for the two sizes, has complete locks and trips, and can be worked with one hand, leaving the other free to steer when getting under

way. It will go on the deck of any motor boat, as shown in the cut.

Here also may be mentioned chain and rope deck pipes, which come from  $1\frac{3}{4}$  inches up, price about 50 cents in galvanized iron. They run up to six inches, but the sizes for motor boats are  $1\frac{3}{4}$  inches, 2 inches,  $2\frac{1}{4}$  inches and  $2\frac{1}{2}$  inches, depending upon the size of the chain. You want one for each bower, and they screw to the deck on each side of the bitts over the chain locker.

In purchasing mooring fittings always get first-class stuff such as one finds at some one of the big South street (N. Y.) ship chandleries. Economy doesn't pay when you are up against real trouble, as the mooring is every time a nor'easter or a sou'easter blows in. You may lose \$2,000 worth of boat for \$10 worth of mooring tackle some fine night when you are comfortably in bed while the little cruiser is fighting it out all alone out there in the gale and the whitecaps. Cheap mooring outfits are the principal reason why so very many motor boats hunt the beach or go adrift every time there is a northeast blow.

Planting the mooring is a matter which cannot be gone at in a light and blithesome spirit, or undertaken by three men in a small dink with a mushroom that weighs from 150 to 250 pounds,

and then there is a neat 60-foot chain attached to it and a dainty watch charm of a buoy which may be one-half the size of the dink itself. Wherefore, if anybody is rash enough to go out with this equipment and attempt to usher the mushroom over the bow the dénouement is apt to put the dink standing on her own nose with the crew floating in picturesque groups on the surface of the briny. If you are going to plant the mooring with your motor boat, get out and anchor directly over where the mooring is to be and keep at it until she is exactly where you want her. Better choose a quiet day for this operation as otherwise the cruiser is liable to gambol around in the most provoking manner imaginable.

Once over the resting place for the mushroom, the next problem is to get her down, and to this end a respectable length of three-quarter-inch rope slipped once through the mushroom ring is the proper caper. Make one end of this rope fast to the capstan bitts so that you can gradually pay out the rope with a round turn around the capstan. Get the mushroom over the counter as quickly as may be and cast loose the fast end of the rope, take both ends with you in the dink, getting some one to row you in the direction of the strongest tide. A little energetic work on the rope

## GOING INTO COMMISSION 317

will get the mushroom into position pretty thoroughly and then you can slip your lowering rope and haul the loose end through the hoop. The buoy you should put overboard with its chain attached. The length of the chain should be about five times the depth of the water at the highest known tide which you have ever seen at that place.

Needless to say that any attempt to lower the 250-pound mushroom by its own chain from your cruiser is sure to result in an assortment of surprises and possibly a leg or a finger or two of the crew going overboard with the chain. It can be done, however, if you have a chain windlass.

As regards getting the mushroom up again at the end of the season, unless you have a pretty powerful windlass, better get some big oyster boat or tug to get her out for you, as she is liable to make quite a journey into the mud during her season's stay below decks.

## CHAPTER IX

### HAULING OUT FOR THE WINTER

THE only motor boat owner I ever heard of who didn't have to haul out was Noah. He had a cinch. When the Ark went aground on Ararat Point, Captain Noah didn't go into a frenzy and bawl at Ham, "You black pirate, shove for your life or I'll carve the heart out of ye!" nor did he shout, "Full speed astern! For cat's sake back her!" at Japhet. No, he simply remarked: "Boys, they've turned the water off and I guess we're ashore on the steeple of the First Baptist Church. Don't get excited; just hang up all the animals by their halters, as there's going to be *some* slope here when this tide gets to going down! We've only got five hundred fathoms under our stern!"

But what goes down must always come up again, as the power cruiser owner remarked to his 200-pound anchor, so nowadays one has to haul out to get above the reach of tide and ice. We also have to lay our boats up for the winter—and thereby hangs a tale.

For there is really a good deal to it, getting a

thirty to fifty-foot power cruiser out of the drink, protecting her from the snows and ice of January, and putting her interior and engine into shape to stand the long months of dampness and disuse. There are half a dozen ways of hauling out, each fitting the pocketbook of some particular kind of human, and his own peculiar worries on the subject. For the city man there is nothing for it but pay your little hauling-out fee—anywhere from \$5 to \$25; and pay your little storage bill—anywhere from \$2 to \$10 per month. For the dweller in some small city beside the river or harbor there are two ways: Either haul out and store somewhere along the beach where motor boats most do congregate, or have her run out on a marine railway, meet her with a truck and keep her in your own backyard. This has the advantage that you can, and will, putter at her off and on all winter long, and so get a great deal more work done on her than if she lies forsaken and forgotten down on the beach.

If you are rich, and fortunate enough to own a place fronting on the water with its own beach, it is a good plan to build your own marine railway leading up to the boathouse, wherein the boat can be kept all winter and worked in out of the weather. A railway suitable for a thirty to forty-

foot boat need not be a very expensive matter, about \$50, and it will be used several times a season for cleaning bottom, new coats of copper paint, repacking stern gland, etc., besides loaning the use of it to friends, hauling out, and putting into commission. Unless a large boat has a pretty strong skeg and rudder-hanger, it strains her to beach her often for such work, and one never gets a satisfactory job done under such conditions. The best and simplest small marine railway I ever saw was made of two forty-foot runs of five-inch by eight-inch long-leaf yellow pine carsills, spaced five feet apart by seven-eighths-inch iron rods, with long threads on their ends which allowed a nut and washer on the inside and outside of each sill. These latter were laid flat and the rods placed about ten feet apart. On the sills went a three-inch channel-iron with the lips looking up, spiked to the sills through holes in the web at three-foot intervals. There were two lengths of this marine railway, the second of which ran out under water and was hauled out after the boat was put afloat again. A snubbing post behind the boathouse provided an anchorage for the falls, which led down through the boathouse and hooked onto the ring of the boat cradle. One two-sheave and one three-sheave hook-block of one-inch rope





PUTTING THE "ADELAIDE" OVERBOARD ALONG WITH A PAIR OF SHEARS

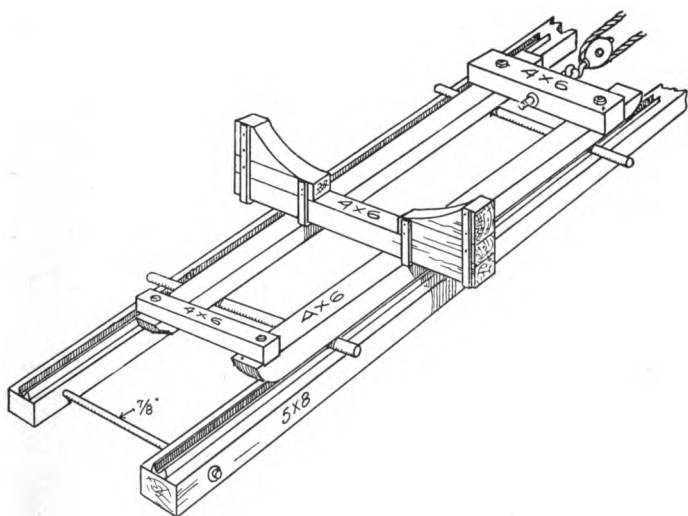

A SIMPLE MARINE RAILWAY

CONSTRUCTION OF CRADLE AND WAYS FOR HAULING OUT A  
POWER CRUISER

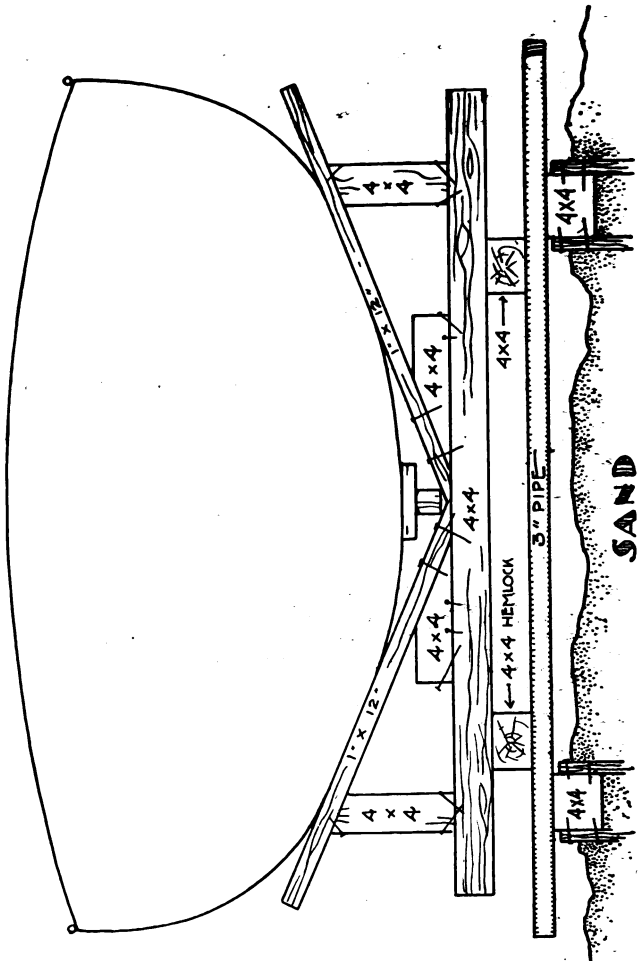

TRANSVERSE SECTION AND DETAILS OF HAULING-OUT WAYS

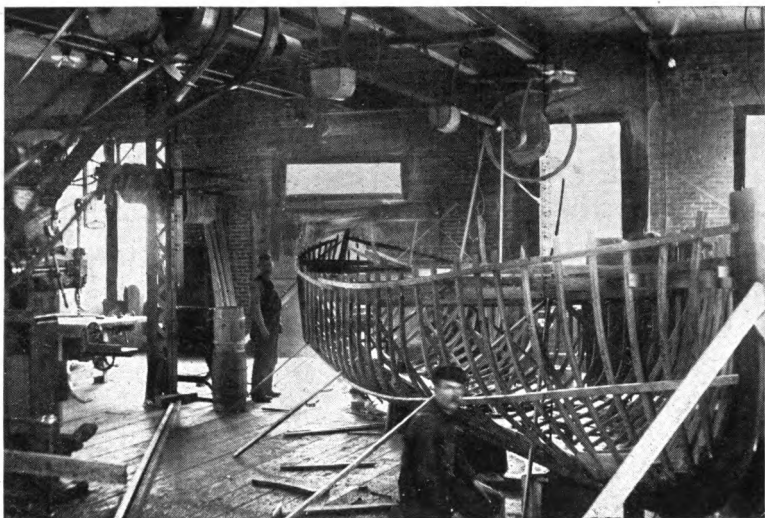

END OF FIRST DAY'S WORK ON THE "GO-SUM"  
The entire frame was set up and bolted together in one day by three men.

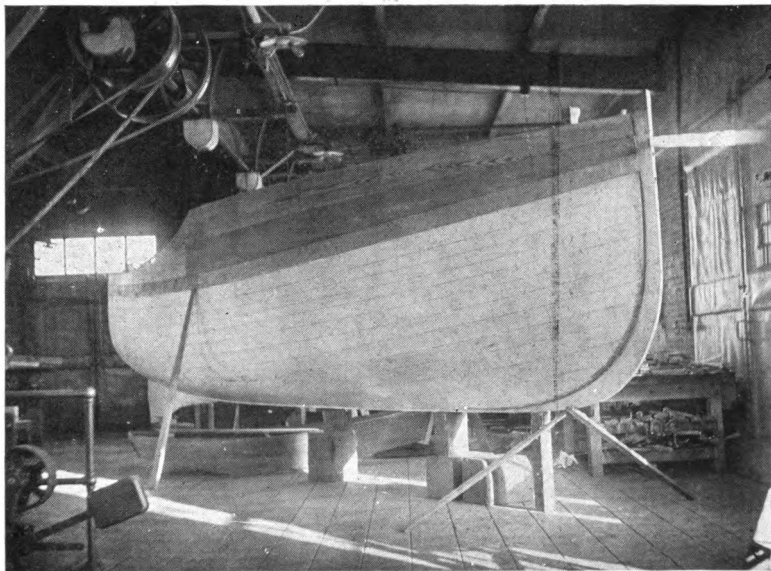

FINISHING THE SKIN AND EXTENSION TRUNK PLANKING  
Calking the seams and smoothing with a round-faced plane was done here.  
Paying with paint and putty at the shipyard.

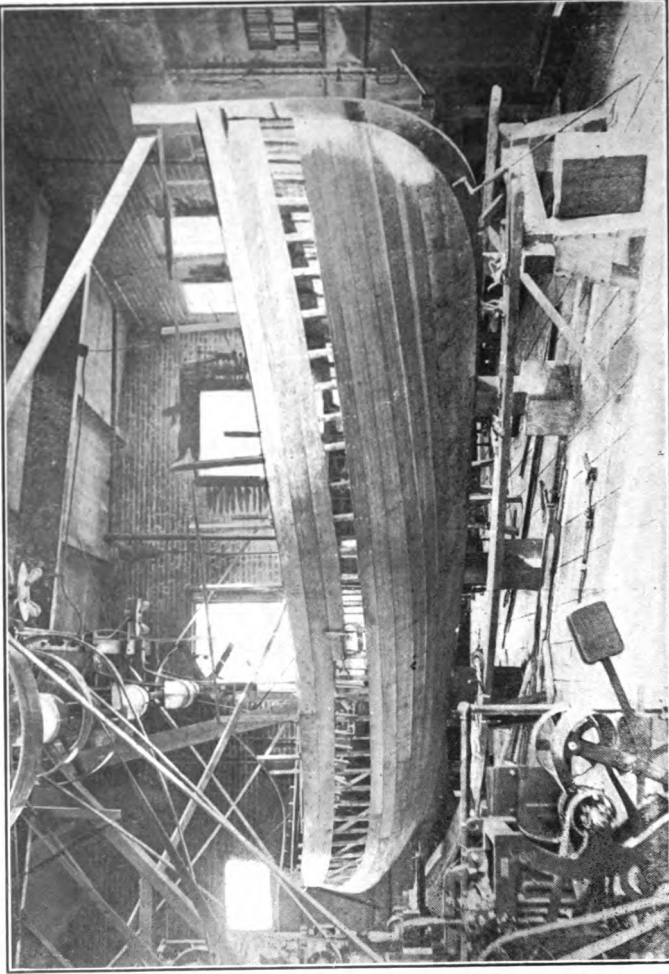

**PLANKING THE "GO-SUM"**

Note, after planking up from the garboards we began planking down from the sheer strakes, so as to bring the filling plank about midway up the side.

size sufficed for tackle. The cradle, as shown in the sketch, is very simply made with two twenty-foot lengths of four-inch by six-inch yellow pine, carrying a cradle-beam in the middle and two crossbeams at the ends. These are all four inches by six inches, bolted through the four-inch by six-inch stringers, and the forward cross-tie is provided with a three-quarter-inch ringbolt. The blocks of the cradle are made sliding by lag-screwing one-half-inch by three-inch iron straps on at the rear, and one-half-inch by three-inch flats at the nose, thus also tying the component pieces of four-inch by six-inch which make up the side block together. There are also two rings on each side of the blocks for the clamping ropes. The simplest and best rolling gear for such a railway is just four two-inch extra-heavy iron-pipe rollers six feet long.

To haul out, the boat is floated into the cradle at high tide, and the clamp ropes passed around her and pulled taut until the blocks come snug under each side. They are then crossed and tied over her deck so she can't get away. The cradle should be set on the railway and tied down with light twine at low tide, or else weighted with rocks and run down if there is no tide. The rollers

should have short lengths of marlin tied to them, to get them back when clear astern.

But, for the great majority of motor boat owners, it is a case of haul out at some handy place along the beach where the boat will be out of the reach of tide and ice during the winter. For such, a home-made cradle and improvised railway is the thing. Get some four-inch by four-inch rough hemlock and lay a track down the beach on about four-foot centers. Carry it on down at low tide thirty feet beyond high-water mark and stake down the rails. If there isn't any tide you can nail on the stakes and then sink the rails, wearing hip boots to do the job. For the cradle you will want two frames like the sketch, Fig. 2, which are bolted to two twenty-foot four-inch by four-inch timbers. A block and falls anchored to a tree or post in the bank, and catching her by the anchor post on the boat, will do the trick of persuading her out of the wet. The rolling stock will be pipe or wood rollers "borried" from the yacht club or from some rigger or furniture storage company.

Once out of the water—let me whisper it in thine ear—the bilge of your boat is not only dirty; it's really filthy! That's the first thing to go for, after the stores are out and engine and toilet

drained. More boats are ruined by leaving mouldy puddles of water around the ribs in the bilge all winter than by any other thing. Above all have a close-fitting canvas cover on her. Better turn her over bottom side up if you can't afford one. More about this later.

One usually hauls out late in November. There are lots of days in October too good to lose, when there are hunting expeditions galore, and also the fish are large and fat in that month. Keep in commission all October, even though your family has to order coal for your house in the first week. Salt water freezes somewhere about twenty-eight degrees, so you are reasonably safe until November, *provided* that you be sure to drain the cylinder jackets when done with the engine.

Once out of commission, drain the engine thoroughly, take the water pump apart so as to be sure that no water is left in pockets or over check valves. Most engines have out-of-commission plugs to drain dead pockets when laid up for the winter. Start these carefully with your pipe wrench or you are likely to twist off the nub of the plug. I usually run the engine dry for a few minutes after hauling out. It heats the entire engine up and vaporizes any water lying in exhaust connections, silencer, etc., besides thoroughly dry-

ing the jackets, etc. After that, drive wooden plugs into the exhaust where it comes through the skin of the ship, and also into the jacket water overflow, and replace the pump checks.

The engines will have considerable free acid in the soot of the combustion chamber and on top of the piston, which will corrode the cylinder walls. Take off the spark plugs and pour in a little kerosene, following with an inch or so of engine oil. Replace the spark plugs with ordinary iron ones, and give the engine a few turns. All the outside bright work of engine and clutch should have a coat of white lead tallow paint, made by mixing half-and-half white lead paint and tallow to form a sort of grease, which you can paint on all over the bright work. It will stay on all winter, and will come off with a wet rag dipped in gasoline or kerosene. This should go on over all exposed brass work, the shaft and clutch, etc. Go outside and pull out all the packing from the stern-gland, and give the shaft and box inside a good coat of the lead-tallow paint. If there is any possible way—and there ought to be—to pull off the screw propeller without unshipping the rudder, some one is liable to come along with a hand wrench and “borry” it some dark night. Better, therefore, get it off and send it up to the house,



tying the key to it, and paint the shaft end with white lead tallow.

All the ignition devices and batteries should be taken out and stored in your house during the winter. It is fatal to electrical apparatus to be left in a damp boat all winter, especially the spark coils. It is best also to take the clutch apart so as to tallow the friction surfaces and prevent them rusting up. All stores and movable brass-work should be kept up at the house through the winter. Also all bedding, rugs, cushions, mattresses, life preservers, sails, awnings, etc., as these will surely mould if left in the boat. Be sure that there is no water in any of the tanks and plumbing and pump the toilet dry, and open up both its inlet and discharge valves to get all water out of pockets, siphons, etc.

You are now ready to go at the bilge. A favorite ballast consists of red building brick in the bottom between the ribs, and gravel ballast bags in the bilge, under the seats and berths. The red bricks being porous, soak up and hold any loose water in the bilge and thus increase their effective weight. But, in the winter, the bilge floor should come up and the bricks come out, and the whole skin of the ship be cleaned with a sponge. When it dries, the skin and the ribs should have two

coats of white lead paint, and then the floor can be put down again, leaving the bricks outside until next season.

The matter of the canvas boat cover is the next to receive attention. It is very important to have it fit snug all around, with a big lap of at least two inches flat against the coaming. This is to prevent drifting snow from getting in and later melting and wetting the bilge. Any small puddle between the ribs will freeze and strain the ribs if allowed to remain there. If the boat has extension trunk cabin, a cover will be needed, extending over cockpit and launch cabin if there is one astern of the extension cabin. In between the cockpit coaming and the sweep of the skin of the ship down to the level of the deck from the end of the extension cabin is a narrow strip of deck drained by scupper holes. In winter the snow fills this space, thaws and freezes again, and you have a permanent lump of ice in there which will strain and work all the surrounding woodwork all the rest of the season. The cover should protect the boat from such small favors of old Boreas. A plain open motor boat requires a cover over the entire coaming, and there must be a ridge pole with at least three triangular frames holding the cover up. A few rough hemlock planks put on

*under* the cover, not over it as is often done, are a great aid in keeping the slopes flat and true, so that they will not bag under the weight of snow. A ridge pole and at least one triangular frame will be wanted under the cover of the cockpit of a cabin sail or motor boat, for the same reason of preventing it bagging. As to material, good ten-ounce duck with ordinary weather shrinkage makes the best and most durable cover. Attempts to waterproof it with paraffin, etc., have usually proven a failure, as covers so treated soon rot and crack, especially in the creases. The reason is because there is always considerable residual acid in all oil and paraffin treating processes, which acid attacks the cotton of the canvas. It is the same acid which attacks the galvanizing of your gasoline tank. The cover should have a stout one-half-inch bolt rope on the ridge and around the edge, and have one-half-inch brass grommets which will snap down over corresponding buttons on the outside of the coaming. If it goes clear outside the skin of the ship it will have to be lashed with one-eighth-inch rope passing under the keel.

If the cruiser has a signal mast and standing rigging, these should be unshipped and taken up to the house. A spruce mast will develop cracks

during the winter and the galvanizing will all come off the wire rope. The masthole as well as anchor rope scuppers and ventilator cowl openings should be plugged up, either with the screw caps which come with them or with wooden caps puttied all around.

It will not do to leave in the window, porthole and door curtains. All the brasswork of poles and rings will get tarnished and the sun will take all the color out of the curtains, so that they will all have to be made new next year. During the summer, people were always around and handling them, so that they remained bright and clean, but the still, damp interior air of the boat in winter is fatal to such furnishings.

Another thing: You expect probably to make a winter workshop of her interior, as there are always a million things to be finished, altered or improved. Even during the summer most motor-boatists go down Sundays to "work in the boat." Sometimes they get under way before nightfall; sometimes they don't. But they are always enjoying themselves to the core, and the habit is sure to stick all through the winter. Wherefore you want everything that can be injured by sawdust, shavings, varnish, emery, grease and paint-

cans, safe and sound out of the boat and stowed away in the little old attic.

Hauling out the boat for the winter usually means taking up the mooring also. The life of the mooring, especially the chain, depends entirely upon how long it remains in the water, and you ought to have at least a bowing acquaintance with the chain once a year. While it is impossible to sink any boat without first filling her with water, she is subject all the time to the danger of going ashore in a storm if one of your mooring-chain links parts anywhere. Getting the 200-pound mushroom or 300-pound scrap car wheel up out of the wet is some pulling. Don't try it in a small boat. Better pay some oyster sloop to get it up for you with their windlass. Clean off all barnacles and seaweed from the mushroom and buoy, and give them a coat of paint at once. Clean the chain carefully, examining it for poor links, pickle in a pail of kerosene, rub it down in the sand, wash and paint all over with white lead tallow.

After the cradle is out and blocked up securely for the winter, your boat will be held in just two places. This is a severe strain, for her whole weight is concentrated at those points and it will in time warp flats in her. The boat should be supported practically along her entire keel, as even

the latter will warp if it is a flat oak plank and only is touched by the supporting blocks at one or two places. As for the cradle blocks, these bear directly on one or two ribs only, and they will not long stay in shape. See that there is a block securely seated all along under her keel, one every four feet, and have flat wedged planks driven in between the blocks and the keel so as to take all the weight of the boat off the cradle blocks. The cradles then should have nothing to resist but whatever tendency to lean the hull may have, which will be a very light pressure. If the whole weight of the boat is carried all winter by only two blocks under the keel it will warp the stoutest oak, and it will never come out again after the boat is in commission, besides introducing a mean, leaky spot.

## CHAPTER X

### BUILDING A POWER CRUISER FROM KNOCKDOWN FRAMES

WITH my chums, I planned this boat, in answer to an urgent need for a cool place to spend the summer within commuting distance of New York. What is more, we only started talking about the boat in February; we had her afloat by May 15, and lived aboard her from that time until September. By way of summer accommodations, she possessed a fine bathroom for'ard, a tiny galley in which breakfast and supper for four could be "shook up" with astonishing facility, a two-berth stateroom, and a large launch-cabin containing the engine under the central table and six large, *real* windows, that could be opened to the breeze, which made this cabin blowy, shady and glorious by day as well as cool by night. Two long lounging berths, or rather seats, went along each side of the launch-cabin, which would sleep two guests at a pinch, and were, in fact, the preferred positions on very hot nights, though the stateroom was seldom hot enough to make one want to change. For a cool,

breezy little summer hotel I have seldom seen the equal of that boat, and we built her at home for less than \$700.

To begin with the design. I saw nothing in the numerous knockdown frame catalogues that exactly suited our purpose. Most of them would do well for week-end cruises or sleeping accommodations for a pair of youngsters with down-town-office jobs, but for us civilized comforts were a necessity, if an all-summer stay was to be enjoyed. A few years' training in New York apartments had gotten us used to condensed comforts, so to speak, so it was no great change to the still more compact accommodations of a small cruiser, *provided* she was completely found. Nor did the rather tubby lines of the average power cruiser appeal to me. I wanted something not over 7 feet 6 inches beam on 33 feet L. W. L., so that a 10-horse engine would "snake" her along like a 13-inch shell when under way on a cruise.

I found a model like that among the knockdown frames, and not in the alleged "cruiser" class, either, but among the meek and lowly open launches. The original was a fast open launch, with a number of records already behind her, and measuring 48 inches deep at the bow, 38 inches amidships and 42 inches astern. I proceeded to



do things to her picture in the catalogue. I added on a foot of height to the bow, carried the raised cabin eave line aft to a point where the eye dictated that the pencil should stop, and swept a taffrail curve down from the cabin eave-lines about where I judged the stateroom should end. I then finished the rest of it in three little peek-a-boo launch-cabin windows, put in three portholes along the extension trunk, added a signal mast and a couple of flags, and the creation was ready for the inspection of an admiring public.

Testing the drawing with an architect's rule, I found that one's naked eye is not such a bad amateur designer after all, particularly if it has been accustomed to look at "sassy" yachts and classy canvas racing goods. The dimensions came out: Launch cabin, 7 feet 8 inches; stateroom (second two portholes), 6 feet 6 inches; cockpit, 6 feet; stern deck, 3 feet, leaving about 12 feet for galley, bathroom and chain locker. We couldn't see that we needed over 3 feet of galley (and after events proved us right), but we *did* want plenty of room for the bathroom; so we gave it the remaining porthole and half the skyline and made it 4 feet 3 inches long, leaving 5 feet for the anchor locker and bow timbers. As to height, your eye said that the boat would look landlubbery to a degree if she

had a fraction more than 2 feet from the eave of the extension trunk cabin down to the fender-wale on the sheer strake, and that above this eave a crown of 6 inches could be put on the roof without said eye being offended. You want 6 feet of headroom, including the carlines (if you can get it), and the keel, keelson and frame cross-timbers usually get away with about 6 inches; so, allowing an inch for flooring, you must provide for 6 feet 6 inches from top of roof down to bottom of keel amidships. As the catalogue spoke of 38 inches amidships, it was quite evident that I should have to go out and steal more than 3 feet somewhere. The crown and extension trunk would give me 2 feet 6 inches of it, and, as the boat would inevitably draw at least 3 inches more than her load water-line as an open launch, I bethought me of the simple expedient of making her 6 inches deeper, giving 3 of them to draft and 3 to freeboard.

So I ordered the frame sent, with ribs, stem and stern posts left 6 inches long, for which the company charged me \$3 extra. The entire frame cost \$85.50, and the freight on it from Michigan to New York was \$7.15. Soon after placing the order a roll of plank patterns and a book of directions arrived from the frame company, and I

spent over a week of evenings in cutting out the patterns. I might digress here and explain that this boat was financed entirely on hot air, as we figured that, by paying for everything as we went along, we would own the thing piecemeal before we knew it. And so it turned out; for, while we still owed money on the engine and a few lumber bills, she was practically all paid for when she was launched.

About this time I ran into a beautiful lot of cypress, for which the owner was willing to trade cash to the extent of 7 cents a foot. It took forty dollars' worth of it to plank the boat and raised extension cabin. I believe you can get good cypress for less than this; but, as there wasn't a single knot in the entire shipment, it got my goat and copped the above palatial price. Be that as it may, I now ran into a thirty-hour job, working evenings, in transferring the plank patterns to the planks. I had them all sawed out to shape on a band-saw later in just one and one-half hours, the charge for the job being \$1.15. Moral: Don't *think* of sawing out these planks by hand yourself. No use trying to compete with a band-saw manned by two men and a small boy. It only makes you ridiculous, and makes your spare-time value look cheap.

The frame arrived in three crates, and I set it up, with the help of two enthusiastic friends, in just one Sunday's work. The illustration shows how it looked at the end of the day's work. The frame company certainly made a beautiful job of the work. Every rib was beveled so that a ribband would lie flat and fair anywhere along the body; the heavy framing around the skeg, shaft-log, stem and stern deadwoods, etc., had all been attended to, so that all you had to do was to bolt the big ship-splice together amidships in both keel and keelson, and bolt the stem timber to the keel below and the keelson above. We did all this work with plain  $\frac{3}{8}$ -inch galvanized iron rodding, peined over washers at either end of the bolt and burred down until the washers sank deep into the oak. My next move was to hire two ship carpenters to help me with the planks. I don't think that an amateur can get on the garboard strake without making more or less of a botch of it—certainly not single-handed. But if one has been careful about setting up the main timbers so as to get them on exactly true, and sees to it that the rabbet meets the keel fore and aft in a fair curve, and is, furthermore, willing to cut and try patiently with the garboard strake before nailing anything fast, there is no reason why a success-

ful job cannot be done. Most amateurs are in too much of a hurry. We were a whole day getting on the four planks of the port and starboard garboard strakes, and chalked it up as a good day's work when the thing lay a good, fair calking fit into the rabbets and keel.

The rest of the planks went on easier—about three whole strakes on each side per day. We left off about the eleventh strake and went up to the sheer strake, as I had ordered the ribs 6 inches long, and would, therefore, have to fit at least one of the intervening strakes. As you are sure to gain or lose in putting on the planks, it is always a good plan to do the sheer strake before planking all the way up, so that any discrepancies can be taken up between the two or three strakes left below the sheer. In planking, you need several C-clamps to hold the planks down on the ribs and at least one chain clamp to pull down snug upon the plank already nailed. You also need a breast drill, with machine twist drills, to drill through the cypress plank and the oak rib, three holes to each plank at each rib, into which are driven copper rivets or galvanized cut nails, whichever are preferred. These have then to be set and clinched inside, and about 2,000 of them will be needed in a boat of this size. It means quite a bunch of work,

and if you can't collect a few friends, handy with tools, to pitch in and help, you had better hire a couple of carpenters.

Another long-winded job is calking the seams and puttying them with white-lead paste. There are about a thousand feet of seams, and it will take five bundles of calking cotton and a pail of white lead; also, about three days' work for one man. There is nothing very hard about calking. Take care to bevel your planks so as to leave them open nearly a thirty-second of an inch on the skin side of the ship, give them a light coat of paint to make the cotton stick, and then feed it out of the roll, tacking it to the seam in little inch loops with the calking iron until you have about a yard of it up. Then go over the seam and drive in the cotton about  $\frac{1}{4}$  inch below the skin of the ship. The point is to keep the cotton coming even and not get it bunchy and hard in spots. When the planks swell the inner edges will crush, and she will bite the cotton hard all along the seam. After calking, run over the whole skin of the ship with a short jack-plane, getting a smooth, fair surface all over, and being careful not to leave any tool-marks, as they will show up later through any amount of paint and sandpapering.

All the work on the sheer strake, which is of oak,

must be countersunk and the holes plugged later with the little wooden plugs which you can buy at any ship chandler's. Inside of the ribs opposite the sheer strake runs the clamp, which is also of oak, with bolts passing clear through sheer strake, rib and clamp, being secured with a nut on the inside. Above the sheer strake is smooth sailing again, as two planks each will generally do for the sides of the extension trunk cabin. We spliced on oak extensions to every other rib, to make a frame for the cabin sides, and mortised the tops of them to receive the tenons of the roof carlines.

The next step was to get on the cockpit coaming, and this I ran clear around to the stateroom, using it for the sill of the launch-cabin windows. The deck was a mere footboard, 7 inches wide, and I made the taffrail broad and flat, as, in getting up on deck for'ard, it would be much easier to run on it than on the narrow deck. We first got out the coaming blocks, and nailed them down on to the clamps; then we fitted the oak deck-planks along each side, and, finally, bent the coaming planks, screwing them to the ends of the coaming blocks with two No. 12 2-inch brass screws at each block. As all this work was countersunk and plugged, it took time.

Then we set up the launch-cabin window mul-

lions, and, as the coaming was nowhere perpendicular, each one had to be fitted so as to bring it true and plumb. Roof carlines joined each mullion; a sill was notched and bent to fit along the top of the coaming, and a broad stop put on each mullion outside, and the launch-cabin was ready for windows. All this work was in red oak, which stains with cherry japalac to give a very passable imitation of mahogany. After this I let the two carpenters go, paying them \$50 each for about eleven days' time, and felt that the money was well spent. There is an immense amount of detail work about a boat, and it uses up time to an unholy extent. If you elect to do it all yourself, well and good; any handy man with tools can make a job of it. But—better start your boat in November, if you want to get her over by June. I gained about two months on the job by hiring those men, and they worked with a finish and neatness that I couldn't hope to equal.

Left to myself, I put in a Sunday nailing on the roof ceiling, which was of  $\frac{1}{2}$ -inch yellow pine tongue-and-groove. It took about 100 board-feet, and the following evening we cut out and sewed the roof canvas, which was 10-ounce duck. I tacked it all around the edges of the cabin eaves, stretching it taut and securing with 4-ounce copper tacks.



To get these latter to start nicely without trying on their favorite trick of turning over in the canvas, provide yourself with a small, sharp jab-awl and give the canvas a dig before inserting the tack point. A trim of heavy oak  $1\frac{1}{8}$ -inch half-round beading was next put on all around the cabin eaves, joining the taffrail at the point where it slopes up to the eave line just aft of the state-room. The brads for this work must be galvanized, and should be sunk with a nail set, filled with wood filler and varnished immediately after putting on, or the weather will be sure to make rust stains on the oak. These can be, in part, removed with oxalic acid and sandpaper, but will never wholly disappear. To put on the taffrail took considerable time and patience. It not only had to be sprung down to fit the sweep of the side of the ship up to the cabin eave, but had also to be curved edgewise to follow the lines of the boat. This latter was not easy, as the taffrail was  $2\frac{1}{2}$  inches across; but it finally came into place with strong clamps, and was secured by two brass screws sunk into each rib top and the sunk head covered with a  $\frac{3}{8}$ -inch oak plug.

The first interior job was to locate the height of the cockpit floor. This should come at least 3 inches above the waterline to make the cockpit

self-bailing, and this latter is well worth while, since otherwise you are in for a bailing job after every storm, and may get the carpets soaked and flooring warped in some nor'easter, when it rains steadily for three or four days. Again, if you do not get the cockpit floor too high, you can dispense with the hatch over the cabin companion, always a source of weakness in the roof, and, withal, expensive. In the *Go-Sum* I located the cockpit timbers, so as to bring the floor 3 inches above the waterline, and laid down a floor of narrow strips of  $\frac{7}{8}$ -inch cypress sawed up out of the waste from the boat planks. The ends of this floor rested on the main oak transom sill, which was made by spiking together three oak timbers sawed out of the waste of the sheer strakes, coaming and deck. The innermost and highest of these formed a stop to the door, and also gave something to which the after-cabin panels could be nailed. The middle piece was the sill proper, and the outer piece formed the ledge on which to nail the ends of the cockpit flooring. It was so placed as to bring the sill 2 inches above the cockpit floor, not only to keep out water, but also to allow the doors to swing free above the cockpit floor. In getting out the panels for after-cabin, stateroom and galley partitions, I made up a design, as

shown, and sent it to a sash-and-door mill for a price in red oak. They returned a quotation of \$32 for the set, but it seemed to be exorbitant (it really was very reasonable), so I ordered the lumber and set to work to make them myself. It was a long, exhausting job, and many of the fits were not as neat as I should have liked. All the frames were doweled together and the panels nailed to the back with brads. This brought two sunk panels looking into the stateroom and two raised panels with chamfered edges looking into the launch-cabin. They did not look at all badly, finished in cherry japalac; but the mill job would have been all insert panels and strong, neat work, mortised and tenoned by machinery. Doing it again, I should certainly have the mill make them and simply fit the panels into the boat, as the lumber alone cost me about \$19. However, after many long evenings of work, often not quitting until twelve or one o'clock, I got them all made and in.

The next job was the berths. How to get comfortable and cheap sleeping accommodations, good for all the year round, if need be, caused considerable cogitation and investigation. I loathed the regulation pipe-berth, and all forms of "davenport" and folding-bed schemes, sold or adver-

tised, had the fatal defect of being square-cornered, while anything that goes in a boat will be lucky if it owns one single right angle in *any* of its four corners. The easiest solution seemed to be a simple 3-inch by 4-inch yellow pine rail, doweled into the panels on both sides of the stateroom and launch-cabin, inside of which could be stretched a suitable canvas bottom tacked to framing strips nailed to the skin of the ship and to the panels fore and aft. Inspection and measurement of this scheme showed a width of 30 inches available at the after end of the stateroom and 22 inches at for'ard end of same. The ordinary steamer berth is but 28 inches wide, and, in point of fact, it is quite wide enough for any one. In the launch-cabin there was 28 inches available for'ard, allowing a foot of gangway around the engine, and 24 inches aft—a little narrow, but not at all uncomfortable, as later events proved. So the stateroom berths were put in with 10-ounce duck and 20-ounce galvanized tacks. A trim of some of the left-over taffrail moulding was nailed on along the berth rail and a 30-inch mattress fitted in very nicely, thickening it up at the for'ard end, where one persuaded it into 22 inches of room with sundry vigorous punches in the side. These made very comfortable berths, and were made up

like a bed at home, with sheets, blankets and white bed-spreads and pillows. A 7-foot runner rug in the stateroom, extending out into the launch-cabin as far as the engine, made a cosy room of it, with the help of four green silk porthole curtains on brass rods and a set of brass-handled drawers under each berth. These drawers were 18 inches wide and 15 inches deep, four to each berth, and held all one's wardrobe.

The launch-cabin cushions were bought after no little examination of available styles. They were 7 feet 6 inches long by 28 inches wide, and cost \$4 each in plain green denim, with the usual button upholstery, or \$7 each in green velveteen. We chose the former, as it could come to no possible harm by getting wet; for I foresaw the times when that boat would be left in the offing with her cabin windows open, the crew ashore, and a thunder-squall coming up to soak everything.

For the launch-cabin floor we chose a hard green buckram and hemmed it with green tape, as we expected to take it up frequently and wash it clean of engine grease, mud, water-stains, etc., and subsequent experience proved it a good idea. We finished the interior of the launch-cabin in cherry japalac and varnish, with an oak cove beading trim let in around all panels and in the

doors under the launch-cabin berths. Two brass yacht lamps in swinging gimbals, with smoke bells overhead, went on the two for'ard panels of the launch-cabin, and the ship's clock and compass-box went on the after-panels. A tiny glass panelet into the port after-panel allowed one to see the compass inside, either by day or night. It beat the small binnacle scheme out of sight.

As I stated somewhere earlier in this chapter, we did not see that over 3 feet of length of the boat needed to be devoted to the galley. We paneled in all one side of this space from the stateroom to the bathroom partitions, to form a large, full-length clothes locker on the port side of the galley. It contained a dozen clothes hooks, which would hold oil-skins and overcoats, to say nothing of such long duffle as brooms, guns, fish-poles and fog horns. The starboard side was the galley proper. At a height of 32 inches I put a horizontal length of  $\frac{7}{8}$ -inch by 6-inch oak on edge and paneled in below it to make a cupboard for staple groceries. Between this board and the skin of the ship went a small iron sink with a rubber stopper, costing \$2.10, and a small baby refrigerator, painted to imitate oak, and costing \$2.75. It was 16 inches long by 12 high and 12 deep, and held a 5-cent cake of ice in one end in a tank that

connected with a little nickel-plated faucet. There was also a movable shelf in the outer compartment, and the amount of meat, eggs, butter and general perishables that little refrigerator would hold was astonishing. All the ship's tea cups hung from hooks on the carlines of the roof, and the plates went in racks behind the ice box. Frying-pans, pots, skillets, etc., went on hooks fore and aft in the galley. We had the finest breakfasts and suppers ever eaten, from that little galley.

The bathroom was finished in white enamel throughout, with a gorgeous display of nickel-plated bathroom fittings. It was always breezy and glorious in the early mornings, as we had generously given it two portholes and the for'ard skylight hatch in its 4 feet 3 inches of length. Its door had a remarkable invention, which consisted of a pier-glass mirror looking into the galley. One could thus dress in the stateroom not 3 feet away from this mirror and observe the habiliments of fashion and the mold of form to one's heart's content. In the bathroom went the smallest enamel corner basin manufactured. It is 13 inches on a side, has a single nickel faucet connecting to the fresh-water tank, and cost \$7. The toilet, of standard yacht pump type with oak seat, cost \$30 complete, installed by a yacht plumber.

This completed the interior furnishings of *Go-Sum*. Her portholes were plain brass, 5 inches, costing \$2 apiece. I put on a 4-inch by 17-foot signal mast, both for looks and for the sake of having a spar to bend a sail to in an emergency. I also made an awning rail of ½-inch galvanized iron pipe running on 16-inch stanchions a foot inside the eaves of the extension trunk cabin. A stout spar from the mast each way to the ends of this rail gave a ridge over which the awning could be drawn taut by lashings through grommets on the hem and passing around the awning rail. It kept both stateroom and launch-cabin cool on the warmest days, as it kept off the sun and gave a foot of shade between the deck and the awning.

The engine was an 11-horsepower, 4¼ inches x 4¼ inches 800 R. P. M., Ferro 2 cycle, and it gave her about 9 knots speed. She went from Sailor's Snug Harbor, Staten Island, to the yacht anchorage off West Ninety-fourth Street, New York, in 1¾ hours' actual timing. It was a mighty nice engine, with an exceedingly fool-proof oil system, and it took *Go-Sum* up to Albany and back and out to Boston by the outside route without any trouble, to say nothing of the innumerable cruises around New York waters.

Over the engine went the oak living room and



dining table of the yacht. It had 1/2-inch round iron legs that went down 4 inches into holes in the oak engine-bed timbers, so that the table could be picked off in case it was necessary to get at the engine and take her apart (which I have never had to do yet, glory be!). Under the table I screwed the ignition equipment complete, batteries and spark coils—a handy place. I only used one engine control—that of the carburetor. A handle for it ran along under the table and came out at the after-end, where it was within easy reach from the cockpit. The timer handle you adjust when first getting under way. The fewer mechanical links you have about a boat the more fun you will have, and the less things will go wrong.

As to fittings, nothing but polished brass running lights, whistle-pump, steering wheel, fog bell, flag sockets and chocks would do for us. I won't say how much time we put in throughout the summer in polishing these infernal things, but will say that we bought the whole outfit at a motor-boat supply house for less than \$30. At the end of the season the only things left that could in any way be called polished were the running lights.

This about winds up the yarn of the *Go-Sum's* building, except the painting and launching. As

to the former, it took a tub of white lead and two cans of "yacht white," which is a quick-drying dead white paint, very like copper bottom paint in its action. Stir and thicken in another can as you use it, to get the best results. To get the boat from the back yard down to the shore cost \$12 for the hire of a truck and riggers, and they ran her into the briny on rollers under the same cradle that I built under her after the planking was all done, calking in and seams puttied. If any crowd of young fellows wants a "double-X" little summer resort to solve the eternal summer problem, just build a *Go-Sum*. If you start in February or March, hire carpenters for the heaviest work and do all the rest of the interior and outside work yourselves. Working evenings and Sundays, you'll have her overboard by June 1, and you'll then have all summer to enjoy her in.

DETAILED LIST OF CONSTRUCTION EXPENSES OF "GO-SUM"

Frame .....	\$85.00	Launch cabin cushions .....	\$8.00
Planks .....	51.00	Running lights, polished brass.....	12.00
Interior woodwork...	35.00	Brass gear chocks, etc.	14.00
Paint .....	8.00	Life preservers.....	3.00
Gasoline tank (60 gals.) .....	14.00	Anchor and rope.....	6.00
Yacht toilet.....	30.00	Awning and rail.....	6.00
Basin and sink.....	7.00	Signal mast.....	8.00
Ice box.....	3.00	Rudder, 1/8-in. boiler plate .....	4.00
Portholes .....	12.00		
Mattresses .....	9.00		

## BUILDING A CRUISER 851

Dinghy .....	\$5.00	Galley floor and locker	\$3.00
L. C. curtains, etc..	4.00	L. C. lamps.....	4.00
L. C. windows.....	7.00	Bilge pump and boat-	
Skylight .....	3.00	hook .....	5.00
Eight stateroom		11-H. P. engine com-	
drawers .....	4.00	plete with screw,	
Miscellaneous brass		shaft, etc.....	207.00
hardware .....	6.00	Paid carpenter labor	
Miscellaneous galvan-		and construction	
ized hardware.....	11.00	hardware .....	124.00
Stateroom carpets....	7.00		<hr style="width: 50px; margin-left: auto; margin-right: 0;"/>
Galley stove.....	2.00	Total cost.....	\$707.00

**THE END**





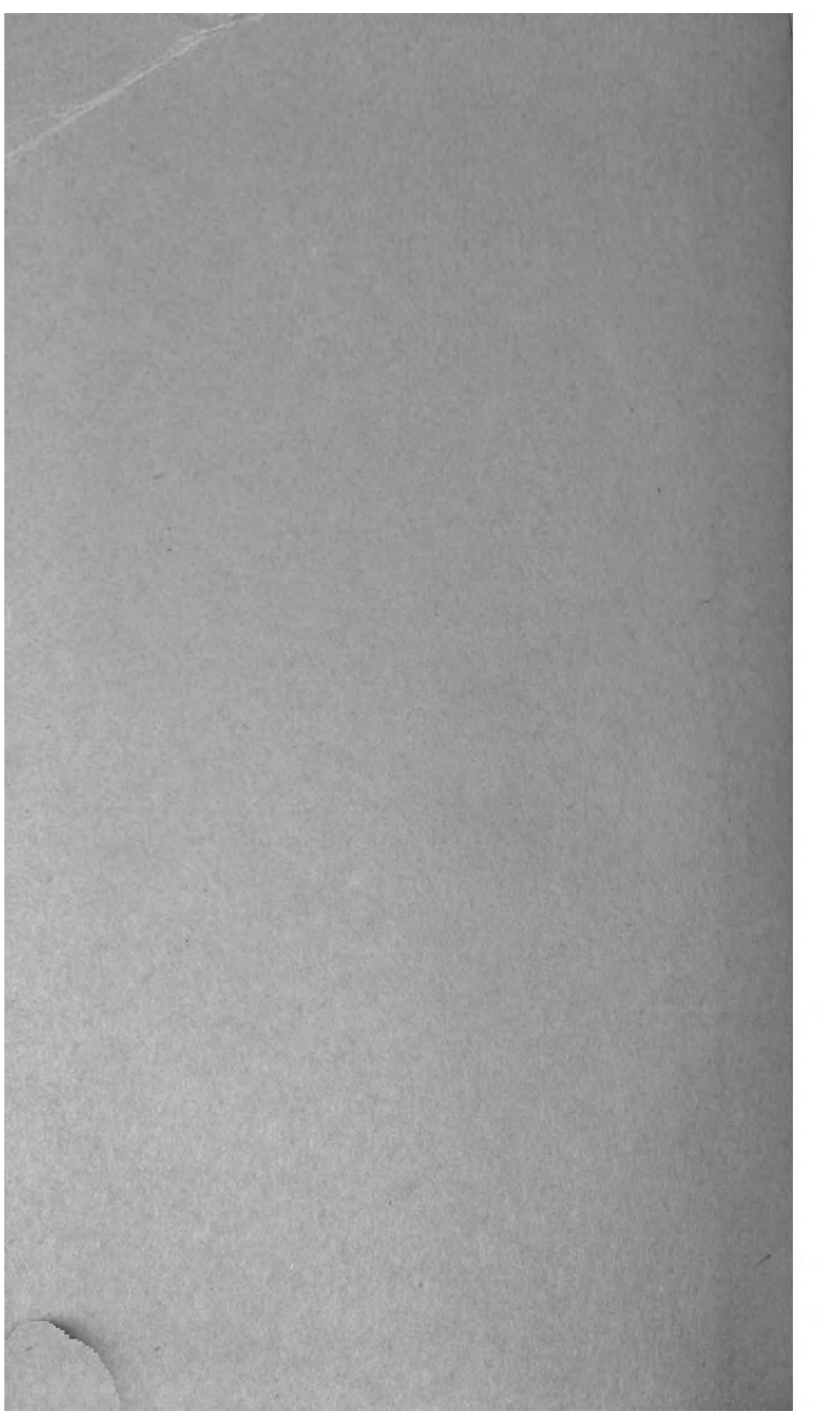

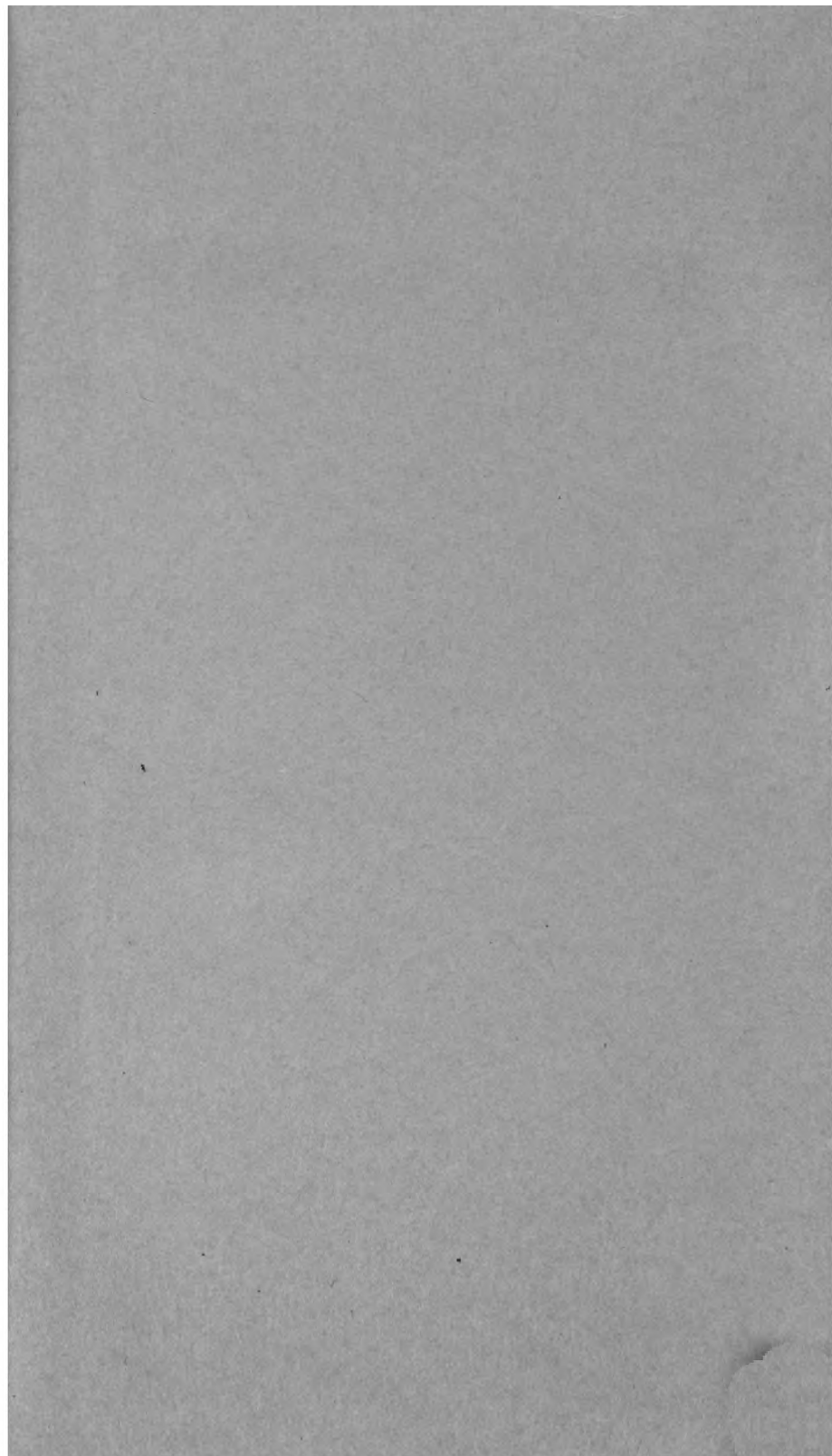

UNIVERSITY OF MICHIGAN



3 9015 00460 0055





BOUND

MAY 6 1949

UNIV. OF MICH.  
LIBRARY

