

Belmont W. Jones

A MANUAL

from Francis P. Magoun
OF

YACHT AND BOAT SAILING.

THIRD EDITION, REVISED AND ENLARGED.

BY

DIXON KEMP.

A.I.N.A.,

AUTHOR OF "YACHT DESIGNING."

LONDON :

HORACE COX,

"THE FIELD" OFFICE, 346, STRAND, W.C.

—
1882.

Eng 5128.82
✓ -

HARVARD COLLEGE LIBRARY
FROM THE LIBRARY OF
FRANCIS PEABODY MAGOUN
THE GIFT OF HIS SON
MAY 8, 1929

B

LONDON :
PRINTED BY HORACE COX, 346, STRAND, W.C.

PREFACE.

THE favour accorded to the First Edition of "Yacht and Boat Sailing" in 1878 and the Second Edition in 1880 leads me to hope that the present Edition will prove equally acceptable.

The chapters on Displacement, Buoyancy, Stability, Lateral Resistance, Centre of Effort of Sails, and other kindred subjects have been omitted from this edition, and will appear in another work. The space, however, occupied by these subjects has been more than filled up by other matter, and the volume is in consequence larger than either of the previous editions.

Among the most notable additions to the book are those of American centre-board yachts and boats, the new-fashioned Itchen yacht, three-tonners, Catamarans or double boats, and many new types of British boats. The lines of the American sloop Parole and Sneak Box, were presented to me by Mr. W. P. Stevens, of Staten Island, New York.

Mr W. Baden Powell has revised and added to the article on "Nautilus Canoes," and Mr. E. B. Tredwen has done the same by the "Pearl Canoes." Mr. W. P. Stevens, of Staten Island, New York, supplied me with an article and drawings on American canoes, and this branch of the subject is now as complete as possible at the present date.

I have introduced a chapter on Steam Yachting as a guide to those who desire to enter into that branch of the pastime, and if it is less attractive than sailing, it still must be considered a branch of "Yachting."

The whole of the chapters on the "Equipment of a Yacht," "Seamanship," "General Management of a Yacht, embracing the Duties

of Seamen and Laws affecting them," "Yacht Racing," and in short every chapter in the book has been thoroughly revised and in many instances largely added to and illustrated. The Appendix of General Information has also been thoroughly revised and greatly added to, so that now it really forms a work by itself.

I must again acknowledge my indebtedness to Mr. G. L. Watson, of Glasgow, who wrote the chapter on Clyde Lugsail Boats; to Mr. C. P. Clayton, of Hythe, Hants, who gave me much information concerning the New Brighton Boats; to Mr. G. King, who wrote the article on Clyde Canoes; and to Mr. J. Beavor Webb, who compiled the table for blocks and rigging for cutters, to which I have now added tables for schooners.

DIXON KEMP.

104, PALACE GARDENS TERRACE,
KENSINGTON, LONDON, W.,
June 1, 1882.

CONTENTS.

PREFACE	<i>page</i>	iii
	CHAPTER I.	
Selecting a Yacht		1
	CHAPTER II.	
Examination of the Yacht		11
	CHAPTER III.	
Building a Yacht		19
	CHAPTER IV.	
The Equipment of the Yacht		26
	CHAPTER V.	
Seamanship		65
	CHAPTER VI.	
The General Management of a Yacht		118
	CHAPTER VII.	
Yacht Racing		131
	CHAPTER VIII.	
Centre-board Boats		173
	CHAPTER IX.	
Sails for Centre-board Boats		197
	CHAPTER X.	
Brighton Beach Boats		228
	CHAPTER XI.	
Centre-board Sloops		233
	CHAPTER XII.	
The Pollywog		238

	CHAPTER XIII.	
Lough Erne Yachts		page 244
	CHAPTER XIV.	
Una Boats		246
	CHAPTER XV.	
The American Centre-board Sloop Parole		252
	CHAPTER XVI.	
The Sharpie and Sneak Boat		254
	CHAPTER XVII.	
New Brighton Sailing Boats		259
	CHAPTER XVIII.	
Lake Windermere Yachts		272
	CHAPTER XIX.	
Yachts of the Norfolk Broads		282
	CHAPTER XX.	
Itchen Boats		285
	CHAPTER XXI.	
Clyde Sailing Boats		299
	CHAPTER XXII.	
Kingstown Boats		310
	CHAPTER XXIII.	
Yachts of Three, Five, and Ten Tons		313
	CHAPTER XXIV.	
Penzance Luggers, Coble, Galway Hooker and Pookhaun, Norwegian Pilot Boat, &c.		326
	CHAPTER XXV.	
The Jullanar		340
	CHAPTER XXVI.	
Double Boats		348
	CHAPTER XXVII.	
Steam Yachting		356

Contents.

vii

	CHAPTER XXVIII.	
Ice Yachting		page 363
	CHAPTER XXIX.	
Canoeing		374
	CHAPTER XXX.	
Amateur Canoe Building		482
	APPENDIX.	
Dictionary of General Information		489
<hr/>		
Index		609

LIST OF PLATES.

	TO FACE PAGE
I. SPAR, RIGGING, AND SAIL PLAN	27
II. 17FT. CENTRE-BOARD BOAT FOR ROWING AND SAILING.....	183
III. CENTRE-BOARD BOATS FOR ROWING AND SAILING	190
IV. 20FT. CENTRE BOARD BOAT	195
V. SAIL PLAN FOR A 17FT. BOAT.....	204
VI. "LE LISON," FRENCH CENTRE-BOARD BOAT	206
VII. CHINESE LUG SAIL—MAIN AND MIZEN	210
VIII. "THE CHAEM"	215
IX. GUNTER SPEIT RIG	221
X. BRIGHTON BEACH BOATS	230
XI. "ALERT," CENTRE-BOARD YACHT	236
XII. THE SLOOP "POLLYWOG"	238
XIII. "THE WITCH," CENTRE-BOARD CUTTER	245
XIV. "UNA" BOATS	250
XV. THE AMERICAN CENTRE-BOARD BOAT "PAROLE"	252
XVI. SAIL PLAN OF "PAROLE"	253
XVII. "ELAINE," NEW BRIGHTON BOAT	261
XVIII. SAIL PLAN OF "THE ELAINE"	265
XIX. "THE JABBERWOCK"	267
XX. LAKE WINDERMERE YACHT	278
XXI. WINDERMERE YACHTS	279
XXII. SAIL PLAN OF WINDERMERE YACHT	280
XXIII. THE NORFOLK "ARROW"	283
XXIV. SAIL PLAN OF THE NORFOLK "ARROW"	284
XXV. ITCHEN BOATS, 30FT. 4IN. AND 27FT.	289
XXVI. ITCHEN BOAT "WILD ROSE"	290
XXVII. ITCHEN BOAT "CENTIPEDE"	291
XXVIII. ITCHEN YACHT, 1882	293
XXIX. ITCHEN BOAT, SAIL PLAN	295
XXX. THE ITCHEN PUNT	298
XXXI. SAIL PLAN OF A CLYDE BOAT.....	302

	TO FACE PAGE
XXXII. CLYDE SAILING BOAT.—GENERAL PLAN	307
XXXIII. KINGSTOWN BOAT, "THE HEATHEN CHINEE"	310
XXXIV. DESIGN FOR A YACHT OF 3 TONS	316
XXXV. SAIL PLAN, YACHT OF 3 TONS.....	317
XXXVI. CUTTER YACHT OF 5 OR 10 TONS	320
XXXVII. "LOBBELEI," 5 TONS YACHT	321
XXXVIII. "FREDA," 5 TONS YACHT	321
XXXIX. THE "COCKER"	322
XL. PENZANCE LUGGER.....	329
XLI. GALWAY HOOKER	334
XLII. GALWAY POOKHAUN	334
XLIII. SHIP'S BOAT FOR ROWING OR SAILING	335
XLIV. BUENOS AYRES WHALE BOATS "BALLENERA"	339
XLV. "JULLANAE" YAWL.....	347
XLVI. THE CATAMARAN "JOHN GILPIN"	354
XLVII. "NAUTILUS" PADDLEABLE-SAILING CANOE.....	381
XLVIII. NAUTILUS RACING CANOE.....	394
XLIX. "NAUTILUS" PADDLEABLE SAILING CANOE, 1881	396
L. NAUTILUS CRUISING CANOES	400
LI. SAIL PLAN, "NAUTILUS" PADDLEABLE-SAILING CANOE.....	412
LII. SAIL PLAN, "NAUTILUS" TRAVELLING CANOE, 1880	418
LIII. NAUTILUS RIGGING PLAN	419
LIV. CRUISING CANOE ON THE MODEL OF "PEARL," No. 3.....	425
LV. PEARL, No. 5, SAILING CANOE	426
LVI. PEARL CANOE, 1882	428
LVII. CLYDE CANOE "WREN"	457
LVIII. SAIL PLAN OF THE CLYDE CANOE "WREN"	460
LIX. MERSEY SAILING CANOE	469
LX. AMERICAN CANOE "JERSEY BLUE".....	476
LXI. AMERICAN RIVER CANOE, 1882	478
LXII. AMERICAN CANOE SAILS	478
LXIII. AMATEUR CANOE BUILDING	483
LXIV. CORACLE LIFE BOAT	521
LXV. ICE BOAT OF THE SEA OF AZOV	541

YACHT AND BOAT SAILING.

CHAPTER I.

SELECTING A YACHT.

IN selecting a yacht, a man, as in making other purchases, will be guided by his tastes and his means. If he is really fond of the sea, and looks forward to the sailing with the professional keenness of a middy or apprentice, his desire will be to obtain a yacht which he can manage himself. If, on the other hand, the dawning yachtsman has boundless wealth, is a little of a sybarite, and determines to spend two or three months afloat because it is the fashion, he, too, will get a yacht to his taste; but she will probably be a big stately schooner, or an equally big, but little less stately-looking yawl, as large cutters are no longer fashionable for cruising.

The man who desires to eventually become a thorough yacht sailor should begin his apprenticeship on board a cutter, which should not be larger than 5, 10, 15, or 20 tons. If she is as big as 10 tons, he should make all the passages in her when shifting ports, and not bid farewell to her at one pier head, and welcome her arrival from another pier head at the next watering place on the coast. If a man goes about attended by the uncomfortable feeling that he shirks all the real daring and adventure of yacht cruising he is not likely to make a perfect yacht sailor; as sailing in ten or twenty matches during a summer, and sleeping in a snug berth in smooth water for a couple of months or so, are of little value compared with the under-way drill inseparable from making passages, it being understood, of course, that the owner does his "trick at the wheel." But it is not only the ten-ton ship that is big enough to convey the manly form of the youthful yachtsman from port to port; many owners of 5-tonners as bold as Will Watch, "take the helm and to sea boldly steer"; and these are the ones we always find to be the best sailor-men,

even though they do not win so many prizes. Of course, living in a 5-tonner to the majority of yachtsmen would be utter misery, and perhaps death. The budding yachtsman has been in the habit, perhaps, of spending a couple of hours every morning over his toilet, surrounded by all the luxuries of the upholsterer's art—velvet-pile carpet, satin damask, cheval glasses, watercolour drawings, Dresden china—and perhaps a valet-de-chambre. The man that has been used to this sort of thing must have the big schooner or yawl, for he will find no room for them inside a 5-tonner. The five-tons man must carry his clothes in a bag, or cram them into a locker 2ft. by 6in.; go on his marrowbones to shave; into the sea for his bath—it is only one step and overboard;—and if he is addicted to cosmétique, he will probably find a piece of “common yellow” a good substitute. The cuisine, of course, would not be such as would raise water bubbles in the mouth of a valetudinarian; the carnivorous propensity will mostly be gratified by steak which, when cut, will resemble the Mudhook Yacht Club burgee of *rouge et noir*; and savoury soups and luscious salmon will be luxuries only obtainable in “canister” form. With all this, the five-tons man will very rapidly become a sailor, and the little ship below will be as neat and cosy as a woman's boudoir; he will have a place for everything, down to a housewife; and at the end of one summer there will not be a part of the ship, from the breast-hook forward to the transom-frame aft, that he will not know the use of.

Of course, for real comfort at sea, the bigger the yacht a man can afford to have the better; but it will seldom be advisable to go beyond 300 tons, as very large sailing vessels are more or less, according to size, unhandy in narrow channels and crowded roadsteads. A yacht of 150 tons and upwards should be schooner-rigged; and we are inclined to think, if her size reaches 300 tons, or say 120ft. in length on the load water-line, that she should have three masts, with all fore-and-aft canvas. “Square rig forward” is generally recommended for a three-masted vessel, as square topsails may be of occasional use in backing and box-hauling, or in scudding in a heavy sea, when small try sails set on the lower masts might get becalmed whilst the vessel dropped between the crests of two seas; but the extra weight aloft, and the extra gear, are to some extent a set-off against these advantages.

A yacht from 150 to 80 tons downwards can also be schooner-rigged, but many yachtsmen prefer the yawl rig for these and intermediate tonnages. The yawl will be the more weatherly craft, will reach as fast, and be faster down the wind. The actual weight of spars will be less for the sail area; there will be less gear; and there will be no mainmast obtruding in the main cabin, or in one of the berths abaft it. It is

undeniable, however, that in heavy weather the schooner, appropriately canvased, is a very easy and handy vessel. In a "fresh gale" (see "Winds" in the Appendix) she would be under main trysail, reefed fore staysail and fourth jib (foresail stowed); a yawl under similar conditions would have main trysail, or double-reefed mainsail, reefed foresail, and fourth jib, with mizen stowed, and would be quite as handy, and would perhaps lie-to a little more quietly. As there will be no difference in the number of men required to work either rig, size for size, we are on the whole inclined to think that the yawl rig is to be preferred for yachts under 150 tons.

But the yawl for comfort must be the real thing, and not merely a big cutter with a long counter, and a mizen mast stepped over the archboard for the sake of "tonnage allowance for rig." This latter class of yawl has really a greater weight of spars in proportion to sail area than a cutter. The main boom is, in a yacht say of 100 tons, within 10ft. or 11ft. as long as the main boom of cutters of equal tonnage; the mast is as long, the bowsprit is nearly as long, the topmast is as long, the gaff is generally longer in proportion to length of boom; and the weight of the mizen-mast, bumpkin, yard, boom, and rigging is generally about ten times the weight of the extra length and extra size of the cutter's boom. These are not the yawls that have an advantage over even large cutters for comfort; and the mizen mast is often stepped in such an insecure manner that it is not safe to put any sail on it in a real blow, when it might, according to the notions of the sailing master, save the crew some trouble to get under way with mizen and head sail alone instead of with trysail. Now, the modern *racing* yawl has so little advantage in snugness over a cutter of equal size, that our advice always would be, for racing—to enjoy the sport with an equal amount of comfort—have a cutter up to 120 tons, and above that tonnage a schooner—say one of 140 tons.

But the cruising yawl proper is a very snug vessel indeed, and has nearly all the good qualities of a cutter, and is really a more comfortable craft, and can be worked with fewer hands, which of course means with less cost. Her mizen mast will be stepped nearly close abaft the rudder head, instead of at the extreme end of the counter; her bowsprit will be shorter and lighter than the bowsprit of a similarly sized cutter (see page 4); her mast will be lighter than a cutter's; and so will her boom, gaff, and topmast be lighter. Her mizen mast will be so stepped that it will be safe in the most violent wind storm to put sail upon it; and this may be often of real advantage in clearing out from an anchorage in a hurry.

The advantage of the yawl mainly depends upon the reduction of weight of spars and gear, apart from the assumed advantage of having the sails more subdivided than they are in a cutter.

We have calculated what the difference in the cubical contents of the spars of the *Kriemhilda* (106 tons) would be if she were changed from cutter to yawl, her length of mainmast remaining the same. Difference in mast, 20 cubic feet; difference in bowsprit (3ft. shorter), 12 cubic feet; difference in main boom (12ft. shorter), 25 cubic feet; difference in main gaff, 4 cubic feet—making a total difference of 61 cubic feet, or one ton weight. The topmast would remain about the same. The bulk and weight of mizen spars would be as nearly as possible as follows: mast, 16 cubic feet; boom, 4 cubic feet; yard, 3 cubic feet; boomkin, 2 cubic feet; or a total of 25 cubic feet, making a net reduction of about 12cwt. The difference in the weight of rigging and blocks would be from 4cwt. to 5cwt., making a total reduction in the weight of spars and rigging of about 17cwt. The removal of this weight would bring about nearly 2in. difference in the vertical position of the centre of gravity of the yacht, and would be equal, so far as influencing her stiffness went, to the taking of 2 tons of lead from the top tier of ballast inside and putting it under the keel outside. The effect of the reduced spars on the momentum acquired during pitching will be mainly governed by the reduction made in the bowsprit; that is, by the influence that reduction has on the longitudinal radius of gyration. To reduce the momentum to its utmost limit, the bowsprit should be reefed close in, and mizen mast unstepped and stowed amidships.

To what extent the bowsprit of a yawl is reduced in comparison to a cutter's may be gathered from the following "facts." The yawl *Florinda*, 138 tons, has a 36ft. bowsprit outboard; the yawl *Corisande*, 153 tons, has 36ft. bowsprit outboard; the cutter *Oimara*, 162 tons, has a 47ft. bowsprit outboard; the cutter *Kriemhilda*, 106 tons, 36ft.; the cutter *Vol-au-vent*, 104 tons, 34ft.; the cutter *Formosa*, 102 tons, 34ft. It is thus apparent that a yawl has nearly 20 per cent. less bowsprit than a cutter. With regard to the length of main boom, we can state that *Florinda* would have 15ft. more boom as a cutter, and, although with that extension her calculated centre of effort would (minus the mizen) be shifted 1.6ft. farther forward, yet would she require a bigger jib when sailing by the wind. To turn *Vol-au-Vent*, *Kriemhilda*, or *Formosa* into yawls under the existing Y.R.A. rule, 11ft. of the main boom of each would have to be cut off, and then, in spite of the presence of a mizen, 3ft. or 4ft. of the bowsprit would have to follow. As a proof of this it can be mentioned that eight or nine years ago, the *Hirondelle* was converted to a yawl, but her bowsprit was not reduced, and it was found necessary to sail her with it reefed in to the first or second fid, and even then she was by no means troubled with weather helm.

It will be gathered that the advantages of a yawl are mainly dependent on the general weight of her spars and rigging being less than are the weight of the spars and rigging of a similarly sized cutter. Taking a cutter and merely reducing her boom in length, whilst all her other spars and her rigging and blocks remain unaltered, and encumbering her with a mizen, would be no advantage at all, either for racing or cruising; in fact, the mizen would far exceed in weight the trifling reduction that had been made in the main boom; hence many "converted cutters" are failures as yawls. Neither has a racing yawl, as frequently sparrred up to the present Y.R.A. main-boom regulation, any advantage in point of weight of spars and rigging over the weight of spars and rigging of a similarly sized cutter—there are exceptions of course—and it could not be expected that such a yawl would obtain any advantage, even with rig allowance, in competitive sailing, so far as sailing by the wind goes. Down the wind and along the wind the inferiority is less patent, and occasionally a heavily sparrred yawl, with her rig allowance, will beat the cutter.

Allowing—as there is not the least doubt about the matter—that a judiciously sparrred racing or cruising yawl has less weight of spars than a cutter of similar tonnage, we come to the consideration of the usefulness of the mizen sail. About this matter opinions widely differ. For sailing to windward, most sailors will agree that the mizen sail is not worth its attendant weight of spars and rigging; but as to the extent it affects the handiness of the craft there will be no such agreement. In 1875 the *Oimara* was converted to a yawl for her winter cruise to the Mediterranean; but, before she was clear of the Clyde, the mizen went by the board. She proceeded without a mizen, and with her yawl boom sailed all over the Mediterranean, and for two seasons, in a similar guise, cruised in British waters. Her sailing master informed us that he never felt the want of the mizen in any weather that he encountered; and this is conceivable when we consider that generally, in heavy weather, the first sail to stow on board a yawl is the mizen. This brings us to consider whether, after all, the advantages of the yawl are not entirely dependent upon her resemblance to a very reduced cutter, with short boom and bowsprit; and whether the advantages would not be increased by the absence of the mizen altogether? The fact that the mizen can be stowed in bad weather, to avoid reefing the mainsail, is hardly an argument in favour of having one; and, as what may be termed its active advantages in affecting the handiness of a vessel are not of much importance, we think that the "reduced cutter," as before hinted, has all the advantages of a yawl without the incumbrance of a mizen. Of course, a cutter with her main boom inside her taffrail is not a very sightly craft; but with the boom-end plumb with the taffrail, and

bowsprit proportionately shortened, the beauty of the cutter rig would not be outraged, and the general weight of spars, rigging, and blocks could be very much less than the weight of spars of a yawl with similar sail area. However, in a fashionable cutter, where the tonnage approaches 100 tons, the main boom becomes a very awkward stick to handle, and for cruising there is not the smallest doubt that a yawl of 80 or 100 tons with a main boom plumb with the rudder head is a much more comfortable craft to work than a cutter of similar tonnage. We have evidence of the objection taken to long booms in the case of the large pilot vessels and fishing vessels, as whilst they are invariably cutter-rigged up to about 80 tons, we find that the schooner rig is preferred above that tonnage.

A modification of the ketch rig is much in use by coasters, and we have often heard it recommended as superior to the yawl rig; but with this we do not agree, as, owing to the narrowness of the mainsail, there is no rig which, area for area, yields such a heeling moment as does the ketch rig. The final conclusion which we arrive at is that, for the yawl to possess any advantages over a snug cutter, she must be very judiciously sparred, and it should be always recollected that the mere fact of carrying a mizen does not make a comfortable sea boat. The yawl's mast can be a trifle less in diameter than a cutter's (we are assuming that the sail area is to be nearly equal), the bowsprit can be very much less, the boom can be very much less, and so can the gaff; the standing and running rigging can be lighter, and so can be the blocks; but great care should be taken that the spars and rigging of the mizen do not exceed the total reduction that has been made in the weight of the main spars and rigging. The weight of mizenmast and rigging on the counter will not, it is true, punish a vessel like a heavy bowsprit outside the stem; but it must be remembered that almost the sole advantage of a yawl, so far as behaviour in a sea goes, depends upon her total weight of spars being less than would be the total weight of spars of a cutter with a similar sail area. The supposed requirements of a racing yawl are incompatible with the advantages generally claimed for the rig; it is, however some satisfaction to know that the yawls which have hitherto been most successful are those which have been sparred and rigged with an intelligent appreciation of the conditions upon which those advantages depend. Apart from behaviour in a sea, the principal advantage of the yawl rig is that, even if her spars as a whole be equal in weight to those of a cutter of similar size, she can be handled with a smaller crew; but this advantage will not be very apparent until 70 or 80 tons are reached.

A snug cutter of 80 tons can be as easily handled and as cheaply worked (six A.B.'s would be required for either) as a yawl of 80 tons, and a

cutter should be preferred on account of her grand sailing qualities. The line is drawn at 80 tons for this reason: a gig's crew must be had out of either yawl or cutter, and if four hands be taken away in the gig, two will be left on board to work the yacht with captain and mate; and even a 60-tonner cannot very well do with less than six A.B.'s for the reason just given. But, whereas six men may work an 80-tonner, whether cutter or yawl, six would be hardly enough for a 100-ton cutter, although they might be quite equal to a yawl of that tonnage; and moreover, if there was anything like a breeze, and four men had to leave the cutter in the gig, it would be hardly prudent to leave the sailing master and mate with two men only on board.

Of all the rigs which the ingenuity of man has devised, not one is equal to the cutter, whether for clawing to windward, reaching along the wind, or running down wind. A cutter with a true wind will beat as far to windward in a day as a yawl will in a day and a quarter; will walk off with a light air when the medley-rigged craft is as good as brought up; and in a breeze under topsail is even more comfortable and easy than the yawl. But the cutter must be snug; there must be no aping the racing cutter, and all the spars must be pretty nearly reduced to the dimensions of the yawl: that is, the boom end must about plumb the taffrail; the bowsprit—say for a 100-tonner—must only be about eighteen inches longer than the yawl's; the mast must only be a little heavier; the topmast must be no longer; and the gaff must be in due proportion to the boom. A common argument in favour of yawls as against cutters is this: a racing cutter of 80 tons is said to be an expensive vessel to work, is an awkward vessel to tackle in a sea, and is wet and uncomfortable, therefore do not have a cutter. But, on the other hand, if you wish to do a little racing without sacrificing comfort or incurring expense you are disinclined to, have a yawl of 80 tons; the allowance for rig will put the vessel on an equality with the cutter, and she will win plenty of prizes; this means that, in the yawl rig a really comfortable cruiser can be had combined with qualities good enough for racing successfully.

There is possibly a very great delusion about this. A yawl to be a successful racer must be ballasted and canvased pretty much as a cutter of equal size, and the expense of racing such a yawl will differ very little from that of racing a cutter; probably, tonnage for tonnage, the expense would be the same. There is as much difference between a cruising yawl and a racing yawl as there is between a cruising cutter and a racing cutter, and it is a great mistake to suppose that a racing yawl includes the comforts of a good cruising cutter of equal size.

The ultimate conclusion is, that the particular rig will depend upon the

size of the yacht, and for cruising the rig should be: cutter up to 80 tons; yawl from 80 to 150 tons; schooner above that tonnage.

In deciding on a yacht for racing, the first thing to exercise the mind is, of course, which is the best size to have? A builder will not unnaturally recommend something very large—something that one can live in with comfort and with all the luxuries of shore life, and at the same time strike an imposing figure in the yachting world. But, as a rule, very large craft are disappointing. If a schooner is decided upon, it will be best not to go much beyond 200 tons; and a yawl should not exceed 150 tons, nor a cutter 120 tons. It can be argued that years ago, in the latter half of last century and at the commencement of this, very large cutters, sometimes exceeding 200 tons, were afloat, and were so much superior in every good quality which a sailing vessel should have, that they were always referred to with pride as the “national rig.” This is very true; but the 200-ton cutter of fifty years ago was a very different kind of craft from what a 200-tonner of the present day would be. These old cutters were only about 80ft. long on the load line, with an extreme beam of 25ft.; they had taunt masts, and what appeared to be long main booms, as so much projected over the taffrail aft; but in fact their main booms were comparatively short—about 65ft., or no longer than *Kriemhilda’s*, which we reckon as of only 106 tons. A 200-ton cutter, built according to existing ideas as to proportion of beam to length, would be a very different kind of ship indeed; she would be about 100ft. long, and have no more than 22ft. beam; but, instead of being weighted with stone for ballast, she would carry probably 100 tons of lead, and her main boom would be at least 80ft. long. Having had some experience in handling a cutter’s main boom which was a little over 70ft. in length, we are quite of opinion that a 200-ton cutter, or even one of 150 tons of the modern school, is not a desirable kind of racing craft; and 120 tons—which means about 90ft. length of load line, or more than the length of the old *Alarm* when she was a 193-ton cutter—is quite a prudent limit to strike.

But a man may be uninfluenced by considerations of size, comfort, prudence, or cost; he may simply want to shine as the owner of a successful racing craft, and pile up a huge, if almost meaningless, heap of prizes in one year. If such is the desire, search must be made amongst the records of matches sailed during the last decade, and little difficulty will be found in coming up with the magic size for prize-winning. So far as the record of the last decade goes—or, indeed, the record of the last thirty years might be taken—we think there is not much doubt that the most useful size, so far as cutters are concerned, for successful racing, has been 60 tons or near that tonnage. *Mosquito*, *Volante*, *Fiona*, *Vanguard*, *Iona*, *Neva*, have

achieved more in the way of prize-winning than any of the same rig of 100 tons and upwards; but within the last four years the 60-ton racer has almost disappeared, and the 100-tonners have constantly proved quite equal to the time allowance they have to concede whenever in competition with yachts of inferior size. Evidence was afforded a few years since that this condition of things might arise. In 1873 the *Kriemhilda*, of 106 tons, in the face of almost unexampled competition, won more than any cutter had previously done, and the brilliancy of the achievement was enhanced by the circumstance that, excepting on two occasions, she won a first prize every time she started, and came in first every time but once, and all the matches were sailed in good breezes. In 1880 two vessels (*Vandura* and *Samœna*) a little longer than *Kriemhilda* on the load line, a little narrower and of considerably heavier displacement, but measuring only 90 tons, were built and had two seasons of unexampled success. It is therefore still quite possible that, for competition in the large class, a cutter of from 80 to 90 tons should be chosen, as the probability is, if the vessel be a good one, such as those designed by Ratsey, Fife, Richardson, or Watson, that a very valuable amount of plate will be collected. Great *éclat* naturally attends the successes of a big craft: she is generally ahead of the fleet—and the sympathies of the crowd invariably go with the leading craft; and if she wins (say from a 60-tonner), she is almost certain to be three or four miles ahead at the finish. This feature in itself is, no doubt, a most impressive one, both on the owner and on the spectator; and there can be no question about the *éclat* of winning with a 100-tonner even eclipsing the splendour of winning with a 90-tonner. This certainly is the vanity of the thing; but there are vanities in sport as there are in other occupations, and if it is a man's vanity not only to win prizes, but to revel in the glory of "coming in first" in the cutter class, then he must have a vessel of 100 tons or 120 tons. If, on the other hand, his vanity, if more peculiar, is less ambitious—is to win, one way or another, the greatest number and the greatest value of prizes—then he may have his wish gratified by owning a yacht not larger than 90 tons nor smaller than 60 tons.

Cutter racing is not confined to 60-tonners nor to 100-tonners. Within the last ten years classes have sprung up, and no class has earned more laurels than the 40-tonners. Three builders—Hatcher, Fife, and Ratsey—have made this class, and until 1881, when the *May* appeared, built from a design by Watson, no other builder had been able to compete with the productions of these famous constructors. For real sport, there is not much doubt that the 40-tonners are to be preferred to the vessels in the larger class: there is no time allowance; the exact merits of the vessels, and of their handling, are easily read; and, as a

rule, the winning vessel can only arrive first at the goal by contesting every inch of water sailed through. An attempt was made five or six years ago to establish a 60-ton class, but it was unsuccessful, mainly because sailing committees did not promptly stop the introduction of vessels which were a few tons over the class. However, we do not think a 60-ton class was much to be admired, and probably a class of 80-tonners would have been more successful. With regard to the 40-tonners, a man fond of the sport need have no hesitation about building for their class: if he succeeds in heading the class, he will have performed a very imposing feat; and, under any circumstances, if a vessel is "built up to the class," he is certain to have most lively sport from beginning to end, and will become acquainted with the art of yacht sailing in the very best school. Some gentlemen keep 40-tonners for the love of the sport of racing them, and live in large comfortable cruising schooners during their season afloat; however, if a man has not too much money, he will find a 40-tonner comfortable enough, and his sailing master will seldom report the weather too bad to show out of port in.

The 20-ton class is a very numerous one, and in no class is competition more keen than in this, and if it would be hard to put a vessel in the 40-ton class that would come out with the longest string of winning flags at the end of the season, it would be even a little more difficult to do so in the 20-ton class. It is not likely that anyone would "yacht" in a 20-tonner for the sake of the mere repute of owning a yacht; a man, to own, race, and live in one of these craft, must love the art of sailing, be enthusiastic in competition, and think of gaining the honours of the match by sheer hard sailing, and not of getting the prize by fluking or wrangling. This also must be said of the 10-ton class and the 5-ton class; and so long as these small classes exist, so long will there be evidence that love of the art of yacht sailing is one of the most striking characteristics of the British gentleman. Some men, of course, revel in the passive pleasure of sailing about in a yacht, without knowing anything or caring anything about the mariner's art, just as some men will derive pleasure from riding on the back seat of a drag, and knowing and caring nothing about the tooling of the cattle in front of him. These are the gentlemen whose yachts we meet and hear of in all sorts of out-of-the-way ports; and as they make "life on the ocean wave" as pleasant as it is possible to make it, be assured that they are agreeable men to cruise with.

CHAPTER II.

EXAMINATION OF THE YACHT.

HAVING decided upon the size of the yacht, the next step will be to find a suitable one of that size. If the intending purchaser advertises his wants, he is certain to have a great many vessels offered him, and all will be highly recommended by the agents of the vendors; each vessel will be the best sea boat of her tonnage, the strongest built, the best found, and the handsomest; and, moreover, the present owner is almost certain to have recently spent several hundred or thousand pounds upon her reconstruction or redecoration. The intending purchaser will be delighted; and, after having got through particulars of the yachts which have been offered for sale, something like bewilderment will naturally follow, and the task of making a final selection will be a little difficult. The best plan will be to begin with treating all the answers as mere information of vessels for sale. Find out when they were built, and by whom, from Lloyd's Register,* and if those that seem unobjectionable, so far as age is concerned, are suitable also in price, go to see them. Then, if one appears to be in every way a desirable craft, bid for her, "subject to a survey and inspection of inventory, showing her hull and equipment to be in a seaworthy and thoroughly satisfactory condition." It will always be necessary to have a vessel surveyed before completing a purchase, unless it is found by Lloyd's Register that the yacht is quite new, or has recently been surveyed. If a survey be required it will be performed upon application by one of Lloyd's surveyors, or by a yacht builder; but if a builder be employed, it will be well not to have the one that built the vessel, as he may not unnaturally incline towards making a more favourable report on her condition than the circumstances may warrant. The fee for surveying will probably be five guineas, with travelling expenses.

* Lloyd's Society for the Registration of Ships (White Lion-court, Cornhill) issue a special book for yachts, stating their tonnage, when and how built, when altered, when repaired, when last surveyed, and all information that it is necessary to possess.

A man may perhaps desire to act as his own surveyor; if he does, he will act very unwisely, as it is only by long experience, and a perfect knowledge of the construction of vessels and of the strains they are subject to, that a man can become competent for such surveys. Nevertheless, as the yachtsman who takes to the sport enthusiastically, and with a resolve to be "thorough," will necessarily want to know in a general kind of way the "marks" to distinguish a good vessel from a bad one, some instruction must be given him.

In the first place as to age. Speaking generally, a yacht should not be more than twenty years old; we do not mean that all yachts upwards of that age should be broken up or sold into the coasting, or fishing, or piloting trade; but that yachts so old as twenty years should be put through a very searching survey. Yachts seldom are broken up, and their fate is to lie year after year in mud docks for sale, and till they are far on the shady side of thirty. Do not be tempted by cheapness into buying one of these; it would certainly end in mortification and disappointment. If the vessel were merely patched up with oakum and paint, she would be a perpetual trouble and expense; and if repaired or renewed as she ought to be, a new vessel had much better be built, as it would be cheaper in the end.

Therefore do not buy a thirty-year old vessel, and one so old as twenty years should only be selected with very great caution; the condition of such an old craft will depend upon the way she has been used and "kept up," and upon the amount of repairs and "renewing" she has undergone. For instance, some vessels at the end of fifteen years are stripped, newly planked, and decked, and all doubtful timbers and beams replaced by new; such a craft would be good for another ten years without further outlay, and she might be bought with as much confidence as a perfectly new vessel. Or if the yacht was originally well built in the best manner by one of the best builders she may at the end of fifteen years require neither new plank nor new frames, but if she has seen much service she is almost certain to require new decks. The condition of a yacht at the end of fifteen years will very greatly depend upon the quality of the materials used in her construction, upon the sizes of the timbers and their disposition, and upon the thickness of the planking, and upon the strength of the fastenings. Some idea of what these should be can be gleaned from the tables in Lloyd's "Yacht Register," compiled from the practice of the best builders of yachts. The timbers (called also frames, and first, second, and third futtocks, where the lengths of the frames are in two, three, or more pieces) will be "double," that is, two timbers will be placed close together, or nearly close together, and act as one frame. Then

there will be a space, and hence "timber and space" means the distance from the centre of one double frame to the centre of another. The spacing should not be greater than the limits allowed by Lloyd's rules, as if the frames are too wide apart the vessel will work and the caulking become loose, with the final result of troublesome leaks. Some builders do not place the timbers of a double frame quite close together, as some ventilation is considered a good thing; but greater strength is obtained if the timbers of each double frame are close together, and the general practice is to so place them close together.

Occasionally a single-framed vessel is to be met with—that is, instead of two timbers being worked close together to form one almost solid frame, one single timber forms each frame, placed at regular intervals. These vessels, unless the timbers are of superior size and placed very close together, should be regarded with great suspicion; the space from centre to centre of the timbers should be at least 35 per cent. less than in a double-framed vessel, and the sizes should be 15 per cent. greater; and if the timbers are too long to be all in one piece, the "shifts" or lengthening pieces of the timbers should be so arranged that two shifts never come on the same horizontal line in adjoining timbers. In almost all vessels the frames of the bow forward of the mast are single, and in some very old vessels these bow frames might be found to be of fir; these frames will require a great deal of inspection and pricking. Some 20-tonners which we have met with have had single frames 12in. from centre to centre in the middle of the vessel, these frames extending over a distance equal to half the length of the vessel; similar frames were used in the bow and stern, but the spacing was increased to 16in. There does not appear to be any objection to this plan, and it has a slight advantage in weight of timber. A plan adopted by Mr. Alex. Richardson in framing the 10-tonner *Lily* was as follows: Sawn frames (4½in. by 2in. under platform, tapering to 2½in. by 2in. under deck) were spaced 3ft. apart, and between each pair of these were three steamed timbers 2in. by 1½in.; this framing has stood fairly well, and for lightness could be recommended. The Harvey Ship and Yacht Building Company used alternate sawn and steamed frames, with a double skin. This plan has now had a fair trial, and, so far as the experience of seven years goes, it appears likely to be very durable, and has an advantage in lightness. In regard to "materials," all the frames should be of oak and so should be the stem piece, stern post, upper portion of dead woods, knight heads, apron, beams, shelf clamp, bilge strakes, and keelson; the keel will generally be found to be either English or American elm. The garboard strakes are generally of American elm, and it is best that the planking above should be of American elm or oak to the load water-line, and teak above to the

covering board or deck edge. Very frequently, however, only the garboard strake is of American elm, and the remainder red pine or pitch pine, with a top strake of oak. Again, sometimes the first four strakes above the garboard are of American elm, and the first four strakes below the deck of oak or teak, and the remainder pine. Occasionally oak plank is used at the bilge, with a wale or "bend" of oak above the water-line; and, again, sometimes the plank is all oak from keel to plank sheer, and nothing in the way of wood material can exceed the strength or durability of a vessel so planked.

The floors and keel fastenings of yachts are now variously contrived. Twenty years ago a builder never thought of constructing a vessel without grown floors and a keelson; but, owing to the increasing sharpness in the bottoms of vessels, or increasing "dead rise," it became very difficult to find suitably grown floors. The result was that iron floors were cast, and these, whilst having an advantage in strength and durability, have the additional recommendation of forming excellent ballast. In some cases (almost always in vessels of 40 tons and under) grown floors, or floors of any kind, are dispensed with entirely; the heels of the first futtocks are brought down to the keel and connected by iron ∇ knees, which are securely bolted in the throat through the keel or through a hogging piece and keel.

If a yacht is met with that has these iron knee-floors, it should be ascertained if she has been ballasted with lead; if it turns out that her ballast has been lead, it will be necessary to have the iron knees very carefully examined, as lead very quickly destroys iron. It should also be ascertained whether or not the floor bolts and other fastenings are of iron; if they are, it is just possible that the lead ballast may have eaten off their heads; and if the yacht has a lead keel bolted with iron, it is very likely that the bolts may have suffered between the wood keel and lead.

If the yacht be twelve or thirteen years old, it will be incumbent to examine her very thoroughly inside and out, unless it is satisfactorily shown that she has recently been so examined, and all necessary repairs made. To effectively examine a yacht the copper should be stripped off, and the planking scraped clean; if, however, the copper be good it will be a pretty fair evidence that the plank underneath is sound, as the copper in such a case is not likely to have been on more than three years; and, of course, the plank and caulking would have been thoroughly examined and made good when the vessel was re-coppered.

If it is stated that the vessel does not require re-coppering nor needs stripping, it will be well to be present when she is hauled up high and dry, or as the water is pumped out of the dry dock into which she has been placed, as the case may be; as, if there are wrinkles or folds in the

copper, giving evidence of strains, it is quite possible, where the opportunity exists, that these "wrinkles" would be "dressed" out. The wrinkles will generally appear in a longitudinal direction, under the channels and under the bilge over the floor or futtock-heads. But if the vessel has been subject to very severe racking or twisting strains, or has bumped on a rock or on very hard ground, the wrinkles may run diagonally or in half circles across the copper. Very long and deep yachts, which have not been properly strengthened longitudinally by internal bilge strakes and continuous diagonal braces across the frames, may be subject to great racking or twisting strains; if there be evidence of such strains, the yacht need not be condemned, but she will require strengthening, and should be put into the hands of a competent builder. In a case where the copper shows unmistakable signs that the vessel works or strains, she should be thoroughly examined in the vicinity of the supposed strains, and be strengthened and fastened in the manner which a builder from his experience may consider necessary. If iron fastenings have been used in the vessel, it is very likely, unless the heads have been counter-sunk and well cemented, that iron rust stains will show on the copper; if such stains are met with, it will be best to have as much of the copper stripped off as the case requires, so that the fastenings may be driven out and new ones put in. The keel should be examined for strains and splits; and if the keel or false keel be worn away from the through bolt fastenings, the bolts should be cut off and re-clinched, and if necessary a new false keel should be fitted.

The stern-post, rudder-post, rudder braces, or gudgeons and pintles must be examined, and if the rudder-post is twisted, or braces or pintles much worn, there will be work for the shipwright.

The chain plates and chain-plate bolts and the surrounding planking and its caulking should be closely examined for flaws and strains, and so also should the stem piece and bobstay shackle plates.

Signs of straining on deck will mostly be apparent in the seam of the covering board abreast of the runners, the mast, at the stem, knightheads, bowsprit bitts, and near the mast partners. If the seams are unusually wide here, as they frequently may be in a yacht that has been much pressed with canvas, "sailed hard" in heavy seas, or that has been weakly built, some strengthening will be required by more hanging knees under the beams, lodging knees and additional knees at the mast partners, or new beams, partners, and knees altogether. If the covering board shows signs of having opened badly in the seam, or lifted from the top strake, the beam ends and shelf or clamp will require very careful examination—the shelf and clamp especially at the scarphs and butts.

To examine the frames of the vessel, the ballast should be removed, and some of the ceiling and some of the outside plank should be stripped off. Lloyd's surveyors, in examining an old ship, usually cut out listings from the plank the whole length of the ship; and they also similarly cut listings from the ceiling inside, under the deck, and over the floor heads; planks are taken off, too, at different parts of the ship, equal in the whole to her length; and the beam ends are examined either by taking out the top strake under the covering board, or by boring under the covering boards. Fastenings, such as trenails and bolts, are driven out, to further test the condition of the frames and fastenings; and the condition of the oakum and caulking is ascertained by examination in several places. If the ship or yacht be completely ceiled up inside, it is obvious that the whole of the framing cannot be examined by such means; but generally a yacht is not so closely ceiled, and an application of a knife to the frames will soon determine whether they are rotten or not.

There is scarcely any limit to the number of years frames of autumn-cut oak will last; but occasionally a sappy piece will find its way among the frames, and it may not last a year, or the frames may decay in consequence of leakage and defective ventilation; but from whatever cause rot may arise, any frame so affected should be removed. Heels and heads of floors and frames are the most likely places to find rot; but of course it may occur in any part of a frame, and, if possible, every timber in a vessel should be thoroughly examined from heel to head.

Old decks are a great trouble to keep tight; and if there is any sign of "weeping" either under the deck at the seams, round the skylights, shelf, or mast, there will be sufficient evidence that caulking is necessary. New decks, however, frequently give trouble in this way if they have been carelessly caulked, or if the yacht has been weakly constructed, or if the caulking was done during wet weather and not under a shed. As the plank dries, it shrinks away from the caulking and paying, and leakage is the inevitable result; this condition can be somewhat ameliorated by wetting the deck two or three times a day, but wet decks are almost as bad as leaky ones, and re-caulking and stopping will be the best remedy. It is the fashion now to lay the deck planks very close together, in order that narrow seams may be obtained; narrow seams of course look very nice, but, as the seams are scarcely wide enough to receive the caulking iron, very little oakum is driven into the seams, and as the marine-glue paying or putty stopping dries, leaks are the result.

The spars will require careful inspection, and if either has cracks running transversely or diagonally, it will be pretty sure evidence that it is sprung. The longitudinal cracks or fissures are not of much consequence

unless they gape very much, run deep and from one into another right round the spar; sometimes, however, if the cracks have not been stopped with putty or marine glue, the wet might have got in and caused decay. The insertion of a knife into various parts of the crack will soon settle this matter. The mainboom should be examined for "springs" near the outer end chiefly; the bowsprit at the gammon iron, or stem head, and at the outer end above and about the sheave hole; the mast, about the deck and under the hounds. The masthead will require very careful examination under the eyes of the rigging and behind the bolsters for rot, and right away to the cap for wrings, which generally show themselves by a lot of little cracks.

The rigging, blocks, and sails will of course require an overhauling. The standing rigging is now generally made of galvanised iron wire or steel wire; if it has seen much service, rust from the inner strands will show itself, and the "lay" of the strands will have been stretched nearly straight. Hemp and manilla rope, if much worn, with a washed-out appearance, should be in certain places unladen, or untwisted, and if there be any signs of stranding, or if the tar is dried up, the rope will have seen its best day. The shells of the block will require examination for splits, and the hook, eye, sheave, and pin for flaws of whatever description. The sails should be laid out and examined; if the stitching in the seams or roping be worn and ragged, if the canvas be black looking, very soft and thin, admitting a great deal of daylight through the woof, then the sails will be only fit for a fisherman or coaster. As a rule, a suit of sails will last through four or five summer cruises; but three months' knocking about, winter cruising in the Mediterranean or elsewhere, will do as much harm as two summer cruises, and it will never be prudent to start on a long winter cruise with sails that have seen more than three seasons' wear. Of course sails may have been exceptionally well cared for—never rolled up wet or unfairly stretched—and the vessel may have been in the happy condition of never having been under way in much of a breeze. Then if they are six or seven years old, and an expert pronounces them fit for a winter's cruise, they can be depended upon; but to be caught in a breeze is bad enough, and it is a great deal worse if when so caught some of the spars, rigging, blocks, or sails give out. A mainsail is most likely to go at the clew or to split from foot to head, but occasionally they split right across from leech to luff. A jib will go all ways; its head will come off, tack or clew will come off, and sometimes they will split or burst out of the stay rope. For racing, a mainsail is of little use after the second year, and even with the greatest possible care they will hardly do the third, as they get

thin and soft and fly right away from the spars into bags with the least weight in the wind. The owners of some small yachts have a new mainsail every season, and this is quite necessary if the yacht is sailed in as many as thirty or forty matches, and if the sail has been frequently reefed.

Lastly, the ground tackle or holding gear must be examined. The anchors and chains should be galvanised, and be of the weight and size set forth in Lloyd's tables.

CHAPTER III. ·

BUILDING A YACHT.

SOME men seem to have quite a passion for building yachts, whether for cruising or racing, and do not believe in the paraphrased adage that "fools build yachts for wise men to buy." So far as a racing yacht is concerned, it is quite natural that a man should wish her first success or fame to be identified with his name, and that he would not care to own a vessel which had already become famous under another man's flag. On the other hand, there are plenty of men who, directly they hear that a yacht is successful, and read of her wonderful exploits in the reports of matches, long to possess the wonderful craft. And so it happens that there is always something for the builder to do. The man who finds excitement in building is always certain to fancy that there is something even in his last success that can be improved upon; and he is glad to meet with the obliging purchaser who so covets the possession of the property he is anxious to discard.

The man who knows nothing whatever of yachts and yachting, in setting out to build, will be mainly troubled to know which builder to go to. He will hear that one builder is famous for cutters, another for yawls, and another for schooners; whilst another, more wonderful than all the rest, is famous for every kind of craft, from the tiny *Una* to the bold Mediterranean cruiser of 300 tons. Then, again, one builder is celebrated for the soundness of the materials he uses; another for the excellence of his fastenings; and another, perhaps, for his disregard of the quality of both materials and fastenings. All this will be very perplexing to the man who has yet to serve his apprenticeship at the sport, and he at last dives into it with something like the feeling with which he took his first header, and inwardly appeals to the honour of the builder:

Build me straight, O worthy master,
Staunch and strong, a goodly vessel,
That shall laugh at all disaster,
And with wave and whirlwind wrestle.

And probably the master does build him a staunch and strong and goodly vessel. But there need be no doubt about the matter. Lloyd's Society for the Register of Shipping have now for five years been in the habit of superintending the building, and afterwards classifying a vessel, according to rules based on the undoubted soundness of the practice of the best builders, and there is no reason why even a yacht intended for racing should not be classed. It may not be considered prudent to use materials to qualify her for the highest grade of seventeen years, but at least every yacht, whether intended for racing or not, should be built of materials to take a twelve year's class. The highest grade of class is A 1 seventeen years, and a vessel that is qualified for this high class is certain to be a "staunch and strong and a goodly vessel;" and it will be of little consequence, so far as these qualities go, which builder has the construction of the vessel, as it will be the duty of the surveyors to see that the work is carried out in a proper manner. The owner will know and feel that he has a vessel which will come out of the heaviest storm unstrained, and should he wish to dispose of her the unquestionable character which she has for strength will facilitate her sale at a full value. Therefore the advice to a man who knows little about yachts cannot be too urgently repeated—always build up to Lloyd's rules and under Lloyd's survey. No matter how high the repute of the builder may be, he will be only the more willing to agree to the survey, and will take delight in showing that he, so far from having any objection to build up to Lloyd's rules, will actually exceed their requirements, both in quality of timber used and in fastenings.

Vessels of the racing sort, of 40 tons and under, are now built with keels out of all proportion to the sizes of their other scantling: thus the *Freda* of 20 tons has a keel sided (by "sided" is meant its transverse thickness) amidships 2ft. 2in. This enormously thick keel of course tapers fore and aft, and is only so thick amidships in order that a heavy weight of lead or iron might be carried underneath. A similar weight could only be carried on a smaller wood keel by greatly increasing the draught, and then the strength and thickness of the keel might be unequal to the weight of the lead and to the boring for the necessary bolts. Sometimes a lead keel, or keelson, is worked inside, fore and aft, between the heels of the timbers and on top of the keel proper.

Various plans have been used for strengthening and binding together the fabric of the hull; but the diagonal iron braces previously referred to are only used in large yachts of great length. In yachts of eighty feet and under in length, thick strakes of hard wood or pitch pine are worked under the clamp and shelf, and run the whole length of the vessel, and

are through-fastened with metal bolts. Similarly two bilge strakes along the curve of each bilge on each side are worked and through-fastened. Limber strakes are also sometimes worked over the heels of the first futtocks which join the heads of the floors, and are through-fastened. A limber strake in a cruising vessel with a floor construction, where there is no keelson, would greatly add to the strength of the vessel; but in yachts of 50 tons and under it would scarcely be necessary to have a "thick strake" above the bilge strakes. Outside a wale or bend is worked and through-fastened; but where all the planking is of hard wood, the wales are dispensed with.

It must be understood, if the yacht about to be built is intended for racing rather than cruising, that it will be an advantage to reduce the scantling, and increase the spacing so far as may seem compatible with strength. The plank also (if the owner is not particular about obtaining a long term of years in Lloyd's Register), from the bilge upwards, can be of red pine instead of teak or oak, and the deck beams can also be of red pine; the bulwarks of red pine, and the stanchions and rails reduced in size so far as may appear consistent with strength. There are racing vessels, of similar tonnage, with as much as two-fifths difference in the size and height of stanchions; and in a 200-ton vessel half a ton of weight might very well be disposed of in this way. Of course it is only fair to say that some of our most successful racing vessels, such as *Florinda*, *Corisande*, *Samœna*, or *Gwendolin*, are built of the heaviest material and full scantling. However, although this may show that a vessel can be so built and succeed as a racer, it is at least an open question whether she would not have been a still greater success had her scantling been reduced.

The metal fastenings of yachts form a subject about which there is a great deal of opposite opinion. The builder who constructs cheaply contends stoutly that there is nothing like iron; on the other hand, the builder who always asks and gets a good price for his work would as soon think of fastening a yacht with cabbage stumps as with iron. Others recommend iron for dead-wood bolts, shelf bolts, and floor bolts, with Muntz' metal for plank fastenings. Others recommend Muntz' metal for all bolts, and a mixture of Muntz' metal and trenails for plank fastening. There is no doubt that iron has advantages, so far at least as long dead-wood bolts are concerned. Iron can be driven very much tighter than copper-rod, and its strength is greater. We have seen iron bolts, that had been made hot and dipped in varnish or oil before they were driven, taken out of a vessel thirty years old, long before galvanised iron was heard of, as clean and bright—in fact, the varnish unperished—as they were at the moment

of driving. On the other hand, if the iron were driven through a shaky piece of timber, or loosely driven, so that salt water might get to it, decay of the iron would be very rapid; hence preference must be given to copper or Muntz' metal. Galvanised iron is often used for shelf fastenings, and it is less objectionable there; but preference should be given to Muntz' metal for all dead woods, as it can be driven as tightly as iron, and, if of the best quality, will clench as well.

Lloyd's give an additional year to all ships or yachts that are fastened from the keel upwards (to within one-fifth the depth of hold amidships from the deck) with yellow metal or copper bolts and dumps, or trenails; in such case the fastenings for the upper strakes of plank to the deck must be properly galvanised, it being also understood that the iron bolts for frames, beams, &c., are to be galvanised. And a further two years are granted if *no trenails* are used at all.* Whether trenails or bolts are used, one is to be put in each plank or strake at every timber; two-thirds of the trenails are required to be driven through, and the butts of the plank must be through-bolted with copper or yellow metal; and the bilge strakes and limber strake should be through-bolted.

Trenails are scarcely adapted for vessels of less than 50 tons, on account of the small size of the timbers; and even in these they should be very sparingly used (and only in the bottom plank), as a 3in. timber must be very considerably weakened if it is bored with holes to receive 1in. trenails.

Metal bolts should in all cases be used for bolting on lead keels; iron keels can be bolted on with iron bolts, but if the vessel is coppered a 3in. strip of zinc should be put between the lower edge of the copper and the iron keel.

Some ten years ago it seemed likely that composite vessels would quite supersede those entirely of wood construction; but so far the composite plan has not advanced in favour. This is really a matter for surprise, as the composite build offers this advantage over the wood structure: so very much more room is obtainable inside on the same weight or displacement. The great question was ten years ago, could a composite vessel be so fastened as to be insured against the possibility of the fastenings giving out? We think the question has now, after fifteen years, been satisfactorily answered by such vessels as Oimara, Selene, Nyanza, Palatine, or Garrion, built by Steele and Co., of Greenock; the Sunbeam and Modwena, built by Bowdler and Chaffler, at Liverpool; the Bella Donna and Seabird, built by Hatcher; and many others. None of these vessels have, so far as we know, ever shown the slightest signs of straining,

* Lloyd's also give an extra year if the vessel is built under cover.

nor have their fastenings decayed; in fact, so far there seems every chance of their out-enduring any of the wood yachts which were constructed at about the same period. For a composite yacht it is best that all the planking (excepting, of course, the deck) should be of hard wood, and that the plank fastenings should be of Muntz' metal screw bolts sunk in the plank, and so insulated that galvanic action could not be set up with the outside copper, the bolts, and the frames. Mr. J. S. White, of East Cowes, has, within the last two years, provided the necessary plant for building composite vessels, and has built four large yachts according to that system of construction, but as yet there is no evidence that composite vessels are coming into general use.

Lloyd's have compiled a table of scantlings for composite and iron yachts, and will in future class such as are built up to their rules. Steel, however, is likely to supersede iron, as Lloyd's will give the same class for one-fifth less weight.

A great many experiments have from time to time been made with compositions for preventing the fouling of the bottom of ships; but up to the present time no specific has been discovered, and the opportunity for someone to realise a large fortune still exists. So far as yachts are concerned, they are generally sheathed with copper; and, for these waters at least, the bottom can be kept clean enough by a couple of scrubblings throughout the season. One of the compositions, such as Jesty's, Day's, Peacock's, or Martin's, is sometimes put over the copper; but, for racing at least, we prefer the copper without the composition, as clean copper has a smoother surface than either of the compositions imparts. Of course, for a racing yacht, the copper cannot very well be cleaned too often; and a month is quite long enough for the vessel to be without a scrub, although there are but few which get one so often. The Admiralty have been making some experiments with zinc as a sheathing for iron ships (the iron being first protected by a slight wood skin), but so far zinc does not appear to offer many advantages. Copper, on the other hand—if the ship be kept constantly moving, or moored, say, in a five-knot tide—will keep comparatively clean, on account of the extensive exfoliation which goes on of the oxychlorides and other soluble salts produced by the action of the salt water on the copper. Oxychlorides are similarly and much more rapidly formed on zinc, but are not so readily soluble; hence very little exfoliation takes place, and a corroded and rough surface is the result, the zinc being finally eaten through. Zinc, therefore, we may conclude, is unsuitable as a sheathing for yachts, especially as evidence exists that such sheathing $\frac{1}{2}$ in. thick has been eaten through in one year. An alloy of copper (2) and zinc (3), popularly known as Muntz' metal,

is largely used as a sheathing for ships; but it is scarcely so good as copper for yachts, as, owing to its greater stiffness, it cannot be laid so well. Another objection to Muntz' metal sheathing is that it does not exfoliate to the extent copper does, and that after being under the influence of salt water any considerable time—say three or four years—the metal becomes rotten; but this defect, it is said, can be remedied by an addition of a small quantity of tin to the alloy. For composite ships Muntz' metal sheathing has some advantage, as it sets up very little, if any, galvanic action with iron; but the risk of galvanic action from copper sheathing in a well-constructed composite ship is so remote that copper is to be preferred even to these, if the difference in cost is not a consideration.

A curious feature in connection with yacht construction is that naval architects should have had so little to do with the designing of yachts. Yacht builders, as a rule, keep draughtsmen, who are instructed as to a design, and thus the builder becomes his own architect. That this plan has succeeded there can be no doubt, and it might even be questioned whether an architect could at present compete with the builder, if the latter bestowed so much time on a design as he ought. But, as a rule, builders are too much occupied with the cares of their business to devote much time to the mathematical consideration of a design; and it is only their experience, and a prudent purpose not to depart in any radical way from a model which practice has proved to be possessed of undeniable good qualities, that keep them from blundering into failure. If we were asked to give a reason why the business of designing happens to be in the same hands as the business of building, we could give no satisfactory answer, if a true one. The truth is that, in the early days of yachting, a naval architect who confined the exercise of his talents to the designing of yachts would have found his occupation by no means a lucrative one; and perforce the builders were compelled to do their own designing, mostly on the pattern of Government cruisers, with such trifling alterations as their experience permitted them to venture upon. Occasionally gentlemen made models of yachts, and the late Mr. Joseph Weld and Mr. T. Assheton Smith had a large share of success; it is even claimed for Mr. Smith that he invented or discovered the value of "wave lines" before Mr. Scott Russell did. But, be this as it may, there can be no doubt that he was as clever at designing as the professional builders of the day. Builders were, in fact, compelled to do their own designing, because the profession of a yacht-naval architect would have been unprofitable. But if builders as a matter of necessity did their own designing fifty years ago, it can scarcely be said that a similar necessity exists now, although the custom does. During

the last ten years there have been, on the average, fifty vessels of all rigs and sizes built annually, and it might be assumed that the emoluments for designing these would keep a goodly number of naval architects in the necessaries of life. The few who have made yacht-naval architecture a study and profession have undoubtedly succeeded well enough to lead to the conclusion that, with more opportunities, they would make a very considerable advancement in yacht design. Builders would be relieved of a great source of anxiety, as the responsibility of a vessel answering the requirements or expectations of the person for whom she was built would be shifted from their shoulders to those of the architect. Such a shift of responsibility would unquestionably be an advantage for the yacht owner, as it is much more likely that a scientifically trained architect, who has opportunities of tracing causes of success or failure, would achieve any given object than that a builder would, whose business occupations necessarily restrict the exercise of his attention and experience on the important work of designing. It is, therefore, satisfactory to note that yacht designing is gradually gaining recognition as a profession; and if improvement is to be made in the form of yachts, we must look for it from the hands of professional yacht designers.

CHAPTER IV.

THE EQUIPMENT OF THE YACHT.

THE equipment of a yacht embraces generally everything that is used or required for working her. Usually it is understood to consist of the spars, standing and running rigging, sails, various tackles or purchases, anchors, chains, warps, boats, lights, &c. The diagram, Plate I., and the references, will assist the explanations that will follow of the various parts and uses of a vessel's outfit or equipment.

SAILS.

- | | |
|--|---|
| <p>A. Mainsail.</p> <ul style="list-style-type: none"> a. Clew of mainsail, with traveller on the horse 13 (chain outhaul and tackle shown underneath boom). b. Main tack. c. Throat. d. Peak earing. e. Head. f. Foot and roach of sail. g. Luff or weather leech. h. Leech, or after leech. i. First, second, third, and close reef oringles. j. First, second, third, and close reef points. k. First, second, third, and close reef oringles or luff oringles. <p>B. Foresail.</p> <ul style="list-style-type: none"> a. Luff. b. Foot. c. Leech. d. Head. e. Tack. f. Reef points. | <p>C. Jib.</p> <ul style="list-style-type: none"> a. Luff. b. Foot. c. Leech. d. Head. e. Tack. <p>D. Gaff Topsail.</p> <ul style="list-style-type: none"> a. Clew. b. Tack. c. Weather earing, or head earing. d. Peak earing. e. Head. f. Foot. g. Luff. h. Leech. <p>E. Jib Topsail.</p> <ul style="list-style-type: none"> a. Luff. b. Foot. c. Leech. d. Head. e. Tack. |
|--|---|

SPARS.

- | | |
|--|---|
| <ul style="list-style-type: none"> 1. Mast. 2. Top Mast. 3. Bowsprit. 4. Boom. | <ul style="list-style-type: none"> 5. Gaff. 6. * Topsail yard. 7. Spinnaker boom. 8. Hounds, bolster, and yoke. |
|--|---|

* Formerly balloon topsails, with a footyard or jackyard, were common in all racing yachts; they are now generally done away with, excepting in schooners and yawls, as they greatly increase the weight aloft, without much increasing the size of topsail.



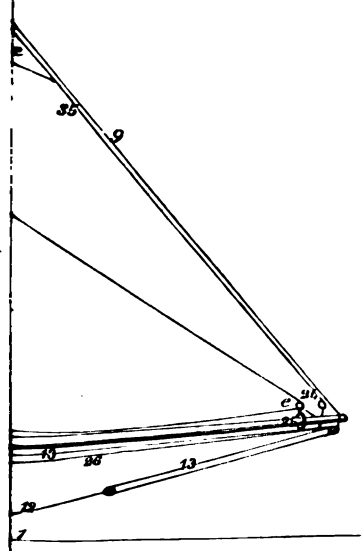

SPARS—continued.

- | | |
|--|---|
| <ul style="list-style-type: none"> 9. Cap. 10. Masthead. 11. Pole of topmast. 12. Truck. | <ul style="list-style-type: none"> 13. Iron horse at boom end for mainsail out-haul to travel on. 14. Mast hoops. |
|--|---|

RIGGING.

- | | |
|--|--|
| <ul style="list-style-type: none"> 1. * Main rigging shrouds. 2. * Sheer pole, termed also sheer batten and sheer stretcher. 3. * Dead eyes and lanyards. 4. * Fore stay. 5. * Pendant. 6. * Runner. 7. Runner tackle. 8. Fall of runner tackle. 9. * Topmast stay (topmast back-stays or shrouds not shown.) 10. * Topmast shifting backstay, or "pre-venter backstay." 11. Tackle of shifting backstay. 12. * Bobstay. 13. Bobstay tackle and fall. 14. Main halyards. 15. Peak halyards. 16. Main sheet. 17. Topping lifts. 18. Reef-earring or pendant. 19. Foresail halyards. 20. Foresail sheet rove through block on clew of sail. 21. Foresail tack. 22. Jib halyards. 23. Jib sheets fast to clew of sail. | <ul style="list-style-type: none"> 24. Jib tack. 25. Jib traveller. 26. Jib outhaul. 27. Jib downhaul and foresail downhaul. 28. Topsail halyards. 29. Topsail upper halyards, or tripping halyards. 30. Topsail sheet, leading through block with pendant, fast round masthead. 31. Topsail tack. 32. Topsail tack tackle. 33. Topsail clew line. 34. Jib-topsail halyards. 35. Jib-topsail tack. 36. Jib-topsail sheet, fast to clew of sail. 37. Mainsail downhaul. 38. Spinnaker-boom; topping lift. 39. Spinnaker-boom; after guy. 40. Spinnaker-boom; hauling and standing parts of whip purchase of after guy. 41. Spinnaker-boom; fore guy. 42. Spinnaker outhaul, the hauling part on the under side of the boom. 43. Spinnaker outhaul, on the upper side of boom; this is the part made fast to spinnaker tack. |
|--|--|

The parts of the rigging marked thus * are termed "standing rigging," and the other parts running rigging."

HULL.

- | | |
|--|---|
| <ul style="list-style-type: none"> 1. Load water-line. (L.W.L.) 2. Keel. 3. Sternpost. 4. Rudder. 5. Deadwood. 6. Forefoot, termed also gripe. 7. Stem. 8. Freeboard. 9. Counter. | <ul style="list-style-type: none"> 10. Archboard. 11. Taffrail. 12. Quarter timbers. 13. Covering board or plank sheer. 14. Rail, or rough tree rail. 15. Channel. 16. Chain plates, or channel plates. 17. Bobstay shackle plates. |
|--|---|

FIG. 1.

HULL.

- | | |
|---|--|
| <ul style="list-style-type: none"> 1. Floor. 2. Frames or timbers. 3. Keel. 4. Garboard. 5. Bilge. | <ul style="list-style-type: none"> 6. Deck. 7. Deck Beam. 8. Bulwark stanchions. 9. Channels and channel plates. |
|---|--|

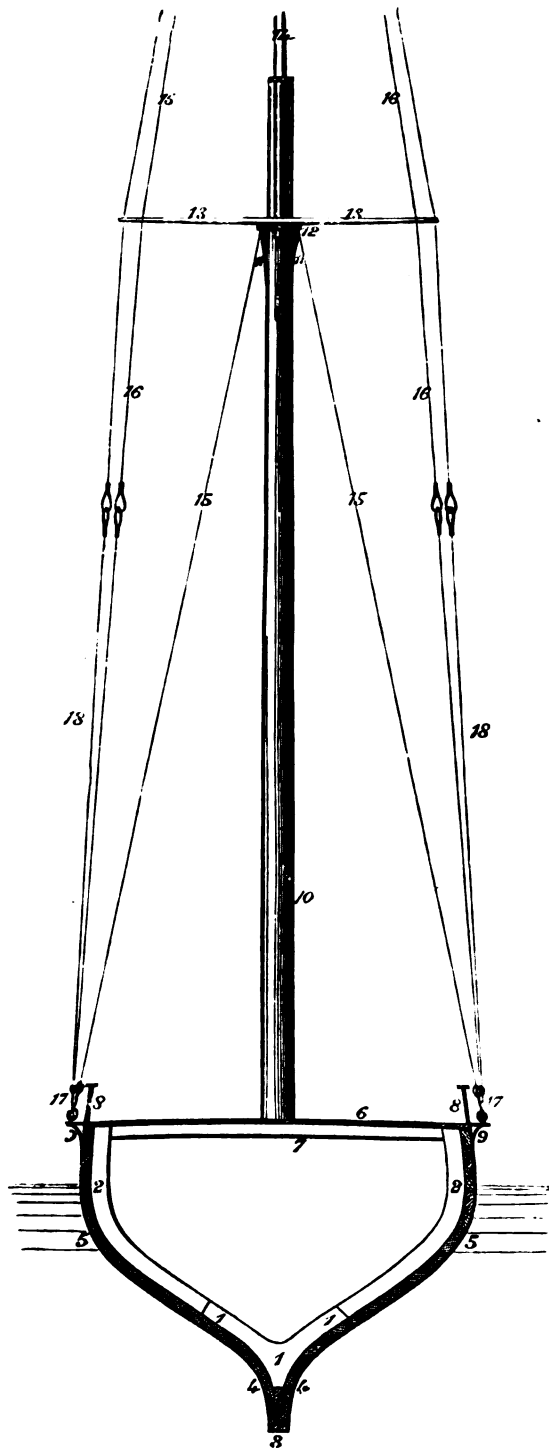

FIG. 1.

MAST AND RIGGING.

- | | |
|---|---|
| <ul style="list-style-type: none"> 10. Mast. 11. Hounds. 12. Yoke or lower cap and bolster. 13. Crosstrees. 14. Topmast. | <ul style="list-style-type: none"> 15. Main rigging or shrouds. 16. Topmast shrouds or backstay. 17. Backstay falls or tackles. 18. Legs of topmast backstays taken off when the topmast is housed. |
|---|---|

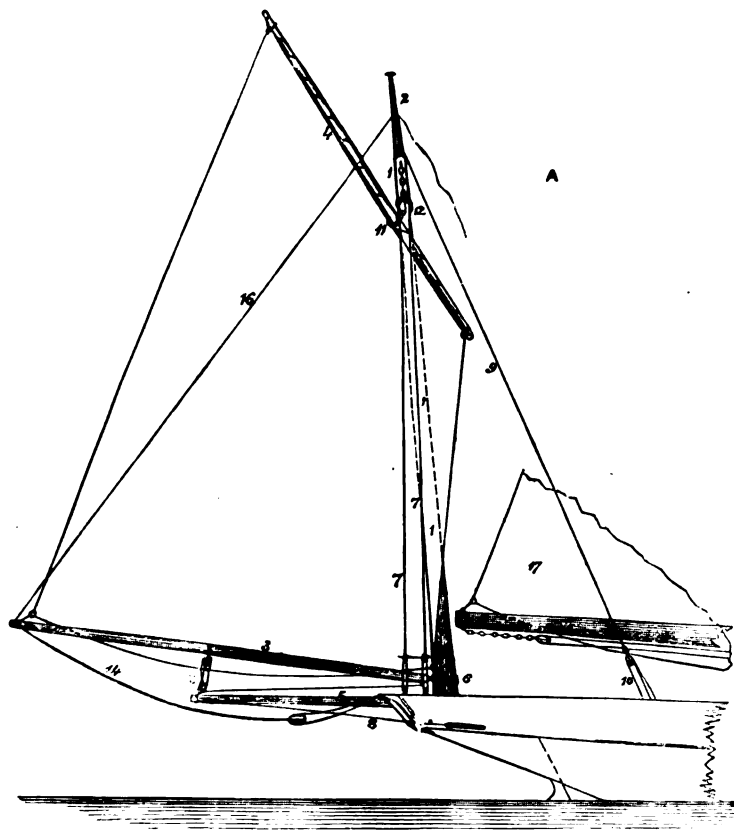

FIG. 2.

MIZEN OF YAWL.

- | | |
|---|---|
| <ul style="list-style-type: none"> 1. Mizzen mast. 2. Pole of mizzen mast. 3. Mizzen boom. 4. Mizzen yard. 5. Mizzen bumpkin. 6. Spider band on mast. 7. Mizzen shrouds set up with lanyards and sheer pole. 8. Mizzen bumpkin guys or shrouds. 9. Mizzen shifting stay, one on each side. 10. Tackle for mizzen shifting stay. 11. Strop on mizzen yard. 12. Iron traveller on mizzen mast, with chain tye or halyard passing through sheave hole above. The tackle on the chain | <ul style="list-style-type: none"> halyard is hidden on the other side of the mast. 13. Mizzen sheet leading in board. 14. Mizzen outhaul and whip purchase slackened up. The outhaul is also sometimes arranged in this manner: the outhaul is first put over the end of the boom by a running eye, then passes through a single block on the clew cringle of the sail, through a sheave hole in the boom end, and then on board. In such case there is no whip purchase. 15. Mizzen tack and tack tackle. 16. Mizzen topping lift. 17. Mainboom and part of mainsail. |
|---|---|

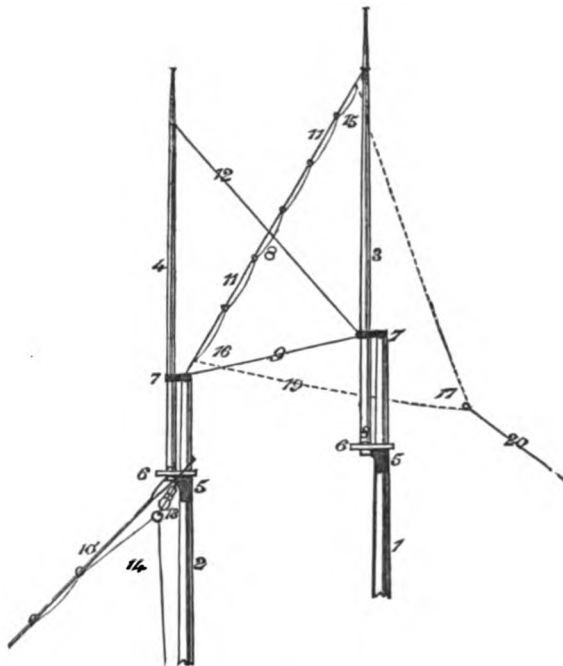

FIG. 3.

MASTS AND RIGGING OF SCHOONER.

- | | |
|---|---|
| 1. Mainmast. | 11. Main-topmast stay. |
| 2. Foremast. | 12. Fore-topmast backstay. |
| 3. Main topmast. | 13. Fore-staysail halyards. |
| 4. Fore topmast. | 14. Head of fore-staysail. |
| 5. Hounds or cheeks of mast. | 15. Head of main-topmast staysail. |
| 6. Lower cap on which cross-trees rest, fore side of topmast. | 16. Tack " " |
| 7. Cap. | 17. Clew " " |
| 8. Topmast fid. | 18. Luff " " |
| 9. Triatic stay. | 19. Foot " " |
| 10. Forestay. | 20. Sheet " " |
| | leading to quarter rail. |

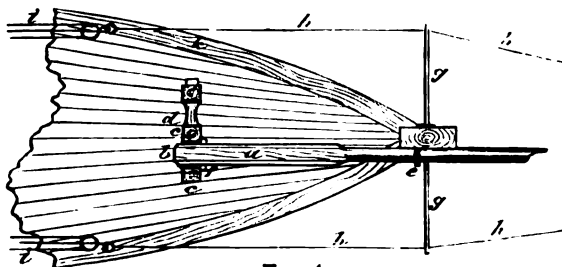

FIG. 4.

FOREDECK FITTINGS, BOWSPRIT AND RIGGING.

- | | | |
|---|--|--|
| a. The bowsprit. | f. Fid. | N.B. The block is usually an iron fiddle one here. |
| b. Heel of bowsprit. | g. Whalers hinged or hooked to the stem. | k. Covering board. |
| c. Bitts. | h. Wire shrouds. | |
| d. Windlass. | i. Tackle for setting up shrouds. | |
| e. Gammon iron, also called span shackle. | | |

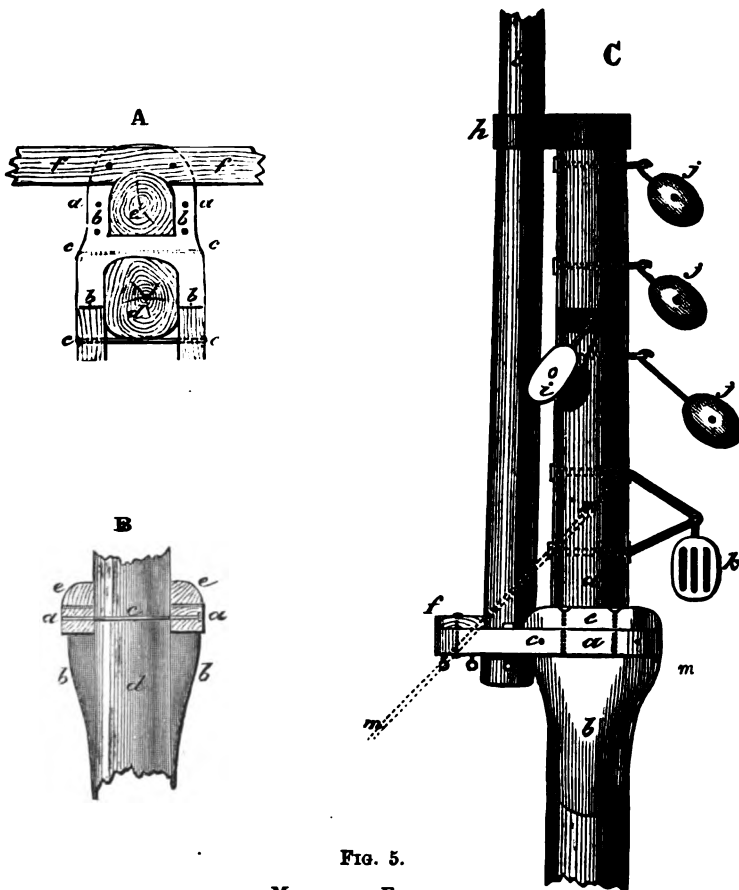

FIG. 5.

MASTHEAD FITTINGS.

Fig. A shows a view of the top side of the yoke or lower cap.

a is the yoke with an iron band round it.

b is a U-shaped iron plate, sometimes fitted over the yoke as shown, and is the strongest plan.

c is an iron bolt.

d is the mast.

e is the topmast.

f the crosstrees fitted with screw bolts and nuts on the fore side of topmast as shown.

Fig. B is the yoke and mast viewed from aft.

a, the ends of the aft arms of yoke.

b, the cheeks, the upper part on which the bolsters rest being the hounds.

c, iron bolt at aft side of mast.

d, the mast.

e, bolsters on which the rigging rests.

Fig. C shows a broadside view of the yoke and masthead.

a, the yoke.

b, the cheeks.

c, iron bolt.

d, the masthead.

h, iron cap.

i, jib halyard block (one on each side of mast, on iron hoop).

j, peak-halyard blocks.

k, Main-halyard block, and span bolt. This bolt should be long enough to keep the parts of the halyards clear of the yoke. Sometimes a single bolt is used with strong spur and plate below.

m shows the position on the cheeks where the eye plates  are bolted to take the blocks for the topping lift.

The sheave in the masthead for the heel rope of the topmast is not shown; the sheave is usually fitted diagonally, and not in the fore and aft line.

e, bolster resting on the hounds.

f, crosstrees.

g, topmast.

The sizes given for blocks in the following table are for cutters; for yawls or schooners of equal tonnage take the sizes set down for the tonnage next below; thus, say a yawl is 100 tons, then take the sizes for blocks from the column assigned to 80 tons.

TABLE OF SIZES OF BLOCKS FOR YACHTS OF VARIOUS SIZES.

IRON STROP BLOCKS.

NAME OF BLOCK.	Description.		TONS.	TONS.	TONS.	TONS.	TONS.	TONS.	TONS.	TONS.	TONS.	
	Number. Double.	Number. Single.	Cut. 8. Yawl 6.	Cut. 5. Yawl 7.	Cut. 10. Yawl 14.	Cut. 15. Yawl 20.	Cut. 20. Yawl 30.	Cut. 30. Yawl 40.	Cut. 40. Yawl 60.	Cut. 60. Yawl 80.	Cut. 80. Yawl 100.	Cut. 100. Yawl 130.
			Size.	Size.	Size.	Size.	Size.	Size.	Size.	Size.	Size.	Size.
Main halyards <i>a</i>	2	—	Ins.	Ins.	Ins.	Ins.	Ins.	Ins.	Ins.	Ins.	Ins.	Ins.
Peak halyards	—	5	4	4½	5	5½	6	7	8	9	9½	10
Mainsheet	1	1	4½	4½	5	5½	6	7	8	9	9½	10
Mainsheet lead	—	2	3	3	4	4½	5	5½	6	6½	7	7½
Jib halyards	—	3	4	4½	5	5½	6	7	8	9	9½	10
Fore halyards	—	2	3	3	4	4½	5	6	6½	7	7½	8
Bobstay (iron blocks) ..	1	1	4	4½	5	5½	6	7	8	9	9½	10
Bowsprit shrouds <i>b</i> ...	2	2	6 & 3	6 & 3	6½ & 4	7 & 4½	7½ & 5	8 & 5½	8½ & 6	9 & 6½	9½ & 7	10 & 7½
Pendant blocks	—	2	3½	3½	4	4½	5	5½	6	6½	7	7½
Runner tackle <i>b</i>	2	2	6 & 3	6 & 3	6½ & 4	7 & 4½	7½ & 5	8 & 5½	8½ & 6	9 & 6½	9½ & 7	10 & 7½
Main outhaul	—	1	3	3	3½	4	4½	5	5½	6	6½	7
Topsail sheet (cheek) ..	—	1	3	3	3½	4	4½	5	5½	6	6½	7
Topmast backstays <i>c</i> ...	4	4	3	3	3½	4	4½	5	5½	6	6½	7
Preventer backstays ...	2	2	3	3	3½	4	4½	5	5½	6	6½	7
Preventer backstay whips	—	2	3	3	3½	4	4½	5	5½	6	6½	7
Jib tack	—	1	3	3	3½	3½	4	4½	5	5½	6	6½
Jib purchase	1	1	3	3½	3½	4	4½	5	5½	6	6½	7
Jib purchase runner ...	—	1	—	—	—	—	—	—	5	6	7	8
Main purchase	1	1	3	3½	3½	4	4½	5	5½	6	6½	7
Peak purchase	1	1	3	3½	3½	4	4½	5	5½	6	6½	7
Topping lifts	—	2	3	3½	—	4	4½	5	5½	6	6½	7
Topping lift purchase <i>d</i> ..	4	—	3	3	3½	4	4½	5	5½	6	6½	7
Spinnaker topping lift <i>e</i> ..	2	—	3	3	3½	4	4½	5	5½	6	6½	7
ROPE STROP BLOCKS.												
Jib topsail halyards ...	—	2	3	3	3½	4	4½	5	5½	6	6½	7
Spinnaker halyards ...	—	1	3	3	3½	4	4½	5	5½	6	6½	7
Spinnaker guy whip ...	—	1	3	3	3	3½	4	4½	5	5½	6	6½
Trysail sheets	2	2	4	4½	5	5½	6	6½	7	7½	8	8½
Fore sheets	—	4	4	3½	4	5	5½	6	6½	7	7½	8
Reef-tackle (fiddle dbl.)	1	1	6 & 3	6 & 3½	6½ & 4	7	7½	8	8½	9	9½	10
Boom guy	1	1	—	—	3	3½	4	4½	5	5½	6	7
Tack tackles	3	3	3	3	3½	4	4½	5	5½	6	6½	7
Burton	—	2	—	—	3	4	4½	5	5½	6	6½	7
Gaff topsail sheet whip	—	1	3	3	3½	4	4½	5	5½	6	6½	7
Down-hauls (forward)	—	3	—	—	3	4	4½	5	5½	6	6½	7
Dead eyes <i>f</i>	—	—	3½	3½	4	4½	4½	5	5½	6½	7½	8½

(a) If a throat purchase is used (as it generally is in racing yachts of 10 tons and over, the upper throat halyard block is a threefold, as one part of the halyards is required for the purchase, and another for the hauling part.

(b) The double blocks on the bowsprit shrouds and runner tackle are fiddles.

(c) A five-tonner has only four single blocks for backstays, two on each side.

(d) These would be single up to 20 tons.

(e) These would be single up to 10 tons.

(f) Some five-tonners have only two shrouds on each side; ten tons and upwards three shrouds; above sixty tons four shrouds for racing.

TABLE OF SIZES OF CORDAGE FOR CUTTER AND YAWL YACHTS OF VARIOUS SIZES.*

NAME OF ROPE.	TONS. Cut. 3. Yawl 5.	TONS. Cut. 5. Yawl 7.	TONS. Cut. 10. Yawl 14.	TONS. Cut. 15. Yawl 20.	TONS. Cut. 20. Yawl 30.	TONS. Cut. 30. Yawl 40.	TONS. Cut. 40. Yawl 60.	TONS. Cut. 60. Yawl 80.	TONS. Cut. 80. Yawl 100.	TONS. Cut. 100. Yawl 120.
	Cf.	Cf.	Cf.	Cf.	Cf.	Cf.	Cf.	Cf.	Cf.	Cf.
Throat halyards	1½	1½	2	2½	2½	2½	3	3½	3½	3½
Peak halyards	1½	1½	2	2½	2½	2½	3	3½	3½	3½
Mainsheet (manilla) ...	1½	1½	1½	2	2½	2½	2½	3	3½	3½
Fore halyards	1	1½	1½	1½	1½	2	2½	2½	2½	3
Bobstay tackle	1½	1½	2½	2½	2½	3	3½	3½	3½	4
Bowsprit shrouds tackle	1	1½	1½	1½	1½	2	2½	2½	2½	3
Pendant	1½	1½	2	2½	2½	2½	3	3½	3½	3½
Runner	1½	1½	2	2½	2½	3	3½	3½	3½	4
Runner tackle	1	1½	1½	1½	1½	2	2½	2½	2½	3
Main outhaul	1	1	1½	1½	1½	1½	2	2½	2½	2½
Reef pendants	1½	1½	2	2½	2½	2½	3	3½	3½	3½
Topsail sheet	1	1½	1½	1½	2	2½	2½	2½	3	3½
Topmast backstay tackles	1	1½	1½	1½	1½	1½	2	2½	2½	3
Preventer backstay tackles	1	1½	1½	1½	1½	1½	2	2½	2½	3
Preventer backstay whips	1	—	1½	1½	1½	1½	2	2½	2½	3
Jib tack	1½	1½	2	2½	1½ w	1½ w	1½ w	2 w	2½ w	2½ w
Jib halyards (chain) ...	1½	1½	2	2½	1½	1½	1½	2	2½	2½
Jib halyards (manilla).	1½	1½	2	2½	2½	2½	3	3½	3½	3½
Jib sheets	1½	1½	1½	2	2½	2½	2½	3	3½	3½
Jib purchase	1	1½	1½	1½	1½	1½	1½	2	2½	2½
Jib purchase runner ...	—	—	—	—	—	—	1½ w	1½ w	2 w	2½ w
Throat purchase	1	1½	1½	1½	1½	1½	1½	2	2½	2½
Peak purchase	1	1½	1½	1½	1½	1½	1½	2	2½	2½
Topping lifts	1½	1½	2	2½	2½	3	3½	3½	3½	4
Topping lift purchase ...	1	1½	1½	1½	1½	1½	1½	2	2½	2½
Jib topsail halyards ...	1	1½	1½	1½	1½	1½	1½	2	2½	2½
Spinnaker halyards	1	1½	1½	1½	1½	1½	1½	2	2½	2½
Spinnaker guy whips ...	1	1½	1½	1½	1½	2	2½	2½	2½	2½
Spinnaker topping lift..	1	1½	1½	1½	1½	1½	1½	2	2½	2½
Trysail sheets	1	1½	1½	1½	1½	2	2½	2½	3	3½
Fore sheets	1	1½	1½	1½	1½	2	2½	2½	3	3½
Reef tackle (fiddle) ...	1	1	1½	1½	1½	1½	1½	2	2½	2½
Boom guy	1	1	1½	1½	1½	1½	1½	2	2½	2½
Tack tackles	1	1	1½	1½	1½	1½	1½	1½	2	2½
Burton	—	—	—	1½	1½	1½	1½	2	2½	2½
Gaff topsail sheet whip.	1½	1½	2	2½	2½	2½	3	3½	3½	3½
Down-hauls, peak, fore- sail, and jib	1	1	1	1	1½	1½	1½	1½	2	2
Lanyards	1	1	1½	1½	1½	2	2½	2½	2½	3
Topsail halyards	1½	1½	1½	1½	1½	2	2½	2½	2½	3
Topsail trip halyards...	1	1	1½	1½	1½	1½	1½	2	2½	2½

(w) Wire jib tack and jib purchase runner.

Cf. Circumference.

In the case of jib halyards the size of the iron of the link is given.

* The relative strength of hemp and wire rope will be found in a table in the Appendix under the head of "Wire Rope."

CIRCUMFERENCE IN INCHES OF WIRE FOR STANDING RIGGING.

NAME.	TONS.	TONS.	TONS.	TONS.	TONS.	TONS.	TONS.	TONS.	TONS.
	Cut. 5. Yawl 7.	Cut. 10. Yawl 14.	Cut. 15. Yawl 20.	Cut. 20. Yawl 30.	Cut. 30. Yawl 40.	Cut. 40. Yawl 60.	Cut. 60. Yawl 80.	Cut. 80. Yawl 100.	Cut. 100. Yawl 120.
Shrouds	1½	1½	1½	1½	2½	2½	3	3	3½
Pendants	1½	1½	1½	2	2½	2½	3½	3½	3½
Bowsprit shrouds	1½	1½	1½	2	2½	2½	2½	3	3½
Forestay	1½	1½	2	2½	2½	2½	3½	3½	3½
Bobstay pendant	1½	1½	2	2½	2½	2½	3½	3½	3½
Topmast stay	½	½	1	1	1½	1½	1½	2	2½
Topmast backstay	½	½	½	1	1½	1½	1½	2	2½
Topmast preventer backstay ..	½	½	1	1	1½	1½	1½	2	2½
No. of shrouds a side	2	2	3	3	3	3	3	4	4
No. of backstays a side	1	1	2	2	2	2	2	2	2
Copper bobstay bar*	½	½	½	1	1½	1½	1½	1½	2

TABLE OF DIMENSIONS OF SPARS TO WHICH THE BLOCKS AND CORDAGE GIVEN IN THE PRECEDING TABLES ARE SUITABLE.

NAME.	TONS.	TONS.	TONS.	TONS.	TONS.	TONS.	TONS.	TONS.	TONS.
	Cut. 3. Yawl 5.	Cut. 5. Yawl 7.	Cut. 10. Yawl 14.	Cut. 15. Yawl 20.	Cut. 20. Yawl 30.	Cut. 30. Yawl 40.	Cut. 40. Yawl 60.	Cut. 60. Yawl 80.	Cut. 100. Yawl 120.
Mast, deck to hounds...	20	23	27	30	34	37	40	44	50
Topmast, fid to hounds.	17	19	24	28	29	30	33	36	44
Main boom	26	29	33	38	43	47	51	55	68
Main gaff	18	20	22	25	28	30	33	36	45
Bowsprit outboard.....	16	17	18	21	24	25	27	30	34
Topsail yards	27	30	35	36	37	38	39	41	43
	18	20	21	22	23	24	25	26	28
Spinnaker boom.....	30	35	40	42	44	45	46	50	58

SCHOONERS.

CIRCUMFERENCE IN INCHES OF WIRE FOR STANDING RIGGING.

R. Racer. C. Cruiser.	TONS.	TONS.	TONS.	TONS.	TONS.	TONS.	TONS.	TONS.	TONS.	
	R. 20. C. 30.	R. 30. C. 40.	R. 40. C. 60.	R. 50. C. 75.	R. 75. C. 100.	R. 100. C. 140.	R. 125. C. 180.	R. 150. C. 220.	R. 175. C. 250.	R. 200. C. 275.
Shrouds	1½	1½	1½	2½	2½	3	3	3½	3½	4
Pendants	1½	1½	2	2½	2½	3½	3½	3½	4	4½
Bowsprit shrouds	1½	1½	2	2½	2½	2½	3	3½	3½	3½
Forestay	1½	2	2½	2½	2½	3½	3½	3½	4	4½
Bobstay pendant	1½	2	2½	2½	2½	3½	3½	3½	4	4½
Topmast stay	½	1	1	1½	1½	1½	2	2½	2½	2½
Topmast backstay	½	½	1	1½	1½	1½	2	2½	2½	2½
Topmast preventer backstay ..	½	1	1	1½	1½	1½	2	2½	2½	2½
No. of shrouds a side.....	2	3	3	3	3	3	3	3	3	3
No. of backstays a side.....	1	2	2	2	2	2	2	2	2	2
Copper bobstay bar*	½	½	1	1½	1½	1½	1½	2	2½	2½

* The eyes in the bobstay bar must not be welded or braised. The ends of the bar should be heated and hammered back by striking the end of the bar on the anvil end on; when the end is driven up twice as thick as the other part of the bar, the hole can be drilled or punched—drilling is to be preferred.

SCHOONERS.

MAINMAST.

IRON STROP BLOCKS.

R. Racer. C. Cruiser.	Description.	TONS R. 20. C. 30.	TONS R. 30. C. 40.	TONS R. 40. C. 60.	TONS R. 50. C. 75.	TONS R. 75. C. 100.	TONS R. 100. C. 140.	TONS R. 125. C. 180.	TONS R. 150. C. 220.	TONS R. 175 C. 250	TONS R. 200. C. 275.
NAME OF BLOCK.	Number. Double. Number. Single.	Size.	Size.	Size.	Size.	Size.	Size.	Size.	Size.	Size.	Size.
		Ins.	Ins.	Ins.	Ins.	Ins.	Ins.	Ins.	Ins.	Ins.	Ins.
Throat halyards <i>a</i>	2 —	4½	5	6	7	8	9	9½	10	10½	11
Peak halyards ...	5 1	4½	5	6	7	8	9	9½	10	10½	11
Peak down-haul..	— 1	3½	4	4	4½	4½	5	5	5	5	5
Main sheet	2 —	4½	5	6	7	8	9	9½	10	10½	11
Main sheet lead	— 2	4	4½	5	5½	6	6½	7	7½	8	8½
Pendant	— 2	4	4½	5	5½	6	6½	7	7½	8	8½
Runner tackle <i>b</i> ..	2 2	4	5 & 4½	6 & 5	7 & 5½	8 & 6	9 & 6½	9½ & 7	10 & 7½	10½ & 8	11 & 8½
Onthaul.....	— 1	3½	4	4½	5	5½	6	6½	7	7½	8
Topsail halyards.	— 1	3½	4	4½	5	5½	6	6½	7	7½	8
Topsail sheet ...	— 1	3½	4	4½	5	5½	6	6½	7	7½	8
Topmast stay purchase	1 1	3½	4	4½	5	5½	6	6½	7	7½	8
Topmast back-stays	4 4	3½	4	4½	5	5½	6	6½	7	7½	8
Preventer back-stays	2 2	3½	4	4½	5	5½	6	6½	7	7½	8
Preventer back-stay whips.....	— 2	3½	4	4½	5	5½	6	6½	7	7½	8
Throat purchase.	1 1	3½	4	4½	5	5½	6	6½	7	7½	8
Peak purchase ...	1 1	3½	4	4½	5	5½	6	6½	7	7½	8
Topping lifts.....	— 4	3½	4	4½	5	5½	6	6½	7	7½	8
Topping lift purchase	2 2	3½	4	4½	5	5½	6	6½	7	7½	8
Spinnaker topping lift <i>c</i>	2 —	3½	4	4½	5	5½	6	6½	7	7½	8

ROPE STROP BLOCKS.											
		5½ & 3½	7 & 4	7½ & 4½	8 & 5	8½ & 5½	9 & 6	9½ & 6½	10 & 7	10½ & 7½	11 & 8
Reef tackle <i>d</i> ...	1 1	5½ & 3½	7 & 4	7½ & 4½	8 & 5	8½ & 5½	9 & 6	9½ & 6½	10 & 7	10½ & 7½	11 & 8
Tack tackles.....	3 3	3½	4	4½	5	5½	6	6½	7	7½	8
Spinnaker halyards.....	— 1	3½	4	4½	5	5½	6	6½	7	7½	8
Spinnaker guy whip	— 1	3	3	3½	4	4½	5	5½	6	6½	7
Topsail sheet whip	— 1	3½	4	4½	5	5½	6	6½	7	7½	8
Topmast staysail halyards	— 1	3	3½	4	5	5½	6	6½	7	7½	8
Topmast staysail tack	— 1	3	3½	4	5	5½	5	5½	6	6½	7
Topmast staysail sheet	— 1	3	3½	4	5	5½	6	6½	7	7½	8
Trysail sheets ...	2 2	5	5½	6	6½	7	7½	8	8½	9	9
Boom guy.....	1 1	3½	4	4½	5	5½	6	6½	7	7½	8
Dead eyes <i>e</i>	— 12	3½	4	4½	5	5½	6	6½	7	7½	8

- (a) The upper throat halyard block will be treble.
- (b) Fiddle blocks.
- (c) Single blocks under 75 tons.
- (d) Fiddle blocks.
- (e) Only two shrouds a-side under 40 tons.

SCHOONERS.

FOREMAST.

IRON STROP BLOCKS.

B. Racer. C. Cruiser.	Description.		TONS	TONS	TONS	TONS	TONS	TONS	TONS	TONS	TONS	TONS
	Number. Double.	Number. Single.	R. 30. C. 30.	R. 30. C. 40.	R. 40. C. 60.	R. 50. C. 75.	R. 75. C. 100.	R. 100. C. 140.	R. 125. C. 180.	R. 150. C. 220.	R. 175. C. 250.	R. 200. C. 275.
NAME OF BLOCK.			Size.	Size.	Size.	Size.	Size.	Size.	Size.	Size.	Size.	Size.
			Ins.	Ins.	Ins.	Ins.	Ins.	Ins.	Ins.	Ins.	Ins.	Ins.
Throat halyards	2	—	4½	5	6	7	8	9	9½	10	10½	11
Peak halyards	5	—	4½	5	6	7	8	9	9½	10	10½	11
Down haul	—	1	3½	4	4½	5	5	5	5	5	5	5
Vang	—	1	3½	4	4½	5	5½	6	6½	7	7	7
Fore-sheet.....	—	2	3½	4	4½	5	5½	6	6½	7	7½	8
Fore-sheet purchases..	2	2	3½	4	4½	5	5½	6	6½	7	7½	8
Pendant.....	—	1	4	4½	5	5½	6	6½	7	7½	8	8½
Runner tackle a	2	2	6½ & 3½	7 & 4	7½ & 4½	8 & 5	8½ & 5½	9 & 6	9½ & 6½	10 & 7	10½ & 7½	11 & 8
Topsail halyards	—	1	3½	4	4½	5	5½	6	6½	7	7½	8
Topsail sheets (cheek)	—	2	4	4½	5	5½	6	6½	7	7½	7½	8
Sheet lead	—	2	3½	4	4½	5	5½	6	6½	7	7½	8
Topmast backstays ...	4	4	3½	4	4½	5	5½	6	6½	7	7½	8
Preventer backstays ..	2	2	3½	4	4½	5	5½	6	6½	7	7½	8
Throat purchase	1	1	—	—	—	—	5½	6	6½	7	7½	8
Peak purchase	1	1	3½	4	4½	5	5½	6	6½	7	7½	8
Spinnaker topping lift	2	—	3½	4	4½	5	5½	6	6½	7	7½	8
Fore staysail sheets	—	2	3½	4	4½	5	5½	6	6½	7	7½	8
„ „ purchases	—	4	3½	4	4½	5	5½	6	6½	7	7½	8
Fore staysail halyards	—	2	3½	4	4½	5	5½	6	6½	7	7½	8
Downhaul	—	1	3½	4	4	5	5	5½	6	6½	7	7
Bobstay.....	1	1	4½	5	6	7	8	9	9½	10	10½	11
Bowsprit shrouds.....	2	2	6½ & 3½	7 & 4	7½ & 4½	8 & 5	8½ & 5½	9 & 6	9½ & 6½	10 & 7	10½ & 7½	11 & 8
Jib halyards	—	3	3½	4	4½	5	5½	6	6½	7	7½	8
Jib tack	—	1	3½	4	4½	5	5½	6	6½	7	7½	8
Jib purchase runner	—	1	—	—	—	5	5½	6	6½	7	7½	8
Jib purchase.....	1	1	3½	4	4½	5	5½	6	6½	7	7½	8
Dead eyes	12	12	4	4½	5	5½	6	6½	7	7½	8	8½
ROPE STROP BLOCKS.												
Spinnaker halyards ...	—	1	3½	4	4½	5	5½	6	6½	7	7½	8
Spinnaker guy whip...	—	1	3	3	4	4½	5	5½	6	6½	7	7
Trysail sheets	2	2	5	5½	6	6½	7	7½	8	8½	9	9½
Jib topsail halyards ...	—	1	3½	4	4½	5	5½	6	6½	7	7½	8
Fore staysail sheets ..	2	2	3½	4	4½	5	5½	6	6½	7	7½	8
Jib sheets.....	—	2	—	—	4½	5	5½	6	6½	7	7½	8
Burton	—	2	3	3½	4	4½	5	5½	5½	6	6½	7
Downhaul (forward)..	—	1	3	4	3½	4	5	5	5	5	5	5

(a) The double blocks are fiddles.

SCHOONERS.

TABLE OF SIZES OF CORDAGE.

NAME OF ROPE.	TONS. R. 30. C. 30.	TONS. R. 30. C. 40.	TONS. R. 40. C. 60.	TONS. R. 50. C. 75.	TONS. R. 75. C. 100.	TONS. R. 100. C. 140.	TONS. R. 125. C. 180.	TONS. R. 150. C. 220.	TONS. R. 175. C. 250.	TONS. R. 200. C. 275.
	Cf.	Cf.	Cf.	Cf.	Cf.	Cf.	Cf.	Cf.	Cf.	Cf.
	Ins.	Ins.	Ins.	Ins.	Ins.	Ins.	Ins.	Ins.	Ins.	Ins.
Main and fore halyards	1½	2	2½	2¾	3	3½	3¾	3¾	4	4½
Fore staysail halyards..	1½	1½	1½	1½	1½	2	2½	2½	2½	3
Jib halyards <i>a</i>	1½ (¾)	2 (¾)	2½ (¾)	2½ (¾)	2½ (¾)	3 (¾)	3½ (¾)	3½ (¾)	3½	4
Topsail halyards.....	1½	1½	1½	1½	2	2½	2½	3	3½	3½
Topsail trip halyards...	1	1	1½	1½	1½	1½	2	2½	2½	2½
Jib topsail halyards ...	1	1½	1½	1½	1½	1½	2	2½	2½	2½
Maintopmast staysail halyards	1	1½	1½	1½	1½	1½	2	2½	2½	2½
Spinnaker halyards and topping lift; also fore vang.....	1	1½	1½	1½	1½	1½	2	2½	2½	2½
Main sheet	1½	1½	2	2½	3	3½	3½	3½	4	4½
Foresheet	1½	2	2½	2½	3½	3½	4½	4½	5	5½
Fore staysail sheets ...	1½	1½	2	2½	3	3½	3½	3½	4	4½
Jib sheets.....	2½	2½	2½	3	3½	3½	3½	4	4½	4½
Topsail sheets.....	1½	1½	1½	1½	2	2½	2½	2½	3	3½
Jib topsail sheets	1	1½	1½	1½	1½	1½	2	2½	2½	2½
Maintopmast staysail sheets	1	1½	1½	1½	1½	1½	2	2½	2½	2½
Spinnaker sheets.....	1	1½	1½	1½	1½	1½	2	2½	2½	2½
Trysail sheets	1½	1½	2	2½	2½	2½	3	3½	3½	3½
Jib tack	2	2½	1½ <i>w</i>	1½ <i>w</i>	1½ <i>w</i>	2 <i>w</i>	2½	2½ <i>w</i>	2½ <i>w</i>	3 <i>w</i>
Tack tackles	1½	1½	1½	1½	1½	1½	2	2½	2½	2½
Main, fore, and jib purchases	1½	1½	1½	1½	1½	1½	2	2½	2½	2½
Downhauls	1	1½	1½	1½	1½	1½	2	2	2	2
Burton	1	1½	1½	1½	2	2½	2½	2½	3	3½
Bowsprit shrouds tackle	1½	1½	1½	1½	1½	1½	2	2½	2½	2½
Fore sheet purchases ...	1½	1½	1½	1½	1½	1½	2	2½	2½	2½
Bobstay tackle	1½	1½	2	2½	3	3½	3½	4	4½	4½
Runners (wire)	1½	1½	1½	1½	2	2½	2½	2½	3	3½
Runners (hemp or manilla)	2	2½	2½	2½	3	3½	3½	3½	4	4½
Runner tackles	1½	1½	1½	1½	1½	1½	2	2½	2½	2½
Topping lifts	1½	1½	2	2½	3	3½	3½	4	4½	4½
Topping lift purchase...	1½	1½	1½	1½	1½	1½	2	2½	2½	2½
Reef pendants.....	1½	1½	2	2½	3	3½	3½	4	4½	4½
Reef tackle	1½	1½	1½	1½	1½	1½	2	2½	2½	2½
Boom guy	1½	1½	2	2½	3	3½	3½	4	4½	4½
Boom guy purchase ...	1½	1½	1½	1½	1½	1½	2	2½	2½	2½
Lanyards	1½	2	2½	2½	2½	3	3½	3½	3½	4

(a) The small figures in brackets are the size of the links for chain halyards.
 (w) Wire rope.

TABLE OF DIMENSIONS OF YACHTS AND SPARS.

Name.	Rig.	'Length of L. W. L.	Extreme Beam.	Ratio of Beam to length = $\frac{B}{L}$	Extreme draught of water.	Length of Mainmast, Deck to Hounds.	Ratio of Foremast to Mainmast.	Ratio of Mainmast to Beam.	Length of Bowsprit outside Stem.	Ratio of Length of Bowsprit to Length L. W. L.	Extreme Length of Main Boom.	Length of Main Gaff.	Length of Topmast Fid to Halyard Sheave.	Area of Lower Sails.
		FT.	FT.			FT.			FT.		FT.	FT.	FT.	SQ. FT.
Sappho	s	122.0	27.0	.221	13.0	73.0	0.94	3.07	a 66.0	0.55	81.0	47.0	48.0	10223
Guinevere ...	s	121.0	23.5	.192	12.0	69.5	0.93	2.95	44.0	0.36	77.0	44.5	45.0	8611
Shamrock ...	s	105.0	25.5	.243	12.0	66.0	0.91	2.64	b 39.0	0.37	64.0	39.0	38.0	6985
Livonia	s	107.5	23.5	.220	12.8	66.0	0.95	2.80	38.5	0.35	70.0	43.0	44.0	7618
Columbia ...	s	98.5	25.5	.259	5.9	69.5	1.00	2.70	c 57.0	0.57	72.5	34.5	41.0	8000
Aline	s	100.0	21.7	.217	11.6	63.0	0.93	2.90	34.0	0.34	63.0	36.0	36.0	6710
Cambria ...	s	100.0	21.1	.211	12.4	62.0	0.93	2.95	41.0	0.41	63.0	37.0	35.0	6418
Gwendolin ...	s	100.0	21.0	.210	13.0	63.0	0.92	3.03	39.0	0.39	70.0	39.0	35.0	6903
Corinne	s	94.0	19.8	.211	12.3	58.5	0.93	2.95	34.0	0.36	60.0	36.0	35.0	5800
Waterwitch.	s	95.7	19.3	.202	12.2	58.0	0.91	3.00	33.0	0.34	62.0	36.0	37.0	5820
Egeria	s	93.7	19.2	.205	12.5	58.0	0.90	3.00	32.0	0.34	63.0	36.5	35.0	5988
Seabelle	s	90.5	19.1	.211	12.0	59.5	0.87	3.13	36.0	0.40	63.0	38.0	38.0	5780
Pantomime ...	s	91.5	19.3	.211	12.0	57.5	0.92	3.00	31.5	0.34	58.0	35.0	34.0	5657
Miranda ...	s	86.7	18.9	.219	13.0	58.8	0.88	3.12	27.5	0.31	64.8	35.5	34.0	5675
Dracena ...	s	80.0	18.0	.225	10.0	52.0	0.94	2.90	28.0	0.35	48.0	30.0	30.0	4005
Flying Cloud	s	73.5	15.7	.213	9.5	46.0	0.95	2.93	23.5	0.33	46.5	28.0	28.0	3632
Florinda ...	y	85.7	19.3	.225	11.9	54.5	33.5d	2.83	36.0	0.42	56.5	42.5	44.0	5257
Jullanar ...	y	99.0	16.9	.170	13.8	53.0	36.0d	3.12	24.5	...	56.5	42.0	38.5	5000
Caroline ...	y	75.0	16.1	.215	11.5	43.5	24.0d	2.72	31.0	0.41	50.7	37.0	35.0	3700
Oimara	y	95.0	19.9	.209	13.0	58.5	...	2.93	47.0	0.50	70.0	47.5	48.0	5500
Kriehilda ...	c	79.3	17.5	.221	12.3	47.5	...	2.72	36.0	0.45	65.0	43.5	44.0	4405
Formosa ...	c	82.0	16.9	.206	12.5	48.7	...	2.88	34.0	0.41	68.0	45.0	42.0	4890
Vol-au-vent	c	79.5	17.4	.219	12.4	48.5	...	2.79	34.0	0.42	67.5	43.0	42.5	4500
Arrow	c	79.2	18.7	.236	11.5	49.3	...	2.70	34.0	0.43	64.0	46.0	41.0	4770
Samcna ...	c	80.8	16.2	.200	...	50.0	...	3.00	34.0	0.42	68.0	44.0	44.0	4590
Vanduaa ...	c	81.3	16.2	.200	...	48.5	...	3.00	31.0	0.39	68.3	43.3	42.7	4650
Fiona	c	73.5	15.8	.215	12.2	44.5	...	2.78	34.0	0.46	60.0	38.0	...	3720
Iona	c	71.2	14.6	.205	11.0	43.5	...	3.02	32.0	0.45	57.5	35.5	...	3400
Daphne ...	c	69.4	14.1	.203	...	44.0	...	3.10	31.6	0.45	62.0	41.0	42.0	3650
40-tonner e	c	66.0	11.5	.174	11.5	43.0	...	3.74	28.0	0.42	57.0	38.5	...	3350
Anناسona ...	c	64.3	11.9	.185	...	40.0	...	3.34	30.0	0.47	53.9	36.0	38.0	3000
Slenthound	c	4.3	11.9	.185	...	40.0	...	3.34	30.0	0.47	53.9	36.0	38.0	3000
Bloodhound	c	59.8	12.8	.205	9.4	38.0	...	3.14	28.0	0.46	49.0	31.5	31.0	2600
Coryphée ...	c	63.3	12.1	.191	9.9	40.0	...	3.30	27.0	0.42	52.0	34.0	32.0	2900
Gleam	c	59.0	12.5	.212	9.0	36.5	...	2.90	26.0	0.44	48.0	32.5	32.0	2500
Myosotis ...	c	59.0	12.4	.210	10.0	37.0	...	3.00	27.0	0.45	47.0	31.5	31.0	2450
Freda	c	49.0	9.8	.200	9.5	34.5	...	3.40	24.0	0.50	43.0	28.0	30.0	2000
Sayonara ...	c	50.0	9.7	.194	...	34.0	...	3.61	24.0	0.48	42.0	27.0	28.0	1980
Vanessa ...	c	47.0	9.8	.209	7.8	31.5	...	3.18	24.0	0.51	39.0	27.5	26.5	1732
Maia	c	50.0	9.7	.194	8.8	34.5	...	3.55	24.5	0.50	43.0	30.0	30.7	2000
Ildegonda ...	c	40.0	9.5	.237	7.5	29.0	...	3.08	20.6	0.51	36.0	27.0	25.0	1550
Torch	c	43.5	9.0	.207	7.0	28.5	...	3.20	20.3	0.47	34.5	23.4	24.2	1530
Maggie	c	44.6	8.8	.197	...	29.0	...	3.30	21.0	0.47	37.0	25.5	26.0	1580
Buttercup ..	c	42.3	7.3	.172	7.8	30.0	...	4.11	20.5	0.49	39.0	25.0	27.0	1320
10-tonner f	c	42.0	7.0	.171	8.0	31.0	...	4.44	21.0	0.50	38.5	26.0	28.0	1830
Neptune ...	c	39.5	7.6	.193	...	28.0	...	3.07	19.5	0.50	35.0	23.5	25.5	1220
Lily	c	36.6	8.1	.221	6.8	25.0	...	3.09	17.0	0.46	31.5	23.0	24.0	1095
Pastime	c	37.3	7.8	.209	6.8	25.0	...	3.20	17.0	0.45	31.5	22.5	22.0	1000
Florence ...	c	39.0	7.8	.200	6.5	27.0	...	3.46	19.0	0.48	32.5	24.3	22.5	1190
Quiraing ...	c	38.6	7.8	.203	...	27.8	...	3.56	20.0	...	33.0	24.0	25.5	1207
Vril	c	28.3	6.5	.230	6.5	22.0	...	3.00	14.5	0.51	24.8	19.0	18.5	756
Freda	c	30.5	6.1	.200	5.3	21.5	...	3.44	16.0	0.50	29.5	19.5	18.0	900

a Bowsprit, 30ft. ; jibboom, 36ft.
 b Bowsprit, 24.5ft. ; jibboom, 20ft.
 c Bowsprit, 24.5ft. ; jibboom, 33ft.

d Length of misenmast deck to sheave hole.
 e f Building at Messrs. Inman's for Mr. Malcolm Murray and Mr. Coddington respectively.

STANDING RIGGING.

MAIN RIGGING.

The most satisfactory plan of measuring off the rigging for a yacht is to make a "spar plan" to scale—that is, a plan showing a broadside view of the yacht with all her spars in their places, as shown by Plate I. and Fig. 1. The latter plan, Fig. 1, is necessary to obtain the correct lengths of the lower-mast shrouds and topmast backstays, as merely taking the length deck to hounds makes no allowance for the "spread" the rigging is to have. (Of course an elaborate drawing is not required, but the scale must be carefully adhered to.) A further allowance must be made for the eyes of the rigging going one over the other, and this allowance will be equal to twice the diameter of a shroud. For instance, the eye of the starboard fore shroud is put over the masthead first; then the port fore shroud, which follows, must be cut longer than the starboard rigging to the extent of twice the diameter of a shroud (twice the diameter is equal to two-thirds of the circumference, the circumference being three times the diameter). The second and third starboard shroud form a pair, and the allowance will be four times the diameter; and so on. (The forestay goes over all, resting on the throat or main halyard bolt.) (See page 31, Fig. 5.) For the eye and splice an allowance equal to one and a half the circumference of the masthead must be made; for the dead-eye an allowance equal to one and a half the circumference of the same. The eye to go over the masthead should be one and a quarter the circumference of the mast at the hounds; the eye at the other end of the shroud should be one and one-eighth the circumference of the dead-eye, so that the latter could be removed if split or damaged, and replaced. The length for each shroud is measured from the top of the bolster to the dead eyes; the drift or space between the upper and lower dead-eyes, or from the channel to the top of the upper dead-eye, will be about the height of the bulwark.

There are two plans for fitting the shrouds, one known as "single eye," and the other as "pairs." In the former plan each shroud has its own eye; but when shrouds are fitted in pairs the wire goes from one dead-eye up round the masthead, and down to the next dead-eye (on the same side). A wire seizing close up to the bolster, round both shrouds, forms the eye. This is the most generally used plan, and the only objection to it is that if the eye bursts a pair of shrouds are gone; and even if one shroud burst, the strain on the remaining one might prove too much for the seizing. This, however, can be said in favour of the "pair" plan, that there are just half the number of eyes to go over the masthead,

and consequently there is a trifle less weight aloft and a neater-looking masthead. If there are four shrouds a-side two "pairs" are fitted; if three one "pair" and one "single."

Formerly, in the case of three shrouds a-side, instead of one single eye and one "pair," two "pairs" were fitted, the aftermost shroud doing duty as a pendant; this plan has been abandoned, as the seizing so constantly burst in consequence of the great angle the pendant made with the shroud.

There are three plans in use for covering the eyes of rigging; 1. Parcelling and serving with spun yarn; 2. Covering with canvas and painting it; 3. Covering with leather.

The first plan is cheapest, but will require renewing every year; the third is the most costly, and lasts the longest; whilst the second is most used, and perhaps looks the neatest. The eyes at the lower ends of the shrouds are generally served with spun yarn; but leather looks neater, and will not turn white, as spun yarn will, by the continual washing whilst dragging through the water; an occasional blacking or varnishing will remove the washed-out appearance that a spun-yarn serving might get.

The lanyards are rove in this manner: A Matthew Walker, or wall knot, is made in one end of the lanyard; the other end is rove out through the foremost hole of the upper dead eye; in through the corresponding hole of the lower dead eye; out through the centre hole of the upper dead eye, and so on, the hauling part coming in through the aftermost hole of the lower dead eye and is then set up by a luff upon luff tackle.

The hauling part (*a*, Fig. 6) is then

secured to its next standing part by a racking; it is then carried up and out through the eye of the shroud at *e*; round the back part of the eye at *b*, and in through at *c*; a tackle is then put on the end, *d*, and when set up the part *d* is seized to a standing part of the lanyard (see Fig. 6).

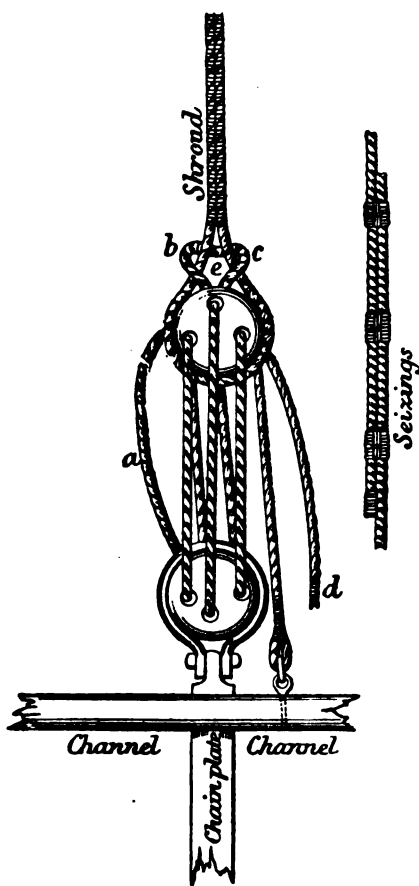

FIG. 6.

Sometimes the fall *d*, instead of being passed through the shroud eye at *e*, is secured by a couple of half-hitches round the shroud and seized as before described. Also, sometimes the fall of the lanyards is secured by a couple of simple turns and seized in the usual way round the eye of the shroud. The sheerpole passes across the eyes of the shrouds immediately over the dead eyes.

Wall knots and Matthew Walkers have, however, been known to draw, and now the general practice in racing vessels is to have a thimble eye spliced in one end of the lanyard, which eye is shackled to an eye bolt in the channel (see Fig. 6) rather ahead of the foremost chain plate; the other end of the lanyard is rove *out* through the foremost hole of the upper dead-eye (always commencing with the starboard fore shroud) *in* through the corresponding hole of the lower dead-eye, and so on; passing round the aft side of the mast, and ending with the port fore shroud: on the port side the lanyard is shackled to the channel under the after hole of the upper dead-eye. As this makes another part, extra setting up will be required, as most likely the lanyards will not render freely through the holes in the dead-eyes; sometimes three parts are set up first, then secured with a racking, and the tackles shifted to set up the remaining parts.

A racking is made as follows: a piece of rope, two or three feet long, is secured to one of the parts of the lanyard by a running eye at *a* (Fig. 7). The other end is then passed in and out as shown. The whole is then jammed up close together, and the part *b* properly secured.

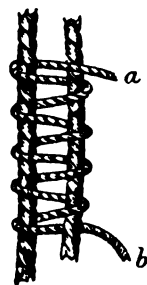

FIG. 7.

Very great care must be taken in setting up rigging so that an equal strain is brought on all its parts.

Cutter or yawl yachts of from 5 to 15 tons usually have two shrouds a side; those from 20 or 80 tons three shrouds a side; and those above 80 tons four shrouds a side.

Schooners usually have three shrouds on each side of main and fore mast. Very large schooners, however, like *Guinevere*, *Boadicea*, and *Elmina*, have been fitted with four shrouds on each side of main and fore mast, or sixteen shrouds in all.

When wire rigging was first introduced, great objection was taken to it, on account of its rigidity; and it was declared that the stretching of the lanyards would not compensate for the stretching which was due to hemp shrouds. Various plans were suggested to supply the deficient stretching quality of wire rigging, such as spiral spring lanyards, and

screw lanyards with india-rubber buffers.* The fact is, however, that the stretching sought to be given to the wire rigging is not required,

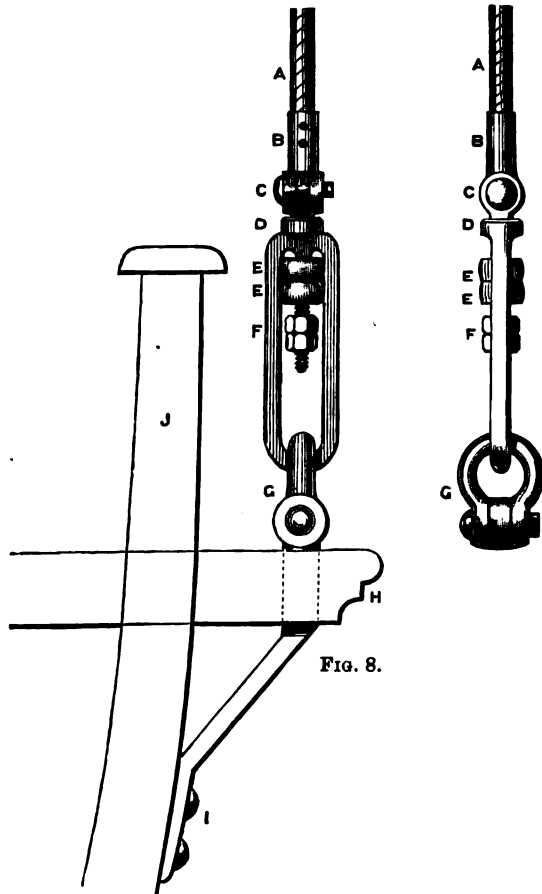

FIG. 8.

and indeed would be a great source of danger. Mr. W. John, in his elaborate report to Lloyd's Committee in 1877 on the dismasting of ships, shows the very considerable stretching qualities which wire rope has, and the general elasticity of wire shrouds and hemp lanyards combined. From his report we learn that the stretch wire rope is capable of before breaking is very considerable, and that not half of that stretch and strength would be exhausted when the mast had arrived at its breaking point, due to bending.†

Rope is more or less elastic — that is, it will “take up again” after it has been stretched, but never quite so much as it

may have been extended; and old rope has scarcely any elasticity at all.

Thus so far there is little danger that a yacht's spars will be lost in consequence of the wire rigging giving out; and, as in ships, it is found

* The late Captain Keane, of East Cowes, proposed the following plan for elastic lanyards or buffer in 1873: A (Fig. 6) is a shroud; B, shod, to be made of good length to prevent stripping, or an eye could be turned in to take a shackle; C, a bolt; D, a collar to receive the bolt for screw nuts; E, india-rubber buffers of the required number and size; F, screw nuts (two in number), to prevent stripping; G, shackle; H, channel; I, chain plate; J, bulwark.

† Mr. W. John, in his report, gives the following formula for ascertaining in tons the breaking strain of wire rope. The square of the circumference of the rope in inches, multiplied by 1.034; that is to say, if the rope be 2in. in circumference, the breaking strength will be $2 \times 2 \times 1.034 = 4.13$ tons, or about 25 per cent. less than authorities on the subject have usually given. The size of steel wire of equivalent strength is generally given as 0.8 of the size of the charcoal iron wire rope; that is to say, if the iron be of 2in. circumference, the equivalent strength in steel would be thus found $2 \times 8 = 1.6$ in. or $1\frac{1}{2}$ in. However, from experiments made by Mr. John, it would appear that the strength of the steel wire varies very considerably, and, whilst the ratio in

that if a mast is so lost, it is generally through some defective ironwork or careless fitting of the rigging.

It has been contended that a yacht's main rigging should be stretchable, because, if she were sailing in squalls or under the influence of successive shocks of wind force, if the rigging did not give to some extent, it would be like attempting to drive a railway train by a succession of blows from a sledge hammer. In stating the case thus ludicrously the fact is entirely overlooked that a vessel's heeling facility affords much greater relief to such shocks than could the yielding property of any rigging, unless indeed the latter were to be so stretchable as to be perfectly useless for stays. In fact, Mr. John clearly shows in his report that, so far as safety goes, the rigging cannot be set up too rigidly, and the less it stretches the better. It was found that in very heavy weather with a ship rolling and pitching heavily, three-fourths of the ultimate strength of the mast and rigging might be tried at any one moment, and that a succession of such trials would inevitably end in disaster. On this subject Mr. John says: "The margin of strength found to exist in the masts and rigging, to meet the heavy strains arising from heavy weather, is so small that every inducement should be offered to builders and owners to increase the support afforded to the masts, and especially when it is known that so much good can be done in this direction, without adding to the top weight, by simply reducing the elasticity of the shrouds. Wire rigging set up by screws unquestionably affords the most suitable and efficient support to iron masts; and it is to be hoped that the practice of adopting them, which has been growing

some cases with soft steel was less than that given, in other cases with hard steel, the ratio of strength was greater.

The breaking strain in tons of single rope, such as the lanyards, was found to be equal to the square of the circumference in inches, multiplied by the fraction 0.2545.

The whole breaking strain in tons of the lanyards, rove in six parts, was found to be equal to the square of the circumference of a *single* part multiplied by the fraction .843. The joint strength of the six parts is considerably less than six times the single part, and the disparity varied between 2.97 and 4.98; and it would appear that ill-made or defective dead eyes had a great deal to do with the apparent loss in strength.

The stretch of lanyards in six parts was found equal to the strain in tons multiplied by the distance from centre to centre of the dead eyes, and divided by six times the square of the circumference in inches of a single part of the lanyards.

The stretch of wire rope was found to be equal to the length of the shroud multiplied by the strain in tons, and divided by the square of the circumference and by 20.

Generally it is found that wire rope, when the strain is removed, does not "take up" all that it has been stretched, and ultimately the stretching quality of the wire will be lost without much loss in strength. The stretching quality of wire rope to some extent depends upon the core being of hemp, and to reduce the stretch it has been suggested that the core should be of wire. Wire rope stretches more rapidly as the strain increases, whereas hemp rope stretches less rapidly; but these peculiarities are mainly observable as the ropes approach the breaking point.

The weight of iron or steel wire rope per fathom can be found by dividing the square of the circumference (circumference²) by 1.1; the weight of hemp rope by dividing the square of the circumference by 4. (See also "Wire Rope" in the Appendix.)

up lately, will extend, and become far more general than heretofore. Where hemp lanyards are adopted the drift between the dead eyes should be reduced to a minimum, and they should be most carefully kept set up. Bobstays, it is considered, should be increased in size, and all eye bolts, pins, and shackles connected with them should be fitted with the greatest care *and of a strength at least equal to that of the bobstay.*"

This was written especially in relation to iron masts, but it is applicable to wood masts, and only in a slightly modified degree, as, although wood masts can be bent to a greater extent than iron or steel masts without breaking, yet will a wood mast reach its breaking point before the stretching and strength of the wire rigging are exhausted, as previously stated.

So far as the requirements of match sailing go, there can be no doubt that the more rigid the rigging can be kept the better are the results. The old-fashioned theory is that the rigging should give readily, and that the masts should have plenty of play. This curious fallacy has been maintained by still more curious arguments and theories; and we have known some sailing masters slack up the rigging to give it the required play. It is obvious that the mast would yield under such circumstances, as the strain would not come upon the rigging until the mast had been very considerably bent—perhaps almost to the breaking point. We need not dwell upon the bad effects of slack rigging* and a yielding mast further than to say, that anything which tends to render the application of the propelling force intermittent, or to absorb any portion of it and reduce its effect, must in some measure detrimentally influence the speed of a vessel; and if rigid rigging is necessary for the good performance of sailing ships, it is equally necessary for the attainment of the highest results in competitive yacht sailing.

TOPMAST RIGGING.

The topmast rigging will be cut (due allowance being made for the spread of the cross-trees), fitted, and served in the same manner as the main rigging, but with single eyes and not in "pairs;" the eyes at the lower end of the shrouds will be turned in round galvanised iron thimbles, to take the hooks of the setting-up tackles, or falls, as they are termed.

Each topmast backstay is usually in two parts, the lower part being the leg, which is in length equal to the housing length of the topmast.

* In selecting wire shrouds, pendants, or stays, care should be taken that flexible wire is not supplied; as flexible wire stretches very badly, "takes up" again very little, and "constant setting-up and never taut" will be the inevitable result.

A thimble is eye-spliced into the upper and lower end of the leg, and a shackle joins it to the upper part.

Yachts above 10 tons usually have two topmast shrouds, or two backstays as they are more generally termed, on each side, and one "preventer" or shifting backstay each side. In yachts of 10 tons and under one backstay and one preventer each side are generally considered sufficient; in these vessels a thumb cleat is usually fitted to the cross-trees, and when the yacht is at anchor the preventer is put in this and set up with its tackle, for the sake of tidiness. In large yachts a cleat or score is also provided on the cross-trees, for the preventers when not in use. A favourite plan, however, is to set up both preventers from their eye bolts aft on the counter; and the only objection to this plan is, that there is more gear for the yards or jibbooms of passing craft to pick up if they come dangerously near; on the other hand, so far as appearance goes, it makes a yacht look a little more rigged.

Schooners, in addition to topmast shrouds and preventers, have a main-topmast stay which leads from the shoulder of the main-topmast to the foremast head (see Fig. 3); some cruising schooners further have a standing fore-topmast stay, which leads from the fore-topmast shoulder to the mainmast head.

The shifting or "preventer" backstays will be measured for length from the shoulder of topmast to taffrail, and then deduct from this length about six or seven feet for the setting-up tackle. In large vessels this tackle always consists of two double blocks, the standing part being generally made fast to the upper block, and then the fall leads from the upper block; but sometimes the tackle is put the other way up, so that the fall leads from the lower block. The advantage of this plan is that several hands can get on the fall for a "drag;" the other plan, however, is more shipshape, and if the fall be put under the cavel round a belaying pin, with a couple of hands to "swig" and one to take up the slack, the tackle will always be set up taut enough. The tackles are hooked to the trysail sheet bolts on the quarter. In some racing yachts a capital plan is adopted to avoid any possible mishap before the backstay can be properly set up: a tail block is seized to the lower end of the preventer just above the eye; a single rope is rove through this block, and one end of it is secured by a running eye to the cavel aft; a knot is tied in the other end to prevent the rope unreeving. The rope is of sufficient length to admit of the preventer being carried into the main rigging without it being unrove. When shifting the backstays, as in gybing, one hand takes hold of the hauling part of this "whip" to leeward, and hauls the backstay aft and gets it set up fairly taut, whilst another hand prepares the tackle

for hooking on as the boom settles over. If backstays are properly worked in this way, a topmast should never be lost in gybing.

In all yachts it is a great advantage to be able to get the topmast quickly on deck, and in those of 40 tons and under the man-of-war plan of sending the rigging up on a funnel can be recommended. A topmast

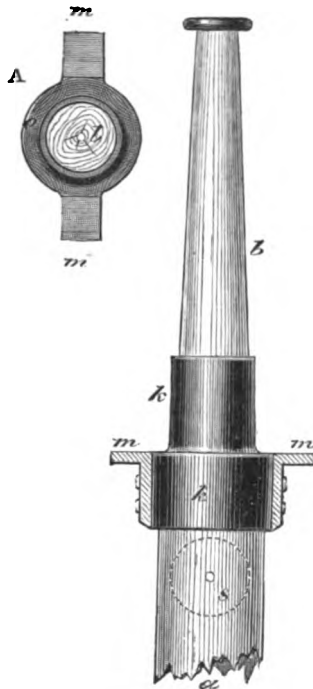

FIG. 9.

on deck, instead of up and down the mast, is as good as a reef; and in small yachts of 5 and 10 tons, where the stick can be easily "man-handled," the funnel arrangements can be made use of. Mr. Beavor Webb adopted the plan in the *Freda*, and Mr. Baden-Powell in the *Kohinoor*, and both commend it. In the annexed diagram *a* is the topmast, and *b* the pole of the topmast; *s* topsail halyard sheave; *k* is the funnel; *m* and *m* are two catches rivetted to the funnel; the catches rest on the cap of the mast in a fore-and-aft direction when the topmast is lowered, and prevent the funnel going down through with the topmast. The funnel, it will be seen, is made to fit on the shoulder of the topmast, the lower part of the funnel being greater in diameter than the upper part. Fig. A shows the funnel viewed from above, *c* being the shoulder, *b* the pole of topmast, and *m m* the catches.

All the topmast rigging, including preventers, also spinnaker and jib topsail halyard blocks, are fitted on the funnel over the shoulder. A stout rope grommet should be fitted on the shoulder of the funnel as a bolster to prevent the rigging being cut. In lowering the topmast the halyards must be unrove from the sheave *s*; then, when unfiddled, the topmast will come down; but the funnel, with the catches resting on the upper cap, will remain at the masthead—that is, the lower half of the funnel will be inside the cap, and the upper half above the cap. All the rigging, &c., of course remains on the funnel. To get the topmast up again, the pole will be shoved up through the funnel, and, when clear of the cap, a hand aloft will reeve the halyards through the sheave hole *s*. In lowering whilst racing, the flag would have to be taken off before bringing the pole through the funnel, as it might foul. So also if there are signal halyards or trip halyards, they must be unrove. Any good brazier would make the funnel, and rivet or weld the iron catches on. The funnel would, however,

be better made of copper. Care should be taken that the lower part of the funnel is made as deep as the cap, and that it fits inside the cap easily, but not too loosely. The upper part of the funnel must be high enough to take all the eyes of the rigging and tails of blocks. The man-of-war funnels have no lower part, and the catches when the topmast is down have to be lashed to the cap; this of course takes up time. A topmast, with the funnel as described in a 5-tonner, can be got on deck in one minute, and be got up again in nearly as little time.

Mr. Thomas Butler, of Barrow - in - Furness, invented a topmast funnel, on the plan shown in the annexed diagram (Fig. 10), and used it in his 3-ton yacht for getting his topmast on deck without unrigging. The funnel (shown by A) is cast in brass, about $\frac{3}{16}$ inch thick. *a* is the pole of the topmast, which is fixed or jammed in the funnel, and does not come below *c*. *b* is the lower part of the topmast. *x* is a stud to insure the funnel getting on the right part of the topmast. *c* is a shoulder to strengthen the funnel, and rests on the masthead

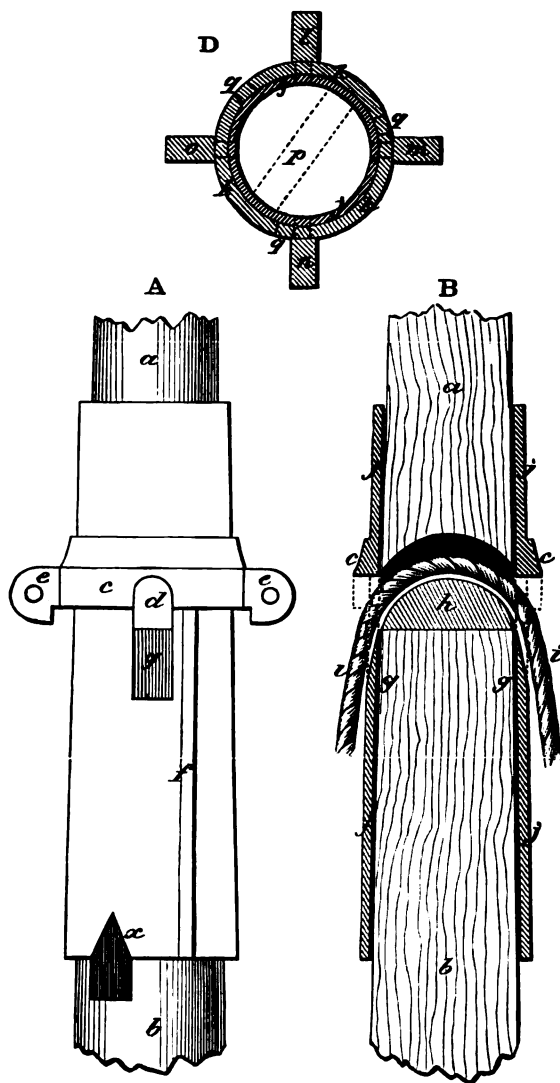

Scale.—3in. to the foot

FIG. 10.

cap when the topmast is lowered. *d* is a hole in the funnel through which the halyard is rove. *g* is a part of the funnel bevelled away to prevent the halyard being cut. *f* is a rib, of which there are three. (As the funnel is necessarily larger at the bottom than at the top,

the top part would fit loosely in the masthead cap; hence the ribs are made to taper to nothing at the bottom, and just fill out the cap when the funnel is lowered inside the cap.) *e e* are two eyes; of these there are four, two for shrouds, one for topmast forestay and one for shifting backstay. They can either be cast with the funnel or rivetted in afterwards. *B* is a section of the funnel, viewed nearly broadside on; *j j j j* shows the thickness of the brass, and *g* the bevellings; *i* the halyard; *k* is a piece of hard wood fitted on the upper end of the topmast, as shown, instead of a sheave. If a sheave were used, it would require a broad one with a good deep score in it. *D* is an end-on view of the funnel; *l* is the fore eye, looking in a fore-and-aft line corresponding with *n*; *o* and *m* are the two eyes for the shrouds; *q q q* are the ribs; *k k* are the shoulders; *p* is the opening for the halyard; *j* is the funnel. If other halyards are required, tail blocks can be made fast round the shoulders for them to run through.

The feature of this arrangement is that the topmast may be got on deck, or rather all that portion of it which is below the topsail-halyard sheave hole, leaving the pole and funnel, with the signal and topsail-halyards, and be sent up again without anyone going aloft to reeve the halyards or fid, as the heel rope can be trusted to keep the topmast up. If necessary, in a squall, topsail and topmast could be lowered altogether by letting go the heel rope; this is of great consequence in small boats, as it enables a larger topsail to be used than a pole mast will admit of without the latter being too big for a sea way.

Various plans have been devised for fidding and unfidding topmasts without going aloft, and the "tumbler" plan has been in fashion some time. In Fig. 11, *A* is a pawl which drops into a score in the topmast as the latter is got up. When the topmast has to be lowered, haul on the heel rope; and when the topmast is lifted sufficiently high, pull on the small rope *B* (which passes over the sheave *C*) until the pawl is clear of the score. The topmast can then be lowered.

The "self-fidding topmast" (Fig. 12) has been used, and was designed and thus described by Mr. Augustine L. Dunphy:

"The fid consists of a properly-shaped bar of iron working rather stiffly on a pin in the heel of the topmast, the slot (see *A*, 1) in which is cut specially to suit the peculiar action of the fid; a stout bolt, *B* (2), firmly screwed into the masthead, completes the whole of the mechanical part of the arrangement.

"*To Fid the Topmast.*—The fid is placed in position, as shown at *A* (2), by hand whilst the topmast is down, and then, hauling on the heel rope, the topmast rises until the projecting part (*A*) of the fid strikes the

bolt B (a score is cut in the cap, so as to enable the fid to clear), and is pushed into a horizontal position when the heel rope is slacked, and the topmast will fall a few inches, fidded as securely as by the old-fashioned bolt (see 4, Fig. 12).

To Unfid.—Haul on the heel rope until the topmast is chock up; the fid rising with topmast again strikes the bolt B, thereby changing its

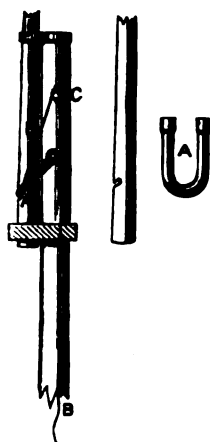

FIG. 11.

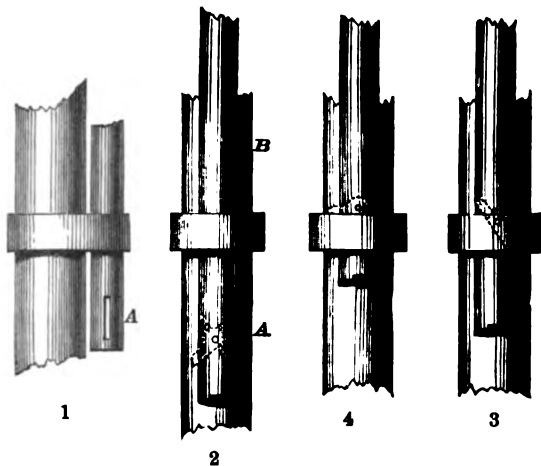

FIG. 12.

position to that shown in (3); ease up the heel rope, and the topmast is free to come down.

“A little extra care is necessary in sending up the topmast, as if driven up too high the fid is fidded and unfidded, when a hand must go aloft to right, or the topmast lowered so as to place the fid in position again. This fid has been in almost constant use, and has never failed me in any case. It will act equally well when the mast is at any angle, and dispenses with the tripping lines, which are always getting foul or being carried away. It never fails to bring down the topmast.”

An automatic fid, invented by Mr. E. Allix, of Southampton (Fig. 13), is an ingenious device. (The agents are Messrs. Fay, ship chandlers, High-street, Southampton.

No. 1 is a vertical section taken through the fid hole, showing the fid and lever.

The action in fidding the mast is as follows: On the mast being hoisted the fid F hangs in a nearly vertical position, wholly within the fid hole as usual, and the curved lower arm of the lever K projects from the fid hole (see No. 4). When the fid has passed through lower cap C¹ (or the tressel trees, as the case may be) to a certain distance above the same, the projecting curved arm K of the lever strikes against the said

cap (or tressel trees), and in passing through the same is oscillated on its pivot and pushed back within the fid hole (as shown in No. 1). By this movement the upper end *e* of the lever is caused first to turn the fid into a horizontal position, and then to engage with the notch in the fid, as shown in position (No. 2). By this means the fid is held up in a nearly horizontal position until by lowering the topmast it rests upon the cap *C*¹ (or tressel

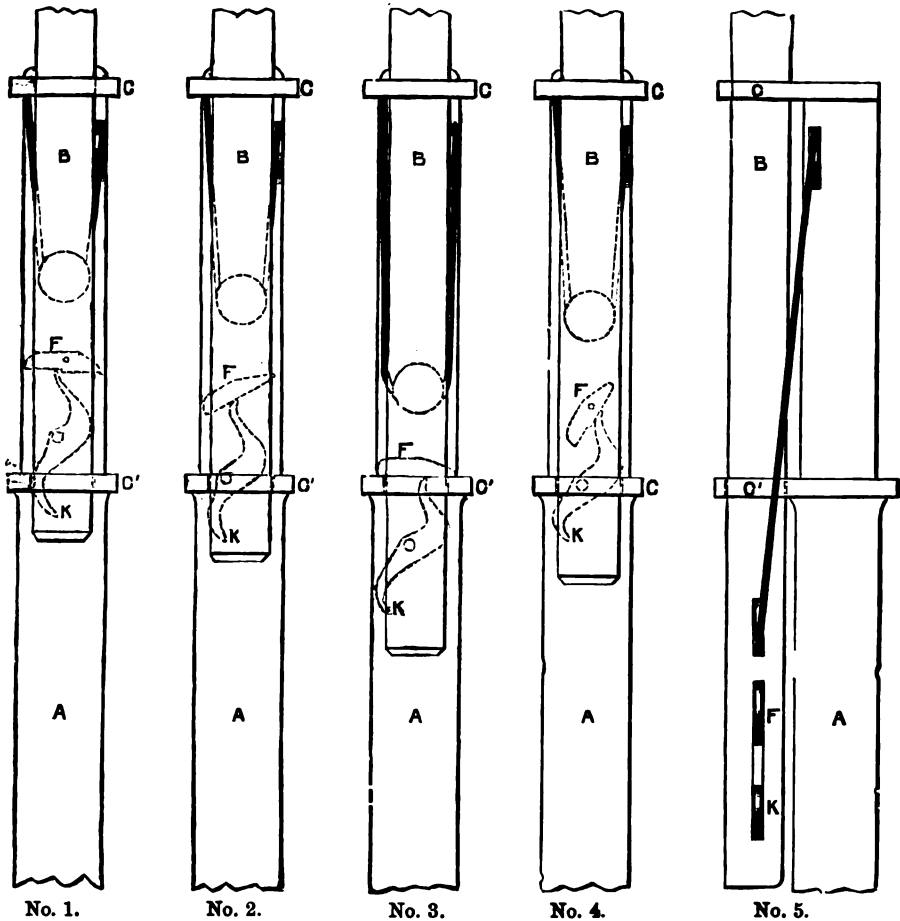

FIG. 13.

trees, as the case may be), as shown No. 3, whereupon the nose of the lever is disengaged from the notch, and the lever *K* allowed to fall back to its former position (No. 2). The topmast is then fided.

In unfidding the topmast is raised slightly, so as just to lift the fid clear of the cap or tressel trees, but not *high enough for the projecting arm of the lever to be acted on*, whereupon the fid is free to fall within the fid hole in the usual way.

One of the most approved plans of self-unfidding topmast is shown by Fig. 14. *a* is the topmast, *y* the yoke, *s* is an iron tumbler fid, pivoted by a bolt shown above *a*. *m* and *n* are slots cut in the topmast, *k* is a small line fastened to the fid, and passed up through a hole bored in the heel of the topmast. To unfid hoist on the heel rope until the tumbler falls into the slot *n*, then lower away. To fid, hoist by the heel rope until the slot *n* is above the yoke. Then pull on the line *k* until the fid is in the horizontal position shown in the drawing. We think this fid is to be preferred to either of the other two.

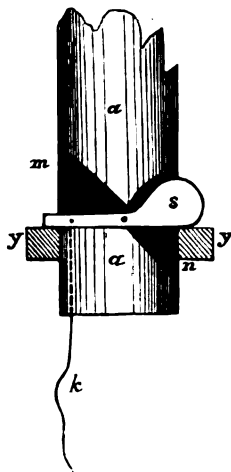

FIG. 14.

PENDANTS AND RUNNERS.

The pendants are made of wire rope, and are put over the masthead before the shrouds, and are covered with canvas. The pendant is usually in length two-thirds the distance deck to hounds. The lower end of the pendant is shod, or, if not shod, an eye is turned in over an iron thimble. A single block is shackled to this end of the pendant, and through the block the runner is rove.

The runner is sometimes made of hemp or Manilla rope, but in large racing vessels it is more frequently made of flexible wire rope. The runner in total length is generally three-fifths the distance deck to hounds. Each end of the runner has a thimble-eye splice, with a strong hook at the end of the standing part, which leads aft to be hooked to an eye bolt on the rail.* In some cruising yachts the standing part of the runner is shackled to the eye bolt in the rail, but the general practice is to have a hook, as the runner has so frequently to be let go to allow the boom to be eased off. The tackle is shackled to the end of the other end of the runner, and usually consists of a fiddle block and single block below, but sometimes the upper block is a common "double." The fall of the tackle always leads from the upper block. With the wind much forward of the beam, very little strain comes on the runner; but they should be kept well set up, or otherwise the mast may go forward, and bring about a slack forestay, and throw an undue strain on the aftermost shrouds.

* The runner should be always hooked so that the point of the hook comes uppermost; this will bring the strain fairly on the throat of the hook; otherwise the hook may be straightened or broken.

FORESTAY.

The forestay goes on "over all;" but now the practice is to have the eye, or collar, large enough to go well up the masthead, above the yoke and over the throat-halyard-block bolt. The collar encircles topmast as well as the yoke: and the eye should be made so that the splice comes just under the crosstrees. (See page 31.) The yoke will then give the spread to the collar necessary to allow the topmast to go up and down without touching it. The collar should be leathered. The stay leads down to the fore side of the stemhead, where it is rove through a hole and under a sheave which is let into the stemhead. The end is then made into a bight (with a thimble or bullseye in it), well seized and set up with a lanyard to the bitts. In reeving the forestay through the stemhead it must not be forgotten that the iron hanks or rings for the foresail must go on it first.*

TRIATIC STAY.

Formerly, in schooners, a mainstay led from the mainmast head to the deck, forward towards the foremast, and was set up by a tackle, one on either side; in tacking or wearing, the lee one had to be eased up, and, if smartness were not displayed the mainmast would fall aft, as the stay had to fulfil the same duty for the mainmast that the forestay does for the foremast. This plan was found very inconvenient in racing schooners, and, about twenty years ago, the fashion became general to carry a stay, termed a triatic, to the foremast head, a larger forestay being introduced to bear the extra strain thrown upon it. The disadvantage of this plan is that it entails some trouble in tacking or gybing, as double fore-topsail sheets and tacks are required. The fore topsail has to be clewed up every time the schooner is put on a different tack, and the sail re-tacked and re-sheeted to leeward of the stay. To obviate this trouble, double triatics, or jumpers, have been tried, the lee one being always eased up; but there was still the difficulty of getting the clew over the main-topmast stay, and the danger of not getting what had been the lee triatic (now the weather one) set up before the vessel filled. On the whole, the single standing triatic gives the least trouble and is the safer, but, of course, one will sometimes give way. If such an accident occurs, it is usual to take one of the main runners forward, and set up.

There are two ways of fitting a triatic stay to the mastheads; the most approved plan is to have a thimble eye spliced into either end of the stay, and shackle it to an eye welded on the masthead cap. The

* In schooners, and in some cutters, when the bowsprit goes out over the stem, the forestay is set up to the spanshackle by a screw bolt and nut.

other plan is to shoe the stay with lugs, and bolt it with a pin to the masthead cap.

TOPPING LIFTS.

In vessels under 20 tons there is one topping lift a side, and the standing part is hooked to an eye in an iron band round the boom. The topping lift is rove through a single block shackled to an eye plate on the cheeks of the mast. The hauling part of the topping lift has an eye, to which the purchase block is hooked or shackled; the purchase consists of a double and single block.

In vessels from 20 to 50 tons the topping lift is single, with the addition of a runner, the standing part of which is fast to the rail, or to the cavel abreast of the mast.

In vessels above 50 tons it is usual to have double topping lifts, with runner rove through a block on the end of the hauling part of the lift; a tackle is hooked to the runner; in such case the standing part of the lift is shackled to the block at the masthead, and leads thence through the block on the boom, and back through the block at the masthead.

Some large vessels have a single topping lift a side, made of flexible wire and covered with canvas. These, of course, have the runner and tackle. These topping lifts look neater than the double (rope) ones, and, so far as we know, overhaul themselves just as readily.

Very small craft have only one single topping lift, and of course, when under way, this one is always slack if to leeward, whereas the practice in larger craft is always to have the weather lift set up hand taut and belayed.

BOWSPRIT SHROUDS.

Bowsprit shrouds are now invariably made of wire rope, and have a thimble eye-splice in each end; one end is shackled to the iron crane at the bowsprit end, the other to the setting-up tackle. This tackle formerly was always outboard, hooked to an eye bolt on the top strake, where it not only dragged through the water and picked up weeds, but was not so readily got at when reefing the bowsprit. The tackle consists of an iron fiddle block and a single block, the latter being at the after end of the tackle. (See Fig. 4, page 30.) An eye bolt is fitted in the deck to take the tackle. This bolt should go through a beam, and have a plate and spur on deck; the strake of deck plank where the bolt is should be of hard wood, and the bolt should be a very strong one. Several vessels have lost their bowsprits through this bolt drawing, crushing through the plank, or breaking off short. Notable instances

occurred in the match for the Queen's Cup at Cowes in 1874, when the *Morna* schooner and *Kriemhilda* cutter lost their bowsprits. Oddly enough, the *Kriemhilda* lost her bowsprit at Torquay the year before from the same cause, and so did *Iona*, and numberless other cases have occurred. Hatcher fits an iron band, with an eye in it, round one of the bulwark stanchions, for the shroud tackle block to be hooked to, and this appears to be a good plan. Another fruitful cause of mishap to bowsprits has been the practice of having an iron shoe instead of a thimble eye-splice in the shroud for the shackle. Even when the shoe is a long one, it will occasionally strip in consequence of the wire parting where the rivets go through, and a shoe should never be trusted for any part of the wire standing rigging.

BOBSTAY.

Various ingenious plans have been invented for bobstays, as no part of a yacht's gear so frequently gives out; but the most usual plan of making up a bobstay is as follows: a copper bar shackled to the stem, and about as long as the bowsprit is high out of the water; then a wire pendant and tackle. The tackle has a single block next the pendant, and a double one at the bowsprit end, the fall leading inboard at the stem. The cordage selected for the tackle is usually bolt rope. A common practice in racing vessels is to have a "baby bobstay," or preventer which is not set up quite so taut as the other; this preventer has no doubt saved some bowsprits, but, on the other hand, it has undoubtedly been the cause of many being carried away. Constantly setting up the jib, or the strain of the jib alone, or the strain of the bowsprit when set down to a crook, will soon cause the fall to stretch or "come up," and then an equal strain comes on both. But very frequently the preventer is set up a little tauter than the other; in such cases, if there be any weight in the wind, the preventer is almost certain to part, and the other if the jerk be very great, may go with it. If the main bobstay should go first, it would be hardly reasonable to expect the other and weaker one to stand; it may, it is true, just save the bowsprit, but the sailing master will have so little confidence in the preventer that he will order the jib sheets to be eased up, and will gill his vessel along, whilst the other bobstay is being patched up, if such a thing as patching be practicable. Another danger attending the practice of having two bobstays is that the main one is never quite so stout and strong as it otherwise would be; and, as it is almost certain that an unequal strain will come upon them, one only has practically always to do the work. Therefore by far the wiser plan is to have one stout and strong bobstay, equal in fact to the united strength of the two.

RUNNING RIGGING.

JIB TACK, JIB HALYARDS, AND JIB SHEETS.

The jib tack requires to be of great strength, and is made indifferently, accordingly to the judgment of the person who has the fitting out of the yacht, of rope, chain, or flexible wire rope. Rope does very well in vessels under 40 tons, but wire is to be preferred, and it is found to stand better than chain. The jib tack *t* is fast to the traveller *a* (Fig. 15), and leads down through a sheave hole *s* at the bowsprit end (inside the crane iron) a block is shackled to the end of the tack through which the outhaul is rove. The standing part of the outhaul is put over one of the bits with a running eye; the hauling part leads on board by the side of the bowsprit. A single rope inhaul is generally fast to the traveller.

The score in the end of the bowsprit has necessarily to be very large, and frequently it is made wider than it need be; at any rate the sheave hole is a source of weakness, and generally if the end of the bowsprit comes off it is close outside the sheave hole, the enormous lateral strain brought on the part by the weather shroud (*k*) causing the wood to give way. To avoid such accidents as these one or two yachts have the sheave outside the iron, as shown by *m*. The tack *n* passes between the ears or "lugs" on the crane iron at *o* and *p*. To *o* the topmast stay is fitted, and the bobstay block at *p*. Of course if the score and sheave were put at *m*, the other score and sheave *s* would be dispensed with. Generally when the end comes off at the sheave *s* the bowsprit immediately afterwards breaks close off at the stem, unless some one is very smart at letting the jib sheets fly, or in putting the helm down. With the sheave hole at *m* no such accident would happen.

Jib halyards are, as a rule, made of chain, as it runs better and does not stretch, and the fall stows in a smaller compass when the jib is set; in fact, the fall is generally run through one of the chain pipes into the forecabin, where it helps a trifle as ballast. However, several large vessels, such as Livonia, Modwena, and Arrow, have had Manilla

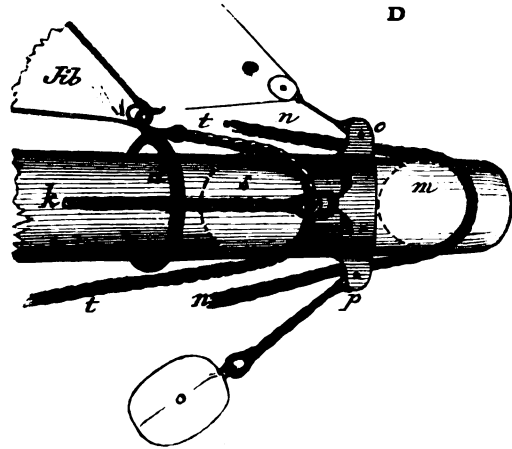

FIG. 15.

rope. The jib halyards are rove through an iron (single) block (which is hooked or shackled to the head cringle of the jib), and then each part leads through an iron (single) block on either side of the masthead (see Fig. 5). The hauling part usually leads down the port side of the mast; the purchase is shackled to the part that leads through the block on the starboard side. In vessels above 40 tons a flexible wire runner is invariably used in addition to the purchase; one end of the runner is shackled to an eye bolt on deck, and the other, after leading through a block on the end of the jib halyard, is shackled to the upper block of the purchase. The purchase consists of a double and single block, or two double; in the former case the single block is below, with the standing part of the tackle fast to it; but where two blocks are used, the standing part of the tackle is made fast to the upper block. As a great deal of "beef" is required to properly set up a jib, it is usual to have a lead of some kind for the "fall" * of the purchase on deck, such as a snatch block. It is, of course, necessary to have a "straight" luff to a jib, but very frequently the purchase is used a little too freely; the result is that a link gives way in the halyards, the luff rope of the jib is stranded (generally near the head or tack, where it has been open for the splice), and sometimes the bobstay-fall is burst. (We once saw the latter mishap occur on board the Oimara during the match at Southsea.) These mishaps can be generally averted by "easing" the vessel whilst the jib is being set up, choosing the time whilst she is in stays or before the wind.

Jib sheets in vessels under 30 tons are usually single, but in vessels larger than 30 tons they are generally double. In the latter case there are two blocks, which are put on the clew cringle; a sheet is rove through each block; one part of the sheet is made fast and the other hauled upon.

FORE HALYARDS, FORE TACKS, AND FORE SHEETS.

The fore halyards are usually fitted as follows: The standing part is hooked or shackled to an eye bolt under the yoke on the port side, then through a single block hooked to the head of the sail, and up through another single block hung to an eye bolt under the yoke on the starboard side. The downhaul is bent to the head cringle or to the hook of the block. No purchase is necessary, as the sail is set on a stay; but in yachts above 10 tons the luff of the sail is brought taut by a tackle hooked to the tack; the tack leads through the stem head. The tackle consists of a single and double block, or two doubles according to the

* The "fall" of a tackle is the part that is taken hold of to haul upon.

size of the yacht. In yachts of 40 tons and upwards the tack is usually made of flexible wire rope. Fore sheets in yachts under 15 tons are usually made up of two single blocks. The standing part is made fast to the upper block (hooked and moused or shackled to the clew of the sail). In larger vessels a double, or single, or two double blocks are used, the hauling part or fall always leading from the upper block. In very large vessels, such as 100-ton cutters or yawls, or 140-ton schooners, "runners" are used in addition to tackles. These are called the standing parts of the sheets: one end is hooked on the tackle by an eye; the other end is passed through a bullseye of lignum vitæ on the clew of the sail, and is then belayed to a cavel. The sail is then sheeted home with the tackle.

MAIN AND PEAK HALYARDS, MAIN TACK, MAIN SHEET, AND MAIN OUTHAUL.

The main or throat halyards are generally rove through a treble block at the masthead, and a double block on the jaws of the gaff. The hauling part of the main halyards leads down the starboard side of the mast, and is belayed to the mast bitts. The main purchase is fast to the standing part, and usually consists of a couple of double blocks, and the lower one is generally hooked to an eye bolt in the deck on the starboard side. In vessels under 15 tons it is unusual to have a main purchase, and when there is no purchase the upper main halyard block is a double one, and the lower a single. However, racing 10-tonners have a main purchase, and many 5-tonners have one. The principal object in having a main purchase in a small craft is that the mainsail can be set better, as in starting with "all canvas down" the last two or three pulls become very heavy, especially if the hands on the peak have been a little too quick; and a much tauter luff can be got by the purchase than by the main tack tackle. Of course the latter is dispensed with in small vessels where the purchase is used, and the tack made fast by a lacing round the goose-neck of the boom. By doing away with the tack tackle at least 6in. greater length of luff can be had in a 5-tonner, and this may be of some advantage. The sail cannot be triced up, of course, without casting off the main tack lacing; but some yacht sailers consider this an advantage, as no doubt sailing a vessel in a strong wind with the main tack triced up very badly stretches the sail, and looks very ugly.

The peak halyards in almost all vessels under 140 tons are rove through two single blocks on the gaff and three on the masthead, as shown in Plate I. and Fig. 5. Some vessels above 140 tons have three blocks on the gaff, and in such cases the middle block on the masthead is usually a

double one. The standing part of the peak halyards to which the purchase is fast leads through the upper block and down on the port side.

A common practice in racing vessels now is to have a wire leather-covered span (copper wire is best) with bullseye for each block on the gaff to work upon, and this plan no doubt causes a more equal distribution of the strain on the gaff. The bullseye has a selvegee strop with a

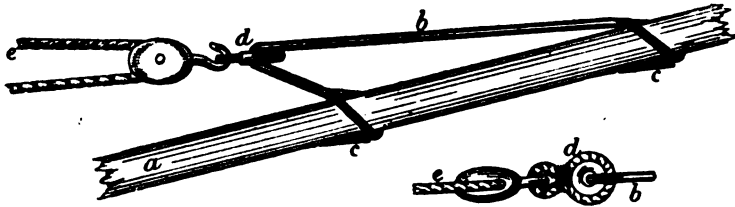

FIG. 16.

thimble seized in it for the hook of the block. In Fig. 16 *a* is a portion of the gaff, *b* is the span; *c c* are the eyes of the span and thumb cleats on the gaff to prevent the eyes slipping. *d* is the bullseye with one of the peak halyard blocks hooked to it.

The main tack generally is a gun tackle purchase, but in vessels above 60 tons a double and single or two double blocks are used. In addition, some large cutters have a runner rove through the tack cringle, one end being fast to the goose-neck of the boom, and the other to the tackle. In laced mainsails the tack is lashed to the goose-neck.

The main boom is usually fitted to the spider hoop round the mast by a universal joint usually termed the main boom goose-neck.

The main sheet should be made of left-handed, slack-laid, six-stranded Manilla rope. The blocks required are a three-fold on the boom, a two-fold on the buffer or horse, as the case may be, and a single block on each quarter for the lead. Yachts of less than 15 tons have a double block on the boom, and single on the buffer.

Most American yachts have a horse in length about one-third the width of the counter for the mainsheet block to travel on. For small vessels, at any rate, this plan is a good one, as the boom can be kept down so much better on a wind, as less sheet will be out than there would be without the horse. A stout ring of indiarubber should be on either end of the horse, to relieve the shock as the boom goes over.

The mainsail outhaul is made up of a horse on the boom, a shackle as traveller, a wire or chain runner outhaul (attached to the shackle, and rove through a sheave hole at the boom end), and a tackle. (See Fig. 17.) In small vessels the latter consists of one block only; in large vessels of two single, or a double and single, or two double blocks.

The old-fashioned plan of outhaul, and one still very much in use, consists of an iron traveller (a large leather-covered ring) on the boom end, a chain or rope through a sheave hole and a tackle. This latter plan is perhaps the stronger of the two; but an objection to it is that the traveller very frequently gets jammed and the reef cleats have to be farther forward than desirable, to allow the traveller to work.

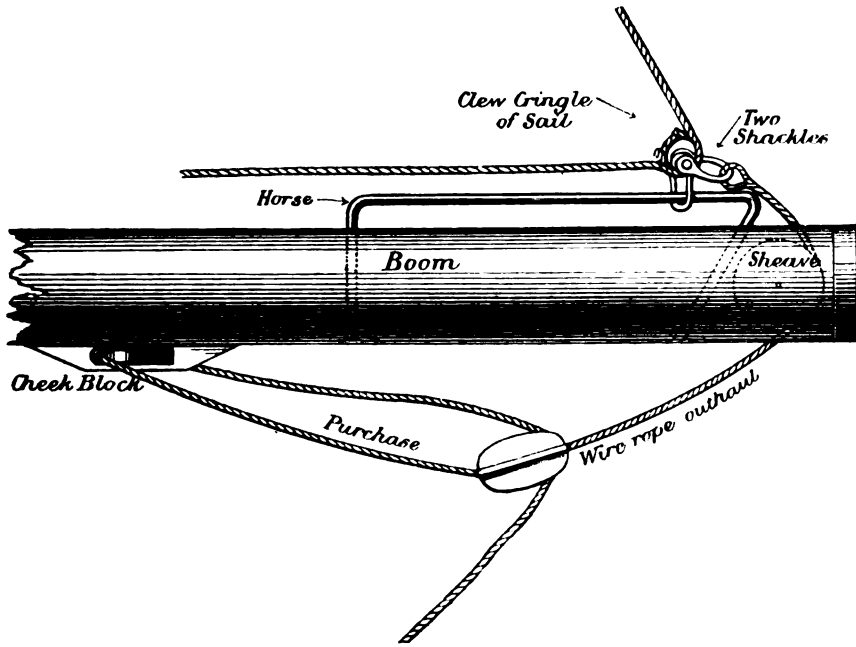

FIG. 17.

Sometimes, instead of a sheave hole, the sheave for the outhaul is fitted right at the extreme end of the boom, on to which an iron cap is fitted for the purpose.

TOPSAIL HALYARDS, SHEETS, AND TACKS.

The topsail halyards in vessels under 10 tons consist of a single rope rove through a sheave hole under the eyes of the topmast rigging.

Yachts of 10 tons and over have a block which hooks to a strop or sling on the yard, or if the topsail be a jib-headed one, to the head cringle. The standing part of the halyard has a running eye, which is put over the topmast, and rests on the eyes of the rigging; the halyard is rove through the block (which has to be hooked to the yard), and through the sheave hole at the topmast head. It is best to have a couple of thumb cleats on the yard where it has to be slung; there is then no danger of the strop slipping, or of the yard being wrongly slung.

When the topsail yard is of great length, as in most yachts of 40 tons and upwards, an upper halyard is provided (called also sometimes a tripping line or trip halyard, because the rope is of use in tripping the yard in hoisting or lowering). This is simply a single rope bent to the upper part of the yard, and rove through a sheave hole in the pole, above the eyes of the topmast rigging. The upper halyards are mainly useful in hoisting and for lowering to get the yard peaked; however, for very long yards, if bent sufficiently near the upper end, they may in a small degree help to keep the peak of the sail from sagging to leeward, or prevent the yard bending.

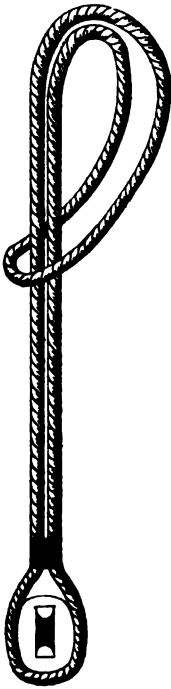

FIG. 18.

The topsail sheet is always a single* Manilla rope, as tarred hemp rope would stain the mainsail in wet weather. It leads through a cheek block on the gaff end, then through a block shackled to an eye bolt under the jaws of the gaff; but in most racing vessels nowadays a pendant or whip is used for this block, as shown in Plate I. The pendant should go round the mast with a running eye. By this arrangement the strain is taken off the jaws of the gaff and consequently off the main halyards. The hauling part of the rope is generally put round one of the winches on the mast to "sheet" the topsail. The topsail tack is usually a strong piece of Manilla with a thimble spliced in it, to which the tack tackle is hooked. The most approved plan of fitting this block and whip is shown in Fig. 18.

Jib-topsail halyards and main-topmast-staysail halyards are usually single ropes rove through a tail block on topmast head; but one or two large vessels have a lower block, with a spring hook, which is hooked to the head of the sail. In such cases, the standing part of the halyards is fitted on the topmast head with a running eye or bight.

SPINNAKER HALYARDS, OUTHAUL, &C.

Spinnaker halyards are invariably single, and rove through a tail block at the topmast head.

The spinnaker boom is usually fitted with a movable goose-neck at its

* The Oimara, cutter, had double topsail sheets rove in this way: one end of the sheet was made fast to the gaff end; the other end of the sheet was rove through a single block on the clew of the sail; then through the cheek block at the end of gaff, through a block at the jaws of the gaff, and round the winch.

inner end. The goose-neck consists of a universal joint and round-neck pin, and sockets. (Square iron was formerly used for the neck, but there was always a difficulty in getting the neck shipped in the boom, and round iron was consequently introduced.) The pin is generally put into its socket on the mast, and then the boom end is brought to the neck.

At the outer end of the boom are a couple of good-sized thumb cleats, between which the after and fore guy are put, there being a running eye in each. The fore guy, when one is used, is a single rope; the after guy has a pendant or whip with a block at the end, through which a rope is rove. The standing part of this rope is made fast to a cavel-pin, or cleat on the quarter, and so is the hauling part when belayed. The after guy thus forms a single whip-purchase (see Plate I.). The outhaul is rove through a tail block* at the outer end of the spinnaker boom, and sometimes a snatch block is provided for a lead at the inner end on the mast. The topping lift consists of two single, a double and single, or two double blocks, according to the size of the yacht.

The upper block of the topping lift is a rope strop tail block, with a running eye to go round the masthead. The lower block is iron bound, and hooks to a strop on the boom.

Formerly a bobstay was used; but, if the boom is not allowed to lift, it will bend like a bow; in fact, the bobstay was found to be a fruitful cause of a boom breaking, if there was any wind at all, and so bobstays were discarded. The danger of a boom breaking through its buckling up can be greatly lessened by having one hand to attend to the topping lift; as the boom bends haul on the lift, and the bend will practically be "lifted" out.

Small yachts seldom have a fore guy to spinnaker boom, but bend a rope to the tack of the sail (just as the outhaul is bent) leading to the bowsprit end; this rope serves as a fore guy, or brace, to haul the boom forward; and when the spinnaker requires to be shifted to the bowsprit, the boom outhaul is slackened up and the tack hauled out to bowsprit end. Thus double outhauls are bent to the spinnaker tack cringle, and one rove through the sheave hole or block at the spinnaker boom end, and the other through a block at bowsprit end. But generally the large spinnaker (set as such) has too much hoist for the jib spinnaker, and a shift has to be made for the bowsprit spinnaker, which is hoisted by

* Formerly a hole was cut in the boom end, and a sheave fitted for the outhaul to run through; this plan is now abandoned, as, unless the boom happens to come with one particular side uppermost, an unfair lead may result.

the jib topsail halyards if that sail be not already set; even in such case no fore guy is used in small vessels, but to let the boom go forward one hand slackens up the topping lift a little, and another the after guy, and, if there be any wind at all, the boom will readily go forward. In a five-tonner the after guy is a single rope without purchase, and the topping lift is also a single rope, rove through a block under the lower cap.

A schooner has a main and fore spinnaker fitted in the manner just described, and the usual bowsprit spinnaker as well, which is usually hoisted by the jib topsail halyards.

As spinnaker booms are now carried so very long, they will not go under the forestay; consequently, when the spinnaker has to be shifted, the boom must be unshipped. To shift the boom, the usual practice is to top it up, lift it out of the goose-neck, and then lower the end down the fore hatch or over the side of the vessel until the other end will clear the forestay.

When spinnakers were first introduced no goose-neck was used, the heel of the boom being lashed against the mast. A practice then sometimes was to have a sheave hole at either end of the boom, with a rope three times the length of the boom rove through each sheave hole. One end of this rope served as the outhaul, the other for the lashing round the mast. To shift over, the boom was launched across to the other rail, and what had been the inboard end became the outboard end. Of course the guys had to be shifted from one end to the other. As spinnaker booms are now of such enormous length, it would be almost impossible, and highly dangerous, to work them in this way, although it might do for a five-tonner.

Spinnaker booms when first fitted with the goose-neck were no longer than the length from deck to hounds, so that they could be worked under the forestay without being unshipped. However, it would appear that the advantages of a longer boom are greater than the inconvenience of having to unship it for shifting, and now, generally, a spinnaker boom when shifted and topped up and down the mast, reaches above the upper cap.

The following plan was worked during the summer of 1876 in the Lily, 10-tonner, but we have never met with it elsewhere. The arrangement was thus described: Take a yacht of say 65 tons, and suppose her 70ft. long and 15ft. beam, with a mast measuring 60ft. from deck to cap, from which if 9ft. is subtracted for masthead, and 4ft. more allowed for the angle made by the forestay, a spinnaker boom, to swing over clear, cannot exceed 43ft. (as the goose-neck is 3ft. from deck), which of course is much too little to balance the mainboom and sail. It is proposed to have a boom of 42ft., and another smaller one of 21ft. made a little heavier than the long one,

and fitted with two irons 7ft. apart; the longer one to be made in the usual manner, with bolts in both ends, for the goose-neck; but the sheaves in the ends to be, one vertical, and the other horizontal. It will then make a very snug storm boom for the balloon jib when shipped singly, whilst the smaller one, by leading a tack rope (or outhaul) through the block on the outer iron will do very well for the staysail. See Fig. 19: in case No. 1, the boom is on end and ready for letting fall to starboard; and in No. 2 dipped and falling to port. A A (No. 1) represents the 42ft. boom, and B B the 21-

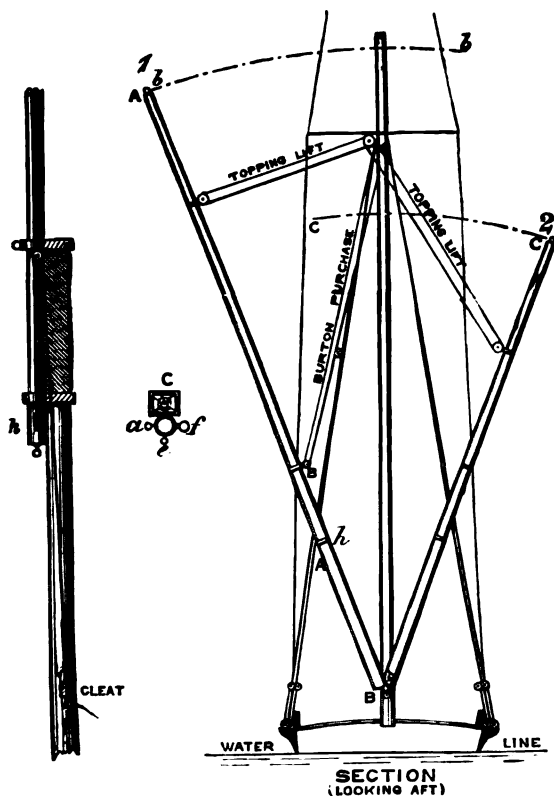

FIG. 19.

footer; the dotted line *b b* the arc the boom would travel if not let run down; and the dotted line *c c* the actual line it travels when housed. *C* in the small diagram represents the outer iron or cap on the end of the small boom (which can be made square or round; in the diagram it is made square, to prevent twisting), and *a* a bolt to which the standing part of the heel rope is made fast by clip hooks; the rope passes through the horizontal sheave at *h*, and back to the block on the cap at *f*. The fall can be belayed to a cleat on the small boom, or would greatly ease the strain on the goose-neck if made fast on the rail or to the rigging. When gybing it would

only be necessary to top the boom by the lift, let go the heel rope, and let it run down ; then swing over, lower away, and haul out the boom when squared. It would be better to hook on the Burton purchase to the cap at *e*, both as an extra support and to make sure of the boom whilst swinging. This plan would not only obviate the danger and trouble of dipping the boom, but give a 57ft. spar, besides giving greater strength, the boom being double where the most strain comes ; and the extra weight is a positive advantage, as helping to balance the main boom. Of course this plan would allow of almost any length of spars, as a 40ft. lower boom would give a 74ft. spar, and still leave 8ft. between the irons ; and in these days of excessive spars and canvas no doubt it would be attempted to balance a ringtail, but the lengths given seem a good comparative length for any class.

A more simple plan for "telescoping" a spinnaker boom is shown by Fig. 20, *a* is the inner part of the boom ; *c* is a brass cylinder with an

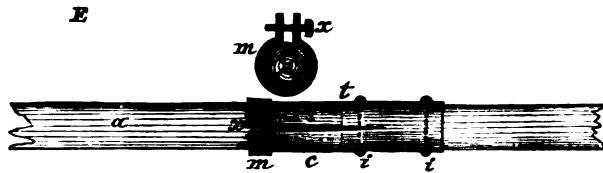

FIG. 20.

angular slot in it at *s*. This cylinder is fixed tightly to the outer part of the boom by the screw bolts *i i*. The two parts of the boom meet inside the cylinder at the ticked line *t*. When the two parts of the boom are to be used together, the ring *m* is put on the cylinder. The inboard part of the boom is then put into the cylinder, and the whole is firmly screwed up by the thumb-screw *x*. Both parts of the boom have their ends "socketed" so as to take a goose-neck, and thus either part can be used alone.

CHAPTER V.

SEAMANSHIP.

SEAMANSHIP comprises the practice of the whole duties of a sailor, including all kinds of work upon rigging, making sail, taking in sail, steering, reefing, working the ship, heaving the lead, and whatever else relates to the management of a ship. Before a man can be called a seaman, he must have practised all the duties enumerated, and be capable of performing them in a satisfactory manner without supervision; he is then called an able seaman, as distinct from an "ordinary seaman," who is a young sailor not yet versed in the practice of the seaman's art. A seaman, as generally understood, is one who is versed in the art of square rig sailing, but there are "fore and aft rig" men as well, and the instruction given in this chapter will relate to the duties of the latter alone, as the square rig, so far as yachts are concerned, may be said to have entirely disappeared.

TO BEND A MAINSAIL.—The throat cringle is first shackled to the eye bolt under the jaws of the gaff. The head of the sail is then stretched along the gaff, and the peak earing passed (*see* Fig. 21, page 66).

The earing is spliced in the cringle by a long eye splice. The splice is shown at *n*. The earing is passed through *d* round through the cringle *e*, through *d* again and through *e* again; then up over the gaff at *i* and *h*, down the other side and through *e* again, and so on up round the gaff four or five times; at the last instead of going up over the gaff again the earing is passed between the turns round the gaff, as shown at *f*, round all the parts that were passed through *d* as shown at *m*, and jammed by two half hitches *m* and *h*. The end *g* would then be seized to the part at *n*.

When the earing is first passed through *d* it is hauled upon to well stretch the head of the sail along the gaff.

In the sketch the earing is not represented hardened up as it would have to be in practice. The cringle *e* would be jammed up

close to the gaff, and the half hitches hardened back close to the cringle at *m*. The earing was shown thus loosely passed for the sake of distinction.

Frequently, when the head of the sail becomes stretched, the cringle comes outside the cheek block *b*. The earing then has to be passed round the gaff between *d* and the cheek block. This in some respects is an advantage, as it prevents the topsail sheet chafing the lacing; on the other hand it looks awkward, as the leach of the topsail is necessarily some distance inside the leach of the mainsail; the leach of mainsail and topsail ought to make an unbroken line.

It is usual to put a piece of canvas parcelling round the earing over the parts where the topsail sheet chafes.

The earing being passed the head of the sail is laced to the gaff. A half hitch is usually taken at each eyelet hole; the lacing then crosses up over the gaff at right angles instead of diagonally, and holds the

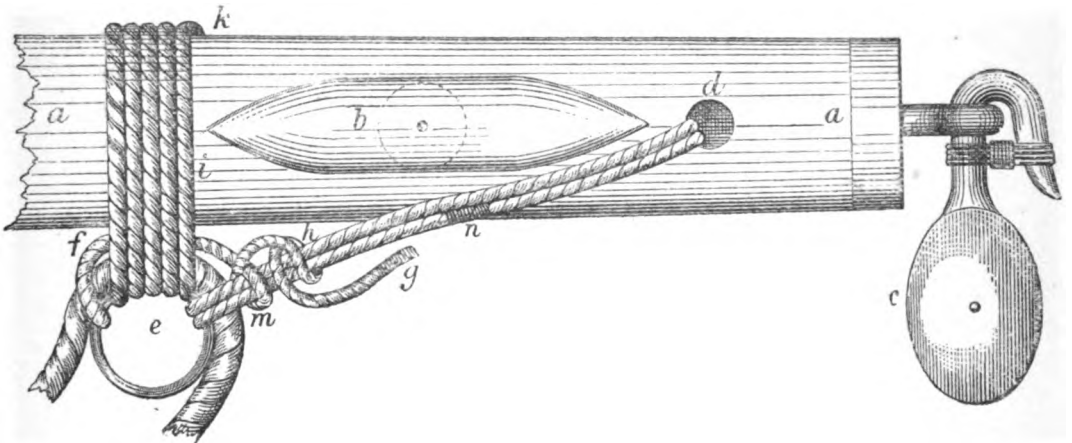

FIG. 21.

a a is the peak end of the gaff.

b is a cheek block for the topsail sheet.

c is a block for peak downhaul, and used also as ensign or signal halyards. The hook of the block, it will be seen, is moused. The block is hooked to an

eye-bolt screwed into the end of the gaff.

The worm of the screw is, of course, a deep cut one.

d is a hole in the gaff end through which the earing is passed.

e is the peak cringle of the mainsail.

sail closer to the gaff. Sometimes the head of the sail is laced from eye to eye with diagonal turns, and laced back again so that the lacing crosses on the gaff thus—XX.

The luff of the sail is next seized to the mast hoops with spun yarn. The clew is shackled to the traveller, and the sail is then bent.

In bending a new mainsail great care should be taken not to get any strain on the head or foot at first. In first hoisting take the weight

of the boom with the topping lifts; set the throat up taut by the halyards, and then get the peak a little more than half up. Then set the luff taut with the tack-tackle, and afterwards set the peak up, but still leave the leech slack. If the weather is damp and any strain comes on the foot, ease the outhaul and let the traveller in. So also if the sail is set and it should rain, ease in the traveller. It is a good plan, especially if the sun is out, to hoist the sail up several days before getting under way, and as it blows about with head and foot slack, it will stretch fairly. If a chance occurs it is an excellent plan to run before a good strong wind for some hours, especially if the leech of the sail appears to be unduly slack. After a few days the head can be hauled out fairly taut on the gaff, and the foot on the boom; but the traveller should always be eased in for rain or dew, and no great strain should be allowed to come on the foot until the sail is fairly stretched. Even for an old sail the traveller should be eased in a little if the sail gets wet, and if it appears necessary the tack or throat purchase should be eased as well for rain or dew.

TO SET THE MAINSAIL.—Take the coats off. Hook on the peak halyards, and mouse the hooks. Overhaul some of the main sheet, and belay on both quarters. Top the boom up five or six feet clear of the crutch, taking care that the crutch is not lifted out of the sockets, and dropped overboard. When the boom is topped up,* haul the main sheet taut, and belay. Cast off the tyers or gaskets, leaving one as a "bunt gasket" amidships at present to keep the sail from blowing out. See that the purchases have been well overhauled (fleeted); and that the peak downhaul and the topsail sheet are rove. Man the peak halyards, cast off the bunt tyer, and hoist the gaff end between the topping lifts, guiding it with the peak line. When the gaff shows above the lifts, hoist away on the throat halyards, and let the sail go up with the gaff as nearly as possible at right angles to the mast. If the sail is peaked before the throat is up (*i.e.*, if the peak of the sail goes up faster than the throat), it will be hard work getting the throat up, if it can be got up at all without resorting to the purchase. Get the throat as high as possible with the halyards, and belay. Leave the peak for the present, and pull the sail out on the foot by the outhaul. Purchase up the throat as high as required, and set the peak up, using the peak purchase until the sail begins to girt in the throat; a few girts here will not matter, as the peak will be sure to settle down a good deal. Sometimes in small yachts, after the throat is set up hand-taut, the peak is got as high as

* It is a practice in racing vessels to unhook from the boom what is to be the lee topping lift whilst hoisting, so that the mainsail will not girt across it, and cause a delay.

it can be without the purchase. The sail is then set up by the main purchase, "peak and all" going up bodily.

When the foot of the sail is laced to the boom the tack is always lashed down to the gooseneck, and the main purchase brings the luff of the sail taut—like a bar of iron. When the sail is not laced (it is seldom laced in a cutter), the tack-tackle is generally hooked on after the throat and peak are up, and the luff of the sail is brought taut by this tack-tackle. But the better plan for a racing yacht is to make the tack fast before hoisting by passing a lashing through the tack cringle and round the gooseneck of the boom; then pull the sail out on the boom; it will be found that the main (throat) purchase will get the luff of the sail much tauter than the tack-tackle can. We are speaking now of setting the sail to the best advantage; but it is quite possible that the skipper may want the tack triced up, for which purpose the tricing line will be hooked on to one of the mast hoops near the throat, and to the tack cringle of the sail.

When the sail is set, coil away, and, if not previously done, make the tyers up in neat bunches, and the sail coats should be folded up ready for stowing away in the sail room.

It is the practice to always have one reef earing rove, and if the weather looks at all threatening a second one should be rove. The first earing should be fast round the boom, then, if the outhaul should burst, or the clew of the sail tear out, the sail will not fly in along the boom nor get adrift. In anticipation of such accidents a common plan is to pass a tyer through the clew cringle and round the boom, three or four times.

If whilst sailing the peak should settle down so much as to require setting up, the best time to choose for doing so will be when the vessel is head to wind in stays. The weight of the boom should be taken by the weather topping lift.

TO REEF A MAINSAIL.—Get the reef tackle on deck and bend it to the reef pendant or earing (previously rove), and hook the fore block to the eye bolt or strop on the boom. Take the weight of the boom by the weather lift, and ease the main sheet, if required, to allow the boom being tossed up. Cast off the main tack, if the sail be not a laced one. Ease up the main and peak purchases till the sail has settled down a reef, and if necessary ease up the halyards by the fall; no more of the peak than actually necessary should be settled down, as the peak will be the heavier work to get up again. Put plenty of strength on the reef tackle (ease the helm a little, so as to take the weight of the wind out of the sail) and harden the earing down on the boom until the last inch is got. Should the cringle not come right home pass a tyer two or three times through it

and round the boom. This "preventer" lashing is commonly rove when match sailing with a reefed mainsail. Then roll the foot of the sail up tightly and neatly, and tie up the reef points (*see* Fig. 22); set up the throat by the purchase, and then the peak if necessary. Browse the tack down. Ease up the topping lift and trim the sheet. A racking should now be put round the boom and earing, and the reef tackle cast off. Then make the earing fast by jamming turns round the boom (*see* Fig. 23). In Fig. 23 the turns and hitches are shewn loosely for the sake of



FIG. 22.

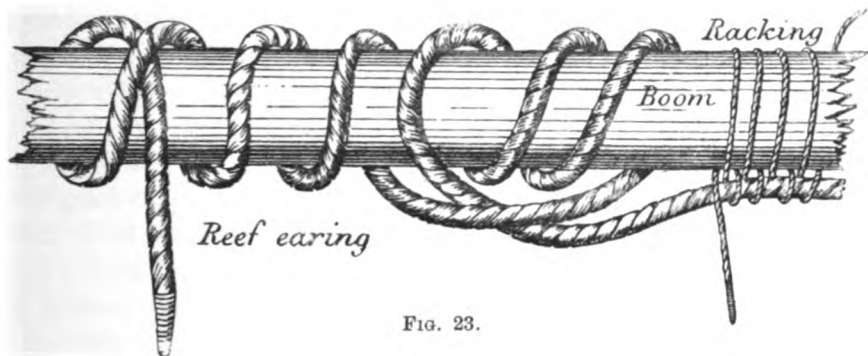

FIG. 23.

distinction; to secure the earing all the turns and hitches are jammed up close together. The end of the racking is also secured before taking off the reef tackle. A couple of hitches round the earing will secure the end of the racking.

Reeve another earing and bend the tackle on to haul down the second reef if necessary. The reef tackle block next the earing has a thimble eye strop. The earing is bent to the eye by a sheet bend with a bight (*see* Fig. 24).



FIG. 24.

Never reef a new unstretched mainsail if it can be avoided, but stow it and set the trysail if necessary.

Having reefed the mainsail, prepare to shift jibs. The jibs generally carried with mainsail reefed or otherwise are as follows:

Mainsail and topsail	No. 1 jib.
Whole mainsail and housed topmast	No. 2 jib.
Single-reefed mainsail	No. 3 jib.
Double-reefed mainsail and reefed foresail*	No. 4 jib.
Three-reefed or closed reefed and double-reefed foresail*	No. 5 jib.
Trysail	Storm jib.

The bowsprit should be reefed in as the jibs are shifted.

* Sometimes in match sailing, if there be much reaching and if the water is pretty smooth, No. 3 and even No. 2 jib is carried with double-reefed mainsail, and No. 3 or 4 jib with

TO SHAKE A REEF OUT.—Set taut the weather topping lift to take the weight of the boom. Untie all the reef points, and be careful that not one is left tied, as the sail may be torn thereby. Ease up (handsomely) the tack-tackle and unhook it. Ease up the reef earing. The reef will now be fairly shaken out, and the mainsail can be set by the purchases, always recollecting to set the throat up first. Bowse down the tack, ease up the topping lift, and trim the sheet.

TO STOW A MAINSAIL.—Put the tyers at proper intervals across the boom. Ship the crutch. Set taut the topping lifts. Overhaul main and peak purchase. Lower the boom by the topping lifts into the crutch. Haul taut the main sheet and belay; cast off the falls of main and peak halyards, and lower (by the main the faster) and gather in the sail on deck. Belay the peak halyards so that the gaff end rests on (say) the port side of the boom. Pull the foot of the sail up on the top of the boom so that the roach just hangs over on one side, say the port side; next take the leech of the sail and lay it along on the top of the foot. Then the whole of the bag of the sail will be on the starboard side. Take hold of this bag (outside) part and lift up and roll over, repeating the operation until the sail is rolled up in a snug bag. [The process of thus lifting the bag or bunt of the sail is termed “skinning” by sailors.] Then hoist the gaff up clear of the boom and lift the whole sail bodily up on the boom, over the foot of the sail. Throw the ends of the tyers up over the gaff, and thereby haul the sail snug up to the gaff; then take the ends of the tyers under the boom up over the gaff again, and tie. Unhook peak halyards and put on the mainsail covers. The peak halyard blocks can be then hooked on again, or hooked to a sling passing under main boom, and will thus keep the boom from sagging with its own weight. When the peak halyards are not so hooked on, an X crutch should support the boom amidships.

TO STOW THE MAINSAIL AND SET THE TRYSAIL.—In heavy weather it is always better to set a trysail than a close-reefed mainsail, as the mast is thus relieved of the heavy strain of the main boom and gaff. Get the trysail gaff clear of the other spars on deck. Bring the trysail on deck, and the trysail sheets. Prepare to heave to under the two head sails by hauling the foresheet a little a-weather of the mast. Ship the boom crutch. Set the topping lifts taut. Overhaul the main and peak purchase. Settle the main boom down into the crutch. Haul the sheet taut and belay. Stow the mainsail and make it up on the boom. Put a lashing on the boom from each quarter, or secure

three reefs. A racing yacht usually carries a jib larger than No. 1, called sometimes a “big reaching jib,” because it is set when there is likely to be a lot of reaching.

the boom down in the crutch by tackles on to each quarter. Take off main and peak halyards and hook the same to the trysail gaff. Unhook the topping lifts, and make them fast in main rigging. Ship the jaws of the trysail gaff to the mast, and make fast the parrel round the mast, the gaff end resting on the deck. Lace the trysail to the gaff. Bend the sheets and belay both hand taut. Hoist and toggle on the parrels, or strops, or lacing (as the case may be) on the luff of the sail round the mast, as the sail goes up.

If the yacht be yawl rigged, and the mizen has been stowed, it should be set before the mainsail is taken off, as the mizen will keep the yacht's head up to the sea. The storm mizen, of course, would be chosen for this purpose.

TO SET A STAY-FORESAIL. (In a schooner this sail is termed the fore-staysail, and the foresail is the gaff sail set abaft the foremast; in cutters the foresail, although, as in a schooner, set on the forestay, is simply termed the foresail or staysail; the proper term is stay-foresail).—Take off the coat and hook on or bend the sheets, hauling in slack of port or starboard one (or both), and belay. See that the downhaul or block is bent to the head cringle, and hoist away.* When the sail is high enough, hook on the tack tackle and bowse down.

TO REEF A STAY-FORESAIL.—Cast off the tack tackle and lower the sail; unhook the sheets; tightly and neatly roll up the foot of the sail and tie the reef points. Hook on the sheets to the reef cringle and belay; re-hoist the sail; hook the tack to the reef cringle and bowse down with the tackle.

TO SHIFT A STAY-FORESAIL FOR A BALLOONER.—Let go the halyards and haul down the foresail by the downhaul; unhook the halyards from the head cringle; hook them on to the balloon foresail with downhaul; and, as the sail is hoisted, toggle the luff on to the forestay, or hook on as the case may be; carry the lee sheet aft and belay (slack) as the crew start hoisting. When the head is chock-a-block bowse down the tack. Trim the sheet. On a wind the sheet is generally brought inside the main rigging, or between the main rigging and the topmast back-stays. For reaching, the sheet is carried outside of all.

TO SET A JIB.—Carry the sail forward tack first. Hook the tack cringle to the traveller; hook on the halyards and downhaul to leeward of the forestay and foresail; belay the sheets hand taut, or one a-weather,

* The downhaul is sometimes kept rove through the hanks and leads through a block inside the stem head. In a racing yacht it is best to have the downhaul made fast to the halyard block and not rove through the hanks, because it is so frequently necessary to shift for a balloon foresail.

as required. Hoist away by the halyards until the sail is about half up; then haul the tack out by the traveller outhaul, hoist the sail and set taut with the purchase. Trim the sheets. Always be careful that the jib sheets are rove through the right holes; nothing shows up the careless mate so much as the sheet for first jib rove through the holes for second jib, or the contrary.

In light winds it will be found less trouble to pull the jib out on the bowsprit before hoisting, and with a few stops uncut.

Generally in getting under way the jib is set up in stops, that is, before it is unrolled. The jib is hoisted up some distance, and then the tack is pulled out on the bowsprit, the sheets being loose, as otherwise the stops would be broken. Upon getting under way the stops are easily broken by hauling in the jib sheet.

When the second jib is set the bowsprit should be reefed, and double-reefed for third jib; otherwise the strain from the jib may cause the bowsprit to break, as the traveller would come far inside the support of the bobstay, and "nip" the spar.

Before purchasing up a jib the runner-tackles should be always taut, and, if necessarily slack, swigged upon unless it is desired to "stay" the mast forward by the jib. If the runners are slack, the effect will be to pull the mast forward and slacken the forestay instead of to straighten the luff of the jib; thus a straight luff to the jib cannot be made until the pendants are "bar taut." It is also of course necessary that the bobstay should be set well taut by its tackle.

To SHIFT A JIB.—Ease up the purchase, slack up the outhaul and pull in by the inhaul, and gather the sail in board by the sheet and foot; then pull the head of the sail down by the downhaul, gathering the sail in-board, and "muzzling" it as it comes on deck over the lee bow. The purchase should always be eased before the outhaul is let go. If the outhaul is let go first, the jib will fly in, and cause such a jerk that the bowsprit might be sprung or the bobstay burst.

If possible, the jib should be shifted when the vessel is before the wind; and often a sailing master will run his vessel off whilst the crew are getting the jib in, so that the sail is becalmed. Sometimes two or three or more hands go on the bowsprit, and gather the sail up as it comes down, but in bad weather the traveller is always let run up close to the stemhead.

If it is seen beforehand that one jib will have to be shifted for another, the tack of the jib which is to be first used is *lashed* to the bowsprit end; the other jib is run out by the traveller and stopped along the bowsprit. To shift, haul taut the weather sheet; one hand cut the

lashing at the bowsprit end; as the jib flies aft haul in by the mainparts of the sheet, and pull down by the downhaul. Hook the halyards, downhaul, and sheets on the other jib and hoist away.

In light weather when a bowsprit spinnaker is carried, it is unusual to let the jib run in, but several of the hands stow it along the bowsprit.

To SET A GAFF TOPSAIL.—Bend the sail to the yard; pass the weather earing first, and then haul the head taut along the yard by the peak earing (see how the peak earing of the gaff was passed, page 66). Tie the stops round the yard, or lace, as the case may be. Bend the sheet to the clew cringle (see Fig. 25). See that the sheet is inside the topping lift, and that it passes under the yard from the mast side before it is bent to the clew cringle. See that the clew line is fast to the clew cringle. Hook on the halyards and bend the trip halyards (see Fig. 26), and hoist the sail clear of the deck. Hook on the tack tackle. A mousing should be put on all hooks.

To keep the sail from blowing away from the mast, it is usual to have a "lazy tack," which consists of a short line, one end of which is fast to the tack cringle of the sail; the other end is passed round that



FIG. 25.



FIG. 26.

part of the main or peak halyards which has been belayed to the mast bits, and is then made fast to the tack cringle the same as the other end was; the line thus forms a kind of traveller, and the main or peak halyard serves as a jackstay.

A gaff topsail should be always sent up to windward, and if the halyard and sheet are to leeward they should be shifted over.

Hoist on the trip halyards until the peak is well up inside the topping lift (the peak will always be the aft end of the yard), then hoist away on all, hauling out the sheet as the sail goes up; otherwise, if the sail blows about, the sheet may get a turn round the gaff end. When the yard is so high that the point where the trip halyards are bent is level with the trip halyard sheave in the topmast, leave the trip halyards adrift, and all hands hoist by the other halyards. When the yard is chock-a-block, belay. Bowse down the tack to the last inch, and belay. Set taut the trip halyards. Pass the lacing and haul taut round the masthead. Haul out the sheet until the sail sits as desired. *A topsail should never be sheeted until the tack has been bowsed down.* If during sailing it is

found that the tack requires bowsing down, the sheet should be eased up first.

Before the topsail is sheeted, a look should always be given to the topmast stay. The topmast should cant forwards a trifle, so as to insure plenty of drift for the sheet. Also a look should be given to see if the peak requires purchasing up.

If the head of the sail be very short, the trip halyards will not be used.

In the case of a jib-headed topsail, it will be hoisted as fast as the masthead-man can lace it. The safest plan is to send the sail up in stops, and make a traveller of the upper lacing round the standing part of the throat or peak halyards.

In running before the wind with the boom square off, if the topsail tack is to windward of the gaff the sheet should be eased a little, and, if necessary to relieve the strain on the weather cloths, the lacing or tack should be eased as well.

TO TAKE IN A GAFF TOPSAIL.—One hand will go aloft to cast off the lacing. When all is ready for lowering, cast off the halyards and trip halyards from the belaying pins. Lower away with the halyards, but keep the trip halyards hand taut, until the yard is "up and down" the mast. Ease up the sheet, and lower away all. If there be much wind, several hands must be put upon the tack at first to haul down as the halyards are started, otherwise the belly of the sail is certain to blow in between the parts of, or over, the peak halyards, and will thus prevent the sail lowering. In such a case do not cast off the "lazy tack" until the sail is on deck. The hand aloft will keep the heel of the yard inside the topping lift as it passes down.

As the yard comes down between the topping lift and the mainsail, haul forward by the tack (casting off lazy tack), so that the heel of the yard (the lower end) goes forward.

When the sail is on deck, unbend the halyards and make the ends fast to a belaying pin. Unbend the sheet, and make it fast round the boom. Roll the sail up on the yard; or unbend it, roll up, and stow below.

Formerly the practice was to lower the topsail to leeward of the mainsail, as it was thought to come down more freely under the lee of the lower sail; but the difficulty is that the sail or yard is almost certain to get foul of the topmast rigging or lee cross-trees, and the crew cannot handle it so well from the lee scuppers. Very often in attempting to take in a topsail to leeward it will take charge and blow out, whereas if it were to windward it would lie flat on the mainsail, and could not blow away. So now the practice is, if the tack be to leeward, for a hand to

go aloft in the lee rigging or up the mast hoops and unhook the tack tackle, whilst another hand goes aloft on the weather side to the mast-head, and lowers a line to him to bend to the tack. When the line is so bent, the hand at the masthead pulls the tack up over the peak halyards, so that the sail can be got down to windward. The heel of the yard is pushed to the weather side of the topmast whilst lowering.

To SET A SCHOONER'S FORE GAFF TOPSAIL.—The sail should be sent up stopped to the yard, with the clew and tack cringles clear. Bend on the halyards, and hoist to the masthead. The hand aloft will then bend on the lee sheet and lee tack to the cringles; then the weather sheet and tack will be bent, first passing them over the main-topmast stay. When this is done, hoist the sail chock-a-block, bowse down the lee tack, then sheet home the lee sheet by the winch.

To WORK A FORE GAFF TOPSAIL.—When the order comes “ready about,” ease up the sheet and tack; clew the sail well up. The foremasthead man will clear the tack and sheet over the main-topmast stay, and must well overhaul the same. As the vessel comes head to wind, bowse down the tack as smartly as possible, at the same time haul out the sheet; but do not sheet home until the topsail is tacked, as it must always be recollected that a topsail cannot be properly set if it is sheeted before the tack is down.

To SET A JIB TOPSAIL.—Pass along the sail, head first, one hand going to bowsprit end with the head cringle in his hand. In large vessels this hand bestrides the bowsprit end outside the topmast stay, with his face towards the vessel; generally in such small vessels as five-tonners there is not such a “seat” at the extreme end, and the hand will sit on the bowsprit weather shrouds if the sail has to be hanked. Bend the sheets, and pass them outside of all. Haul in the lee sheet, and place one hand to attend to it, and ease up if necessary. Hook or toggle the hanks on to the topmast stay, cutting the stops and hoisting as the hanks are so hooked or toggled. When all the hanks are on, hoist to the required height, set the tack down, and trim the sheet.

A jib topsail in very small yachts is sometimes set flying, as the bowsprit end of such craft is not a pleasant place for a man of the customary weight of eleven stone. At the bowsprit end a tail block is fast; through this block a rope is rove, both ends being kept in-board. To set the sail, bend both ends of this rope to the tack cringle, and bend the halyards to the head cringle. Haul the sail out on the bowsprit by the *under* part of the outhaul, and hoist at the same time. The bight of the outhaul will therefore come in-board, and its *upper* part will serve as the inhaul when the sail has to be handed. The sail can be hoisted to any required

height. One hand, of course, must go to the bowsprit end to pass the sheet.

If the halyards are to windward the sail can be hoisted to windward; if otherwise it will be hoisted to leeward of the foresail and jib.

In strong winds a jib topsail should never be hoisted so high as in light airs, as the higher it is the more strain it will bring on the topmast.

Also, in strong winds, one hand should always be stationed at the sheet to ease up during strong puffs. A good plan is to put a tail-tackle on the sheet. The sheet can then be eased or hauled in as required very readily by the tackle.

TO SET A SCHOONER'S MAIN TOPMAST STAYSAIL.—See that the halyards are on the lee side of the main-topmast stay. Bend on the halyards, tack and sheet; see that the sheet has been passed outside the main rigging and main-topmast rigging. Hoist to foremast head in a bunch; then, as the hand aloft hooks the hanks on the main-topmast stay, the deck hands will hoist. When hoisted, set the tack taut, and belay. Trim the sheet. It is very usual for the sheet to lead to the boom end; it cannot very well be got too far aft.

TO SET A SQUARESAIL.—The yard has a strop and thimble eye seized in it at the centre of length of yard; on the fore side of the mast a wire jack stay or jumper reaches from masthead to deck, on which the thimble eye on the yard strop travels. The braces are rove through single blocks at each yard arm, and one end made fast to the cavel aft, the other part is for hauling. The fore braces are single ropes leading from each yard arm through single blocks at the bowsprit end. The lifts go from each yard arm through single blocks hooked to the upper cap at masthead, and lead to the deck. When at anchor the yard is generally lowered half-way down, and then pointed up and down the mast. It is more ship-shape, however, to lower the yard down to about level with the tier of mast hoops and square across, with all the braces and lifts set taut. The only objection to the latter plan is that it may be fouled by passing vessels.

To set the sail, reeve the earings through the block at each yard-arm, and through a block near the strop on the yard amidships; then hoist the yard up. Bend or hook one end of each earing to the corner head cringles of the sail, and hook the four halyards to the middle cringle; hitch the lizard to the cringle or hook of halyard block. (The lizard is a short piece of rope with an eye at one end; the eye travels on the jumper, and the tail is fast to the sail; thus the sail is kept from blowing away.) Bend on the tack and sheet; then hoist by the halyards, and afterwards pull out the weather earing; take in the slack of the lee earing. Get out the boom with fore and after guys on it, and the outhaul rove through the sheave

hole at boom end; bend the outhaul to the tack cringle of the sail, and haul out.

To take in the sail, let go the weather and lee earing; then let go the sheet, and tack outhaul, and gather the sail aboard; then, when the sail is all in-board, let go the halyards and haul down with downhaul. As the sail is hoisted by the foresail halyards, the fore downhaul will be used as well.

To SET A SPINNAKER.—The boom must be got ready first. Hook or bend the lower block of the topping lift to the boom (it is usually a tail block.) Reeve the outhaul in the sheave hole or block at the spinnaker boom end; be careful that the part of the outhaul which has to be bent to the tack cringle is on the fore side of the spinnaker boom topping lift and over the fore guy; put on the after guy and fore guy.* Hoist the boom well above the rail, and launch forward until the gooseneck† can be shipped in the socket; hoist until the boom is “up and down” the mast, and high enough for the lower end to be shipped on the gooseneck. (It is usual to put the gooseneck in the socket on the mast first, and then bring the socket which is in the end of the boom to the shank—see Fig. 27—*c* is the boom and *p* the gooseneck, *a* the mast.) Lower the boom and haul aft, or “square the boom.” If the boom be already shipped and “up and down the mast,” one or two hands will take the guys aloft and put over the end. The standing part of the after whip will be made fast to the quarter, and the hauling part rove through a sheave hole or turned round a pin. The hand aloft will cast off the boom lashing, and push it away clear of mast and cross-trees for lowering by the topping lift.

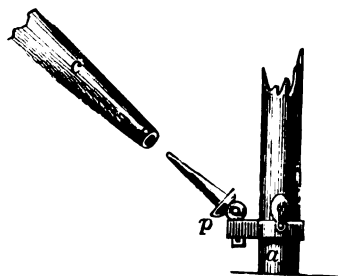

FIG. 27.

See that the halyards are clear and on the fore side of the spinnaker boom topping lift. Bend on the halyards and the outhaul to the sail (see Fig. 25). If the spinnaker is to answer the purpose of bowsprit spinnaker as well, another outhaul must be bent, leading through a block on bowsprit end. Generally the fore guy in such cases is made to do duty for this purpose; but if there be a fore guy beside the tack outhaul, care must be taken in bending the latter to see that it is *over* the fore guy, and not *under*. Bend on the sheet and belay, with one

* A fore guy is not always used in small yachts.

† Square goosenecks are going out of fashion now, as it is some difficulty to get the socket fair for taking the gooseneck. With a round gooseneck and round socket this difficulty is avoided. If the boom should be shipped unfair, a spike in one of the holes will easily twist it round.

hand to attend to it to ease up if necessary. Hoist away on the halyards, and when the sail is up chock-a-block put all hands on the outhaul, easing up the sheet all that is necessary, so as to make the sail lift in order that it may be boom-ended; drop the boom down and trim the sheet. In light winds, the sail is very frequently pulled out on the boom whilst it is being mast-headed. This is all very well if there be plenty of help at hand, and if there is not much wind; but generally, if the sail be hauled out on the boom first, it is found almost impossible to get the head up chock-a-block. If the sail cannot be boom ended, slacken up the sheet until the sail lifts, and haul it in again as the tack is brought to the boom.

To prevent the sail going up full of turns, there is a swivel at the head, but this will not always prevent turns, as the swivel is likely to jam if any part of the sail fills; and a good plan is for a man to stand by the mast and run the luff of the sail through his hands as it goes up.

When sailing in a strong wind more or less quarterly, the boom will often rear on end in a troublesome manner, and sometimes fall forward with the sail round the topmast stay. To prevent this, "square" the boom a little and ease the sheet. Sometimes a spinnaker is reefed by tying a knot in the head; and sometimes the balloon foresail is set as a spinnaker.

TO TAKE IN A SPINNAKER.—Top the boom up, well clear of the rail, otherwise when the sail is taken off it the boom may drop into the water and be broken. Take hold of the foot of the sail, let go the outhaul, and haul the sail in smartly by foot and sheet; gather the sail in to the mast, well muzzling it, and then let go the halyards, and haul down.

The halyards should never be started until the sail has been hauled in-board from the boom; if the halyards are started first, and there be much wind, the sail is almost certain to blow away and then get into the water, and cause a great deal of trouble.

TO SET A SPINNAKER ON THE BOWSPRIT.—Bend on the tack and halyards to leeward of jib and foresail; hoist and then pull out by the outhaul; trim the sheet; take in the jib, or let it run down by the head and stow and stop along the bowsprit.

TO TAKE A SPINNAKER IN FROM THE BOWSPRIT.—Pass the weather sheet round the fore stay to leeward and make fast to the bits; let go the outhaul, and haul the sail in-board smartly by the weather sheet and by the foot over the lee bow. In strong winds it will be sometimes necessary to let the sail fly in by cutting the tack adrift. In such cases the best plan, if there is only one sheet, is to bend a line to this sheet,

with a running bight in it. Take this line forward, and haul the bight close up to the clew cringle of the sail. One hand will go out on the bowsprit and cut the tack (outhaul), which he will not allow to unreeve, and will bring the end in-board with him. As the sail flies aft, smartly haul it in-board by the line that has been bent round the sheet, and get hold of the foot as soon as possible; gather the sail together, so that it cannot blow out whilst the foot is being hauled in-board; when the foot is all in-board gather the sail together and lower by the halyards.

It should be clearly understood that the halyards must not be started until the foot is hauled in and the sail gathered together; and, should the sail blow out, "spill" it by gathering the folds together, or it may take command and blow away, and perhaps at the same time pull someone overboard, or foul the lee crosstrees and be torn.

To SHIFT A SPINNAKER BOOM.—Man the topping lift and hoist away. Slack up the fore guy, ease up the after guy as required, and do not let the boom swing forward. When topped carry the after guy and whip forward, passing it outside runners and rigging. Top the boom until it is lifted clear out of the gooseneck; lower by the topping lift, whilst three or four hands take it by the heel and carry it aft on the side of the mast it has to be next used. When sufficiently low and far enough aft to admit the upper end passing under the fore stay, launch forward again and hoist away; ship the gooseneck as before, and reeve the guys. Sometimes, where the forehatch is near the mast, as in small vessels, the heel of the boom is lowered into the forecastle; this, of course, is a simpler plan than launching the heel of the boom aft. If handled with care, the heel of the boom can be lowered over the side.

In small yachts which have spinnaker booms as long as the deck length is overall, the general practice is to top the boom a few feet and then let it swing forward. The boom is then unshipped and launched aft on the opposite side of the mast. When the fore end can be cleared of the forestay or foresail sheets, it is launched forward again, gooseneck re-shipped, and guys made fast.

To SET A RINGTAIL.—In the first place, an iron hoop has to be fitted at the main boom end (similar to the upper cap at masthead) to take the boomkin. One hand must get on the main boom. Bend the main peak downhaul to the boomkin (generally called ringtail boom), and hoist it to the main boom; steady it through the iron at the main boom end; cast off the peak downhaul; reeve an outhaul through the sheave hole in the end of the boomkin, and launch the spar the required distance out; then lash the heel to the main boom. In reeving the outhaul, care must be taken that the hauling part only is outside the topping lift. The head of the ringtail

is bent to a yard, with three or four spare feet for inner end. Bend the main peak downhaul to this yard for a halyard; bend both ends of the downhaul to the tack cringle (the clew cringle for the sheet will be in-board). Hoist the sail, then pull out to boomkin end by the under part of the downhaul, and sheet as required.

To take this sail in, the first thing to do is to haul it in by the sheet and inhaul whilst the outhaul is slacked up. Lower by the halyards as fast as the sail is gathered in. The boomkin will be got on board by aid of the peak downhaul.

To SEND UP A TOPMAST.—Lash a tail block to the upper cap at masthead; through this reeve a rope and bring down to deck; reeve an end through the sheave hole in topmast, and make it fast some distance below the shoulder, stopping the end securely. (The heel of the topmast should be aft.) Hoist away; point the topmast through the lower cap; then make the heel rope fast to topmast, cast off the other rope, and hoist the topmast up through the upper cap by the heel rope. Put the eyes of the rigging over the pole, topmast stay over all; reeve the halyards, hitch on the tail blocks for jib-topsail and spinnaker halyards, and then send up the topmast by hauling on the heel rope and fid. Set up the backstays by the tackles.

The topmast will be sent down by reversing the order given above.

To HOUSE A TOPMAST.—Ease up the topmast stay and backstay falls. Hoist away on the heel rope until the topmast is sufficiently above the lower cap for the hand aloft to unfid. Settle down the topmast by easing up the heel rope. When lowered, so that the eyes of the rigging come close to the cap, belay the heel rope and lash the heel of topmast to the mast. Unshackle the legs; hook the tackles on again in, and set hand taut.

If the vessel has much list, the topmast will not come down very readily, and the weather backstays should be kept taut, so as to keep the topmast in the line of the mast, and to prevent it breaking by sagging to leeward with its own weight. Also if there be much sea it may be found necessary to steady the topmast by the preventer. Generally the vessel should be eased or hove to whilst a topmast is being housed if there be much wind and sea.

Plans for fidding and unfidding topmasts from the deck without going aloft are given on page 48.

To REEF A BOWSPRIT.—If the jib is set, ease up the sheets and belay them, well slack. Cast off the bobstay fall and the falls of the shrouds and topmast stay. Knock out the fid, and then launch the bowsprit in by the shroud tackles; fid and set up all the tackles.

TO TAKE A REEF OUT OF THE BOWSPRIT.—Overhaul all the tackles; launch the bowsprit out with heel rope and tackle, or by the rack-plate and wheel; fid and set the tackles taut again.

In setting up the bobstay tackle, it is usual in racing yachts, before starting in a match, to set the bowsprit end down until it nearly touches the water.* This is done in order to give more hoist and drift for the jib, as by frequent setting up the blocks would soon come “chock-a-block;” moreover, the bobstay fall is certain to “come up” or stretch a good deal, so much so that very frequently at the end of a match a bowsprit, instead of being bent downwards, is steeved in the air.

TO GET UNDER WAY RIDING HEAD TO WIND AND TIDE, TO RUN BEFORE THE WIND.—Heave short; set the jib in stops; take the foresail coat off and hook on the halyards and sheets; top the boom and cast the gaskets off the mainsail. To cast to starboard, put the helm to port, heave the anchor up smartly; as the anchor is a-weigh break out the jib and set the foresail, keeping the port jib and foresheet taut. As her head goes off set the mainsail, steady the helm, and trim the sheets.

TO GET UNDER WAY RIDING STEM TO TIDE WITH WIND ASTERN, TO RUN BEFORE THE WIND.—Heave short; loose the mainsail; set jib and foresail; break out the anchor, and when a-weigh set the mainsail.

TO GET UNDER WAY RIDING HEAD TO TIDE AND STERN TO WIND, TO BEAT TO WINDWARD.—Heave short; set the jib in stops, and hook on the fore sheets. To cast to port: put the helm to starboard, heave up the anchor; break out the jib, set the foresail (with starboard sheets hauled flat) and smartly set the mainsail. If the mainsail is set before the anchor is a-weigh, the peak should be dropped down.

TO GET UNDER WAY WHEN RIDING HEAD TO WIND AND TIDE BY CASTING TO STARBOARD, TO PROCEED ON PORT TACK CLOSE-HAULED.—Heave short; set the jib in stops; hook on the fore sheets with the port one fast. Set the mainsail. Put the helm to port, and heave up the anchor. As the anchor is a-weigh break out the jib with port sheet hauled a-weather. Slack off the mainsheet. As the vessel's head pays off let draw the head sheets, haul in mainsheet and sail her.

* Although no doubt this is a convenient way of allowing for the stretching of the fall of the bobstay, yet it is attended by some risk to the bowsprit. The spar is bent until it nearly reaches its breaking point, and if any further strain comes upon it, as there might whilst diving into a head sea, the bowsprit is in great danger of being broken; or if the shrouds and tackles should stretch badly, as they sometimes will, the bowsprit would most likely break, as a lateral strain would come on the bowsprit besides the downward strain. The safest plan is to set the gear up so that there is neither a downward nor upward curve in the bowsprit, and there should be as little stretch as possible in the gear. In 1878 a few yachts tried flexible wire falls to the bobstay, but after being well set up they stood very little strain, and two or three bowsprits were lost through the fall bursting.

TO GET UNDER WAY; RIDING HEAD TO WIND AND TIDE, BY CASTING TO PORT TO PROCEED ON PORT TACK.—Heave short; set the jib in stops; bend on the fore sheet, with starboard one fast. Set the mainsail. Put the helm to starboard; get the anchor; break out the jib; hauling starboard sheet in; ease off the main boom a little on the port quarter; keep the helm to starboard till the vessel's head wears off so as to bring the wind on the port quarter; the main boom will then gybe over; trim the sheets and sail the vessel. It may sometimes be advisable not to set up the peak of the mainsail until after the vessel has wore round. In the case of a yawl the mizen would be set to get under way with, and not the mainsail.

TO GET UNDER WAY AND LEAVE AN ANCHORAGE TO RUN FOR IT.—If possible choose slack-water time or when the tide is running to leeward. Set the trysail, reefed foresail and fourth jib. Watch for "smooths" to heave up the chain; but, if the sea is so bad that the vessel pitches head and shoulders under, so that there might be danger in pinning her down by heaving short, or if she sheers about so as to get the cable jammed hard athwart the stem, then unshackle the chain, make fast the buoy rope outside the hawse pipe, wait till the vessel sheers the way she is wanted to cast, then slip the chain and sail her.

If the vessel is wind rode, and on a lee shore, it will be prudent to claw out to sea for an offing. Set the storm canvas as if for a thrash to windward. Heave short, set the jib with the sheets slack, set the foresail, and if the vessel is to be cast on the port tack, haul in the port foresheet; put the helm to port; slack out a little mainsheet. As the vessel sheers to starboard break out the anchor or slip, and when she pays off enough so as to make sure of not flying to again, ease the fore sheet over, trim the main sheet and sail her. If the vessel does not gather way, but drives towards the shore, stand by to let go the anchor again: if one anchor has been slipped, the other should be ready on the bow. If there is not too much sea, the kedje with hawser bent to it should now be carried out in a boat; then as the anchor is hove short haul in on the hawser. When the anchor is off the ground haul the vessel ahead by the hawser, when the kedje is apeak, sheet the jib, and break out the kedje. When anchored on a lee shore a vessel should never wait till the wind and sea gets so bad that it is neither safe to remain nor to attempt to leave.

TO TACK A CUTTER.—When the order is given "ready about," the fore deck hands will go to their stations at fore sheets and jib sheets, and one of the after guard to the main sheet, seeing all are clear. The cry of "Helm's a-lee" will be the signal that the helm is being put down.

As the vessel nears the wind the jib will begin to lift; then handsomely ease up the sheet and overhaul it. If the vessel is coming round smartly, ease up the fore sheet or fore sheet purchase as well; the hand aft hauls in the main sheet if the breeze be very light and the vessel slow in coming up to the wind. When the vessel has passed the point "head to wind," begin to haul in the jib sheet, and get the sail sheeted and belayed before the vessel is full again and gathers way; handle the fore sheet in the same way, and overhaul the main sheet. Care must always be taken not to pull the jib sheet over the forestay, and get a strain on it before the vessel has passed the "head to wind" point, or is filling on the opposite tack to the one upon which she has been sailing; otherwise a back sail will be formed, and the vessel may fall off again. On the other hand the jib, when the time comes for working the sheets, must be sheeted with all despatch; as, if the vessel is allowed to fill before the jib sheets are in, it will be hardly possible to get them in properly without a tackle if there be a nice breeze. So with the fore sheet.

In tacking a vessel in a sea, the fore sheet should as a rule not be let go until it is seen whether the vessel is going to fill on the other tack or not, as the sail may be wanted to pay her head off: when the vessel fills, the fore sheets must be handled with smartness. If there is much sea, a "smooth" should be watched for, to tack in. Never, if it can be avoided, attempt to tack with a big comber rolling in on the weather bow, as a "miss-stays" may be the consequence, to say nothing of the water that might be thrown on deck.

The helmsman will soon find out how the vessel likes the helm put down for quick staying; but generally the vessel should be kept a good full before giving lee helm. Then at first ease the helm down gradually, so as to shoot a good distance, and make as big a circle as possible, but be very careful not to keep the vessel shooting till her way is stopped; as she comes near head to wind, put the helm right over to the rail, and keep it there till the vessel fills and gathers way on the other tack; keep the vessel a little off a good full till she is reaching along, and then bring her to wind "full and bye."

To TACK A YAWL.—The only way in which tacking a yawl is different from tacking a cutter is that there is the mizen-stay to work. The stays lead forward from the mizen-mast head, and are set up by tackles; only the weather one is set up. The weather tackle is overhauled in tacking, and the lee set taut, and forms the weather one when the vessel has filled on the opposite tack. Generally a yawl does not stay so quickly as a cutter, and more frequently requires backing off by the foresail.

TO TACK A SCHOONER.—Keep the vessel a good full. As the vessel comes head to wind ease up the jib sheet, but do not let it “fly”; overhaul the fore sheet purchase and fore-staysail purchase, and overhaul fore-topsail tack and sheet and clew up. When the vessel is head to wind cast off the standing part of fore sheet and fore-staysail sheet. As she passes the point “head to wind” haul in jib sheets and belay; haul in the standing part of the fore sheet and fore-staysail sheet and belay; then be smart with the purchases and get the foot of the foresail as straight as possible; fore-staysail sheet not quite so “straight,” as there should be a little flow in the after leech, owing to the angle made by the luff of the sail, and if the foot be hauled “bar taut,” the leech will generally be so too. Tack and sheet the foretopsail.

In hauling in the fore sheet all hands should be outside it, and not between the sheet and the rail. Care should also be taken that the fall of the purchase is clear and ready to lay hold of directly the standing part of the sheet is fast. One hand should be selected to stand by the fore sheet cavel, and he should belay. Directly the order “belay!” is given all hands should haul on the fall of the purchase; the belaying hand taking care that a turn of the standing part of the sheet is caught round the cavel. It is highly important that the fore sheet of a schooner should be well taut; as, if the foot be slack, the sail, not being set on a boom, is certain to bag more or less. And when sailing close-hauled and the wind frees a trifle, the fore sheet should always be the last one to be checked.

STERN WAY IN TACKING.—In square-rigged ships “stern way” is commonly the result of letting the head yards lie aback during tacking, but a fore-and-aft vessel, in tacking under ordinary conditions, should not be subject to stern way. However, sometimes, even in smooth water, if a vessel has been brought head to wind either too suddenly or too slowly, she may get stern way, or be placed in the situation known as “in irons,” when she will neither fall off on one tack nor the other, after being brought head to wind. If the vessel has stern way, it must be recollected that the action of the rudder is different from what it is with head way; that is to say, if during stern way the helm be put to starboard, the action of the water on the rudder will force the stern to port and the bow to starboard; and if the helm be put to port, the stern will be forced to starboard and the bow to port. Under the influence of head way opposite results are obtained. The rudder has very reduced effect in turning a vessel one way or the other during stern way.

Let it be assumed that a vessel has been sailing on the port tack, and on the helm being put down that she failed to get farther than

head to wind, or that she got in irons ; the result would be that the wind would drive her astern—this would soon be discovered by looking at the water over the quarter or stern, as the “wake” will show in eddies along the side of the vessel. The helm would be to starboard, and would have to be shifted to port, and the starboard fore sheet and jib sheet hauled in, and the main boom eased off. The stern would gradually drive to starboard, and the bow, under the influence of head sails aback, would go off to port. The head sails being aback would of course increase the stern way, and directly the vessel’s head was well off the wind, and the vessel insured against coming to again, the head sheets should be eased up and hauled in to leeward. She would require to fall off till the wind was brought nearly abeam before she gathered headway, and then the boom could be hauled aboard again.

Under the influence of stern way the pressure of water on the lee quarter can be made to help turn the vessel just the same as the pressure on the lee bow helps to press the bow towards the wind when a vessel moves ahead. Or suppose the vessel be head to wind, and has stern way on, and it is desired to cast her head to port, or fill her on the starboard tack ; then if she be listed or heeled to port by all hands going on the port side or port quarter, the ardency of the pressure on the port quarter will press the stern to starboard, and necessarily the bow turns to port.

Thus, it will be frequently found, that the bow of a vessel, if she has sternway, and is heeled, will very rapidly fall off to leeward ; even though the head sails are not aback, and the rudder, from the way it is turned, should prevent her doing so.

It should, therefore, be remembered, that when a vessel gets in irons, and is under the influence of stern way, that she should be, if possible, listed on the side it is sought to make the lee side. Easing the main boom off will allow the stern to come up against the wind more rapidly, and will help heel the vessel.

MISSING STAYS.—To get in irons or to get stern way on a vessel is not exactly missing stays, as to miss stays means to come up head to wind and then to fall off on the same tack again—in fact, to fail in going about. Generally a vessel has a tendency to miss stays through having too little after-canvas ; that is to say, the centre of effort of the sails is too far ahead of the centre of lateral resistance, and consequently she may even carry her helm a-lee and have very little to work upon in tacking. The fault may be cured by reducing the head sail ; by increasing the after sail ; by shifting the mast aft without reducing the sail ; by rounding up the fore foot and heel ; or by rounding up the heel.

But a vessel may generally stay well enough, and only fail in going

about through meeting a sea on her weather bow as she is brought to the wind; or through the wind following her round; or through the helm being put down too quickly or too slowly; or through the head sails being badly worked; or through her having insufficient way on when the attempt was made to tack. Whatever the cause, directly it is seen that the vessel is going to fall off on the same tack again after coming to, lose no time; haul the fore sheet, and jib sheet too, if necessary, up to windward, slack out the main sheet, and, if the vessel has stern way, bring the helm amidships. Directly she has fallen six or seven points off the wind, ease over the head sheets and trim them to leeward; and as she gathers headway haul in the main sheet, and sail the vessel a good full, and try again. At the next attempt, as the helm is put down, ease up the jib sheet smartly and haul in the main sheet, but let the fore sheet lie till the vessel falls off on the desired tack.

GYBING OR WEARING.—To gybe or wear is to keep the vessel off the wind by bringing the helm to windward until the wind comes astern and then on the opposite side to which it has been blowing. This manoeuvre has sometimes to be resorted to when a vessel miss-stays. Set taut the weather topping-lift. Ease off the main sheet until the boom is well off the lee quarter, and if there be much wind or sea, trice up the main tack and lower the peak; if a topsail is set it should be clewed up. Have as many hands as can be spared at the main sheet. Put the helm up. As the vessel's head goes off and brings the wind nearly astern, rally in the main sheet, and be careful that there is a smart hand stationed to take a turn with it. As the vessel comes nearly stern on to the wind, overhaul what has been the weather runner; catch a turn with the main sheet; and, as the boom goes over, meet her with the helm, so that she does not fly to, head to wind. Ease up the topping lift, and trim tacks and sheets.

If the vessel be already before the wind with the main boom square off, when it is necessary to gybe her, take the same precautions, if there be much wind, by tricing up the main tack, lowering peak, and clewing up topsail, not forgetting to set the weather topping-lift well taut, if it is not already taut, as it certainly should be. Luff a little, and get in some of the main sheet; when the boom is on the quarter (at about an angle of 45° with the keel), steady the helm and put up gradually, still getting in the main sheet. Hook on what has been the lee runner and set taut. Then, as the wind is brought astern, overhaul the weather runner, belay the main sheet, let the boom go over, and meet the vessel with the helm. Overhaul the lee-topping lift, and trim tacks and sheets.

These are the ordinary precautions taken in gybing whilst cruising; but in match sailing, unless something like a gale of wind be blowing, the

main tack is not triced up, nor is the peak lowered. There will, however, be the topmast preventer backstay to attend to. Station one man at the weather preventer to overhaul and unhook the tackle as the boom comes amidships. One hand to the fall of the whip of the lee preventer, who must haul the backstay aft as fast as the main boom is brought aboard; he must get the whip as taut as he can, and belay before the boom is gybed. The tackle must be then hooked on the preventer to set it up. In large vessels two hands should be told off to the lee preventer.

In a schooner similar precautions will be taken, and there will be the fore-topmast preventer backstays to attend to, and the fore-topsail should be clewed up. The fore sheet can be left until after the main boom is over.

CLUB HAULING.—Club hauling may have to be resorted to in a narrow channel sometimes when there is neither room to stay nor wear. Get an anchor on the lee bow with a warp bent to it; lead the latter to the lee quarter. Have the cable ranged on deck unshackled; put the helm down, and keep shooting with the sails shivering. When way is stopped, let go the anchor; as she is brought head to wind let all the cable run out through the hawse pipe, and haul in on the spring. The anchor, of course, will be got in over the stern.

Another better plan for a small vessel is to bend a warp to the kedge, and as the helm is put down drop the kedge over the stern, then hold on and haul in on the warp.

To HEAVE TO.—Haul the fore sheet up to windward, and the jib sheet until the clew just clears the forestay; ease the main sheet until the vessel lies quiet with her helm amidships, or a little to leeward. A vessel will lie like this very quiet, just forging ahead perhaps a knot an hour or so, and occasionally falling off, when she will take a great list as the wind comes abeam; directly, however, the after canvas is well filled she will spring to again, and if she is coming up with too much way on, so as to be likely to get head to wind, she must be checked by weather helm. To lie-to very dead so as to pick up a boat or speak another vessel, &c., it will be well to let the jib sheet fly and haul the fore sheet hard a-weather, with main sheet eased and helm a-lee.

In heaving to in heavy weather the mainsail is stowed and boom lashed, in the crutch, to each quarter. Instead of the mainsail a reefed trysail is set, or storm trysail, which is either jib-headed or has a very short gaff, and is hauled up close to the hounds in order that it should not get becalmed when the yacht is in the hollow of the sea. Bowsprit is run in until the outer end is within a few feet of the gammon iron, and storm jib set on it, with both sheets fast, and clew hauled up to windward of the forestay. Foresail stowed. Trysail sheet (a luff tackle) hauled aft.

In the case of a schooner the storm jib can be tacked inside the forestay to the bits, with clew just to windward of the foremast; main-trysail close reefed, or storm trysail, as the weather requires.

A yawl would be hove to just the same as a cutter, but if she were riding to a floating anchor a storm mizen might be set, but no other sail. As a rule the more sail a vessel will bear when she is hove to in bad weather the better, as the sail will tend to check the weather rolling; for this reason ships usually heave to under topsails, as the lower sail might be becalmed in the trough of the sea; for the same reason the trysail is cut narrow and high, and the same amount of canvas close to the deck would not be nearly so effective. Sail at the extreme ends of a vessel is never required, and a yawl hove to under storm jib and mizen would not lie nearly so quiet as she would if hove to under storm trysail and storm jib inside the forestay, as every time the headsail was becalmed she would be fetched to against the sea very hard by the mizen, or as the mizen was becalmed as she scended, she would fall off to a troublesome extent.

The helm can be left to take care of itself, or the tiller lines will be belayed on each side, slack, so as to allow a great deal of freedom for falling off with the sea. The general practice, however, is to have a hand to attend to the helm to humour the vessel as she falls off and bring her to again quietly up to the sea. A vessel will generally fall off as the crest of a wave comes in on the weather bow, and come to as the bow is in the hollow of a wave, or as the crest of a wave lifts the stern. Shallow vessels fall off much more freely than deep vessels, and come to with much more way on. The principal danger is that, if much way be gathered in coming to, a vessel should also meet with a big comber on the weather bow; to avoid this danger the man at the helm should meet the vessel as she runs off, and bring her to with the helm so that she fairly bows the sea, always being careful not to get her head to wind. At the same time, as before said, a vessel must be allowed to fall off freely with the sea, to the extent perhaps of three or four points, or until the wind was nearly abeam; but in bringing her to, her head should never be allowed to come within a couple of points of the wind.

TO HEAVE TO AFTER RUNNING BEFORE A HEAVY SEA.—Give warning below that the vessel is about to be brought by the wind, and see that everything is well secured about the deck. Watch for a "smooth" (which is brought about by several large waves meeting, and being broken up and dispersed into several small ones). Put the helm down, rally in the main sheet smartly; meet the vessel with the weather helm before she gets head to wind. Trim the head sheets as necessary. If the vessel has been running with a great deal of canvas set, it must be reduced as the vessel is

brought to the wind; and the throat of the mainsail should be lowered half down, and the tack triced up as the vessel comes to.

TO HEAVE TO TO PICK UP A BOAT.—It will be supposed that the wind is blowing off shore, and that the yacht is in the offing waiting for the boat. As the boat gets off into deep water, the yacht will reach in past to leeward of her from fifty to one hundred yards clear; then put the helm down, and shoot up towards her, keeping the jib sheet and fore sheet fast so as to lie a-weather as she fills on the other tack; or the jib sheets can be slackened well up so that the jib can blow about. If well judged the boat will now be close under the lee side of the yacht, and a hand will be ready to throw a line into her as she comes alongside. If the wind is blowing on the shore similar tactics will be observed, but a greater sweep must be taken in coming to, and the main sheet must be well rounded in as the helm is eased down. Sometimes under such conditions the yacht will run in to windward of the boat and wear round, but generally it is safer to keep to leeward and bring the yacht to.

SQUALLS.—If a squall is long foreseen, the sailing master will of course have snugged down and got his vessel so as to meet it end on if possible; but if caught unawares lose no time in letting jib sheets fly, and haul down the foresail. Set the topping-lifts taut; let the throat run half down the mast, and trice up the main tack. Or let the peak drop down between the topping-lifts until the gaff is about square to or at right angles to the mast. Then haul up the main tack and the mainsail will be scandalised. If the sail be a laced one the throat must be let down instead of the peak, keeping the peak downhaul fast to the centre of the boom to leeward to prevent the sail blowing out. In short-handed vessels the throat is generally let down in preference to the peak, as the sail is the more easily managed, and the throat can be got up again if necessary more easily than the peak could.

If the vessel has the wind abaft the beam when she is actually struck, put the helm up a little to keep her before the squall. If the squall strikes her before the beam, put the helm down. If the vessel gets struck or knocked down on her side before the sails can be lowered, and will not come to, cast off the jib sheets, pull the foresail down by the downhaul. Haul the main boom well aboard, cast off the throat halyards and the throat will fly down, then cast off the peak halyards and haul in on the peak downhaul. If the vessel does not right, get the kedje up if a bottom can be reached, bend the hawser to it and let go over the stern; then the vessel may wear round so that the wind will take her on the other side. If the ballast or anything else shifts to leeward, trim it back to windward. Close up the companion hatchways and skylights to keep the water out.

TO SCANDALISE A MAINSAIL.—Set taut the topping lifts. Trice up the tack as high as possible, and lower down the peak between the lifts.

SAILING BY THE WIND.—Sailing a vessel successfully on a wind is quite an art, and no amount of tuition will make a man a good helmsman if he be not "to the manner born." However, there is scarcely a yacht sailor who does not think he can steer a boat on a wind better than any other man. Still the fact remains, that some men cannot sail a vessel on a wind, and no amount of instruction will teach them to know for themselves when a vessel's sails are full or when they are "near." Some vessels are so beautifully balanced—that is, their centre of effort and centre of lateral resistance are nearly in the same vertical—that in moderate breezes they will "sail themselves" on a wind and only require a little weather helm now and again as the wind heads them. Yet a bad helmsman will find more difficulty or do worse in steering one of these vessels than he would in steering a very hard-mouthed vessel—one that carries a lot of weather helm, for we never suppose that a vessel carries lee helm. The well-balanced vessel is what may be called sensitive to her helm, or "tender mouthed," and the least touch of her helm will bring her to, and the gentlest pull on the weather tiller lines will take her off; such a vessel steered by a man with a "coarse hand" will be always "off" or "near," and never really "full and bye;" one minute he will slam the helm down to bring her to the wind, and the next haul it savagely to windward to keep her off the wind; whereas, if the vessel had been left alone with a free tiller, or with only the very slightest strain on the weather tiller lines, she would keep herself full and at the same time eat to windward as she luffed to every free puff. A vessel that carries a lot of weather helm does not require such delicate handling, and a man may tear away at the weather tiller lines until he is black in the face and he cannot do much harm; he will be delighted to find he has got hold of something to "hold on by," and all the strength in his arms will no more than keep the vessel out of the wind. But, although a good helmsman cannot be made out of a naturally bad one, it does not follow that a few hints would not be of service to the inexperienced who may have the light hand, quick eye, and sensitive skin of a perfect timoneer.

In the first place the sails should be as nicely balanced as possible, so that in a topsail breeze, when the channels are barely awash, the weather tiller lines only require to be kept just taut, with the rudder turned no more than six or seven degrees off the keel line. We are, of course, assuming that the sail plan has been so judiciously arranged that the effort of the sails when effectively trimmed, will be balanced by the lateral

pressure on the hull. If the sails are so well balanced then the weather helm will about equal five or six degrees in a moderate breeze, and it should not much exceed this nor be much less; if it is much in excess the vessel will be what is called ardent, and her constant effort to fly to will necessitate the helm being kept "right across her keel," which will very much interfere with her speed. On the other hand, if much less than six degrees of weather helm is carried in such a breeze the vessel will be what is called "slack," and will require constant doses of lee helm, and the result will be that the vessel will crab to leeward, and in tacking will be so slow in coming to that she will probably lose all her way before she gets head to wind, and then will require helping round by the foresail.

If the vessel in a nice breeze does not seem to gripe as she ought—that is, does not make much effort to fly to, and so cause a good strain on the weather tiller lines to keep her off the wind—first see what the effect of drawing in the main sheet a trifle will do; if this only improves matters a trifle, and the boat seems dead in the water or does not pass through it with any life, go forward or to leeward, under the foot of the mainsail near the mast, and have a look at the jib sheets and foresheet. See that the jib sheets are not pinned in, and that they are rove through the right holes. If the first jib be set and the sheets rove through the second jib-holes, the foot will be in a curve and the sail more or less in a bag; the effect will be to drag the vessel's head off the wind, and not assist in driving her ahead an inch. If the sheets be rightly rove, but hauled in too flat, the foot of the jib will be straight enough, and the sail generally be flat enough; but the effect will be that the sail, being trimmed too flat, will, as in the other case, press the vessel's head off the wind, and be of little service towards driving her ahead. It requires some experience of jibs and the way of trimming their sheets to know when they are trimmed so as to be most effective, and it would be difficult to frame advice on the point; but the leech should be straight, the foot gently curved or "flowing" with the sheet, and the luff should not lift—*i. e.*, shake. If the luff lifts it will be a sign, as a rule, that the sail is not sheeted flat enough. On the other hand, the clew should be well off the lee rail, and the sheet and the foot should make a gentle flowing curve from bowsprit end to sheet hole; if the sheet and the foot, when the sails are full, make a "straight line," it will be a pretty sure sign that the sheet is too flat. It is a good plan to have the jib sheets marked at the sheet holes by a piece of yarn, for sailing by the wind. But of course it must always be remembered that a jib must be sheeted to suit the strength of the wind.

If the vessel carries an excessive amount of weather helm, more than previous experience of her sailing would lead one to expect, and does not pass through the water freely, it may be relieved by easing off the main-sheet a trifle, and flattening-in the jib sheets, but the main sheet must not be so much eased as to cause the sail to lift, nor must the jib sheet be flattened-in so as to make the jib simply a pressing sail. In vessels that are broad across the deck at the bow the jib sheets can be much better trimmed, as there is less chance of getting the sheets too flat; hence, as a rule, second jibs are always made to stand better than first jibs, as they do not go out so far on the bowsprit, and the angle made by the sheet is therefore coarser. [In very narrow vessels outriggers are frequently used to lead the sheets through and get more spread.]

It can be supposed that the sails are all nicely trimmed, doing their work properly, and that the vessel carries just the right amount of weather helm, and will fly to directly the weather tiller lines are released. Under these conditions the tiller is handed over to the young helmsman, and we will first say a few words as to the position he should take. As a rule, the steersman stands near to or sits on the weather rail, and this is undoubtedly the best position; he can then look into the jib and foresail, see when they are inclined to lift, and at the same time watch the luff of the mainsail and the vane or flag, which, if there be a topsail set, should flicker just on the weather side of the yard. But sometimes in light winds a man may sit on the lee rail and watch the head sails from under the lee of the mainsail, and this will be occasionally a capital position if a jib topsail be set. The weather tiller-line must, of course, be rove through the sheave in the weather rail, then, with the fall in his hand to leeward, the helmsman can keep his vessel off or bring her to at will. Of course, we do not mean that a man might always equally well sit down to leeward and steer, but there is no better place for seeing the sit of the sails, and an occasional visit to leeward will often prevent the necessity for shouting out "How are our head sheets?" which invariably produces a general scramble of the crew to the lee bow, and a meaningless chorus "All right, sir!" Some men we have seen get a deck cushion and sit down by the side of the tiller and hug it as if they had got hold of the neck of a favourite donkey. They may be very good helmsmen, but their hunched-up appearance, as they squat on their haunches cuddling the tiller, necessarily makes one form a very poor opinion, at least, of their "style," and frequently the man can be put down as more or less of a sloven.

It can be concluded that the best position for the helmsman when sailing on a wind is as near the weather rail as possible; he can then

really see for himself what the head sails are doing, and the admonition "She's near for'ard" need never be heard.

The jib is perhaps the best guide for the young helmsman, and if he steers by that alone, he ought always to be able to keep his vessel full and yet not allow her to get off the wind. With a nice topsail breeze—not strong enough to lay the vessel in to the deck—the luff of the jib will be just rippled, or the canvas into which the luff rope is stitched will more or less "bag," and will be in a constant state of quivering; but the luff of the sail must not be allowed to lift, *i.e.*, to go into large folds, as, if it does, it will be a sign that the vessel is too near. If you are keeping the vessel a good full there will be no ripples or wrinkles in the luff of the jib—unless the jib be a very old and badly-stretched one—and all the sails will be quiet.

In sailing by the luff of the mainsail, as some men do who cuddle the tiller, the young helmsman may be apt to get his vessel off the wind, as he will be constantly thinking she is "near," through the eddy wind out of the foresail making the luff of the mainsail shake. The luff of the mainsail is thus a not very trustworthy guide for the inexperienced helmsman; still, as a rule, when the luff of the mainsail lifts and the disturbance begins to travel aft across the belly of the sail in waves, it will be a pretty sure sign that the vessel is "starved of wind," and a little weather helm should be given her.

Sailing by the vane, whip, burgee, or racing flag, is sometimes said to be the easiest and at the same time the most trustworthy guide for close-hauled sailing; but a very little experience will soon prove the fallacy of this. If the vessel is moving along at a good pace, say five or six knots an hour, the flag will blow aft nearly in a line with the keel, and if there be a square-headed topsail set, the flag will flicker on the weather side of the yard. But in such light winds as we are now assuming to blow, there may be quite a different current of wind aloft. Thus we frequently hear the remark "She's near for'ard" responded to by the helmsman, "She's all full aloft—look at the flag,"—and probably the flag will be right across the vessel. Or the flag may blow out to windward of the topsail yard, or droop and cause the helmsman to think that he has got his vessel head to wind, and he will of course haul the tiller to windward. This, perhaps, will cause a shout of "Bring her to!" or "Let her luff, she's all off the wind," and an appeal to the vane or racing flag will only show what a misleading guide it is. In fact, trying to sail the vessel by a vane, or by the luff of a topsail, will be certain to cause "remarks" to be made forward, and as these remarks have always an irritating effect on the steersman, he had better sail on a

wind by the head sails than by the flag, especially so as he will thereby be able to keep the lower sails doing their work, and it is the lower sails which must be mostly depended upon for getting through the water.

An old hand will sit down by the tiller and, perhaps, close his eyes, and still fairly sail a vessel on a wind, as long practice will tell him whether the sails are full or not by the feeling of the wind on his face. He will not deign to look at jib, mainsail, or flag, but will give the vessel lee or weather helm just as he feels the wind on his face comes freer or shorter. This really is a very good guide, and the steersman when he gets thoroughly acquainted with the sailing of a vessel on a wind will find a "chill" on his face a very trustworthy hint as to the doing of a paltry, shy, or baffling wind.

In sailing on a wind, keep an eye on the head sails, after sail, upper sail, and vane, and the other eye to windward, for nine times out of ten the direction of an impending puff can be seen as it travels towards the weather bow of the vessel, rippling the water in its course. If the dark ripples are seen coming broad on the bow, you will know that it will be a good luffing puff, and as it takes hold of the vessel, ease the weather tiller lines, and let her luff to it freely, but do not allow the jib to lift; then, if the puff is a mere "chill," out of a passing cloud, perhaps, and leaves the wind as before, do not wait till the puff has passed over before the helm is hauled a-weather again, or the vessel will be left nearly head to wind, and this would be a very lubberly proceeding; therefore, before the "free puff" has blown itself out, haul up the helm and get the vessel full and bye again.

If you see that the puff is a strong one, of the nature of a squall, do not get nervous and luff before it strikes the vessel, unless of course it is considered prudent to shoot up head to wind to meet it. If you begin luffing and lifting the sails before the squall strikes, you will deaden the way of the vessel, and then the squall will have much greater effect in heeling the vessel, and will perhaps take the topmast away—as a very frequent cause of topmasts being broken is by being caught in a puff when the vessel has no way, or but little way on.

But puffs as frequently come ahead as broad on the bow, and the head puffs are the more difficult to deal with. Keep a good look-out for these "nose-enders," and if lucky enough to see one before it reaches the jib, keep the vessel off a little, and, if possible, prevent the sails lifting at all. These puffs will be most frequently met with when sailing along under high land or under trees; one minute a puff will come broad on the bow or on the beam and lay the vessel in to the skylights, and the next one will come right ahead and bring her upright as a monolith; and

what with luffing to one puff and keeping away for another, the helmsman will have his vigilance very highly tested. He, of course, will not be able to keep the sails from lifting at all, as the puffs are more or less revolving, and Palinurus himself could not successfully dodge them; still, with care, a vessel should never be allowed to get head to wind so as to want backing off by hauling the fore sheet to windward and easing off the main boom—this would not be seamanlike, and would betoken great inattention.

In luffing to free puffs, or in keeping away for foul ones, do not "slam" the helm about; that is, do not shove it down as if you were trying to avoid striking something, or haul it up as if you were bearing away round a mark. In most cases easing the tiller lines will enable the vessel to luff all that is necessary, and when free puffs are about a very light hand should be kept on the tiller lines, and the vessel will dance herself to windward and eat out on the weather of one whose tiller has been held in an iron grip during all the puffs. Get all the luffing possible out of a vessel, and never miss the smallest chance of a gripe to windward, even to a quarter of a point of the compass; but do not put the helm down so coarsely that there is a danger of bringing the vessel nearly head to wind; if this is done the helm will have to be put hard up to get her off the wind again, and nothing so interferes with good performance on a wind as too much ruddering. A good helmsman must have a light hand and unceasing vigilance, as "weatherly qualities" are in no small manner dependent on the way a vessel is steered. Therefore it cannot be too frequently repeated that the faintest semblance of a luffing puff must never be disregarded, and the vessel must at the same time be humoured so tenderly to it, that no one shall see what the helmsman is about unless by watching his movements very closely. On the other hand, in using weather helm in keeping off to avoid a foul puff, it will not do to be too slow with the helm, or the vessel will be stopped, and, without way on, it will be some trouble to get her full and going again. Therefore always put the helm up as promptly as possible, but do not haul it savagely on to the weather rail as if you were going to sail "large" for the rest of the day. If a puff is not seen coming broad on to the bow look out for one coming ahead, and directly the jib shows the slightest sign of lifting, drag steadily on the weather tiller lines; if the puff is a very bad one, the helm must be smartly hauled aweather, but as a rule the foul puffs will not vary in direction more than a couple of points from the direction of the true wind, and they must be accorded with by as delicate a use of the helm as for "luffing puffs."

Thus the secret of close-hauled sailing consists in such a constant watching of the wind and such a use of the helm to meet its variations, that the vessel is always "full and bye," and never "near" and never "off" the wind. When a man can so sail a vessel, he will be a perfect helmsman, and will make her eat to windward as fast as the very best professional skipper could.

Speaking of professional skippers reminds us that many of these have a funny habit of "sawing" the helm backwards and forwards; that is, they haul on the weather tiller lines and then ease them without apparent motive, generally accompanying the performance with a corresponding see-sawing motion of the body, by first resting on one foot and then on the other. Probably this peculiar habit was acquired on board fishing vessels in the winter, when the men might find sawing the helm and working their bodies about promote warmth. It certainly is no assistance to a vessel, and is very "bad form."

Sailing a vessel in a strong wind, say with the scuppers full of water, will not be quite such a delicate operation; still, the wind will vary a great deal, and the very most must be made of the free puffs, and the effect of foul ones reduced as much as possible. The vessel will of course carry a great deal more weather helm, and when the sails are nicely trimmed the jib will be found the most reliable sail to steer by, as the luff of the mainsail will lift a great deal from the mere effect of the wind out of the foresail. Look out for the very hard puffs, and do not allow the vessel to needlessly bury herself; on the other hand, do not get frightened at a little water on deck, and throw the vessel in the wind. Sail her along heartily, even to the rail under, but never forget to ease the tiller lines for the smallest freeing of the wind; and for the very heavy puffs do not luff before they strike, but luff into them as they strike; the vessel will then not be knocked down so badly, and will walk off with increased speed by the aid of the puff.

It must not be supposed that it is a good thing for a vessel to be sailed with her rail under and the water nearly up to her skylights; but in sailing on a wind she should not be luffed up for the mere sake of getting her out of such a condition if it is only a passing puff that has laid her in; luffing, as a rule, in close-hauled sailing, in our deep-bodied, heavily-ballasted yachts, is to take advantage of free puffs; but occasionally when the puff is very strong, and neither free nor foul, advantage may be taken of its strength to do a little luffing, and at the same time clear the lee deck of water; in such luffing the chief care of the helmsman will be not to get the vessel so near the wind as to much stop her way or risk getting in irons.

Frequently in match sailing a vessel is found to be heading for her mark, and the hope of the helmsman will very properly be that she will fetch without making a tack; but he must not get anxious about it, and hug the wind; if he does the vessel's way will be deadened, she will make an unusual amount of leeway, and it will be a hundred to one against her fetching. He must sail her along boldly, not getting off the wind and courting another tack, but exercising all his care in keeping her an exact full; she will probably fetch, and if her head now and again falls to leeward of the mark, it will probably come to windward of it again; on no account get nervous and try to *steer* for the mark. If such an attempt is made, the mark will not be fetched, and the attempt will be quite contrary to the principle of the art of close-hauled sailing, which art cannot be regulated by "steering" for fixed marks. There is an old saying "keep a vessel full and she will eat herself to windward, but try to sail her in the wind's eye and she will crab to leeward." Occasionally a little "niggling," as it is called, may be indulged in if the mark is very near; but even then the vessel must not be sailed so fine as to cause the head sails to actually lift; and when within fifty yards or so of the mark she should be ramped along a good full and shot up to windward of the mark with good way on, as if she be gilled up to the mark with little way on, and got met at the last moment by an unfriendly puff, a collision with the mark would be almost a matter of certainty. This, although a most humiliating spectacle, very often happens, as skippers will do almost anything to save a tack; but it is only the smartest of them that can judge when a tack can be profitably saved and when not. (*See "Over-reaching."*)

SAILING A VESSEL ON A WIND IN A HEAVY SEA.—It will require some nerve to sail a vessel successfully on a wind in a heavy sea. Often a haunting fear that the bowsprit will be carried away, or the deck swept by a green sea, makes a man have the vessel's sails constantly lifting; the result is that she tumbles about in the sea like a log, sags to leeward, and gets the character of being a bad sea boat. Do not fear the breaking of a bowsprit or a green sea on deck; be not unmindful of either, but above all things keep the vessel ramping full; this is the secret of success in sailing on a wind in a sea. Of course it is assumed that the vessel is properly canvassed: if she has two reefs down in the mainsail, that the foresail is single reefed, third jib set, bowsprit reefed, topmast housed, and everything securely lashed on deck. The vessel should be canvassed so that in the true strength of the wind the covering board would be well out of the water—a fourth of the height of freeboard. In a sea it will not do to sail a vessel rail under, as a weight of water on

deck and the fact of the vessel being over on her side will greatly interfere with her good performance; therefore a vessel should be canvassed so that her rail will not go under, and in the squalls she must be eased judiciously with the helm, always remembering that although occasional easing may be prudent the chief aim must be to keep her full. The main boom should be eased off a couple of feet or so farther than it is in smooth water, and the weather topping-lift should always carry the weight of the boom. The fore sheet should also be eased, but the jib sheet should not be eased so much as to cause the jib to lift badly, as the jib will be wanted to keep the vessel out of the wind.

As a rule the vessel will be found to pitch pretty regularly, and one sea being very much like another, the vessel will be sailed through all, hard and a good full. Do not let her sails shake, as her way will be stopped; she will then pound the sea and jump two or three times into the same hole. Those on board will say "what a horrid bad sea boat she is, that she pitched two or three times to the once of any other vessel, and always had her deck full of water." But keep a wary look-out for the big seas. One will be seen rolling in on the weather bow, gradually gaining in height, and perhaps rising, pinnacle like, just at the point where the vessel will meet it. This is the wave to be ready to meet; it will rise higher and higher as it gets towards you, and will either curl over and break up by its own exhaustion, or from the fact of its meeting the vessel, and there will be in either case a ton or two of water on deck. Just before the big wave reaches the vessel there will be an unusual hollow or deep trough, and into this she will and must go; before she can recover herself the big wave will roll over and fairly swallow her up; then there will be a smooth; a number of small waves will be formed; the vessel will give one or two deep dives—the result of her bow being thrown up by the big wave—and then be steadied for a minute or so in the smooth.

When a big sea like this is seen on the weather bow, the vessel's helm should be eased down a little just before the sea reaches her, so that she may take it more fairly stem on; but in luffing into the wave do it in good time, and directly she is fairly into it put up the helm again, and fill her sails before she has time to get head to wind. The object in easing the vessel is of course to ease the shock both by deadening her way and by presenting the stem to the sea instead of the bluff of the bow; therefore directly the sea and the vessel have met, the effect is over, and the vessel must be filled instantly; that is, she must be put off the wind again to a good full and bye.

The most tiresome of all seas to sail a vessel in are those which are

met with on a weather-going tide in more or less shallow water, such as on the Brambles, at the mouth of Southampton Water, or on the Bar at the entrance to the Mersey, or at the Nore. Here the sea is furrow-like; that is, the troughs are long and deep, and the crests of the waves are a succession of sharp ridges instead of the long-backed waves met with in deep water. So long as a vessel keeps time with these waves, that is, so long as she only pitches once into each hollow, there will be a regular succession of pitching and scending; but if, through the wind heading her, or through careless steering, her way becomes deadened, and she pitches twice into the same hollow, or if she does so through meeting a trough of unusual length, there will be trouble on deck in the way of water, as the vessel will meet the wave crest just as she takes her second dive instead of when she scends from her first. There will be two or three very quick dives after this, and the helmsman must keep the vessel full; not shake her up because she is taking these unpleasant plunges, but keep her full in order to keep her going through the sea, and to get her into the regular fall and rise of the waves again, or, as the sailors say, make her toe and heel to the tune.

It can be supposed that the vessel is sailing in a pretty regular sea, and that she rises, and at the same time cleaves through a wave as at A (Fig. 28). Whilst she is going up through the wave, or scending, she

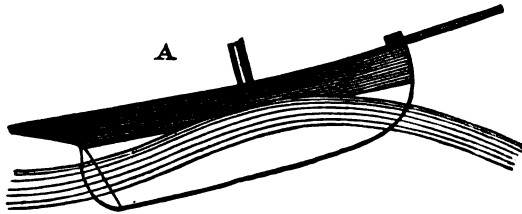

FIG. 28.

will show a tendency to come up to the wind, as her stern will be so little pressed by the water that it will go off to leeward. She will stop

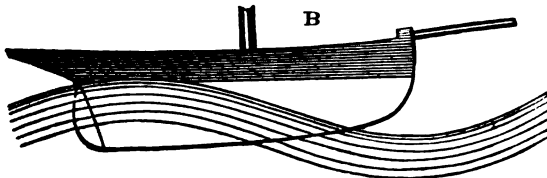

FIG. 29.

in suspense for a moment and then pass rapidly through the wave, and the next moment will be in the position B (Fig. 29), when her bow, being unsup-

ported, it will fly off the wind. This latter tendency must be guarded against, as in another moment the vessel will be in the position C (Fig. 30), with water well nigh up to the bowsprit bitts. She will rise streaming with water at *d*, and take the position A again, and so on *ad nauseam*. Very frequently a vessel will shoot so far through a wave when in the position A, that she even gets farther through it than shown by B; this is what

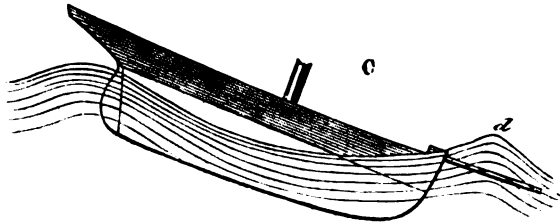

FIG. 30.

a vessel does that is sailed fast through a sea with a lot of canvas and with a tremendous momentum, due to the speed and weight of the vessel and her manner of ballasting. Often three bigger waves than usual will come one after the other and then there will be a smooth, but frequently the three are thought to follow, when in reality the vessel is only plunging from the effects of the motion imparted to her by one big wave. At any rate when the vessel gets into the position B, she should be put as fairly into the sea ahead of her as possible. If there is no big sea ahead she will fall harmlessly enough into the trough and will hardly require easing.

In sailing a vessel hard through a sea like this, the motion will necessarily be unpleasant, as, instead of rising leisurely as it were to the waves, and pitching gently, the vessel will more or less of her own momentum throw herself ahead; this will not only make the motion quick and unpleasant, but will put a great strain on the gear, but as it is more a question of getting through the sea than riding over it with comfort and with safety to the gear, the last words on this subject will be, keep a firm hold of the weather tiller lines.

SAILING OFF THE WIND.—Sailing off the wind means that the vessel is more away from the wind than the close-hauled point, and applies up to the time when the wind blows four points abaft the beam, when the wind would be quarterly. In sailing with the wind abeam, the head sheets must not be eased up too much, but a good strain must be kept on them, as the vessel is almost certain to gripe a great deal, and to show a tendency to fly to; of course, if the head sheets are eased up so that the sails are always lifting, this tendency will be much more urgent.

Neither must the main sheet be eased off too far; if it is, the weather cloths of the sail will "lift" and go into folds. If the fore part of the sail does so lift, the main sheet must be drawn in a little until the sail has the full weight of the wind and falls "asleep." Frequently the luff of the sail may be quiet enough, but the topsail may lift, and that will be a sign that the mainboom wants hauling aboard a little, so as to get the peak more inboard, and thus make the topsail stand better. But the mainsail must not be pinned for the mere object of making the topsail stand; if the luff of the latter be to windward of the topmast, the cause of its lifting may be the eddy wind round the topmast.

With the wind abeam the vessel will be laying her course, and the helmsman will have to steer by compass or by keeping some object straight on for the bowsprit end. Every tendency the vessel shows to fly up in the wind must be promptly met by the helm; do not hold the helm as if the object was to keep it rigidly in one position, nor wait until the vessel's head has ranged up two or three points. Watch the compass card or the object you are steering for, and directly the vessel brings her head to windward give her a little weather helm and keep her straight if you can. If she shows a tendency to fall off, meet her promptly with a little lee helm, and always remember that the object is to make her keep a straight course, and to prevent her yawing either on or off the wind. It will not be a question of keeping the sails full and no more than full, but that of making the vessel go straight as an arrow for her object, always recollecting that if she yaws about that of itself will stop her way, and there will be also the retarding action of the rudder to bring her back on her course; therefore using a little helm promptly will prevent yawing, and the checking of the vessel's way from this cause will be reduced to a minimum.

But a vessel may gripe through the wind shifting more aft, or she may show a tendency to run off through the wind coming more ahead, therefore the vane must be watched, and the blowing of the wind on the face should also be regarded. In match sailing especially, slight alterations in the wind should be observed, and we have frequently seen the main sheet laid along the weather side of the deck in the hands of the crew, who slackened off or drew in the boom to suit every slight alteration in the wind. Of course this would only be done in very light winds, but all cases and alterations in the wind that make a palpable difference on the amount of weather helm carried, should be promptly provided for by trimming the sheets.

With a beam wind if there is much strength in it—so strong that a topsail lays her in to the deck edge—the vessel in the puffs will now and again shove her rail under, but she should never be permanently sailed with

more than two or three planks of the deck awash. Sail should be shortened without hesitation if the reach is a long one, and if the wind seems bent on a good steady blow. But if it is a mere puff, or if the reach be a short one of a half mile or so, the vessel must be eased to get the water off deck, and ramped along again in the lulls. Some judgment must be exercised in so easing a vessel, as if her sails are made to lift very much her way will be stopped; on the other hand, if she has to sail with her lee deck full of water up to the rail, that will stop her way, and so the aim must be to stop her speed as little as possible from either cause, and as before said, if the reach be long and the wind a lasting one shorten sail.

SAILING OFF THE WIND IN A HEAVY SEA.—In sailing along the wind in a sea—it would not be attempted if the sea were very heavy—the helmsman will find some difficulty in keeping his vessel from gripping-to or running off, as the sea will carry her about a great deal. He should be well prepared to give her lee helm promptly if she shows a sign of running-off, and should either keep the lee tiller line in his hand, or the tiller itself, or should have someone to leeward of the tiller, the latter if the vessel be a big one, say of 70-tons, or upwards. If the vessel gripes-to, she must be given weather helm; but checking the tendency to “run off her helm” will require the most care, and lee helm should be given a vessel directly her head begins to fall off when sailing along the wind. With a heavy beam sea a sensation will be experienced of slipping down the side of the waves as the seas pass under her; but the great danger will be from a beam sea breaking aboard, and, as before said, if the sea is very heavy, she should be either put head to it or before it.

TO RUN BEFORE THE WIND IN A HEAVY SEA.—Have the boom topped up, so that the boom end will clear the combers if possible during the lee roll. Bend the boom-guy by making fast with a clove-hitch the thimble end to the boom, about two-thirds of the length of the boom from the mast. Take the guy forward, pass the bight round a cleat or snatch block, and bring the end back, and reeve through the thimble, and belay. Sometimes the guy is simply taken forward and belayed, or set up by a tackle.

If the sea is very heavy the mainsail should be stowed and trysail set. The squaresail, reefed, should be always set under such circumstances, but it is best to have the trysail as well, because if an accident happened to the squaresail, the vessel can be brought to wind and hove to under the trysail. The trysail should be sheeted pretty flat, as the sail will then tend to check the weather rolling and inclination to fall off. The foresail would be lowered, but a small jib should be always kept set.

Another reason for preferring a trysail to a close-reefed mainsail is that the head of the sail would be higher, and would keep the wind whilst in the trough of the sea, whereas a close-reefed mainsail might be becalmed. For the same reason, to avoid being becalmed, a reefed square sail should always be hauled close up to the hounds.

In running before a wind and sea great care must be taken that the vessel does not get by the lee; that is, that she does not run off so much as to bring the wind on the other quarter and gybe. The lazy guy would most likely prevent the boom coming over; if it did not look out, and keep clear of the main sheet if you are near the counter; and lie down on deck, as, if the boom is brought up suddenly by the runner, it may break and sweep the deck.

Supposing the vessel gybes without any other accident, "meet" her promptly with the helm, and do not let her fly to; then prepare to gybe the vessel back again if necessary; get in some of the main sheet; drop the throat or peak down; put the helm up and gybe her handsomely.

If when running under squaresail the vessel broaches to, that is, flies up into the wind and gets aback, brace the squaresail sharp up, and haul the weather jib sheet taut; keep the helm hard up until the vessel is before the wind again. If the vessel flies to quite head to wind, the squaresail must be stowed and the foresail set, if necessary, to back her head off.

It is generally supposed that a large quantity of sail must be carried when running before a heavy sea, in order to keep ahead of the waves; or, in other words, to avoid being pooped. This is not exactly the case, as the speed of large waves is much too great for any vessel to run away from them; thus an Atlantic wave 200ft. in length (such as would be met with in a brisk gale) travels at the rate of twenty miles an hour, and no vessel could run at that speed. The height of such a wave might be about 35ft., but probably would be not more than 15ft. and the object of having much canvas set would be that a vessel might not get becalmed in the trough of the sea, and by suddenly losing her way cause an overtaking wave to be broken up; a quantity of water might then possibly fall on board. [It must always be understood that it is not the water which travels, but only the wave motion]. This would be termed "pooping," and to avoid such accidents square topsails have been much recommended for large cruising yachts, as, owing to their loftiness, they are unlikely to get becalmed in the trough of the sea. However, pooping more frequently happens from quite a different cause, in this way: as a wave advances it will sometimes grow in height and lose in length, and as a wave form cannot be sustained after a certain proportion of height to length has been reached, the crest of the wave becomes suddenly sharp

and still higher, and ultimately curls over on the side it has been advancing. If this breaking up of a wave—which under such circumstances might rise to a height of 50ft.—should happen close to the stern of a vessel, she will be inevitably pooped; that is to say, some of the water will fall on board, and the crew will have to hang on for their lives.

Large deep sea waves, when they approach shallowness, alter in form and lose their speed; they become shorter and higher (deep-sea waves whose original height was 40ft. have been said to rise to 150ft. as they approach the coast), and then the crests, travelling faster than the troughs, topple over in broken masses. Hence waves in shallows or near the coast are more dangerous than deep-water waves.

CARRYING AWAY A BOWSPRIT.—Directly the bowsprit is gone, ease the main sheet and haul the fore sheet a-weather; but if the vessel has been reaching well off the wind, she must be brought to wind, and in either case hove to. If the bowsprit is carried away near the stem, in consequence of a shroud bursting, the outer end will fly aft. Lower the jib and unhook from the traveller. Put the bight of a rope under each end of the bowsprit,

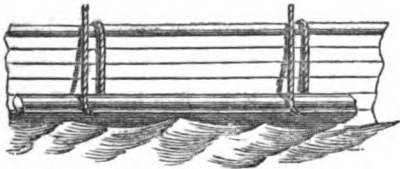

FIG. 31.

the end of the inner part of each rope being fast on the deck; haul on the other part, and thus roll or par-buckle (*see* Fig. 31) the bowsprit up the side of the vessel to the deck. Then clear the gear. The bowsprit may be got out again properly secured.

If the end of the bowsprit breaks off outside the jib-tack sheave hole, let the jib sheet fly; or take the jib in altogether, as most likely a change will have to be made. Get the end of the bowsprit on deck, take the gear off, and re-fit it to the bowsprit end by lashings.

If the topmast should not be carried away by the loss of the bowsprit, try and save it. Let go the topsail sheet and halyards, and get the topsail down. Take the jib topsail halyards or spinnaker halyards forward, and set taut as a topmast stay, to steady the topmast.

CARRYING AWAY A BOWSPRIT SHROUD.—Let the jib sheet fly. Put the helm down and bring the vessel on the other tack immediately; if there is not sea room to keep the vessel on the other tack, let the jib run in and heave to. Then repair damage, or set up the shroud by tackles. (*See* "Strop" in Appendix.)

CARRYING AWAY A BOBSTAY.—Let the jib sheet fly and heave to. If it is the fall that has broken, the bobstay will have to be fished up and a new one rove. If the shackle on the stem or the bar is broken so that it cannot be repaired, and there is no second shackle or bar on board, the vessel must

be sailed without a bobstay. Reef the bowsprit in, set a small jib, and do not sheet the jib too taut. In squalls, or when falling into a wave hollow, ease the vessel with the helm. Many fishing vessels, some of 80 tons, are never fitted with bobstays; but of course they have very short bowsprits.

If there is any sea, the vessel should not be sailed without a bobstay and with no jib set, as the bowsprit would under such conditions most likely be carried away. The stay rope of the jib will support the bowsprit, but the jib sheet should be well lightened up. (*See "Strop" in Appendix.*)

CARRYING AWAY A TOPMAST.—A topmast when broken invariably falls to leeward, and it would be very difficult to give directions for clearing the wreck away. It will hang by the topsail sheet from the gaff, by the tack over the peak halyards, by the backstay over the peak halyards, and by the topsail halyards if they were belayed to windward. In clearing the wreck and unreeving, be careful not to let anything go until it has been properly secured or lashed, so as not to tumble on deck.

CARRYING AWAY A MAST.—The best thing to do, if the weather is very heavy, is to unreeve tacks, lanyards, and backstay tackles, and ride to the wreck, as it will make a capital floating anchor. When the weather moderates, the mast can be got alongside, the gear cleared, and the sail got on board. In a large vessel the mast will probably be too heavy to handle, and will have to be made fast astern. In a small yacht the mast may be rigged as a jury mast. Supposing the mast has been carried away five or six feet above the deck, put the heel of the mast against the stump on the aft side so that it cannot fetch away; take the lower main halyard block forward to stem head; put guys on the masthead, and lead one to each side of the yacht. Lift up by the masthead, and set taut by the main halyards, and when the latter have got sufficient purchase hoist the mast to a perpendicular, steadying by the guys. When upright lash the mast to the stump, seize bights in the shrouds to shorten them, and set up by the lanyards. If the mast be worked round to the fore side of the stump, the boom gooseneck can be shipped as before. Set the mainsail reefed or double reefed as required, or set the trysail.

If the mast be carried away close to the deck, unship the stump, and step a spare spar to lash the heel of the mast to. Or the broken mast could be stepped. In this case it would be better to improvise sheers by taking a couple of spars, such as topsail yard and trysail gaff; and, after lashing their ends together, rear them over the mast hole, one leg in either scupper. A tackle should be lashed to the apex of the sheers for hoisting the mast by. Keep the sheers in their place by guys leading forward and aft.

Sheers might be used for getting the mast and boom on deck, or

for rearing the mast on end at first, by rigging them aft, when the heel of the mast is to be lashed on deck.

In case of a mast being carried away close under the hounds, preparations for getting the rigging and halyards aloft again can be made by throwing a line over the masthead, and hauling a tackle to pull a man aloft by. If the masthead is carried away, the main halyard block can be lashed above the rigging round the yoke. The peak hoisted by one of the topping-lifts, or by a couple of blocks of the peak halyards, one to be lashed to the masthead over the main halyard block.

When the masthead is badly sprung above the yoke, but is kept from falling by the topmast, let fly the jib sheets, heave the vessel to, and lower the mainsail as quickly as possible. Lower the topmast half-way down, and lash the heel to the mast. Unhook main and peak halyard blocks, and unreeve jib halyards. Then prepare for rehoisting mainsail as if the masthead were carried away. The topmast will keep the mast head from falling.

CARRYING AWAY THE FORE STAY.—Ease up fore and jib sheets, slack out the main sheet, and run the vessel off the wind. Put a strop round the bowsprit close to the stem, and set the lee runner up to it. If the fore stay cannot be secured by tackles, haul an end of the cable up to the masthead by the foresail halyards, and take a bight round the mast above the yoke. Set up the cable through the hawse pipe. Sometimes a jury fore stay is rigged out of one of the hawsers. (*See "Strop" in Appendix.*)

CARRYING AWAY A RUNNER.—The greatest strain comes on the runners (by runners is meant the pendant runners and tackle), when the wind is a little abaft the beam; and if the weather one is carried away, the vessel should be instantly thrown head to wind, and put on the other tack until the runner is repaired. The vessel should be met by the helm when near head to wind, and not put on the other tack until the main sheet is hauled in. If there be not sea room to sail the vessel when on the other tack, heave to.

CARRYING AWAY A TRIATIC STAY.—If the triatic be carried away, and the mainmast does not go with it, put the helm up, slack out the main sheet, and run the vessel off the wind. Take the lee main runner forward, outside the main rigging, and set up to the fore-runner bolts. If there be a fresh breeze, stow the mainsail, and then repair the damage.

CARRYING AWAY A TOPMAST BACKSTAY.—Throw the vessel up in the wind, let fly the topsail sheet, jib topsail sheet or spinnaker sheet, and if the damage cannot be quickly made good take in the topsails.

TO ANCHOR WHEN ON A WIND WITH WEATHER-GOING TIDE.—Get the anchor ready on the bow, and some cable ranged on deck. Have the mainsail ready for lowering. When nearly abreast to leeward of the spot where

the anchor is to be let go, lower the main sail and put down the helm; when head to wind bring the helm amidship, take in jib and foresail and shoot to the spot where the anchor is to be let go. Unless there is so little wind that the vessel will be wind rode when she is brought up it is important that the mainsail should be stowed before she comes to anchor; otherwise as she swung round to before the wind with the tide, the consequences might be very awkward.

To ANCHOR WHEN ON A WIND WITH LEE-GOING TIDE.—Have the anchor and cable ready. Have jib and foresail ready for lowering. When abreast to leeward of the spot where the anchor is to be let go take in jib and foresail, put the helm down and shoot up head to wind, and when way is deadened let go the anchor and stow the mainsail; or if plenty of hands are on deck, lower the mainsail as the vessel is brought to. The vessel will of course lie head to wind and tide.

To ANCHOR WHEN RUNNING BEFORE THE WIND, BUT AGAINST THE TIDE.—Stow the mainsail, take in the jib, put the helm down, shoot head to wind, lower the foresail, and let go the anchor.

Or stow all the sails, and do not alter helm. When the tide has brought the vessel to a standstill, let go the anchor.

To ANCHOR WHEN RUNNING BEFORE THE WIND, AND WITH THE TIDE.—Take in jib and foresail, haul in the main sheet, put down the helm, and when head to wind keep shooting till way is stopped; let go the anchor, and stow the mainsail.

If moorings have to be picked up, the same course will be followed; but judgment must be exercised, so that when the vessel shoots up to the watch buoy her way is almost or quite stopped.

ANCHORING IN AN OPEN ROADSTEAD.—In coasting it may be frequently convenient to bring up for the night under the land, but if the weather looks at all bad seaward, the precaution should be taken to unshackle the cable and bend the watch buoy on. Then if the sea did get up in a great hurry the cable could be slipped, and recovered on another occasion.

To MOOR.—Veer out chain about double the length of cable it is intended to ride by; when the vessel has dropped astern and brought the cable taut, let go the second anchor; veer out chain, and heave in on the anchor first let go until an equal length of chain is out. If the yacht will not drive to a spot suitable for the second anchor, send out a kedge and warp in the boat; warp the yacht to the kedge, and let go the anchor. Or the second anchor and chain can be carried out in the required position in a boat. In such case, only as much chain as it is intended to ride by need be veered out to the first anchor.

The quantity of chain to ride by will greatly depend upon the nature of the bottom, the strength of the tide and wind or sea. Generally about three times the depth of water at the top of flood is sufficient for a smooth-water berth.

To UNMOOR.—Heave in on one anchor, and pay out chain on the other. Break the first anchor out of the ground, cat, and then get the other. In some cases the second anchor might be got by the boat under-running the chain.

THE MANAGEMENT OF OPEN BOATS.

QUALITIES OF OPEN BOATS AS TO STIFFNESS.—Small open boats must never be regarded as if they possessed the qualities of deep and heavily ballasted yachts. They should not be sailed "gunwale under" as a small yacht is, and the puff or squall which a small yacht can be sailed through with impunity, will necessitate the open boat being thrown head to wind with head sheets eased up, or off the wind with aft sheets eased.

No system of ballasting will much increase the range of stability of a boat—(by boat is meant something of the type of the Surbiton gigs)—and it must be clearly understood that it is not the initial stability, or the stiffness of the boat at small angles of heel upon which her safety depends, but upon her range of stability, that is to say upon the amount of stability or power to recover herself she has, when heeled to very great angles when the gunwale might be pressed under water. For competitive sailing, a boat to succeed must resist being heeled at all very potently, that is, she must have great initial stability, so as to be able to carry a large area of canvas without heeling more than to a point midway between her waterline and gunwale. This stiffness is more dependent upon breadth of beam than upon the weight of ballast carried low, and an inexperienced boat-sailer finding a boat very stiff at first might be tempted into pressing her beyond the danger point.

On the other hand, depth of hull of itself does not add to stability, but by ballasting it does, and lengthens out the range of that stability so that a boat may always have righting power at any possible angle of heel, providing she does not fill with water and sink. Thus safety does not so much depend upon the great stiffness which enables a boat to carry a large press of canvas without heeling to any considerable extent, as upon the range of her stiffness or the continuation of that stiffness, even up to the time when she might be blown over on her beam ends. Now shallow open boats have a very low range of stability, and directly their

gunwales are put under, they are likely to be blown over. A high side out of water in a large way increases the range of stability, and the higher, in reason, a boat's side is out of the water the safer she will be.

Boats are most frequently capsized in disturbed water, and the cause is generally ascribed to a sudden squall, or to the fact that the boat being unduly pressed, some of her loose ballast shifted to leeward. But a boat among waves might be, and no doubt frequently is capsized without any accession of wind or movement of the ballast.

It can be supposed that a boat is sailing with a beam wind, and with a beam sea, and that her inclination, due to the pressure of wind on her sail is 15° . If she got into the position shown in Fig. 32, she would practically be inclined to 30° and she would probably upset. Assuming that the boat had no sail set, she would not get into such a position, as she would accommodate herself to the wave surface and her mast would correspond to the perpendicular drawn to the wave surface (*see* Fig. 32). Even with sail set the boat would more or less so accommodate herself to the wave surface, minus her steady angle of heel; but the increased pressure on the canvas, due to the righting moment of the boat, which would have to be overcome, would prevent her recovering herself entirely. That is, if the boat be heeled to 15° relative to the horizon, or to the normal surface of the water represented by the vertical line, and a wave came to leeward as shown, she would be in the position of a heel of 30° relative to the perpendicular to the wave surface; but, inasmuch as the wind pressure is only capable of heeling her to 15° the boat would ultimately recover herself to that extent, and her mast would be represented by the vertical. However, long before a boat could so recover herself, she might be swamped or blown over.

With a beam sea a boat will roll a great deal, and this condition is a prolific source of accidents. If a boat is being sailed at a permanent angle of heel of 15° , and by the action of the wave she is made to roll another 15° , she will frequently be in the position of being heeled to 30° ; and if the extreme part of the roll should occur jointly with such a position as shown in Fig. 32, the boat would inevitably upset.

Next it can be supposed that the boat is being sailed at a permanent angle of heel of 15° , that she has an extreme roll of 15° , and that there came a sudden wind squall. Then if the extreme leeward roll, and the squall took place together when in the position shown by Fig. 32, she would blow over and nothing could save her. But she need not be in such a position as that depicted and yet be blown over: if the boat has a heel of 15° , and an extreme leeward roll of 15° , then if the extreme roll and a squall occurred together the boat would be upset, whatever her actual

position among the waves, whether she was on the trough, on the side, or on the crest of a wave. Further it must be always understood that a force of wind which will, if applied steadily, heel a boat to 15° , will if applied suddenly heel her to double that inclination; thus it is not so much the force of the squall as the suddenness of its application wherein lies the danger.

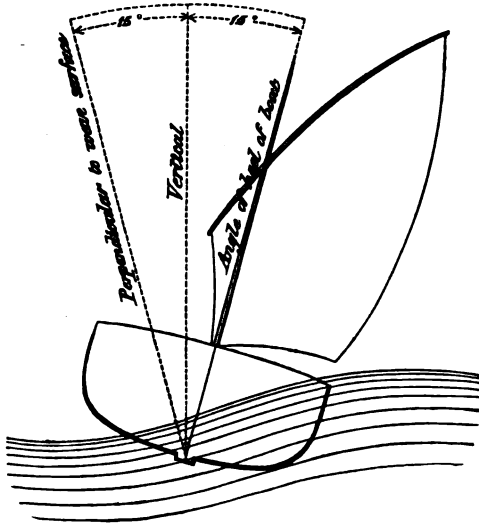

FIG. 32.

SAILING AMONGST WAVES.—When a boat is among waves (especially with a beam wind), ballast should not be trimmed to windward, nor should the passengers sit on the weather gunwales, as a boat after being in a position similar to that shown by Fig. 32 will take a very heavy weather roll, possibly fly up in the wind, be taken aback, and blown over.

The canvas that will permanently heel a boat to 15° may be carried safely enough in smooth water with a beam wind, but the case is altogether different among waves, and so much canvas should not then be carried, perhaps by one half. Many ships' boats and pleasure boats are annually lost through recklessness in carrying canvas in rough water; and, although a boat may go out among waves a dozen times without being subject to either of the coincident conditions described, yet may she the very next time: therefore immunity is not necessarily impunity. It will thus be seen that there is very considerable danger attendant upon sailing a boat among waves, a danger perhaps not always understood.

In sailing among waves the ballast should be well secured, the passengers should sit in the bottom of the boat, and the main sheet should be kept in the hand. If the sea is abeam the boat should be watched very closely, and if a bigger wave than usual rolls in on the

weather beam, ease the sheet and run off the wind a little, the wave will then pass harmlessly under the boat. Do not luff with a beam wind or sea, and in keeping away never forget to ease the mainsheet.

In sailing by the wind among waves the danger of being blown over will be considerably less, but nevertheless there is danger, and it must not be assumed that because an experienced and skilful boat sailer sails a mere cockle-shell safely about among waves, that anyone could do so without experience or skill. In boat sailing safety mainly depends upon knowing what is dangerous.

In sailing by the wind the main sheet might be belayed with a slippery hitch, with the fall close to the hand (resting over the knee is a good plan) and the fore sheet should lead aft. If there is much sea do not pin the main sheet in, but the fore sheet can be drawn fairly taut. Luff the boat fairly into the big seas that roll in on the bow, and fill her again promptly. The foresail will be found of great assistance in taking her head off, and hence it should be sheeted pretty flat. In puffs and squalls the boat should be luffed up and the fore sheet eased, and always do this before the gunwale gets under; as when the gunwale goes under, the boat soon loses way and then the power of luffing will be gone, and the boat may perhaps fill and sink. If a boat does not come to quickly and relieve herself of wind, let fly the main sheet and ease her that way, but recollect in all cases that whatever is done must be done promptly.

If the boat has a mizen the main sheet can be eased at the time of putting the helm down, as the mizen will bring the boat head to wind, but generally in luffing for hard squalls the main sheet need not be eased; but the fore sheet should be, as that will allow the boat to fly to more readily.

If the boat has only a mainsail and mizen, ease the main sheet in luffing if the squall be heavy, and leave the mizen to bring her to.

In luffing for squalls, should the boat get head to wind, haul the fore sheet a-weather, put the helm up, keep the main sheet eased off and press down what is to be the lee quarter (see foot-note in the Chapter on New Brighton Boats). If the boat has only one sail, haul the boom on what is to be the weather side and put the tiller on the opposite side; as the boat gets sternway on she will pay off, then right the helm, ease the boom over, and sail her. If the boat has a mizen as well as mainsail, the mizen sheet should be eased whilst the boom is held over. If an oar is handy, the boat can be helped off the wind by a "back-water" stroke or two off the lee quarter, or a forward stroke or two on the weather bow. But the boat sailer must not get nervous and throw his boat head to wind for every little catpaw or small sea; he must,

whilst being careful that his boat is not capsized by a squall or filled by shipping water, sail her boldly but not recklessly, and keep her a "good full," or she will surely drive to leeward. It is particularly incumbent that a boat should be kept full when sailing among waves, hence the great necessity of her being appropriately canvassed. However, if the boat is sailing across a weather-going tide she may be "squeezed" a little, but never allow the sails to lift.

TACKING.—Whilst tacking a small boat always remember that it is not the tiller of a big yacht that is grasped, and do not shove the helm down with all the force at hand; bring the boat head to wind with the tiller about half over, then put it hard up and ease again to amidships as the vessel gathers good way. With a big boom mainsail a small boat in smooth water will shoot head to wind and fill on the other tack in less time than it takes to write it, but in a sea she may require some help, and the moment for tacking should be when a "smooth" comes on the water. If there is an uncertainty about the boat coming round, do not let go the fore sheet until the boat's head is fairly off on the other tack. If the boat has no head sail, haul the boom aboard as the helm is put down, and keep it to windward until she pays off. Never forget that a boat can always be helped round by an oar.

Above all things never attempt to tack with a big wave coming in on the weather bow.

SAILING ALONG A WEATHER SHORE.—In sailing along a weather shore, it is generally found safer with a boom mainsail to luff up in the wind and ease the fore sheet, if there be one, than to ease the main sheet and attempt to relieve the boat without much altering her course; however, if the weather shore be the bank of a river and close aboard, there will be the risk of going stem on into the bank; and this will be especially awkward if the boat has a long bowsprit. It is not pleasant to go into the bank of a river, but it would be preferable to capsizing. Still, in match sailing a great deal of valuable time might be lost by luffing up, and a boat can be relieved and kept going by judiciously easing the main sheet and running her off; but never deliberate as to what shall be done—that is, whether the boat shall be luffed up at the risk of running into the bank, or whether the sheet shall be eased and the boat run off the wind. Always remember in the case of squalls that "he who hesitates is lost."

SAILING ALONG A LEE SHORE.—When sailing along a lee shore in squally weather (if it is a matter of choice, always work the weather shore), smartly luff up to the squalls in preference to easing the main sheet, and thus keep the boat going. If the squall be very heavy, the

fore sheet should be let fly so as to bring the boat head to wind quickly. If the main sheet is eased off much the boat loses way, and then by help of her foresail may take off against her helm and shove her nose ashore; so easing the main sheet in squalls should be avoided, if possible, when sailing along the lee bank of a river or by the side of mud or sand flats. Generally the boat will "come to" quickly enough without the fore sheet being eased; but, if the squall looks to have much weight in it, ease the sheet and luff up in good time; then prepare to lower the mainsail, if necessary.

In lowering a sail in squalls, great care should be taken to spill the sail as it comes down, as, if it fills and blows out in bags, it may not only cause trouble in handing it, but upset the boat.

RUNNING BEFORE THE WIND AND SEA.—Running before a wind and sea in a small boat may to the inexperienced appear a very simple and safe operation; but, in reality, it is a very dangerous one, and many a small boat has been lost in attempting to "run away" from a sea. The two principal dangers will arise from getting by the lee and broaching to: the boat's head will be most likely to fall off to leeward, or rather her stern lift to windward, as a wave crest passes underneath her bottom from astern. But with equal peril she might have "broached to" as the wave crest lifted her bow; the boat's head will be turned towards the wind, and then, if she be not well managed, she will get broadside on to the waves, and the next roller will almost inevitably swamp her. If the rig be mizen, mainsail, and foresail, the mizen should be stowed before the boat is put before the wind; the lee foresheet should be belayed slack, and the weather one should be led aft. As the boat begins to fly to, haul the weather fore sheet in, and put the helm up; but very frequently the helm is not of much use if the boat is among breakers in shallow water, as she will be carried along on the back of a comber. Thus it very frequently happens that a boat that has successfully battled with the waves in the offing comes to grief as she gets among the surf to try and effect a landing or to run over a bar into harbour. In running over a surf an oar off the quarter will be found much more effective than the rudder to steer with, but the oar should always have a line fast on it, and it should be belayed to a cleat on the gunwale, in case it has to be left when the sail requires attention.

A small boat, if there is much wind, and especially if there be sea as well, should never be run dead before the wind, but with the wind a little on the quarter; then gybe over, and run on the other tack, to make the destination.

In gybing, always haul the boom well aboard as the helm is put up.

As the wind passes from dead astern and comes on the other quarter, taking the boom over, shift the helm promptly and prevent the vessel flying to.

HEAVING TO.—Circumstances may arise when it will be necessary to heave to. The best plan will be if the boat has a mizen to set it on the mainmast, or shift mizen-mast and all to the mainmast step; a small piece of the foresail might be shown with the fore leech just to windward of the mast. A boat will lie to pretty comfortably under a small head sail with sheet hauled up close to the mast. The helm will require unremitting attention. However, if an open boat has to be hove to on account of the sea and wind, the best plan will be to ride to a raft made of mainmast, oars, &c., lashed together. This will break the seas, and keep the boat head to the sea. For half decked

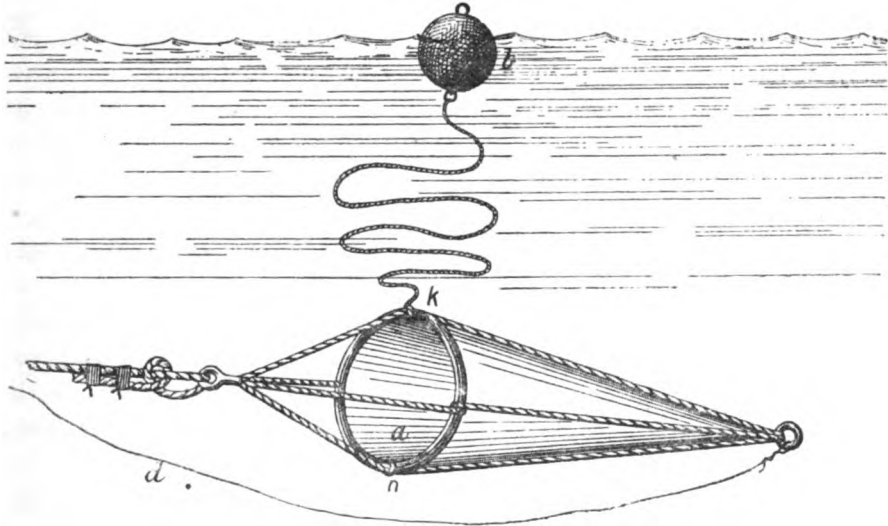

FIG. 33.

boats a drogue is a good contrivance for keeping head to the sea. They are much used on the north-east coast. The drogue consists of a hinge-jointed galvanised iron ring about 2ft. in diameter. A conical canvas bag, made of No. 0 canvas, is sewn to this ring, and roped as shown in the sketch, Fig. 33. A bridle is fitted to the ring, to which the riding hawser is bent; *d* is a tripping line; *b* a cork buoy to prevent the drogue diving. When thrown overboard the mouth of the drogue, *a*, opens and fills. To get the drogue on board the tripping line *d* is hauled upon. When not in use the ring is folded together by the joints at *k* and *n*, and the bag snugly stowed round it.

When riding to a drogue a boat might keep a small mizen set; it

would help keep her head to the sea, and make it easier work for the man who had charge of the helm. Of course only a reefed or small mizen would be set.

REEFING.—In reefing, the tack and sheet should always be shifted to the reef cringles before the foot of the sail is rolled up and the points tied. Always roll up neatly and as tightly as possible, not only for the look of the thing, but because otherwise the points for the second or third reef may not reach in case they are required. In shaking out a reef always untie the points and loosen the foot before shifting the tack and sheet.

ROWING IN A SEA.—The principal thing to avoid in rowing in a sea is getting broadside on to the waves; if a boat gets into such a position she may roll over or be knocked over or be swamped. If possible, row head to the sea, and if the boat is carried too far to windward, take the opportunity of running her off whenever a smooth presents itself. In running before the sea the boat will most likely show a tendency to broach-to, and so get into the trough of the sea that way, this tendency must be instantly checked. In landing on a beach through a surf, it is frequently a good plan, if the boat is not sharp sterned, to row her in bow to the surf, or stern first.

In boarding a vessel that is under way, always row up under her lee. In boarding a vessel at anchor, always bring the boat's head up to the tide, and take a good sweep in coming alongside. Give the order "In bow" when about fifty yards off, and "Oars" (the order for the men to toss their oars in), so that the boat shoots alongside with her way nearly stopped. Avoid if possible going alongside a vessel stem on.

As a rule a boat should always be beached through surf with her sails stowed, as, if she got broadside on among the breakers with sail up a capsized would be inevitable. Upon nearing the beach on a flat shore recollect that here the wave water itself is moving, and will carry the boat along until it finally casts her up on the beach: as each wave overtakes the boat care must be taken that it does not twist her round broadside on.

As the water at the stern may be moving faster than that at the bow, the tendency of the stern wave will be to turn the boat round if the wave does not take the boat fairly end on. This effect of the overtaking waves can be reduced by towing something astern—a spar broadside on, for instance, made fast to a bridle—and by approaching the shore stern first, so that the bow is presented to the overtaking waves.

If the beach is a steep one the best plan is to row in as hard as possible, choosing at last as the moment for beaching when a sea begins to break and pour in on the beach.

GENERAL CAUTIONS.—Great care should always be taken when passing under the lee of a ship at anchor or other large object, if there is anything like a breeze, as when the boat draws clear she will have but little way on, and to be met then by the full blast of the breeze will cause her to heel more than if she were moving at her best speed; or, if she has to go under the lee of a passing or meeting vessel, she will equally get becalmed, though not for so long a time; she will, however, get the breeze again much more suddenly than if the passing ship had been at anchor, and may consequently be knocked down more. None of the crew of a boat should ever sit on the weather gunwale when passing under the lee of a ship, as the sudden loss of wind will bring the boat upright, and so much weight on one side may cause the crew to be pitched into the water, or possibly, if the boat got caught aback as she heeled to windward, she might capsize.

The first best thing to do is to give all objects such a wide berth that the boat cannot be becalmed by them. If the boat is beating to windward, and would have to bear up very much to clear the ship at anchor, it would be better to make a board and weather the ship; this can also be done, if managed in good time, to weather a ship that is *meeting* the boat, *i.e.*, is running before the wind; but a boat should never be put across a vessel unless so far ahead as to render collision impossible. If in the attempt to weather a ship there seems a doubt about doing it, do not commence squeezing or nipping; ramp the boat along, and tack or bear up in good time and go under the ship's stern if both are beating, and under her lee if the ship is free.

If there be no choice, and the small boat has to pass under the lee of the ship, then have the main sheet cast off and held ready and clear to run out; if the boat has nearly lost her way before she gets the breeze again she will scarcely answer her helm to luff; and if she is knocked down to near the gunwale edge let the sheet fly without hesitation.

If the passing vessel be a steamer going at a great speed, she will leave a considerable wash, and small boats should avoid this, although it is the delight of some boat sailers to get into it and ship "green water," as they love to call it.

If the boat carries lee helm trim her by the head a little, or if the main sheet will admit of it harden it in and ease the fore sheet a trifle; at all events so manage that the boat carries enough weather helm to fly up in the wind when the tiller is let go. If a boat carries lee helm she may refuse to come head to wind, and under some circumstances this might be highly dangerous.

A single hand should never attempt to row and sail at the same time; if occupied with rowing he cannot attend to the helm and sheets, and the

prudent course would be to lower the sail and propel the boat entirely by oars. In case the rig includes a mizen or foresail, one or both could be kept set, but the fore sheet should be belayed so that a slight pull on the fall will release it.

The crew of the boat should invariably sit on the bottom boards on the weather side, or if there be much sea, amidships. No one should be allowed to climb the mast if the boat is under way, as the weight aloft might capsize her. Nor should any of the crew stand on the thwarts so that they might get thrown down in the lee side of the boat when she lurched, or otherwise imperil her safety.

In cases where the main sheet leads through a block, through a bull's-eye, through a thimble, through a hole, or other similar arrangement, the boat sailer should ever and anon cast his eye on the fall of the sheet and see that there are no turns or kinks in it. If the fall be coiled up, see that the running part is uppermost and the end underneath. New rope and wet rope are specially liable to get foul turns in them. It will also be prudent to see that nothing like a boat's stretcher, mop handle, thole pin, or bailer lies in the coil of a fall of a sheet.

CHAPTER VI.

THE GENERAL MANAGEMENT OF A YACHT.

THE OWNER, MASTER, MATE, &c.

THERE is no code of regulations for the discipline of a yacht, but generally the custom of the merchant service is observed. The master is not required by law to have a certificate of competency, and frequently he is only capable of making coasting passages. However, many masters of large vessels are skilful navigators, and could take a yacht to any part of the globe. The chief requisite in a master for a yacht, whose cruising does not extend beyond the English and Irish Channels, is that he should be a thorough master of fore-and-aft sailing, and that he should be clean and tidy in his habits, able to enforce cleanliness and tidiness in the crew, have perfect command over the crew, and carry out the owner's wishes cheerfully and respectfully. Most yacht masters rise from "before the mast" after they have served a season or two as mate or second mate, and generally they assume their new station with a full appreciation of its consequence—that is, they are alive to the serious responsibility of being in charge of a vessel—take her about with a caution and patience that are unceasing, and assume an appropriate dignity in their intercourse with the crew. Some men, however, appear to be quite incapable of feeling that dignity, and at one moment are too familiar with the crew, and the next squabbling with them. Such men should not have charge of a yacht, and if an owner wishes to cruise in comfort he will get a sailing master who, above all things, is "master of the crew," conducts himself as such, and is observed as such.

The master has sole control on board, subject of course to the wishes of the owner, who ought, however, never to have occasion to interfere with the discipline or working of the yacht. If the owner has any fault to find with the conduct, whatever its nature, of any member of the crew, he should make that complaint to the master; this will show the master that he is responsible for the discipline, good behaviour, and

efficiency of the crew, and the crew will not have the opportunity of saying they do not know who is master, or that the owner is master, and that the titular master is only so in name.* But if the owner observes any misconduct or gross inefficiency on the part of any member of the crew, and the master apparently does not notice it, then the owner should bring the master's attention to it, and, if necessary, insist on the delinquent being discharged. This will really strengthen the position of the master, and inspire him with courage to take command of the crew, instead of being content with a kind of slovenly discipline.

The owner should always keep up a kind of formality in addressing the sailing master, and address him as Mr. So-and-so, and not as Harry or John, as the case may be. The owner in this way can do a great deal towards making the crew regard the master with respect; as, if it is seen that the owner treats the master with a flippant familiarity, the crew will do so too. The crew should always address the master as "Sir," and not in an offhand way, such as "All right, skipper," or "All ready, captain."

If the owner wishes any work done on board, or requires the gig or boat, he should tell the master of his wishes or send a proper message to him, and not issue direct orders to the crew; all such usurpations of the proper duties of the master are subversive of discipline, and should be carefully avoided. If the owner goes on shore and wishes the boat to return for him, he should give the orders to the master; but if he forgets to do this he should upon landing give the order to the coxswain, whose duty it will be to repeat the order; thus, if the owner says, "Come for me at half-past four," the coxswain will answer, "Half-past four, sir," to show that he understands the order.

The master should always ship the crew, and generally should be allowed to ship the mate as well.

The mate, like the master, should always be addressed as "Mr.," alike by the owner, master, and crew. When the master is on deck the mate's place is forward, and he superintends the setting and taking in sails, and generally sees that the master's orders are efficiently carried out. He also takes charge of the yacht's spars and rigging, and with the assistance of the carpenter and boatswain sees that all necessary work is done upon it, and from time to time reports the condition of the rigging, spars, and sails, to the master.

When orders are given to get under way, the mate superintends all the necessary preparations for weighing the anchor and making sail;

* In some small vessels the owner is actually master, and then he deals with the crew as such.

so also in bringing up, he prepares for taking in sail and letting go the anchor.

When the master is below, the mate goes aft and takes charge of the deck and issues orders as if he were the master; but, although it may be his watch on deck, he does not make any serious alteration in the vessel's course, or shorten, or set sail, or reef without informing the master of what he is about to do. Then if the master considers it necessary, he may go on deck himself, and perhaps summon his watch from below.

The boatswain takes charge of the sail room and ship's chandler's stores, sees that all the tackles, spare sails, &c., are properly stowed and in good order. With the mate he superintends the washing down, scrubbing, cleaning of brass work, and blacking down the yacht or rigging.

In a few instances a quartermaster is shipped, and his duties are to look after the signal flags, guns, the helm, time, the watches, and the stowage of heavy stores.

The carpenter notes the condition of the spars, decks, fittings, &c., sounds the pumps every morning or oftener if the condition of the hull requires it.

The coxswain of a boat has to see that she is kept clean and in readiness for use, rows the stroke oar when passengers are in her, and takes the yoke lines when only the crew. The coxswain of the owner's gig has usually one shilling or so a week extra for taking charge of her, and he, as before said, is held responsible by the master for her condition and the condition of everything belonging to her.

The dinghy man (in a large yacht he has a mate) is at everyone's call on board, goes on shore on errands, rows the steward on shore, &c. He is generally given 1s. a week extra.

WATCHES, BELLS, THE HELM, THE CREW.

WATCHES.—The master is always in charge of the deck, excepting when long passages are being made; then watches are set. The master takes the starboard watch, and the mate the port watch. The second mate is in the master's watch, or, if no second mate, the boatswain. The two mates generally tell the men off into their respective watches when they are shipped. If the yacht is short-handed in making a passage, the steward musters in the master's watch and the cook in the mate's. The watches are usually set at eight o'clock of the first night

at sea, and the master takes the first watch; but on leaving a foreign port for home the mate takes the first watch. Following out the axiom that the "master takes the ship out, but the mate brings her home," the mate has thus charge of the navigation on the homeward voyage, if he is capable of the duty, the master superintending only.

When a yacht is in harbour, or when only sailing about in the daytime and bringing up at night, no watches are kept, and the whole crew, including master and mate are on deck. When sailing about for a few hours in the daytime the master takes sole charge of working the yacht and generally steers. He issues all orders, and the mate sees that they are carried out. Thus, in working to windward, if the yacht has to be tacked, the master says "Ready about!" The mate answers "All ready, sir." The master then puts down the helm, saying "Helm's-a-lee!" the mate answers "Helm's-a-lee, sir!" and directs the crew to ease up the head sheets and haul them aft again as required. When the master hails with "Ready about," none of the crew should bawl out "All right, sir," or answer in any way whatsoever, but if the mate is not on deck, the second mate or boatswain should take his place, answer "All ready, sir," and see that the head sheets are worked properly. The master will see that the aft sheets are properly worked. With a good and attentive crew, the first hail of "Ready about," or even a sign, will send all the men to their stations, and the more quietly a yacht can be worked the better it will be for the nerves of the passengers.

In making long cruising passages watches are set, and the master and mate take alternate watches, as before stated. The twenty-four hours are divided into seven watches, thus—five of four hours duration, and two of two hours, the latter being called "dog watches" and always occur between four and eight o'clock in the afternoon. The object of having dog watches is to obtain an uneven number, as otherwise the same men would always be on duty in particular watches. During the dog watches—from four o'clock to eight—a great deal of liberty is allowed the men, and the watch below as well as the one on deck do their own odd jobs, tell yarns, sing, and generally amuse themselves in such a way as is consistent with the good working of the yacht.

When going to sea the first (starboard) watch is set at eight p.m., and the master takes that watch. Eight bells are struck and the port watch retires below. At twelve o'clock (midnight) the port watch is called by the second mate or boatswain going to the fore hatch or scuttle, and hailing "Port watch ahoy!" or "Eight bells sleepers!" The watch below should answer "Ay, ay!" turn out immediately, and be on deck in five minutes. Any lagging is regarded as very bad

form, and a man is looked upon with contempt who does not turn up on the first summons. The watch lasts from twelve to four, and is termed the middle watch. At four a.m. the sleeping watch would be called in the same way, to come on deck and take the morning watch from four to eight, and so on for the forenoon watch, afternoon watch, the "dog watches," and first watch again. When in harbour, or at moorings, an "anchor watch" is kept by one man, whose spell is two hours, the port and starboard watch supplying the men on alternate nights. This watch looks out for any dangers that a yacht may be in, summonses the watch below if necessary, and strikes the bells.

BELLS.—As a rule, "Bells" are only struck on board yachts between eight in the evening and eight in the morning, but in large yachts they are regularly struck all through the twenty-four hours, whether the yacht is at sea or in harbour.

The bells are struck in this way: one stroke (or one bell) is half-past twelve; two strokes struck quickly (or two bells) one o'clock; two strokes struck quickly, followed by one (or three bells), half-past one; a double two (or four bells) two o'clock; a double two and one (or five bells) half-past two; a treble two (or six bells) three o'clock; a treble two and one (or seven bells) half-past three; four double strokes (or eight bells) four o'clock. Then commences one bell for half-past four, two bells for five o'clock, and so on, eight bells struck every four hours.

But during the dog watches after four bells have been struck for six o'clock, one bell is struck for half past six, two bells for seven o'clock, three bells for half-past seven, but eight bells again for eight o'clock.

HELM.—When watches are set it is usual for one of the crew to steer, and not the master or mate. Two men out of each watch are usually selected (generally among themselves) to steer, who are known to be good helmsmen. Each man is at the helm for two hours, and this is called a "trick." When the time has expired the other man goes aft as four bells are struck. If he does not go immediately he is reminded by the hail "Spell O!" The man who relieves should always, if the weather will permit, come aft along the lee side, and, crossing over the tiller, from the lee side to weather side, come behind the other helmsman, and take the lines out of his hand from abaft.

The man, as he gives up the helm, states the course as, say, E.S.E., or "Full and by," as the case may be. It is the duty of the new comer to repeat the course, to show that he understands it, and the officer in charge of the deck, should be near to hear that the course is correctly given. The relieved man retires behind the other one, crosses the tiller, and finds his way forward along the lee side of the yacht.

If the officer of the watch requires the course altered, he gives the course anew, as E. by S., or "keep her off," or "bring her to," or "no more away," &c., and it is the duty of the man at the helm, to repeat the order audibly, to show that he understands it. In bad weather, it is usual to place a second hand at the helm, and then the man whose trick it is, stands to windward of the tiller with the weather tiller line or wheel in his hand, and the other to leeward with the lee tiller line. He assists in pushing the tiller to windward, or hauling it to leeward, as occasion requires. Frequently a young hand is given a spell at the helm in light winds, in order that he may gain a knowledge of steering.

THE CREW.—When an order is given to any member of the crew by the master or the mate, such as "Ease the fore sheet," or "Take in the slack of that sheet," it is the duty of the man to audibly repeat the order to show that he understands it, as "Ease the fore sheet, sir," &c. While the crew are at work, or during the watches from 8 a.m. to 4 p.m., there should be nothing like "recreation" permitted on the fore deck or in the fore-castle, but the men should go about their work quietly, never converse loudly, nor hail one another from one end of the vessel to the other. All orders should be obeyed instantly and cheerfully, with a ready response or a cheery "Ay ay, sir!" Nothing could be worse than for the crew when an order is given to sit and stare, and then to leisurely proceed to do it with an air which plainly says, "I am doing it, but you might just as well have done it yourself." In most cases, in working the yacht the master should give the order to the mate, who will direct the particular man or men who are to carry out the order. As before said, the order should be obeyed with alacrity; if it is not, it will appear that the men do not know how to execute it, or that they are so stupid that they do not understand it, or that they are such bad sailors that they do not know that a seaman's first duty is ready obedience.

Whenever any member of the crew shows the least slackness in executing orders or in any way neglects the ship's work, shows symptoms of insubordination, indulges in mutinous talk, gives insolent or even pert answers, he should be instantly warned by the master of the mistake he has made, and upon the second offence should be given his "discharge ticket." If a seaman obeys all orders promptly and executes them conscientiously, he will be respected by the master and other officers; but if he is doubtful in obedience and a sloven in his work, the master, very properly, will have a contempt for him, and will take advantage of the first opportunity for unshipping him.

AGREEMENTS, LIBERTY MEN, DISCIPLINE, &c.

In all cases a clear and distinct agreement should be signed by the crew, even though they do not "sign articles" under a shipping master; and this agreement should contain in detail such regulations as are referred to in No. 7, sect. 149, of the Merchant Shipping Act, 1854, which says that regulations may be made with the crew "as to conduct on board, and as to fines, or other punishments for misconduct which have been sanctioned by the Board of Trade as regulations proper to be adopted and which the parties agree to adopt." The agreement should therefore clearly set forth the rules to be observed on board as to wages, clothes, duties, general conduct, liberty, discipline, &c. (*see* the article "Seamen" in the Appendix). It will be found to be a very difficult matter to make and enforce rules after the crew has been shipped and berthed on board. The rules should therefore be agreed to and signed at the time of shipping.

As a rule there is more difficulty in maintaining discipline on board a yacht seldom under way than on board one which is constantly making passages. A yacht is in such thorough order, that after she is washed down, the brass work cleaned, and her sides "chamoied," there is nothing left to do except perhaps row the owner on shore and bring him off again. The men have nothing to do but eat and sleep, and as they cannot be doing this all day, there comes a longing for going ashore. The master has to be asked for "liberty," and if the man cannot claim it as a right the master may refuse, and the man then most likely has a fit of sulks, and takes the first opportunity of being insolent. This is frequently the origin of squabbling on board; but, on the other hand, sometimes the master allows too much liberty, and almost permits the crew to leave and rejoin the vessel when they please in spite of a signed or understood agreement to the contrary. This is worse than no liberty at all, and usually ends with the contented men who stay on board from week's end to week's end abusing those who are everlastingly on shore, and the result is a regular fo'c'sle row. The best plan is for the master, directly the yacht is in commission, to have some system about liberty. The usual plan is for the crew to have alternate afternoons and evenings on shore, or "watch and watch," when lying in a harbour or safe roadstead; but when lying in an open roadstead the question of liberty should be left entirely to the discretion of the master.

It is useless to tell an owner that he should not keep his yacht at anchor for weeks at a stretch, but get under way every day; there may

be a variety of reasons why he does not want to get under way, but one is enough, and that is, the yacht is his own, and he need only get under way when he chooses. As a rule, the master will know the habits of the owner, and only engage men who he knows can stand a life of comparative idleness and confinement.

Drink should be under very strict regulation. It is customary to serve out grog, just one "glass," on Saturday nights to drink to "sweet-hearts and wives," and as a rule owners allow the master to serve out a glass on a dirty night, or after a long dusting to windward, or after heavy work—striking topmasts and reefing or setting trysail in heavy weather; or when the whole ship's company have been kept up to midnight or later; but the master should take every precaution to prevent drunkenness among the crew, and should never overlook more than one offence in a season. This rule should be observed with great strictness.

Smoking should be permitted on the fore deck for a half hour after breakfast and dinner, during the dog watches, and in the first watch if the men so please; and the men are sometimes allowed a pipe at eleven o'clock as "lunch." On board some yachts indiscriminate smoking is permitted, but in those best regulated smoking is only permitted at the times stated. Smoking should not be permitted below, and never abaft the mast. Some owners, however, permit the men to smoke below just whenever they please; other owners permit it at any time except when meals are underway in the main cabin.

In the daytime the crew should always appear in the uniform of the yacht; but at night when making passages they are allowed to wear any old clothes they might have on board; but when the watch comes on deck at 8 A.M. to relieve the morning watch they should be in uniform. If there is still work to do, such as cleaning out boats, or work upon rigging, the watch would appear in their dongaree suits or "jumpers" if they had any, but the man who took the helm would be in his cloth and serge uniform. In bad weather the men wear any old clothes under their "oilys."

A great many complaints are made about yachts' crews, and some very hard things have been said against them; no doubt many yacht sailors are ill-behaved, sometimes indolent, sometimes intemperate and dirty in their habits, and frequently show an extraordinary spirit of insubordination. Now, we are not inclined to wholly blame the crews for this; in the first place, they are almost entirely untutored in anything like discipline, or the discipline they are used to is of the most

slipshod character; there is no restraint on their habits, and if they exhibit anything like insubordination, the master, perhaps as ignorant as they are, has no code or system to guide him in restraining it. Again, it must be understood that very much more is expected from a yacht sailor than from a seaman of the mercantile marine. He should be smartly built, be very active, be pleasant in his manners, and be as cleanly, as respectful, and as well conducted as a highly trained manservant; at the same time he must be a seaman. Now all that is required of a merchant sailor is that he should be a thorough seaman, and should show no mutinous tendency; he may be as ill-shapen as Caliban, and as rough in his manner, and dirty in his person as a pitman, but no one will complain of this. He is kept in restraint by very severe laws, but the very nature of the characteristics expected in a yacht sailor forbids the application of the Merchant Shipping statutes to him in their integrity. A yacht sailor must be governed by quite a different hand, and in a large measure discipline and good behaviour on board must rest with the moral force of the master rather than with any restraints that could be employed under the Merchant Shipping Act. No Act of Parliament will make men clean in their persons, polished in their manners, or shapely in their forms; and a master in seeking these characteristics in a crew can only employ the means adopted for such ends in a household. He will take particular care, of course, that the men he engages are seamen; and he must exercise the same care in seeing that they are men who have the other qualifications for a yacht sailor.

We hear a great deal about men saying "this is not yacht rules," and "that is not yacht rules," but if the seamen venture to say this we immediately think that the master does not know what "yacht rules" are, if there be any such rules. We have already shown that such rules as there are for working ship are in accordance with the custom of the Merchant Service, and should be, and we believe are, rigidly observed. The other rules for the good conduct and personal behaviour of the men must rest entirely with the master; if he has the moral force necessary to govern men he will have a happy and orderly yacht's crew; if he has not, and attempts to supply the deficiency by the application of statutes that were intended for quite a different condition of things he will always be master of a bad crew.

Masters as a rule have that necessary moral force, and the very fact that most of them rise from "before the mast" is evidence of this. And this brings us face to face with the fact that yacht sailors, taken as a whole, are not the ungovernable and ill-assorted lot of men that we are sometimes

asked to believe; and most masters exhibit a wonderful tact in maintaining what is not so much discipline as a ready compliance and respectful demeanour. (See the article "Seamen" in the Appendix).

WAGES OF THE CREW—CLOTHES—GENERAL EXPENSES.

The expenses of yachting is largely governed by the number of hands employed, and the magnitude of this part of the necessary expenditure can be calculated from what follows.

It is usual to pay the master of a yacht by the year, and the wages vary according to the size of the yacht and the qualifications sought. Thus, the master of a 10-tonner may only have 50*l.* a year, whilst one in charge of a 100-tonner may have 100*l.*, and one in charge of a 300-tonner as much as 200*l.*, and we have known instances of the master of a large steam yacht receiving as much as 400*l.* per annum. Again, if a master for a racing yacht is required, very nearly as much will have to be paid for one to take charge of a 40-tonner as for one of 200-tons. The master is not always paid by the year, but sometimes 1*l.* 15*s.*, 2*l.*, or 2*l.* 10*s.* a week whilst the yacht is in commission, and sometimes, for the sake of securing his services, 10*s.* per week whilst she is laid up; when such is the rule the master does not always keep charge of the yacht whilst she is laid up, but the owner pays a trifling sum per week—ranging from 5*s.* to 10*s.*—to a shipkeeper who may be an agent who undertakes such work, or a yacht sailor; but the most satisfactory plan would appear to be to pay the master by the year, and make him live near the place where the yacht is laid up.

The remainder of the crew will be paid as follows—from the time they are engaged commencing to fit out the yacht until she is laid up :—

Mate	per week	£	s.	d.	Cook	per week	£	s.	d.	
Boatswain	"	1	8	0	Seaman	"	{	1	3	0
Steward	"	1	15	0			to	1	6	0

The master, mate, cook and steward, usually live at the expense of the owner, and if a table is not kept for them they are paid board wages of 12*s.* each per week.

The seamen find their own provisions; but if a long voyage is contemplated they should either be victualled by the owner or he should ascertain that they lay in sufficient stores for the requirements of the voyage.

Often 1*s.* per week is kept back from the seamen's wages as conduct

money, and if either commits an offence during the week the *1s.* is stopped; the fine however is seldom inflicted, as few masters have the courage to enforce it.

The coxswain of the gig is usually given *1s.* per week more than the other men, as before stated. The "dinghy man," whose duty it is to row the steward ashore, &c., for marketing, and to fetch letters off, and generally to do the carrying to and fro, also has *1s.* per week extra. In racing yachts the masthead men are sometimes paid *1s.* per week extra.

The steward and cook sometimes have more than the wages given above, and sometimes less. In large yachts where a second steward is carried, the wages given to a good steward are perhaps as much as *2l.* The second steward's wages will vary from *1l.* to *1l. 10s.* according to whether he is a man or a boy, and to his efficiency.

We have known a professed cook to receive as much as *5l.* per week, but generally a sufficiently good cook can be obtained for *1l. 10s.* or *1l. 15s.* It is a common practice in yachts of 70 tons and under to have a steward who can cook as well; in which case the "cook" is dispensed with. One of the fore deck hands acts as cook for the forecabin, and assists the steward at times in the cabin.

The clothes given to the crews are usually as follows: *

MASTER.		£ s. d.			£ s. d.
2 blue cloth suits		8 8 0	1 neckerchief		0 5 0
1 cloth cap and gold band.....		1 1 0	1 cap.....		0 5 0
1 silk neckerchief		0 6 0	2 pairs of shoes		1 2 6
1 pair canvas shoes		0 7 6			8 19 6
1 pair leather shoes		0 15 0			
		10 17 6			
MATE.			COOK.		
1 blue cloth suit.....		4 4 0	Similar to Steward.		
1 pair pilot trousers		1 1 0	SEAMEN.		
1 frock.....		0 10 6	1 pair pilot trousers		1 1 0
1 cap		0 5 0	2 pairs of white duck trousers		0 10 6
1 neckerchief		0 5 0	1 serge frock		0 10 0
2 pairs of shoes		1 2 6	2 white duck frocks		0 12 0
		7 8 0	1 cap		0 5 0
BOATSWAIN.			1 red cap		0 1 6
Similar to Mate.			1 straw hat		0 4 0
STEWARD.			1 hat or cap riband		0 1 0
1 blue cloth suit.....		4 4 0	1 neckerchief		0 5 0
1 serge suit		3 3 0	1 pair canvas shoes		0 7 6
			1 pair leather shoes		0 10 0
					4 7 6

* The number of hands carried by yachts of different tonnages will be found set forth in a table in the succeeding chapter on Yacht Racing.

Sometimes the master is given only one suit of blue cloth.

If white duck suits are not given to the men, it is usual to give them a dongaree suit of blue linen to do their rough work in, and an extra pair of pilot trousers.

Very frequently, especially in small yachts, only one suit is given all round, with one pair of shoes. Thus the crew's outfit largely depends upon what the owner considers it necessary to give them.

It has been established over and over again in law courts, that the clothes are a livery and belong to the owner, but it is the custom to allow the men to take them away when the yacht is paid off. If a seaman is discharged for misconduct his clothes are retained. If he takes them away he can be sued for the value of them in the County Court. (See the article "Seamen" in the Appendix).

It would of course be impossible to estimate what the exact expenses of yachting would be apart from those enumerated, as so much depends upon the owner himself and how he likes the yacht "kept up." Also a great deal depends upon the sailing master, as no doubt the custom of ship chandlers to pay commissions greatly influences unscrupulous masters in "making bills." Roughly the expenses, exclusive of those incidental to the crew as already enumerated, can be set down at 6*l.* per ton, assuming the yacht to be five months in commission from the day she commenced to fit out to the day she laid up.

These expenses would be (applied to a yacht of 60 tons) made up as follows :

	£	s.	d.
Interest on £2000	100	0	0
Insurance	50	0	0
Annual depreciation	60	0	0
Repairs and renewal of hull, taking an annual average of 5 years	70	0	0
Renewal of sails and rigging, taking an annual average of 5 years	60	0	0
Ship Chandlers' stores, oil, paint, varnish, brushes, charts, flags, cooke, &c.	50	0	0
Hire of store	10	0	0
	400	0	0

The above expenses would not vary much whether the yacht were out four months or six months.

The crew expenses would be as follows :

	£	s.	d.
Sailing Master, per annum	70	0	0
Mate 20 weeks	35	0	0
Steward ditto	35	0	0
Four seamen ditto	100	0	0
Clothes	45	0	0
Board wages	36	0	0
	321	0	0

When a yacht is hired (the usual charge for which is from 30*s.* to 35*s.* per ton per month) the owner finds clothes and pays the crew, excepting perhaps the steward and cook, and the hirer pays half the laying up expenses, and generally the hirer pays the insurance ; the latter will be about 10*s.* per cent. per month.

CHAPTER VII.

YACHT RACING.

ONE of the principal causes of success in yacht racing is that of being "always ready;" ready with the entry, ready with the vessel whether she requires copper scrubbed or trim altered, ready with the sails and gear, ready with the instructions, ready in getting into a berth, ready to start, ready for every shift of canvas, ready for every evolution in sailing, and ready to receive the first gun at the finish. Therefore, always be ready and never be above being prepared. The experienced racing man knows that if he is prepared with his spinnaker, and another man is not, after bearing up round a mark, that an enormous advantage will be gained. Or in hauling round a mark if he has got everything in time made snug, and sheets laid along and manned ready for rallying aft, and another man has to luff round with everything adrift on deck, and the boom off the quarter, his vessel will get a quarter of a mile out on the weather of the sloven before the latter has got his boom aboard or jib sheets in. If proper preparation is made for every shift of canvas or manœuvre in sailing, the vessel will be worked as if all the gear and sails were parts of machinery, but if no preparations are made, everything will be in confusion on board; there will be shouting and bawling and running about, sails sent up head downwards, sheets and halyards bent on foul, or fouled among the numberless coils of ropes on deck, the crew will be distracted, the sailing master hoarse and furious, and the owner mortified to see such an utter want of discipline and system on board his vessel. On the other hand, if everything is ready beforehand, the crew will understand exactly what they have to do, each man will fulfil his task with a cool head and ready hand, the sailing master will be tranquil and manage the vessel cleverly, and the owner will be delighted, and think that half the pleasure of match sailing is in seeing a good crew, who know their work, set about it in a seamanlike and systematic manner. There must be no shirking; whatever a man is set to do, he must do thoroughly, and with a will; if he does not do this he should be

unshipped without compunction, as one lazy, slovenly, or half-hearted hand on board will spoil three good ones.

Now everyone knows that there are various things to be done in yacht sailing at one and the same time, and it will be patent that it is desirable that each thing should be done by the same hands each time, if possible. Nothing looks worse on board a racing yacht if when such a simple order as "check the fore sheet a trifle," a half a dozen men or so jump up and rush into the lee bow, when one of the crew could have quietly executed the order. On the other hand it shows a worse spirit if the men begin talking among themselves as to who shall go to do it; but if one hand is told off as the fore sheet man, he will know that he has to check the sheet, and if the sheet has to be got in instead of eased, the mate will send another hand or more to help. For the more important stations men always are told off; thus one hand is always selected for masthead-man, bowsprit-end-man, &c.; and so far as the number of the crew will admit, there should be a just and effective division of labour.

CREWS.

Under the Y.R.A. rules, there is no restriction as to the number of hands a yacht may carry in a match, and this plan is found to work best, as no sailing master will carry more hands than are absolutely necessary, and if crews were limited, sails must be limited also, or a yacht would be frequently short handed. The only argument used in favour of limiting hands, is that a man with a lot of money and a disposition to spend it, would, by carrying a large number of hands, get an advantage over a man with less money or differently disposed about spending it. The plain answer to this is that no sailing master ever dreams of carrying more than the necessary number of hands, and every yacht should be allowed to carry that number.

Attempts have been made to lay down a rule for so many hands for so many units of a yacht's tonnage, but any such rule fails, for the reason that although one man to every 5 tons may be a good proportion for a yacht of 100 tons, yet one man would not be sufficient for a 5-tonner. For match sailing, the following table will be found to accord pretty regularly with practice. The numbers include master, mate, and boatswain, but not pilot, cook, or steward.

It is usual, however, for cook and steward to muster on deck during a race and assist in hauling, &c., and if they do so they justly claim "racing money" just as the seamen do.

Size of Yacht.	Ordinary Crew* of racing yacht.	Extra Hands.	Total Racing Crew.	Extra Hands, Amateurs.	Total with Amateurs.	Crew of Cruising Yacht.*
5	1	3	4	4	5	1
10	2	3	5	5	7	2
15	2	4	6	7	9	2
20	3	5	8	8	11	3
40	5	5	10	9	14	5
60	7	5	12	10	17	6
75	8	6	14	—	—	7
100	10	8	18	—	—	8
125	11	9	20	—	—	9
150	12	10	22	—	—	10
175	13	11	24	—	—	11
200	14	12	26	—	—	12
225	15	13	28	—	—	13
250	16	14	30	—	—	14
275	17	15	32	—	—	15
300	18	16	34	—	—	16

* Cook and steward not included.

The number of the ordinary standing crew given for a racing yacht is somewhat in excess of what a cruising yacht would carry, but as the spars, sails, and gear of a racing yacht are so much heavier, the crews must be heavier also.

For racing it will not matter what the rig is, whether cutter, schooner, or yawl, the same number of hands will be required. In a cutter, the sails, spars, and gear are heavier to handle than in a schooner, or yawl of similar tonnage, on the other hand, the number of sails and the extra gear of a schooner or yawl require more hands.

A sailing master will generally endeavour to make up a racing crew from men who have been in a racing yacht before; this of course cannot always be done, and it follows that somebody must ship the green hands. However, excepting the circumstance that a hand who has been in a racing yacht is already "proved and rated," there is no disadvantage in having one or two green hands, as a couple of matches will make them perfect, if they have been trained as good yacht sailors in other respects.

Men widely differ in their smartness and in their habits; and a man may be tolerated in a racing yacht in spite of his moral delinquencies and faults of temper, because he is a very smart seaman, but a sloven should be given a very wide berth, as he will not only be offensive to the rest of the crew, but in all probability no seaman. As a rule, the smartest men (*i.e.*, the cleverest and most active) are the most cleanly in their habits, the most prompt in doing their work, and in obeying orders, and the most satisfied, not to say proud, of their lot. On the other hand, a sloven is dirty in his habits, indolent, slow in obeying orders, and an inveterate grumbler. He quarrels with the catering, with the

work he has to do, with the liberty he gets, and with the places he visits. Such a man should find no berth in a racing yacht, and if a sailing master unfortunately ships such a creature, and does not instantly unship him when his character is patent, that sailing master will not be doing his duty to the owner, to himself, or to the rest of the crew.

Sometimes what is known as a "sea lawyer" is got hold of; a man who is always standing on his rights, and will argue on behalf of another member of the crew if the latter is requested to do something which he is not compelled to do by Act of Parliament. He is generally brimful of "instances," which as a rule are about as *à propos* as a fiddle at a funeral, and consumes the best part of his time in arguing out whether he is obliged to do what he is told or not. The "sea lawyer" will upset and make dissatisfied any crew, and should be cut adrift on the first opportunity.

It is frequently said that the men who come from this place, or that place, are better or smarter than others; but this is entirely a mistake. Good Cowes men are as good as good Southampton men; good Colne men are as good as either; and as there is no difference in the degrees of worth of the men, so is there no difference in the degrees of their badness. At Cowes, or Southampton, if a man is shipped who has never been in a yacht before, the probability is, that he will be no seaman at all—a sort of half waterman and half labourer. If such a one is shipped from the Colne, the probability is that he will know a great deal about seamanship as represented by a smacksman, but he will be a rough hand, and if he has to work upon rigging, or in any way assist in fitting out, his work will be rough; his manner will probably be rough also; he will handle things roughly, and may possibly have a perpetual desire to smoke, and perhaps will expectorate on the deck, and show a partiality for the after part of the vessel. This man will never much improve in his habits, but he will be good at hauling, good at belaying, good at reefing, and good and trustworthy in bad weather.

THE COST OF YACHT RACING.

The cost of yacht racing is a very important item, and, of course, so far as crew expenses go, will depend upon the number of matches sailed. The other expenses, which relate to the hull, sails, spars, and rigging, can be put down at from 50 per cent. to 60 per cent. greater than those for the cruising yacht. The crew expenses will also be a heavy item, as the number will not only be greater, but there will be the extra money, and food and drink or "grub money" on racing days.

In most yachts, the practice is to give the men meat, bread, and beer (or, on wet cold days, rum), on the days when matches are sailed; no doubt this practice is in much favour among the crews, as frequently enough food is left to supply the mess another day. However, a fashion has been introduced of paying the men half-a-crown each on racing days, and making them find themselves in food and drink. This greatly simplifies the accounts, and prevents the owner's good nature, or inexhaustible means being imposed upon.

The expenses of a 10-tonner will serve to show the nature and extent of the cost of yacht racing. It will be assumed that she commences to fit out on the 1st of May, and is laid up on the 30th of September, therefore that she is in commission twenty-two weeks.

EXPENSES OF A RACING TEN-TONNER.

	£	s.	d.
Sailing master (per annum)	50	0	0
One Seaman, twenty-two weeks, at 28s.	28	12	0
Clothes for master and man	10	10	0
Three extra men for twenty matches, 10s. each	30	0	0
Winning money for the same, for (say) ten matches, another 10s. each...	15	0	0
Food and drink money for twenty matches with paid crew at 2s. 6d. per head *	12	10	0
Winning money to master and man for (say) twenty matches, 1l. each ...	40	0	0
Losing money for the same, for twenty matches, 10s. each	20	0	0
Pilot for thirty of the matches sailed, at 2l. a match	60	0	0
Entrance fees	20	0	0
New mainsail †	26	0	0
Fitting out expenses	20	0	0
Ship Chandler	10	0	0
Store	10	0	0
Hauling up and launching	15	0	0
Insurance	20	0	0
	£387	12	0

As a set off to these expenses, there will be, of course, the prizes, which would probably amount to 200l. But even deducting this, it will be seen that racing a 10-tonner is a very expensive amusement.

Of course, these expenses could be very greatly reduced. In the first place, no more than twenty matches need be sailed; next, amateur crews might be more often made use of; a pilot need not be had so often if the owner or his master, or one of the owner's friends is well acquainted with the waters in which the matches are sailed; and a new mainsail need only be had every other year. However, if forty matches were sailed in one season, a new mainsail would be a necessity.

* Until within the last four years the invariable practice was to find the men in food, beer, and grog, and many years' experience proved that the liberality of the owner was almost systematically abused; consequently the practice of giving "grub money" was introduced, and has been found to work well.

† The old mainsail will about pay for other new sails, repairs to sails, &c.

The expenses of a 15-tonner will not greatly exceed that of a 10-tonner, and the general cost of keeping one, irrespective of racing, will not be much in excess of the smaller vessel. But in a 20-tonner, although two hands might very well manage her, the sailing master takes the form of a regular "skipper." In a 10 or 15-tonner, the master works just as the man does; turns out at six o'clock to scrub down, takes his turn with the other hand at every kind of work and liberty. In a 20-tonner, the skipper does not show on deck until after breakfast, and his greatest exertion is usually steering the vessel and talking to the owner, the same as it is on board other large yachts.

With regard to one branch of the expenses enumerated, that of "racing money" or the extra money given to crews on racing days, has long formed a vexed question, and hitherto all attempts to introduce a uniform system have failed. Formerly it was 1*l*.* all round and 5*l*. for the skipper, but during the last quarter of a century, the practice has sprung up of giving the men 10*s*. for racing and losing, and 1*l*. for racing and winning, and in most cases 2*s*. 6*d*. per head grub money; but some owners find the men in beer, beef, and bread.

The sailing master is rewarded by a per-centage on the nominal amount won; a "crack skipper" will expect 10 per cent. on the total year's winnings, but it is unusual to pay more than 5 per cent.

It need scarcely be said that the yachts whose owners pay both winning and losing money are more in favour among the men than the yachts of those who only give the 1*l*. for winning, and the result is that those who ship in the latter have a standing grievance unless a prize is won for every start. Occasionally an owner who has no knowledge of the customs of yacht racing appears to place an undue value upon the exertions of a crew, and when victory is secured rewards the sailing master and crew out of all proportion to their services. The answer may perhaps be made that the importance of the services is proportional to the desire of the owner to win; this may be so, but the practical effect of such excessive liberality on sailing masters and crew, is to make the former foolishly vain and presumptuous, and the crew insolent and indifferent about everything but racing. Fortunately this evil appears to work its own cure, as the owner soon finds that instead of winning more prizes by paying liberally or foolishly, he wins fewer and finds that his vessel and crew are hated with undisguised zest by the crews of all other vessels.

* It was quite common until within the last quarter of a century for the owner of a yacht, such as were about Cowes, to present the crew with 2*l*. each after winning a prize; but then that prize would most likely be the only one of the season, and won in the only match the yacht sailed.

It has been argued that if racing money is given at all, the *1l.* for winning and nothing for losing system does not seem just. A vessel cannot win by the exertion of the crew alone, and if she could, it may be taken for granted that the crews would exert themselves to the utmost without the stimulus of extra pay. A yacht's success depends upon her excellence as compared with the excellence of other vessels, upon her canvas, upon her sailing master and crew, and upon the varying fortune of wind. It therefore does not seem just that if a crew exert themselves to the utmost and lose, that they should have nothing, whereas if they had won, a *douceur* of *1l.* to each man would have been given. It may be argued that many owners would not race if they had to pay *10s.* losing money, because they know their vessels are not so good as some others, and therefore that their chances of winning are more remote. This it has been said may justify the owner in not racing, but it is hardly fair to the crew if he does race. If the *1l.* winning money is fairly earned, the *10s.* losing money is equally well earned, and the difference of *10s.* between the two *douceurs* is quite sufficient to maintain the desire to win. But there is still another very strong argument to be advanced on behalf of the *10s.* losing money plan. The extra men get *10s.* for coming on board to race, and if these men are given *10s.* besides their ordinary day's pay to come out of a strange vessel, it certainly is no more than just that the regular crew of the yacht should have *10s.* besides their day's pay as well. The extra men have comparatively little work to do beyond the pulling and hauling during the race, but the regular crew of the yacht have most likely a hard day's work before the race, and a harder one after the race. It is not the fact that the work is no harder on board a racing yacht than on board a cruiser; in reality there is no comparing the two, and the life on board a cruiser is ease, luxury, and indolence, compared with the worry, discomfort, and work on board a racing yacht. We therefore think that the general practice of giving racing money is a just one, and that it should be apportioned as follows: *1l.* for racing and winning first prize, *15s.* for racing and winning second prize, and *10s.* for racing and winning no prize. If the losing money is not given, only *10s.* should be given for winning.

MANAGEMENT OF MATCHES.

The first rule of the Yacht Racing Association,* is that "all races and all yachts sailing therein, shall be under the direction of the flag officers or

* The full text of the sailing rules of the Yacht Racing Association, as revised for 1882, will be found in the Appendix.

sailing committee of the club under whose auspices the races are being sailed." All matches are to be subject to their approval, and they have the power to settle all disputes, and their decision is to be final, unless they choose, "upon the application of the parties interested, or otherwise, to refer the questions at issue for the decision of the council;" but there can be *no appeal* from the decision of the flag officers of a club, or sailing committee to the Council, nor can a party interested in a dispute demand as a *right* that the matter shall be referred to the Council, the option of so referring disputes to the Council rests entirely with the flag officers or sailing committee. However, the practice is, where both disputants request it, for the flag officers or sailing committee to refer the dispute, and in most cases such a request from one disputant has been complied with. Also in cases where a general principle is involved, or where none of the Y.R.A. rules appear to clearly meet the matter in dispute; or where the reading of a rule is doubtful, or is open to more than one interpretation, the flag officers or sailing committee have of their own accord referred disputes to the Council.

However, whenever the cause of a dispute is clear and whenever a rule exactly meets the case, or whenever there can be no question that a breach of a rule has been committed, the flag officers or sailing committee should decide the case for themselves. They should apply the rules as stringently as possible, but at the same time should remember that the rules were founded upon the principle of "fair play" only, and were not intended to be penal in their operation; exemplary penalties or decisions should be avoided; on the other hand, that class of protest which has been aptly termed "frivolous and vexatious," should be discouraged.

In most cases breaches of rules are more or less the result of accident or errors of judgment, and in giving decisions regard should be taken of the character of the breach, and of the manner of its occurrence. But a protest should not be dismissed for the mere reason that it has had no effect on the issue of a race, although in certain instances that feature could be properly considered; still in the majority of cases it is impossible to say how far a breach of the rules has influenced a result, even though it be such a trifling matter as carrying an anchor on the bow in a "cruising trim race" or "side lights in a race at night." It is not a sufficient excuse to say that a breach of a rule was the result of an error of judgment, carelessness, forgetfulness, or ignorance; no such pleas are admissible; nor should it be overlooked that a rule may be designedly and persistently broken. On the other hand, a rule might be broken through an entirely accidental cause; such for instance as a delay in the delivery of an entry, or the dragging of moorings; such breaches

might reasonably be overlooked, if satisfactorily accounted for; but if a yacht crosses a line too soon through an error of judgment, or touches a mark through an error of judgment, or in a cruising-trim race fails to start with an anchor on the bow, and fails to carry one all through the race, such errors of judgment or persistent breaches of rules could only be regarded adversely.

POSTPONEMENT OF RACES.

The flag officers or sailing committee can only postpone a race on account of unfavourable weather, such as a calm, a fog, or a very heavy wind.

FLAGS.

A yacht which is competing in a match is required to fly a distinguishing "rectangular flag of suitable size." Flags of "suitable size" for yachts of various tonnages will be found under "Flag" in the Appendix.

ENTRIES: POST ENTRIES: RE-SAILED MATCHES.

Many a time an owner has been disappointed in sailing because his entry arrived too late, and he should recollect that by the Y.R.A. rules, a yacht must be entered for a match at *least* forty-eight hours before noon of the day appointed for starting the race. But a *longer* time may possibly be required, and in inserting the dates of a match in a diary, the date of closing the entries should be inserted as well.

A club cannot accept post entries, but sometimes a yacht, which was not properly entered, is allowed to start upon the other competitors signing a paper that they do not object. If the other competitors did not do this, and if the post entry won the prize, the club or regatta committee could be sued by the owner of the second vessel; and he could recover the amount of the prize.

Entries can be made by telegram, and it is considered a sufficiently good entry if proof is given that the telegram was despatched or handed in at the telegraph office *before* noon of the day on which the entries closed. So also if it can be *proved* that a letter was posted in such time that the entry ought in the ordinary course to have arrived before noon of the day on which the entries close, the entry should be considered a good one. A plea of forgetfulness, or a general statement that somebody was "told to enter the yacht, and forgot to do it, or neglected doing it, or was given a letter to post and forgot to do so, or was told to despatch a telegram and forgot to do so," does not justify the acceptance of a post entry. Telegrams should be confirmed by letter.

Post entries are condemned for two strong reasons ; in the first place they are disliked by the owners of the yachts that have already entered in good time ; in the second place, they are disliked by clubs and regatta committees, because owners are induced to hang back until the last moment to see if the weather will suit their yachts, or to see if they can arrive in time to sail. The chance of swelling an entry by admitting a late comer, that had not deferred entering for any of the above reasons, is a very remote one, and post entries are now rarely heard of.

A yacht cannot be entered for a race under two rigs, but if there are two or more distinct races at the same time, or a prize for each rig, she can enter under a different rig for each. If it is a race where there is an "allowance for rig," a yacht cannot be entered under different rigs. In a race where there are distinct prizes for more than one rig, and where the rig of the "first yacht in" determines the rig of the winner of the principal prize, an owner may enter a yacht of each rig, but in no case can two yachts of the same rig be entered in a race.

In *all* cases the form of entry provided by the Y.R.A. should be signed by the owner or his representative before the race is started. So also in all cases should the declaration that the rules have been strictly observed be signed before a prize is presented.

In races that are ordered to be re-sailed, from whatever cause, *all* the original entries can start, and no yacht, whether she was among the original starters or not, requires to be re-entered. The yachts in fact are regarded as the entries in a race which has been postponed.

If a yacht commits a breach of the sailing rules in a race which is unfinished, no action can be taken under the alleged cause for protest ; and should the race be re-sailed, the breach of sailing rules is, practically, considered as not having taken place, and the offending yacht starts on exactly the same terms as the others, and can win the prize, providing, of course, no breach of the rules occurs during the re-sailed race.

INSTRUCTIONS.

Sailing committees should be very clear in the instructions they issue as to the manner of starting and the marks in the course, and in no case should verbal instructions be given, nor should verbal alterations be made to written instructions.

A sailing committee can, however, if they so choose, issue verbal alterations to instructions ; but such verbal alterations, the same as all other alterations, should be clearly made known to the person in charge of *every* competing yacht in the race, otherwise a yacht that had not been made acquainted with the alterations, but had fulfilled the original

instructions, could claim the prize, so also could the yacht that won the prize by fulfilling the altered instructions. As mistakes in issuing instructions are usually the result of a simple misunderstanding, the fairest way is to pronounce the race void, and order it to be re-sailed.

A secretary, acting under the direction of the committee or flag officers, can deliver verbal alterations or instructions; but such alterations or instructions would render a race void, or cause the yacht or yachts acting upon such verbal alterations or instructions to be disqualified under a protest, if it were proved that the secretary had acted without authority or direction from the flag officers or sailing committee.

STARTING; INTERVAL BETWEEN MATCHES, &c.

The starting rule of the Yacht Racing Association has now been in use seven seasons, and is well understood both by owners and sailing masters. In that rule it is enjoined that the signal flag (of the Merchant Shipping Code) denoting the race shall be hoisted half an hour before the signal to start is made. This is sometimes supposed to mean that there must be a separate half hour between each race; this, however, is not the case, and so long as the signal flag for a race is hoisted half an hour before the time appointed for the race to be started, the rule will have been complied with. This may be of great importance at some regattas where several matches are to be sailed.

The flag denoting the race *must* be hoisted for twenty-five minutes before the time set down for the start, and then pulled down so that the blue peter may be hoisted for the remaining five minutes; but, as before said, there may be *any* interval between distinct matches which a committee may find convenient; or the matches may be started all together if their half-hour flags were hoisted together. To start several matches together, however, would be dire confusion, and a suitable interval should be chosen. For quarter of an hour intervals the starts could be thus arranged:

Signal flag denoting race.	Time for hoisting signal flag.	Time of hauling down signal flag, hoisting Blue Peter, and firing preparatory gun.	Time of hauling down Blue Peter, and firing gun for the start.
B	H. M. 9 30	H. M. 9 55	H. M. 10 0
C	9 45	10 10	10 15
D	10 0	10 25	10 30
F	10 15	10 40	10 45
G	10 30	10 55	11 0
H	10 45	11 10	11 15
J	11 0	11 25	11 30

There are two ways of starting yachts in a match by Y.R.A. rules—one from anchors or moorings, and the other under way; the latter is frequently termed a flying start.

If the start is from anchors or moorings, the yacht should be taken to her station in good time; and to wait for a yacht that is late in getting to her station would not be fair, as it would certainly spoil the start of those which were in time. Indeed, if it could be proved that a yacht would have won a prize but for the delay in the start beyond the appointed time after the first signal had been given, a claim would hold against the responsible persons.

As a rule yachtsmen prefer under-way starts, so as to get their sails properly set, and to know exactly what sail to set.

At the time of entry each yacht is assigned a number, and in case of her crossing the line too soon this is hoisted as a recall.

To assist sailing masters in judging whether their vessels are over the line or not, it is desirable that there should be two marks on one side; thus by bringing them into one it could be seen exactly when a vessel reached the line. There should be a third mark to limit the length of line, otherwise the start might be a very sprawling one. At

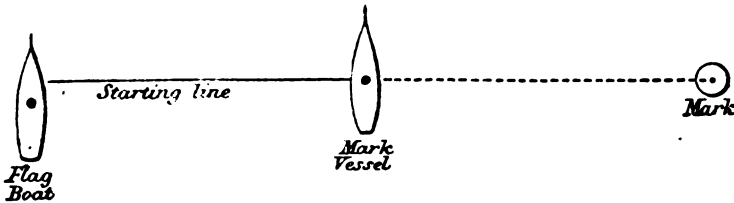

FIG. 34.

the same time the line should be at least a quarter of a mile in length. The two marks forming the "bearings" for the line might be on shore, or one of them might be, or both might be afloat. The shore mark might be a flagstaff, tower, &c. The "flag boat," forming the outer boundary of the line, and not the direction of the line, need not be strictly in a line with the "mark vessel" and inner mark, whether the latter be on shore or not.

If there is a great difference in the size of the competing yachts, the owners of the small ones would prefer a start from moorings with all sail down, as they would be able to haul up their canvas quicker than the larger yachts, and so gain an advantage. This is not fair to the yachts of larger tonnage, and the most just plan is to start yachts under-way, or with after canvas set.

There is another reason why, when starting from moorings, yachts,

if the state of the tide and wind permits, should be allowed to set after canvas previous to the signal for the start; when a start has to be made with all canvas down, a 10-tonner will carry two or three more hands, than she otherwise would, for the sake of getting up the canvas quickly. Five or six men are quite sufficient to work a 10-tonner when once she is underway, but it is the practice to carry eight when the start is from moorings with all canvas down; a 10-tonner is thus often made to carry about quite an unnecessary deck load. Of course the larger the yacht the greater is the number of these "canvas hoisters," and years ago the practice was to turn them into a boat, waiting alongside, directly the canvas was up. To prevent this practice a rule was passed that no one should join or leave a yacht after the preparatory gun had been fired. The Y.R.A. have modified this by limiting its application to paid hands. (*See the section "Leaving a Yacht during a Match."*)

It will be assumed that the race is for 10-tonners; and, as the method of starting and general conduct of a race is the same for yachts of all sizes, a 10-tonner will answer the purpose of illustration as well as one of larger size. If the start is from moorings, go up to the buoy to pick it up just as you would to pick up any other buoy. (*See "Seamanship."*) If the yacht is before the wind, lower all sail and go up to the buoy with way so much deadened that the yacht scarcely moves, due allowance of course always being made for tide, whether foul or fair; in beating up to the buoy, the yacht must be rounded to and made shoot head to wind up to the buoy. Get hold of the buoy and hawser and haul about ten or twelve fathoms on board; then bend on the quarter spring to the hawser, veer out the hawser again and belay the spring with some slack aft. In starting from anchors, if the chain has to be slipped, the spring will be bent to the chain as it would be to the hawser. If the anchor has to be weighed, no spring will be bent on. If a yacht starts from her own anchor and slips and the anchor has to be got by a boat, it is best to bend a trip line to the crown of the anchor with a buoy. Also if the anchor has to be weighed in a 5-tonner, it will be found best to put a trip line on the anchor and pull it up over the bow regardless of the cable, which can be got in at leisure.

Too much of the hawser should not be hauled in, as the yacht may drag, and this would render her liable to disqualification; neither should the rudder be put hard across, as that will cause the yacht to sheer and bring the stream of the tide on one bow, or on the broadside, and the force of the stream acting on such a surface may cause the yacht to drag, and this would render her liable to disqualification.

Sometimes when starting from moorings or anchors, permission is

given to set after canvas prior to the gun for the start being fired; but if the yacht is riding head to the tide with the wind blowing astern, she could not keep at her moorings with mainsail set. In such cases the sail will not be hoisted till the last two or three minutes. But everything must be got ready long before the five-minutes gun.

The breeze we will assume to be of whole-sail strength, that is that the biggest topsail, not being a balloon, can be just carried on a wind, and that the first part of the course lies to windward. See that the topsail is bent to the yard, and that the halyards are properly bent; also bend the second topsail, roll it up on the yard, and stow it away with the other spare spars on deck "ready when wanted." Haul No. 1 jib out by the traveller in stops, hook on the halyards, and let it lie on the bowsprit; get the mainsail (with boom well topped) and the foresail ready for hoisting. If the jib topsail will be wanted, hank it on to the topmast stay, stow it on the bowsprit end, and bend the sheets. See that the sheets are clear for hauling in aft.

See that everything is stowed below that will not be required on deck, and also see that everything that is on deck and not in immediate use is securely lashed. Have an axe ready to cut the quarter spring in case it jammed.

At the five-minutes gun place the crew at their stations.

The helmsman of the day then takes the helm; with him aft will be the pilot, who will also look after the quarter spring and attend to the main sheet; the mate will cast off the spring or hawser forward, clear the jib halyards for hoisting, and with another hand hoist the jib and take in the lee jib sheet; one hand will hoist the foresail and attend to the lee fore sheet if necessary; two hands will man the peak halyards, and two the throat, the jib and foresail men tailing on directly they have pulled these sails up. This will be work for eight hands; if the pilot is not allowed to work, the jib-halyard hand will go aft and cast off the spring and jump forward directly it is done.

As the time approaches for the firing of the gun to start, try to realise that everything must be done at once. If the yachts are lying head to wind and tide, and have to fill on starboard tack, the helmsman in the last fifteen seconds will put his helm to starboard, so as to make sure of the wind catching the yacht on the starboard bow. As the gun fires the mate will throw overboard the bow fast, and the quarter spring will be hung on to until the yacht is fairly filled on the right tack, when it will be thrown overboard by the pilot; all hands will hoist away. The pilot will overhaul some of the main sheet and drag it in again directly the yacht begins to move through the water, and the helmsman will gradually bring

her to the wind. Get all the sails set and properly purchased as quickly as possible is advice that cannot too often be repeated, and when they are so set coil up all ropes, &c., and "clear the decks."

If the yachts are to proceed against wind and tide, and to fill on starboard tack (*i.e.*, cast to port), the helm will be put to starboard just before the start, in order to sheer the yacht's head to port or off the wind (in reality the stern will come more to windward than the bow will go off to leeward). Great exertion must be made to get the mainsail up quickly if it is not already set.

In starting to run with the tide and wind, hold on the quarter spring until the vessel is fairly swung round before the wind. If to run before the wind against the tide no quarter spring will be required, although one is generally bent on. In all cases get the canvas set as quickly as possible, and directly the hands who are hoisting the head sails have got them up hand taut, they should jump on to the main and peak halyards; the purchasing will be done after the sails are fairly hoisted all round.

In starting every caution must be exercised to avoid fouling other yachts; but frequently a foul cannot very well be avoided if a yacht has no way on, and is simply moving with the tide; but if the vessel has gathered way she is under control, and no foul should take place.

In an under-way start great care must be exercised that *no part* of a yacht (her bowsprit, boom, and sails included) is on the line before the signal to start. (In case of a calm a yacht is not allowed to have her anchor out over the line to haul across with when the gun has been fired for the start.)

The strength of the tide and the wind should be so well judged that the yacht can, with full way on, go over the line at the very moment the blue peter is lowered and the gun fired. In all cases the master should strive for a weather berth, especially so if the start is for a thrash to windward. If the yacht is a little too early she must be stopped: yaw her about; haul the foresail up to windward; haul the main boom in; or if the vessel is by the wind it can be run well off her quarter—this only if there be plenty of help to get it in again. In extreme cases the yacht can be put about, but she should not wear unless there be a lot of time, as it will take her right away to leeward.

If the yacht is on the wrong side of the line when the gun fires she must be careful to keep clear of all yachts that are crossing or have crossed the line properly; so also must it be recollected that in under-way starts all yachts are amenable to the sailing rules directly the preparatory (five minutes) gun has been fired; however, there is a special rule that yachts

coming into position from the wrong side of the line after the signal to start must keep clear of yachts which are starting or have started properly.

Whether the start be from moorings or under way the master should, to the best of his judgment, get the exact canvas up at first that can be carried; and if it is a case of reefing, always remember that it is a great deal easier to let a reef out than take one in.

If it is to be a start before the wind, a reef may be required when the yachts draw on the wind; in such cases the practice is to start with a reef down and jib-headed topsail over it. When the yacht is brought by the wind the topmast is housed, or got on deck if the rigging is fitted on a funnel.

HEAD-REACHING TO WINDWARD.

If two yachts are standing by the wind in close company on the same tack, and the weathermost yacht head-reaches so much as to get into the other's wind, the latter may require to tack; but she must not do so until she can clear the stern of the weathermost yacht, as fouling in attempting to stay under such conditions would be cause for disqualification. (*See the section "Weather Bowing."*)

HEAD-REACHING TO LEEWARD: TACKING.

It frequently happens that when two yachts are beating to windward, and standing in close company on the same tack, that the yacht to leeward head-reaches and requires to tack across the other's bow; in such a case she must not do so until she can tack without interfering with the weather yacht whether she is going to either starboard or port tack.

HEAD-REACHING AND WEATHERING.

It is assumed that the yachts in the match are close-hauled standing on starboard tack on their first board in the beat for No. 1 markboat; jibs have been purchased up till the luff is as straight as the forestay, peak purchased up, main tack bowsed down, topsail tack hauled down and clew sheeted home,* and sails trimmed to the exact inch

* As a matter of fact, a gaff topsail is seldom "sheeted home" in a racing yacht; there is usually a foot or so drift of sheet between the gaff and clew cringle to insure being able to sheet the sail flat. When the cringle is "home" the foot of the sail will very likely not be stretched, and will belly away from the gaff; it will then be time to think about getting a pull on the topmast stay; or topsail halyards, if the topsail has settled down, as it frequently will, especially if the halyards be new. A gaff topsail will usually require "sheeting" after the main peak has been purchased up.

of sheet. With water just squeezing through the lee scuppers, the helmsman has plenty of weather helm to play upon in luffing to the "free puffs."

Two yachts have started abreast of each other, but one a hundred yards or so to leeward. The one in the lee berth holds much the better wind, and is gradually eating up to the other and head-reaching too. At last she is close up under the lee bow of the craft to windward, and in another half-minute her weather quarter-rail promises to strike the bowsprit or lee bow of the other; which has to give way?

To begin with, we must clearly understand what is taking place. Close-hauled means sailing so close to the wind as a vessel can be sailed with a view of economising distance or time, or both, in reaching a particular object. The vessel that is "weathering," and at the same time head-reaching, can in this case be taken as a standard for the condition of being close-hauled. It is thus quite clear that the vessel to windward does not fulfil that standard, and is in the condition—an uncontrollable one it can be admitted—of bearing away on the other. This, under Rule 20 of the Y.R.A. (the Luffing and Bearing Away rule), a yacht is not allowed to do, and she must luff up to enable the other to clear her. However, the general practice in such a case is for the leeward yacht to be given weather helm to keep clear of the one to windward; then when she has drawn clear ahead the weather tiller lines can be eased, and she will literally fly out across the bow of the other. This, on the whole, is the better course; and further, it is the course that must be followed if the leeward yacht head-reaches from a position astern, as by the Luffing and Bearing Away rule "an overtaking vessel, if to leeward, must not luff, so as to interfere with the yacht she has overtaken, until she has drawn clear ahead."

It may possibly be argued that the leeward yacht is not luffing, that she is (for her) only a bare close-hauled, and that it is the windward yacht that is bearing away. Such a dispute can only be settled in one way: the leeward yacht was in the position of the overtaking vessel, and should have kept clear of the yacht to windward. Therefore in all cases if the leeward yacht is head-reaching, and at the same time weathering, we think it is good policy for her to keep clear of the yacht she is likely to foul to windward. It will not do for the yacht to defer using a little weather helm until her weather quarter is so close under the bow of the yacht to windward that the fact of putting her helm up would have the effect of swinging her quarter on the bow of the other.

HEAD-REACHING AND SAGGING TO LEEWARD.

But it may happen that the yacht which is to windward is head-reaching, although not holding so good a wind as the other; in such a case the yachts may converge, and the lee quarter of the windward yacht may be likely to foul the weather bow or bowsprit of the leeward yacht. In this case it will be the duty of the windward yacht to keep clear of the one to leeward, as she is in the condition of a yacht bearing away, and is the overtaking yacht and must keep clear of the other; and moreover, by the rule before referred to, a yacht in the position of the one to leeward, that is being overtaken, may luff as she pleases to prevent another passing to windward; and further, when two yachts have the wind on the same side, and if no question of overtaking is involved, the yacht which is to windward must keep clear of the other.

If the windward yacht has deferred luffing, or shaking up if necessary, until such time as the bowsprit end of the other is close to her lee quarter, it will be too late to luff, and a little weather helm will probably take the yachts clear. The leeward yacht will be pretty certain to have been well blanketed by the one to windward; her way will therefore be stopped, and the other, under the influence of her weather helm, will lift her stern to windward and forge clear.

If the yachts are not too close when the blanketing takes place, it is the practice for the helmsman of the leeward yacht to put the helm down as the sails begin to shake, and make a shoot to windward clear of the wash of the other; but care must be taken not to keep the vessel shooting so long as to lose her way, as she might get in irons.

When the leeward yacht is passed like this, it will be a good time to choose for getting a pull on any of the purchases that may require it.

PORT AND STARBOARD TACK—CROSS TACKING.

One of the most frequent causes of protest arises out of the rule that provides for keeping vessels clear of each other when crossing on opposite tacks. The Y.R.A. rule is simply that of the Board of Trade, which says that "a ship which is close hauled on the port tack shall keep out of the way of the ship which is close hauled on the starboard tack."

In the first place, it must be clearly understood that the rule was not intended to put any penalty or odium on a vessel for being on the port tack; the rule was solely intended to keep vessels clear of each other, and for this purpose it was necessary that the rule should say which

of two positions should be the one which must *always* yield. It was decided that the port tack should be chosen, but there could be no particular reason for preferring the port tack to the starboard tack for the purpose. It undeniably gives an advantage to starboard tack, and often, so far as match sailing is concerned, a seemingly unfair one; and hence, perhaps, there is often some feeling imported into the situation when two yachts are crossing on opposite tacks.

A yacht on the port tack may be so far ahead of the one on the starboard tack as to be able to almost cross clear ahead of her, but not quite. If there is the least doubt about it, the yacht on the port tack must give way, however hard or apparently unfair it may seem for her to do so. If she does not so give way and fouls the other yacht, or if that other yacht has to bear away or luff to avoid a collision, the yacht on the port tack must be disqualified without hesitation.

But frequently the yacht on the port tack could have crossed clear ahead of the yacht on the starboard tack, providing the latter had not luffed at the last moment, and by so luffing succeeded in striking the lee quarter or boom end of the yacht on the port tack.

Apart from the obligation* of conforming to match sailing rules, if it were proved in court that no collision would have happened if the vessel on the starboard tack had not luffed, the decision would be that the vessel on the port tack should not be liable for any damage done to the other vessel: or that each vessel should pay her own damages. The Board of Trade rule is that, when one of two vessels has to keep out of the way, the other shall hold a steady course, and also that no vessel shall neglect any ordinary precaution in special cases. *On the other hand, the decision of a sailing committee, in such a case as just quoted, would properly be that the vessel on the port tack was alone in fault. In competitive sailing, the temptation to make close shaves is very urgent, and any decision which would tend to encourage such practices should be avoided as the risks are so great.*

By the Y.R.A. rule the yacht on the port tack is bound to give way if a *risk* of collision is involved. It is usual for the vessel on the starboard tack to "nip" a little when one on the port tack is coming towards her; and this tells the vessel on port tack that she must not expect her to give way. If, however, a vessel on the port tack is crossing just clear ahead of the other, and that other luffs and touches

* If two yachts agree to sail under and be bound by particular rules, such as those of the Y.R.A., and whilst sailing under them a collision or damage occurred, it would not be right to repudiate such a contract for the sake of appealing to another set of rules, such as sanctioned by an Order in Council under the Merchant Shipping Act, which might be different.

the quarter of the vessel on port tack, as before stated, the case is somewhat altered, and involves wilfulness on the part of the vessel on the starboard tack; but the answer manifestly is that the vessel on the port tack is not justified under the rule in placing herself in a position where the other can touch her, as the *risk of collision* is clearly involved. However, as the rule was not intended to give a special advantage to the vessel on starboard tack, she should not needlessly bully the unfortunate one on port tack by luffing for the *purpose of making a foul*.

The right of luffing has been claimed for the starboard tack, because some old yacht-sailing rules enjoin that the vessel on the starboard tack should *never bear away* but *luff* or *tack* if a collision is imminent; no such rule now exists, and the right of luffing is claimed by the yacht on the starboard tack on the ground that the vessel on port tack has under Y.R.A. rules unconditionally to get out of the way. Nevertheless, if a man luffed his yacht and wilfully struck another yacht on port tack, which would have gone clear but for the luffing, and loss of life or injury to person ensued, it would not avail him in a court to plead that the yacht on the port tack was bound to get out of the way whatever the yacht on starboard tack did. A sailing committee might, as before said, reasonably hold that view, but no court of law would. Frequently we hear an ignorant sailing master threaten to give another yacht (which is crossing him on port tack) the bowsprit or stem; it need scarcely be said if a collision did ensue that a court would properly take account of the threat, and in case of loss of life a more serious charge even than that of wilful injury would be made against the person responsible for the collision.

It has already been said that it is the practice to nip or luff the vessel on starboard tack a little when approaching one on the port tack, to show the latter that she must give way; and it is most important that the vessel on the starboard tack should never begin to *bear away* under such conditions unless she positively intends to go under the stern of the one on the port tack. By bearing away it will encourage the belief on board the vessel on the port tack that she is to pass ahead; then if the vessel on the starboard tack luffs and says she will not allow this, it may be too late for the vessel on the port tack either to bear away or to go about to avoid the risk of collision. The safer thing for the yacht on port tack to do under such circumstances will be to luff or tack, as this will deaden her way. The vessel on the starboard tack should also luff up, and the two will probably come alongside. A protest will follow, and the vessel on the port tack will excuse herself by saying it would not have happened if the vessel on the starboard

tack had not begun to bear away. This may be true, but, inasmuch as it was the duty of the vessel on the port tack to keep clear, no matter what the vessel on the starboard tack might do, the former would be disqualified.

Further, the practice of bearing away by a yacht on the starboard tack when approaching one on port tack is a dangerous one, from the fact that, if the vessel on the port tack also bears away, a collision is almost inevitable, and under the aggravated conditions of accelerated speed. Beyond this, in the event of the vessel on the port tack not giving way, there is generally great difficulty in proving that it was necessary for the vessel on the starboard tack to bear away to clear her. Legal decisions could be quoted in which, in the case of collisions, the vessel on the starboard tack has been distinctly blamed for not having luffed, instead of having kept away; but the Board of Trade rule is absolutely silent on the point, and gives no instructions whatever to the vessel on the starboard tack further than enjoining that when one of two vessels has to keep out of the way, the other shall keep her course; the Y.R.A. rule is equally silent on the point, and it was found inconvenient to stipulate (on account of the "Luffing and Bearing Away" rule, and some of the rules as to rounding marks) that where one of two vessels has to keep out of the way the other shall keep her course.*

However, many cases do occur, when it would be much easier for the vessel on starboard tack to avoid one which has actually and improperly got across her on port tack, by using a little weather helm instead of lee helm; in fact, if the vessel on starboard tack is to strike the other on the starboard quarter (well aft), it is evident that the collision could be better avoided by the vessel on starboard tack bearing away than by luffing. Of course this assumes that the vessel on the port tack has fairly got across the other, and is thus unable to do anything herself to avoid the impending collision. It is quite natural that the masters of square-rigged ships should prefer bearing away to going about, on account of the ease of the one operation in comparison with the labour of the other; but if there is any law (beyond the seaman-like custom of the sea) which condemns them in penalties for the consequences of bearing away instead of tacking, the Board of Trade rule ought clearly to warn them of it. In the merchant navy the general practice is for the vessel on port tack to go about some time before she gets near the other; but in the case of yachts in competitive sailing the vessel on port tack invariably holds on to the last moment, and the vessel on

* For instance, the "luffing and bearing away" rule is contrary to the spirit of such a direction as this, but it has been argued that the overtaken vessel should neither be allowed to bear away nor luff to prevent another passing.

starboard tack, knowing that the other, according to the rule, ought to give way, does the same. And the result is that the question generally amounts to this—What is best to do?—and not what the sailing rule says ought to be done. So far as we know, the rule that the vessel on starboard tack should luff, and not bear away, has never been general; and, although some clubs have gone so far as to say what the vessel on the starboard tack is to do, we cannot call to mind any case where a yacht has been mulcted in a penalty for bearing away instead of luffing. The clubs which had an instruction on the point before their adoption of Y.R.A. Rules were Royal Dart, Royal Victoria, Royal Cornwall, Royal Albert, Royal Welsh, Royal Cinque Ports; all the others (including Royal Squadron and Royal Thames) were silent on the point, simply requiring the vessel on port tack to keep out of the way of the other. The Royal Victoria rule was the most explicit, and ran as follows: “Yachts on the port tack must give way to those on the starboard tack; and wherever a doubt exists of the possibility of weathering the one on the starboard tack, the one on the port tack shall give way; if the other keep her course and collision occurs, the yacht on port tack shall pay all damages and forfeit all claim to the prize. The yacht on the starboard tack shall never bear away; but if she is obliged to luff or tack to avoid the other yacht, the yacht on the port tack (so obliging her to luff or tack) shall lose all claim to the prize.”

We believe this rule was framed by the late Mr. G. Holland Ackers, who had a very strong opinion on the point, and published it as a kind of axiom in his Signal Book, &c. The effect of the rule would be, if stringently enforced, that no protest would stand if the vessel on starboard tack kept away instead of luffed. Would this check the dangerous practice of bearing away? We think not. We believe that the greatest safeguard will be in sailing committees and the council of the Y.R.A. firmly administering the very letter of the rule, as it now exists, in all cases where a risk of collision has been proved through the vessel on the port tack not giving way. It is much too late to talk about disqualification and penalties after a collision has occurred.

A vessel on port tack approaching another on the opposite tack should never be “nipped” in the hope of weathering. It will not aid her if the other “nips” also, and a collision may be the result. A trusty hand should be placed in the lee quarter to watch the other vessel. Pilots, as a rule, cannot be trusted for this task; they are unused to vessels of such speed, and the vessels, so to speak, slip from under their feet, and so their judgment is entirely at fault. If the look-out in the lee quarter has the least doubt about weathering, and if you know

he can be trusted, put the helm down at once so as to tack well clear of the other vessel, and not have to hustle round under her lee bow and get a tremendous smothering. If it is decided to bear away, begin in good time so that the vessel on the starboard tack may know what you are going to do. It should be always remembered that the whole onus of keeping clear rests with the vessel on the port tack.

As a rule, a sailing master when caught on the port tack will prefer bearing away to tacking, as less ground is lost, and the risk of getting a smothering is avoided.

In bearing away a hand should be always sent to the main sheet (whether it be the vessel on port or starboard tack), to slack out some if necessary, to enable the vessel to get off the wind more rapidly. (*See also "Approaching a Shore Close-hauled."*)

A yacht on the port tack can therefore be disqualified under the following conditions :

1. If she is struck by a yacht which is on the starboard tack, no matter how that striking was brought about.
2. If she herself strikes a yacht which is on the starboard tack.
3. If she causes a yacht which is on the starboard tack to luff or tack to avoid a collision.
4. If she causes a yacht on the starboard tack to bear away to avoid a collision.

HOVE TO ON PORT TACK.

Ordinarily, if a yacht is hove to on port tack and another yacht is approaching her, close-hauled on starboard tack, the one on port tack should in good time fill and get way on and tack or bear away so as to clear the other yacht. But if the yacht on port tack is disabled she could hardly be expected to do this, and the yacht on the starboard tack should keep clear; so also if the yacht on the starboard tack is free and the yacht on the port tack is hove to (whether disabled or not), the former should keep clear.

OVER-REACHING.

In beating to windward for a mark great care must be taken not to over-reach; that is, not to stand on so long as to be able to more than fetch a mark when the yacht is put about. In most cases a cutter yacht will fetch a mark (if not more than half a mile distant) on the next tack if the mark is brought to bear abeam—*i.e.*, at right angles to the keel, or eight compass-points from the direction of the vessel's head. This

is supposing that there is no tide. If the tide be going to windward, so much need not be allowed; if the tide be going to leeward, more than eight points must be allowed. The helmsman, by watching his vessel and objects on shore or around on previous tacks, will be able to judge how much should be allowed for tide; and he should always remember that it is better to err by allowing too much than too little, providing of course that the vessel does not over-reach so much as to lose her position in the match.

Frequently when working across a lee-going tide it looks, when the yacht is put on her last board for the mark, that too much has been allowed for tide; this may or may not be the case, but great judgment should be exercised in ramping along, as not to fetch after over-reaching would be an error fatal to the reputation of a sailing master.

When working by long boards and a vessel tacks for her mark, say a mile off, and can just lie for it, she should be sailed along a good full, and not be nipped or squeezed; if in the end she does not fetch, it cannot be helped, but it is certain that she will not have lost so much ground by having to tack again as she would have by sailing out a long board with her sails lifting.

WEATHER BOWING.—BEARING AWAY.

A favourite pastime of a sailing master is to "weather bow" another vessel in working board and board to windward, or otherwise in cross tacking, that is in tacking to place his own vessel in such a position on the bow of the other that she immediately intercepts the wind of that other vessel, and causes her head sails to lift. If the vessels are pretty evenly matched, the leading one will be able to put the other under her lee quarter every time they tack. The one to leeward may ramp off, but she will never get clear unless she is a very much faster vessel. The object of the leeward yacht will be to get into cross tacking, and this her adversary will try to prevent, and tack as frequently as she does. This diversion may possibly be a bad thing for them, so far as the result of the match goes, as their frequent tacking cannot be otherwise than a gain to the yachts which are working by longer boards.

If the leeward yacht finds that the one to windward will not permit her to get into cross tacking, she will probably, as aforesaid, ramp off and endeavour to get through the lee of the weather yacht. For the leeward yacht to do this successfully, that is, to be able to reach far enough ahead to tack across and weather the other one, she must be the faster vessel, or otherwise she will still find the other on her weather bow every

time they tack. As the lee yacht is ramped off, the weather one is commonly sailed hard too, or what is known as a "good full." But the helmsman must be very careful with his weather helm, as the windward yacht is supposed to keep her luff, and is not allowed to bear away so as to prevent the other yacht passing to leeward; thus, the windward yacht should be kept no more than a "good full and bye" whilst another yacht is under her lee.

In speaking of "bearing away" it must not be assumed that the yachts get very much off the wind; if they did—say three or four points—the effect would be that the leeward yacht would come out clear ahead of the other. This is not the kind of "bearing away" which is practised. Strictly speaking the "bearing away" is simply sailing "ramping full," with a heavy hand on the weather tiller lines. It would be difficult to disqualify a yacht for this under the "bearing away" rule; but, nevertheless, if one yacht is sailing hard, when close hauled, to endeavour to get through the lee of the windward yacht, it would be most unfair for the other to ramp off after her.

A common practice to escape the vigilance of the "weather-bowing" craft is to make a feint at tacking, or, as it is sometimes called, to make a "false tack." The master sings out "ready about!" loud enough to be heard perhaps on board the windward yacht, and the crew go to their stations as if about to tack. The master eases the helm down, but is careful that the yacht does not pass the head to wind point; he keeps her shooting, and one hand hauls the fore sheet up, and perhaps takes in the slack of the weather jib sheet. The master of the windward vessel thinks it is a real tack, and puts his vessel about; the other thereupon reverses his helm and backs his vessel's head off on the same tack again. This trick does not always succeed, but it does sometimes. In practising this subterfuge great care must be taken by the leeward yacht that she is not so close to the windward yacht as to bring about a collision by putting her helm down. If a collision ensued the leeward yacht would be held to blame.

In standing across another yacht with the intention of tacking, to give her a weather bower, great judgment must be exercised or the yacht may escape the intended blanketing. If the yacht *crosses* close ahead she must *tack* close ahead (a little to windward), and even then she may just miss getting on the weather bow of the other. The latter will know this, and instantly commence to ramp along and clear her wind; perhaps the next time she stays, if to starboard tack, she may be able to put the one, which offered her the weather bower, about.

If in standing across another yacht some distance to windward, the

master desires to weather bow, he must be careful not to stand too far, as if he does he will find himself on the weather beam of the other instead of weather bow. If the yacht crosses say ten lengths ahead, she should be tacked after she has passed clear four lengths; or, say when the other is seven lengths off her lee quarter. She will then be, allowing for the time or distance lost in tacking, exactly in her rival's wind.

A yacht that is head-reaching to windward of another yacht is frequently sailed hard so as to pass close on the weather of the other, as the "shake up" is effective in proportion to the closeness of the yachts to each other. This process of "killing" an antagonist was formerly very much practised; very few sailing masters now, however, ramp off after a vessel they are already beating by head-reaching. This would not be "bearing away to hinder a yacht passing to leeward" as forbidden by the Y.R.A. rule; but is the kind of bearing away, or jockeying, which was sensibly forbidden by the old rule, which said, "a yacht may not bear away out of her course so as to cause another yacht to bear away to avoid a collision."

A great deal of time would be wasted by a sailing master attempting, by "weather bowing," to stop every vessel that came in his way, big or small; this would be very foolish. The first aim should be to get all the speed and advantage possible out of a vessel; secondly, if you come across a vessel that appears to have as good or better a chance of winning than yourself, endeavour to stop her by legitimate means, but do not needlessly waste time with a vessel that has little or no chance of winning; thirdly, if you are beating a vessel that, next to yourself, has the best chance of winning, by keeping with her, do not leave her; fourthly, if, when sticking to a vessel you are being beaten by her, part company and try your fortune on a different cast.

APPROACHING A MARK ON OPPOSITE TACKS FOR ROUNDING.

It frequently happens that two yachts are approaching a mark on opposite tacks, and the one on the port tack may be able to weather the mark, whilst the one on the starboard tack cannot do so until she goes on the other tack. In Fig. 35, D will be the mark, A a vessel on the starboard tack, and B the one on port tack. It would be the duty of B to give way, even though it were at the finish of a race, and that she was in a position to cross the line E; she would be clearly ahead of A, but might not be able to quite weather her, and so would have to give way. We recollect a case similar to the above happening

at Cowes between the Kriemhilda and Arrow, in 1874, in a match of the Royal Albert Yacht Club; the Arrow was on port tack and gave way, but the late Mr. Chamberlayne said he never gave way more reluctantly in his life; yet, as it was clearly his duty to do so, he ordered the helm of the Arrow to be put down, and the Kriemhilda got round the mark first.

The foregoing case is very clear, and there can be no doubt as to what the vessel on the port tack should do; but the case would be more difficult to deal with if the yachts were in the position with regard to a mark shown in Fig. 36 and 37. Also if the vessel on port tack is nearest the mark which has to be rounded, as at B (Fig. 36), she must give way to a vessel on starboard tack in the position

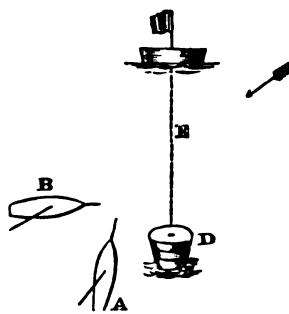

FIG. 35.

of A when both are close hauled approaching a mark, as D, to proceed in the direction of (say) E. It is evident that B must get out of the way by bearing up and passing under the stern of A, unless B is so far ahead as to be able to stay round the mark clear of A. In such a case the following conditions must be considered: A is the yacht on the starboard tack; B the yacht on the port tack; D a buoy which the yachts have to round and proceed in the direction of the arrow E. B goes into stays under the lee bow, but a little ahead of A, so

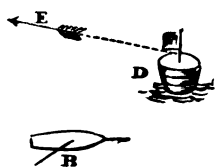

FIG. 36.

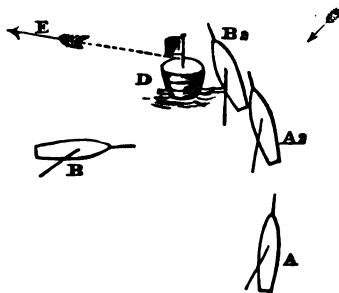

FIG. 37.

that when they arrive at the buoy they are in the position of A 2 and B 2, and a collision ensues. B will claim the foul, and argue that A should have given her room at the buoy; A will claim the foul, and say that B should not have gone into stays in a position where A could strike her. B in this case would be in the right, *provided always that the foul would not have occurred if A had not altered her helm by putting it up.* But B would not be justified in tacking in such a position

if she thereby caused A to put her *helm down or luff* to avoid a collision; nor would she be justified in so tacking if a collision ensued, and A did not alter her course one way or the other. On the other hand, A would not be justified in putting her helm up, and so cause a collision or a fouling of the mark.

APPROACHING MARKS ON THE SAME TACK FOR ROUNDING.

The foregoing were exceptional cases to show what has to be done when yachts are approaching marks close hauled on opposite tacks; but more frequently yachts approach marks on the same tack. By the Y.R.A. rule, yachts must give each other room at marks, but a yacht is not justified in attempting to establish an overlap at the last moment, when it may be impossible for the outside yacht to give room. A yacht in rounding a mark, whether she is hauling round or wearing round, always deadens her way more or less, and if a yacht is close astern so as to be only just clear, it is quite easy for her to make an overlap; but this is just what she is not allowed to do. The overtaking yacht must have, beyond all dispute, established an overlap before the other has altered her helm to round; this means before the other has altered her course and is actually rounding the mark. It frequently happens in light winds that a yacht gets jammed by the tide at a mark, and can only just hold her own abreast of it. A yacht that comes up astern can pass between such other yacht and the mark if there be room; but, if there be not room, she must pass outside.

In running for a mark to haul round, it is generally prudent (if not hauling against a foul tide) to keep well to leeward of the mark, and haul up gradually to it, so that by the time the mark is reached all the sheets are flattened in; in fact, the vessel should be almost "brought to" by the mere hauling aft the sheets, and with as little helm as possible. If the yacht has to be "brought to" against the tide, only a short sweep should be made in rounding; but the sheets must be got aft smartly, so that when the vessel is actually rounding the mark they are properly trimmed. This is particularly necessary if the yacht has to be brought by the wind, as, otherwise, when the helm is put down she will not come to quickly, and a yacht that may be astern could, by a better hauling of her sheets, come up and cut her out.

If the mark has to be gybed round and the wind is light, the yacht should be run dead for the mark, and should gybe close at the mark, always allowing for tide. The boom can be handled easily, and the

shorter the circle the vessel can be turned in, the better. But if there is a strong wind, and an attempt is made to make a short turn by wearing close round the mark, it will probably end in disappointment or disaster. Instead of attempting a short turn, the vessel should haul up to windward of her course a little, and gybe over when one hundred yards or so from the mark; there will then be time to trim the sheets properly, and the vessel will not overshoot the mark nor lose any ground. When a vessel is judiciously rounding a mark like this, she may find one ahead that has attempted to make a short turn of it by gybing at the mark, more or less "all standing." This vessel, before she can be met with her helm, will probably fly to; so look out and go under her stern, if there is room to do so without striking her, and then through her lee. If an attempt is made to keep on her weather, a luffing match will be the result; or perhaps a disastrous collision, as your vessel that gybed first will have great way on, whilst the other, gybing and then flying to, would have almost stopped dead. If a collision under such circumstances did occur, the overtaking yacht would be held to blame, as, although it might have been a lubberly thing to have allowed the leading vessel to fly across the one that was coming up astern, still the latter being the overtaking yacht would have to keep clear. Therefore keep a sharp look-out, and, as before said, if there be room, go under the other vessel's stern, and you certainly will be able to get through her lee. If there be not room to so go under her stern, be ready to give lee helm if necessary to clear her to windward, and you probably will succeed in passing her.

If, when sailing pretty nearly close-hauled, the mark has to be rounded by wearing or gybing, so as to return on a parallel course, the rounding will be an awkward one. If there is much wind it will be prudent to keep well to windward of the mark. Begin to bear up when a hundred yards or so away from it, easing the main sheet a little, but not touching the head sheets; then as the yacht is nearly close to the mark hard up; as the vessel wears round to nearly before the wind, steady the helm and let the boom go over as easily as possible. Be careful not to ease too much main sheet; steady the helm directly it is seen that the vessel has had enough to bring the boom over. The object will be to turn the vessel slowly at first, making a long sweep; then quickly, and then slowly again at the last. In bearing up round a mark in this way care must be taken that neither the boom nor any of the lee rigging touches the mark boat; and if the markboat is flying a large flag, be careful not to touch it, as although merely touching such a flag would not be held to be a foul, still there would be the risk of the flag getting hung up in some of the yacht's gear, and the boat itself might be dragged alongside.

In gybing always be smart with the topmast shifting backstays and the runners; get them hauled taut before the boom actually goes over, and let go the weather backstay and runner as the boom comes amidships.

As a hauling mark is approached always get the sails well set for coming in on the wind. Anything that requires setting up should be attended to before the mark is reached. If a jib requires shifting do not forget that it can be done more easily whilst before the wind than on the wind. Very frequently a vessel is run off the wind on purpose to get in the jib; but this can only be done at a great loss of distance.

Sails will require frequent "setting" during a match, and a sharp look round must be taken constantly, especially when coming to wind from sailing off the wind. In getting a pull on the topsail tack do not forget to ease the sheet first. In setting up the peak of a mainsail always take the weight of the boom with the topping lift. In setting up a jib always see that the runners are taut.

In light weather and with a foul tide, yachts frequently drive back past a mark after fairly rounding it. A case, recently argued, involved the following conditions: In the diagram, Fig. 38, A is a buoy which

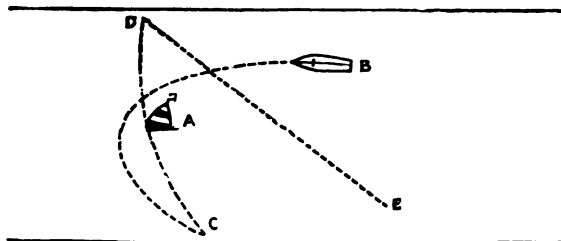

FIG. 38.

has to be rounded on the port hand. B is a yacht running before the wind for the buoy; she hauls round the buoy and stands close hauled to C, where she is fairly above the buoy. The yacht is put about at C, and stands across towards the buoy again, but fails to weather it; she fetches the point D, and stands towards E. It was contended that B not having weathered the buoy in standing from C to D, did not round it on the port hand. But it is quite clear that if the yacht when at C was clear ahead of the buoy A, the rounding would be a good one.

Let it be supposed that the yacht B was beating to the buoy and weathered it, and then ran up past the buoy to E or to a point abreast of C, it could not be contended that the buoy had not been rounded (it always being understood that a mark has not to be "circumnavigated"). If, when the yacht arrived at E or abreast of C, the wind fell light and

the tide carried her back past the buoy, and she ultimately repassed the buoy on the side D, that would not affect the first rounding, which would be held to be a good one.

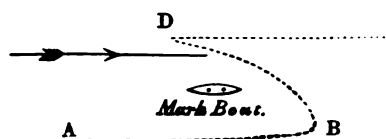

FIG. 39.

This case can be differently illustrated; at the finish of a race a mark boat had to be left on the starboard hand in the direction of the arrow (Fig. 39). The yacht instead passed up, leaving the mark on her port side in the direction of the dotted line from A to B; then round the mark until fairly below it at D, where she turned and repassed the mark, leaving it on her own starboard side, thus fulfilling the conditions.

In cases like these, the only point to decide is whether the yacht has been in a position to make the rounding a good one. In the first case (Fig. 38) when at C, it would be required to be proved beyond all doubt that the hull and spars were fairly clear of the buoy in a line at right angles to the last course (the course in the direction of B to A), and unless the yacht were clear of the mark by such a test, the rounding would not be a good one. A similar test would decide the other case (Fig. 39) by the position at D.

CAUSING A MARKBOAT TO MOVE HER POSITION.

By the Y.R.A. rules if a mark boat shifts her position the race shall be re-sailed again if a committee chooses to so order it; and if a yacht causes a markboat to shift her position, by veering out chain for instance, a yacht can be disqualified. In light weather, when yachts have been driving with the tide, chain has frequently been veered out by the man in the markboat to enable a yacht to clear without fouling; but if a yacht is drifting helplessly on to a mark she must let go her anchor. It has been objected that the man in the markboat might get frightened and veer out chain when the yacht did not require it to be veered out to enable her to avoid fouling; but a man is hardly likely to get frightened when a yacht is slowly driving in a calm, and if there was any breeze at all he would have no time at the last moment to give chain to his vessel. Most times a yacht goes "straight for" the markboat, and clears it by an alteration of the helm at the last moment. If, under such circumstances, a man in a markboat got scared, and imagined that he could avoid an impending danger by veering out chain, it would show very great folly, as if the markboat was to be struck it could not be avoided by veering out chain at the last moment.

REQUIRING A YACHT TO TACK WHEN APPROACHING A SHORE OR OTHER OBSTRUCTION CLOSE-HAULED.

When two vessels are standing on the same tack for the shore, a shoal, or other obstruction, and the leeward yacht cannot tack without coming in contact with the windward one, she may hail the windward yacht to go about, but she must herself at the same time tack; but if the obstruction is a *mark* in the course, such as a buoy or vessel, &c., which has to be rounded, the leeward yacht cannot so hail the windward one to go about and give her room to tack. If the leeward yacht requires to tack to weather the mark she should ease her helm, and wait till the other one has drawn clear. [This is the Y.R.A. rule.]

When one of two yachts has to tack, the common practice is for the windward one to wait until the other has actually put her helm down before she does so herself; if this is not done she will probably find that the yacht which was to leeward of her has shot up on her weather quarter—some distance astern perhaps, but still on her weather quarter—instead of under her lee beam or lee quarter. This will be annoying, but naturally it is the thing that the vessel which was to leeward will endeavour to effect; and if previous to tacking her position was under the lee bow of the other, she is almost certain to effect her object whatever the other might do.

The rule clearly says that the windward vessel shall tack directly she is hailed to do so (providing of course that the vessel to leeward is in actual danger of running aground if she holds on any longer), and that the leeward vessel must at the same time tack; but what the sailing master of the leeward vessel generally does is to gently ease the helm down, and sail his vessel to the last moment, so as to bring her round well on the weather quarter of the other. This is not always achieved, for the reason, as before said, that the windward vessel waits until the other is fairly tacking, or else, in staying, sails round in the same way that the leeward vessel does.

If the yachts are abeam and very close together—say not more than a length apart—the windward yacht should put her helm down directly she is hailed. If she waits until the other is putting her helm down, and then eases her own helm, the bowsprit of the leeward yacht may strike the counter of the other, as the bow of the one will be swinging round against the stern of the other. Therefore, in such a case the windward yacht should be very prompt in putting her helm down, and if the other fails to put hers down at the same time she can be protested against.

The leeward vessel is the judge of her own peril, but this does not justify her in needlessly putting another vessel about, and in all cases actual peril must exist.

If, when a vessel has just tacked for water, she meets another vessel standing in on starboard tack, she should promptly hail that vessel to go about; but if she herself has gathered way on the port tack, the one on starboard tack can force her round again; and it is no excuse for non-compliance if the vessel on the port tack says, "We have just tacked for water." If she has room to tack again without getting aground, she must do so, and then immediately afterwards can, if necessary, hail the vessel on her weather to tack, to enable her to avoid striking the ground. As a rule, it is a dangerous experiment for a vessel that has just stayed to attempt to clear another by putting her helm up, as she may have little or no way on; the safer plan is to put her helm down.

BEFORE THE WIND UNDER SPINNAKER.

The crew ought to be able to rig and to have all the spinnaker gear ready in five minutes; thus in ordinary weather about that time should be allowed for getting the boom out and spinnaker halyards and outhaul bent, and shifting backstay aft, before bearing up round a mark. If it is to be a dead run, take care that the boom is on the right side, so that the vessel can be run for the next mark without gybing; allow for the tide, if any, scan the wind, and determine which side the spinnaker boom shall be on. If after bearing up it is found that a mistake has been made, and that the vessel will not run for the mark in consequence of the main boom being on the wrong quarter, do not try to make her and run by the lee. When running by the lee the mainsail will be doing but little or no good, and, further, the main boom may come over suddenly and pull down the topmast by striking the preventer, or break itself on the runner. Haul up to windward a little, and fill the mainsail; but if it involves hauling up more than a point, and the "run" be a long one, gybe over at once and run straight for the mark.*

If the boom has to go square off, ease up the topsail sheet a little if the topsail tack is to windward of the gaff, and ease the topsail lacing and tack too, if it strains badly across the peak-halyard blocks. If the peak of the mainsail falls aboard, ease the peak purchase a trifle, but not until

* If the run be 12 miles, and the vessel haul up a point and run, say, on port tack for half the distance, and then gybe over and run on the other tack, she will increase her distance to 12½ miles.

after the topsail sheet has been eased, as the sudden strain thrown on the after leech and sheet of the topsail might cause something to burst. Take in the slack of the weather topping-lift before easing up the peak purchase, or the boom may come down on the rail. The weather topping lift should always carry the weight of the boom in running or reaching with the boom broad off. In a sea the boom should be topped up three or four feet.

Be careful, if there be much weight in the wind, not to ease the boom off so far as to allow the gaff to press heavily on the lee rigging, as the jaws of the gaff might thereby be broken.

In strong winds the small spinnaker only should be boomed out, and if the boom rears on end, the tendency can be checked by giving plenty of sheet; also by pressing the boom down. Frequently when the topmast is housed the second spinnaker is boomed out with a Spanish reef in the head; *i.e.*, the head of the sail made into a bight, and the halyards bent to it; or sometimes the head of the sail is tied up in a knot.

In heavy weather it will not be prudent to run with the boom square off, nor to run dead before the wind; keep a little to windward of the course, and then gybe over and run for the mark on the other tack.

With the weight of the boom and spinnaker boom shifted forward the vessel will go down by the head, and if she does not like the trim the crew should be placed abaft the tiller lines or on the quarter deck.

If the run be a dead one, the helmsman will have two objects in view: 1. To run straight for the mark. 2. To be careful that the mainsail is not gybed through getting by the lee; an average course will have to be made by running off when the wind will permit, and drawing to again.

OVERTAKING YACHTS.—LUFFING, AND BEARING AWAY.

If, when before the wind, a yacht is ahead, and you cannot pass her, run dead in her wake or a little to windward of her wake so as to cover her; you may do her a little harm in this way and prevent her getting away farther. If you are overtaking a vessel and desire to pass her, give her a wide berth either to windward or to leeward; to leeward for choice, as if the vessels are dead before the wind your antagonist cannot bear away after you to do any harm; if you try to pass to windward, a senseless luffing match will most likely be the result.

If a vessel is coming up fast astern and threatening your weather quarter, and you make up your mind that she shall not pass to windward, do not wait until her bowsprit is over your quarter before you luff, but take a wipe out across her when she is fifty yards off or so. She will then know what you mean to do, will probably be unable to get on your weather at all, and more probably will not try it. If she bears up to attempt to go through your lee, do not follow her off; if you do, it will probably end, after frequent backing and filling, in her ultimately getting her bowsprit over your weather quarter, and a long luffing match will ensue, followed up perhaps by a protest for bearing away.

The Council of the Y.R.A. have decided that if a yacht allows another yacht to come up on her weather and to be actually in the act of passing ahead, the yacht to leeward may not deliberately luff for the mere purpose of causing a foul. The Y.R.A. rule says, "a yacht may luff as she pleases to prevent another *passing to windward*;" but if the overtaken yacht allowed the other to come up close abeam (say) before she luffed, it is obvious that the weathermost yacht may be unable to luff also to keep clear; in such a case a foul would be the deliberate act of the leeward yacht, and the foul could not be claimed, as it would be absurd to argue that the leeward yacht luffed as allowed by the rule to prevent the other passing to windward. No luffing under such circumstances would then prevent the yacht "passing to windward."

When one of two yachts which are close together succeeds in going through the lee of the other yacht, the latter, if possible, should run dead in the wake of her antagonist that has just passed her. If the wind is very light, she may succeed in holding her. But the yacht that has just passed through the lee of the other should luff out to a clear berth, and she may thus be able to rid herself of the intended covering. If there be an obstruction to sea room she will be unable to luff out clear perhaps, and may very likely try to get clear by running off to leeward; but here she will find that the sternmost yacht can follow her, and generally running off the wind in such a case is of no avail. It must be understood that the prohibition contained in the Y.R.A. rule on "luffing or bearing away" is not involved here, as it is presumed that one yacht has passed clean through the lee of the other, and if she drops back again that other yacht which was passed becomes in the position of an *overtaking yacht*. An *overtaking yacht* is not precluded from bearing away provided she does not cause the yacht overtaken to bear away also to avoid collision; but an *overtaken yacht* is forbidden to bear away to hinder another passing to leeward; that is, a yacht that is *overtaken* by another yacht must concede an unmolested passage to leeward.

An *overtaking* yacht, if to leeward, is not allowed to luff so as to cause the yacht to windward to luff to avoid a collision until she (that is the *overtaking* yacht) has drawn clear ahead.

It must be clearly understood that the foregoing relates to "yacht racing" alone. Yachts ordinarily are subject to the customary rule of the road, which enacts "that if two yachts are running free with the wind on the same side, the yacht which is to windward shall keep out of the way of the yacht which is to leeward;" and "every vessel overtaking any other vessel shall keep out of the way of the last-mentioned vessel;" and "when one of two ships are to keep out of the way the other shall keep her course." It is thus quite clear that by the ordinary rules of the sea a yacht that is being overtaken must neither luff nor bear away to prevent an overtaking vessel of whatever description passing her.

By the rule of the road before referred to, a steam yacht must keep out of the way of all sailing vessels; but there is one position in which the sailing vessel would have to keep clear of the steam yacht. It frequently happens that a sailing yacht is overtaking a steam yacht, and in all cases the overtaking vessel, whether she be under steam or sail, or both, must keep out of the way of the one she is overtaking. The popular opinion was, that in all possible directions of approach, the steam yacht must keep out of the way of the sailing yacht; but by the new regulations which came into force September, 1880, there is, as shown, one direction of approach under which it is the duty of the sailing yacht to keep clear of the steam yacht. A vessel, it must be understood, is only considered as an overtaking one when she is steering in the direction of the one ahead or in the wake of the one ahead, and only in such case would the sailing vessel have to keep clear of the steamer she might be overtaking.

SAILING ALONG A WEATHER SHORE OR LEE SHORE— OVERTAKING.

In sailing along a weather shore always remember that, although a yacht may "luff as she pleases to prevent another yacht passing to windward," she may not shove the other yacht ashore or on to any obstruction; on the other hand, a yacht overtaking another yacht should not attempt to make an overlap just upon reaching an obstruction. This means that *the leading yacht can keep her luff up to the very moment that an obstruction is reached, even supposing that an overlap will occur simultaneously with reaching an obstruction. If the overtaking yacht goes ashore or in*

*any way receives or inflicts damages under such circumstances, she is solely responsible.**

In all cases remember that the windward yacht can only demand room in case she would, by holding to her course, actually strike an obstruction or take the ground.

It frequently happens, when sailing along a shore, bank, &c., to shun a tide or otherwise, that an overtaken yacht allows one astern to come up on her weather, being fearful of getting into a luffing match when so near the ground; in such a case the overtaken yacht often warns the other that she is coming to windward at her own risk, and that no further room will be given her. Presently an arm or outward bend in the bank, or a shallow, warns the overtaken yacht to bear away a little, but she is careful to do so only just far enough to clear the ground herself, and leaves no room for the overtaking yacht on the ground that a warning was given the latter that she came to windward at her own risk. The warning, however, would be of no avail if the windward yacht got ashore or if a foul ensued, providing always that the overtaking yacht had established an overlap with her bowsprit or some part of her hull before reaching the obstruction.

In sailing along a lee shore, the weather yacht in all cases is bound to give the one to leeward room.

In sailing along a weather shore, if the yacht drags the ground, promptly ease off the boom and put the helm up, and send all hands forward. The boom is run off to give the vessel greater list, so as to lighten her draught, and also to prevent her coming to, and so forge further aground. The object of sending the men forward is, that by tripping the vessel by the head, the draught is lessened. If the vessel drags whilst running along a lee shore, haul the boom in and put the helm down.

CLOSE-HAULED AND SAILING FREE.

According to Rule 19 of the Y.R.A., a yacht that is sailing with the wind free must keep out of the way of one which is close-hauled, and there appears to be only one exception to this rule, which will be alluded to under the "Meeting end on" section. In match sailing yachts are likely to get into positions where one going free might foul one that is close-hauled under the following conditions:

1. In beating for a mark when a yacht that is close-hauled might meet one that has already rounded.

* See "Approaching a Shore or other Obstruction" (page 232), as to the rights of the leeward yacht. See also the Y.R.A. rule, "Obstructions to Sea Boom."

2. In running for a mark when the yacht that is before the wind might meet one that has rounded, and is now close-hauled.

In either case it is the duty of the yacht which has the wind free to give way to the yacht that is close-hauled. In most cases it will be safer for the yacht which is free to go under the stern of the other, as by crossing ahead she might compel the yacht that was close-hauled to bear up or luff, and if she did so, the yacht that had the wind free would be disqualified. (See the last paragraph of "Meeting end on" section.)

MEETING END ON ON OPPOSITE TACKS.

In sailing with a beam wind, or if one yacht has the wind abaft the beam and another yacht has the wind on the bow, and they be going in opposite directions, they may meet each other end on so as to involve a risk of collision.

Formerly in such a case it was the duty of each yacht to put her helm to port: that is, the yacht on the port tack *bore away*, whilst the yacht on the starboard tack *luffed*.

The new rule which came into operation September, 1880, has been incorporated in the Y.R.A. rules, and enjoins that when yachts are sailing with the wind free on opposite tacks, the yacht with the wind on the port side must keep out of the way of the other.

The new rule is an improvement on the old "meeting end on" rule, as frequently two ships not actually meeting end on would port and risk a collision, when, by each holding on her course, they would have gone clear. Also frequently when meeting end on, one might be close-hauled and the other free; in such a case it was still the duty of both to port, but often the close-hauled ship contended that the one which was free ought alone to give way. By the new rule, in all cases of yachts meeting end on, or nearly end on, the yacht on port tack must keep out of the way of the yacht on starboard tack. Of course it is understood that the yacht on the starboard tack must keep her course, and not endeavour to prevent the yacht on port tack passing to windward.

In Fig. 40, let A be a yacht close-hauled, and B one with the wind on the quarter; it is quite plain if B attempted to pass to leeward that she might go ashore; B would therefore haul out and pass on the weather side of A, and A would get a temporary blanketing; also, if there were no shore, B could elect to pass on the weather side of A. Her duty is to keep clear, and A would not be justified in frustrating her movements.

But the close-hauled vessel might be on the port tack (*see C, Fig. 40*). In such a case it would be the duty of D (although having the wind on the starboard side) to keep clear.

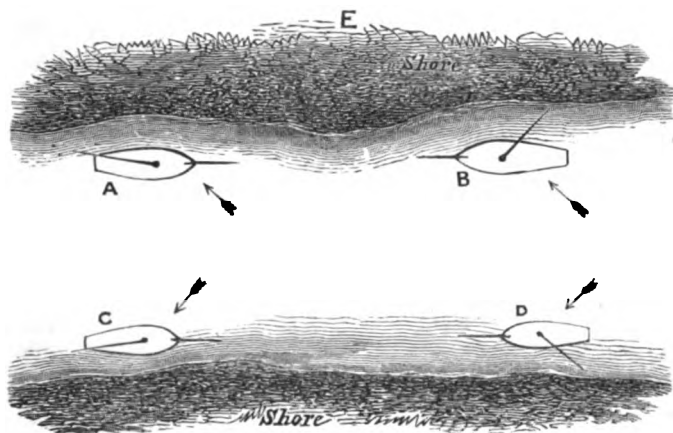

FIG. 40.

If sailing along a shore D would not risk getting aground, but would haul out and pass on the weather side of C.

SAILING FREE.

But it may so happen that the two yachts may be free and be crossing on opposite tacks. Thus, say the wind is W., and one yacht is steering N.N.W., and the other S.S.W., each a point and a half free, they will be approaching each other at an angle of 134° . In such case it will be the duty of the yacht with the wind on the port side to keep clear of the other, as this would be a clear case of crossing on opposite tacks, and not of "meeting end on." This, however, is a situation not likely to occur in match sailing.

In sailing free, if two yachts have the wind on the same side, the one which is to windward must keep out of the way of the other. (This has been already explained under the head of "Luffing and Bearing Away.")

SIDE LIGHTS.

In one of the Y.R.A. rules it is enjoined that all yachts sailing in a match at night shall observe the Board of Trade rules as to the carrying of lights. This rule interpreted strictly would mean that the side lights are to be put in their places at sundown. Sailing masters exhibit an

extraordinary aversion to exhibiting side lights in a match, for the reason, as they say, that it is not politic for any vessel to let another know what she is doing. This is a reason that will not hold water, and owners should insist upon lights being carried in their proper places. Of course if a match is within a half hour or so of being concluded at sundown, the rule would not be enforced, but where a case of "sailing at night" is involved, it would be inexcusable not to carry lights. It is sometimes supposed that it is sufficient to have the lights on deck ready to show, but obviously if all the yachts in a match did this the lights would be useless, as if the yachts could see each other so as to know when to show their lights, there would be no occasion for exhibiting them at all.

This is one of the rules which owners should see observed as a matter of honour, and no occasion for protest should ever occur under it.

YACHTS IN DIFFERENT MATCHES.

It is now a common practice for two or three or even more matches to be started on the same day to sail over the same course, and the Y.R.A. found it necessary to enjoin that the sailing rules apply to all yachts, whether sailing in the same or in different matches. Frequently a big vessel has unjustifiably bullied a small one round when beating to windward, but under the Y.R.A. rules a small vessel which is on starboard tack can force a large one that might be on port tack to give way. It seems scarcely credible that such a rule should be required, and it is even less credible that it should be occasionally observed with doubtful willingness.

SCULLING.

The practice of sculling small boats by moving the rudder backwards and forwards (*see* "Sculling" in the Appendix) is common in calms, and considerable progress can be made by this means. The question has been raised on several occasions as to the permissibility of such sculling during a match, and two or three protests have arisen out of the practice. It is very useful to scull even large yachts occasionally when they will not come round in light winds, and no one could contend that this was not a legitimate use to make of the rudder; it would be simply "steering," but as no means of propulsion but sails are permissible it certainly is a moot point as to whether sculling, if used as a means of propulsion, should be allowed; and it is satisfactory to note that the Council of the Yacht Racing Association has decided that sculling with the rudder is only permissible for actual steering.

ANCHORING.

Yachts may anchor during a race, but must weigh again, and not slip. Several instances have occurred where a yacht, when kedging in a tideway on foul ground, has been unable to get the kedge on board again. In such a case the crew would heave on the warp until it burst; but if the yacht had let go her bower and chain this could not be done, and the yacht would be compelled to slip and buoy the chain. No adjudication has been made by the Council that exactly bears upon these cases, but the common sense view would appear to indicate that if a yacht burst her warp in endeavouring to recover her kedge, she should not be disqualified on the grounds of slipping. Neither should a yacht be disqualified if after making every endeavour to weigh her bower, she failed and slipped.

Cases have occurred in calms where kedging has been resorted to as a means of propulsion. The kedge has been dropped over at the bow, and the crew walked aft with the warp, hauled the kedge up over the stern, and let it go again over the bow; or the kedge has been let go over the stern, and recovered at the bow. To get round a mark against a tide such kedging might be successfully practised, but under the rule "that no mode of propulsion except sails shall be allowed," it is clearly forbidden.

SOUNDING.

In the Y.R.A. rules it is enjoined that no instrument other than the lead and line shall be used for sounding. This rule was adopted many years ago by the Thames clubs to stop the practice of shoving a boat along by a pole, yard, or sweep under the pretence of sounding with the same.

LEAVING A YACHT DURING A MATCH.

Under most old club rules no one was allowed to join or leave a yacht after the preparatory gun had been fired. This rule was called into existence on the Thames in consequence of the practice of having a number of hands on board a yacht prior to the start to assist in hoisting the canvas, and these men were turned out into a boat directly the canvas was hoisted. But even supposing that such a practice should be prevented, there would appear to be no reason why a mere passenger should not join or leave a yacht during a match, and under Y.R.A. rules it is

simply enjoined that no *paid* hand shall join or leave a yacht during a match. This of course gives permission to a passenger or owner to leave, but no paid hand could go from the yacht in a boat to put the passenger on shore ; but in the case of accident or injury to some person on board, he could be put on shore or on board some other yacht by the crew.

In the case of a man leaving a yacht by falling overboard, it is assumed to be an accidental circumstance ; and if the man has been recovered again by the yacht's own boat or a life buoy, or picked up by another yacht, neither the yacht that lost the man nor the one that picked him up would be disqualified if one or the other afterwards became entitled to a prize by coming in first or by time allowance. But if a yacht or yachts had been in such a position that she or they would in all probability have won the match, had it not been for rendering assistance to recover a man, the committee can order, if they so please, the race to be re-sailed between the yachts which were prevented winning as stated and the yacht that actually did win. Nothing is said about the yacht that lost the man overboard being allowed to take part in the match if ordered to be re-sailed, whatever position such yacht may have been in at the time of the accident ; and the inference is that a yacht which is deprived of her chance of winning a race by losing a man overboard must abide by the consequence of her own accident and not be given another chance.

AMENABLE TO RULES.

In a match a yacht is held to be amenable to rules directly the five minutes gun has been fired or the Blue Peter hoisted ; and she ceases to be amenable to the rules directly she has completed the course by passing the winning flagboat or mark. A yacht, however, should, after finishing a contest, be most careful to keep clear of all other yachts that have not completed the course, even to the extent of giving way to one sailing free on port tack if she herself is close-hauled on starboard tack.

CHAPTER VIII.

CENTRE-BOARD BOATS.

ALTHOUGH it may be difficult to say what is a boat and what is a yacht, when we are speaking of small craft, yet we think a great deal of this difficulty will be removed if we define a boat to mean a vessel that is not wholly decked, and that can be rowed. In selecting one of these craft that is either open or partly open, the main guide, of course, will be the locality. Thus, if the boat is for Brighton, one of the shallow centre-board beach boats used thereat will be the most suitable, inasmuch as they can be readily "beached" or hauled out of water, it being necessary that they should be so hauled up, as there is no sheltered or safe anchorage at Brighton. For the Thames above bridge, where the winds are light and baffling, a very light centre-board gig is the most useful, as it sails well in light winds, and is easily rowed in calms. On the Mersey, where the boats can lie afloat, and where generally there is more wind and sea than any ordinary boat could well tackle, a heavier and deep keel sailing boat is in use. At the same time, a keel boat quite as light as the Surbiton boats has been introduced on the Mersey; but, in order that they may safely encounter the rough water, are nearly wholly decked in. On the south coast all sorts of sailing boats are to be met with, from the old-fashioned skiff and wherry to very many versions of the Itchen boat.

The centre-board, it appears, was invented, or rather adapted, from the lee-board by Captain Schank, of the British Navy, somewhere about 1774. We have not come across any contemporary record of the invention, but in Charnock's "History of Marine Architecture," published in 1802, the fact is alluded to, together with a description of a boat with a sliding keel built by Captain Schank at Boston, Massachusetts, in 1774, for Earl Percy (afterwards Duke of Northumberland). The engraving Fig. 41, on the next page, represents this boat, and, so far as we know, is the oldest authentic record of the sliding keel. At about the same time Captain Schank was

very strongly urging the English Government to cease building deep ships, and to build shallow ones, fitted with one or more sliding keels. The Admiralty were not, however, to be persuaded into such a startling revolution in naval architecture; still they so far humoured Captain Schank,

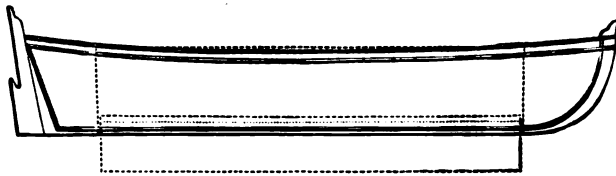

FIG. 41.

that in 1789 a boat was built and fitted at Deptford Dockyard, according to the plan shown in the accompanying engraving (Fig. 42). The use of the three boards was as follows: In tacking, or laying to, the centre-board and after board were raised; in wearing the centre-board and fore-board were raised; also in scudding the centre-board and fore-board were raised; going over shallows the three boards were raised. On a wind the three boards were lowered, each to such depth as seemed best to balance the sails. The report of the trials made with this boat seem to have very favourably impressed the Admiralty, and Captain Schank was intrusted to

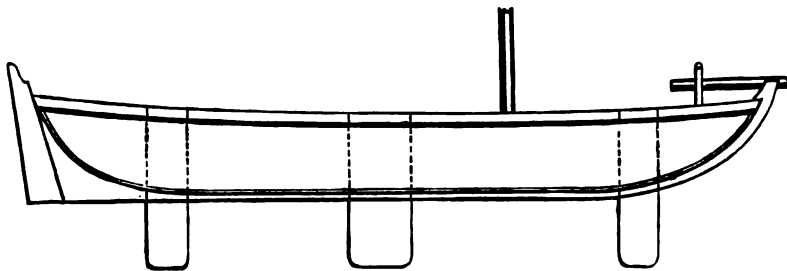

FIG. 42.

design a cutter of 60ft. length and 20ft. beam, with three sliding keels. She had a midship section something like a barge, and a draught of water of 6ft. 6in., and was named the "Trial." She was reported to be a good sea boat, and very handy; but another vessel with centre-boards called the *Lady Nelson* was less favourably reported upon, and the Admiralty, we believe, built no more centre-board ships, and, so far as we were concerned, the invention was lost sight of until the visit of the *America* in 1851 drew attention to them. Not that the *America* had a centre-board, but other American yachts had, and Englishmen about this time became very curious about Transatlantic naval architecture.

The centre-board was still a contrivance something like Earl Percy's, but, instead of being dropped equally fore and aft, was pivoted at the fore end, as shown in the accompanying sketch (Fig. 43) according to a plan introduced by Captain Shuldham, of the British Navy.

The small centre-board American sloop *Truant* was brought over here in 1853, and, although only 20ft. on the water line and 1ft. 2in. draught, beat all the crack 7-tonners in the Prince of Wales' Yacht Club a quarter of an hour in a thrash from Blackwall to Northfleet in a nice breeze, and was very roundly abused for her success. All sorts of stories were current about her shifting ballast, and her crew having their pockets filled with

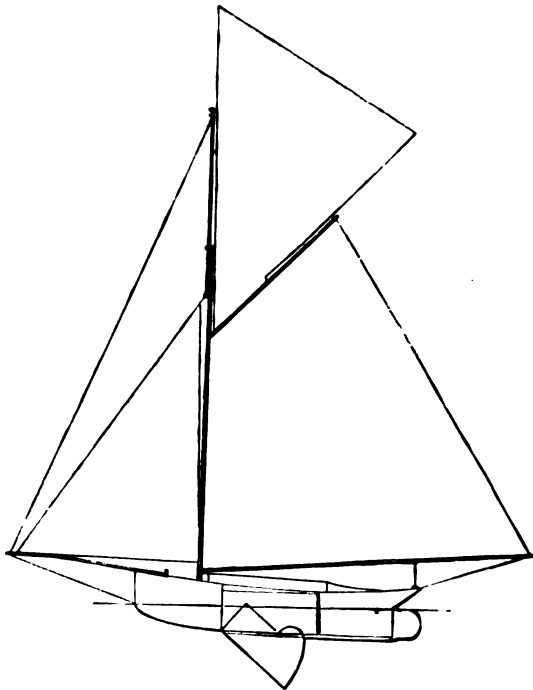

FIG. 43.

lead shot! After this success *Truant* went to the Mersey and Lake Windermere, but what ultimately became of her we do not know. Her rig was as shown in the drawing over leaf (Fig. 44), and is the same as the fashionable sloop of the present day, excepting that the foresail or jib is laced to a foot yard, and tacked at about one-fifth its length from the outer end of the yard on a bumpkin.

The *Una* was the next importation from America, and, although generally resembling the *Truant* in hull, differed in sail plan, as the mast was stepped farther forward, and she had no headsail whatever.

The double centre-board was much advocated in America in 1871, but we believe that no large yacht was built on the plan. However, in 1876 the idea occurred to Mr. W. Jeans, of Christchurch, to have a small craft

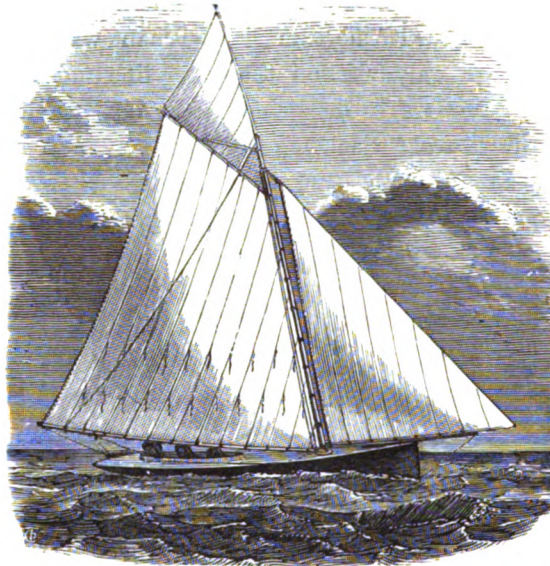

FIG. 44.

provided with two boards, and he published the following description of the boat and drawing (see Figs. 45 and 46):

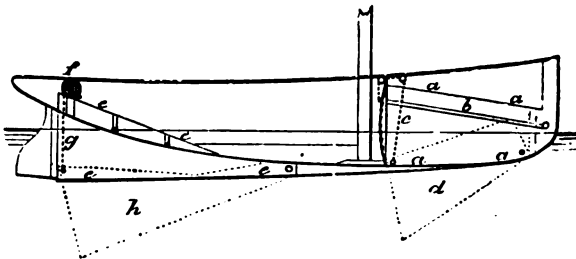

FIG. 45.

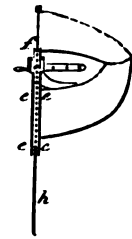

FIG. 46.

The letters *a a a a*, show the fore trunk ; *b*, lever ; *c*, chain ; *d*, keel ; *e*, aft trunk ; *f*, wheel ; *s*, chain ; *h*, aft keel.

Mr. Jeans thus referred to his boat :—

“I found her answer remarkably well, both for speed, hardiness, and weatherly qualities. The keels, which are of iron, are situated fore and aft. The fore keel, having its trunk in the cuddy, takes up no room in the boat, and is lifted by a lever and chain band, which runs over a couple of sheaves on the deck beam to get a straight pull. Holes are bored about

an inch and a half apart in the support of the after end of the trunk to take a pin, which regulates the depth of keel. The trunk of the aft keel is the dead wood in the run of the boat. The keel is lifted into its trunk by a small wheel and winch, the wheel being large enough to take up the chain in one turn without overlapping, a dog catching it at any required depth.

“The advantages are these. The keels take up no room in the body of the boat; they can be regulated to carry any kind of helm. By lifting up the fore keel in wearing the boat is much sooner round. If there is a doubt of her not coming about in a seaway, wind up the aft keel, when she will immediately shoot into the wind, dropping it again as soon as she fills on the other tack. In beating to windward in a seaway she will fetch where she points, unlike the ordinary centre-boarder, which, having no grip forward, is knocked to leeward with every sea. She is 12ft. long on the keel, and 6ft. beam, and though of such extraordinary proportions, is remarkably fast, which, I am convinced, partly arises from the proper depths which can be given to the keels, whereby the rudder (except for altering her course) is never out of the line of the keel, consequently never helping to stop her way.”

Perhaps the two boards may be found useful under exceptional circumstances, but the single centre-board, as generally in use, is much to be preferred. A boat fitted with a single board will be more sensitive to slight alterations of her helm, and generally will be more agreeable to sail on a wind. The strongest reason for having two boards would be in the case of a shallow vessel that had to keep the sea, and might have to scud in very disturbed water and generally to encounter heavy weather. However, a yacht of the deep type, with strong fixed keel, would be better adapted for such work.

As a rule the centre of area of the board should be in the same vertical line as the centre of effort of the sails, unless the centre of lateral resistance shows a very great departure from the centre of effort.

Numerous contrivances have been suggested to admit of the inside housing of the board being dispensed with altogether, and a very practical plan was proposed a short time ago. It consisted of a single plate of iron pivoted at the far end, and made to rest, when hauled up, on one side of the keel. An extension of this plan formed by adding to the plates and forming them into a kind of fan will be found illustrated by Fig. 47. It will be seen that the leaves of the fan are pivoted to the side of the keel at x . The keel is cut away, and a plate, a , bolted over the chamber, so as to form a kind of box or case to take all the leaves when the fan is shut. See the small sketch. The leaves k, k, k , are connected at

their after ends by studs and slots. The fan is closed by a bar, working in a pipe *p*, as shown. The bar is attached to the lower leaf by a stud, which works in a fore and aft slot, *s*. The lifting bar should be jointed, so that when the fan is closed, the handle part, *h*, will fold down by the side of the

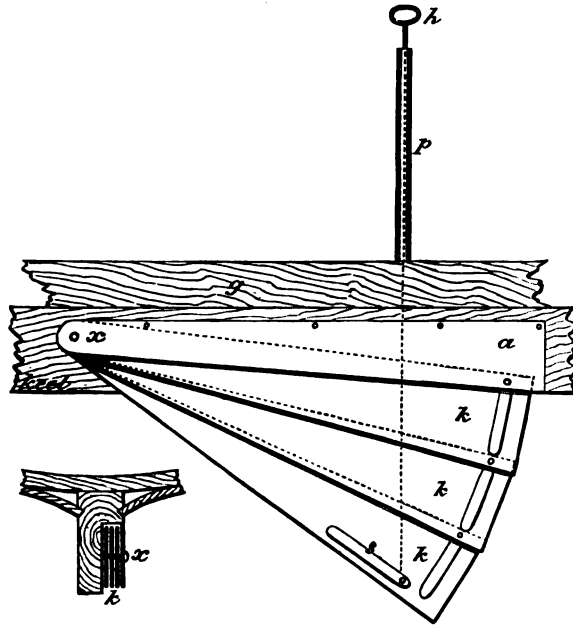

FIG. 47.

pipe. The slots should be cut wide enough to ensure the studs working easily in them. The heads of the studs should be thin, and the edges nicely bevelled off. The number of leaves could be of course increased, but

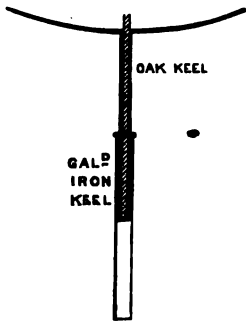

FIG. 48.

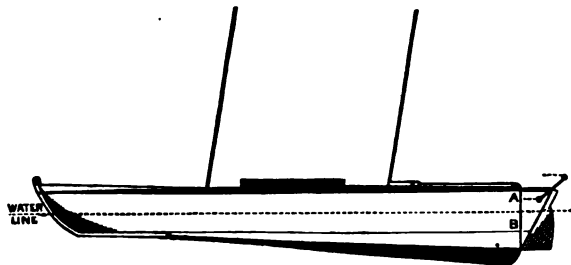

FIG. 49.

two would in most cases be probably found sufficient and less liable to get locked or jammed.

In 1870 a boat was built by Messenger, and called Wideawake, with

a kind of shoe keel. The boat or rather canoe was 15ft. 10in. long, and 3ft. 2in. beam, depth, gunwale to keel, 1ft. 4in. She had an oak keel increasing in depth from 2in. forward, to 6in. aft. To this keel was fitted a hollow galvanised keel—a kind of case, in fact, to take the oak keel—12ft. long, made of $\frac{1}{2}$ in. iron (*see* Fig. 48). The keel was pivoted forward 4ft. from the stem plumb to load line. Care was taken to make the iron case fit the oak keel. The case was raised by a wire fastened to the stern end of the case, and passing through a tube as shown by A B, Fig. 49.

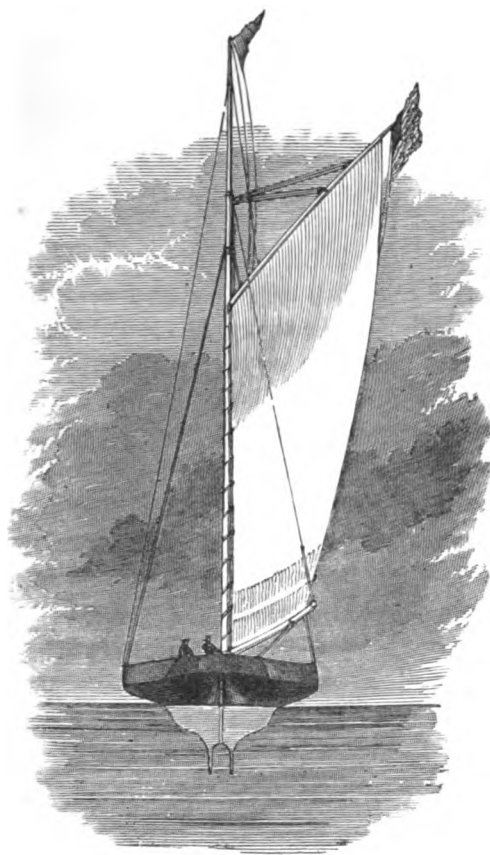

FIG. 50.

The wire passed over a pulley on deck and was secured at mainmast. The keel weighed 28lb.

A better plan than the shoe keel was fitted a few years ago in a small boat, Robin Hood, by Searle, for Mr. W. B. Forwood. She had an oak keel 5in. deep, in the under side of which a slot 9ft. long and 3in. deep was cut; into this slot a galvanised iron plate $\frac{1}{2}$ in. thick, 9ft. long, and 3in.

deep was fitted. It was raised and lowered by a rod at each end, working in upright lead pipes.

Among the many curious contrivances to prevent leeway, one exhibited at the Exhibition of 1851 is as strange as any. The designer's idea appears to have been, that to obtain the greatest advantage in the way of stability, a yacht should be very broad and big above water, and very narrow and small under it (*see* Fig. 50 on the preceding page); and that to get a large amount of lateral resistance, two keels should be had instead of one shaped longitudinally as shown by Fig. 51.

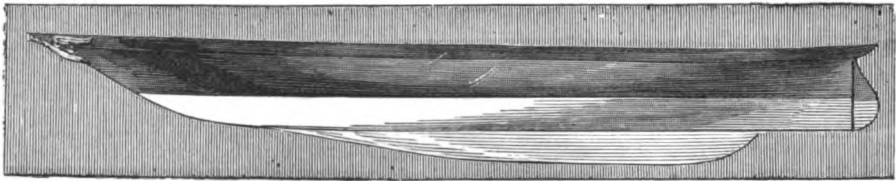

FIG. 51.

So far as the question of stability is concerned, we need scarcely say more than that it would be much increased if the greatest beam were put on the water line; but as the idea of parallel keels is continually cropping up, it may be well to point out that they cannot be of any advantage. In the first place, there is an extra surface for friction provided by the doubling of the keels, and as surface friction enters so largely into the aggregate resistance of a vessel double keels should be condemned for this reason alone. Secondly, the actual increase in the lateral resistance would be only a very small percentage of the added surface, as the water would practically be locked up between the two keels, and so really out of the four sides of the keels, only one side (the leeward one of the leeward keel) would meet with lateral resistance.

In 1877 Lieut. Tipping, R.N., and Mr. A. J. Lane proposed plans for double centre-boards which were almost identical. The boards were pivoted at the stem and near the stern post; and connected by a bolt working in a slot amidships. The slot was in the fore-board and the bolt in the after-board. The boards were dropped down amidships, being held by the pivots at bow and stern. The boards when lowered made a sort of expanded V, viewed broadside on. The objection to these plans would be that the after-board would be of very little use.

Among many other contrivances, the time-honoured lee-board may be mentioned, and the "horizontal keel," descriptions of both of which will be found at the end of the book.

CENTRE-BOARD BOAT FOR ROWING AND SAILING.

The boat most generally in request on the Thames is the one for "rowing and sailing," or centre-board gig. This boat, for the man who likes the exercise of rowing and the pleasure of dodging a wind between the banks of a river, is admirably contrived. But he who has one need be content to limit his cruises to the water upon which she was intended to sail, until he has become a perfect master of the art of boat sailing. He should not be tempted into "cruises" down the river to Sea Reach, to Sheerness, Leigh, or Shoeburyness, as he may be "caught" in a nor'-wester; and then, if he has only been used to open-boat sailing in smooth water, and to very little of that, it may go hard with him. He will find it impossible, even supposing he can reef down and so far handle his craft as to tack her, to get to windward against a lee tide and yeasty sea; and the probability is that, even if the tide be a weather-going one, the sea will be so bad that she will be blown farther to leeward every tack than the tide will carry her to windward. Under these conditions there will be no alternative but to "up helm" and run for it; and, as it may be no more practicable to get into Sheerness than up Sea Reach, the situation of the "outward bound" boat sailer would be decidedly unenviable. Why not put her head to the sea and row her? she is a boat for rowing and sailing. Well, a man cannot row a boat head to sea and wind with much success, and the need of doing so would be a rather severe argument against the sailing qualities of the boat. Then rig and throw overboard a floating anchor, ride to that, and wait till the turn of the tide. Very capital advice, and an old hand might do it, but not a frightened novice. The broad truth is, that a light centre-board gig, easy to row, and not an indifferent performer under canvas in smooth water, is not fit for open water where there might be a real sea—as different to the "magnificent furrows" of up-river as a chalk-pit is to a fox-hole; and even in the hands of a skilled boat sailer, such as a coast waterman, they would be out of place in Sea Reach under canvas.

The annexed diagram (Plate II.) shows a design for a centre-board gig which has been largely built from. The boats proved to be fast sailers, and very light to row. The drawing is made to half-inch scale; but, as it is rather small to work from, the following tables can be referred to in laying off.*

* Full instructions for laying off are given in "Yacht Designing" and "Yacht Architecture," but a brief outline of what has to be done can be given here. In the first place, the stem, keel, deadwood, and sternpost should be laid off full size; if a floor cannot be obtained long enough to

The references to the body plan (Fig. 52) are as under: w is the load water-line (L.W.L.); $a a 1$ and $a a 2$; $b b 1$ and $b b 2$; $c c 1$ and $c c 2$ are "diagonals;" o is the middle vertical line, from which all distances are measured; $p p$ are perpendiculars denoting the extreme breadth; $m m$ is a kind of base line 10in. below the load water-line, and parallel thereto; x is a water-line.

The numerals 1, 2, 3, 4, &c., denote the respective sections or timbers and their stations in the sheer plan and half-breadth plan. No. 9 is the "transom," and of course will be a solid piece of wood, and not a "frame."

lay the keel off in one piece, it can be divided in two or three pieces; or a floor can be improvised by placing a sufficient number of deals or planks together, both for the keel and body plan. When the floor is prepared, strike in the load water-line with a chalk line or straight edge; then, at right angles on either side of this line, set off by aid of an L square all the sections 1, 2, 3, 4, &c. On each section mark off the distance from the load water-line to the top of the keel; and from the top of the keel to its under side. Place a batten (made of inch fir or American elm) over these marks or "spots," as they are called, and chalk in the shape of the keel. The batten can be kept in its place by a nail on either side of each spot. (Of course if the keel has no curve it can be laid off by a simple straight edge or chalk line.) The rounding up of the fore-foot can be obtained by putting in a couple of lines between No. 1 station and the fore-side of the stem, at right angles to the load water-line, and transferring the distances measured on these lines from the sheer plan to the floor. A mould out of a piece of half-inch fir can be made from the drawing on the floor, including stem, dead wood, and sternpost; but if the keel is to be cut out of a piece of American elm ten or twelve inches deep, then it can be laid off on the timber, striking the load water-line (or a line parallel to it) and sections as described. The remaining portion of the timber can be sawn into floors, &c. The body plan will be laid off by simply transferring the drawing from the paper to the floor. First, the load water-line w will be put in; then the middle vertical line o , and the perpendiculars $p p$; the base line m will follow; and then the diagonals a, b, c . The distances given for No. 1 section will be taken from the table and set off on the diagonals a, b, c , each distance to be marked by a "spot" or small cross on the diagonal; the *height* of the section from the load water-line to the gunwale, and the *depth* from the load water-line to the top of the keel, will be taken from the table or from the sheer plan; the *half breadth* of the section at the gunwale, and at the load water-line, will be taken from the table or from the half-breadth plan. All the "spots" having been put on the diagonals, and on the water-line, and at the point representing the gunwale height and half breadth, a batten will be placed over the "spots," and its shape chalked in. The batten should be about 6ft. long, $\frac{1}{2}$ in. deep, and from $\frac{1}{2}$ in. to $\frac{3}{4}$ in. thick. The batten will be kept to the "spots" by nails on either side of the batten, not through it. If the curve be unfair, the nails must be slightly shifted until the curve shows fair. If great accuracy is needed, the diagonals can be laid off in long lines to represent a half-breadth plan to further fair the design; this, however, will be scarcely necessary. Moulds will be made to represent each half section; but the midship mould and two others, Nos. 3 and 7, should be a whole one. The moulds can be made from rough $\frac{1}{2}$ in. deal. A piece 2in. wide will represent the middle line o , and the curved parts will be nailed together as required, and fitted with saw, plane, or spokeshave to the lines on the floor. The load water-line must be carefully marked on each mould, both on the perpendicular (o) and on the curve. Having got the building blocks in readiness, set up a line by the aid of a spirit level, at a convenient height above them, to represent the load water-line—a straight edge would do. Put the keel on the blocks, and wedge it up until into its proper position with the load water-line. Then, having got the stem and sternpost into position, fix the representative load water-line to them inside, from the aft side of stem to fore side of stern post. A chalk line should be struck up the centre of both stem and sternpost. The transom and the "full" moulds will then be adjusted and fixed at their proper stations by ribbands. Presuming the rabbets to have been cut, the planking can be proceeded with, and the floors and timbers fastened in as the planking proceeds. The ribbands will be removed as the planking requires.



PLATE II.

SHEER PLAN

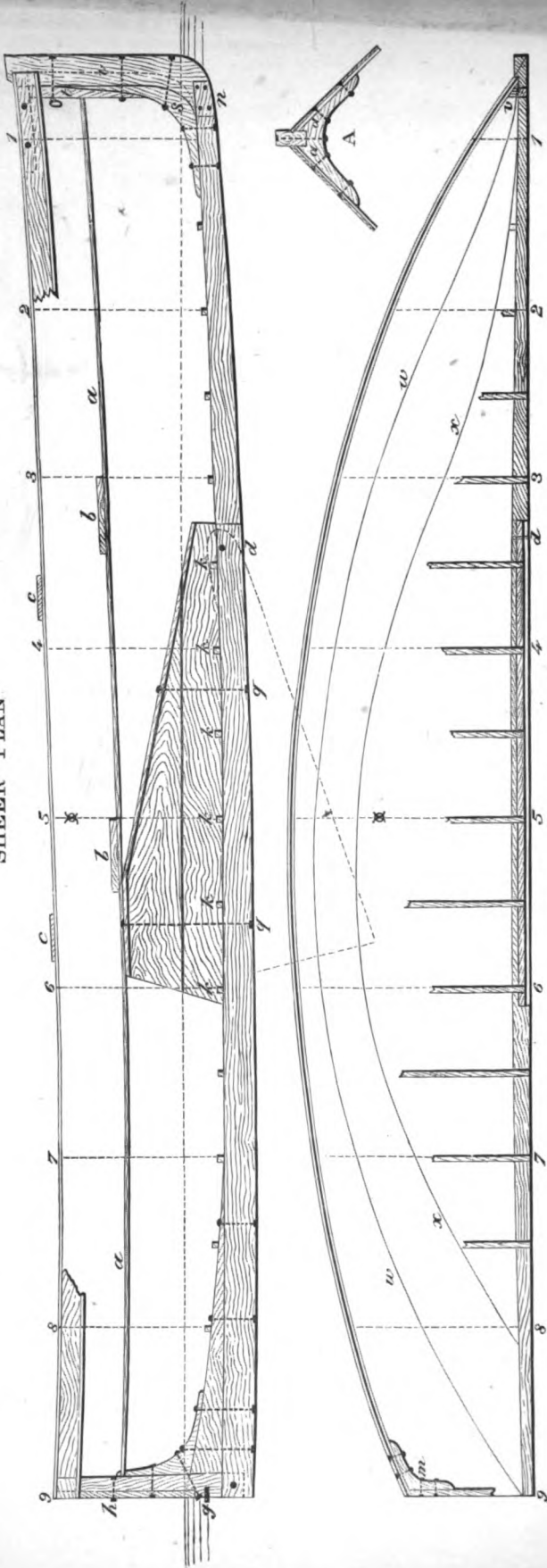

HALF BREADTH PLAN.

SCALE OF FEET.

17ft. Centre-board Boat for Rowing and Sailing.

LAYING OFF TABLE.

No. of Sections.	1	2	3	4	5	6	7	8	9
Sheer Plan and Half-breadth Plan.									
Heights above L.W.L. to top of gunwale	1 10½	1 9½	1 8½	1 7½	1 6½	1 5½	1 5½	1 6	1 6½
Depths below load water-line to top of keel	0 2	0 3½	0 4½	0 5	0 5½	0 5½	0 5½	0 5½*	0 5
Depth of keel	0 3	0 3½	0 3½	0 3½	0 4	0 4	0 4	0 4	0 4
Half breadths at gunwale	0 7	1 6½	2 2	2 7	2 9	2 8½	2 6	2 1	1 5½
Half breadths at L.W.L.	0 2½	0 11½	1 8½	2 3	2 5½	2 5½	2 0½	1 3½	0 1½
Body Plan.									
Diagonal a	0 3½	0 10½	1 2½	1 4½	1 6½	1 6½	1 4½	0 11½	0 3
" b	0 6½	1 6	2 1½	2 5½	2 7½	2 7½	2 4½	1 10½	1 0½
" c	0 9	1 11	2 7½	3 0½	3 2½	3 2½	2 11½	2 6	1 9

* Depth to top of dead wood, 3½in.

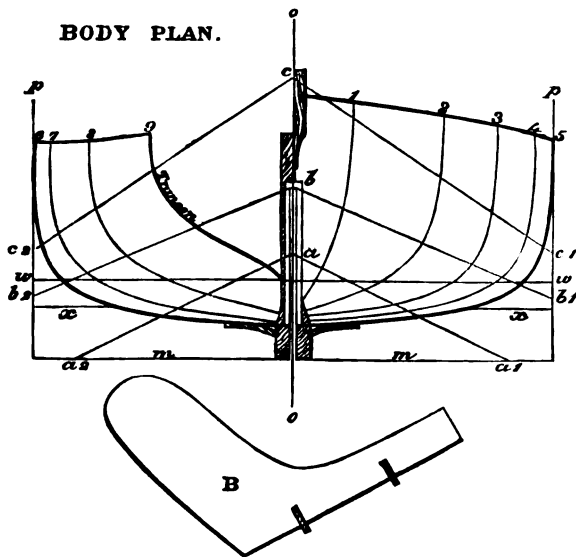

FIG. 52.

The distance *a* (Fig. 52), above the load water-line, *w*, is 3½in. measured on the vertical line *o*. The distances *a* 1 and *a* 2 from the vertical line *o*, measured along the horizontal line *m*, are 2ft. 3½in.

The distance *b*, above the load water-line (*w*), is 1ft.; *b* cuts the perpendicular *p* at *b* 1 and *b* 2, 2in. below the load water-line *w*.

The distance *c*, above the load water-line *w*, is 2ft. 2in.; and *c* cuts the perpendicular *p* at *c* 1 and *c* 2, 3½in. above the load water-line *w*.

x is a water-line struck 3in. below w , but will be of no assistance in laying off, as it does not intersect the frames sufficiently at right angles.

All the half-breadths, and the distances measured from the middle vertical line o along the diagonals to the various sections (as given in the tables), are *without* the plank; so in laying off *no allowances* will have to be made for the thickness of the plank.

The length of the boat is 17ft., and the breadth 5ft. 6in., and the extreme breadth, with the plank on, 5ft. 7½in. Weight of displacement of boat to L.W.L. about 12cwt.

The sections 1, 2, 3, 4, &c., are 2ft. apart, and No. 1 is 1ft. from the fore side of the stem at the L.W.L.

The frames actually will only be 1ft. apart; but every other one is left out in the Body Plan.

The scantling of the boat will be as follows: Keel, sided (thick) amidships 4½in., tapering gradually to 2½in. forward, and 3½in. aft. The moulded depth of the keel will be found in the table.

Stem, 2½in. sided; 4½in. moulded (*i.e.*, its fore and aft thickness) at head, and 5½in. at knee scarp.

Sternpost, 3in. sided and moulded at heel; 2in. moulded at head.

Floors, ¾in. sided and 2in. moulded (deep) at heels, gradually tapering to ¾in. at heads. The floors will be fitted across the keel by ¾in. joggles. Timbers at the sides and above floors, ¾in. square.

Plank, ½in. thick. Gunwales, 1in. thick, 1½in. deep.

Stringers (lettered a in the Sheer Plan) 1in. square, fastened through timber and plank. Seats and rowlocks as at $b b c c$.

The centre-board or plate will be 5ft. 4in. long, pinned or pivotted in the keel below the garboard strakes, as shown in the Sheer Plan and Half-breadth Plan (Plate II.) at d , 5ft. 9in. from fore side of the stem at L.W.L. The slot in the keel to admit the plate will be 5ft. 7in. long by ¾in. in width. The floors where this slot comes will have to be cut through. The heels of these floors will be fitted with ¾in. joggles, and let in to the under side of the centre-plate case, as shown at $k k k k k$ in the Sheer Plan. One 4in. copper nail through each heel (outside the centre-plate case) will be sufficient to fasten these floors to the keel. (The case must be very carefully fitted to the shape of the keel, and luted with white lead.) The centre-plate case will be fastened through the keel by long galvanised iron (¾in.) bolts. The case will be made of inch pine; the plate of ¾in. iron.*

* Mr. J. C. Wilcocks gives the following instructions for fitting a centre board case: "If you can get a piece of plank 18in. broad out of which to make the case, so much the better; if not, put the broadest piece you can obtain for the lower portion, and the narrowest at the upper side. Select a piece—if possible without knots—of good sound pine; some use teak or mahogany, but it is unnecessary, although, if you keep the boat brightly varnished,

Sometimes the case has been made of galvanised iron, and fitted into the slot. With such cases it will be best to fit a keelson over the heels of the floor, as at *k k*, &c., on either side of the case. These keelsons would

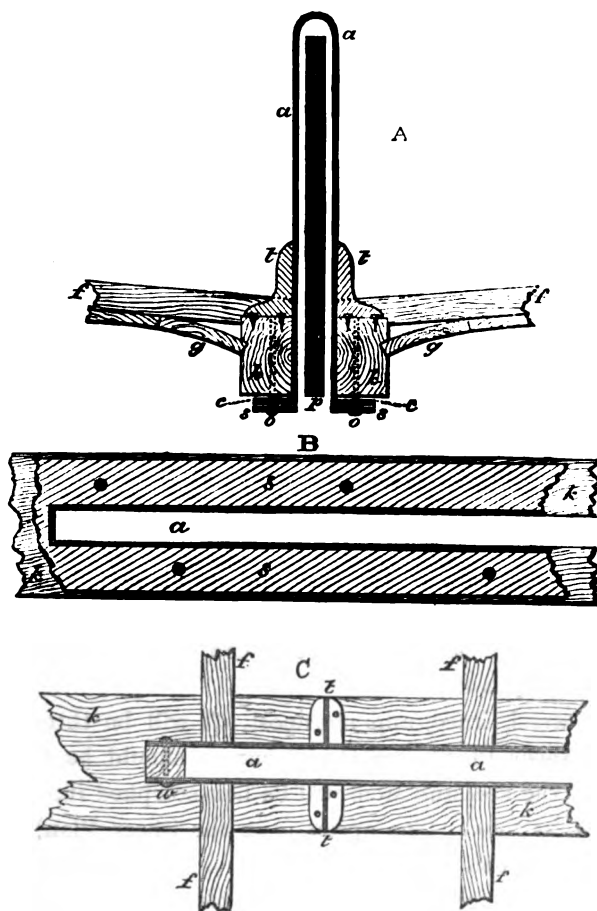

FIG. 53.

require to be about 3in. deep and 2in. broad, with one fastening between each pair of floors. However, as a rule, no such keelson is fitted, a couple

it is to be recommended. In making and fixing the case the most critical work is boring the planks through from edge to edge with a long gimlet like that used by bellhangers; this should be done in a horizontal position, a straight edge being laid on the plank occasionally, whereby to test the directness of the whole, and maintain the direct progress of the gimlet by bringing the straight edge over it, and observing whether the stem of the gimlet is parallel with the straight edge. I had four bolts of galvanised $\frac{1}{2}$ in. iron through each side, those near the extremities being 8in. from ends. These bolts had small heads on them, and passed through the keel, where they were securely riveted on rings. A groove was made in each side of the case at the ends to take a piece of inch fir, which must be carefully fitted and luted with white lead; the slip of fir should be fastened through each side of the case, and the nails rooved and clinched."

of screws or nails in each heel of the floors being considered sufficient. The case would be prevented dropping through the slot in the keel by two small iron knees on either side, riveted to the case and fastened to the keelson.

Mr. W. Baden-Powell has furnished me with the following plan adopted by him in fitting a galvanised iron centre-board case. *a* (see sketch A, Fig. 53) is the iron case, passing through a slot in the keel and turned up underneath as at *c*. Over the lips, *c*, of the case, turned under the keel, an iron keel-band is fitted, as at *s* in Fig. A; and *s* in Fig. B shows the under side of this keel-band. Bolts are put through this keel-band, lips of the case, and keel, and fastened with washer and nut upon top of the keel as at *o o*. (The keel-band lips are shown a little apart for the sake of distinctness; of course, in construction all would be drawn close together.) Two small T angle-iron knees are fitted each side of the case (*a*), riveted through the case and screwed down to the keel *k*, as at *t t*. Without these knees the case is likely to get wrenched on one side or the other unless well secured to a thwart. To prevent leakage, a piece of tarred or varnished tape should be laid in the angle of the lips of the case before screwing it up with the keel-band. The latter can be made of inch or thicker iron, as it will serve as outside ballast.

Fig. C shows a view of the case and its fittings, looking down from the inside of the boat; *a* is the inside of the case; *k* the keel; *t* the iron knees; *f f* two floors. *w* is a piece of wood forming one end of the case, and through-bolted, as shown.

The dead wood, knee, and sternpost aft will be through-fastened, as shown in the Sheer Plan; and the sternpost should be tenoned into the keel. Forward the keel and stem will be box-scarphed into each other, and through-bolted, as at *n*. The apron (*s* in the Sheer Plan) will be bolted through keel and stem. The stemson *t* is a kind of filling-up piece, and serves as nightheads for additional plank fastenings forward. The upper through bolt in the stemson should have a ring through it, as shown.

The gunwale (or inwale, equivalent to the clamp or shelf in a yacht), rests on the timber heads, will be secured to the stem forward by "breasthook," as shown by *a*, diagram A (see Sheer Plan, Plate II.). This breasthook will have one fastening through the stem, and two through each gunwale and top strake, as shown. The gunwale and top strake will be fastened all through and secured to the transom by the knee, as shown at *m* in the Half-breadth Plan, through-fastened. A fastening will also be put through the gunwale and strake into the transom.

The floors should reach from the keel to three or four inches above the load water-line; and the timbers from the gunwale down the sides of the floors to within eight or nine inches of the keel.

The transom will be $1\frac{1}{2}$ in. thick, fitted at the back of the sternpost, as shown in the Sheer Plan.

The rudder will be shaped as shown by the diagram B (under the Body Plan, Fig. 52). Pintles will be dispensed with, and instead gudgeons and braces used, through which a brass rod will pass. This arrangement is necessary, as the rudder will hang considerably below the keel. If the braces are fitted over the gudgeons on the sternpost and a transom at *g h* (Sheer Plan), the rudder will lift on the rod if the boat drags on the ground, and will not unship.

The rabbet in the stem will be cut at about 2 in. from the inner edges of the stem piece as shown by the ticked line *v* in the Sheer Plan. The rabbet in the keel (being a continuation of the rabbet in the stem) should be cut not less than one inch from the upper edge; and the same from the upper edge of the dead wood aft, and be deep enough to take a good fastening.

The boat will take about 4 cwt. of ballast with three hands on board; this ballast should either be in the form of shot bags, or flat bricks of lead cast to rest on the top of the floors, but sunk between them. These bricks would be under the platform or bottom board, which should be securely fastened, but at the same time be readily movable. If there is no objection to a cast-iron platform, the "bottom boards" can be dispensed with, and a thin iron slab cast to fit over the floors on either side of the centre plate. For such a boat as the design given the slabs would be 6 ft. long by 1 ft. 6 in. broad, and $1\frac{1}{2}$ in. thick near the keel and $\frac{1}{2}$ in. nearest the bilge. They would be cast with grooves to fit the floors, and the grooves would gradually deepen from nothing at the bilge to $\frac{1}{2}$ in. depth at the keel side. In the stern the usual bottom board or "stern sheet" would be fitted; and forward either a board or a grating would be similarly fitted.

Of course, no plan of lead or iron ballasting will make such a shallow boat as the centre-board gig stiff, in the ordinary meaning of the word, and the large sails (plans of which will be given hereafter, with diagrams of other boats) should not be set unless two or three hands are on board to sit to windward.

The plate or board has been made rather smaller than is usual; but it has been found that a very large board, whilst it adds largely to frictional resistance, does not add proportionately to weatherliness. A very small piece of board will check the leeway tendency of a well-shaped and fast boat, and no doubt quite enough has been shown in the design.

A belief sometimes exists that a centre-board adds to the stability of a boat: so it does if made of iron or other metal, just the same as an iron or other metal keel would; but if the material be wood not heavier than

water, the tendency of the board would be to upset the boat, as the wood would strive to come to the surface, or, in other words, to float: thus, the larger a wood board were made, and the deeper it were lowered, the more urgent would be its tendency to assist in upsetting a boat. A board, however, causes the process of heeling to be a little more slowly performed, as the board has to be moved through water, and the resistance to the board being so moved is of the same nature as the resistance of the water to any plane moved in it. Thus, when a boat is once permanently heeled, or has settled down on "her bearings," as it is termed, the board will be of no more use for stability, as its tendency will be to float or come to the surface. If the boat is struck by a squall which only lasts, say, four or five seconds, the board may possibly prevent an upset that otherwise would take place; but if the squall continues, and is of a strength to upset the boat without the board, the boat will be assuredly upset with the board, only it may take two or three seconds longer to do so.

The question of decking is one which will naturally arise in selecting a boat. No doubt a locker of some sort, to stow cushions, gear, and sails in, is a desideratum in a boat; but a deck forward and aft, with waterways amidships, as shown in a sketch given farther on, must increase the weight, and for up-river sailing are quite unnecessary. However, if the boat-sailer is equal to the "stress and the strain of wind and the reeling main," and can confidently knock about in Sea Reach, he will find the decks and waterways a great comfort. They will keep out all the water likely to lop on board, and nothing worse than spray need ever get into the well amidships. A partly decked boat with waterways, built by Messenger, of similar dimensions to the one we have given a design for (Plate II.), but fuller forward and aft, made a trip to Margate and back and to Harwich; and, whilst she behaved just as she ought in a breeze with some sea, she was not too heavy to row if occasion arose. However, trips to Margate from the Thames, or from Southampton to Portland, are not quite the work for centre-board gigs, and boats much better adapted for the purpose can be built.

A centre-board boat, somewhat deeper, with more rise of floor, also with less length to beam, than the one of 17ft. length, may perhaps be a handier boat in narrow water, where frequent tacking is inevitable, and at the same time be not more laboursome to row. A diagram for such a boat is given on Plate III., with body plan represented by Fig. 54, and, in order that the drawing may be utilised for boats of varying sizes, tables have been compiled to different scales, so that a boat of 10ft., 12ft., 15ft., or 20ft., can be built therefrom.

The displacement (or weight of water which the boat displaces when

immersed to the load line, or, in other words, the weight of the boat, including everything she carries) of each boat, as given, is not mathematically correct, and need not be so considered; it is only given as a guide for the builder in ballasting, and it may be necessary or convenient to sail the boat lighter or deeper.* With regard to ballast, it will be found in practice that every passenger on board who sits to windward is of more value than an equal weight of ballast in the bottom of the boat would be. Of course there will be a limit to the number of passengers it is desirable to take in a boat of 12ft., and probably most men will conclude that one besides the helmsman is enough. When sailing in smooth water, shifting the ballast to windward can be largely indulged in if a practised hand besides the helmsman is on board to look after it; but in a sea the ballast should be well secured.

The sail dimensions given are for cruising, and are not so large as those of the gigs raced at Surbiton; the difference is about equal to

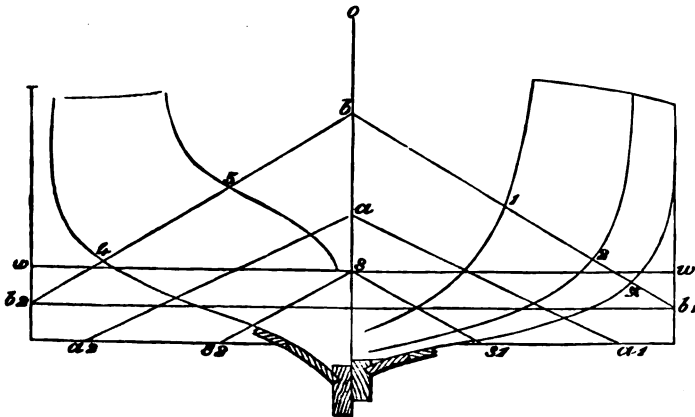

FIG. 54.

one-seventh the linear dimensions—that is to say, the sail of the 14ft. boat, or any of the other boats given, would be one-seventh longer in the foot, one-seventh longer in the head, one-seventh longer on the luff, and one-seventh longer on the leech for a racing outfit.

In all cases where measurements are given they must be adhered to, as the drawings are too small to work from, and “fairing” the moulds will be a matter of judgment.

* The displacement of these boats can thus be found approximately: multiply the length on the load line by the beam on the load line, and the depth amidships to the rabbet of the keel; next multiply the product by the co-efficient 0.35 (see “Yacht Designing,” page 76) and the product will be the displacement of the boat in cubic feet nearly. The co-efficient will of course vary according to the sharpness or fulness of the boat. The co-efficient for yachts varies from .25 to .4. The common co-efficient being .32. There are 35 cubic feet of salt water in 1 ton. (See “Displacement per inch of Immersion” in the Appendix.)

BOAT OF 10FR.

	No. 1	No. 2	No. 3	No. 4	No. 5
	Section.	Section.	Section.	Section.	Section.
	ft. in.	ft. in.	ft. in.	ft. in.	ft. in.
Height above L.W.L. to gunwale	1 2½	1 1	1 0	1 0	1 1
Depths below L.W.L. to top of keel	0 4	0 5½	0 6	0 6½	0 7
Half-breadths at gunwale.....	1 0	1 7½	1 10½	1 9	1 0
Half-breadths at L.W.L.	0 7½	1 4	1 8	1 4½	0 1
Half-breadths s diagonal	0 5	0 8½	1 9½	0 8	0 1
Half-breadths on a diagonal ...	0 8½	1 2½	1 4½	1 1½	0 4
Half-breadths on b diagonal	1 0½	1 7½	1 10½	1 8	0 10½

Distance No. 1 section is from fore side of stem	1ft. 7in.
„ No. 2 „ No. 1 section	1ft. 7in.
„ No. 3 „ No. 2 „	2ft. 2in.
„ No. 4 „ No. 3 „	2ft. 4in.
„ No. 5 (transom) No. 4 „	2ft. 4in.

Diagonal *a* is struck 4in. above L.W.L., and *a* 1 and *a* 2 are 1ft. 7in. from the middle vertical line *o*. Diagonal *b* is 11in. above L.W.L. The diagonal *s* at *s* 1 and *s* 2 is 9½in. from the vertical line *o*.

Length, 10ft.

Breadth, 3ft. 9in.

Pin of centre plate from fore side of stem, 3ft. 3in.

Length of plate on top edge, 3ft. 6in.

Length of plate on under edge, 3ft. 10in.

Greatest breadth of plate, 1ft. 2in.

Least breadth of plate, 4½in.

Thickness of plate, ½in.

Weight of plate, 40lb.

Weight of displacement of boat when immersed to L.W.L., 3½cwt.

Weight per inch of immersion at L.W.L., 10wt.

BALANCE LUG SAIL (see FIG. 55).

Mast, thwart to sheave hole	10ft. 0in.
Luff of sail	4ft. 0in.
Leech	13ft. 3in.
Foot	10ft. 0in.
Head.....	10ft. 3in.
Tack to peak earing	14ft. 6in.
Clew to weather earing	10ft. 0in.
Area of sail	80 square ft.

BOAT OF 12FR.

	No. 1	No. 2	No. 3	No. 4	No. 5.
	Section.	Section.	Section.	Section.	Section.
	ft. in.	ft. in.	ft. in.	ft. in.	ft. in.
Heights above L.W.L. to top of gunwale	1 5½	1 3½	1 2½	1 2½	1 3½
Depths below L.W.L. to top of keel	0 4½	0 6	0 7	0 7½	0 8
Half-breadths at gunwale.....	1 2½	2 0	2 3½	2 1½	1 3
Half-breadths at L.W.L.	0 8½	1 7	2 0	1 7½	0 1½
Half-breadths s diagonal	0 6	0 10	0 11½	0 9½	0 1½
Half-breadths on diagonal <i>a</i>	0 10	1 5½	1 8	1 4½	0 4½
Half-breadths on diagonal <i>b</i>	1 2½	1 11½	2 3½	2 0	1 0½

PLATE III.

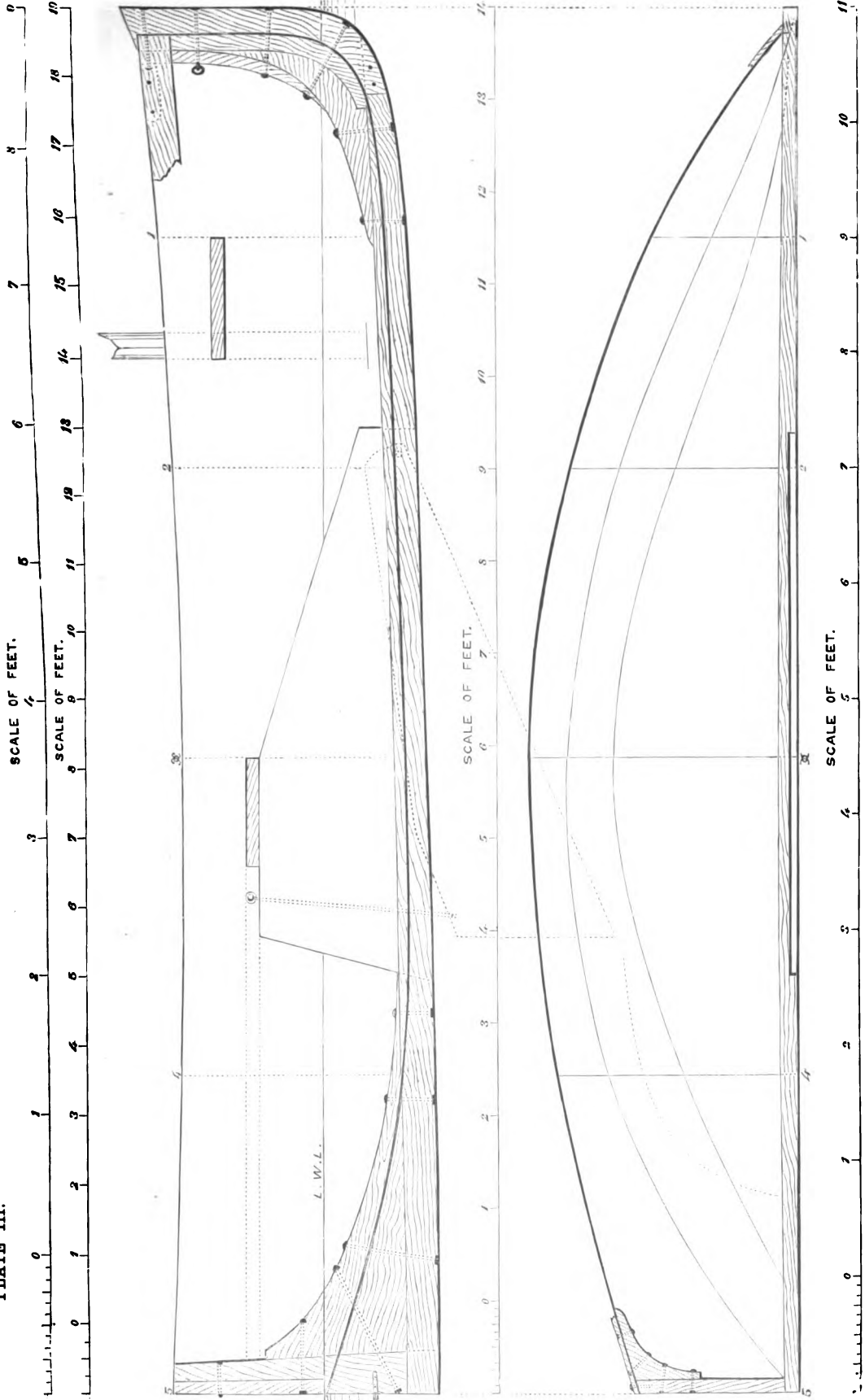

Centre-board for Bowing and Sailing of 10ft., 12ft., 14ft., 15ft., and 20ft.

- No. 1 section is 2ft. from the fore side of stem.
- No. 2 section is 2ft. from No. 1.
- No. 3 section is 2ft. 6in. from No. 2.
- No. 4 section is 2ft. 9in. from No. 3.
- No. 5 (transom) is 2ft. 9in. from No. 4.

Diagonal *s* at *s* 1 and *s* 2 is 11½in. from the middle line *o*.
 Height of diagonal *a* above load line, 4½in.; *a* 1 and *a* 2 are from the middle line *o*, 1ft. 11in.
 Height of diagonal *b* on middle line *o* of Body Plan above L.W.L., 1ft. 1½in., and at *b* 1 and *b* 2 is 3in. below L.W.L.

All the half breadths given are without the plank.
 Length from fore side of stem to aft side of transom, 12ft.
 Greatest breadth moulded (i.e., without plank), 4ft. 7in.
 Aft side of mast from fore side of stem, 3ft.

Weight of displacement of boat when immersed to load line, 60wt.; weight per inch of immersion, 1¼wt.

Pin of centre plate from perpendicular at fore side of stem, 3ft. 11in.

Length of plate on its under edge, 4ft. 8in.

Length on its upper edge, 4ft. 3in.

Greatest breadth of plate, 1ft. 4in.

Least breadth, 5½in.

Thickness, ½in.

Weight of plate, 50lb.

Siding (thickness) of keel amidships, 4in.; ditto at stem, 2in.; ditto at sternpost, 2½in.

Moulded depth of keel, 3½in.

BALANCE LUG SAIL (see FIG. 55).

Mast, thwart to sheave hole	10ft. 0in.
Luff of sail	5ft. 6in.
Leech	16ft. 0in.
Foot	12ft. 0in.
Head	12ft. 3in.
Tack to peak earing	17ft. 6in.
Clew to weather earing	12ft. 0in.
Area	105 square ft.
Halyards bent to yard, 5ft. from lower end.	
Tack, 1ft. 6in. from fore end of boom.	

BOAT OF 14FT.

	No. 1 Section.	No. 2 Section.	No. 3 Section.	No. 4 Section.	No. 5 Section.
	ft. in.	ft. in.	ft. in.	ft. in.	ft. in.
Heights above L.W.L. to top of gunwale	1 8½	1 6	1 5	1 5	1 6
Depths below L.W.L. to top of keel	0 5½	0 7	0 8	0 8½	0 9½
Half-breadths at gunwale	1 5½	2 4	2 8	2 6	1 5½
Half-breadths at L.W.L.	0 10½	1 10½	2 4½	1 10½	0 1½
Half-breadths <i>s</i> diagonal	0 6½	1 0	1 1½	0 11	0 1½
Half-breadths on diagonal <i>a</i>	1 0	1 8½	1 11½	1 7½	0 5½
Half-breadths on diagonal <i>b</i>	1 5½	2 3½	2 8½	2 4½	1 3

- No. 1 section is 2ft. 4in. from the fore side of stem.
- No. 2 section is 2ft. 4in. from No. 1 section.
- No. 3 section is 2ft. 10in. from No. 2 section.
- No. 4 section is 3ft. 3in. from No. 3 section.
- No. 5 (transom) is 3ft. 3in. from No. 4 section.

Diagonal *a* above L.W.L., 5½ in.; *a* 1 and *a* 2 from middle line *o* (see Body Plan, Fig. 44), 2ft. 3in.; diagonal *b* above load line, 1ft. 4in., and at *b* 1 and *b* 2 is 3½ in. below the L.W.L.; diagonal *s* at *s* 1 and *s* 2 is 1ft. 1½ in. from the middle line *o*.

All the half-breadths given are without the plank.

Length from fore side of stem to aft side of transom, 14ft.

Greatest breadth moulded (i.e., without the plank), 5ft. 4in.

Aft side of mast from fore side of stem, 3ft. 6in.

Weight of displacement of boat when immersed to load line, 8cwt.

Weight per inch of immersion at load line, 1½ cwt.

Pin of centre plate from perpendicular at fore side of stem, 4ft. 6in.

Length of plate on its under edge, 5ft. 5in.

Length on its upper edge, 5ft.

Greatest breadth of plate, 1ft. 6in.

Least breadth, 6in.

Thickness of plate, ½ in.

Weight of plate, 110lb.

Siding (thickness) of keel amidships, 4in.; ditto at stem, 2½ in.; ditto at sternpost, 3in.

Moulded depth (i.e., depth from top to under side), 4in.

BALANCE LUG SAIL (see FIG. 55).

Foot	14ft. 0in.
Head, measured along the ticked line (<i>a</i>)	14ft. 3in.
Leech	19ft. 9in.
Luff	6ft. 0in.
Tack to peak earing	21ft. 0in.
Clew to weather earing	14ft. 8in.
Area	155 square ft.

Yard is slung 6ft. from lower end. Tack is bent 1ft. 9in. from fore end of boom.

BOAT OF 15FT.

	No. 1 Section.	No. 2 Section.	No. 3 Section.	No. 4 Section.	No. 5 Section.
	ft. in.	ft. in.	ft. in.	ft. in.	ft. in.
Heights above L.W.L. to top of gunwale	1 10	1 7½	1 6	1 6	1 7½
Depths below L.W.L. to top of keel	0 6½	0 7½	0 8½	0 9½	0 10
Half-breadths at gunwale	1 6½	2 6	2 10	2 8	1 7
Half-breadths at L.W.L.	0 11	2 0½	2 6½	2 0½	0 1½
Half-breadths <i>s</i> diagonal	0 7	1 0½	1 2½	0 11½	0 1½
Half-breadths on diagonal <i>a</i>	1 1	1 10	2 1	1 9	0 5½
Half-breadths on diagonal <i>b</i>	1 6½	2 6	2 10½	2 6½	1 4

No. 1 section is 2ft. 6in. from the fore side of stem.

No. 2 section is 2ft. 6in. from No. 1 section.

No. 3 section is 3ft. 1½ in. from No. 2 section.

No. 4 section is 3ft. 5½ in. from No. 3 section.

No. 5 (transom) is 3ft. 5½ in. from No. 4 section.

Diagonal *a* above L.W.L., 6½ in.; *a* 1 and *a* 2 from middle line *o* (see Body Plan, Fig. 67), 2ft. 4½ in.; diagonal *b* above load line, 1ft. 5in., and at *b* 1 and *b* 2 is 3½ in. below the L.W.L.; diagonal *s* at *s* 1 and *s* 2 is 1ft. 2½ in. from the middle line *o*.

All the half-breadths given are without the plank.

Length from fore side of stem to aft side of transom, 15ft.

Greatest breadth moulded (i.e., without the plank), 5ft. 8in.

Aft side of mast from fore side of stem, 3ft. 9in.

Weight of displacement of boat when immersed to load line, 10cwt.
 Weight per inch of immersion at load line, 2cwt.
 Pin of centre plate from perpendicular at fore side of stem, 4ft. 9in.
 Length of plate on its under edge, 5ft. 10in.
 Length on its upper edge, 5ft. 4in.
 Greatest breadth of plate, 1ft. 9in.
 Least breadth, 6in.
 Thickness of plate, $\frac{1}{2}$ in.
 Weight of plate, 130lb.
 Siding (thickness) of keel amidships, $4\frac{1}{2}$ in.; ditto at stem, $2\frac{1}{2}$ in.; ditto at sternpost, 3in.
 Moulded depth (i.e., depth from top to under side), 4in.

BALANCE LUG SAIL (see FIG. 55).

Foot	14ft. 0in.
Head, measured along the ticked line (<i>a</i>)	15ft. 3in.
Leech	20ft. 0in.
Luff	7ft. 0in.
Tack to peak earing	21ft. 6in.
Clew to weather earing	15ft. 6in.
Area	168 square ft.

Yard is slung 6ft. 3in. from lower end. Tack is bent 2ft. from fore end of boom.

BOAT OF 20FR.

	No. 1 Section.	No. 2 Section.	No. 3 Section.	No. 4 Section.	No. 5 Section.
	ft. in.	ft. in.	ft. in.	ft. in.	ft. in.
Heights above L.W.L. to top of gunwale	2 6	2 2	2 0	2 0	2 1
Depths below L.W.L. to top of keel	0 5	0 6 $\frac{1}{2}$	0 11 $\frac{1}{2}$	1 0	1 0 $\frac{1}{2}$
Half-breadths at gunwale	2 0	3 4	3 9	3 6 $\frac{1}{2}$	2 1
Half-breadths at L.W.L.	1 3	2 8 $\frac{1}{2}$	3 5	2 8	0 1 $\frac{1}{2}$
Half-breadths <i>s</i> diagonal	0 10	1 5	1 7 $\frac{1}{2}$	1 4	0 1 $\frac{1}{2}$
Half-breadths on diagonal <i>a</i>	1 5	2 5 $\frac{1}{2}$	2 9 $\frac{1}{2}$	2 4 $\frac{1}{2}$	0 7
Half-breadths on diagonal <i>b</i>	2 0 $\frac{1}{2}$	3 4	3 10 $\frac{1}{2}$	3 4 $\frac{1}{2}$	1 9 $\frac{1}{2}$

No. 1 section is 3ft. 4in. from the fore side of stem.

No. 2 section is 3ft. 4in. from No. 1 section.

No. 3 section is 4ft. 2in. from No. 2 section.

No. 4 section is 4ft. 7in. from No. 3 section.

No. 5 (transom) is 4ft. 7in. from No. 4 section.

Diagonal *a* is 8in. above L.W.L., and *a* 1 and *a* 2 are 3ft. 3in. from the middle line *o*.
 Diagonal *b* is 1ft. 11in. above L.W.L., and at *b* 1 and *b* 2 is 5in. below L.W.L.; diagonal *s* at *s* 1 and *s* 2 is 1ft. 7 $\frac{1}{2}$ in. from the middle line *o*.

All the half-breadths given are without the plank.

Length from fore side of stem to aft side of transom, 20ft.

Greatest breadth moulded, 7ft. 3in.

Aft side of mast from fore side of stem, 4ft. 10in.

Weight of displacement of boat when immersed to load line, 1 ton 6cwt. (1.3 ton).

Weight per inch of immersion, 4cwt. at load line.

Pin of centre plate from perpendicular at fore side of stem, 6ft. 3in.

Length of plate on its under side, 7ft. 6in.

Length on its upper side, 6ft. 9in.

Greatest breadth of plate, 2ft. 0in.

Least breadth, 9in.

Thickness of plate, $\frac{1}{2}$ in.

Weight of plate, 200lb.

Siding (thickness) of keel amidships, 5in. ; ditto at stem, 3in. : at sternpost, 3½in. Moulded depth of keel, 6in.

BALANCE LUG SAIL (see FIG. 55).

Mast, thwart to sheave hole	15ft. 6in.
Luff of sail	10ft. 0in.
Leech	27ft. 0in.
Foot	20ft. 0in.
Head	20ft. 6in.
Tack to peak earing	30ft. 0in.
Clew to weather earing	20ft. 0in.
Area of sail	300 sq. ft.

The 10ft. boat, planked with ½in. mahogany, would weigh, inclusive of centre-plate and case, sails, and spars, about 2cwt. Thus it would take ¼cwt. of ballast and one person of 8st. (1cwt.) to bring her down to the intended load line ; but she might with advantage carry one more passenger or 1cwt. more ballast. Every additional cwt. would sink her an inch deeper ; but it is of little use crowding a large quantity of ballast in a shallow boat in the hope of making her stiff. For light rowing the plate, ballast, and sails could be removed.

The 12ft. boat, inclusive of sails, spars, and plate and case, would weigh, with the same thickness of plank, about 2½cwt., and should have at least 2cwt. of ballast, or one person and 1cwt. of ballast, besides the helmsman, for sailing with the large balance lug sail.

The 14ft. boat with ½in. plank, and including centre plate and case, spars, and sails would weigh about 3¼cwt., and would require from 3cwt. to 4cwt. of ballast, according to the number of passengers on board.

The 15ft. boat would be planked with ½in. stuff, and would weigh, inclusive of centre-plate and case, spars and sails, about 3¾cwt., and would require 3cwt. or 4cwt. of ballast, according to the number of passengers on board.

The 20ft. boat would weigh, inclusive of centre-plate and case, spars and sails, about 7cwt. To get her down to the load line, she would take four passengers of 12st. each, and about half a ton of ballast. As such a large boat is not adapted for rowing (excepting on emergencies), it would be advisable to have 5cwt. of iron cast in the form of a keel, with a slot in it for the centre-plate to work in. An iron keel, 12ft. long, with an average width of 4in. and depth of 3½in., would weigh about 5cwt. The iron keel forward would extend as far as the mast and aft to within 3ft. of the stern post. A filling-up piece of wood, well rounded up towards the stern post, will finish the keel off aft, and the same forward tapering to "nothing" at the scarp of the keel with the stem. The iron keel should be 4½in. deep in its mid length, and 3in. at either end. Transversely it would, of course, taper to match the taper of the under side of the wood

PLATE IV.

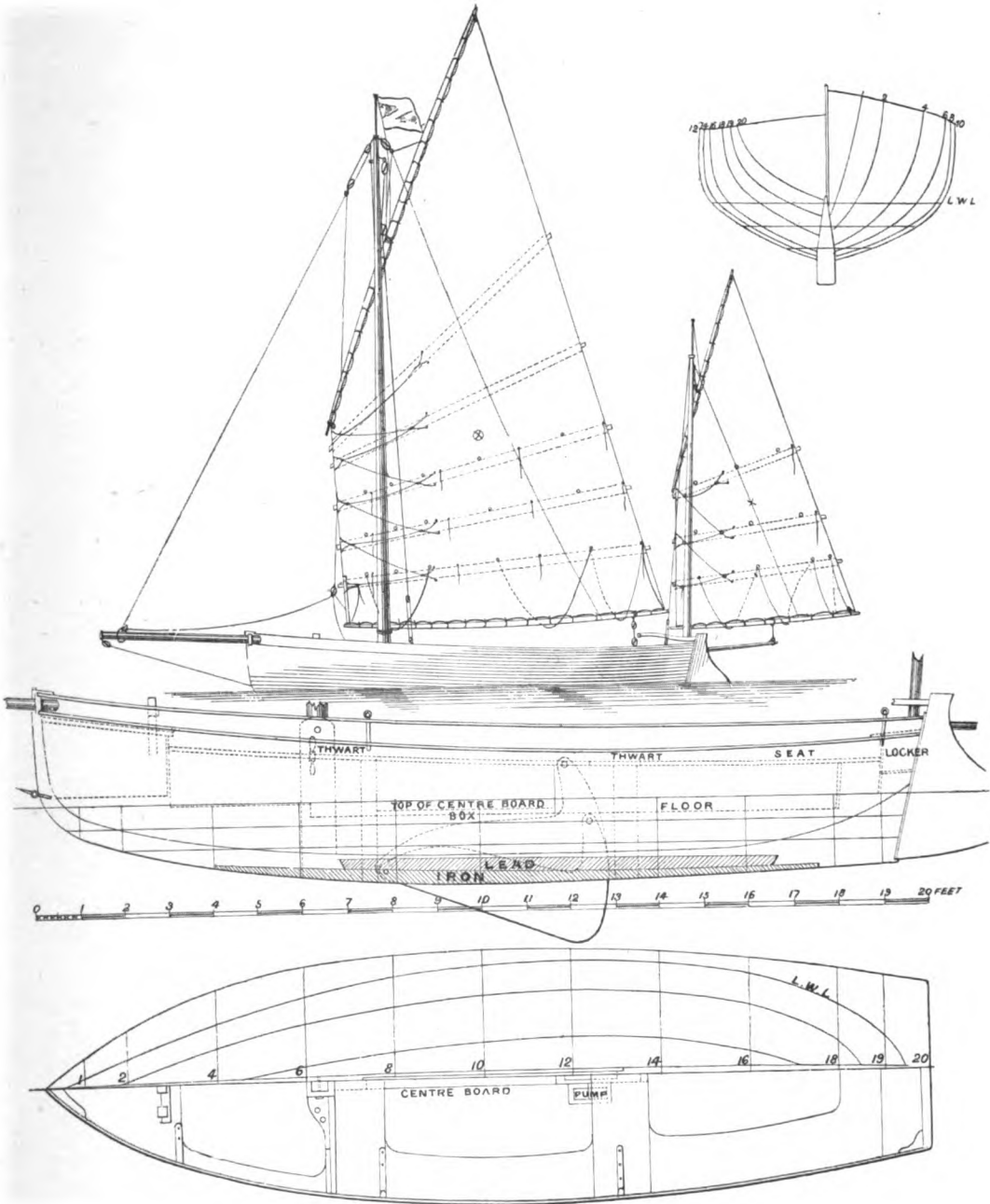

Open Sailing Boats.

keel. The best cruising rig for such a boat would be the balance lug, foresail, and mizen, of about the extreme proportions given for the 17ft. boat (Plate V.); but the mast should be stepped one foot farther aft, and the boomkin for the foresail should be shortened one foot.

Centre-board boats, such as shown in the diagram, are peculiarly adapted for shifting-ballast, as the centre-plate case makes a kind of fore-and-aft bulkhead which will always prevent the ballast sliding to leeward. Still, sliding is not the only danger accompanying the practice of shifting ballast. If a man is single-handed, he might be unable in an emergency to trim his shot bags or other dead weight in time, or his mate may be unable to do so, and it cannot be too often impressed upon the young boat sailer that he must well look after loose ballast in the bottom of a boat (secure it if possible), and never be tempted into carrying a lot of sail on the strength of the ballast being shifted to windward.

A larger kind of open sailing boat, well adapted for sea work, was designed in 1880 by Mr. R. C. Carline, and built for him by Patrick, of Lincoln. (*See* Plate IV.)

The centre-board is so arranged that it is not in the way, as the box stands up only 1in. above the floor boards, except the aft end thereof, and the greater portion of it is under and abuts up to the aft thwart. Only 9in. of it projects on the fore side of the thwart, so as to enable a folding rod to work the board up and down. By the side of this raised part is fixed a square wooden force pump, which discharges the bilge water into the centre-board box. The chambers are 3in. square, and the exposed side of the pump can be readily taken off if required. It works easily, and gets rid of the water most rapidly—a very desirable thing in an open boat. The ballast consists of a lead and iron keel weighing 5cwt., with about 1cwt. of iron inside.

The main and mizen sails are battēn lugs, with very high peaks, and it will be observed that the yards are slung so that the masts cut them nearly in the middle. This prevents the sail sagging to leeward, and the yard and boom can be kept very nearly at the same angle. Mr. Carline says he found that a boat can carry a greater area of canvas with a sail cut with a high peak than with a flat head, and also a larger sail with battens than without. This is a common experience.

The boat carries her canvas exceedingly well; indeed, for racing she is under-canvassed. She has proved herself to be a capital sea boat, handy and fast. She raced once, and, in a good breeze, took the first prize. Although the other boats were much larger they had to be continually baled out, whilst this one was comparatively dry, the pump only being used twice, for a minute or two each time.

Area of mainsail, about 230 square feet ; mizen, 75 square feet ; jib, 70 square feet ; Total area, 375 square feet. Displacement, 1·2 ton.

Mast, gunwale to truck	22ft. 6in.
Yard, extreme	20ft. 6in.
Main boom, extreme	14ft. 6in.
Mizen mast, gunwale to truck	14ft. 6in.
Yard, extreme	10ft. 0in.
Mizen boom, extreme	8ft. 3in.
Luff of mainsail	8ft. 6in.
Luff of mizen	6ft. 3in.
Bowsprit, outboard.....	6ft. 9in.
Foreside of mast from fore side to stem	5ft. 9in.

CHAPTER IX.

SAILS FOR CENTRE-BOARD BOATS.

OPINIONS are very much divided as to the best kind of rig for a centre-board gig; but, at any rate, the balance lug in some form or other appears to be most generally in favour. It has been contended that a boat rigged with a single balance lug is likely to miss stays, and this is perhaps true in what is termed a "lop;" but a boat with one large sail in the hands of a clever boat-sailer, need never miss stays in smooth water at least, unless the wind headed the boat round, and then of course she would miss stays, whatever her rig. It is an advantage to have the sail all in one piece for going to windward—tacking out of the question—and for a single hand it is of course convenient to have no head sails to work. No description of boat will stay quicker or with more certainty than the American cat-boat, or Una, and, if not brought head to wind by too free a use of the rudder, they lose very little way in tacking.

On the other hand, a boat with one sail may fail to go about in a disturbed sea, and may get in irons; whereas if she had a foresail the operation of tacking, without getting stern way on, might have been successfully performed by keeping the head sheets a-weather. A clever boat-sailer will always work his head sheets without inconvenience even in a lop, as he will see his craft safely filling on the opposite tack before he attempts to "let draw," and, as the head sheets will lead aft, he need not move from his seat. The argument *pro* and *con*. the foresail can, therefore, be summed up thus: In light winds it is an advantage to have the sail all in one piece, especially for beating, and the trouble of working the head sheets does not exist; but in strong winds and rough water there will be more security in a smaller mainsail, with the addition of a headsail; and, although there will be the trouble of working the head sheets, there need be no difficulty about it even for one hand. Concluding that it is "safest to be safe," it will be best to be provided with a foresail for sailing in rough water.

Another very strong argument in favour of the foresail or jib in addition to the balance lug is this: if there be much wind, the boat when sailing "along," or off the wind, will exhibit a very great tendency to come to against her helm, that is, she will require a great deal of weather helm to keep her out of the wind; this tendency will be greatly relieved by the jib. Again, if there be any sea, the boat will have to be constantly "chucked" up in the wind to avoid a comber that may be coming in on the weather bow, for it will not do to sail boats very hard in rough water; yet must they be kept full, and to avoid getting into irons after luffing to a comber, or to meet a heavy puff, a foresail will be found very useful. The foresail can either be set on a bowsprit or bumpkin, as shown in Plate V. representing the standing lug rig. The manner of fixing the bumpkin will be found described in the chapter on Itchen boats.

Many experienced boat-sailers recommend a mizen instead of a foresail, and they argue that a mizen can be made as great a help to a boat's staying as a foresail. There is not much doubt that a mizen is a powerful lever to assist in throwing a vessel's head to wind; but it is of no use for paying a boat's head off, if she gets in irons. However, as shown in Mr. Baden Powell's sketch, if the tiller is carried aft (say 2ft.) of the rudder, to act as a mizen bumpkin, then each time the tiller is put down, or to leeward, the mizen will be brought to windward and push the stern round. This may be so, and, if the boat kept moving through the water, she would no doubt ultimately describe an arc of a quadrant through the wind acting on the mizen; but when a boat is in irons she does not move through the water—at least not ahead, although she may get stern way on. Now if the mizen is kept across the boat whilst she is in irons, it will, if it has any effect at all, drive her astern as well as tend to push the stern on one side. As the latter motion will be counteracted by the direction the rudder is necessarily turned (presuming that the boat is making stern way), we doubt if the mizen can be manœuvred so as to be of much service in the case of a boat that has no head sail getting into irons. In fact, the proper thing to do, if a boat in a "lop," when under main and mizen sail, did get into irons, would be to let the mizen sheet go, and reverse the helm, and then haul the mainboom over to the side which is to be the weather one when she has filled; then, with stern way on, the boat's head will be boxed off, and she may be helped by a timely kick from a cross sea. Thus far the conclusion is forced upon us that, if two sails are decided upon, the foresail and mainsail have a slight advantage over the mizen and mainsail.

There may possibly be some advantage in open water in the main and mizen rig, if warning of a "kick-up" has not been taken advantage of to reef. Going into the eyes of an open boat to reef her foresail in a "lop"

is by no means a pleasant or safe operation to perform, and indeed it should not be attempted unless a counterbalancing weight is put in the stern ; the boat will then plunge violently, but there will be less danger of her being swamped. Now, with the main and mizen rig there will be no foresail to reef, and as the mainsail will be all in board, reefing when *in extremis* will be a comparatively easy operation. Again, if the mainsail has to be lowered in a hurry, the mizen will bring the boat to the wind, instead of taking her off as a foresail might. But the danger as last indicated can easily be avoided by letting go the head sheets before lowering the mainsail. Then the foresail might be found of service for scudding before a strong wind at sea. On the other hand, the mizen might be of use in rowing, in keeping the boat's head to the wind at sea. However, as snugging down should be never deferred, with a rising storm, until the sea got up so as to make reefing a foresail a matter of danger, we still cast in favour of the sloop or main and foresail rig.

The question here naturally arises, if the mizen is of use as well as the foresail, why not have both ? We certainly do not see why both should not be had ; and, if the wind is so strong as to necessitate the mainsail being stowed, the boat will be fairly handy and manageable under mizen and foresail, although the canvas would scarcely be large enough to get her to windward with the wind dead on end.

The fashion of lacing the sail to a boom is now general whatever the rig, and no doubt the plan has many advantages—the principal of which are that the foot can be kept straighter, and thereby the sail generally flatter, and in easing the sheet little or much the sail does not go into a bag ; on the other hand without the boom, if the boat be struck by a squall, the wind will be spilled from the sail directly the sheet is loose ; but the case is different with a boom sail ; and if the squall be heavy it will be necessary to luff the boat up in good time and then ease the sheet, and prepare to lower the sail in case the squall should not abate.

To the question of how much sail it is prudent to give an open boat, the answer very much depends upon the requirements and capabilities of the boat-sailer. Sail areas of open boats, we find, vary very considerably ; and in proportion to the length of boats multiplied by breadth, range from 1 to 3.* Thus we find some cruising gigs, 17ft. long by 5ft. 6in. in beam (equal to 93·5 square feet), with about 90 square feet of canvas in their

* To find the area of a lug sail, divide the sail into two triangles by a line from clew to weather earing ; take the length of the long side of each triangle ; multiply it by a perpendicular from the long side to the angle on the opposite side ; add the two products together, and divide by 2. The quotient will be the sail area.

sails; whilst other boats, only 14ft. by 5ft. 3in. (equal to 73 square feet) that are raced, have sail areas of 180 square feet, or 2.4 times the area of that found by multiplying the breadth into the depth. The latter proportion will only be safe in the hands of an expert, and the novice should begin with very small sails, or, in other words, the sail area should not exceed the length of the boat multiplied by her breadth.*

Sometimes in the sloop rig the jib or foresail, instead of being tacked outboard to a bumpkin, is laced at its foot to a boom; the sail is then "tacked" by this boom to the stem head, so much sail being forward of the stem as the space between the mast and the stem requires. A pair of sheets are required as usual, and the *weather* one should always take the weight of the sail; the *lee* one is consequently slack, but only so slack that when the boat is put about it takes the strain as the weather sheet. Thus the sheets need no trimming in tacking. The objection to this "revolving jib" is that it cannot be readily "spilled," as after the sheet is gone the sail will sometimes be balanced by the wind; hence the sail may not only be an inconvenient one, but a dangerous one. This objection can be somewhat removed by having the tack fast some distance ahead of the centre of length of the boom.

The "balance lug," Fig. 55—which was introduced at Surbiton by Mr. Burgoine (boat builder, of Kingston-on-Thames), about twelve years ago—is a sail so arranged that it requires no dipping in going about; that is, it lies on the mast on one tack, and from the mast on the other. In this respect it resembles the "standing lug" illustrated on Plate V., and in the New Brighton rig and Mersey canoe rig; but the Surbiton lug has the advantage of a larger piece forward of the mast to "balance" the after part of the sail; hence the term balance lug.

The boom and yard are generally of about the same length, and the length of the mast is in a measure governed by the amount of peak, or round given to the head of the sail. If the yard is slung in its amidships, the sail should have great peak, and it will stand or sit better than if the sail be cut flat-headed. If the yard be slung nearer its lower end than amidships, the

* The most successful gigs that compete in the matches of the Thames Sailing Club have enormous sail areas, all in one piece as a balance lug. These sail areas frequently equal three times the area, found by multiplying the length of the boat by the beam; and the boats, being dexterously handled, carry the sail well, and appear wonderfully handy. Of course it would be madness for a mere tyro to think of handling such a sail, even with plenty of live ballast on board. The most handy size for match sailing up river, where short boards only can be made with the wind "dead on end," appears from experience at Surbiton to be the 14ft. boat, and they are given as much as 5ft. 3in. beam to enable them to carry large sails. One of these boats has a sail of the following dimensions: Luff, 9ft; leech, 22ft.; foot, 17ft.; head, 16ft.

sail, if not cut with a high peak, is apt to sag to leeward; and the same might happen if the sail be very flat-headed and slung, say, one-third of the length of yard from the lower end or heel of yard. A good place for

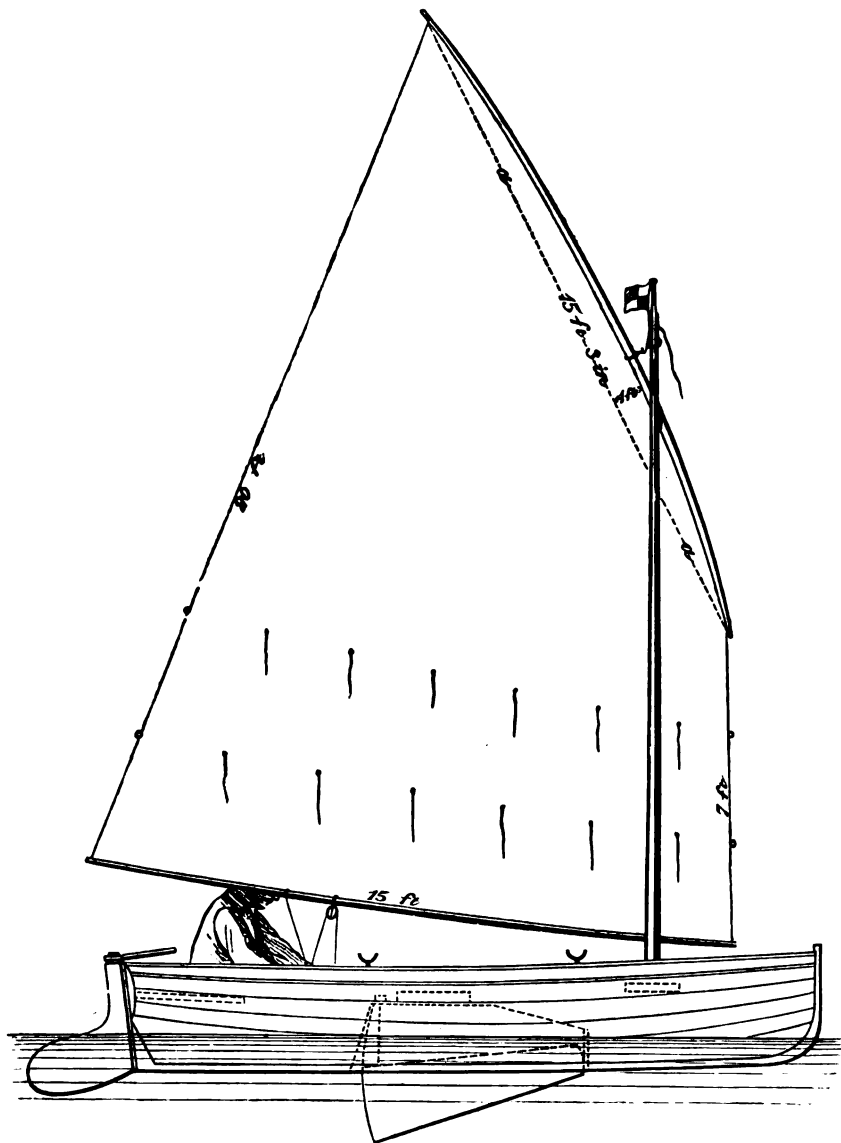

FIG. 55.

the slings of a well peaked and round headed sail will be about one-tenth the length of yard from its amidships. (The head and foot of the sails are always laced to yard and boom.)

A Surbiton boat, however, has the yard slung at about two-fifths its length from the lower end, but then the head of the sail has not so much round as shown in the diagram. However, a squarer sail and a better standing one can be obtained by slinging the sail nearer amidships and giving as much round to the head as shown in the drawing; the luff will be shorter than is generally given, but this probably will be found an advantage.

About one-seventh of the foot of the sail should be forward of the mast, and in slinging the yard and in bending the tack to the boom care must be taken that this proportion is not much exceeded. If too great a proportion of the sail is put forward of the mast it will not "balance," and in luffing to squalls, especially with the boom off the quarter, it will be found that, although the boat may come to a little, the sail will not spill. This peculiarity may be attended by some danger in the case of squalls or in clearing an obstacle, and may be accounted for by the fact that the ardency of the wind pressure on the fore part of the sail will be so great that it will more than balance the pressure on the greater area of the after-part, which, ordinarily, with the aid of the rudder, should bring the boat head to wind speedily.

No rig is handier for tacking in smooth water than the balance lug, and should a boat so rigged by any mischance show a tendency to miss stays or get in irons, her head can easily be paid off by holding the foot of the sail over to the side which is to be the weather one. This, of course, will stop the boat, and press her bodily to leeward or force her astern, and the sail should never be kept a-weather a moment longer than is necessary. Should the boat not gather way again quickly after the boom has been put over on the lee quarter again, the main sheet must be eased a trifle.

The sail is hoisted by a single halyard; to one end of this halyard a block is spliced; the other end is rove through a sheave hole in the mast head and bent to the yard; through the block a rope is rove, the standing part of which is made fast to the mast thwart and the hauling part through a block at the mast step. This forms a whip purchase, but if the sail be a large one a gun tackle purchase is used. The halyard is bent or hooked to a thimble-eye strop on the yard. The sail can be kept to the mast by a parrel thus contrived: a grommet strop, with thimble-eye seized in it, will be put on the yard about 6in. above the slings; another similar strop will be put on the yard at about 2ft. 6in. (for a 14ft. boat) below the slings; a line must be spliced to the lower thimble, and rove through the upper one round the aft side of the mast, back through the lower thimble. Thumb cleats must be put on the yard to prevent the strops slipping.

When the sail is set, the line must be hauled as taut as it can be got and belayed.

But a neater plan than this is the mast iron, as shown in the diagram; the halyard is fast to an eye in the iron, and the latter is hooked to the thimble-eye strop on the yard. The disadvantage of the iron traveller is that the tack and sheet of the sail must be let go when the sail has to be lowered, or otherwise the sail will not lower. As the sail comes down the fore-end of the boom must be carried forward.

If an iron mast traveller be used the yard will be slung as shown in Fig. 55; if a parrel be used instead of the iron, the yard will be slung a little lower down, as the strop will be hauled close up to the sheave hole; consequently the sheave hole will be a little lower down, and the mast may be a trifle shorter.

A downhaul should always be bent to the yard.

The tack will be bent to the boom abreast of the mast and lead through a block, either on mast thwart, or deck, as may seem most handy. The Surbiton plan for the tack is thus worked: a thimble is stropped to the boom abreast of the mast, and to the thimble 5ft. or 6ft. of line is spliced; the line is passed once round the mast, back through the thimble, then through a galvanised iron eye-bolt screwed into the mast some convenient distance below, and belayed to a cleat on the mast. For a 15ft. boat a gun tackle purchase should form the tack. In setting the sail it is often found that the luff can be got tauter by swigging on this tack than by hauling on the whip purchase of the halyards.

If topping lifts are used (they may be handy whilst reefing, or to brail the sail up), one part will be made fast to the masthead and lead across the sail, and through a thimble made fast under the boom by a seizing (or it can pass through the thimble in the strop of the main-sheet block) and up the other side of the sail, through a block at the masthead and the "fall" down by the side of the mast.

A wire forestay is generally set up to the stem head, and it is better that a gun-tackle purchase, or double-block purchase should be used for the setting up instead of a lanyard, as the mast (sails and all) can be lowered by it for passing under bridges, &c. The mast should be stepped in a tabernacle, which tabernacle will be open on the aft side and fitted in the aft side of the mast thwart. The forestay will go over the masthead by an eye; a thimble eye will be at the other end of the stay to take the lanyard or hook of the setting up tackle. There will be a single wire shroud each side of the mast fitted the same as the forestay, but set up by lanyards to the eyes of neat chain plates fitted to the gunwale. Sometimes, however,

the lanyard is rove through a thimble seized to the thwart or to a timber, or through a thole hole in a rowlock.

The main sheet is arranged thus; standing part fast to the boom, then through a single block under one gunwale, then through a block stropped to boom and belayed under the other gunwale; for the 10ft. boat, thimbles might be used instead of the blocks.

In the 10ft., 12ft., and 14ft. boat, the "Una" plan of main sheet may be suitable. An end of the sheet is fast to one quarter; the other passes through a block on the boom, and through another block on the opposite quarter. For sailing on a wind it may be found that with the blocks on the gunwales the boom cannot be hauled in flat enough; so unless the blocks are on the transom at the extreme stern the blocks should be fitted inside the gunwale. Another plan is to have the standing part of the sheet fast to the extreme end of the boom; other end through a double block with traveller on a horse; then through a single block on boom back through the double block, and belay by hitching the hauling part round the parts of the sheet above the double block.

Some of the Surbiton boats have the mainsheet thus fitted: A single block on main boom and one on a horse, also one on the deck a little ahead of the horse. The sheet is fast to the block on the boom, then leads through the block on the horse, back through the block on the boom, through the block on deck, and belay.

Another form of the lug known as the "standing lug" or settee sail has been referred to, and is shown in Plate V., adapted from the lugs used in the boats belonging to the New Brighton Sailing Club. (A detailed description of the New Brighton rig will be given further on.) It will be seen that the tack of the sail is close to the mast, and very little canvas is consequently forward of the mast. The dimensions and areas of the sails adapted for the 17ft. boat are as follows:—

MAINSAIL.

	ft. in.		ft. in.	
Head (measured along the yard)	15 0		3 3	Luff
Leech	18 0		17 0	Tack to peak earing
Foot	11 9		13 0	Clew to weather earing

This sail is drawn with 1ft. 4in. round to the head.

FORESAIL.

	ft. in.		ft. in.	
Leech	8 6	Foot	6 6	Luff
				10 9

MIZEN.

	ft. in.		ft. in.	
Head	9 0		2 6	Luff
Leech	9 6		10 6	Tack to peak earing
Foot	6 6		7 0	Clew to weather earing

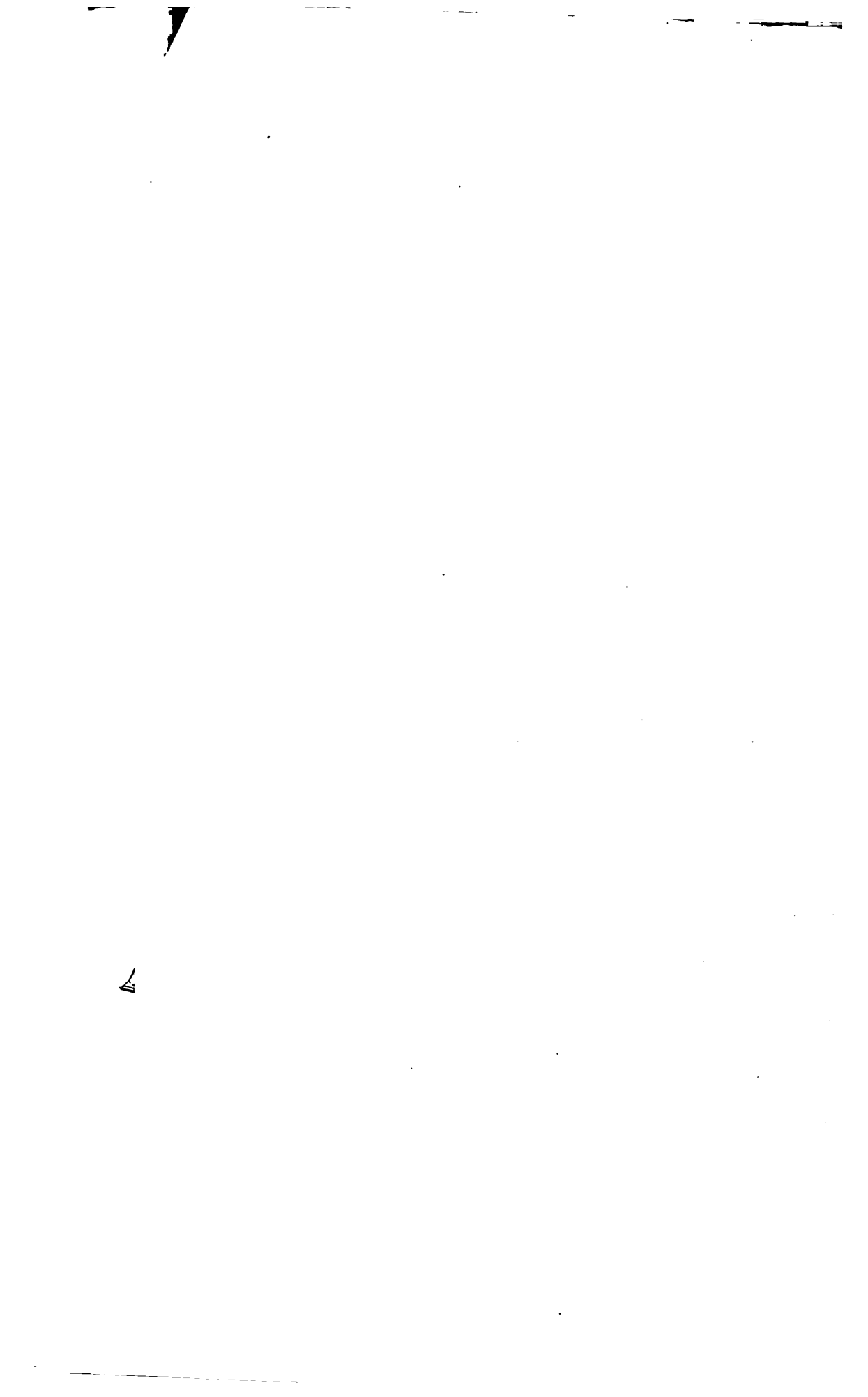

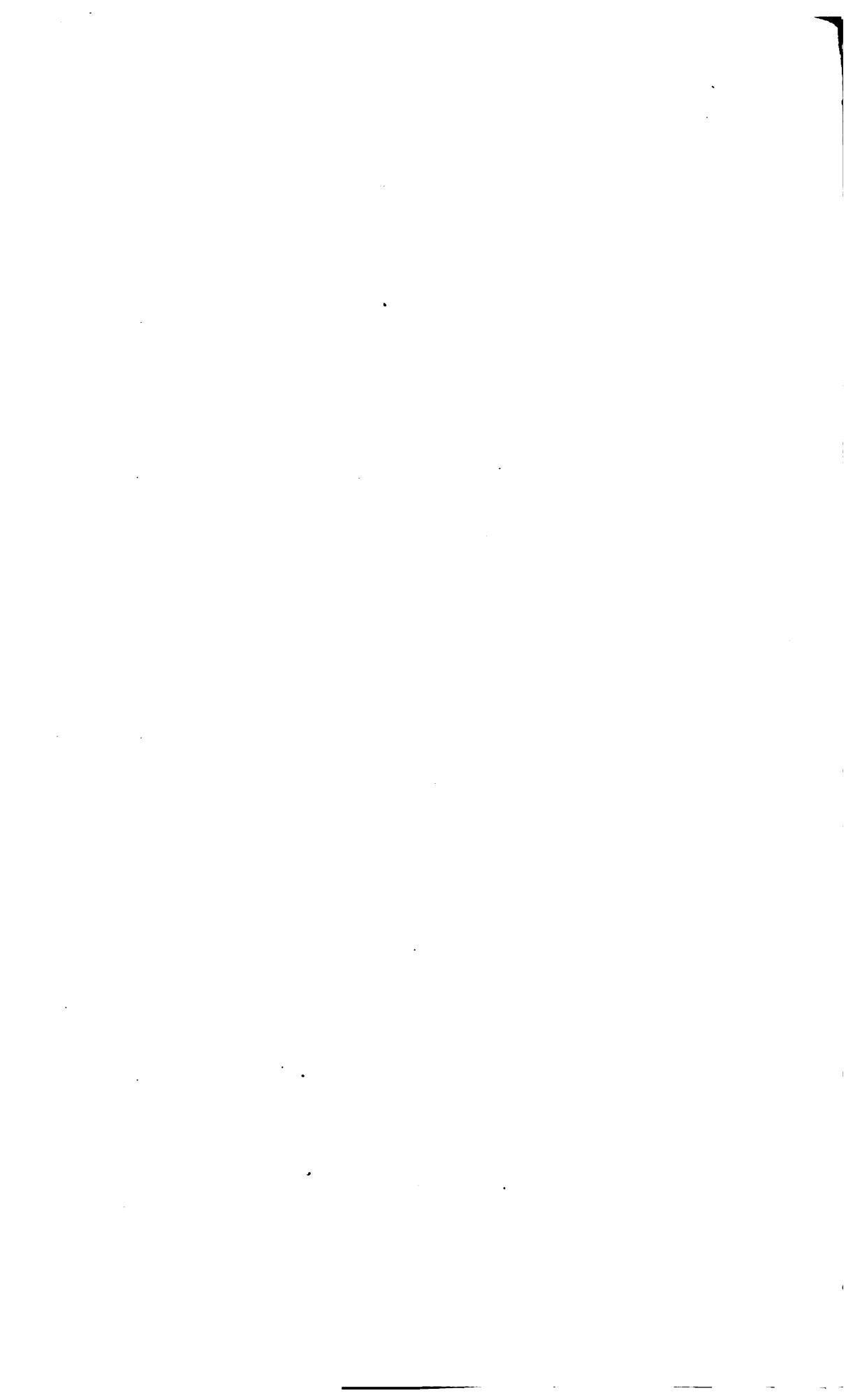

	AREAS.	sq. ft.
Mainsail		119
Foresail		27
Mizen		38
Total		184

Area of reduced mainsail for single-hand sailing, 85 sq. ft. (4ft. 6in. to be taken off yard).

The dimensions of these sails will do equally well for the balance lug of the Surbiton type, as practically the only alteration to make would be in lacing the sail to the boom, and having the tack tackle fast to the boom instead of to the sail. The great round to the head will be an advantage, as it makes the sail square; and if the yard be a trifle longer, it is not carried quite so high.

The sail area shown in the drawing is a large one, but with three or four hands sitting to windward the boat would carry it well enough in moderate breezes and smooth water. For ordinary single-handed sailing it would be prudent to have a smaller mainsail, reduced as shown by the ticked line *a*; the sling would then come at *c*. The foresail should also be 2ft. shorter in hoist, and 6in. less on the foot; the mizen would be shortened 2ft. on the head.

The boat could be sailed with mainsail alone without shifting the mast, but she would probably be handier if the mast in such a case were shifted 1ft. farther forward. For turning her into the sloop rig, the mizen would be unshipped, the mainmast shifted 3ft. farther aft, and the foresail tacked to the stem instead of to the boomkin.

For a tyro who knows little or nothing of sailing, the 10ft. centre-board dinghy, rigged with a single balance lug, is a suitable craft for schooling, and, if he is fortunate enough to be located near a place where there is some shallow water, he may find out all about sailing without the assistance of a coach.

For centre board boats of the Una type various rigs are used, and on the Seine the French have brought into use an adaptation of the "sliding gunter rig." The drawing on Plate VI. illustrates this rig.

The rig, it will be seen, although of the sloop character, differs from the sloop in detail. The mainsail is a kind of sliding gunter, and the arrangements for hoisting and setting it are as follows. The mast is stepped on deck and pivoted in a tabernacle, by which it can be readily lowered for passing underneath bridges, warps, &c. *a* shows the heel of the yard (see Plate VI. and A Fig. 56). On this yard is a wire rope span from *c* to *a* (see large sketch), which passes through a block at *k*. The details of the arrangement will be more clearly understood by studying the smaller

diagrams (Fig. 56). In A, *a* is an iron hoop traveller on the mast. Into the arms of this traveller the heel of the yard is inserted, and is so hinged as to form what is known as a universal joint. The hoisting halyard *n* is made fast to an eye in this traveller and passes through a cheek block on the mast at *x*. Sometimes a block is on the traveller, then (see F) one end of the halyard is put through the cleat on the mast as shown at *y*, and then has a knot tied in it to prevent it unreeving. The other end is passed through the block on the traveller, and then through the cheek block at *x*.

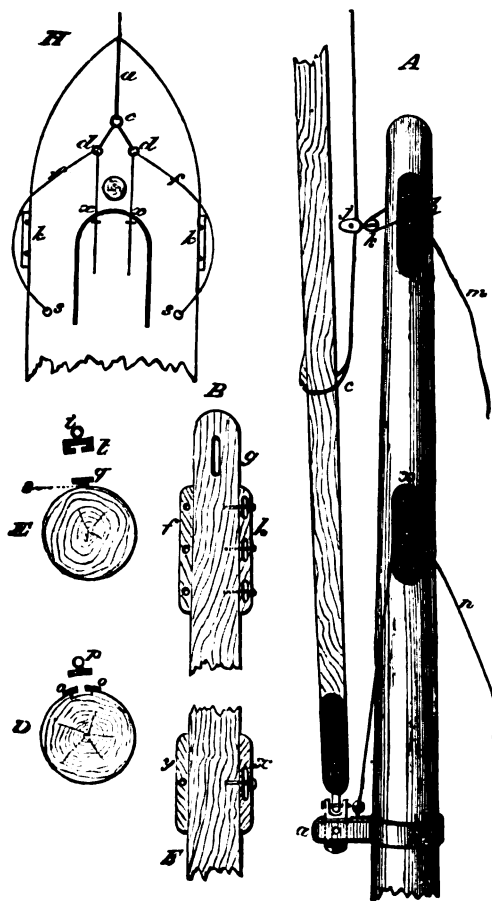

FIG. 56.

block *k* is not used. One end of the halyard is seized to the iron or brass block *j*, and then passes over the sheave at *k*.

In Fig. B, the upper sheave above *h* is used for the foresail halyards; one end of the halyard is stopped by a wall knot after being rove through the hole above *f*; the other end is then passed through a block hooked to the head of the foresail, and then over the sheave above *h*.

The sheave below *h* is used for topping-lifts; one end of the topping-

part of the halyard, and then through the cheek block at *x*. If the sail is a very large one a whip purchase is also used. A block is seized to the halyard *n*, and through this block a rope is passed, one end of it being fast on deck.

In Fig. A, *c* represents an eye splice in the lower end of the wire rope span kept from slipping by a thumb cleat. This span passes through an iron block *j*. To this iron block a small wood block *k* is seized, and through the latter the halyard *m* is rove. The halyard *m*, in the first place, is rove through a cleat on the mast (see Fig. B) *f*; then through the block *k*, and over the sheave in the cheek block *h* (Fig. B). The halyard at *f* is stopped by a wall knot. In the diagram A, *m* is the hauling part or fall of the halyard. In the smaller sized vessels the

PLATE VI.

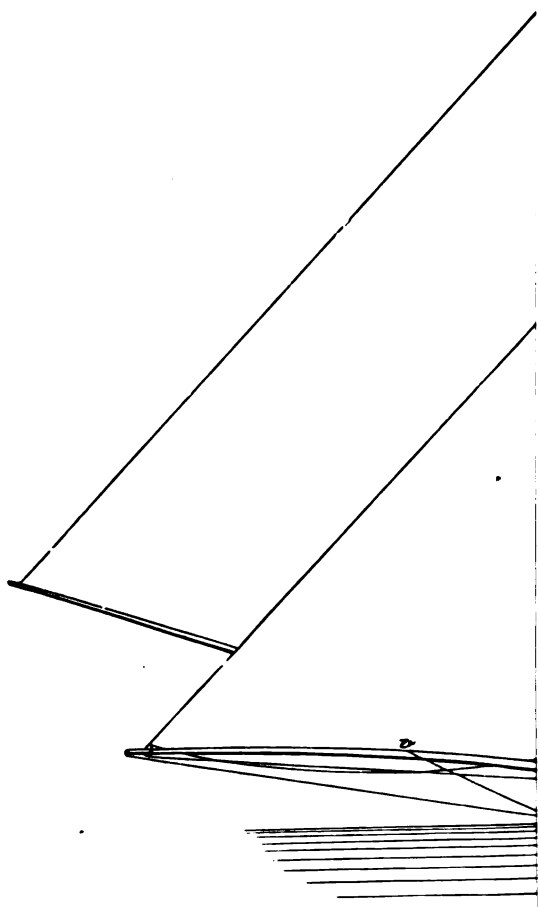

"I

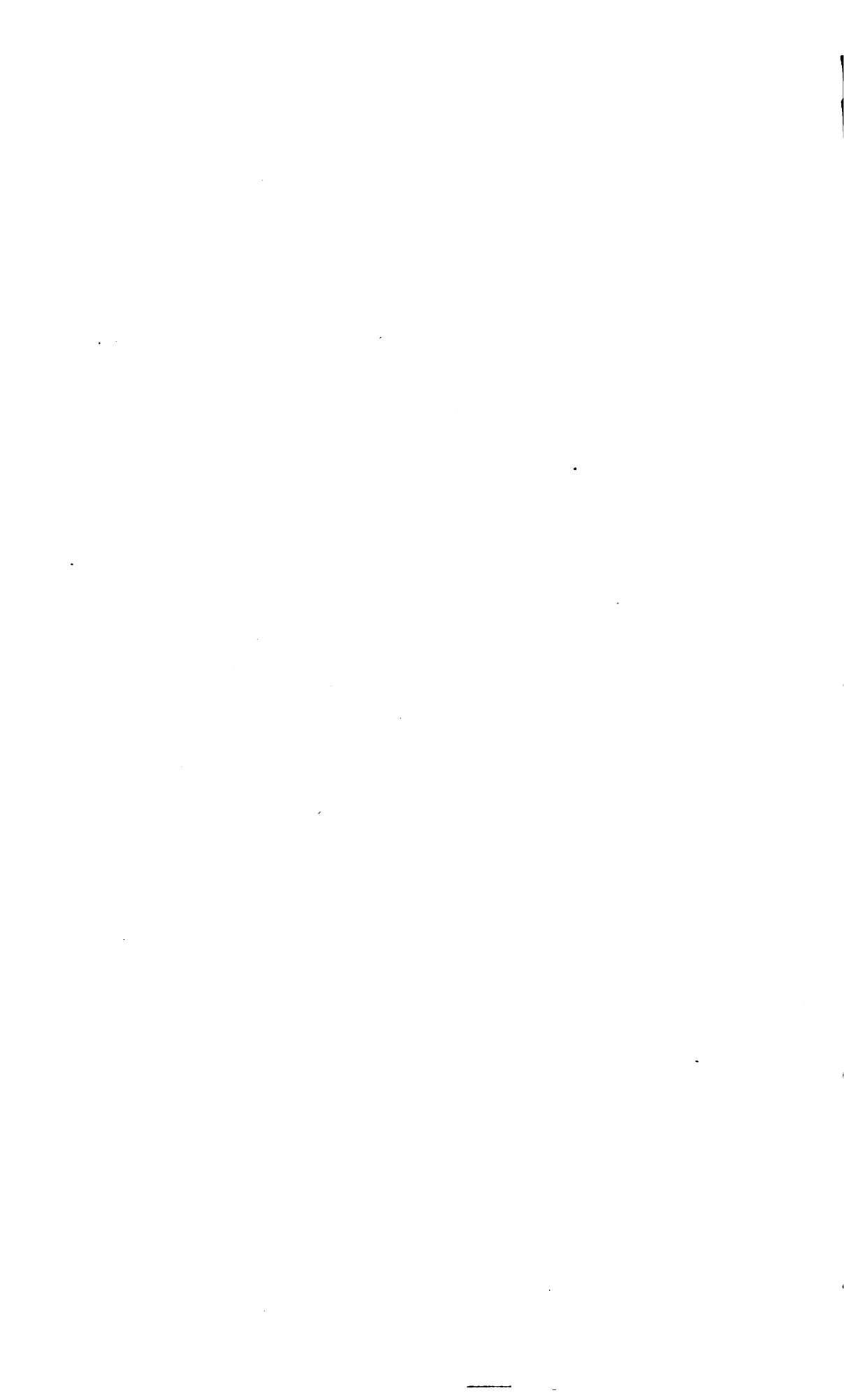

lift is stopped at the hole *below f*; the other is passed through a thimble seized on the under side of the main boom and is then carried up over the sheave *below h*. The large sheave hole at *g*, Fig. B, is used for spinnaker or square sail halyards. Mast hoops are not often seen. The sail is kept into the mast thus: Diagram D is a section of the mast; *o o* are two brass plates screwed to the lips of a channel cut on the aft side of the mast. *p* is a traveller about two inches deep which works in the channel formed by

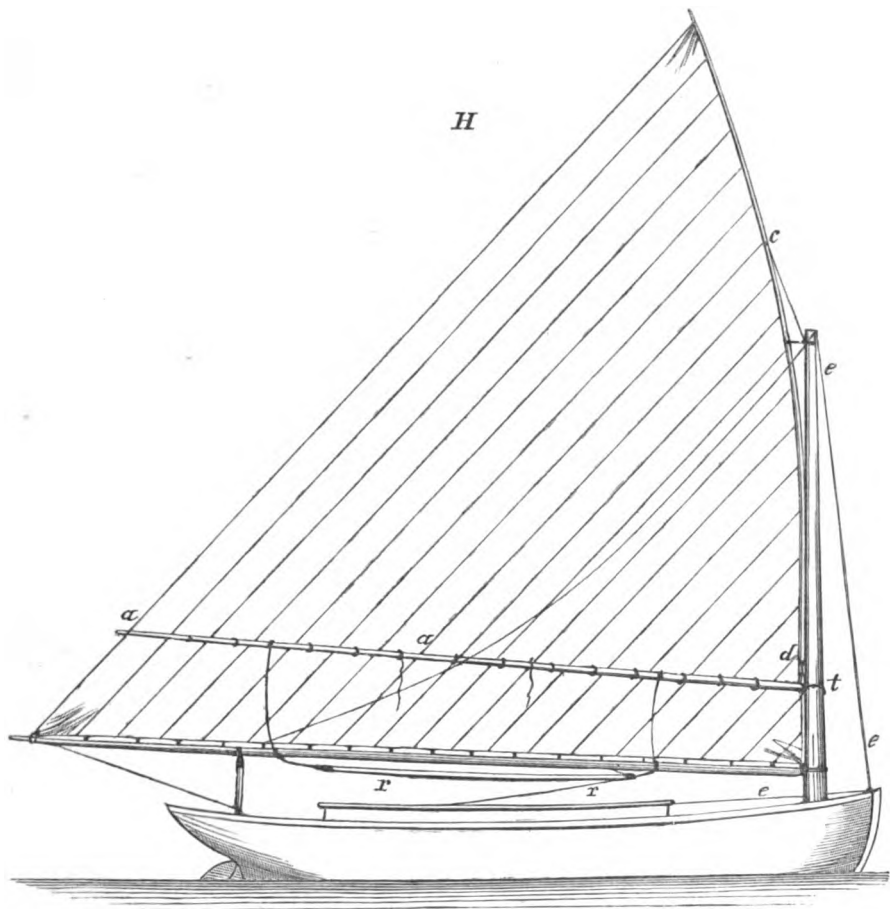

FIG. 57.

o o; the traveller has an eye to which one of the eyelet holes or cringles in the luff of the mainsail is seized. Generally as many of these travellers are used as there would be hoops if hoops were used.

Another arrangement is shown by E: *g* is a T-shaped bar of iron screwed to mast (or sometimes instead of a T-iron a plate of simple bar-iron is screwed over a fillet of wood, as shown by *s*, for lightness); *t* is the small

traveller about two inches square which is shipped over *g*; *i* is the eye for seizing the luff cringles of the mainsail *x*.

If either of these travellers is used, the iron mast-traveller for the yard is dispensed with. A traveller (made with a socket to take a gooseneck on end of the yard) is inserted in the channel *o o* (see D.) or over the guide *q* (see E).

One end of the main sheet is fast to the boom end; it from there leads through a double block on deck, through a single block on the boom, back

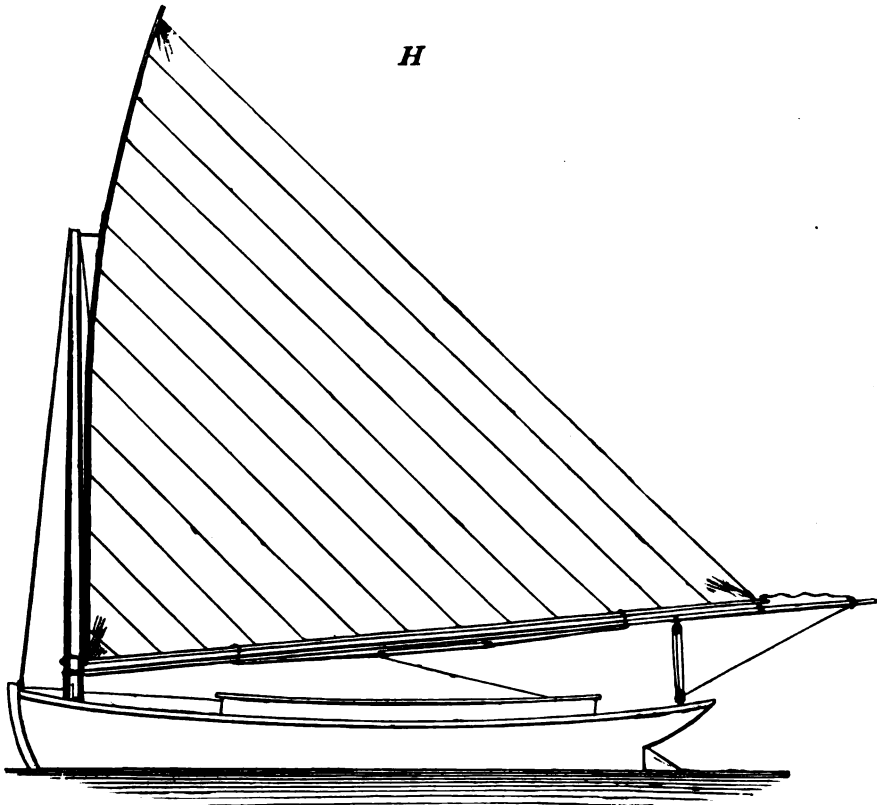

FIG. 58.

through the double block on deck again, then through another single block on the boom and belay.

The bobstay is made of wire rope; one end has an eye in it, and this eye encircles the bowsprit at *v* (see large sketch); it then passes through a block on the stem at the water-line, through another block on the bowsprit end; a tackle is hooked to this end of the bobstay (at bowsprit end) to set it up.

The foresheets are very well arranged for handiness. In diagram H. *a*

represents the line of the foot of the foresail; *c* being the cringle in the clew of the fore-sail. To this cringle two short pieces of rope are spliced with thimble eye at *d d* as well. The foresheet is fast on the deck to an eyebolt at *s*; it then passes outside the channels *k* through the thimble *d* and through the coamings of the well at *x* and is then belayed. It will be observed that in the diagram the foresail is represented hauled amidships.

The sails that we saw were exceedingly well cut and tabled, and were made of cotton duck.

A very similarly worked mainsail is used in America for the "cat boats" of Rhode Island. An illustration of this rig has been given me by Mr. R. B. Forbes, of Milton, Mass., and is shown by Figs. 57 and 58. *a* is a boom laced to the sail and used for reefing. *r* is a tackle for hauling the reef down. The halyard *c* comes down to and belays to a cleat on the heel of the yard at *d*, close to the traveller *t*. By simply slacking the halyard *c*, and hauling on *r* the sail is reefed (see Fig. 58).

CHINESE LUG SAILS.

The Chinese plan of battening a sail has been very much recommended, and there is not much doubt that battens will keep a sail from going into a bag; the only objection to them of any importance is that they so much increase the weight of the sail. For a sail of the proportions given in the drawing (scale $\frac{1}{2}$ in. to 1 ft.), the battens should be 1 in. thick, and 1 $\frac{1}{2}$ in. deep, tapering towards the ends (three battens, 1 ft. 6 in. distant at the luff of the sail, and 2 ft. at the after leech). A reef band is sown on the sail to receive each batten, and the latter will be lashed at either end to leech and luff of the sail through thimbles; and, again, a thimble will be securely seized to each end of the battens, for the reef earings to be rove through.

The sketch shown on Plate VII. (scale $\frac{1}{2}$ in. equal to 1 ft.), made by Mr. W. Baden Powell, shews the arrangement of battens. Mr. Powell thus describes the gear and fitting of the sail:

"*Rig*.—Mainsail of the largest size the boat will carry in a steady moderate breeze, placed forward so that its centre of effort comes ahead of the centre of lateral resistance of the boat; mizen of the same cut as main, but of such size and so placed as to bring the centre of effort of the whole sail plan aft of the centre of lateral resistance (for a small boat should always carry weather helm; without it safety does not exist).

"*Fitting*.—The mainsail is fitted with a yard, a boom, and three or four battens; the sail is laced to yard and boom; the battens are lashed at their ends to luff and leech, and are, as it were, rove through a horizontal

seam on the sail formed by sewing a 'reef band' across the sail to take the batten. The battens are made of pine, and taper at the ends like topsail yards. They are about 1½ in. in diameter in the middle. The reef earings reeve through thimbles on the boom ends, and belay to 'patent' cleats on the boom.

" *Halyards*.—Toggle on the single part to a becket or strop on the yard. The battens and the yard are kept in to mast by toggle and becket parrels.

" *Tack* is a single rope, leading from the well to a block on deck at side of mast; it then toggles to a becket on boom, about one-eighth the boom's length from fore-end. Both tack and halyards can be fitted with a purchase for setting up, according to the size of the craft.

" The sail should be cut with very great 'peak' (yard as long as boom), so as to allow of a forestay, by which to lower the mast. The mast fitted on a 'tabernacle'* and pinned above deck, is a *sine quâ non*, whether the boat be used for river or sea work; bridges and tow ropes come against your mast in river work—ships' warps in harbours; and, when at anchor fishing, or tide waiting in a sea chuck-up, it is almost impossible to stand up forward and unship the mast, yet the great swaggering stick will not permit your little ship to ride easy.

" A topping-lift is fitted, standing part fast to masthead, then down one side of sail, to reeve through sheet block strop thimble; then up on other side of sail to and through a block at masthead, and down to the deck. Being through sheet block strop, which toggles on to boom, this topping-lift remains with sheet on mast when sail is taken off and stowed away, and is thus ready for a change of sails.

" A kind of gathering line, or sail keeper, is fitted to hold the sail up clear of the deck at the mast when it is lowered down, thus: one end fast at masthead, then down the side of sail on which the mast is not, and round under boom, and up, making it fast round the mast about 1 ft. above the boom: thus, when going to set up sail, you place forward end of boom, yard, and batten all in a bunch, between the mast and gathering lines, then the after ends through between the two parts of the topping-lift;

* A tabernacle is simply a perpendicular square trunk, or spout, as it is usually open on the aft side, made to take the lower part of the mast; if the mast is stepped on deck (as those of the river barges are) the heel of the mast will be pivoted on a bolt passing athwartships through the sides of the tabernacle above the deck as shown in Plate VII. Brass or iron plates should be fitted to the tabernacle where the bolt passes through, and there should be an iron band or ring on the heel of the mast. In an open boat the mast can be pivoted near the bottom of the tabernacle, thus: a bolt is fixed through the tabernacle (athwartship); on the heel of the mast is an iron band with two scores 1½ in. deep cut in it to fit the bolt; a score is also cut in the heel of the mast to correspond with those in the iron. The mast head is fitted on the bolt by the score, and when on end is kept in its place by an iron or clamp on the thwart as usual. If the mast is pivoted on deck, it will be safer to have holes *through* the iron on the heel of the mast instead of mere scores for the bolt to pass through.

PLATE VII.

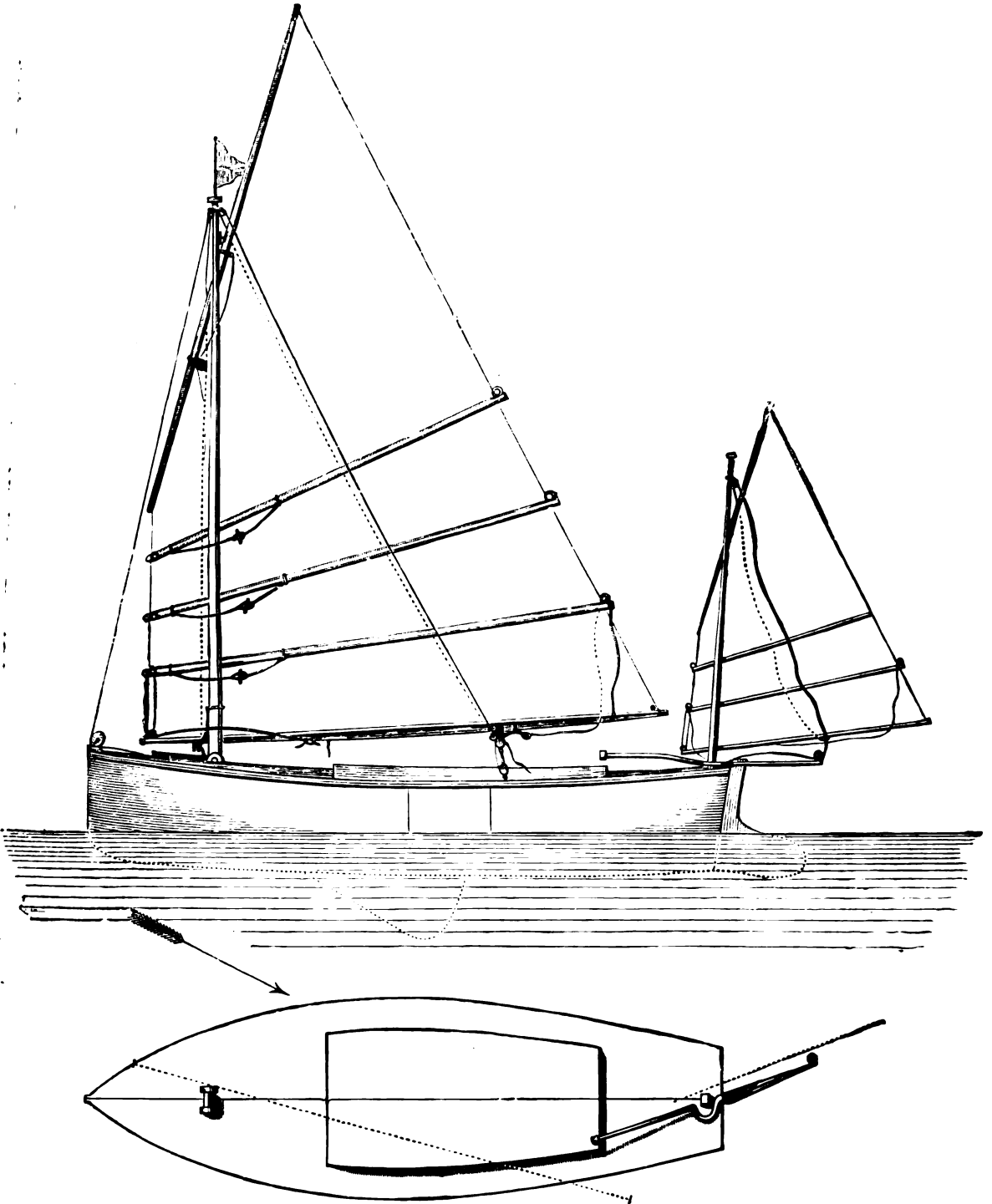

Chinese Lug Sail : Main and Mizzen Rig.



toggle the sheet, tack, and halyard on, and the sail is ready to set; the batten parrels can be toggled at any time afterwards, as they only effect a good 'sit' to the sail.

"The tiller should be formed as if double, *i.e.*, one part leading aft, and used as mizen boomkin, and the other on fore side of rudder with a U bend in it, to allow it to clear mizenmast. Thus fitted when working ship, on putting the helm down the mizen sheet is brought to wind, and main sheet is off, consequently she would turn like a bicycle; or when the helm is put up, mizen sheet is thereby eased, and off she must go.

"A battened sail can easily be reefed 'in stays,' *i.e.*, while going about, without even checking the boat's way, for the battens do not require the reef points to be tied, except for neatness, unless it is a very deep reef.

"A boat thus rigged can be hove-to in bad weather at sea, or, when waiting for tide into harbour, thus: take the mainsail off the mast, bunch yard and boom together, and span it with a rope: to the centre of the span fasten your boat's hawser, let the sail and battens hang loose, heave it overboard, and pay out the hawser; lower the mainmast, and haul mizen sheet fore and aft. Thus she will ride head to wind, and the sail will break much of the sea. The storm main lug may then be got ready, in case you have to cut and run."

Mr. Powell found, in canoe sailing that with battens he could carry much more sail (in the ratio 5 to 7) and the canoe would lie closer to wind. Also in running the canoe was much steadier, and did not roll so much as with the sail without battens. In gaff sails, where the peak halyards assist in keeping the sail flat, or in any sail that is well cut and can be kept flat, the advantage of battens will not be great. However, lug sails are very difficult if ill cut to keep flat, and battens in these may be found of service.

The regular "Chinese lug" was thus described by "Mercator," a writer in the *Field* in 1871.

"Almost every district in China has a distinctive type of sail, some highly peaked, others with little or no peak, some with the leech greatly rounded at the peak, others with it cut almost or quite straight, some very narrow at the head and wide at the foot, others wide at the head and much the same width all the way down, some rigged on the starboard side, and others on the port side of the mast, some with sheets leading from all the battens, others with sheets from the lower ones only; in fact, the changes are rung in almost every conceivable way, but all are provided with a brail, but which more resembles in its uses a topping-lift. As to the material of which the sails are made; matting is that most usually

employed in native craft of any size, this article being extremely cheap in China, and when dry comparatively light; but for small boats, twenty to twenty-five feet gigs, and the like, a stoutish duck is the best, both for wear and look.

“The battens, it will be seen (*see* Fig. 59), are so arranged that the top and bottom ones do duty for yard (or gaff) and boom respectively, the intermediate ones radiating more or less sharply, according to the shape of the sail. The number for a gig would be five or six, to be increased with the size of the sail. To each batten is fastened a loop or parrel, if one may so call it, generally of rattan, but occasionally (in very small boats) of rope. The shape and position of these loops are indicated in the following sketch,



X Y being the batten, the dotted line the loop, and Z the position of the mast, looking down from above. From this it is apparent that these loops do duty as parrels; and, the battens being made of bamboo, there is nothing to prevent the sail being easily hoisted and lowered, even when to windward of the mast. There is no tack proper, but the lower batten is made fast to the mast at the point where they intersect. The halyard (M) exactly resembles the simplest form used with lug sails, and is made fast to the forward portion of the upper batten, the exact place being regulated by the shape and sit of the sail. The luff projects 1ft. or 15in. (or even more, according to the size of the sail) forward of the mast. The sheets generally lead from several of the lower battens, one from each, and by a little mechanical arrangement are united into one sheet in such a way that the pull is everywhere equal. In some boats, where the sail projects some distance over the stern, two sets of sheets are required, one on each side. The sail when set is trimmed so that the lower batten is parallel to the keel. The brail or topping-lift is fitted in a very simple and efficient manner. A line leads from the masthead down the inside of the sail (*i.e.*, the side on which the battens are), through an eye 1ft. or 2ft. from the after end of the lower batten, up again on the outside of the sail through another eye rove in the end of a short pendant from the masthead, and down again to the point where the lower batten and mast intersect, where it is made fast ready for use. The sail thus hangs in the bight of the brail as in a sling. The following sketch (Fig. 59) illustrate the sail described.

At Shanghai the completely battened lug sail is in much favour, and the description of yacht in use there will be found illustrated on Plate VIII., which represents the Charm, Mr. C. J. Ashley.

It will be seen that the keel in form is crescent-shaped, or, in other words, the curve given to the keel tends upwards instead of downwards, as is usual in ordinary vessels. In the East this kind of keel is common, and we find it carried out to an enormous extent in the model of a Bombay yacht (the property of the Duke of Edinburgh) in the Naval Museum at South Kensington. The keel of this yacht is quite like a half-moon, but the draught forward is much greater than aft. There is no advantage in thus giving a vessel "gripe," as the centre of lateral resistance could be got forward without such an extraordinary and, when a small draught is necessary, inconvenient contrivance.

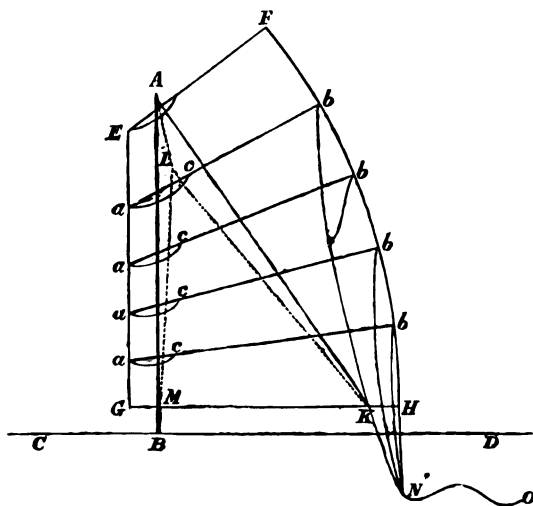

FIG. 59.

"AB, mast; EF, head of sail; EG, luff of sail; *ab*, battens; CD, line of gunwale; GH, foot of sail; FH, leech of sail; *ac*, loops or parrels; AK, brail leading through eye at K, the position of the brail on starboard side of sail being shown by dotted lines KL, AL, and LM; the letters *bN* denote sheets hanging loose (over the sail instead of abaft it, as they would be when hauled in for sailing), leading into a single one, NO."

The Charm, it will be seen, is extremely shallow, and would take little ballast, as her weight of hull, spars, fittings, and stores would bring her down nearly to the load water-line. The floor timbers in the fore-body, it will be seen, are lower than those of the midship body, and abaft the midship section the timbers retain the flatness of the floor in the middle-body. One peculiarity of the after-body is, that the timbers are projected at right angles from the dead wood, and the gentle curve which we find in English yachts (made by filling up the angle in the runs) is not found in the Charm.

The length of the yacht is about three times her beam, and she thus has great stability; and this she needs, looking to the loftiness of her

canvas. The chief excellence of the Chinese lug consists in the flatness of its surface. This flatness is brought about by battens, which are extended across the sail, as shown by 4 (Fig. 60) on the plan, and by the use of bowline-bridles the whole way up the after leach of the sail. These bridles lead into two bowlines, and the bowlines again into one part, the latter leading to a double block on the bumpkin (8) extending from the taffrail, so that hauling on this single part brings an equal strain on each bowline-bridle. These bowline-bridles are numbered 7 in the drawing. To keep the sail into the mast a lacing (5 in the drawing) rove through parrels which extend from the luff of the sail to well into its belly; these parrels are distinguished by 6 on the sail plan. Beyond this, a hauling parrel is used to keep the

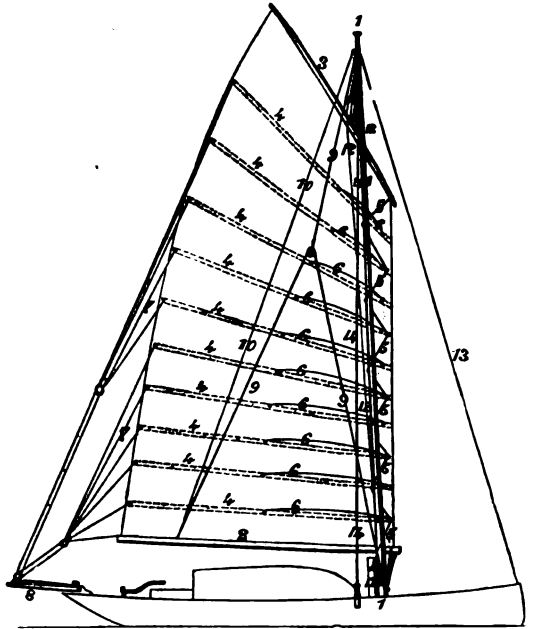

FIG. 60.

yard into the mast, marked 12 on the drawing. The standing part is made fast to the yard, passing round the mast, then through a block on the yard, the hauling part leading to the deck. The topping-lift shown by No. 9 explains itself, the line denoted by figures 10 being the topping-lift on the port side. The topping-lift passes through a single block at the masthead. The other figures indicate as follows: 1, the mast; 2, the boom; 3, the yard; 11, main halyards; 13, forestay; 14, shroud. The mast can be unshipped at pleasure, as the drawing shows; and, as there is neither bowsprit or topmast, such a vessel could be dismantled in a very few minutes. The Charm has a booby hatch, and under this there is a great

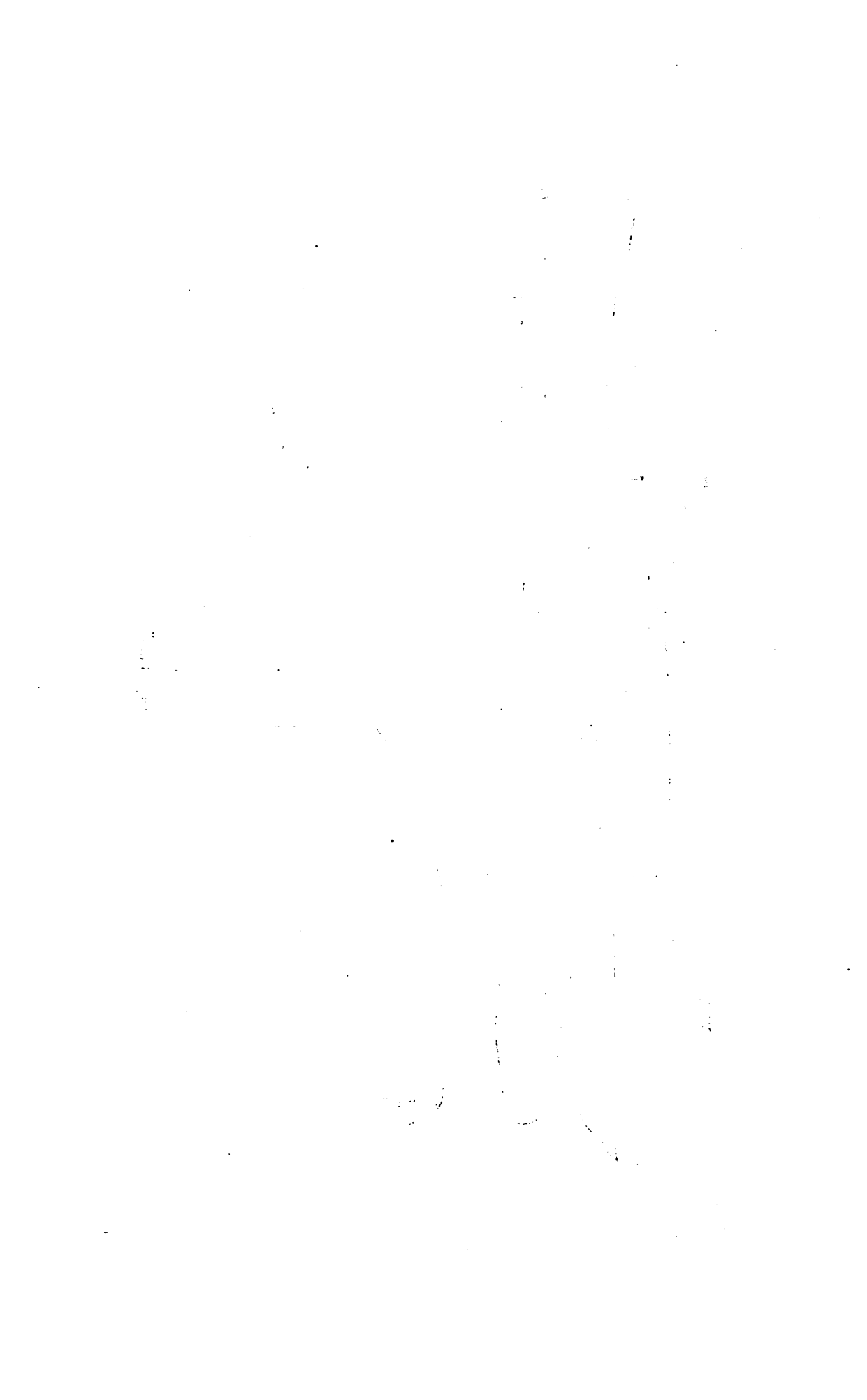
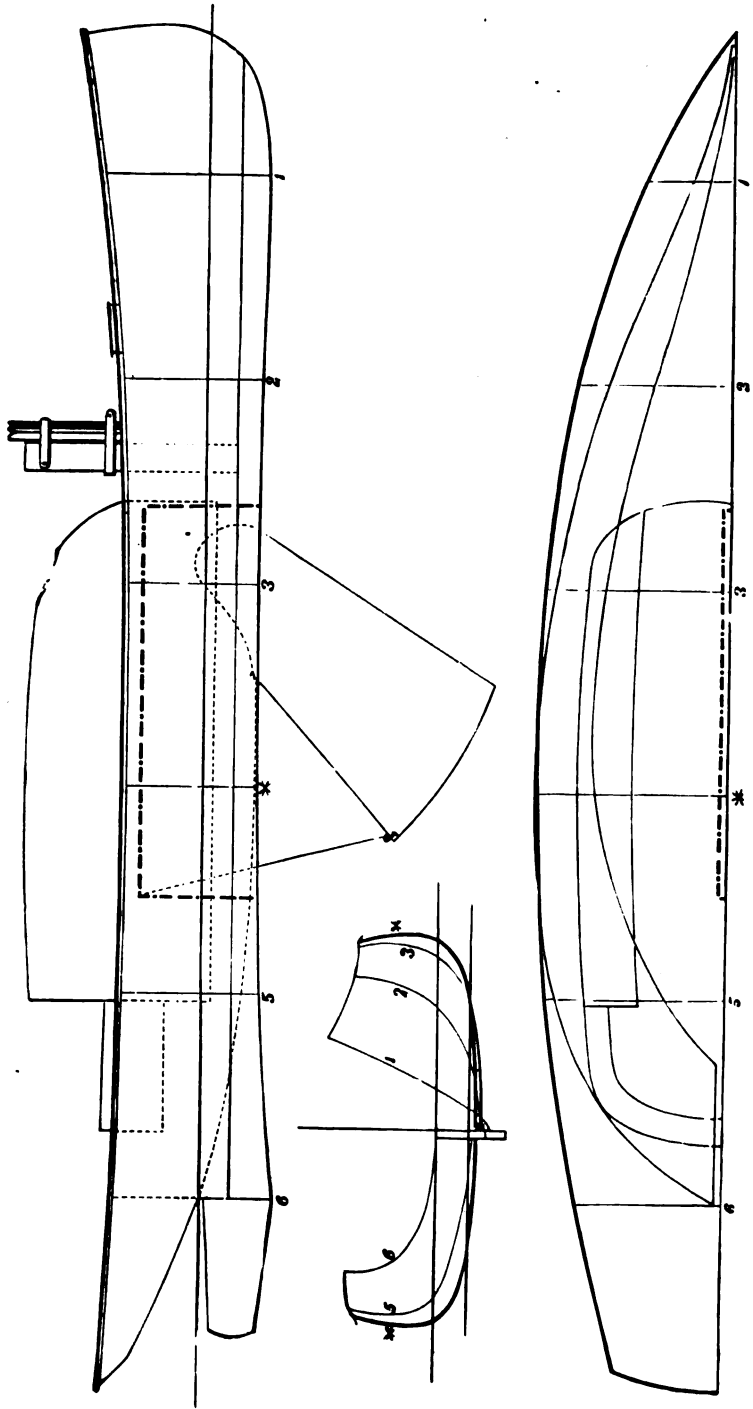

PLATE VIII.



"The Charm."

deal of room. The centre-board is shown in the sheer plan lowered to its full depth, and the lines — . — show its case. When hauled quite up, the board would protrude above this case; but this need never be done, as the draught could not thereby be made less than it is at all times aft. The dotted lines above the keel aft show the intersection of the timbers with the dead wood; the dotted lines in the middle-body show the plan of the cabin, and the cockpit forming the entrance to the cabin.

The following table refers to Plate VIII., representing the yacht Charm :

No. of Sections.	Half-breadth at Load Water Line.		No. of Sections.	Half-breadth No. 2 Water Line.		No. of Sections.	Height from Load Water Line to Plank Sheer.		No. of Sections.	Depth from Load Water Line to under-side of keel.	
	ft.	in.		ft.	in.		ft.	in.		ft.	in.
1	1	2	1	0	8½	1	3	4½	1	1	8½
2	3	10½	2	2	4	2	2	8	2	1	8
3	5	6	3	4	0	3	2	5	3	1	7
4	6	1½	4	4	2	4	2	5	4	1	7
5	5	4	5	1	9½	5	2	6½	5	1	9
						6	2	9	6	2	2

Distance the sections are apart, 6ft. 6in.

Distance No. 1 section is from fore side of stem at L.W.L., 4ft. 6in.

Distance water lines are apart, 1ft.

Length on L.W.L., 37ft.

Beam on L.W.L., 12ft. 3in.

Beam, extreme, 12ft. 5in.

Displacement, 9·26 tons.

Centre of displacement below L.W.L., 0·736ft.

Metacentre above centre of displacement, 8·2ft.

Area of sail, 990 sq. ft.

Luff of sail, 35ft.

Leach of sail, 54ft.

Foot of sail, 26ft.

Head of sail, 21ft.

Tonnage by R.T.Y.C. rule, 20·3 tons.

Area of L.W.L., 295 sq. ft.

Displacement for lin. of immersion at L.W.L., 0·7 ton.

SPRIT SAILS.

Sprit sails formerly were in high favour, but during the last twenty years they have gradually fallen into disuse. It is still a favourite rig, however, among watermen, and they probably adhere to it because the sprit stretches the sail so flat. The old Ryde wherries, celebrated for their fine weatherly qualities, were sprit-rigged, but of late years they have generally adopted the gaff instead of the sprit. The advantages of the sprit over a gaff for setting a sail in a small boat cannot be denied, as by crossing the sail diagonally it takes up all the slack canvas in the middle of the sail, even if it be an old sail. On the other hand, a sprit is an awkward spar to handle, and it need be much longer and heavier than a gaff to set similar sails.

In small boats the luff of the sail is usually laced to the mast through eyelet holes about 2ft. apart; the throat is secured to an iron traveller, or sometimes to a grommet strop. In large sails galvanised iron rings or mast hoops are used. The tack is lashed to a small eyebolt screwed into the

mast. The sail is hoisted by a single halyard and belayed to the gunwale to serve as a shroud. The foresail is also belayed by a single halyard, and belayed to the opposite gunwale. The sprit is supported on the mast by a

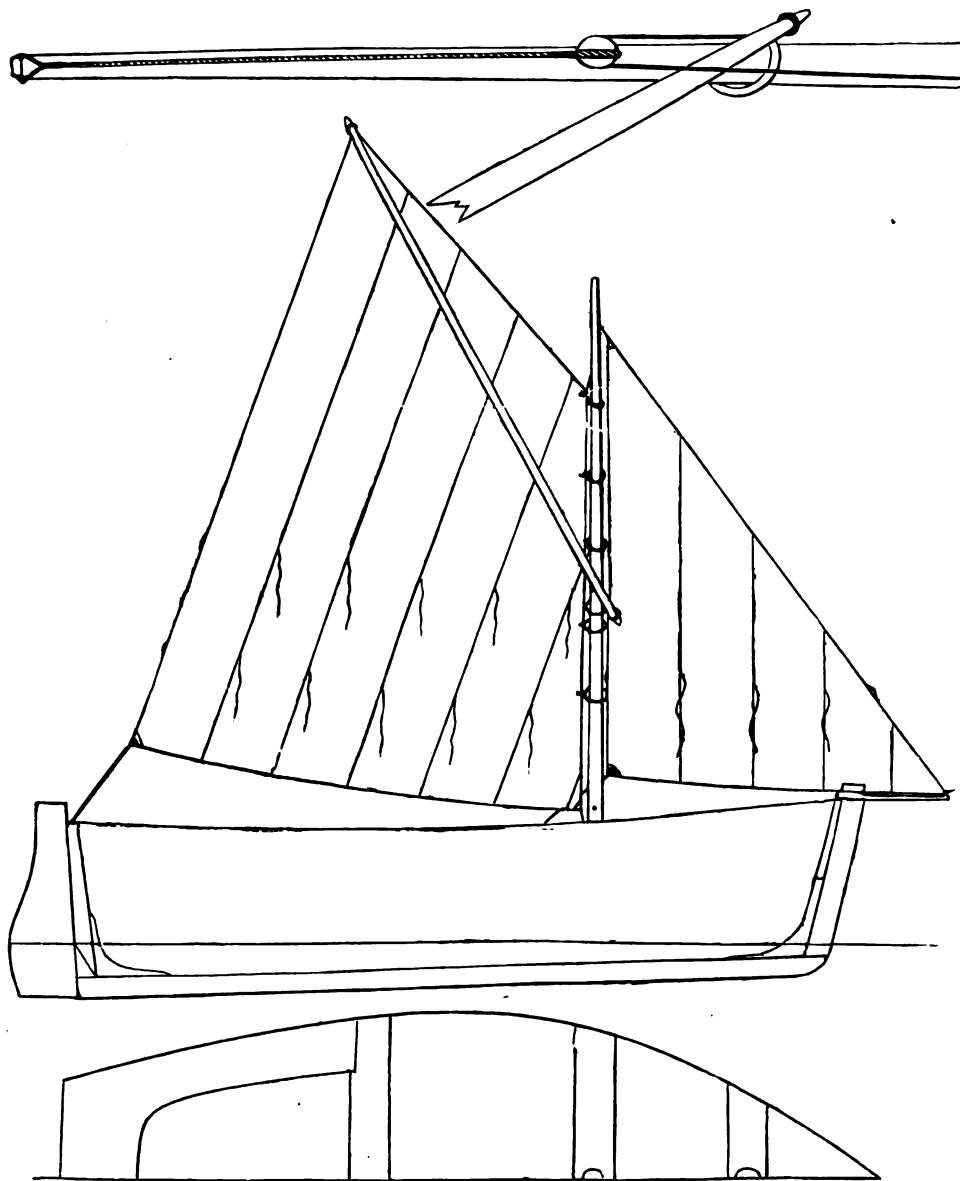

FIG. 61.

strop called a snotter; this strop is a piece of rope with an eye spliced in each end; it is put round the mast, and one end rove through an eye; the heel of the sprit is put in the other eye. After the sail is hauled up on the

mast the upper end of the sprit is put into the eye or loop on the peak of the sail, and then shoved up and the heel slipped into the snotter. The sail is then peaked by pushing the snotter and heel of sprit as high as required; the sail is then sheeted. If the sail is large and the sprit heavy, a traveller and whip purchase are used. (See Fig. 61.)

A pendant with a running eye in it is fitted over the masthead; at the lower end of this pendant is a block, through which the hauling part is rove, one end being fast to the thwart. Sometimes a gun-tackle purchase is used instead of the whip purchase. Either is to be preferred to the snotter alone, as without any other support the snotter will be continually slipping

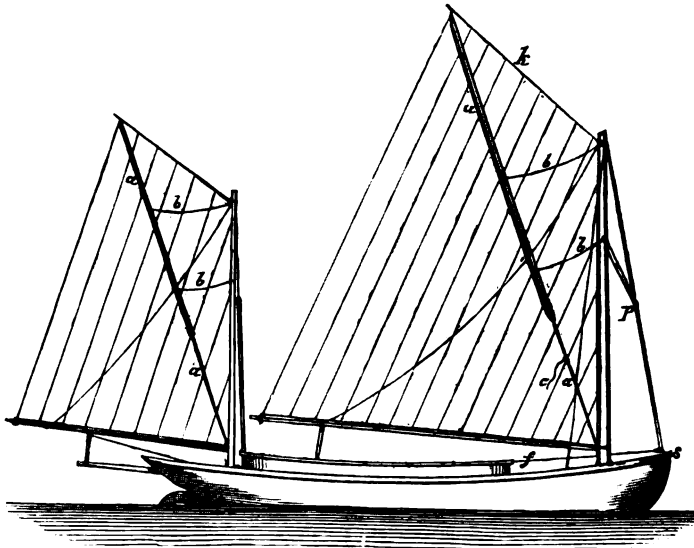

FIG. 62.

down. If there should be much wind when the snotter slipped down the mast the heel of the sprit might go through the bottom of the boat; and this accident has very often happened. The waterman's remedy for this is wetting the mast, but the single whip purchase is to be infinitely preferred, as it not only keeps the sprit from slipping down, but enables the sail to be set better.

An improved form of the sprit sail rig is in use in America, an illustration of which has been made by Mr. R. B. Forbes, as shown (see Fig. 62). The sprit comes down to the gooseneck of the boom and is inserted in a pocket *a*, stitched diagonally across the sail: *b b* are brails on both sides of the sail, but leading through one purchase block *p*; *p*, of course, is a double block. The standing part of the purchase is fast to the stem at *s*, then leads up through the block *p*, down through a block on the stem *s*,

and the fall *f*, to a cleat inside the waterways. *c* is a reef point, one on each side of the mast, round which they are tied when the sail is reefed. When reefing the mast is allowed to rake aft, either by having a long slotted step for the mast, or by pivoting it in a tabernacle. (See the French rig, Plate VI.) The process of reefing is very simple: luff into the wind, slack up sheets, haul on the brails; make everything fast, rake the mast, and fill away again. Fig. 63 shows the sails reefed with the upper part of the luff of the sail brailed up. To make a neater "brail up" another pair of brails might be attached to the head of the sail at *k*, and lead to *a*, then to the mast head down to the block *p*. This forms a very easily reefed sail.

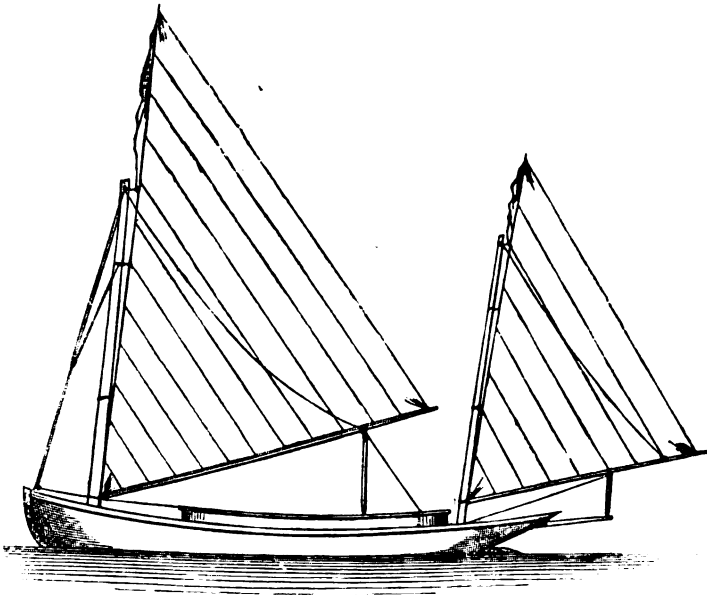

FIG. 63.

Fig. 64 represents another American rig (drawn by Mr. Forbes), and has the advantage of the sails being in three pieces. The main and mizen are fitted on the lateen plan, but are shoulder of mutton in shape. *a* is the halyard made fast to the yard, and leading over a sheave in the mast head to the deck. *B* is another halyard leading through a bull's eye at the mast head and belayed to a cleat on the heel of the yard at *f*. The yard or reefing boom *d* is jointed to a traveller *c*. The reefing tackle is shown by *e*. *r r* are reef points. The foresail is hanked to a wire stay. A short club yard, *g*, is laced to the foot of the foresail; the fore sheet block is fast to this yard, and works on a traveller across the deck.

To reef the sails luff up head to wind and cast off the halyard *a*, and the sail will lower until the traveller *c* rests on the boom at *o*, *b* of course

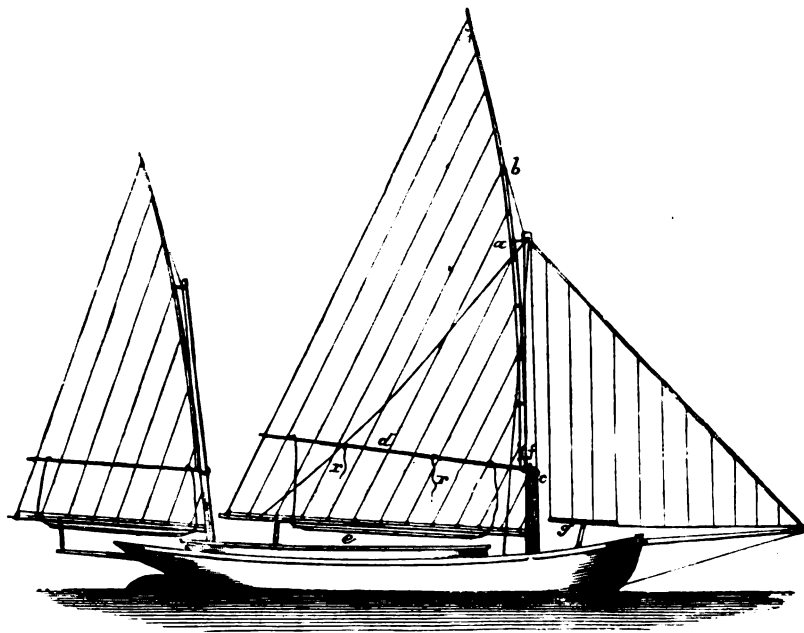

FIG. 64.

coming down to the bull's eye on the mast head. Haul on the reefing tackle *e*, and tie the points at leisure (see Fig. 65). Next let the foresail

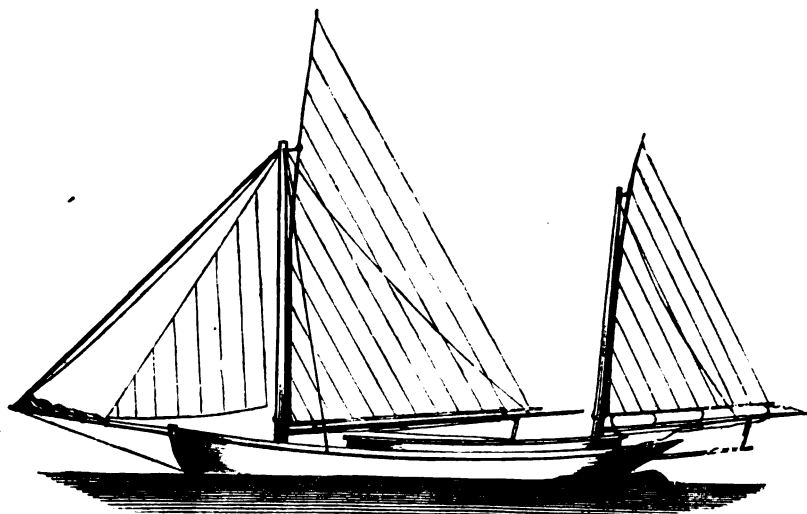

FIG. 65

run down, and stow it on the bowsprit. To further shorten sail stow the mainsail. The small jib is set flying.

THE SLIDING GUNTER.

The sliding gunter, it has been claimed, has all the advantages of the lug sail; has lighter spars compared with sail area, and is less dangerous. This may be true enough of the old-fashioned dipping lug, which no doubt is a dangerous sail, but we very much question if the gunter will ever be able to compete with the balance lug, in weight of spars or in handiness, effectiveness, or safety.

The mast, it will be seen by Fig. 66, is in two pieces, the upper part sliding on the lower by two irons. When hoisted the lower part of the luff of the sail is laced to the mast. The irons should be of brass or of galvanised iron, covered with leather, and they should be kept well soaped or greased.

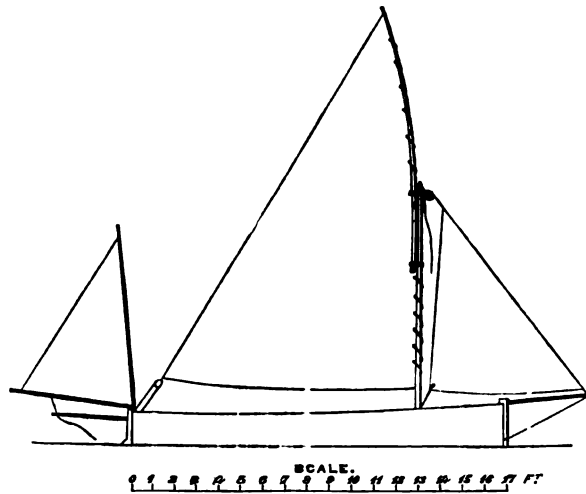
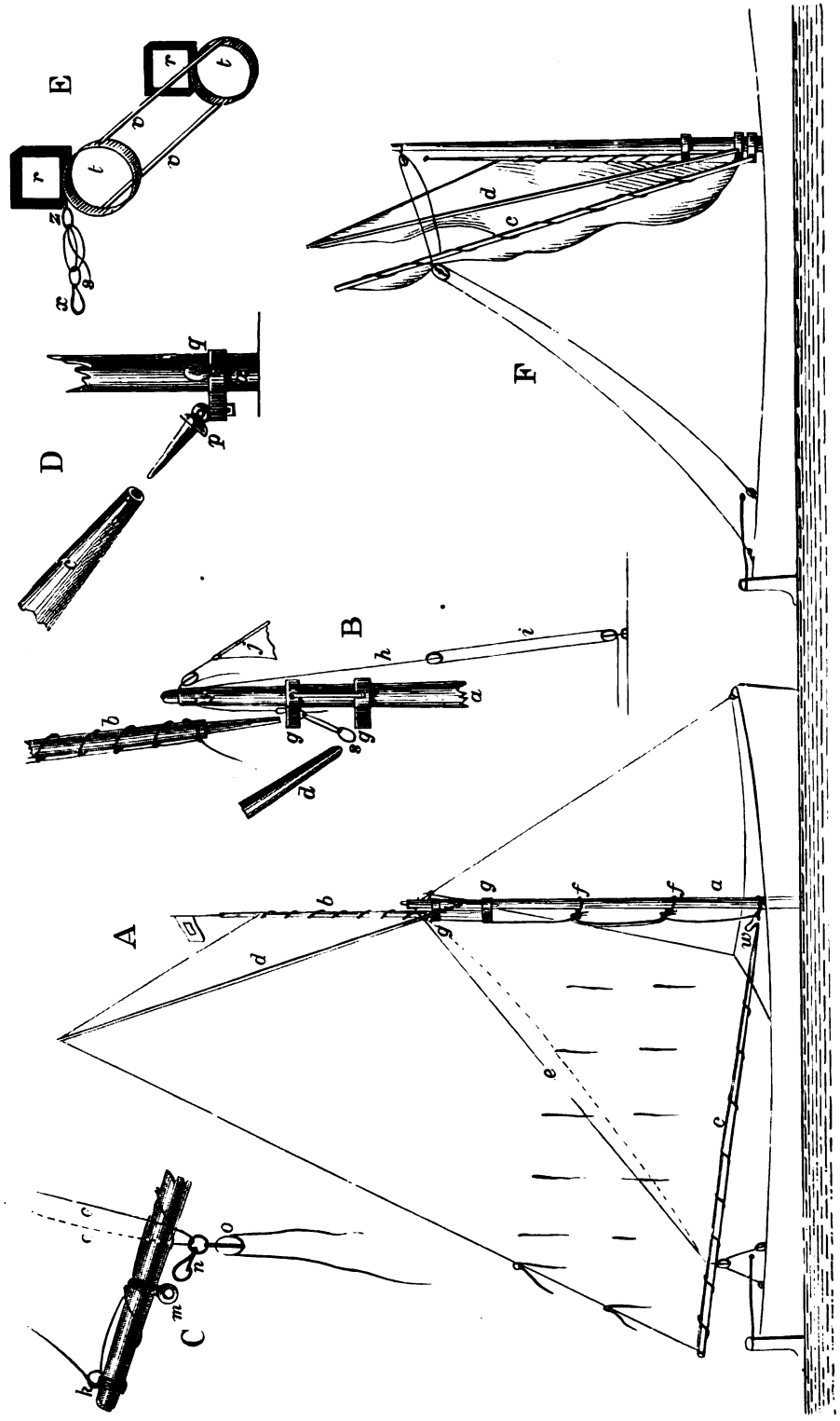

FIG. 66.]

The irons are fitted to the upper part of the mast (usually termed the yard), and should fit the lower part very loosely, as a common peculiarity of the iron is to jam either in hoisting or lowering—mostly during the latter operation—especially if the boat be heeled. The yard is hoisted by a single halyard rove through a sheeve-hole at the lower masthead. The halyard is fast to the heel of the yard, and a score is cut out for it on the fore-side of the yard; it leaves the yard at the upper iron. The gunter rig is sometimes applied to long boats with three masts, a stay foresail being invariably used. The sketch given shows a sail fit for a 17ft. boat (such as Plate II.), and has foresail and Mudian mizen.



PLATE IX.



Gunter Sprit Rig.

GUNTER SPRIT RIG.

Some years ago Mr. Baden-Powell brought out a rig which was a combination of the gunter and sprit. He first fitted it to canoes, and afterwards to a centre-board gig. The objects sought were a lofty sail, with a mast readily shortened for going under bridges, &c.; reduction of top hamper or weight when reefed down; and mast and spars of such length as could be stowed inside the boat. The rig was intended entirely for cruising, and not meant to compete against the balance lug for racing. The following diagrams (Plate IX.), on a $\frac{1}{4}$ inch scale, will show the rig:

- | | |
|---|---|
| <p>A shows the sail set.
 <i>a</i> is the mast.
 <i>b</i>, the topmast.
 <i>c</i>, the boom.
 <i>d</i>, the sprit.
 <i>e</i>, topping-lift; the ticked line shows the topping-lift to leeward.
 <i>f</i>, mast hoops.
 <i>g</i>, gunter irons.
 <i>w</i>, a hook on the gooseneck to hook to the reef cringles when the sail is reefed.
 B is a view of the mast head.
 <i>a</i> is the mast.
 <i>b</i> is the topmast unshipped from the gunter irons <i>g</i>.
 <i>d</i> is the sprit unshipped from the snotter <i>s</i>.
 <i>h</i> is the standing part of the halyard passing through the sheave at the mast head, and fast to an eye on the upper gunter.
 <i>i</i> is the purchase for the halyard, the standing part fast to the lower block.
 <i>j</i> is the head of the jib.
 C is a view of the boom end.
 <i>k</i> is the clew of the sail lashed to boom.
 <i>m</i> is a grommet strop with thimble eye.
 <i>n</i> is a clip or spring hook on swivel ready to be hooked into the eye <i>m</i>.</p> | <p><i>o</i> is the main-sheet block.
 <i>e</i> is the topping-lift.
 D is a view of the boom and gooseneck.
 <i>p</i> is the gooseneck on the mast <i>a</i>.
 <i>c</i> is the boom ready to be shipped on gooseneck.
 <i>q</i> is a block for the fall or hauling part of the main halyards. (This block can be on the mast thwart or deck; see B.)
 E is a bird's-eye view of the gunter iron.
 <i>r</i> is the square part into which the topmast is stepped.
 <i>t</i> is the ring traveller shipped on the mast.
 <i>v</i> two iron stays or connecting rods which hold the gunters together.
 <i>s</i> is the snotter loosely laced.
 <i>x</i> is an eye splice to take the sprit, with a thimble seized in at <i>s</i>.
 <i>s</i> is another thimble with a tail lashed to the gunter. A rope or lanyard is spliced to the thimble <i>s</i>, and rove through and through the thimbles <i>s</i> and <i>s</i>, so that the snotter can be made of a length to suit the length of the sprit.
 F is a view of the sail brailled up by the topping-lift, and with topmast housed.</p> |
|---|---|

The sail is laced to both boom and topmast, and *tied* to the mast hoops. To stow the sail, lower away by the halyards (which are fast to the upper gunter iron); unship the sheet block from the boom; unship the sprit; unship the topmast from the gunter; unship the boom from the gooseneck; untie the sail from the mast hoops; roll up, and stow away. The mast can be unstepped or not at pleasure.

In large 16ft. craft it was found necessary to have a fore stay.

A down-haul should be bent to the gunter iron.

To reef, lower the topmast (the sprit of course comes down with it) by the halyard to first or second reef band ; lay the foot of the sail neatly in folds along the boom, and tie round the boom with the reef nettles or points.

FALMOUTH LUGGERS.

The following excellent description of the Falmouth luggers was written by Mr. Wilcocks :—

“The mizen-mast is shown after the manner of the Mount’s Bay craft, much more taunt than is necessary for setting the ordinary mizen, so that the second foresail may be set in its place in light weather. The only different arrangement required would be a longer outrigger, and a mast-hoop or traveller on it, to accommodate the set of the ordinary mizen. The bowsprit should be somewhat longer than here represented (Fig. 67) to get

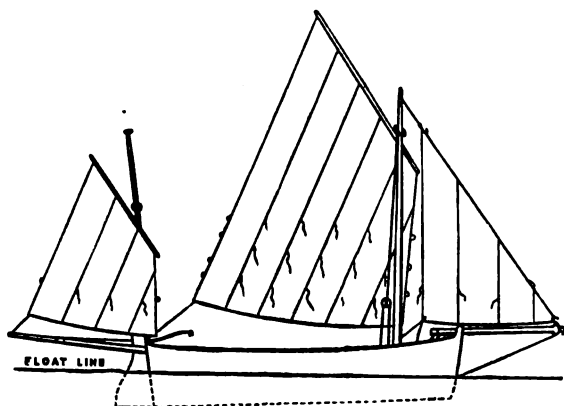

FIG. 67.

the jib a little further out. If the mast were stepped at the position shown by the heel of the bowsprit, the rig would be like the Falmouth boats, and it is a good plan to have such a boat fitted also in this manner. The omission of a jib in the Falmouth boats is for the convenience of dispensing with a bowsprit whilst running alongside shipping. Fig. 68 is a sketch of the Falmouth waterman’s rig. It is in use for boats from 14ft. long up to substantial little craft, apparently of as much as 7 or 8 tons. From the mast being so far forward, we might imagine a boat thus rigged would pitch heavily in a head sea, and I cannot altogether divest myself of this impression ; therefore, should prefer to have two places for stepping the mast, with a moderate-sized jib to balance the after cauvas, when the mast

is in its after position. Boats intended to carry their masts so very far forward should be built with additional free-board forward to allow for plunging if caught in troubled water. This is well attended to in the Guernsey fishing boats, which are built very high forward, and answer well. In a large boat it is a good plan to have a horse of galvanised iron across the stern for the main sheet, with a single and double block, the double block grommeted to a thimble traversing on the horse. There will then be no sheet to tend in going about when under the mizen and lug foresail, the only thing required being possibly a touch to the double block, to get it well down to the extremity of the horse. In making the horse, the smith must not forget to weld on a collar to either end, that the traversing thimble may not slip round the turns of the horse at the sides of the boat. In small boats, up to 18ft. in length, a single sheet made

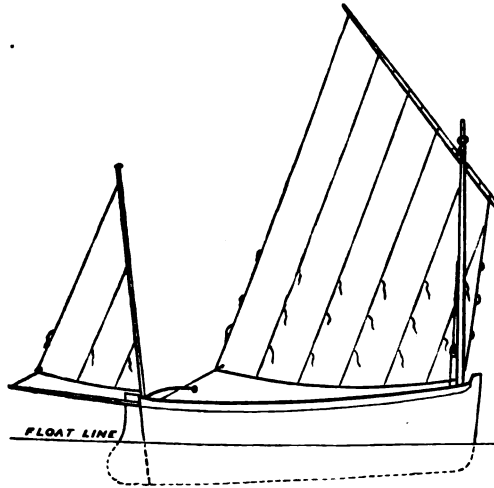

FIG. 68.

fast to a belaying pin through the transom board, is the safer plan, unless the boat be a deep-bodied craft, especially built for sailing. It is often desirable to shorten sail by tricing up the tack in all kinds of sailing craft. For this a tackle must be provided to keep a strain on the luff of the sail, as the peak would otherwise immediately fall on letting go the tack. The upper block should have a pair of sister hooks, which can easily be attached to the second cringle of the sail, and by aid of a small block secured close to the slings of the yard, the tack can be triced up when required. It is an unusual thing to trice up the tack of a lugsail; nevertheless, in anything but a small boat, the handiness is unquestionable, and, in fact, in a boat fitted with one large lugsail, it is often necessary to do so."

LOWESTOFT LATEEN SAIL.

The lateen rig has not been much adopted on the English coast, owing probably to the length and weight of the yard required, and the awkwardness of the reefing arrangements. Sometimes the sail is reefed along the foot, as shown in the engraving of a Lowestoft lateen (*see* Fig. 69), and

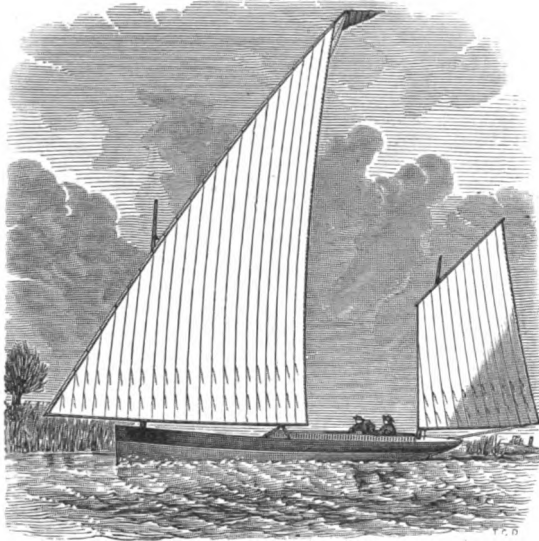

FIG. 69.

sometimes along both foot and head yard. In the sketch given, the sail is shown with very great peak, but the sails are sometimes planned with the yard more across the mast, and with a longer boom. A lug mizen is generally a part of the rig. The boom is kept to the mast by an iron traveller or ring.

The settee sail is an adaptation of the lateen; the yard does not reach quite down to the tack, so that a short up-and-down luff is obtained to the extent of two or three reefs as shown in Plate V.

ALGOA BAY LATEEN.

The lateen rig is met with all over the world, and is much in use on parts of the African coast. In Algoa Bay, Cape of Good Hope, a curious contrivance for hoisting the sail on sheer masts instead of on a single mast has been adopted; the plan is common to the prahus of the Eastern

seas, and to the river rafts of the Mayaquil rivers. Mr. William Fleming, of Port Elizabeth, Algoa Bay, had a boat fitted in this way as shown by the accompanying sketch drawn by him (Fig. 70); the rig is thus described :

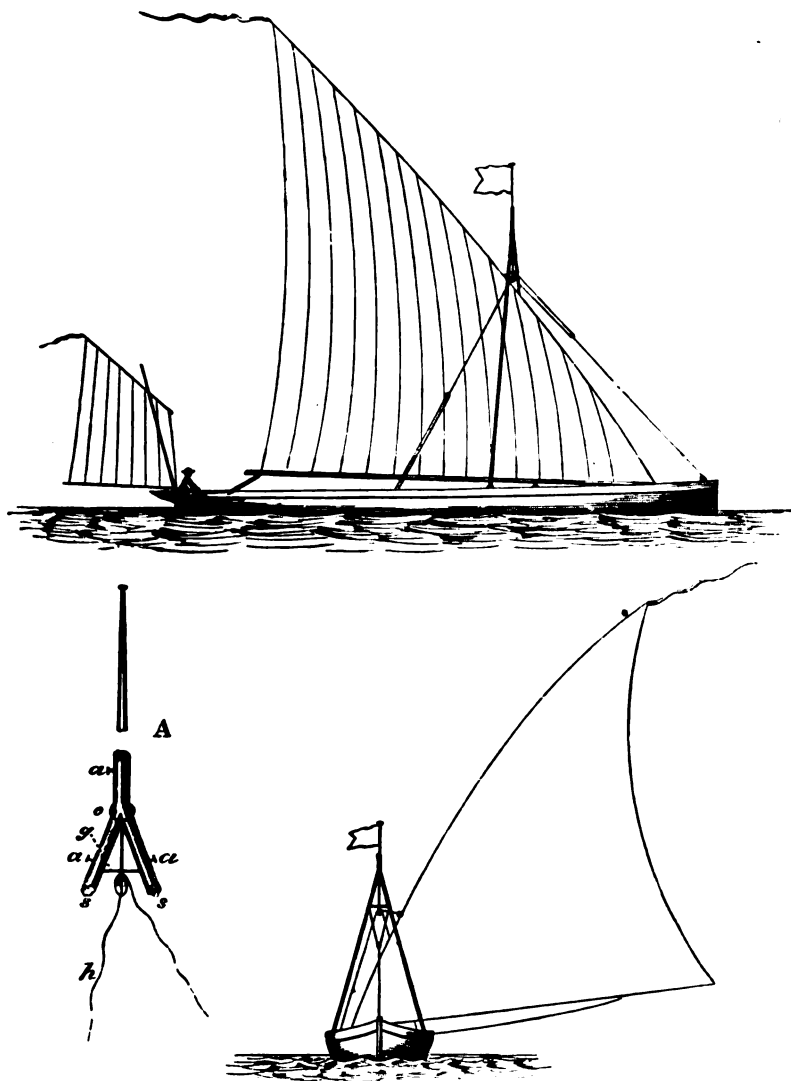

FIG. 70.

In lieu of the usual way of fitting and stepping a mast, two short poles are fixed triangle fashion, and secured to each side of the boat with a goose-neck, so as to move fore and aft. The heads of the poles fit into sockets, *s s* (diagram A), which can be made either of iron (galvanised) or of gun metal; a transverse bar, *g*, keeps the sockets from

opening at the throat. The sockets must be made deep, to fit the spars well in, and a small bolt, *a a a*, running right through for further security. The upper socket will hold a flag pole. The forestay will be fast to each mast by a bridle, and the runner and pendants will on either side be fast to a mast. A double block with tail is made fast round the neck of the sockets at *o* (A), for the halyards to work through. The standing part of the halyards is fast on the yard, then leads through the block under the throat of the socket, through a block on the yard, and back through the double block. The advantage of the two mast plan is obvious—no dipping of a lug when going about, and affording scope for any variety of cut

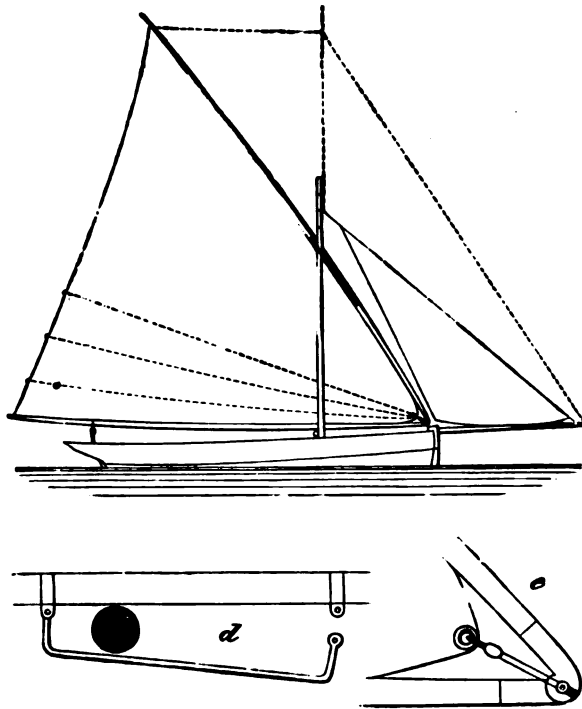

FIG. 71.

sail, peculiarly adapted for lateen rig. Masts and sails can be lowered by the run by just slacking up the forestay, and hauling on it again when required to make sail, without starting halyard, sheet, or tack. The tack of the sail may be fitted to travel on a horse, and kept in any position by a rope rove through a single block, one to be fitted on each side. Wire rope should be used for forestay and the pendants. The plan now suggested has this advantage, that everything can be lowered at a moment's warning, masts and sails snugly stowed in the boat, and if necessary to use oars, no masts stand in the way to prevent doing so effectually.

Commander T. B. Horner, R.N., has proposed the following plan for a lateen sail (Fig. 71) :

The yard at its heel is pivoted into the fore end of the boom *e*, and can be lowered so as to reef the sail diagonally by the foot, as shown; while the "down tackle" at the mast keeps all in place, and a leathered bar (which may be called the "truss-rod"), fitted to open on a hinge (*d*), acts as a traveller to bind the yard to the mast, and to follow the shifting of it aft as reefed; while a horse and traveller abaft the rudder-head would be useful to keep the boom down in working to windward. The main sheet and down-tackle being overhauled when lowering the yard for furling, the sail would make up upon the boom.

The tack might be triced up like a cutter's, by having a few hoops or a lacing on the yard; while, by being rounded at the luff, a single block purchase, making fast to a belaying pin formed by lengthening the pin of the pivot (as shown at *e*), would stretch all flat again with ease.

A topmast could be added to the rig, and a topsail set as indicated by the dotted lines, the sheet of which might be fitted with an india-rubber stopper at the bitts, to meet the spring of the lateen yard.

CHAPTER X.

BRIGHTON BEACH BOATS.

THE Brighton beach boats enjoy a very high repute on the South Coast, and no doubt they are very capable little vessels, and well adapted for the work they are put to. As there is no sheltered anchorage at Brighton, the boats are hauled up on the beach; and a more or less flat floor is necessary for this operation, in order that the boats may be floated as far up on the beach as possible. The boats are fitted with stout bilge keels three or four inches deep, on one of which a boat rests as she is hauled up. Ways are now laid down for hauling the boats up and launching them off; but a few years ago the boats were hauled over the beach, by a capstan, without ways. The latest boats are built with much more rise of floor than formerly, and their sailing qualities are said to be improved thereby.

There are many advantages justly claimed for the Brighton beach boats. They can be run over a sandbank in a foot or two of water to the "smooth on the other side;" whilst the deep boat, of equal length perhaps, must remain pile driving outside in the loup. They can be allowed to take the ground without fear of their not getting upright again; and, if necessary, they can be run ashore to effect a landing. These certainly are advantages which cannot be claimed for a 5-tonner of the modern school, and it is not surprising that for coast work the beach boat is in such very high favour.

Mr. Thomas Stow, of Shoreham, and Mr. Hutchinson, of Worthing, have built many successful beach boats, and the design on Plate X. was taken from a model made by the former. The "fairing" process required the design, as taken from the model, to be modified a little, and the midship section* is a trifle farther aft than it was in the model; but no important departure has been taken from the original lines as first taken off. It will

* The practice in building the Brighton beach boats is to place the midship section at about the mid-length of the boat, and rake it forward a little. Probably better results would be obtained by having the mid-section in the position we have placed it, and, as the after body appears to be all that could be desired as to form and length, there is no object in raking the mid-section forward.

be seen that some portion of the counter is immersed, and we believe that this is admissible under the rules of the Brighton Sailing Club, whose present rule of measurement takes length from stem to sternpost. The design has a trifle more displacement than the generality of the boats; but this can be considered an advantage.

The rig common to all, we believe, is that known as the cutter, and the boats require a very great deal of head sail; but, as the design given (Plate X.) has a finer entrance than is usual, the probability is that such a boat would require less head sail than the ordinary run of beach boats, and would consequently be less hard on her helm.

The boats are decked-in up to the mast, and the counter is also decked, whilst a water-way is built round the midship sides of the boat about 1ft. wide, with 3in. coamings. The centre plates were formerly much larger than that shown in the design; but, with so much keel under the boat, very little plate is necessary, and, indeed, the boat would hang to windward very well without any plate down at all.

The general floor construction of the boats is shown by Fig. D, representing a floor section at No. 6. The floor is joggled to the keel as shown, and shaped to the mould at each section; the floor is then taken out and joggled and bevelled to receive the plank, as the boats are generally clench built. Where they are carvel built the construction is shown by Fig. A, representing the midship section; in either case the heels of the floors are cut through to admit the centre plate. As a rule the heels of the floor timbers are cut off a trifle short so that they do not go right through the case, as shown in A. The heels of the floor timbers are, in fact, tenoned into the centre-board case. The construction at No. 7 station is shown by Fig. B, where considerable depth has to be given to the throat of the floor. Sometimes the floors aft and forward are steamed and bent into their stations, being afterwards removed to be joggled (as shown by Fig. C, representing No. 2 station forward) if the boat is clench built.

The centre-board case is generally of wood with a knee, as shown by *a*, Fig. A, to keep it in its place, and to generally strengthen the floor of the boat.

Greatest length from fore side of stem plumb at L.W.L. to aft side of stern post on deck	21ft.
Greatest beam moulded	6ft. 10½in.
Greatest beam extreme	7ft.
Weight of hull (exclusive of iron plate, iron keel, and ballast, spars, sails, and crew)	14cwt.
Iron keel	4cwt.
Centre plate	1½cwt.
Ballast inside	5½cwt.

Spars, sails, and gear	7cwt.
Crew	8cwt.
Total weight of displacement to L.W.L.	2tons.

Moulding (depth) of wood keel from top to under side, 5in.
 Siding (breadth) of wood keel 4in. amidships, tapering to 2½in. forward and 3in. aft.
 Siding of stern post, 3in.
 Siding of stem, 2½in.
 Siding of floors, 1½in.
 Siding of timbers, 1½in.
 Distance floors are apart from centre to centre, 10in.
 Thickness of plank, ½in. (Clench work.)
 Length of iron keel, 12ft. ; depth, 4in., tapered in breadth fore and aft to shape of wood keel.

SPARS.		ft. in.
Mast, deck to hounds		19 0
Boom, extreme		20 0
Gaff, extreme.....		16 0
Topmast, heel to hounds		16 0
Topsail yard		18 0
Bowsprit, outside stem.....		16 0

Mast is stepped 8ft. from the fore side of stem.

Luff of mainsail.....	16 0
Head of mainsail	15 6
Foot of mainsail	19 3
Leech of mainsail	28 0
Tack to peak earing	30 3
Clew to throat	24 9
Foot of foresail	8 0
Luff of foresail	18 0
Leech of foresail.....	17 0
Foot of jib	16 0
Luff of jib	26 0
Leech of jib	16 0
Luff of jib topsail	24 0
Foot of jib topsail.....	12 0
Leech of jib topsail	15 0

LAYING-OFF TABLES.

Sections.	1	2	3	4	5	6	7	8	9	10	11
SHEER PLAN.											
Heights above L.W.L. to deck*.....	2 9½	2 6	2 3½	2 1½	2 0	1 10½	1 9	1 9½	1 10	1 11	2 0
Depths to upper edge of rabbet.....	—	1 2†	1 3½	1 4½	1 5	1 6	1 7†	1 3†	—	—	—
Depths to top of wood keel.....	—	1 0	—	—	—	—	—	1 7½	—	—	—
HALF-BREADTH PLAN.											
Half-breadths on deck.....	0 10	1 11½	2 8	3 1	3 4	3 3½	3 2	3 0	2 10	2 7	2 3½
Half-breadths on L.W.L.....	0 5	1 3¾	2 3	3 0	3 3	3 2½	2 9½	1 11	0 9	—	—
BODY PLAN.											
Diagonal a	0 9¾	1 11	2 8¾	3 3½	3 5¾	3 5½	3 3½	3 1½	2 10	2 5	2 0½
Diagonal b	0 9¼	1 10	2 8¼	3 4	3 6¾	3 6	3 3½	2 11½	2 5¼	1 10	1 0
Diagonal c	0 8½	1 8	2 6	3 1¾	3 4½	3 3½	3 0	2 5½	1 9½	1 0½	—
Diagonal d	0 6½	1 5	2 1¾	2 7¼	2 9¾	2 8	2 4	1 8½	1 0	—	—
Diagonal e	0 4¾	0 11½	1 3½	1 6¼	1 7½	1 7	1 4	0 10	0 3	—	—

* The deck is flush with the gunwale.

† The heels of the floors at Nos. 2, 7, and 8 stations are not joggled as those at Nos. 6, 5, 4, and 3 are (see diagram B). The ticked line in the drawing represents the lower edge of the rabbet 2½in. from the top of keel.

PLATE X.

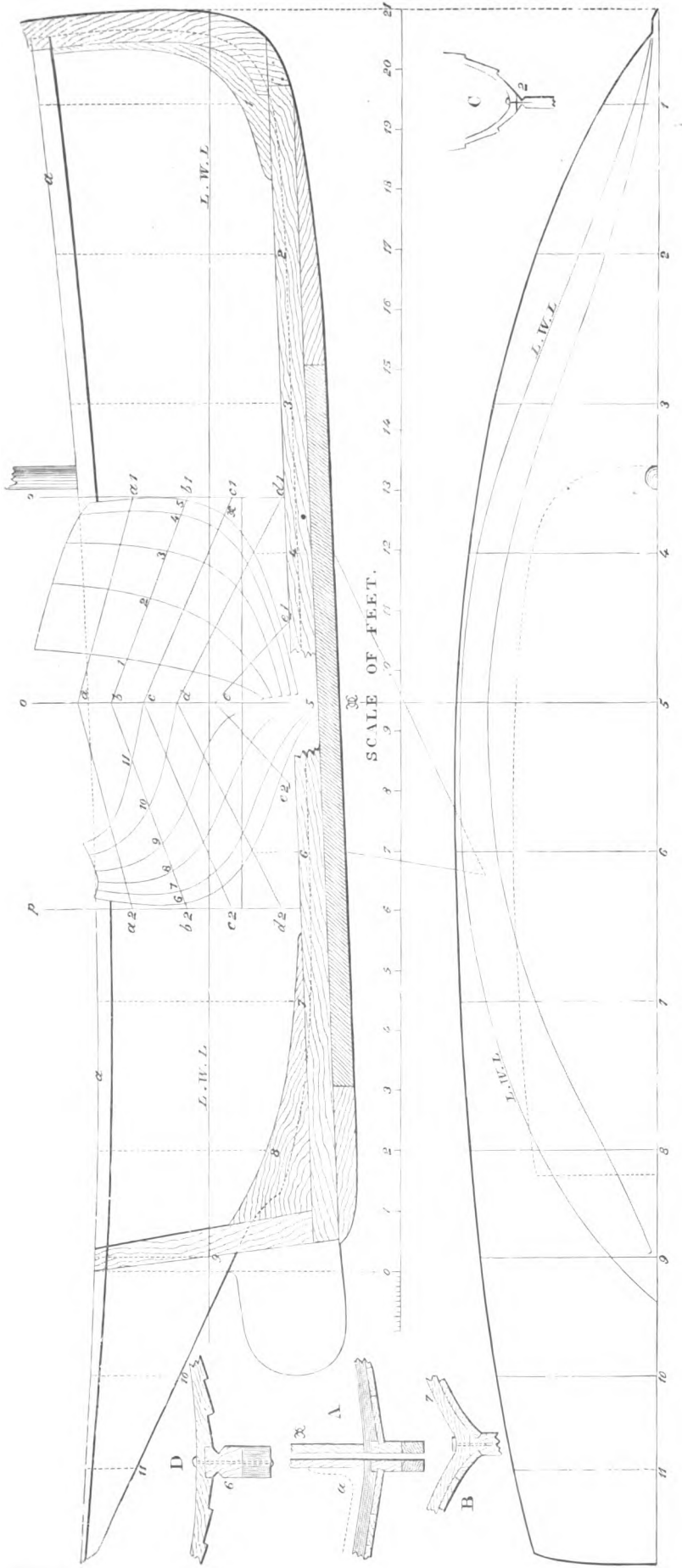

BRIGHTON BEACH BOAT.



No. 1 station is 1ft. 6in. from the fore side of the stem. Nos. 1, 2, 3, 4, 5, 6, 7, and 8 stations are 2ft. 6in. apart. No. 9 station is 1ft. 9in. from No. 8. No. 10 is 2ft. from No. 9. No. 11 is 1ft. 6in. from No. 10.

a diagonal is struck on the middle vertical line *o* (see body plan) 2ft. 2in. above the load water-line; it cuts the side perpendiculars *pp* at *a* 1 and *a* 2 at 1ft. 3in. above the load water-line.

b diagonal cuts *o* 1ft. 8in. above L.W.L.; cuts *p* 4in. above L.W.L.

c diagonal cuts *o* 1ft. 1½in. above L.W.L.; cuts *p* 4in. below L.W.L.

d diagonal cuts *o* 6½in. above L.W.L.; cuts *p* 1ft. 1½in. below L.W.L.

e diagonal cuts *o* 1in. below L.W.L.; and at *a* 1 and *a* 2 is 1ft. 3in. below L.W.L., and 1ft. 4½in. out from *o*.

All the half-breadths given are *without* the plank.

The counter is generally fitted with a kind of large, long fore-and-aft rudder trunk or slot, long enough to allow the rudder to be lifted up through the counter, if necessary, before beaching.

CENTRE-BOARD BOAT
SCALE $\frac{1}{2}$ IN = 1 FT.

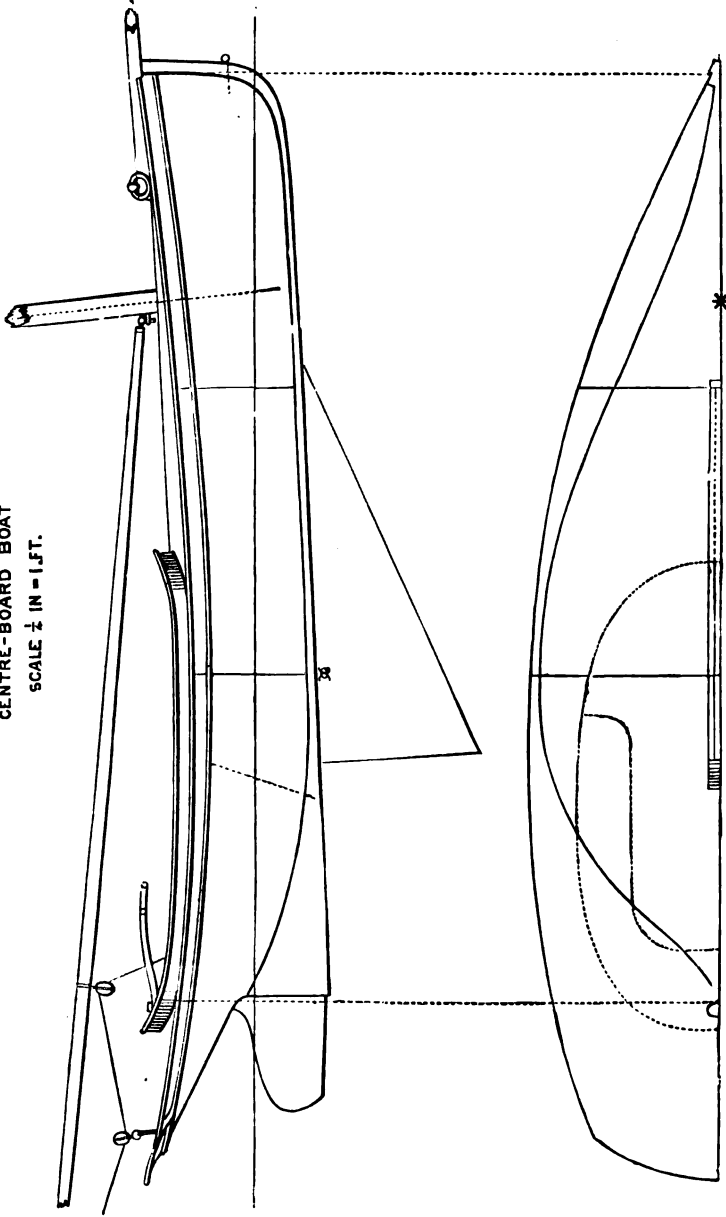

FIG. 72.

CHAPTER XI.

CENTRE-BOARD SLOOPS—THE ALERT.

A DESIGN for a centre-board boat, somewhat shallower than the Brighton Beach boats, and one admirably adapted for smooth-water sailing, is shown on Fig. 72. It will be seen that the mid-section is very much further aft than in any of the other centre-board boats of which lines are given, and in this respect the design more agrees with the American model. The bow is long and well formed, and no doubt a boat built on the lines would be fast.

Length stem to sternpost on deck	20ft.
Breadth, extreme, with plank on	8ft.
Weight of displacement to L.W.L. (about)	1·6 ton.
Weight of ballast	8 cwt.
Mast, deck to hounds	20ft.
Hounds to topsail sheave	6ft.
Main boom	22ft.
Main gaff	12ft.
Bowsprit outside	6ft.
Siding of stem	2½ in.
Siding of sternpost	3 in.
Siding of keel amidships	4 in.
Siding of keel fore end	2½ in.
Siding of keel aft end	3 in.
Thickness of plank	¾ in.

In the body plan, Fig. 73, more sections are shown than there are

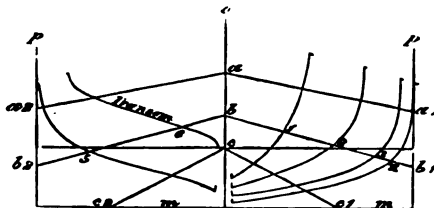

FIG. 73.

stations in the sheer plan; in the sheer plan every other station has been omitted.

LAYING-OFF TABLE.

	1	2	3	4	5	6
	ft. in.	ft. in.	ft. in.	ft. in.	ft. in.	ft. in.
Height above L.W.L. to deck edge.....	2 0	1 8½	1 5½	1 4½	1 4½	1 8
Depths to rabbet line of keel	0 8	0 9½	0 11½	1 1½	0 10½	—
Half-breadths on deck	1 9½	3 0	3 8	3 11½	3 10½	3 4½
Half-breadths on L.W.L.	1 1	2 4	3 5	3 9	2 11	0 1
Half-breadths on diagonal a.....	1 8½	3 0	3 9½	4 0	3 10½	2 10
Half-breadths on diagonal b.....	1 4	2 5½	3 3½	3 7½	2 10½	0 9½
Half-breadths on diagonal c.....	0 8½	1 2½	1 8	1 10½	1 2½	0 1

All the half-breadths are without the plank.

No. 1 section is 4ft. from the extreme fore side of stem.

No. 2 section is 3ft. from No. 1.

No. 3 section is 3ft. from No. 2.

No. 4 section is 3ft. from No. 3.

No. 5 section is 3ft. 6in. from No. 4.

No. 6 section is 3ft. 6in. from No. 5.

Diagonal *a* is struck on the vertical line *o* (Body Plan) 1ft. 6½in. above the L.W.L., and cuts the perpendiculars *p p* 9½in. above the L.W.L. at *a* 1 and *a* 2.

Diagonal *b* is struck on the line *o* 8in. above the L.W.L., and cuts *p p* 4in. below L.W.L. at *b* 1 and *b* 2.

Diagonal *c* is struck on *o* at its intersection with the L.W.L., and cuts the horizontal line *m* at *c* 1 and *c* 2.

The rig it will be seen by Fig. 74 is the ordinary sloop. The main sheet is thus worked: one end fast to the boom end; the other leads through a block on the counter, then through another block on

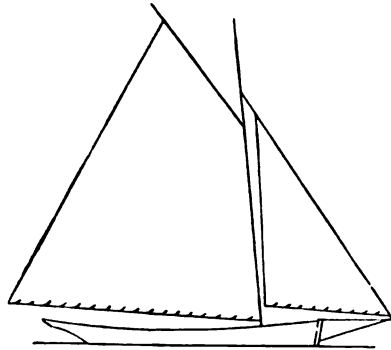

SCALE ¼ IN = 1 FT.

Fig. 74.

the boom, and belays inside the boat close to rudder head or on one side of the rudder head.

Of the many successful centre-board sloops and other boats which Burgoine of Kingston has turned out, none have been more successful than the *Alert*, whose lines, by the kindness of Mr. W. M. Dunnage (her owner), we are able to give. These small craft are built specially for

lake or river sailing, and it is not expected that an Alert would be able to successfully compete in a sea-way with a deep-bodied yacht, or even with a boat of the Itchen type. Nor can it be said that the Alert would be at home on such a river as the Mersey, where the New Brighton boats compete; but on rivers where the stream is less rapid, and the wave disturbance very small, we do not think a better type of boat could very well be designed. In fact, the Alert may be said to be the production of expediency, as a long course of experience has taught Mr. Burgoine the best type of sailing boat, whether it is of the sloop rig or balance lug rig, for such smooth-water sailing as can be had on the Thames between Teddington and Surbiton. The Alert, it will be seen, is a kind of combination of the shallow, the deep-keeled, and the centre-board type, and she appears to have, judged by her performances, a fair share of the good qualities of each type.

The Alert is sloop rigged, with main and fore sail, and her sail area strikes one as being very small; but some of her success to windward is attributable to her snug sail plan. The sails are made of American cotton duck. The topsail is cut on the lateen plan, the yard being up and down the mast. The halyard is made fast to the yard, so that it comes nearly chock-a-block with the halyard sheave in the mast when the sail is hoisted. The heel of the yard comes 9in. or so below the foot of the sail; a heel rope is fast to the yard, which serves as a tack, and (with one turn round the mast) is belayed on deck. Another plan is to have a thimble-eye seized to the heel of the yard, through which the topsail halyard is rove; the halyard thus serves as a kind of jackstay for the topsail yard, and does away with the heel rope or tack. A heel rope, however, is, we think, to be preferred, as in the hurry of hoisting one might forget to reeve the halyard, and there is always the possibility of something going wrong when a hauling rope is made to do duty as a stay as well. As will be seen, Alert has no topmast, the lower mast having a "pole," or mast-head, 8ft. 6in. long, which serves to set the lateen topsail.

The spinnaker gear is thus fitted. The boom has iron jaws to fit the mast, but no parral. At the outer end is a shoulder; inside the shoulder is a good-sized hole through the boom. Two or three inches from the hole are two thumb cleats. The fore guy passes through a block at the bowsprit end, and each end of the guy has an eye-splice, one end being kept on board on port side, and the other on starboard; when in use one of the eyes is put over the boom-end, and back to the thumb-cleats. On the tack cringle of the spinnaker is a grommet strop. To set the spinnaker, the eye of the fore guy is shoved over the boom end back

to the cleat; then the after guy is put on; next the grommet on the tack of the sail is shoved through the hole, and the bight brought up and put over the small end of the boom formed by the shoulder before spoken of. This arrangement effectually prevents the eyes of the guys slipping off. The sail is then hoisted, and the boom launched forward as the sail goes up. Of course the guys and sheet must be attended to as required, but the boom is not squared until the jaws are got to the mast. For lowering, the boom should be eased forward and unshipped before letting go the halyards; the sail can then be easily spilled, and gathered in as the heel of the boom is brought aft.

The iron keel is 14ft. long, measured from sternpost, 4½ in. deep, with an average thickness of 4½ in. The keel shown in the drawing (Plate XI.) includes the iron keel.

	ft.	in.
Length, stem to sternpost, at L.W.L.	17	5
Length on L.W.L.	19	3
Breadth extreme	7	3
Extreme draught of water, including centre plate	4	0
Draught of water at heel of keel	2	7
Thickness of iron centre plate	0	0½
Midship section abaft centre of length of L.W.L.	1	8
Centre of buoyancy abaft centre of length of L.W.L.	0	7½
Centre of lateral resistance abaft centre of length of L.W.L.*....	0	6
Centre of effort of lower sails abaft centre of length of L.W.L. ...	1	1
Area of load water-plane	75	sq. ft.
Area of midship section	5·6	sq. ft.
Displacement	1	ton 16 cwt.
Displacement per inch of immersion at L. W. L.	2½	cwt.
Weight of centre plate	½	cwt.
Ballast inside	9	cwt.
Weight of iron keel.....	7	cwt.
Total ballast.....	16½	cwt.
Tonnage Y.R.A.	3¾	tons
Mast, deck to hounds	16	6
Pole	8	6
Deck to hounds of pole (for topmast stays).....	23	6
Mast, deck to topsail halyard sheave	22	10
Mast, deck to strop of fore halyard block	18	0
Mast, diameter at deck	0	4½
Main boom	19	6
Greatest diameter	0	2½
Gaff	12	9
Diameter at jaws.....	0	2
Bowsprit, outboard.....	8	0
Bowsprit, end to mast	14	0
Bowsprit, diameter at stem	0	3½
Topsail yard.....	19	0
Diameter	0	2½
Jack yard	4	6

* The centre of lateral resistance is in the same vertical, whether with centre plate up or down.

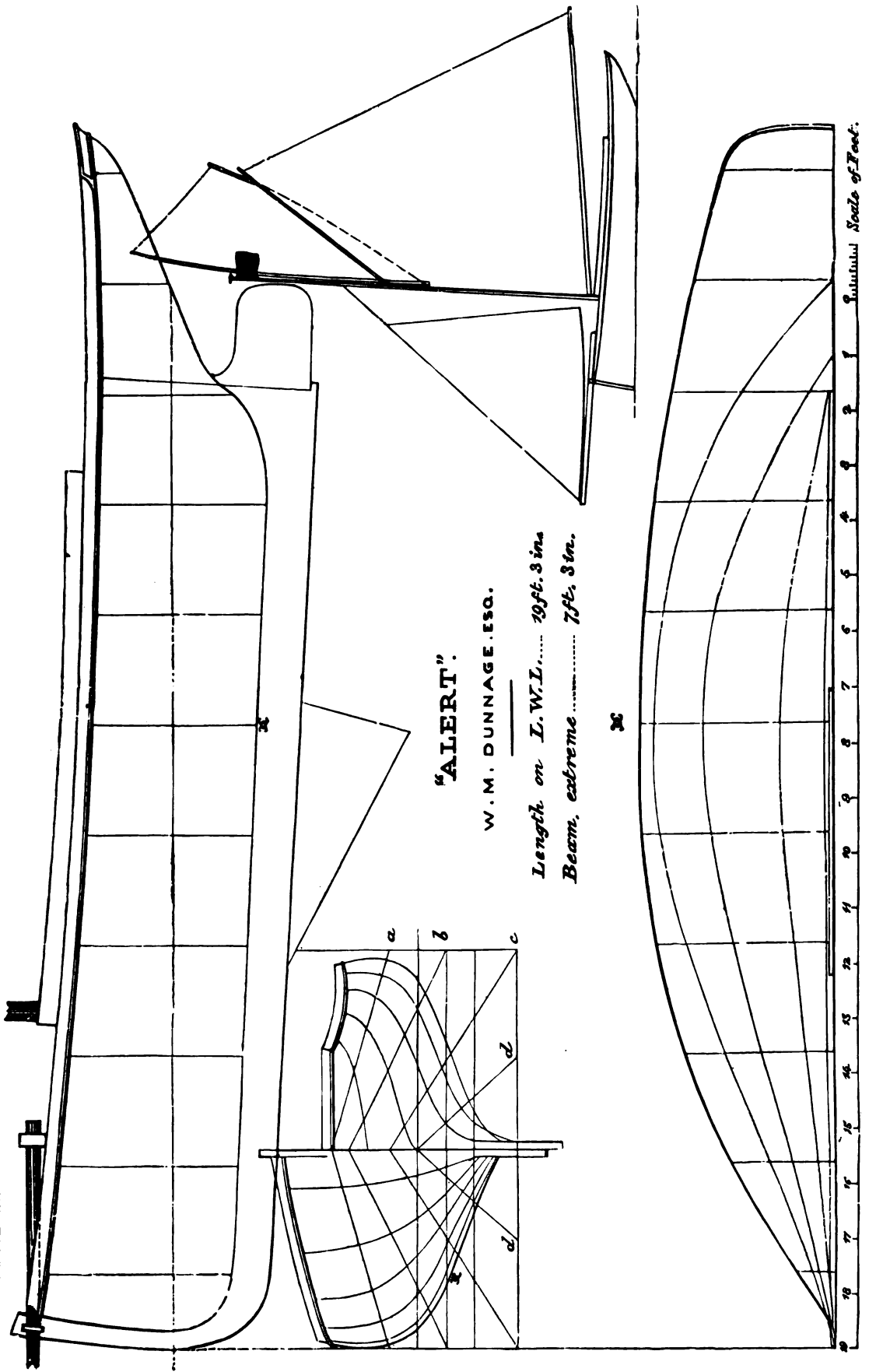

"ALERT".

W. M. DUNNAGE. ESQ.

Length on L. W. L. 19 ft. 3 in.

Beam, extreme 7 ft. 3 in.

Standard Scale of Feet.



	ft. in.
Diameter	0 1½
Spinnaker boom	18 9
Diameter	0 2½
Centre of mast from fore side of stem at L.W.L.	6 0
Luff of mainsail	13 6
Leech of mainsail	24 0
Angle of gaff with horizontal	5 30
Area of mainsail	270 sq. ft.
Area of foresail	90 sq. ft.
Area of topsail	70 sq. ft.
Total sail area	430 sq. ft.

TABLE OF OFF-SETS.

Sections.....	1	2	3	4	5	6	7	8	9	10	11
	ft. in.	ft. in.	ft. in.	ft. in.	ft. in.	ft. in.	ft. in.	ft. in.	ft. in.	ft. in.	ft. in.
Height to plank sheer	2 2½	1 11½	1 9½	1 8	1 7	1 6	1 5	1 4½	1 4	1 4½	1 4½
Half-breadth on L.W.L.	0 5	1 2½	1 11½	2 8	3 1½	3 3½	2 11½	2 7½	1 6½		
Half-breadths, No. 2 W.L.	0 3	0 9½	1 3	1 9½	2 2½	2 5	2 1½	1 5½	0 5½		
Half-breadths, No. 3 W.L.	0 1½	0 4	0 6½	0 8½	0 11	1 0½	0 10	0 8½	0 1½		
Half-breadths, keel	0 1	0 1½	0 2	0 2½	0 2½	0 2½	0 2	0 1½	0 1		
Half-breadths on deck	0 8	1 10½	2 9	3 3	3 5½	3 6	3 5½	3 3	2 11	2 6	2 0

No. 1 section is 1ft. 4in. from the fore side of stem at the load water-line. The remaining sections are 2ft. apart.

The water lines are 6in. apart.

(a) Diagonal is struck 1ft. 6in. above the load water-line, and cuts the side perpendiculars at 6in. above the load water-line.

(b) Diagonal is struck at 1ft. 2in. above the load water-line.

(c) Diagonal is struck 6in. above the load water-line.

(d) Diagonal is 1ft. 2½in. out from the middle vertical line.

The keel is 5in., sided amidships, tapering to 2½in., the thickness of stem, and 3in. at stern-post. The timbers are 1in. square, and 1½in. deep at the heels.

The plank is ½in. thick.

CHAPTER XII.

THE POLLYWOG.

THE Pollywog is a 3-ton centre-board cutter, built expressly for sailing in Milford Haven, the lower half of which, ten miles in length, varies from one and a half to three miles in breadth; and the upper portion, navigable for a further distance of thirteen miles, averages half a mile in width. There are also numerous creeks, locally called "pills," having a narrow deep-water entrance, but inside expanding to from two to four square miles in area, the greater portion of which is dry at half tide.

The object aimed at was a boat light, handy and quick in stays for the quiet upper waters of the Haven, having sufficient weight and power to face the rougher and heavier seas of the lower portion, with light enough draught for the "pills," large enough to accommodate half a dozen people for an afternoon's sail, and small enough to be worked single-handed; to be, above all, safe, comfortable, and fast. This is the result: As regards speed, nothing of her size in the district has nearly equalled her. She is very dry, and a good sea boat in spite of her heavy spars, and is exceedingly quick in stays; she has frequently been worked single-handed by her owner in a strong breeze and a heavy sea, and has always behaved very well.

There are several peculiarities in her construction worth noticing.

The centre-board, weighing $1\frac{1}{2}$ cwt., is pivoted in the usual manner in the keel, and has the usual rope at the after end to pull it up with; but, as 170lb. is rather a heavy weight for one man to lift in a hurry, another cord is shackled to the centre-board a few inches in advance of the former one; it leads over a sheave at the top of the centre-board case and down the fore end, where it divides; *i.e.*, another cord is spliced in. These lead through two pulleys at the foot of the mast, and back, one on each side of the case under the platform; an end of each is fastened to an indiarubber spring, somewhat similar to a large chest expander, but with a thimble at each end, and requiring a weight of





about 60lb. to stretch it 3ft. The other end of the spring is hooked to a floor right aft. When the centre-board is hauled up, the springs are relaxed, but upon its being lowered they are in tension and supporting about 120lb. of its weight, leaving only some 40lb. to be lifted by hand; if therefore the boat runs over a rock or bank, the board rises almost as easily as a wooden one would do. The springs are $1\frac{1}{4}$ in. diameter, 4ft. long, weigh about 2lb. each, and were obtained from R. Middleton, Chester-street, Birkenhead, the price being 9s. per pound.

The centre-board case was made of 1in. American yellow pine, and thus fitted (see Fig. 75): A rabbet 1in. deep was cut in the keel to exactly take the case, three oak dowels being fitted on each side; the case was well

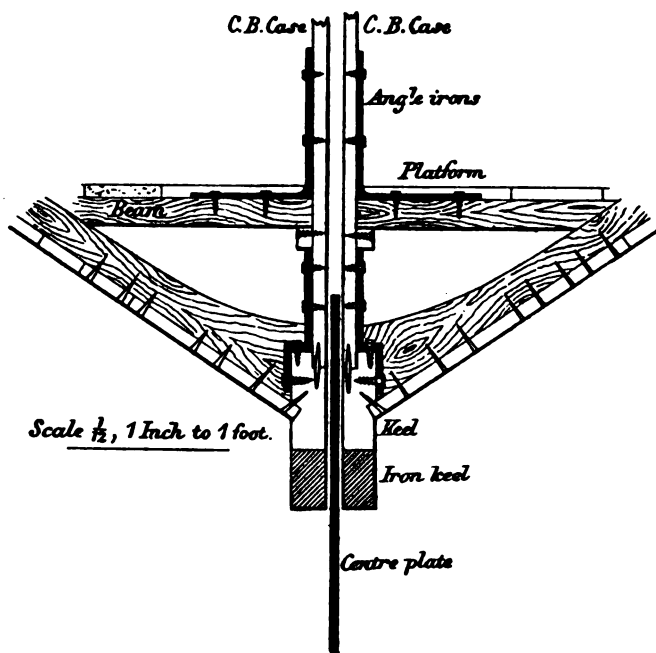

FIG. 75.

bedded in white-lead putty, and driven home; three iron supports on each side were screwed both to the case and to the keel; there has been no leakage from this joint since the boat was launched.

The Pollywog is half-decked, with waterways; and two bulkheads, one aft of the mast, the other about 2ft. forward of the sternpost; these are entered by close-fitting hatches; she is therefore practically a life-boat. A $3\frac{1}{4}$ in. pump with ball valves, and discharging on both sides, will rapidly clear her of any water that may find its way in.

The spinnaker boom is in two pieces, with a simple socket joint (similar to a tent pole); the two ends, which are alike, have each a hole

through which a piece of small line is passed, and, knotted or spliced, forms a loop. The spinnaker halyard is an endless rope leading from the masthead down each side of the forestay, with a piece about 3ft. long spliced in. The spinnaker itself has the sheet spliced into the clew cringle; the luff rope has a loop at the upper end, and is left about 4ft. long at the tack. The sail is thus set: The sheet first made fast to the bitts, the free part of the halyard bent to the head of the sail,

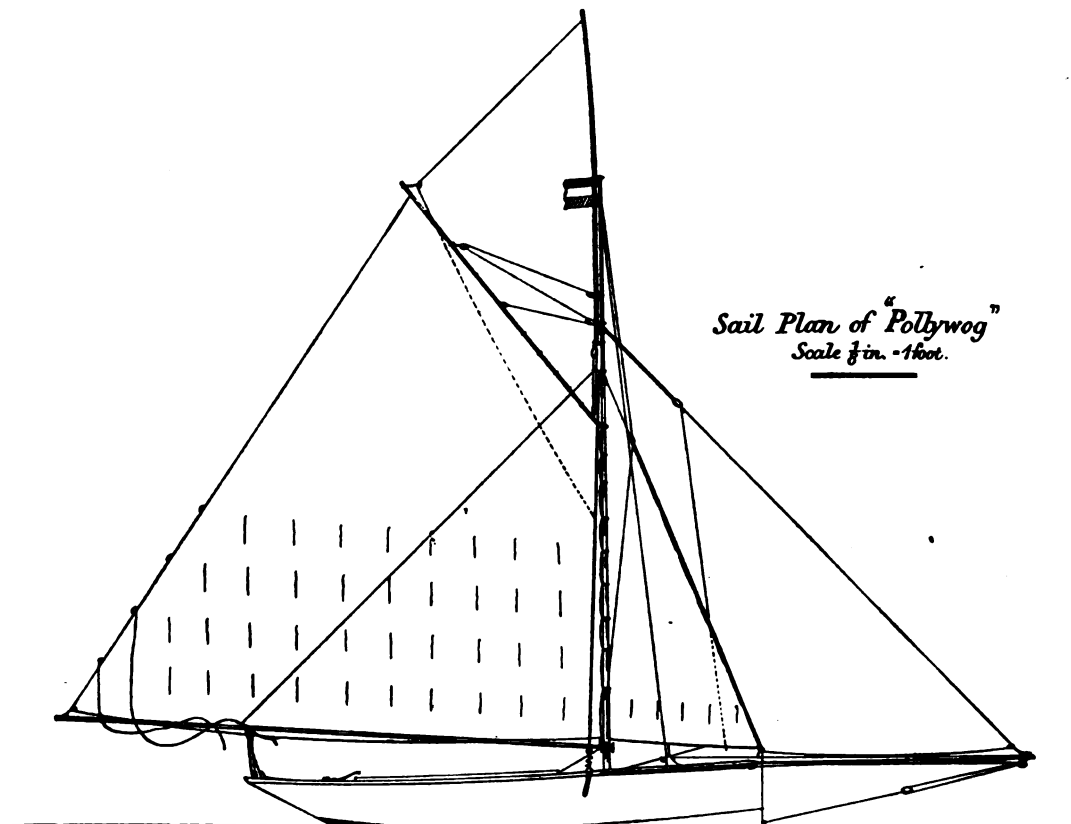

FIG. 76.

the tack passed through the loop at the end of the boom (end immaterial), and bent to it with a clove or other hitch, a guy passed outside the shroud and bent to the same end of the boom. The sail is then hoisted, and as it goes up the boom is fitted together and launched forward; the loop on the inner end dropped over any pin on the spider hoop, and then squared by the guy. In gybing, the inner end is lifted off the pin and launched aft, the guy being let go and passed round the mast and outside the shrouds to the other quarter; the sail is then lowered

and run up the other side, without casting off, tack, sheet, or halyard; as soon as the mainsail has swung over, the spinnaker boom is launched forward as before and squared by the guy.

The topsail is on the American plan, the yard being up and down the mast, and projecting about 5ft. above it.

The dinghy is 7ft. 6in. long over all, 3ft. 8in. beam, and 2ft. 2in. deep; weighs 90lb. with bottom boards, &c., but without oars or rowlocks, and has carried two ladies and three gentlemen at a time to the yacht, with about 5in. of freeboard. Its keel, gunwale, timbers, thwarts, garboards, and bilge strake are American elm, stern and stem oak, planking yellow pine. It tows well, and can be lifted easily by one man into the Pollywog, where it fits comfortably into the well.

The yacht was designed and built by Capt. Barrington Baker during his leisure hours of the winter of 1880-81, with the occasional help of a man for rivetting, planking, &c.; the item of wages therefore only came to 7l.; but of course, if built by paid labour, the estimate would have to be increased accordingly.

The Pollywog has on several occasions sailed at a very high rate of speed for a boat of her length. In July, 1881, the distance between Dale Point and Pembroke Dock, nine statute miles, was covered in one hour and twenty-five minutes, being at the rate of 6.29 statute miles, or 5.46 knots, per hour. The wind was of lower sail strength abeam, and water smooth; but the boat was twice almost becalmed for a few minutes when passing under the headlands of South Hook and Weare. The tide was a very slack neap, but what little there was was against the boat. The party on board consisted of five ladies and two gentlemen, who were all up to windward. Her best recorded speed, however, was on her return from Saundersfoot Regatta, near Tenby, in September, 1881, when she ran under all sail and spinnaker (with a gybe half way) from the Monkstone (3.33 P.M.) to Giltar Head, 3½ statute miles; then hauling up with the wind just forward the beam to St. Govan's Head, 10 statute miles (5.30 P.M.); good steady breeze and nearly smooth water, slack neap tide, favourable first hour, then against her; the total distance to St. Govan's being 13½ statute miles in one hour and fifty-seven minutes, being at the rate of 6.92 miles, or 6.01 knots, per hour. From St. Govan's Head to Linney Head, six statute miles, almost close-hauled under all plain sail (topsail doused), tide *nil*, being in the slack water, took exactly fifty-nine minutes, being at the rate of 5.28 knots per hour.

The account of this cruise appeared in *Hunt's Yachting Magazine* for November, 1881; but the time is there put down to the nearest,

five minutes, the foregoing being the correct times and distances. These headlands are very well marked, and were passed within from ten to twenty fathoms, and the time carefully taken. The distances are from point to point, but the boat actually sailed a little more on account of other headlands projecting slightly.

DIMENSIONS, &c., OF POLLYWOG.—PLATE XII.

Length on L.W.L., 18ft.	Plank (yellow pine), $\frac{3}{4}$ in.
Length over all, 21ft. 6in.	Rail (American elm), $\frac{3}{4}$ in. by 2in.
Beam, extreme, 6ft. 8in.	Seats, &c., teak.
Draught of water aft, 2ft. 3in.	Sections are without plank and 18in. apart.
Draught, including board, 4ft. 10in.	Mast, deck to hounds, 17ft.
Displacement, 1 ton 15cwt.	Mast, deck to truck, 25ft.
Ballast on keel, $4\frac{1}{4}$ cwt.	Mast, diameter at deck, $4\frac{1}{4}$ in.
Centre-plate, $1\frac{1}{2}$ cwt.	Boom, 23ft.
Ballast inside, 16cwt.	Diameter at sheet, $3\frac{1}{2}$ in.
Total ballast, 22cwt.	Gaff, 13ft.
Keel (American elm), sided amidahip, 5in.	Diameter, $2\frac{1}{2}$ in.
Keel, moulded, 6in.	Bowsprit, outboard, 11ft. 6in.
Stem and sternpost (oak), sided, $3\frac{1}{2}$ in.	Bowsprit, diameter at gammon iron, $3\frac{1}{2}$ in.
Worked timbers, sided, $1\frac{1}{2}$ in., spaced 18in.	Spinnaker boom, 23ft.
Bent timbers (American elm), $\frac{3}{4}$ in., moulded, by $1\frac{1}{2}$ in., sided, between each pair of worked.	Centre-board, $\frac{3}{4}$ in. boiler plate.
	Area of board immersed, about 12 square feet.

Area of mainsail	284 sq. ft.
Area of foresail	40 sq. ft.
Area of jib	84 sq. ft.
Area of topsail	50 sq. ft.
Total area of sails	458 sq. ft.
Area of spinnaker	250 sq. ft.

LIST OF BLOCKS, CORDAGE, &c., OF POLLYWOG.

	BLOCKS.		CORDAGE.		REMARKS.
	Number.	Size.	Fathoms.	Size.	
		in.		Cir. in.	
Main halyard.....	2	4	9	$1\frac{1}{2}$	
Peak halyard	3	4	15	$1\frac{1}{2}$	
Jib halyard.....	2	4	10	$1\frac{1}{2}$	
Fore halyard	1	3	6	1	
Topsail halyard	—	—	9	$\frac{3}{4}$	1 thimble instead of block.
Spinnaker halyard.....	—	—	10	$\frac{3}{4}$	1 thimble instead of block.
Main sheet	1	4	} 18	$1\frac{1}{2}$	double block.
	3	$3\frac{1}{2}$			
Jib sheet	—	—	7	1	
Fore sheet	—	—	5	1	leads through eye-bolts on deck.
Topsail sheet	—	—	10	$\frac{3}{4}$	thimbles instead of blocks.
Topping-lifts (each)	1	3	$6\frac{1}{2}$	1	
Bobstay purchase	2	3	6	$1\frac{1}{2}$	iron blocks.
Spinnaker guy	—	—	5	$\frac{3}{4}$	
Beef pendants and outhauls.....	—	—	20	$1\frac{1}{2}$	
Warp	—	—	25	2	
Wire rigging	—	—	12	1	
Wire rigging, bowsprit shrouds	—	—	3	$\frac{3}{4}$	

Capt. Barrington Baker first rigged the Pollywog throughout with lin. cordage, but found it cut the hands, and so altered to the sizes given in the table.

The shrouds are "singles" on each side, and, as the lanyards were always stretching, Capt. Baker invented the plan shown on Fig. 77. The hooks, *a c*, are of $\frac{3}{4}$ in. by lin. galvanised iron, and the screw, *b*, $\frac{1}{8}$ in. There is a hole in the head of the pin. The nut is formed by *c*; the dotted lines show how the hooks could be strengthened by making them into links.

The cost of building a similar boat would be as under :

Timber	£10 0 0
Copper nails, &c.	3 0 0
Ironwork (galvanised)	7 0 0
Centre-plate	2 0 0
Iron keel	2 0 0
Ballast	2 0 0
Indiarubber springs	2 0 0
Spars	2 10 0
Cordage	1 0 0
Wire rigging	0 10 0
Sails	15 0 0
Blocks	1 10 0
Pump	2 0 0
Anchor and chain	3 10 0
Cork cushions	1 0 0
Warp	1 0 0
Painting and extras	4 0 0
Total	£60 0 0

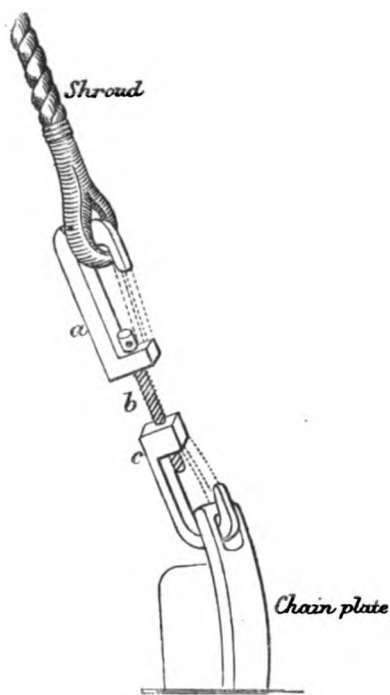

FIG. 77.

To which should be added the cost of labour, which will vary according to the locality.

CHAPTER XIII.

LOUGH ERNE YACHTS.

THE shallowness of the upper waters of Lough Erne, and the turbulence of the lower, have necessitated a kind of compromise between the shallow American centre-boarder and the deeper-bodied English yacht. A large fleet—some thirty or forty—of these centre-board yachts are on the Lough, and most of them were designed and built by their owners. The *Witch* (Plate XIII.) was designed and built by Mr. Edward Saunderson, and is a very capable boat, both on the smooth and narrow water of the Upper Lake, and in strong breezes on the rougher water of the Lower Lake.

The centre-plate or “dipper” is made of $\frac{1}{2}$ in. boiler plate, and is pivoted inside the case. A slot, *a*, is cut inside the case $1\frac{1}{2}$ in. deep, and 2 in. wide, the lips of which are protected by iron plates. A short iron bolt or stud projects on either side of the plate, and travels in the slot. The board can be raised bodily by two tackles, as shown; but in sailing it is usual only to raise the after end. The fall *k* leads over the drum of a winch at *w*. At *w* is also a sheave for the pennant part of the tackle, *m*, which lifts the fore end of the board. This sheave is fitted at one end of the barrel of the winch.

The *Witch* has oak frames 2 ft. 6 in. apart, with $\frac{1}{2}$ in. wrought iron floor-knees. Between each pair of frames is a steamed timber of American elm.

Length on load-line	38ft.
Beam, extreme	12ft. 4in.
Draught of water extreme	4ft. 4in.
Displacement.....	12 tons.
Lead on keel	5 tons.
Lead inside.....	1 ton 9 cwt.
Iron centre-plate	11 cwt.
Iron floors	7 tons 8 cwt.
Mast, deck to hounds	33ft.
Masthead.....	5ft.
Main boom.....	42ft.
Main gaff	26ft.
Bowspit outside stem	26ft.
Topmast.....	18ft.

PLATE XIII.

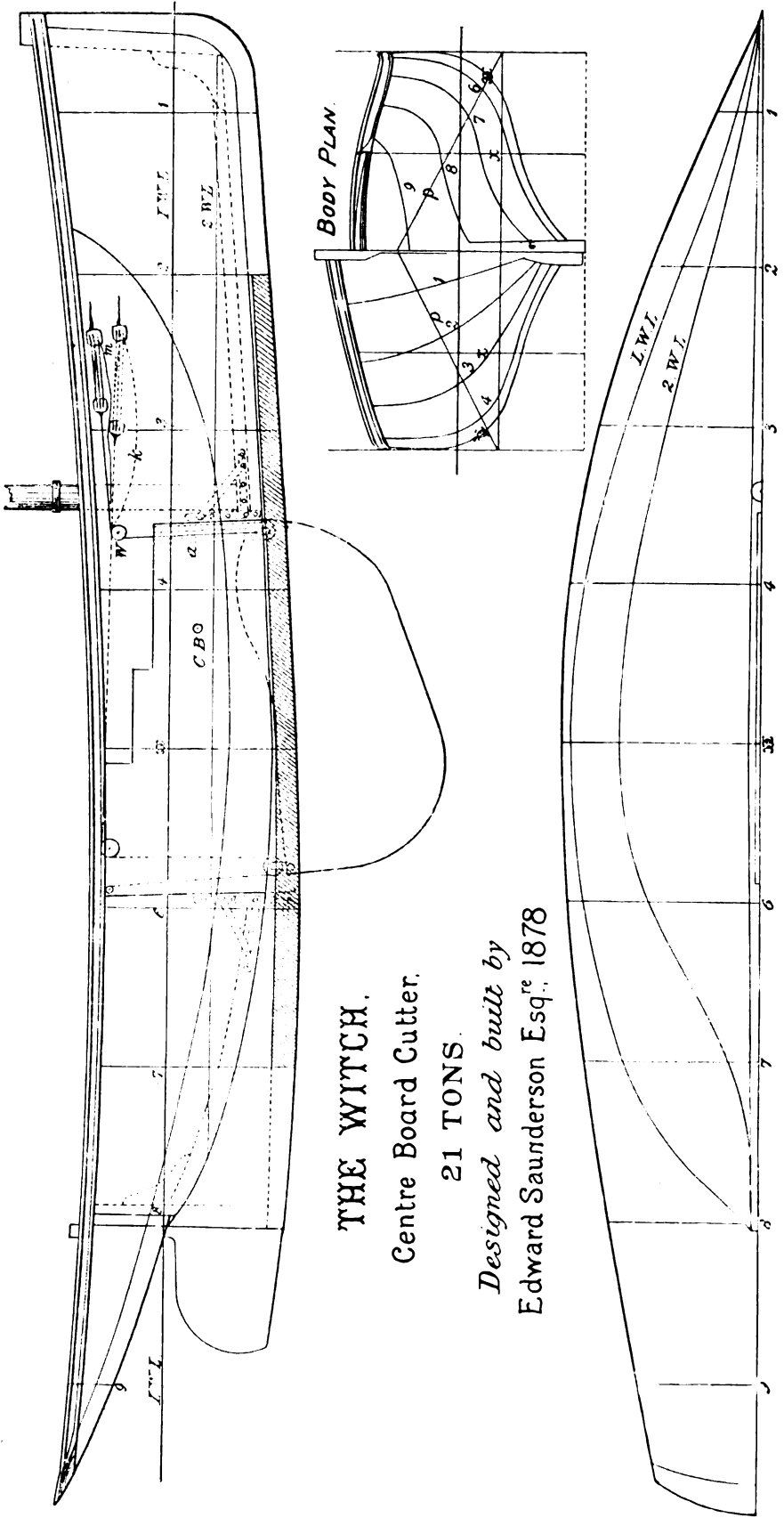

THE WITCH.

Centre Board Cutter.

21 TONS.

Designed and built by
Edward Sanderson Esq^r, 1878

Luff of mainsail.....	29ft.
Area of mainsail	1175 sq. ft.
„ jib.....	575 sq. ft.
„ foresail.....	230 sq. ft.
„ topsail.....	373 sq. ft.
Foreside of mast from foreside of stem.....	14ft. 8in.

TABLE OF OFFSETS FOR LOUGH ERNE YACHTS.

No. of Section	1		2		3		4		5 Mid.		6		7		8		9	
	ft.	in.	ft.	in.	ft.	in.	ft.	in.	ft.	in.	ft.	in.	ft.	in.	ft.	in.	ft.	in.
Heights from L.W.L. to covering board.	3	6	3	0½	2	7½	2	2	2	0	1	11½	2	0	2	3	2	6
Depths from L.W.L. to lower edge of rabbet of keel	1	6	2	4	2	8	2	11	3	2	3	0	2	1	0	3	—	—
Half-breadths on deck	1	7½	4	0	5	6	6	0	6	2	6	0	5	6	4	8	3	7
Half-breadths on L.W.L.	0	11	2	9	4	7	5	9	6	1	5	9	4	4	0	7	—	—
Half-breadths No. 2 W.L.	0	5	1	6	3	0	4	3	4	7	3	8	1	2	0	2½	—	—
Half-breadths on diagonal p	—	—	—	—	—	—	—	—	6	1½	5	7	4	6	2	10	0	5
Depths below L.W.L. on buttock line s.	—	—	—	1	1½	1	9	1	10½	1	6	0	7	—	—	—	—	—
Heights above L.W.L. on buttock line s	—	1	1½	—	—	—	—	—	—	—	—	—	—	0	8½	2	0½	—
Depths of lead keel.....	—	0	6	0	10	1	0	1	0	1	0	0	10	—	—	—	—	—

No. 1 section is 3ft. 1in. from fore side of stem. The remaining sections are 5ft. apart. The midship section is shown on both sides of the body plan. Every other section is left out, the frames being 2ft. 6in. centre to centre, with a steamed frame between these, making the actual spacing 1ft. 3in. centre to centre.

No. 2 water-line is 1ft. 3in. below L.W.L.

Diagonal *g g* is struck on middle line 1ft. 11in. above the L.W.L. (See Body Plan.)

The buttock line *s s* is 3ft. out from middle vertical line of body plan. This buttock line is shown in the sheer plan.

Sometimes whilst sailing in shallow water the after end only of the dipper is raised; and at all times with the fore end below the keel the lateral resistance is found to be very effective.

Mr. Saunderson altered the Witch in 1880 by filling out the bow and rounding up the fore foot; these alterations are included in the table of offsets, but not shown on the drawing. The alterations were pronounced improvements. During the winter of 1881 Mr. Saunderson further altered the Witch by giving her an overhanging stem like Buttercup.

The drawing shown on Plate XIII. is on a scale of ¼ in. to a foot.

CHAPTER XIV.

UNA BOATS.

THOSE wonderful little crafts called "Una" boats were introduced to us in 1853, in this way: the late Marquis of Conyngham (then Earl Mount-Charles), was in America in 1852, and in the boat building yard of Robert Fish (now well known as a yacht designer), saw the boat since celebrated as the "Una." He sent her to London by steamer, whence she was transported by rail to Southampton, and then towed to Cowes. The Una, we believe, spent a summer on the Serpentine, but she did not there excite the interest she did at Cowes. In fact, the Cowes people almost regarded the Una as a little too marvellous to be real. To see the Una dodging about on a wind and off a wind, round the stern of this craft, across the bows of that one, and generally weaving about between boats where there did not look room enough for an eel to wriggle, astonished the Cowes people, who had never seen anything more handy under canvas than a waterman's skiff with three sails, or an Itchen boat with two. In short, the Una with her one sail showed such speed, and was so handy, that in less than a year there was a whole fleet of Unas at Cowes, and about the Solent. The genus was named Una after Lord Conyngham's importation, and to this day no class of boat is a greater favourite for smooth-water sailing.

In America, the Una or "cat-rig" as it is termed, is a great favourite, and at Newport, Rhode Island, where the rig is mostly seen, the boats enjoy a great reputation for handiness, weatherliness, and speed. There is no doubt that the one sail plan is the best for weatherly qualities and for handiness, if there be no sea, and if it is all turning to windward. In a sea, however, the heavy mast, stepped so far forward, makes the boats plunge dangerously, and the boats themselves are so shallow that they are not very well adapted for smashing through a head sea. Off a wind they are extremely wild, and show a very great tendency to broach to.

This tendency of coming to against the helm is common to all shallow boats when they are sailed off the wind; and if the rudder of a boat has to be kept right across her to check the tendency, speed is of course very much retarded. As a rule it is found that lifting the centre board greatly relieves the weather helm; and as the board is not wanted off a wind, to increase the lateral resistance it is always better to haul it up; the boat will steer all the better for it, and there will be less surface for friction.

Some boat sailers have used a small jib on a short bowsprit when sailing off a wind; the bowsprit would run out through an iron fitted to the stem head, and the heel could be lashed to the mast if no bitts were fitted, as there need not be. A shroud would be required each side, and a bobstay, but if the bowsprit were a mere bumpkin only three or four feet long, no shrouds would be required. If it were found necessary to luff up in squalls, the head sheets should be the first to be started, therefore they should lead aft. A few years ago a boat built on the model of the *Una*, had her mast shifted to 5ft. abaft the stem and a jib or foresail added and mainsail reduced; she was found very easy on her helm when sailing off the wind, as might be expected; but on a wind she would not lie so close, and quite proved the inferiority of the two sails, so far as sailing in smooth water went. The advantages of the one sail are almost wholly confined to sailing to windward in smooth water, and, as sailing to windward under such conditions is the principal charm of sailing a small boat at all, the *Una* rig will retain its popularity.

A shallow boat like the *Una* is a little more unsafe perhaps than an ordinary sailing skiff, because they carry so much sail; and a person might be tempted into pressing them, because of the enormous stiffness they show up to the time that their gunwale or deck becomes level with the water.

However, with skilful management "*Unas*" are safe enough, and on the whole are not so dangerous as an open boat of similar length. They should always be luffed to squalls before their deck has a chance of being immersed, and a foot or two of main sheet (which should be held in the hand) given them if they cannot be relieved sufficiently without their being brought head to wind—a course never desirable if it can be avoided, as the boats soon lose steerage way. It is never advisable to let the main sheet go altogether with a boom sail, as it is with one without a boom, as the sail will not spill, and the boom may get in the water, which would be awkward, to say the least, if the boat got stern way on.

The "*Una's*" stores, copied from an inventory of the same, made when she was packed off by rail to Southampton, were as under: One

mast, one boom, one gaff, one pair of oars, one sail, one sail cover, one hatch cover, one rudder and tiller, four blocks, one main halyard, two bell-metal rowing-pins, four pigs of lead ballast. All that need be added to this list is a "baler," and it would do for a Una of the present day.

The rig, it will be seen upon reference to the sail plain, Fig. 78, is simple in the extreme, and even the famed balance lug cannot beat it in this respect. The sail is hoisted by a single halyard. The standing part is made fast on the gaff at *a*, then leads through a double block

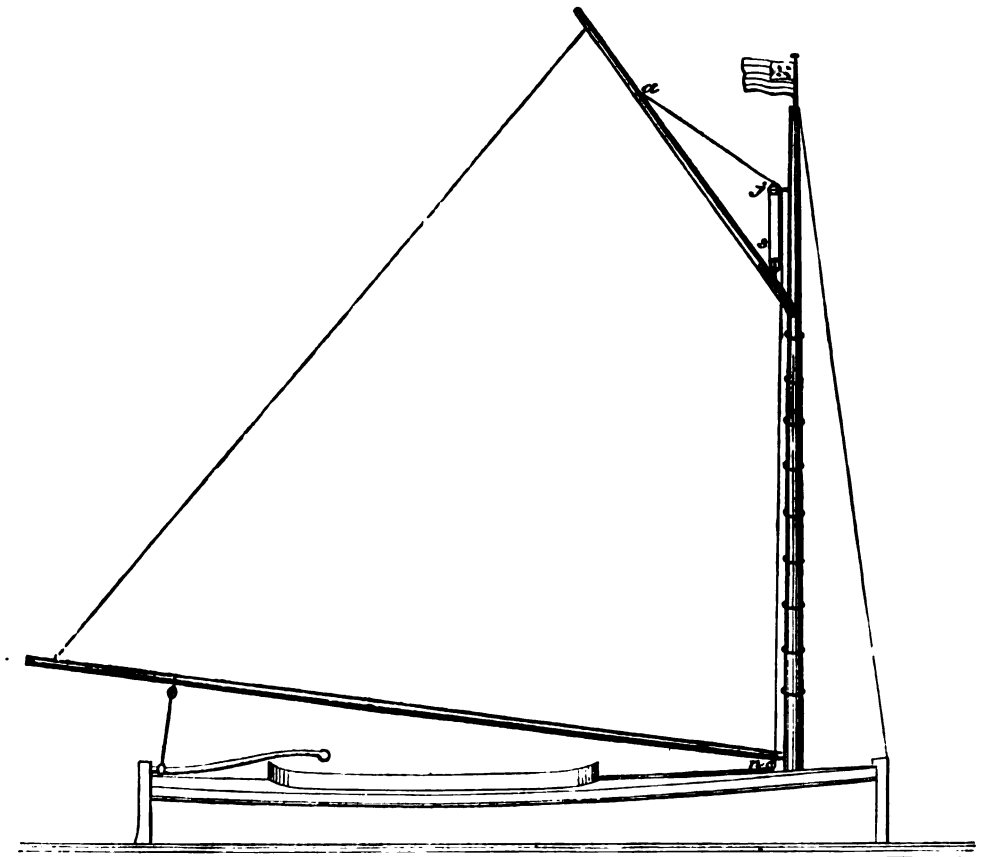

SAIL PLAN "UNA" BOAT 4" INCH SCALE.

FIG. 78.

at *j* on the mast, through a single block *s* on the jaws of the gaff, up through *j* again, and down to the deck where the fall leads through a block *n* by the side of the mast, and belayed on the aft end of centre-board case. The fall can then be taken aft to the hand of the helmsman, who, in case of need, can drop the sail between topping-lifts (not shown

in the drawing) without leaving the tiller. The Una had no stay at all, but the Cowes fashion now is to have a forestay, which prevents the mast going aft when sailing on a wind. The larger Una boats over 20ft. are fitted with topping-lifts, and the smaller ones would be all the better for them, as a lift is handy in setting, stowing, or reefing the sail.

The main sheet is made fast to an eye bolt on one quarter, close to the intersection of gunwale and transom; it then leads through a block on the boom, and through a block on the other quarter, the fall coming into the well or cockpit to belay. This plan of fitting the main sheet is still known as the "Una," just as the plan of working the halyards all in one is.

Practically, the Cowes Una boat of the present time differs very little from the original. The floor, it will be found, upon reference to the diagrams and tables, is a trifle flatter than the Una's; the quarters are lifted a little, as will be seen upon comparing the transoms; and there is more freeboard—the latter being a very desirable addition. The load water-line of the two crafts are almost identical, as will be found by comparing the half-breadths for the same. The centre-boards are of about equal area, the only alterations being that the modern plan is to pivot the board in the keel below the garboard, whilst formerly they were pivoted in the case inside the boat. The Cowes Una has a trifle less draught forward than the original, and the stem piece does not tumble aft; but, in other respects, there is not much difference in the two sheer plans, always of course remembering the increase in the freeboard. The draught of water of the Cowes Una forward appears to be excessive, and off a wind at least she would be lightened by the head to the extent of three or four inches.

The design for a Cowes Una (Plate XIV.) has been made so that it is adapted for either a real "Una" of 15ft. 6in. in length, or one of greater size 21ft. in length. The sail plan of the Cowes boat is a smaller one than the Una had, but it will be found large enough for ordinary sailing. The sail, of course, will be laced to the boom, and a topping-lift would be found of service to keep the boom up when the peak is lowered, or when running off the wind.

The Una is still in existence on the estate of Lord de Ros, in Ireland, the late Marquis of Conyngham having presented her to that nobleman in 1873.

DIMENSIONS, &c.

	UWA.	15ft. 6in.	21ft.
	ft. in.	ft. in.	ft. in.
Length, extreme	16 0	15 6	21 0
Beam, extreme	6 6	6 6	8 8
Keel sided amidships	0 7	0 4½	0 6
Keel sided fore end	0 2	0 2	0 2½
Keel sided aft end	0 2	0 2	0 2½
Moulding (depth) of keel	0 2½	0 4	0 5
Floors sided	0 ½	0 1	0 1½
Floors moulded	0 1½	0 1½	0 2
Timbers sided	0 ½	0 1	0 1½
Thickness of plank	0 ½	0 ½	0 ½
Thickness of top strake	0 ½	0 ½	0 1
Mast, deck to hounds.....	16 0	14 0	18 6*
Boom	18 0	15 6	21 0
Gaff	9 3	7 6	10 0
Luff of mainsail	12 0	9 9	13 0
Foot of mainsail	17 6	15 6	20 8
Head of mainsail.....	9 0	7 0	9 6
Leech of mainsail	19 0	17 8	23 6
Tack to peak earing of mainsail	20 0	16 0	21 0
Clew to throat earing.....	19 0	17 0	22 9
Centre of mast from the fore side of stem at L.W.L.....	2 0	2 0	2 6
Diameter of mast at deck	0 4½	0 4½	0 5
Diameter of mast at hounds	0 2½	0 2½	0 2½
Weight of displacement of boat to L.W.L. (approximate).....	13 cwt.	14 cwt.	1¼ ton.

* An American 21ft. Cat Boat would have about 3ft. more mast, and 2ft. more boom. The Cat Boat's mast would rake aft ½ in. in 1ft.

LAYING-OFF TABLE, ¼ IN. SCALE.

	ft. in.	ft. in.	ft. in.	ft. in.	ft. in.	ft. in.	ft. in.	ft. in.	ft. in.
Heights to top of timbers above L.W.L.	1 6½	1 3½	1 1½	1 0	0 11½	0 11	0 11½	1 1	
Una " "	0 11	0 9½	0 8½	0 8	0 8	0 8½	0 9	1 0	
Depths below L.W.L. to rabbet	0 6½	—	—	—	0 9	0 8½	0 6½	—	
Una " "	0 7½	—	—	—	0 8½	0 8	0 6½	—	
Half-breadths on deck	0 8½	1 9	2 5½	2 11	3 2½	3 1½	2 10	2 1½	
Una " "	0 7½	1 7	2 4	2 11	3 2½	3 1	2 9½	2 3	
Half-breadths on L.W.L.....	0 4½	1 2	1 11½	2 5½	2 9½	2 8	1 11½	—	
Una " "	0 4	1 1	1 10½	2 6	2 9½	2 8½	2 1	—	
Half-breadths on diagonal k	0 7½	1 6½	2 2½	2 8½	2 11½	2 10½	2 5	1 4½	
Una " "	0 7	1 5½	2 2	2 8½	2 11½	2 10½	2 5½	1 6½	
Half-breadths on diagonal m	0 6	1 2	1 8	2 0	2 2½	2 1	0 9	0 5½	
Una " "	0 5½	1 1½	1 8½	2 1½	2 3½	2 1	1 7	0 6	
Half-breadths on diagonal s	0 8½	0 7½	0 10½	1 0½	1 2	1 1	0 9	—	
Una " "	0 3½	0 8	0 1	1 2½	1 3	1 0½	0 7½	—	

All the half-breadths are without the plank.

In the body plan of the Cowes Una the midship section is shown on both sides of the middle line, o, between Nos. 4 and 6 sections. The station for the midship section is shown at No. 5 in the sheer plan.

No. 1 section is 1ft. 3in. from the fore side of the stern; all the other sections are 2ft. apart, but No. 8 (transom) is 2ft. 3in. from No. 7 station.

In the case of the Una, No. 8 (transom) is 2ft. 9in. from No. 7 station.

Diagonal k is struck 10½ in. above the L.W.L., and at k 1 and k 2 cuts the side perpendiculars p p 1½ in. below the L.W.L.

PLATE XIV.

COWES "UNA" BOAT, 1878.

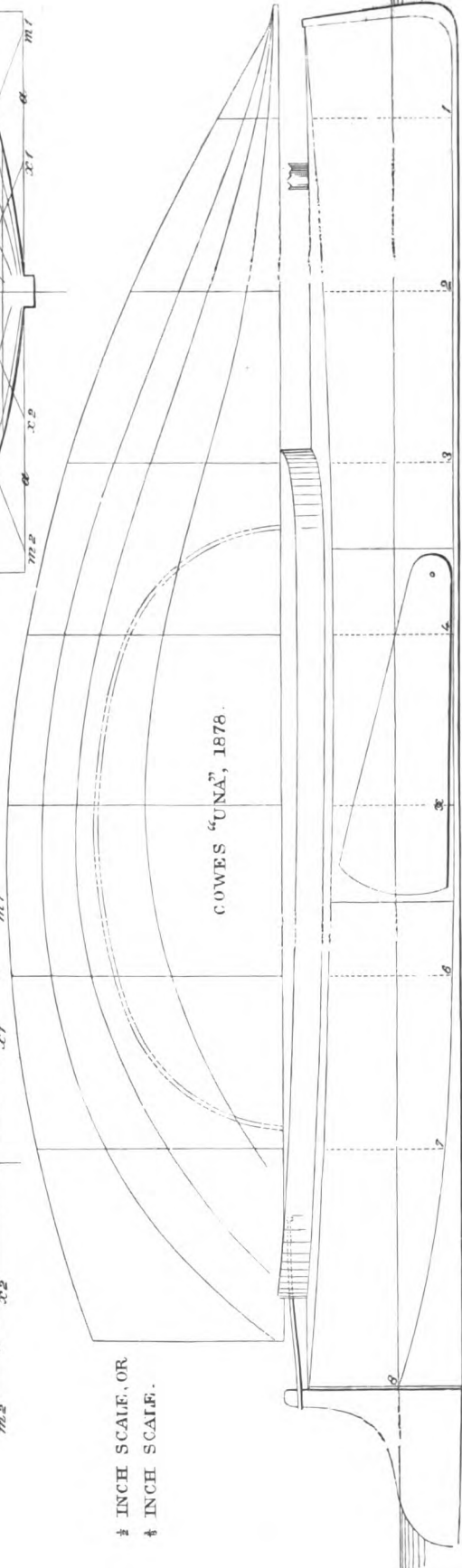
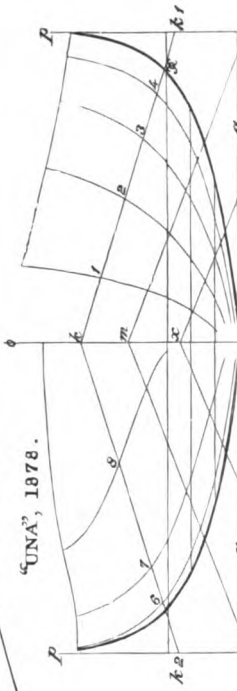
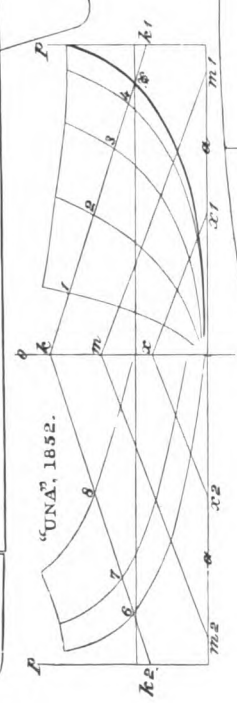
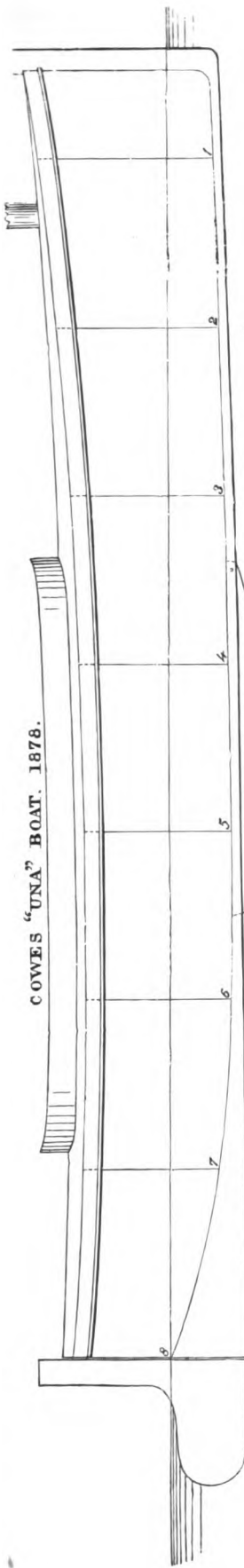

1/2 INCH SCALE, OR
1/4 INCH SCALE.

ORIGINAL "UNA" 1852.

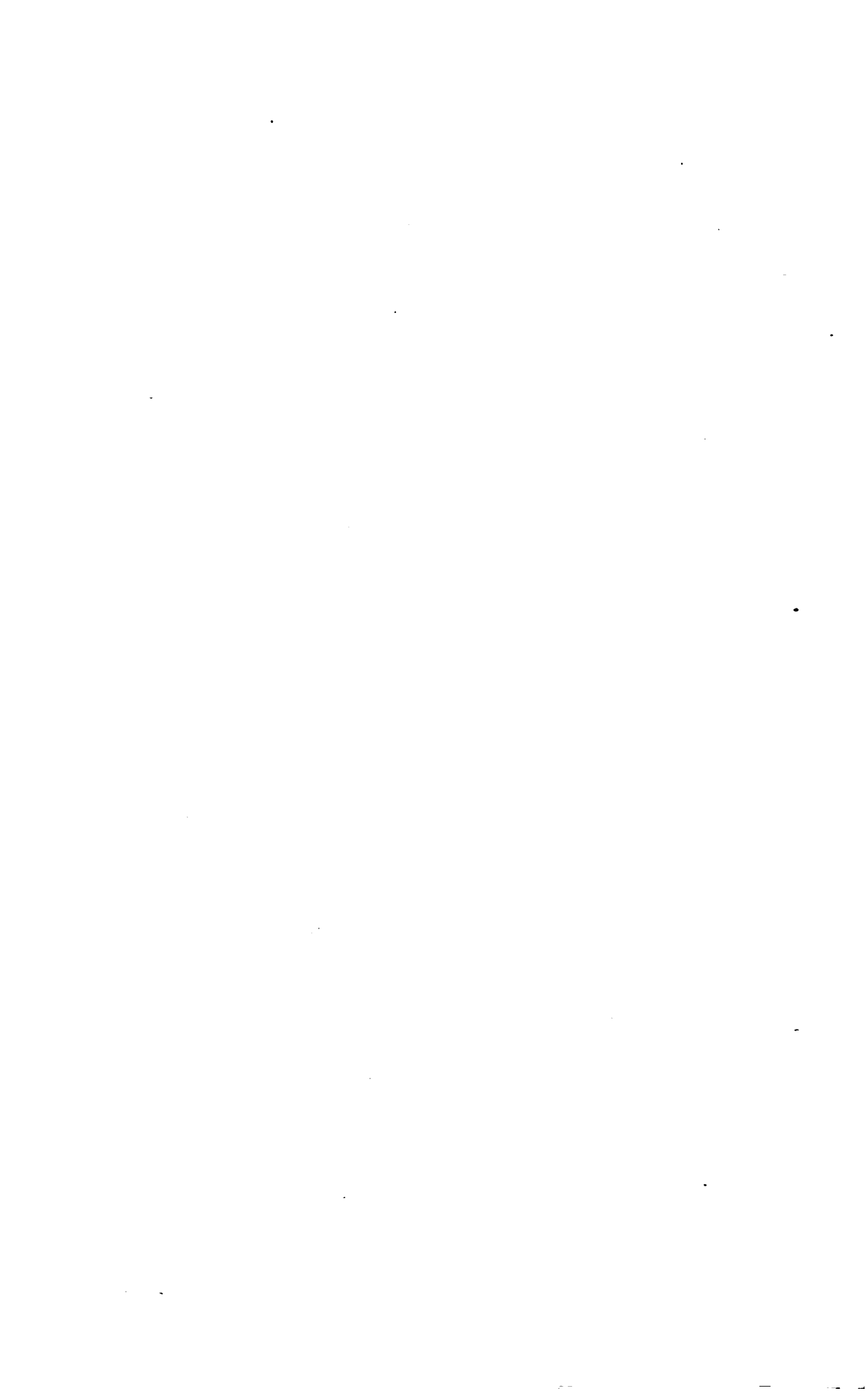

Diagonal *m* is struck 4½ in. above the L.W.L., and at *m* 1 and *m* 2 is 3ft. out from the middle vertical line *o*.

Diagonal *s* is struck 1½ in. below the L.W.L., and at *s* 1 and *s* 2 is 1ft. 6in. out from the middle vertical line *o*.

The base line *a a* is 9in. below the L.W.L., and parallel thereto.

LAYING-OFF TABLE FOR 21 FT. "UNA" BOAT, ½ IN. SCALE.

	ft. in.	ft. in.	ft. in.	ft. in.	ft. in.	ft. in.	ft. in.	ft. in.	ft. in.	ft. in.
Heights above L.W.L. to top of timbers	2 0½	1 8½	1 6	1 4	1 3	1 3	1 3	1 3½	1 5½	—
Depths below L.W.L. to rabbet	0 8½	—	—	—	1 0	0 11½	0 8½	—	—	—
Half-breadths on deck	0 11½	2 4	3 3½	3 11	4 3	4 2	3 9½	2 10	—	—
Half-breadths on L.W.L.	0 6½	1 7	2 6½	3 4	3 8	3 6½	2 7½	—	—	—
Half-breadths on diagonal <i>k</i>	0 10½	2 0½	2 11½	3 7½	3 11½	3 10	3 3	1 8½	—	—
Half-breadths on diagonal <i>m</i>	0 8	1 6½	2 3	2 8	2 11½	2 9½	2 1½	0 7½	—	—
Half-breadths on diagonal <i>s</i>	0 4½	0 10	1 2½	1 4½	1 7	1 5½	1 0	—	—	—

All the half-breadths are without the plank.

No. 1 section is 1ft. 10in. from the fore side of the stem; all the other sections are 2ft. 8in. apart, but No. 8 (transom) is 3ft. 2in. from No. 7 station.

Diagonal *k* is struck 1ft. 2½ in. above the L.W.L., and at *k* 1 and *k* 2 cuts the side perpendiculars *p p* 2 inches below the L.W.L.

Diagonal *m* is struck 6in. above the L.W.L., and at *m* 1 and *m* 2 is 4ft. out from the middle vertical line *o*.

Diagonal *s* is struck 2½ in. below the L.W.L., and at *s* 1 and *s* 2 is 2ft. out from the middle vertical line *o*.

The base line *a a* is 1ft. below the L.W.L., and parallel thereto.

CHAPTER XV.

THE AMERICAN CENTRE-BOARD SLOOP PAROLE.

THE light draught beamy centre-board boat is in high repute in America, and the sloop rig is quite as much the fashion as the cat rig. The "jib and mainsail boats," as they are characteristically termed, for speed in light winds and smooth water are probably unsurpassed, and the handling of them is followed with keen enjoyment by a large number of boat sailers on the American seaboard. Their length on water-line varies from 24ft. to 28ft., and their breadth from 10ft. to 11ft. 6in.

The drawing on Plate XV. shows the lines of Parole, one of the fastest boats yet built by Mr. Jacob Schmidt, of Tompkinsville, Staten Island, New York. He also built other successful boats, such as Dare Devil, Pluck and Luck, Susie S., &c.; and he is one of the best open boat sailers in New York Bay.

The drawing is to $\frac{1}{4}$ in. scale, and the water-lines are 4in. apart. The scantling of the timbers of American elm would be $1\frac{1}{4}$ in. moulded by 2in. sided, and be spaced 1ft. apart. The plank would be $\frac{3}{4}$ in. thick; stem and stern post $2\frac{3}{4}$ in. sided. The centre-board appears to be unnecessarily large, and might very well be less in depth.

The sail plan, Plate XVI., shows the racing outfit. The main sheet is led through two blocks on outriggers extending some distance over the stern (an invention of Mr. Schmidt), and through a block travelling on a horse. The inner block on the boom is a match block, and only used when the boat is close-hauled.

The mast is 10in. diameter at the deck, and $5\frac{1}{4}$ in. at the truck. The mast is stayed on each side by one shroud with a "spreader" (a kind of crosstree, a view of which is given at *a*, Plate XVI.) about half-way up; *b* (Plate XVI.) is the shroud. There is also a "spreader" for the bowsprit shrouds, or whiskers, as we should term them.

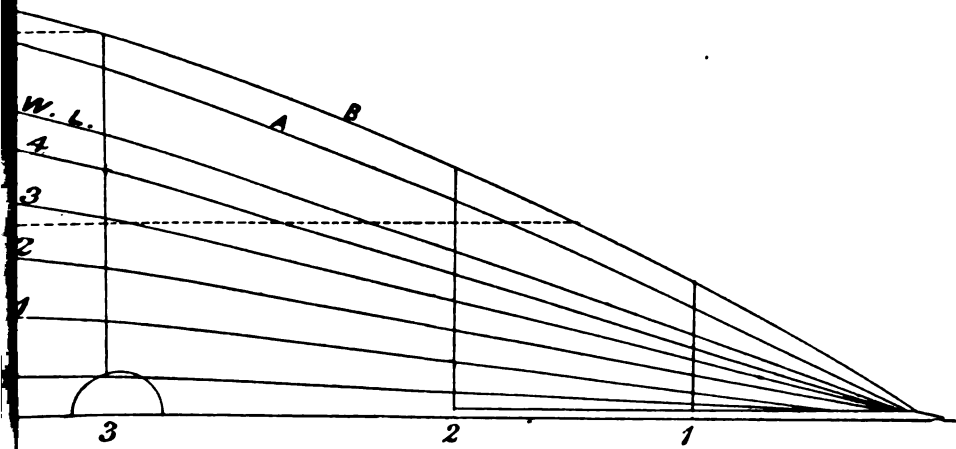
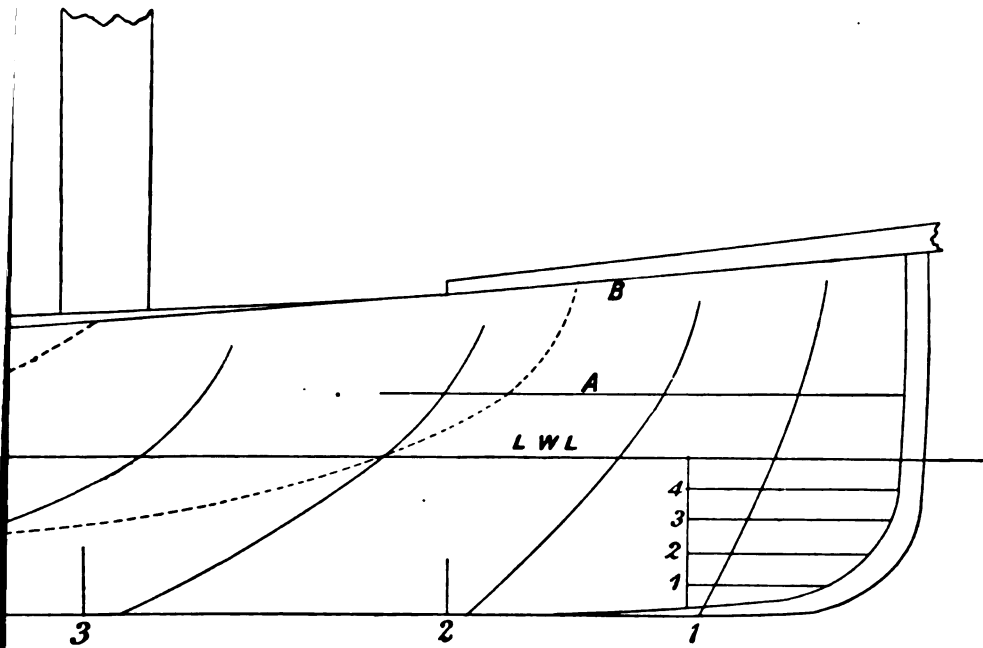



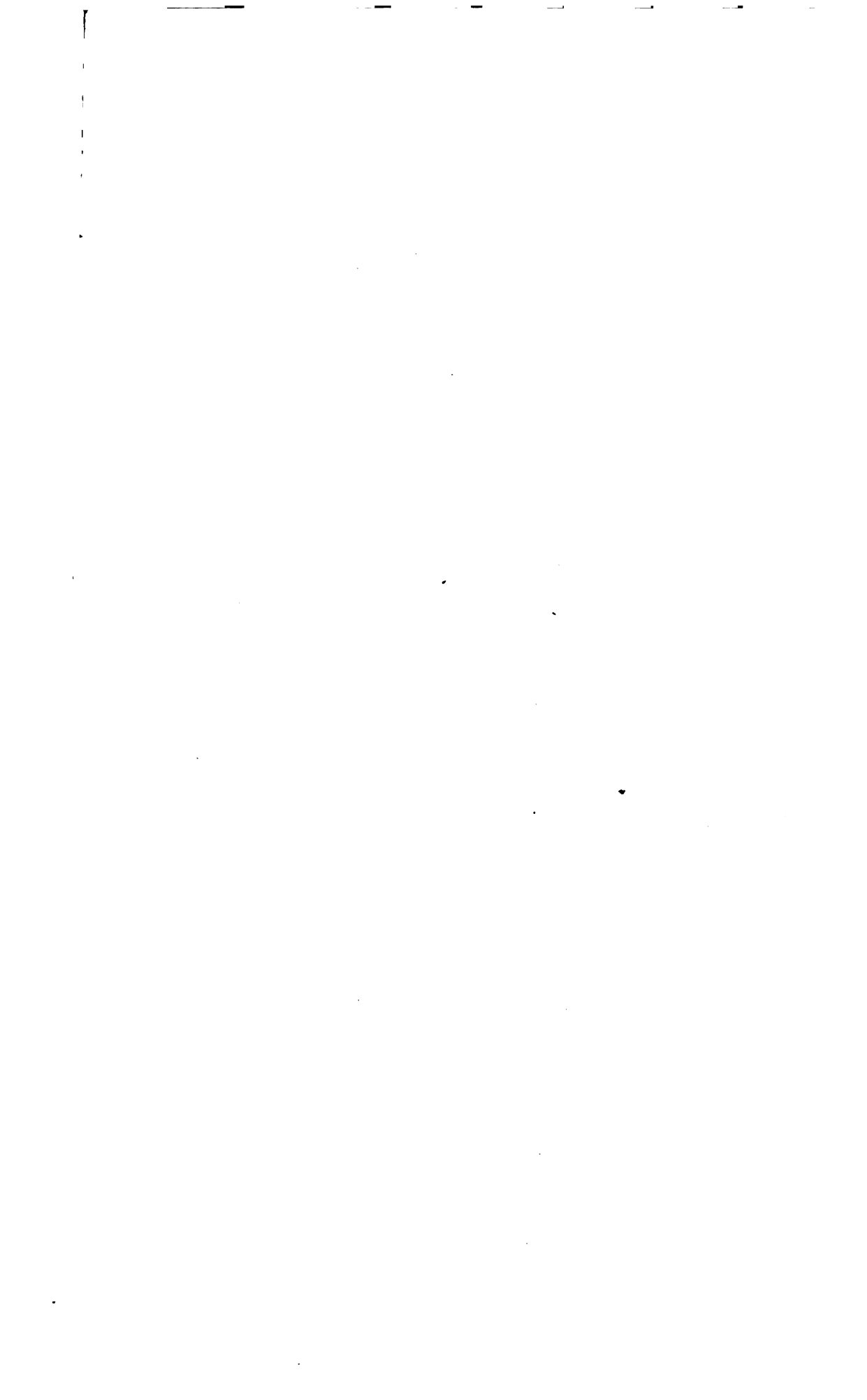

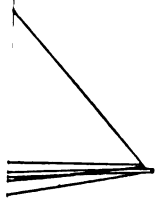

ALLISON

In racing, a crew of seventeen is sometimes carried, although it is difficult to see what good so many men can be on board a boat except to sit to windward and shift ballast.

The ballast of Parole consists of seventy-seven sand bags, the average weight of each being 45lb., or about $1\frac{1}{4}$ ton in the aggregate.

TABLE OF DIMENSIONS, &c., OF PAROLE.

Length on load water-line	27ft.
Breadth, extreme.....	11ft. 3in.
Breadth on load water-line.....	10ft.
Draught of water.....	1ft. 8in.
Draught with board down	7ft. 3in.
Displacement	4.5 tons.
Centre of buoyancy abaft centre of length of L.W.L. ...	0.5ft.
Centre of buoyancy below L.W.L.....	0.6ft.
Centre of lateral resistance abaft centre of length of L.W.L. (with board down or up), inclusive of rudder .	2.3ft.
Centre of effort of sails (mainsail and jib) abaft centre of lateral resistance	0.4ft.
Area of immersed board.....	25 sq. ft.
Area of mainsail	1056 sq. ft.
Area of jib	484 sq. ft.
Total area of sails	1540 sq. ft.
Luff of mainsail	30ft.
Leech of mainsail.....	48ft.
Foot of mainsail	38ft. 6in.
Tack to peak earing	46ft. 6in.
Clew to throat	46ft. 6in.
Luff of jib	46ft.
Leech of jib	35ft.
Foot of jib.....	27ft. 6in.
Mast, deck to upper cap.....	38ft. 3in.
Fore side of mast from fore side of stem	8ft. 2in.
Bowsprit, outboard	22ft. 1in.

The water-lines 1, 2, 3, &c., are 4in. apart. The other measurements can be taken from the drawing, Plate XV.

CHAPTER XVI.

THE SHARPIE AND SNEAK BOAT.

THE existence of the sharpie can be traced back to 1835 on the Connecticut coast. They are supposed to owe their origin to the oyster men, who originally pursued their calling in log canoes; but, large trees failing, they resorted to a flat bottomed boat something like the Wexford flat bottomed boat. The floor of a sharpie is usually rockered or rounded up at both ends (*see* Fig. 79); but Mr. Thomas Clapham, a well-known

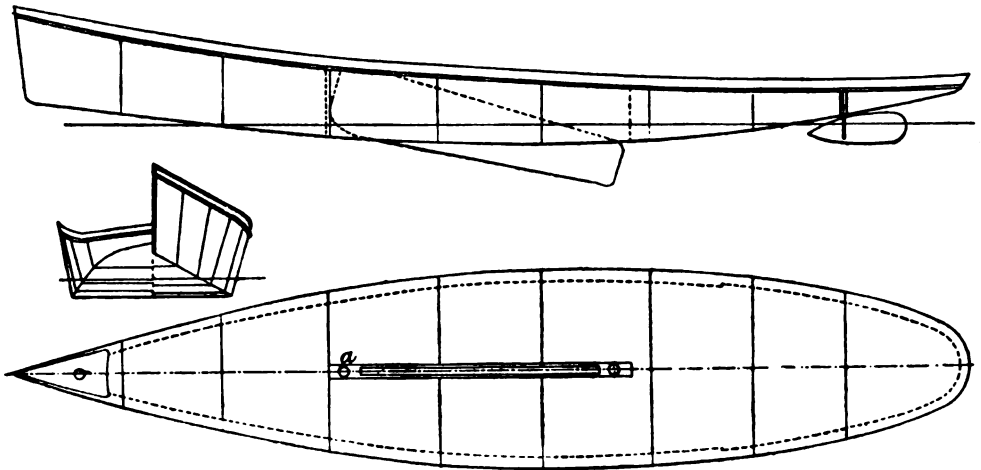

FIG. 79.

builder of these boats at Roslyn, Long Island, U.S., has introduced a form of the "skip jack" which he terms the "Nonpariel" (*see* Fig. 80), the bow end being immersed. The bow end was immersed in the Nonpariel with a view of obviating the "spanking," or hammering, of the flat floor when the boats are driven in lumpy water; but it is said to be of no avail, and, like the "skip jack," the "Nonpariel" spansks as much as the veritable sharpie.

The sharpie varies in her proportions of beam to length from four to five, but the craft of about five beams to length are said to make the greatest speed. Each side, it will be seen, flares out three or four inches to each foot of extreme depth, and, whilst the bow end is usually > or

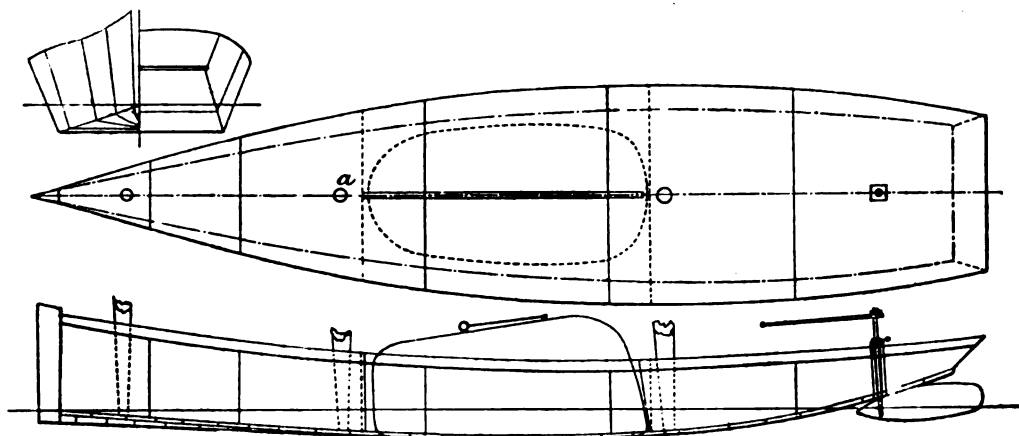

FIG. 80.

sharp shaped, the stern end has usually a square transom. The construction is extremely simple; the stem and transom and midship section are got into position, and the bottom is then planked transversely. As

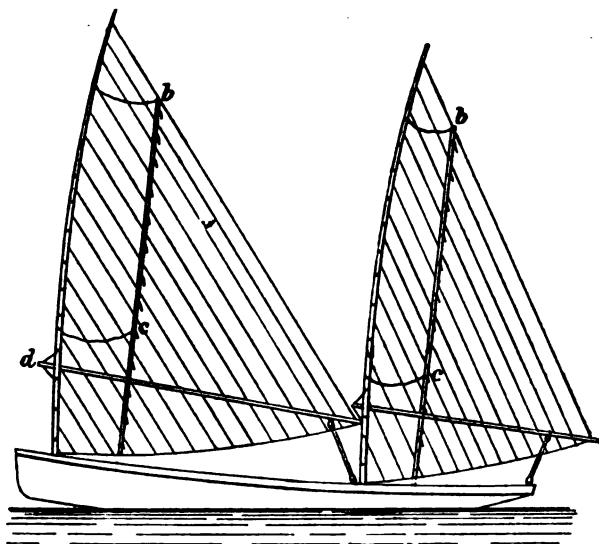

FIG. 81.

a rule, the fore end and aft end of the boat are decked, and in the larger craft a cabin is built. A sharpie 20ft. by 5ft. beam on deck would be 4ft. 3in. broad at the bottom, and 1ft. 8in. deep from gunwale to bottom amidships.

The foremast is usually about six times the beam in height, and mainmast shorter, or about five and a half times the beam. The masts are very slight and tapering, bending like a bamboo yard. The sails are leg-of-mutton shaped, extended by a kind of horizontal sprit (*d*, Fig. 81), a tackle being on the mast for purchasing out the sprit. *b* and *c* are brails used for reefing the sail, reef points are also sewn on the reef bands as shown.

The centre-board is large, and so is the rudder. The latter is usually of the balance type, one-third being in front of the rudder post. An iron pipe is fitted into the stern end to act as sternpost; through this the rudder post is carried, and secured by a collar. The ballast, if any is carried, usually consists of sand bags.

a in Figs. 79 and 80 shows where the mast would be stepped if sloop rigged.

With skilful management these boats can be sailed in lumpy water; but they heel very freely, and great dexterity and quickness are necessary in sailing them in a breeze. Off the wind it is said that a 40ft. sharpie will travel 12 or 14 knots an hour, and with everything flattened in and board down will lie to the wind like a centre-board sloop.

THE SNEAK BOAT.

The home of the sneak boat, or sneak box, or devil's coffin, as the contrivance is indifferently termed, is Barnegat Bay, a piece of water some forty miles long and six miles wide on the coast of New Jersey. It is separated from the Atlantic by a narrow strip of sand, and is thus cut off from anything like ocean waves. Large numbers of the sneak boats are to be seen in the bay, the usual size being 12ft. long by 4ft. breadth.

The keels are of oak 4in. wide and $\frac{3}{4}$ in. deep; plank $\frac{1}{2}$ in. thick. The keel has a crook or bend forward to suit the shape of the boat. The hood ends of the planks are fitted along the gunwale instead of in the stem, the bottom plank or garboard running along the keel and up round each side of the stem. An inwale is sometimes worked, but often omitted as the deck covers the timber heads.

A square well is covered with a hatch with lock to stow guns, &c., as the boats are largely used for wildfowl shooting. No thwarts are used, a moveable box forming a seat for rowing. When duck shooting the crew sit or lie on the floor boards, the deck being covered with sedge.

The rowlocks are fitted in wooden brackets, which fold down to

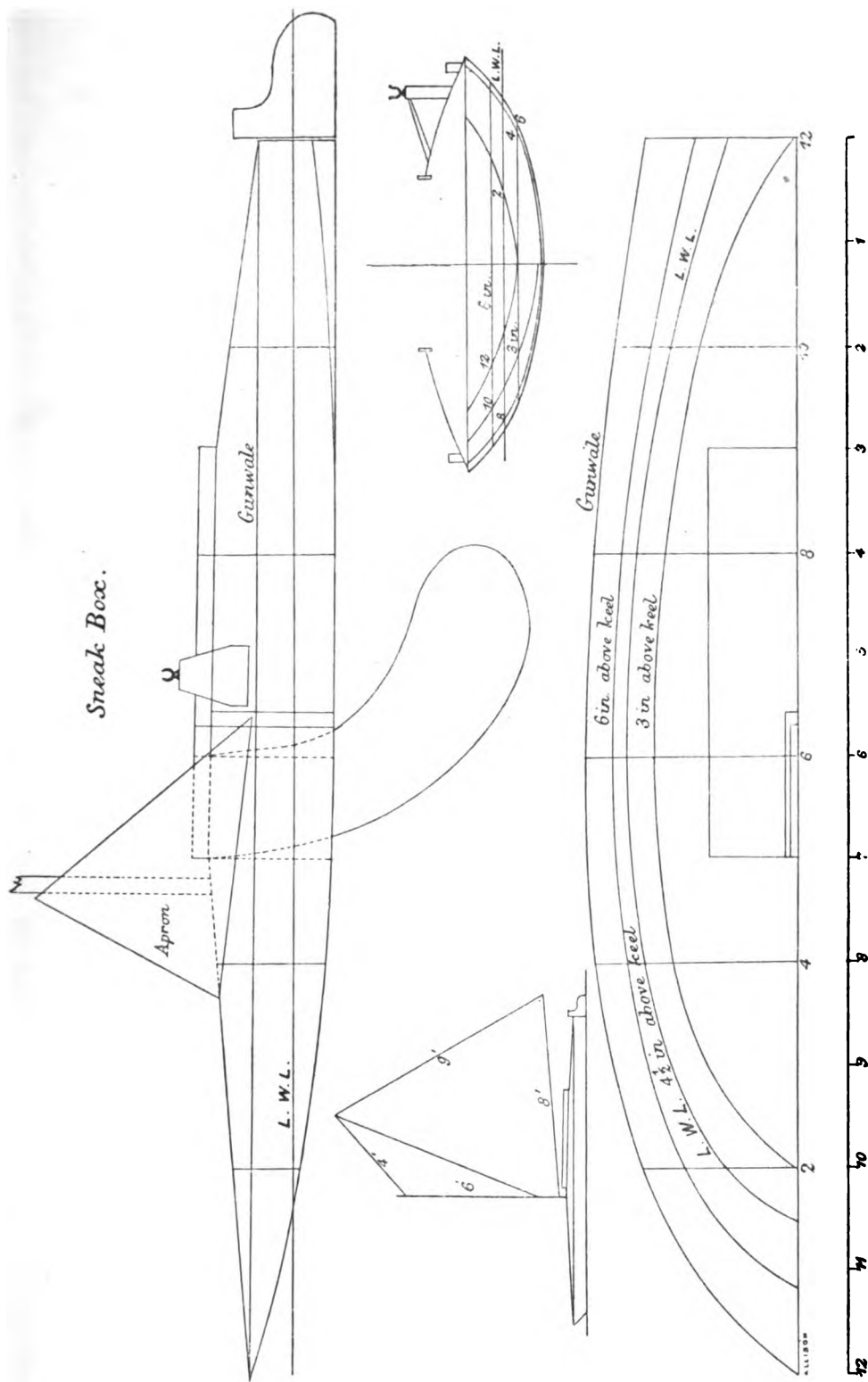

Fig. 82.

the deck. A strip of oak on each side aft serves as a washboard, and also as a rack for holding the decoys.

The most peculiar feature of the boats is the dagger centre-board, which lifts out of the case entirely, as a sword from its sheath. As a protection against rough water an apron is tacked to the deck forward of the well, and set up to a peak by a short spar as shown in Fig. 82.

With their flat bottoms the boats will float in very little water, and can be dragged with ease over mud or marsh. The rig is a small sprit-sail, and either an oar or a rudder is used for steering; the boats are taken out in all kinds of weather, and may be seen flying about the bay when larger craft are at anchor; but of course, as in all such boats, skill and experience in their management alone make them safe.

The "sneak box" appears to be an adaptation of the old Irish canoe as found at Kilkee on the West coast. These canoes developed into a rowing boat, and were thus illustrated (Fig. 83) and described by Commander Horner, R.N.

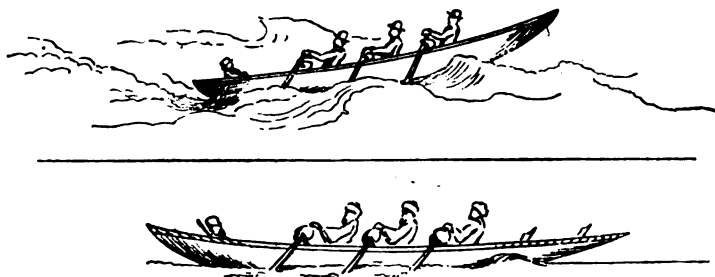

FIG. 83.

Commander Horner says: "I recommend any one, wishing for a new sensation, to take a pull in one after a gale. They never ship a drop of water, and literally dance over the tops of the waves. A six-oared one, such as I went in once from Arran to Galway, would I think be very useful in going over surf." The lower sketch represents a similar boat, the caique of the Bosphorus.

CHAPTER XVII.

NEW BRIGHTON SAILING BOATS.

THE New Brighton Sailing boats differ somewhat from those of a few years ago, the principal change being the introduction of a counter. The counter, it may here be said, is a great assistance to small boats, as it enables them to have longer and better buttock lines, and hence a better or cleaner delivery, no eddies being formed astern. Further, with the counter when much pressed by a beam or head wind, they are handier, and gain a little power; they also run before a sea drier, and much additional room is obtained on board for working the aft sails. The counters are limited in length to 4ft. 6in., and must be clear of the water at the sternpost when ballasted and in trim for sailing, but without crew on board.

The boats were not allowed to be decked, and no appliances permitted to keep out water; they have, however, a kind of "fore peak" forward, by fitting a platform level with and forward of the fore thwart, and the counter may be decked as far as the sternpost. To get rid of the water that may be shipped, a 3½in. pump is fitted amidships, with a discharge both sides.

The freeboard was cut down as much as possible, as it told in the "girth" for measurement;* in the design of the Elaine (Plate XVII.) an attempt was made to compensate somewhat for this deficiency by wash strakes aft.

The Elaine was designed in 1877 for Mr. John Bouch (Com. N.B.S.C.) by Mr. C. P. Clayton, of Hythe, near Southampton, and to him we are indebted for particulars of the New Brighton Boats. The Elaine has less

* The measurement rule of the New Brighton Sailing Club (until the adoption of the Y.R.A. rule) was as follows: "Take the extreme length from fore part of stem to after part of sternpost; girth at greatest *circumference*, by passing a line from gunwale under the boat's bottom, and back to the same point on the same gunwale. The total size of the boat is obtained by multiplying the girth by 1ft. 7in. (1.58ft.), and adding the product to the extreme length. The boats to be raced in one class, and the maximum size of the racing boats to be 50ft. club measurement." Applying this rule to Elaine, we have greatest girth 16ft. 10in., and length 23ft. 3in., thus summed: $16.83 \times 1.58 + 23.25 = 49.84\text{ft.}$

displacement than these boats are usually given, and she has been most successfully sailed against all the crack boats of the club.

The length of the *Elaine* from fore side of stem to aft side of sternpost is 23ft. 3in., and her greatest beam 6ft. 4in.; her greatest draft aft with crew (six hands) on board is 3ft. She has 6cwt. of iron on her keel, and 2cwt. of iron inside.

Some of the New Brighton boats are, however, of much heavier displacement. Thus, the *Tyro* (a very successful boat, designed and sailed by her owner, Mr. G. H. Wilmer), has 24cwt. of iron ballast, 6cwt. of which is on the keel. The weight of the boat is about 14cwt., and of her gear about 6cwt. Her displacement with crew on board is 2·7 tons (54 cwt.). Other boats have 14cwt. or 15cwt. of lead ballast, 8cwt. or 9cwt. of which are placed on the keel. All these boats have deeper and fuller bodies than *Elaine*, and a trifle less beam.

The displacement of *Elaine* to the load water-line shown in the drawing (supposed to be with six hands on board) is 2 tons. The light displacement which brings the counter out of water, as at *x* (see Sheer Plan), is 2in. less or equal to half a ton less. The displacement per inch of immersion at the load water-line is $\cdot 25(\frac{1}{4})$ ton.

Six men of about 12 stone each would weigh half a ton, but probably such a heavy crew would not often be found. This number is not found too many for working the sails; and, as a light-displacement boat like *Elaine* depends so largely on her crew for ballast and stability, it is a serious matter to be one hand short. Probably, as in the case of the centre-board

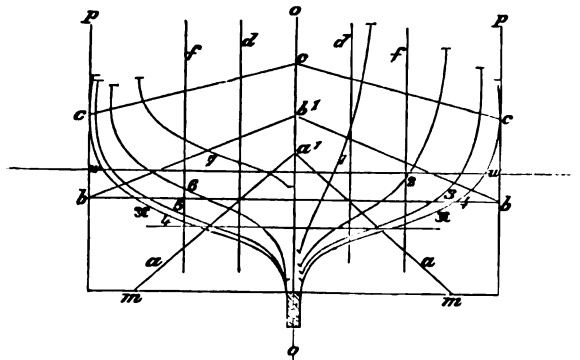
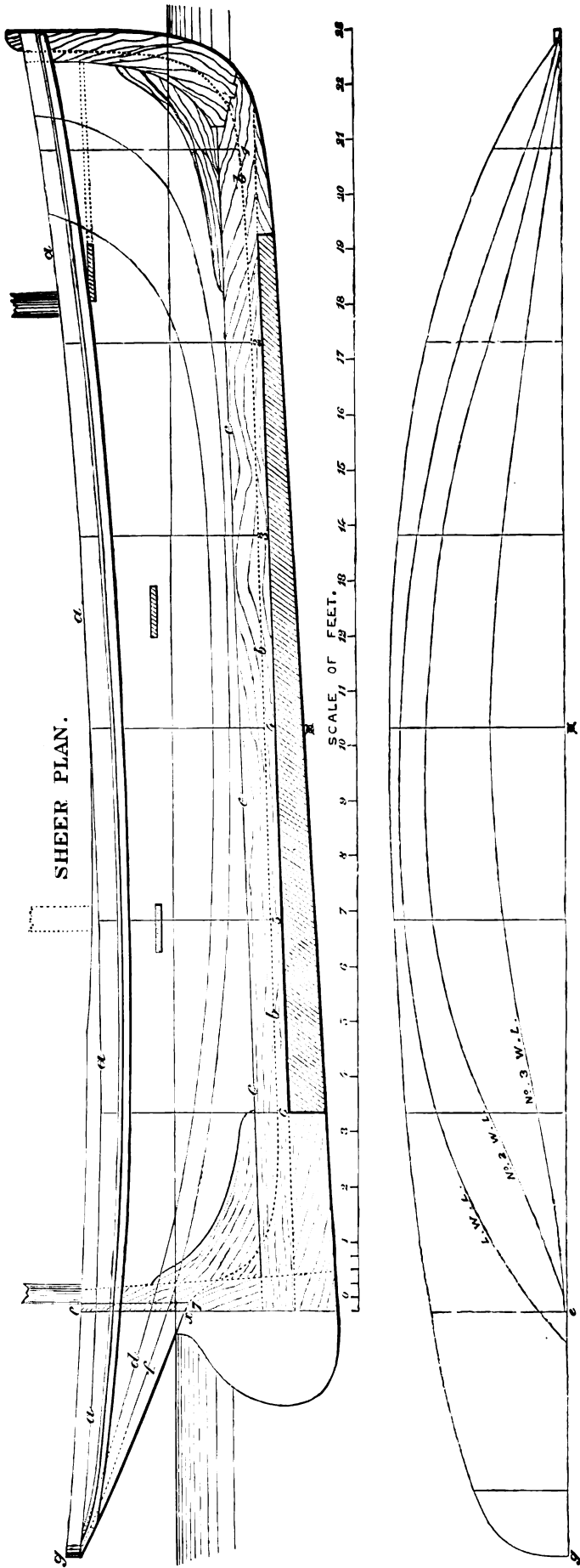

FIG. 84. BODY PLAN OF "ELAINE."

gigs before referred to, five or six hands sitting to windward are much more potent as a means of acquiring stability than any practicable quantity of lead or iron in the bottom of the boat or on the keel would be. In light



PLATE XVII.



SHEER PLAN.

SCALE OF FEET.

HALF BREADTH PLAN.

"Elaine," New Brighton Boat.

winds the crew would stow themselves in the bottom of the boat; but the "half-ton" stowed well to windward is indispensable in anything like a breeze blowing abeam or on the bow.

Of course, with so much weight on the keel, and such great draught and rising floor, these boats cannot very easily be "beached" or hauled up without a cradle, as the Brighton beach boats are; and on the Mersey they usually lie afloat.

The following measurements and particulars refer to the design of the Elaine:—

Sections	1	2	3	4	5	6	7	8
SHEER PLAN.								
Heights above L.W.L. to top of rail...	2 3½	1 10½	1 7½	1 5	1 3½	1 3½	1 5	1 7½
Depth to rabbet-line of keel	1 2½	1 5	1 6½	1 8	1 9½	1 11		
HALF-BREADTH PLAN.								
Half-breadths at gunwale rail	1 1½	2 5½	2 11½	3 1½	3 0½	2 10½	2 5½	1 8
Half-breadths L.W.L.	0 6½	1 9½	2 7½	2 11½	2 10½	2 3½	0 5½	
Half-breadths No. 2 W.L.	0 4½	1 3½	2 1½	2 5½	2 3½	1 4½	0 1½	
Half-breadths No. 3 W.L.	0 2	0 7½	1 0½	1 3½	1 0½	0 5½	0 1½	
BODY PLAN.								
Half-breadths on a diagonal	0 7½	1 4	1 7½	1 8½	1 7½	1 3½	0 5½	
Half-breadths on b diagonal	0 10	1 11½	2 8	2 11	2 10	2 4½	1 5½	
Half-breadths on c diagonal	1 0½	2 4	3 0½	3 3½	3 2½	2 11½	2 4½	

All the measurements include the thickness of the plank.

In the Sheer Plan the heights are measured to the top of the gunwale, lettered *a*; the depths to the lower edge of the rabbet of the keel *b*.

The top of the keel is shown by *c*.

In the Body Plan (Fig. 84) the diagonal *a* cuts the base line at *m* and *n*, 2ft. 5½in. from the middle vertical line *o*; and at *a* 1 the diagonal cuts *o* 3in. above the load water-line *w*.

The diagonal *b* cuts the perpendiculars *p p* on the second water-line as shown, and cuts the middle vertical line *o* at *b* 1, at a distance of 10in. above the load water-line *w*.

The diagonal line *c* cuts the perpendiculars *p p* 9½in. above the load water-line *w*, and cuts the middle vertical line *o* at *c* 1, at a height of 1ft. 7½in. above the load water-line *w*.

The buttock line *d* is 10in. from the middle vertical line *o* (Body Plan), and the buttock line *f* 1ft. 3in. from the middle vertical line *o*.

The vertical sections are 3ft. 6in. apart, and No. 1 section is 2ft. 2in. from the fore side of the stem plumb with load water-line. The water-lines are 5in. apart.

The counter is 4ft. 6in. long, measured from aft side of sternpost or transom at *e* to *g*. (See Sheer Plan and Half-Breadth Plan.)

The keel is sided amidships 3in., tapering to 2½in. at the ends. The keel is 9in. deep, 6in. of which is worked inside, and 2in. outside below the rabbet.

The transom (7 station) is solid, 1½in. thick.

The frames are 1½in. sided, 2in. moulded at heels of floors, and tapering to 1in. at timber heads. Three bent or steamed frames come between each pair of stations shown on the Sheer Plan.

The stem and stern posts are 2½in. sided.

The foremast is stepped 5ft. from the fore side of the stem; the mainmast 16ft. 3in. from the fore side of the stem.

The sails of the *Elaine* are slightly different to those of the other lugs in use on the *Mersey*, as they are cut with an excessive roundness to the head (see Plate XVIII.), on a plan common in Callao and Monte Video; it is recommended as a good expedient for making a sail sit flat. The head of the fore lug of the *Elaine* has as much as 19in. round, and the yard was bent to nearly fit the sail, or to the extent of 15in. (The yard could be bent by being balanced over a beam with a weight at either end, or it could be shored down at either end, for a week or two.) The sail has never puckered along the yard in consequence of excessive round in the head, nor has it ever shaken in the leech; in fact, it sits like a drum-head.

The yard is 3½in. in diameter at the centre, and tapers well towards the ends. A rock-elm batten, 1in. thick and tapering at the ends, is

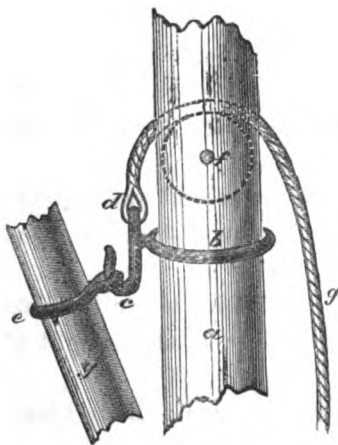

FIG. 85.

made to fit the yard by grooving, and runs nearly the whole length of the yard, and is secured to it by lashings or lacings. The yard should be made longer than at first required, as the head of the sail frequently requires pulling out.

The foremast is 4½in. in diameter; it is fixed into a clamp at the after side of the fore thwart; it is stayed with two light wire shrouds set up with lanyards to the gunwales. The purchase to the jib and purchase to the bobstay hold the mast forward.

The fore halyards are single 2½in. rope, leading through a sheave in the centre of the mast, and the yard is hoisted "chock-a-block," the heel or lower part of the yard being

kept to leeward. There is a traveller on the mast, as shown in Fig. 85; *a* is the mast; *b* is the traveller; *c* is a hook (a solid weld on the traveller), with an eye at *d*, to which the halyard is eye-spliced, seized or bent; *e* is a selvage strop round the yard *y*, just long enough to have a thimble seized in it, to take the hook at *c*; *f* is the sheave in the mast; *g* is the halyard, but not hauled taut.

The tack of the sail is set down by a gun-tackle purchase, or double purchase, leading from an eye-bolt on the keelson of the boat; as it takes two or three hands to bowse the tack down with a gun-tackle purchase. Unless the luff of the sail is kept taut, the peak drops and lets the boom down, but never inconveniently or harmfully, and a small pull on the main sheet puts the matter right. However, there can be no doubt that the peak, if possible, should be kept well set up, and a taut luff will generally succeed in doing this. The tack, tack cringle, and luff rope of the sail must be very strong, to stand the enormous strain put upon it. The head of the sail must be very tightly laced, and the lacing holes are best sewn, instead of "eyeleted."

The boom is fitted to the mast by a goose-neck, made to ship and unship without collar, nut, or pin; the fall of the tack tackle, being generally belayed round the boom at the mast, keeps the boom in its place.

The clew of the sail must be free whilst the tack is bowsed down, the clew is then hauled out on the boom by a traveller similar to the mast traveller. The boom should be a good stiff stick, as, if it bends, a slack leech and belly to the sail will be the result. The sheet is a gun tackle purchase, and on a wind the boom is hauled in as flat as it can be got.

In tacking, the heel of the yard is pulled the other side of the mast by main force as the boat comes head to wind; a short line fast to the heel of the yard is found to facilitate this operation.

In lowering the sail the first thing to do is to let the clew loose and cast off the tack.

In reefing, the tack tackle and hook of the boom traveller are shifted to the reef cringles, the sail set up, and then the reef points tied. Points are put close to the reef cringles, to tie the ends up snugly. The reef bands are 2ft. apart.

The mizen is set the same as the mainsail, but the tack and clew are made fast to the boom by lashings, as the heel of the yard can be easily shifted.

The Monte Videan boats have a claw on the heel of the yard,

made as shown by Fig. 86, to fit on the aft side of the mast; then no dipping is required at all. *a* is the yard, *c* the claw, *d* the mast.



Fig. 86.

Sometimes instead of a claw, a double iron is used, the part which encircles the mast being hinged and fastened by a pin. These contrivances serve to keep the yard steady whilst reefing, and admit of the tack tackle being dispensed with; the tack tackle, however, is generally preferred, as it fairly

brings a strain on the luff and foot of the sail.

The topmasts are generally put up through a split cap *c* (Fig. 87)

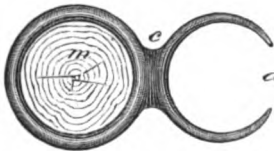

Fig. 87.

on the mast head *m*. The top mast is got on end by hand. The halyards and backstays are cleared through the gap *a*. The heel of the top mast has a rope rove through it, by which it is lashed to the mast. Another plan was adopted in the Elaine, thus:

An iron cap, *A* (Fig. 88), is fitted to the topmast *k*, and remains on the topmast a fixture; when the latter is got on end it is shoved

up in front of the mast, and "shipped" by putting the part of the cap *a* over the masthead (*m*) as the topmast is got up. The heel of the topmast is then lashed to the mast. The part of the iron *a* must fit loosely on the masthead. For lightness the parts *a* and *k* are often made equal; in such case the masthead, or "pole" of the mast, must be reduced to the size of the topmast. The iron cap is riveted as shown at *r*. *B* shows the masthead, with topmast, and iron cap fitted on at *a* and resting on the iron rigging hoop *d*. The shroud *s* is hooked to an eye in the rigging hoop *d*. The jib halyards *h* are hooked to an eye at the fore side of the hoop. The Elaine's topmast is 20ft. long, with the cap in the centre of length.

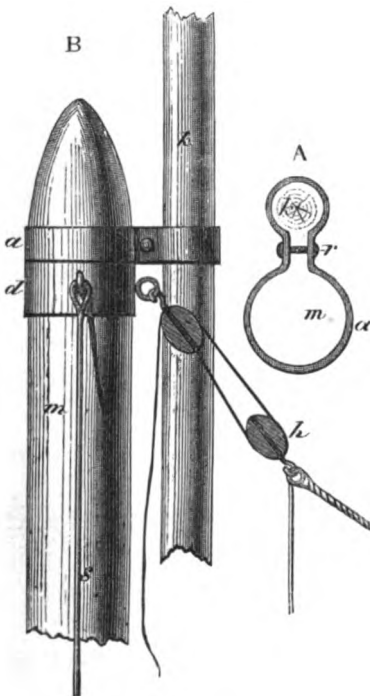

FIG. 88.

much additional area. On the other hand, they add to the gear; and,

Two or three of the boats have topsails on bamboo yards; but they are of no use on a wind, and do not give



PLATE XVIII.

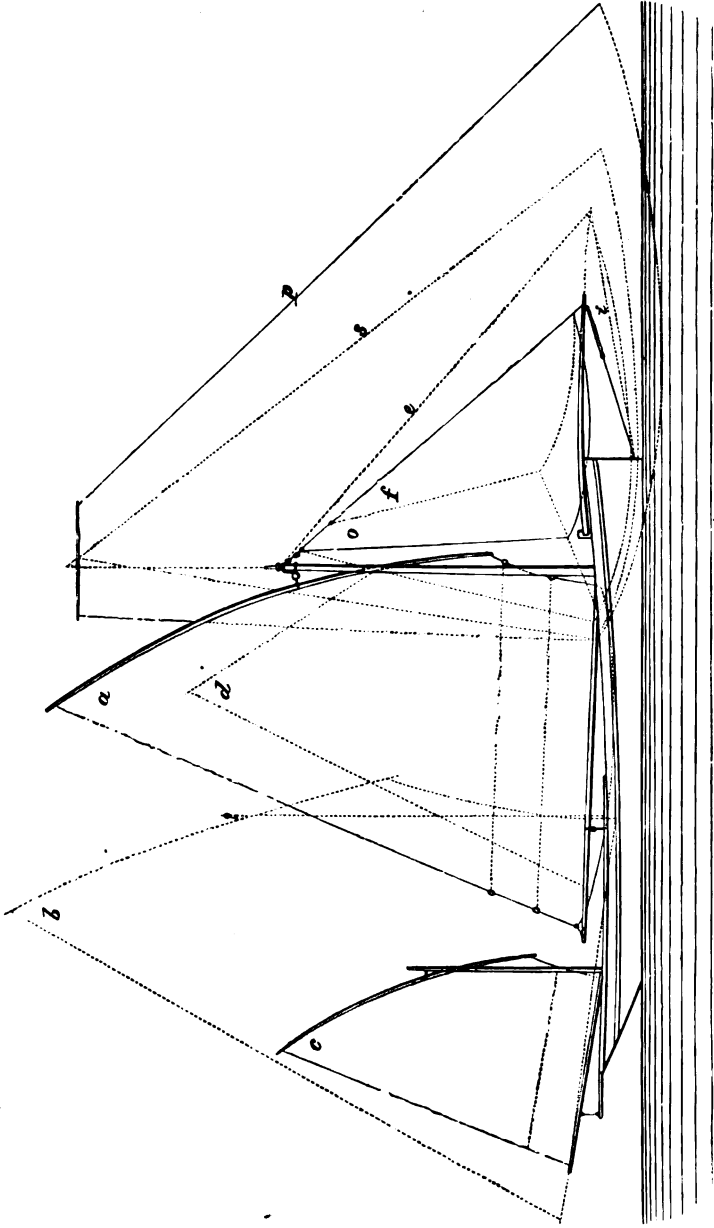

Sail Plan of "The Elaine."

as the boats are already full of necessary sails, gear, and spars on match-sailing days, everything in the slightest degree superfluous is rigidly condemned.

The bowsprit is shipped through an iron hoop on the stem, and the heel fitted into a socket in the mooring bitt, which is fixed about a foot ahead of the mast; the bobstay is of wire, and is set up with a gun-tackle purchase, the outer block being hooked into an eye at the end of the bowsprit.

There are no shrouds to the mizen mast; the sail is hoisted by single halyards. The foot of the sail is generally laced to a boom. The sheet is taken down to a short bumpkin which ships and unships, and projects about 3ft. beyond the taffrail. The standing part of the sheet is fast to the bumpkin end, it then leads through a strop block on the boom, down through a sheave in the bumpkin end, and from there leads on board. The mizen mast is shipped into a clamp, at one side of the rudder, at the fore side of the transom. Care must be taken that there is plenty of drift between the mizen boom and bumpkin, so as to get the sheet well in.

The jib sheets are led through an eye bolt inside the gunwale, or on one of the fore-thwart knees; they lead aft, and are belayed to a pin in the centre of the thwart, and can consequently be handled without going to leeward.

The main sheet is single, and works on a short iron horse about 1ft. 2in. long, secured to a thwart about two-thirds of the length of the boom from the mast. The standing part of the sheet is fast to a single block on the traveller; it leads through a single strop block on the boom (or a clip hook block, hooked into strop), then back through the block on the traveller and the fall hitched round the parts.

All the boats have jib-booms (for carrying balloon jibs), and these are shipped the same as the topmasts, with a gap in the jib-boom iron or cap on jib-boom.

The dimensions of the Elaine sails are as follows :

	Luff.	Leech.	Head.	Foot.	Tack to peak earing.	Clew to throat weather earing.
	ft. in.	ft. in.	ft. in.	ft. in.	ft. in.	ft. in.
Foresail, <i>a</i>	5 0	26 0	21 6	16 0	25 0	17 0
Mainsail, <i>b</i> , for running	10 0	28 6	18 6	18 0	27 6	21 0
Mizen, <i>c</i>	3 0	14 0	18 0	9 0	15 0	9 6
Small sprit foresail, <i>d</i>	10 0	20 0	10 0	14 0	19 0	17 0
Balloon jib, <i>e</i>	20 0	14 0	—	18 6		
Working jib, <i>o</i>	16 6	12 6	—	10 6		
Small jib, <i>f</i>	15 0	10 0	—	7 6		
Spinnaker, <i>s</i>	29 0	23 6	—	22 0		
Big Spinnaker, <i>p</i>	33 0	23 6	4 6	30 0		

‡ Bobstay of jibboom.

The reference letters refer to Plate XVIII.

	ft.	in.
Mainmast from heel (stepped on top of keel) to sheave hole	20	0
Foremast ditto	17	0
Diameter mainmast	0	3½
Foremast	0	4½
Fore yard	21	8
Diameter	0	3½
Fore boom (mast to outhaul sheave)	16	6
Diameter	0	4
Topmast.....	20	0
Above cap	10	0
Diameter	0	2½
Bowsprit, outside.....	7	0
Diameter	0	3½
Mizen mast	10	9
Diameter	0	3½
Two spinnaker booms	21ft. and	7ft.

In 1880 the New Brighton Sailing Club rescinded the restriction placed upon the sail plan of the boats, and in 1881 allowed the boats to be decked; as a consequence, gaff sails and the cutter rig almost entirely supplanted the picturesque lug. The Pearl, a boat built in 1880 (22ft. 6in. long by 6ft. 8½in. breadth), is cutter-rigged, and her sail plan is representative of the others which have been altered from the lug rig.

DIMENSIONS OF PEARL'S SPARS AND SAILS.

	ft.	in.
Mast, gunwale to hounds.....	15	0
Mast head	3	6
Gaff	14	0
Boom	26	6
Bowsprit (outboard)	6	3
Jibboom	6	0
Topmast above cap	10	0
Topsail yard	13	0
Ringtail boom (beyond boom-end iron)	10	0
Ringtail boom inside iron	6	0
Spinnaker boom	25	0
Luff of mainsail.....	13	9
Leech of mainsail	27	6
Head of mainsail	13	6
Mast stepped from fore side of stem	8	0

The topmast is fitted with a heel rope, which passes through a sheave hole in the mast head. When the topmast is hoisted the rope is belayed, and no fid is used. Cross trees are hinged to the heel of the topmast, and are pointed up as the topmast (backstays and hal-yards included) is slewed up through the split cap (*see* Fig. 87). The jibboom is fitted in the same manner as Elaine's. The "ring tail" is fitted similarly to the plan described under the head of "Seamanship" (*see ante*).

A few years ago the New Brighton boats had no counters, and were

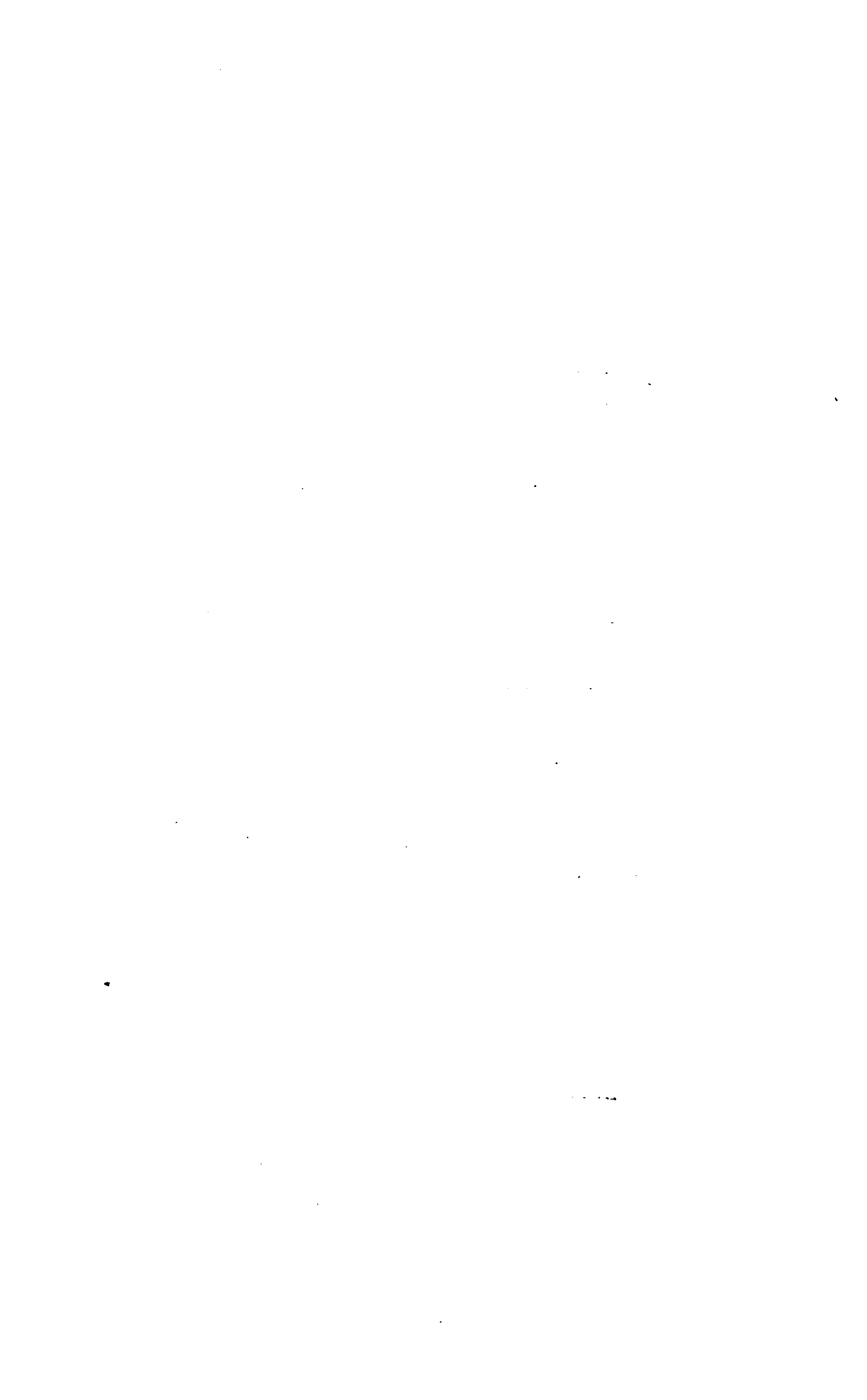
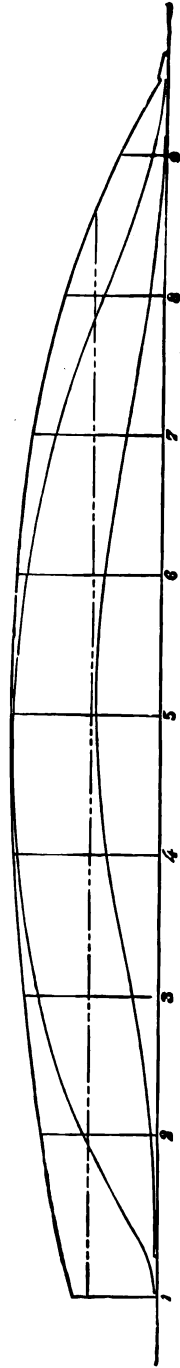
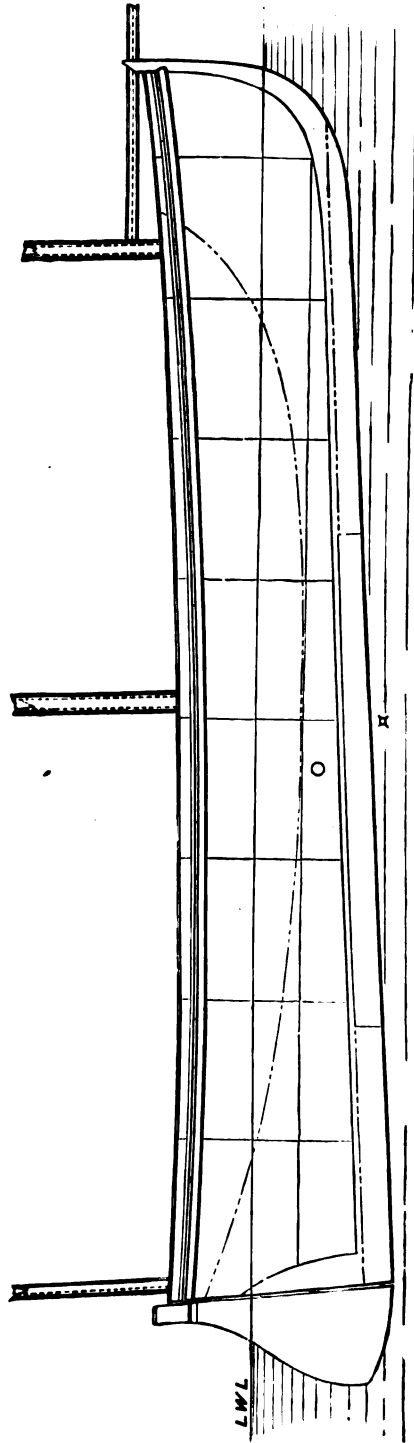

PLATE XIX.



"The Jabberwock."

fitted with sprit sails, as already explained, and Plate XIX. (*see* Fig. 89 for her body plan) represents such a boat, named the Jabberwock. She was designed by Mr. Clayton, and was very successful.

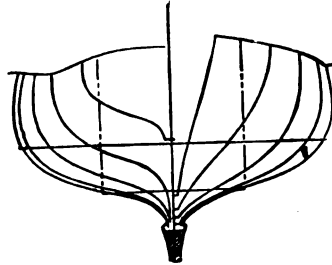

FIG. 89.

The Jabberwock had a length between stem and stern post of 26ft. 6in., and greatest beam of 6ft. 9in., and she had no counter. Her draught aft was 3ft.; amidships 2ft. 5in. She had 7cwt. of ballast outside on her keel, and 4½cwt. inside, besides a crew of five or six.

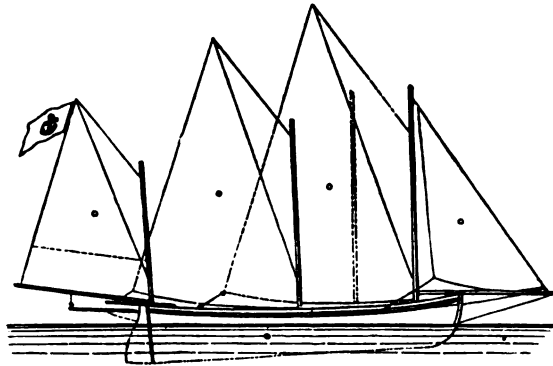

FIG. 90.

The boat sailed well with jib, sprit-foresail and mizen (*see* Fig. 90), and was very handy; the main-sprit being only set in light weather. A very snug rig was made by stepping the mainmast in the thwart shown by the ticked line; jib tacked to stem head and reefed mizen.

THE MANAGEMENT OF NEW BRIGHTON OPEN SAILING BOATS.

Generally open boats of the New Brighton Sailing Club are moored at the back of the landing stages of Woodside or New Brighton, and are consequently obliged to unship their masts. Only a few of them are moored sufficiently in the open to enable them to keep their masts standing.

When lying at moorings, the spars are generally secured at one side of the boat, and the sails at the other, covered over with one large sail cover, and lashed to the thwarts.

A little practice soon enables the crews to get up the working lug sails in five or six minutes. The foremast and bowsprit are first shipped. The jib is the first sail set, to act as a forestay, to keep the head of the mast forward; the jib is hauled out with a single outhaul, the halyards having a gun tackle purchase. Belaying pins are placed at the after side of the foremast thwart for securing halyards, &c.

When the jib and jigger are set, the boat is manageable, and can be cast off from her moorings, the big foresail being put up last; this is done, by first hooking on the tack purchase, then getting the yard into position, so that the grommet strop can be hooked on to the mast halyard traveller; when hoisted the tack is bowsed down, a double purchase being necessary in boats of the Elaine size; last of all, the clew of the sail is hooked into the boom outhaul traveller, hauled out, and the fall secured to a cleat on the lower side of the boom.

The main sheet is generally kept in well taut on a wind, the boom not being allowed to sag away over the side, which it would do if the sheets were double, and taken down to the gunwales.

The lug yard is always kept to the leeward of the mast, and as the halyards are rove through a sheave placed fore and aft, in the centre of the mast, it produces a tendency to keep the head of the sail to windward.

In smooth water the boats will always easily stay, under almost any sail, but in rough water, the helmsman must watch his chance so as not to get a lump of sea on his weather bow just before the boat gets up in the wind; the helm must be put down gradually, so as not to stop the boat's way; the jib is passed over as soon as the boat has properly paid off, and gradually eased over, so as not to stop her way. It is often advisable to ease the jib sheet at the same time that the helm is put down to let her come head to wind quickly, and then if the boat shows signs of missing stays, a hand going into the bows tends to bring her head to wind (this being a recognised dodge with Liverpool speculating gigmen),* and this

* The practice of going into the lee bow of a boat as the helm is put down is a very old one; by immersing the bow to leeward, the pressure is increased and the boat's head forced to the wind. On the other hand, by collecting the crew on the weather bow as the helm is *put up* the boat will wear, or bear up faster. The author of an article on seamanship in the *Encyclopædia Britannica*, in allusion to this subject, says "A practice of seamen in small wherries or skiffs, in putting about, is to place themselves to leeward of the mast. They even find they can aid the quick turning motion of these light boats by the way in which they rest on their two feet, sometimes leaning on one foot and sometimes on the other. And we have often seen this evolution (tacking) very sensibly accelerated in a ship-of-war by the crew running suddenly to the lee bow as the helm was put down. And we have heard it asserted by very expert seamen, that after all attempts to wear ship (after lying to

hand can hold out the clew of the jib, and so, if necessary, force her round—care, of course, being taken to reverse the helm if the boat gets stern way on her.

Hauling in the last inch of the jigger sheet, just as the helm is put down, is advisable in racing, as it helps make a boat come to quickly; and then easing it off and not taking it in again until the boat is well under way, allows her to start again quickly.

The mizen lug yard is easily pushed by the helmsman to the lee side of the mast, but the fore lug yard requires a little handling: the easiest and best way to get it over is by fixing a couple of light ropes, about a fathom long, to the foot of the yard, the ends being allowed to drop down at each side of the boom, and by hauling in the weather one, just before the boat comes upright in stays, the yard bends slightly, and passes round the left side of the mast, and flies into its position to leeward, ready for the next tack, this can be done by one hand without jerking the boat unnecessarily, for the most essential element for speed in these as in all other light boats is to get the crew to keep quiet, and if necessary to lay well up to windward, often to the extent of getting one leg and part of the body over the weather side—as the spare spars and sails are lashed up to the sides of the boats, they assist the crew in keeping this position.

Most careful handling of the helm is necessary in rough water, as a very slight touch will often keep a sea out. It is generally found that the light displacement boats are the liveliest, and driest, in rough weather; and those that take a large quantity of ballast have a high freeboard to keep them dry. A full section forward prevents a boat dipping and taking in volumes of water over the bows, but it is decidedly detrimental to speed in lumpy water, as it hammers on the top of the seas, and so stops the boat's way; a long floor with hollow sections near the keel under the mast seems to answer best.

In reefing the fore lug, the halyards are lowered the necessary distance down the mast, then the hook of the tack tackle block is hooked into the reef cringle in the luff, and the tack bowsed down; the clew outhaul traveller hook is then placed into the opposite reef cringle in the leech, and the clew hauled out; last of all, the foot of the sail is rolled up, and tied with the reef points; reef points are also placed close up to the cringles to make the ends of the sail snug. This can be done so neatly that the reefed sail looks as if it had been changed for a smaller one; and as it can

in a storm) have failed, they have succeeded by the crew collecting themselves near the weather foreshrouds the moment the helm was put up." The man that goes into the lee bow to help bring the boat head to wind should not remain there, but move aft to the quarter on the opposite side; this will assist the boat's head in falling off. (See also "Sternway" in the chapter on "Seamanship.")

be done easily and quickly with practice, it is infinitely preferable to changing sails, and is of great advantage when racing. Reefing the mizen and changing jibs is also often necessary.

The calico lug for running (*see b*, Plate XVIII.) is generally kept in the boat bent, with the head laced to the yard, and foot to a boom; the running-lug mast is the full length of the boat inside, and is shipped into a thwart, about two-thirds the distance aft, between the fore and mizen masts, a single light rope backstay is used, and the yard is hoisted with single halyards, and the tack hauled down with a light line to a hook in the thwart, the sheet is always attached to the boom, and does to make up the sail with, it is led over a fair-leader aft in the counter, and then led inboard. The jigger can be unshipped or brailed up, to allow the big sail to receive all the wind. Topping lifts are fitted to the working lugs for handiness, and to enable the fore boom to be shifted to the other side of running lug; this running lug is only used for running or reaching with a beam wind, and would only sit in a very light air to windward.

The balloon jib is hoisted by ready rove single halyards; the jib-boom is shipped with the outhaul ready rove, no bobstay being of any use; after the sail is got out on the jib-boom, the sheet is passed well aft, clear of, and outside, all other gear and rigging to leeward, then, when the halyards are hoisted, the sail is set: these balloon jibs add greatly to the speed in reaching, being very large, and cut with a round foot, which hangs close to the water.

In setting the spinnaker, the topmast having been got on end (as already explained, with a backstay fitted to the shoulder, and halyards ready rove), the backstay is first taken aft and secured; the guy is passed outside the rigging; the halyards and sail are on the fore side of the mast shrouds and hoisted chock-a-block, being passed through the space between the mast and the rigging the sheet is secured to the bowsprit, or lee gunwale; the guy is bent to a small rope cringle in the tack of the sail; the cringle is of sufficient size to take the spritted point of the spinnaker boom, which is then pushed forward, and the goose neck at the inner end shipped into a socket on the mast, or into a rowlock hole in the gunwale ahead of the rigging. It is drawn aft by the guy, and trimmed to the wind. A hand is kept to sit on the boom to keep it down.

A topping lift is used for the big spinnaker booms, then the boom is shipped into its place before the sail is hoisted, care of course being taken that the outhaul is outside the topping lift, and runs clear of the guy. These points being continually forgotten by amateurs, it is advisable to mention them here, half of the time generally employed in setting a spinnaker is wasted in getting the gear straight (*see* "Seamanship").

In the New Brighton Sailing Club races the boats generally make a flying start, the boats being allowed to pass the line as soon as they can after the second gun, the boats only start from moorings when the tide is too strong to head against, or the wind is light and in the same direction as the tide.

CHAPTER XVIII.

LAKE WINDERMERE YACHTS.

THE peculiarity of the Lake Windermere yachts is their long immersed counters, shown in the accompanying sketch of the *Truant*, one of the old yachts owned by Mr. W. B. Forwood, of Blundell Sands, Liverpool.

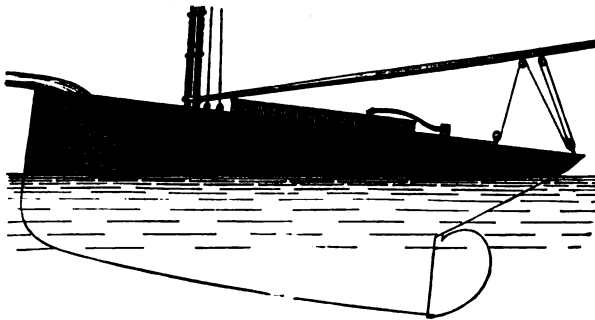

FIG. 91. THE TRUANT.

The fashion of immersing the counter, it appears, arose some eight or nine years ago out of an intended evasion of the rule of measurement, which was simple length between stem and sternpost. The Windermere Club, with a view of checking the advantages gained by immersion of counter, supplemented the rule by a condition that the counters abaft the sternpost should not exceed 6ft. 6in. in length.*

We imagine that the advantages of getting an excess of length by immersing the counter were discovered in this way: The Windermere craft more or less bore by the head, "shoulder," and consequently carry a very great deal of weather helm. Hence they were being continually trimmed by the stern, and always with some advantage; and thus it was realised that an immersed counter is an advantage if length cannot be obtained in any other way without paying a penalty for it.

* In the autumn of 1881 the Windermere Club adopted the water-line as the basis of measurement, the limit being 26ft. 6in., and resolved to class the boat by the new Y.R.A. tonnage rule.

The Windermere yachts are mostly distinguished for their fine weatherly qualities, and it is believed by good judges that no other craft in the world of similar length are so good to windward. They are sailed with great boldness, of course; and there need be no fear of sailing them too hard, so far as danger is concerned, as, owing to the great weight they have on the keel, it would be impossible to capsize them.

These boats are the safest that could be built, as they are really uncapizable; and if wholly decked in, no mishap need ever happen with them, further than the breaking of spars and bursting of gear. They can, moreover, be handled single handed, as there is very little gear to work: but the principal feature that should command the attention of the nervous is their almost absolute safety. Men are continually inquiring for a boat that will not capsize, or one that will not sink; but, whilst it is easy enough to make a small boat unsinkable, it is practicably impossible to make one uncapizable—we mean, of course, a 20ft. boat of the ordinary type. Now a small yacht built and ballasted like either of the designs we give would be uncapizable, and it might easily be made unsinkable by having a water-tight bulkhead forward and aft. Of course, if carelessly sailed, such boats might get knocked down nearly on their beam ends, and, if the crew got scared, or were not careful where they had put their hands and feet, they might get a header; but the yacht, directly the pressure on her sails had passed, would right herself. Of course it would be nothing but the result of gross carelessness if a yacht did get knocked down on her beam ends; as in the case of squalls the boat should be luffed, and the jib sheet, if necessary, eased. It will not do to wait until the squall actually knocks the boat over; she must be eased with lee helm directly the first breath of the squall is felt. If the boat gets hove down and loses way, the power of luffing will be gone, and then, if water got into the mainsail, "righting" would be a slow process; and further, if water got into the hold, and if there were no water-tight compartments, the boat would sink. With such craft as these it is always the proper thing to do to ease the head sheets first, and not the aft sheets, as by easing the latter the power for luffing is reduced, and by easing the head sheets it is increased.

Mr. W. B. Forwood, owner of the *Truant*, writing upon the sailing qualities of these craft, says: "The Windermere yachts are rigged as sloops, with pole masts. We have found by experiment that they go to windward much faster with one large jib than with two smaller sails. This, I know, is contrary to the general opinion on the subject; but there is no doubt whatever that the yachts are closer-winded with one jib than they are with jib and foresail. When sailing on a wind the main sheet is hauled in

as taut as it can be got, the boom forming the smallest possible angle with the keel. The helmsman steers by the luff of the jib, and, as the boats are very sensitive, they require most careful steering. Very heavy squalls are frequent, and they come down from the mountains without warning and with great fury. The boats are always sailed through these squalls, but are eased a trifle with the helm, so that they do not take the full weight of the wind; great care, however, is taken that they are not eased so much as to lose way. The squalls are generally "revolving," and if the boats were permitted to stop they would probably be taken next moment aback; so they are kept going to keep steerage way on, and follow the wind round. If a squall be very black and heavy, the jib sheet is eased a trifle, so as to luff quickly; but the main sheet is never in such cases started.

"It is astonishing what a weight of wind these boats will bear; they rarely sail without a topsail, and I never yet took a reef in my mainsail. They have 1ft. 6in. waterways, and 6in. coamings to cockpit; still, when very hard pressed, the water sometimes comes in over the coamings. The boats, however, are probably doing their best when only two or three inches of the deck are immersed. In sailing before the wind only fore-and-aft canvas is allowed, and no booming out permitted. As the boats have a tendency to bury their bows in running and reaching, all hands are put on the counter, until the taffrail is almost level with the water; and the more weight there is put on the counter under such circumstances, the better they seem to go. As the boats flare out a great deal above water at the foreside of the rigging (being so short and beamy), they 'shoulder' to leeward, and by trimming aft the shoulder is lifted out of the wave on the lee bow. On a wind the tendency of the boats is to lift their stern and depress their bows, but 'shouldering' does not appear to such an extent."

It is quite clear that a yacht which required so much weight shifted aft whilst moving must be wrong somewhere, and in the case of the Windermere craft we had not long to search for a cause of the defect. The midship section was placed only eight or nine feet abaft the fore side of the stem; and this fact, coupled with 8ft. beam, necessarily gave the yachts a very short and full bow. The bow was given a slight hollow at its extreme fore end; but this of itself was not an important relief, and the bow was essentially one that would bury itself, and be incapable of very high speed, excepting under a propelling power* out of all proportion to the size of the boat. The Windermere yachts had, as may be supposed, a comparatively long and fine after-body, and if they were driven stern first at a

* With a good strong and pretty steady breeze, the yachts have thrashed to windward six miles (equal to eight and a half miles), run seven, and reached eight in 3 hours 35 minutes; this would give a mean speed of nearly seven knots per hour, which must be considered exceedingly good.

speed of nine knots what was the bow end would still subside; only, under such conditions, it would form the stern of the vessel. Most American yachts, which have comparatively short after-bodies (generally the proportion of after-body to fore-body is as 4 to 5) subside by the stern at high speeds, and many English yachts which have long bows and comparatively short runs do the same—notably the cutters built by Fife do so. On the other hand, yachts of the cod's head and mackerel's tail type with short entrance and long run, bore by the head—that is to say, the hollow of the wave forward is so large that the bow sinks into it.

The depression by the bow was, no doubt, in the case of the Windermere yachts, much aggravated by the sail pressure; they have enormous sail areas (about 15 per cent. more than any five-tonner), and as the head resistance they encounter at high speeds is very great, the depression due to the leverage of the sails alone must be very considerable. Also the depression may be increased through inequalities in the wedges of immersion and emersion, and these latter influences will always have to be regulated by trimming. However, there is not much doubt that if the Windermere craft had been propelled nine or ten knots an hour by steam, in an upright position, they would still have "bored," on account of their midship section being placed so far forward. Still the forward position of the midship section need not be an unmixed evil; on a wind, when the speed is necessarily low, the shorter and fuller bow may be a positive advantage, and no doubt there is some reason for the old saying "A full bow eats itself to windward." However true this may be, so far as the ardency of the pressure on the lee bow assisting the boat to windward is concerned, there is now no room for doubting that a long entrance (of course of the proper form) is better for sailing on any point than a short entrance.

As the immersion of the counter was countenanced by the Windermere club, there was no reason why it should not have been treated as an integral part of the vessel, as it was in the Jullanar. But, strangely enough, at the time when this chapter was written in 1878, most of the Windermere craft were designed as if they were to be only 20ft. on the load line, with the counter clear of the water at the stern post, the counter being subsequently immersed according to the trim required in sailing. In the design (made in 1878), Plate XX., the whole length (26ft. 6in.) allowed by the club rule was appropriated, and the midship section was placed, as it would be in any ordinary yacht of similar length, a little abaft the middle of length of the load water line. The bow is consequently about 4ft. longer than was the usual length of bow of a Windermere yacht, and the stern is shorter, but not so much as the bow is longer, because the whole length (excepting a couple of inches) has been taken for the permanently immersed length.

Most of the Windermere yachts show a little less bilge, and are fuller near the garboards, than the designs (Plates XX. and XXI.); but all, we believe, have the greatest beam at the deck.

The No. 1 design (Plate XX.) has 8ft. 9in. beam, and would show a hollow line of immersion at 20° heel; but the No. 3 design is very clean on the line of immersion at that inclination.

No. 1 design is of too great displacement to compete with success on Lake Windermere, and would be more suitable for coast sailing, where beaching is not necessary.

No. 2 design (Plate XXI.) has less displacement, but would scarcely be able to successfully compete with the Windermere yachts.

No. 3 design (Plate XXI.) is of still lighter displacement, or about the same as the displacement of the Windermere yachts. The centre of buoyancy is a little farther forward than in either of the other designs; still the entrance is very much longer and finer than that of any Windermere yacht was in 1878; but the after-body, for mere fineness, closely resembles the after-body of such a yacht.

As to the capabilities of the designs for competition against the Windermere craft of the present, No. 3 would probably turn out the most successful. So far as theoretic principles go, either design ought to be capable of beating the Lake craft of four years ago, if the handling were equal; and if No. 3 did not succeed, because her bow is too long and her stern too short, we should, as we stated in 1878, have to begin to study the subject afresh; and all the knowledge acquired during the last thirty years in the way of naval science might have been regarded, so far as the requirements of Lake Windermere were concerned, as utterly useless.

Capt. J. H. Anderson built a boat, at Toulon, from No. 3 design in 1879, and he has sailed her successfully in all kinds of weather against all kinds of craft in the Mediterranean regattas under the name of "Windermere." He says she never bores by the head, and is as handy as a cat boat. She "pounders" in a sea a good deal, like all such craft will, and no doubt under such conditions a long lean 5-tonner would easily beat her.

In 1879 Mr. Herbert Crossley built a Windermere yacht (*see* Fig. 92) from his own design, named Syren, and which in some respects resembles the No. 3 design. He placed the midship section in exactly the same position as is the midship section of No. 3 design, that is, 14ft. from the fore side of the stem, and made the counter form a permanently submerged or integral part of the after-body. He has raced this yacht with great success against the old-fashioned Windermere craft.

The topsail shown on Plate XXII, is not so large as the American

sloops of similar size carry. The usual shape of an American topsail is shown in Fig. 43, p. 175). It will be seen that the yard is "up and down" the mast and the foot, laced to a jack yard, extends far beyond the head of the main sail. This sail is known in America as a club topsail; it can be only carried in light winds, and is not adapted for squally weather.

The sails of the yachts are made of duck, and are admirably contrived for flatness by the local sailmaker. The sloop rig, it has been proved by

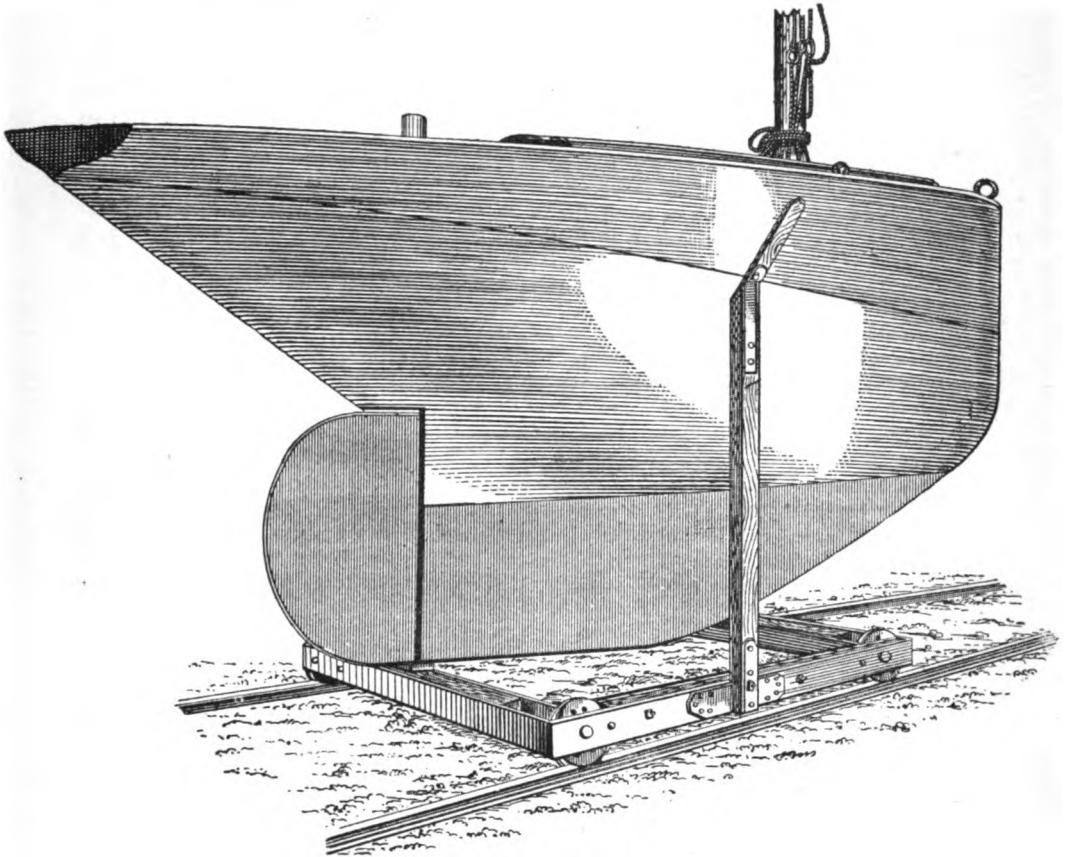

FIG. 92.

experience, is much the best for going to windward on the smooth water of the lake, and no difficulty is ever experienced in handling it.*

The sail plan is shown in the sketch (Plate XXII.), and it will be seen that the gear is very simple, all running through single blocks. The main halyard block is not shown in the sail plan. The upper block is hooked to an eye in the main rigging iron, about 1ft. 6in. above the

* For sea-going work at least 5ft. should be cut off the length of gaff given in the table; this Capt. Anderson found it necessary to do, and it bears out the experience of the Americans with their sloops at sea, all of which have gaffs about half the length of main boom.

jaws of the gaff. The standing part of the halyard is fast to the upper block; the other end is passed through a block on the jaws, then through the upper block.

The hulls are pumice-stoned outside, and then black leaded, very great attention being paid to the condition of smoothness of the bottom.

LAYING-OFF TABLES.

No. 1. DESIGN.

Sections	1		2		3		4		5		6		7		8		9		10		11		12	
	ft.	in.	ft.	in.	ft.	in.	ft.	in.	ft.	in.	ft.	in.	ft.	in.	ft.	in.	ft.	in.	ft.	in.	ft.	in.	ft.	in.
Heights above L.W.L. to deck.....	2	7	2	5	2	3	2	1	1	11½	1	10½	1	9½	1	9	1	9½	1	9½	1	9½	1	10½
Depths below L.W.L. to rabbet of keel	2	0½	2	11	3	3	3	5½	3	7	3	8½	3	9½	3	8	3	4	2	11	2	4½	1	7
Depths to under side of keel	—	3	3½	—	—	—	—	—	—	—	—	—	—	—	—	—	—	—	4	6	—	—	—	—
Depths of lead keel	—	0	6½	1	2*	1	6½	1	10½	2	1	2	2	2	1½	2	0	½	1	10½	—	—	—	—
Half-breadths on deck	1	1½	2	1½	2	11½	3	6½	3	11½	4	2½	4	3½	4	3	4	2	3	11	3	6	2	8½
Half-breadths on L.W.L.	0	7½	1	4	2	1½	2	10	3	4½	3	9	3	10½	3	10	3	7½	3	3	2	7½	1	7
Half-breadths, No. 2 W.L.	0	4	0	10½	1	6½	2	2½	2	8½	3	1	3	2½	3	0½	2	8½	2	2	1	5½	0	7
Half-breadths, No. 3 W.L.	0	1½	0	5½	0	11	1	4	1	8½	1	11½	1	11½	1	10	1	6½	1	0½	0	5	—	—
Half-breadths, No. 4 W.L.	—	0	2	0	4½	0	7½	0	10	0	11½	0	11½	0	9½	0	6½	0	2½	—	—	—	—	—
Half-breadths on diagonals, 1	0	3½	0	8½	1	1½	1	5	1	7½	1	9	1	9½	1	8½	1	6	1	2½	0	9½	0	3
Half-breadths on diagonals, 2	0	7½	1	2½	1	10	2	3½	2	7½	2	10½	2	11	2	9½	2	7	2	2½	1	9½	1	1½
Half-breadths on diagonals, 3	0	9	1	6½	2	3½	2	10½	3	4½	3	8	3	8½	3	8½	3	5½	3	1½	2	7½	1	9½
Half-breadths on diagonals, 4	0	11½	1	10½	2	8	3	3½	3	9½	4	1½	4	8	4	2½	4	1½	3	9½	3	3½	2	5½

No. 1 diagonal radiates from the middle vertical line of the body plan at 1ft. 4in. below L.W.L., and cuts the lower water line at 1ft. 8½in. from the middle line. No. 2 diagonal radiates from the L.W.L., and cuts the third water line at 2ft. 9½in. from the middle line. No. 3 diagonal radiates from the middle line at 10in. above the L.W.L. No. 4 diagonal radiates from the middle line at 1ft. 9in. above L.W.L., and cuts the side perpendicular 5in. above L.W.L.

No. 2. DESIGN.

Sections	1		2		3		4		5		6		7		8		9		10		11		12	
	ft.	in.	ft.	in.	ft.	in.	ft.	in.	ft.	in.	ft.	in.	ft.	in.	ft.	in.	ft.	in.	ft.	in.	ft.	in.	ft.	in.
Half-breadths on deck	1	1½	2	1	2	11	3	6	3	11	4	2	4	3½	4	3	4	2	3	11	3	6	2	8
Half-breadths 1ft. above L.W.L.	0	9	1	7½	2	6	3	2½	3	8½	4	0	4	1½	4	1½	3	11½	3	8½	3	3	2	5
Half-breadths on L.W.L.	0	6	1	2½	2	0½	2	9	3	3½	3	7½	3	9	3	8½	3	6	3	1	2	5	1	6
Half-breadths, No. 2 W.L.	0	3	0	8½	1	3½	1	10½	2	4½	2	9	2	10½	2	9	2	4½	1	10	1	2½	0	5½
Half-breadths, No. 3 W.L.	0	2	0	3½	0	8	1	0½	1	4	1	6	1	6½	1	5	1	2	0	9	0	4	—	—
Half-breadths, No. 4 W.L.	—	0	2	0	3½	0	5½	0	7½	0	8½	0	9	0	7½	0	5	0	2½	—	—	—	—	—
Half-breadths, diagonal (n)	0	10	1	8½	2	5½	3	1½	3	7	3	10½	4	0	3	11	3	9	3	5½	2	11½	2	3
Half-breadths, diagonal (a)	0	6	1	1	1	7½	2	1	2	5½	2	8½	2	9	2	7½	2	5	2	1	1	8	1	0
Half-breadths, diagonal (m)	0	2	0	5½	0	9½	1	1½	1	4½	1	5½	1	6½	1	5½	1	3	0	11½	0	7	0	2

n diagonal is struck 1ft. 6in. above the L.W.L., and cuts the perpendiculars p p, at n 1 and n 2, 7½in. below the L.W.L.

a diagonal cuts No. 3 water line, at a 1 and a 2, 8in. from the perpendiculars p p.

m diagonal is struck 1ft. 5in. below the L.W.L., and cuts No. 4 water line, at m 1 and m 2, 1ft. 6in. from the perpendiculars p p. All the water (horizontal) lines shown in the body plan are 1ft. apart.

* These depths refer to the filling up piece of wood forward of lead keel, and forming fore foot.

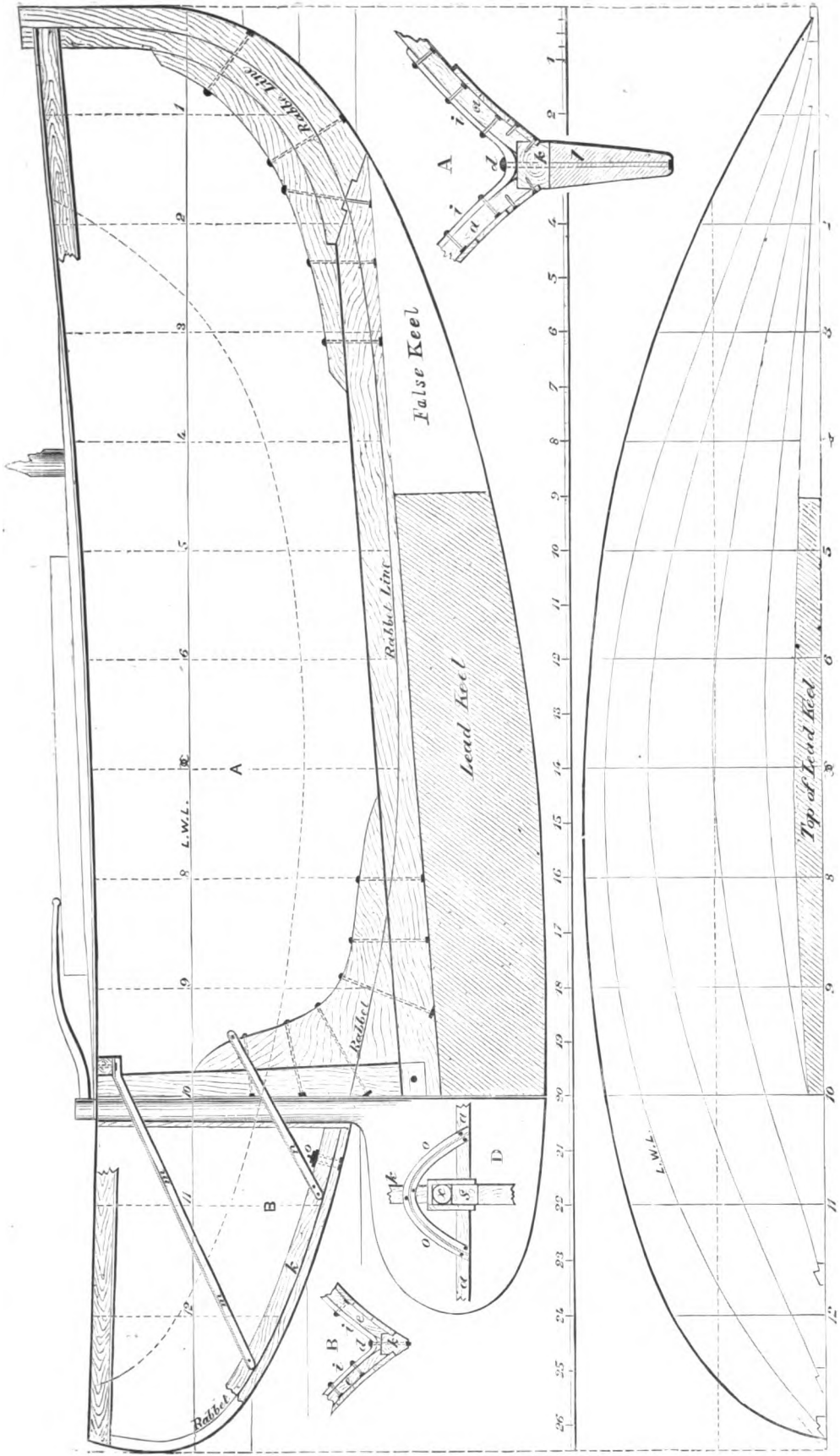

Lake Windermere Yacht, length 26ft. 6in. Design No. 1.

PLATE XXI.

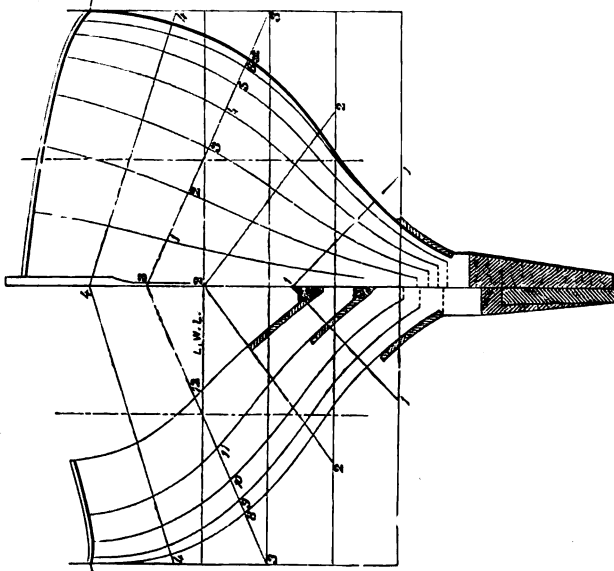

Design No. 1.

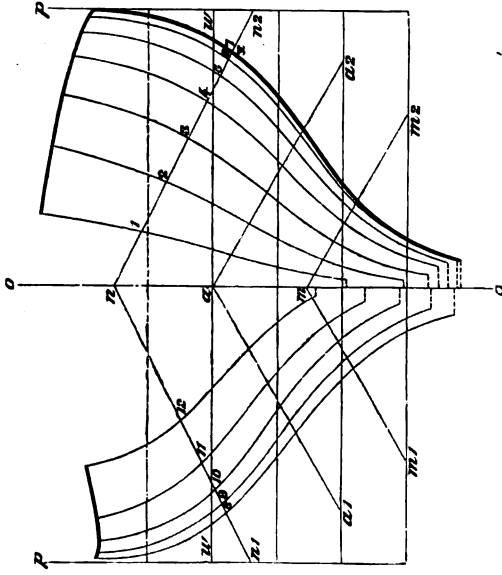

Design No. 2.

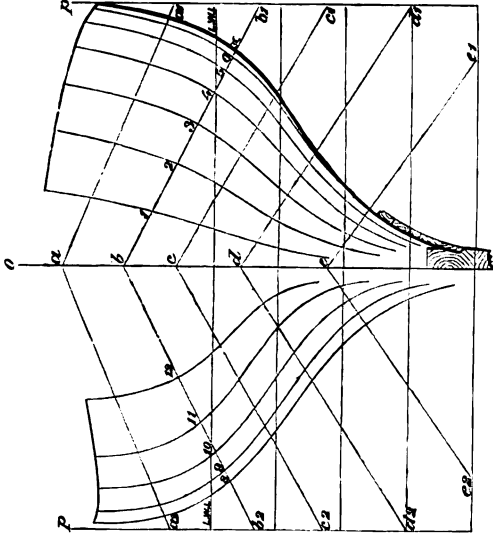

Design No. 3.

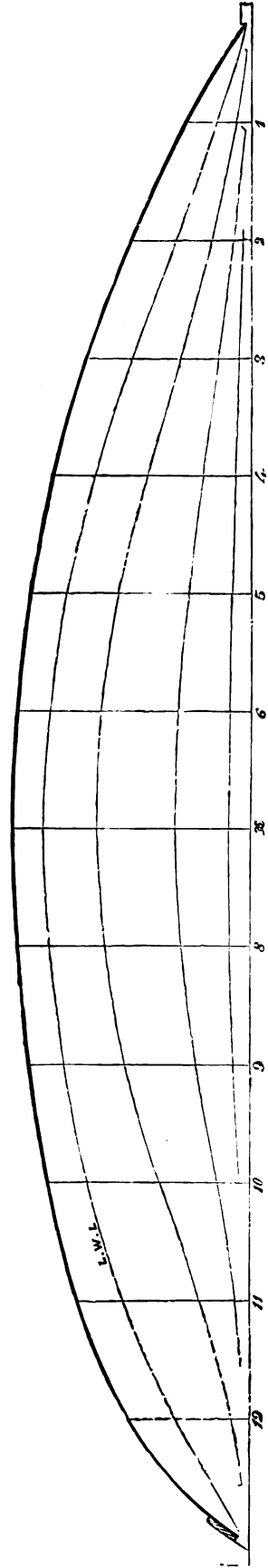

Design No. 3.
Windermere Yachts.

No. 3. DESIGN.

Sections	1	2	3	4	5	6	7	8	9	10	11	12
	ft. in.	ft. in.	ft. in.	ft. in.	ft. in.	ft. in.	ft. in.	ft. in.	ft. in.	ft. in.	ft. in.	ft. in.
Depths below L.W. to rabbet	—	2 8	3 0	3 3	3 5½	3 7½	3 8½	3 7½	3 4	2 11	2 4	1 7
Depths to under side of wood keel	—	3 1	—	—	—	—	—	—	—	4 6	—	—
Half-breadths on deck	1 1½	2 0½	2 9	3 3½	3 8½	3 11	4 0	3 11	3 8½	3 5	2 11	2 1
Half-breadths on L.W.L.	0 6½	1 3	1 11½	2 7½	3 1½	3 4½	3 6	3 5	3 2½	2 9½	2 1½	1 3
Half-breadths on a diagonal.....	1 1	2 0	2 8½	3 4	3 9	4 0	4 1½	4 0½	3 11½	3 7	3 1	2 2
Half-breadths on b diagonal.....	0 11	1 8½	2 4½	2 11½	3 4½	3 7	3 8½	3 7	3 5	3 1	2 7½	1 10
Half-breadths on c diagonal.....	0 8½	1 4½	1 11½	2 5	2 9½	3 0	3 0½	2 11½	2 9	2 4½	1 11½	1 4
Half-breadths on d diagonal.....	0 5	0 10	1 3	1 8	1 11	2 1	2 1½	2 1	1 10	1 6	1 0½	0 7
Half-breadths on e diagonal.....	0 1½	0 4½	0 7	0 9½	0 11½	1 0	1 0½	1 0	0 10	0 7	0 4	0 0

a diagonal is struck 2ft. 3½in. above the L.W.L., and cuts the side perpendiculars on the body plan at a 1 and a 2, at 7½in. above the L.W.L.

b diagonal is struck 1ft. 4in. above the L.W.L., and cuts the side perpendiculars at b 1 and b 2, at 8in. below the L.W.L.

c diagonal is struck 7in. above the L.W.L., and at c 1 and c 2 cuts the side perpendiculars 1ft. 8½in. below the L.W.L.

d diagonal is struck 5in. below the L.W.L., and cuts the side perpendiculars at the intersection of the same with the 4th water line.

e diagonal is struck 1ft. 9in. below the L.W.L., and at e 1 and e 2 is 8ft. 2½in. from the middle vertical line o.

TABLE OF DIMENSIONS OF Nos. 1, 2, AND 3 DESIGNS.

HULL.	1	2	3
Length, extreme	26ft. 6in.	26ft. 6in.	26ft. 6in.
Length between stem and sternpost.....	20ft. 0in.	20ft. 0in.	20ft. 0in.
Greatest beam, moulded	8ft. 6in.	8ft. 6in.	8ft. 0in.
Beam on L.W.L. moulded	7ft. 9in.	7ft. 6½in.	7ft. 0in.
Draught of water aft at sternpost	6ft. 5in.	6ft. 5in.	6ft. 5in.
Displacement	7·2 tons.	6·4 tons.	5·7 tons.
Area of midship section	17·5 sq. ft.	16·3 sq. ft.	14 sq. ft.
Midship section aft centre of length L.W.L.	0·8ft.	0·8ft.	0·8ft.
Centre of buoyancy aft centre of L.W.L.	0·5ft.	0·5ft.	0·2ft.
Metacentre above C.B.	0·7ft.	0·73ft.	0·85ft.
Centre of lateral resistance aft centre of L.W.L.	0·0ft.	0·0ft.	0·05ft.
Centre of effort of sails ahead of C.L.	0·8ft.	0·8ft.	1ft.
Weight of lead keel	4 tons.	3½ tons.	3 tons.
SPARS AND SAILS.			
Mast, deck to topsail halyard sheave	38ft. 6in.	38ft. 6in.	34ft. 5in.
Bowsprit, outside of stem	17ft. 0in.	17ft. 0in.	16ft. 0in.
Main boom, extreme	25ft. 0in.	25ft. 0in.	24ft. 0in.
Gaff, extreme	21ft. 6in.	21ft. 6in.	21ft. 6in.
Topsail yard	25ft. 0in.	25ft. 0in.	22ft. 0in.
Foot of mainsail	24ft. 3in.	24ft. 3in.	23ft. 6in.
Head of mainsail	21ft. 0in.	21ft. 0in.	21ft. 0in.
Luff of mainsail	21ft. 0in.	21ft. 0in.	19ft. 0in.
Leech of mainsail	36ft. 0in.	36ft. 0in.	32ft. 9in.
Tack to peak earing	40ft. 0in.	40ft. 0in.	37ft. 6in.
Clew to throat.....	29ft. 8in.	29ft. 8in.	27ft. 0in.
Foot of foresail	23ft. 0in.	23ft. 0in.	22ft. 0in.
Luff of foresail	35ft. 0in.	35ft. 0in.	34ft. 0in.
Leech of foresail	27ft. 6in.	27ft. 6in.	25ft. 0in.
Mainsail area	574 sq. ft.	574 sq. ft.	440 sq. ft.
Foresail area	317 sq. ft.	317 sq. ft.	272 sq. ft.
Total area	819 sq. ft.	891 sq. ft.	712 sq. ft.

The sections are 2ft. apart, and No. 2 section is 2ft. from the fore side of the stem (Plate XX.).

The water-lines are 1ft. apart.

The timbers numbered at, 1, 2, 3, 4 on the sheer plan will be sawn 2in. sided, moulded 3in. at heels, and tapering to 1½in. at heads. A steamed timber 1in. moulded and 1½in. sided between each pair of sawn timbers.

Stem 4in. sided; 4in. moulded at head; 1ft. 2in. moulded at scarp with keel. Keel 1ft. 2in. sided amidships, tapering to 4in. at its fore end, and 5in. at its after end. Uniform depth of keel 7in.

The keel of No. 3 design will be 10in. sided amidships, tapering at ends as in Nos. 1 and 2.

The under side of the keel at No. 2 section for No. 1 and No. 2 designs is 3ft. 3½in. below the L.W.L.; the underside of the keel at the sternpost is 4ft. 6½in. below the L.W.L.

The draft forward of No. 3 design is less than the others. The depth to under-side of keel fore and aft will be found in the table for No. 3 design. In other respects the sheer plan accords with each design.

The sternpost is 5in. sided, and 7in. moulded at the heel, where it is tenoned into the keel.

Garboard strake 1½in. Plank ½in. Top strake 1in.

The general plan of floor construction is shown by figure A, Plate XX., which represents the mid-section; this plan will extend from No. 3 station forward to the sternpost. *a a* are the timbers or frames joggled on to the keel as shown; *k* is the keel; *l* lead keel; *i* stout iron knee floors; *d* head of a yellow metal bolt passing through iron floor, keel and lead keel.

Figure B shows the floor construction of section 11 beyond the sternpost; *k* is the counter keel and *a a* are frames joggled on to it as the frames are to the main keel; *i* is an iron floor knee bolted through the counter keel at *d*.

A better plan of floor construction will, however, be found given for the Itchen boats, three and five tonners, &c., farther on.



The rigidity of the counter aft will be maintained by angle iron stays, arranged something in the manner adopted in the construction of Jullanar. The counter keel, *k*, is 4½in. sided and 5in. deep; *m* is a stay of  iron or  iron bolted to the counter keel and to a deck beam; there are two such stays as these, and from the counter keel they gradually spread out until where they are bolted to the deck beam they are 3ft. apart. Two other similar stays as *n* (shown) are fixed to

PLATE XXII.



Sail Plan of Windermere Yacht.

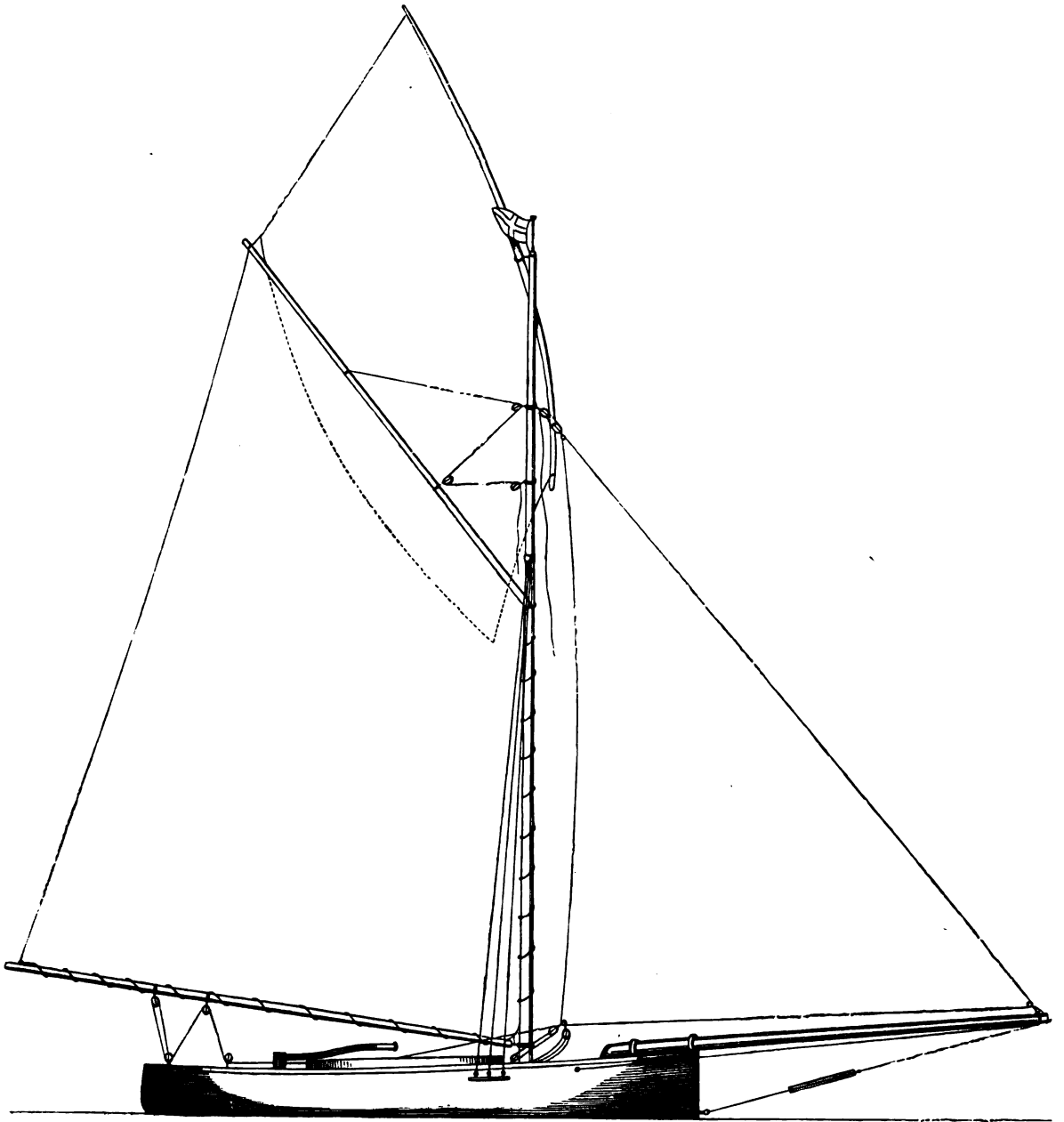

the lower end of the keel, and held together at the back of the dead wood at the sternpost by a bolt. To ensure the keel and counter frame against being forced away from the sternpost a kind of yoke made of T iron is bolted to the keel and brought round each side of the sternpost, where the ends are bolted to the timbers or frames that abut therefrom. The stretch D shows this yoke *o* bolted to the keel *k* and frames *a a*. The sternpost is shown by *s*, and the rudder post and trunk by *x*. In the sheer plan a section of the \perp iron yoke is shown at *o*.

CHAPTER XIX.

YACHTS OF THE NORFOLK BROADS.

THE following description of the yachts of the Norfolk Broads and of the Arrow was written by Mr. G. Christopher Davis.

The East Anglian waterways possess a type of yacht in many ways remarkable. A light draught on account of the shallowness of the upper parts of the rivers, great beam, a very large sail spread, a good weight of ballast, an enormous jib, and an equally enormous counter are their chief peculiarities.

Many years ago the favourite rig was the lateen, and a handsome rig it is; very easy to handle. The old lateeners were very bluff in the bows, very beamy and shallow, with a fixed keel, varying in depth according to the nature of the waters on which they were to be used. At Hickling, where there are 400 acres of water with a depth of 3ft. only out of the channel, the midship section of these old boats was nearly flat, so that with a 15in. keel they would only draw about 2ft. of water. Many carcases of these boats lie about Hickling slowly rotting, or turned into huts for the eel-fishers. As the cutter (or, more properly, the sloop rig, consisting of main-sail and large jib), came into vogue, many lateeners were converted, and still exist. The newer boats are all of the cutter rig, and, instead of the keel being stuck on at right angles to the bottom, there is a pretty though sharp curve uniting the two. The boats now in existence may be roughly divided into two classes, 4-ton and 10-ton boats; the smaller ones draw from 3ft. 6in. to 4ft., and the larger ones from 5ft. to 6ft. The counters on both are very large, in many cases being quite one-third of the boat's length over all; the bowsprits extend outward to a distance in many cases exceeding the length from stem to stern-post; the rudders are very large and powerful, and it may be imagined that a boat so rigged will turn with great rapidity.

Yachts last so long on these waters, and change hands so often in the course of their existence, that new yachts are not often built. Lately, however, several handsome craft have been turned off the stocks, and



PLATE XXIII.

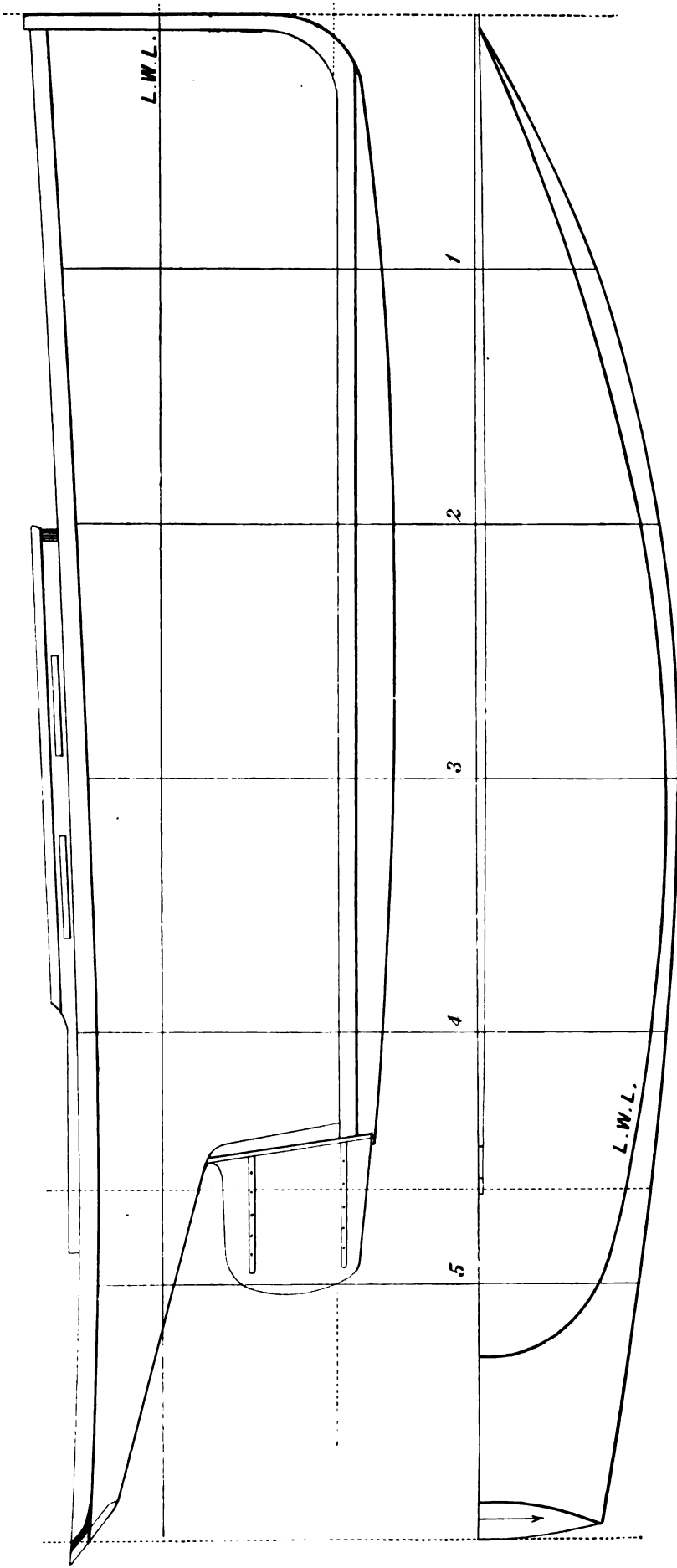

The Norfolk "Arrow."

the Arrow (Plates XXIII. and XXIV.), belonging to the commodore of the Yare Sailing Club (Mr B. V. Winch), is one of the best. She is of a more graceful form than the old river model, and is a good sea boat as well as able to hold her own with the river craft.

The body plan is given over leaf, Fig. 93.

Her principal dimensions are as follows :

	Ft. in.
Length over all	38 6
Length, stem to sternpost	29 6
Length of counter.....	9 0
Length on water-line	34 0
Greatest beam	10 0
Beam on water-line	9 9
Draught of water	6 0
Depth inside	6 7½
Depth of keel from planking amidships	1 5
Rudder	4 0
Mast stepped from stem	9 9
Height of mast from deck to upper cap	36 0
Height of topmast above upper cap	21 2
Length of bowsprit outboard	26 2
" boom.....	31 4
" gaff	26 0
" topsail yard	32 6
" leech of mainsail	42 0
" luff of mainsail	24 6
" luff of jib	42 0
" foot of jib	35 0
" leech of jib	30 0
" leech of topsail	25 0
Weight of lead on keel.....	2½ tons.
" inside ballast	4½ tons.

The internal accommodation of the yacht consists of a main cabin about 9ft. long, with 5ft. 3in. head-room; a fore cabin with ornamental stove and mantelpiece, lavatory, and w.c., and a roomy fore-castle. The fittings are all polished pitch pine, and the general appearance of the yacht inside and out would do credit to any of the crack builders. She was built by Kemp, of Mutford Bridge, near Lowestoft, in 1877.

She has a large open cockpit, and takes a crew of a man and a boy, besides her owner. She carries a strong weather helm, and by backing the jib she will wear right round in little more than her length. Her tonnage by the Norfolk and Suffolk rules, which take half the counter in the length, is 12 tons; by the new rule of the Y.R.A. she would be about 10 tons.

Although the sections are very hollow under the water-line, yet they are fuller than the usual type of river boat, and her counter is not so pronounced. As to speed, she is at least the equal of any other boat on the rivers, and her performances at sea have been very good, considering her long bowsprit.

In August, 1878, she sailed in a match from Lowestoft to Yarmouth and back, about twenty miles; there was a good bit of sea on and a stiff breeze. The other competitors were the *Merle*, a sea-going 10-tonner of some note; the *Kismet*, a sea-going 10-tonner; and the *Gem*, a fast river yacht. The *Arrow* carried all lower sail, and, after a pretty pounding,

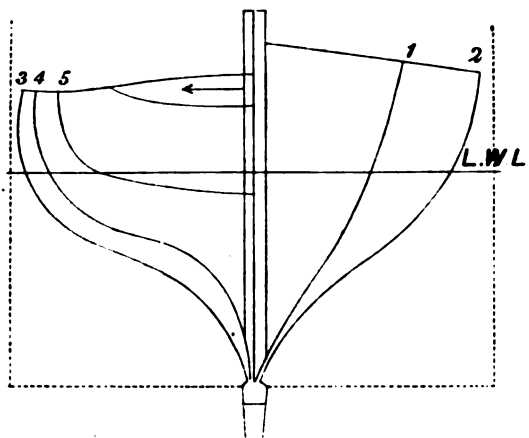
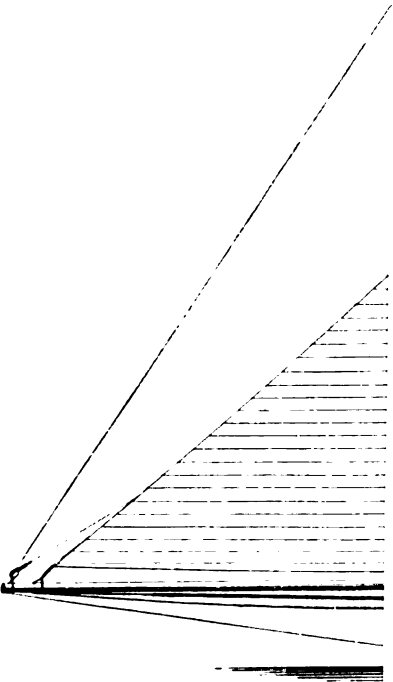

FIG. 98.

arrived off Lowestoft considerably ahead of the other yachts, and apparently an easy winner. Then she paid the penalty of stirring up Father Ocean with such a long prod, for the bowsprit carried away close by the gammon iron, which, of course, lost her the race. In another match, sailed at the same time, the *Wanderer*, 20-tons, carried away her mast, and the *Kiama*, 41-tons, also came to grief.

PLATE XXIV.





CHAPTER XX.

ITCHEN BOATS.

THE boats of the Itchen Ferry fisherman have a very high reputation in the Solent, and no doubt they are of a superior model to many coast fishing craft. For many years match sailing amongst them has been an annual occurrence, and probably the contests on these occasions, combined with the true racing spirit which animates all the Itchen-Ferry-men, have tended to produce and maintain a model adapted for speed; and the nature of the work the boats are put to has happily prevented their sterling qualities as hard weather craft being in any way sacrificed to the exigencies of competitive sailing. The standard of value for competitive sailing among these boats has always been simple length, and if the theoretical tendencies of such a rule is generally to produce mere skimming dishes, it has hitherto had no such effect on the Itchen fishing boats. Of late years, too, gentlemen fond of racing small craft, have built boats on the Itchen model, and these, although still competing under the "length rule," do not grow more beamy and shallow, but on the contrary (owing to considerations hereafter to be referred to) have become less broad in the beam and deeper. The designs which we give on Plates XXV. and XXVIII. represent these modern racing craft more than the fishing boats, but in a general way the hulls of both fishing and racing craft agree in model.

The design for the 30ft. boat, or 10-tonner (Plate XXV.), was made for a boat of 27ft. length by Mr. Shergold, a well-known draughtsman of Southampton, to compete in the 27ft. class in 1877. The design has not been altered in any way, but a scale was made to correspond with a length on deck of 30ft. 4in. This gave a beam of 9ft. 6in. and a tonnage, under the new rule of the Y.R.A., of 8.57 tons. Under the old rule the tonnage was 9.8 tons.

The Rayonette, we might here say, was lengthened in the spring of 1877, and is now 29ft. 9in. long on deck, but her beam is only what it was

when her length was 27ft., that is 9ft. The 30ft. design we give, has thus 6in. advantage in beam, 7in. in length, and is exactly 1 ton larger. There is no doubt that 6in. of beam is a very great advantage, so far as these boats are concerned, when they compete generally by length; so also in sailing under the Y.R.A. rule, in the case of two boats of such proportions as $29\cdot7 \times 9$ and $30\cdot3 \times 9\cdot5$, we should expect to find the 6in. excess beam of more value than the time which would have to be conceded. The *Rayonette* was wonderfully stiff under canvas, and her sail plan this season (1882) is to be considerably increased. Her ballast corresponds with that given in the table.

The *Rayonette* figured very fairly in the 10-tons class five years ago, and in a good breeze was a match for most of the 10-tonners of that day to windward, but failed in running and reaching, as the ordinary 10-tonner had about 9ft. more length. 30ft. is now the fashionable length for a 3-tonner, and when a 10-tonner has only 30ft. in length, it may be assumed that there is a wide difference in the proportion of breadth to length, and that consequently the results of encounters on different points of sailing between a 10-tonner like *Rayonette*, 30ft. long, and one like *Florence*, 39ft. 9in. long, would very much vary. For instance, in a match of the Prince of Wales Yacht Club, sailed in June, 1877, in a good strong breeze, between *Rayonette* (9-tons), *Lily* (10-tons), *Mildred* (10-tons), *Zephyr* (10-tons), *Alouette* (5-tons, 33\cdot5ft. long by 5\cdot8 beam), the *Rayonette* was absolutely the last reaching down the river to Southend; being 12 minutes astern of *Lily*, which was leading. In the thrash back, with housed topmast, *Rayonette* passed all but *Lily*, and gained 4 minutes on that craft. This probably may be taken as a good example of what a boat like *Rayonette* can do,* and it is evident that what she loses in running and reaching, cannot be made up by what she might gain in beating, if her competitors happened to be any of the crack 10-tonners. Whether an addition of 6in. to the beam, such as given in the design now published, would improve such craft so as to enable them to compete successfully with the best of the 10-tonners is doubtful, but at any rate, the extra 9ft. of length will always keep a good 10-tonner ahead when sailing off the wind.

Of course for sailing in the 30ft. class, the 6in. extra beam is certain to tell to windward, supposing all other things to be equal.

It will be noted that the length of the design given in the table is 30ft. 4in.; the odd inches would disqualify the boat for the 30ft. class, and in building it would be necessary to bring the sternpost upright from

* It also, we believe, bears out the experience on the *Mersey* when the *Wonderful* sailed against the 10-tonners there.

the keel, so that the length on the deck line did not exceed the 30ft. limit. However, the usual practice in all clubs now is to follow the Y.R.A. rule and take the length on the L.W.L.

The 30ft. design and the 27ft. design being identical, we need make no remark about them.

The 25ft. (Plate XXVI.) boat was designed by Mr. Shergold for Mr. Fay, who successfully raced her under the name of *Salus*; she was bought in 1871 by Mr. Beavor Webb, who re-named her *Israfel*. She won ten prizes out of twelve starts whilst in Mr. Webb's hands, and he sold her to Mr. H. Little, who has raced her with varied success, under the name of *Wild Rose*, in the 25ft. class.*

The 21ft. (Plate XXVII.) design represents that of the *Centipede*, the most successful fishing boat ever turned out by Mr. D. Hatcher. In the drawing, the design is represented as for a boat of 22ft. 8in. length, but all the sections are exactly as they were in the 21ft. boat, the *spacing* between the sections only having been increased, so as to bring the length up to that necessary to make 5 tons with the same 8ft. beam. The water-lines, with the extra spacing as shown, certainly look very much better, even than they did in the 21ft. design, and no doubt a boat of the extra length would be a very fast and capable craft; and, moreover, would be eligible for the 23ft. class. The *Centipede*, we might say, had very much less weight in her iron keel than given in the table, and the siding of her wood keel was less: the siding of the keel has been increased solely with the object of getting more lead underneath it.

The Itchen boats are always carvel built, and are usually decked forward, with a stern sheet aft, and are open amidships with a water way and coaming round. The floor construction is variously contrived, but the most approved plans are those shown in the designs for the 30ft. and 23ft. boat respectively (Plates XXV., XXVII. and XXVIII.) Sometimes a hogging piece, or keelson, of wood, iron, or lead, is worked upon top, the main keel of about half the siding of the latter, so as to form a stepping rabbet for the heels of the frames. A sectional view of this construction is shown at midship section, Plate XXV. The heels of the timbers rest on the top of the main keel, and are spiked to the keelson. The whole is secured by iron floor knees, bolted as through frame and plank. Aft a stepping line to take the heels of the timbers has to be cut in the dead wood. The spaces between the plank floor and keelson are filled with concrete made with cement and boiler punchings, or cement and lead shot. This is smoothed off level with the top of keelson.

* As recently as September, 1879, she competed successfully on Southampton Water against all the crack Itchen boats.

In the 21ft. design (Plate XXVII.), no keelson is worked. A stepping line is set off on the keel and dead woods, as shown by *s*. At each station for a frame, a joggle is cut in the keel and dead wood, *b b*, for the heel of the frame to be step-butted in, as at *a, a, a*. A sectional view of this fitting is shown by *A*. The heels of the frames are bolted through the keel, and the whole is secured by iron floor knees. This plan is to be preferred, unless the keelson is of metal, on account of it having an advantage for ballasting. Any spaces left between the sides of the keel and the plank should be filled with concrete, made as before described. The rabbet (*r*) will be cut as shown, and the garboard strake should be fastened with as long spikes as practicable.

All the Itchen boats have, we believe, what are known as "raking midship sections;" that is, the broadest width of each succeeding water-line is progressively farther forward, from the load water-line downwards. This peculiarity is most apparent in the Centipede. It will be seen that her greatest beam on the L.W.L. is very far aft of the greatest breadth of the lower water-line. The introduction of lead keels and the reduction in the proportion of beam to length, will perhaps cause the rake given to the midship section to be somewhat modified in future, and its advantage under any conditions is at least a debateable point.

With regard to the proportion of beam to length there is evidence that the proportion is gradually getting less; there is no doubt that the lead keels and lead ballast are the cause of this, perhaps assisted by an apprehension that at some time or the other the boats will have to compete under the "tonnage" rule. However, the fishermen still patronise beam, without any such apprehensions, and one of the most successful boats in their class has 9ft. breadth to 21ft. length.*

Until 1876 an Itchen boat was never seen with a counter; now counters have become common, but, as the regular Itchen boats are square sterned, we have so represented them in the preceding designs. A counter of course gives them a more finished appearance, and helps hold the boats a little if much pressed on a broad reach. They, however, make very little back water wash off the lee quarter, as the

* There is not much doubt that a heavy lead keel (and a little less beam if thought desirable) is safer than so very much beam and very little outside weight. The fishing boats, as a rule, have very little siding to their keels, and the weight of iron that can be got underneath is consequently very small. It is generally thought, however, among the fishermen, that a foot or so extra beam will more than compensate for the absence of a ton or so weight on the keel. There is a very great mistake about this, and the beamiest of the Itchen boats, as they are necessarily the shallowest, and have, moreover, little or no weight outside and loose ballast inside, are by far the most unsafe, as, although very stiff at first, they lose their righting power as they get near their beam ends. In 1880 one of the beamiest of the Itchen boats (19ft. by 9ft.) was capsized in a squall through the loose ballast shifting, and a beamy Itchen boat with no great weight on her keel requires as much looking after in a squall as a *Una*.

PLATE XXV.

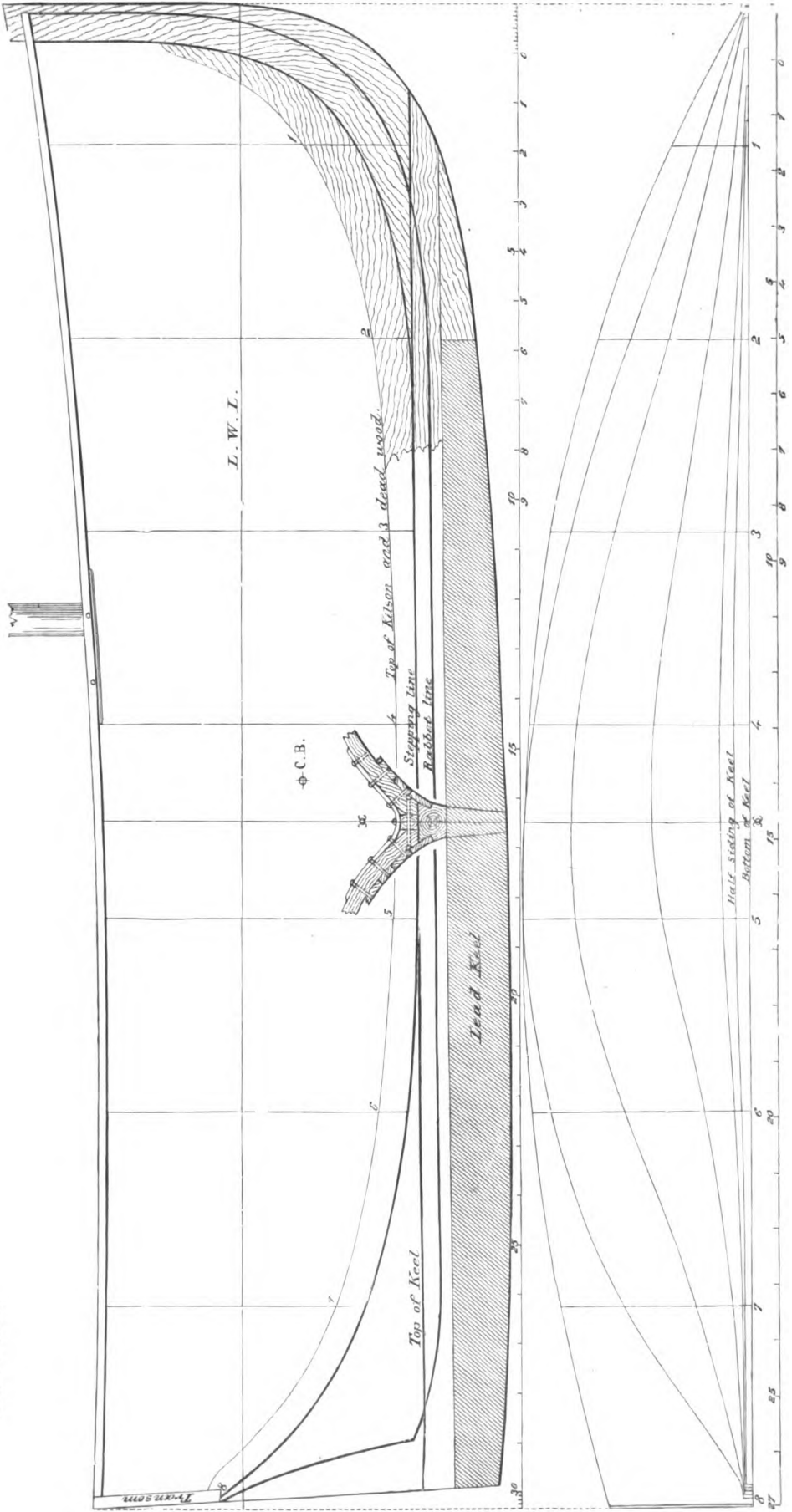

Ichen Boats of 30ft. 4in. and 27ft. in length, with scale of feet for each.

transom is so high set. If a counter were given to the preceding designs, the buttock lines would be dropped a little at the transom, according to the length of overhang. The transom would have to be a little wider, too, as otherwise the counter would be very narrow at the arch board.

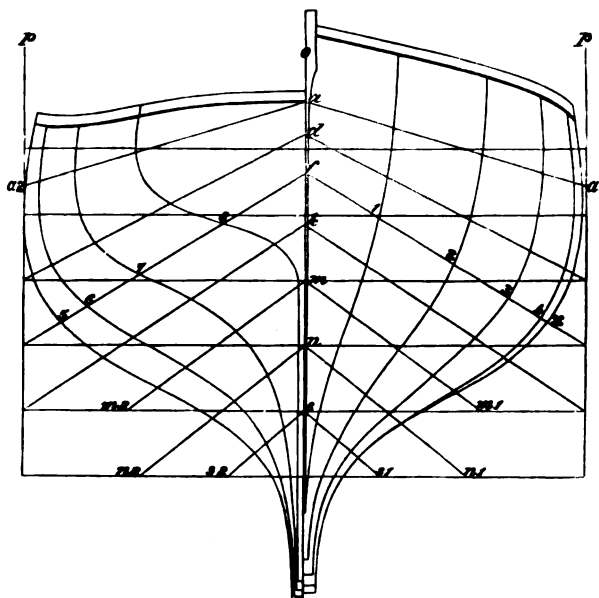

FIG. 94.

LAYING-OFF TABLE FOR 30FT. 4IN. BOAT (SEE PLATE XXV. AND FIG. 94).

No. of Section.....	1	2	3	4	m	5	6	7	8
Heights above L.W.L. to top timbers	ft. in.	ft. in.	ft. in.	ft. in.	ft. in.	ft. in.	ft. in.	ft. in.	ft. in.
Depths below L.W.L. to stepping line	2 3	3 4	3 7	3 7	3 7	3 7	3 4	2 6	—
Depths below L.W.L. to underside of keel	4 0	—	—	—	—	—	—	—	4 3
Half-breadths at gunwale	1 5	2 11	3 11	4 5½	4 6½	4 6	4 3	3 9	2 9½
Half-breadths on L.W.L.	0 10½	2 2½	3 5½	4 3	4 5½	4 5½	—	—	—
Half-breadths on diagonal a ...	1 4½	2 11½	4 0½	4 8	4 9½	4 9½	4 7	3 11½	2 10½
Half-breadths on diagonal d ...	1 4½	2 11½	4 1½	4 10½	5 0½	5 0½	4 8	3 9½	2 5
Half-breadths on diagonal f ...	1 3½	2 9½	3 11	4 7	4 9	4 8½	4 2	3 1½	1 6
Half-breadths on diagonal k ...	1 1	2 4	3 4½	3 10½	4 0	3 11½	3 4½	2 3½	6 0
Half-breadths on diagonal m ...	0 10	1 9½	2 6½	2 11½	3 0	2 11	2 4½	1 4½	0 1½
Half-breadths on diagonal n ...	0 5	1 1½	1 9	1 11½	1 11½	1 10½	1 5	0 8½	0 1½
Half-breadths on diagonal s ...	0 1½	0 6½	0 11½	1 0½	1 0½	1 0	0 8	0 3	0 1½

No. 1 section is 3ft. from the extreme fore side of stem. All the other sections are 3ft. 11in. apart, but the aft side of the transom is only 3ft. 10in. abaft No. 7 section. The midship section is midway between No. 4 and No. 5 section. The water lines are 1ft. 1½in. apart.

Diagonal a is struck 3ft. above the L.W.L., and at a 1 and a 2 cuts the perpendiculars p p 1ft. 8in. above the L.W.L. Diagonal d is struck 2ft. 6in. above the L.W.L. Diagonal f is struck 1ft. 10in. above the L.W.L. Diagonal k is struck 11½in. above the L.W.L.

Diagonal *m*, at *m* 1 and *m* 2, is 2ft. 11in. from the middle vertical line *o*.

Diagonal *n*, at *n* 1 and *n* 2, is 2ft. 9in. from the middle vertical line *o*.

Diagonal *s*, at *s* 1 and *s* 2, is 1ft. 2in. from the middle vertical line *o*.

All the half-breadths are *without* the plank; but in the drawing the boat is represented with the plank on.

The lead keel will be 23ft. 6in. long, 9in. deep at its fore end, 1ft. 3in. amidships, and 11in. aft.

The breadth of the keel on the top at its fore end will be 4in.; amidships, 7in.; aft, 4in.; uniform breadth of the under side, 3in.

LAYING-OFF TABLE FOR 27FT. BOAT (SEE PLATE XXV. AND FIG. 94).*

No. of Section	1	2	3	4	5	6	7	8
	ft. in.	ft. in.	ft. in.	ft. in.	ft. in.	ft. in.	ft. in.	ft. in.
Heights to top of timbers above L.W.L.	3 5	3 0½	2 8½	2 6	2 5½	2 4½	2 4	2 4½
Depths below L.W.L. to stepping line	2 1	3 0	3 2	3 2	3 2	3 2	3 0	2 3
Depths below L.W.L. to under side of wood keel	3 7	—	—	—	—	—	—	3 10
Half-breadths at gunwale	1 3	2 7	3 6	4 0	4 0½	4 0	3 10	3 4
Half-breadths on L.W.L.	0 9	1 11½	3 1½	3 9½	4 0	3 11½	3 6	—
Half-breadths on diagonal <i>a</i> ...	1 3	2 7½	3 7½	4 1½	4 3	4 2½	4 1	3 6
Half-breadths on diagonal <i>d</i> ...	1 3	2 7½	3 8½	4 4	4 6½	4 5½	4 1½	3 4½
Half-breadths on diagonal <i>f</i> ...	1 1½	2 5½	3 5½	4 1	4 2½	4 2	3 9	2 9½
Half-breadths on diagonal <i>k</i> ...	0 11½	2 1½	2 11½	3 5½	3 6½	3 6	3 0	2 0
Half-breadths on diagonal <i>m</i> ...	0 8½	1 7	2 3	2 7½	2 7½	2 7	2 2	1 3
Half-breadths on diagonal <i>n</i> ...	0 4½	1 0	1 6	1 8½	1 9	1 8	1 3	0 7½
Half-breadths on diagonal <i>s</i> ...	0 1½	0 6	0 9½	0 11	0 11½	0 10½	0 7½	0 3½

No. 1 section is 2ft. 8in. from the extreme fore side of stem. All the other stations are 3ft. 6in. apart, but the aft side of transom is only 3ft. 4in. from No. 7 section. The midship section is midway between No. 4 and No. 5 sections.

The water-lines are 1ft. apart.

Diagonal *a* is struck 2ft. 8½in. above the L.W.L., and at *a* 1 and *a* 2 cuts the perpendiculars *p p* 1ft. 5½in. above the L.W.L.

Diagonal *d* is struck 2ft. 2½in. above the L.W.L.

Diagonal *f* is struck 1ft. 7½in. above the L.W.L.

Diagonal *k* is struck 9in. above the L.W.L.

Diagonal *m*, at *m* 1 and *m* 2, is 2ft. 7in. from the middle vertical line *o*.

Diagonal *n*, at *n* 1 and *n* 2, is 2ft. 6in. from the middle vertical line *o*.

Diagonal *s*, at *s* 1 and *s* 2, is 1ft. 1in. from the middle vertical line *o*.

All the half-breadths are *without* the plank, but the drawing represents the boat with the plank on.

The lead keel will be 21ft. long, 8in. deep at its fore end, 1ft. 1in. at the midship section, 1ft. at No. 7 section, and 9in. at its after end; breadth, 6in. amidships, 3½in. forward, 4in. aft on its upper side; breadth on its under side, 3½in. all through.

LAYING-OFF TABLE FOR 25FT. BOAT (SEE PLATE XXVI.).

No. of Section	1	2	3	4	5	6	7	Trm.
	ft. in.	ft. in.	ft. in.	ft. in.	ft. in.	ft. in.	ft. in.	ft. in.
Heights to top of timbers above L.W.L.	3 2	2 10	2 7½	2 5½	2 4½	2 4½	2 5½	2 7
Depths below L.W.L. to rabbet line...	1 6	2 9	3 1	3 2½	3 2	2 10	1 8	—
Half-breadths at gunwale	1 3½	2 11	3 9	4 0½	4 0½	3 8½	3 0	2 5
Half-breadths on L.W.L.	0 6	1 11	3 3	4 0	3 11	2 10½	0 9½	0 1½
Half-breadths on diagonal <i>k</i>	1 2½	2 10½	3 11½	4 6	4 5½	3 11½	3 1	2 6
Half-breadths on diagonal <i>m</i>	1 0½	2 7½	3 8½	4 4½	4 3	3 6	2 4½	1 9
Half-breadths on diagonal <i>n</i>	0 8½	1 11	2 10	3 3½	3 0	2 2½	1 1	0 5½
Half-breadths on diagonal <i>s</i>	0 1½	0 10	1 3½	1 6½	1 3½	0 8	0 1½	0 1

* This design is the same as the 30ft. 4in. design, the scale only having been altered.

James C. ...
L.W.

PLATE XXVI.

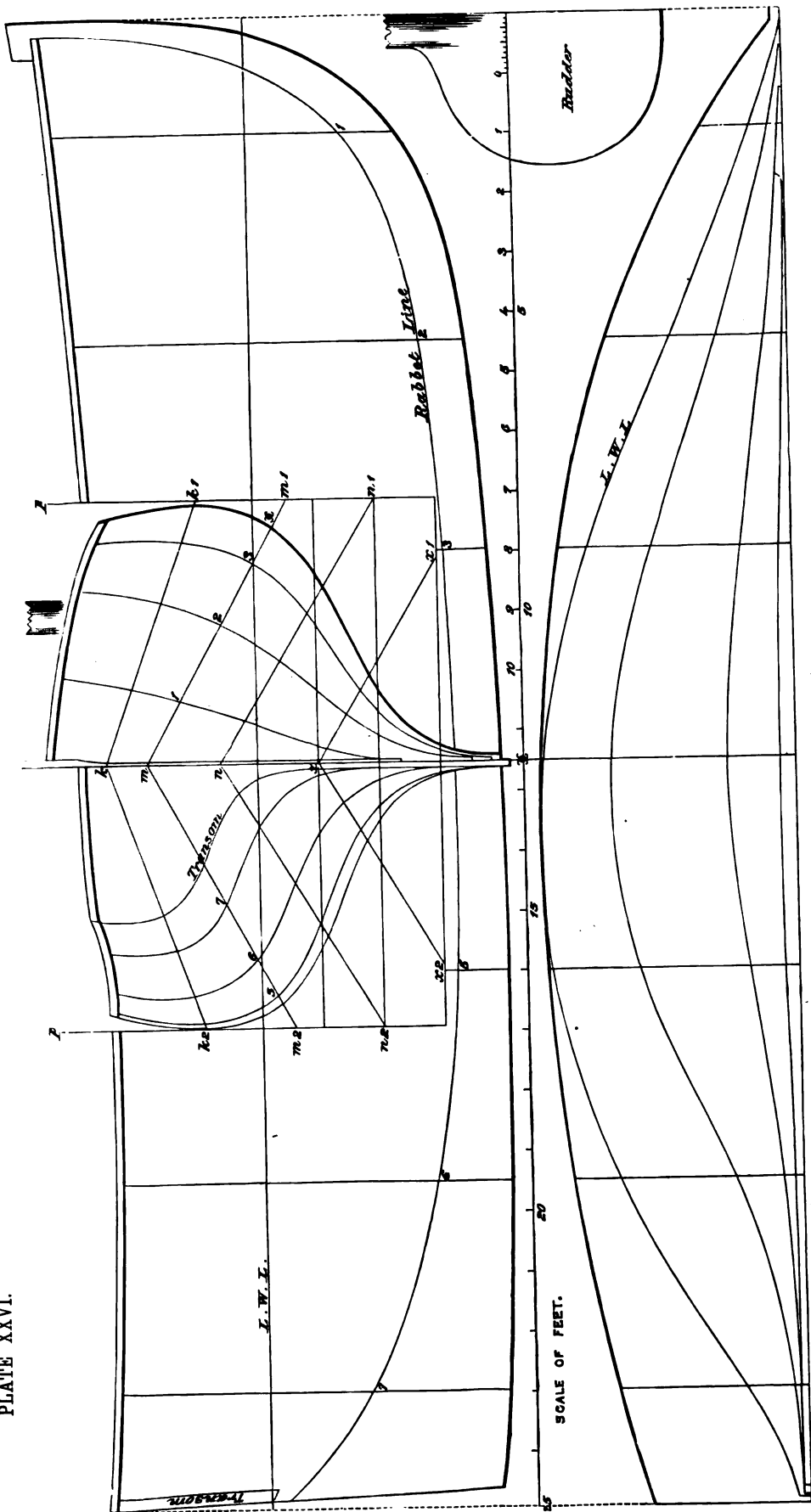

Itchen Boat "Wild Rose," 25ft.

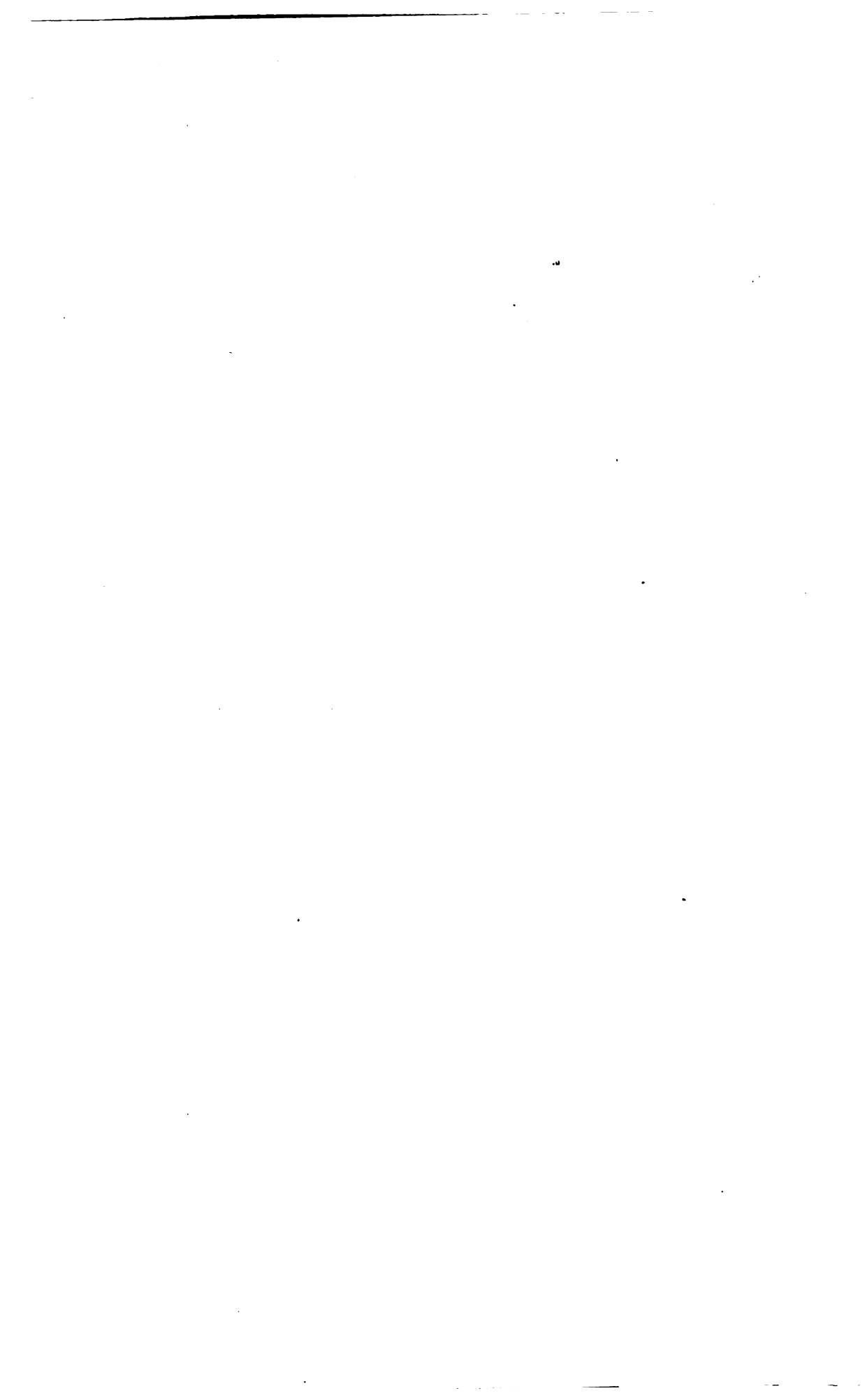
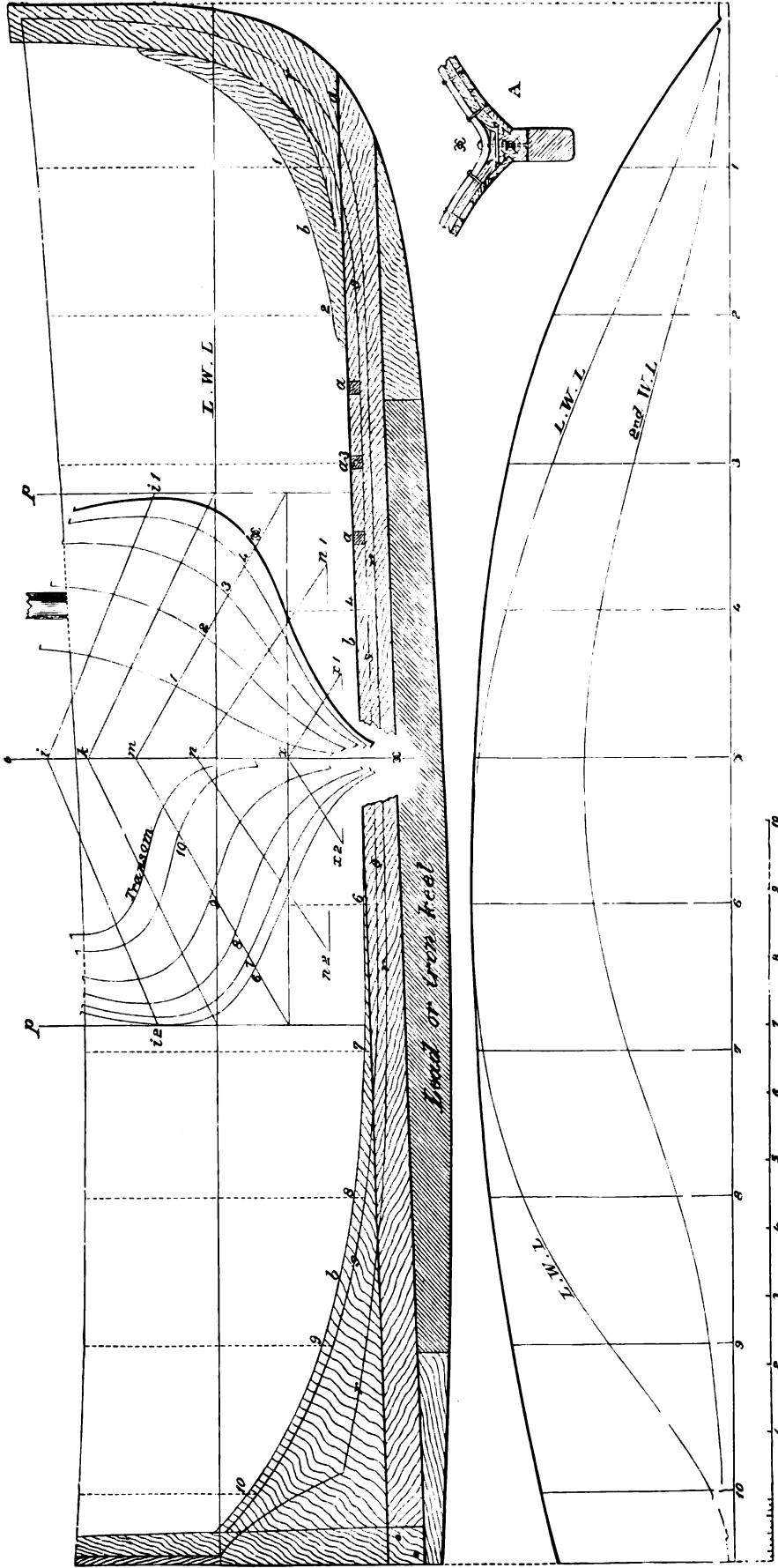

PLATE XXVII.



Itchen Boat "Centipede," 22ft. 8in., and 21ft.

No. 1 section is 2ft. from the extreme fore side of stem ; all the other sections are 3ft. 6in. apart, but the transom is (at the deck) 2ft. from No. 7 section.

The water-lines are 1ft. apart.

Diagonal *k* is struck 2ft. 6in. above the L.W.L., and at *k* 1 and *k* 2 cuts the side perpendiculars *p p* 11 $\frac{1}{2}$ in. above the L.W.L.

Diagonal *m* is struck 1ft. 9in. above the L.W.L., and at *m* 1 and *m* 2 cuts the side perpendiculars *p p* 6 $\frac{1}{2}$ in. below the L.W.L.

Diagonal *n* is struck 7 $\frac{1}{2}$ in. above the L.W.L., and at *n* 1 and *n* 2 cuts the side perpendiculars *p p* at 2ft. below the L.W.L.

Diagonal *x* is struck 1ft. below the L.W.L., and at *x* 1 and *x* 2 is 3ft. 4in. from the middle vertical line of the body plan.

All the half-breadths are *without* the plank just as the others are, in readiness for setting off in the mould loft ; but the design is shown with the plank on. The design also shows a keel of only 3in. siding amidships, instead of the thickness we have given in the table.

LAYING-OFF TABLE FOR 22FT. 8IN. BOAT (SEE PLATE XXVII.).

No. of Section.....	1		2		3		4		5		6		7		8		9		10		Trm.	
	ft.	in.	ft.	in.	ft.	in.	ft.	in.	ft.	in.	ft.	in.	ft.	in.	ft.	in.	ft.	in.	ft.	in.		
Heights to top of timbers above L.W.L.	2	6 $\frac{1}{2}$	2	5	2	3	2	1 $\frac{1}{2}$	2	0 $\frac{1}{2}$	1	11 $\frac{1}{2}$	1	11	1	11 $\frac{1}{2}$	1	11 $\frac{1}{2}$	2	0 $\frac{1}{2}$	2	1
Depths below L.W.L. to stepping line (<i>s</i>)	1	8	2	0 $\frac{1}{2}$	2	1 $\frac{1}{2}$	2	2	2	3	2	3 $\frac{1}{2}$	2	3	2	1	1	8	0	6 $\frac{1}{2}$	—	—
Half-breadths at gunwale ...	1	6 $\frac{1}{2}$	2	6 $\frac{1}{2}$	3	2 $\frac{1}{2}$	3	6 $\frac{1}{2}$	3	8 $\frac{1}{2}$	3	9	3	8 $\frac{1}{2}$	3	5 $\frac{1}{2}$	3	2	2	9	2	5 $\frac{1}{2}$
Half-breadths on L.W.L. ...	0	8 $\frac{1}{2}$	1	8	2	6 $\frac{1}{2}$	3	3 $\frac{1}{2}$	3	8	3	9	3	6 $\frac{1}{2}$	3	0 $\frac{1}{2}$	1	8 $\frac{1}{2}$	0	3 $\frac{1}{2}$	0	1
Half-breadths on 2nd W.L. ...	0	3 $\frac{1}{2}$	0	9	1	4 $\frac{1}{2}$	1	10	2	1 $\frac{1}{2}$	2	0	1	5 $\frac{1}{2}$	0	8 $\frac{1}{2}$	0	3	0	1	—	—
Half-breadths on diagonal <i>i</i> .	1	7 $\frac{1}{2}$	2	7 $\frac{1}{2}$	3	4 $\frac{1}{2}$	3	10 $\frac{1}{2}$	4	2	4	2 $\frac{1}{2}$	4	1	3	10	3	5 $\frac{1}{2}$	2	10 $\frac{1}{2}$	2	7
Half-breadths on diagonal <i>k</i> .	1	5 $\frac{1}{2}$	2	5	3	2	3	9 $\frac{1}{2}$	4	1 $\frac{1}{2}$	4	2	4	0 $\frac{1}{2}$	3	8	3	1 $\frac{1}{2}$	2	3 $\frac{1}{2}$	1	10 $\frac{1}{2}$
Half-breadths on diagonal <i>m</i> .	1	2 $\frac{1}{2}$	2	0 $\frac{1}{2}$	2	8 $\frac{1}{2}$	3	2 $\frac{1}{2}$	3	6 $\frac{1}{2}$	3	6 $\frac{1}{2}$	3	4 $\frac{1}{2}$	2	11	2	2 $\frac{1}{2}$	1	3	0	10
Half-breadths on diagonal <i>n</i> .	0	9	1	4 $\frac{1}{2}$	1	11	2	3	2	4 $\frac{1}{2}$	2	4	2	1 $\frac{1}{2}$	1	8 $\frac{1}{2}$	1	1	0	4	0	1 $\frac{1}{2}$
Half-breadths on diagonal <i>x</i> .	0	2 $\frac{1}{2}$	0	6 $\frac{1}{2}$	0	10	1	0 $\frac{1}{2}$	1	1 $\frac{1}{2}$	1	0 $\frac{1}{2}$	0	9 $\frac{1}{2}$	0	6 $\frac{1}{2}$	0	3 $\frac{1}{2}$	—	—	—	—

No. 1 section is 2ft. 4in. from the extreme fore side of the stem. All the other sections are 2ft. 2in. apart, but the aft side of transom is only 10in. from No. 10 section.

The water-lines are 1ft. apart.

Diagonal *i* is struck 2ft. 5in. above the L.W.L., and at *i* 1 and *i* 2 cuts the perpendiculars *p p* 10in. above the L.W.L.

Diagonal *k* is struck 1ft. 10in. above the L.W.L.

Diagonal *m* is struck 1ft. 1 $\frac{1}{2}$ in. above the L.W.L.

Diagonal *n* is struck 3in. above the L.W.L., and at *n* 1 and *n* 2 is 2ft. 10in. from the middle vertical line *o*, and 1ft. 7in. below the L.W.L.

Diagonal *x* is struck at the 2nd water-line, and at *x* 1 and *x* 2 is 1ft. 3in. out from the middle vertical line *o*, and 1ft. 9 $\frac{1}{2}$ in. below the L.W.L.

The side perpendiculars *p p* are 3ft. 11in. out from the middle vertical line.

All the half-breadths are *without* the plank, and the boat is represented in the drawing *without* the plank.

Depth of lead keel at its fore end, 7in. ; at its amidships, 8 $\frac{1}{2}$ in. ; at its aft end, 5 $\frac{1}{2}$ in.

Width (siding) of lead keel at its fore end, 2 $\frac{1}{2}$ in. ; at its amidships, 5 $\frac{1}{2}$ in. ; at its aft end, 4in.

Length of lead keel, 14ft.

21FT. BOAT.

For the 21ft. boat the same laying-off tables will be used, the sections being identical with those of the 22ft. 8in. boat. The spacing between the sections is, however, less.

No. 1 section is 2ft. 2in. from the extreme fore side of the stem ; all the other sections are 2ft. apart, but the transom is only 10in. abaft No. 10 section.

SCANTLINGS.

	30ft.	27ft.	25ft.	23ft.	21ft.
Siding of stem	3½in.	3in.	3in.	2½in.	2½in.
Siding of sternpost	4in.	3½in.	3½in.	3½in.	3in.
Siding of keel amidships	7in.	6in.	6in.	5½in.	5in.
Siding of keel fore end	3½in.	3in.	3in.	2½in.	2½in.
Siding of keel aft end	4in.	3½in.	3½in.	3½in.	3in.
Moulding (depth) of keel	7in.	6½in.	6in.	5½in.	5in.
Siding of timbers	2in.	2in.	1½in.	1½in.	1½in.
Room and space	1ft. 11in.	1ft. 9in.	1ft. 9in.	1ft. 1in.	1ft.
Thickness of plank*	1in.	1in.	1in.	¾in.*	¾in.*
Thickness of garboard strake	1½in.	1½in.	1½in.	1in.	1in.
Thickness of top strake	1½in.	1½in.	1½in.	1in.	1in.
Thickness of clamp	1½in.	1½in.	1½in.	1½in.	1½in.
Thickness of transom	2½in.	2½in.	2in.	2in.	2in.
Breadth of rudder	3ft.	2ft. 9in.	2ft. 6in.	2ft. 3in.	2ft.

* An inch strake as a wale should be worked above the water-line at the broadest part of the boat; this will make the boat the required width.

DIMENSIONS, &c.

Length, fore side of stem to aft side transom on deck	30ft. 4in.	27ft.	25ft.	22ft. 8in.	21ft.
Breadth (moulded)	9ft. 4in.	8ft. 4in.	8ft. 7in.	7ft. 10in.	7ft. 10in.
Breadth with plank on	9ft. 6in.	8ft. 6in.	8ft. 9in.	8ft.	8ft.
Draught of water, extreme	5ft. 4in.	4ft. 10in.	4ft. 1in.	3ft. 4½in.	3ft. 4½in.
Displacement	9 tons	6·5 tons	5·8 tons	3·8 tons	3·5 tons
Displacement per inch of immersion at L.W.L.	9cwt.	7cwt.	6cwt.	5½cwt.	4½cwt.
Weight of ballast inside	3½ tons	2½ tons	2 tons	1½ tons	1½ ton
Weight of lead keel	2 tons 8cwt.	1 ton 16cwt.	1½ tons	1 ton	18cwt.
Tonnage Y.R.A.	9½	7½	6½	4½	4½

SPARS AND SAILS.

	30ft.	27ft.	25ft.	23ft.	21ft.
	ft. in.	ft. in.	ft. in.	ft. in.	ft. in.
Centre of mast from fore side of stem on deck ...	11 6	10 9	9 9	8 8	8 2
Length of mast, deck to hounds	25 0	22 6	21 6	19 6	18 9
Length of mainboom extreme	27 6	26 0	24 4	21 9	19 3
Length of main gaff extreme	20 6	18 6	17 9	16 3	14 3
Length of bumpkin outside	2 6	2 4	2 0	1 9	1 3
Length of bowsprit outside	16 0	14 6	12 6	12 0	11 6
Length of topmast fid to sheave	20 6	19 6	18 0	17 0	16 0
Length of topsail yard	24 0	23 0	21 0	20 0	18 0
Length of topsail yard	18 0	17 0	16 0	15 0	14 0
Length of spinnaker boom*	27 6	25 0	23 0	21 0	19 0
Luff of mainsail	23 0	20 0	19 3	17 9	16 6
Leech of mainsail	39 0	36 0	34 0	31 0	29 6
Foot of mainsail	27 0	25 9	24 0	21 4	18 10
Head of mainsail	20 2	19 0	17 6	15 8	14 0
Tack to peak earing	41 2	38 0	36 0	32 0	30 0
Clew to weather earing (throat)	32 9	31 0	29 0	27 0	24 0
Foot of foresail	14 6	13 0	11 6	0 0	9 0
Luff of foresail	25 0	23 0	22 0	21 0	17 6
Leech of foresail	23 0	21 0	20 0	18 0	15 6
Foot of jib†	17 0	16 0	15 0	14 0	13 0
Luff of jib	36 0	33 0	30 6	27 0	24 0
Leech of jib	24 0	22 0	21 0	20 0	17 0

* As they only have one spinnaker, it has to be set on the bowsprit occasionally; hence the length of the spinnaker boom is usually about the length from the mast to the bowsprit end.

† With a reef down the boats are frequently sailed without a jib, the bowsprit being run in and stowed.

In the table, page 293, Plate XXIX. should be Plate XXVIII.

10

11

12

13

14

15

The fashionable 30ft. boat of the year 1882 is represented on Plate XXVIII. The body plan resembles the Itchen type; but the draught of water is greater, and the counter makes the "boat" nothing more or less than a yacht. Still, as they have grown out of the "Itchen boat," and still sail by a simple length measurement, it can be assumed that the 1882 craft is still to be identified with Itchen Ferry, especially as the Itchen Ferry builders Payne and Luke have assisted in introducing these new-fashioned craft.

The design given on Plate XXVIII. is similar to one Mr. A. O. Bayly built this spring (1882) at Watkins's, Blackwall, the chief difference being that his has a trifle more fore foot and 4in. more freeboard. In the table of dimensions which follows will be found particulars of a 30ft. boat built from a design by Mr. C. P. Clayton for Major Foster, to be named Keepsake. This boat is a very great departure from the Itchen Ferry type, having a deep peg-top form of midship section, excessive rake of sternpost, and fore foot very much rounded up.

TABLE OF DIMENSIONS.

	Plate XXIX.	Keepsake.	Rayonette.	Raven.	Ladybird.
Length on water line	30ft.	30ft.	29ft. 10in.	27ft.	30ft.
Breadth, extreme	9ft. 6in.	9ft. 8in.	9ft. 1in.	9ft.	9ft. 6in.
Draught of water, extreme	7ft.	7ft.	—	—	—
Displacement	13·3 tons	13·7 tons	—	—	—
C.B. aft centre of length	1·0ft.	1·1ft.	—	—	—
Mast, deck to hounds	26ft.	27ft.	24ft.	25ft.	24ft.
Main boom	32ft.	30ft.	25ft.	28ft. 3in.	25ft. 6in.
Gaff	21ft.	21ft. 9in.	17ft. 9in.	19ft. 3in.	18ft. 10in.
Bowsprit, outboard	17ft.	18ft.	16ft.	17ft. 6in.	16ft.
Topmast, fid to hounds	23ft.	24ft. 6in.	19ft.	21ft.	—
Topsail yard	23ft.	—	19ft.	23ft.	—
Spinnaker boom	35ft.	—	25ft.	27ft.	—
Area of mainsail	736 sq. ft.	712 sq. ft.	—	—	—
Area of foresail	120 sq. ft.	190 sq. ft.	—	—	—
Area of No. 1 jib	160 sq. ft.	180 sq. ft.	—	—	—
Total area of lower sail	1016 sq. ft.	1082 sq. ft.	—	—	—
Centre of mast from fore side of stem	9ft.	11ft.	11ft. 2in.	10ft. 6in.	10ft. 9in.
Ditto from gammon iron	11ft. 6in.	14ft.	11ft. 2in.	10ft. 6in.	10ft. 9in.
Lead on keel	8 tons	7 tons 15cwt.	6 tons.	—	—

Only about 3½ tons of Rayonette's ballast is on the keel.

Ladybird and Rayonette are having their spar plans increased as follows: Mast, 1ft. 6in.; boom, 2ft. 6in.; gaff, 1ft. 6in.

In all cases in laying off the boats the table of offsets should be relied on rather than measurements taken from the Plates.

TABLE OF OFFSETS FOR 30FT. BOAT WITH COUNTER (PLATE XXVIII).

Sections	1	2	3	4	5	6	7	8	9	10	11	12
Heights above L.W.L. to underside of covering board	3 5½	3 1	2 11¼	2 9	2 7½	2 6	2 5½	2 5½	2 5½	2 7	2 8½	2 10½
Depths below L.W.L. to lower edge of rabbet line	2 5	3 7½	4 2½	4 4½	4 4½	4 4½	4 4	4 1	3 7½	1 4½	0 9 a	2 5 a
Depths below L.W.L. to underside of main wood keel	—	—	4 6	—	b	—	—	—	4 6	—	—	—
Depths below L.W.L. to underside of false keel and lead keel	2 11	4 4	5 4½	6 1½	6 8½	7 0	7 0	6 8½	6 3	—	—	—
Half-breadths on deck	1 7	2 8	3 6½	4 1½	4 6	4 7½	4 7½	4 7	4 6	4 3½	—	—
Half-breadths on L.W.L.	0 5	1 6	2 6½	3 6½	4 2	4 5½	4 4	3 10	2 9½	1 1½	—	—
Half-breadths on No. 2 W.L.	0 3½	1 1½	2 0½	3 0½	3 8½	3 10	3 6½	2 9	1 6	—	—	—
Half-breadths on No. 3 W.L.	0 2	0 8	1 5	2 2	2 8	2 8	2 3	1 5½	6 0½	—	—	—
Half-breadths on No. 4 W.L.	—	0 3	0 8½	1 2½	1 5½	1 5½	1 2½	0 9	0 3½	—	—	—
Half-breadths of main keel and lead keel on top	0 3	0 3½	0 4½	0 6	0 7½	0 8	0 7½	0 6	0 3½	0 3	—	—
Half-breadths on underside of wood and lead keel	0 3	0 3	0 4½	0 5½	0 6	0 6	0 5	0 4	0 3½	0 3	—	—
Half-breadths on No. 1 diagonal	1 4½	2 7½	3 8½	4 6½	5 1½	5 4½	5 4	5 0½	3 11½	3 0	1 8	—
Half-breadths on No. 2 diagonal	0 10½	2 1	3 1½	4 0	4 7	4 9½	4 7½	4 2	3 4½	2 4½	1 2	—
Half-breadths on No. 3 diagonal	0 5½	1 5	2 3½	2 11½	3 4½	3 5½	3 2½	2 7½	1 10½	0 8½	—	—

a These are measured above L.W.L. to ridge of counter.

No. 1 section is 1ft. 6in. from the fore side of the stem at the L.W.L. The overhang of stem is 2ft. 4in. The sections are spaced 3ft. apart. The water-lines are 1ft. apart. No. 1 diagonal is struck 3ft. 6in. above the L.W.L., and cuts the side perpendicular 8½in. above the L.W.L. No. 2 diagonal is struck 1ft. 9in. above the lead water-line.

All the half-breadths (except those given for the keel) are exclusive of the plank, or what is termed moulded half-breadths. Double timbers at the stations 3, 4, 5, 6, 7, 8, 9, inclusive, 3½in. moulded at heels (and tapering to 2½in. at heads), and 2in. sided. These double timber frames to be side-bolted together with ½in. galvanised iron bolts. Between each pair of frames on either side two steamed timbers of American elm to be worked 2½in. sided and 1½in. moulded, and all the fastenings through these to be clinched on the

b The underside of the main keel is parallel to the L.W.L.

inside. The garboard strake 9in. by 1½in.; rest of the plank when worked up, 1½in. Top strake, 1½in.; flat of deck, 1½in.; shelf, 3in. by 3in.; deck beams, 3in. by 3in.; bilge strake, 6in. by 1½in. Deed wood bolts, ½in.; all other through bolts ½in.; bolts through lead keel, 1½in., spaced 1ft. 6in., and driven on alternate sides. The iron plates to be six in number, and placed at 3, 4, 5, 6, 7, and 8 stations; to be side-bolted through the frames. These plates to be of ½in. iron, with a 5in. flange, unless a 5in. angle iron be worked across the plate from frame to frame; a through keel bolt to be screwed up with nut on the upper side of each flange; a short coach screw bolt in the flange and keel opposite each through bolt.

Stem, sternpost, and deed wood, 6in. sided. Moulded depth of keel, 7½in. The half-siding of keel will be obtained from the Table of Offsets.

PLATE XXIX.

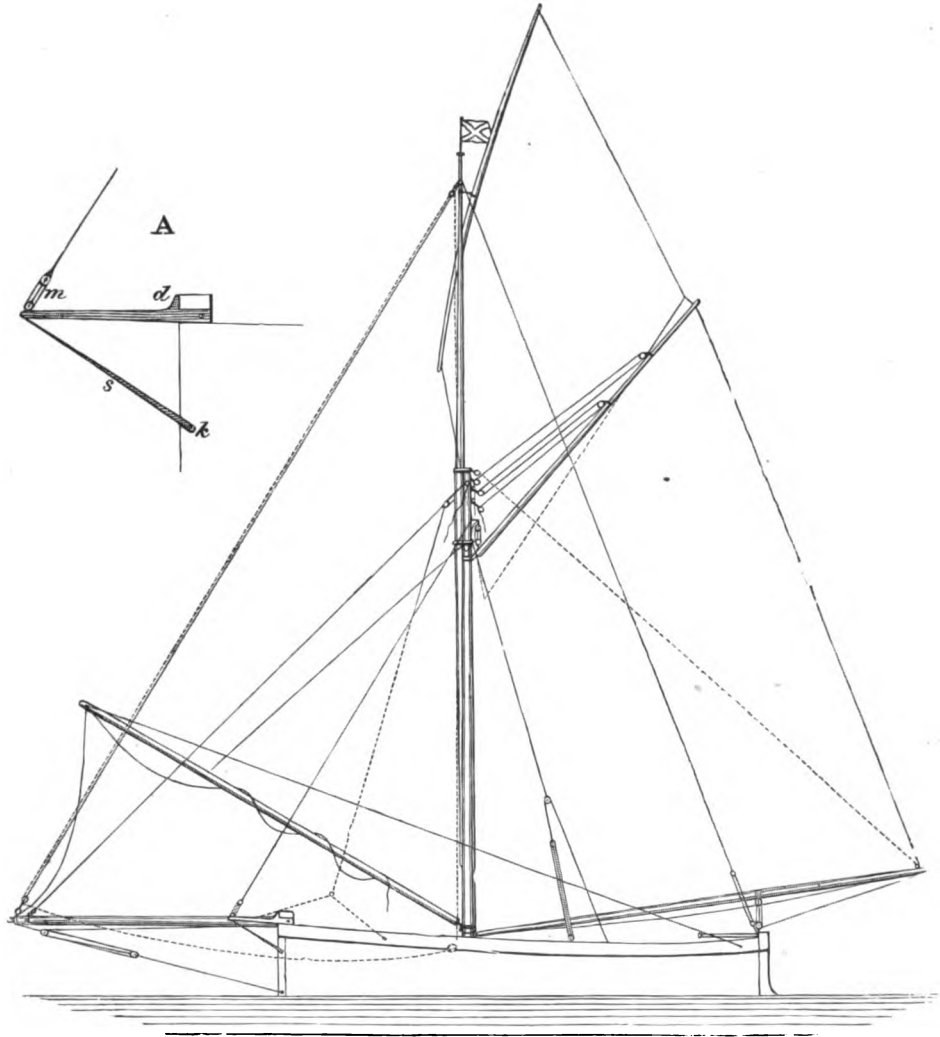

ITCHEN BOAT.
SCALE $\frac{1}{2}$ = 1 FOOT.

In rig the Itchen boats have undergone very marked changes. A quarter of a century ago a bowsprit or a bumpkin was quite an innovation; the common rig being foresail with tack fast to stem head, and sheet working on a horse; mainsail without boom, with sheet working on a horse, and very frequently a mizen was added. The mast was long, and the gaff short, and the rig was generally commended because all the sail was in board. However, it would seem that the boats were lacking in head canvas, as "bumpkins" were introduced somewhere about 1851. In 1852, the best boats had what was then considered sharp bows, with a full midship section, a hollow floor, and square stern: the dimensions for a single-handed boat were, length 18ft. 6in., breadth 7ft. 8in., height out of water 1ft. 9in. The stem and sternpost were perpendicular, the fore foot being only slightly rounded off. Some of them had cast iron keels weighing from 2cwt. to 3cwt. The foresail was set on a bumpkin instead of at the stem head as formerly. The dimensions for the sails of a boat of the length given were: hoist of mainsail 17ft. 6in.; boom 13ft.; gaff 10ft.; bumpkin 3ft. 6in.; a bowsprit is also carried.

Excepting the length of boom and gaff, these dimensions are pretty much the same as would be given to a similar craft at the present time; in fact the long mast is retained, and the boom and gaff is very much increased in length.

All the Itchen boats still have the bumpkin,* which is a small iron bar (see A, Plate XXIX.) fitted to the stem head as shown at *d*; the bumpkin has an iron stay (*s*) welded to it, and bolted to the stem at *k*. The forestay is set up to the bumpkin by a lanyard as shown at *m*. The boats have two shrouds a-side, a pendant and runner, topping lift, topmasts, backstays, preventers, and all the rest of the usual yacht gear, including, of course, purchases.

The dimensions for the sails given are large, and intended for a racing outfit. For a "fisherman's" outfit the mast would be reduced in length about one-ninth, and the boom and gaff about one-seventh. Compared by length and breadth of water-line, the sail areas are about equal to those of the Windermere yachts, but probably one of the latter would be more than a match for any boat on Southampton Water.

It will be seen by Fig. 95 that the span-shackle is welded to the bumpkin in the case of the yacht with the overhanging stem; this is done in order to get a longer foot to the foresail, as otherwise could not have been done with the mast stepped so far forward. The bumpkin

* The *Rayonette* we believe is the only boat without one, and hers was only discarded when she was lengthened in 1877.

and span-shackle should be made of bar iron 3in. by $\frac{1}{2}$ in., and the span-shackle (or gammon iron as it is sometimes termed) should be securely welded to it as shown. The span-shackle will be an open ring having a couple of lugs at *a*. A shackle will be bolted to these lugs as shown,

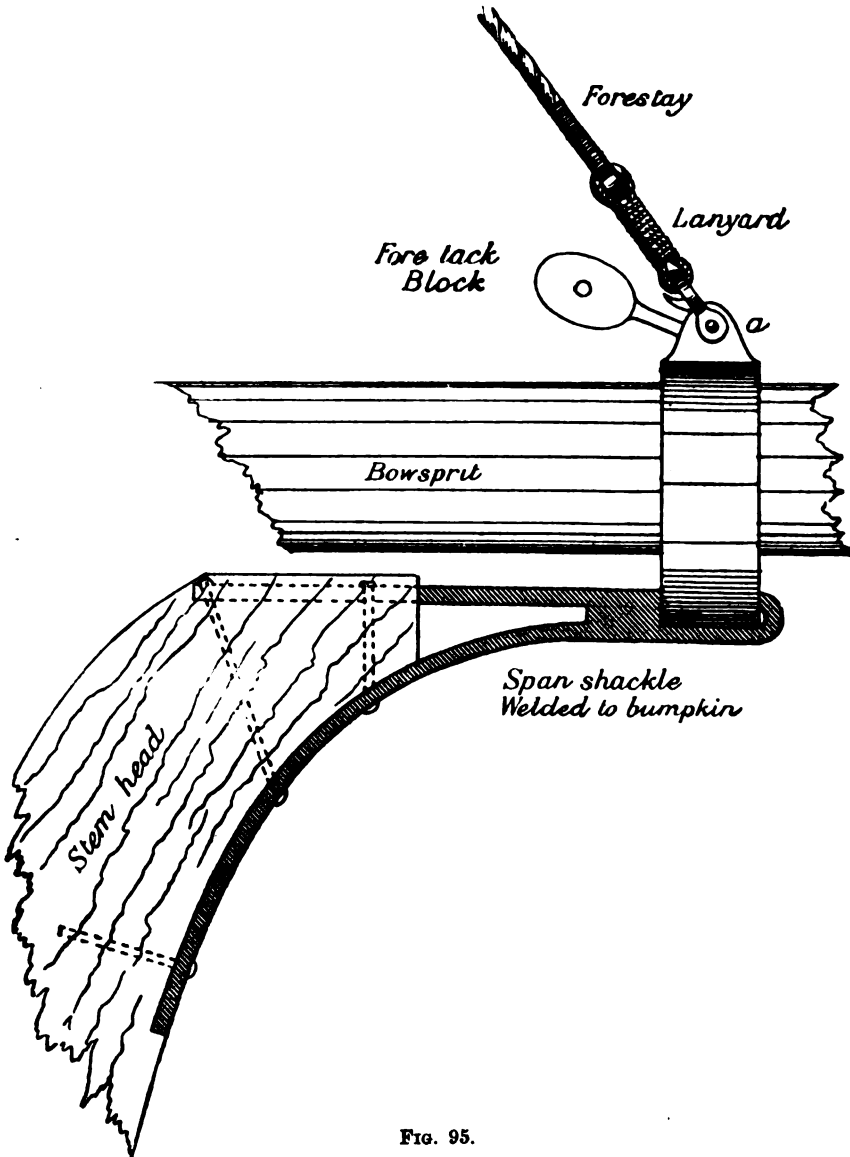

FIG. 95.

to which the forestay will be set up by a lanyard. The fore-tack block will be hooked to the bolt of the shackle.

It must be noted that the bumpkin iron is sunk into the stem head, otherwise the lateral strain on the bowsprit might wrench it off.

ITCHEN SAILING PUNTS.

Until 1877 the boats of this class sailing in the local match for punts 13ft. long were little better than ordinary rowing skiffs rigged with a foresail on a short bumpkin, and a sprit mainsail without a boom. Since the formation of the Itchen Ferry Boating Club in 1879, mainly for match sailing between boats of the above length, very great improvements have been made, not only in the shape of the punts, but in their sail plan. They are all of the same length, viz.: 13ft., hence no time allowance is required. For such little craft they have very heavy lead

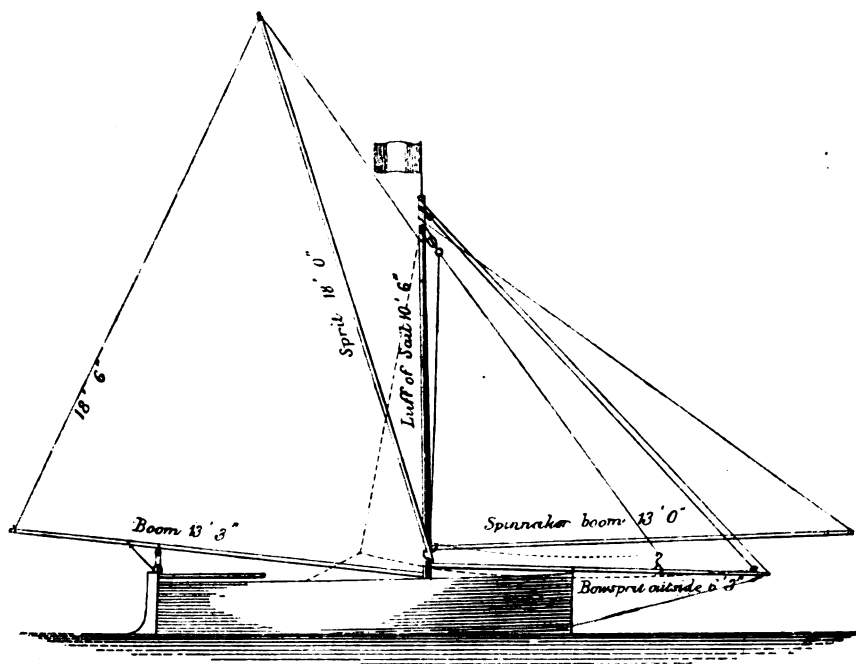

FIG. 96.

keels, some, being 4cwt. The ballast usually consists of iron pigs with slings in them, as shifting is allowed; however, a few of the new boats have shot bags. As will be seen from the sail plan, they have a long mast and carry a sprit mainsail with a boom, this sprit is very long, in fact much longer than the boat; they have a bowsprit on which they set their foresail. This bowsprit is made long enough to set the spinnaker as a jib; they have a small boom also to set the spinnaker on when before the wind. The punts are mostly owned by foremen of the various building yards, shipwrights, and masters of racing yachts. The number of races for such boats in Southampton Water must be very

great, as the two most successful boats in 1878, viz., the *Laura*, owned by Mr. Hatcher's foreman, and the *Tritonia*, owned by one of the Messrs. Payne, flew some fourteen winning colours each at the end of the season, after the fashion of racing yachts.

The lead keels, also the pieces of false wood keel fore and abaft this lead, are put on with nuts and screws, and can easily be taken off, leaving the boat a serviceable punt (see Plate XXX.)

The rig of the boats is shown by Fig. 96. The bobstay is a single part set up to the bowsprit by a lanyard.

The halyards are worked as shown by Fig. 97. In A, the head of the foresail is shown by 1; the standing part of the halyard is put over

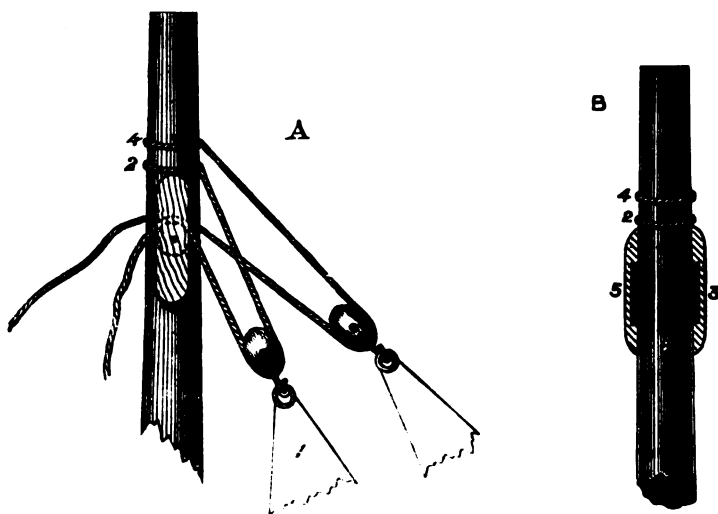
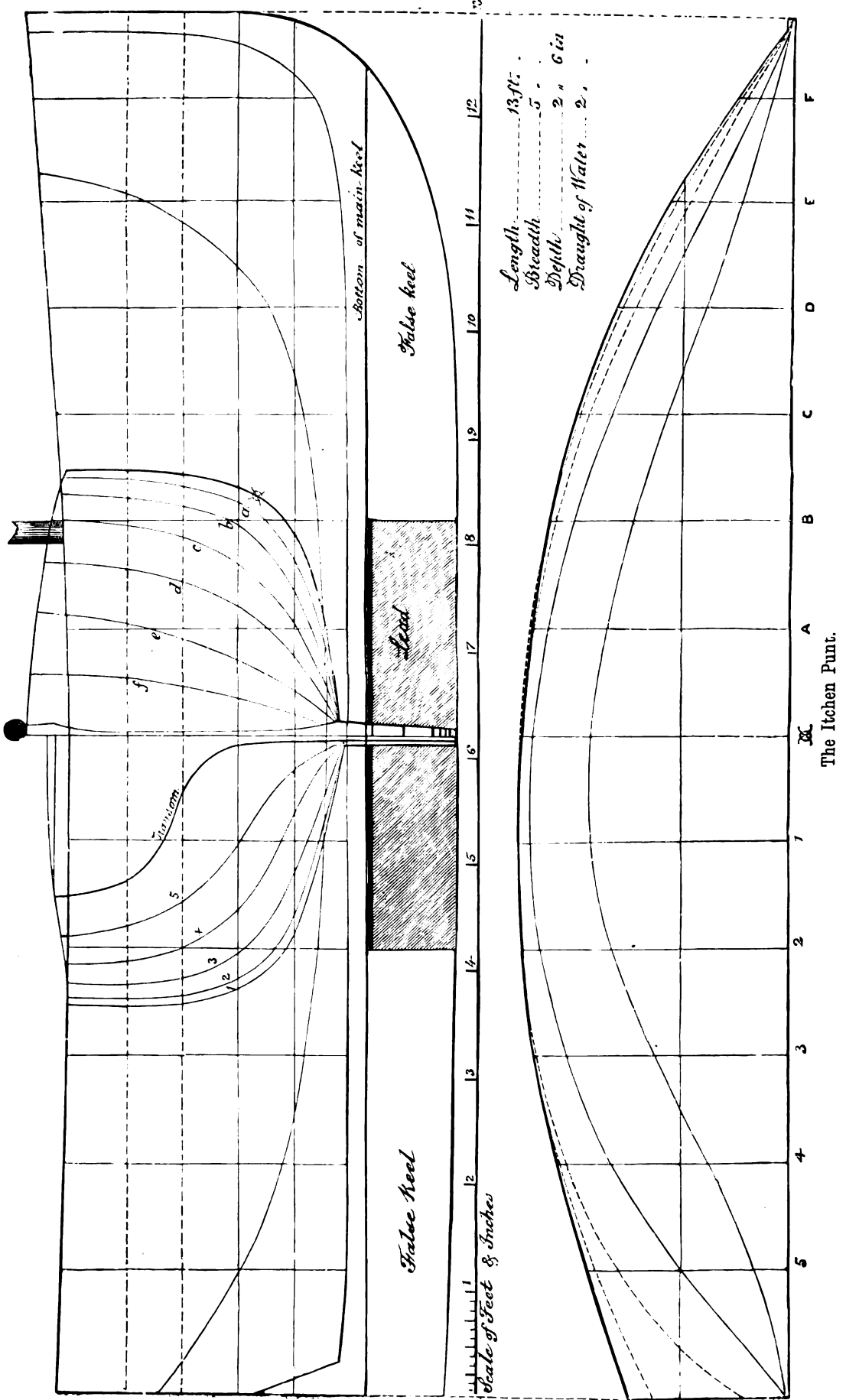

FIG. 97.

the mast at 2. The hauling part is rove through a cheek block; see 3 on B, which is the mast head viewed from astern. The jib, or spinnaker halyards are similarly fitted; the standing part is at 4 in A, the hauling part is rove through 5 in B. The main halyard is fast to a mast traveller and then passes over a sheave in the mast at 6 in B.

In Ireland, at Kingstown and Queenstown, a sailing boat something like the *Itchen* punt is in use. They are built to compete in a class not exceeding 18ft. in length. A novel feature in these boats is that, when not racing, they have counters screwed on to their transoms. Counters are not allowed whilst they are racing.

PLATE XXX.





CHAPTER XXI.

CLYDE SAILING BOATS.

SINCE 1875 open boat sailing has become wonderfully popular on the Clyde, and this is hardly to be wondered at, as the Firth offers special opportunities for this capital sport. Snug anchorages, fairly smooth water, little or no run of tide, and the facilities given by the railway and steamboat companies for readily getting from the city to the coast, induce most young fellows who are in the least degree nautically inclined to keep a boat of some sort; and during the summer months, in the bright northern evenings, from every coast village may be seen a fleet of little vessels flitting along the shore in the smooth water, and lying over to the land wind, which in good weather, rises as the sun sets. Many of these boats are racing craft, and as each principal waterplace has its local lugsail club, there is no lack of sport on the Saturday afternoons, there being always one, and sometimes two or three events for the little ships. As the prizes are of considerable value, and quite worth winning,* the class of boat has been gradually improved, and while three years ago they were simply ordinary fishing skiffs, ballasted with stone or sand bags, these have given place to such powerful craft as shown in the drawing, with lead keels, spinnakers, and all the modern racing paraphernalia.

The boats are divided for racing purposes into three classes, 17ft., 19ft., and 22ft. The drawing shows a 19ft. boat on a scale of $\frac{1}{4}$ in. = 1ft., but tables of offsets and proportional scales are given, so that it can be used for all three sizes; there are also a few 15ft. boats, but the principal racing is among the larger ones. Prior to 1878 the only dimension taken into account was length, that being measured over all, but as this

* The prizes of one 19ft. boat, the Vanguard, amounted in 1877 to £35, while the 22ft. boat, Thisbe, netted over £45.

was thought likely to produce a fleet of "Popohgas," the ordinary Y.R.A. rule was adopted by the Western and Royal Aquatic Clubs, the classes being now fixed at 1½, 2½, and 3½ tons, so as not to unclass existing boats. As far as possible time allowances are discouraged, and no *new* boats are given time, but those built prior to 1878 get time from their larger rivals according to the following scale, which has worked fairly well in practice:

For 17ft. boats, 12 seconds per ¼ ton per knot.
 For 19ft. boats, 10 " " "
 For 22ft. boats, 8 " " "

Excepting one or two of the earlier boats, all are built with square sterns, the increased power got by this form apparently making up for the unavoidable drag aft, while the over-all measurement, which prevails in most of the clubs, precludes a counter. It is questionable, however, whether a short neat counter could not be made "to pay," at least in heavy weather, and when the boats are necessarily travelling at a high speed; though at small inclinations, and speeds up to three or four miles an hour, this form of after end leaves the water smoothly enough, the stern board being then fairly out of water.

An idea of the advance made in the building of these craft may be gleaned from the following table of particulars of the best boats of their day:

Date of building	1873.	1875.	1877.	1878	1879
Name of boat.....	NEVA.	LILY.	VANGUARD.	Build.	Bwild.
Builder	M'Inistan.	Fife.	Paton.	Paton.	—
	ft. in.	ft. in.	ft. in.	ft. in.	ft. in.
Length	18 9	19 0	19 0	19 0	22 0
Breadth	5 7	5 8	5 6	6 0	5 3
Depth from top of gunwale to top of keel	2 0	2 4	2 8	3 3	—
Freeboard	1 3	1 5	1 8	1 10	1 9
Draft aft.....	1 9	2 0	2 3	2 4	5 0
Draft forward	1 4	1 4	1 6	1 6	3 0
Mast, extreme length	20 0	—	21 0	21 0	} 20ft. deck to hounds. 15ft. gaff. 19ft. boom.
Yard, extreme length	19 0	—	19 6	19 6	
Weight of ballast inside	6cwt.	10cwt.	17cwt.	20cwt.	8cwt.
Weight of ballast on keel	none	none	none	3cwt.	40cwt.
Displacement (about)	11cwt.	16cwt.	24cwt.	31cwt.	80cwt.

The steady increase of displacement is the most remarkable feature in this table, it presenting indeed but a microcosmic history of yacht-building from the time of "America" to "Vanessa."

The boats are generally entirely open, but the Largs and Western Clubs intend allowing a deck in future, while one or two clubs even

now permit the boat to be covered from the mast forward, the space below forming what is called "the den," where provisions, &c., may be kept dry, and where the luxurious owner and friends sleep when away on a cruise, covering the other four feet of their bodies with a tarpaulin.

There being no inducement, under the measurement rule, to cut down free board, they are given plenty of it, some as much as 24in. the average, as may be seen from the table, being about 22in. for a 19ft. boat, which is not found too much for the heavy sea which a sou'-wester tumbles up between Cumbrae and Porten Cross. Even with this a quantity of water gets aboard, and employs any spare hand baling besides the man at the pump. All the best boats are fitted with large pumps, 2½in. and 3in. in the barrel; they are generally on the aft thwart with discharge to both sides, or through the bottom. An ingenious, albeit expensive kind of pump has been adopted in one or two instances; this is shown in the mid section and general plan (Fig. 99, and Plate XXXII.)—the barrel is pivoted at the foot so as to cant over to either side of the boat, the pumper being thus able to sit up in the weather bilge while at work. The discharge of this pump was through the lower part of the stern board, possibly after the idea of Ruthven's jet propeller.

Another pump, made, and we believe patented, by Messrs M'Conechy and Co., Glasgow, attains a like object in a simpler way. It is a lever pump, and by a very simple but effective arrangement, the lever can be shifted to either side, thus securing all the advantages of the other, and being much more easily worked.

The general construction and arrangement of these boats is shown in the drawings (Plate XXXII.), and the scantlings are in pretty close accordance with the following tables, but some of the fittings, being as far as we know, peculiar to these boats, deserve particular mention, such as the ballast shelf, main-sheet horse, &c. These are illustrated in the cuts, and their uses further explained by the text.

In the larger boats, and where there is an extra heavy lead keel, a keelson may be advantageously adopted.

The weight of a 17ft. boat built to these scantlings would be about 5cwt., hulls, spars, sails, &c., complete, of a 19ft. boat 7cwt. to 8cwt., while a 22ft. boat would weigh 15cwt. to 18cwt. The displacements, if built to this drawing, being 22cwt., 31¼cwt., and 49cwt., would leave 17cwt., 23cwt., and 31cwt. for ballast and crew. Of this ballast, one-fourth might advantageously be put on the keel, but, unless lead were used, this amount could not be got in the space at disposal.

TABLE OF SCANTLINGS AND DIMENSIONS OF SPARS.

Length of boat	17ft. boat	19ft. boat	22ft. boat
Beam, extreme	5ft. 4 $\frac{1}{2}$ in.	6ft.	7ft.
Depth from top of gunwale to top of keel amidships...	3ft. 0 $\frac{1}{2}$ in.	3ft. 4in.	3ft. 11 $\frac{1}{2}$ in.
Keel, of American elm, sided	2in.	2 $\frac{1}{2}$ in.	2 $\frac{1}{2}$ in.
Keel, of American elm, moulded	6in.	7in.	8in.
Apron, of American elm	3 $\frac{1}{2}$ in. \times $\frac{1}{2}$ in.	3 $\frac{1}{2}$ in. \times 1in.	4in. \times 1 $\frac{1}{2}$ in.
Frames, all bent, sided	1in.	1 $\frac{1}{2}$ in.	1 $\frac{1}{2}$ in.
Frames, all bent, moulded.....	$\frac{3}{4}$ in.	$\frac{1}{2}$ in.	1 $\frac{1}{2}$ in.
Frames, spaced centre to centre	8in.	9in.	9 $\frac{1}{2}$ in.
Floors, of oak (in every alternate frame space), sided	1 $\frac{1}{2}$ in.	1 $\frac{1}{2}$ in.	2 $\frac{1}{2}$ in.
Floors, moulded at throat.....	3in.	3in.	4 $\frac{1}{2}$ in.
Stem, of oak, sided.....	1 $\frac{1}{2}$ in.	2in.	2 $\frac{1}{2}$ in.
Stem, of oak, moulded (about)	6in.	7in.	8in.
Sternpost, of oak, sided.....	2in.	2 $\frac{1}{2}$ in.	2 $\frac{1}{2}$ in.
Sternpost, of oak, moulded at keel	7in.	8in.	9in.
Sternboard, of oak, thick	1in.	1 $\frac{1}{2}$ in.	1 $\frac{1}{2}$ in.
Gunwale, American elm	1 $\frac{1}{2}$ in. \times 1 $\frac{1}{2}$ in.	2in. \times 1 $\frac{1}{2}$ in.	2 $\frac{1}{2}$ in. \times 1 $\frac{1}{2}$ in.
Planking, garboard strake, elm	6in. \times $\frac{1}{8}$ in.	6in. \times $\frac{1}{8}$ in.	6in. \times $\frac{1}{8}$ in.
Planking, thence to sheer strake, yellow pine	5in. \times $\frac{1}{8}$ in.	5in. \times $\frac{1}{8}$ in.	5 $\frac{1}{2}$ in. \times $\frac{1}{8}$ in.
Planking, sheer strake, mahogany	5 $\frac{1}{2}$ in. \times $\frac{1}{8}$ in.	5 $\frac{1}{2}$ in. \times $\frac{1}{8}$ in.	6in. \times $\frac{1}{8}$ in.
Thwarts	7in. \times 1in.	7in. \times 1 $\frac{1}{2}$ in.	7in. \times 1 $\frac{1}{2}$ in.
Thwarts, mast thwarts	7in. \times 1 $\frac{1}{2}$ in.	7in. \times 1 $\frac{1}{2}$ in.	7in. \times 1 $\frac{1}{2}$ in.
Wirings, elm	3in. \times $\frac{1}{2}$ in.	3 $\frac{1}{2}$ in. \times 1in.	3 $\frac{1}{2}$ in. \times 1 $\frac{1}{2}$ in.
Mast beam, double-kneed, with lodging knee to wiring	2in.	2 $\frac{1}{2}$ in.	2 $\frac{1}{2}$ in.
Mast, deck to hounds	18ft.	19ft. 6in.	20ft.
Mast, hounds to truck	—	—	9ft.
Mast, diameter at deck	3 $\frac{1}{2}$ in.	4in.	4 $\frac{1}{2}$ in.
Yard or gaff, length extreme	18ft.	20ft.	14ft.
Yard or gaff, diameter at slings	2 $\frac{1}{2}$ in.	2 $\frac{1}{2}$ in.	2 $\frac{1}{2}$ in.
Cruising yard or gaff, length extreme.....	15ft.	17ft.	—
Cruising yard or gaff, diameter at slings	2 $\frac{1}{2}$ in.	2 $\frac{1}{2}$ in.	—
Boom, length extreme	16ft.	18ft.	18ft.
Boom, diameter at sheet	2 $\frac{1}{2}$ in.	2 $\frac{1}{2}$ in.	2 $\frac{1}{2}$ in.
Bowsprit, outboard	5ft.	5ft. 6in.	10ft.
Bowsprit, diameter at gammoning iron	2in.	2 $\frac{1}{2}$ in.	2 $\frac{1}{2}$ in.
Spinnaker or shadow sail boom, length extreme	16ft. 6in.	18ft. 6in.	21ft.

The usual rig for boats 19ft. and under is a single standing lug, as shown in the plan (Plate XXXI.), but for cruising, and for racing in some of the clubs, a standing lug, with boom on foot, and short bowsprit with jib, are used; these are shown in the plan by dotted lines. For the single lug the mast is stepped about one-seventh of the boat's length from the stem, for the lug and jib, about 18in. further aft. Most of the boats are fitted for both rigs, and, farther, have several mast steps, so that the rake of the mast may be altered. One of the mast beams is generally bolted to the gunwale, this being strengthened at the part by a heavy clamp piece running two to three feet fore and aft. The mast is further supported by a wire shroud on each side, and a forestay (1 $\frac{1}{4}$ steel). These are shackled to the crane at the masthead, made as shown in Fig. 98, and have a large thimble spliced in at the other end to take the lanyard. Many of the boats are fitted with "channels," to give more spread to the rigging, the mast being so far forward, so lofty,

PLATE XXXI.

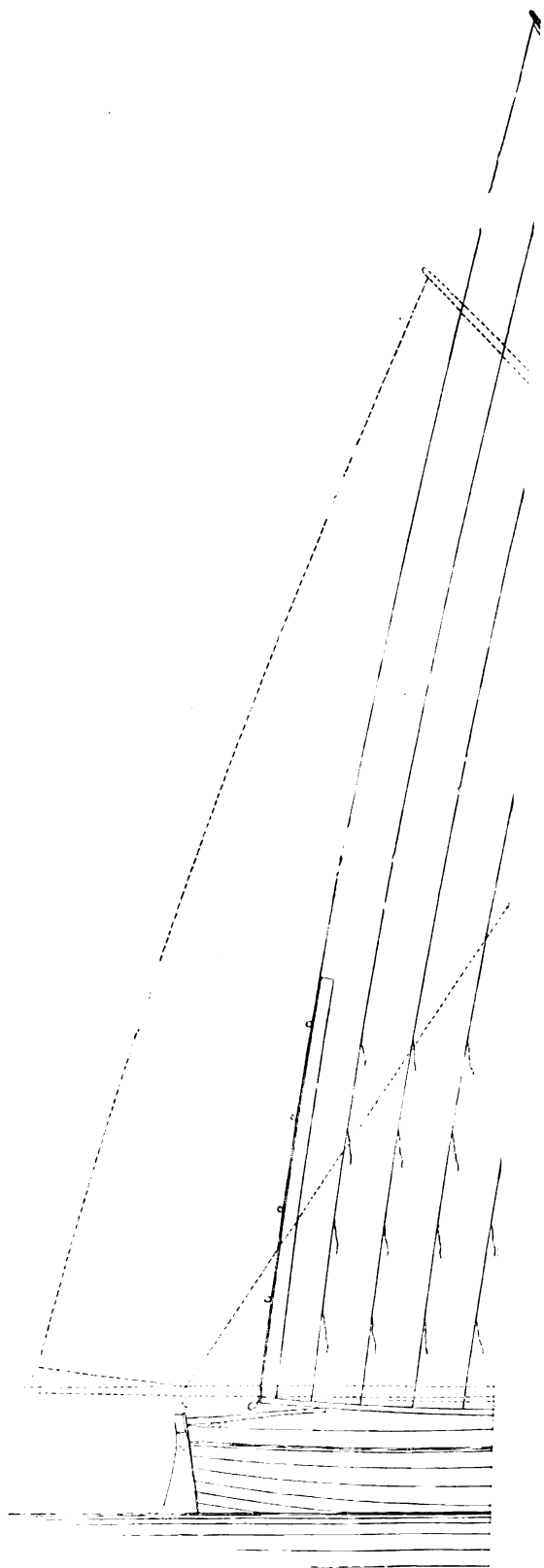

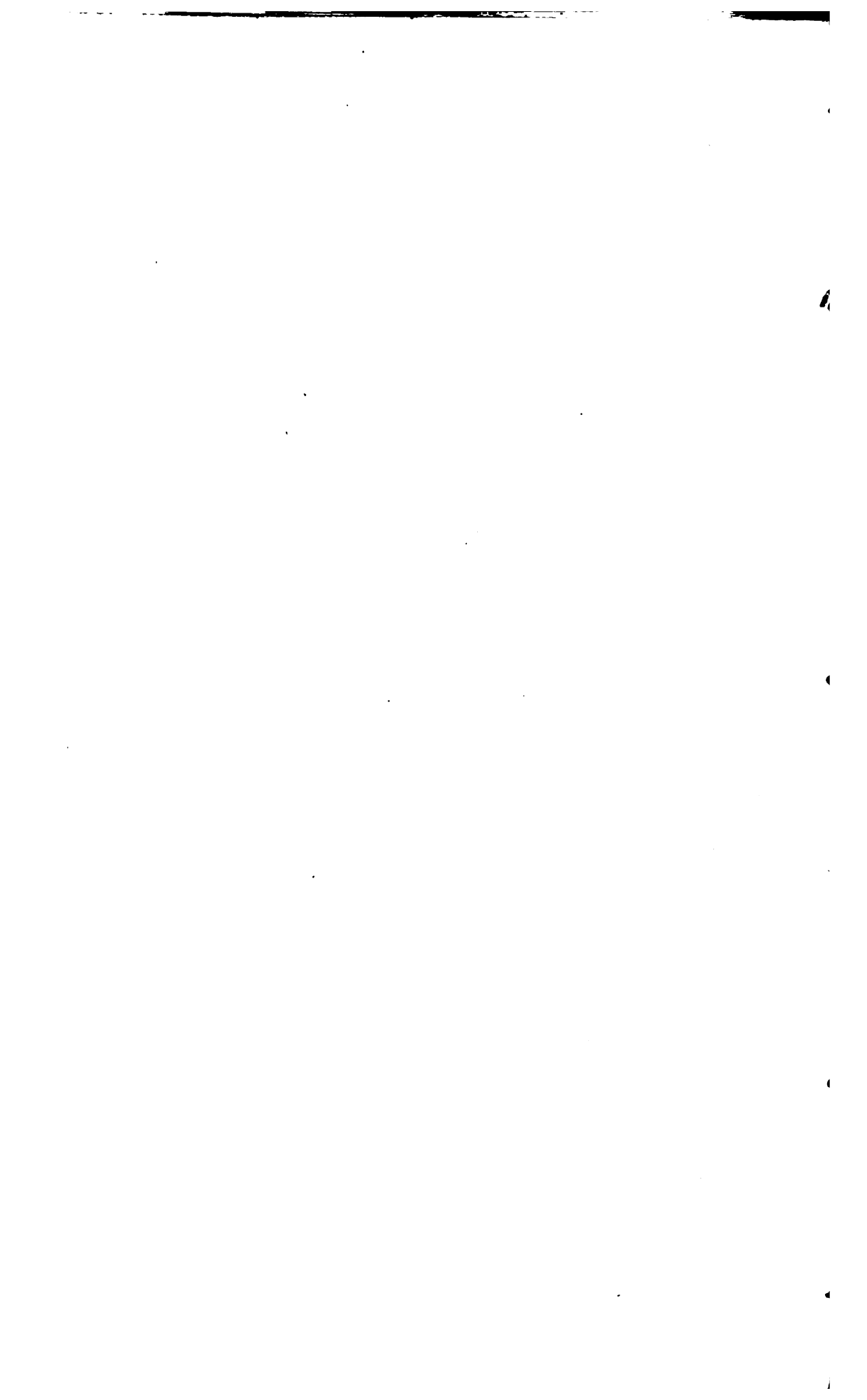

and the boats so fine in the nose, that without these the shrouds would give little support; they are of the "skeleton" kind, being made as shown in the sketch. The lengths and diameters of mast and spars are given in the table. A traveller works on the mast, and in construction is identical with that of the New Brighton boats described at page 262, the hook being welded solid on the ring, and hooking into a selvedge strop on the yard, the halyard (2in. tarred hemp) being spliced into its eye. But into the other end of the halyard a double

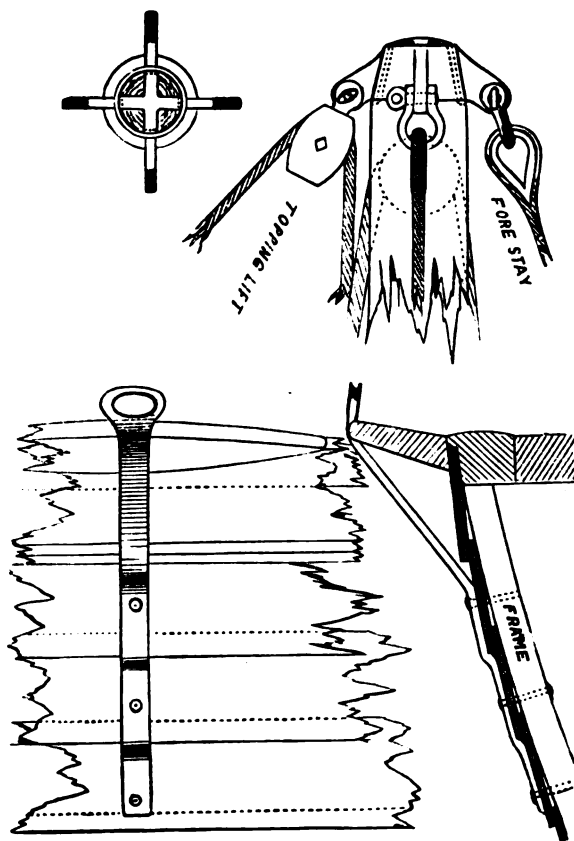

FIG. 98.

block is spliced; and a fall rove through this, and a single block at the foot, forms a luff tackle purchase for hoisting. The single thick rope is cut a foot or eighteen inches short, so that the yard has to be lifted up and hooked on; this of course is necessary, that the sail may be hoisted "chock-a-block." The tack is simply slipped on to a hook in the mast beam, the tackle on the halyards bringing the necessary strain on the luff to peak the sail. The main-sheet is a gun-tackle

purchase, the upper block shackling on to the clew of the sail, while the lower has a thimble spliced on to its tail, which works on the horse across the stern, as shown in the sketch (Fig. 99). When the boom lugsail is in use, the same sheet is simply shackled into a strop on the boom, thus doing for both. It is evident that by carrying the horse back, say a couple of feet (which might easily enough be done), all the advantages of a boom sail could be retained; there is, therefore, a rule which enacts that "if a horse is used it must be at right angles to the keel."

The spars and sails carried by these boats are enormous; one 19ft. boat, indeed, having a mast 21ft., deck to hounds, or 18in. longer than the five-tonner *Diamond*. She, however, was exceptionally heavily sparred, the general proportions being :

	Luff.	Head.	Foot.	Leech.
	ft. in.	ft. in.	ft. in.	ft. in.
19ft. boats	12 6	16 0	14 6	25 6
17ft. boats	12 0	14 6	13. 6	23 0

With such canvas aloft, the latest improvements in ballasting must be adopted, and the new boats are all fitted with metal keels, 3 cwt. to 5 cwt. in weight. In one or two, all the internal ballast is also lead; but, whether lead or iron, it is neatly cast in blocks, weighing about a hundredweight, which fit close down to the skin, but hang entirely on the keel and floor timbers. As shifting ballast is allowed in the *Largs Club*, most boats, whether belonging to this club or no, are fitted with a shelf for stowing weather ballast in each bilge, as shown in the arrangement plan and midship section (Plate XXXII. and Fig. 100). This shelf also makes a capital seat for the crew, where they are well up to windward and also in shelter. The celebrated *Largs* boat *Neva* (possibly borrowing the idea from the China clippers, which, when racing, hung water-butts over the weather side) used to get her ballast still farther to windward, by slinging pretty nearly all of it (some 6cwt.) right outside. The *Western Yacht Club*, however, has most stringent rules against shifting ballast, and rigidly enforces these rules, also limiting the crew to three in the 17ft. and 19ft. boats, and four in the 22ft. boats, so as to prevent, as far as may be, "live ballast."

These boats go out in pretty well any weather, the sail reefing down very snug, and the boats, when not recklessly driven, being most seaworthy little craft. Accidents of any kind are therefore rare, and

we cannot call to mind a fatal one, owing doubtless to the excellent rule enforced in all the clubs, that "every boat shall carry life-saving apparatus sufficient to float every person on board." The modern boats seldom or never miss stays, but in the event of their doing so, it is admissible to use

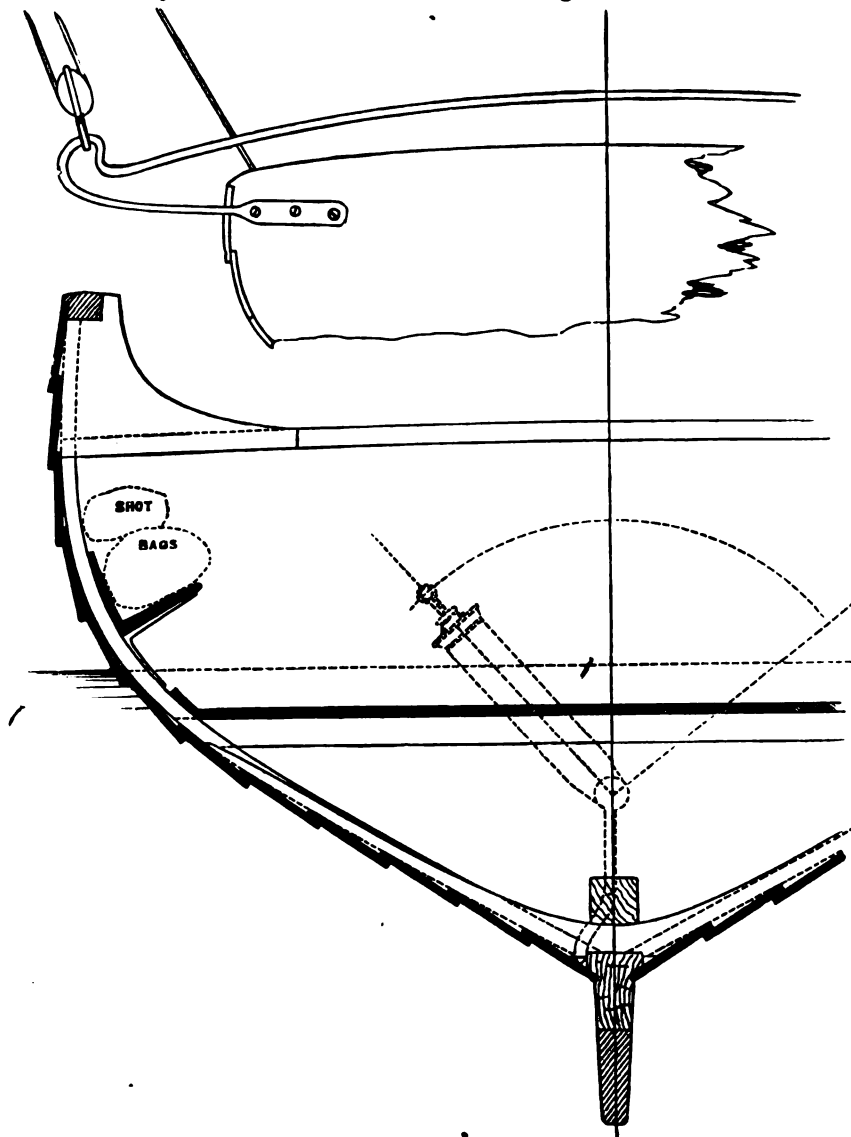

FIG. 99.

an oar to put them round, "but the strokes are to be backward, and in no case to be ahead," a very necessary clause, as before its introduction, a morbid horror of missing stays prevailed, especially in calm weather. At one time in running, the Western Club did not permit extra sails, and

did not even allow "booming out," but the Western now follow the rule of the other clubs and allow spinnakers, or more generally "shadow sails." The shadow sail is generally an old lug sail hoisted opposite the other, and the boom shipped into a snotted on fore side of mast.

The 22ft. boats are invariably rigged as cutters, with mainsail, foresail, and jib, and small topsail on the pole mast. They carry also the usual balloon canvas for running to leeward, and occasionally indulge even in jib topsails. In the following table we give particulars of the best boats in this class, the "Thisbe," built by McLaren, of Kilcreggan, and owned by Mr. Allan Macintyre, and the "Ayrshire Lass," built by Fife for Mr. Thomas Reid, of Paisley. It is by the courtesy of these gentlemen we are enabled to give the following particulars. Alongside are given those of a 22ft. boat built to our drawing.

Name	THISBE.	AYRSHIRE LASS.	DESIGN.
Length, extreme	21ft. 11in.	22ft.	22ft.
Breadth, extreme	6ft. 11in.	7ft.	7ft.
Draught of water aft	3ft. 8in.	3ft. 6in.	3ft. 2in.
Draught of water forward	2ft.	2ft. 6in.	1ft. 9in.
Displacement (about)	3.15 tons	2.4 tons	2.45 tons.
Ballast (total)	2 tons 5cwt.	1 ton 10cwt.	1 ton 11cwt.
Ballast lead inside	1 ton 9cwt.	1 ton 4cwt.	18cwt.
Ballast iron inside	—	10cwt.	—
Ballast on keel	16cwt.	6cwt.	13cwt.
Mast, deck to hounds	20ft. 6in.	19ft.	20ft.
Boom, extreme	18ft.	19ft.	18ft.
Gaff, extreme	14ft.	15ft.	14ft.
Bowsprit, outside	10ft.	12ft.	10ft.
Area of plain sail	513 sq. ft.	520 sq. ft.	500 sq. feet.

The Clyde boats are invariably clencher built, so that in the event of anyone building to our drawings it would be necessary to put up a "roof tree" between stem and stern post, then make half moulds for, say, 2, 4, 6, and 8 sections, pivoting these on their centre lines so as to swing round and do for both sides. She may be planked to these moulds, the frames then bent in, and last of all the floors, as if the floors are put on before planking it is unlikely that the bottom will be kept as fair. The sections can be drawn down full size from the following table of offsets.

In all cases the water-lines are named from the load, or first water-line *downwards*. The diagonals are also named in like manner, the *top* one being *first* diagonal, and so on. The gunwale heights and breadths explain themselves. The dimensions given are in all cases *moulded*, that is, to the inside of the plank. If it is desired to make

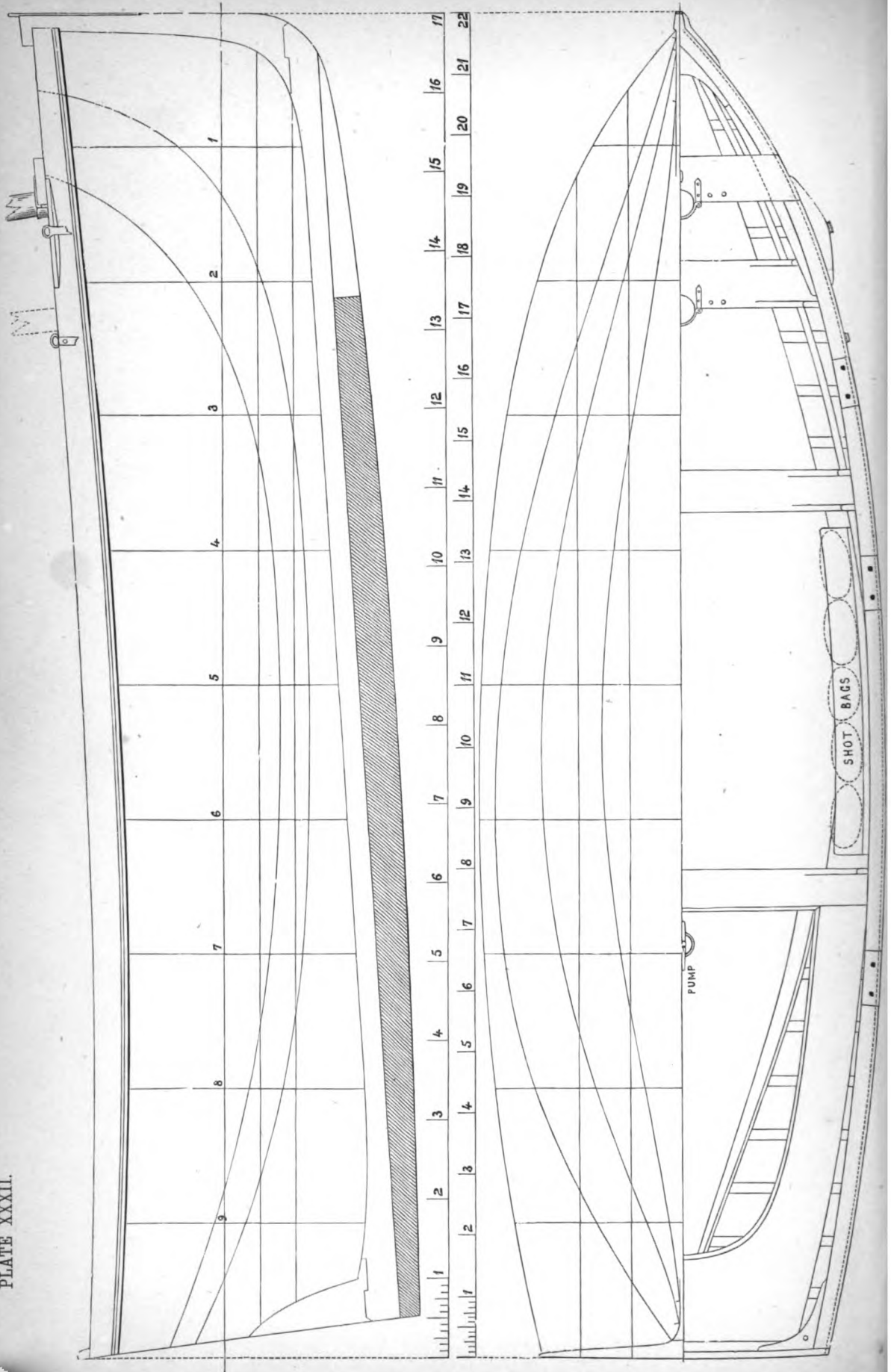

calculations of any elements of these boats, once and a half the thickness of plank must be drawn on.

The stations (see Plate XXXII.) are spaced exactly $\frac{1}{10}$ th of the extreme length apart, and are at right angles to the water line. The

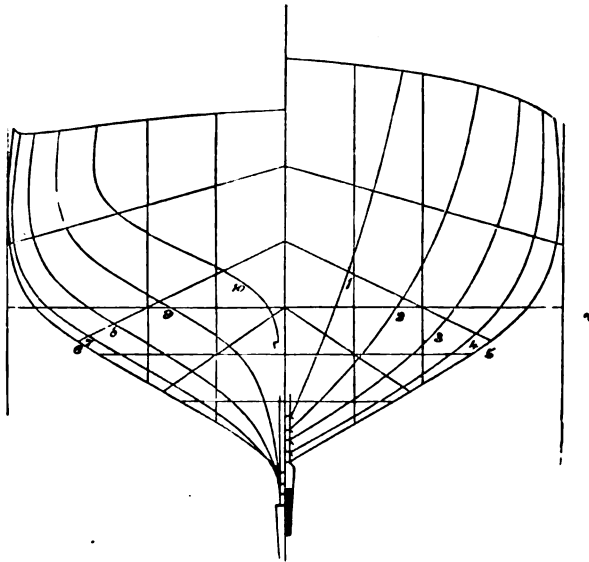

FIG. 100.

shape of stern-board is shown in projection on the body-plan; in laying it down for building, the rake of post would have to be allowed for to get the *actual* shape.

TABLE OF OFFSETS FOR A 17ft. BOAT-

No. of Section	1		2		3		4		5		6		7		8		9		10	
	ft.	in.	ft.	in.	ft.	in.	ft.	in.	ft.	in.	ft.	in.	ft.	in.	ft.	in.	ft.	in.	ft.	in.
Heights above L.W.L. to top of gunwale	2	2 $\frac{1}{8}$	2	1 $\frac{3}{8}$	1	11 $\frac{1}{8}$	1	10 $\frac{1}{8}$	1	9 $\frac{1}{8}$	1	8 $\frac{1}{8}$	1	7 $\frac{1}{8}$	1	7 $\frac{1}{8}$	1	8	1	8 $\frac{1}{8}$
Depths below L.W.L. to rabbet	1	0	1	1 $\frac{3}{8}$	1	2 $\frac{1}{8}$	1	4	1	5 $\frac{1}{8}$	1	6 $\frac{3}{8}$	1	7 $\frac{1}{8}$	1	8 $\frac{1}{8}$	1	8 $\frac{1}{8}$	1	—
Half-breadths at gunwale	1	1 $\frac{1}{4}$	1	9 $\frac{3}{8}$	2	2 $\frac{1}{8}$	2	4 $\frac{1}{8}$	2	6	2	6 $\frac{1}{2}$	2	5 $\frac{1}{8}$	2	4 $\frac{1}{8}$	2	1 $\frac{1}{8}$	1	9
Half-breadths at L.W.L.	0	5 $\frac{1}{8}$	1	0 $\frac{3}{8}$	1	6 $\frac{7}{8}$	2	0 $\frac{1}{10}$	2	3	2	3 $\frac{1}{2}$	2	2	1	10	1	0 $\frac{1}{8}$	0	1 $\frac{1}{8}$
Half-breadths, No. 2 W.L.	0	3 $\frac{1}{8}$	0	8 $\frac{1}{8}$	1	1 $\frac{1}{8}$	1	6 $\frac{1}{10}$	1	8 $\frac{1}{8}$	1	8 $\frac{3}{8}$	1	6 $\frac{1}{8}$	1	0 $\frac{1}{8}$	0	5 $\frac{1}{8}$	0	0 $\frac{3}{8}$
Half-breadths, No. 3 W.L.	0	1	0	3 $\frac{3}{8}$	0	7 $\frac{1}{10}$	0	10	0	11 $\frac{3}{8}$	0	11 $\frac{1}{8}$	0	8 $\frac{1}{8}$	0	5 $\frac{1}{8}$	0	2	0	0 $\frac{3}{8}$
Half-breadths on 1st diagonal	0	10 $\frac{1}{8}$	1	6 $\frac{1}{8}$	2	0 $\frac{1}{8}$	2	5	2	7 $\frac{1}{8}$	2	8 $\frac{1}{8}$	2	7 $\frac{1}{8}$	2	5 $\frac{3}{8}$	2	1 $\frac{1}{8}$	1	7 $\frac{3}{8}$
Half-breadths on 2nd diagonal	0	8	1	2 $\frac{1}{8}$	1	8 $\frac{1}{8}$	1	11 $\frac{1}{8}$	2	2	2	2 $\frac{1}{8}$	2	0	1	9 $\frac{1}{8}$	1	3	0	7 $\frac{1}{8}$
Half-breadths on 3rd diagonal	0	5 $\frac{3}{8}$	0	10 $\frac{1}{8}$	1	1 $\frac{3}{8}$	1	3 $\frac{1}{8}$	1	4 $\frac{1}{8}$	1	4 $\frac{1}{8}$	1	3 $\frac{1}{8}$	1	0 $\frac{1}{8}$	0	7 $\frac{1}{8}$	0	1 $\frac{1}{8}$

The stations are spaced 1·7ft. apart (1ft. 8 $\frac{1}{2}$ in.), No. 1 station being the same distance from fore-side stem. The water-lines are a bare 5 $\frac{1}{8}$ in. apart; the more exact way to lay them off will be to measure 16in. below the load line, and divide it into three equal parts.

The side lines are parallel to the centre line, and 2ft. 7 $\frac{1}{4}$ in. out.

The first diagonal cuts the centre line 1ft. 3 $\frac{1}{8}$ in. above the load line, and cuts the side line 7in. above the load line.

The second diagonal cuts the centre line 7½in. above the load line, and the side line 7½in. below it.

The third diagonal cuts the centre line at the load line, and cuts the third water line 1ft. 3½in. out.

TABLE OF OFFSETS FOR A 19ft. BOAT.

No. of Section	1	2	3	4	5	6	7	8	9	10
	ft. in.	ft. in.	ft. in.	ft. in.	ft. in.	ft. in.	ft. in.	ft. in.	ft. in.	ft. in.
Heights above L.W.L. to top of gunwale	2 6	2 4½	2 2½	1½	1 11½	1 10½	1 10½	1 10½	1 10½	1 11½
Depths below L.W.L. to rabbet	1 1½	1 3½	1 4½	1 6	1 7½	1 8½	1 10½	1 11½	1 11½	—
Half-breadths at gunwale	1 2½	2 0	2 5½	2 8½	2 9½	2 10	2 9½	2 7½	2 4½	2 0
Half-breadths at L.W.L.	0 6½	1 1½	1 9	2 3	2 6½	2 7½	2 5½	2 0½	1 2½	0 1½
Half-breadths, No. 2 W.L.	0 3½	0 9½	1 3½	1 8½	1 11½	1 11½	1 8½	1 2½	0 5½	0 0½
Half-breadths, No. 3 W.L.	0 1½	0 4	0 7½	0 11½	1 1½	1 0	10 ½	0 6	0 2½	0 0½
Half-breadths on 1st diagonal...	0 11½	1 9	2 3½	2 8½	2 11½	3 0½	2 11½	2 9	2 4½	1 9½
Half-breadths on 2nd diagonal...	0 8½	1 4½	1 10½	2 2½	2 4½	2 5½	2 3½	2 0	1 5½	0 8
Half-breadths on 3rd diagonal...	0 6 ½	0 11½	1 3½	1 5½	1 6½	1 6½	1 5½	1 2½	0 8½	0 2

The stations are spaced 1·9ft. apart (1ft. 10½in.), No. 1 station being the same distance from fore-side stem.

The water-lines are spaced exactly 6in. apart.

The side lines are parallel to the centre line, and 2ft. 11in. out.

The first diagonal cuts the centre line 18in. above the load line, and cuts the side line 8in. above load line.

The second diagonal cuts the centre line 8½in. above the load line, and the side line 8½in. below it.

The third diagonal cuts the centre line at the load line, and cuts the third water-line 1ft. 5½in. out.

TABLE OF OFFSETS FOR A 22ft. BOAT.

No. of Section.....	1	2	3	4	5	6	7	8	9	10
	ft. in.	ft. in.	ft. in.	ft. in.	ft. in.	ft. in.	ft. in.	ft. in.	ft. in.	ft. in.
Heights above L.W.L. to top of gunwale	2 10½	2 8½	2 6½	2 5	2 3½	2 2½	2 1½	2 1½	2 1½	2 2½
Depths below L.W.L. to rabbet...	1 3½	1 5½	1 7½	1 8½	1 10½	2 0	2 1½	2 3½	2 3½	—
Half-breadths at gunwale	1 5	2 3½	2 9½	3 1½	3 2½	3 3½	3 2½	3 0½	2 8½	2 3½
Half-breadths at L.W.L.	0 7½	1 3½	2 0½	2 7½	2 11 ½	3 0 ½	2 10½	2 4½	1 4½	0 2½
Half-breadths at 2nd W.L.	0 4½	0 11½	1 5½	1 11½	2 2½	2 2½	1 11½	1 4½	0 6½	0 1
Half-breadths at 3rd W.L.	0 1½	0 4½	0 9½	1 0½	1 3½	1 2½	0 11½	0 7½	0 2½	0 0½
Half-breadths on 1st diagonal ...	1 1½	2 0½	2 8½	3 1½	3 4½	3 5½	3 5	3 2½	2 9½	2 1½
Half-breadths on 2nd diagonal...	0 10½	1 7½	2 2½	2 7½	2 9½	2 10	2 8	2 3½	1 8½	0 10½
Half-breadths on 3rd diagonal ...	0 7½	1 1	1 5½	1 8½	1 10	1 10	1 8	1 4½	0 10½	0 2½

The stations are spaced 2·2ft. apart (2ft. 2½in.), No. 1 station being the same distance from fore-side stem.

The water lines are spaced exactly 7in. apart.

The side lines are parallel to the centre line, and 3ft. 4½in. out.

The first diagonal cuts the centre line 1ft. 8½in. above the load line, and cuts the side line 9in. above load line.

The second diagonal cuts the centre line 9½in. above the load line, and the side line 10½in. below it.

The third diagonal cuts the centre line at the load line, and cuts the third water line 1ft. 8½in. out.

As to cost, a modern racing 19ft. boat is a pretty expensive toy. About the most successful builder of them, Walter Paton, of Millport,

N.B., charges 22*s.* to 23*s.* per foot, and other builders are pretty much the same; the items, therefore, would sum up about as follows:

	£	s.	d.
Hull and spars, 19ft., at 23 <i>s.</i> per foot	21	17	0
Plain, pump, and other fittings not supplied by builder ...	3	10	0
Lead keel, 6 <i>wt.</i> , at 23 <i>s.</i> per <i>wt.</i>	6	18	0
Internal ballast, 10 <i>wt.</i> , at 22 <i>s.</i> 6 <i>d.</i> per <i>wt.</i>	11	5	0
Shot in bags, 4 <i>wt.</i> , at 32 <i>s.</i> per <i>wt.</i>	6	8	0
Blocks, running and standing rigging	8	0	0
Sails	15	0	0
Three life belts, at 15 <i>s.</i>	2	5	0

Total for boat complete and ready for racing £75 3 0

If internal ballast is of iron, deduct £8 10*s.*

[NOTE.—Since this article was written there has been an enormous stride made in the construction of “Clyde Sailing Boats” through the general adoption by nearly all the clubs of the Y.R.A. rule of measurement. Although this was decided on in 1879, the effects are only seen now, the various builders having launched a number of *miniature yachts* which in no way possess any special features as to hull, sails, or ballasting. They are, indeed, simply models of big yachts; in one or two instances, indeed, they have been built direct off the lines of five or ten tonners, the scale being altered to suit. Three-and-a-half, two-and-a-half, and one-and-a-half ton yachts have therefore been competing in the old 15ft., 19ft., and 22ft. classes, the new boats being one-third to one-half longer, and having half as much displacement again as their rivals, while they have the further advantage of carrying a large proportion of the ballast outside, the result being that the old type of boat is likely to be improved off the face of the water. One or two of the builders, however, stick pretty closely to the old type of boat, simply adding a counter; the present build may be somewhat deeper than the vessel shown in the plate, but if a counter be drawn on (the buttock lines will give a good enough guide as to its outline) she will very fairly represent them.

Iron masts were successfully introduced last year in several of the boats, they being found as light as, and much stiffer than the wooden ones. They were made of boiler tube, about 4in. diameter, and $\frac{1}{8}$ th to $\frac{1}{4}$ in. thick, tapered at top by slipping a small piece inside, and then a smaller, somewhat after the fashion of the Chinese bamboo fishing rods.

Lead and everything else being now much cheaper, 5*l.* might be deducted from the cost as given above of a 19ft. boat of the old type. The cost of a 2½-tonner (corresponding to the old 19ft. class), with all lead ballast, racing sails, and gear would not fall far short of 150*l.*

In the table (page 300) are given the particulars of a 2½-tonner for better comparison with the old boats.]

CHAPTER XXII.

KINGSTOWN BOATS.

AT Kingstown the Irish Model Yacht Club instituted races for boats of 18ft. length on the load-line, and the contests between these small craft were very keen, and in a breeze some fine examples of boat sailing were often seen. The rules required that the boats should not exceed 18ft. length, and that they should have no counter. The club also instituted a class for "three tonners," and it occurred to Mr. Ardagh E. Long that an 18ft. boat might also be a three-tonner. With this object in view he designed the exceedingly nice-looking boat *Heathen Chinee*, depicted on Plate XXXIII.

	HEATHEN CHINEE.	LANTHE.
Length	18ft.	17ft. 11in.
Breadth, extreme	7ft.	5ft. 2in.
Draught, extreme	4ft. 3in.	4ft.
Displacement	3·5 tons.	3·5 tons (about).
Ballast inside (iron)	12cwt.	1 ton 16cwt.
Ballast on keel (iron)	1 ton 2cwt.	None.
Mast, deck to hounds	16ft. 6in.	14ft. 3in.
Pole	8ft.	9ft. 9in.
Boom, extreme	18ft.	18ft.
Gaff	14ft.	13ft. 8in.
Bowsprit outboard	8ft. 3in.	9ft.
Topsail yard	18ft.	18ft.

Generally the proportion of beam to 18ft. length is from 5ft. 6in. to 5ft. 8½in., and two considerations have thus limited the beam. In the first place it has not been anticipated that a three-tonner with only 18ft. length could compete with a three-tonner of 25ft. or upwards, and so the beam of the 18ft. boats has been kept down to that necessary to make two tons, for the sake of time allowance; in the second place, in the 18ft. class time is allowed by a rule of length and beam added together. For these two reasons beam has usually been limited to the proportions named. The boats have, however, not been successful in the three-tons

PLATE XXXIII.

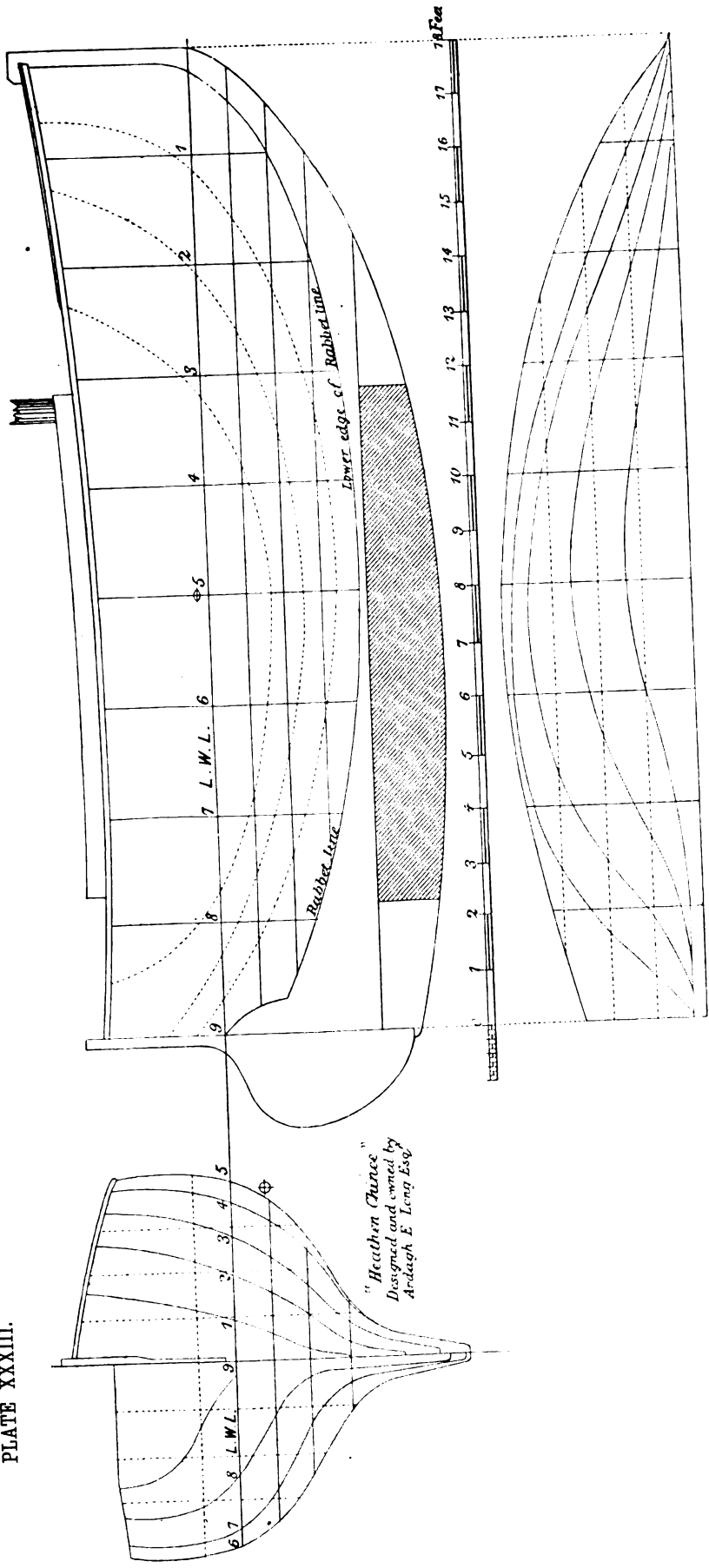

Kingstown Boats: The "Heathen Chinese."

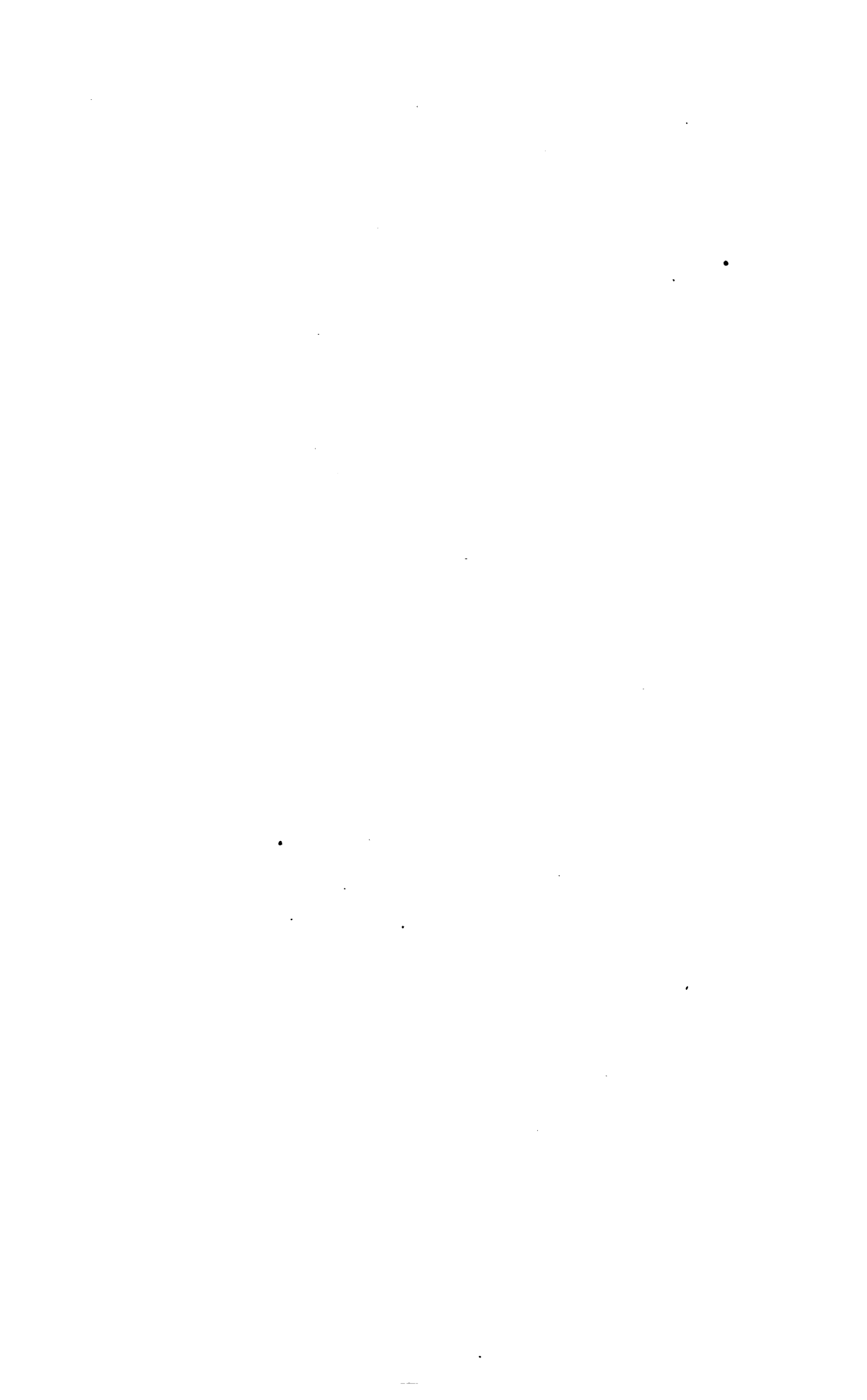

class, and it is a moot point whether they would not have been better for a little more beam. They have about the same displacement as Heathen Chinees, but are a trifle deeper in the body; they are undeniably fast along the wind, but do not carry their canvas quite so well as they might, that is, in comparison with the three-tonners. And the Heathen Chinees, with her greater beam, it can be concluded would not be successful against her narrower and longer compeers in the three-ton class.

The Ianthe is the narrowest boat of the class, and is cutter rigged; but the hitherto most successful boat, Shrimp, has a few inches more beam, and is sloop rigged. The one headsail is set flying with tack to bowsprit end like a jib, with as many as four jibs to suit different points of sailing, strength of wind, or reduced mainsail. The forestay is set up to the stem by a lanyard, and on going about the clew of the headsail is, of course, hauled round this stay.

The topsails are very peaked, similar to Alert's (see Plate XI.), the tack being fast to the heel of the yard. A spinnaker is carried, and the booms for the same are usually longer than the boat—the Shrimp's being about 24ft. long.

The boats are actually only half open, as they are decked forward and aft, with a large cockpit amidships. The Ianthe had a movable deck (formed with cockpit) so as to be qualified as a real open boat. The deck was a heavy one of 2in. pine, screwed down to a stout gunwale with strips of india-rubber listing between.

In the 18ft. class counters are not allowed, even though they be included in the 18ft. length; but, nevertheless, counters are found to be of such service to the boats, and so convenient in working the long boom that most of them are fitted with movable counters, which are fixed when it is not *de rigueur* to sail without one.

The counter is usually about 4ft. long, and is framed and planked. The fore end corresponds to the transom, but is fitted with a rudder case or trunk, of which *t* in Fig. 103 is a section. Fig. 101 represents a fore end view of the counter; *a, a, a, a*, are large $\frac{1}{2}$ in. washer plates screwed to the end frame; *b, b, b, b*, are $\frac{3}{4}$ in. bolts with large heads, so as to have a good grip of the washers. On the fore side of the transom frame of the boat similar washers are fitted, and the bolts thereon are screwed up tightly by thumb-screws, as shown by *s s*, Fig. 102. The counters are securely held by this arrangement; but if additional strength were required to meet any unusual strain, a tye rod might be used similar to that recommended for the Windermere boats (see Fig. 104).

If accurately and securely fitted these counters look well and answer well, but viewed end on appear rather narrow on account of the "tuck up"

and narrowness of the transom, necessary for sailing as a square-sterned boat. (See remarks on this subject in reference to fitting counters to the Itchen boats, p. 288.)

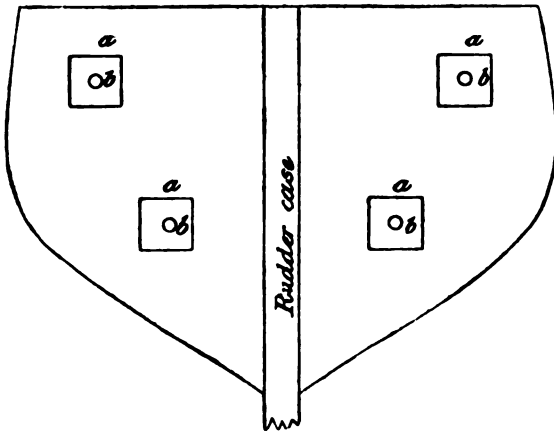

FIG. 101.



FIG. 102.

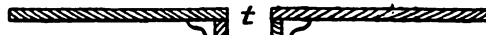

FIG. 103.

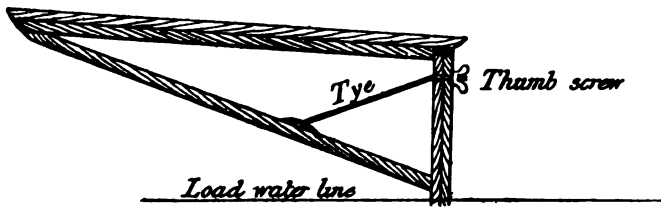

FIG. 104.

The lines of the *Heathen Chinee* are represented on Plate XXXIII., but the following table of "offsets" will be referred to in making moulds for building.

No. of Section	1		2		3		4		5		6		7		8		9		
	Midship																		Transom
	ft.	in.	ft.	in.	ft.	in.	ft.	in.	ft.	in.	ft.	in.	ft.	in.	ft.	in.	ft.	in.	
Heights to covering board *.....	2	8	2	5½	2	3	2	1½	2	0½	2	0	2	0½	2	0½	2	2	
Depths to rabbet †	1	5	2	1	2	6	2	8	2	9	2	7½	2	3	1	8			
Half-breadths on deck	1	3½	2	2½	2	10	3	3	3	5	3	4½	3	2½	2	9	2	2½	
Half-breadths 8in. above L.W.L.	0	11½	1	10½	2	7½	3	2	3	5½	3	5½	3	3½	2	7½	1	1½	
Half-breadths on L.W.L.	0	9½	1	7½	2	4½	2	11½	3	3½	3	4½	3	0½	2	1	0	2	
Half-breadths W.L. 2	0	6	1	3	2	0	2	7	2	11½	2	10½	2	3½	0	11	0	2	
Half-breadths W.L. 3	0	2½	0	9	1	4½	1	11	2	2	1	11½	1	2	0	3½	0	2	
Half-breadths W.L. 4	—	0	3½	0	8½	1	0½	1	1½	0	10½	0	4½	0	2	0	2	0	

The water-lines are 8in. apart.

The sections are 2ft. apart.

All the half-breadths include the plank.

* Underside of covering board.

† Lower edge of rabbet.

CHAPTER XXIII.

YACHTS OF THREE, FIVE, AND TEN TONS.

THREE-TONNERS.

THE sailing of three-tonners has long been a fashionable accomplishment with the sailor men who live on the shores of St. George's Channel, but only within the last two years has it become a general fashion. Formerly anything of a certain length and breadth served for a "3-tonner," but yachtsmen have grown much more exigent, and these small yachts must now be as handsome in design as *Formosa*, *Samæna*, or *Vanduaara*, and as scientifically worked out. The most experienced yacht designers are employed in draughting their lines, and their spars, gear, sails, and ballast are all of the most approved pattern and quality. There was a temporary battle of opinion as to whether the class should be 3 tons or $2\frac{1}{2}$ tons, and an attempt was made to settle the matter on the Thames. But after a serious debate the committee of the Nore Club effected a compromise by deciding that the limit of tonnage should be 3 tons, and the limit of length 25ft. The length limit was proposed because an idea prevailed that some of the Clyde $2\frac{1}{2}$ tonners might be transported to the Thames, and, as their length did not exceed 25ft., it was contended they would have no chance against a 3-tonner of greater length, as the Nore Club did not until this year use time allowances. The $2\frac{1}{2}$ -tonner was supposed to have some virtue because it was in regular sequence with the Y.R.A. classes 40, 20, 10, and 5 tons; and moreover with a certain proportion of beam to length double dimensions give eight times the tonnage, and therefore the dimensions of a $2\frac{1}{2}$ -tonner would if doubled produce a 20-tonner. Hence it was thought that the class would serve as an experimental one to assist in designing 20-tonners, just the same as 5-tonners have or ought to have served as the experimental models of 40-tonners. However, the $2\frac{1}{2}$ -tonners found no more favour on the Thames than they did at Kingstown, and the little vessels which have been built on the Thames for the below-bridge clubs are of 3 tons.

The design given in Plate XXXIV. is longer than any of the celebrities of St. George's Channel, and probably has a little more displacement than any of the Kingstown yachts. The displacement was increased with the necessary increase in the depth consequent upon the reduced beam. But as the displacement is disposed of longitudinally in the wave form, it can be concluded that the design has no undue fulness.

Of the several new 3-tonners which have this present (1882) year come into existence only one exceeds 27ft. in length, and that one is 28ft., and is building at Plymouth from a design by Mr. Ash for Lord Francis Cecil. Two others built on the Thames this year have only 4ft. 6in. draught, and less than 6 tons displacement. They all in a general way agree with the design given on Plate XXXIV., which was first published in the *Field* in the spring of 1881. However, in making a long and narrow design it is difficult to avoid points of resemblance, and it may be truly said of all British modern racing yachts that they bear a strong family likeness to each other. The Spankadillo (designed by Capt. H. Bayly and built by him this year), however, has a much deeper bilge, and is generally heavier than the design on Plate XXXIV. The Spankadillo has 4 tons 3cwt. in her lead keel.

The Naida was designed by Mr. Fairbrass, of Whitstable, for Mr. C. Courtney, in June, 1881, and was built at Plymouth. She has sailed on the Thames in a light wind against the Muriel—a 3-tonner, designed by Mr. G. L. Watson, and owned by Mr. H. C. Fox—and was defeated by her; but in a hard reef-sail breeze a day or two later Naida proved herself quite the equal of the Muriel.

The Primrose was designed by her owner, and built for him by Watkins of Blackwall.

The Snarley Yow was designed by Mr. Baden Powell, and built for him and the Marquis of Ailsa at the Culzean Yacht Works, Maybole, N.B. In the two or three matches she has yet sailed she has shown power and speed in strong breezes of a superior quality to any of the others.

The frames will be spaced centre to centre 1ft. Moulded 3in. at the heels, and 2½in. sided; then tapering to 2½in by 2in., and at heads 1½in by 2in. Plank, 1in. thick. Floors of angle iron, 3" × ¼". Arms of angle iron floors, 2ft. Metal bolts for lead keel, 1¼", spaced 2ft. Deadwood bolts and stem, sternpost, and shelf ¾". Deck beams, 2½" square, and spaced 2ft. Shelf or clamp, 4" × 2". Stem sided 3½"; sternpost 4". The bulwark will simply be a piece of 3in. stuff, 2½in. on underside, and 1½in. on top; cleats can be fixed to the inboard or bevelled side.

The sail plan of the 3-tonner is given on Plate XXXV.

TABLE OF DIMENSIONS, &c., 3-TONNERS.

	Design.	Snarley Yow.	Naida.	Spankadiillo	Primrose.
Length on deck—stem to sternpost ...	29ft. 2in.	—	—	28ft. 2in.	27ft. 10in.
Length on load water-line	27ft. 3in.	28ft.	26ft. 8in.	27ft.	26ft.
Rake of stern post (from plumb line 4ft. in length)	3ft. 1in.	38°	—	2ft. 4in.	35°
Breadth moulded	4ft. 10in.	4ft. 8in.	—	4ft. 10in.	5ft. 1in.
Breadth extreme	5ft.	4ft. 10in.	5ft. 4in.	5ft.	5ft. 3in.
Extreme draught of water	5ft. 9in.	6ft.	5ft. 6in.	6ft. 2in.	4ft. 6in.
Draught of water 4ft. from stem	3ft. 2in.	—	—	—	2ft. 1½in. ^a
Mean draught of water	4·5ft.	—	4·7ft.	4ft. 1in.	3·8 ft.
Area of load water-plane	95 sq. ft.	90 sq. ft.	94·5 sq. ft.	94 sq. ft.	92·8 sq. ft.
Area of midship section	14 sq. ft.	14 sq. ft.	12·7 sq. ft.	16·8 sq. ft.	12·36 sq. ft.
Area of vertical longitudinal section	125 sq. ft.	—	—	138 sq. ft.	—
Area of immersed surface	278 sq. ft.	—	—	—	—
Area of canvas per square foot of wetted surface	2·6ft.	—	—	—	—
Displacement in tons	6·5 tons.	6·7 tons.	5·3 tons.	7·4 tons.	5·2 tons.
Displacement per inch at L.W.L.	4½ cwt.	—	4½ cwt.	—	4½ cwt.
*Coefficient of displacement	·36	—	·3	—	·337
Midship section abaft centre of length of L.W.L.	1·5ft.	—	—	1·5ft.	2·2ft.
Centre of Buoyancy, ditto	0·75ft.	—	—	1·2ft.	1·35ft.
Centre of lateral resistance, ditto ..	1·2ft.	—	—	—	1·24ft.
Centre of effort of lower sails, ditto ..	1ft.	—	—	—	·84ft.
Centre of buoyancy below L.W.L.	1·5ft.	—	—	—	1ft.
Meta-centre above centre of buoyancy..	·65ft.	—	—	—	—
Ballast inside	5cwt.	—	—	—	—
Ballast outside	3½ tons.	4 tons.	—	4½ tons.	—
Total ballast	4 tons.	4 tons.	3½ tons.	5 tons.	3 tons.
Tonnage Y.R.A.	3 tons.	2·98 tons.	3·12 tons.	2½ tons.	—
Mast from fore side of stem	11ft.	—	—	10ft. 4in.	10ft. 9in.
Mast deck to hounds	19ft. 6in.	20ft. 9in.	20ft. 9in.	19ft. 6in.	21ft.
Pole of Mast	10ft.	—	4ft. 6in. ^b	4ft. 6in. ^b	9ft.
Diameter of mast at deck	5in.	—	—	5½in.	5in.
Main boom, mast to pin of sheave	25ft. 6in.	26ft.	25ft. 6in.	25ft. 6in.	25ft. 6in.
Greatest diameter	5in.	—	—	5in.	4½in.
Gaff, throat pin to hole	17ft. 6in.	18ft. 6in.	18ft. 6in.	17ft. 6in.	16ft.
Gaff, diameter at jaws	3½in.	—	—	3½in.	—
Bowsprit stem to shoulder	16ft.	14ft.	16ft. 6in.	16ft.	12ft.
Diameter of bowsprit at stem	5½in.	—	—	5in.	4½in.
Topmast fid to sheave	—	—	21ft. 6in.	18ft.	—
Topsail yard	26ft. 6in.	—	—	24ft.	26ft.
Ditto	18ft.	—	—	—	—
Greatest diameter of topsail yards	4½in. & 3½in.	—	—	—	—
Spinnaker boom	28ft.	—	27ft. 6in.	—	27ft.
Greatest diameter	4½in.	—	—	—	—
Centre of mast from fore side of stem..	11ft.	—	—	10ft. 9in.	10ft. 9in.
Area of mainsail	470 sq. ft.	490 sq. ft.	—	470 sq. ft.	425 sq. ft.
Area of foresail	95 sq. ft.	110 sq. ft.	—	95 sq. ft.	90 sq. ft.
Area of jib	158 sq. ft.	150 sq. ft.	—	160 sq. ft.	160 sq. ft.
Total area of lower sail	723 sq. ft.	750 sq. ft.	760 sq. ft.	725 sq. ft.	675 sq. ft.
Luff of mainsail	17ft.	—	—	—	16ft. 8in.
Leech of mainsail	32ft.	—	—	—	32ft. 3in.
Head of mainsail	17ft. 3in.	—	—	—	—
Foot of mainsail	24ft. 9in.	—	—	—	—
Tack to peak earing	32ft. 6in.	—	—	—	—
Clew to throat	28ft. 9in.	—	—	—	—

* Coefficient of displacement = $\frac{\text{Displacement} \times 35}{\text{Length} \times \text{Breadth} \times \text{Mean Draught.}}$

^a This was taken at 2ft. 2in. abaft fore side of stem.

^b This is length of masthead.

TABLE OF OFFSETS (PLATE XXXIV).

Sections	1.	2.	3.	4.	5.	6.	7.	8.	9.	10.	11.	12.	13.	14.	15.	16.
ft. in.	ft. in.	ft. in.	ft. in.	ft. in.	ft. in.	ft. in.	ft. in.	ft. in.	ft. in.	ft. in.	ft. in.	ft. in.	ft. in.	ft. in.	ft. in.	ft. in.
Heights, L.W.L. to underside of covering board	3 0	2 9½	2 7	2 5	2 3½	2 2	2 1	2 0	1 11½	1 11½	1 11½	1 11	2 0	2 0½	2 1½	2 2½
Depths to underside of wood keel	—	—	—	3 11	—	—	—	—	—	—	—	3 11	—	—	—	—
Half-breadths on deck	0 5	1 0	1 5½	1 9½	2 1	2 3½	2 4½	2 4½	2 4½	2 4½	2 4½	2 4½	2 2½	2 0½	1 8	0 10½
Half-breadths 1ft. above L.W.L.	0 4½	0 10½	1 3½	1 9	2 0½	2 3½	2 4½	2 5	2 5	2 5	2 4	2 2	1 9½	1 3	0 3½	—
Half-breadths on L.W.L.	0 3	0 8½	1 2	1 7	1 11½	2 3	2 4½	2 4½	2 4½	2 3½	2 1	1 8½	1 1	—	—	—
Half-breadths No. 2 water-line	0 2	0 7	1 0	1 5	1 10	2 1½	2 4	2 4½	2 3½	2 1	1 8½	1 1½	0 5½	—	—	—
Half-breadths No. 3 water-line	—	0 5	0 9	1 1½	1 6½	1 10½	2 1½	2 1½	2 0	1 7½	1 0½	0 6½	0 1½	—	—	—
Half-breadths No. 4 water-line	—	0 1½	0 5	0 8½	1 0	1 3½	1 6	1 6½	1 4½	0 11½	0 6	0 2½	0 1	—	—	—
Half-breadths No. 5 water-line	—	—	0 2½	0 4½	0 6½	0 8½	0 9½	0 9½	0 8½	0 6	0 3½	0 1½	0 1	—	—	—
Half-breadths of keel	—	—	—	0 3	0 4½	0 6½	0 7	0 7	0 6½	0 4½	0 3½	0 2½	0 2	—	—	—
Depths of lead keel and false keel	—	—	—	0 5	0 11½	1 5	1 8	1 10	1 10	1 9	1 7	1 4½	—	—	—	—

No. 1 section is 1ft. 3in. from a perpendicular dropped at deck on the fore side of stem.

The other sections are 2ft. apart.
The water-lines are 9in. apart.

All the half-breadths are exclusive of the plank, except the half-breadths of the keel, which includes the thickness of the plank.

The under-side of the keel and the rabbet line across Nos. 5, 6, 7, 8, 9, 10, and 11 sections are parallel to the lead water-line; the sections are therefore perpendicular to the keel.

The lead keel shown in the Plate is 12ft. 6in. in length; it would be well to cut off 2ft. from the fore end. The lead keel is 7in. on its underside amidships, tapering to 6in. aft and 5in. forward.

PLATE XXXIV.

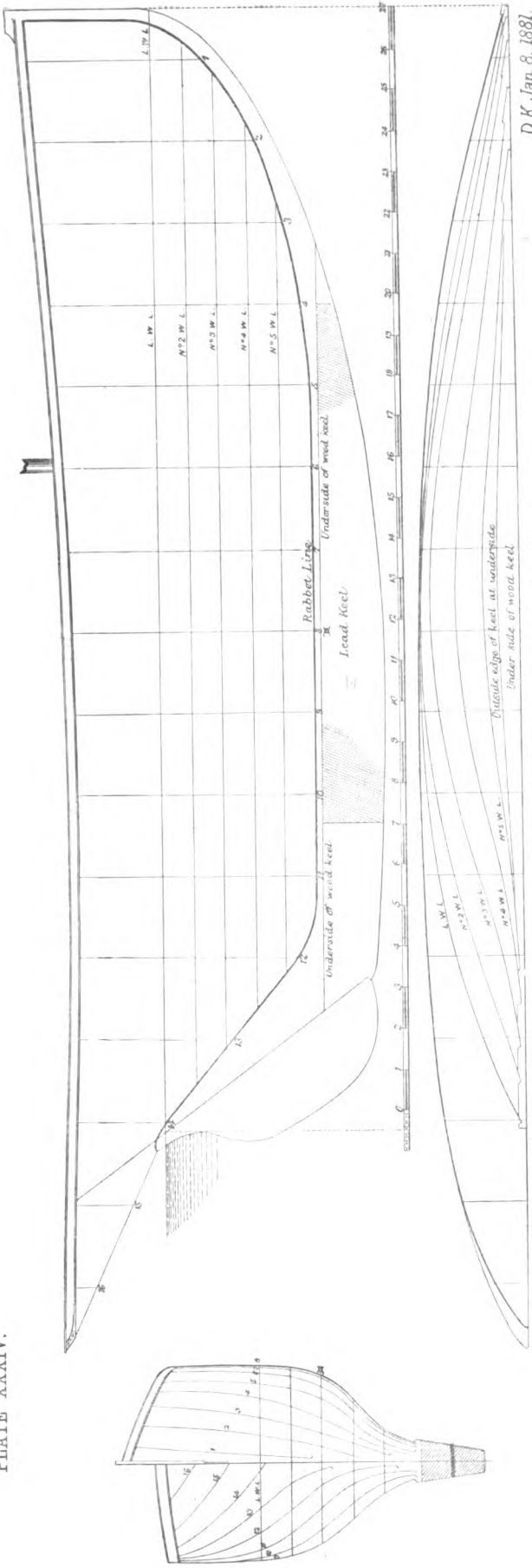

Design for a Yacht of 3 Tons

DK Jan 8, 1881.

S. Cattell & Co. Eng



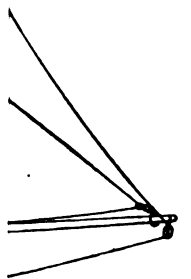

4 4 4 4 4
D.K. Jan 8, 1881

TABLE OF BLOCKS AND CORDAGE, 3-TONNER.

	Number of double blocks.	Number of single blocks.	Size of blocks.	Size of cordage.	Length of cordage.
			Inches.	C. F. Ins.	Fathoms.
Throat halyards	2 ^a	—	4	1½	22
Peak halyards.....	—	5	4	1½	22
Main sheet	1	1	4½	1½	23
Main sheet lead	—	2	3	—	—
Jib halyards	—	3	4	1½ ^b	14
Fore halyards	—	2	3	1	11
Bobstay tackle (iron blocks)	1	1	4	1½	7
Bowsprit ahrouds	2	2	3	1	6
Pendant and block.....	—	2	4	1 ^c	2
Runner	—	—	—	1½	2
Runner tackle.....	2	2	3	1	3
Mainsail outhaul	—	1	3	1	3
Beef pendants.....	—	—	—	1½	3
Topsail sheet whip.....	—	1	3	1	2
Topmast backstays tackle	— ^d	4	3	1	6
Preventer backstays tackle	2	1	3	1	12
Jib purchase	1	1	3	1	13
Main purchase	1	1	3	1	13
Peak purchase	1	1	3	1	13
Topping-lifts	—	2	4	1½	12
Topping-lift purchase	—	4	3	1	7
ROPE STROP BLOCKS.					
Jib topsail halyards	—	2	3	1	14
Spinnaker halyards	—	1	3	1	11
Spinnaker topping-lift	—	2	3	1	11
Fore sheets	—	4	3	1	8
Jib sheets	—	—	—	1½	8
Beef tackle (fiddle).....	1	1	5½ & 3	1	12
Tack tackles	3	3	3	1	12
Lanyards	—	—	—	1	6
Deadeyes.....	—	4	3½	—	—
WIRE ROPE.					
Shrouds (two each side)	—	—	—	1½	3
Pendants	—	—	—	1½	4
Bowsprit shrouds	—	—	—	1½	5
Forestay	—	—	—	1½	1
Bobstay pendant	—	—	—	1½	11
Topmast stay	—	—	—	1	6½
Topmast preventer backstays	—	—	—	1	—

a If a throat purchase is used, the upper block must be threefold.

b If chain ½ in.; a single block on each side of masthead, and one to hook on head cringle of jib; jib tack of wire; also main outhaul.

c Wire pendant.

d If a topmast is carried.

FIVE-TONNERS.

The design which is given for a 5-tonner has been built from more than once, and the vessels proved fast, weatherly, and remarkably handy.

In considering a design, the fact must not be lost sight of that if the centre of buoyancy is high, advantages will accrue from having the whole of the lead ballast on the keel; but there are two objections to so much weight being placed outside. In the first place, owing to the major part of the weight of the yacht being concentrated some distance below the

bulk of the displacement, an uneasy sea boat will be the consequence, and possibly one that will only perform indifferently well in a sea, from a racing point of view. This is saying nothing more nor less than that great stiffness, with a small weight, is incompatible with good sea going qualities; or that great metacentric height and a small displacement are antagonistic to certain qualities that are usually sought for in a yacht. It does not matter whether the ballast is inside the hull or outside the hull. There is no special virtue in having the ballast inside the hull; if there was that virtue could be obtained by placing a casing of wood over the lead on the keel. The relative performances of yachts in a sea way are governed by their metacentric heights and the weight of their displacement, and the forms of their hull and their radii of gyration. In the design the object sought was a metacentric height equal to that of any other 5-tonner, and greater weight, to effect an improvement if possible whilst performing in disturbed water.

It might very well be argued that depth and weight of displacement were carried far enough in *Freda*, and that there could be no object in taking more. She was successful in light weather and heavy weather, and had as much internal room as any one could desire; and, moreover, one or two attempts to build a 5-tonner of heavier displacement did not result in a realisation of expectations. However, the design we give has very considerably larger displacement than *Freda*, is deeper and longer, and has more internal room, and, as before said, proved successful so far as ease in a lumpy sea went, with a good turn of speed.

The other objection to a yacht carrying a great weight of lead on her keel—equal, perhaps, to nearly two-thirds her total weight—is the enormous lateral strain it causes when the yacht is heeled. It is found almost impossible to keep a yacht tight that has a heavy lead keel; her slight frames are certain to “straighten” a little, and the seams, from the garboards upwards to the bilge, are sure to open a trifle when she is heeled. However, this is regarded as an inevitable defect in a racing yacht, and few will forego the advantages of having a heavy lead keel merely because it may cause a yacht to leak a few gallons an hour in strong winds.

The longitudinal disposition of the displacement of the fore and after body of the design (Plate XXXVI.) and of *Cocker* accords exactly with the wave form; but the bow end of both *Freda* and *Lorelei* is a trifle fuller than the wave curve form. The displacement of the after body of *Lorelei* is so disposed as to agree exactly with the wave form.

The *Cocker* was designed and built by the Marquis of Ailsa in 1881, and competed with varying success against the famous five tonners *Cyprus* and *Nora*.

COMPARATIVE TABLE OF ELEMENTS OF FIVE-TONNERS.

	Design.	Freda.	Cooker.	Lorelei.	Cyprus.
	ft. in.	ft. in.	ft. in.	ft. in.	ft. in.
Length on deck stem to sternpost	33 10	31 4	34 8	31 6	—
Length on load water line.	32 0	30 4	32 0	31 6	29 11½
Rake of sternpost from plumb-line (4ft. in length)	2 3	1 8	4 2	2 5	—
Breadth moulded	5 10	5 11½	5 9¾	5 10	—
Breadth extreme	6 0	6 1½	5 11½	6 0	6 4
Extreme draught of water.	6 2	5 5½	5 9	5 4	—
Draught of water 4ft. abaft foreside of stem at L.W.L.	3 2	4 0	3 4	2 11	—
Mean draught of water ..	4 11	4 7	4 9	4 3	—
Area of load water-plane ..	132 sq. ft.	124 sq. ft.	128 sq. ft.	134 sq. ft.	—
Area of midship section ...	18·3 sq. ft.	16 sq. ft.	15·3 sq. ft.	14·8 sq. ft.	—
Area of vertical longitudinal section	157 sq. ft.	149 sq. ft.	152 sq. ft.	132 sq. ft.	—
Area of immersed surface.	360 sq. ft.	353 sq. ft.	—	318 sq. ft.	—
Area of canvas for square foot of wetted surface...	2·34 sq. ft.	2·24 sq. ft.	—	2·47 sq. ft.	—
Displacement in tons	9·2 tons	7·7 tons	8·2 tons.	7·5 tons.	8 tons.
Displacement per inch of immersion at L.W.L. ...	6¼ cwt.	6 cwt.	6 cwt.	6¼ cwt.	—
Co-efficient of displacement	·341	·322	·303	·3294	—
Midship section abaft centre of length of L.W.L.	1·5ft.	1·2ft.	1·1ft.	1·9ft.	—
Centre of buoyancy ditto...	1ft.	0·4ft.	1·5ft.	0·8ft.	—
Centre of lateral resistance ditto	2ft.	1·1ft.	1ft.	1·4ft.	—
Centre of effort of lower sails ditto	1·4ft.	0·5ft.	0·5ft.	0·5ft.	—
Centre of buoyancy below L.W.L.	1·66ft.	1·44ft.	1·5ft.	1·37ft.	—
Centre of lateral resistance ditto	2·6ft.	2·2ft.	2·2ft.	2·2ft.	—
Metacentre above centre of buoyancy	0·81ft.	1ft.	·93ft.	1·1ft.	—
Centre of effort of sails above L.W.L.	15·5ft.	15·4ft.	14·8ft.	14·3ft.	—
Ballast inside	1 ton.	2 tons 14 cwt.	—	—	2 tons 9 cwt.
Ballast outside	5½ tons.	1 ton 18 cwt.	5 tons.	4 tons 3 cwt.	2 tons 11 cwt.
Total ballast	6½ tons	4 tons 12 cwt.	5 tons.	4 tons 3 cwt.	5 tons.
Tonnage Y.R.A.	4½ tons	4½ tons	4½ tons	4½ tons	—
Mast, deck to hounds	21ft. 0in.	20ft. 6in.	22ft. 9in.	22ft. 0in.	22ft. 2in.
Masthead	4 6	4 0	4 0	4 0	5 0
Diameter at deck	5½in.	5½in.	6½in.	0 5½	0 6
Main boom	29 0	28 0	28 0	27 0	26 0
Greatest diameter	5½in.	5½in.	5½in.	0 5½	0 5½
Gaff	20 3	19 0	19 0	19 0	18 6
Bowsprit outboard	12 6	15 0	17 0	14 0	15 9
Diameter at stem	4½in.	5½in.	5½in.	0 5	—
Topmast, fid to hounds ...	19 6	18 6	21 0	20 0	18 0
Topsail yard	19 0	18 0	30 0	—	—
Spinnaker boom	34 0	35 0	34 0	33 0	—
Centre of mast from fore-side of stem on deck ...	13 3	12 4	13 6	12 0	—
Luff of mainsail	17 9	17 3	20 0	18 0	—
Leech of mainsail	35 0	34 6	37 0	32 0	—
Angle of gaff with horizontal	53°	51°	53°	51°	—
Area of mainsail	564 sq. ft.	530 sq. ft.	604 sq. ft.	526 sq. ft.	—
Area of foresail	120 sq. ft.	110 sq. ft.	138 sq. ft.	104 sq. ft.	—
Area of jib	150 sq. ft.	160 sq. ft.	221 sq. ft.	139 sq. ft.	—
Total area lower sail	834 sq. ft.	800 sq. ft.	963 sq. ft.	769 sq. ft.	—

TABLE OF OFFSETS OF THE DESIGN FOR A FIVE-TONNER (SEE PLATE XXVII).

No. of Section	Midship.													
	1	2	3	4	5	6	7	8	9	10	11	12	13	14
Heights above L.W.L. to covering board	2 10	2 7	2 5	2 3	2 1½	2 0½	2 0	1 11½	1 11½	1 11½	2 0	2 0½	2 1½	2 2½
Depths below L.W.L. to underside of wood keel	—	—	3 8	—	4 0	4 6	—	4 1½	—	—	—	—	—	—
Half-breadths on deck	1 4	2 1	2 6	2 9	2 10½	2 10½	2 10	2 9½	2 8½	2 7½	2 6	2 3½	2 1½	1 10
Half-breadths 1ft. 6in. above L.W.L.	1 1½	1 10½	2 5½	2 5½	2 10½	2 10½	2 10	2 9½	2 8½	2 7½	2 5½	2 2½	1 9	—
Half-breadths 9in. above L.W.L.	0 11½	1 9	2 4½	2 9½	2 11	2 10	2 9	2 9	2 7½	2 4½	2 0½	1 4	—	—
Half-breadths on the L.W.L.	0 9	1 6½	2 3	2 8½	2 10½	2 10	2 9	2 7	2 3½	1 10	1 2	0 3	—	—
Half-breadths No. 2 W.L.	0 5½	1 2½	1 11½	2 5½	2 8	2 6½	2 3½	1 11½	1 6½	0 11½	0 3	—	—	—
Half-breadths No. 3 W.L.	0 2½	0 9½	1 5½	1 11½	2 1½	1 10½	1 7	1 2½	0 9½	0 3½	—	—	—	—
Half-breadths No. 4 W.L.	—	0 4½	0 10	1 2½	1 4	1 1½	0 10½	0 6½	0 3	—	—	—	—	—
Half-breadths on underside of wood keel and top of lead keel	—	—	0 4½	0 6½	0 7½	0 6½	0 5½	0 5	0 5	—	—	—	—	—
Depths of lead keel below wood keel	—	—	1 3½	1 10½	2 1½	2 1	2 0½	1 10½	—	—	—	—	—	—

No. 1 section is 3ft. 6in. from the fore side of the stem at the L.W.L.
 Nos. 1, 2, 3, 4, 5, and 6 sections are 3ft. 6in. apart.
 Nos. 6, 7, 8, 9, 10, 11, 12, 13, and 14 sections are 1ft. 9in. apart.
 The water-lines are 1ft. apart.
 All the half-breadths are given without the plank.
 The heights above the L.W.L. are exclusive of the covering board.
 Siding of stem, 4½in.
 Stern post, 5in.
 Siding of keel amidships, 1ft. 6in., tapering as shown in the table.
 Underside of lead keel amidships, 8in.

Lead keel 15ft. long commencing from No. 3 station from stem.
 Moulded depth of wood keel, 7in.
 Timbers, 2in. sided.
 Frames, 2½in. moulded at heels, 1½in. at heads.
 Spacing, centre to centre, 1ft. 9in.
 Bent timbers, 1½in. sided, 1½in. moulded between each frame.
 Garboard strake, 1½in. American elm.
 Plank, 1in.; deck plank, 1½in.
 Deck beams, 2½in. sided, 2in. moulded.

All the bolts through the keel and frames should be arranged as much out of line as possible; to effect this, it will be well to drive the floor bolts obliquely—that is, if a bolt enters the keel near the edge on the port side, it should come out near the edge on starboard side. The next bolt should enter the keel on starboard side and come out on port side, and so on. Similarly for bolts through the frames.

PLATE XXXVI.

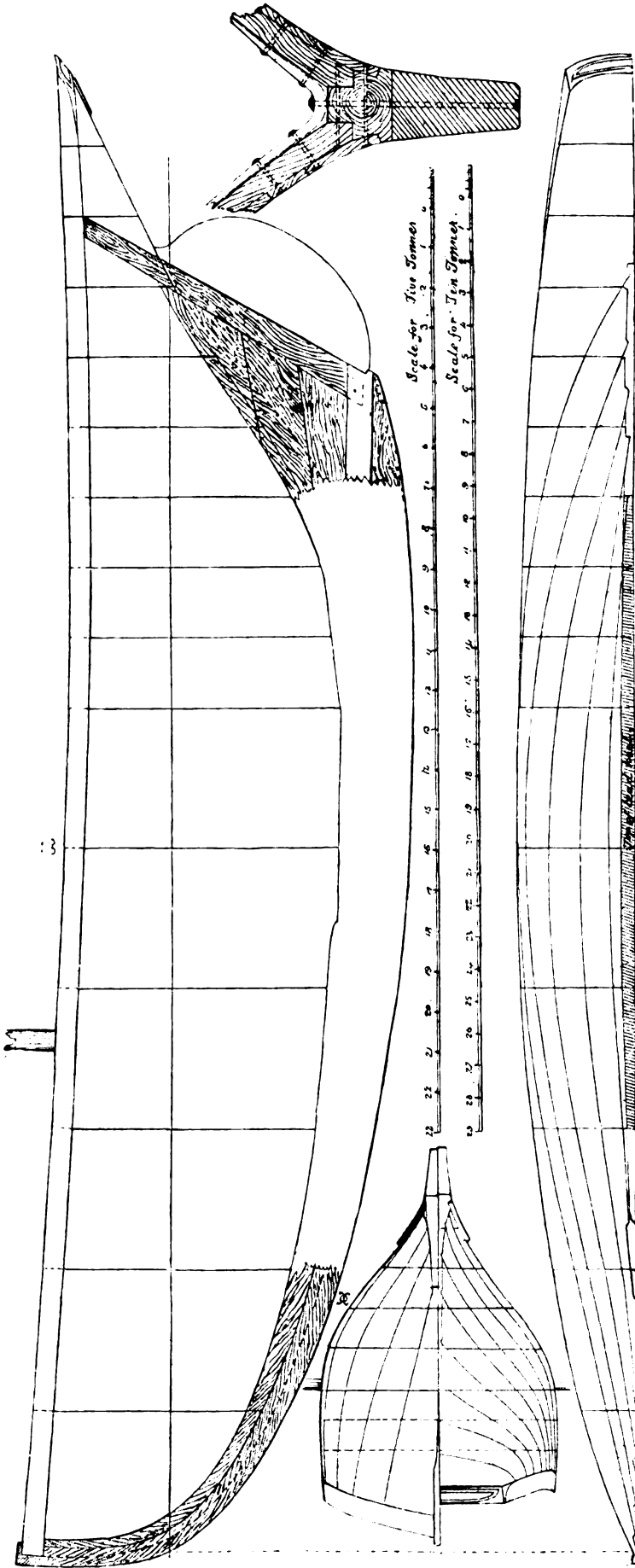

Cutter Yacht of 5 or 10 Tons.





PLATE XXXVII.

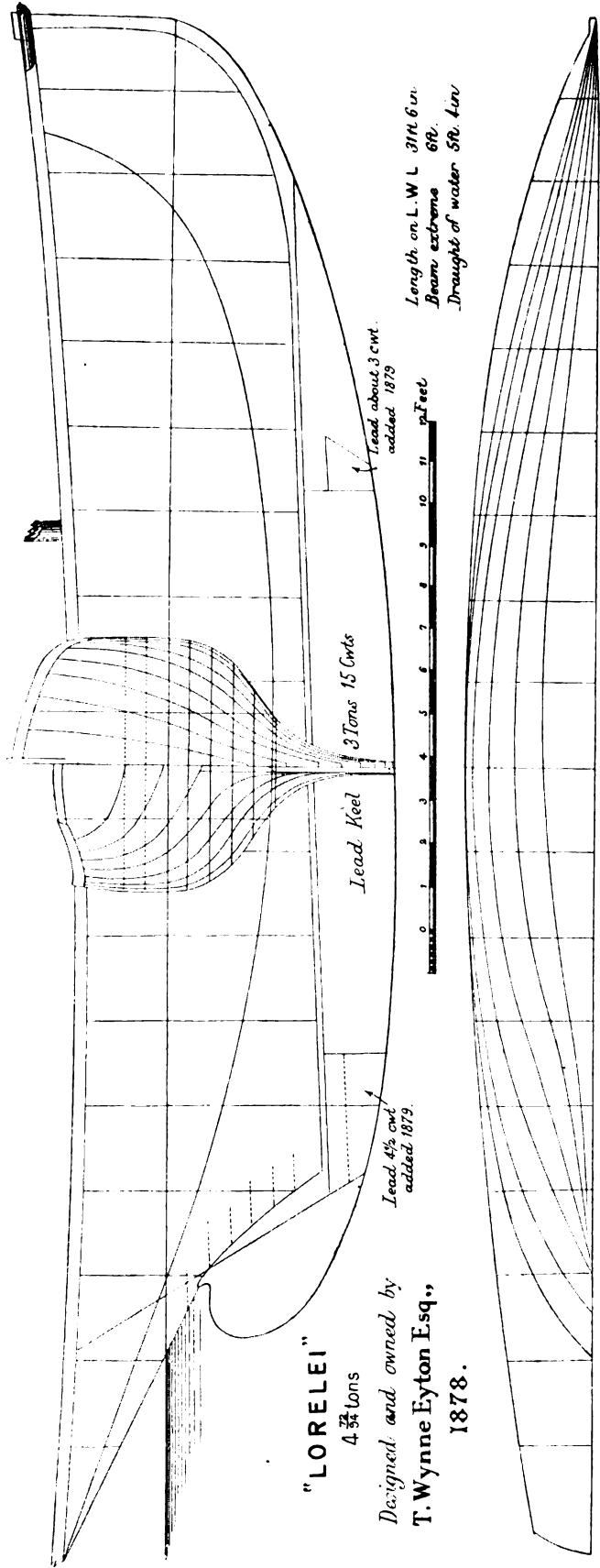

"LORELEI"

4 ³/₄ Tons

Designed and owned by

T. Wynne Eytton Esq.,

1878.

Length on L. W. L. 31ft 6 in.
Beam, extreme 6ft.
Draught of water 5ft. 4in

Lead about 3 cwt.
added 1879

11 Feet

3 Tons 15 Cwts

Lead Keel

Lead 4 1/2 cwt.
added 1879

1878.



PLATE XXXVIII.

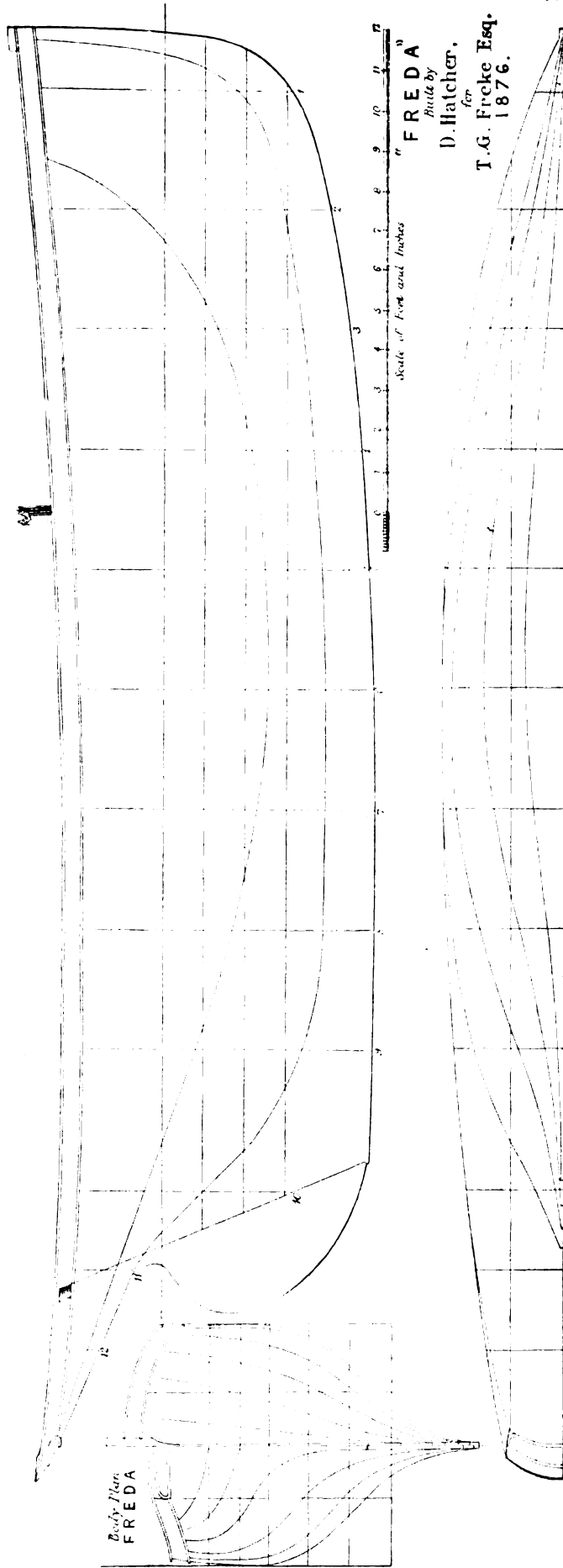

TABLE OF OFFSETS FOR "LORELEI" (PLATE XXXVII.)

No. of Section	1	2	3	4	5	6	7	8	9	10	11	12	13	14	15	16	17
Heights above L.W.L. to covering board	3 3 0	2 9 1/2	2 9 1/2	2 7 1/2	2 5 1/2	2 3 1/2	2 2 1/2	2 0 1/2	1 11 1/2	1 10 1/2	1 10 1/2	1 9 1/2	1 10 1/2	1 10 1/2	1 11 1/2	2 1 1/2	2 2 1/2
Half-breadths on deck	0 10 1/2	1 6 1/2	2 0 1/2	2 5 1/2	2 7 1/2	2 9 1/2	2 10 1/2	2 10 1/2	2 10 1/2	2 10 1/2	2 10 1/2	2 8 1/2	2 6 1/2	2 4 1/2	2 1 1/2	2 0 1/2	1 8 1/2
Half-breadths 1ft. above L.W.L.	0 7 1/2	1 8 1/2	1 10 1/2	2 3 1/2	2 7 1/2	2 9 1/2	2 10 1/2	2 11 1/2	2 11 1/2	2 11 1/2	2 10 1/2	2 9 1/2	2 8 1/2	2 5 1/2	2 1 1/2	1 7 1/2	—
Half-breadths 6in. above L.W.L.	0 6 1/2	1 1 1/2	1 8 1/2	2 2 1/2	2 6 1/2	2 8 1/2	2 11 1/2	2 11 1/2	2 11 1/2	2 11 1/2	2 10 1/2	2 9 1/2	2 7 1/2	2 4 1/2	1 10 1/2	0 11 1/2	—
Half-breadths on L.W.L.	0 5 1/2	1 0 1/2	1 6 1/2	2 0 1/2	2 5 1/2	2 8 1/2	2 10 1/2	2 11 1/2	3 0	2 11 1/2	2 10 1/2	2 9 1/2	2 6 1/2	2 4 1/2	1 10 1/2	0 11 1/2	—
Half-breadths No. 2 W.L.	0 4 1/2	0 9 1/2	1 4 1/2	1 9 1/2	2 2 1/2	2 6 1/2	2 9 1/2	2 10 1/2	2 11 1/2	2 11 1/2	2 11 1/2	2 7 1/2	2 2 1/2	1 7 0 1/2	1 4 1/2	—	—
Half-breadths No. 3 W.L.	0 3 1/2	0 7 1/2	1 1 1/2	1 6 1/2	1 11 1/2	2 3 1/2	2 7 1/2	2 9 1/2	2 10 1/2	2 11 1/2	2 11 1/2	2 6 1/2	2 2 1/2	1 8 0 10 1/2	0 1 1/2	—	—
Half-breadths No. 4 W.L.	0 1 1/2	0 5 0 9 1/2	1 2 1/2	1 7 1 11 1/2	1 7 1 11 1/2	2 4 1/2	2 4 1/2	2 4 1/2	2 5 1/2	2 4 1/2	2 1 1/2	1 7 1 1 1/2	0 11 1/2	0 4 1/2	—	—	—
Half-breadths No. 5 W.L.	—	0 3 1/2	0 6 1/2	0 10 1/2	1 2 1 5 1/2	1 8 1 9 1/2	1 8 1 9 1/2	1 8 1 9 1/2	1 9 1/2	1 8 1 9 1/2	0 9 1/2	0 5 1/2	0 3 1/2	0 0 2 1/2	—	—	—
Half-breadths No. 6 W.L.	—	0 1 1/2	0 4 0 6 1/2	0 10 1/2	1 2 1 5 1/2	1 8 1 9 1/2	1 8 1 9 1/2	1 8 1 9 1/2	1 9 1/2	1 8 1 9 1/2	0 9 1/2	0 5 1/2	0 3 1/2	0 0 2 1/2	—	—	—
Half-breadths No. 7 W.L.	—	—	—	0 3 1/2	0 5 0 9 1/2	0 11 1/2	1 1 1 2 1/2	1 1 1 2 1/2	1 1 1 2 1/2	1 1 1 2 1/2	0 6 1/2	0 4 1/2	0 2 1/2	—	—	—	—
Depths below L.W.L. to underside of rabbit	—	—	—	0 2 1/2	0 5 0 9 1/2	0 6 0 11 1/2	0 6 1/2	0 6 1/2	0 7 1/2	0 8 1/2	0 9 1/2	0 5 1/2	0 4 1/2	—	—	—	—
	—	—	—	2 8 1/2	2 9 1/2	2 11 1/2	3 1 3 1/2	3 2 3 1/2	3 3 3 1/2	3 4 3 1/2	3 5 3 1/2	3 6 3 1/2	3 7 3 1/2	—	—	—	—

No. 1 section is 1ft. 7 1/2 in. from the fore side of the stem at the L.W.L.
The water-lines are 6in. apart.

The half-breadths include the thickness of the plank.
The heights include the covering board.

TABLE OF OFFSETS FOR "FREDA" (PLATE XXXVIII.)

No. of Section	1	2	3	4	5	6	7	8	9	10	11	12
Heights above L.W.L. to covering board	3 1 1/2	2 10 1/2	2 7 1/2	2 5 1/2	2 3 1/2	2 2 1/2	2 1 1/2	2 0 1/2	2 0 1/2	2 1 1/2	2 2 1/2	2 3 1/2
Depths below L.W.L. to rabbit	1 10 1/2	3 0 1/2	3 5 1/2	3 7 1/2	3 10 1/2	3 11 1/2	4 0 1/2	3 11 1/2	3 6 1/2	1 1 1/2	2 2 1/2	2 3 1/2
Half-breadths on deck	0 6 1/2	1 8 1/2	2 4 1/2	2 8 1/2	2 10 1/2	2 11 1/2	2 11 1/2	2 10 1/2	2 8 1/2	2 5 1/2	2 2 1/2	1 10 1/2
Half-breadths 1ft. 6in. above L.W.L.	0 8 1/2	1 5 1/2	2 2 1/2	2 8 1/2	2 11 1/2	3 0 1/2	3 0 1/2	2 11 1/2	2 8 1/2	2 4 1/2	1 10 1/2	—
Half-breadths 9in. above L.W.L.	0 5 1/2	1 3 1/2	2 0 1/2	2 7 1/2	2 11 1/2	3 0 1/2	3 0 1/2	2 11 1/2	2 8 1/2	1 9 1/2	0 2 1/2	—
Half-breadths on L.W.L.	0 4 1/2	1 1 1/2	1 10 1/2	2 6 1/2	2 11 1/2	3 0 1/2	3 0 1/2	2 10 1/2	2 3 0 1/2	1 9 1/2	—	—
Half-breadths No. 2 W.L.	0 2 1/2	0 9 1/2	1 5 1/2	2 1 1/2	2 7 1/2	2 9 1/2	2 8 1/2	2 2 1/2	2 1 1 0 2 1/2	0 2 1/2	—	—
Half-breadths No. 3 W.L.	0 1 1/2	0 5 1/2	0 11 1/2	1 5 1/2	1 10 1/2	1 11 1/2	1 8 1/2	1 0 1/2	0 5 1/2	0 2 1/2	—	—
Half-breadths No. 4 W.L.	0 1 1/2	0 2 1/2	0 5 1/2	0 8 1/2	0 10 1/2	0 11 1/2	0 8 1/2	0 5 1/2	0 2 1/2	0 2 1/2	—	—

No. 1 section is 1ft. 5in. from the fore side of stem at the L.W.L.
Nos. 1, 2, 3, 4, 5, 6, 7, 8, 9, and 10 sections are 3ft. apart.
Nos. 10, 11, and 12 sections are 2ft. apart.

The water-lines are 1ft. apart.
All the half-breadths given include the thickness of the plank.
The heights are exclusive of the covering board.

TABLE OF OFFSETS, "COCKER" (PLATE XXXIX.)

	No. 2 Section.	No. 4 Section.	No. 6 Section.	No. 8 Section.	No. 10 Section.
	ft. in.	ft. in.	ft. in.	ft. in.	ft. in.
Height to deck above L.W.L.	2 11	2 5	2 1	2 0	2 0
Depth L.W.L. to underside keel	3 10	5 1	5 8	5 9	—
Half-breadths on deck	1 9	2 8	2 10	2 9	2 5
Half-breadths 1ft. above L.W.L.....	1 5	2 5½	2 10	2 9	2 1½
Half-breadths on L.W.L.....	1 2	2 3	2 10	2 8½	1 3
Half-breadths No. 2 W.L.....	0 9½	1 10½	2 7½	2 1½	0 3
Half-breadths No. 3 W.L.....	0 5½	1 3½	1 10	1 2	—
Half-breadths No. 4 W.L.....	0 3½	0 7½	0 11	0 5½	—
Half-breadths keel.....	0 1½	0 5½	0 5½	0 4	—

All the half-breadths are without the plank. No. 2 section is 5ft. 8in. from the fore side of the stem. No. 10 section is 2ft. 4in. from the aft side of the sternpost. The other sections are 6ft. apart. Nos. 1, 3, 5, 7, 9, are not included. The waterlines are 2ft. apart.

TEN-TONNERS.

The design for the yacht of 5 tons can be used for one of 10 tons by multiplying all the *linear* measurements by 1.25; or by dividing the *linear* measurements by 0.8. Thus, take the length on the water-line of the 5-tonner as an example. The length is 32ft., then

$$32 \times 1.25 = 40; \text{ or } \frac{32}{0.8} = 40.$$

The cubic quantities will, of course be doubled, and it might appear to be a rather anomalous condition for a yacht of "10 tons" racing tonnage to have 18 tons actual weight or displacement; but such an apparent anomaly is very likely to occur whilst only two dimensions are used in the Y.R.A. tonnage rule to express nominally a quantity in cubic measure. In publishing this design in 1878 we apprehended no objection to a "10-ton" yacht having 18 tons displacement, providing so much weight secures some good quality not otherwise obtainable at so small a cost, and since that date 10-tonners have been built which exceeded 18 tons displacement, until in 1881 Buttercup (Fig. 105) appeared with a displacement of 22 tons. The object of every yacht designer is to design a craft that can carry the sail of a yacht which by Y.R.A. tons measures much larger than she herself does and obtain the given speed, and yet be assessed at less than some given value, say 18 tons. The design we give (Plate XXXVI.) was prepared with a view of obtaining the utmost advantage out of the Y.R.A. rule. It is for a 10-tonner, 40ft. long, and only 7ft. 7in. in breadth; but, by virtue of increased depth, she has the displacement and sail area of a 13-ton craft, 40ft. by 9ft., and in all probability would be the equal of such craft in point of speed, judging from what recently built 10-tonners have achieved. In designing a yacht of

PLATE XXXIX.

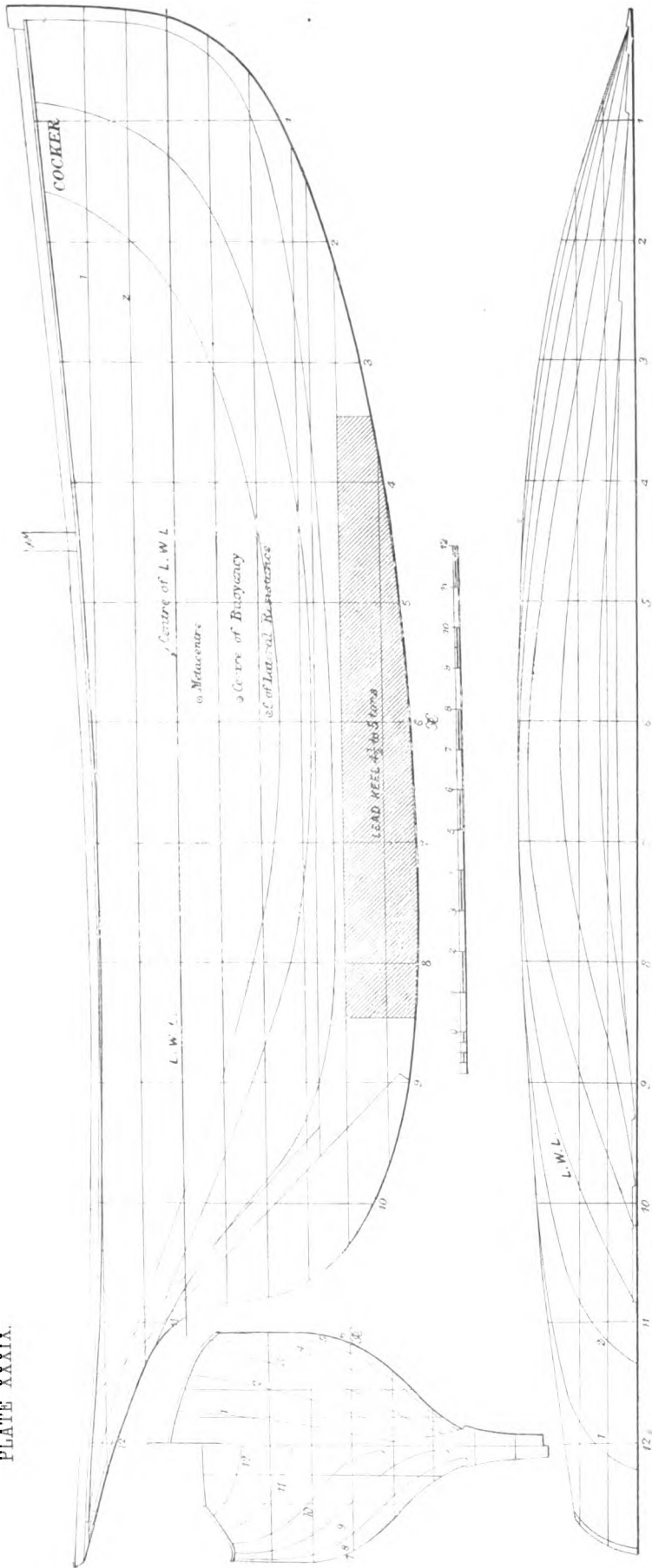



such extreme proportions the main things to consider will be a sufficiency of depth, a proper amount of displacement, and as small a frictional surface as possible. The principal dangers of increasing the depth are these: too great displacement may be the result, and too large an area of wetted surface. The inconvenience of too great displacement is that, with any given length, the entrance or the run may be too full, or the middle body may be too full, so that when high speeds are contemplated exaggerated wave-making would be the result. This inconvenience may, however, exist with a comparatively small displacement, but of course will be less pronounced.

The objection to an excessive area of wetted surface is that at low velocities, or in light winds, the frictional resistance will be exaggerated, and the results anticipated from the large sail area may entirely fail.

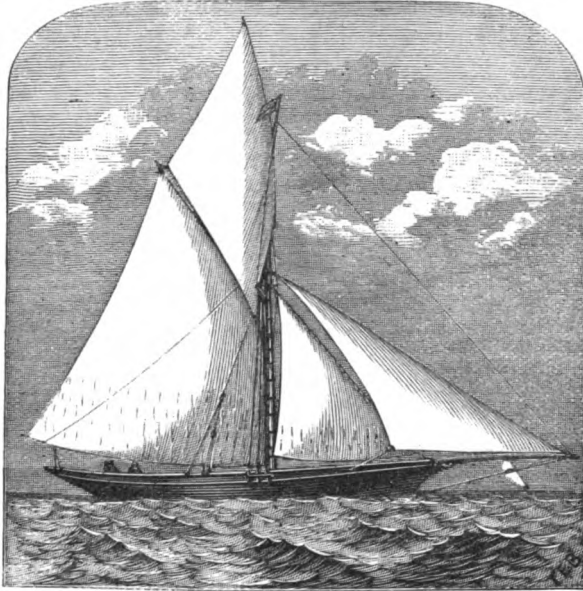

FIG. 105.

To avoid a too great displacement, a suitable quantity was determined upon at the outset in making the design for a 5-tonner; and to avoid any unfair fulness, it was disposed of on the wave principle by Mr. Colin Archer's formulæ. In order that the fore body might be of the wave form, without being unduly lean, it was necessary to cut away the fore foot, or what is usually termed gripe, as much as possible, and this condition necessarily involved that the depth of body amidships should be great. Here two objects were at once secured: a reduction of wetted surface, where it most needs reduction on account of the intensity of the friction on the surface of the fore body; and the

practicability of stowing the weights at a great depth to compensate for the reduction in beam. To what extent the objects sought have been attained can only be surmised by a comparison with other yachts of similar pretensions.

The Buttercup was designed by Mr. Robert Hewitt, a well-known Thames yachtsman; the design was afterwards put into working form by Mr. T. V. Trew (a naval architect and yacht builder), and she was by him built at Barking in Essex.

COMPARATIVE TABLE OF ELEMENTS OF TEN-TONNERS.

	Design.	Lily.	Florence.	Buttercup.
	ft. in.	ft. in.	ft. in.	ft. in.
Length on deck, stem to sternpost	42 3	37 9½	39 8½	—
Length on load water-line	40 0	36 6½	38 6	42 2
Rake of sternpost from plumb line, 4ft. in length	2 3	2 1	—	—
Breadth moulded	7 4½	7 10½	—	—
Breadth extreme	7 7½	8 1	7 9½	7 3
Extreme draught of water	7 10	6 9	6 6	7 9
Mean draught of water	6 3½	5 11	—	—
Area of load water-plane	209 sq. ft.	200 sq. ft.	—	—
Area of midship section	29 sq. ft.	21·2 sq. ft.	—	—
Area of vertical longitudinal section ...	245 sq. ft.	216 sq. ft.	—	—
Area of immersed surface	550 sq. ft.	530 sq. ft.	—	—
Area of canvas per square foot of wetted surface	2·33 sq. ft.	2·06 sq. ft.	—	—
Displacement in tons	18 tons	13 tons	12·9 tons	22 tons
Midship section abaft centre of length of L.W.L.	1·9ft.	1·45ft.	—	—
Centre of buoyancy ditto	1·25ft.	0·96ft.	—	—
Centre of lateral resistance ditto	2·5ft.	1·35ft.	—	—
Centre of effort of lower sails ditto	1·7ft.	1·5ft.	—	—
Centre of buoyancy below L.W.L.	2·07ft.	1·65ft.	—	—
Centre of lateral resistance ditto	3·25ft.	—	—	—
Metacentre above centre of buoyancy ...	1·1ft.	1·76ft.	—	—
Centre of effort of sails above L.W.L.	19·4ft.	18·9ft.	19·4ft.	19·5ft.
Ballast inside	10 cwt.	2 tons 12 cwt.	—	1½ tons
Ballast outside	11 tons	4 tons 3 cwt.	—	12 tons
Total ballast	11 tons 10 cwt.	6 tons 15 cwt.	—	13½ tons
Tonnage Y.R.A.	9·95 tons	9·6 tons	9·3 tons	10·44 tons
Mast, deck to hounds	29 0	25 0	27 0	30 0
Masthead	5 3	—	—	—
Diameter at deck	8½in.	6½in.	—	—
Main boom	38 6	30 6	32 6	39 0
Greatest diameter	7in.	5½in.	—	—
Gaff	25 0	23 0	24 3	25 0
Bowsprit outboard	19 0	17 0	19 0	20 6
Diameter at stem	7in.	6½in.	—	—
Topmast, fid to hounds	27 0	24 0	22 9	27 0
Topsail yard	30 0	—	—	—
Spinnaker boom	40 0	—	—	38 0
Centre of mast from fore side of stem at deck	15 0	15 5	15 3	17 4
Luff of mainsail	26 0	—	23 6	—
Leech of mainsail	44 0	—	—	—
Angle of gaff with horizontal	53°	53°	53°	53°
Area of mainsail	910 sq. ft.	722 sq. ft.	860 sq. ft.	940 sq. ft.
Area of foresail	180 sq. ft.	162 sq. ft.	170 sq. ft.	180 sq. ft.
Area of working jib	230 sq. ft.	211 sq. ft.	240 sq. ft.	250 sq. ft.
Total area of lower sail	1320 sq. ft.	1095 sq. ft.	1270 sq. ft.	1370 sq. ft.

TABLE OF OFFSETS FOR TEN-TONNER (SEE PLATE XXXVI).

No. of Section	midship.													
	1	2	3	4	5	6	7	8	9	10	11	12	13	14
Heights above L.W.L. to plank sheer	3	3	3	2	2	2	2	2	2	2	2	2	2	2
Depths below L.W.L. to underside of wood keel.....	7	3	0	2	9	8	6	2	5	5	5	6	7	9
Half-breadths on deck	1	8	2	3	5	7	8	7	5	3	3	3	2	—
Half-breadths 1ft. 10in. above L.W.L.	1	4	2	3	3	3	3	3	3	3	3	3	2	—
Half-breadths 1 1/4in. above L.W.L.	0	11	2	2	3	3	3	3	3	3	3	3	2	—
Half-breadths on the L.W.L.	0	2	1	1	1	1	1	1	1	1	1	1	1	—
Half-breadths No. 3 W.L.	0	7	1	1	1	1	1	1	1	1	1	1	1	—
Half-breadths No. 3 W.L.	0	3	1	0	2	2	2	2	2	2	2	2	2	—
Half-breadths No. 4 W.L.	—	—	0	6	1	1	1	1	1	1	1	1	1	—
Half-breadths on underside of wood keel and top of lead keel	—	—	0	6	1	1	1	1	1	1	1	1	1	—
Depths from bottom of wood keel to bottom of lead keel	—	—	0	6	0	8	0	9	0	8	0	6	0	—

No. 1 section is 4ft. 4in. from the fore side of the stem at the L.W.L.

Nos. 1, 2, 3, 4, 5, and 6 sections are 4ft. 4in. apart.

Nos. 6, 7, 8, 9, 10, 11, 12, 13, and 14, are 2ft. 2in. apart.

The water-lines are 1ft. 3in. apart.

All the half-breadths are given without the plank.

The heights above the L.W.L. are exclusive of the covering board.

Siding of stem and sternpost, 4in. Sternpost 6in.

Siding of keel amidships, 1ft. 8in., tapering as shown in the table.

The lead keel will be 18ft. long, and commences from No. 3 station counting from the stem.

The underside of lead keel will be as nearly as possible of 8in. uniform width.

Moulded depth of keel, 8in.

Timbers, 2in. sided.

Timbers, 3in. moulded at heels, 2in. at heads.

Spacing, centre to centre, 2ft. 2in.

Bent timbers, 1 1/4in. sided, 1 1/2in. moulded between each out timber.

Garboard strake, 1 1/4in. American elm.

Plank, 1 1/2in.; deck plank, 1 1/2in.

Deck beams, 2 1/2in. sided, 2 1/2in. moulded.

NOTE.—It must be understood that in "laying-off" a yacht, either from a drawing or from offsets, some "fairing" will be necessary; and this "fairing" should be very carefully performed before the moulds are made.

CHAPTER XXIV.

PENZANCE LUGGERS, COBLÈ, GALWAY HOOKER AND POOKHAUN, NORWEGIAN PILOT BOAT, &c.

PENZANCE LUGGERS enjoy a very considerable reputation for weatherliness, and it has even been said that in this quality they exceed the famous cutter yachts of this kingdom. Be this as it may, there is no doubt that with two large and well cut sails, a sharp entrance, and equally sharp run, they are highly adapted for sailing by the wind. They vary in length from 40ft. to 52ft. length of keel, and have a good proportion of beam, usually a little less than one-third the length on deck, or about 0·3 of that length. The greatest beam is on deck, the turn of the bilge is very easy, and the floors nearly straight, with but little dead rise. The displacement of the boats is comparatively small, and although the greatest transverse section is ahead of the centre of length of load line, yet is the centre of buoyancy a little abaft that centre. The displacement of the fore-body and the displacement of the after-body are thus nearly equal, and this is accounted for by the more or less rake given to the mid-section—so that practically the mid-section is not so far forward as the position shown in the drawing—and to the steepness of the buttock lines aft and the lightness of the draught forward. It will be observed that there is little or no dead wood aft, in fact it is “all vessel” there, and the comparative fulness of the buttock lines is compensated for by the fineness of the horizontal or water lines, as shown in the Half Breadth Plan. It is said that the Penzance luggers are wonderfully dry in a head sea, and they are particularly lively. They have long easy lines; an almost perfectly balanced fore and after body; no weight in the ends; no heavy bowsprit, or boom, or rigging; and not a large weight of ballast to carry. The mast, it is true, is stepped rather far forward, but the absence of a bowsprit more than compensates for this, and, whilst it may increase the momentum acquired during pitching and scending, it does not cause them to plunge their bows under. A smaller class of lugger, built on the same lines,

but about 30ft. on the keel, for the Pilchard fishing, are open in the middle, and only decked fore and aft. One of these boats went to Australia in 1848 with five hands for the "diggings." She called off the Cape and took the mails to Melbourne, actually beating the regular Packet, although she had to make a raft or floating anchor of her spars to ride to during a heavy gale.

It is claimed that the Penzance luggers are capable of very high speed, and although they are not asserted to have done such wonderful things as the Yorkshire luggers have, there is no doubt that they are capable of attaining a speed equal to that attained by any other craft of similar length. The design we give (Plate XL.) is that of the Colleen Bawn, built at Penzance, by Mr. J. R. Wills, and she is one of the fastest luggers yet built in the west. It will be seen that she has about the length of load line of a racing 20-tonner, but has 5ft. more beam than any such yacht has, and less draught of water. However the "Dewdrop," also built by Mr. Wills, could beat her in a breeze, although she was only 45ft. on the keel and had no counter. The Dewdrop was bought by Mr. T. G. Freke, and fitted up as a yacht. He gave her new spars and a couple of "lugs" which were of unusual size, the bumpkin outrigger for the mizen being 29ft. outboard; still there was not spread enough for the mizen, and a foot-yard was used after the fashion of the foot-yard to a balloon topsail. She had a mizen staysail and was very remarkable for her close-windedness.

The rig it will be seen, upon reference to Fig. 108 (page 331), consists of two lug sails, usually made of cotton and tanned with oak bark and catechu. The fore lug has to be dipped in tacking, but the mizen is a working one and requires no dipping, the tack being made fast at the mast. There is no rigging to either mast, beyond a burton to the foremast and a stay to the mizen. The burton is brought to windward of the mast, and so is the tye-tackle.

The sails are seldom reefed, and they are made with only one reef band. When it is necessary to shorten sail, the mizen is shifted forward and a smaller mizen set; and this shifting goes on until the small "watch" mizen (used when riding to the nets with foremast unshipped) is reached. The boats are usually provided with the large fore lug, and three mizens besides the watch mizen. They cannot very well be hove to, and have to be kept "trying" by the wind or scudding before it; however, it must be a heavy gale that causes them to "up-helm," and then no craft of similar size afloat can excel them in running for the land.

The sail is hoisted by a chain halyard called a tye and a tackle or purchase, consisting of two double blocks, the fall leading from the lower

block. The sheave hole at the masthead for the tye has only a "dead sheave," that is, a half sheave fitted in the hole. The mast traveller is two half hoops jointed together by eyes, and they are said never to jam (see "Traveller" in the Appendix). The tack of the fore lug is hooked to the short bumpkin outside the stem head, but when the other mizen-lugs are shifted forward the tack is hooked to the stem head. The fore sheet tackle is hooked to an outrigger outside on the wales just abreast of the mizen mast.

The mizen stay tackle is hooked to a ring bolt in the centre of the deck.

The mizen sheet is fitted in this way (see Fig. 106): on the bumpkin* is an iron traveller, to the underside of which the chain sheet is fast; the sheet is rove up through a sheave hole at the end of the bumpkin

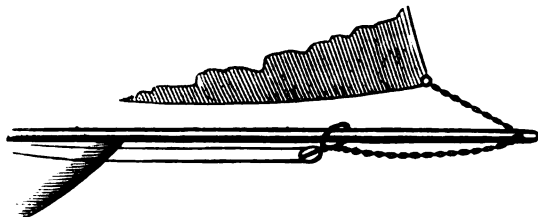

FIG. 106.

and hooked to the clew of the mizen. A block is hooked to the traveller, through which a rope is rove, one end being made fast on board. There are no stays to the bumpkin.

In tacking, the sheet is unhooked from the sail as the helm is put down; as the boat comes head to wind, the halyards are eased up and the after-leach of the sail hauled down upon until the after-end of the yard or peak can be shifted round by the fore-side of the mast; the tack is never started. The sail is gathered in by the foot and leech, and passed round the fore-side of the mast. By not letting go the tack the fore-part of the sail acts as a jib, and assists in paying the boat's head off. If the boat does not pay off readily, the foreyard is kept into the mast so that only the fore-part of the sail can fill, and the mizen sheet is let fly.

In the mackerel season, from February to July, they carry about one and a quarter mile of nets on the S.W. coast of Ireland. In the herring season, from October to January, they carry from half to three-quarters of a mile of nets on the S.W. coast of England.

When hauling or shooting the nets, rollers are fixed on the coamings of the hatchways and on the rail of the bulwarks, to enable the nets

* Called outrigger in the West country.



PLATE XL.

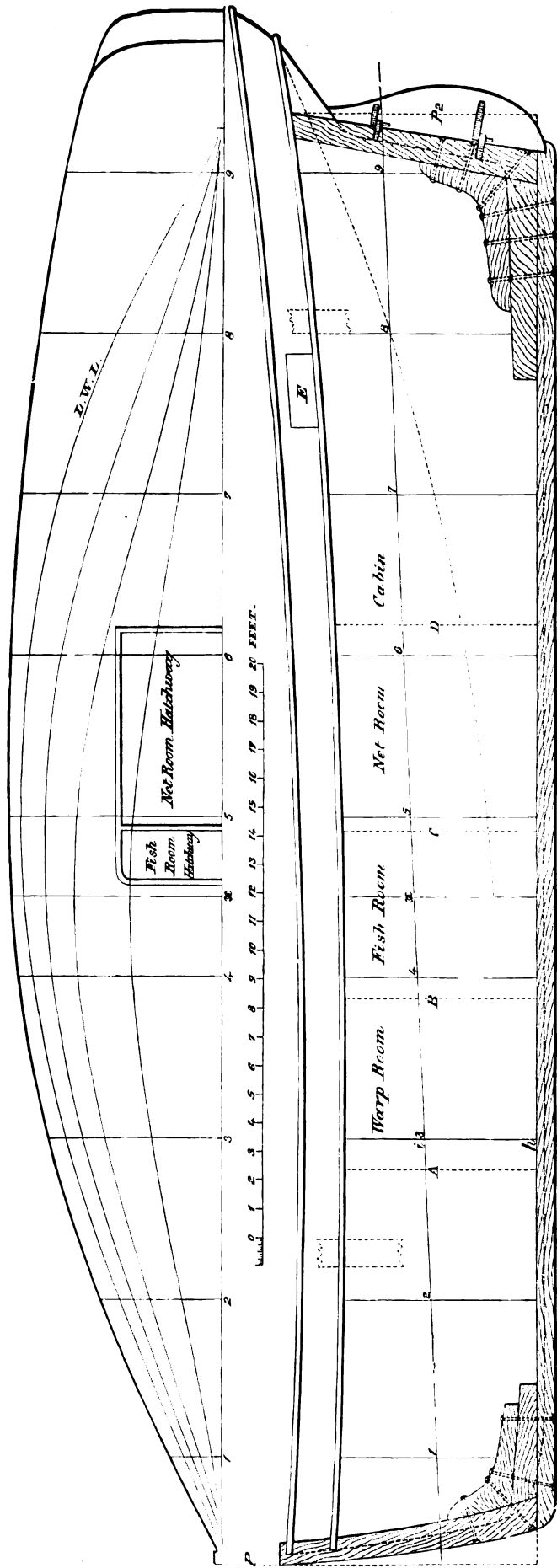

PENZANCE LUGGER.

to run well and to prevent their being damaged. Before the net is shot over the side, a shoot rope is bent to the head of the net by stops. The stops are long enough to allow the shoot rope to lie about half way down the net. The use of this rope is to save the nets, should a vessel sail through and cut them. The boats ride to the nets by this rope.

The boats are usually manned by six men and a boy, who are employed as follows: Two at the capstan getting in the net; one forward to cast off the stops of the shoot rope; two at the net-room hatchway to shake out the fish, and stow the net; one at the helm, and the boy to coil away the shoot rope.

It will be noticed upon reference to the Body Plan and Sheer Plan that the top of the keel, and *not* the load water-line, is the base line from which all heights are measured. All the sections shown in the Sheer Plan are therefore perpendicular to the base line or keel, and not to the load water-line. The curved lines shown in the Body Plan are water-lines; they are set off in this way: in the Sheer Plan (Plate XL.) at No. 3 section, measure the distance from *h* to *i*; set off this distance on the middle line (*o*) of the Body Plan as at *j*, measured from the base line; then draw the ticked line *t* at right angles to *o*, and where this line cuts No. 3 section at *v* will be the spot for the water-line on that section. The points in the other sections will be similarly found, and, when complete, a line drawn through the spots will represent the water-line, and will be more or less curved.

No. of Section	1	2	3	4	κ	5	6	7	8	9
SHEER PLAN.										
Heights from top of keel to covering board.....	7 0	6 11	6 10	6 10	6 10	6 11	7 1	7 5	7 10	8 6
Depths from L.W.L. to top of keel	3 5	—	—	—	—	—	—	—	—	5 4
BODY PLAN.										
Half-breadths at deck	1 9½	4 2½	6 0	7 0	7 3	7 3½	7 3	6 11	6 4½	5 6
Half-breadths, <i>a</i> diagonal	—	—	—	—	—	7 10½	7 9	7 4½	6 4	4 4
Half-breadths, <i>g</i> diagonal	1 9½	4 3½	6 2½	7 3½	7 6½	7 7¼	7 4	6 6¼	4 11¼	2 2
Half-breadths, <i>k</i> diagonal	1 7¼	4 1	5 9½	6 7½	6 9½	6 9½	6 1	4 10	3 2	0 9
Half-breadths, <i>m</i> diagonal	1 5	3 5½	4 7½	5 1	5 0½	4 9¾	4 0½	2 11½	1 8½	0 4½
Half-breadths, <i>n</i> diagonal.....	1 0	2 3	2 9	2 10	2 8½	2 6	2 0	1 4½	0 9	0 3

All the half-breadths are without the plank.

No. 1 section is 3ft. 8in. from the fore perpendicular P. The other sections are 5ft. 8in. apart, and No. 9 section is 2ft. from the aft perpendicular P 2.

All the half-breadths given are without the plank.

The water-lines shown in the Half-breadth Plan are 1ft. apart in the Body Plan.

Diagonal *c* is struck 9ft. above the base line, and cuts the perpendicular *p* 6ft. above the base line.

Diagonal *g* is struck 7ft. 4in. above the base line, and cuts *p p* at *g 1* and *g 2* at 4ft. 9in. above the base line.

Diagonal *k* is struck 5ft. 11in. above the base line, and cuts *p p* at *k 1* and *k 2* at 2ft. 11in. above the base line.

Diagonal *m* is struck 4ft. 2in. above the base line, and cuts *p p* at *m 1* and *m 2* at 6in. above the base line.

Diagonal *n* is struck 2ft. 5in. above the base line, and at *n 1* and *n 2* is 3ft. 8in. out from the middle vertical line *o*.

The midship section is midway between No. 4 and No. 5 sections.

The fore bulkhead A, forming the warp room (see Sheer Plan), is 13ft. 9in. abaft the fore perpendicular.

The bulkhead B is 6ft. from A, C 6ft. from B, D 7ft. from C; E is the companion entrance to the cabin.

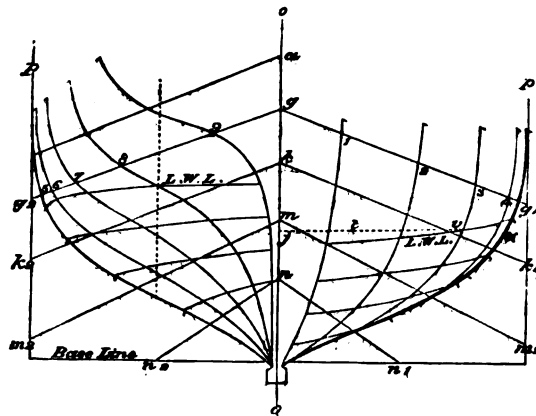

BODY PLAN.

FIG. 107.

	ft. in.
Length on deck, fore side of stem, aft side of sternpost.....	51 0
Length on keel	48 0
Rake of sternpost	1 4
Breadth, moulded.....	14 7
Breadth, extreme, with plank on	14 10
Draught of water, extreme	6 0
Mid-section ahead of centre of length of load line	1 8
Centre of buoyancy abaft centre of length of load line	0 4
Displacement to load water-line	36 tons
Displacement per inch at load line.....	1 ton 2cwt.
Tonnage, B.M.	41 tons
Ballast	14 tons

	ft. in.
Siding of keel, stem and sternpost.....	0 6½
Moulding (depth) of keel.....	0 9
Siding of frames	0 4
Room and space	1 5

In the drawing only every fourth frame or section is shown.

	ft. in.
Fore mast, deck to sheave	37 6
Mizen mast, deck to sheave	29 0
Mizen mast, deck to topsail halyard sheave.....	37 6
Mizen bumpkin, outside	20 0

	ft. in.
Foremast, diameter at deck	0 11
Foremast, diameter at sheave.....	0 6½
Mizenmast, diameter at deck	0 10½
Mizenmast, diameter at sheave	0 6½
Fore tack bumpkin, outside	1 3
Luff of fore lugsail	26 0
Leech of fore lugsail	46 0
Foot of fore lugsail	34 0
Head of fore lugsail.....	28 0
Clew to weather earing of fore lugsail	36 0
Luff of mizen lugsail	20 0
Leech of mizen lugsail	41 0
Foot of mizen lugsail	29 0
Head of mizen lugsail	24 0
Clew to weather earing of mizen lugsail	36 0
Area, fore lugsail	980 sq. ft.
Area, mizen lugsail	780 sq. ft.

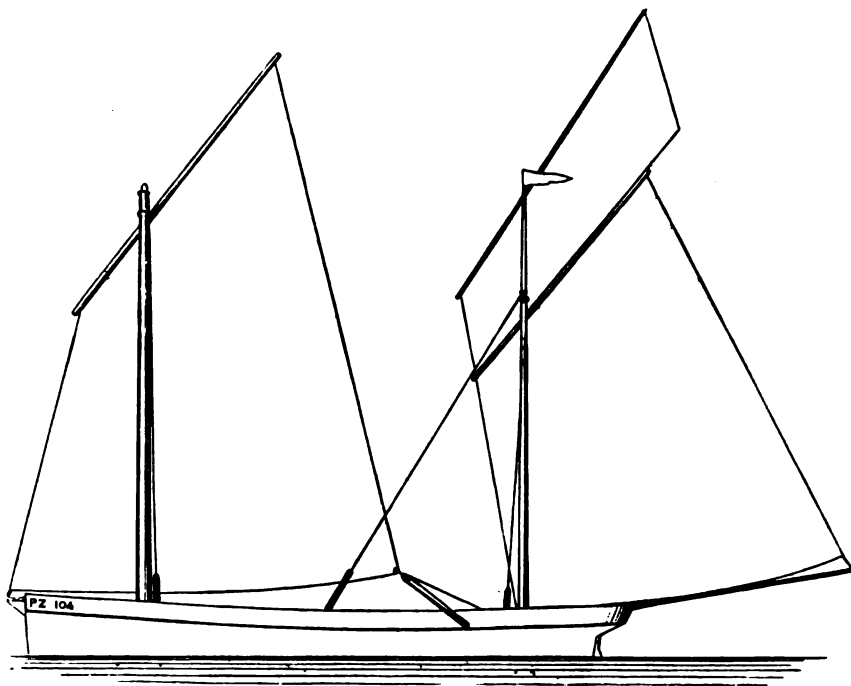

PENZANCE LUGGER.

FIG. 108.

THE COBLE.

No boat is more distinctive in type than the coble of the north-east coast. Their high, sharp bow and long, flat floor adapt them for rough water and for beaching stern foremost through surf. Their speed and performance in a sea, as compared with the speed and performance of a

well-formed and well-handled yacht of similar length, are, however, no doubt exaggerated. Running before a sea they require clever handling, as, on account of the excessive fore gripe, they evince a tendency to fly up in the wind or broach to. The peculiarly deep rudder checks this tendency

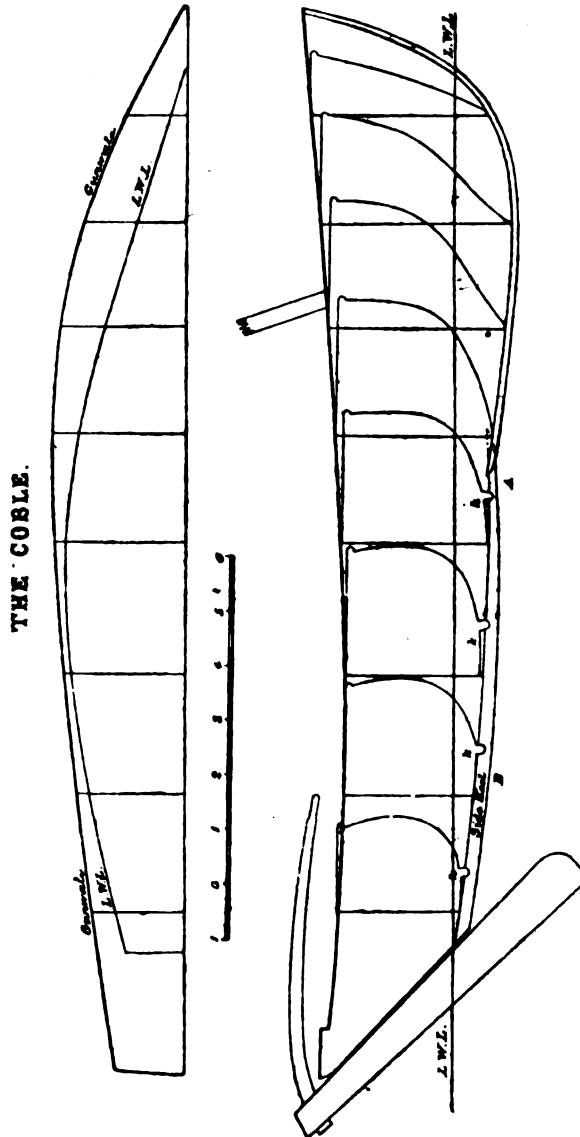

FIG. 109.

somewhat, but the rudders are generally so narrow that they do not keep the boat so straight as they might be kept with some keel "drag." However, "drag" would be inimical to beaching stern first, as the small draught aft (with rudder unshipped) admits of their being landed high on a beach;

and the sharp, high, and flaring bow keeps the surf from breaking on board. The coble is very weatherly, and is perhaps seen to greatest advantage when hanging up against a head sea or wind.

The side keels (shown by *k* in the cross sections) overlap the fore keel at A. The fore keel sometimes is at least a third shorter than shown.

The boats are measured for length from the heel of the sternpost to the scarp of the stem or fore foot, and this length is called the "ram." The length of the "ram" varies from 15ft. to 40ft., and the extreme breadth is about one-fourth the length over all. The drawing on page 379 was made by Mr. G. Christopher Davies from a typical boat of 20ft. length. The mast of such a boat is stepped 5ft. 6in. from the stem, and rakes aft as shown (Fig. 109). It is about 14ft. above the gunwale, and the only stay is the halyard brought to the weather side. The sail is a square, flat-headed, dipping lug, with tack fast to the weather bow, a little forward of the mast. In moderate weather a jib and mizen are carried. When a jib is carried, the tack of the lug is brought to

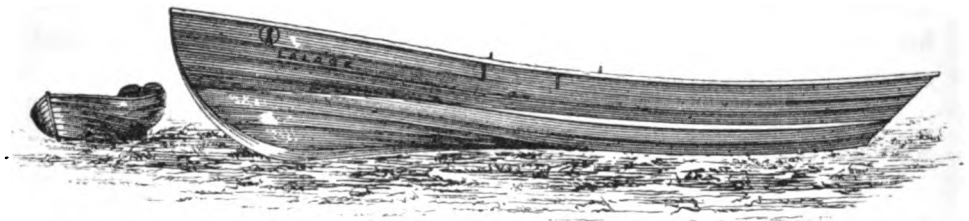

FIG. 110.

the mast; but they are not then considered so weatherly as they are when the tack is on the weather bow. The boats are made to carry their canvas a long time, and the only ballast used consists of bags of sand.

The Yorkshire cobles are generally round-sterned, and have very hollow bows at the load line, and a great deal of shoulder above. The Durham and Northumbrian boats are fuller at the load line. Builders of these boats are Mr. Cambridge, of Filey; Mr. Hopwood, of Flamborough; and Mr. Trotter, of South Shields. The Filey boats are noted for good qualities under canvas.

At Cullerwater there is a squadron of "private" cobles, of which Sir Hedworth Williamson is commodore. The leading dimensions of the *Lalage* (Fig. 110), one of the most noted of this fleet, are as under:

	ft. in.		ft. in.
Length over all	31 8	Mizen mast	20 6
Ram	21 8	Head of main lug	15 6
Breadth extreme	7 0	Foot of main lug	16 6
Side	2 5	Luff of main lug	21 6
Mast	30 5	Leach of main lug	23 0

The lug mizen is, mast for mast, of proportionate dimensions. The jib is about 10ft. on the foot. Standing lugs would probably be found much handier for ordinary work, as the constant dipping in beating to windward would be avoided.

THE GALWAY HOOKER AND POOKHAUN.

The Galway hookers are noted on the west coast of Ireland for their weatherly qualities. They average from 11 to 16 tons, and being short, broad boats, with very hollow bows, they are exceedingly lively in a sea-way, but seldom ship a sea; perfectly safe in every way except running when deep, when they have sometimes been pooped, owing to their lean hollow runs.

Speaking of these hookers, Commander Horner, R.N., says "they are very bluff above and hollow beneath, and I often tried to persuade them to alter, and at last, after seven years, found one man, Gill, of Arran, who promised to do so, and who a year after sent me word that his new boat, launched just in time for a regatta, couldn't be looked at—beating everything." (See Plate XLI.)

The sails were made of a coarse stuff called "band linen," saturated with a mixture of tar and butter, which never thoroughly dried.

Horses and travellers are not used for the main sheet, but when on a wind the sheet is belayed by a single nipping hitch round the timber-head on the quarter, taut down, keeping the mainsail very flat.

They carried a strong weather helm, and were quick in stays.

They were cleverly handled by the Claddagh fishermen, and few things could be conceived prettier than a fleet of them working out for the fishing ground with the sun shining through their brown and red sails.

The Galway pookhaun (Plate XLII.) is a smaller boat than the hooker, and used for both rowing and sailing; but it is built with the same ideas, of great tumble-home of topside to keep the gunwale out of the water when heeling over, and very raking sternpost, for quickness in stays. The sail of the pookhaun is single, cut as a triangle, with a yard on part of fore side, to set as a lug; and when working to windward the fore end of the yard is dipped abaft the mast, and she is brought round very cleverly—often, when blowing fresh, the man at the tack taking a flying swing round the mast with it. They sail exceedingly well, and are very graceful and picturesque boats under sail.

The mainsail in the hooker is laced to the mast, the lacing going

PLATE XII.

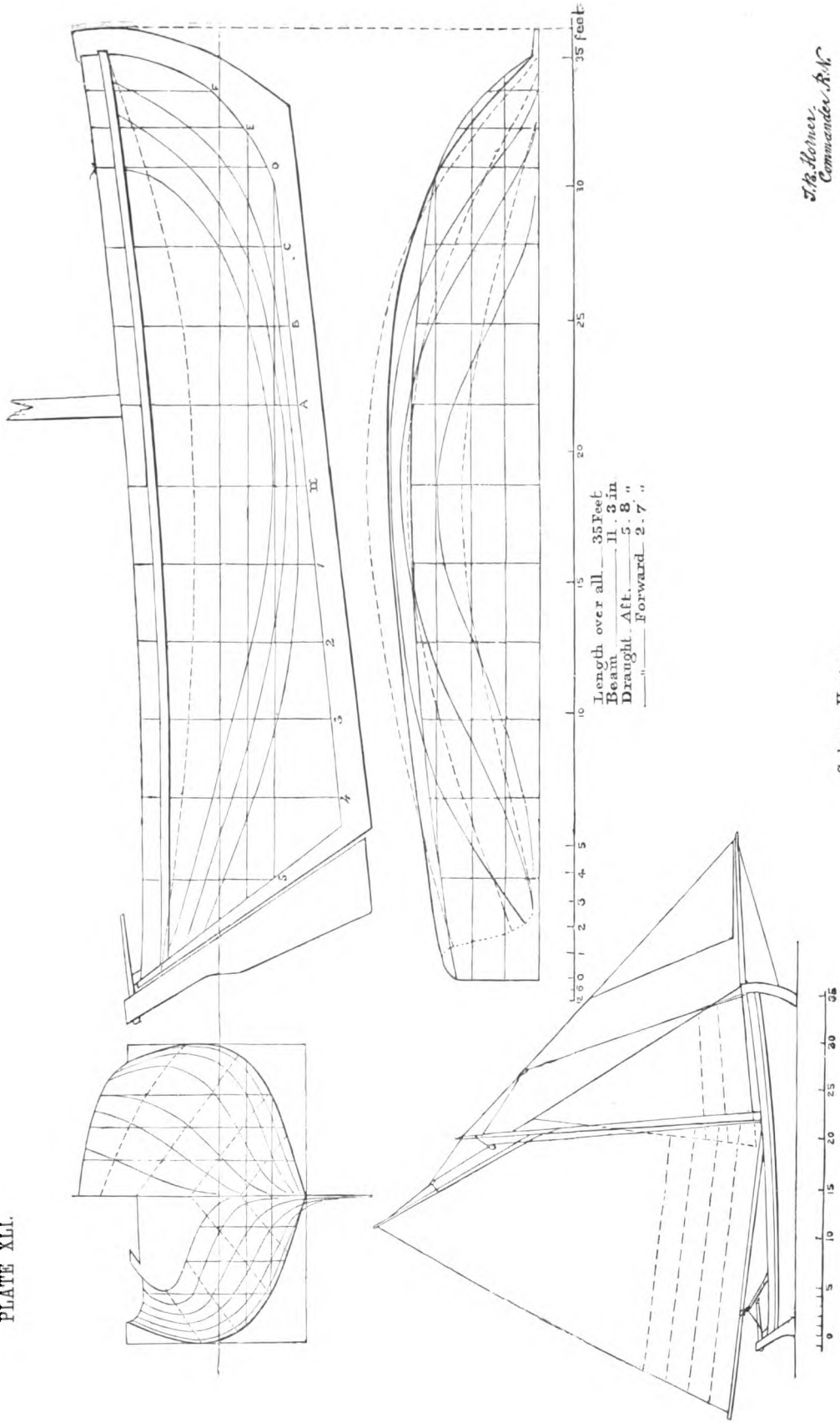

Galway Hooker.

J. K. Scherer,
Commander, U.S.N.

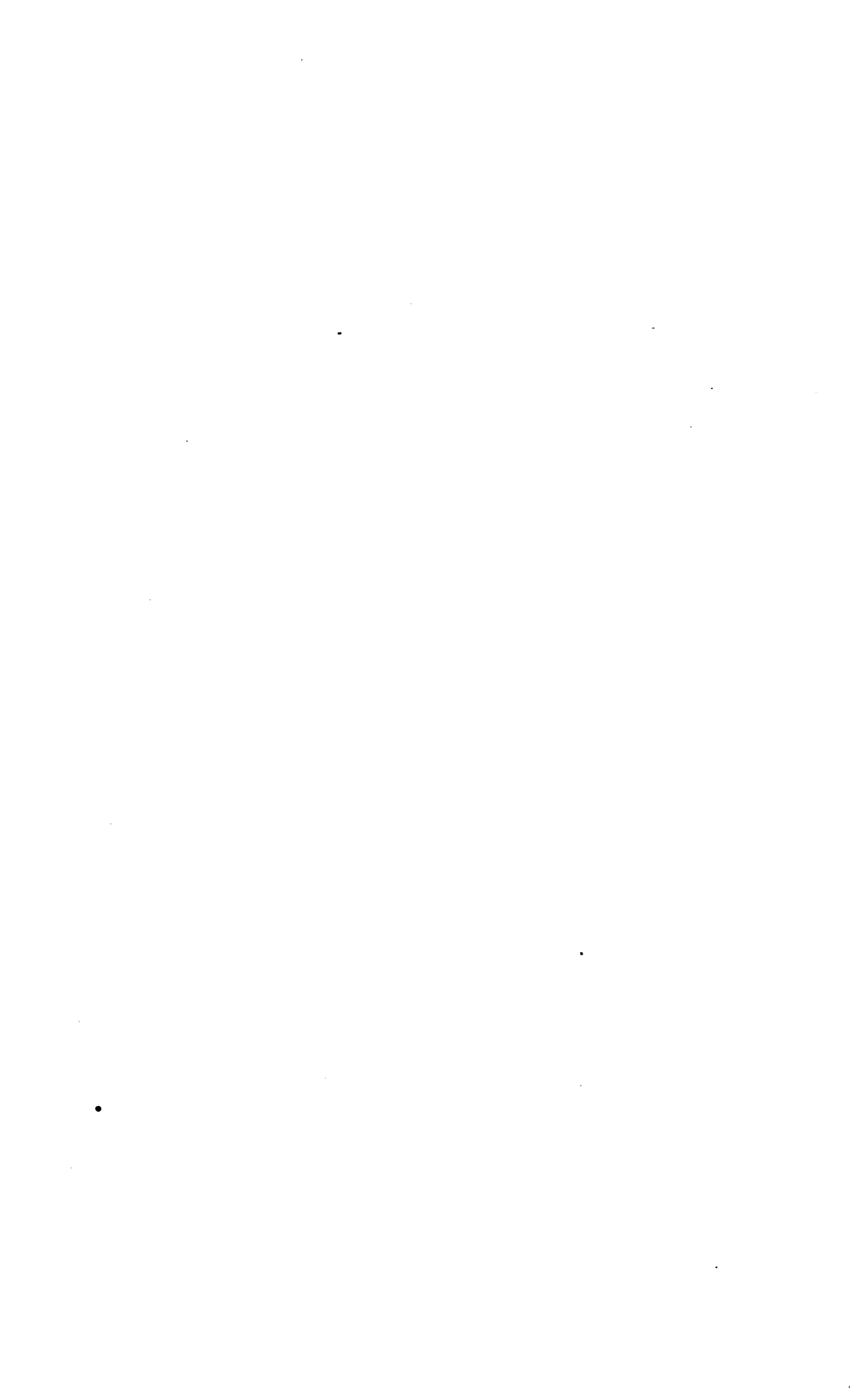
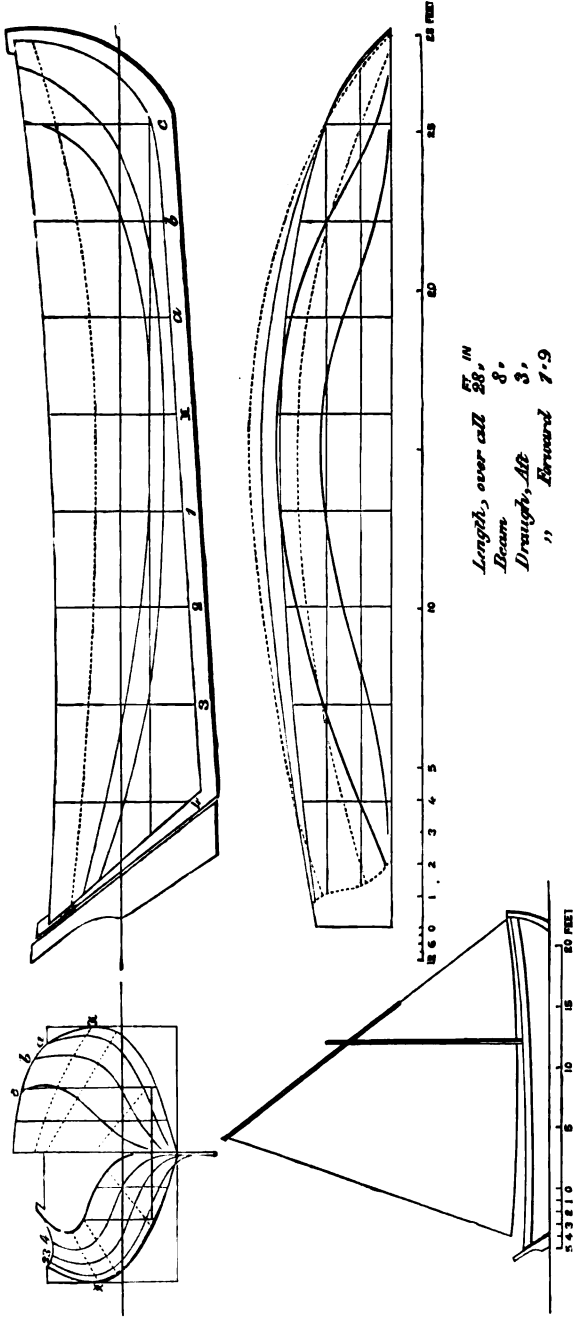

PLATE XLII.



Galway Pookhaun.





PLATE XLIII.

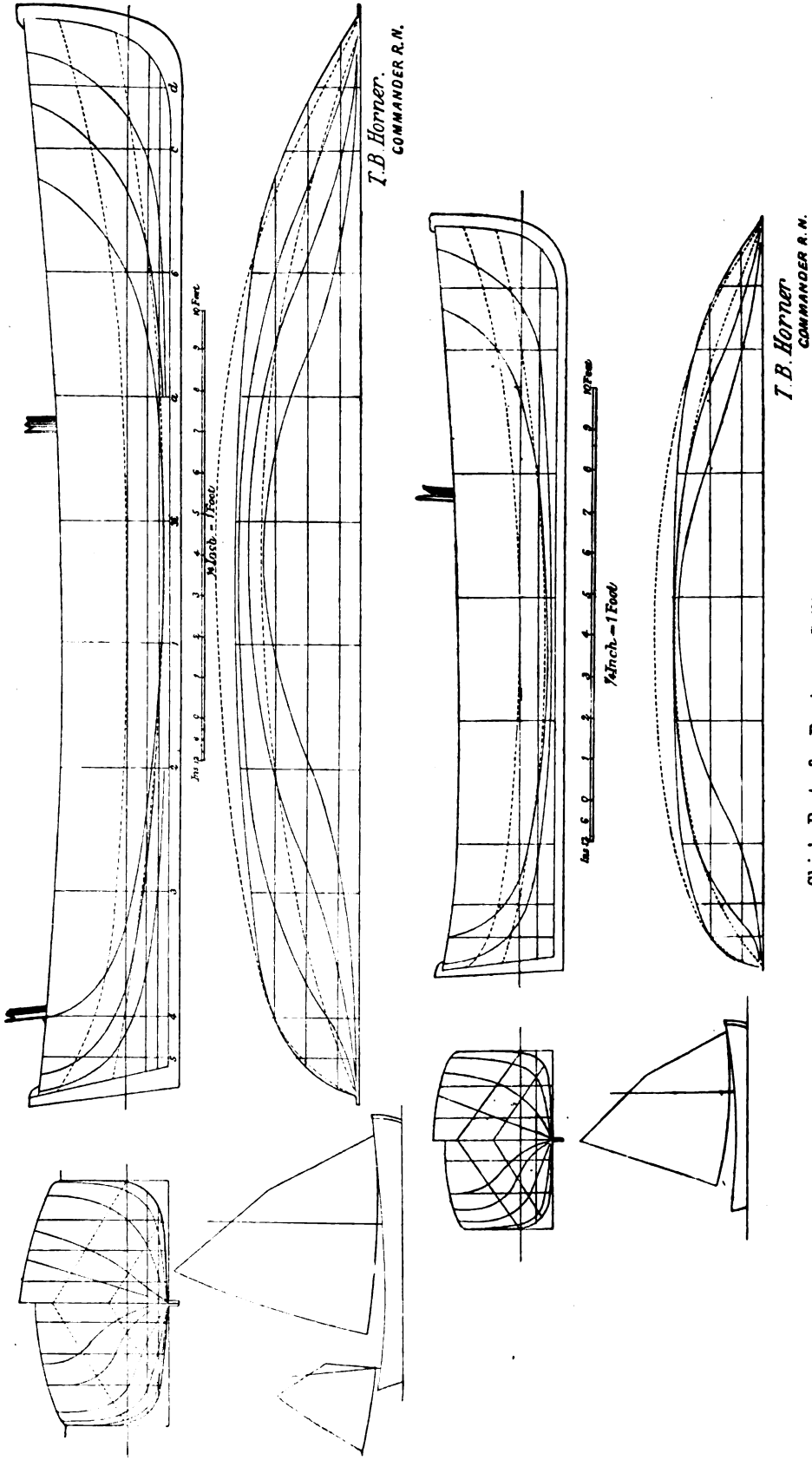

Ship's Boats for Rowing or Sailing.

T. B. Horner
COMMANDER R. N.

T. B. Horner.
COMMANDER R. N.

1 Inch = 1 Foot

through the cringle and back again, round before the mast; the sail coming down with the greatest ease when head to wind. The ballast is of stone, built into the bottom of the hooker and making a fire hearth, with a deck above as far aft as the mast.

SHIP'S BOAT FOR ROWING OR SAILING.

Commander T. B. Horner, R.N., in 1858, designed a boat for the Channel Island survey, and she was afterwards fitted for the service. The lines of this boat are shown on Plate XLIII. She has, it will be seen, a very flat floor, square bilge, and fine, deep ends; she was therefore very buoyant, like a lifeboat. She was reported to be fast, weatherly, dry, and steady under oars or canvas.

Commander Horner subsequently designed another boat of smaller dimensions for general use (see Plate XLIII.). She is reported to have been a wonderful boat against a head sea with four hands, and generally rowed fast. Under canvas she was equally a success. The transom could of course be made "square," if preferred.

The standing lug, with mizen and head sail, would be a good rig for either of these boats. The mast would remain where shown, and the fore part of the lug would be done away with. The head yard would remain about the same, but the lug would be given greater peak.

Sand bags could be carried for ballast.

BELFAST YAWLS.

This type of whale boat is said to have been imported from Norway, and even the Galway hooker and pookhaun exhibit evidence of Norwegian origin. The Belfast yawls vary in length from 12ft. to 30ft. The larger craft above 20ft. keel have two masts, the shorter one being stepped forward. The mast is stepped in the keelson, and fits into a half circle cut out of the thwart. It is stayed forward, and is kept in position without any mast clamp on the thwart.

The tack of the sail is hooked to a hook on the bow. There are two hooks on each bow, the after one being used when before the wind. The halyard consists of a tye and single whip purchase. The standing part of the purchase is fast to the gunwale, and the fall is also belayed to the gunwale. There is no traveller, and the tye runs over a half sheave at the mast head. This fitting is in great repute among the Belfast men, as there is little chance of the yard jamming in hoisting or lowering.

The main sheet is a single rope rove through a bull's-eye on a swivel on the sternpost. The sail is extended by a boom, the latter having a pin at the outer end, which is put into the clew cringle of the sail. The other end is lashed to the mast. A bowline is sometimes used as represented in the cut (Fig. 111). This bowline is set up to the towing bollard or "Samson," with which these boats are always fitted. The sail is

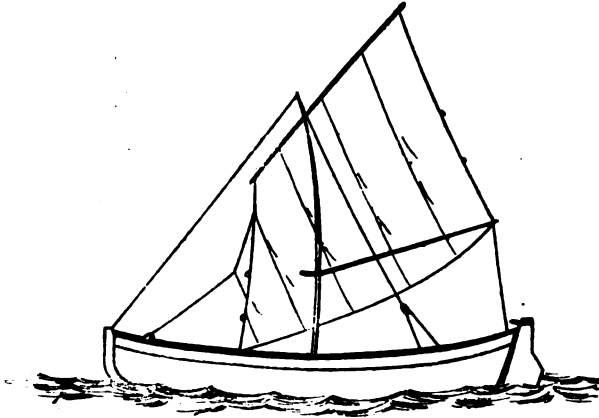

FIG. 111.

cut so high in the clew because it should not get into the water during rolling. The mast is stepped amidships. In squalls the sheet or halyard is let go. In running, if the bows dive, the halyard is eased a little.

The boat is steered by a yoke and long lines, all the crew sitting amidships. Stones are used as ballast. The rig is a very rude one, and it could not be expected that such craft would do much to windward where short tacking would of necessity be frequent.

NORWEGIAN PILOT BOATS.

The lines of a Norwegian pilot boat on page 338 were drawn by Mr. Colin Archer, of Laurvig, Norway. It is not often that prettier or cleaner water lines will be met with; and if the flare of the bow were reduced, the fore-foot rounded up a little, a lead keel added, and a suitable sail plan, we think that a very fast and weatherly yacht could be built from the lines. Mr. Archer thus describes the boats:

"I doubt if English boats of the same size are as handy with a small crew in all kinds of weather. A pilot and his 'boy' (technically so called—he may be an 'old boy') will go to sea in one of these boats and stay there (perhaps for a week) till he finds a vessel. When this

happens, perhaps somewhere between the Naze and the Skaw, the boat goes close alongside, the pilot jumps on board, and the 'boy' is left to bring the boat home the best way he can. The sail is a sprit, and, notwithstanding the formidable dimensions, one man is supposed to be equal to all contingencies.

Whole length of mast about	33ft.
Diameter at deck	11in.
Diameter at top	4½in.

"There are no shrouds—only the forestay. They balance on a wind with the foresail and mainsail, but generally carry a jib or two for sailing free, and often a jib-headed topsail hoisted on a long pole."

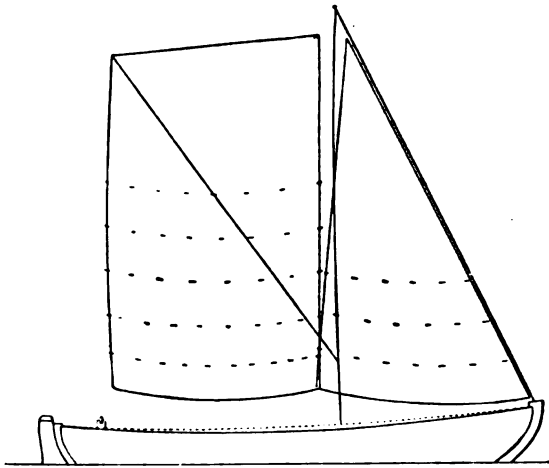

FIG. 112.

The mackerel fishing-boat is the same model; they carry about 600 fathoms of nets, three to four hands. These boats will live a long time in a seaway and keep pretty dry (they are decked); but their great "forte" is their extreme quickness in answering their helm, a necessary quality when ships have to be boarded from them in a gale of wind; and they will work to windward through surprisingly narrow places, and at a good rate too. These boats are all oak except the timbers—thirteen to fourteen strakes 1½in. boards—clinker-built, with juniper treenails with heads, placed about 4½in. apart. They look clumsy, chiefly from their upper works spreading so much. If this feature—which, however, gives them an enormous reserve of buoyancy—were altered, they might be made to look well enough, though peculiar. The boats carry about one-third to one-fourth of their total weight in ballast, generally consisting of iron ore, which is plentiful in the neighbourhood of Laurvig.

Length extreme	33ft.
Length on L.W.L.	30.2ft.
Breadth extreme	11.6ft.
Breadth on L.W.L.	10.0ft.
Draught of water	4.2ft.
Displacement	7.5 tons.
Area midship section	15 sq. ft.
Area load water-plane	198 sq. ft.

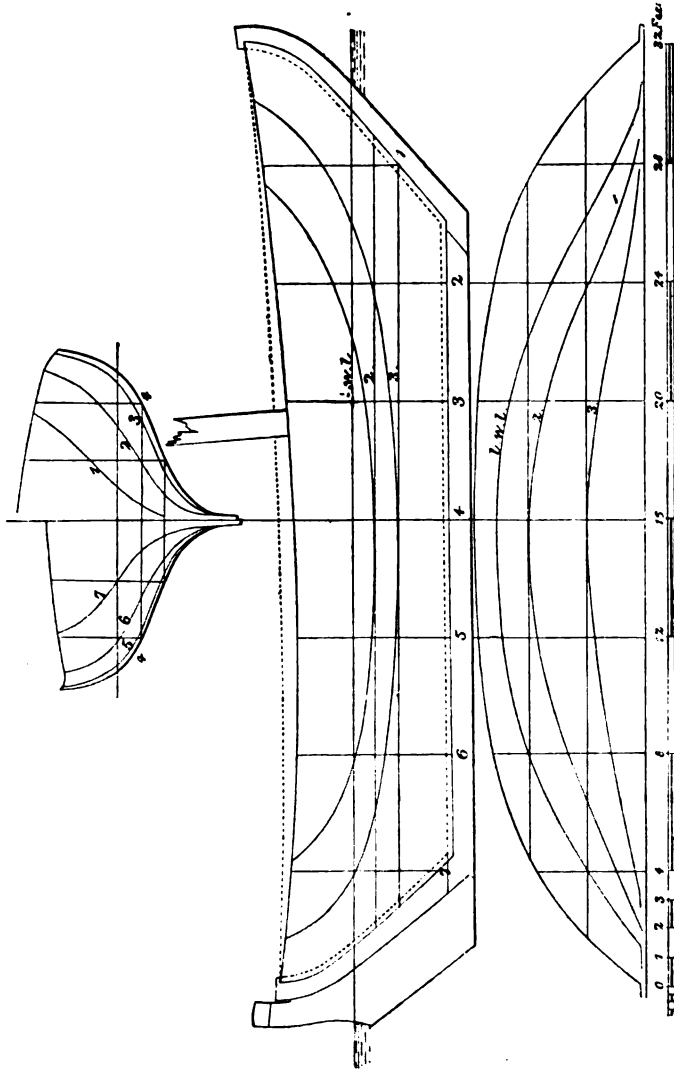
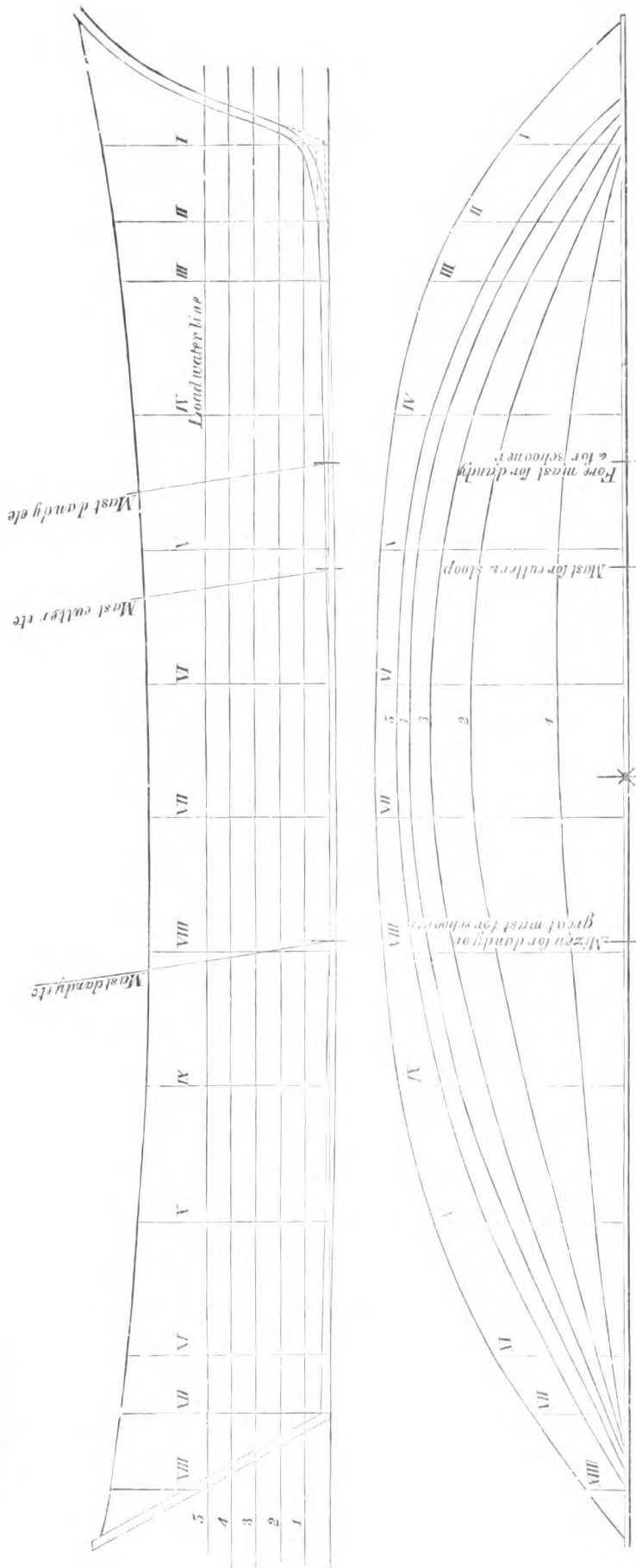

Fig. 118.

Meta-centre height	4.46ft.
Centre of buoyancy aft, centre of length of L.W.L.	5ft.
Midship section forward of centre of length of L.W.L.	0.4ft.
Area of mainsail	500 sq. ft.
Luff of mainsail	24ft.
Leech of mainsail	22ft.
Head of mainsail	14ft.
Foot of mainsail	14ft.



PLATE XLIV.



Buenos Ayres Whale Boat "Ballenera."

THE BUENOS AYRES WHALE BOAT (BALLENERA).

In the rough waters of the La Plata, with its shallow beach and many shoals, where the dreaded Pampero S.W. and S.E. winds bring up in a very little time a tremendous but short sea, no vessel, it is said, has proved itself so good in every respect as the Ballenera; and this assertion has been in a measure confirmed by the circumstance that in the spring of 1881 two Italians crossed the Atlantic from Buenos Ayres to Caprera in the Mediterranean. The craft in question has grown out of the ship's boat, and is now a decked vessel for conveying passengers and cargo, rigged as sloop, cutter, dandy, schooner, and even topsail schooner. (Plate XLIV. and Fig. 114.) The largest of them are 60-tonners; the largest with one

mast, 40-tonners; and the smallest, 10-tonners. They draw, loaded, from 5ft. 5in. to 3ft. 9¼in., and unloaded, 2ft. 10in. to 2ft. 1½in. When quite loaded (over loaded) their deck is level with the water; nevertheless the smaller

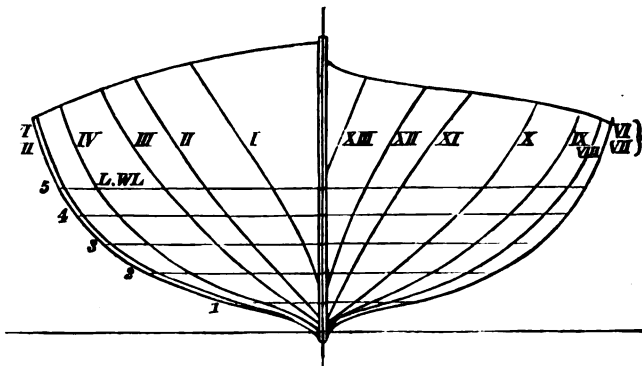

FIG. 114.

ones, instead of a railing, have only a small ribbon or moulding to prevent the men from sliding off deck. Loaded or empty, all the same to them; they run out in the worst weather, and sail from Buenos Ayres to Montevideo, and even further. A whale boat with reefed mainsail is very seldom seen, and a capsized whale boat has never yet been heard of in Buenos Ayres. They are very swift and handy, sail near the wind, and tack with certainty. All, except the topsail schooners, sail with three men, and a man alone very often makes a cruise of a day into the open sea with the smaller ones. The builders have the following way of measuring the spars: SLOOP OR CUTTER.—Mast=length of keel, placed at one-third keel length from the bow; boom=one-fourth its length outboard; gaff = half boom; topmast = gaff; bowsprit (sometimes only a bumpkin) = beam of the boat. DANDY OR SCHOONER.—Foremast, as cutter = keel length, placed at quarter-keel length from bow; mizemast = one-third shorter than foremast (for dandy), placed half-way between foremast and stern; boom, one-third its length outboard.

CHAPTER XXV.

THE JULLANAR.

THE Jullanar (Plate XLV.) in contour is different from most other vessels, and some peculiarities in her design, if not of much value, are at least original. For instance, her sternpost is upright and built very far in the vessel, so that a large portion of her counter is immersed; and her keel is raked so much that her draught of water at the sternpost is about twelve times what it is at the stem. But setting aside the fact that the *America*, built in 1851 by Mr. George Steers, and the *Kitten*, built by Mr John Harvey in 1852, varied in their draught of water fore and aft in much the same way, there is no doubt that the long immersion of counter abaft the sternpost were not the novelties they were first thought to be.

In 1852 and 1853 there was a great discussion as to the desirability of altering the manner of taking length for tonnage. Length was taken along the keel to a plumb-line dropped from the fore side of the stem at the deck. This measurement was mainly objectionable because it tempted a man to make a vessel very short on the keel and long on the water-line, and by tripping a vessel the position of the plumb-line could be greatly altered. To meet the difficulty and obtain fixed points, it was proposed to alter the manner of arriving at the length by taking the distance on deck from stem to sternpost. In April, 1853, Mr. William Cooper, under the *nom de plume* of "Vanderdecken," published a letter in *Hunt's Yachting Magazine*, in which he showed how easy it would be to evade such a rule. He said:

"My plan is as follows: To contract the length between stem and sternpost, by placing the sternpost as near the midship section as the form of the midship section will admit of [nearer, we presume, in proportion as the section approached the V form], consistent with giving power to the operation of the rudder; to project the main body of the vessel considerably beyond the main sternpost, without any keel, false sternpost, or dead wood whatsoever, but with a strong, secure frame of timbers

laid upon a keelson. This projection of the main body thus assumes the form of one immense counter, but, being below the load water-line, enables the preservation, despite the trammels of measurement, of a powerful floating vessel with lengthy water-lines.

“Unless some positive advantage, other than that of cheating the measurement for tonnage, may be found to exist upon actual experiment, I should be very sorry to see it introduced; if, however, such may turn out to be the case, then our ‘fixed points’ for measurement become exploded. My present object is to call the attention of yachtsmen to the probability that such an evasion of measurement as I have stated is practicable, and that yacht club sailing committees should be prepared for it.”

Mr. Cooper no doubt here gave a very faithful description of the existing Jullanar; however, in the next number of the magazine (May, 1853) appeared a letter stating that, in consequence of the deck measurement for length having been in use *some years* on one of the Irish lakes, Mr. Marshall, of Dublin, had built a vessel named Banshie, of 10 tons, long before “Vanderdecken” made his proposal. She is said to have had a perpendicular sternpost, with a very long counter, fine water-lines, rudder out of sight, and the immersed counter was said to help the vessel a very great deal.

Thus, so far as we can at present trace, Mr. Marshall, of Dublin, “many years” before 1853, invented the Jullanar; but what is odd is the fact that a kind of Banshie was quoted twenty years later by Mr. C. E. Strong as a tonnage-cheater. The accompanying sketch (Fig. 115) is

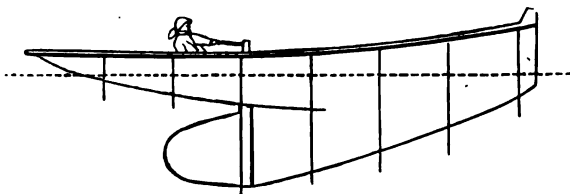

FIG. 115.

an exact representation of the sheer drawing of the vessel Mr. Strong published in *Hunt's Magazine*, in February, 1873, as a “tonnage-cheater.”

Two years later, in 1875, the Jullanar was laid down, and, whilst she was building, extraordinary stories were current about the wonderful position of her sternpost, and the effect it would have upon her tonnage. However, Mr. Bentall informs us that he had no idea or thought of evading a tonnage rule in designing Jullanar, and that she was the produce of many years' study.

Jullanar exemplifies up to a certain point what may be considered a

true principle in ship designing, so far as the development of speed goes. The design, taken broadly, shows in an eminent degree how three leading principles in the design of a sailing ship, although primarily antagonistic, can be so reconciled as to assist each other. We have length, the wave form, and a minimum of immersed surface which form the principle of small resistance; an effective plane for lateral resistance, which is the principle of weatherliness; and great stability, which is the principle upon which depends the magnitude of the propulsive force. It cannot be supposed that the apt combination of these fundamental principles was the result of mere chance, and it becomes necessary to here state how Jullanar was designed. Mr. Bentall, writing in February, 1877, said:

“The object I had in building Jullanar was not to avoid any rule, but to carry out a principle to its legitimate results—that is, ‘the longest water-line, the smallest frictional surface, and the shortest keel.’ I could carry it no further and keep her centres right.”

The latter sentence refers to the “theoretical assistance” Mr. Bentall received from Mr. John Harvey. The original design of Jullanar in its crude state as it came from Mr. Bentall resembled, so far as the contour of the sheer plan goes, the design now published of the actual Jullanar, but in reality the general design was a very different affair. The midship section was of smaller area, and had much more hollow near the garboards; the displacement to the designed load-line was lighter (about 143 tons, so far as we recollect); and the area of immersed vertical longitudinal section (sheer draught) was greater, and differently disposed. So also was the disposition longitudinally of the displacement. Mr. John Harvey altered the design, taking away here and adding there, until he got the centres of gravity of various equidistant water planes, and the fore-and-aft position of the centre of buoyancy corresponding to those water planes, into such positions as accorded with a certain theory formed by Mr. Harvey.

Jullanar was built from Mr. Harvey’s modified drawing, and Mr. Bentall has acknowledged that Mr. Harvey gave him “efficient assistance.”

The craft was afloat in 1875, and was soon reported to be a wonder to windward, and fast along the wind; whilst her qualities as a sea-boat were pronounced unparalleled. In 1877 Jullanar (having been bought by Mr. A. D. Macleay) made her *début* as a racing craft, and her performance fully justified all Mr. Harvey had predicted concerning her.

It would be interesting and instructive to know what process Mr. Bentall employed in designing Jullanar; but the probability is that

no system was pursued farther than that sketched out by himself, as just now quoted. The fact is, one arbitrary and unusual condition led up to certain modifications of the common type, and Mr. Bental could not very well have had his short keel without the other conditions as well.

For instance, by placing the sternpost upright and in such an unusual position, great depth under the load line was necessary at the heel of the keel, and very little depth forward under the load line. In fact, in spite of the great difference in the draught of water fore and aft, as Mr. Bental designed it to be, Mr. Harvey found it necessary to cut a large piece away from the fore foot, and add a little to the draught aft. By cutting away so much of the dead wood, of course the area of immersed surface was largely reduced, and thus Mr. Harvey was able to attain one of the objects Mr. Bental had in view. With the keel so much raked upwards, it became almost impossible to have anything like hollow lines forward, and the displacement would have been seriously reduced—in fact, the Jullanar would have been in the condition familiarly known as “all ends and no middle.” The consequence is that the lines which bound horizontal planes in Jullanar’s fore body are convex, and do not resemble wave lines. This was another condition favourable for reducing the immersed surface, inasmuch as a smaller displacement would have been the cause of an increase in the immersed surface. Another important condition depended upon the abstraction of dead wood from the fore body and upon the parabolic character of the horizontal lines (water lines); and that was, that the displacement of the fore body is so disposed as to be a pure wave form.

We are not aware if Mr. Bental or Mr. Harvey had any particular object in making Jullanar’s water lines convex, beyond that of keeping a certain amount of displacement in the fore body, and the area for surface friction small; but Mr. Colin Archer, in 1877, when he made known his theory as to the true form of wave bow, pointed out that such a bow could exist without the presence of a single line with a contrary flexure in the vessel. This is undoubtedly true; and, supposing that all we need have in a vessel is the wave-form bow, independent of the form of any particular horizontal curve, to obtain the best results, then the Jullanar, so far as her fore body is concerned, exactly fulfils the condition.

What we consider the weak point about Jullanar is her attenuated after body. In fact, the displacement of the after body is disposed almost similarly to that of the fore body—that is, the curve of displacement of the after body more nearly resembles a curve of versed sines

than a trochoid. Whether or not Jullanar would have been a better vessel if the displacement of the after body had been greater, so as to correspond with the trochoidal curve, is more or less a matter of conjecture; we are inclined to think that she would. No doubt the fineness of the after body of Jullanar is to a great extent dependent upon the place where her sternpost is fixed; and if her sternpost had been raked aft from the heel of keel to the end of her water line (50°), *à la Kitten*,* no doubt she would have had fuller lines aft, and thus have had a heavier after body.

Jullanar has not a large area of lateral resistance, but it is a most effective one. Here again we find the fortuitous combination of conditions, which we have before spoken of, operating to render the surface effective for its purpose. Mr. Harvey, to get the centre of gravity of the vertical longitudinal plane sufficiently far aft, cut away more of the gripe than even Mr. Bentall had designed for, and by so doing the keel obtained the excessive upward rake.

We next come to consider the stability, or sail-carrying power, of Jullanar. Here again it is interesting to note that the fortuitous combination of conditions rendered the condition on which Jullanar's stability mainly depends a possible one. Hitherto all attempts to evade the effects of the Y. R. A. tonnage rule, by increasing the proportion of length to beam, had been limited by the fact that a consequent increase in depth involved an excessive area of immersed surface. But Jullanar, like a well designed yacht with a much rockered keel, has great depth of middle body as well as length, and consequently carries her ballast low. At the same time the area of her immersed surface is small, for the reason which has been sufficiently pointed out.

The stability of Jullanar is of a satisfactory character; but it is not of so potent a nature as it might have been with a little more beam. Mr. Bentall, in his letter heretofore quoted from, does not say why he gave Jullanar so little beam. He says his object was to get the longest vessel on the load-line with the smallest area of immersed surface. Lengths and areas are not directly comparable, and possibly Mr. Bentall meant that his object was to get the longest vessel on the load-line in ratio to length of keel. At any rate, the proportions of the linear dimensions of length, breadth, and depth of Jullanar exemplify in a certain manner the truth of what those who have made yacht naval architecture a study have long contended, that the best sea-going craft is one of

* The Kitten was 43ft. on the load line, and had 55° rake of stern post. By putting her sternpost upright from heel of keel, she would have had 8ft. of immersed counter. Her draught of water at heel of sternpost was 6ft. 8in.; forward, 2ft. in from stem, about 2ft. 6in.

long body in proportion to her breadth of body, accompanied with great depth of body and small initial stability. A vessel with a faint bilge, small initial stability, and great depth will not have violent lateral motion among waved water, such as rolling, lurching, and lifting of the whole mass; and one that is long and deep will have, compared with short vessels, no violent fore-and-aft motions, especially if her displacement is so apportioned that her weights are necessarily concentrated in the middle of the vessel. The disadvantage of small initial stability is that, even with low wind pressures, the vessel will take an excessive heel; her deck will be a difficult one to walk upon, and so will be her cabin floor. However, the discomfort of a steep platform may be considered compensated by the fine behaviour of the vessel that has it among disturbed water. [The stability of Jullanar compared with some other yachts will be found referred to in "Yacht Architecture."]

It is beyond doubt that speed is proportional to length, other things being equal; and Jullanar affords a striking example of the deficiency of length alone for speed purposes where no equality in other essential qualities exists. For instance, Florinda is 14ft. shorter on the load-line than Jullanar, yet is her speed, under what may be considered as the most favourable circumstances for developing the same, equal to the speed of Jullanar. We have not far to look for the reason of this. The initial stability of Florinda is much greater than that of Jullanar, and consequently, in moderate whole sail breezes and smooth water, she can carry her canvas much more effectively—or, in other words, she then commands a greater propelling force. This will be easily understood by reference to the diagram showing the curves of stability of the yachts in "Yacht Architecture."

Florinda, like Jullanar, has a small area of immersed surface; but she has comparatively little draught of water, and her keel has but a moderate upward rake. Now Jullanar's excellence in a good whole sail breeze depends on her weatherliness, and speed. Florinda has equal, perhaps superior, speed under such conditions; but she compares unfavourably for weatherliness. In the first place, her form—she having very little depth of body, and an expanded V form of section—is not so suitable as Jullanar's for lateral resistance; and, secondly, her small rake of keel renders her dead wood less effective than it would be if she had the same area differently disposed. If her sternpost were given more rake—without increasing her length of load line—and if the piece removed were placed along and under her keel aft, and if some of the dead wood forward were removed, there is not much doubt that her weatherly qualities would be improved.

COMPARATIVE TABLE OF DIMENSIONS.

	Florinda.	Jullanar.
Length on load line	85ft. 9in.	100ft.
Breadth, extreme	19ft. 4in.	16ft. 10in.
Breadth on load line.....	19ft. 1in.	16ft. 8in.
Draught forward 5ft. from stem.....	7ft. 3in.	2ft. 9in.
Extreme draught	11ft. 9in.	13ft. 8in.
Mean draught	10ft. 1in.	9ft. 4in.
Least height of freeboard	3ft. 1in.	3ft. 10in.
Area of load water plane.....	1100 sq. ft.	1085 sq. ft.
Displacement in cubic feet	5250 cubic ft.	5540 cubic ft.
Displacement in tons	150	158
Displacement per inch of immersion at L.W.L.	2.62 tons.	2.6 tons.
Area of immersed vertical longitudinal section	901 sq. ft.	934 sq. ft.
Area of midship section	106 sq. ft.	106 sq. ft.
* Midship section abaft middle of length of L.W.L.	8ft.	1ft. 6in.
Centre of buoyancy abaft middle of length of L.W.L.	1.3ft.	0.4ft.
Centre of buoyancy below L.W.L.....	2.75ft.	3.44ft.
Centre of lateral resistance abaft middle of length of L.W.L.	3.6ft.	3.3ft.
Centre effort sails ditto	4ft.	1.5ft.
Meta-centre above centre of buoyancy	4.75ft.	3.13ft.
Meta-centre above centre of gravity	3.7ft.	3.3ft.
Area of immersed surfaces	2200 sq. ft.	2178 sq. ft.
† Co-efficient of displacement311	.359
Ballast	54 tons.	79.5 tons.
Portion of this ballast on keel	8 tons.	6 tons.
Area of mainsail	2762 sq. ft.	2737 sq. ft.
Area of foresail.....	778 sq. ft.	650 sq. ft.
Area of jib.....	1045 sq. ft.	875 sq. ft.
Area of mizen	672 sq. ft.	726 sq. ft.
Total area lower sail	5257 sq. ft.	4988 sq. ft.
Mainmast, deck to hounds	54ft. 6in.	53ft.
Mizenmast.....	33ft. 6in.	36ft.
Main boom.....	56ft. 6in.	56ft. 6in.
Main gaff	42ft. 6in.	42ft.
Bowsprit outside	36ft.	24ft. 6in.

* The Jullanar has a rake to the midship section, and the position given is at the point where the greatest section was found.

$$\dagger \left(\frac{\text{Displacement in cubic feet.}}{\text{Length} \times \text{breadth} \times \text{mean draught.}} \right) = \text{Co-efficient.}$$

PLATE XLV.

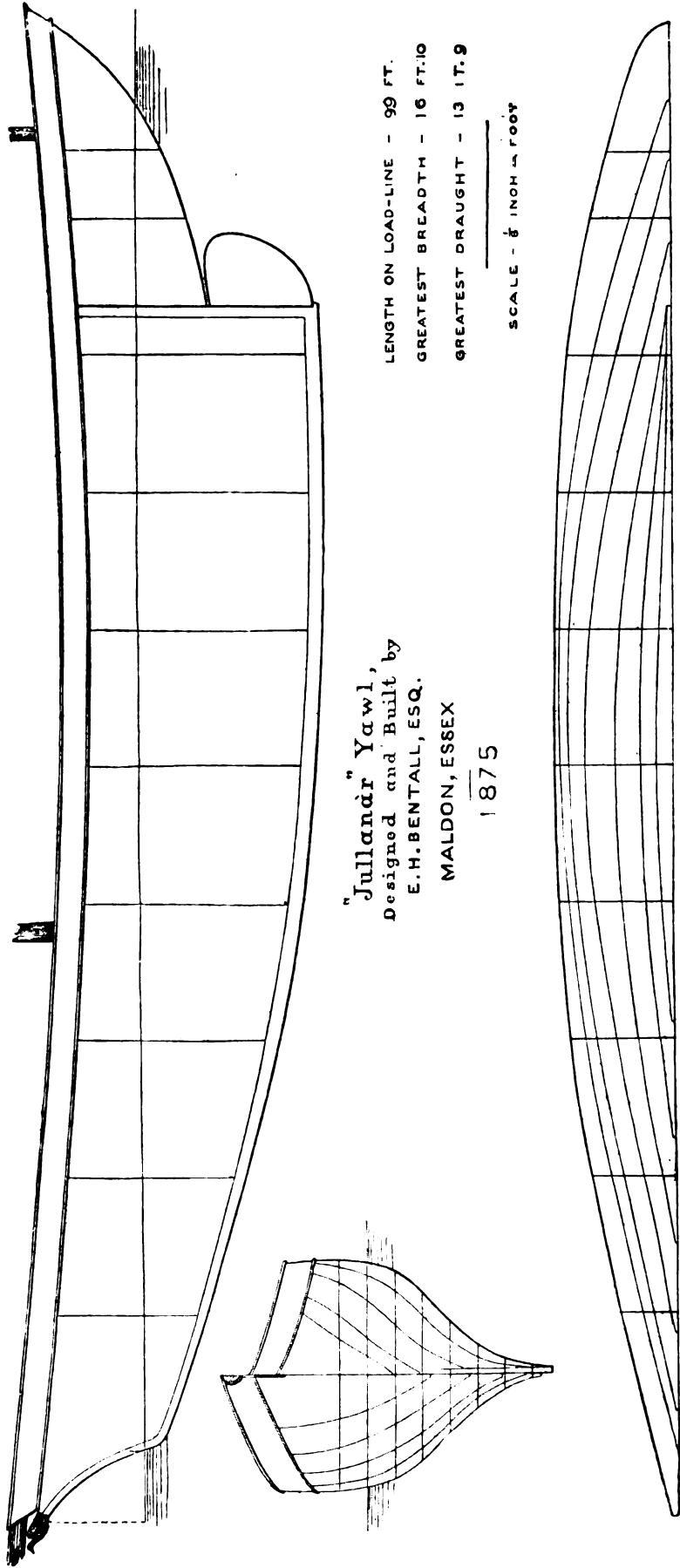

"Julland" Yawl,
Designed and Built by
E. H. BENTALL, ESQ.
MALDON, ESSEX

1875

LENGTH ON LOAD-LINE - 99 FT.
GREATEST BREADTH - 16 FT. 10
GREATEST DRAUGHT - 13 FT. 9

SCALE - $\frac{1}{8}$ INCH = 1 FOOT

JULLANAR.—TABLE OF HALF BREADTHS AND DEPTHS.

No. of Sections	1	2	3	4	5	6	7	8	9	10	11	12	13	14	15	16	17	18	19	20	21	
Half breadths on deck.....	ft. 15 29	ft. 20 32	ft. 41 51	ft. 60 67	ft. 73 78	ft. 81 83	ft. 84 85	ft. 84 85	ft. 83 84	ft. 83 84	ft. 83 84	ft. 83 84	ft. 83 84	ft. 83 84	ft. 83 84	ft. 83 84	ft. 83 84	ft. 83 84	ft. 83 84	ft. 83 84	ft. 83 84	
Half breadths, ft. above L. W.L.	0 8	1 3	2 5	3 7	4 7	5 6	6 3	7 1	7 8	8 0	8 3	8 4	8 4	8 3	8 0	7 5	6 8	5 6	4 3	2 8	1 3	—
" at L. W.L.	—	0 7	1 7	2 7	3 8	4 7	5 6	6 3	7 0	7 5	7 7	7 8	7 5	7 0	6 3	5 3	4 0	2 7	1 3	0 2	—	—
" at No. 2 W.L.	—	—	0 5	1 4	2 4	3 4	4 3	5 1	5 8	6 2	6 4	6 3	6 0	5 3	4 3	3 3	2 2	1 0	—	—	—	—
" at No. 3 W.L.	—	—	—	0 4	1 0	1 9	2 6	3 3	3 8	4 1	4 3	4 1	3 8	3 3	2 6	1 8	0 8	—	—	—	—	—
" at No. 4 W.L.	—	—	—	—	—	0 6	1 1	1 6	2 0	2 2	2 3	2 3	2 2	1 8	1 4	1 0	0 4	—	—	—	—	—
" at No. 5 W.L.	—	—	—	—	—	—	—	0 4	0 5	0 8	1 0	1 2	1 1	1 0	0 6	0 5	0 3	—	—	—	—	—
" at No. 6 W.L.	—	—	—	—	—	—	—	—	—	0 4	0 4	0 4	0 4	0 4	0 4	—	—	—	—	—	—	—
" at No. 7 W.L.	7 6	7 1	6 6	6 0	5 6	5 1	4 9	4 5	4 2	4 1	4 0	3 9	3 8	3 9	4 0	4 1	4 3	4 6	5 0	5 4	5 9	—
Height above L. W.L.	0 0	2 8	4 4	6 6	7 3	8 6	9 8	10 8	11 7	12 5	13 0	13 2	13 3	13 4	13 5	13 7	13 5	4 8	3 6	2 0	—	—
Depth below L. W.L. to underside of keel.....																						

The sections are 5ft. apart, No. 1 commencing from the fore-side of the stem. Every other section is omitted in the drawing.

The water-lines are 2ft. apart.

All the measurements are given in feet, and decimal parts or $\frac{1}{10}$ of a foot, with plank on.

CHAPTER XXVI.

DOUBLE BOATS.

DOUBLE boats, in some form or the other, are met with all over the world, and the principle is adopted with the main object of acquiring great stability. But, although double boats may have in this way great stability, it must not be supposed that they are uncapsizable. They could be capsized by carrying a heavy press of canvas, or they might be thrown over by a sea, just as a lifeboat is sometimes.

In 1873, the late Mr. H. Melling, of Liverpool, had what he termed a safety yacht constructed on the double hull principle, as shown on the opposite page (Fig. 116). Mr. Melling thus described his boat: "Happen what may, she cannot sink, for even if scuttled she will remain as a strongly-put-together life-raft. She can accommodate herself to draw only one foot of water, although of the size of 15 tons. She can be beached at pleasure without risk of straining. She can be anchored and put into places out of the way of harm or being run down or afoul of, and ride to her anchor in a roadstead, light and buoyant, with little strain on her cable. All is of pine wood, light and buoyant, having no ballast whatever. She has comfortable cabin accommodation on deck, affording a good 'look-out' fore and aft. Galley and stowage berths are in the forecabin, and by a system of casks stowed away in the pontoons and on deck she could carry stores, provisions, water, &c., for a voyage, which as they are emptied and bunged up will add materially to her safety. She made very good weather of it in turning down the Dee and along the Welsh coast over shallows against a strong wind. In running back off the wind she attained extraordinary speed.

"The use of the boards are as follows: if the fore board is down, or part down, it makes her stay in a sea way; if the aft one be down it holds her steady in scudding, and prevents broaching to; if they be all down, she holds a good wind and makes no lee way. They can be let down partially

or wholly as required by a chain, and can be hauled up by hand. They are weighted to sink by themselves, and house themselves as soon as she touches the ground. Her pontoons are 30ft. long, and 2ft. 6in. in diameter,

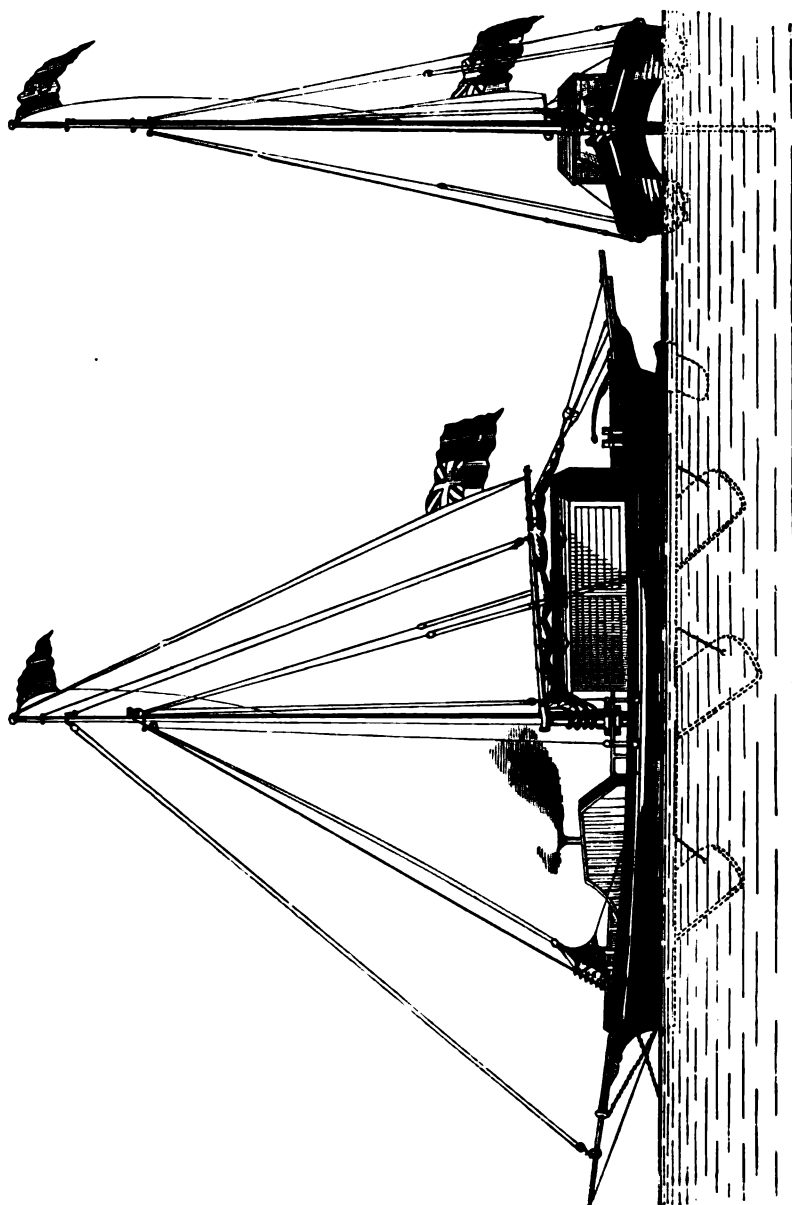

FIG. 116.

representing enormous floating power; and, as it is almost unnecessary to say, water-tight pontoons or air chambers are the most powerful principle of buoyancy known. In the drawing her broadside view is given, with

the submerged portion shown by dotted lines. The 'end-on' view more clearly shows the power of the vessel, and the peculiarity of her construction."

In the spring of 1868 Mr. John Mackenzie, of Belfast, constructed a double boat, but without dropping keels. He thus described her: "There are two boats of equal size, each 21ft. keel, 3ft. beam, and 3ft. deep. Each boat is divided by bulkheads into four compartments, two of these being 6ft. 6in. long, so as to be used for sleeping purposes; a hatch is in one compartment and a movable skylight in another, which is also adapted for ventilation; these hatches are screwed down on indiarubber, and can be made quite air-tight. A keel is provided on each boat, 15in.

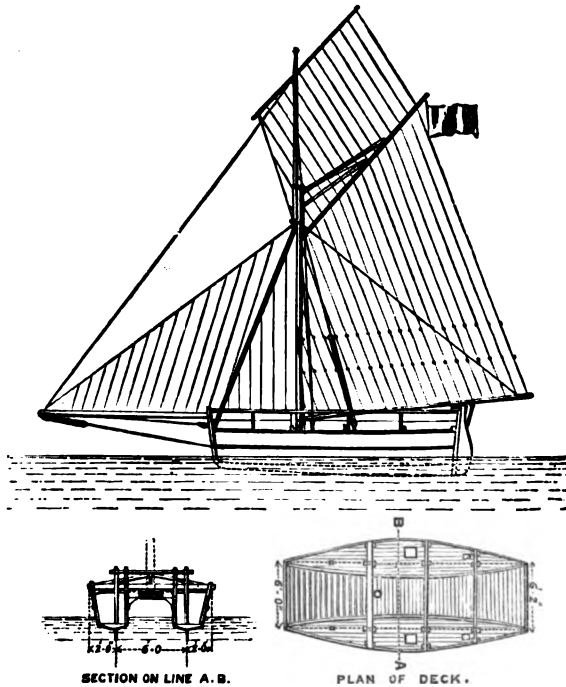

FIG. 117.

deep at the stern or heel, diminishing forward to 6in. Bolted to the keel by strong iron knees are stanchions which rise through the deck, on which the rail is fixed; to these stanchions the cross-beams connecting the boats are fixed, the timbers or ribs also rising through the deck for a similar purpose, where the cross-beams are placed. The skin is 1in. thick, being in one board on either side of the keel; the sides are in two, each 18in. deep, the seams being covered by a continuous strip of wood. By this method there are only four seams in each boat which require caulking, so that leakage is rendered nearly impossible. The boats are connected by

five trussed beams, the one at which the mast is stepped being double trussed. A platform rests on these beams, a space of 3in. being left at either side to allow air compressed by a cross-sea to escape from underneath; from the mast forward this platform is formed of open-work. Immediately under the platform is a chest, 2ft. broad and 6in. deep, capable of carrying 6cwt. of water to serve as ballast in heavy weather. It is provided with brass valves in bottom, which in light weather or in case of accident can be opened, and the water discharged in a few minutes; when the box is emptied, by closing the valves a third chamber or boat is formed, capable of carrying 7cwt. or 8cwt., in case the other two got waterlogged. It may seem strange to place the ballast in the position described; but this extra weight—which is absolutely required to enable the boat to beat up in a strong sea—makes her also stay with certainty and speed by its central position. A boat of this description, no doubt, will carry her sail without ballast; but no craft with a very light draught will stay in a heavy sea without an additional weight to that of the hull and spars. A helm is attached to each boat, and these, being coupled together by a connecting rod, are worked by a tiller in the centre, so that both are moved in the same direction.

“It might be supposed that a boat so constructed would wet those on board very much; but this is not the case, as the buoyancy is so great that very few waves break over the platform. Those that do come on board, being principally in front of the mast, disappear through the open-work before mentioned. When on a cruise and lying at anchor, a waterproof tent can be rigged up on deck, in which there will be a clear inside space of 8ft. by 6ft., sleeping berths being provided for four persons in the boats as before mentioned. A permanent cabin on deck is in my opinion very objectionable, as it interferes with the working of the sails, and is a serious hindrance to beating to windward. I had various opportunities during the last two summers of testing the qualities of this boat. The best opportunity was afforded during last summer by a cruise along the Antrim coast, and by frequent sailing in the Irish Channel, sometimes in half a gale of wind. I always found her to stay well, and go to windward in a very satisfactory manner. The greatest speed attained was ten knots an hour. During the summers of 1868 and 1869 she was moored in the centre of Bangor Harbour (which is a tidal one), without any trouble. When the tide ebbs the boats sit down on an even keel, and I consider it a great advantage to be able to run into harbour at nearly any state of the tide, as it takes away the risk of mooring in an exposed bay; or if running for shelter, you are much more likely to be able to enter a harbour than with an ordinary boat.”

We have seen double boats which were constructed out of two halves; that is, an ordinary 5-tonner, say, was cut in halves in a fore and aft vertical direction through keel and deck, and then set apart 6ft. or 7ft., and connected by beams. Of course the inner sides of the

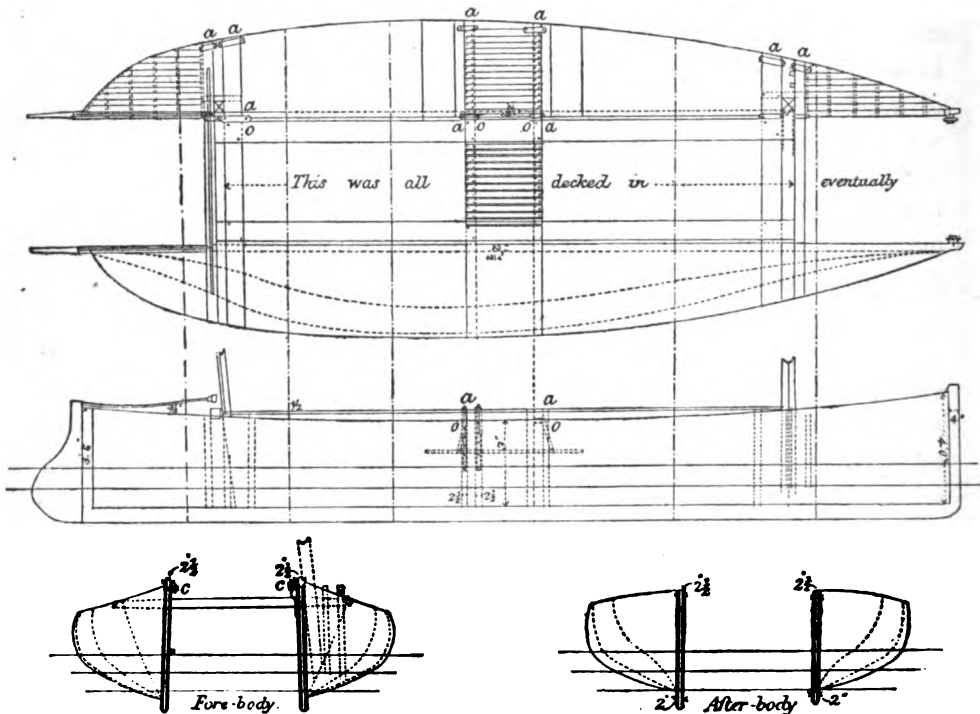

FIG. 118.

halves were covered over with plank, and made a perfectly flat surface. These boats attain a great speed. Major Conway Gordon built such a boat at Madras, and she is now to be seen at Southsea. Her construction is shown in Fig. 118.

In America a double boat was introduced in 1876 called a Catamaran. The boats were designed by Mr. N. G. Herreshoff, and were thus described in the *Scientific American* (Plate XLVI. and Fig. 119):—

“Increased safety is one of their merits, the stability being so great that the entire rig has been blown from these boats without capsizing them, and the builder of the *Amaryllis* states that after sailing her in all winds and weathers he has yet to see the windward hull lifted clear out of the water. Another recommendation that the lady passengers appreciate is the comparative freedom from careening. Then, too, there is less spray and no shifting of ballast; the boat is easily handled and can be polled in a calm with very little exertion. It is not claimed that the catamaran

can supersede the single-hulled boat; it can lay no closer to the wind, it cannot carry so many passengers, and, though the deck can be spacious and a tent pitched over it at night, the boat seems not so well fitted for cruising. Catamarans are not good sea boats. Finally, the catamaran has two faults, namely, it is slow in stays, and is prone to 'pitch pole,' or upset endwise, as the *Amaryllis* once did. These evils can be much palliated by proper construction.

"The Feejee boat and the majority of catamarans possess this objection—in rough water the independent motions of the hulls will ultimately wrench them from the deck, unless the connections are excessively heavy. An important requisite of speed is lightness. No

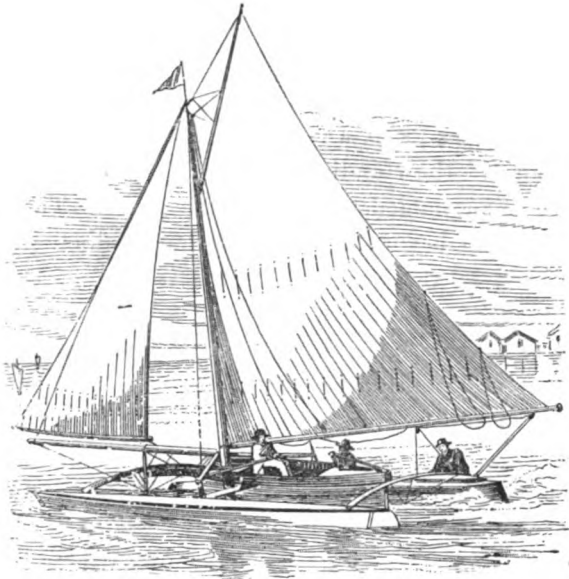

FIG. 119.

boat can sail well that possesses such solidity as to bind the two hulls immovably together. How to make a light deck frame which will control motions which it cannot resist is the problem which in boats of Mr. Herreshoff's build is well solved.

"The *Amaryllis*, *Arion*, *Teaser*, *John Gilpin*, and *Tantarella*, the catamarans which Mr. Herreshoff has built thus far, are substantially alike, differing only in details and size. As the reader could gain no clearer idea of the peculiarities of these boats than by reading Mr. Herreshoff's patent specifications, we subjoin an extract therefrom, to be read in connection with the accompanying illustrations of the *John Gilpin* (Plate XLVII.).

“A A are respectively the port and starboard hulls, each complete in itself, and constructed with a centre-board case, centreboard, O, rudder, &c. There should be a tight deck on each, with provisions for pumping. In large vessels the space below deck in each hull may be utilised.

“Points near the bow of each hull are connected by slightly curved beams, D, trussed with rods, *b*, and united to the hulls at each end by universal joints, C C. A similar trussed beam is similarly joined to each hull near the stern. The hulls may pitch independently of each other, and the universal joints, C, will impose no restraint on the movement. A straight timber, M, extends longitudinally along the centre, just below the transverse pieces, B, and secured to each. Two straight sticks, D, extend across at a higher elevation, about midway between stem and stern. An upright, or nearly upright link, E, bears on each hull a little one side of the centre line, with a universal joint free to work in all directions. The upper end of each link, E, is similarly jointed to the under side of the cross-piece, D. G” is a car of light, oval form, G being a deck, and G” the standing room, with a suitable raised rim or bulwark, adapted to accommodate persons, stores, &c. The car is secured to both the transverse beams, D, and the longitudinal piece, M. It is furthermore secured to the mast, H, which it aids to support, and by which it is in turn supported. The weight of any load upon the car, G”, is transmitted to the hulls, A, through the medium, mainly, of the cross beams, D, and upright links, E, which bear amidships, and partly through the other cross-pieces, B, which bear near the ends, respectively.

“Stiff diagonal braces, D’, connect the ends of the beams, D, with the bowsprit, which latter is also firmly connected to the mast.

“A short upright, M’, is fixed to the forward end of the piece, M, and aids to support the bowsprit, I. It also receives a bob-stay, *m*, which extends from the forward end of the bowsprit under the piece, M’, to the foot of the mast, H. Another fore-and-aft stay, *m*’, extends from the foot of the mast to the after end of the timber, M. Two other stays, *h h*, connect the foot of the mast with each end of the cross-beams, D, and still another, *h*’, with the top of the upright, M’. A pair of stays, *d d*, connect the ends of the cross beams, D, with the front end of the timber, M, and another pair, *d’ d’* connect the same ends with a point near the after end of the same beam, M. All these may be steel wire, galvanised, tinned, or otherwise protected from oxidation. The whole produces a light framework, supporting the deck and its load, and also the mast and bowsprit, upon the hulls, with freedom for the latter to both pitch and roll.





“An elastic restraint upon the rolling is imposed through the medium of arms, A¹ A¹, of ash, or other strong and elastic material, extending from each hull toward the other, and terminating near, but not touching the central timber, M. These arms, A¹, may be connected to the boat, through the medium of bolts, with indiarubber washers, or the like, to increase the elasticity.

“Their inner extremities are connected by links, A³, with an inner piece, G', of ash, or other elastic material, held a little below the deck, G. When in either a ground swell or choppy sea, one or both the hulls seek to roll, the motion is arrested simply by this train of elastic connections. The result is a limited freedom of the rolling, the pieces, A¹ and G', yielding upward and downward to accommodate the motion, and promptly bringing each hull to an even keel so soon as the disturbing strain is diminished.

“The helm, J¹, is applied, not on either of the rudder-heads, but on a shaft, J, in the central part of the structure, and further forward than the rudders. On the lower end of this shaft are arms, J², extending obliquely backward. To the end of each a rod, K, is jointed, which connects to an arm on the rudder on the opposite side—that is to say, the rod K from the port arm, J², extends to the starboard rudder, and the rod K from the starboard arm, J², extends to the port rudder.

“In turning a double boat, one hull necessarily makes a shorter turn, or describes a curve of less radius than the other. This requires that the rudders of the two boats should be turned to unequal extents, the boat which is the inside one, or nearest the centre of the curvature, having its rudder turned to the greatest angle. Such motion is obtained through my arrangement.

“If the compound vessel is to be turned to port, the helm is put starboard in the usual manner; turning the arms, J² J², to the same extent, but by reason of their oblique position and their being centred considerably in advance of the rudder-posts, the port rudder is turned through a greater arc than the other. When on the other hand the vessel is to be turned to starboard, the helm, J¹, is put to port, as usual, and the rudder on the starboard boat, which is then on a similar circle, turns through the greatest arc.

“Each side, and below the bowsprit, are longitudinal pieces, L, of hard wood, which, in addition to their obvious service as supports for men handling the job, contribute somewhat to the strengthening of the framework.’

“In the John Gilpin, the space between the deck, G, is divided into two parts, the after one containing the elastic beam, G', and the forward

being used as a locker. The elastic arms, A¹, are strengthened by the diagonal arms, A². Also the inner or free ends of the elastic arms, A¹, connected with the mast by links, P, shewn in the sectional view. The sheet is run along the longitudinal timber, M, thence through the floor of the standing room, G''.

"The dimensions of the John Gilpin are as follows: Length of hull, over all, about 32ft.: width of each hull, on deck, 28in.; depth of each hull at ends, 2ft. 5in.; draft of hulls, with load, 1ft. at each end, and probably about 21in. amidships; distance of hulls apart from centre to centre, 16ft.; mast is stepped 12ft. 10in. from extreme bows. The car is 14ft. 10in. long; length of bowsprit, 22ft. 8in.; length of boom, 31ft. 4in.; length of gaff, 17ft.; luff of mainsail, 20ft.; mainsail and jib are of the usual shape. The upright links, E, are 16ft. 6in. from extreme bows, and the centre boards, O, are immediately abaft, with wells 2ft. long on deck. The boats draw 4ft. with centre boards down. The rudders are about 2ft. long. In every part lightness and strength seem combined. The mast is very light, being about 5½in. in diameter at H, and tapered to the foot. The shrouds are each three loose wires of the usual telegraph size. The iron work is galvanised throughout. Weight of boat, completely equipped, about 3300lb. (1.47 ton). It will carry seven or eight passengers, but the best speed is with the fewest on board. The cost was \$1000.

"Of the Tarantella, more recently built, Mr. Herreshoff speaks in the highest terms. The only point of difference between the John Gilpin and the Tarantella is that the latter is 15in. longer. The Tarantella has been timed to make 18 miles per hour, with the wind free, and the maximum speed to windward, Mr. Herreshoff states, is 6½ miles per hour. The boat makes no lee way in smooth water, but a rough sea lifts her bodily to leeward. She steers very readily, but does not come about as quickly as a single-hulled boat. The stern of the weather boat will rise about eighteen inches out of the water, with the bow submerged, in strong winds. Her motions are easier than any other boat of the same size, but when driven very hard in rough water she is very wet."

When the stern of the weather boat lifts, it is customary for one of the crew to sit on it, as shown in Fig. 119.

CHAPTER XXVII.

STEAM YACHTING.

THE introduction of steam into the pleasure navy has been retarded by two principal influences. In the first place, steam was considered inimical to yachting—indeed, going about in a steamer was not admitted to be yachting at all; in the second place, the old-fashioned condensing engines were so extravagant in burning coal, that motives of economy prevented many who had no prejudice about the matter to adhere to sail. However, with the introduction of the compound surface condensing engine the objection to steam on account of its extravagance was swept away, and the many advantages the steam yacht has over the sailing yacht have proved too much for mere prejudice.

The principal advantage of a steam yacht over a sailing yacht is, leaving cost out of the question, that she can make passages or traverse the sea in the weather that is the most agreeable; that is, in calms and smooth water, when the sailing vessel would be lying helpless, and those on board half suffocated with the heat and stagnant air. In a calm twenty-four hours a steam yacht can reel off 240 miles, or, say, go from the Thames to Weymouth, whilst the sailing yacht would be waiting for a breeze, and perhaps when that breeze came there would be more than an agreeable amount of it to please the passengers on board. Of course, as a sport or pastime, steaming can bear no comparison to sailing, and, as a recreation, the advantage is greatly on the side of the yacht with sails. It is true there are auxiliary steam yachts—yachts fully rigged for sailing and with small steam power; but whilst they have in a modified degree the advantages of both steam and sail, they are very costly to work.

In building a steam yacht, the aid of a person well acquainted with their construction and fitting with engines should be sought; and in buying a second-hand vessel a competent surveyor should be employed to examine her. As a rule, iron steam yachts—and these are to be

preferred—are built up to Lloyd's class, and one of their surveyors would survey the hull for soundness and boiler for strength; but a competent engineer should be employed to examine the engine.

The first cost of an iron steam yacht, tonnage for tonnage, is not greater than that of a wood sailing yacht; but the accommodation of the former will of course be much inferior on account of the space taken up in the best part of the vessel by the engine and boiler; so, in considering the cost, it will be fair to compare two vessels of about equal accommodation.

A steam yacht 56ft. on the load line, with 10ft. beam and 6ft. draught of water, would have accommodation about equal to that of a cruising sailing yacht 46ft. long, with 10ft. beam and 7ft. 6in. draught of water. The probable cost of the steam yacht, assuming her to be fitted with compound surface condensing engines by a good builder, would be about 1500*l.*, or, if expensively fitted, 1700*l.* The yacht, however, could be obtained of some firms for about 1200*l.* The sailing yacht would cost about 800*l.*

The expenses of working the steam yacht would be as follows:

Coals for forty days, or 10,000 miles steaming	£60	0	0
Engine room stores.....	8	0	0
Ship chandlers' stores	8	0	0
Repairs and renewals.....	40	0	0
Master, 16 weeks at 50 <i>s.</i>	40	0	0
Engineer, 16 weeks at 50 <i>s.</i>	40	0	0
One seaman at 25 <i>s.</i>	20	0	0
Clothes for master	10	0	0
Clothes for engineer	10	0	0
Clothes for seaman	4	0	0
Board wages for master and engineer, 12 <i>s.</i> each	19	4	0
	£259	4	0

To this might be added 75*l.* for interest on first cost, and 100*l.* for annual depreciation. Insurance 30*l.*

The wages for master are put high, as it is assumed he would not be a yearly servant; however, frequently a master of a small steam yacht is given no more than 40*s.* per week under a yearly engagement.

A fireman or stoker of experience might be obtained for 2*l.*, or even 35*s.*, a week, who would be able to drive the engines; but in the end it would be found more economical to obtain the services of a skilled engineer even at a cost of 3*l.* per week. There is no rule about boarding engineers, and frequently no board wages are paid; but it amounts to the same thing in the end whether the wages are divided under two heads or not. If night passages have to be made, a good fireman or stoker would have to be shipped in addition to the engineer.

If the engines were non-condensing, the first cost would be about 120*l.* less; but for coast work it is almost a matter of necessity to have condensing engines, or the boiler will early give trouble.

Expenses for working a 20-ton sailing yacht :

Ship chandlers' stores	£10	0	0
Repairs and renewals.....	40	0	0
Master, at 40 <i>s.</i> per week	32	0	0
Seaman, as mate, at 27 <i>s.</i> per week	21	12	0
Seaman, at 25 <i>s.</i> per week	20	0	0
Clothes for master	10	0	0
Clothes for seamen	8	0	0
	<hr/>		
	£141	12	0

Interest on capital, 40*l.*; annual depreciation, 50*l.*; insurance, 16*l.*

In making passages of more than twelve hours' duration, only one hand at a time would go below for a watch, unless the owner could take a watch on deck, which would be in the mate's watch.

It will be noted that in making these estimates stewards and cooks have not been included.

A steam yacht of 100 tons would cost about 4500*l.*, and have the accommodation of a cruiser of 60 tons, and the expenses of working her would be :

Engine room stores.....	£25	0	0
Coal for forty days, or 10,000 miles steaming	80	0	0
Ship chandlers' stores	15	0	0
Repairs and renewals.....	120	0	0
Master, 16 weeks at 50 <i>s.</i> per week	40	0	0
Engineer, 16 weeks at 50 <i>s.</i> per week	40	0	0
Stoker, 16 weeks at 35 <i>s.</i> per week	28	0	0
Mate, 16 weeks at 30 <i>s.</i> per week	24	0	0
Three seamen, at 25 <i>s.</i> per week each	60	10	0
Clothes for master	10	0	0
Clothes for engineer	10	0	0
Clothes for stoker and seaman	20	0	0
Board wages for master and engineer	16	0	0
	<hr/>		
	£488	10	0

Interest on capital, 225*l.*; annual depreciation, 300*l.*; insurance, 80*l.*

The stoker would be capable of taking charge of the engine during a watch, and two of the seamen should be able to stoke. The stoker would only take charge when making long passages, when he would have one seaman in his watch below; when merely cruising about for a few hours during the day, the stoker would be in the engine-room with the engineer.

The cost of a sailing yacht of 60 tons would be about 2000*l.*, and the expenses of working her as follows:

Repairs and renewal of hull, taking an annual average of 5 years ...	£270	0	0
Renewal of sails and rigging, taking an annual average of 5 years...	60	0	0
Ship chandlers' stores, oil, paint, varnish, brushes, charts, flags, cooke, &c.	50	0	0
Hire of store	10	0	0
Sailing master, at 50 <i>s.</i> per week	40	0	0
Mate, 16 weeks at 30 <i>s.</i> per week	24	0	0
Four seamen 25 <i>s.</i> a week each	80	0	0
Clothes	45	0	0
Board wages for master.....	8	0	0
	<u>£387</u>	<u>0</u>	<u>0</u>

Interest on capital, 100*l.*; annual depreciation, 60*l.*; insurance, 50*l.*

A 300-ton steam yacht would cost about 11,000*l.*, and afford the accommodation of a 200-ton sailing yacht, and the working expenses would be:

Engine room stores	£50	0	0
Coal for forty days, or 10,000 miles steaming	170	0	0
Ship chandlers' stores	20	0	0
Repairs and renewals	300	0	0
Master, at 3 <i>l.</i> per week	48	0	0
Engineer, at 3 <i>l.</i> per week	48	0	0
Mate, at 2 <i>l.</i> 10 <i>s.</i> per week	40	0	0
Second engineer, at 2 <i>l.</i> per week	32	0	0
Three stokers, at 28 <i>s.</i> per week	67	4	0
Boatswain, at 30 <i>s.</i> per week	24	0	0
Carpenter, at 30 <i>s.</i> per week	24	0	0
Three A.B.'s, at 28 <i>s.</i> per week	67	4	0
Three A.B.'s, at 25 <i>s.</i> per week	60	10	0
Clothes for master and mate.....	20	0	0
Clothes for engineers	20	0	0
Clothes for boatswain, seamen, and stokers	50	0	0
Board wages for officers	35	0	0
	<u>£1075</u>	<u>18</u>	<u>0</u>

Interest on first cost, 550*l.*; annual depreciation, 800*l.*; insurance, 200*l.*

The cost of a 200-ton cruising yacht would be about 7000*l.*, and the working expenses as follows:

Repairs and renewals	£300	0	0
Ship chandlers' and other stores	80	0	0
Master, at 3 <i>l.</i> per week	48	0	0
Mate, at 2 <i>l.</i> per week.....	32	0	0
Boatswain, at 30 <i>s.</i> per week	24	0	0
Carpenter, at 30 <i>s.</i> per week	24	0	0
Three A.B.'s, at 28 <i>s.</i> per week	67	4	0
Six A.B.'s, at 25 <i>s.</i> per week	120	0	0
Clothes for master and mate.....	20	0	0
Clothes for crew	50	0	0
Board wages	16	0	0
	<u>£781</u>	<u>4</u>	<u>0</u>

Interest on first cost, 850*l.*; annual depreciation, 450*l.*; insurance, 150*l.*

The first cost of a 300-ton auxiliary steam yacht would exceed that of the cost of a full steam yacht, as, although the engines might not cost quite so much, the heavy spars, rigging, and sails would cost probably ten times as much as those in the steamer.

The 300-ton auxiliary would be shorter and broader, but in reality the accommodation would be superior, as the engine-room would be proportionately shorter, and the extra breadth would add to the size of the cabins.

The cost of working a 300-ton auxiliary steam yacht, so far as engine-room expenses go, would be about the same as the full steam yacht; but there would be six additional seamen to provide for, amounting to 150*l.* There would be also wear and tear of sails; but, as the engine and boiler would probably be used less in proportion, a fair set-off would be arrived at. However, there is no doubt that for home cruising, or even for cruising to the Mediterranean or Baltic, the full steam yacht will prove the more economical and most satisfactory.

For making extended voyages to the South Atlantic or Pacific, the auxiliary steam yacht is to be preferred, as often they may be able to reel off 4000 or more miles right away with a leading wind. Also, as an auxiliary steam yacht has generally more beam to length and a great deal more under-water depth of body than the full steam yacht, they are as a consequence better and steadier sea boats, and on that account are to be preferred.

In making a long voyage great care should be taken in selecting an engineer; a thoroughly experienced working man should be obtained—one who not only knows how to drive an engine, but who is also capable of readjusting any of its parts and effecting slight repairs. The second engineer should also be what is known as a “donkey man.” As much as 4*l.* a week and board wages have been paid to an engineer for long voyages, and 3*l.* to second engineer.

A certificated “second engineer” is frequently engaged to take charge of a yacht’s engines, and, if a steady, sober man can be found, a certificated “second engineer” will be a most invaluable one to employ. These second engineers have often been “donkey men,” that is, men who, having acquired a fair education, have risen from firemen or stokers. The Board of Trade qualifications for second-class engineer are as follows: “The candidate must be twenty-one years of age, and have served an apprenticeship to an engineer, and prove that during the period of his apprenticeship he has been employed in the making and repairing of engines; or if he has not served an apprenticeship, three years’ employment in a factory or workshop where engines are made or repaired will

suffice; but in either case he must also have served one year at sea in the engine-room. If he has not been apprenticed to an engineer, nor worked in a factory for the stipulated time, four years' service at sea in the engine-room will qualify him. However or wherever he may have been employed, he must be able to give a description of boilers and the methods of staying them, together with the use and management of the different valves, cocks, pipes, and connections. He must know how to correct defects from accidents and decay, and to repair them, and to understand the use of the barometer, thermometer, hydrometer, and salinometer. He must state, when asked, the causes, effects, and remedies for incrustation; and his educational attainments must be ample enough to pass in the first five rules of arithmetic and decimals, besides which he will be questioned as to the construction and fixing of paddle and screw engines."

In selecting a "second engineer" to put in charge of a yacht's engines, one who is fresh from the factory or with only one year's sea service should be avoided; the "donkey man," who has worked up to his certificate at sea, on the other hand, will be a thoroughly reliable engineer to engage.

In engaging an engineer the owner should make it clearly understood to him that he will be under the authority and direction of the master. This understanding is absolutely necessary.

The owner of a small steam yacht who desires to become acquainted with the working of his engines should obtain the following books: "The Safe Use of Steam" (price 6*d.*), Crosby, Lockwood, and Co., 7, Stationers' Hall-court; Donaldson's "Practical Guide to Marine Steam Machinery" (5*s.*), G. Wilson, 356, The Minories; Goodeve's "Text-Book of the Steam Engine" (6*s.*), Crosby, Lockwood, and Co.; and Murray's "Marine Engine" (3*s.*), Weale's Series. Also a copy of "The Marine Steam Engine for the Use of the Officers of Her Majesty's Navy" should be obtained, if possible. It was published by Longman, Pater-noster-row; the latest edition is 1860.

CHAPTER XXVIII.

ICE YACHTING.

FASCINATING pastimes like yacht and boat sailing ought to sink into insignificance when compared with the fascinations of ice yachting, if speed alone be the cause of excitement. It is, however, difficult for a Briton to realise the extraordinary enthusiasm ice-boat racing or sailing gives rise to in Canada, the United States, and some parts of Europe. The mere idea of being conveyed through the air in a boat at a rate equal to the speed of the fastest express train repels rather than fascinates; however, those who have experienced the extraordinary velocity of an ice yacht say that when the first dread of the lightning-like flight is overcome, the longing for the fast travelling of an ice yacht becomes quite a fascination.

Ice boating in England has been attempted on many occasions, and in Folkard's "Sailing Boat" are numerous plans for making such contrivances; however, none of these agree with the American plan of making ice boats, but, as the Americans have had more experience of ice-boat sailing than any other people in the world, we may take it for granted that their plan is in every way better adapted than any other for the attainment of high speed and safety. A winter seldom occurs in America when no ice-boat sailing is possible; and on the Hudson and smaller lakes of Canada the sport is as much a winter amusement as cat-boat sailing is at the watering-places during the summer months. In the British Isles we do not often get a long enough duration of frost to render ice boating possible; but ice boats have been constructed and sailed, and the frequent inquiry for information concerning them would lead one to think that, with suitable opportunities, ice-boat sailing would become as popular here as it is in North America; and, as the boats are very simple and inexpensive in construction, there is no reason why the amusement should not be taken up by anyone who knows anything at

all about boat sailing or boat steering. The engraving which we give of the American ice yacht, Haze (owned by Mr. Aaron Innes, of Poughkeepsie, U.S.), is, we presume, a fair example of Transatlantic ice yachts, although they are not all exactly alike in every detail. The different parts of the yacht and the mode of construction can be readily understood from the engraving, and all we need do is to describe these parts, and

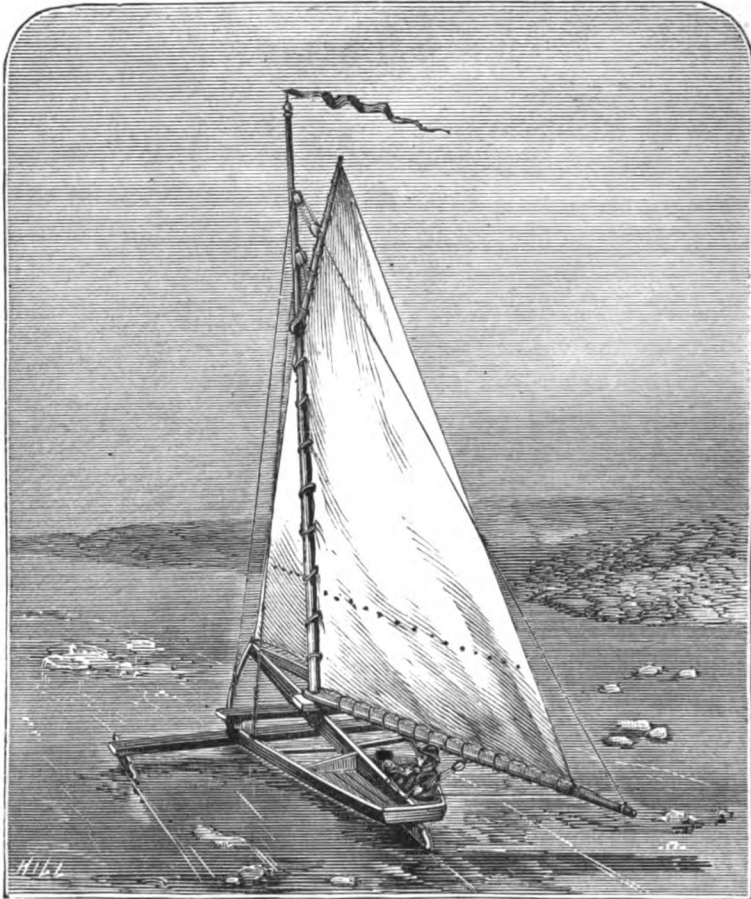

FIG. 120. THE AMERICAN ICE YACHT "HAZE."

give the sizes of the material, such as used in the construction of the Haze.*

The keel, or centre timber, is 24ft. 6in. long, 3in. wide, and 9in. deep (an ordinary "deal"). The side frames are 2½in. thick and 4in. deep.

At the mast a timber, 1ft. wide, by 3in. deep and 7ft. 6in. long, is fitted on top across the side frames. Underneath the mast timber is the

* The engraving is copied from the *Scientific American*.

"runner" plank, of 1ft. width, 8in. depth, and about 16ft. long, the side frames, mast plank, and "runner" plank being all bolted together. Sometimes the side framing is continued forward of the mast timber round to the bowsprit, and thus makes the construction look more boat-like.

The after part of the frame is bottom-planked with inch boards to form the deck.

The "runners" are three in number, one fixed to either end of the runner plank (which crosses the keel at right angles), and the third is fitted aft to the keel timber and rudder post, and is used as a rudder, the pintles being "upside down." This rudder-runner is usually somewhat smaller than the other two, and is fitted with a tiller.

The runners are securely fitted, in a line parallel with the keel, to the ends of the runner plank. They are 6in. deep, 2in. thick, and 2ft. 6in. or 3ft. long. Each runner is shod with steel, and rounded up at the fore end. The shoe is solid, and is 1½in. deep. One inch of this depth is ground to an angle of 90° V; the remaining ½in. forms the upper part of the shoe, and is square with the top, which is 2in. wide. The steel is "tapped" on the upper side about an inch deep. Into these taps ½in. bolts are screwed, and are long enough to pass through the runner and runner plank; their heads are then secured with counter-sunk nuts before the runner is fitted to the "runner plank."*

As a rule, nothing but the two sails are carried, and the ice yachts of Toronto have but one lateen sail. These lateen sails are similar to the sail described on page 296, and reproduced in Fig. 121. The dimensions of the spars of the Haze are as follows:

Mast, step to cap.....	20ft.
Mast, diameter at heel	5in.
Mast, diameter at cap	3½in.
Bowsprit, beyond mast	16ft. 6in.
Bowsprit, depth at mast.....	6in.
Bowsprit, depth at outer end.....	3in.
Bowsprit, width†	3½in.

* In the Naval Museum, South Kensington, there is the model of a Finland ice boat. The runners of this boat are large skates, 7in. or 8in. deep, about 2ft. long, and about 1in. thick. They are very much rounded up at the fore end, like a Dutch skate. They are fastened by transverse bolts to the sides of pieces of timber of the same length as the skates. The cross timber, or "runner plank," is sunk into the top of the pieces of timber to which the two side skates are bolted. The after centre skate (there are three skates in all, including the rudder skate) is of similar pattern, and is fixed as a rudder. The keel of this boat is 24ft. The breadth across the runners is 12ft. The Finland model is also said to represent a "Canadian" ice boat. It is of the Γ form, with timbers fitted to it in an X form for strength. An ice boat constructed in 1878 for Lake Windermere had the "skates" pivoted to the runners, so as to have a fore and aft motion. The idea was to ease jolting in coming upon irregularities in the ice, but it is difficult to understand that the jolting could be relieved by such a method.

† The bowsprit is fitted to the keel by a clamp iron ½in. by ½in., and by a through-bolt abaft the iron. The bowsprit can be a mere continuation of the keel timber.

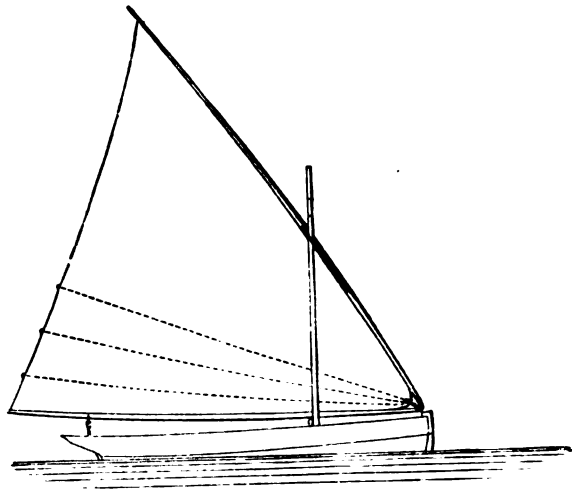

FIG. 121.

	ft.	in.
Jibboom, length (when one is fitted)	15	3
Jibboom, diameter at centre	0	2½
Jibboom, diameter at ends	0	2
Mainboom, length	29	4
Mainboom, diameter at centre	0	4½
Mainboom, diameter at ends	0	2½
Gaff, length	8	9
Gaff, diameter	0	2
Mainsail, luff	14	6
Mainsail, foot	28	0
Mainsail, head	8	0
Foresail, leech	15	0
Foresail, luff	22	0
Foresail, foot	14	6

The ice boats are usually of about the dimensions given; but one, the *Icicle*, owned by Mr. J. A. Roosevelt, has a framework 32ft. long, is 26ft. between the runners, and the runners are 7ft. 6in. These appear to be extreme dimensions. An ice boat built for a gentleman in the North of England in 1879 was 12ft. long, and the runner plank was about 7ft. long, the sizes of the timber being proportionately small. The weight, however, is of use when sailing with a beam wind, to keep the boat from excessive heeling, it being a not uncommon circumstance for the weather runner to be lifted four or five feet off the ice; and in such an event the yacht is luffed sharp up.

The favourite points of sailing are with the wind a point or so before the beam, right abeam, or a point abaft the beam. With such a wind, a straight course over perfectly smooth ice, free from hummocks and cracks, and a gale of wind, it is claimed that these yachts can and do travel at the rate of sixty or more miles an hour. Every winter we see

numerous records of such time made, and they are apparently well authenticated; at any rate, it seems incredible that, year after year, American gentlemen should enter into a conspiracy to deliberately publish false times. There is not the shadow of a reason for believing that the time given for making a mile (a statute mile is understood) is persistently exaggerated.*

An elucidation of the phenomenon of a vessel sailing faster than the wind has frequently been attempted, but, up to the time when this was written in 1879, with no clear conception of the mechanical principles involved. In the first place, it must be distinctly understood that a boat's speed before a wind which blows with a constant velocity cannot equal the speed of the wind; under different conditions it is conceivable, and in accordance with mechanical principles, that the speed of a boat may equal, and greatly exceed, that of the wind. If the boat were before a wind which is travelling at the rate of 30 sea miles an hour, the direct impulse of the wind on the sails, if *fixtures*, would be equal to 6lb. per square foot. But the sails are not fixtures, and move before, or away from, the wind; the pressure is thereby gradually diminished until it is balanced by the resistance met with by the boat on the ice. As the resistance of an ice boat is very small, a high speed—nearly equal to that of the wind—is reached before the resistance and the wind pressure become uniform. Thus, say the velocity of the wind were 30 miles an hour, and the speed of the boat 20 miles an hour, the resultant pressure of the wind would be only of that due to a wind speed of 10 miles, or about $\frac{1}{3}$ lb. per square foot. But if the wind makes a more or less acute angle with the line of advance, the conditions are entirely altered; the pressure of the

* The following extract from a letter, copied from the *Spirit of the Times*, March 1, 1879, whilst it gives a denial to the fictitious speed attributed to some ice yachts, confirms the report of the amazing speed an ice yacht is capable of: "As to the speed of ice yachts much has been said, and a great deal has been said devoid of truth. A wind on the beam—what we call three-quarters free—is the wind for speed, and there are times that a yacht attains a speed of sixty-five to seventy miles per hour (in fact, there is no limit to their speed, conditions of ice and wind favourable); but the yacht is not able to maintain this high speed long, as the helmsman is continually obliged to deviate from a straight course, on account of hummocks, cracks, or rough ice, and the course of a yacht is always zigzag instead of straight. I have often, in company with Commodore Grinnell, of the N.H.I.B. Club, raced with the express trains on the Hudson River Railroad. We would beat down on a train with a good west wind, and often run side and side with the train over a mile; then the wind would light up, and the train would draw ahead. At other times we would pass a train like a rocket, and run a mile and a half ahead, when we would be compelled to tack across the river and bear away again. Meantime the train would crawl up, only to be beaten again for a mile or two. The fastest time between Ponghkeepsie and New Hamburg that I know of was made this winter. The distance is nine and three-quarter miles, and the run was made by the yacht Zephyr, of the N.H.I.B.C., in ten minutes. The Phantom made the same run, some years ago, in twelve minutes. The yacht Whiz was reported, and has a record of the same course of nine and three-quarter miles in seven minutes. This is another mistake as she never made the time, but it went the round of the papers all the same."

wind does not diminish with the advance of the boat, and its effective impulse is determinable on mechanical principles, which will admit as possible a speed of the boat much greater than the actual speed of the wind. However, it is scarcely possible that any water-borne boat propelled by sails could ever be made to exceed the speed of the wind which impelled it, on account of the enormous growth of the resistance due to wave-making; but "ice boats" may be regarded as having almost no head-resistance; the slightest force will give them motion, and keep them in motion. The only friction is from the lee runner, as when sailing the weather runner seldom touches the ice, and the lee runner, cutting into the ice, prevents excessive leeway.

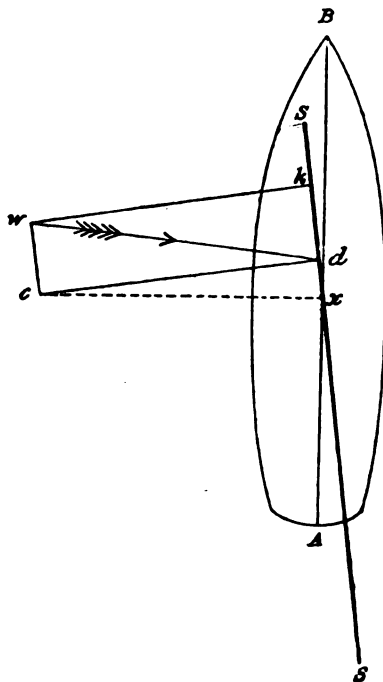

FIG. 122.

To illustrate the principles involved, it will be assumed as a fact that ice boats in America have been timed to sail at the rate of one mile in a minute by the aid of a force due to a velocity of thirty sea miles an hour of the wind. Such a wind force is termed a "fresh gale" by sailors, and a ship would be under reefed topsails, reefed courses, or possibly fore and mizen topsails furled. In Fig. 122 we will suppose A B to be a boat fixed so that it cannot move. The line $w d$ represents on a scale the direction and force or speed of the wind equal to 30 miles an hour. The line $s s$ represents the balance lug sail of an ice boat. It

is obvious that the wind, blowing on the sail from the direction shown, would tend to drive the boat in the direction of its own motion. But the force $w d$ is made up of two components—one, $c d$, is acting at right angles to the sail, and the other, $d k$, acting along the plane of the sail without any potent effect. The component $c d$ can be further regarded

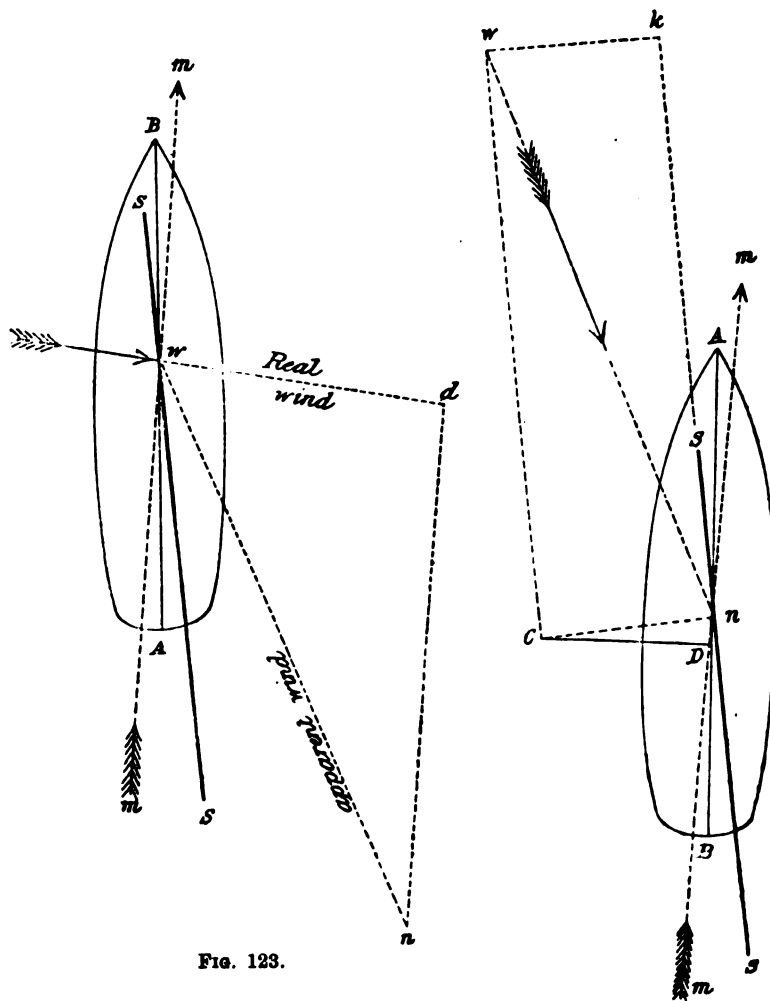

FIG. 123.

FIG. 124.

as a force made up of three other components—one, $c x$, acting at right angles to the keel of the vessel, and tending to drive her to leeward; another, $x d$, acts in a line with the vessel's keel, and tending to drive her ahead. The third force is resolved vertically in a downward direction, and need not be considered.

Hitherto we have only dealt with the "real wind," and we have now to consider what takes place when a boat, under the influence of $x d$, gathers way, or commences to move in a direction to meet the wind at a more or less acute angle. In Fig. 123 $A B$ is the boat set in motion* by the component of the wind $x d$, and is proceeding in the direction of the arrow $m m$; the difference between the arrow and the keel line represents the angle of leeway, or amount of leeway made. The dotted line $w d$ represents the direction and velocity of the real wind, as in Fig. 122; but the wind *apparently* will now be blowing more ahead, and it is the *apparent wind* with which we have to deal. The apparent wind is thus determined: On a line parallel to $m m$ set off a distance (see $d n$, Fig. 123) by scale (same as the wind scale) to represent an opposing motion equal to the speed of the boat (assumed in this case to be sixty miles an hour, or double the velocity of the wind). Join $n w$, and the dotted line $n w$ will represent the force and direction of the *apparent wind*.

This apparent wind must now be regarded as the propelling force, and not the real wind as shown in Fig. 122. In Fig. 124 let the dotted line $w n$ represent the direction and force of the *apparent wind*; by a parallelogram of forces the line of force $w n$ has two components, one acting in the direction $w c$, or $k n$, and the other in the direction $c n$. The component $c n$ is farther resolved into three components, as before shown by Fig. 122, represented by $c D$ and $D n$ in Fig. 124, and another acting vertically, not shown. It is the component $D n$ which impels the boat forward. It will be seen that the force $D n$ is very small, or only about one-seventh of the force $c D$, which is striving to drive the boat to leeward; but the resistance to leeway is very great, whilst the resistance to headway is very small. Consequently the boat moves a scarcely perceptible distance in a broadside direction, but gathers speed in the direction of her keel, or rather in the direction of the line $m m$, which includes the broadside motion or leeway. The boat continues to gather way or increase in speed from the rest position shown in Fig. 122 until the resistance she meets with, from friction of the skates on the ice and resistance to the rigging, &c., equals the force shown by $D n$. The speed of the boat then remains uniform so long as the wind is constant.

If the speed, *with the same wind force*, could be increased, by diminishing the resistance, beyond sixty miles an hour, the apparent wind would draw more ahead, and then obviously the effective impulse, $D n$, would be further diminished, until the apparent wind were brought right ahead,

* The sail is represented as hauled flat in. In practice the sail would be well off at the moment of starting, and would be gradually hauled aboard as the speed increased and the apparent wind drew more ahead.

when D_n would disappear altogether; the sails would "lift," and a fresh start would have to be made.

From what has been said it will be concluded that on any point of sailing between a quarterly wind and a wind on the bow, if any great speed is realised, the boom must be hauled close aboard, the exact angle with the keel being determined by the speed of the boat or by the direction of the apparent wind, and not by the direction of the real wind. When a point dead to leeward has to be made, it is thought that the point is reached more quickly by hauling up to 45° from the course, and then, when half-way, gybing or tacking, and making for the point to be reached, thus traversing a right angle.

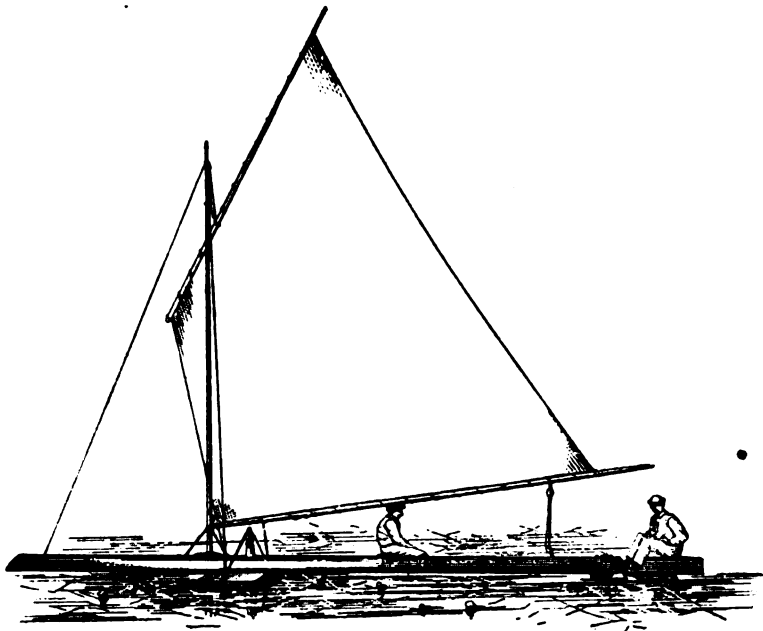

FIG. 125.

Sailing for a point dead to windward is not such rapid work, and we believe ice boats do not make a course nearer than $3\frac{1}{4}$ points of the real wind, and their speed over the ice is not one-half of what it is with a beam wind, but it is believed to just about equal the speed of the wind.

The usual mode of coming to rest from a high speed is by running off to dead before the wind, and then luffing to sharply until head to wind. The boat is "anchored" by turning the "rudder runner" right across the keel.

The ice yachts just described would be much too heavy for sailing on the thin ice of our lakes, and three years ago Mr. Herbert Crossley,

of Windermere, built one of very slight construction, as shown in Fig. 125.

The fore-and-aft frames are made of yellow pine, 34ft. long 9in. deep and 1in. thick. These are spaced 1ft. 3in. apart (inside measurement) with a bottom plank of equal thickness; thus the structure forms an open box. Besides the bottom plank the fore-and-aft frames are connected forward by a cross piece of pine 9in. by 1in., in which is an eye-bolt for the forestay.

Aft is a similar cross piece 9in. broad fixed 2ft. 6in. from the end, and forms a seat for the steersman.

The foreside of the runner frame is 10ft. 6in. from the fore end of the frames, and is also of 1in. pine 3ft. broad and 12ft. across from runner to runner. The runner frame is secured by screw bolts and nuts to the bottom plank, and also by 1in. iron stays, screwed up by a nut on an iron stanchion of 1in. iron. The stanchion is fitted with a shoulder at its lower end, and is screwed up with a nut underneath the bottom of the box and the runner frame. Two other stays of $\frac{1}{2}$ in. iron connect the head of the stanchion with the top edge of the fore-and-aft frames. This construction will be seen in Fig. 125.

The runners are 4ft. 3in. long and 3in. deep, also of 1in. pine, securely attached to the runner frames. On the lower edge is the steel skate, $\frac{1}{2}$ in. thick and 2in. or 3in. deep. The lower edge is bevelled to make a sharp edge of about 45°. The flat side of the sharp edge is outside. These skates are rounded up at the ends like an ordinary skate. They are screwed to the side of the runner, or they can be let into a channel ploughed out of the underside of the wood runner and then be secured by screws.

The after runners are glass bullseyes, as shown by *b* in Fig. 126, about 8in. in diameter. The bullseyes were cast with shoulders as shown, and secured to a wood circular chock by clamps, *c c c*, Fig. 126. The wood is 2 $\frac{1}{2}$ in. thick, and between it and the glass is a sort of buffer made of $\frac{1}{2}$ in. felt; india rubber will not do, as it gets hard or freezes. The bullseye is 1 $\frac{1}{2}$ in. thick, $\frac{1}{2}$ in. of the thickness forming the shoulder for the clips *c c c* to take hold of. Through the centre of the wood a bolt with a broad head is passed (the head is sunk into the wood) and screwed up by a nut through the bottom plank on the under-side of the fore-and-aft frame. These glass runners are fitted nearly as far aft as the seat of the steersman.

The bullseyes were introduced to admit of the boat being readily swung round under the influence of the rudder.

Fig. 127 shows the rudder, 1ft. 3in. long, 4in. deep, with a handle 1ft. 9in. long. The rudder is of iron with under edge of steel ground

to 9° thus, ∇ . The under edge of the rudder has a longer bearing than shown in Fig. 127, or is deeper under the bolt *a*. The bolt *a* passes through two iron plates which are secured to a cross piece of 2in. deal, worked above the bottom board. It will be seen that the rudder is capable of an up-and-down motion as well as lateral. The bolt *a* is 2ft. 9in. from the fore edge of the seat of the steersman. To allow of the lateral motion of the rudder, a large dove-tailed slot $>$ is cut out of the bottom board, 1ft. 9in. long, and 1ft. across at the after end. The bolt *a* comes at the pointed end of the slot. A circular piece is cut out of the side of each fore-and-aft frame to allow the handle of the rudder to be put well over. The rudder, of course, is

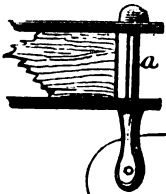

FIG. 127.

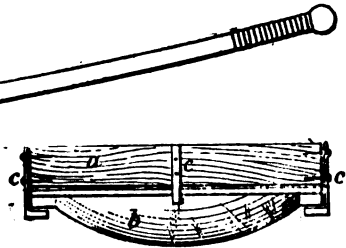

FIG. 128.

not intended to be used as a runner, as it is in the American ice yachts, but is used to assist in stopping the yacht by pressing it into the ice.

Six inches forward of the fore edge of the steersman's seat a cross piece is fitted, projecting on each side to form a place for the feet. Of course, this cross piece is fitted to the underside of the frame.

The mast is stepped in a chock on the bottom plank, 10ft. from the fore end of the frame, and is secured by three iron stays attached to an iron band round the mast 2ft. above the bottom plank. One stay forward, and one on each side leading a little aft. Besides these stays the mast has a shroud on each side, set up by a lanyard to the runner frame and a forestay.

Mast from the bottom plank to shoulder 22ft., luff of mainsail 11ft. 6in., leech 29ft. 6in., foot 20ft., head 17ft. 3in., tack to peak earing 26ft. 3in., clew to weather earing 25ft., slings 6ft. 3in. from weather earing.

The boom works on the mast by a gooseneck fitted into a socket on the iron band which goes round the mast for the lower stays before referred to.

The sail, it will be seen, is a standing lug.

CHAPTER XXIX.

CANOEING.

NAUTILUS CANOES.

BRITISH canoeing includes such various branches of work, and so many forms of canoes, each adapted particularly to its own branch and generally to all the others, that a consideration of canoe designs can hardly be successfully entered upon without first glancing at the rules and practices which at present guide the members of the Royal Canoe Club, who form the majority of British canoeists.

To construct a concise definition to comprehend a "canoe" is not an easy matter. No doubt the rules of the Royal Canoe Club do in a measure dictate what is and what is not a canoe; but there are still many loopholes left by which a canoe can be invested with qualities which strictly do not belong to the "canoe" proper. The disintegrated materials from which a concise definition might be abstracted are, among others, some of the following: A canoe is a vessel propelled with a paddle or with sail by a person or persons facing forward; she is a vessel capable of navigating shallow water as well as open rough water; and she is a vessel not too large or heavy for land portage by two men when her ballast and stores have been removed. Therefore, a vessel propelled by oars or machinery, which, either by bulk of hull or weight of fixed ballast cannot be lifted by two men, is not adapted to the requirements, nor entitled to the appellation, of a "British canoe."

The cruising work, for which a British canoe is mainly constructed, demands that she shall be as small and as light as possible compatible with sea-going qualities and carrying capacity; but the occasional sailing matches in which such a craft may compete, suggest an increase of power by size and weight for sail-carrying purposes; and, therefore, in order to protect the majority and to foster craft of the cruising type, it has been found necessary to check by club rules the introduction of mere racing machines, which, by lead, beam, and sail-area, might desert the canoe definition and become miniature yachts.

The Royal Canoe Club, however, does not attempt to define or limit the size, design, construction, or crew of canoes, except as regards sailing and paddling matches; and, therefore, provided the canoeist does not intend to compete in the club matches, he may build his craft in any manner his experience or fancy may dictate. But there can be no question that under the club rules a most serviceable type of canoe for general cruising, and also a very perfect class of sea-going sailing canoes have been produced; and as the canoes we are about now to consider are to conform strictly to the club rule, it may be advisable to set the rule out in full.

“Canoes eligible for these races shall be not over the following dimensions: 1ST CLASS.—Any material and build—greatest length over all from stem to stern post, not more than 20ft., with a limit beam of 2ft.; but the beam may be increased by 1½in. for each whole foot of length decreased; greatest depth at fore end of well under the centre of the deck to the garboards not more than 16in. Fixed keel of wood not more than 2in. deep; a metal band not exceeding ½in. in depth may be added to the wooden keel, in which case the depth of the keel, inclusive of band, must not exceed 2in. One or more centre-boards are allowed of any material, thickness not exceeding ½in., length (combined if more than one) not exceeding half the canoe's length;* depth of drop not exceeding 18in. below the fixed keel or its metal band. When hauled up they must be completely housed within the canoe. All ballast, anchors, or other metal weights (except centre-boards and metal keel band before described, and metal deck fittings) shall be carried within the canoe above the garboards. Ballast may be shifted during a race, but all ballast on board at starting must be carried throughout the race.

“2ND CLASS CRUISING CANOES.—Canoes in this class shall not exceed the following limits, namely: beam, 30in.; depth from underside of deck to garboard streak, 16in.; keels and centre-boards as in 1st Class. Weight of canoe, including all spars, gear, fittings, and ballast, not over 150lb.”

Having thus far glanced at the general features of canoeing, the next step will be to attempt a practical classification. Hitherto a canoe has generally been classed under one or other of the original type classes, namely, Rob Roy, Ringleader, or Nautilus. Such a classification would only be useful so long as the original model remained unaltered, and succeeding canoes were exact copies of the originals. Even then it is an unsatisfactory attempt at classification; but it will be patent to all canoeists that succeeding Rob Roy and Nautilus canoes have been built widely differ-

* The limit as to thickness of centre-boards not to apply to centre-boards existing in canoes up to 24th November, 1881, provided the owners of such canoes applied to the secretary to have them registered previously to 31st December, 1881.

ing from their predecessors, and also that many craft, taking points from each, have sprung into existence, and claimed a type title of their own.

The Rob Roy was a small, short, strong, and straight-floored canoe, chiefly intended for paddling, and was built without sheer. The Ringleader was a craft similar to the Rob Roy, but of great length, and very light build—in fact, a river canoe. The Nautilus was a short beamy craft, chiefly intended for sailing and cruising in open waters, and was built with considerable sheer, a rockered keel, and rising floor. Therefore, it may be taken that, under this classification, all canoes built with sheer and rockered keels must belong to the Nautilus class, and canoes built without sheer belong to the Ringleader type if long and light, or to the Rob Roy if short, strong, and flat; of course variations must result from such a classification, unless simply “sheer” or “no sheer” is to determine the question of type.

The following is submitted as a more practical classification:—

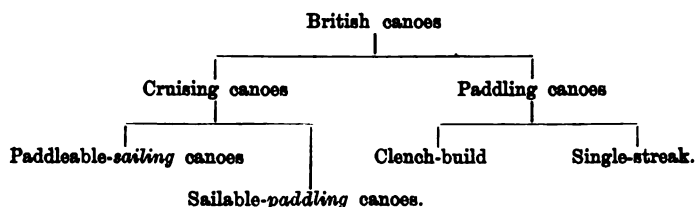

“NAUTILUS” PADDLEABLE-SAILING CANOE.

The paddleable-*sailing* canoe is a vessel designed for cruising on navigable rivers, lakes, and seas, and for sailing matches—a craft in which sailing is the chief mode of propulsion. The *sailable-paddling* canoe is intended for navigating inland lakes, rivers, and canals, and in her paddling is the chief mode of propulsion.

A universal feature of British canoes is that they are “decked,” and, with the exception of a few river craft, the decks are of wood permanently and substantially built to the canoe. An equally prominent, but not so universal, feature is that, with the exception of the club “fours” and a few two-handed canoes, each canoe is manned by one man only; but, when considering the subject of *sailable-paddling* canoes as regards their adaptability to extensive foreign cruising and exploration, we shall endeavour to point out the advantages, if not superiority, of double-handed canoes for touring purposes.

The design and construction of a paddleable-*sailing* canoe will first be considered. The design represented by Plate XLVII. has stood the test of existence, and has originated several craft highly successful both as cruisers and racers; but the design has been slightly

altered from the one recently built to—as will be duly pointed out—in order to rectify such weaknesses as were made apparent by practical tests; the centres of “lateral resistance” and “effort of sails,” have been placed conformably to the dictates of actual trial; and the various fittings and equipments as to sizes, shapes, and positions, are not speculative, but the tried results of the experience of many good canoeists.

Under the sliding scale of the club rules canoes have crowded into the lengths between and inclusive of 12ft. and 15ft., and of these perhaps 14ft. canoes are the most numerous. The most generally serviceable sailing canoe (which may be paddled) will be found under the dimensions of 13ft. length, by 2ft. 10½in. beam. Another club rule is that the depth at the fore end of the “well,” from under the centre of deck to garboards, shall not exceed 16in.; keel outside not more than 2in.; centre-board not more than 18in. deep.

On these leading dimensions the design has been constructed:

The “sheer plan” is that from which all the heights, depths, and lengths are taken, and is shown at the scale of ¾in. to 1ft.

The “body plan” gives the measurements from which building moulds are to be made. The body plan is shown on the scale of ¾in. to a foot.

The deck plan is inserted to show the well coamings and locker and the foot-steering gear. Scale ¾in. to 1ft.

All the plans are drawn to the outside edge of the plank, so that in making building moulds, &c., allowance must be made for the thickness of plank, and also a piece must be cut out of the moulds to fit over the inboard portion of the keel to the upper edge of the rabbet. The moulds need only be “half moulds,” *i.e.*, representing the shape of one side only to the middle vertical line, and will then be worked for both sides, fixing a fore-and-aft cord as the centre line. If, however, there is any doubt as to the capabilities of the workman (even if with a good man, great accuracy is required), then whole solid moulds fixed in position, form the only safe plan, as with half moulds the sides of the boat may, by carelessness, vary very considerably.

Canoes and other small boats are usually built up from a straight-edge building block, and therefore the rocker, or upward curve of the keel from that straight-edge is given; the heights of stem and sternposts, and their “set” or “rake,” will be taken from the drawing, and they will be fixed in position to the keel before the latter is fixed to the building block. The other heights, whereby the correct sheer is obtained, will be taken from the sheer plan table, page 414, and transferred to the building moulds; and, to insure these moulds being in position, the load water-line should be marked on both stem piece and stern post and on

each mould; and a hole should be bored through each mould at the cutting of the water-line with the middle line; or, if the whole mould be not solid a batten should be nailed across each, the top edge of which batten should be level with the load water-line; then a tightly-stretched chalk line, nailed to marks on stem and stern posts, should cut the aforesaid water-line points or battens on the moulds. Without this precaution moulds and "lines" are useless, and one might as well build according to the rule-of-thumb plan of allowing the plank to take its own form.

In the sheer plan (see Plate XLVII.) the vertical positions for timbers are placed one foot apart. No. 1 is one foot from vertical of fore side of stem. The heights are measured from the load water-line to the upper side of the deck at gunwale; and the depths are measured from the load water-line to the lower edge of the rabbet on the keel. The back rabbet, or inside position, of keel will be seen in the longitudinal section plan.

The rocker or upward curve of the keel above the straight edge is at the sternpost 1 in., and at the fore end (at 6 in. in from perpendicular of stem) the rocker is $4\frac{1}{2}$ in.; at No. 1 station it is 3 in., at No. 2 it is $1\frac{1}{2}$ in., at No. 3 it is $\frac{3}{4}$ in.; fore edge of stem at load water-line is $1\frac{1}{2}$ in. in from perpendicular of stem; sternpost at L.W.L. from aft perpendicular is $1\frac{1}{2}$ in.

The keel, from No. 3 to No. 7 sections—*i.e.*, in the wake of the centre-board slot—is sided at rabbet line 2 in., and is $1\frac{1}{2}$ in. at lower edge; the siding—*i.e.*, thickness—at rabbet line forward and aft of this should not be less than $1\frac{1}{2}$ in. The cutwater of stem should be reduced on the fore edge to about $\frac{3}{4}$ in.

Selecting the wood for the keel will be a matter of choice. For hard work teak is recommended; for great strength and weight greenheart; but red pine (not pitch) has been found quite strong enough for all ordinary work.

The next point of importance is the skin, or plank, and the mode of putting it on. Except for the roughest coast-bumping or for home lake sailing, oak is uselessly strong and heavy. A combination of mahogany and cedar, well seasoned and properly fastened, forms for a sailing canoe as strong and light a build as can be desired—that is to say, the canoe should be built with the three lower strakes, mahogany (the garboard very wide), and the three upper strakes of cedar, ranging from about a quarter to three-eighths of an inch thickness.

Various modes of planking have been tried with the object of obtaining a smooth outer surface, and a light but strong skin; of these the most successful are the "clincher," the "ribband carvel," and the "double skin." The ordinary carvel build requires sufficient thickness of plank to allow of caulking, but this increases the weight beyond what is advisable for a canoe. The "double skin" plan is as follows: When

the stem and stern posts have been set up and fastened off, and the building moulds—say one foot apart—carefully and strongly fixed in position, and firmly battened round at their heads by a kind of temporary gunwale, and the centre-board case or cases fitted and fixed, this framework is turned upside down, and again fixed in position. Thin, well-steamed planks of cedar, about “wager boat” thickness, are tacked in position edge to edge, over the moulds, as if for carvel-planking; over this is then laid, plank by plank, a somewhat thicker skin of steamed cedar, the edges of which come over the centres of the planks of the inner skin. The two skins are then fastened off as if one, along the rabbet line, with brass screws; the edges of the outer skin are then pierced along and copper nailed as in ordinary building. The craft is then turned up and the nails are clenched off on the inside. It will also be found necessary on some strakes to nail along the inner skin edges also. In such case the holes will be bored from inside and nails driven from outside. Very few timbers will be needed, and the double skin will be found to possess great strength. A good coat of varnish or strips of varnished calico between the skins would no doubt add greatly to the strength and watertightness of the structure.

In the ribband-carvel build (see Fig. 128), the planks of, say $\frac{1}{4}$ in. to $\frac{3}{8}$ in. stuff, are tacked on to the building moulds edge to edge. Ribbands



FIG. 128.

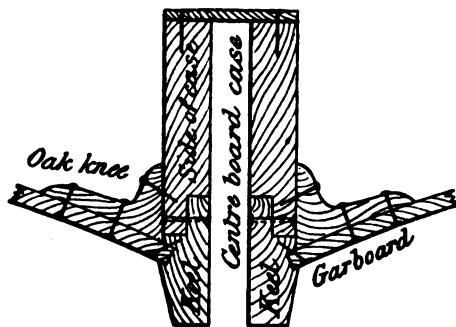

FIG. 129.

of clean-grained oak, about $1\frac{1}{4}$ in. wide and $\frac{1}{4}$ in. or $\frac{3}{8}$ in. thick, are laid along on the inside of the joints of the plank between the timbers which are placed in the vertical positions shown in the sheer plan; the edges of the planks are then pierced and nailed through the ribbands, and clenched on the inside, or they may be screwed into the ribbands. A stronger plan is to work a $\frac{1}{4}$ in. ribband in whole lengths, cutting out notches in the backs of the timbers and moulds to take each ribband. In all cases a strip of varnished linen should be laid over the joints of the plank before the batten is fitted, and the linen should be continuous

from end to end. The timbers are about $\frac{3}{4}$ in. sided by $\frac{3}{4}$ in. moulded. No doubt this mode, and that of the double skin, give a very fine outer surface; but the number of nails required is nearly double that employed in a clincher-built boat, and with neat workmanship a clincher boat can be built with next to no "lands" showing on the outside, and yet be of sufficient strength.

The garboard plank will be 6in. or 8in. wide at the broadest part, and the other planks will be as broad as the shape of the canoe will admit of being worked, and will of course vary in breadth and shape.

The construction of the section of slot in the keel and centre-board case is shown by Fig. 129.

The most convenient mode of "laying off" a canoe for building will be obtained by working in the following manner: Take a sheet of common wall paper of 14ft. length, and on the reverse side draw in, with a straight edge, a strongly marked and straight "load water-line;" then, by measurements from the scale drawing and from the table draw the "sheer plan" at full size. On similar paper, and in like manner, draw the "body plan," and from the body plan cut out moulds of stiff brown paper from which to make the wooden building moulds, *taking off* a margin from the paper or from the wood mould to allow for the thickness of the planking. As before said, the *load water-line* must be carefully marked across each mould; or, better still, a batten should be nailed across the mould to represent the load water-line. (See "Boat Building" in the Appendix.)

The mast steps, centre-board case, bulkheads, coamings, rudder, and centre-board can all be laid off on the sheer plan; and provided the points of measurement are correctly placed—no matter how rough the drawing—the builder will have a clear eye to his work, and the trouble of laying her off on a mould floor will be avoided.

PADDLEABLE SAILING CANOE.—TABLE OF DIMENSIONS.

	ft.	in.
Length over all, stem to sternpost	13	0
Beam, extreme	2	10 $\frac{1}{2}$
Depth from deck to garboard, fore end of well.....	1	3 $\frac{1}{2}$
Sheer, forward, from midships	0	9
Sheer, aft	0	5
Freeboard at midship (No. 7)	0	7
Draught at midship (No. 7).....	0	8
Rake of sternpost, °		
Centre of mainmast from fore side of stem	2	4
Centre of mizenmast from aft side of sternpost	1	2
Mid-length, from perpendicular at fore side of stem	6	6
After bulkhead from mid-length	2	8
Length of centre-board slot.....	3	8
Fore end of centre-board slot from mid-length.....	3	4



PLATE XLVII.

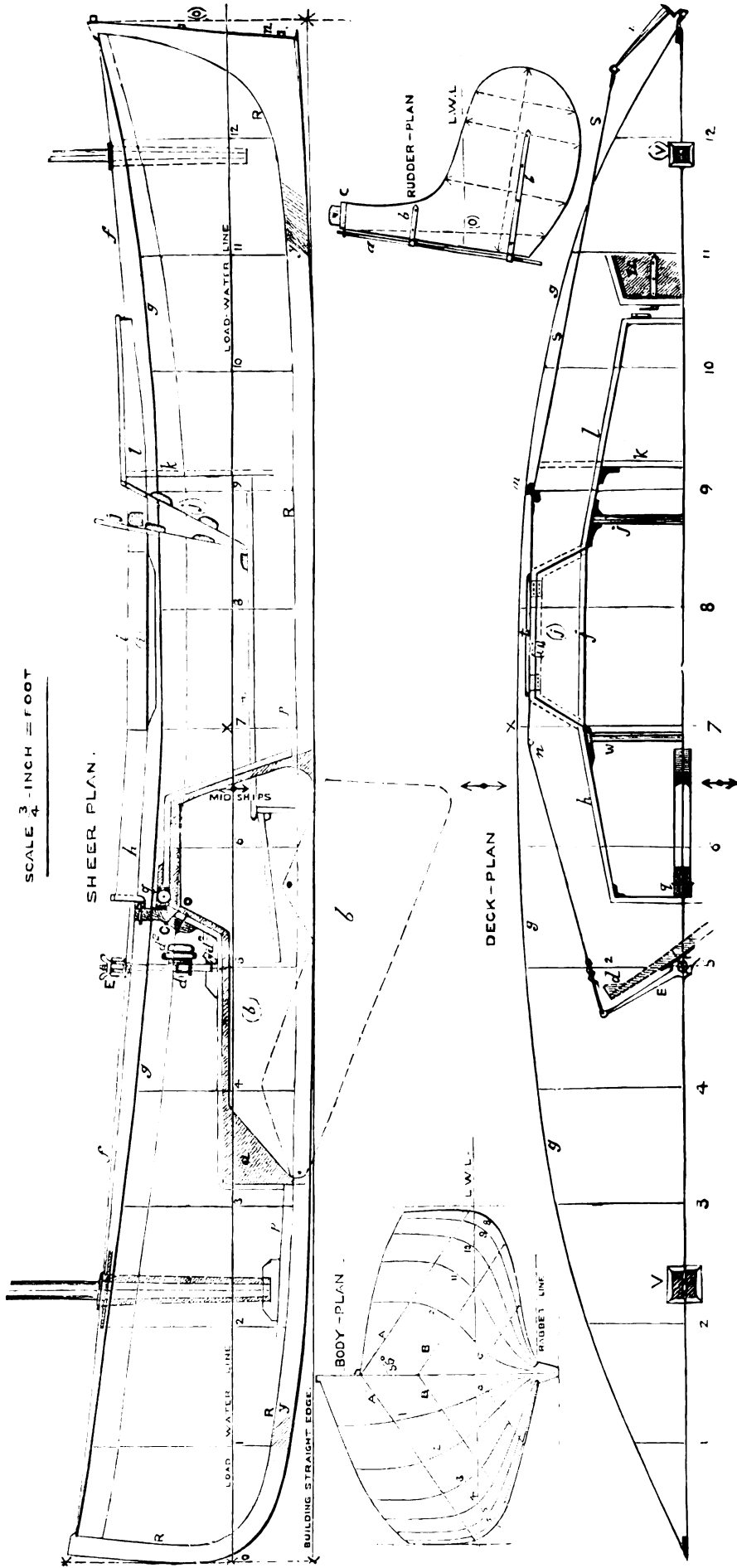

"Nautilus" Paddleable-Sailing Canoe, designed by W. Baden Powell, Esq.

TABLE OF DIMENSIONS—continued.

	ft. in.
Fore end of well, forward of midships	1 0
Length of fore end of well	1 6
Length of middle, or flap piece of well	1 6
Length of after piece of well	0 8
Length of locker opening	1 3
Height of well coamings	0 2
Foot yoke for a 5ft. 8in. man forward of midships	1 6
Centre of lateral resistance aft of midships	0 9
Budder: depth of fore side, 1ft. 7in.; extreme length, 1ft. 7in.; length at head, 3in.; length at 6in. down from head, 3in.; length at load line, 10in.; depth below load line at centre of rudder, 11in.	

TABLE OF HEIGHTS AND DEPTHS. (See PLATE XLVII.)

Number of Section	1	2	3	4	5	6	7	8	9	10	11	12
SHEER PLAN.—FIG. 1.												
Height of gunwale, including deck above load line	14½	12¾	11	9½	8¾	7½	7	7	7¼	8	9	10¾
Height of gunwale at stem above load water-line = 16 inches.												
Ditto at sternpost = 12 inches.												
Depths—Lower edge of rabbet below load line	3½	5	5½	5¾	6	6	6	6	6	6	6	4½
Depth of top streak	2½	—	2½	—	2½	—	2¼	—	2¼	2	1¾	*1¼
Rocker of keel above straight edge .	3	1½	¾	¾	—	—	—	—	—	—	—	¾
BODY PLAN.—FIG. 2.												
Diagonal A is started on middle line at 12in. above L.W.L.	5¾	10½	14¼	16⅞	19	20	20½	20¾	19¼	17¼	14	8½
Diagonal B 6in. above L.W.L.	4½	8½	11¾	13¾	14¾	15½	16	15¾	15	13¼	10¾	6
Diagonal C, at L.W.L.	2¼	4¾	6	7	7¾	8	8¼	7¾	7¼	6¼	4½	2½
Half-siding (width) of keel at rabbet	½	¾	¾	1	1	1	1	1	¾	¾	¾	½

The diagonals form an angle of 55° to the middle line; or diagonal A cuts the L.W.L. at 1ft. 5½in. from the middle line measured on the water-line; diagonals B and C are each parallel to A, and 5in. apart.

It may be again mentioned that all the body plan measurements are to the *outside edge*, so that plank, deck, &c., must be *allowed* for in making the building moulds.

SHEER PLAN.—PLATE XLVII.

- | | |
|---|--|
| <i>o</i> , the perpendicular at the fore end of load water line. | <i>h</i> , forward side-coaming of well. |
| (<i>o</i>), the perpendicular at the aft end of load water-line. | <i>i</i> , coaming of sailing flap, or opening in side deck. |
| <i>a</i> , the centre-board slot and case. | (<i>i</i>), flap, side deck. |
| <i>b</i> , centre-board, lowered for sailing. | <i>j</i> , back-board and shifting beam, used for paddling. |
| (<i>b</i>), centre-board, housed in the case. | (<i>j</i>), back-board in sailing position. |
| <i>c</i> , knee, which steadies the centre board case at point of greatest pressure. | <i>k</i> , water-tight bulkhead. |
| <i>d</i> , foot steering yoke of wood, and <i>d 2</i> is a side chock to prevent the foot slipping off. | <i>l</i> , locker side-coaming. |
| <i>E</i> , foot-steering gear deck-yoke. | <i>m</i> , floor boards. |
| <i>R</i> , rabbet line, lower edge. | <i>n</i> , sternpost and metal gudgeons. |
| <i>f</i> , upper side of deck at middle line. | <i>p</i> , a line showing upper side of keel. |
| <i>g</i> , upper side of deck at sides. | <i>X</i> , position of greatest beam. |
| | <i>q</i> , centre-board sheave hole. |
| | <i>y</i> , keel scarping. |

* Taper to ½in. at stern.

DECK PLAN.

(i), supports for flap deck.	u, locker lid and hinge.
s, wire steering-lines, passing round brass buttons at m.	v, mainmast hole and case.
t, beading to keep flap, when open, from jamming the steering wires.	(v), mizenmast hole and case.
	w, apron beam for "well" cover.
	x, rudder-yoke.

RUDDER.

(o), aft or sternpost, perpendicular.	b, gudgeon metals.
a, rudder pin or rod.	c, (shaded part) is brass cap for yoke to fit over.

The general features of the design may now be reviewed. In the first place, in the design just described, *sailing* requirements were given the chief attention; secondly, it will be well to bear in mind that the word "design" includes both "model" and "fittings," and the same model can be fitted either for pleasure sailing or for sailing cruises by arranging such fittings as centre-boards, bulkheads, mast cases, &c., conformably to the use the boat is to be put to. Sleeping accommodation, for instance, does not demand that the model shall be altered, but requires a 6ft. space in the centre of the canoe; therefore two small centre-boards, having a joint area equal to the larger single board, become a necessity, and by this means an effective lateral resistance is maintained; still, a considerable amount of weatherliness is sacrificed unless the after-board is constantly and carefully worked.

Limited by the club rules, the leading dimensions of the model have been fixed upon, viz. : length, 13ft.; beam, 2ft. 10½in. A model 12ft. by 3ft. would give greater sail-carrying power, and would be more adapted for quick turning and eating to windward; but the "floor" would be considerably shortened, and the boat generally cramped as to the fore-and-aft arrangement of her fittings; 14ft. and 15ft. length give better results as to speed in running and reaching, and, to some extent, as to speed and ease in rough water; but the necessary reduction of beam to 2ft. 7½in. for 15ft. length takes away a considerable amount of initial stability, which, on account of the existing club rules, cannot be compensated for by increasing the depth of hull, and thereby lowering the weights; the increased length also comparatively retards the vessel's turning, unless her keel and floor line are considerably rockered.

The dimensions given provide good beam for stability, sufficient length for fine lines with good length of floor, and not too great a length for quick turning.

The fore-and-aft positions of the various fittings have been settled in compliance with the following requirements: The weights must be crowded as near midships as possible, so as to give easy performance in

rough water; consequently the after end of the centre-board and the fore side of the man must be brought as close together as possible, allowing, however, sufficient room between them for the shifting ballast to cross the floor. The centre-board must not come much abaft amidships, because the centre of lateral resistance would thereby be thrown so far aft that a large unhandy mizen would have to be carried to properly balance the centre of effort of the sails with the centre of lateral resistance of the hull. The man must not sit too far aft, as that would necessitate very full lines aft; at the same time the weights would be separated, and being nearer the ends, bad performance in a seaway would be the result. The performance, governed by the longitudinal position of the centre of buoyancy and the distribution of the weights, is not that of power to carry sail, nor even sailing or steering performance in smooth water, provided the normal trim has not been altered; but it is the performance of the canoe in a sea—whether she takes kindly and dryly to a head sea or a following sea without plunging and diving violently. The masts, in order to get spread for the sails, have to be placed far forward and aft; but their weight is small compared with that of the man, centre-board, and ballast.

CENTRE-BOARDS.

The foot steering gear requires the centre-board case to be sufficiently low at the locality of the foot yoke—*i. e.*, 3ft. 9in. forward of the man's back—to allow the foot yoke to swing at eight inches above the foot boards. This, combined with reducing fore-and-aft weight, has suggested the form of centre-plate shown in Plate XLVI.. The centre-board case is thus fitted to the keel (see Fig. 129, page 379). The sides of the case are rabbetted into the keel as shown, and fastened by screws which go clean through the keel, the ends being subsequently filed down in the slot.

The centre-board should be made of $\frac{3}{4}$ in. iron "boiler plate," and should be galvanised; the measurement should be taken from the drawing, and laid off full size on paper; the paper mould, having the pin hole and chain hole marked on it, should be sent to the foundry, and great care should be taken in seeing that the plate is perfectly straight. Cast-iron centre-boards are often used, but they are bad, in that sudden breakage is the common result of a hard lateral bump on the ground, and also that, to obtain the same weight as "boiler plate," a thicker plate must be carried.

On the position, forms, and areas of the centre-board or boards and rudder depends, to a very great extent, the successful sailing (apart from actual speed) of the canoe. As has been already pointed out, the position

of the centre-board is determined by the requirements of space for the man and the stepping of the masts; two or three canoes, noted for their sailing qualities, have been ingeniously fitted with "fan" centre-boards, which collapse into a case which does not come above the floor boards. Such centre-boards can, of course, be placed regardless of the well seat and steering gear; and, provided they are of a pattern and make which gives sufficient rigidity when in the sailing position, they are undoubtedly of service.

But the position of the sails in a canoe does not admit of much variation. Leaving out of the question extraordinary rigs, the centre of effort of the mainsail-and-mizen rig (which is the most popular in canoes) will be generally found to be at the mid-length, or not more than eight inches abaft it; then, the canoe being of shallow draught, the rudder, to be effective, has to be somewhat large in area, and, being at the extreme end of the vessel, naturally carries the centre of lateral resistance considerably aft; then, to bring the centre of lateral resistance forward and near to the vertical of the centre of effort of the sails, the centre-board has to be placed slightly forward of midships; therefore, it is evident that the position and area of the centre-board is of the first importance, and its mechanism merely a matter of convenience.

Two square feet area of centre-board has in practice been found amply sufficient, even in match sailing; and whether this area be given in one large plate or two small ones is practically immaterial as far as lateral resistance is concerned, but in relation to turning and manoeuvring there is a great deal to be said on both sides. In the first place, the single board and the double board are equally efficient in counteracting leeway, that the single board is the more delicate and perfect for eating to windward; and the double is more perfect than the single for reaching and running, and is undoubtedly the more powerful weapon for manoeuvring when skilfully handled. With the single board the canoe on a wind will answer the least touch of her helm or alteration of her sheets; and, except for shoal water, the board need not be touched from start to finish. It is often asserted that a single centre-board (of course in relation to other centre-boards) is not so good for beating in rough water, for the reason that her head is easily knocked off the wind by every sea; but it should be remembered that a boat does not eat to windward by virtue of gripe or forefoot; she works on her common centre of lateral resistance, and, though the bow may be knocked off the wind by the seas, a like facility of movement exists for bringing her to, and, further, the single-plate boat is able to take advantage of smooths or free puffs for getting a screw up and a rapid fill away again. It is the crest of the wave that will knock the bow off the wind, but this is almost

an advantage, and it places the vessel in the best position—"three corner ways on"—for dropping gently down the back of the sea, off the wind, and, consequently, "all full," and gathering way for a neat luff up the face of the next sea.

No doubt the double centre-boarder, in the hands of a skilful canoeist, has many advantages over the single-plate craft; but, to utilise these advantages to their full, a judgment and quickness are needed, which can only be obtained by long and constant practice. The experienced hand in a double centre-boarder will use his boards, by alternate lifting and dropping, when on a wind or reaching, almost in preference to his rudder; in fact, the working of the boards will be attended to before working the sheets. The ease with which the centre of lateral resistance can be thus shifted forward or aft of the centre of effort of the sails places within his grasp a power of turning which in match sailing is of the first importance. If from any accident the mizen is lost or has to be stowed, the canoe will be handy under mainsail if the after board be hauled up; and if caught in a squall, the mainsail can be stowed and the canoe hove to under mizen and fore centre board—the aft one being of course hauled up. Without going into details of intricate manœuvres, it may be stated that when the canoe is sailing, say, close-hauled, if the afterboard be suddenly hauled up, the craft will fly up into the wind's eye. Of course this can be augmented by easing the fore sheet, and also by putting the helm down—*i.e.*, bringing the rudder to windward. In like manner, for quick bearing away, the after-board would be kept down, the fore-board lifted, the mizen-sheet eased off, and the helm put up.

Beyond these qualities, the double board permits of space for the owner to sleep on board, and this, in some waters, is no small advantage; for the greatest genius at tidal calculations, when cruising in navigable tidal waters, may more than once find himself benighted and tide-bound far away from his anticipated night post, and with a considerable strip of soft black mud between the edge of the water and *terra firma*. In such a predicament, a canoe of the dimensions we have been considering will, if fitted so as to allow of sleeping space, prove a safe, if not comfortable, miniature hotel for the night.

The leading measurements for fitting a canoe of the dimensions shown in the design (Plate XLVII.) will, with two centre boards, be as follows: The fore end of the slot for the foremost plate will be 3ft. 10in. forward of midships; the length of the slot, measured on the lower edge of the keel, will be 2ft. 4in.; length of lower edge of plate, 2ft., and drop, 1ft. 3in.; the forward end of the after slot will be 3ft. 3in. abaft midships, and the length of the slot will be 1ft. 8in.; length

lower side of plate, 1ft. 6in., and drop, 1ft., giving a joint area of 2.5 sq. ft.

The inboard shape of the fore plate, *i.e.*, that portion which remains in the keel and case when the plate is lowered for sailing—should be as small, especially at the fore-end, as is consistent with keeping the plate rigid laterally; many canoes are fitted with the centre-board case extending up to the deck and open along its top; in such cases the plate is usually hung by its fore-end from a bolt at the deck, and at its after-end by its hauling-up gear, the advantage being that a plate so fitted (instead of being bolted at its fore-end through the keel) can be lifted out of the canoe through the deck, and thus be speedily removed when requisite without having to lift the craft herself out of the water.

The after-plate should be inclosed in as small a case as possible, so as to give stowage space in the locker; a case of triangular form, the after end of which comes up to the deck, will be found to act well. Such a case gains support from the deck, and permits the hauling-up gear to be worked above deck; the after-board should be light, and may be made of zinc, as lateral resistance only is required, and weight should be avoided.

The after-end of all centre-board cases should be raked forward at its upper end in order to prevent the water heaping up and overflowing at the chain-hole when the boat is moving rapidly, or when in lumpy water.

A very heavy centre-board is by no means an unmixed good in a canoe. In smooth-water sailing it doubtless adds considerably to the canoe's stiffness; but in lumpy water its thumping leverage will soon be felt by the boat, and, sooner or later, something will start unless the craft and centre-board case are built and fastened with unusual strength.

The hauling-up gear in the single-plate fitting (Sheer Plan, Plate XLVII.) would be a small galvanised iron chain, shackled to the hole in the forward upper corner, and cut to the exact length between that hole, when the centre-board is down, and the upper edge of the sheave (*g*) in the top of the centre-board case; to this end of the chain a small single block, metal stropped, should be shackled, with a thick india-rubber ring placed on over the shackle to act as a buffer; the standing part of the hauling line is then spliced into an eye-bolt at the after-end of the top of the centre-board case, and the hauling-part having been rove through the block, is finished off by having a wooden toggle spliced in its end at such length that when the board is down the toggle is at the block, and when the board is up a turn is taken on the hauling-part round a patent tumbler cleat, fitted on the after end of the upper side of the centre-board case.

For a light plate, a split-ring handle may be put into the last link of the chain, the buffer, however, being placed over the chain first.

STEERING GEAR.

There are many ways of fitting the steering gear; in fact, so many, that it would only be confusing to attempt to describe and consider each kind. The two most common modes are where, in the one case, the yoke lines are led direct to a foot-yoke; or, in the other, to a deck-yoke, which is connected to the foot-yoke. The most serviceable of these is undoubtedly the deck-yoke gear; this gear is shown in the sheer plan, and is marked *d*, *d*², and *E*, and in the deck plan *d*², *E m* and *z, s*.

The rudder-yoke fits over the brass-capped rudder-head, and should be 14in. wide, with an eye at each end. The foot-yoke is made of hard wood, 16in. wide, and of sufficient strength to act as a stretcher for both feet, for it will be thus used when the canoe is being paddled; the yoke rod should be a round brass tube inclosing an iron or a steel rod, the heel of the rod steps in a block on the top of the centre-board case, the upper end having been pushed up through a brass-bound hole in the deck, a shoulder of brass, with a squaring above it of about 1½in., is soldered on to the rod, and to this the foot-yoke is tightly clamped; it should be at such a distance from the lower end of the rod as to bring the foot-yoke, when in position, about 8in. above the surface on which the skipper's heels are to rest; the head of the rod should project about 1½in. above the deck. At ¼in. above deck the rod is filed square, for the deck-yoke to ship on to, and the squaring is carried up about ¾in., that being about the thickness of the boss of the yoke; then the last half an inch of the rod is formed into a screw, on to which a thumb nut (*E*) is screwed to keep the deck-yoke in its place. The deck-yoke requires an eye at each end; and the yoke should be of iron, as neither copper nor brass is strong enough for fittings 18in. or 20in. long.

The yoke lines should be made either of solid brass or copper wire, and must be stout, and may be fitted thus: Having fitted a copper or brass thimble into each of the four eyes of the rudder and deck yokes, with powerful nippers, simply take the ends of the two wires, and, having passed them round the thimbles in the rudder-yoke, twist the ends round their own standing parts; then at the fore end fit in like manner to two thimbles, making the wires of such length as will place these two thimbles at about one foot from the eyes of the deck-yoke when it and the rudder are shipped in position. A small lashing line is now spliced to each of the fore ends of wire, and, being rove

through the yoke thimbles and the wire thimbles, say three turns, makes a powerful but easily workable gear.

The wires would naturally thus lay along near the middle of the canoe; but to keep them clear of the canoeist, and also of the deck flaps, locker, &c., little brass studs are screwed into the deck, as shown at *m* and *n* in the deck plan, a single one opposite the fore end of well, and two diagonally placed, are put in abreast of the after end of the well.

One great advantage of this plan is that, for unrigging, simply the rudder-yoke and deck-yoke are taken off, and the wires folded round them. The lines do not lead down below through the deck, coaming, or bulkhead, and are not in the way when stowing or unstowing spars under the side deck. The yoke on deck is very handy for hand steering whilst kneeling up working at the mast gear.

In the case of foot-yoke only, the wires are fitted much in the same way as above; but they have (before being fitted at the second end) to be passed through perhaps both coaming and bulkhead, in order to get a fair lead to the stretcher-yoke; and the rudder-yoke ends should be fitted with snap swivels, so as to be detachable from the yoke.

The rudder-pin (*a*, Rudder Plan, Plate XLVII.) should be, as shown, of the whole length of the sternpost; the gudgeon metals (*b*) are so placed as to allow the rudder to travel up the pin when it strikes the ground. These rudder fittings—and indeed all the metal fittings of a canoe, should be of copper, or gun metal, or brass.

DECK FLAPS.

The flap side deck was contrived for the "Rob Roy" by Mr. Macgregor in 1868; it is to allow the skipper to sit to windward, and should have an easy opening and shutting, and yet be water-tight. The flap being just abreast of the body, the hands are often placed heavily upon it in getting in or out of the canoe; this demands good supports under the main deck (marked *i i* in the deck plan, Plate XLVII.), and for water-tightness washers should line the edges.

APRONS, &c.

The apron of the Nautilus racing canoe is thus fitted: A piece of macintosh of suitable size is fixed by nails to two battens (see Fig. 130). The battens are of the length of the fore end of the well, and are kept in position by two fillets, which are nailed to the deck, near to and parallel to the coaming. The macintosh is nailed about an inch or an inch and a quarter from the edge of the batten, and a flap is left to go over the fillet

as shown. The macintosh is also secured to the top edge of the batten by a nail, and half round fillet. The side battens being fitted to the exact span of the coamings, stretch the macintosh tightly across the well. The fore end of the macintosh is a loose drop piece over the coaming, and tucked under an india-rubber band across the deck.

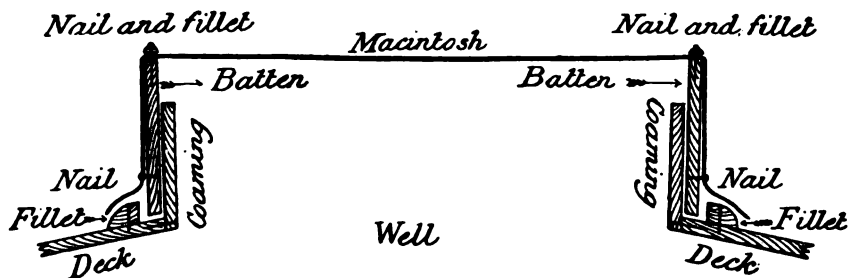

FIG. 130.

The parts of the sides of the macintosh which come from the flap deck aft have no battens, but have an indiarubber cord in the bottom edge, and a button-hole at each corner to button on to a small stud screw at the aft end of the flap piece (a small brass drawer handle will do for a stud). When sailing the apron has to be unbuttoned on the weather side.

Across the well is a shiftable beam, which supports the apron if heavy water comes on it. The whole thing comes away immediately if a capsize takes place, or any sudden "jump up" is required. When not in use the whole apron can be rolled up into a very small space.

For canoe travelling a macintosh coat is required, such as used in the Nautilus canoe of 1870. The coat is long, and closed like a petticoat from the bottom to the breast, where there is a neck opening with three buttons. Fixed by waterproof glue close under the arms is a macintosh founce; run through the bottom hem of which is an elastic cord. The hem of the founce is placed over the hatch and hatchway coaming, and abaft the backboard, thus forming a kind of tent. The founce should be full behind to allow stooping forward without detaching its hold on the coaming. Elastic bands round the cuffs of the coat will prevent water running up the sleeves. The object of having a long inside coat is that it will then do duty as a macintosh for shore walking.

MAST FITTINGS AND TABERNACLE.

The tabernacle for lowering the mainmast is a matter of importance. The ordinary method is to cut a well through the deck for the mast heel to travel in (as described for the Nautilus racing canoe, page 394); but, as the bow of a canoe is very frequently immersed when working

on rough water, it is undesirable to have any opening in the deck. The tabernacle is thus fitted: Two pieces of oak placed in the ordinary form of a tabernacle, *c* (Fig. 131), secured at the heels by a block (*G*), and passing up through a blocking piece under the deck *a* (Fig. 131), and through the deck *b*. The two heads are each $3\frac{1}{2}$ in. high by $2\frac{1}{2}$ in. wide fore and aft, and half an inch thick, the heels being considerably tapered off for lightness; (*c*) in the sketch is a blocking piece, firmly bolted in between the uprights, and let through the deck and deck block. Against this the mast heel lodges. The mast heel should be $1\frac{1}{2}$ in. square, from heel to half an inch above the tabernacle; then round and taper to 1in.

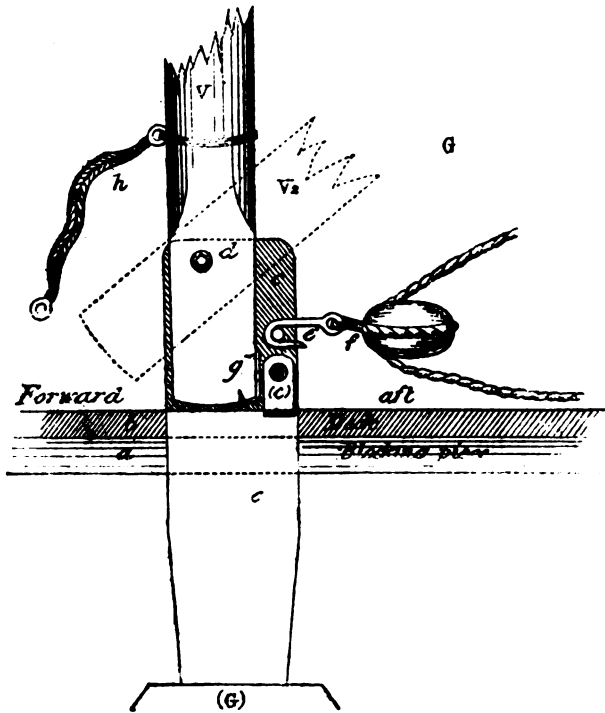

FIG. 131.

at head. The mast is bolted between the tabernacle heads, at three-eighths of an inch from the top of the heads at *d*. At *e* is a through bolt, on to which, between the heads, the halyard blocks hook. The mast heel and the outer sides of the tabernacle heads should be brass plated, and there should be a small piece of indiarubber screwed on the heel as a buffer (*G*). The mast is set up by a forestay, which should be small galvanised wire about one-tenth of an inch in diameter, from the swivel clip (clipped to a thimble in the masthead block strop) down to a small single block, which, when the mast is up, comes about four inches above

the stem-head. The fall is fast to stem-head, and then leads through the stay block and through the stem block or cheek sheave, and into a cleat near the well. So long as the mast is set up, the halyard blocks *f* cannot be unshipped from the bolt *e*, but when the mast is lowered as far as shown by the dotted line, the halyard blocks can be unhooked.

The mast is fitted with a ferrule joint at 4ft. 6in. above the tabernacle pin, and then the upper portion, 4ft., including a 6in. ferrule to ship *over* lower mast, makes a total of 8ft. 6in. pin to truck. With the exception of unclipping the forestay, all the gear remains on the masthead, and the sail is kept on the upper part of the mast, with its halyards bent on and parrels in sailing position.

THE NAUTILUS SHORE TENT.

The Nautilus tent for camping on shore is of the "Alpine" form, but divided into two pieces by a joint of buttons and holes along one side of the ridge rope, and this junction is protected above by a flounce or bonnet stitched on the opposite side of the ridge rope, and buttoned to small buttons on the joint side of the tent; four slight poles are embedded in a hem at each corner, their lower ends sticking into the ground, and their upper ends are held in strongly stitched pockets; only one rope, the ridge rope, is needed, and is set up either to a couple of pegs driven into the ground, or to tree stumps; two pegs are used on each side in windy weather. The poles should be jointed, and need only be slight in diameter; the Nautilus had ash, but bamboo would be equally good and much lighter. The ground space is 6ft. by 6ft., and the height under the ridge is 7ft. The ends join down the middle, and are double flap jointed, with button and hole as a fixer. A kind of curtain 1ft. deep goes round the lower part of inside, stitched on about 6in. above the edge, and is used for tucking under the ground sheet.

THE NAUTILUS AFLOAT TENT.

The tent, for use afloat, is formed as a slanting roof of light mackintosh sheeting, with stout calico perpendicular sides and angular fore end. It is fitted as follows: the roof is a sheet of mackintosh 6ft. long by 4ft. wide; along the centre of this on the *inside* runs a ridge rope, the fore end of which is half-hitched round the furled mainsail and its spars just about over the deck yoke, and then leads down to eye-bolt at mast on deck; the after end is then rolling hitched to the mizen mast at 4ft. above deck, and the end is hitched to the aft ring at sternpost as a backstay; the main boom is then triced up to a height of 2ft. above

deck at fore end, and 4ft. at after end, the tent being well stretched along underneath it.

The calico side pieces are triangular in form, being 2ft. 6in. deep at after end, and 6in. deep at fore end; they are stitched on to mackintosh roof at 2in. inside its edge, so that the edge overhangs and shoots rain off. At the fore end is a triangular piece which forms a sharp-ended wind shoot to the tent; a bamboo spreads out the lower after end of roof, and the sides hitch to the various sailing cleats along the deck by little lanyards; the after end of the tent is closed in by a curtain of calico. Any part of the tent sides or ends can be cast adrift and triced up in a moment, or the whole can be cast off from deck and tucked up over the boom, if necessary to shift the canoe's berth, or in daytime if not getting under way.

With this form of tent the canoe rides at anchor head to wind, and there is ample room inside for the skipper to change his clothes and cook his dinner, &c., afloat, and so be absolutely independent of landing, which is often difficult, dirty, and dangerous after dark.

A good thick blanket, an air pillow, and an air cushion (3ft. by 1ft. 6in.) is all that can be desired for bedding, and if they are carefully kept by day wrapped up in the mackintosh part of the tent, a dry and comfortable bed is always at hand.

LIGHTS.

If cruising in navigable waters, a good riding lamp is absolutely necessary; and the same lamp should have a green and a red slide to fit over two-thirds of its globe, the remaining third being reflector. In practice it is amply sufficient warning to other vessels if the proper colour, of good size, is shown on its proper side in good time. To attempt to exhibit two permanent side lights or one combination fixed lamp in a canoe is a great mistake; one lamp is quite enough to have to trim and look after, and should be capable of doing duty as cabin lamp, anchor lamp, and side lamp in turn.

PUMPING AND BALING.

Last, but by no means least, in fittings, we come to the pumping or baling gear. For river or small lake work a sponge and an ordinary bowl baler will be ample; but for sea or large lake cruising it is almost a necessity to have an effective pump. The points to be achieved were a powerful pump of small size and light weight, if possible of double action, so as to pump in bilge as well as at kelson. The difficulty was

at length solved at the Culzean Yacht Works, Maybole, and a most powerful double-action pump was turned out: one suction pipe draws rigidly from its well in midships, and the other by a flexible pipe can be used in either bilge, or also amidships; and the discharge pipes of both ends can be united, and discharge into the centre-board case or over deck or side. Each suction works independently of the other, so that where the water, when the canoe is heeling over, is all in the bilge, the bilge pump works, and the midship sucker draws air only. These pumps are now being fitted to small yachts, and can be fitted vertically or horizontally. The pound or two of extra metal to be carried by the canoe fitted with one of these pumps will not be grumbled at by those who know the danger of taking on board a lumping sea when a mile or two away from land.

THE "NAUTILUS" RACING CANOE OF 1879.

The Nautilus of 1879 (Plate XLVIII.) was designed for "special racing service,"* and not for general work, and consequently, both in form and fittings, differs considerably from the type of canoe previously described. The Royal Canoe Club measurement rule, as already shown, limits length and beam by a sliding scale of relative proportions. The fixed keel of wood is not to be more than 2in. deep outside, including the metal keel band, which must not exceed half an inch in depth; the depth of the canoe at the fore end of the well, from underside of deck to the upper side of the garboards, must not exceed 16in.; all ballast and metal weights, except centre-board and keel band, must be carried *inside* the canoe; ballast may be shifted; and there is no limit beyond these as to ballast or rig or mode of building.

Bearing these limitations in mind, the idea was to create a craft which, without being of excessive displacement, thereby requiring a heavy equipment of ballast, should have sufficient area of lateral resistance of hull to perform well "on a wind" without being dependent on a centre-board, and at the same time by this greater draught of water to obtain a low centre of gravity of ballast. The next point of importance was to obtain a long light bow, with little or no "gripe;" a deep drag aft, with a raking post and powerful rudder; the sail plan being that of a "Ketch" without head sails, the latter being incompatible with such a sheer plan.

The draught of water and weight of ballast are the only drawbacks

* The Nautilus won the Royal Canoe Club Challenge Cup at Hendon, 1879, beating Pearl, the winner in 1878, and several others.

the 1879 Nautilus has for inland cruising. At sea, however, and in lake and navigable water, the depth and weight are advantages.

A freeboard permitting a 25° list, coupled with a flat deck at fore end of the well, determined the draught of water at that station in the length, owing to the club limitations of depth and keel; from this point the keel is raked so as to allow a great draught aft to be taken. Between the well and the mast is placed a centre-board, which is used solely in manœuvring, though at first trial it was anticipated that it might be necessary for beating to windward. Experience, however, has shown that the canoe goes to windward equally well without it, and it might be replaced for manœuvring purposes by a very much smaller and lighter board.

A watertight bulkhead is placed at each end of the well, so that water shipped is confined to the well space, and therefore comparatively harmless. The well and deck fittings and steering gear are exactly as described for Plate XLVII., excepting that the centre-board, as already mentioned, is forward of the well altogether.

The mainmast is stepped in a tabernacle, to admit of its being lowered when passing under bridges, and in cruising is worked and set up by a fore stay and tackle; but for racing the mast heel is bolted to the kelson block by a long perpendicular slide bolt screwed on the fore side of the mast heel, which is worked by hand from the deck. This bolt is an ordinary slide bolt, such as is fitted to doors, shutters, &c.

The ballast consists of two kinds: firstly, 70lb. of shot in three bags, for shifting to windward; and, secondly, lead blocks cast to fit close down on her garboards, weighing 190lb., and a centre-board of boiler plate, weight about 65lb. The lead lies in four blocks equally dispersed between the two bulkheads, and the shot bags are about at the midship section. (The sail plan will be described further on.)

TABLE OF OFF-SETS. (See PLATE XLVIII.)

Number of Section	1	2	3	4	5	6	7	8	9	10	11	12	13
	in.	in.	in.	in.	in.	in.	in.	in.	in.	in.	in.	in.	in.
Heights above L.W.L. to top of plank sheer	12½	10½	9½	8½	7½	7½	7	6½	7	7½	8½	9½	10½
Depths below L.W.L. to rabbet line	4	5½	7	7½	8½	9½	10½	11	11½	12½	13½	13½	8½
Depths below L.W.L. to under-side of keel	4½	6½	8½	9½	10½	11½	12½	13½	13½	14½	15½	15½	16
HALF-BREADTHS.													
Half-breadths at deck	6½	10½	13	14½	15½	16	16½	16½	16	15½	14½	12½	8½
Half-breadths 6in. above L.W.L.	5	9	12½	14½	15½	16	16½	16½	16	15½	14½	12	7½
Half-breadths 3in. above L.W.L.	4	7½	11½	13½	14½	16	16½	16½	16½	15½	14	11	6½
Half-breadths on L.W.L.	2½	5½	9½	12	14½	15½	16½	16½	16	15	13	9	3½
Half-breadths No. 2 water line	0½	2½	5½	8½	11½	13½	15	15½	14½	13	9½	5	1½
Half-breadths No. 3 water line	—	0½	1½	3½	5½	7½	9½	9½	8½	6½	3½	1½	0½

PLATE XLVIII.

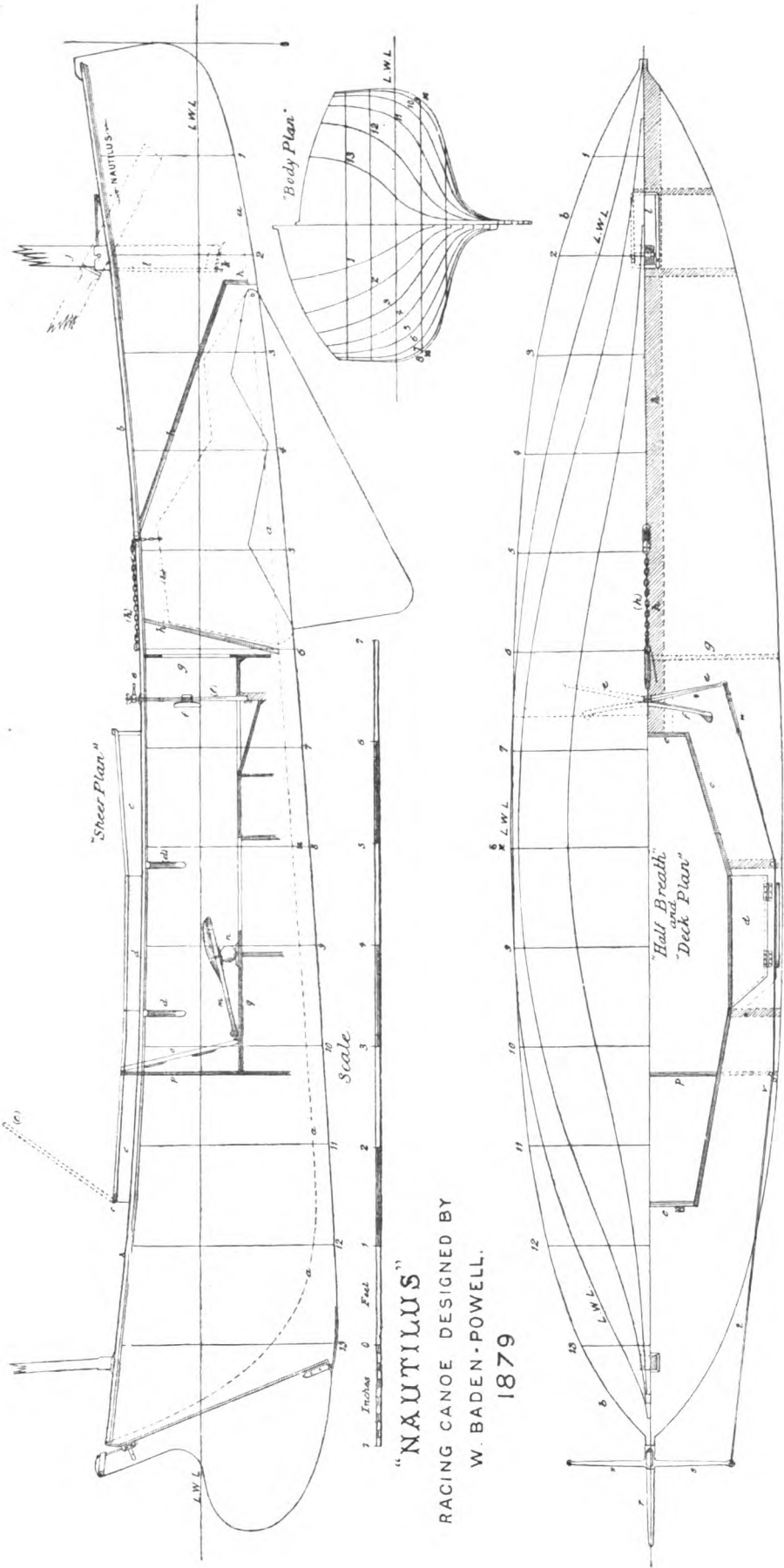

"NAUTILUS"
RACING CANOE DESIGNED BY
W. BADEN-POWELL.
1879



“Nautilus” Racing and Cruising Canoe, 1881. 395

Length on L.W.L., 13ft. 8in. Beam, 2ft. 9in.

The sections are 1ft. apart. No. 1 section is 1ft. from the fore end of the load water line (L.W.L.), and 1ft. 1½in. from the plumb line. The stem tumbles home 1½in. at the deck.

The water lines are 3in. apart.

SHEER PLAN.

a, rabbet line.	(h), chain and tackle for lifting centre-board.
b, plank sheer of deck.	i, centre-board when lowered.
c, coaming of well.	(i), centre-board when hoisted.
(c), lid of looker.	j, mast.
(d), knees to support side deck where the opening is made.	k, step of mast.
d, movable part to make opening in coaming.	l, tabernacle.
e, deck yoke.	m, seat.
f, yoke for the feet.	n, ball support of seat.
g, bulkhead, watertight.	o, backboard.
h, centre-board case.	p, bulkhead, watertight.
	q, platform over ballast.

HALF-DECK PLAN.

b, gunwale or plank sheer line.	(h), chain and tackle.
c, coaming of well.	j, mast.
d, flap opening in coaming and in the deck water-ways.	l, tabernacle and opening in deck for working mast bolt.
e, deck yoke.	p, bulkhead.
f, yoke for the feet.	r, rudder.
g, bulkhead.	s, yoke on rudder.
h, centre-board case. This shaded part also represents a fore and aft carline to which the fore deck is screwed. A similar carline is fitted aft.	t, wire yoke lines.
	v, stud guides for yoke lines.
	w, lanyard for setting yoke lines taut.

THE “NAUTILUS” RACING AND CRUISING CANOE OF 1881.

The Nautilus of 1881 (Plate XLIX.) was designed and constructed in the autumn of 1880. She is a canoe intended for cruising on navigable rivers, lakes, and the sea, and for racing in the Royal Canoe Club matches. Being intended chiefly for cruising, many sailing points have been put aside for cruising requirements; but, notwithstanding such drawbacks, she has performed well as a sailer, having during the season 1881 won five first and two second prizes in ten starts, and in two of the other matches she gave up on account of wind failing, and in a third she capsized when leading by nine minutes.

The leading idea of the design is to have accommodation for sleeping afloat, and, in addition to this, a light draught, powerful sailing lines, and water-tight compartments. In taking a space of 6ft. for the middle or sleeping compartment, the designer was much tempted to shorten the centre-plate, and to sacrifice some handiness by fitting a second centre-plate aft; but a small amount of figuring, backed strongly by experience,

suggested the advisability of one centre-plate only, and that the balance be made up by a deep rudder; the result of this is a roomy locker aft, with less gear to work, and smaller risk of leaks.

The plank, decks, and fittings of Nautilus are mahogany; her keel is of pine, and frames are of oak. She is planked on the ribband carvel plan, and her deck is laid in three pieces on each side—first piece from stem to fore end of well, second piece alongside of well to its after end, and third piece from after end of well to sternpost, on each side. The centre-board case extends right through the craft so as to enable the centre-plate to be lifted in or out for transporting purposes; it is made of $\frac{3}{4}$ in. mahogany, and is rabbeted to the keel, and is supported by the deck, the bulkhead, and by a knee on each side, placed abreast of the plate hump. The centre-plate is cut from boiler plate, and is of the shape introduced by "Pearl;" the hauling-up gear, however, is fitted so as to lead straight into the well through the fore coaming, thus giving a direct pull, and avoiding the splashing of the gear in the water when the lee deck becomes immersed, which is common to gear fitted along the side deck. At the fore side of the well there is fitted to the deck a cleat rack, with side pieces attached to the well coamings; this forms a convenient place to stow the rope coils in, and keeps the halyards and reef lines clear of the deck yoke, and further acts as a breakwater to water washing aft along the deck.

The following table and key will show the various dimensions and leading points of the design:

NAUTILUS RACING AND CRUISING CANOE, 1881. (See PLATE XLIX.)

No. of Section	0	1	2	3	4	5	6	7	8	9	10	11	12	13	14
	in.	in.	in.	in.	in.	in.	in.	in.	in.	in.	in.	in.	in.	in.	in.
Height above L.W.L. to under side of deck	16	14 $\frac{1}{2}$	12 $\frac{1}{2}$	11 $\frac{1}{2}$	10	9 $\frac{1}{2}$	8 $\frac{1}{2}$	8 $\frac{1}{2}$	8 $\frac{1}{2}$	8 $\frac{1}{2}$	8 $\frac{1}{2}$	9 $\frac{1}{2}$	10 $\frac{1}{2}$	11 $\frac{1}{2}$	13 $\frac{1}{2}$
Depths below L.W.L. to rabbet	—	5	5 $\frac{1}{2}$	6	6	6	6	6	6	6	6	6	5 $\frac{1}{2}$	4 $\frac{1}{2}$	—
Depth of keel and metal band below rabbet	—	1	1	1	1	1	1	1	1	1	1 $\frac{1}{2}$	1 $\frac{1}{2}$	1 $\frac{1}{2}$	2	—
Half-breadths at deck	—	6	10	12 $\frac{1}{2}$	14 $\frac{1}{2}$	15 $\frac{1}{2}$	16 $\frac{1}{2}$	16 $\frac{1}{2}$	16 $\frac{1}{2}$	16	16	14 $\frac{1}{2}$	12 $\frac{1}{2}$	8 $\frac{1}{2}$	$\frac{1}{2}$
Half-breadths at L.W.L. to outside of plank	—	3 $\frac{1}{2}$	6 $\frac{1}{2}$	9 $\frac{1}{2}$	12 $\frac{1}{2}$	14 $\frac{1}{2}$	15 $\frac{1}{2}$	16 $\frac{1}{2}$	16 $\frac{1}{2}$	16	15	13 $\frac{1}{2}$	9 $\frac{1}{2}$	4 $\frac{1}{2}$	—
Half-breadths at 3in. below L.W.L. ...	—	1 $\frac{1}{2}$	4 $\frac{1}{2}$	7	10	12 $\frac{1}{2}$	14 $\frac{1}{2}$	15 $\frac{1}{2}$	15 $\frac{1}{2}$	14 $\frac{1}{2}$	12 $\frac{1}{2}$	9	4 $\frac{1}{2}$	1 $\frac{1}{2}$	—
Diagonal half-breadths from 6in. above L.W.L. to L.W.L. at No. 7.....	—	4 $\frac{1}{2}$	8 $\frac{1}{2}$	11 $\frac{1}{2}$	13 $\frac{1}{2}$	15 $\frac{1}{2}$	16 $\frac{1}{2}$	17 $\frac{1}{2}$	17 $\frac{1}{2}$	17	16 $\frac{1}{2}$	14 $\frac{1}{2}$	11 $\frac{1}{2}$	7	—

LEADING DIMENSIONS UNDER RULES OF ROYAL CANOE CLUB.

Total length, 14ft.; beam, 2ft. 9in.; depth inside, 16in.; keel, 2in.; draught, 7in.

Sections 1ft. apart, No. 1 being 1ft. from fore end L.W.L.

Stem and stern posts sided at rabbet, 1 $\frac{1}{2}$ in.

Keel from No. 2 to No. 7 sections sided 2in. tapers to ends.

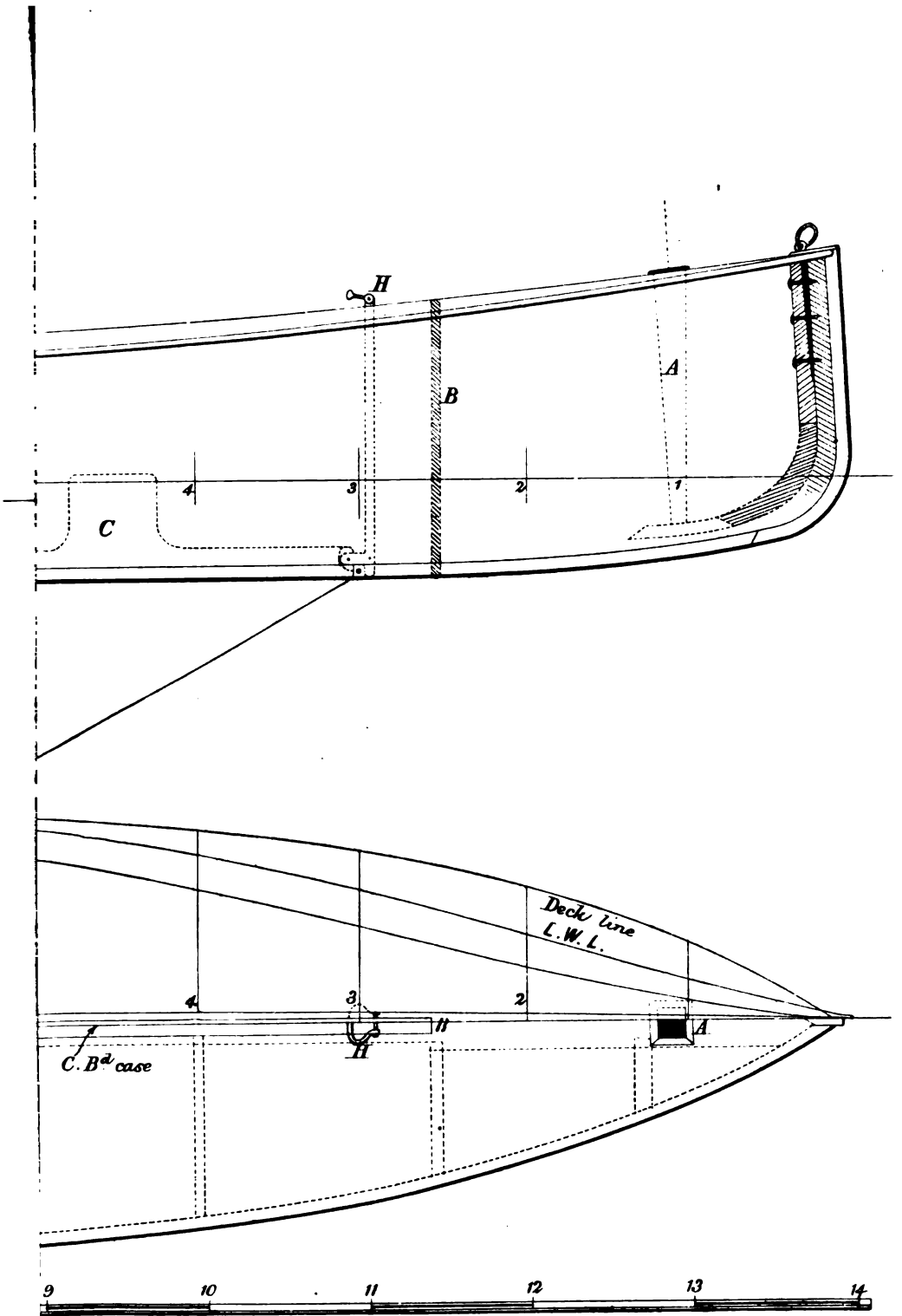

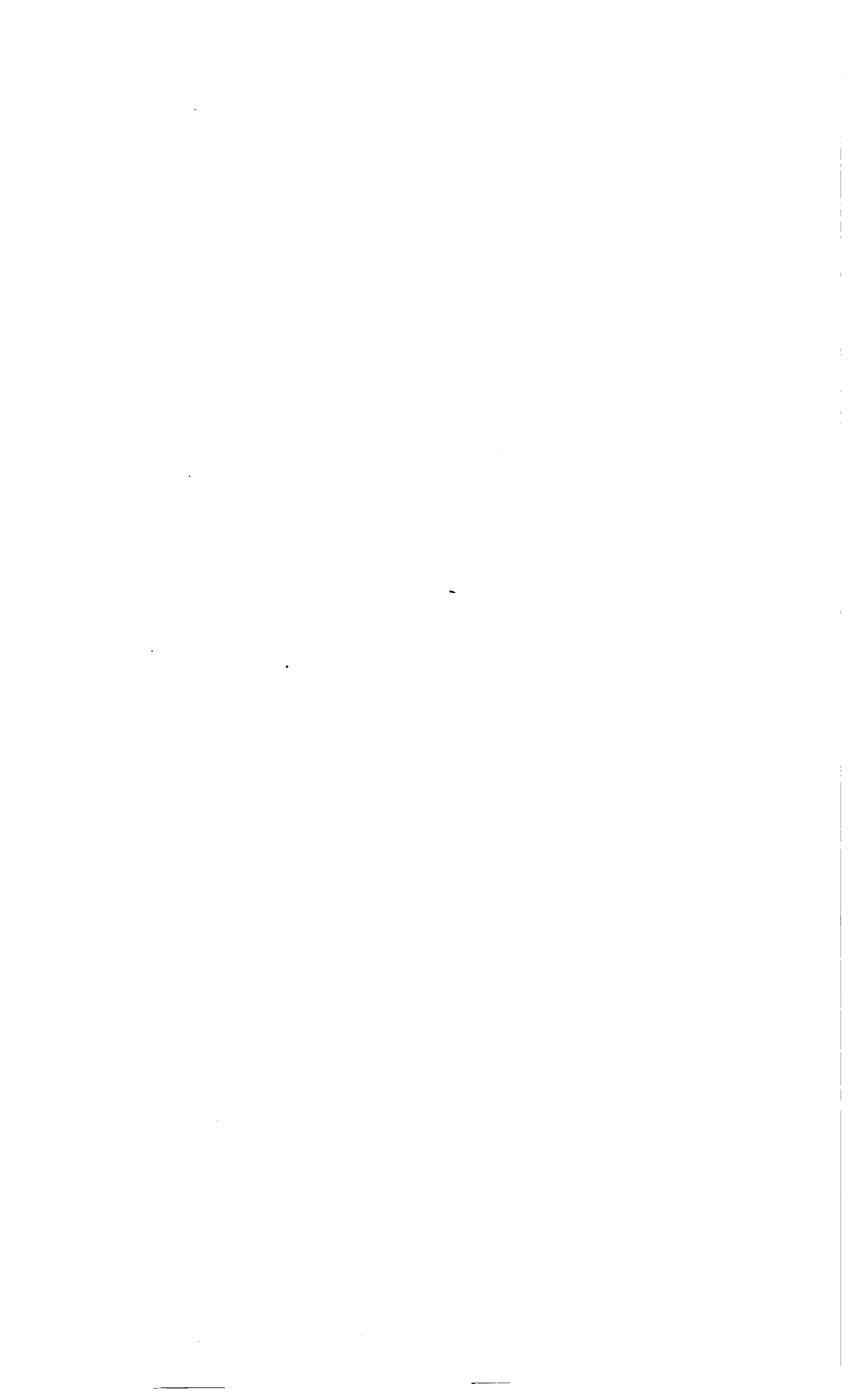

SHEER PLAN.

- A, Main and mizen mast cases
- B, Fore and after ends of centre-plate case.
- C, Centre-plate of iron.
- D, Fore bulkhead with door.
- E, Drain pipes, one each side of centre-board, draining fore compartment.
- F, Foot-steering yoke and rod.
- G, Deck yoke connected with F.
- H, Centre-board lifting handle.
- I, Centre-board chain sheave, chain and buffer hauling-up gear.
- J, Cleat rack leading ropes clear of yoke, &c.
- K, Fore hatch, fitting over coamings of well.
- L, After hatch.
- M, Paddling thwart, shiftable, forms middle floor board when not in use.
- N, After bulkhead and door.
- O, Floor boards.
- P, Paddling backboard beam, shiftable.
- R, Ring-bolt at each end, bolted between apron and post.
- S, Sheave for rudder tricing line.

DECK PLAN.

The same letters denote the same things as in Sheer Plan. Dotted lines show beams, carlines, and knees below deck, and hatches above coamings.

The chief characteristics of the craft are—first, that sailing is the chief mode of propulsion; that so long as any wind exists, sailing will be the most successful mode of making progress. Second, wind failing, the canoe can be paddled with the double-bladed paddle with ease, or the half-paddle may be used in conjunction with the foot-steering gear.

As to paddling against a head wind in open water in any but a long, low, narrow paddling canoe, it is simply self-inflicted hard labour; sails would do the work in far less time, and with ease and comfort to the canoeist (of course assuming the craft to be properly fitted with centre-plate and proper sail plan). Take, for instance, two canoes bound to a spot two miles dead to windward; one paddles there and the other sails there. Given that the paddler makes in one hour his course of two miles, the sailing distance will be, at four points, two and three-quarter miles; and allowing for some leeway, say three to three and a quarter miles, this in speed per hour would place the two craft at the spot at the same time; but the sailing craft would probably do four and a half miles or even five miles an hour through the water; that is the advantage.

Side flaps in the decks have been done away with, and the laying-down position adopted by “*Nautilus*” for sailing; the result is an all-round gain of comfort to the skipper and of strength and dryness to the craft.

The craft is not fitted aft with a second centre-plate, but has a large, deep rudder, so that it can be hauled up in shallow water by a tricing line passing through the sheave *s*. The rudder can be fitted (on Mr. Stoke's plan) so that the yoke is held at the sternpost head, and the rudder head can be raised or lowered *through* the yoke by means of the tricing line; thus fitted, the yoke lines remain level with the deck, and the yoke not being raised does not foul the mizen or necessitate its being topped up or kept set high on the mast.

The bulkheads are water-tight, and are fitted with doors, which when closed prevent any but a dribble of water getting into the compartments; drain pipes are fitted at *e*, so that the compartments may be drained whilst under way without any trouble.

The well is covered in two fashions—one being wooden half-hatches, which stow on top of one another aft when not in use; the other being a mackintosh apron with an elastic-banded edge, and supported by a light flat board of 10in. length and the width of the coamings, which rests on the coamings, and slides backwards or forwards as the apron is to be extended or reduced. A telescoped bamboo rod draws out underneath the apron as the wooden support is drawn aft, and this supports the middle line of the apron forward.

During cruising this canoe has carried her centre-plate of 83lb. and 100lb. of shot in bags, her sail plan being 95 square feet in mainsail and 25ft. in mizen. Fishing rods stow in the fore compartment on one side, and a long light box containing all food stores and eating gear is stowed in the other fore compartment. The roll of tent, in which is wrapped bedding and night clothing, is stowed across the floor at fore side of after bulkhead under *l*. The clothes bag (a mackintosh double-necked round bag) stows inside the locker, and in the two corners of the locker, against the bulkhead, hang the cuisine in its bag and the lamp.

“NAUTILUS” CRUISING CANOES.

The “Nautilus” canoe depicted on Plates XLVII. and XLIX. were intended chiefly for cruising on navigable rivers, lakes, and seas, and also for occasional match sailing. In such a craft compactness of dimensions, lightness of hull and fittings, and other requisites for ease of transportation, were considered of secondary importance to seaworthiness and sail-carrying power; and the canoe was intended more for pleasure *cruising* in ordinarily frequented navigable waters than as a *travelling* craft for navigating inland lakes, rivers, and canals in thinly-populated districts.

The canoe (Plate L.) we are now about to consider is designed to perform the latter work, of travelling. The term *cruising* is distinguishable from a voyage in that the cruise extends from port to port, with the intention of returning to the home port; whereas the *voyage* would be a journey to some distant place, and intermediate ports would only be visited for stores and necessaries. It will therefore simplify matters to assume that cruising consists of short trips in home waters, whereas travelling includes journeys to distant places and to places in foreign lands.

To arrive at a suitable design for a travelling canoe, the starting point should be that *sailing and paddling are equal in value as modes of propulsion*; and then the nature of the particular travelling the proposed canoe is most commonly to perform must be considered before preponderance is given to the one quality or the other. It is on this preponderance of sailing or paddling requirements that the leading details of construction and equipment are dependent for their proportions and position. For instance, where the work is chiefly to be the navigation of rivers and canals, paddling will be of more value than sailing, and consequently the craft should have small beam and good length; and as transport on land and “carrying over” will be constantly occurring, lightness of structure and fittings will be most desirable. A low freeboard and a well-rounded deck also will make paddling easy, and yet allow sufficient room inside. On the other hand, if the canoeist is bent on a rough tour, in which he will probably have to cross large open lakes and arms of the sea, and yet often have to work his way down rivers and through canals, sailing will, or should, undoubtedly play as important a part as paddling; hence good freeboard and beam, coupled with a flat floor, are necessary for this work.

To go any further on this side of the balance would simply be towards making a craft which would be useless as a general travelling canoe, and inferior as a sailing canoe; and on the other side one would be nearing the details of ordinary river or “hack” canoes, whose form and fittings are easy of design and application.

The travelling canoe *par excellence* is that in which paddling and sailing are considered as of equal value as means of propulsion—a craft that paddles “light off the hands,” that sails and “goes full and by” without making much leeway, has good freeboard and moderately rounded deck, is built lightly but strongly, and is fitted with a water-tight compartment for safety, and in which stores and clothes may be kept dry—at the same time be the conveyance or the camp of her master.

The drawings on Plate L. show : Firstly, a "one-man canoe," Fig. A ; and, secondly, a "two-man canoe," Fig. B. Either or both these canoes can be built from the body plan D, from which the building mould plan E is taken ; bearing in mind, however, that for the "one-man " or Fig. A canoe the sections 1, 2, 3, 4, &c., are 1ft. apart, where in Fig. B they are 1ft. 2in. apart ; otherwise the same heights and breadths are common to both.

As to the drawings, the sheer plan (Figs. A and B) is that from which all heights, depths, and lengths are taken, and also shows the position, longitudinally and the sectional shape, of various fittings.

SHEER PLAN A. (PLATE L.)

a Centre-board case.	m Burdens, or floor boards.
b Centre-board lowered.	(m) Heel boards.
(b) Centre-board housed.	n Stern post and stern band, with gudgeons.
c Tabernacle.	o The two rudder bands and gudgeons.
(c) Chock for ditto on keel, with mast-heel chock on deck.	(t) The pin passing through these gudgeons.
d Foot steering yoke.	P Top side of keel.
e Deck yoke for rudder lines.	q Centre-board up-haul.
f Middle line of deck.	R Rabbet line.
g Beading, covering top of top streak and edge of deck.	t Rudder up-haul sheave.
h Coaming of fore side of well.	u Locker lid.
(i) Side deck.	V Mainmast standing.
‡ Side coaming of well.	V ² Ditto in paddling position.
j Backboard and shifting beam.	(V) Mizzenmast and case.
k Watertight bulkhead.	w Fore hatch.
l Coaming of locker hatchway.	(w) After hatch.
	y Scarp of keel, with stem and post.
	z Rudder yoke.

IN FIG. C.

1, 2, 3, 4, 5, and 6 represent the planks.	I Coaming of well ; and (i) side deck.
M The floor boards.	w Hatch, covering the well.
(m) Bilge burdens.	

TABLE OF DIMENSIONS.—FIG. A.		ft.	in.
Length over all, stem to sternpost		14	0
Beam, extreme.....		2	6
Depth, underside deck to garboards, taken at the fore end of the well.....		1	1
Sheer forward, above gunwale at X.....		0	7
Sheer aft, ditto		0	4
Freeboard at midship section (No. 7)		0	6
Draught at ditto		0	6
Centre of mainmast from fore side stem		1	6
Centre of mizenmast from stern post		2	0*
Midship mark <i>z</i> from perpendicular of fore side of stem head		7	0
Water-tight bulkhead aft of mark		3	0
Centre-board slot, fore end from fore perpendicular		2	0
Centre-board slot, length on underside of keel		2	4

* Shown as 1ft. 6in. in the drawing.

N A U T I L U S
Cruising Canoes Single & double handed
Designed by
W. BADEN POWELL 1880.

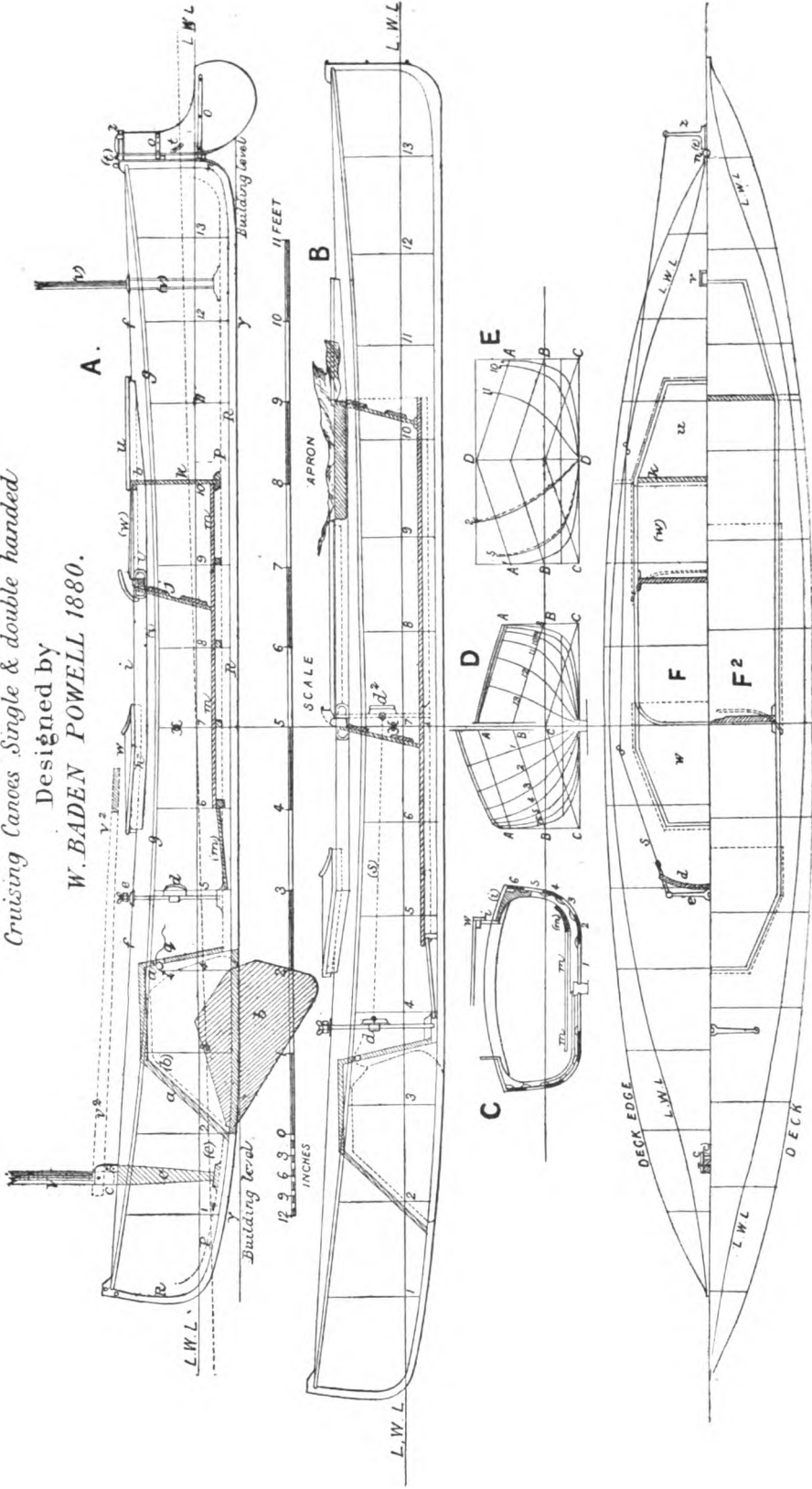

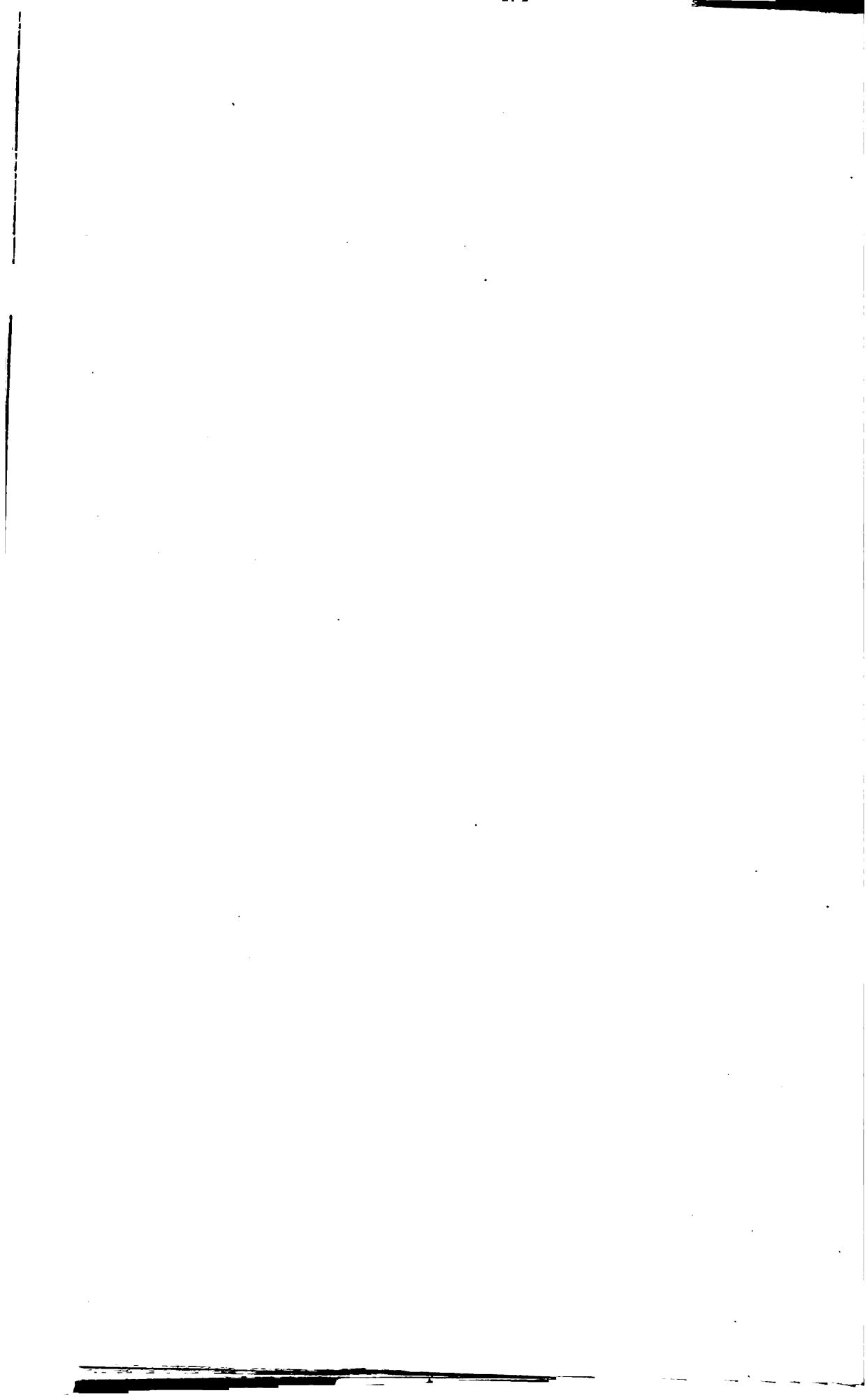

TABLE OF DIMENSIONS—continued. ft. in.

Fore end of well from midships.....	1 3
Length of fore end of well, on middle line	1 0
Length of main well, to bulkhead.....	3 3
Length of locker hatchway, on middle line	1 3
Height of well coaming	0 2
Foot yoke rod from midship mark (for a man about 5ft. 8in. in height)	2 9
Fore side of backboard beam aft of midships	1 9
Heel of backboard, ditto.....	1 6

TABLE OF HEIGHTS, DEPTHS, AND BREADTHS (PLATE L.)

No. of Sections	0	1	2	3	4	5	6	7	8	9	10	11	12	13	Stn.	
Height of gunwale, including deck, above load line	13	11½	9¾	8½	7½	6¾	6½	6	6	6¼	6½	6¾	7½	8½	10	
Depths, lower edge of rabbet below the load line	—	3	4¼	4¾	5	5	5	5	5	5	5	5	5	4¾	—	
Rocker of keel above building straight edge	7	2½	1	½	—	—	—	—	—	—	—	—	—	—	5	
Half-breadths of gunwale, g, from mid-line, without beading	—	½	5¾	9½	12	13½	14	14½	14¾	14¾	14½	14	12½	10	6	½
Half-breadths on diagonals. Fig. E A	—	—	9¼	—	—	14¾	—	15½	—	—	14¾	—	10½	—	—	
B	—	—	6¾	—	—	13½	—	15¼	—	—	14	—	9	—	—	
C	—	—	3½	—	—	9¾	—	12¼	—	—	9¾	—	5	—	—	
L.W.L. widths at 2, 5, 7, 10, 12	—	—	4½	—	—	12½	—	14½	—	—	13	—	7	—	—	

The diagonals are placed (Fig. D): A at 10in. above the load line on the *middle line* (marked DD in Fig. E), and 5in. above the load line on the side perpendiculars; B starts from a height of 5in. on the middle line, and cuts side perpendiculars at load line; C starts from middle line at load line, and cuts side perpendicular 5in. below load line.

The whole of the half breadths are to the outside edge of plank, so that, in building from them, allowance should be made for the thickness of the plank at every section (see dotted lines (2), (5), Fig. E); thickness of deck in the heights is included; therefore, in making the building moulds 2, 5, 7, 10, 12, the thickness of deck should be deducted from the heights above water-line.

We next come to the internal arrangements and disposition of the weights; here the starting point must be the man and his luggage. The backboard has been placed at 1ft. 9in. abaft the centre of length; a space has then been left, for reasons which will appear in due course, and the fore end of the luggage compartment is found at 3ft. aft of midships; forward is placed a small light centre-board, which should be of sheet steel or thin galvanised iron; and with the mainmast at 2ft. in from the stem, and the mizen at 2ft. from the stern, a good balance will be found to exist with sails of 32.5 and 19.5 square feet. Either a tent may be carried, or the owner may sleep on board, the foot steering

rod of course being unshipped for such work; the tent, with cooking gear "made up" inside, can be stowed under the after hatch (*w*).

When sailing, the backboard beam *j* is removed, and the after hatch is slewed round, and its after end is tucked under the after end of the fore hatch, or it is shipped over the locker lid; the canoeist then reclines at full length, with the tent roll for a pillow. This alters the trim and puts the canoe down by the stern about 2in., which brings the centre of lateral resistance aft, and gives a good balance for sailing, and the deeply immersed rudder holds a powerful sway over the movements of the craft. The rudder is fitted with two gudgeons, which when it is down rest on top of the two lower gudgeons on the sternpost band; a pin passes through these four gudgeons, and is held by a gudgeon at the head of the stern band, of larger bore; in this gudgeon, which is wormed, the head of the pin, which is also wormed for about a quarter of an inch, is screwed. A hauling line, which is fast to an eyebolt at one side of stern head, is rove through the sheave (*t*), and through a block or sheave fastened on the other side of the stern head, and then leads in to hand. The rudder is then liftable, and in the case of grounding, fouling weeds, backing astern, carrying over, going down rapids, and the like, the rudder should be hauled up until the upper rudder gudgeon comes in contact with the stern head gudgeon; in carrying over, or in any work out of water, it will be better to take the rudder off entirely.

The following mode of building is recommended: East India teak or pitch pine for the keel, mahogany for stem and stern posts, mahogany or oak planking for Nos. 1, 2, and 3 planks (Fig. C), and cedar for Nos. 4, 5, and 6; red pine shelf (under deck edge inside, Fig. C); sawn oak timbers cut from "crooked" pieces, with grain following round—cross grain being worthless—at stations 2, 4, 6, 10, and 12, and at 4in. and 1ft. 8in. abaft α section (Fig. A), and intermediate timbers, at 8in. apart, of steamed bent American elm; deck in six pieces—viz.: two half fore decks from forward to fore end of well, and aft two half decks coming from aft to bulkhead, of cedar; the two side decks (*i*) of mahogany; the seams of deck at middle line (*f*) and at ends covered by a $\frac{1}{4}$ in. beading.

The most successful mode of planking is the "ribband carvel," details of which have already been given. The ribband, however, in the present canoe may be even smaller, and be either of oak, American elm, or even cedar; the planking should be not less than $\frac{1}{4}$ in. in any part, and the garboards should be *screwed* to the keel with brass screws at most 4in. apart, and the hood ends or plank at stem rabbet should all be screwed.

The building moulds must have notches cut in them as the planking

goes on, to admit the ribbands; the sawn timbers are fitted and notched so as to fit close over the ribbands and on to the plank, and should be about $\frac{1}{2}$ in. sided, and $\frac{3}{4}$ in. moulded depth, with the inboard edges rounded away. The steamed American elm ribs are $\frac{1}{2}$ in. by $\frac{3}{4}$ in., and may be screwed to the ribbons or through-fastened.

The centre-board case should be of light construction, and should, with the slot in the keel, be no wider than is necessary for the centre place. No trouble should be spared to insure the case being water-tight.

The bulkhead *k* should be of mahogany $\frac{3}{4}$ in., or cedar $\frac{1}{2}$ in., and be well bedded against the timber at No. 10 station with marine glue or white lead. It should be tested and made water-tight *before* the deck is put on; so also the centre-board case.

The coamings, for all but very rough work, may be of cedar, and so also the hatches *w* (*w*) and *u*.

The rudder should be of mahogany, and bound all round with a copper band. A bilge stringer of American elm $\frac{3}{4}$ in. by $\frac{1}{2}$ in., or even larger, would add very little to the weight of the canoe, and would greatly strengthen it. Such a stringer might be fitted between *m* and (*m*), Fig. C, or on the side above (*m*), and should go from the bulkhead to the stem, and be screwed to the timbers, with chocks under it where it fastens to a bent timber if necessary.

The keel band should be light, and either of copper or galvanised iron; the stem and stern band to be of copper; the deck and rudder yokes of copper. The arms of the rudder yoke should be on the after end, as even a fore-and-aft pull is with such yokes still turning the rudder; the foot-yoke is of wood, and its rod should be a steel rod, covered with brass. The foot-yoke is *fixed* to the rod, and the deck-yoke fits on to a square head, the upper part of which is wormed; and a thumbscrew nut keeps the yoke on firmly. The deck should be bushed with brass where the yoke rod comes through. The yoke lines should be solid stout copper wire, with thimbles twisted in at each end, and lashed to the rudder yoke, and set up with a lanyard to the deck yoke and abreast of the “well.” They should pass between brass deck studs, to keep them set in working position.

The design in its leading features differs considerably from existing canoes, and it may be well to give the chief reasons which dictated the design. First of all, the canoe is to be as small as will comfortably carry a 12-stone man and about 60lb. of luggage in a draught of water of about six inches; she must be of sufficient freeboard and beam to cross large open lakes in ordinary weather; she is not intended to carry

ballast, but is intended to carry sail, therefore the floor must be kept flat. Freeboard is of far more importance, coupled with a flaring bow and quarters, in getting over rough water, than is any amount of rounding of deck—indeed, were it not for requisite strength, it would be preferable to take 2in. of rounding from the deck and put it into the freeboard; but then in steps paddling, which demands a low freeboard when the beam is wide; however, in the design the freeboard is as low as it comfortably and safely can be, and the deck is kept at a sufficient rounding for strength. It will doubtless be noticed that considerable flare is given to the sections at the bow and stern above water. In a racing canoe this would be an error. But for a travelling canoe the flaring bow forms a great help towards a dry passage in broken water.

The double-handed canoe (drawing B) is a craft which is becoming exceedingly popular, not only as the “married members’ canoe,” but as a travelling craft; there is a good deal to be said in favour of a craft which will carry two men on a cruise, and yet be not too large for one to manage in the absence of the rest of the crew. In the first place the original cost is for *one* canoe, and though she is some 2ft. or 3ft. longer, and has a few more fittings, yet her cost should not be more than about 3*l.* over that of a “single;” secondly, her “keep” or “housing” by the year is for *one* canoe; so also her cartage, railway, steamboat, and such portage charges, are for one canoe; and many similar points might be invoked to show that her working expenses are not much over those of a “single,” and very considerably under those of two canoes.

Two good hands could, in travelling, work the double-handed canoe nearly twice the distance in a day that two single-handed canoes could be worked in the same circumstances. At sailing in a reaching wind she would be faster than the short single, in lumpy water she would have more weight to carry her way on; in a calm or head wind both can pound away with the paddle, and work can be continued “watch and watch” if need be; so that literally the double-handed canoe could be kept going on her course day and night with scarcely more hardship to the crew than is entailed in working a 5-ton yacht down Channel.

The design is arranged for two moderate weights, such as twelve stone and nine stone, which we may take as average for a “married member’s” canoe; in that craft the “better half,” *i.e.*, the heaviest weight, should be in the forward seat, and then the “light weight” and the baggage in the locker will bring about the correct balance. When it becomes necessary to jump out and shove off from the ground when running a rapid, it is the “heavy weight” who should do

so, and should do so from the fore end, so as to prevent her swinging broadside to the stream. When the canoe is being towed, and the after sitter remains on board to steer her, the foot yoke forward is connected by two wires, (s) Fig. B, to another foot yoke which is fitted into a step on the keel and into a notch or chock on the afterside of the back-board beam of the fore compartment; the after well is covered by a macintosh apron abaft the half hatch. When the canoe is to be worked by one man only, he would sit in the after place and put the luggage under the fore hatch and join the two hatch covers together.

The canoe shown is for about twenty-one stone of crew; for two men of twelve stone the sections from No. 7 each way should be 1ft. 3in. apart, *i.e.*, length 17ft. 8in. The placement of the masts and centre-board should be the same, measuring from the ends, as in the "single" canoe; a slight advantage might be found, where much lake work is contemplated, in having a small centre-board aft in addition to the one forward, but as its case takes up valuable space in the locker, and as centre-board cases are apt to get out of order on long rough journeys, and leak, on the whole, it will be better to omit the after centre-board where rough work is anticipated.

The same rig and sails should be given to the "double" as to the "single," for though longer and more heavily weighted, she may often have to go single-handed, and even when double-handed sufficient speed will be got out of the suggested rig and area.

Where the chief work is to be lake sailing slide flaps will be very useful, but where much hauling about, and jumping in and out are anticipated, side flaps are utterly out of place. If fitted to the travelling canoe the after end of the flap should be just forward of the backboard beam, and it should be strongly hinged at the outer edge, and, in short, strongly fitted in every way, as it is just about in the place that one's hands lay hold of to raise the body in case of a sudden jump up or out. A broken, and perhaps lost overboard, flap would be a dangerous mishap to a canoe in rough water.

The hatches by which the well is covered may be seen in the drawings, and it will be noticed that on the after end of the fore hatch, and on the fore end of the after hatch, are small coamings, with a beading on them; these coamings are for the purpose of holding the "coat apron" flounce (see page 389).

One side under the fore deck, forward of the foot yoke, should be as nearly as possible filled up by a macintosh air bag or air bed. Such a bag is of little weight, and makes it impossible for the canoe to sink. If sleeping in the canoe, or indeed any camping out is contemplated, an

air bed will be found a great comfort. It should be specially made, having one end smaller than the other, so that when folded lengthways and blown out it just fills the space on one side under the fore deck. If a bed, it should be wrapped up in a macintosh sheet, which for sleeping in the canoe will form the tent between the masts, or ashore acts as ground sheet. The canoe should be fitted with a strong pair of slings, ready for hoisting her on to steamers or quays, &c. For each end of the canoe a strong webbing band, with an eye at each end, is passed under the keel, the eyes meeting over the middle of the deck, at about 3ft. in from the end; a piece of lin. or 1½in. manilla is spliced into the two eyes, and is of such length as, when fitted at its other end with a pair of clip-hooks, to reach the mid-length of the canoe; here a large-sized galvanized iron ring, having the after sling rope spliced to it, and also coming to the mid-length, hooks on to the fore sling, and the steamer's crane hook hooks into the ring. The sling thus fitted can be shipped or unshipped in a very short time, even when afloat in rough water.

Sails for the cruising, or travelling, canoes will be found described further on under the head of "Canoe Sails."

SAIL CARRYING POWER OF CANOES.

Paddling demands an upright position of the man's body, but sailing equally demands a lowering of the weights, and consequently a reching position; and further, when running dead before a strong wind under a press of sail, even though a spinnaker be set, the head of the lug will get forward of the right angle, and cause violent, if not dangerous, rolling. Comfort, combined with safety, will be obtained under these circumstances by lying back, and firmly wedging one's shoulders between the two sides of the after well-coamings. To obtain this the bulkhead is placed six inches further aft than it would be for the ordinary back board, and the back board is supported for paddling by a shiftable beam, which can be removed when sailing, and then the back board is inclined against the bulkhead.

A British sailing canoe, of racing build and equipment, is undoubtedly the most delicate of all sailing craft in the world to handle. Her sail-carrying power almost entirely depends on the artificial shifting of her centre of gravity to windward by moving her ballast and crew. She is the craft *par excellence*, in which "crew" and "craft" are linked together, and form one working machine. The small depth of body and keel allowed by the club rules, coupled with the necessarily large proportion and weight of crew, spars and sails, to the small hull, cause a far higher

position of centre of gravity in a canoe than would be found in any other class of vessel.

The beam allowed by the club being very trifling for sailing purposes, it will be readily understood that the "righting couple" (see page 9) must be very short at any angle of heel, unless the weights are moved rapidly over to windward as the vessel heels; consequently, righting force or stability will be limited to comparatively small angles of heel, and there will be a point at which stability will vanish and the craft capsize.

As soon as the canoe begins to heel, the weather bilge is lifted out of water, and a large bulk of body is immersed on the lee side, and

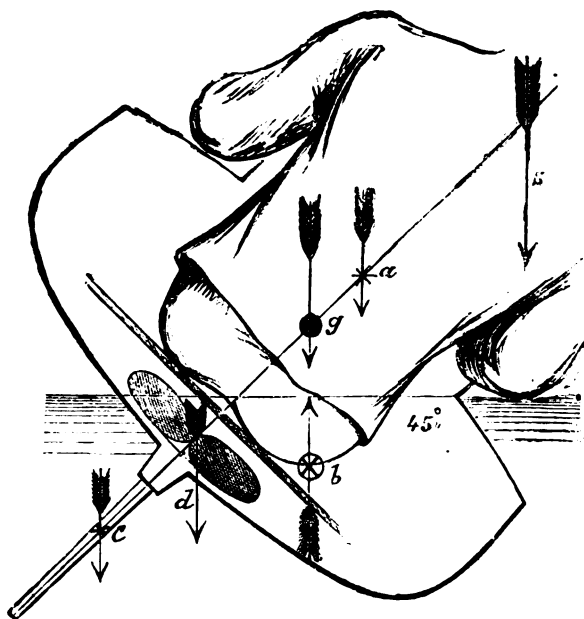

FIG. 132.

consequently the centre of buoyancy is rapidly shifted out to leeward. Supposing, then, that her weights remain in midships (Fig. 132), there would be a considerable and gradually increasing righting power, till, practically, the deck is awash, or about at a heel of 25° ; but the centre of gravity is now being lifted, as it were, and some of the weights, such as that of the man's body, is coming into the vertical in which is the centre of buoyancy, and that of the spars and sails is shifting out to leeward. This is rapidly shortening the righting lever, and therefore the vessel is nearing the capsizing point, and at 45° she has brought them into the same vertical, and then a capsize must follow. But before

this point is reached the man's balancing power, aided by that of ballast trimmed to windward, comes into play, and the craft receives a new lease of righting life, as in Fig. 133; the only danger then remaining is that of the lee well-coaming getting under water, or of the ballast or man suddenly falling to leeward.

In Figs. 132 and 133 the positions of the centres are slightly exaggerated, in order to show the movements more clearly: *b* in each drawing represents the centre of buoyancy (through which a force is always acting upwards at right angles to the surface of the water); *g*, the centre of gravity, is the mean centre of gravity of all the weights, such as ballast, man, spars, sails, centre-board, and weight of hull; a force is always acting downwards, in a vertical direction through *g*. Each of these two forces is equal to the exact weight of the canoe and all she contains. The horizontal distance between the verticals of *g* and *b* is the "righting couple," and, so long as *g* has any horizontal distance to windward of *b*, there is stability; but in Fig. 132, *g* and *b* have been brought into the same vertical line, the meta-centre (*m*, in Fig. 133) has been brought to coincide with the centre of gravity, and consequently the vessel is in equilibrium, and a cockroach walking across the deck might settle the question of "capsize" or "right."

The centre of gravity of the separate parts of the canoe may be considered individually: *a* is the centre of gravity of the canoeist; *d* the centre of gravity of the ballast; *c* the centre of gravity of the centre-board. The arrow *s* reminds the reader that spars and sails are heavy, and have a centre of gravity.

The curve of stability of a canoe, in which the ballast is not shifted, and the man's position is not altered more than an attempt at a perpendicular balance, made whilst retaining a midship seat, would show considerable stability at small angles of heel, say 10° to 25° ; thence, however, it would rapidly decline, and arrive at a vanishing point at about 45° ; but, if the ballast and man both shift up to windward, the curve will be a far more powerful one, and the canoe would be safe, even though a puff put her over suddenly to 45° .

Suppose a canoe to be sailing, and heeled over to an angle of about 20° , and working short tacks where there is no time to trim ballast over, and where the wind is coming in sudden puffs, it will often be found necessary to do a multitude of things at the same moment; such as to sit over to windward, to luff sharply before steerage way has been lost in consequence of the sails banging about, to ease off the head sheet and flatten in the mizen, and, perhaps, to lift the centre-board for shoal water, and then have to go about suddenly, and perform much the

same thing on the other tack, with perhaps the addition of taking in or shaking out a reef or two.

The necessity of performing the operations quickly in a canoe suggest and somewhat dictate the various fittings and arrangements; for instance, sitting up to windward can best be performed when the craft has been fitted with side deck flaps; to luff or bear away at the same moment that one's hands are engaged about the sheets and halyards, pointedly suggests the advisability of steering with one's feet. To work the sails smartly, and keep the canoe bottom downwards, it is essential

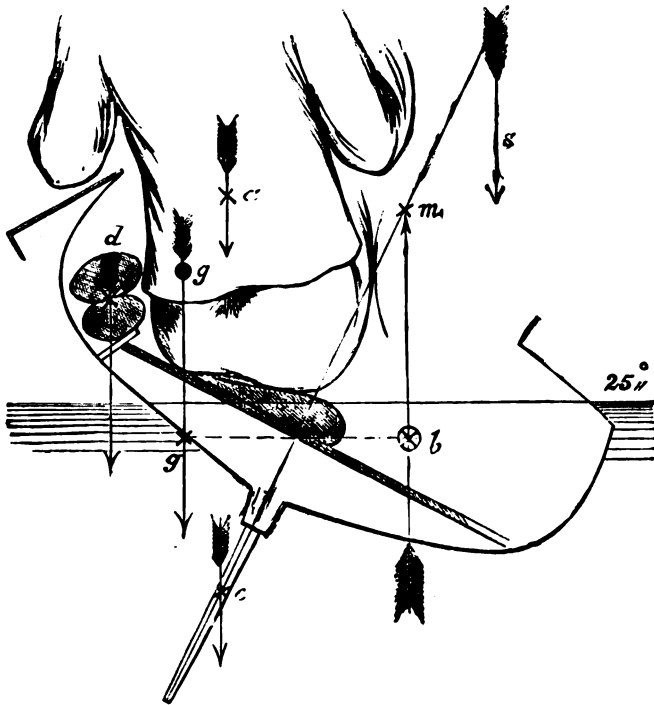

FIG. 133.

that the chief sail should be, with its gear, forward of the man, and the various ropes and centre-board lifting gear must all be close at hand, so as to be readily worked by the man without leaving his sitting position.

The canoe, limited in its dimensions by the club rules, is essentially a craft of small displacement—a craft, in fact, in which balancing the crew and a little ballast out to windward has more to do with, and is more successful at, sail carrying than any weight of ballast stowed below; the ballast cannot be got low enough to act as does the lead mine in a 5-ton yacht, and it is becoming more and more acknowledged that,

for canoe sailing, a pound of shifted ballast is more effectual than ten pounds of weight stowed beneath the floor boards.

To allow a good and sufficient margin for heeling over and for rough water, freeboard in sailing canoes is very seldom less than 6in., and much more often will be found to be 8in. Taking this as a fair margin, the depth of the canoe's body, from water-line to garboards, will be 6in.; weight of boat, gear, and man will not put the foregoing size of canoe down to this depth of immersion; consequently, ballast must be taken in until she has come near to, or down to, her marks. The arrangement of this ballast will be a question of how best it can be handled in working the boat; the heavy man will possibly require no more ballast to put his boat down to her designed load-line than he can conveniently handle as shifting ballast; whereas the light weight may have much more than he could possibly shift, and, consequently, must stow some below the floor.

Having arrived at the correct weights, and the most useful way of stowing them, the next question will be as to how much sail the canoe, so weighted and balanced, will stand; it is a point that can scarcely be found out by calculation, but can be most surely ascertained by experiment. A suit of sails will never be wasted, for in making them and trying them much experience will have been gained, even if the sails are never used again; the same masts and rigging will, or should, be available for each and every suit of sails the canoe is fitted with; and in making them for a new canoe it should be kept in mind that once a spar is cut no amount of watering will make it grow longer; so it will be well to have all spars and ropes longer than actually necessary at first; then, when the craft has been carefully tried, the owner will know how much may be cut off.

The rigging scheme should be this—give the craft sails of the *full length she can use*, and in hoist stop them at the area it is anticipated she will be able to carry to a moderate breeze; leave the masts long enough for larger sails, then the same spars and gear will do throughout. If she is found to be over-stiff for the first rig, either ballast can be taken out or more sail added, and in such case it is only a matter of increasing the hoist, taking care, however, that the relative sizes are kept up so as not to disturb the position of the centre of effort.

CANOE SAILS.

Almost every conceivable rig and sail has been tried on canoes—cutter, sloop, schooner, yawl, dandy, and even top-sail schooner have appeared; gaff sails, Chinese lugs, standing lugs, dipping lugs, balance lugs, sprit sails, settee sails, lateen sails, sliding gunters, sliding sprits,

split lugs, and leg-of-mutton sails have all been tested. Now, for racing, the balance lug main-and-mizen rig is the common favourite.

These two working sails and a spinnaker for running appear to give the best all-round results. Topsails and jibs are often used, but they are difficult to handle—not of much value as drivers, and they require a considerable amount of extra gear.

It has been pointed out that the peculiarities of a canoe considerably dictate the forms and positions of her fittings; but the position of her masts depends to a great extent on the situation of her centre-board or boards, and that the proportions and positions of her sails must be agreeable to the centre of lateral resistance. We now come to the consideration of the various rigs and rigging adaptable to the requirements of the canoe; and, whilst considering the subject of sails, it will be well to bear in mind that the particular cut or shape—such, for instance, as a high-peaked head *versus* a low or square head—can be indulged in in accordance with individual ideas of beauty, to any extent, so long as the relative areas and position of the centre of effort are not disturbed in relation to the centre of lateral resistance.

It has often been contended, on paper, that the most perfect rig for going to windward is that which has two sails, the large or driving-sail aft, and the small or balancing sail forward. This plan is not always the best for canoes, even apart from the peculiar requirements of the canoe.

In a cutter yacht, where the main sheet is never started, and the vessel can be allowed to lie over till the wind passes over her sails, the mainsail is properly the after sail; but in boats and canoes which cannot be safely permitted to lie down and drag through a squall, the chief sail should undoubtedly have its centre forward of midships, and should be supplemented by a balancing sail in the shape of a mizen.

A jib in canoes is a troublesome snare, its driving power is comparatively small, and it is only in play when the wind is abeam or forward of the beam; yet it entails a lot of extra gear, requires constant watching, and in a really bad squall is suicidal to the boat.

The two-sail rig is, however, handy and effective on all points of sailing and manœuvring, “before the wind” both main and mizen are “drawing well,” and in a squall when on-a-wind the mizen luffs the boat, and the pressure is taken off her by spilling or reducing the big sail; the centre of gravity of the mainsail is forward of the centre of lateral resistance, consequently by spilling the mainsail the centre of effort of sail is thrown aft, and the boat luffs sharply; or, for bearing away, the main sheet is kept flat in and the mizen eased up, the centre of effort thereby being thrown forward, and the canoe goes off the wind; both manœuvres

being, of course, greatly facilitated by the judicious use of helm and centre-board. The two-sail rig, supplemented, of course, by efficient handling and reefing gear, should not too lightly be cast aside in favour of some, perhaps, prettier fancy rig, for in a really bad and lasting squall in open water, the presence of the above qualities will decide whether the canoe will live through it or not.

SAIL PLAN FOR PADDLEABLE-SAILING CANOE.

In the Sail Plan (Plate LI.) the main-and-mizen rig is shown formed by two balance lugs. The sails, however, need not necessarily be balance lugs; but if gaff or sprit sails are substituted the masts have to be shifted forward, which is undesirable, as the weights should be kept as much in-board as possible. It may be objected that the rig shown in the drawing has too much gear to be handy for cruising purposes, but the rig is not put forward as a rig admitting of rapid shifting, but as a moderately well-proportioned sailing rig.

It is always easier to do away with parts of gear than to invent them, consequently a full design must be more satisfactory than a bald one, as in such case each owner can adopt, alter, or discard details according to his fancy. There is always something to learn in the matter of rigging, even by the oldest hands; and slight alterations in the arrangement of the gear can often be made to add greatly to the ease and enjoyment of the canoe sailer.

In Plate LI. (Sail Plan I.) G is the centre of gravity of the sail; A, the tack of the sail; B, the throat; C, the peak; D, the clew; e, reef or batten bands; f, the ends of the battens; g, fairlead bands for reef earings; h, strengthening pieces at all corners and cringles.

The numbers refer to the ropes and blocks, and some are reproduced on a larger scale in diagram II., Plate XL.: 1, the tack; 2, main halyard; (2), main halyard snotter; 3, peak halyard, acting also as forestay; 4, peak halyard span; 5, double topping lift; 6, main sheet; 7, reef earings; (7), ends of reef earing and cleat for belaying them on; 8, spinnaker halyard block; (6), main sheet gear. Fig. (6), main sheet gear; 5, topping lift; 6, main sheet, showing block and snap hook. Fig. 2, mast-head and slinging plan, in which the ropes are numbered as above.

	Mainsail.		Mizen.	
	ft.	in.	ft.	in.
Tack to peak	14	10	7	3
Clew to throat	11	0	4	11
Foot	9	4	4	5
Luff	6	4	3	0
Head	8	9	4	4
Head rounding	0	2½	0	1
Leech	15	4	7	4

PLATE LI.

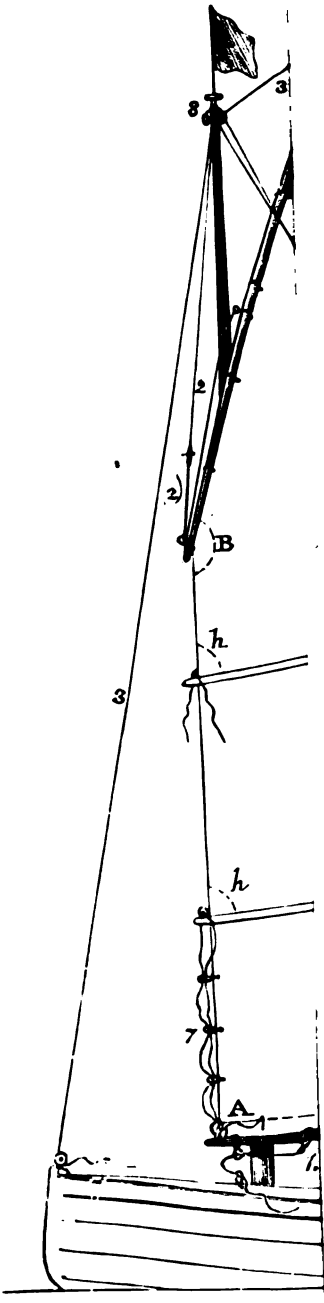

10 9

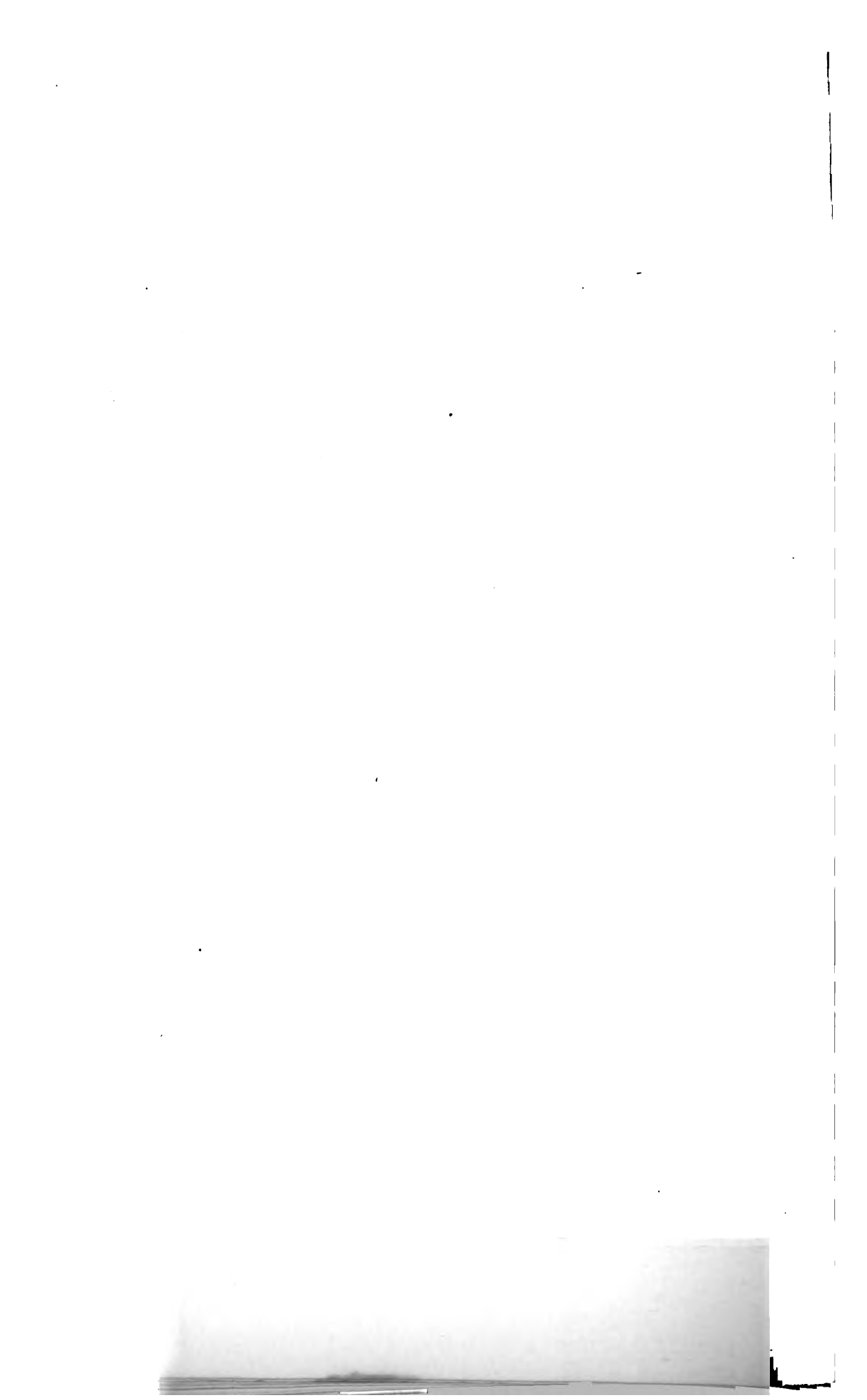

Centre of effort of whole main and mizen is 4in. aft of midships;
centre of effort of first-reefed main and whole mizen 9in. aft midships.

	Area.
Mainsail	76·2
Mizen	16·5
Total Area.....	92·7

The total area here shown as 93 square feet will be found as much as the canoe can well carry on a wind in from light to moderate breezes. She could, of course, carry more in light airs and calms, but that would entail the use of longer and heavier spars, which would tell heavily against her in any other weather. The plan, however, is drawn so that the first reef taken in the mainsail leaves a total area of 71·5 square feet, 55 in mainsail, and 16·5 in mizen, with centre of effort in same vertical as centre of lateral resistance. The proper principle for making a sail plan for canoe is—give her (correctly balanced) as much sail as she can stand in a good steady sailing wind, and a reef extra for fine weather.

For running in light-weather racing, a spinnaker may be set. Such a sail requires only one extra spar, a boom of about 7ft. to 8ft. length, and a halyard and outhaul. It is by no means an easy sail to handle, and should not be set in a breeze until considerable practice has been gone through in light airs; for the above rig the luff would be 12ft. and the foot 7ft.—36 square feet.

The mizen shown in the sail plan is an ordinary balance lug, fitted with an ordinary “standing” tack and a “standing” topping lift; the lower part of the topping lift branches into two parts so as to gather in the sail when lowered, and thus save the trouble of tying reef points or furlings. The reef earings are fitted thus: the standing part of each is fast to the boom, the earing is then rove up through rings on luff rope of, and after one through rings on, the sail, passing through a thimble on the upper side of the batten and down the other side of sail, through rings to and through a thimble on the boom, both parts are brought to the after side of a thimble, lashed on the boom abreast of the mast, and at that point where the sail is hoisted are spliced into one another, the single part is then brought through the thimble and leads to a cleat at the well; on lowering the halyard this reef line is hauled on and the reef comes snugly down as the sail is lowered.

The mizen halyard may be fitted thus: a wooden toggle is fitted to the end of the halyard, two grummet eyes of rope are fitted on to the yard, one at the fore end and the other at middle, the halyard is passed through the upper eye and passed round the opposite side of the mast to that on which the yard is, and then toggled to the eye at fore end

of yard; the tauter the halyard is set up the closer the yard is jammed to the mast. The batten, which is contained within a broad band of tape stitched on to the sail, keeps the sail set flat, and avoids the necessity of tying the reef points.

The mainsail should be made of fine calico sheeting in one width, and the stuff should be nailed out on a floor, and the sail shape marked off in pencil or coloured chalk, taking the selvedge for the leech. Narrow stay-binding tape should then be stitched on all round, except the leech, and the stuff cut outside the tape, allowing sufficient for turning in. Eyelet holes must be sewn where required for lacings, &c., and the sail should be strongly roped on the luff and slightly on the head-corner patches, for strength should not be forgotten. Next the sail may be lightly set on its yard and boom and hoisted, and then well wetted all over and left to dry. After this the reef bands and batten bands may be put on.

For spars yellow pine is generally preferred. Many use bamboo; but, except for a flying topsail, or other light sail, bamboo offers no advantage. Well-picked yellow pine spars look well and stand well.

The main tack can be fitted in many ways. A good plan is that in which a snorter, or short piece of stout rope, or flat sennit is fitted to the boom abaft where the mast will be. It is taken round the opposite side of the mast to that on which the boom lies, and is then rove through a thimble on the under side of the boom, and finishes with an eye. The tack pennant is toggled to this eye, and then leads through a block or eyebolt in the deck under the boom at foreside of mast, and may be used either in single part to a cleat at the well, or fitted with a block and whip. (*See also farther on.*)

In reefing, the tack-earring should always be hauled down first, then the after-earring, and the points can be tied whilst sailing.

The drawing shows the yard as slung with main and peak halyards. In this rig, when the peak halyard is let go, the main being fast, the sail spills just as a gaff sail does. This is very handy in a squall; and the sail can be better set than is the case where one halyard only is used. The gearing for these halyards is shown in the masthead plan II. in Plate LI.; (2) is the mast snorter, made either of rope or flat sennit. It is lashed to the yard on the mast side, and leads round the mast to and through a thimble at the fore end of the yard, and is then finished off in an eye to which the main halyard toggles. The reason for having these snorters is, on the one hand, that they receive the chief wear and tear and can be renewed, thus saving the halyards and tack pennant from being cut and shortened; on the other, that, if of flat sennit, greased, they travel on the mast more freely, and do not cut into the spar as rope

does. No. 4, the peak span, is best made of copper or brass wire cord. It divides the strain on the spar, and permits the peak halyard to shift upwards when the sail is reefed. A metal thimble, with a grommet of rope on it forming an eye, travels on the span, and the peak halyard is toggled to the eye.

The topping lift (5), a most useful piece of gear, is fitted by having its standing part—a running eye—round the masthead; the end is taken down one side of the sail to and rove through the thimble, in the sheet-block strop, then up on the other side of the sail to reeve through its block on side of masthead, and down to block at side of mast at deck, and into hand at the well.

The peak halyards may be taken down to a block on stem head or at side of mast, and lead into the well.

With the large sails now in use a forestay will be found almost necessary to hold the masthead from coming aft when close hauled by the wind. Another very useful piece of gear is a mast jackstay, fast at both ends to the mast, one at the masthead, and the other having passed down outside the sail on the opposite side to the mast, comes under the boom and up, and belays round the mast, some 6in. above the level of the boom; when the sail is lowered, it is snugly gathered in by this jackstay and the topping-lift, and all the gear can be unbent from the yard and boom, and then the sail, rolled round, can be slipped out from the gear, and all the ropes neatly frapped up and down the mast.

The mainsheet is fitted at one end with a large eye, the splice ends of which are formed into a good-sized knot, sufficient to prevent it unreeving; the sheet is used single when running or reaching, and, when close hauled, the eye is slipped over a hook on deck aft of the well, and the sheet becomes doubled thereby.

The battens, which cross the sail at the reef-bands, are usually made of yellow pine or bamboo, and should be stoutest at about one-third from the fore end, and be parreled to the mast by a snotter, with toggle and eye, or by a lacing; and, thus fitted, the sail stands without any shifting, as well on one tack as on the other.

The sail, as shown, is rigged on the port side of the mast; the jackstay is not marked, as it might be confusing to the inexperienced reader; it, however, comes down on the port side of the sail.

It will be found a great convenience to fit the main mast so as to be lowered as already described; in such case the mast will be pivoted to a tabernacle an inch or two above the deck, and a small hatchway will be necessary on the fore side of the mast in the deck to allow the heel to come up; the mast will be held upright either by a forestay or a heel

tackle. There are many ways of fitting the heel and lowering gear ; the chief point, however, is to remember that with a long heavy mast there is considerable leverage about its heel, and therefore the deck and mast case fittings must be strong.

The mainmast should be a "grown" fir spar, straight and tapering, if possible, with little more than the bark taken off. Length, from deck to masthead shoulder, 12ft., cut square at and below deck, 2½in. diameter at deck, and tapering below to 1½in. rounding, commencing 3in. above deck, taper to 1½in. at head. The mast should be cut rather longer, say 13ft. or 14ft. deck to hounds at first, it can then, after trial, be reduced to the length suitable to the sail. The boom should be cut 10ft. long, and reduced at the after end when the sail has settled into shape. Yellow pine, 1½in. diameter in centre, taper to 1in. at fore end, and ¾in. at after end. The yard should be of yellow pine, cut 9ft. 6in. long, same size as boom, or a little less, or it may be a slight spar, with a fish batten of elm seized on its upper side.

A double 1½in. or 2in. block and a single block should be stropped with strop and thimble, and lashed firmly to the mast just above the deck ; the double block at the after side and the single one on the starboard side of the mast, and on the port side a stout brass ring, lashed on by the same lashing, will serve as a leader for the topping lift. At the masthead there should be a good-sized sheave hole and sheave for main halyards, three single blocks, 1½in., stropped with strop and thimble, lashed on above the mast shoulder, so that one hangs each side, and one on the fore side—these take the peak and spinnaker halyards and the topping lift ; a truck above and a neat brass flag rod gives a finished look to the masthead.

All spars, blocks, and lashings should be varnished, the mast being afterwards glass papered and oiled.

Blocks should be of boxwood, and have metal sheaves.

The mizen sheet may lead to a boomkin, but it will be better led to the rudder. The standing part fast to back edge of rudder just above water, then led through a block on mizen boom and in to hand at the "well."

SAILS OF "NAUTILUS" RACING CANOE.

The sail plan and its fittings of the Nautilus racing canoe are shown, except as to dimensions, on p. 412, Plate LI., the chief difference being that the mizen in the racing canoe is, in proportion to the mainsail, very much larger, *i.e.*, about half instead of about a quarter the size of the mainsail. The sails are five in number, viz. : a racing mainsail, No. 1 mizen, No. 2

mizen, No. 1 spinnaker, No. 2 spinnaker. The mainsail is 100 square feet area, with bamboo yard, and three bamboo battens and a pine boom; boom 11ft., yard 9ft., spinnaker boom 11ft. The reefing gear is simple and effective; the stuff used is woven cord lightly dressed with boiled linseed oil (to prevent shrinking or swelling when wet). The after earing is rove thus (see Fig. 134): make one end fast on the boom at *a*, plumb from under the reef cringle, then lead up through small brass rings sewn on to the sail, and lead through a block at the after end of the batten (*b*), thence, in a line parallel with the batten, through a stout brass ring lashed on the batten; then through one of two blocks (stropped and seized head to head as a sister block), and back through a block seized to the stout ring and down through small rings (*c*) on the sail, and fast to boom at *d*. The fore earing is made fast at tack end of boom (*e*),

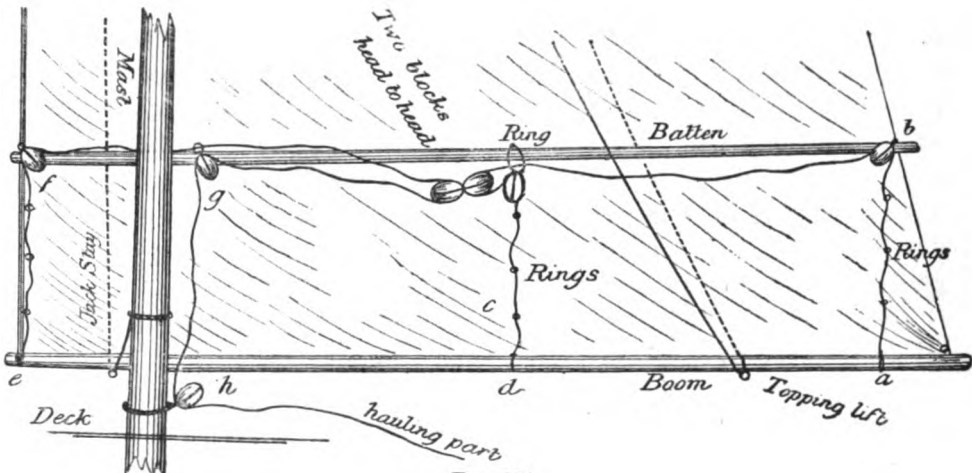

FIG. 134.

and leads up, through sail rings, to and through a block at fore end of batten (*f*), thence along batten to and through the other of the two blocks already mentioned as being stropped together, and back to a block lashed on batten abreast of mast at *g*; thence down to a fair-lead block (*h*) at heel of mast on deck, and belay the hauling part to a cleat. This gear can be fitted to each reef, but is in practice only necessary for first and second. When a reef is hauled down it may be further secured by ordinary points. The boom being held up by the mast jackstay and the double topping lift, a reef is taken in by simply easing away the halyard till the batten is down; and when the reef is down, the sister block is close up to the batten block at mast.

The No. 1 mizen is 50 square feet area, and is fitted with one batten only; No. 2 mizen is 25 square feet, and fitted also with one batten reef.

The mizen reefing gear is of the same pattern as that of the mainsail. The large mizen makes a good bad-weather mainsail with No. 2 mizen set aft.

No. 1 spinnaker is set on a long boom, which has a ferule joint about $\frac{1}{2}$ in., so as to be shortenable for stowage, and also for using with No. 2 spinnaker; the spinnaker is 60 square feet area.

The mainmast is a "grown stick" of white pine, and is 15ft. 6in. from deck to head, and 2 $\frac{1}{2}$ in. diameter at deck, tapering to 1 $\frac{1}{2}$ in. at head.

The mizen is 8ft. deck to head, 1 $\frac{1}{2}$ in. diameter at deck.

Rigged in this way, the canoe works perfectly, and so long as an air of wind is going the paddle keeps the "watch below."

SAILS FOR CRUISING CANOES (PLATES LII. AND LIII.)

One of the first principles in planning the sails for a canoe is to keep the centre of effort as low as possible, and where a large sail area is wanted, it should rather be obtained by long boom and yard than by a lofty mast and narrow sail. Now stowage of spars demands that they be kept as short as may be, and also it will be found that where the masts are considerably towards the ends of the craft a mizen of considerable size will have to be carried; if a fair sail balance is to be made combining these requisites—a good sail area, a low centre of effort, ease of stowage of spars, and a good working balance—the sail plan here given will be found an efficient one for all-round work.

The outline idea is that the main and mizen lugs are to be used in all weathers up to a "fresh breeze," and that then for stronger breezes the mizen lug is to be set on the main mast, and the storm mizen on the mizen mast. The total lug area is 52 square feet—*i. e.*, 32.5 in the main, and 19.5 in the mizen; and the storm mizen is a sail of 9.5 sq. ft. The rig itself and the various fittings have been amply tested in practice afloat, except as to the proposed mode of mast tabernacle, contrived to avoid a hole in the fore deck. The following letters denote the chief fittings:

- | | |
|-------------------------------------|-------------------------------------|
| a Main halyards. | l Stay tackle. |
| a 2 Hauling part of ditto. | m Mast parrel on batten. |
| b Main topping-lift. | n Cleat on boom for hand reef line. |
| b 2 Main topping-lift hauling part. | o Yard grommets. |
| c Tack parrel. | p Main sheet grommet. |
| c 2 Main tack. | q Main jack stay (dotted). |
| d Reef batten of bamboo. | R Main blocks. |
| e Reef earing. | s Mizen sheet. |
| e 2 Hauling part of reef earing. | t Mizen tack. |
| f Reef earing blocks and fairleads. | u Mizen halyards. |
| g Reef sister blocks. | v Mizen topping lift. |
| h Hand reef line. | w Mizen jack stay (dotted). |
| i Main sheet. | x Main and mizen reef bands. |
| j Mast joint ferrule. | y Buttonhole slit in band |
| k Forestay. | z Patches on sails for rings. |



SAIL PLAN

*"Nautilus," Travelling Canoe,
1880.*

MUSEN

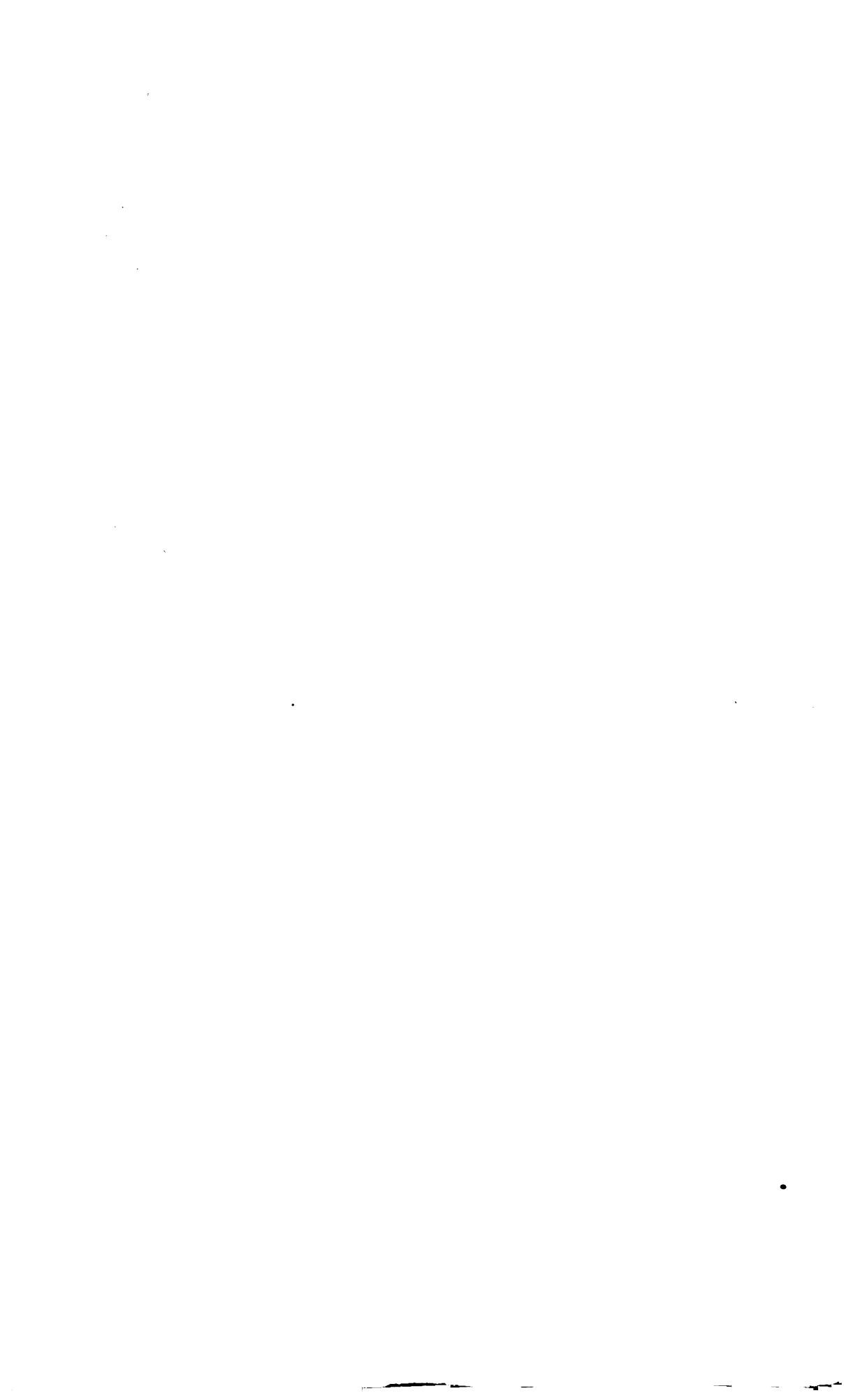



*Mast Head
Strop*

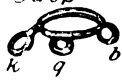
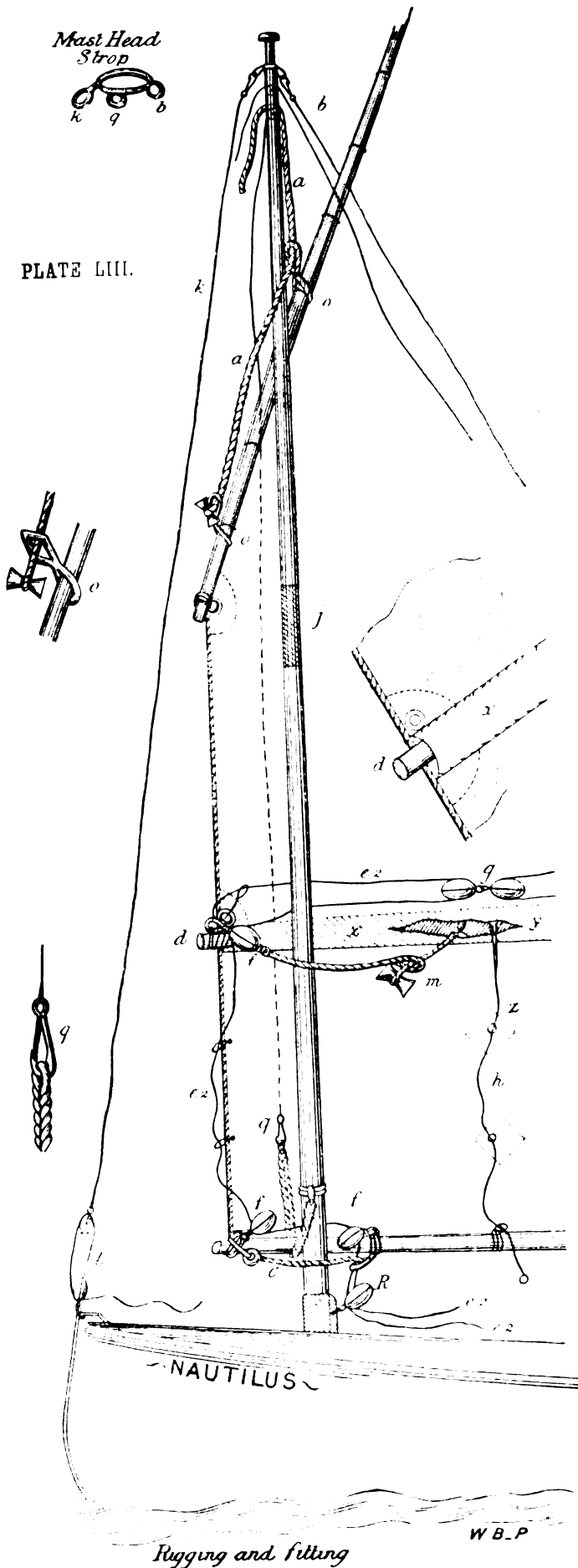

PLATE LIII.



In the accompanying sail and gear plans there will be found only such gear and fittings as have a pronounced value in the working of the craft and the sails. Not a single thing can be omitted; each has its use, and has been introduced under the light of experience.

The drawings (Plates LII. and LIII.), are intended to show the position, form, and make of the sails, and are drawn to scale; the gear, however, is put in the drawing in a pronounced manner, in order to make the details clear to those who may desire to rig in the same manner. The blocks, for instance, are shown much larger than scale drawing would show them; the ropes are shown thick and slack, so that their “lead” and use may be easily picked out.

The gear at the mast head is either toggled or snap-hooked to a mast-head strop, *k q b*, so as to be easily taken off for the various shifts of sail. The main halyards are rove from the deck block, *R*, up to the sheaves in mast head, and rove through from forward aft and *a* rove through a grommet (seized on to yard at 2ft. in from fore end), and then taken on opposite side of the mast to that on which the yard is, and toggled to a grommet which is seized on to the yard at 6in. from the fore end. Another plan is to have a flat sennit parrel from the fore end of the yard rove through the inner grommet, and ending in an eye just above the grommet, and to this toggle the halyard; fitted thus the sail is held tightly in to the mast.

A jackstay toggled at masthead leads down on the starboard side of the sail, and snap hooks to a sennit band, which passes under the boom and up on the port side, and is seized to the mast about a foot above deck; this jackstay is most useful in keeping the sail steady when being lowered or hoisted. The batten parrel, *m*, is either made of flat sennit or four strand line; the fore end of fore part is either seized or spliced into the reef block strop, *f*, and the end finished off with an eye; the after part toggles to this eye, and the after end is seized to the reef batten, so that when toggled the parrel binds the batten into the mast. The main tack parrel, *c*, is also flat sennit with an eye at each end, the fore end is seized on to the boom about 3in. in from fore end of boom, and it then passes on opposite side of mast to that on which the boom lies, and is rove through a grummet or ring, which is seized on to the boom about 9in. from fore end, to the after eye of the parrel the tack hauling part *c 2* is toggled and rove through the deck block *R*. The stay is snap-hooked or toggled to the mast head strop at *k*, and its tackle is shown at *l*. The topping-lift—without which no sail is either safe or handy—is fitted by toggling the standing part to the masthead strop at *b*; then, passing down the starboard side of the sail, it is rove through the main sheet thimble, where the main sheet is spliced into a snap-hook, which hooks to the grommet at *p* on

the boom; it then leads up the port side of the sail, and is rove either through a block toggled to a fourth eye (not shown in the sketch) in the mast strop, or through a sheave in the mast head above the halyards, and down to and through block R and into hand.

The reefing gear is much the same as that for the "Nautilus" racing canoe; but the block *g*, Fig. 134, has been dispensed with by doubling the parts of the ropes and making one end fast at *d* (Plate LII.). It has been used constantly, not only in canoes but in boats and is a most successful and sure working plan. The reef-line, in the first place, is woven cord (see page 416). The after part of the earing is fastened to the boom by a "clench," or by forming an eye by sewing the end back to the standing part, and then seizing the eye to the boom. Then lead the reef earing up through brass rings, which are firmly stitched on the sail on the patches (*z* in Plate LIII.), and through the block *f* (Plate LII.) at after end of the batten *d*; then through a thimble or ring stropped in above the next *f* block in on the batten; then through the sister block *g*, and back to and through the last-mentioned *f* block, and down through the rings *e*, and fasten to the boom. When the sail is fully hoisted the sister block *g* should rest nearly against *f* block, about an inch off. Next reeve the fore part of the reef earing. Make the standing part, *e* 2, fast by clenching it through the cringle or eyelet hole on the luff of the sail at *d* (as shown in the rigging plan, Plate XLIII.); then take it away aft in line with the batten, and reeve it through the block *g*; lead forward again to and through *f* at fore end of batten; then down through the rings to and through block *f* at fore end of boom; then along the boom to and through fair lead block *f* abaft the mast, and then through R and into hand. The reef blocks for this rig should be not less than 1in. blocks, and should have brass sheaves. The blocks at R should be two double blocks, 1½in. or 1¾in. blocks, with brass sheaves strongly stropped. Copper wire grommets, if neatly made and seized, will be found to make most durable strops for blocks; but where much twisting and working occurs rope only should be used.

The hand reef line *h* is fast to the batten *d*, and leads down through rings on the sail and a ring on the boom, and is finished off by having a ring spliced into its own end. This line is used for snugging that part of the sail where the reef gear does not come, and the ring at the end of *h* is in such case taken hold of by means of a boathook till brought into hand, and is hitched to the cleat *n* on the boom (Plate LII.). The hand reef line may also be used when the sail has to be shortened quickly for a short passing squall, and then shaken out again.

The gear on the mizen is fitted in the same way, except as to the topping-lift. It has been found in practice that a kind of crow's-foot form of topping lift is best to keep the sail and reef gear clear of the rudder yoke when the sail is lowered; but as the mizen lug is to be shiftable, so as to set as a mainsail and give place to the storm mizen, it is necessary to be able to detach the topping lift; therefore the standing part is fast to the masthead on the starboard side, and the lift leads down that side of the sail, and at about two feet above the boom it divides into two parts by splicing a part to it. These two branches then go under the boom, reeving through two thimbles (seized on to the boom in a fore-and-aft direction), and then going up on the port side of the sail to about two feet above the boom, and there ending each in an eye splice. The hauling part, which is rove through a sheave or block at the mast head, comes down to and toggles into these two eyes (*v*). The sheet is a single line toggled to the boom at *s*, and reeving through an eye-bolt in the sternpost head, leads in to hand.

When the lug mizen is used as a mainsail, the storm mizen is rigged by gathering the lacing together in clear turns, and dropping them over the mizen mast head; then hitch the end of the tack below the halyard block, leaving sufficient play for gybing, &c.; then hitch the head earing through the mast head sheave hole, and toggle the sheet on to the strop. The brail is kept on the sail, as shown in the drawing, a line fast to the clue then leading up to and through a ring on the leech at 2ft. 4in. up, then to a block on the luff at 5ft. 8in. up, and down to a block at the tack. This sail should be roped all round, and a light bamboo boom laced on foot.

The area of mainsail, 32.5 square feet, and of mizen lug, 19.5—52.0 square feet, will be found ample for travelling in moderate winds, and then when it blows fresh the mizen lug is set forward, and the storm mizen of 9.5 feet is set aft—equal to 29.0 square feet—a nice snug suit.

The reef band (*x*) is made of wide tape, stitched on slack—*i.e.*, the tape will not stretch, but the sail will when new, so the band has to be put on slack to avoid girting the sail. The batten bamboo (*d*) is passed into this pocket formed by the sail and tape band, and is seized to the sail cringles at each end. At the stations on the batten where the reef blocks are to be lashed, the band is slit and button-hole stitched (*y*). The slits must be long enough to allow the lashing of the blocks when the sail has been slacked in along the batten.

The yard and boom should be of bamboo, which, if possible, should have a “knot” at each end when cut to the right length. The mast

may be of yellow pine; a "grown stick" is best, though apt to buckle and kink.

With regard to the mainsail, where complete stowage is desired the sail may be kept on the upper mast—that is, keeping the halyards fast, let go the tack (c), and pull close up on the topping lift (b), and lower away the mast by slacking up *l* till the sail comes to hand, then unhook main blocks R either by hand or by boat hook, and roll them and all rope bights and ends into the sail, keeping tack and batten parrels on the mast above the mast joint. Then unclip the fore stay at masthead, and the jack stay at lower end, and unship the upper mast, frap the sheet round all, and stow below. Or, if only to be stowed for a short time, when the sail is set, let go the tack, haul down the reef, lowering halyards at the same time, tie the sail by gaskets (like reef points on the yard), and pull the sail "up and down" by the topping lift and halyard, and lower the mast half down. After a little experience and practice, it will be found that there are many other modes of dealing with this sail in setting, stowing, reefing, or shifting it.

THE "PEARL" CANOE.

Canoeists are by no means agreed as to the best form for canoes, and Mr. E. B. Tredwen, one of the most successful canoe sailers of the R. C. C. has taken a great departure from the Nautilus racing type in building the "Pearl" canoes. Mr. Tredwen contends that a flat floor rather than a rising floor is better for canoes. With a flat floor the canoeist sits lower, and can sit farther to windward when the canoe is heeled, and consequently assist the stiffness of the canoe; and, moreover, the flat-floored canoe will draw less water, and so is to be preferred for cruising in shallows. A flat-floored canoe having considerable initial stability can be sailed without ballast, and, as in cruising the weight of stores to be carried may preclude the carrying of much ballast, a flat floor is especially requisite in a canoe built for cruising and not for racing. An illustration of the truth of this assertion may be seen in the Thames sailing barges, which can carry very heavy cargoes on one voyage, and then sail the return voyage entirely without ballast. Mr. Tredwen has done a great deal of cruising in open water in the Pearl, and no doubt the design shows a very buoyant and good "all-round" canoe. Mr. Tredwen says, "As to the various modes of building, the double skin is the least satisfactory, for the water gets between the planks, and the boat soon rots out, while leaks are frequent and very difficult

to stop. I prefer the ribband carvel, but use brass screws throughout instead of copper nails." The ductility of copper being very great, a strong outward strain on a plank will sometimes cause a copper nail to lengthen, so that there is a leak when the plank returns to its former position. A nail will sometimes bend in soft wood while being clinched or rooved, and the first severe strain straightens the nail and causes a leak. The cost of brass-screw fastenings is about 2*l.* more than copper nails, and the extra labour would probably be not less than 2*l.* more on each canoe. The screws drive much easier if first dipped in grease.

The lines shown on Plate LIV. are those of a very successful canoe Mr. Tredwen built in 1874, which are recommended as a good form to be adopted for a strong, useful, cruising canoe, fitted both for river and sea-going qualities. In order that it may not be supposed that this design is a "theory" that has never been put to a practical trial, it may be as well to preface the description of the design with a brief history of the successive canoes of the "Pearl" type, their faults and failings, and thus most powerfully to show the necessity for those details of the design which cruisers who dislike weight and complications may otherwise object to.

The first, inspired by Rob Roy's books, was 14ft. 6in. long by 26in. beam, with considerable rise of floor like all the original Rob Roys, but with a straight sternpost, so that she could carry a rudder without any difficulty. She had the usual 2in. keel from end to end, and was intended for use without any ballast.

It was soon discovered that the 2in. keel and the rising floor were great inconveniences. When the canoe ran aground, she lay over at a considerable angle; and on one or two occasions, in such circumstances, shifted from one bilge to the other so suddenly as to throw her skipper over into the shallow water. The keel was found objectionable in another way; it prevented the possibility of turning the canoe in a short space, and made her take very long sheers to either side when running on the wave of passing steamers or crossing strong eddies. It gave some lateral resistance, just sufficient to persuade her owner that his canoe could sail (more especially when no other sailing craft were near), and there was such pleasure in sailing as to decide him that it was an indispensable part of canoeing. The canoe being fitted with a rudder, foot steering was adopted almost from the commencement; but the gear was primitive—a loop for the foot at the end of each rudder line. This answered fairly well; but once when aground, on getting up in a hurry and making a long spring to the shore, the rudder-line loop remained on the foot, and the skipper found himself prone in the water instead of erect on the bank.

It was therefore decided to build the next canoe with a flat floor, and without the 2in. keel, so as to insure her standing steady and upright when aground. But the new canoe would be unable, except in running off the wind, to utilise her sail-carrying power in the absence of any keel to give lateral resistance. It was therefore decided to give her a centre-plate; and in order that this should not destroy all comfort when the canoe was to be slept in, the centre-plate was divided, and the larger part put forward, the smaller aft, leaving an uninterrupted run of 6ft. amidships for sleeping in. This canoe was 14ft. 6in. by 30in., with side deck flaps, and after being used one season she was re-decked, raised upon to give her a bolder sheer, and spread out amidships so as to become 31½in. broad, and the side deck flaps were abolished. During the following season she was found to be much improved by the increase of sheer and beam, especially the latter, and she was tested on sea and river. In one trip she went round the Land's End. On her way back to London, she was slept in one night at Caversham (Reading); and on the following day, in a stark calm, with all her gear, stores, tent, &c., on board, was *paddled* from Reading to Hampton Court, a distance of fifty-three miles, through seventeen locks. This was in July, 1872.

In 1873 the next Pearl was built, 15ft. by 30in., the beam being reduced in order to come within the classification (as then constituted) of the Royal Canoe Club. She had a fore centre-board of ¼in. sheet-iron, about 30lb. weight, 30in. by 14in., and an after centre-board of about 10lb., 18in. by 12in.; she raced with 16lb. of iron ballast, and had no flap side decks, but a wider hatchway and narrower side decks. On March 31, 1874, the R.C.C. classification rules were amended, and the dimensions, which previously had been not exceeding 20ft. long and 30in. wide, were altered to the present sliding scale, the extremes being 20ft. by 2ft. to 12ft. by 3ft.; and Pearl No. 3 was built 15ft. by 2ft. 7¼in.

"PEARL" CRUISING CANOE.

The design which is now presented is founded on that of Pearl No. 3,* but with this alteration, that the depth amidships, gunwale to keel, is increased 2in., and the bow sections are rather fuller aloft than was considered expedient in 1874. But these alterations are not "theoretical," for the canoe *Anonyma* was built very closely to this design in the spring of last year by Turk, of Kingston, and has proved a very good canoe. There is the further difference that in this design only one centre-plate is shown, whereas Pearl No. 3 and *Anonyma* each had two

* Winner of R.C.C. Challenge Cup, 1878.



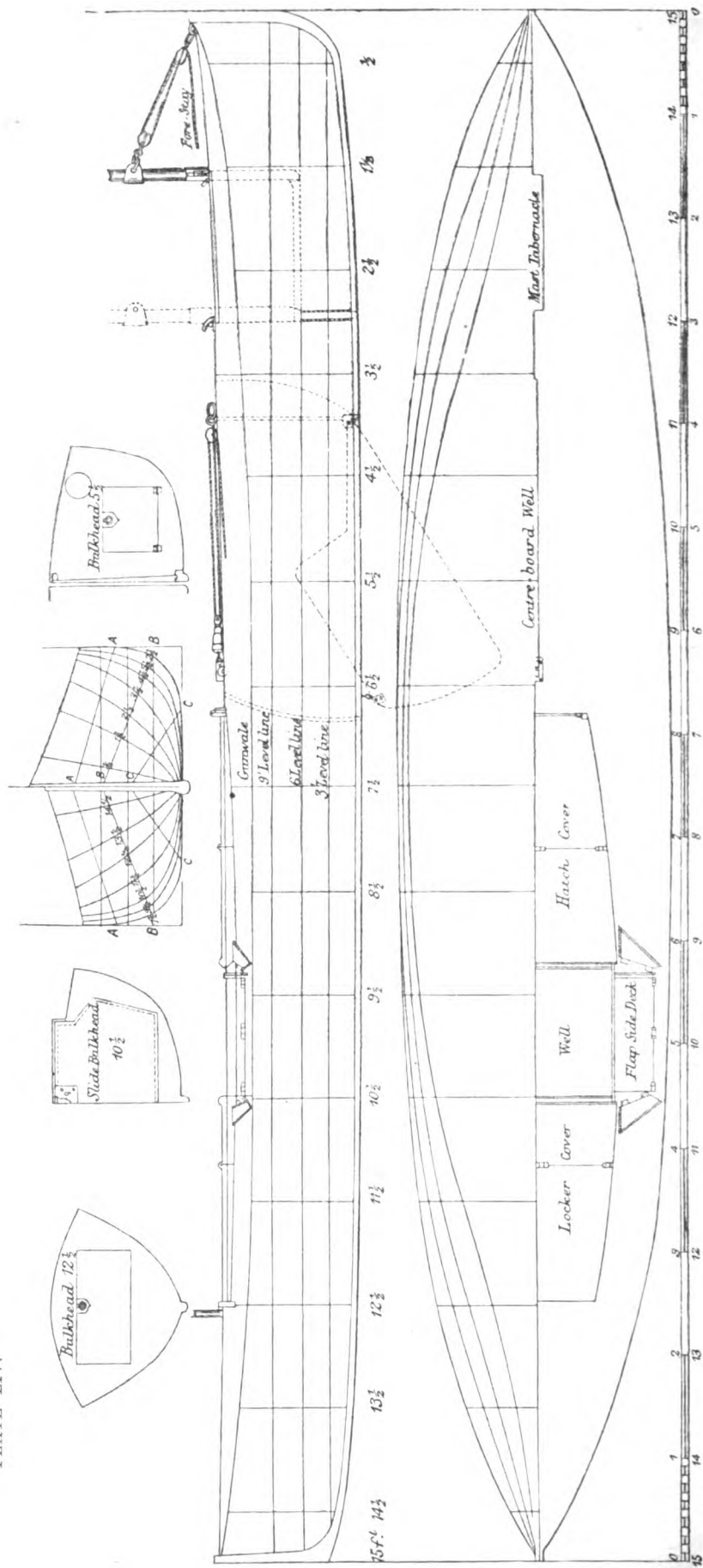

CRUISING CANOE ON THE MODEL OF PEARL N° 3,
DESIGNED BY E. B. TREDWEN.

centre-boards. But Pearl No. 3 was sailed and raced one season without the after centre-board, and she answered very well.

As the great desire of cruisers appears to be the reduction of weight, the design has no after centre-board, and no 'tween deck. The 'tween deck has been found very convenient for the stowage of long spars; and, in order that cruisers without 'tween decks may have sufficient length of stowage, it is suggested that the bulkhead at 5ft. 6in. from the bow should have a round hole (or two) near the deck. To the rim of this hole is secured the neck of a long waterproof bag (into which the spars can be thrust), which will prevent the compartment being flooded in case of a spill, and at the same time provide length for the stowage of spars.

Bulkheads make a canoe much safer than air-bags can, because with bulkheads the security is always present; but with air-bags there is always the temptation to keep them collapsed for convenience of stowage, and, as a capsize generally comes as a surprise, not as a part of the programme, the canoeist is very likely to find the air-bags empty when it is too late to inflate them. The bags, too, are always liable to be pierced by nails, screws, or boathook ends, and rendered unserviceable. Even when they are inflated and *in situ*, the water can run into the ends of the boat under the air-bags and make her very unmanageable in any sea. Some air-bags are made of such slight material that they would infallibly burst under the strain of supporting the weight of canoe, stores, and crew.

TABLE OF OFFSETS OF CRUISING CANOE, 15FT. BY 2FT. 7½IN., ON THE MODEL OF “ PEARL ” No. 3. PLATE LIV.

No. of Section	½	1½	2½	3½	4½	5½ Bulk-head.	6½	Mid. 7½	8½	9½	Side 10½ Bulk-head.	11½	12½ Bulk-head.	13½	14½
	in.	in.	in.	in.	in.	in.	in.	in.	in.	in.	in.	in.	in.	in.	in.
Height from level of rabbet-line amidships to gunwale	16	14	13	12½	11½	11½	11½	11	11	11½	11½	11½	12½	13	14
Half-breadths at gunwale	3½	8½	12	14	15	15½	15½	15½	15½	15½	14½	13½	11½	8	3½
Half-breadths at 9in. level line	2½	6	10	12½	14½	15½	15½	15½	15	15	14	12½	9½	6	2½
Half-breadths at 6in. level line	1½	3½	7½	11	13½	14½	15	15½	15	14½	13	10½	7½	3½	1½
Half-breadths on 3in. level line	¾	2½	5½	8½	11½	13½	14	14½	14	13½	11½	8½	5½	2½	¾
Half-breadths on diagonal A	2½	7	10½	12½	14½	15½	15½	16	15½	15½	14½	12½	10½	7	2½
Half-breadths on diagonal B	2	5½	8½	11	13½	14½	15½	15½	15½	14½	13½	11	8½	5½	2
Half-breadths on diagonal C	1½	3½	5½	7½	9	9½	10½	10½	10½	9½	9	7½	5½	3½	1½
Rise of rabbet line	2½	1½	½	—	—	—	—	—	—	—	—	—	½	1½	2½

The level lines are 3in. apart, and heights are measured from level of rabbet-line amidships.

The sections are 1ft. apart, and are numbered according to their distance from stem in feet. Nos. 6½ and 8½ do not appear on body plan of design, the scale being too small to permit their being shown.

The half-breadths on the diagonals are measured from the centre towards the side. Sheer, forward, 5in.; aft, 3in.

THE "PEARL" CANOE, 1880.

So far as the shape of the water-lines go, both ends are very much alike in the Pearl canoe for 1880* (Plate LV.). Mr. Tredwen says he adopted this design in consequence of an experiment he made in building two canoes on sections or moulds of the same shape, but differently placed, so that one had a short bow and long stern, the other a long bow and short stern, the displacement of both being about equal; in fact, the water-lines in the fore-body of one were nearly the same as those in the after-body of the other. These two canoes, rigged and ballasted alike, have been sailed against one another in every variety of weather, and the results obtained are that the long-bowed canoe performs the better in light winds, or when heavily loaded with ballast; but the short-bowed canoe always comes to the fore in a strong wind, or when carrying only a small quantity of ballast, or sailed entirely without ballast. Mr. Tredwen says that the Pearl of 1880 is a "compromise between the two, and, having a fair proportion of the good qualities of both, made a good all-round performer."

TABLE OF OFFSETS OF "PEARL" CANOE FOR 1880. (PLATE LV.)

No. of Section	1	2	3	4	5	6	Mid. 7	8	9	10	11	12	13				
Depths †	in.	ft.	in.	ft.	in.	ft.	in.	ft.	in.	ft.	in.	ft.	in.	ft.	in.	ft.	
Half-breadths No. 1 level line	2½	0	3	0	3	0	3	0	3	0	3	0	3	0	3	0	3
Half-breadths No. 2 level line	6	0	11	1	1½	1	2½	1	3½	1	4	1	3½	1	3½	1	2½
Half-breadths No. 3 level line	4½	0	9½	1	0½	1	2½	1	3½	1	3½	1	3½	1	2	1	0½
Half-breadths No. 4 level line	3½	0	7½	0	11½	1	1½	1	2½	1	3	1	3½	1	2½	1	1½
Half-breadths on diagonal <i>k m</i> ...	4½	0	4½	0	8½	0	10½	1	1	1	2	1	2½	1	1½	1	1
Half-breadths on diagonal <i>o q</i>	4½	0	7½	0	10½	1	0½	1	1½	1	2½	1	3	1	2½	1	1½
Half-breadths on diagonal <i>o q</i>	3	0	5½	0	7	0	8	0	8½	0	9	0	9	0	9	0	8½

The level lines are 3in. apart.

The sections are 1ft. apart.

The half-breadths on the diagonals are measured from *m* towards *k*, and from *o* towards *q*.

The base line *q k, k k*, is 1ft. 0½in. below No. 1 level line.

* Winner of E.C.C. Challenge Cup, 1880, and of Thames Valley Sailing Club "Silver Burgee" in 1881.

† The depths are measured from No. 4 level line to the under edge of rabbet line.

PLATE LV.

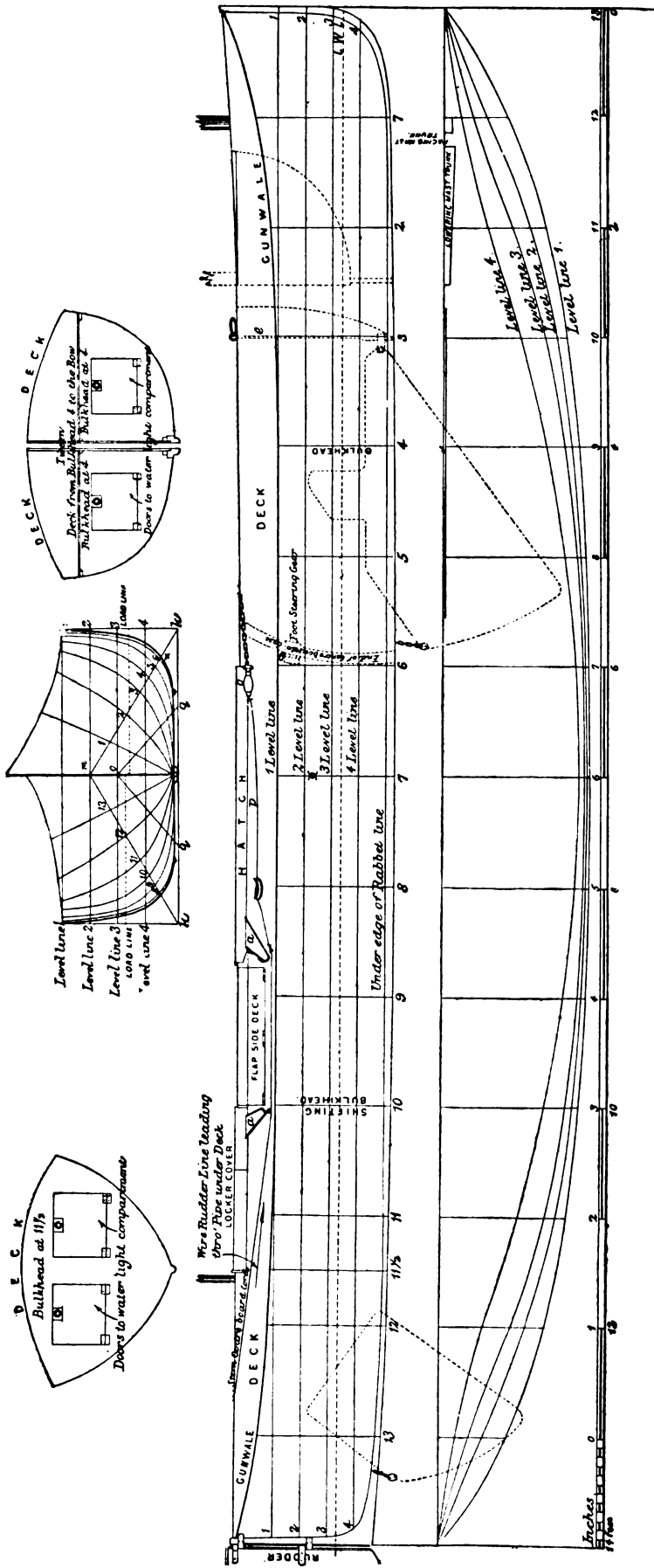

"Pearl No. 5," Sailing Canoe. Designed and built by E. B. Tredwen, Esq.



THE "PEARL" RACING CANOE, 1882.

The Pearl of 1882* (No. 6 of the name) was designed with a view to sailing not only in the R.C.C. matches, but also in the races of those other clubs that admit canoes to race with time allowance for size, but do not permit shifting ballast—for instance, the Thames Valley Sailing Club at Hampton, and the Thames Sailing Club at Surbiton. The floor, instead of being flat, as in the preceding canoes of the series, has a rise of $1\frac{1}{2}$ in.; the height of side is also $\frac{1}{2}$ in. more than in the 1880 Pearl, the depth amidships being 14in., an increase of 2in.

The fore centre-board is also brought further aft, and the size of the after centre-board is increased so that she may carry more after canvas.

This canoe is also built on the ribband-carvel system, and has a new feature in the ballast well, which extends from the aft end of fore centre-board for 18in. (to section No. 6). In this space there are no ribbands, frames, keelson, or other projection on the inside surface of the planking; but the skin is doubled diagonally by an internal planking of $\frac{1}{4}$ in. oak, which supplies the strength which would otherwise have been given by keel, ribbands, and timbers. This enables the ballast, whether shot-bags or solid lead, to be stowed to best advantage, and lessens the chance of damage from the accidental dropping of a piece of lead on to the plank.

In such a small craft that may sometimes be capsized and almost bottom up, it is very necessary that such a weight of ballast, 170lb., should be secured so that it cannot shift and drop through the side of the boat, as happened last season with a certain centre-board gig. To each bilge is securely screwed a keelson (A, Fig. 135) running the whole

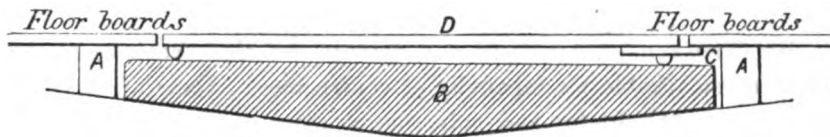

FIG. 135.

length of the ballast well. The floor boards are screwed to these keelsons so as to project about 1in. over the ballast well, and at the after end of the well the projection of the floor board on one side is cut away for 4in. so that the lead castings (B) can one after the other be put under the projection on the opposite side, dropped on to the planking, and then slid forward into place, when the cover (D) is put on, the projecting ledge (C) being slipped under the floor board on the side where the

* Winner of R.C.C. Challenge Cup, 1882.

space is cut out for fitting in the castings, and then the other side dropped down into place; this keeps in the last piece of ballast.

All the other fittings of the canoe are so similar to those already described under Pearl (1880), or under the separate headings of the "Centre-boards," &c., as not to require any further comment.

TABLE OF OFFSETS OF 1882 "PEARL," No. 6 (PLATE LVI. AND FIG. 136).

No. of Section	1	2	3	4	5	6	MID. 7	8	9	10	11	12	13
	in.	in.	in.	in.	in.	in.	in.	in.	in.	in.	in.	in.	in.
Height from level of rabbet line amidships to gunwale.....	17	15½	14½	14½	14	14	14	14	14	14½	14½	14½	15½
Half-breadth at gunwale.....	6½	11½	13½	15	15½	16	16	16	15½	15	13½	11½	6½
Half-breadth at 12in. level line.....	4½	9½	13	14½	15½	15½	16	16	15½	14½	13½	9½	5½
Half-breadth at 9in. level line.....	3½	7½	11½	13½	15½	15½	15½	15½	15½	14½	12½	8½	4½
Half-breadth at 6in. level line.....	2½	5½	9½	12½	14	14½	15½	15½	14½	12½	9½	6½	3
Half-breadth at 3in. level line.....	1½	3	5½	8½	11	12½	12½	12½	12	9½	6½	3½	1½
Half-breadth on diagonal line A to A	4½	8	10½	13	14½	—	15½	—	15	13½	11½	8½	5½
Half-breadth on diagonal line B to B	2½	4½	5½	7	7½	—	7½	—	7½	7½	6	4½	2½
Rise of rabbet line	1	½	½	—	—	—	—	—	—	—	½	½	1

The sections are 12in. apart in table, and numbered in feet from the stem. In the drawing Nos. 6 and 8 are omitted to avoid crowding.

The half-breadths on the diagonals are measured from the centre towards the side.

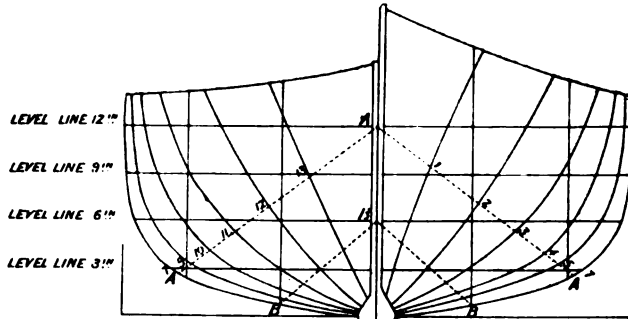

FIG. 136.

Mr. Tredwen designed all the fittings for the Pearl, and some of them are remarkable for ingenuity of contrivance. Some of these fittings are shown in the Plates and cuts, but a more detailed account of their arrangement and uses will be necessary.

CENTRE BOARD.

The strength requisite to resist the strain of a heavy centre-board in lumpy water can be given to the case without much addition of weight. The sides of the case should be rabbeted into the keel, and fastened by long screws (a, Fig. 137) three inches apart. The fore bulkhead is stationed so as to support the centre-board case where there is the heaviest strain. The sides of the case may be tapered towards the ends and towards the deck, leaving the greatest thickness along the lower edge. A piece of

PLATE LVI.

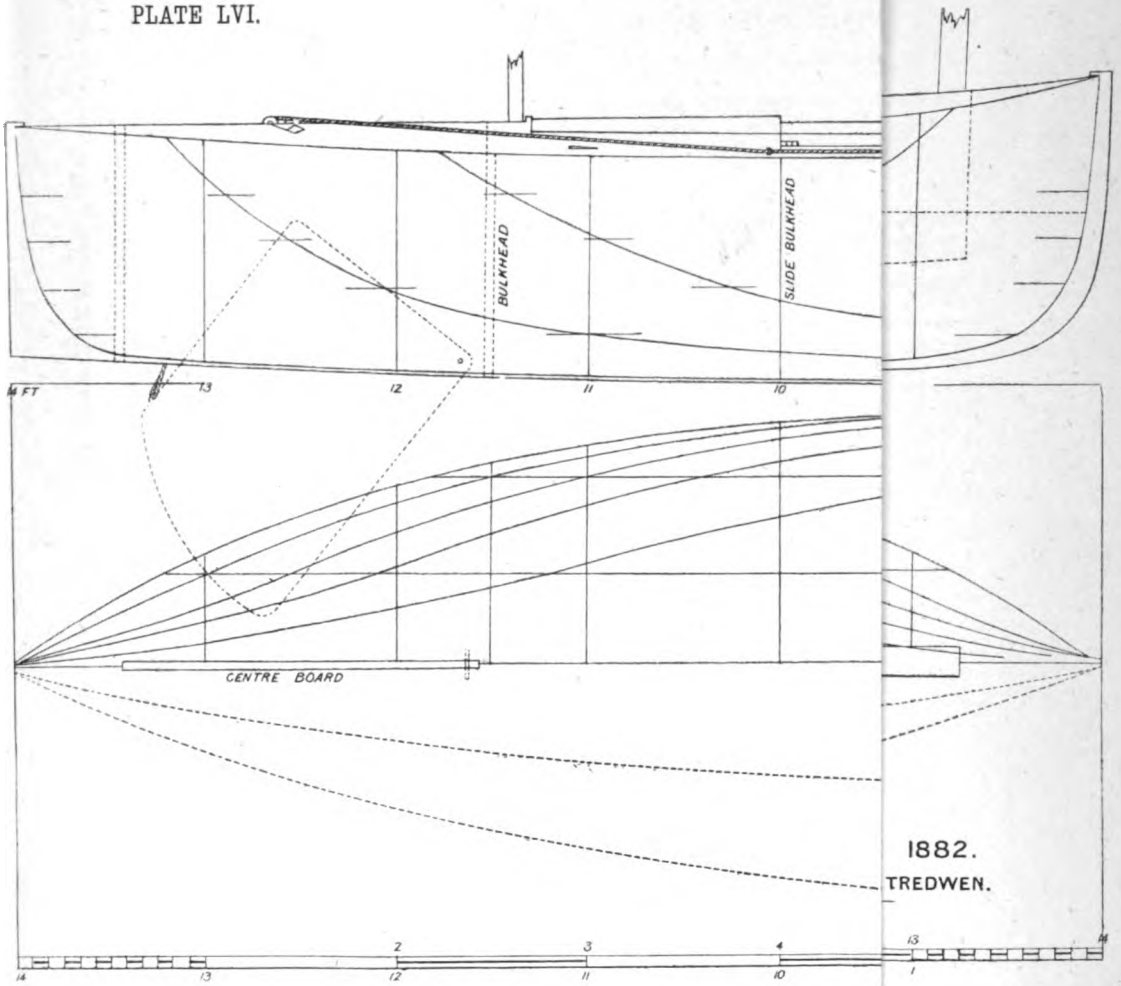

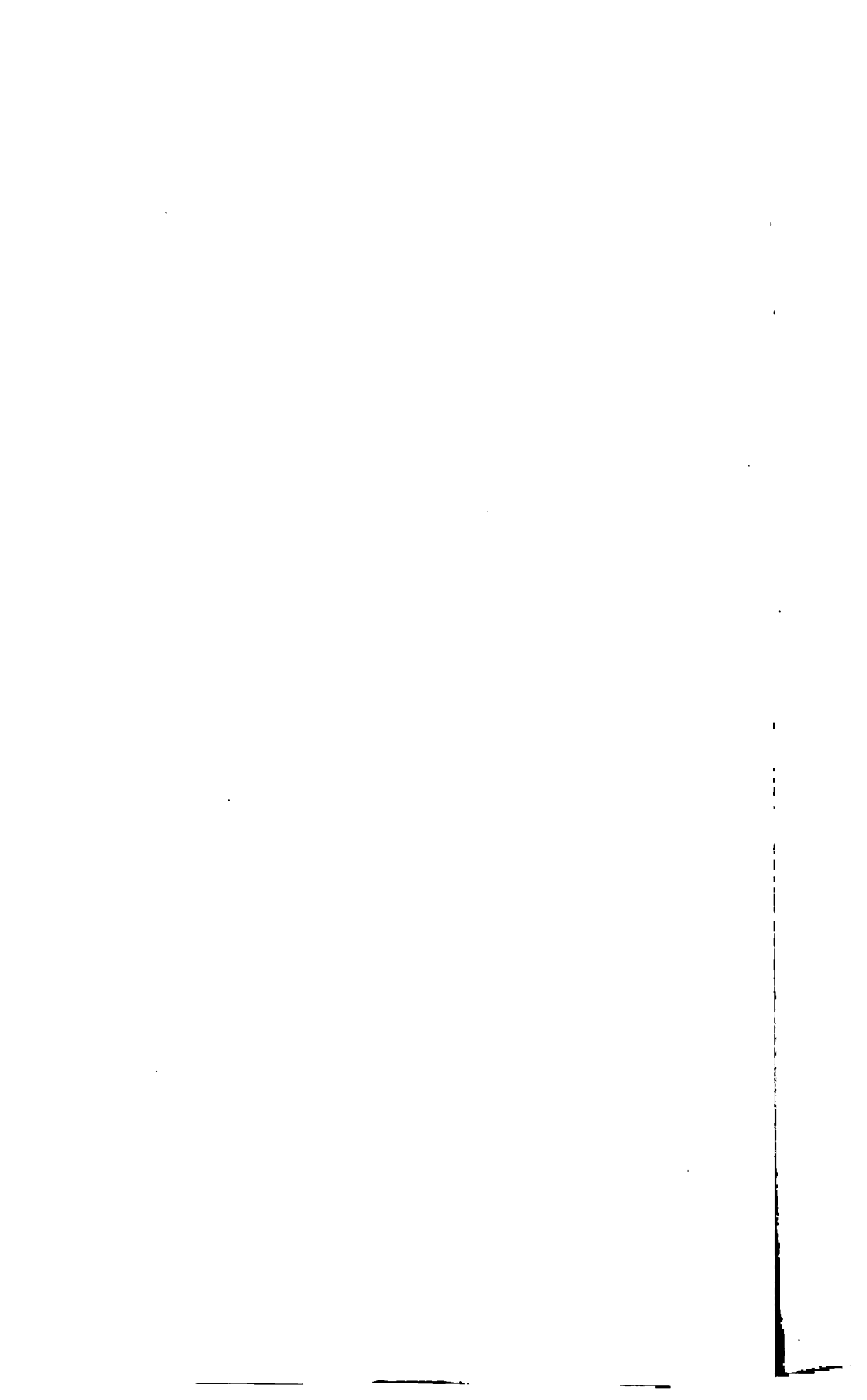

wood about one inch square is then screwed with alternate vertical and horizontal fastenings into the keel and into the side of the centre-board case (B, Fig. 137). The slot through the keel is cut about two inches longer than the inside dimensions of the case, so that the cross ends of the case go down through the keel, and are through fastened to the keel. Each side of the case is bound with a strip of brass from the deck to the keel at the part where the greatest friction takes place, in order to protect the wood. This brass is marked T in Fig. 137, and is about 1 in. wide and $\frac{1}{3}$ in. thick.

The centre-board of the 1882 Pearl is of yellow metal (ship sheathing or Muntz's metal), $\frac{1}{2}$ in. thick, weighing 68 lb. The material was chosen in order to obtain the smoothest possible surface, and also because it will not affect the compass to the same extent as an iron centre-plate.

In order that the canoe may be easily moved about in general cruising and travelling, it is necessary that the ballast and centre-plate shall be readily removable; 60 lb. is quite heavy enough for a plate to be conveniently handled, and three square feet of wrought iron plate, $\frac{1}{2}$ in. thick, gives about this weight. (See "Weight of Boiler Plate" in the Appendix.)

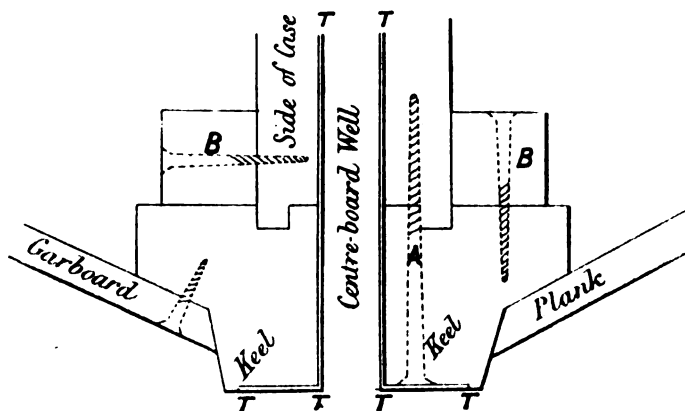

FIG. 137.

The plate, after being cut into the shape and fitted to the case, should be galvanised to prevent rust, and to preserve a smooth surface, so as to offer less frictional resistance to the water. The cost of galvanising should not exceed 1½d. per pound. The plate is slightly increased in weight and thickness by galvanising, a fact which must not be lost sight of in fitting the case.

A heavy centre-board plays an important part in making a canoe self righting, and a rough-water cruiser with a 60 lb. centre-board should still have good righting power when she is heeled till the water flows in

over the lee coamings. The Pearl, in the Challenge Cup Race 1879, was thrown on her beam ends, and shipped a large quantity of water, but aided by the weight of her centre-board she was righted as soon as the pressure of wind was shaken out of her sails, and she was able to continue the race.* In the event of a complete capsize, the weight of the centre-board assists the canoe to right, steadies her while her skipper gets in again, and when running in a cross sea prevents her rolling gunwale under, and shipping water faster than he can bale out.

The shape of the plate should be designed so as to place the weight as low as possible, and give a large surface for lateral resistance, but at the same time there should be plenty of grip in the trunk when the plate is lowered to the full extent. The ordinary triangular shape is not the best for a heavy plate, the part left in the trunk being so narrow as to throw an undue amount of strain on the sides of the case. The annexed diagram (Fig. 138) A, B, C, D, is a very good shape, its length being 2ft. 9in., and breadth 1ft. 4in. The dotted outline shows the part of the plate remaining in the case when it is lowered 18in. below the keel band, the limit of drop allowed by the Royal Canoe Club rules.

The corners A and B are reduced in thickness about $\frac{1}{4}$ in. on each side, to allow room for the fittings, and a $\frac{1}{4}$ in. hole is drilled through each. The projecting arm is of the full thickness, and has a hole through its upper edge, D, which forms a handle by which to lift the plate in or out of position, and a small hole at E takes a pin above the deck, to support the centre-board while the chain is being placed in position for hoisting or lowering. The edges of the plate, from A to C and C to B, are sharpened to reduce resistance in the water, and the angle C is rounded off to prevent its catching in the ground when the canoe is being hauled astern with the centre-board not quite housed in the trunk. If a small area of canvas only is carried, or if no intention exists of sailing in strong winds, it may be better to use a lighter centre-board, of say $\frac{1}{2}$ in. plate, and then the projecting arm, D, is doubled or trebled by pieces riveted on, so as to make it $\frac{1}{2}$ in. thick, to fill the trunk and prevent undue play. The after-end of the centre-board is raised or lowered by a galvanised short link chain; the end link is longer than the others, and is shackled to the plate by two brass lugs (B) and two bolts, as represented in Fig. 139.

If the centre-plate does not exceed 36lb. ($\frac{1}{2}$ in. iron), it may be hung on a rope instead of a chain, and the buffer may be dispensed with. The

* The Lurline, in one of the races at Hendon, in 1879, capsized and filled with water when under full racing sail (120 square feet), but was, nevertheless, able to continue the race, and come in third in a fleet of eleven. This element of safety is far more important in cruising, where the canoeist's life depends on the canoe, unaided by any extraneous assistance.

rope should be the best cable-laid, about $\frac{3}{4}$ in. diameter, with an eye-splice worked in one end, lined with a brass thimble, through which the rivet passes to fasten it to the two brass lugs or plates on the centre-board.

A light centre-board will not require the purchase tackles for hauling up which is shown on the designs.

The fore-end, A, in the case of a fixed centre-board, is bolted to the keel by a pin through the hole in the corner; but a rather more compli-

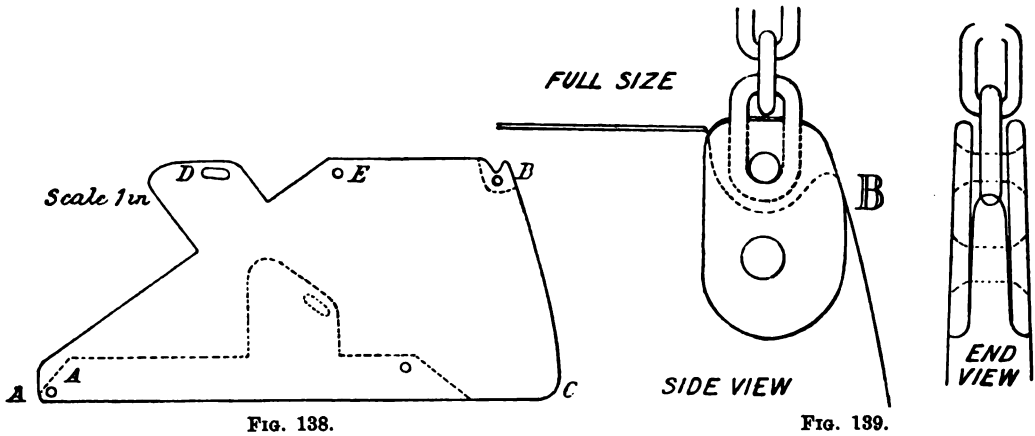

FIG. 138.

FIG. 139.

cated arrangement is necessary in order that the plate may be lifted out of the canoe easily when afloat or aground. (See Fig. 140.)

L in Fig. 140 is the fore-end of the centre-board case sloping forward in the arc of a circle, with centre at B, radius B A (Fig. 138). The pin, H (Fig. 140), is bolted through the keel at three-quarters of an inch from

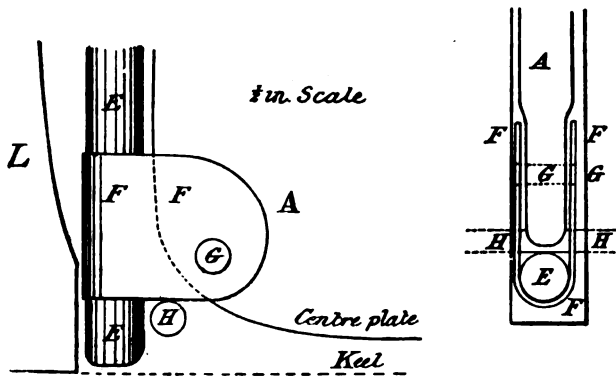

FIG. 140.

the fore-end of the slot. A brass-bound iron pipe, E (half-inch diameter outside), in length equal to the depth from top of deck to bottom of keel, is bound round, half an inch from one end, by a piece of sheet brass, F,

3in. by 1½in., which is securely brazed on. The fore-end of the centre-board, A, is bolted by the rivet, G, to both sides of the brass plate, F. The other end of the rod, E, on deck is fitted with a brass ring to serve as handle. The bolt, H, prevents the rod, E, from shifting aft, or dropping below the level of the keel. The chain at the after-end of the centre-board is about a yard long, and leads over a pulley, M (Fig. 141, which gives a bird's-eye view of the deck), and through a snatch block, N, both with chain sheaves turned to the shape, R. The snatch block, N, is so constructed that the side can be opened so as to slip the chain into the block, and it can then be closed, so that when the centre-board is lowered, the fore-end of the buffer, O, brings up against the block. The buffer, O, is an india-rubber cylinder, 1½in. diameter outside, with ½in. hole through it, brass capped at each end. The chain runs through this buffer, which eases the

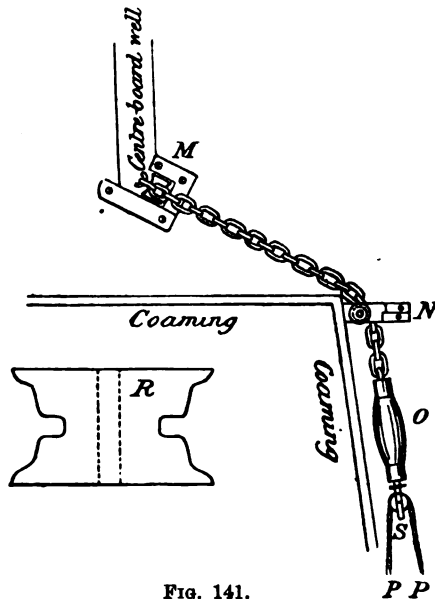

FIG. 141.

shock when the centre-board is let go by the run. Without this check the momentum of 60lb. dropping 18in. would carry away the block, N. The line, P, is made fast to an eye-bolt in the side deck near the hand, and leads through a brass-bound block at S, and is the tackle by which the plate is hauled up, the line being fastened to a cleat on deck.

It is easy enough to take out the centre-board when the canoe is lying on the shore; but on a cruise it is often necessary to lighten the boat while she lies afloat alongside a rock or jetty, over which she has to be dragged. In this case the centre-board is hauled up by its tackle nearly as far as it will go. The skipper then goes forward, and, with one foot

on the fore-deck alongside the centre-board trunk, lays hold of the handle or ring in the top of the rod, E, and pulls it up until its foot is clear of the trunk. It is then swung forward a little, and allowed to rest on the deck at the fore-end of the trunk. A pin is then passed through the hole, E (Fig. 138), to prevent the after-end of the centre-board dropping while the line P is cast off, and overhauled from the block S. The snatch block, N, is then opened, the chain is free, and the centre-board can be lifted ashore by the handle D, or by a hand each to the rod E and the chain. The after centre-board, being quite in the stern, should not be too heavy, but must have weight enough to insure its dropping freely when let go.

The Pearl of 1882 has been fitted with another arrangement (Fig. 142) for hauling up and lowering the centre-plate, suggested by Mr. W. P. Stephens, New York, which is an improvement on the foregoing, there being less friction and the fittings being simpler. The pulley at the after end of the slot, on deck, is arranged to lift off, and the standing block of the purchase is fixed to the top of the rod at the fore end of

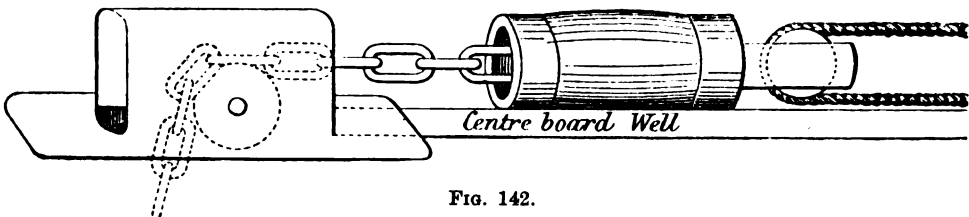

Fig. 142.

centre-board, so that the centre-board and all its gear can be lifted out and cleared away at one operation. The top of the rod must be kept forward by a catch fixed to the deck at the fore end of the slot. The pulley is not fastened to the deck, but fits down into a frame or rim of brass which is screwed to the deck.

Whatever tackle is employed for working the centre-boards it should always be on deck outside the well, so as to be available in rough-water sailing when the hatches are battened down, and the well is inaccessible except at the expense of a good drenching.

WELL AND DECK FLAPS.

Mr. Tredwen says that deck flaps are of much use to insure safety by allowing the canoe sailer to sit well to windward, but a contrivance is necessary to keep seas out of the well in rough water. The contrivance consists of four weather-boards hinged to the deck (represented by A in different aspects in the three diagrams annexed), and of two fixed coamings the full height of the main coamings where they butt against

them, and about $\frac{1}{2}$ in. high at their outboard ends (C, Figs. 133 and 135). These fixed coamings (C) are parallel, and close to the cuts across the deck, and consequently at right angles with the ordinary well coamings, and are screwed securely to the deck, and their inboard ends butt on to the well coaming and are screwed to it. They entirely prevent any leakage along the deck from forward into the opening of the flap side deck, and support the fore and aft well coamings, which are weakened by the interruption of their continuity. The deck must be supported by a strong knee, where the cut for the side deck flaps is made, from the well coaming right down to the bilge. The second set of coamings, or weather-boards (A), are placed transversely, hinged to the deck, and, when raised, their inboard ends fit closely against the beading or coaming

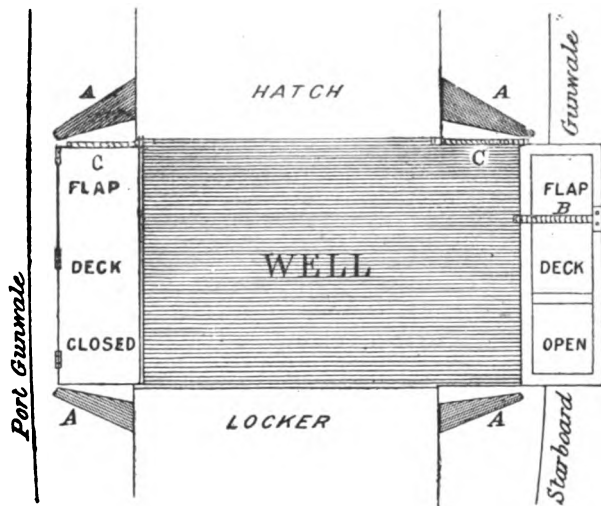

Fig. 143.

of the hatch cover; and they are not intended to exclude leakage along the deck, but they serve as catches, around which the mackintosh coat fits, to prevent any sea breaking into the well. The inboard ends must therefore project about half an inch *above* the hatch cover when they are raised. Many canoes have had these hinged coamings fitted without the fixed coamings, and without sufficient width to project above the hatch cover; and, as they neither exclude water running back along the deck, nor provide a holdfast for the macintosh, the whole contrivance is useless. Fig. 143 is a bird's-eye view of the deck; Fig. 144 shows the canoe in section, the port flap closed, the starboard open; the port weather-board A 1 lying flat on deck, the starboard (A) standing up; Fig. 145 is a view of the starboard side, the fore weather-board raised, the after one folded down on deck.

In rough water the skipper wears a macintosh coat, the body or skirt of which is 2ft. long from under the arm, and 8ft. in circumference at the bottom. In the seam around the bottom is an indiarubber cord, which gathers it together and makes it fit tightly round the four weather-boards and across the hatch and locker covers. A small

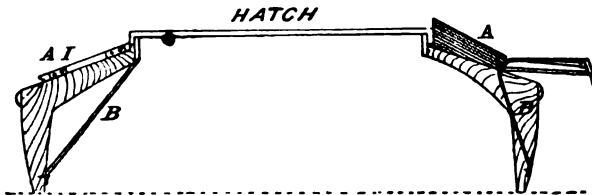

FIG. 144.

beading across each of these prevents any leakage under the macintosh, so that no water can find its way into the well. Each deck flap is provided with an indiarubber spring, marked B in Figs. 143 and 144; this is made of flat indiarubber cord about $\frac{1}{4}$ in. by $\frac{3}{8}$ in. (obtainable at any waterproofer's), its ends fastened to the woodwork of the bilge, and the flap by screw plates. When from frequent use the rubber gets slack, it can be shortened by loosening the screws through one of these plates, drawing the rubber further under the plate, and then screwing tight again. The red rubber is more durable than the grey under exposure to weather. The springs keep the flaps closed tight, and also keep them open when folded back to the full extent, but close the flaps when they are raised a little further than is shown in Fig. 144.

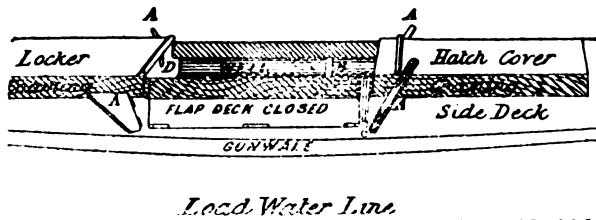

FIG. 145.

The flaps can be opened or closed under the canoeist's macintosh without any difficulty.* All the hinges to these fittings should have brass pins, otherwise they soon get broken or jammed, especially in salt-water cruising. The flaps should be of $\frac{3}{4}$ in. mahogany, strengthened by a frame-

* The coat opens from the neck down the breast for only six inches, and is fastened by a double fold and two rows of buttons, so that no water can find its way through, except in over the collar. The ends of the sleeves have inner cuffs, gathered round the wrist with indiarubber cord, so as to clasp the wrist tightly and prevent any water running up the arms.

work of hard wood, or doubled transversely by a piece of $\frac{1}{4}$ in. plank, as they often get hard knocks; and they should be hung with the hinges projecting $\frac{3}{16}$ ths of an inch above the deck, so as to lie $\frac{3}{8}$ in. above the deck when open, otherwise they are liable to be wrenched off over the cords leading from the mizen or the after centre-board. The hinges must not lie on the deck and be screwed down to the deck, but must be placed vertically in the fore and aft cut, and screwed into the side or edge of the flap deck and the inwale.

In the event of a capsize, the macintosh coat fitted round the weather-boards would at once become free, as its holdfast will yield to a strong upward pull.

A canoe is so small, and the height of freeboard so little, that it is impossible to keep the seas off the deck, if sailing in rough water. It is therefore much better, for the sake of comfort, safety, and speed, to recognise this fact, and fit the canoe to sail through, as well as over, the combers; and this is successfully accomplished by the macintosh fitting around the weather-boards. There are many occasions when it would be quite impossible to lay a course across a tideway with a beam wind and lumpy sea without this arrangement, for the waves will break clean across the canoe, which will lurch, occasionally coaming under, and would be swamped in a very short time if the well were not completely battened down.

The hatch cover underneath is fitted round the sides with ledges which fit outside the well-coamings snug down to the deck, and so prevent any water getting into the fore part of the well.

REFERENCES TO "PEARL" FOR 1880.—PLATE LV.

IN SHEER PLAN.

a, Weather boards. (See Fig. 143.)
e, Rod. (See Fig. 140.)

o, Spring. (See Fig. 141.)
p, Centre-board tackle. (See Fig. 141.)

SPARS AND SAILS OF THE "PEARL."

Mr. Tredwen has two modes of fitting a lowering mast; the original was to have a quadrant-shaped trunk or case (as shown by K, Fig. 146), in which the mast is stepped. The trunk is lined with copper, to prevent any water finding its way into the canoe through this opening, and a brass pipe (H), from the bottom of the case out through the keel, empties the water in the same way as the valves in the bottom of a lifeboat. The mast is encircled, at the level of the deck, with a square brass ferrule, to the aft side of which there is secured a crossbar (F), on which the mast pivots when being raised or lowered. The crossbar turns in two hooks or crutches (G), securely screwed to the deck. The mast can be raised and maintained

in position either by a forestay leading from the masthead through a block at the stem head, or by a heel rope, as represented in the diagram. The heel rope D is liable to be chafed through where it passes through the mast at A. If C and B are both double blocks, and the end of the rope D be made fast at C and then led twice from C to B and back again, a sufficient purchase will be obtained to raise the mast without the line going round the heel of the mast. Instead of the pulley at C an ordinary double block may be used attached by a sister-hook to the ring in the stem head, and instead of the pulley at B a similar double

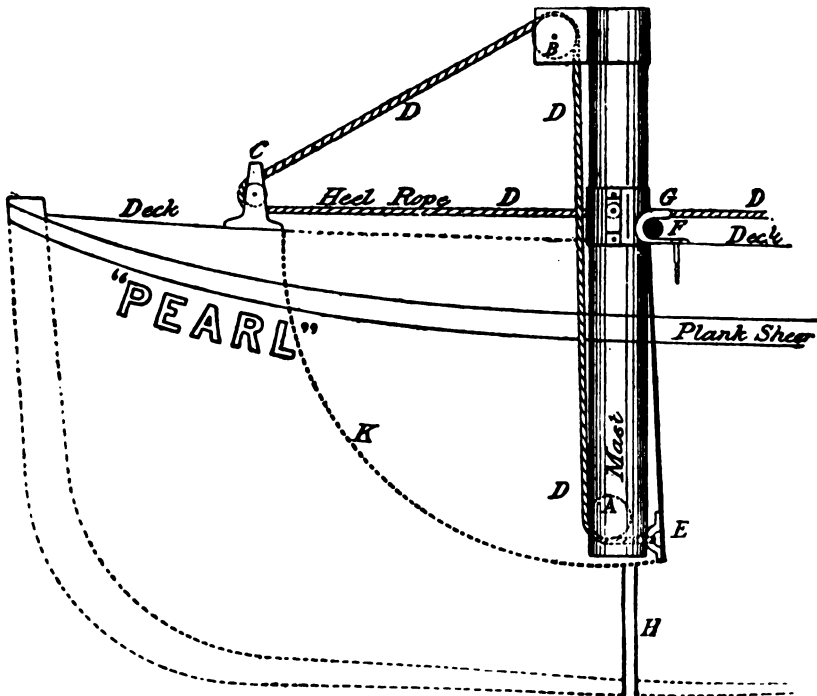

FIG. 146.

block and sister-hook may be hooked to an eye on the ferrule around the mast at B. When a forestay is employed the mast must be well back in the boat, or else a bumpkin will be required to take the stay clear of the luff of the sail, unless the latter is cut with a great deal of peak, and a very small part of the sail on the foreside of the mast. A flat-headed sail has a shorter yard, and when slung so as to have a good breadth top and bottom on the fore side of the mast, it sits very well. The mast, fitted with a heel rope, can be placed well forward in the canoe, and the sail does not then interfere with the paddle, when both modes of propulsion are used simultaneously. In the diagram, A is the sheave in the

heel of the mast; B, a sheave fitted on a ferrule around the mast, 6in. above the deck; C, a sheave on deck; D, heel rope made fast to an eye at E; F, crossbar on which the mast pivots; G, pair of crutches for F to pivot in. On slacking the rope D the mast falls aft, the heel of the mast A coming up to the deck towards C.

The Pearl of 1882 has been fitted with a mast tabernacle, which is an improvement on the foregoing. The length (fore and aft) is about 17in., the depth 1ft., and the breadth $2\frac{1}{2}$ in. at the deck, tapering to 2in.

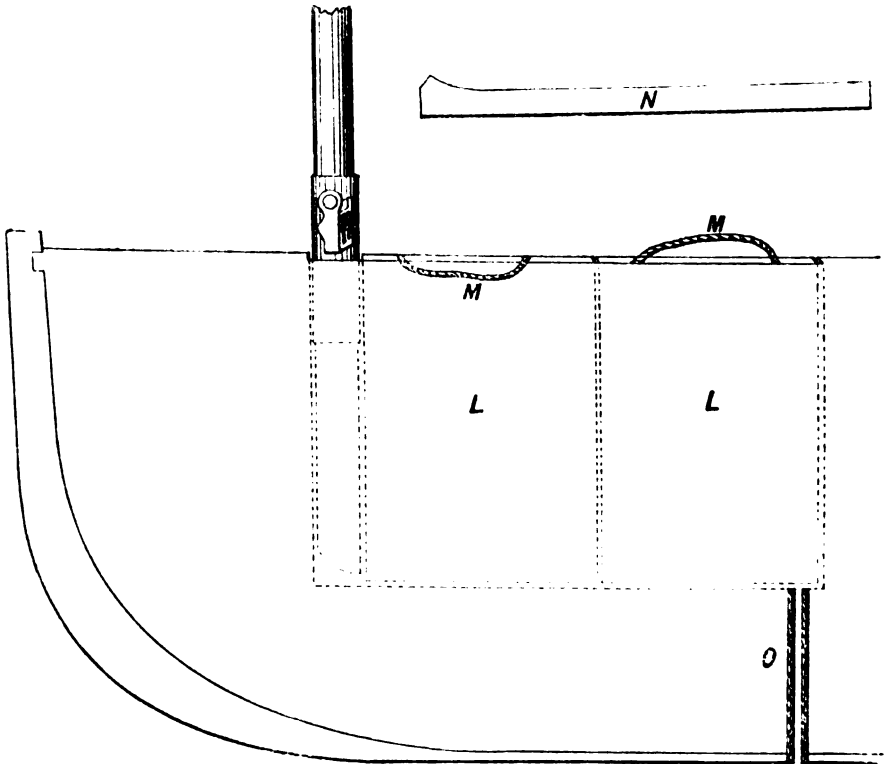

FIG. 147.

at the base. The case is lined with copper, and a pipe from the after corner runs off any water through the keel (O, Fig. 147). A piece of wood about 2in. shorter than the tabernacle, dropped into it, serves as a chock to keep the heel of the mast forward, and the mast is raised by a tackle hooked on to an eye, on a ferrule about 6in. above the deck. The fore part of the mast heel is rounded away, so that, as the mast is hauled up by the tackle, the heel can slide down the fore end of the tabernacle in front of the wooden chock lying at the bottom (N).

When it is desired to step the mast at the after end of the tabernacle,

the wooden chock is not required. The mast then pivots on the cross-bar, which is held by the crutches or hooks screwed to the deck at the after end of the tabernacle. The mast may be stepped (but not as a lowering mast) in any part of the tabernacle, by means of two light wooden boxes made to fit into and fill the spaces on the fore side and the aft side of the mast. These boxes, if placed both on the same side of the mast, will give it a fixed step at either end of the tabernacle. The facility with which the position of the mast can be shifted is a great recommendation of the square tabernacle, as it enables one to obtain a proper balance between the centre of effort of the sails and the lateral resistance of the canoe. When the mast is not often required to be lowered, the hoisting tackle and chock are unnecessary, and the mast can be lowered by merely lifting out the boxes and handing it down.

The sail (represented by Fig. 148, on $\frac{1}{2}$ in. scale) is a cruising sail with one reef hauled down, and the dotted outline shows the sail fully set. The total area of the sail is about 55 square feet, reducible by three reefs, each reef containing 14ft., 13ft., and 12ft. respectively. The close-reef, or third reef size of the sail, will therefore be 16 square feet.

The material of the Pearl's sails is "washed longcloth," one-yard widths joined together by seaming the selvages, or the same material 9ft. 3in. wide. This width is not obtainable at any ordinary linendraper's, but is made in about 60-yard pieces at about 3s. 6d. per yard. The leach of the sail, from the peak (I) to the upper batten (J¹), is a selvage edge, to which the other seams run parallel, the first seam taking very nearly the line of the topping-lift. The sail is bound all round with strong tape, the luff with a treble thickness or with strong webbing. There are three battens (indicated by dotted lines) across the sail, one at each reef. The easiest mode of applying the battens is to have a piece of tape stitched along both its edges to the sail, thus making a pocket for the batten. Instead of the tape seamed pockets, the Pearl has long bags or pockets made to fit the battens, and stitched to the sail across the side next the mast, so that the whole thickness of the battens is interposed between the mast and the sail so as to prevent the sail pressing against the mast when closehailed, with the mast to leeward; the luff of the sail therefore never becomes a back sail, and the sail sets equally well on either tack. Two openings are cut out of each pocket, at K and L, in order to make fast blocks to the battens. These blocks are made fast by grommets seized with fine waxed twine. At each of the points J and M other blocks must be made fast. Across the sail, up and down from K to K and L to L, strips of tape are stitched, great care being taken to keep the tape slack

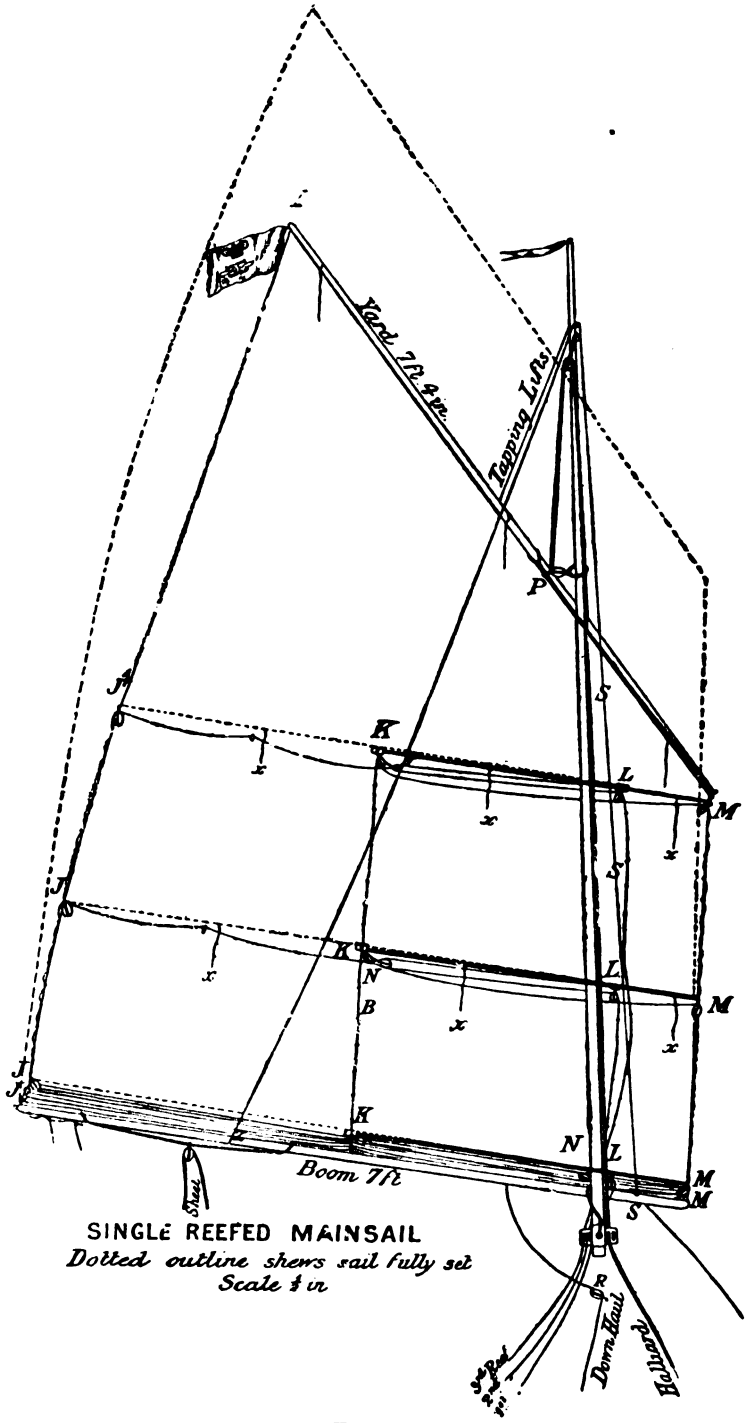

FIG. 148.

and at a less tension than the sail, so as not to *draw*, or girt, the sail, and spoil its sit. Along these tapes, and also on the luff and the leach, are rows of brass rings ($\frac{1}{2}$ in. outside diameter, obtainable at Nettlefold's, High Holborn), sewn on at intervals of 2in. The running gear for each reef is in three parts. The first, of No. 1 flax sash line, which is platted line (these lines must *not* be of *laid* cord), is secured to the after end of the boom, and leads up through the rings on the leech and the block at J, and along the batten to N, where it turns into a bight to form a strop round the block N, and is securely seized, and then the line turns back through the block K, and forward along the batten, through the block M and the row of rings on the luff, down to the boom, where it

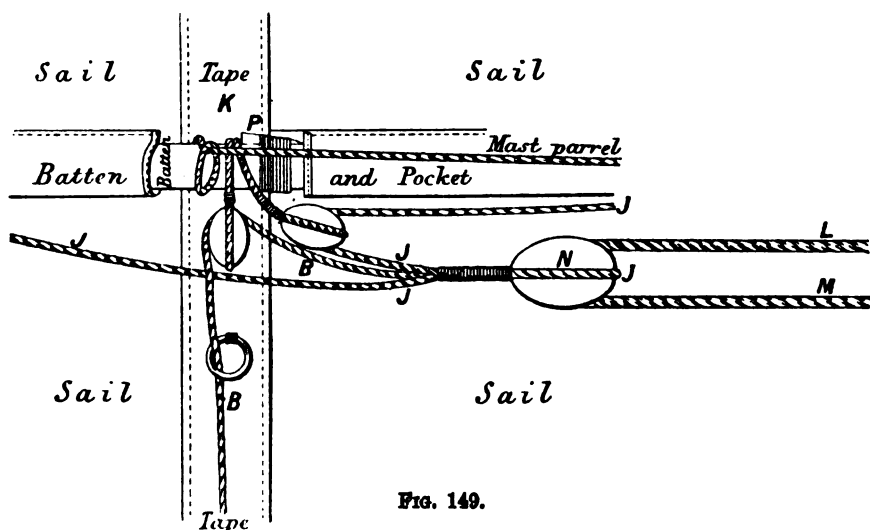

FIG. 149.

is made fast. The second line is a short one; B, its end, is fastened to the strop of block N, and it leads through block K down the row of rings, and is made fast to the boom. There are thus two lines leading through the block at K; but, as both run simultaneously, the working is quite smooth. Two single blocks or a double block can be used at this point K, but the double block seems to give most friction to the line from M, and two single blocks give the best result. The third line, stouter than the others (No. 2 flax sash line), is made fast to the fore end of the batten at M, and, being rove through the blocks N and L, down through the row of rings at L L, through the threefold block on the port side of the mast, and back to the hand, becomes the tackle, by pulling which the reef is gathered together at the leech, luff, and the points K K and L L. All three reefs are fitted in the same manner, the ends of the lines in the second and third reefs being attached to the

battens instead of to the boom, as in the first reef. The arrangement of the ropes and blocks will be more clearly understood by referring to diagram (Fig. 149). The regular conventional reef points (*x*) are also tied to the battens at intervals, as a reserve, in case of the reef tackle getting carried away.* It cannot be too strongly insisted that these running gears must be made of platted line, because if there is any twist or lay in the cords they will twist up where the three parts join at N. Before being fitted, the lines should be drawn through the hands several times to remove any tendency to twist, well stretched, rubbed with boiled linseed oil, and hung in a current of air to dry for a fortnight, or if wanted in a hurry they should be rubbed with beeswax, so that their smooth working may not be interfered with by wet. The Willesden Waterproof Company is now making some waterproof flax platted cord, which may probably serve the purpose better than the oiled or waxed cords, but it has not yet been tested. If the experiment results satisfactorily, the waterproof cord will be obtainable from Messrs. Good and Son, Arthur-street, London Bridge, who also supply the No. 1 and 2 flax sash line.

The blocks required for each reef are four $\frac{3}{4}$ in. at M J, and K K, and two $1\frac{1}{4}$ in. blocks at N and L. All these cords and blocks can be obtained of W. Good and Sons, Arthur-street East, London Bridge.

A parrel of strong cord (varnished to prevent its shrinking with wet or stretching with heat) leads from P to M on the yard, around the mast, and a similar parrel on each batten goes around the mast from M to K. The weight of the sail is thus divided, and spread fairly over the length of the mast when the sail is to leeward, and a great amount of strain is thus removed from the masthead.

There must be small wooden stops or cleats (P, Fig. 149), fastened with small screws and seizings of thread to the battens at K and L, to prevent the grommets slipping along the battens out of place. The parrels should be made with an eye-splice in each end, and one end being passed around the batten at K, the other end is passed through the eye and drawn taut so as to hold fast. The eye-splice in the other end is then looped over a hook screwed into the fore end of the batten at M, whence it can be unhooked in a moment, and if the line becomes stretched and slack it can be shortened by laying or twisting the end round, or by tying a knot in it. In the end of each batten there is a screw eye to which the blocks are grommeted, and the ends of the reef-lines are led through these eyes and then knotted, and the lines can be

* Care must be taken in cutting this gear, or there will be a difficulty in keeping the numerous lines of the exact lengths required for its successful working.

lengthened or shortened in a moment by shifting the knot if it is found that either has stretched so that the reef does not haul down snug all along.

The downhaul, for getting down the whole sail, is made fast to the yard at P, and leads down through a block on the deck at R. The three reef tackles, and this downhaul, lead along the deck through four eye-bolts (screwed into the deck) within easy reach of the hand, and the ends are knotted, so that they cannot go astray, but must always be ready to hand when wanted. This arrangement is convenient on a dark night when everything is invisible, and prevents accidents happening from mistaken identity of the various cords. The downhaul is important for getting down sails in sudden emergency; also in case of an upset the downhaul becomes essential to gather in the sail after the halyard is let go, otherwise the canoe cannot be righted without great difficulty.

The halyard is made fast to a hollow brass curtain ring running on the mast, and then passed through a block stopped and seized to the yard before passing through the masthead block. This arrangement always keeps the yard well set up to the mast, and yet allows the yard to lower down easily.

The double topping-lift leads through two blocks, one on each side of the mast, just above the halyard block, and the ends are knotted together and one line led down the mast through the second sheave of the pulley next the halyard and along the deck to a cleat, and by letting go from this cleat the sail, when lowered, can be dropped on deck. The topping-lift should always be hauled taut before reefing. A line (S), which leads from the masthead through a block or thimble on the boom, is fastened to a small cleat on the after end of the boom, and this line prevents the fore end of the boom from dropping when the halyard is let go while a reef is being hauled down, and is essential to the proper working of this reefing gear. The tack is made fast to an eye (A, Fig. 150) through a lug on the side of the treble pulley of the reefing lines on the ferrule around the mast at the deck, and to this ferrule are riveted the brass treble blocks on the one side for the reef tackles, and on the other for the main and spinnaker halyards and topping-lift. On the yard there are at intervals three or four ties with which to make up the sail when lowered down.

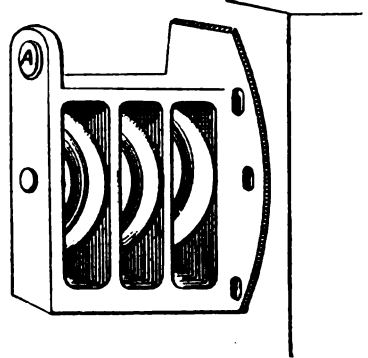

FIG. 150.

The racing sail is represented on a smaller scale, $\frac{1}{4}$ in. to the foot (Fig. 151). Its area is about ninety square feet, and it is fitted with the same gear as the cruising sail.

Mr. Tredwen says "objection may be taken to the appearance of these sails; that the foot is too narrow, the leech being rounded in too much; but this much can be said in favour of a short boom and narrow sail: the sail is less in the way of the paddle, and it is safer in squally weather

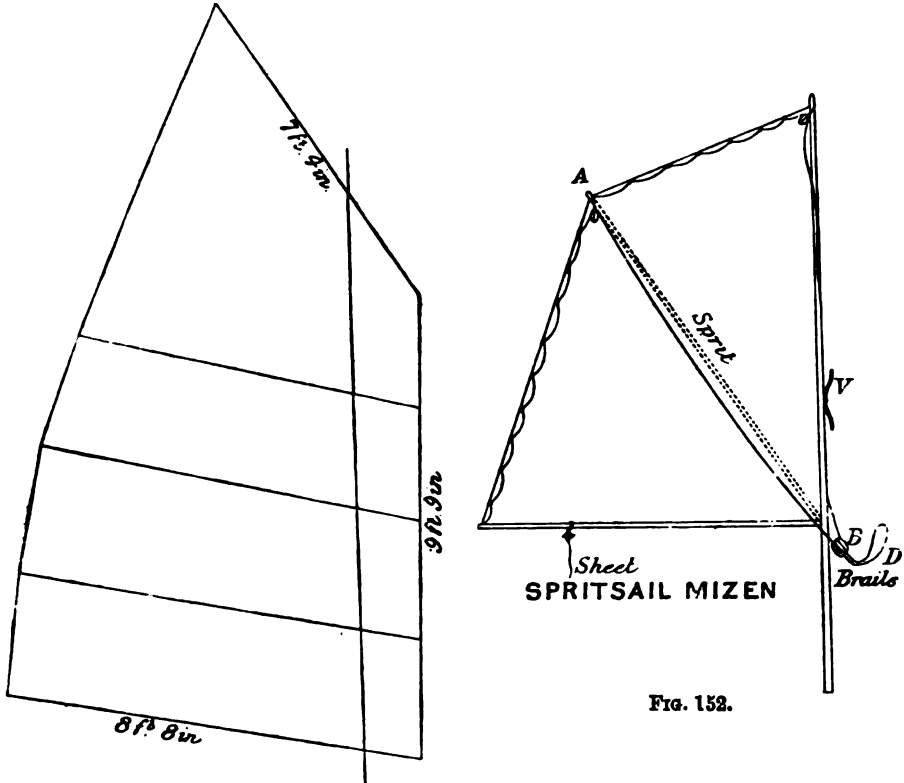

FIG. 152.

RACING MAINSAIL. $\frac{1}{4}$ INCH SCALE.
FIG. 151.

than a wide sail, as in a sudden puff a long boom dips into the water, and acts as a paddle backing on the lee side to prevent the canoe luffing up, while the water holds the sail aft like a belayed mainsheet, and keeps it full of wind. If the squall lasts a minute, the canoe is almost certain to upset under these conditions. A small sacrifice of beauty is certainly repaid by the safety acquired in a narrow sail." "Area for area," a low and wide sail imparts less heeling impulse than a high and narrow one; but the results of the wide sails getting in the water are more to be feared than the greater heeling impulse of the taller, narrower sail, which can be kept clear of the water.

In squally weather the sail would be of course reduced, and the boom would be well topped clear of the combers.

The spritsail mizen (Fig. 152) is fitted with a brail, running from the boom end through a row of rings up the leech, and through a block at the sprit head (A), then down the sprit through a double block at the foot of the mast at B, and then (leaving about a foot or so of slack in a bight) it passes over the other sheave of the double block to the masthead, and along the top of the sail through rings to the sprit end, where it is made fast. A finger being put into the bight (D) of the brail, one pull furls the whole sail (the sheet being overhauled); or, by pulling one line only, the sail can be reefed into a jib-header. A line is always kept fast to the masthead long enough to wind two or three times round the sail when brailed up, and this being fastened to the cleat on the mast at V, the sheet can be untoggled and the sail stowed away, ready to be re-set at a minute's notice, there being no halyards, tack, &c., to adjust. This kind of sail has been found to work well up to 40 square feet, and, although rather unsightly, it is handy as a mainsail in a Rob Roy, where the sail is set low. The canoeist can look under his boom, by a pull on the brail, to see what is under his lee. The sprit is run through a tape pocket to insure a good sit of the sail when reefed to a jib-header.

The Pearl is fitted with a "roller mizen," and Mr. Tredwen says it has these advantages: "It can be reefed down to any size required to establish a proper balance of effort with the mainsail, and no sail can be reefed so easily and rapidly, for there are no halyards and tacks to be cast off or hauled in, and the operation can be performed without taking the skipper's eyes off his course ahead."

This sail has two booms; the upper one is round, on which the sail is rolled; the lower one is oval, so as to give great strength in the direction required, with a minimum of weight. A ferrule J (Fig. 153), with an arm brazed on, is fitted to each end of the oval boom, and in the top of each arm is a hole, in which the spiles or axle pins of the upper boom revolve. Riveted on the ferrule at J¹ (Fig. 154) at the fore end of the boom, there is a brass cheek block, through which the cord A runs. The upper boom or roller is of equal diameter throughout its length. Two discs of brass (A on the upper boom),

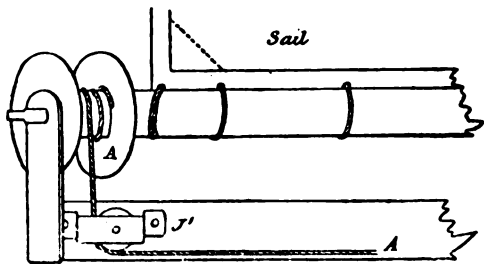

FIG. 154.

3in. diameter, are brazed to a ferrule 1½in. long, and make a reel, which

is driven on to one end of the roller, the other end being lightly ferruled; two pins are screwed into these ends through the holes in J, and the roller is thus hung so as to revolve freely.

In cutting the sail, the angle of the luff and foot must be rather less than a right angle, otherwise the sail in rolling down will wind

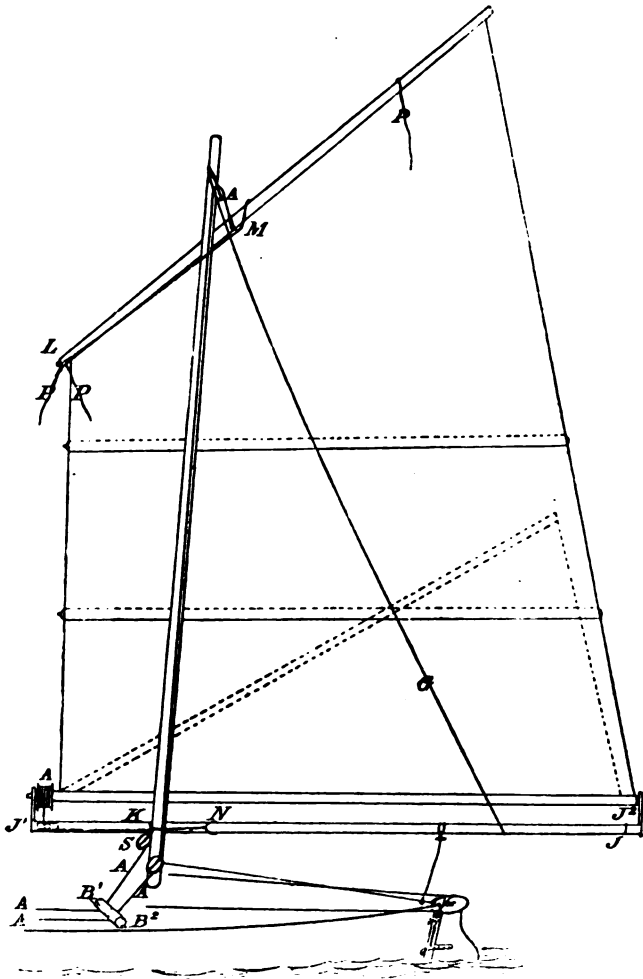

FIG. 155.

over the reel and get jammed. The sail is bound round its edges with strong thin tape, and two bags or pockets, open at the fore end but closed at the leech, are stitched across the sail, to take bamboo* battens about $\frac{1}{4}$ in. diameter. These pockets are applied as in the cruising sail already described, so that the whole thickness of the battens is interposed

* Bamboos can be obtained of C. Farlow (fishing-rod maker), in the Strand, near Temple Bar; or of Whitby, Bassnett-street, Liverpool.

between the sail and the mast. The battens are of "Tonquin Cane," greenish-yellow in colour, very light weight, and tapering very slightly. The ends of these canes are ferruled lightly and plugged with wood, and neatly rounded off to prevent them cutting holes through the ends of the pockets, which are stitched up to keep the canes in place. The sail being rolled down on the roller as far as it will go, and lashed round by the tyers, P, on the yard, is snugly furled, and ready to be rigged.

The mast is first fitted with halyard blocks at its head and foot, and a double topping lift, G (Fig. 155). The sail is then placed in the bight of the topping-lift, and its fore end is supported by a line from the mast head, made fast to the lower boom at K; the same line, continued down to an eye on the side of the mast just above deck, makes the tack. A parrel around the mast is fixed to the yard from L to M, and a similar one to the boom from J¹ to N; and a block, S, is lashed to the boom at K. Some preparation must now be made for the halyard and downhaul on deck. A screw eye-bolt must be fixed in the deck at B², for a double block to hook on to; or, better still, a brass double cheek block, delineated in the diagram (Fig. 156), is slipped into a couple of

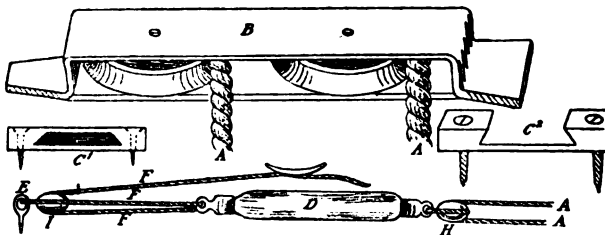

FIG. 156.

catches, C¹ and C², which are firmly screwed to the deck at B¹ and B² (Fig. 155). Another screw eye-bolt (E, Fig. 156) is then securely fixed in the side deck, about two or three feet forward of the skipper's seat, to which a single block (I) is hooked. A line (F) is made fast to E, and rove through the brass eye of a very powerful indiarubber doorspring D, back through the block I, and then to a cleat within easy reach of the skipper's hand. A single block (H) is then seized on to the other end of the spring, and everything is ready for the running gear. The line A, which is halyard and downhaul in one (a piece of No. 1½ extra super flax sash line), is made fast to the yard near M (Fig. 155), and is led through the blocks at the head and heel of the mast, around one sheave of B block, through the block H, and then back around the other sheave of B, through the block S, along the boom, and through the cheek block at J¹ up to the reel A. The line is then cut to the right length, and

the end passed through a hole in the disc which forms the aft side of the reel, and tied in a knot.

For hoisting (having toggled on the sheet and cast off the tyers P), a good pull on the line F is given; this line is then fastened to the cleat, which sets the peak of the sail as shown by the dotted diagonal lines in Fig. 155. The line A now bears the same relation to the sail as the cord to a window blind; pulling one side of the bight on deck hoists the sail, and pulling the other side of the bight lowers it. The door-spring, which must be a very powerful one, is necessary to keep the tension right, for the bight of A A sometimes lengthens or shortens as the sail is hoisted or lowered. When the sail goes up, the slack of the halyard A is rolled round on the reel, and is payed out again as the sail comes down.

When it is necessary to take the sail off the boat entirely, it is first rolled down as far as it will go, the peak remaining set (as shown by the dotted outline in Fig. 155); the line F is then cast off from its cleat, and the yard drops on to the boom in the bight of the topping lift. The sail is then made up by being lashed round with the tyers P, the tackle on deck is unhooked from the eye E, the block B is slid out of its catches, the mast unshipped, sheet untoggled, and everything can be stowed below, ready to be reset.

Mr. Tredwen says: "All this rigging may appear very complicated; but when it has once been fitted there is far less trouble in working the sails than when they are rigged in more primitive fashion."

The roller mizen is suited for sails of any size up to 40 square feet. The Pearl and Lurline both race with sails of this kind, 6ft. in the luff and 6ft. in the foot, giving an area of about thirty-six square feet fully set.

A spinnaker ought to be set without the canoeist leaving his seat, and Mr. Tredwen's plan to achieve this is as follows: The material should be fine in texture, so as to hold a minimum of water, dry rapidly, and stow away in a small compass when not set. The Pearl's cruising spinnaker is as follows: foot, 6ft.; hoist, 7ft. by 9ft. 3in. The edges are bound round with light tape, and all the corners doubled to give extra strength where the strain is greatest. To each corner is attached a swivel to prevent any twisting of the sail, and the halyard and tack both fasten on by clip-hooks. When the sail is not set the spinnaker halyard is hooked to the thimble on the main boom, through which the topping lifts lead, and the other end is led through an eye-bolt on deck within easy reach of the hand. The tack leads through a thimble on the fore end of the boom, and both ends are made fast to an eye in the side deck within reach of the hand. The sail when stowed away is rolled

up, the three corners outside in readiness for the halyard and tack to be hooked on. The spinnaker boom of the Pearl is 10ft. long, made with a fishing-rod joint in the centre for convenience of stowage. The outer end has a hook (see Fig. 157), almost a complete circle, which travels out along the sheet to the corner of the sail as the sheet is hauled taut. The inner end of the boom is fitted with a brass boathook head, which hooks on to a loop of cord spliced to an eye on the lee-half deck. If the mainsail gybes on to the spinnaker, the inner end of the boom is unhooked from this loop, the sheet is allowed to slip clear of the hook in the outer end, and is passed around the mast by means of the boathook, and hauled in on the other side. The sheet is then again slipped into the hook on the boom end, which is run forward till it

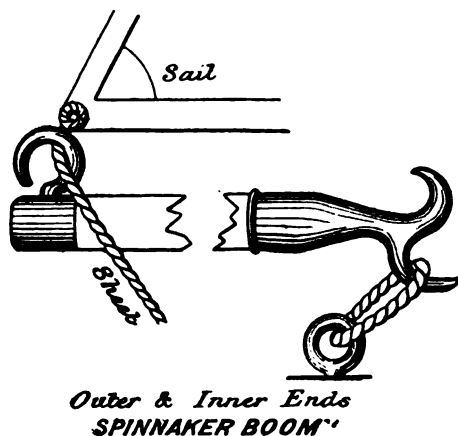

FIG. 157.

reaches the corner of the sail. The boathook end is then looped down to the deck, and the sheet hauled aft till the sail is set to the best advantage.

When the wind draws more abeam, the spinnaker can be made to sit well by means of a guy made fast to the boom, and led through an eye on the weather gunwale to a cleat aft, and, being bowsed down taut, prevents the boom from lifting.

In the Pearl, when before the wind, the spinnaker is always pulled up and hauled down on the starboard side, but there is no difficulty in booming it out from either side as the mainsail is gybed. This sail is indispensable in racing.

The standing lug is the sail generally adopted by beginners, because it is that usually provided by the builder. There are a few details which, if attended to by the canoeist himself in the rigging of the sail,

may make it much safer and more serviceable than is generally the case. The angle of the luff with the foot of the sail should not be greater than a right angle; so that there may be a good rise in the boom, which makes it easier to paddle when the sail is set, and enables the canoeist to see what is under his lee.

The masthead should be fitted with a halyard block in a long grommet, seized round the middle, so that it forms both the strop of the block and the eye to fit round the masthead. A screw put into the masthead just above the eye prevents it from slipping off; this block is better than a sheave in the mast, because the halyard runs freely and is less likely to get jammed. A toggle spliced to the end of the halyard should fasten into the bight of a grommet on the yard. Attached to the mast just above the deck is a double block. The grommet around this block and around the mast must be short, so that the block sits close to the mast; this carries the halyard and tack. Work an eye-splice in the end of the tack, and tie a knot over the splice, which will prevent the eye running through the block and going adrift. The mast being stepped, the halyard and tack should be cut of sufficient length to allow both ends of each to be held in the hand while sitting in the canoe. The hauling parts of tack and halyard should then be led through two eyes screwed into the deck, within reach of the hand, about a foot the fore side of each cleat, and the ends being knotted they cannot get out of reach.

When getting under way step the mast, and put the toggle of the halyard (A) through the eye of the tack (B); haul taut both lines on deck and cleat them. To set sail without quitting the seat cast off the hauling parts of the halyard and tack from their respective cleats, and with the boat-hook bring the other ends (which are toggled together) to your hand. Loop these ends to the yard and boom, and haul taut the other ends, and make fast. The sheet should lead through an eye at the fore end of the well on deck, with a knot in its end to prevent it from going adrift. To stow the sail let go halyard and tack simultaneously, and haul in on the sheet.

To reef such a sail is easy, because it can be got into the well, and the points tied down and the sail hauled out, and re-set very quickly. It can also be very quickly shifted for a smaller sail of similar shape. When the sail is taken off and stowed away, the tack and halyard should be toggled together, so as to be ready for use again when required. It is very important that the sheet should lead through an eye on deck, and have its end knotted, otherwise the canoeist may find himself running before the wind, the sail flapping

about in front of the mast, and the canoe refusing to be brought head to wind. A canoeist once found the situation still further complicated by the boom, which was *hooked* to the mast (instead of tacked by a line), becoming unhooked; the halyard, which led through a sheave in the masthead, was jammed, and the sail was skylarking about with an apparent determination to capsize the canoe, whose skipper was

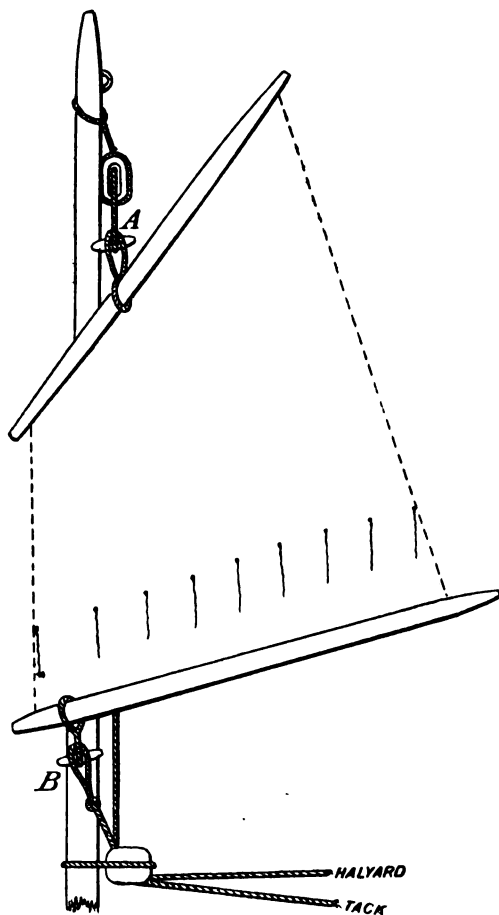

FIG. 158.

desperately lashing at the sail with his paddle. The screw-eyes can be obtained at Nettlefold and Sons, High Holborn, as also little brass washers to fit each size.

When designing a suit of lug sails, having made the largest and planned a reef to reduce its area by, say, one-third, the second sail should be cut so as to be a size smaller than the large one reefed. So, when the canoe cannot carry No. 1 reefed, shift for No. 2, which

should also have reef points, to still further reduce the sail area when necessary. If the canoe carries a mizen—and such a long craft as a canoe cannot be properly handled, on a wind, without two sails, besides which the carrying of a mizen allows the foremast to be stepped well forward, so that the boom does not interfere with the paddle—there should be a No. 3 lug (cut a size smaller than the reefed No. 2) to serve as mizen. This can also be used as a storm foresail on occasion. A stickler for symmetry of appearance would insist on a lug mizen to match the lug mainsail in shape; but if the canoeist is willing to sacrifice appearances for the sake of convenience it will be better to carry a sprit mizen of the Pearl pattern, as described on p. 444, Fig. 152. If symmetry of appearance be specially desired, both main and mizen may be made on this pattern; but if the sail is of large size the one brail line along the head will not be sufficient to make a neat stow of the reef. Two small blocks (or thimbles) must be fixed to the mast about a foot below the head of the sail, and a line led through one of the blocks round the sprit, through the sail (a hole being worked or eyeleted for the purpose one foot below the sprit head), and through the other block on the mast. The ends are then both made fast to the brail at a point so that the bight gathers the sail tightly when the brail has hauled the sprit close to the masthead block. The largest sail of this kind that has been tried on the Pearl was 40 square feet, and, if a larger sail is required, it will be better to adopt the China lug, with reefing gear, and the sail may be fitted with one, two, or three reefs, as each canoeist may think fit.

CANOE TENT.

When cruising alone—and some of the most notable canoe trips, which have assisted so much to popularise the pastime, were solitary ones—it is too great a load for one canoe to carry a large tent, ground sheet, and rugs. The labour, too, of dragging up the canoe, unloading and carrying up the stores, becomes heavy and irksome when performed single-handed. A good arrangement of tent, which can be set up on the canoe afloat or ashore, is, therefore, necessary on many trips; and a description of one that has been in use on the Pearl during several seasons may prove serviceable to canoeists.

There are several points to be studied in planning such a tent—lightness of construction, head-room, snugness, and facility of erection from within the canoe when afloat.

The lightest material for the cover is fine cotton, oiled. Macintosh

is heavier, if of good quality, besides being more expensive. It is a great convenience to have daylight to read by in wet weather, and to be able to see what is passing around without having to disturb the fastenings of the tent. Four rounds of glass inserted in the cover (about two inches diameter) confer these advantages. There should be two holes drilled through each piece of glass close to the edge to insure their being fixed securely.

Considerable head-room is required for cooking and dressing; but to ride safely at anchor while sleeping, it is necessary to have an arrangement for diminishing the size of the tent before turning in.

The framework on which the tent is supported is of bamboo, which gives great strength with a minimum of weight; it consists of a ridge-pole; two uprights, one at each end of the well; two curved pieces of bamboo, one at each end of the ridge-pole, to act as end frames; and three slips of oak to spread the roof between the end frames. The ridge-pole is jointed for convenience of stowage. The uprights consist each of two pieces of cane telescoped like a Japanese fishing

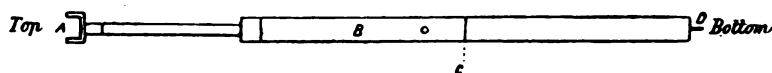

FIG. 159.

rod (Fig. 159). A brass pin (C) on a lanyard, when passed through the hole in the middle of the larger cane, keeps the inside cane raised. The ends of the canes are ferruled, and the top of the smaller cane is fitted with a crutch to carry the ridge-pole. The aft upright is stepped in the mizen-mast case, and the fore upright passes through a grommet on the coaming at the fore end of the well, and a spike (D) in its foot fits into a hole in bottom boards.

Each end of the ridge-pole is fitted with a square ferrule to fit the crutches of the uprights, and to these ferrules are fitted the curved end frames (Fig. 160). Each end frame is surrounded at the middle by



FIG. 160.

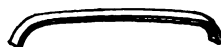

FIG. 161.

a brass ferrule, to which is brazed a square socket to fit the ferrule on the end of the ridge-pole. On the reverse side of the ferrule from the socket is a screw hook (E), and a similar hook is screwed into each end of the frame (F).

The three slips of oak (Fig. 161) are $1\frac{1}{2}$ in. wide by $\frac{3}{8}$ in. thick, their

ends bent by steam, and they are not shipped until after the roof has been put on.

The tent cover or roof is shaped as in the sketch (Fig. 162), and is strongly taped along the ridge, and across each end at the dotted lines.

The uprights being erected at each end of the well, and the ridge-pole, with its end frames fitted on, being laid in the crutches of the uprights, the tent cover is brought out of the locker, the grommet at the after end of the ridge-line (1) is fastened to the hook on the aft side of the end-frame (E, Fig. 160), and the corresponding grommet is looped on to the hook at the opposite end of the ridge-pole. The

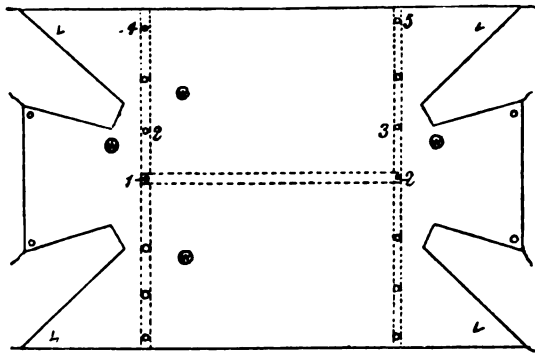

FIG. 162.

grommets at 2 and 3 are then looped on to the hooks at the ends of the frames (F, Fig. 160), and the grommets at 4 and 5 are fastened to catches (Fig. 163) on deck, constructed of a hook (passed through a brass plate and brazed), which can be closed by a brass catch pinned to the plate, and turning rather stiffly on its pin (Fig. 163). The other side of the tent is similarly fastened, and the corners (L L) tucked in and tied together. The pieces of oak are then slipped between the ridge-pole and the cover, and the roof is complete. A lacing to the lower edges through eyelets or rings in the cover and eye-bolts on deck makes all



FIG. 163.

are hooked down to the catches on deck. The small sprit mizen is very handy for this work, as it can be unshipped and stowed away in a moment to make way for the upright of the tent, and can be shipped again as quickly next day.

The glass windows (W) are very advantageous, and enable one to make sure, by observation, that the anchor is holding, or to see the

cause of any unusual noise, without having to get up and raise the side or end of the cover.

If any canoeist should consider this mode of setting up a roof to be elaborate, and should object to the necessity of carrying a spar on purpose to serve as ridge-pole, a somewhat similar cover, but narrower at the fore end, and both ends *split* like the door of an Alpine tent, can be arranged to fit over the mast as a ridge-pole, the mast being lowered part way, and lashed to the mizen masthead, the cover passed over the mast, and spread by the bent pieces of oak lashed at intervals to the mast. This shape is specially suitable for riding at anchor, as the fore part of the tent is low, and opposes a very small surface to the direct action of the wind. When camping in the canoe, the hatch covers, unshipped and laid upside down across the coamings, make a very convenient table, and a small "Cyclops lamp" (from the Stella Lamp Company's Dépôt, Oxford-street) at the fore end of the well will illuminate the whole tent. This lamp is very convenient, being collapsible, and can be hung from the top or the back. The stores and cooking gear should be carried in one or two boxes. The Pearl has two, stowed one each side of the fore centre-board case, at the fore end of the well, so as to be readily accessible. The sides of the boxes are fitted with brass trunk handles, and the tops covered with very tight-fitting lids.

Bedding: A down quilt, made to the shape of the canoe's floor, is a comfortable thing to sleep on, and a large maud makes a nice covering. The bedding can be stowed in a very small space if carefully rolled up, fastened round and across by leather straps, which can be tightened up till the bundle is compressed into the smallest possible compass. The clothes bag serves as pillow, and the whole kit is kept dry during the cruise by being tied up in a double-mouth waterproof bag, made large enough to fill the whole of the after-locker. It not only serves to keep its contents dry, but, in case of a spill, fills the locker so completely that very little water can get into that compartment, even if the slide bulkhead is not perfectly tight; and, laid under the down quilt, it also helps to take off the hardness of the bottom boards, and keeps down the damp when sleeping; and in a very cold night the bag is a very warm berth to sleep in.

CLYDE CRUISING CANOES.

Prior to the establishment of the Clyde Canoe Club in 1874, there was no settled class of canoe on the northern waters, and Rob Roys were the only craft in which any cruising was done. In 1874 the Rambler

was built from the drawings in Mr. Baden Powell's "Canoe Travelling," and Mopoon, Bothnia, and Wren succeeded. Unlike the Rob Roy or Nautilus, she might be called a cross between a birchbark and kaiak, and, as will be seen from the drawing (Plate LVII.), she is built with very hollow lines, and the ends are too fine to accord with an English canoeist's idea of a cruising canoe, and are, indeed, finer than the ends of Clyde canoes, although many of them are 16ft. and 17ft. in length, with 32in. beam. The Wren cannot, therefore, be taken as typical of all Clyde canoes, but rather as one of many not very distinct types to be met with on the Clyde.

One of the most important things in the build of a canoe is to have her built so as to keep the inside as dry as possible. For that purpose the idea of building canoes with sheer was adopted first in the Nautilus. The Clyde canoes have a similar sheer, which commences from the bow, and rises in a gentle curve to the requisite height necessary to keep her nose out of the waves, and, with the assistance of a slight flam, the advancing waves are gently thrown aside, when otherwise they might have been on deck.*

The principal dimensions of the Wren are: Length over all, 14ft. 6in.; beam, 2ft. 5½in.; depth, 10in., measured from under side of garboards to top of sheer strake amidships. The planking (five planks on each side, top strake being teak), is white pine, ¼in. thick, clincher-built. The deck is, by preference, mahogany, ¼in. thick, and is put on in four pieces, fastened with brass screw nails to strong deck beams, and carlines running fore and aft on port and starboard side of canoe. By doing so, one portion of the deck can be lifted for internal repairs without disturbing the rest of the deck work. Bow and stern posts are of mahogany, and keel of American elm; water-tight bulkheads forward and aft, with one sliding bulkhead at aft end of well. The mainmast is stepped 2ft. 6in. from perpendicular of bow, and mizen 3ft. 6in. from perpendicular of stern.

The greatest beam is parallel for 18in. at centre of canoe, and the after end of the well is 20in. aft of centre of canoe.

At aft end of well, behind sliding bulkhead, there is a hinged hatch giving access when afloat to a commodious locker; and on aft watertight compartment there is a small hatch, usually made from 7in. to 8in. square, giving access to locker, where lamps and other such like articles can be stowed when afloat. From the foot steering gear to the mainmast step

* Builders of Clyde canoes are Mr. W. Ogle and Mr. W. Macalister, Dumbarton, the prices varying from 12*l.* to 15*l.* The sails are made by Mr. Mackenzie, Greenock. The Lily, one of the best Clyde canoes, was built by Mr. Ogle.



PLATE LVII.

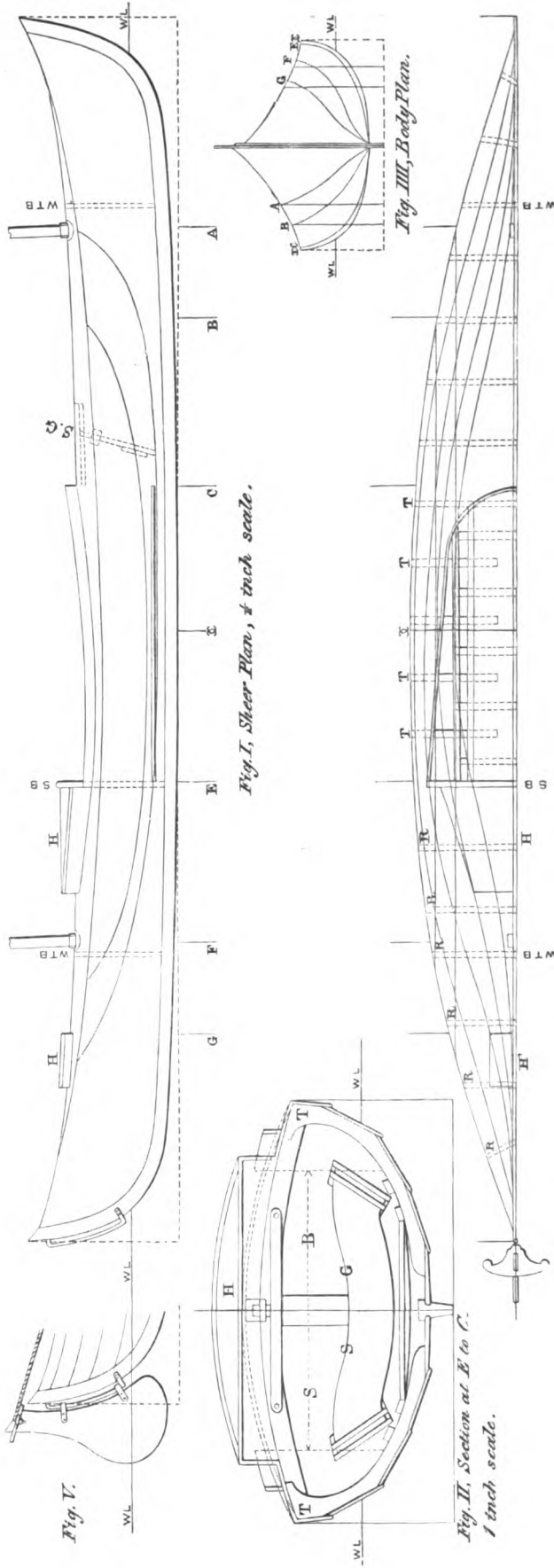

Fig. III, Deck Plan, & inch scale.

Clyde Canoe, designed by C. G. Y. King, Esq.

there is also good stowage room for tent, meat tins, bread box, and whatever else of that description may be required.

By keeping the mainmast well forward the canoe is supposed to lie better to the wind than if it were, say, 1ft. or 1ft. 6in. further aft. With a keel of 1½in. in depth, she goes well to windward, and, having 2in. rocker fore and aft, can be put about like a boat without using the paddle.

The masts are stepped into square sheet-brass sockets from 9in. to 10in. in depth, 1½in. square at the deck, and tapering to 1in. square at the bottom. These sockets are watertight, so no danger arises from their being full of water. Watertight bulkheads are made a close and tight fit to their respective sections, and are bedded down with red or white lead. They are cut out of half-inch pine; if made much thinner, they are liable to get stove in when spars are stowed below, or when baggage is too energetically shoved fore and aft. The sliding bulkhead is the width of the well, and made to slide into a tapered groove, and, like the other bulkheads, is made of half-inch wood, but by preference mahogany. The ribs (which are ¾in. by ¼in.) and timbers are spaced 8in. apart, and, with the exception of those within the well, are made of American elm steamed and bent to position. The "well" timbers and knees are clean grained oak bends, and cut to fit the cross sections. If cut from natural bends they will be all the stronger. The coaming round the well is made of ¼in. elm. This wood is by far the best where the front part of the well is curved, otherwise oak, mahogany, or cedar have been used. On one side of the well, under the deck, is a chart locker about 2ft. long, and occupying the full width from the coaming to the gunwale. The formation of this locker tends to strengthen the well amidships, as it is impracticable to have short beams joined to a carline. On the other side (starboard) is fitted a slight shelf or open locker, likewise giving extra strength to the deck. This is useful to hold pipe, handkerchief, and other light and often-needed articles.

REFERENCES TO PLATE LVII., "WREN" CANOE.

FIG. I.—SHEER PLAN.

M M, mainmast.
M, mizenmast.
H H', hatches.
W T B, water-tight bulkheads.
S B, sliding bulkheads.
S G, steering gear.

FIG. II.—SECTION AT E. TO C.

T, timbers in well.
H, top of hatch,
S to B, sliding bulkhead.
S G, stretcher and foot steering gear combined.

FIG. III.—DECK PLAN.

H H', hatches.
W T B, water-tight bulkheads.
S B, sliding bulkhead.

R R R, ribs.
T T T, timbers in well.

FIG. IIII.—BODY PLAN.

FIG. V.—RUDDER PLAN.

PRINCIPAL DIMENSIONS.

	ft.	in.
Length over all	14	6
Beam	2	5½
Depth, centre of well deck to garboards.....	0	10
Sheer fore from gunwale at amidships	0	8
Centre of mainmast to perpendicular of stem	2	6
Centre of misenmast to perpendicular of stern	3	6
Aft end of well from centre of canoe	1	8
Length of canoe well	3	6
Width of well aft	2	1
Diameter of circle of well at fore-end.....	0	9½
Width of hatch at after-end of well	1	10
Width at after-end of hatch.....	0	11
Height above deck of hatch.....	0	1½
Width of hatch on after-locker	0	7
Length of hatch on after-locker	0	7
Height of well coamings	0	1½

CLYDE CANOE FITTINGS.

The diagrams in Plate LVII. to a great extent explain themselves.

Fig. 164 shows details of the rudder arrangement, half full size.

The rudder mountings are all brass. The rod C is ¼ in. diameter, and is shaped to the curve of the stern, and is made fast to the stern-post by means of the flat and tapered pin A and the clamp B.

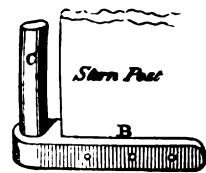
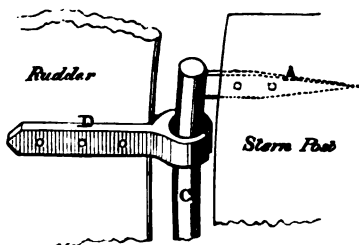

† Full Size
FIG. 164.

Two clips similar to D are fastened on the rudder top and bottom. These clips have a ⅜ in. hole bored in them, and a slot cut out to clear the flat pin A when the rudder is being shipped. The pin A is ½ in. full thick, and when shipped the clamp B keeps the rudder in the position required. This is the simplest and neatest way in which rudders can be fitted on curved sternposts.

Figs. 165 and 166 show two very common methods of rudder connections.

In Fig. 165, A is a brass rod, which is dropped through the brass eyes B B, the eyes on the rudder being at a shorter distance apart than those on the sternpost, so as to prevent the rudder being lifted out of position by the waves.

Fig. 166 shows the common pintle arrangement.

Fig. 167 shows the Wren's stern squared. The false sternpost is shown by A, made fast to the stern by means of square pintles in square sockets at B B. The rudder can then be fastened to A, either

according to Figs. 165 or 166. C and D are guards of sheet brass, placed so as to keep weeds from catching the rudder or false sternpost.

The rudder is worked by the foot steering gear with brass chain, copper wire, and brass wire cord, having been tried in succession between the rudder and foot yoke. Brass chain answers well, never kinks, and takes up little room when gathered up. The chain leads to the foot yoke under the deck, so as not to hamper the deck with gear lying in the way of often-used ropes.

The hatch or well covering was originally of wood, similar to those still in use on the Clyde. It was not fastened in any way to the well coaming, but had simply a counter coaming of elm, fitting over well

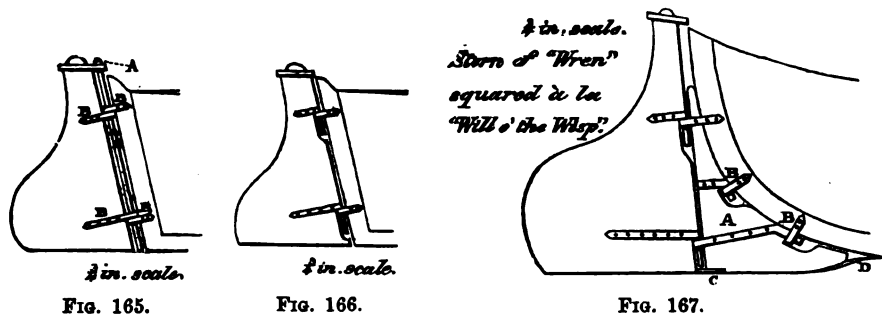

coaming. This hatch is made in two pieces, which are joined by leather hinges, so that the whole well need not be covered in. If wanted, the whole hatch could be removed and placed either forward of the well on deck, or on top of locker aft. At present the hatch or apron in use is that used by the Mersey Canoe Club, and similar to that described on page 389. It is of waterproof cloth. This cloth is fastened to battens, in length equal to length of well; and to keep the battens in position a strip of mahogany is nailed to the deck along both sides of the well, and the battens are jammed between these strips and the coaming. At the fore end of the well is an indiarubber cord $\frac{3}{4}$ in. to $\frac{1}{2}$ in. thick, which keeps the front portion of the apron close to the coaming at deck.

CANOE PADDLE.

For the propulsion and guidance of canoes the use of the paddle is the primary method. Mr. King's paddle is 8ft. long, and can be divided into two lengths at its centre by a brass ferrule socket. In putting together the blades are placed at right angles. The supposed advantage gained by one blade being feathered is that, in paddling against a head wind, one blade cuts the wind while the other does the work. A slight movement of the wrist is all that is necessary to perform the feathering operation; it does not

tire the arm, and, when once acquired, is easily kept up all day. The paddle shaft is $1\frac{1}{8}$ in. in diameter, and the blades are 15 in. long by 8 in. wide; an indiarubber ring close to each blade serves to keep off trickling water.

CLYDE CANOE SAILS.

With the improvement in canoe design, sails for canoes have improved very much; their use at first being auxiliary to the paddle, it is only within a few years that much attention has been paid to their utility for cruising and racing purposes, and consequently beating to windward.

Wren's sail plan and gear were of the simplest description possible. Plate LVIII. gives a view of the sail plan, to the scale of $\frac{1}{4}$ in. = 1 ft., and in design of rig is simple and easily handled. The masts, main

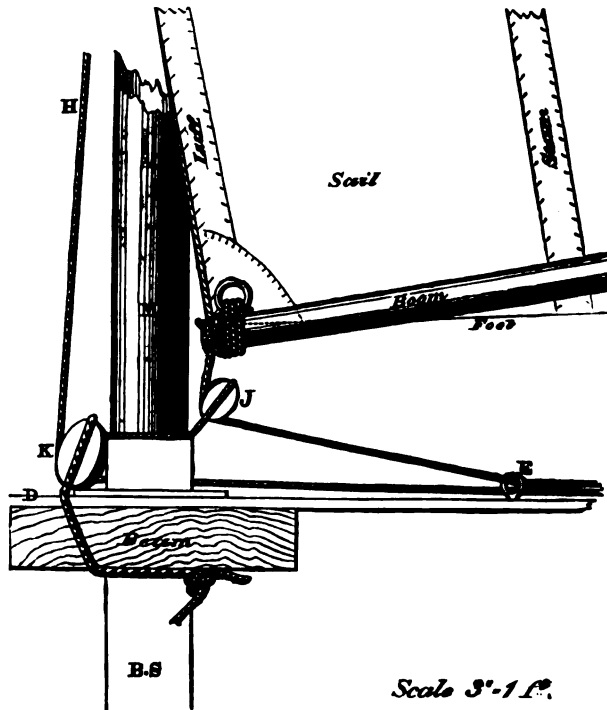
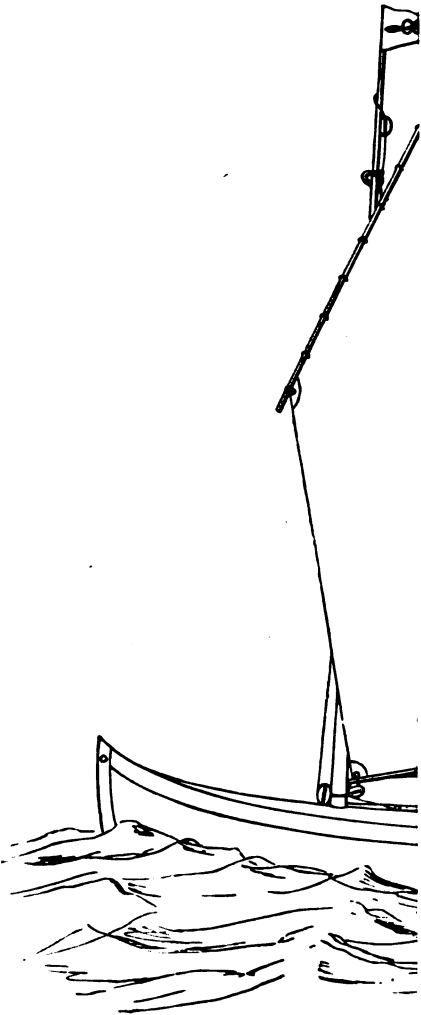

FIG. 168.

and mizen, are good strong yellow pine sticks, $1\frac{1}{8}$ in. diameter at deck, square in the step, and tapering to 1 in. square at the foot; diameter at masthead, $\frac{3}{4}$ in.; height above deck, 8 ft. for main mast and 5 ft. for mizen. The mizen mast is thus stouter in proportion to length than the main, and the advantage gained in having both masts alike at the step is evident, when the mizen mast and sail can be set forward instead

PLATE LVIII.



of the main in almost any weather. To each sail (main and mizen) there are the following ropes—halyard, tack, and sheet; and, as both sails are rigged alike, the sketches Figs. 168 and 169 may do for each.

In Fig. 168, K is the halyard block at deck; J, tack block at foot of mast; M, mast; D, deck; E, eye-bolt through which tack is passed to its cleat; H, halyard; B S, brass socket for mast, made watertight; Beam, an extra strong beam athwartship at each mast, to strengthen deck. The tack block is made fast round the foot of the mast, close to the top of brass step socket, and the halyard block fastening is passed through a hole in the deck and beam on the fore starboard side of the mast, then the two ends of the lashing are tied under the beam round the mast step.

In Fig. 169 is shown the masthead gear, where B represents the brails, C, the traveller, with hook, on which the strop E is hung with running eye round the yard; T, halyard block; H, halyard; M, mast. Brails are seldom used on the Clyde canoes, the folds of the sail being usually gathered in as sail is lowered. Also few canoes are fitted with a

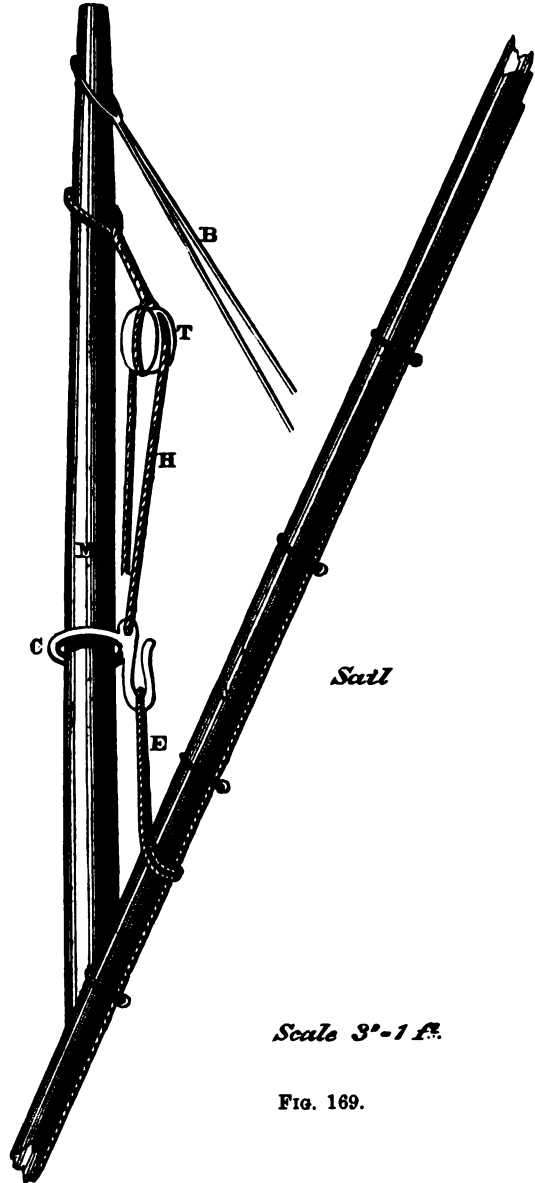

Scale 3"-1 ft.

FIG. 169.

downhaul, which, although not on the Wren, is of the greatest benefit when the sail requires to be lowered suddenly in heavy winds. The ropes are of woven linen. Woven cord is very suitable, as it does not unravel, although some never use it, as it cannot be spliced. For a mainsail sheet

a good length of 1in. Manilla rope is very suitable, as it is not so thin as to cut the hands when holding it in in a strong breeze. The mizen sheet is rove through a block at the stern, thence along the deck to its cleat close to the well. Paget's patent rocking cleats are by far the best, as one hitch holds anything. Sails are made of stout linen material, in cloths from 10in. to 12in. wide, and if made by a sailmaker all the better. At each corner are strengthening gores, of the same material as the sail. The leech is as usual the selvage, and the head, foot, and luff are corded, instead of being, as some sails are, bound with tape.

The more complicated reefing gear of the English canoes are sometimes to be met with on the Clyde, but generally the rig is much more simple. Centre-boards are but little used on the Clyde; perhaps the reason is that their increased weight makes hauling canoes above high water mark when cruising and camping a nuisance.

For cruising, the Wren has a special mainsail of 25 sq. ft., and the mizen is left at home.

When raced, the ballast carried in the Wren was about 100lb. of lead, placed well aft; and as the well is extra wide at its after end, the canoeist is enabled to sit well to windward.

CLYDE CANOE CRUISING.

For clothes, the canoeist may be advised to take an every-day suit for wearing ashore, as well as his usual knickerbockers, stockings, shoes, jersey, and cap for wearing afloat. For provisions, should the cruise be intended to extend over a couple of weeks, in localities where shops are never heard of, an extra supply of everything should be taken, but not so much as to have a superfluity of any one thing. Tea, coffee, or cocoa, according to choice, can be taken; preserved milk, bread, butter, tins of meat, soup, and fruit; matches should be kept in an empty pickle bottle; corkscrew, and many other little articles which suggest themselves to the requirements of the would-be *voyageur*; but it is a well-known fact that the oftener one goes cruising, the fewer unnecessary are taken.

Sleeping costume is perhaps the most variable of all costumes, and the novice to a great extent has to please himself. Some put on a complete suit of clothes, roll a thick muffler round the throat, and put on a double supply of stockings. Others, again, envelope themselves in a Highland cloak, having on a spare boating suit; others, who carry railway rugs, Scotch plaids, or the common household blanket, don a nightshirt; while some sleep in sacks, with only their heads visible.

In almost every instance, each member while afloat is seated on a cushion about 2in. thick, 20in. wide, and from 2ft. 6in. to 3ft. long. These cushions are covered with American cloth (waterproof) and stuffed with hair, and in the evening, when the tent is pitched, make admirable couches for repose.

THE CLYDE TENT.

Some canoeists who indulge in river cruising prefer to sleep on board their craft, sometimes afloat, and sometimes on shore. Truly the simplest style of camping out alone is sleeping in the canoe. Sleeping on board, afloat or on shore, is, however, a thankless job, and there is not the comfort or satisfaction that arises from the use of a tent. The canoe is, for sea cruising, too unstable for such use afloat, and is seldom designed for such use ashore, although it may have the recommendation that dryness of couch is thereby obtainable. For general comfort and satisfaction, a tent is truly the *sine qua non* for sleeping in, and there can always be found a plot of ground beside a running stream where the canvas walls can be erected.

A tent must have many qualities; it must be light to carry, simple in its erection, free from draughts, strong enough to stand up in a gale of wind, and, above all, perfectly watertight. The members of the Clyde Canoe Club claim that the Clyde tent combines these qualifications, and no true canoeist who has once slept in a Clyde tent cares to try any other design. Its most essential item is dryness internally, in the heaviest rainfall. One great feature is the simplicity of its construction, in that the floor, walls, and roof are in one length of cloth, sewn together at the floor edge.

The tent shown in the drawing is made suitable for the accommodation of two canoeists.

Fig. 170 is a drawing of the floor or ground sheet, walls, and roof, extended or unrolled before setting up.

Fig. 171 is a view in elevation of one side of tent.

Fig. 172 is a view in elevation of the back of tent.

Fig. 173 is a view in elevation of tent door, shown closed.

Fig. 174 is a detail from Figs. 171 and 172.

Fig. 175 enlarged view of A galvanised tent pin in Fig. 171.

Fig. 176 an enlarged view of R, Fig. 171.

Fig. 177 is a detail of tent pole.

Fig. 178, canoe lamp.

These illustrations will now be considered in detail, so that the construction may be better understood.

The corner letters in each view of tent are all intended to correspond with each other.

In Fig. 170 B to F, or the rectangular piece B F M Z, is the floor or ground sheet; E F L M and L C B P, walls; L E D K, and D K C L the roof, K to D being the ridge; V is a ventilator. The strip marked S

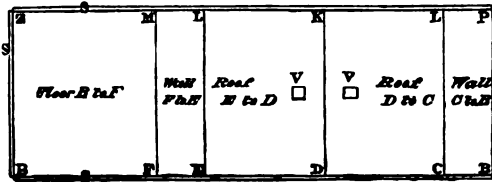

Plan of Tent extended. Scale 1"=2ft.
FIG. 170.

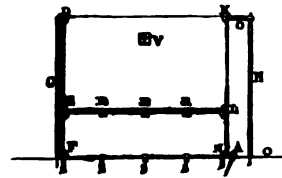

Side Elevation Scale 1"=1ft.
FIG. 171.

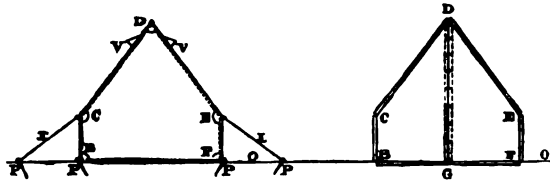

Back Elevation.
Scale 1"=1ft.
FIG. 172.

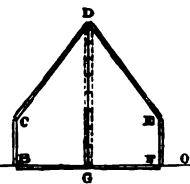

Front Elevation.
Scale 1"=1ft.
FIG. 173.

is for hemming or counter-hemming the back and front ends of tent to floor, walls, and roof.

In Fig. 171 D K is the ridge; D E L K, one side of roof; E F N L, wall; F N, edge of ground sheet; O, ridge pole (horizontal); G, tent pole (perpendicular) and back of tent, placed close to the tent; H, tent pole

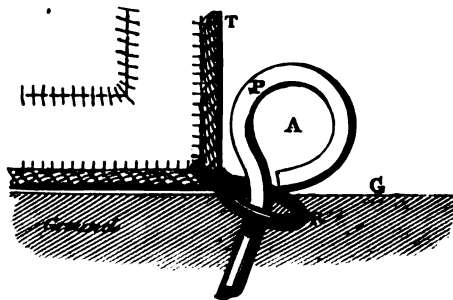

A Fall Stave.
FIG. 174.

at door, sometimes 12in. or 18in. from front of tent, to allow free ingress or egress to tent; V, ventilator; R R R, guy rings; S S S S and A, tent pins.

Fig. 172, D, ridge; C D and D E, roof; C B and E F, walls; B F, ground sheet; I, guy ropes; P, tent pins; V, ventilator shown open—when required to be shut, a cord leading to the inside closes it.

Fig. 173, D, ridge; C D and D E, roof; C B and E F, walls; B F, floor; D G, door shown shut, with eyelets for lacing same; when open, a space equal to a triangle B D F is formed by tying the two corners G to the angles C and E.

Fig. 174 shows the corner tent pin A in Fig. 171, or any other tent pin full size.

Fig. 175 shows tent pin to scale of 3in. = 1ft.

Fig. 177, O, ridge pole; G H, front and back tent poles; A and B, iron or brass pins, B being thrust into the ground to steady the pole, while A on each pole keeps the ridge pole O steady.

Fig. 176 is an enlarged view of R in Fig. 171, showing the ring R, to which stout woven cord guy ropes, like I in Fig. 172 are fastened.

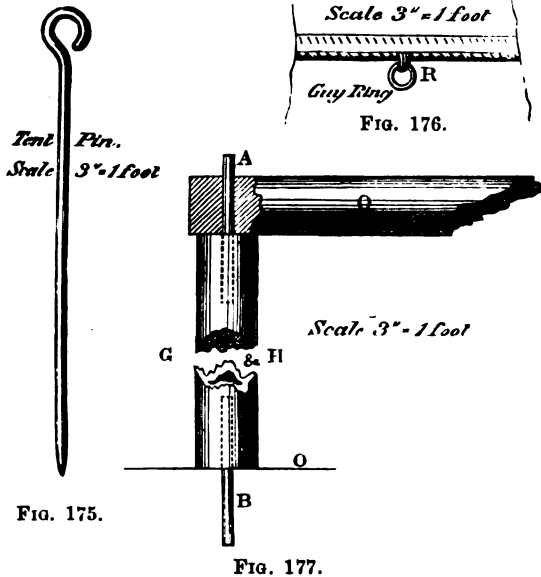

FIG. 175.

FIG. 177.

Fig. 178 shows a copper lamp, which is hung up to the ridge pole inside the tent at night. The glass globe is of thick glass, and is protected by two cross copper wires. The lamp divides in the centre, thereby enabling the oil receiver and lamp proper Z to be removed for cleaning or renewing oil or wick. Y Y Y Y are rings through which a rope is rove to steady the lamp while at the masthead when paddling at night after dark.

In the construction, having cut out in one length sufficient cloth to make the floor, walls, and roof, and sewn the edges Z B and P B (Fig. 170) together, the back end, Fig. 172, can now be sewn in, as also can the door end, Fig. 173, care being taken that the corners B F E D and C

take their right places. The door is sewn along all its outside edges, except from B to F, and, after being laced, is kept close down by means of the lacing cord being made fast to the tent pin at G.

Figs. 171 and 172 show outside finished dimensions, and the dotted lines correspond to the strip S in Fig. 170, which, being a double seam, gives extra strength. Along all the edges, such as F M, E L, C L, B P in Fig. 170, and B C D E F in Figs. 172 and 173, there is a stout cord sewn, and on each edge F M, E L, C L, and B P, and B F front and back, and at suitable intervals, there are brass rings sewn; those along the ground lines, to receive the tent pins to hold ground sheet down; and along E L and C L, are similar rings as R in Fig. 171 and R in

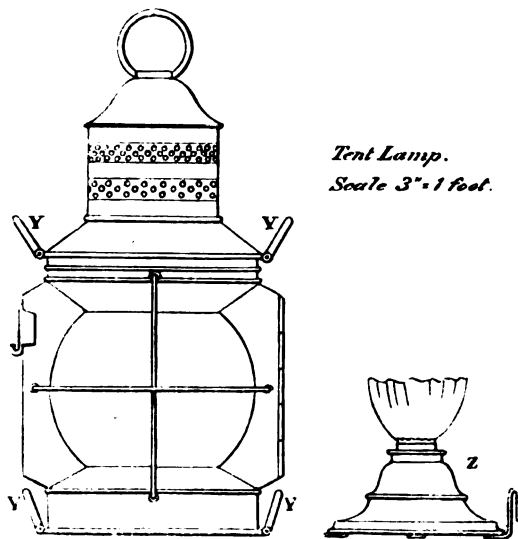

Tent Lamp.
Scale 3" = 1 foot.

FIG. 178.

Fig. 176, to which guy ropes are attached, and at the ground end of guy rope is a loop in which is clipped round the tent pin when same is being driven home.

Those who object to the use of iron tent pins possibly do so because they have always used wooden ones. The Clyde tent pin is of $\frac{1}{4}$ in. galvanised iron, 10 in. long, with a ring at top end (A in Figs. 174 and 175) large enough to admit the finger, thus enabling them to be easily withdrawn from the ground and fastened together in a bundle.

The inserting of a wooden peg necessitates the use of a mallet or any stone lying about handy; their wear and tear necessitates frequent renewal, and their insertion is difficult in stony ground. The use of iron obviates all difficulties of these kinds. The tent poles G and H are each in one length, according to height of tent at ridge pole. They

are of 1½ in. yellow pine. The ridge pole varies in length according to length of tent. It is likewise of 1½ in. pine, and is jointed like a fishing rod at its centre, so as to be handily stowed below. This joint is made of a strong brass tube 10 in. long, one half of the ridge pole being inserted for five inches, and fastened to the brass tube by a couple of screws, while the other half of the pole fits exactly into the remaining five inches.

To erect the tent, stretch the ground sheet flat on the ground and fasten it close down by means of the pins, and let them be angled inwards, as in Fig. 172. The roof and walls will now be lying in a heap. Next pass the ridge pole through the hole specially prepared for it at D in Figs. 172 and 173, then insert tent-pole pins through the holes at each end of ridge pole, and keep back end pole close to the end of tent, leaving front pole 12 in. or 18 in. clear from the door (see Fig. 171). Then commence at either end, and stretch guy ropes, and press pins closely down to the ground, the pins being angled inwards. If properly set and strained, the roof and wall will sit as flat as a board. The material used is either bleached or unbleached calico, and, to render it waterproof, it should be coated over, when erected, with two coats of boiled oil and terebin (extract of turpentine tree), one gill of the latter to two quarts of the former being a good proportion of mixture. The tent as shown by drawings was actually designed to accommodate two canoeists, and is of the smallest suitable size which it is advisable to make. Similar though larger ones are in use, in which four can sleep comfortably, with baggage inside.

The tent, with poles and pins, weighs about 18 lb.; it can be erected in three minutes, by two canoeists, and, for a cost complete of 2*l.* 2*s.*, is within reach of all canoeists who care to order it from any sailmaker, or cheaper still if they make it themselves.

Some tents are made with roof sloping down to where the ground sheeting should be, and have no walls, no floor beyond a separate waterproof ground sheet. These tents are never dry, and, not being waterproofed, they secrete the rain, and are thus objectionable companions when packing up in a hurry in the morning. The rain possibly does not penetrate as it falls, but when touching the inside it at once trickles on the hand. The majority of special canoes are designed to suit the waters they are intended to be used on, but the same can never be said of tents, which are suitable anywhere.

One very good and general plan is, when several canoeists are camping together, to carry a small tent, like the one described, specially for holding baggage, and to be used as the kitchen of the camp.

Novices in camping have often great difficulty in selecting a suitable

and simple cuisine. The best known is the Russian lamp, or Rob Roy cuisine, obtainable at Mr. Hepburn's, 93, Chancery-lane, London. In the north it is accredited with the euphonious name of the "Devil," on account of the roaring propensities of the blast when burning.* One simple arrangement is to have a copper pot with frying-pan lid, which can hold inside it a five-wick lamp, handle, and legs for pot to stand on. For cooking purposes it is seldom used, except in wet weather, as there is always sufficient dry drift wood to be found along the shores above high-water mark to make a fire large enough to cook for the camp. A half-gallon tin of methylated spirit is carried; and as such a commodity is seldom procurable among the western isles, it is used as little as possible.

MERSEY SAILING CANOES.

A class of boat is rapidly getting into favour on the Mersey, which, in some respects, is better adapted for the combined recreation of "paddling and sailing" in the open sea than are any of the canoes hitherto described. We are indebted to Mr. C. Arthur Inman for a description and drawing of the Mersey craft (Plate LIX.); and it would be strange indeed if that home of "canvas-backs" did not turn out something specially serviceable in the way of boats. Although these Mersey sailing boats are termed "canoes" and "canoe yawls," it is quite plain that they are as much "sailing boats" as the Surbiton gigs are. It is true that they have grown out of the Rob Roy canoe; but a vessel 17ft. long, 4ft. 6in. broad, and 2ft. deep, that carries "passengers," 1cwt. of ballast, has a large sail area, and is, moreover, rowed and not "paddled," is better described by the word "boat" than "canoe."

The boats are usually of one length, 17ft.; and a breadth of 4ft. 6in. is found to answer well. The depth from gunwale to under side of keel is 2ft., and the keel is 4in. deep. They are decked all over, excepting the well, which has 1½in. coaming all round, and is usually of the form shown in the drawing. The well is carried so far forward to enable the crew to reach the mast, or anything forward of it, without getting on the deck. The canoes are clench built, of white or yellow pine ¾in. thickness when worked up. The stem and sternpost are alike, 1½in sided, with 2½in. outside rabbet, and about 3in. inside, enough to take the plank fastenings and serve as apron.

The steering arrangement is very capitally contrived with yokes coupled by rods or chains as a tiller, as shown. Strengthening pieces (running fore and aft) are worked above and below the deck, through

* King and Brown, 93, Wigmore-street, keep most excellent cooking stoves.

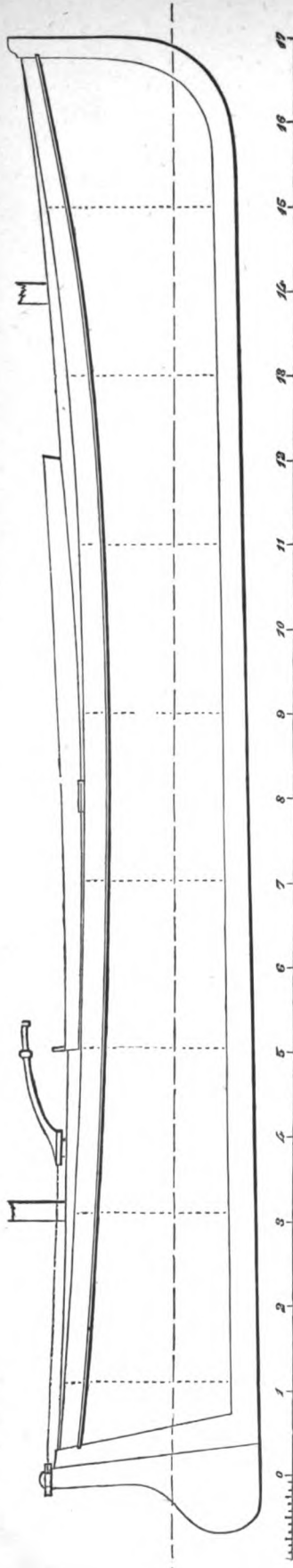

SCALE $\frac{1}{4}$ IN. TO 1 FOOT.

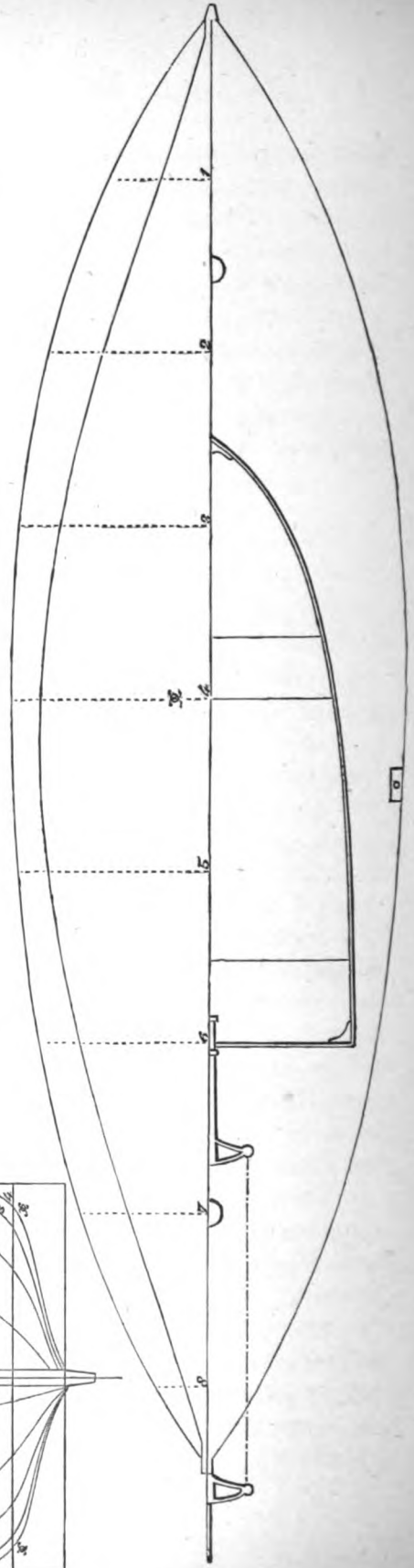
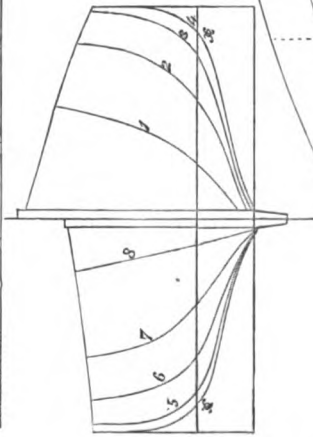

which a bolt with collar passes, and is secured with nut and washer underneath. On the upper part of the bolt, above the collar, the yoke and tiller (all in one) are shipped on the bolt, and kept from unshipping by a pin. In case the tiller and yoke be of wood, a brass socket is fitted in the hole to prevent the collar of the boat wearing away the wood.

Generally about 1cwt. of ballast is carried, in flat lead or iron bricks. The boats carry three passengers; two sitting aft on the stern sheets, and one on the fore seat.

The rig, it will be seen, is the main and mizen; and in strong winds, with small mainsail and small storm mizen, they sail fast, and are dry.

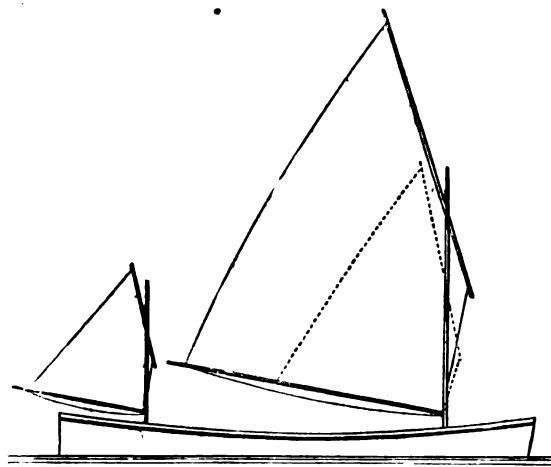

FIG. 179.

As they are decked in, these little boats may be seen out in all weather, and are considered as dry and safe as the New Brighton boats; but, of course, could not compete with them.

In form the boats are comparatively full forward, and have a long clean after-body; compared with the usual run of sailing boats, they are longer in proportion to their breadth, but if cut off at No. 7 section they would not much differ from the ordinary sailing boat.

The 4in. keel is found quite sufficient, in the way of dead wood, to check lee-way; but, with a comparatively small sail area (only 100 square feet), such boats could hardly be expected to compete with the beamy Surbiton craft.

The main and mizen rig is found to answer well, and the boats stay well under it in smooth water. In rough water they require to be handled with more care in tacking; and if a boat seems likely to miss stays, the rowlock is close by the helmsman, and he can help her round with a stroke of an oar. However, generally they are backed round by hauling

the foot of the mainsail to windward if they hang in stays; but the oar, if used, has this advantage—it keeps the boat going.

	ft.	in.
Mainsail, foot.....	10	0
Mainsail, head	10	0
Mainsail, luff	5	0
Mainsail, leech	14	6
Mainsail, tack to peak earing.....	14	8
Mainsail, clew to weather earing	10	9
Small mainsail, foot	6	6
Small mainsail, head.....	7	6
Small mainsail, luff	2	6
Small mainsail, tack to peak earing	9	0
Small mainsail, clew to weather earing.....	7	0
Mizen, foot.....	4	6
Mizen, head	2	6
Mizen, luff	2	4
Mizen, leech	6	0
Mizen, tack to peak earing	5	9
Mizen, clew to weather earing	4	9

It will be seen that the sails are not laced. The boom is fitted with goose-neck or jaws to the mast, and the tack is bowsed down by a rope which leads through a block on the aft side of mast on the deck.

The builder of the Mersey canoes is Mr. Samuel Bond, Mersey-street, Birkenhead. Sailmaker, Mr. J. E. Jarvis, 8, Tabley-street, Liverpool.

A good material for the sails would be “ $\frac{3}{4}$ Bleached Linen Drill,” made by Messrs. Foster, Conner, and Son, Linen Hall, Belfast. This material has been used by Mr. Arthur Hill Coates, of Bangor, Belfast Lough, for the balance lug of a centre-board gig with excellent results.

The Mersey tent is recommended for its lightness and portability. The strength is adjusted to meet all strains, and in roughest weather, on an exposed coast, they have been snug and safe. The material is not waterproofed, as waterproofing adds considerably to the weight. On the other hand, if the tent is not waterproofed, it takes a considerable time to dry after rain or heavy dew if no opportunity exists for drying it. The gable form of the roof has a sufficient angle to shed the water; there is never any drip; but then no seam in the roof is allowed, and this is an important point. When planning a tent for extreme portability, floor space is of more value than standing height. These gable tents are about 7ft. square, and 4ft. 6in. high to the ridge—ample height for sitting in; these dimensions make a roomy tent for two men and their luggage, and the space is not too small for three men. The weight of tent, with poles, pegs, and ropes, is under 12lb.; this does not include waterproof floor sheet, which may be either of macintosh or oiled grey sheeting; the latter is less expensive, but is more difficult to procure in a short time, because of the slow drying of the oil. Mr. Samuel Bond can give all further particulars as to costs, &c., of the tent.

SLEEPING HAMMOCK.

The annexed sketch (Fig. 181) will show the method of providing head and feet room in a hammock, invented by Mr. T. H. Holding, which can be slung inside a 6ft. tent.

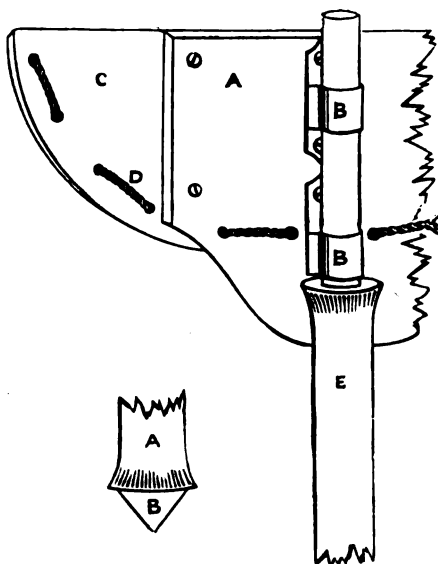

Fig. 180.

Fig. 181.

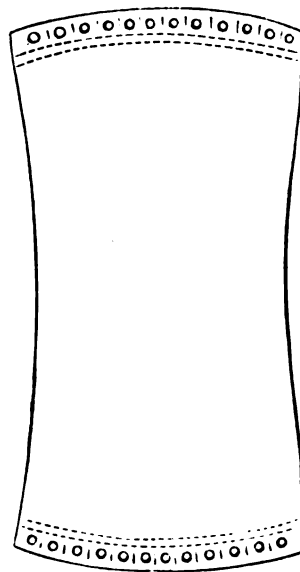

Fig. 182.

- A. Stiffener, $\frac{3}{4}$ in. elm.
- B B. Brass slots, or eyes, for head of rests to fit into.
- C. Spreaders, $\frac{3}{4}$ in. elm, 9in. across, and 5in. deep.
- D. Cord running through eyelets in hammock sheet.
- E. Hammock rests, from 28in. to 30in. long.

The stiffener (A) is made of elm because of its toughness and proof against splitting. The bottom is run down to rest against the rest proper, which is planed flat on the inner side on purpose to fit close to the stiffener. This takes a portion of the strain off the top eyes.

The eyes (B) are an inch inside their ring, and have seven holes top and bottom. An important point in fitting these on is that the screws should go clean through stiffener and spit elm, as well as the metal itself.

The spreader, C, requires twelve holes, through which the cord—a stout one, by the bye—is rove, to lace the canvas or hammock close up. These cords should be either rove in a hem of the hammock or be sewn strongly to the hem of the same.

The rests, or props, may be 28in. or 30in., or even 33in. long. Their length depends on taste purely.

The hammock (Fig. 182) should be cut much the shape of this sketch. It will be observed that the ends are oval, and the sides hollowed. If, by way of experiment, you hang up a straight-ended and straight-sided sheet, and then get into it, you will observe that all your weight is thrown on the middle of the canvas, or lower eyelets, whilst the sides will be quite loose. To obviate this is to lengthen the centre or shorten the sides. This should be done in three ways: (a) Hollow the sides, and put cords in tight; (b) shorten the ends at edges, and (c) lengthen the centre. The dotted lines in side eyelets are supposed to represent two plies or thicknesses of canvas, one reaching farther into the piece than the other. A hem must not be left, because, owing to the shape of the ends when turned back, it would not fit, and would not be so strong as pieces sewn on. The eyelets should be brass, $\frac{1}{4}$ in. or $\frac{3}{8}$ in., the same as sailmakers use. The material does not need to be so heavy as some might suppose. All linen is strong, and a good stout, unbleached linen sheeting has held me many a night, and, when testing it, two children besides, without giving signs of collapsing.

The slinging process is as follows: In Fig. 180 is shown the foot of rest. These rests are best turned in a lathe. The foot flanges out broader to prevent sinking when the sleeper's weight is on it. Should the rest girth, the consequences to the tent might be serious. Presumably you have fixed up your tent without a wrinkle. When it was made you had two horizontal slits an inch and a half long cut through the two edges where they overlap at each end of the tent, stoutly bound with linen tape, and a piece of canvas was sewn on at that particular place to give greater strength. These slits are just as far from the bottom as the hammock rests are long—32in. Take the head rest, and place it close beside the tent pole; then press it well down so that B is buried in the sod. Slip the ring or thimble (of brass), round which the guy lines are permanently rove, over the top of the rest, and then do the foot rest the same. You drove in the four pegs when you fixed up the tent itself. Now go out and bind each cord or guy tight round its respective peg; in fact, so tight that the rests cause the tent ends to bulge outwards somewhat. Now you return inside and cook your tea-supper, and have no absolute need to go out again. Bedtime comes. You take the hammock in your hand, lift the brass thimble (*i.e.*, double end or angle of guy lines) off the top of rest, and slip the brass eyes of stretchers over rest head, then place guy thimble over these. The foot or outer end is done of course the same. Now test it by your full

weight; it gives a little. Test it again; it is firm, and gives no more. Go outside and brace up to tightest pitch.

For pillow, any spare dry garments rolled up will do quite well. Your bed clothes, *i.e.*, *sleeping bag*, is an important item.

If the rests sink much, the cord would press on the slits of the tent ends, and, as something must give to your weight, an inconvenient rent would result, either at ridge pole or down the ends.

A, Fig. 180, represents the foot of rest, and B the blunt inverted cone shape of the ends which go into the ground.

Why the spreader and stiffener are in two pieces is to give greater strength and lightness. A piece of tubing planed the full size would not stand the strain. The screws must go clean through both planks. It will be seen that six stout screws in each end, or twelve in all, are ample to bear the weight of any ordinary man without risk.

AMERICAN CANOES.

The first canoes used in the States were Rob Roys, and No. 3 Nautilus, imported from England, about 1870, and from them many others were built, differing more or less, but without any essential modifications. The rigs used were either sliding Gunter, small standing lug, or two leg-of-mutton sails (the sharpie rig), the areas being but small. Many still hold that no paddle should exceed 7ft. in length, and that a beam of 28in. is all that can be paddled easily. Up to 1880 many long voyages had been made by individuals; but only one or two clubs were in existence, and there was no union among canoeists, and no attention had been given to the development of racing craft. In the winter of 1879-80 the establishment of the Canoe Association gave a new impetus to the sport, as it brought new boats from all parts of the country, and a general interchange of ideas being very noticeable at the next meeting in 1881.

Centre-boards of various styles are coming into vogue, some using a dagger board (Fig. 183), some wood, and some of over 60lb. in iron. The trunk is very small, and, if the board be not too heavy, it is easily lifted out and laid in the boat. To accommodate these boards the A.C.A. rules say nothing about centre-boards being "completely housed within the canoe."

The balance lug is very generally used for the larger boats, and the lateen for the smaller ones, as shown in Fig. 184. This sail only has one rope, the sheet, and is set as follows: A spike is fixed in the

top of the mast, and a ring is lashed to the yard. Holding on to the yard at the peak end, this ring is hooked on to the spike in the mast-head, the end of the yard is let go, and the boom is drawn aft (which

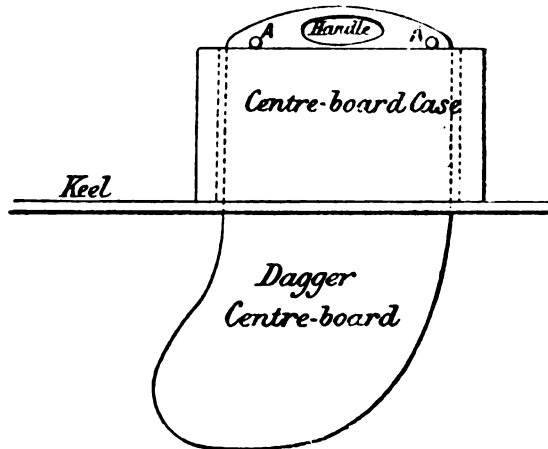

A.A. Stops to prevent the plate dropping too far.

FIG. 183.

raises the peak), until the crutch or jaw, about one foot from its fore end, can be made to encircle the mast, the weight of the boom and the pressure on the sheet keeping all in position.

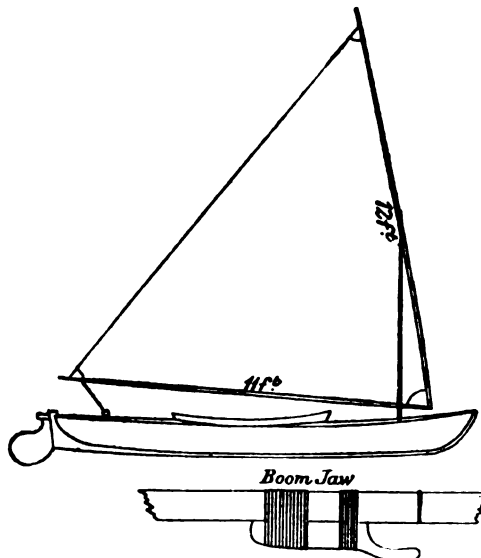

FIG. 184.

The paddling and sailing canoe Jersey Blue (Plate LX.) was designed and built by Mr. W. P. Stephens, of New York, and fairly represents the

type of canoe hitherto popular in America: Length, 14ft.; beam, 30in.; depth amidships, 10in.; sheer forward, 6in.; aft, 4in.; mainmast, from bow, 2ft. 6in.; mizen from bow, 11ft. 6in.; the mizen is only used when

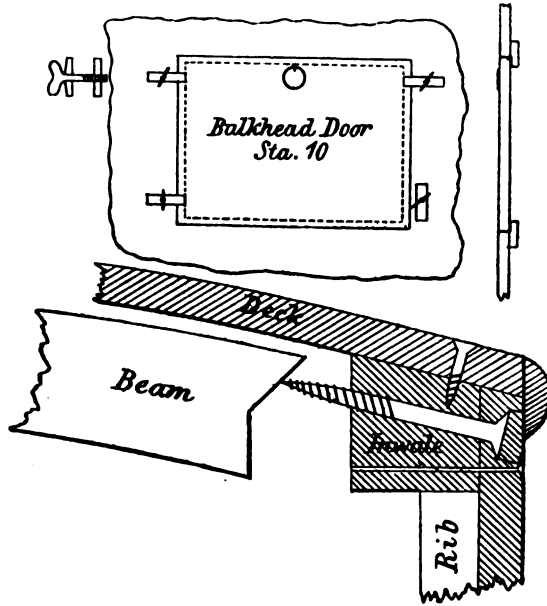

FIG. 185.

the canoe is rigged with two lugs or two leg-of-mutton sails, but not with the lateen. Fore bulkhead, 3ft. 5in.; fore end of well, 5ft.; slide bulkhead, 8ft. 6in.; after end of well and bulkhead, 10ft.; door in after

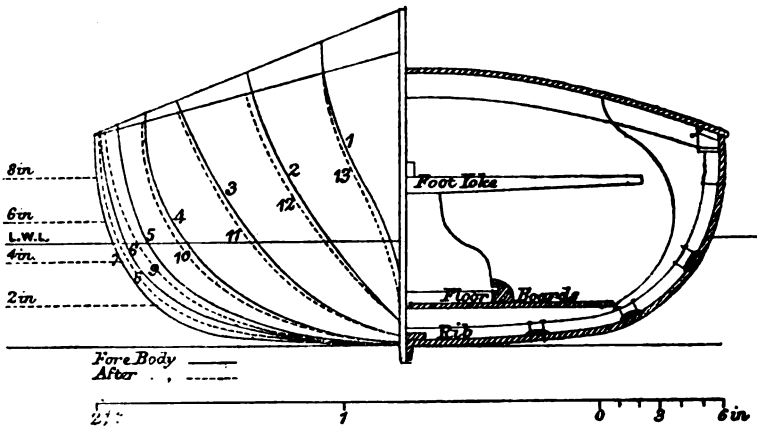

FIG. 186.

bulkhead, 11in. by 8½in. (Fig. 185). Stem, stern, and keel sided, ¾in.; keel, 1¼in. deep, ¾in. wide on lower edge; keelson, 2in. wide by ¼in. deep amidships. Thickness of planking, ¼in.; build, ribband-carvel; ribbands, 1½in.

wide, $\frac{1}{4}$ in. thick, rounded on inside to $\frac{1}{8}$ in. on edge. Timbers, sided, $\frac{3}{8}$ in.; moulded, $\frac{1}{2}$ in. at keel and $\frac{3}{8}$ in. at head. Footboards, $\frac{1}{4}$ in.; inwales, lin. by $\frac{3}{4}$ in. amidships, and lin. by $\frac{5}{8}$ in. at ends. Deck beam, $\frac{1}{2}$ in. by lin.; knees, sided, $\frac{1}{2}$ in. Inner coaming, $1\frac{1}{4}$ in. deep by $\frac{3}{8}$ in. thick. Stem and stern of hackmatac, natural crook; keel and keelson, white oak. Planking, white cedar, with upper streak and deck of Spanish cedar; ribbands of ash or oak, morticed into stem and stern posts, and screwed fast; timbers are spaced 9in., and are jogged over the ribbands. Fastenings on stem and stern posts, $\frac{3}{8}$ in. brass screws, along keel copper nails and burrs, along other seams copper tacks through plank and ribband, with points clinched, spaced four between each timber. Copper nails at each timber through plank, ribband, and timber, at each edge of plank, and a nail is driven through the centre of each plank at every timber.

The rudder wires run in brass tubes below deck, entering at station 12 just below inwale. The foot-steering gear is arranged to slide back and forth, and is secured by a short line made fast to an eye-bolt. The circular aperture in floor boards near fore end of well is for the sponge.

TABLE OF OFFSETS FOR CRUISING CANOE, "JERSEY BLUE." (PLATE LX.)

No. of Section	0	1	2	3	4	5	6	Mid. 7	8	9	10	11	12	13	14
Depth at gunwale	16	14 $\frac{1}{2}$	13	11 $\frac{3}{4}$	11	10 $\frac{1}{2}$	10	10	10	10 $\frac{1}{2}$	10 $\frac{1}{2}$	11 $\frac{1}{2}$	12	13	14
Half-breadths at gunwale	—	4 $\frac{1}{2}$	8	11	13	14 $\frac{1}{2}$	14 $\frac{1}{2}$	15	14 $\frac{1}{2}$	14 $\frac{1}{2}$	12 $\frac{3}{4}$	10 $\frac{3}{4}$	8	4 $\frac{3}{4}$	—
Half-breadths at 8in. from line A B ...	—	2 $\frac{1}{2}$	6 $\frac{1}{2}$	9 $\frac{1}{2}$	12 $\frac{1}{2}$	14 $\frac{1}{2}$	14 $\frac{1}{2}$	15	14 $\frac{1}{2}$	14 $\frac{1}{2}$	12 $\frac{3}{4}$	9 $\frac{1}{2}$	6 $\frac{3}{4}$	2 $\frac{1}{2}$	—
Half-breadths at 6in. from line A B ...	—	1 $\frac{1}{2}$	4 $\frac{3}{4}$	8 $\frac{3}{4}$	11 $\frac{1}{2}$	13 $\frac{1}{2}$	14 $\frac{1}{2}$	14 $\frac{1}{2}$	14 $\frac{1}{2}$	13 $\frac{3}{8}$	12	8 $\frac{3}{4}$	5	2	—
Half-breadths at 4in. from line A B ...	—	0 $\frac{3}{4}$	3 $\frac{1}{2}$	6 $\frac{3}{4}$	10	12	13 $\frac{1}{2}$	13 $\frac{1}{2}$	13 $\frac{3}{8}$	12 $\frac{3}{8}$	10 $\frac{1}{2}$	7	3 $\frac{3}{8}$	1 $\frac{1}{2}$	—
Half-breadths at 2in. from line A B ...	—	—	1 $\frac{1}{2}$	4 $\frac{3}{8}$	7 $\frac{1}{2}$	10 $\frac{1}{2}$	11 $\frac{1}{2}$	12	11 $\frac{3}{8}$	10 $\frac{3}{8}$	8	4 $\frac{3}{8}$	1 $\frac{1}{2}$	0 $\frac{1}{2}$	—

All heights are measured from line A B at bottom of garboards amidships.

The level lines are 2in. apart.

The sections are 1ft. apart, counting from the stern.

The dimensions in laying-off table are all to outside of skin; for which $\frac{1}{4}$ in. allowance must be made in cutting the moulds.

AMERICAN RIVER CANOE. (PLATE LXI.)

This canoe was designed by Mr. W. P. Stephens for use in narrow and shallow rivers, and among dams, rapids, log jams, &c.

As many canoeists who prefer a small boat, will at the same time, carry a great weight of stores, &c., the displacement has been made as large as consistent with the dimensions, viz., 14ft. by 27in., the full lines resembling the model of open canoe so popular in Canada. To secure control of the canoe under paddle only, the keel is well rockered and ends cut away. The outside keel is dispensed with, saving an inch in draft. A

PLATE LX.

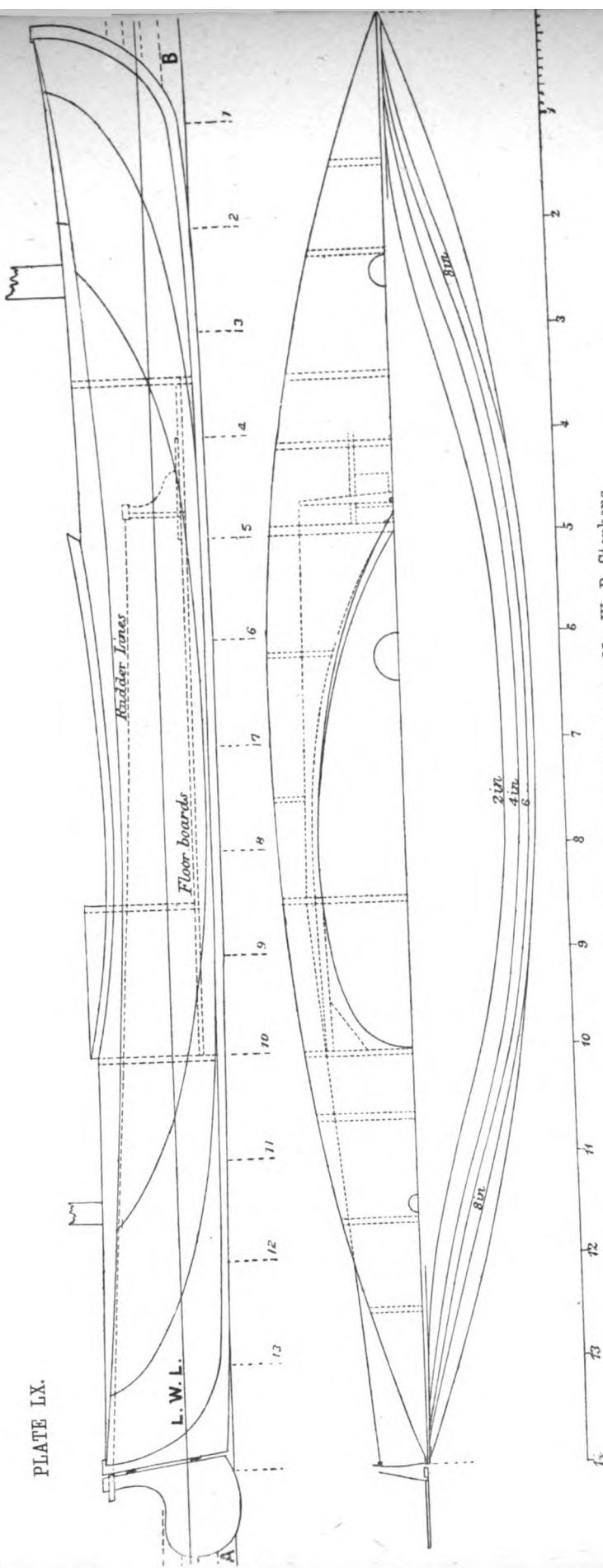

American Canoe "Jersey Blue." Designed by Mr. W. P. Stephens.



projecting keel is a disadvantage in running rapids, or in dragging over obstacles, and the wide oak keel with bilge keels will fully protect the bottom. The rig shown (Plate LXII.) is known as the "Cincinnati Lateen," It came into favour lately for small canoes, the chief advantage being its simplicity and freedom from extra gear; but the long boom, together with the necessity of luffing to take in sail, and the impossibility of reefing

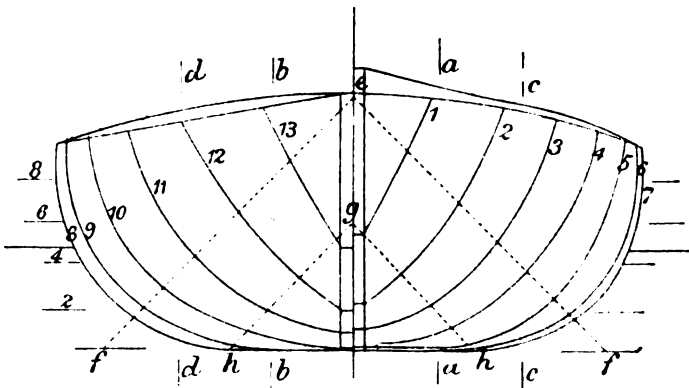

FIG. 187.

snugly and quickly, are disadvantages in most waters. For cruising, two sails are carried, the mainsail being sometimes used alone in the second tube. For racing, one large sail is preferred, running up as high as 60ft. area. The centre-board is known as a dagger board (Fig. 183), and may be of wood or sheet iron. When not in use it is shifted entirely out and laid on

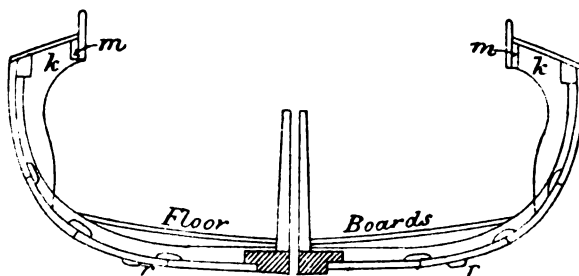

FIG. 188.

the floor. If sleeping room is required for a taller man, the trunk may be shifted forward. It is often desirable to cover the well entirely in shipping, for which purpose, in this boat, a section of the floor boards is made so as to be taken out and locked over the space between fore and aft hatches. The apron used is similar to that described for Nautilus or Pearl. Paddle, jointed in centre, 8ft. long.

LAYING-OFF TABLE. (PLATE LXI.)

Sections	1	2	3	4	5	6	7	8	9	10	11	12	13	14
	ins.	ins.	ins.	ins.	ins.	ins.	ins.	ins.	ins.	ins.	ins.	ins.	ins.	ins.
Depth at Gunwale	12	11 ⁵ / ₁₆	10 ⁹ / ₁₆	10 ¹ / ₂	9 ³ / ₄	9 ¹ / ₂	9 ¹ / ₂	9 ¹ / ₂	9 ¹ / ₂	9 ¹ / ₂	9 ¹ / ₂	9 ¹ / ₂	10 ¹ / ₄	10 ¹ / ₄
Half-breaths on deck	3 ³ / ₄	7 ¹ / ₂	9 ¹ / ₁₆	11 ¹ / ₂	12 ¹ / ₄	12 ¹ / ₄	12 ¹ / ₄	12 ¹ / ₄	12 ¹ / ₄	12 ¹ / ₄	12 ¹ / ₄	10 ⁹ / ₁₆	8	4 ³ / ₈
Half-breadths, 6in.	—	4 ¹ / ₁₆	7 ³ / ₁₆	9 ¹ / ₁₆	11 ⁹ / ₁₆	12 ³ / ₈	12 ⁹ / ₁₆	12 ⁹ / ₁₆	12 ⁹ / ₁₆	12 ⁹ / ₁₆	11 ¹ / ₁₆	8 ¹ / ₁₆	4 ¹ / ₁₆	1
Half-breadths, 4in.	—	2 ¹ / ₂	5 ³ / ₈	8 ³ / ₁₆	10 ⁹ / ₁₆	11 ³ / ₈	12 ¹ / ₁₆	11 ¹ / ₂	11 ¹ / ₂	9 ⁵ / ₁₆	6 ¹ / ₁₆	2 ¹ / ₈	—	—
Half-breadths, 2in.	—	—	2 ³ / ₄	6 ⁵ / ₁₆	8 ⁹ / ₁₆	10 ³ / ₁₆	10 ³ / ₈	10 ³ / ₈	9 ¹ / ₂	7 ¹ / ₄	3 ³ / ₈	—	—	—

Length, 14ft.; beam, 27in.; depth midships, 9¹/₂in.; sheer at bow 3¹/₄in., stern 2¹/₂in.; rocker of-keel, 1¹/₂in.

Depths given are from upper edge of gunwale to base line, excluding ¹/₄in. deck.

Half-breadths are from centre line to inside of planking.

Midship mould is made ¹/₂in. under width to allow for spreading.

Stem and stern sided ¹/₂in. Keel sided, mid. at rabbet, 3in.; moulded, ¹/₂in. Planking, five streaks on a side, ¹/₂in. Ribbands, 1¹/₂in. by ³/₁₆in. Timbers sided, ³/₈in.; moulded, ¹/₂in. at heels, and ¹/₂in. (spaced 8in.) at heads, all bent. Gunwales, ¹/₂in. by and ¹/₂in. Deck, ¹/₂in. thick. Bulkheads, ³/₈in.; bulkhead timbers, ¹/₂in. by ¹/₂in., bent. Side pieces to well, ¹/₂in. by 1in. Sides of trunk, ¹/₂in. Floors, 1in. deep at centre (spaced 8in.) by ¹/₂in. thick; floor boards, ¹/₂in. thick.

Water-lines, 2in. apart. Sections, 1ft. apart from fore side of stem.

a b and *c d*, buttock lines; *e f* and *g h*, diagonal lines; *k k*, side knees; *l l l*, deck beams, 1¹/₂in. by ¹/₂in.; *m m*, side pieces of well, to which, with knees *n n*, the coaming is secured; *o o*, head ledges of trunk; *r r*, bilge keels. (Plate LXI. and Figs. 187 and 188.)

	ft.	in.
Foreside of stem to mast tubes	(2 0
Foreside of stem to after mast tubes	(3 7
Fore bulkhead		10 7 ¹ / ₂
Shifting bulkhead		3 6
After bulkhead		9 0
Fore end of well		10 6
After end of well		5 0
Fore end of slot		10 6
After end of slot		5 11 ¹ / ₂
		7 0

THE MANAGEMENT OF CANOES.

Sail can be carried in almost any breeze so long as the water keeps moderately smooth, but beware of sailing a *light* canoe in really rough water. "Big seas" are not here referred to; these will be referred to hereafter. Rough water throws a light canoe about in sudden and unavoidable jerks, and a puff into the sails at a wrong moment, or perhaps a lump of water, may just give the canoe a finishing touch to a capsized; at the best her pace will be slow, and her working uncertain under sail, as soon as the water gets a rise of a couple of feet or more; then out with the paddle and in with the mainsail; the mizen, however, may be of use if paddling to windward.

With regard to heavy seas, the canoeist should bear in mind that there is a great difference between a "sea" and a "swell." With a fresh breeze "white horses" begin to show on a comparatively smooth

PLAT.

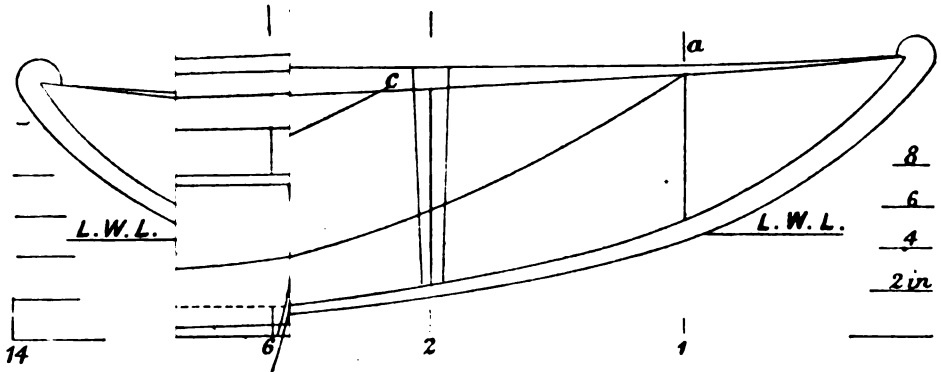

8
6
4
2 in

AMERICA

Designe

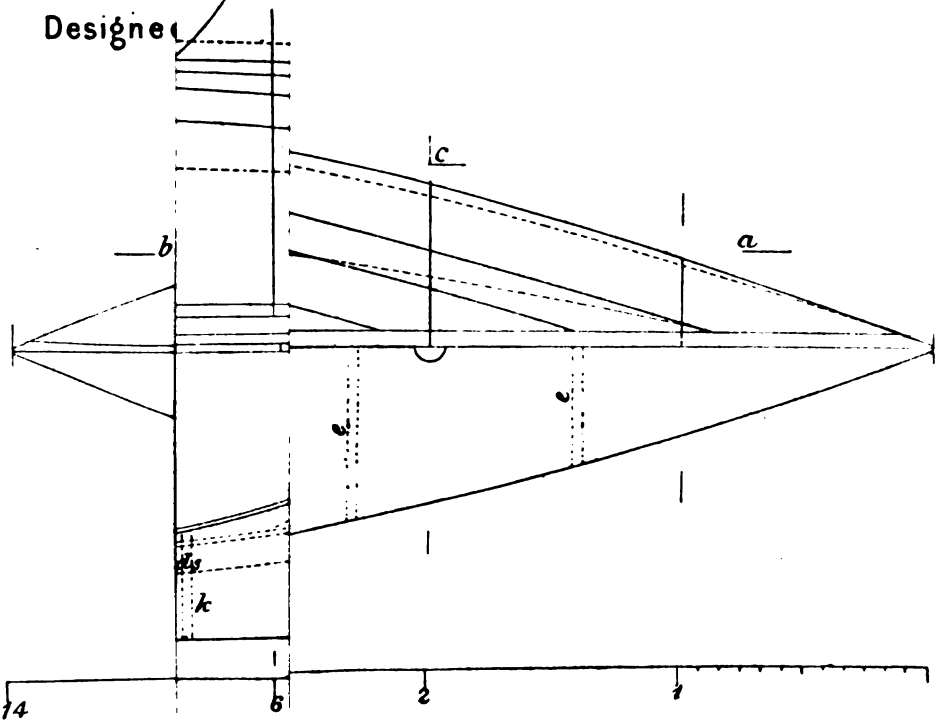

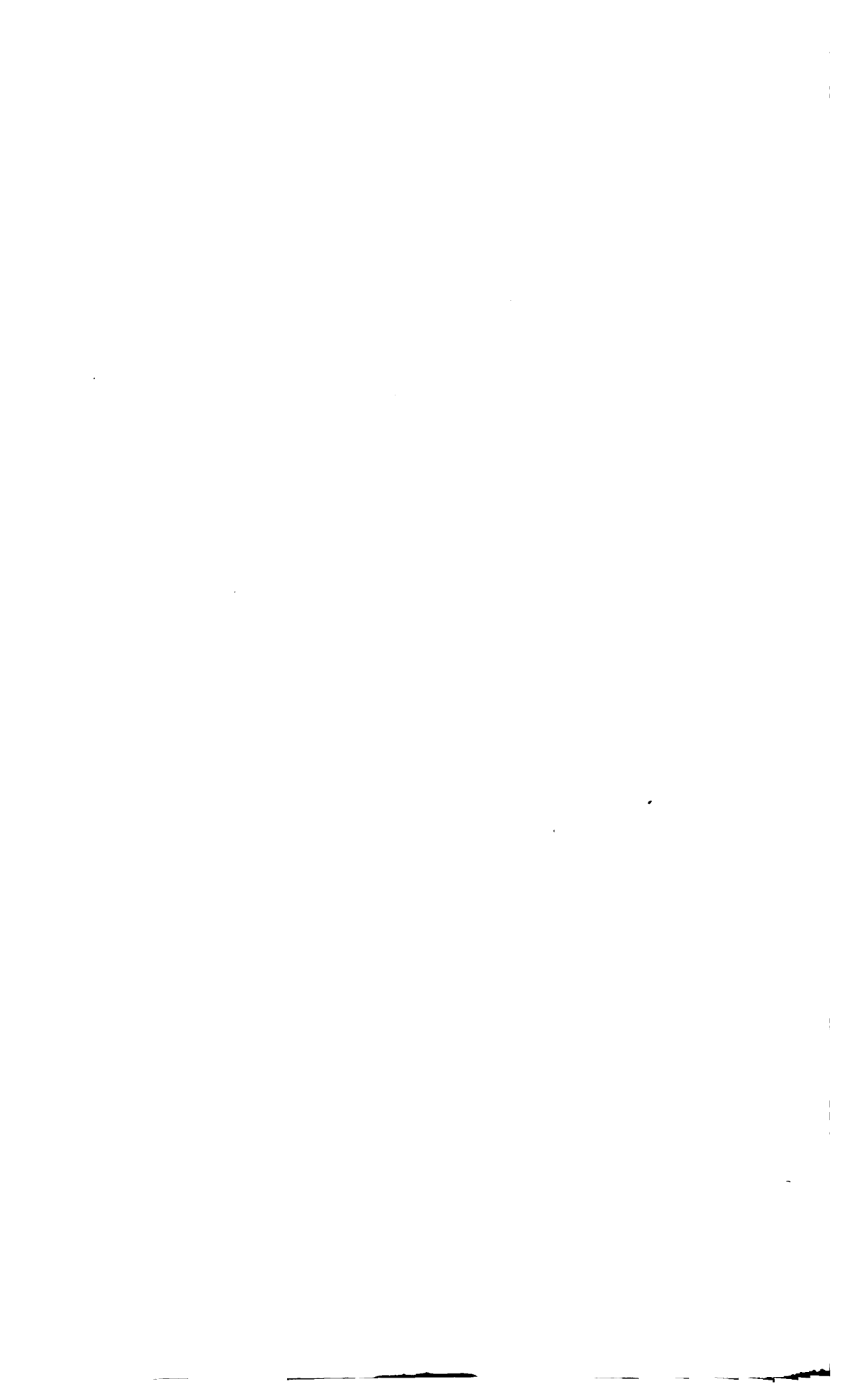
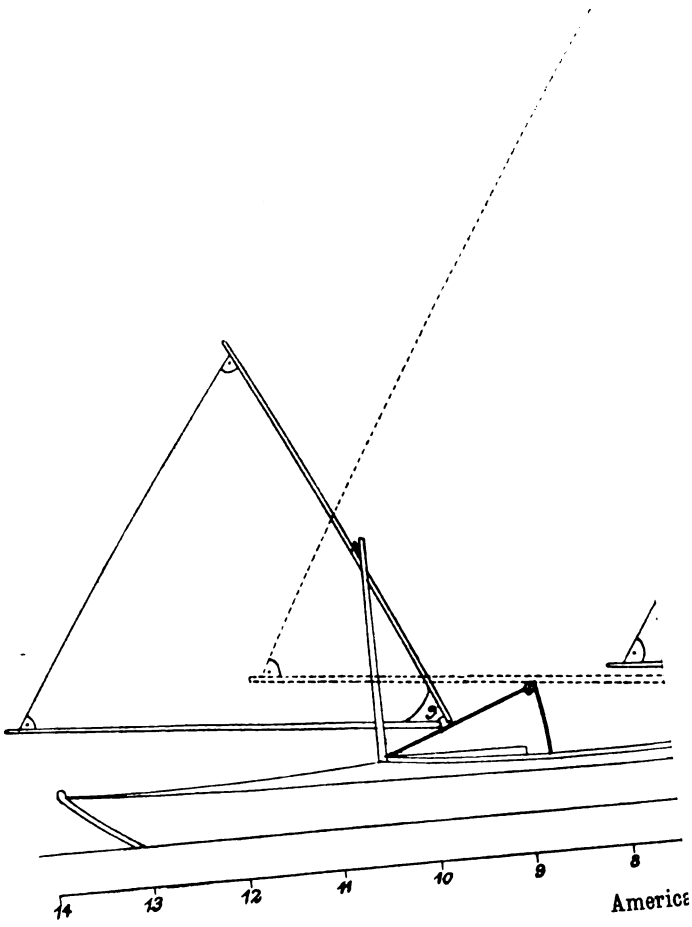

PLATE LXII.





sea, but if there is at the same time a steep swell on, then the ruffled swells appear somewhat in the form of "huge seas." Canoes and boats can easily, with fair management, live in such water, and have often done so, hence the stories of sails being becalmed in the hollows between the waves, &c. But a "sea" is a vastly different thing to look at and to put a boat at; a broken sea not only has way on, but generally has weight on in its angry top, which, if not cleverly negotiated, would crush a canoe up like a steam roller going over an egg shell. It is not often that a canoe is worked in a "high" sea; but what is not uncommon is for a canoe to be caught out away from port and get into a nasty sea, a savage sea, before she can get into shelter. For an old hand to work safely through it is merely a question of whether he possesses the requisite amount, in equal parts, of pluck and caution, and sufficient physical strength to avoid a collapse from exhaustion. He knows from practice how best to handle his craft as the various forms of water approach him; he knows, too, when to carry on and when to ease her, and how to put her at a hollow breaker. But to the man who is not an old hand at the work, such work is no mere inconvenience; it soon becomes a struggle for life, and a flurried twitching of the rudder and a dip or two of the paddle the wrong way may end that struggle in a few short moments.

There are one or two short maxims on which the handling of a canoe in a sea are founded, and, being very simple, they can easily be called to mind by beginners when trying their craft against a "steamer's swell." Unless in a well-ballasted sailing canoe, never keep sail on when the seas begin to break and come aboard, because by the time they get to breaking aboard you will probably be unable to get the sails in, and a sea into the sail might be a finisher; or, if you have to leave your seat to get hold of the sail, a sea is pretty sure just to board the canoe, and, once waterlogged, it is hard work for even a practised hand to get rid of the water. Never allow the canoe for one moment, except of course in the act of turning, to be broadside on to the sea; it may be all very well in a little popple or tide overfall to treat the crests with indifference, and let them "break across the deck;" but if you intend a safe return to land don't try any such duck-pond pranks with a heavy sea. To work safely through really heavy water a zig-zag course *must* be steered; the seas should, when possible, be dodged; but where it becomes necessary to "take" a sea put her at it nearly end on, with plenty of way on (the weight in the boat rather forward than aft); then, as soon as she passes the head of the sea, drop her down sideways on the back of it; if, on the contrary, you

attempted to let it break athwartship over the deck, you would probably find yourself suddenly caught up and hurled broadside along before the sea for a few moments, then a thundering roar, a cold weight of water all over you, crackling of planks, a greenish glimmer, and a want of air would proclaim to you that somehow your canoe, or the wreck of it, was above you instead of under you.

When about to reef in rough water do not put the canoe end on to the sea; on the contrary, keep some way on her; lower away the halyards, and haul the boom in, and with the reefing gear little or no difficulty will be found; reef the mainsail first, then shift the mizen, and so be prepared to shift mainsail if necessary.

When running before a sea keep the weight aft in the canoe by removing the backboard beam and lying down, haul down the mizen, and when a breaker is coming along stop the canoe's way by back strokes with the paddle, else she may be overended or broached to. If the canoe runs her bow under a sea, let go the halyards promptly, and ease down the sail till the bow lifts again. In running for shore, before getting into the breakers, turn her round head upon sea, and back in when in the smooths, and paddle ahead to meet each heavy breaking sea.

The paddle should always be ready for use in a sea way, and the most useful mode is to have the ordinary double-bladed paddle jointed in the middle, and a piece of bamboo 3ft. long, brass tipped, fitted to join into the ferrule, and so make a long-handled single paddle as a help to steering and working in a sea way.

Never go to sea, even for an hour's sail, without a compass; fogs turn up even in the summer. Before going on a long cruise test all fittings and gear carefully, and certainly have an experimental capsizing to test, above mere calculation, that the air bag and compartment are sufficient to support canoe and skipper when swamped; after the canoe is righted practice getting on board by striding the bow or stern, or over her side amidships; *finally, have a life-belt on whenever there is risk of an upset.*

The following instructions for getting into a canoe after an upset were written by Mr. Tredwen: "In a paddling canoe with bulkheads nothing is easier than to get in over the side. The canoe being righted, the hands should be placed one on each gunwale or coaming; the elbow of the arm whose hand is on the offside should be thrown up; and the vault is accomplished very much like a tyro at gymnastics rushes through his 'slow rise' on the horizontal bar. If the canoe has a great deal of water in her, and there is any popple on, the near-side hand should grasp the paddle and hold it across the canoe (at right angle to the length of the canoe), with blades flat on the surface of the water, the hand

being as close as possible to the near-side coaming. I have for several years used a Rob Roy canoe, with side lockers to the well, and with movable doors from the coamings to the bilge keels, so that the canoe always empties herself in righting. When a sailing canoe capsizes, her crew should immediately endeavour to clamber *over*, instead of diving under her, and thus avoiding the risk of getting 'netted' by the loose lines. He should then hang on the canoe like a reefer on the topsail yard, cast off the halyard, and get in on the downhaul, so as to gather the sail in towards the deck. The canoe, being then no longer pinned down by the weight of water on the outspread sail, begins to right; he keeps on top of the revolving hull, and gets into the well when that comes uppermost, and bales out. It is presupposed that the halyard and downhaul are both led to eyebolts on deck, placed within reach of amidships, so that the crew always know where to get the ends, even when they are under water, and the baler and sponge are secured by lanyards so as not to get lost overboard."

CHAPTER XXX.

AMATEUR CANOE BUILDING.

(IN AMERICA.)

THE first point in constructing a boat that must be at once very light and strong, is the selection of proper woods for the different parts. Those generally employed (in America) are, for keel, kelson, and timbers, white oak; bow and stern, hackmatack; knees ditto; ribbands of ash or oak; planking of white cedar; upper streak and deck of Spanish cedar or mahogany, teak being practically unknown. In selecting the oak for keel, &c., the end grain of the wood should be examined, and each piece cut so that the nails will pass *through* the layers of growth (*a*, Fig. B, Plate LXIII.), instead of between them, as in *b*.

Figs. A, B, C, and E show the dimensions and the proper direction of the grain in the keel and kelson, ribs and ribbands. The grain in the bow and stern pieces should run about parallel to the rabbet, as cross-grain will split in time. White cedar varies greatly in quality, that with many knots usually being harder and stronger than the clearer southern cedar.

To support the boat while building, a plank is fastened to trestles, with its upper edge (which is cut to the same curve as the rocker of keel) about 2ft. from the floor, and on this the keel is placed. If many boats are to be built, however, the following plan is much better, as the keel is more accessible; the moulds and frame may be set up much more quickly and accurately, with little chance of shifting, and a convenient place is always at hand for tools, &c.

A bench or table (Figs. G, H, and K) is built, with the top, which must be perfectly level, about 27in. from the floor for canoe work. The length is 13ft.; width at centre, 2ft. 6in.; at ends, 1ft. A centre line is drawn, and also transverse lines 2ft. apart, each representing the position of a mould, of which there are six in a 14ft. canoe, while fewer are often used; the work can be done more quickly and accurately, and the labour of making the extra moulds is but little if the canoe is properly laid down.



PLATE LXIII.

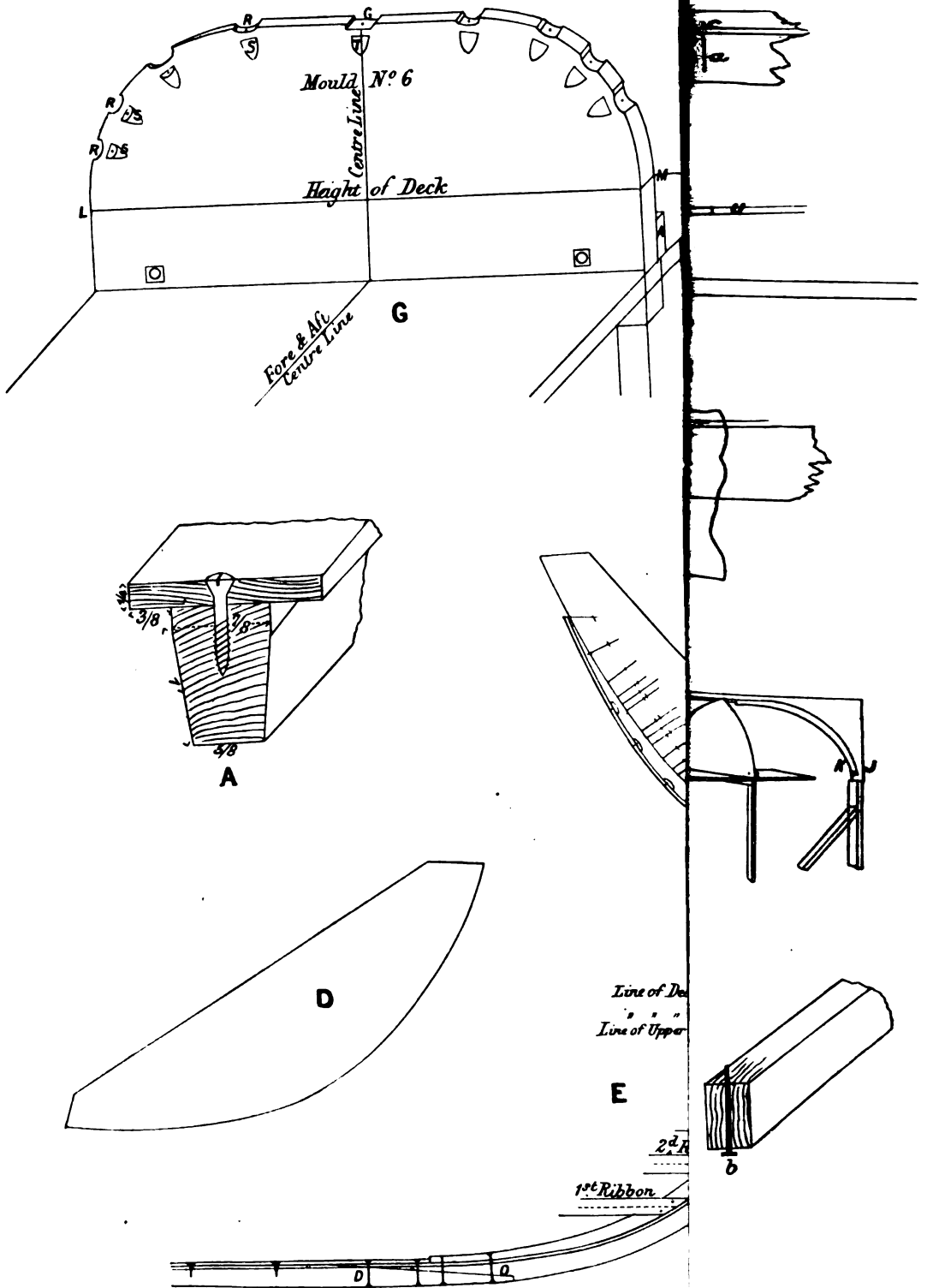

Strips of wood $1\frac{1}{2}$ in. by 1in. are nailed across the table at each mark (*a*, Figs. G, H, and K), the moulds being fastened to them by screw bolts. The dimensions and model being decided on, a drawing is made full size of the canoe, the common brown "detail paper" being used, stretched on a floor or wide board. This drawing should show the moulds, rabbet lines, bulkheads, &c., and should be carefully faired. From it a "rabbet mould" (Fig. D) is made for the stem, and, if necessary, one for the stern, fitting the lines E F and D C (Figs. E and F); also the building moulds (Fig. G), which are best cut out of one wide board, unless the boat is very large, when they may be built up of several pieces. A line is drawn in the sheer and body plans parallel to the base line, representing the height of the building table, and consequently the straight edge of each mould, and crossing the bow and stern at H I and J K (Figs. F, H, and K). As each mould is cut out it is adjusted to this line, the height of the deck L M (Fig. G) marked on it, and a centre line drawn; then, the notch at G for the keelson being cut, and holes bored for the bolts, it is set in place.

The stem, sternpost, and keel are sided $\frac{3}{4}$ in., tapering to $\frac{1}{2}$ in. on fore edge and $\frac{3}{4}$ in. on bottom of keel, and the keelson, or "keel batten" is $1\frac{1}{2}$ in. by $\frac{1}{2}$ in. Scarphs are made at D O and F P (Figs. E and F), and all are fastened together with copper nails and burrs, or brass screws, the latter being also used to fasten keelson to keel.

The rabbets of stem and stern are next marked out, using the rabbet mould (Fig. D) and partly cut, leaving some wood for trimming down after the ribbands are on and the exact bevel determined. The rabbet lines must be in exactly the same positions on each side of the frame or the garboards will not fit both sides, and at least $\frac{3}{4}$ in. of dead wood should be left inside of rabbet to screw the plank to. The frame is next laid in place on the drawing, tested as to length and the positions of bulkheads, timbers, moulds, mast steps, &c., marked both on *top* and *bottom* of keel, also the lines H I and J K drawn on stem and stern, then it is placed on the moulds, adjusted, and fastened temporarily.

No definite rule can be given for the laying of the planks, as the number and widths vary with the form of the boat; for an ordinary canoe five will answer if planked ribband carvel, or six if lapstreak (clinch), the garboard being about 5in. wide at midships for the former. The upper streak will be about $1\frac{1}{2}$ in. wide at bow, $2\frac{1}{2}$ in. at midships, and $1\frac{1}{2}$ in. at stern, and its width will be laid down on the draft and transferred to the moulds. To get the garboards, a ribband, shown in section in Fig. C, $1\frac{1}{2}$ in. by $\frac{1}{2}$ in., rounded on the back, and 14ft. long, the backs being flattened to $\frac{1}{2}$ in. near the ends, where they enter the bow and stern, is tacked to the midship mould, its centre being 5in. from keel;

then the ends are clamped to stem and stern, and it is nailed lightly to the other moulds, being shifted as required, until it bends in a fair and regular curve, then, after marking where it crosses each mould as well as stem and stern, it is removed. The distances between the nearest edges of the garboard and upper streak on each mould, and bow and stern, may now be divided into the same number of equal parts (probably three), which will bring the planks as straight as possible; but if the midship section has a flat floor and straight sides, the planks on the bilges may be made narrower, and the broad and binding streaks proportionately wider, the edges being run in with a ribband, as with the garboard. The frame and moulds are taken down, the joggles cut in the stem and stern to receive the ends of the ribbands, and also those in the moulds (R R, Fig. G; and holes bored in the latter (at S S) for screws to hold the ribbands and keel, then all are set in place again, the moulds bolted fast, the keel screwed fast to them from below (at T), the stem and stern adjusted by the lines H I and J K, and shored from the floor. A batten (U U, Fig. H) is tacked on each side at the height of the deck, and the spacing of the timbers is laid off on it as on the keel; then, as each ribband is screwed on, the positions of the timbers are laid off on it on in and out sides by a strip of wood bent through the marks on keel and batten, so as to insure the nails all coming in vertical lines, and to aid in setting the timbers. So much care in marking off is seldom taken by boat-builders; but amateurs must expect to make up by slower working and more careful measurements for that training of eye that only comes from long practice. Before going farther the frame should be carefully tested, a plumb-line being held on stem and stern, and the keel carefully examined as to the curve or rocker, as any error now cannot be remedied later, but will probably increase.

All being correct, a ribband is screwed on each side (a centre line being first drawn on the flat side of the ribband), the screws passing through the slots in moulds (S) and into the round side of ribband, and the ends are screwed to the stem and stern. A small piece of the planking ($\frac{1}{4}$ in.) is now applied to the face of the ribband and rabbet, and used as a guide to trim the latter to the exact bevel and depth. To get the shape of the garboards, a "staff" (W W, Figs. H and I) is used, of $\frac{1}{4}$ in. board, about 4 in. wide and half the length of the boat. It is cut roughly to the curve of the fore end and clamped inside the rabbet, then laid over the moulds and tacked to them, and also clamped to the ribband. The staff must be handled very carefully, and not forced or sprung in the direction of its width (to or from the keel), but allowed to lay over the mould freely and easily, as the accuracy of the work depends on the way it is placed.

A similar piece is clamped to the stern, overlapping the first, and the two are firmly screwed together. A single piece the length of the boat is frequently used, but two are easier to handle. The staff being in position, a line is drawn on it (*a b*, Fig. H) at the height of garboard seam (centre of first ribband), and a similar line at the stern, also lines over each mould, which are numbered 2, 4, 6, &c, then the lines *c d* are drawn across staff and rabbet about 2in. apart near the ends, and opposite each timber in the middle of the boat. A pair of compasses are set to any distance from 1in. to 3in. and a circle struck with them on the staff to reset them in case the distance is changed, then placing one point on the rabbet at *a* (Fig. H) a mark is made on the line *a b* at *b*, and the operation repeated on each of the other lines, measuring in every case from the rabbet line, where the outer surface of the garboards will intersect the keel or stem to a point on the staff on the same line *c d*. When each point on the rabbet is marked, the staff may be removed and transferred, the board selected for the garboards adjusted and tacked firmly in place (Fig. I). Before removing from the moulds, one line on the stem is selected and marked thus \times , as a guide in placing the garboards. The lines on the staff are now produced on the plank, those over the moulds being again numbered, and the compasses employed to set off the same distance again on each line from the points *d, d, d*, until the outline of the garboard is marked by a line of spots *c', c', c'*. A batten is bent through these spots and a line drawn, the rabbet moulds being used for marking the extreme ends.

The planking may be sawn and planed to thickness before marking out; but the usual mode of working is to use $\frac{3}{4}$ in. board, first sawing and planing the edges to shape, and then slitting by hand into two pieces, which will be $\frac{1}{2}$ in. when planed. In this way both boards must be alike in shape and quality. Now to lay off the other or *upper* edge of the garboard (that edge nearest to gunwale is meant when *upper* edge is mentioned), the distances on each mould from the rabbet line to the centre of the ribband must be measured and laid off on their respective positions on the plank, the rule being used, or, better still, a stick 6in. long on which the breadths are marked from the moulds. A batten is run through these spots, and the edge sawn and planed to them. It is apparent that if the staff moves at all, either on the boat or on the plank, while the marking is going on, the garboards when finished will not fit. To make a perfect fit without afterwards trimming requires care and practice, and will hardly be possible at first; but it can be done, and an effort should always be made to accomplish it.

The garboards must be bevelled at the ends to fit the rabbet, then, *
an assistant holding the middle, the fore end is adjusted by the marks *
*

and held with a screw clamp, while the clamp is bent to place, clamped to the ribbands, and pressed into the rabbet for about 2ft., or to the first mould. A few holes are bored on lower edge into the keel, and nails (of copper) or screws inserted to hold it in place; then the upper edge is tacked to the ribband with $\frac{3}{4}$ in. copper tacks spaced four between each pair of timbers, their points being turned into the oak. Now the holes may be bored and seamed slightly, and the screws ($\frac{3}{4}$ in. brass) put in along rabbet, spaced about 2in. apart, copper nails being used where they will pass through the keelson, so as to receive a burr or rove.

If the screws are put in the fore end first, in bending the plank to place a crack will probably follow, as the strain will all be on one point of the plank; further, the plank should fit solidly in the rabbet before the screws are put in, as any attempt to draw it close by the screw would either split it or cause the head of the screw to draw through the thin wood.

The end being fastened, the plank is laid in place for about 2ft. more and nailed, then another 2ft., until all is finished by screwing the after end fast. There is one point (Z, Fig. H) at each end where all the innate "cussedness" of the garboards seems to concentrate, and where especial care will be needed to make a tight joint.

The garboards being on, a "spiling" is taken in the same manner for the next streak after the second ribband is put on, and the same operations gone through with of setting the staff, taking the "spiling," laying off on the board, sawing out, laying off the widths (at stem and stern as well as at moulds), planing up and nailing. The planks can be put on in one length or may be "butted," the scarf being 2in. long, fastened with tacks. The "binding streak" must be $\frac{1}{2}$ in. wider on its upper edge, as it laps under the upper streak, no ribbon being needed. In laying the planks delicacy of handling is necessary and mere force worse than useless. In boats with a very round bilge, the bilge streaks are usually of $\frac{1}{2}$ in. stuff, worked concave on the inside and convex outside until $\frac{1}{2}$ in. thick to fit the curve of the bilge. No steaming is needed for any of the planks if shaped as directed. In some models the faces of the ribbands require to be bevelled slightly before the planks are laid, and it sometimes happens that a ribband will spring between the moulds, so as to lap more on one plank than on its neighbour, which must be remedied before nailing.

After the planking is completed the bolts are taken from the moulds, the stem and stern loosened, and the boat turned over on trestles; the stem and stern are then shored up plumb, the midship mould bevelled, and several shores run from the floor to the sides. The ribs or timbers are

sawn 1 in. wide, $\frac{3}{4}$ in. thick at heels, and $\frac{3}{4}$ in. at heads, long enough to reach from the centre of keel to the gunwale. They are steamed and bent over a "timber block" of a little greater curve than the midship section, some not being bent close to the block to fit the ends of the boat. A timber is taken as near the required shape as possible, if a little *too round* it may be straightened in a vice, and is sawed in two, making, when planed, two $\frac{3}{4}$ in. pieces; it is laid in place, the heel at centre of keel, or overlapping an inch, and the position of the first ribband marked. It is then removed, and a "joggle" cut of the shape of the ribband, using a small section as a pattern, and, for cutting, a gauge of the required shape. The timber is then replaced and the next joggle marked and cut, each one being cut before the next one is marked, as the timber draws down in fitting. When the timber is fayed closely to the skin and ribbands, and limber holes cut, the keel is nailed, and then the remaining holes bored and nails put in, those at the bottom being rivetted before boring for the upper ones. Two nails are driven through each *ribband* near the edges of the adjoining planks, and one through the centre of the plank, the nails being rivetted over burrs. Should there be any "lumps" or unfair spots in the boat, they can be removed in timbering by trimming down the timber or driving a wedge under it before nailing. After part of the timbers are nailed in, braces or "cross spalls" are put in at the ends at No. 2 and No. 12 stations, and at other points if necessary, the moulds being unscrewed and removed, and the remaining timbers put in.

As the bulkhead timbers, which are square, $\frac{3}{4}$ in. by $\frac{3}{4}$ in., must be fitted more accurately, a "spiling" is taken for each half timber, as in Fig. J. A piece of thin board is fitted at the point where the bulkhead is to go, and lines drawn and measurements taken as described for the garboards, then the board is laid on the timber and the marks transferred to it. The joint is left slightly open on the side towards midships, for caulking if needed. The bulkhead, of $\frac{3}{4}$ in. pine, is not fitted closely to the planking, but is rivetted to the face of the timbers. The heads of the timbers are next cut off about $\frac{3}{4}$ in. below the gunwale, and the upper streak, which is a little too high, having been made the full height of deck, is planed down, using a concave mould of the proper curve of deck, until the sheer is fair, and the height $\frac{1}{4}$ in. less than before to allow for deck. Notches are cut in the bulkheads to admit the gunwales, which are 1 in. by $\frac{3}{4}$ in. at centre and $\frac{3}{4}$ in. by $\frac{3}{4}$ in. at ends, and they are fitted and bent into place, resting on the heads of the timbers. The positions of the latter are marked off, the gunwales removed and joggled to fit them, replaced, nailed in, and planed down to the round of deck. The deck beams are sided $\frac{3}{4}$ in., 1 in. deep at ends, and 1 $\frac{1}{4}$ in. at centre, joggled

into gunwales and fastened by 2in. screws through plank and gunwales. Ridge pieces $\frac{3}{4}$ in. thick, and wide enough to carry the mast tubes safely, run down the centre of the deck, and are jogged into and screwed to the deck, beams, and bulkheads. Three knees are placed on each side of well, sided $\frac{1}{2}$ in., and nailed through plank and ribbons, a screw running through the gunwale into each.

The framework of the well consists of two fore and aft "side pieces," running from the main deck beam to the after bulkhead, and screwed to both as well as to the knees. If the well is rounded at the corners, knees are put in the angles between the bulkhead and side pieces. The coaming is steamed, bent in, and rivetted to the knees and side pieces before the decks are laid, the latter, of $\frac{1}{4}$ in. Spanish cedar, being fitted to it, making a better joint than if the coaming were bent in after the decks were in place. Before laying the decks the boat is carefully tested and any leak stopped. The decks are laid with $\frac{3}{4}$ in. screws $2\frac{1}{4}$ in. apart. In building a lapstreak boat no ribbands are needed, but the general method of working is the same, except that each streak must be $\frac{3}{4}$ in. wider for the lap, which must be bevelled and tapered down at each end until the lap is smooth outside at rabbet. Nails are used for fastening the laps spaced $2\frac{1}{4}$ in., every other one passing through a timber. The latter are $\frac{5}{8}$ in. by $\frac{3}{4}$ in., rounded on the inner edges, and are in one length from gunwale to gunwale. They are steamed, and taken from the steam box to the boat; then, one person taking each side, the holes being previously bored and nails inserted in the planking, the timber is bent into the boat, and the nails driven, those through the keel first, and the others in succession from keel to gunwales. The bulkheads are fitted as before described. In both boats the floor boards, $\frac{1}{2}$ in. thick, are carried on "floors" $\frac{1}{4}$ in. thick and 2in. deep at centre, tapering to nothing where they meet the bilge, and screwed to the planking from below, or, in the first described boat, rivetted to the timbers, as in a yacht, and adding greatly to the stiffness of the bottom. In building from stocks, the frame and moulds are made in the same manner, but set up on a plank, the keel being down; and all is firmly shored from the ceiling, the subsequent operations being similar to those described. Where many boats are built, the planking is done on a table, as above, the boat turned over and placed on stocks where the inside work and decking is done, and then moved ahead to a pair of trestles, where the brasswork and fittings are put on, other boats taking her place meanwhile on the stocks and table.

The scantling given has proved strong enough for craft 14ft. by 30in., carrying up to 70ft. of sail, but would need to be increased slightly for racing craft.

APPENDIX.

DICTIONARY OF GENERAL INFORMATION.

A.

A.B.—Able seaman, who must be able to hand, reef and steer, splice, knot, turn in rigging, &c.—able-bodied seaman, as distinguished from a youth or ordinary seaman.

Aback.—A sail is said to be aback when the wind strikes it from ahead and tends to force a vessel astern; generally applied to square-rigged ships. In a fore-and-aft vessel the sails would be said to be aback if their clews were hauled up to windward, or if the vessel came up head to wind, and went off on the opposite tack without the head sheets being handed over; or if the wind headed the vessel and struck her from the opposite side to that which it had been blowing so as to cause the sails to lift. (See also "All Aback For'ard!")

Abaft.—A relative term used to denote the situation of an object or point that is astern of another, and begins from the stem head, or from the fore part of any spar or other object; generally the term means towards the stern, or in the direction of the stern.

Abandon.—To leave a ship and take to the boats.

Abeam.—At right angles to a vessel's broadside or keel; opposite to the vessel's centre of length.

Aboard.—Inside a ship or on the deck of a ship. "Come aboard, sir," is a sailor's way of reporting himself on board after leave of absence. To run or fall aboard a vessel is for one vessel to come into collision with another. A sail is said to fall aboard when, from the lightness of the wind or other causes, it ceases to blow out. To haul the boom aboard is to haul the boom in by the mainsheet from off the lee quarter.

About.—Having tacked. "She's about;" she is going to tack or has tacked. "Ready about" is the signal given for the men to prepare to tack the ship. "About ship" or "Bout ship!" is the order given to tack, that is to put the vessel on the opposite tack to the one she is on when the order is given to tack.

Abreast.—Synonymous with "Abeam." Side by side. *To Brest.*—To come abreast.

Accommodation.—The cabins of a vessel.

Acker.—A tide coming on the top of another tide.

Ackers' Scale.—A graduated time allowance computed by the late Mr. G. Holland Ackers, now superseded by the Y.R.A. scale.

A Cock Bill.—An anchor hanging by its ring to the cat head. The situation of yards when one arm is topped up.

Across Tide.—Crossing the stream of the tide so that it comes broadside on. If a vessel in beating to windward crosses a tide fairly at right angles on one tack, she will stem it on the next, or have it stern on, according to whether the tide be lee-going or weather-going. (See "Weather-tide.")

Admeasurement.—An old-fashioned way of expressing the builder's tonnage of a ship calculated by length and breadth.

Admiral.—The highest rank in the Navy. Formerly there were admirals of the red, white, and blue, with the intermediate ranks of vice and rear of the red, white, and blue. When the white ensign was taken exclusively for the Royal Navy about twenty years ago, the red, white, and blue divisions were done away with. Admirals now fly a St. George's Jack, which is a white square flag with red St. George cross in it at the main, fore or mizen, according to their rank. A vice-admiral has a red ball in the upper (hoist) canton of the flag; a rear-admiral two balls.

Admiral of the Fleet.—An honorary distinction bestowed on admirals for long service, &c. If an admiral of the fleet has a command, he hoists the "union" at the main.

Admiralty Flag.—A red flag with yellow fouled anchor (horizontal) in it, flown by the Sovereign and Lords of the Admiralty.

Admiralty Warrants.—Warrants granted to clubs and the members thereof, granting permission to fly the white ensign, or the blue ensign, or the red ensign with device on it. The Admiralty warrant will only be granted to yachts which are registered according to the provisions of the Merchant Shipping Act. The warrant itself, as delivered by the Admiralty to a club, is a very simple document, and runs as follows: "Whereas we deem it expedient that the vessels belonging to the Royal . . . Yacht Club shall be permitted to wear the blue [or white, or red, as the case may be] of Her Majesty's fleet on board their respective

Admiralty Warrants—continued.

vessels with the distinctive marks of the club, we do therefore, by virtue of the power and authority vested in us, hereby warrant and authorise the blue ensign of Her Majesty's fleet, with the distinctive marks of the club, to be worn on board the respective vessels belonging to the Royal . . . Yacht Club accordingly."

The privilege bestowed by this document is clearly set forth, and is nothing more or less than a permission to fly one of the ensigns used by Her Majesty's fleet. The red ensign, it can be stated, may, under the Merchant Shipping Act of 1854, be flown on board any vessel without permission of the Admiralty, unless a device be put on it; in the latter case a warrant must be obtained from the Admiralty for permission to use the device.

Thus it will be seen that an Admiralty warrant confers only a single privilege, but the Government allows yacht owners who have a club certificate of the Admiralty warrant to avail themselves of certain exemptions from Excise and other dues. These exemptions are not important, and are briefly these: Members of yacht clubs (possessing the warrant) may remove their own furniture or property from place to place in the United Kingdom in their yachts (providing the furniture is for their own use) without taking out a coasting licence; members may deposit wines or spirits, &c., as sea stock in the Customs warehouses, on arrival from foreign ports, free of duty, and re-ship such wines, spirits, &c., for another voyage; members may enter harbours without paying duties, and may make fast and lie to any Government mooring buoys, when such are not required by any of H.M.'s ships; and a yacht need not have her name painted on her stern; the master or mate need not have Board of Trade certificates, even for foreign cruising; men or boys can be shipped or unshipped, or agreements can be made with seamen without reference to the Registrar-General of Seamen; crew space is under no limitations, and official logs need not be kept (see the article "Seamen" further on); but any yacht taking on board a passenger at a foreign port, or leaving one at a foreign port, is liable to dues as a packet boat. It will thus be seen that a yacht owner has the privilege of considerable freedom in his avocation of pleasure, but before he can obtain the warrant which confers these privileges his yacht must, as before stated, be registered in accordance with the provisions of the Merchant Shipping Act, and it is compulsory that every yacht of and above fifteen tons internal capacity shall be registered. Yachts smaller than fifteen tons requiring to fly the blue, or white, or club red ensign must also be registered (see the article "Registry").

Excisable goods are only allowed to be taken on board free of duty upon the yacht clearing for some foreign port; and, if a

Admiralty Warrants—continued.

yacht owner purchases wines, spirits, or other excisable goods at a foreign port, he may deposit the same in a British Customs warehouse free of duty, and take the same on board again on his clearing for another foreign voyage. Nothing is said about a yacht being allowed in a general sort of way to buy goods out of bond free of duty; but a great deal of laxity no doubt prevails in the matter, as it is a very easy thing for a yacht to be cleared for a foreign port without the owner having any intention of proceeding to the place mentioned in the clearance. A curious incident occurred in connection with this matter in 1864. A yacht cleared for a certain foreign port, and took on board wines and spirits from a Customs warehouse free of duty, the master giving the usual bond of 100*l.* that the same should not be landed or used out of the yacht. The yacht did not go foreign, and consequently did not call at the place mentioned in the clearance, and upon her return to the port of departure the Customs officers paid her a visit. All the wines and spirits had been consumed, but, as the yacht had not been to the place mentioned in her original clearance, the officers proceeded to estreat the bond; however, on a declaration being made that none of the stores had been taken out of the yacht, and, in fact, were consumed on board, the bond was not estreated, and only double duty imposed on the total quantity of excisable goods which had been taken on board the yacht. The owner at the time declared that this exaction by the Customs officers was owing to his not having "tipped" them when they paid a visit to his yacht. Be that as it may, there is little doubt that the officers were not exceeding their duty, although they must have been aware that many yachts when they take wines and spirits on board in the summer months from bond clear for a port merely to comply with one part of the regulation, whilst no intention exists of actually visiting the port. However, since the abatement of the duties on foreign wines and spirits, and tea, the practice of buying stores out of bond has much diminished.

Exemptions from harbour dues can only be claimed in Government harbours, such as Portland, Plymouth, Kingstown, or Holyhead new harbour; and it is doubtful if the Admiralty can give exemption from all dues for such natural harbours as Portsmouth, Falmouth, Milford, Cork, or Dartmouth if the local harbour board think proper to impose dues; indeed, at some of these places dues are exacted. For instance, a yacht using the Catwater at Plymouth has to pay some trifling tonnage due, and we have even heard of yachts being asked for the "Tinker" dues at Plymouth. However, these impositions are exceptional, and beyond the home harbours yachts, by special request, are privileged to enter all similar foreign harbours free of dues; but this exemption, whether at home or abroad, does not apply to private harbours

Admiralty Warrants—continued.

or docks, such as Ramsgate, Torquay, Dover, Havre, Boulogne, Ostend, and such places. For using such ports or docks the dues or tolls must be paid, and they are fixed at a much higher rate per ton than the harbour or town dues levied at some ports.

Yachts holding warrants are usually allowed to make use of Government buoys, if the same be not required for any of Her Majesty's ships.

When a yacht changes hands the warrant must be returned through the club secretary to the Admiralty.

The Admiralty warrant is never granted to persons hiring yachts, and they can only legally fly the national or red ensign; that is, the warrant is only granted to persons actually holding a yacht's Register.

The Admiralty warrant is not granted to foreigners who may be members of British yacht clubs unless they have been naturalised, and can thus legally hold a British Register. A foreigner obtaining a British Register by making a false representation is liable to have the vessel made forfeit to the Crown (see "Ensign").

Adrift.—Floating with the tide. Generally driving about without control. Also a vessel is said to be adrift when she breaks away from her moorings, warps, &c. The term is also applied to loose spars rolling about the deck; sheets or ropes which are not belayed, &c.

Afloat.—The state of being waterborne after being aground. To be on board ship.

Afore.—The contrary of abaft. Towards the forward end of anything.

Aft.—An abbreviation of abaft, generally applied to the stern. To go aft is to walk towards the stern; to launch aft is to move a spar or anything else towards the stern. To haul aft the sheets is to bring the clew of the sail more aboard by hauling on the sheets.

After.—The state of being aft, as after-sail, after-leech, after-side, &c.

After Body.—The part of a vessel abaft her mid-ship section.

After End.—The stern end of a vessel or anything else, or the end of anything nearest the stern of a vessel.

After Guard.—Men stationed aft to work sheets, &c. In racing yachts, if there be any amateurs on board, they are generally made use of as an after-guard. In merchant ships the ordinary seamen or landmen enjoy the distinction.

After-most.—A thing or point situated the most aft of all.

Afternoon Watch.—The watch between noon and four o'clock.

After Part.—The stern extremities of a vessel or anything else.

After Peak.—The hold of a vessel near the run. A small cuddy or locker made in the run of a boat aft.

After Rake.—Contrary to fore rake. The rake or overhang the stern post has abaft the heel of the keel. To incline sternwards.

Aftward.—Towards the stern; contrary to forward.

Against the Sun.—An expression used to show how a rope is coiled: from right to left is against the sun, from left to right is with the sun. The wind is said to blow against the sun when it comes from the westward.

Agreement.—The document executed, when a vessel is built, by the builder and the person for whom the vessel is being built. The following is a form of agreement which has been used:

An Agreement between Messrs. _____,

of _____, yacht builders, hereinafter called the builder, of the one part, and _____, of _____, Esquire, hereinafter called the owner, of the other part.

The builders shall build and equip a yacht according to the specification and drawings marked A, B, C, and signed by the parties hereto. The yacht shall be built and completed in all particulars according to the requirements of the said specification, and the whole of the workmanship and material shall be such as shall be required by Lloyd's Rules, and such as will entitle the yacht to be classed at Lloyd's as a yacht A 1 for a term of fifteen years. The whole of the work shall be executed under the special survey of Lloyd's surveyor, and to the satisfaction of Lloyd's committee; and also to the satisfaction of _____, marine architect, hereafter called the architect. The yacht shall be delivered to the owner complete as aforesaid, safely moored in _____.

In consideration of these premises, the builder shall be entitled to be paid by the owner as follows:— _____ pounds on the signing of this agreement; a further sum of _____ pounds when the said yacht shall be in frame, and the architect shall have given a certificate in writing under his hand that the yacht is in frame, and all the work up to that stage has been done to the satisfaction of Lloyd's surveyor and to the satisfaction of the architect; a further sum of _____ pounds when the yacht shall be completely timbered and planked, and the deck laid, the coamings fixed, and the architect shall have given a certificate in writing under his hand that the yacht is completely timbered and planked, and the deck laid, and the coamings fixed, and that all the work up to that stage has been done to the satisfaction of Lloyd's surveyor and to the satisfaction of the architect.

When the vessel shall have been duly launched and classed at Lloyd's 15 A 1, and when the said architect shall have given a certificate under his hand that the vessel has been completed in all respects to his satisfaction, according to the said plans and specification, and the vessel has been delivered afloat, and complete in all respects for sea, and moored in safety in _____, the owner shall pay to the builder the further sum of _____ pounds.

The yacht from and after the payment of the said sum of _____ pounds, to be paid on the signing of this agreement, shall be, and continue to be, the property of the

Agreement—continued.

owner; and all the materials intended for, or appropriated to the said yacht, shall be deemed to be the property of the owner.

If at any time the builder shall become bankrupt, or enter into any arrangement with his creditors under the Bankruptcy Acts, or shall fail or be unable to complete the said vessel in accordance with this agreement, or shall in the opinion of the architect be guilty of any unreasonable delay in the execution of the work agreed to be done, then it shall be lawful for the owner to enter upon the builder's yard and take possession of the said yacht, and to cause the work included in this agreement to be completed by any person or persons whom he shall see fit. All damage that shall happen to the said yacht agreed to be built as aforesaid, or to the materials intended to be used in her construction, by fire or otherwise, previous to her being delivered to the owner complete as aforesaid, shall be forthwith made good by and at the expense of the builder.

The architect and the owner shall at all times be permitted to have access to the said yacht during the progress of the works.

The builder shall deliver the said yacht complete for sea, according to the said plans and specification, afloat at _____, and classed at Lloyd's as aforesaid, on or before the first day of _____, one thousand eight hundred and eighty, and in default he shall pay for each and every day after the said first day of _____ during which the said yacht remains undelivered or unclassified as aforesaid, the sum of _____ pounds a day as and for liquidated damages; and the said sum of _____ pounds a day may be deducted by the owner from any money payable, or to become payable, by him to the builder.

The builder shall not be entitled to make any claim or demand upon the owner for work done upon the said yacht, or in connection with the building or equipment thereof, or for any alterations or extras beyond the remuneration hereinbefore mentioned, except in respect of work for which written certificates, describing the work as extra work, shall be given under the hand of the architect and countersigned by the owner.

No work done on the said yacht without a written order signed by the architect, and countersigned by the owner, shall be deemed to be extra work. The builder shall not be entitled to an extension of the said time by reason of any extra work or alteration being ordered unless a written order for such extra work be signed by the architect and countersigned by the owner, and unless the architect shall think fit at the time such written order is given by written certificate under his hand to extend the time fixed for completion, and then the time shall be extended only so far as the architect by the said certificate shall determine.

Any dispute arising between the builder and the owner respecting anything contained

Agreement—continued.

in this agreement, or in the specification and plans above referred to, or in any way relating to the building, equipping, or delivery of the yacht, shall be referred to the said architect, whose decision shall be final, or, him failing, to some other arbitrator to be agreed upon between the parties, or to be nominated, in case of difference, by the registrar of the Admiralty Division. The costs of any such reference to be in the discretion of the arbitrator. This agreement may be made a rule of the High Court of Justice if the court shall so think fit.

Specification.—

DESIGN AND DIMENSIONS: The yacht to be built according to drawings and plans furnished by _____, and to be of the following dimensions:—The length on deck from the fore side of the stem to the aft side of the stern post to be 50ft.; and the length between perpendiculars, measured along the rabbet of the keel from the after side of the stern post, to a perpendicular dropped from the fore side of the stem at the deck to be 46ft.; and the breadth, from outside to outside of the planking in the broadest part of the yacht, to be 11ft.

KEEL: The keel to be of sound English or American elm, 10in. sided, and not less than 8in. deep, to taper fore and aft to stem and stern post. If the keel be in two pieces, the scarph to be not less than 6ft. long, butted and bolted with $\frac{1}{2}$ in. metal bolts, six in number. A solid iron keel to be cast and fitted underneath the main keel amidships, as shown in plan, 26ft. in length; the builder to make the moulds for and find the iron.

STEM: To be a sound piece of English oak, with a grown crook, 5in., sided and 14in. moulded, properly butted and scarphed into keel, and bolted with $\frac{1}{2}$ in. copper bolts.

STERN POST: The stern post to be of English oak, 7in., sided at top, and 9in. moulded.

KNIGHTHEADS AND APRON: The knightheads and apron to be of English oak.

DEADWOODS: The upper deadwoods of English oak, and of sufficient depth to receive the timbers, and to be bolted with $\frac{1}{2}$ in. metal bolts.

FUTTOCKS AND TIMBERS: The futtocks and timbers to be of English oak, with room and space centre to centre of 18in., and to be 4in. sided and 4in. moulded, each to be step-butted and bolted to the keel, deadwoods or hogging piece. The heels of first futtocks to be securely fastened to keel with wrought-iron knee floors, through-bolted to keel and futtocks with $\frac{1}{2}$ in. metal bolts. Iron floor plates $\frac{1}{4}$ in. thick, to be fitted to sufficiently connect the heels of the futtock frames. The double timbers to be bolted together with $\frac{1}{2}$ in. square iron, galvanised, and the heels and heads to fit closely and neatly.

GARBOARDS: The garboard strakes to be of sound American rock elm, not less than 9in. wide and 2in. thick.

PLANKING: Six strakes below the water line to be of English oak, the sheer strake and six topside strakes of teak, and the remainder of

Agreement—continued.

the planks to be of pitch pine, the whole to be wrought in parallel strakes 2in. thick, and not more than 5in. deep (the sheer strake to be 7in. wide), and in long lengths to have a $\frac{1}{2}$ in. copper bolt clinched through every other frame, and to have a cast metal $\frac{1}{2}$ in. dump in the remaining timbers. The butts of the planks to be well fitted and caulked, and to have not less than 5ft. shift unless a whole stake intervenes between two butts, and each butt to have $\frac{1}{2}$ in. wrought copper bolt through the centre of the plank, and the timber next thereto. All fastenings to be punched home $\frac{1}{2}$ in. deep to receive putty stops.

SHELF: The shelf to be of English oak, 4in. thick by 4in. deep, as shown in the drawing C, showing the midship section, through-fastened to top and second strake with $\frac{1}{2}$ in. metal bolts at every timber, and to have a strong galvanised iron breast-hook forward, and galvanised iron knees aft. Beams to be dovetailed to the shelf, and well bolted with metal bolts. The clamp to be 2 $\frac{1}{2}$ in. thick.

BILGE STRAKES: Two bilge strakes of English oak 6in. by 2in., running fore and aft to be worked on each side, and to be through-fastened with $\frac{1}{2}$ in. copper bolts, and to have a galvanised iron breast-hook forward, and to be bolted into transom frame with metal bolts aft.

DECK BEAMS: The deck beams to be of English oak, 4in. sided and 4in. moulded, and to have about 4in. rise at centre; to have galvanised iron knees where required, carefully fitted and bolted through the top timbers and top strake with $\frac{1}{2}$ in. metal bolts; the bitt and mast beams, and the other beams, to have a galvanised iron hanging knee at each end, with three $\frac{1}{2}$ in. metal bolts through each arm. English oak lodging knees to be fitted between the beams in wake of the mast, and where required.

COVERING BOARD: The covering board to be of teak, 7 $\frac{1}{2}$ in. wide and 2in. thick, properly secured to top strake and clamp, and to project about $\frac{1}{2}$ in. outside of the plank.

DECK PLANK: The deck plank to be of picked, well-seasoned Quebec yellow pine, free from knots and defects, in long lengths, tapered as required; no feather edges to be left at endings of planks, forward or aft, the ends to butt $\frac{1}{2}$ in. into covering board; the plank to be 2in. thick, and to be dowelled and nailed diagonally, with yellow metal nails at the sides, so that no nail heads show.

BULWARKS: The bulwark stanchions to be of oak, 3in. moulded and 3 $\frac{1}{2}$ in. sided at deck. The bulwark skirting to be of teak.

RAIL: The top rail to be of American elm, 3 $\frac{1}{2}$ in. by 2in., free of defects, and fitted fair.

RUDDER: The main piece of rudder to be of one solid piece of English oak, and to have a carefully fitted water-tight rudder trunk; to have strong copper braces, fitted with a rule joint, sunk into stern post; also a strong brass or gun metal bearing at heel, to have an iron strap round the rudder head,

Agreement—continued.

and the rudder head to fit, and work in a metal collar, sunk into the deck with chock of teak; to have a neat brass cap, with name of yacht engraved thereon; to have two neat carved oak or mahogany tillers, with brass fittings.

CAULKING: The outside planking to be thoroughly and carefully caulked, and the seams carefully payed and puttied, and the deck to be very neatly and carefully caulked and payed with marine glue, the whole of the seams of hull and deck planking to be made tight; the outside planking to be painted with three coats of paint; two coats of composition to be laid on the bottom, and at the end of the season, or when required by the owner, the hull to be sheathed with copper sheets carefully laid on, 18oz. below the water-line and 20oz. at and above the water-line.

BALLAST: The builder to supply and carefully stow a sufficient quantity of pig-iron ballast (besides iron keel) to put the yacht to the designed load-line; the ballast to be painted with one coat of red lead paint. The builder to supply lead ballast if so required by the owner, allowing for the difference between the prices of pig-iron ballast and lead.

BITTS: The bowsprit bitts to be of sound English oak fitted and fastened in the usual way, mast bitts of English oak to be fitted on the fore-side and aft-side of mast, with usual cross pieces and all other necessary belaying bitts, pin racks, cleats, cavels, loading sheaves, eye bolts, and other usual deck fittings to be found and fitted as required.

PUMP: A properly-constructed lead pump to be fitted, 4in. in diameter, with lead tail pipe, and rose at bottom, and the discharge pipe to lead under the gunwale.

WATER-CLOSET: To have a patent water-closet of the most approved construction, with mahogany seat and fittings complete.

DECK FITTINGS: All the usual hawse pipes and chain pipes to be properly and carefully fitted; channels and chain plates, bolts, and dead eyes as required; bowsprit gammon iron at stem to be covered with leather.

BOBSTAY SHACKLE AND ROD: To have strong bobstay shackle cast in copper to fit the stem, and to let in flush with the wood so far as may be prudent, and riveted through, the bobstay chain to be of galvanised iron, and fitted to bobstay shackle.

DAVITS: To have boat's davits fitted to ship on one side, also one small anchor davit to ship on either bow.

RIDGE ROPE STANCHIONS: To have six brass stanchions for ridge ropes on either side of the same, to be hand-burnished in the best manner and fitted into square sockets in rail and lower part of bulwarks stanchions.

METAL CLEATS: To have two well-burnished brass cleats on taffrail, and two galvanised iron cleats on bow, and to have, if required, a neat elm grating extending from taffrail to mizen mast. To have iron roller in sheave fitted for hawse pipe to take chain cable.

Agreement—continued.

HATCHES : The companion to be of teak fitted with brass slides as required, and to shut in with shifting panel or doors at after side, and secured with brass hasp and padlock. The fore hatch to be of teak, to be very carefully fitted as required by owner. The sail room hatch to be of teak of convenient diameter, to be securely fitted with coamings on deck, and fastened with brass lock on the aft side, and brass hasp and padlock on the fore side.

SKYLIGHTS : The main cabin and other skylights to be of teak, fitted on teak coamings, and made to ship and unship in the usual way, and to have proper brass fastenings inside, and to be thoroughly water-tight in every way, and the glass panes to be protected by neat brass guards, or by galvanised iron or teak bars, as required by the owners. A curtain sliding on brass rods to be fitted to the skylight in the main and after cabins. Skylight coatings to be provided.

COMPANION LADDER : The companion ladder to be fitted as required, with glass windows, if required, at back of ladder, opening into after cabin.

CEILING : The yacht to be ceiled throughout, down to the ballast line, with 1½ in. pitch pine, carefully planned and fitted on the timbers; below ballast line to be coated with red lead, gas tar, or varnish.

PLATFORM : The platform and platform beams to be of fir, and laid as required; the floor to be secured to beams with brass screws. The floor at the foot of companion to be formed of a neat American elm grating, carefully fitted.

MAIN CABIN : The main cabin to be fitted according to the plans supplied by owner, with hard wood panelled bulkheads, doors, sofas or bed berths, with lee boards. The cabin to be fitted with polished pitch pine panels, and mahogany styles. One mahogany cupboard or sideboard to be fitted at the after end or both ends of each sofa, and a mahogany shelf with small open rail extending the whole length of the cabin to be fitted above each sofa. A small mahogany bookcase to be fitted against one of the bulkheads. All locks, bolts, hinges, hasps, or other fastenings, and all keys in the main cabin, and in every other part of the vessel to be made of brass.

STOVE : An approved stove to be fitted in forward bulkhead of the main cabin, with fender and irons complete; brass screw coamings for funnel, and length of copper chimney to lead clear of rail.

FORECASTLE : The forecabin to be bulkheaded, as required, and fitted with lockers, shelves, cupboards, locks, door, rack, table, seats with lockers underneath, and to have the usual lockers, and the lockers for chain and coke, closely ceiled to prevent dirt or dust from the same getting into the hold; also similar lockers to be fitted below the pantry, and fore state room floor. To have a neat iron ladder from floor to deck, fitted to ship and unship; a portable commode to be fitted, if required, in the forecabin, and one in after cabin.

Agreement—continued.

SHEET LEAD COVERINGS : The floor underneath the cooking stove, and all the wood work near the stove, to be neatly covered with sheet lead, nailed with copper tacks.

WATER TANK : A properly constructed galvanised iron water tank, with manhole, to be provided, and fitted below the floor with pump and supply pipe attached, with brass deck plate, and screw cover for the same.

COOKING STOVE : A patent cooking apparatus (No. 3), of Atkey's make, to be fitted complete with Atkey's patent ventilation coamings; length of copper piping to funnel sufficient to lead clear of rail.

HAMMOCKS : Three hammocks, with bedding complete, to be fitted.

MOPS, BROOMS, &c. : All the usual mops, brooms, brushes, buckets, squeegee, and other forecabin articles to be supplied.

PANTRY : The pantry to be fitted up as required, with dresser, shelves, liquor holes, racks, hooks, drawers, lockers, &c., and mahogany door opening into main cabin.

FORE STATE ROOM : The fore state room to be fitted with bed berth of mahogany, with drawers underneath, mahogany washstand, and a folding mahogany slab to form a writing table; cupboard, underneath shelves, racks, &c., mahogany door, &c. The space on port side of companion way to be fitted with seats or lockers, as required.

LADIES' CABIN : The ladies' after cabin to be fitted with polished wood panels, same as main cabin, with mahogany bed berths and washstands, cupboards and drawers, as required, and the sofas to be fitted with lockers underneath, and the doors to be fitted as required.

LAVATORY : The lavatory to be fitted with patent washstand, with tap and water; a tank for water supply, and a patent water closet of the best construction, to be fitted with mahogany seat, the lavatory to be bulkheaded or doored, as required.

SPARS : To be supplied with a complete set of spars, as required for a yawl of 25 tons, the whole to be carefully made, and all the ironwork to be of the finest quality, and galvanised, the dimensions of the spars to be according to plans supplied by the owner.

MAINMAST : The mainmast to be a picked spar, as free from knots as may be, of Oregon or Baltic red pine, fitted complete in every respect as required.

MAST STEP : The mast to be stepped into a solid iron mast step to be furnished by the builder.

HOOPS : The usual mast hoops properly riveted to be fitted to mast.

CROSTREES : The crostrees to be carefully fitted as required.

BOWSPRIT : The bowsprit to have a galvanised iron rack plate on the upper side from the heel to the stem, and a stout galvanised iron pinion where fitted to the bitts, with handle for the same, and a lignum-vitæ roller between the bitts with a score round the centre to allow for the passage of the rack plate; also a plain stout lignum-vitæ roller between the

Agreement—continued.

bits on the under side of the heel of the bowsprit. A small, square, iron fid as required, sheave at outer end, traveller leather covered.

WHISKERS: Galvanised iron whiskers, fitted with preventer rods and all the other usual fittings for the bowsprit as required, to be carefully fitted.

MAIN-BOOM: The main-boom to be fitted to mast with iron band and universal joint, and all other fittings, including reef cleats, to be neatly fitted as required.

GAFF: The gaff to be fitted with strong iron jaws, and the other fittings as required.

TRYSAIL GAFF: The trysail gaff to be similarly fitted so that the jaws may be used with either gaff.

TOPMAST: The topmast to be fitted with galvanised iron self-acting fid and a brass-bound sheave in heel for mast rope; all the other fittings to be carefully made as required.

TOPSAIL YARD: The topsail yard to be supplied of such dimensions as may be required.

SQUARESAIL YARD AND BOOM: A square-sail yard and boom to be fitted in the usual way as required.

MIZEN-MAST: The mizen-mast, boom, boom-kin, yard, &c., to be fitted as required, and the mast to be stepped securely.

RIGGING AND BLOCKS: The standing and running rigging of wire, hemp, and manilla of suitable sizes, to be most carefully fitted, and the patent blocks for the same to be all of the best make, the whole standing and running rigging, blocks, tackle, &c., to be fitted complete in every detail. The main and gaff halyards to be of the best Russian hemp, the jib halyards of chain.

SAILS: A complete suit of sails fit for a yawl of 25 tons, to be found by the builder, and made by Laphorn and Ratseys, and to consist of mainsail, two mizens, foresail, four jibs, two topsails, squaresail, trysail, and a complete set of sail covers, properly painted, to be supplied, and bags for the smaller sails.

ANCHORS: One Trottman anchor of 1½ cwt., one other anchor of 1½ cwt., and one kedge anchor, to be supplied.

CHAIN CABLE: Ninety fathoms of 9-16 chain cable, galvanised, to be supplied.

HAWSERS: Two hawsers of 60 fathoms each, suitable for the yacht, to be supplied.

WINDLASS: An improved ratchet windlass with double lever to be fitted.

PAINTING: The outside of the vessel to be made as smooth as possible, and to have the usual number of coats of the best oil paint. A gilt strake.

VARNISH: Bulwarks and all woodwork fittings on deck to have three coats of the best varnish.

INSIDE PAINT: The underside of the deck, and such other parts of the vessel as may require it, to have three coats of the best zinc white.

UPHOLSTERY: The upholstery work to be complete, and to consist of Brussels carpet for the main cabin, ladies' cabin, and state room, hard-seasoned oilcloth for the lavatory.

Agreement—continued.

SOFAS: The sofa mattresses, backs, and pillows to be of hair, and covered with rep, Utrecht velvet, or leather, as required.

CABIN TABLES, CHAIRS, &c.: A mahogany swing table to be fitted in main cabin, with cloth cover complete, also three folding chairs, Atkey's Osborne swing lamp, and the stove before mentioned.

STATE ROOM BEDS: The berths in the state room and ladies' cabin to be fitted with hair mattresses, down feather bolsters and pillows of the best quality, and three blankets of the finest quality to be supplied for each bed.

TOILET CHINA: The usual toilet china to be supplied to each berth, but to be selected by owner.

LAMPS: A suitable bronze swing lamp to be supplied to each berth.

STATE ROOM SOFAS: The sofas or seats in the after state room or ladies' cabin to be fitted with hair mattresses covered in cretonne, rep, or Utrecht velvet, as the owner may decide.

BOATS: A suitable gig, to be supplied with oars, brass rowlocks and yoke, mahogany back board, and elm grating, and boat hooks, complete in every respect; also a dinghey, with brass rowlocks and oars.

BINNACLE: A binnacle of teak, with brass lamp and fittings, and approved compass.

WINCH: A lever ratchet winch to be fitted on each side of the mainmast.

SIDE LAMPS, &c.: Side lamps (dioptric) to be supplied, together with screens and galvanised iron stanchions, made to fit into the rail or into stanchions fixed on the rail. The lower part of the stanchions to be made to fit into the covering board, or into fastenings on the lower part of the bulwark stanchions. The side light screen to be made with brass hinges, so as to fall flat when out of use. An anchor lamp (dioptric) to be supplied. A rack to be fitted in the forecabin to receive the screens and lamps.

LEAD LINE: A hand lead and properly marked line to be supplied.

BELL: A ship's bell of the size required by the Board of Trade to be supplied, and to be fitted on deck if required.

LEGS: Galvanised iron legs to be provided, with fittings complete.

FINALLY: The whole of the workmanship and materials to be of the very best quality; and notwithstanding any omission from this specification, the builder is at his own expense to complete the vessel in every detail, in what is understood as hull, masts, spars, ironwork, and deck and cabin fittings as usual in first-class yachts, with all joiner's, cabinet maker's, painter's and plumber's, and upholsterer's work appertaining thereto.

Agreement.—A form of agreement provided by the Board of Trade for yacht sailors to "sign articles" on. (See *Seaman.*)

Aground.—A vessel is said to be aground when her keel or bottom rests on the ground.

Ahead.—Forward; in advance of.

Ahoy.—An interjection used to attract attention in hailing a vessel, as "Galatea Ahoy!"

A-Hull.—A ship under bare poles, with her helm lashed a-lee. An abandoned ship.

Air-Tight Cases for Small Boats.—By air-tight cases is meant cases that will keep out water. The most general form of case is made of zinc, copper, or Muntz metal. Macintosh bags have been used; they are put inside wood lockers, and then inflated, the object of inflation being of course to fill the lockers, and thus practically making the lockers impervious to the influx of water. As any kind of bag is liable to be punctured or otherwise damaged, metal cases are to be preferred—they should be fitted inside wood lockers. To render a boat un-submergeable she must be provided with cases which will displace a quantity of water equal to the weight of the boat. A ton of salt water is equal to 35 cubic feet of the same: now suppose a boat 16ft. long and 6ft. broad weighed 15cwt. ($\frac{3}{4}$ ton) with all passengers, gear, air-tight cases, &c., on board, then she would require air-tight cases equal in bulk to $26\frac{1}{2}$ cubic feet, as there are $26\frac{1}{2}$ cubic feet of water to $\frac{3}{4}$ ton weight. But it may be taken that the wood material used in the construction of the boat, the spars, and wood cases, would be self-supporting. Say that these weighed 5cwt., then 10cwt. ($\frac{1}{2}$ ton) would remain to be supported; $\frac{1}{2}$ a ton is equal to $17\frac{1}{2}$ cubic feet. A locker 6ft. long, 2ft. broad, and 1ft. 6in. deep would contain 18 cubic feet, and so would support the boat with her passengers on board, or prevent her sinking if filled to the gunwale with water. Of course it would be rather awkward to have such a large locker as this in so small a boat, and the air-tight spaces are usually contrived by having a number of lockers, some under the thwarts, in the bow end and stern end of the boat, and sometimes above the thwarts under the gunwales.

Some boats are made un-submergeable by a cork belting fixed outside below the gunwale. One ton of cork is equal to 150 cubic feet of the same, and will support $3\frac{1}{2}$ tons in water. Thus, roughly, cork will support three times its own weight in water. Supposing it is sought to support a boat equal to 10cwt., as stated above; then a belting of cork will have to be used equal to $17\frac{1}{2}$ cubic feet, plus a quantity equal to the weight of the bulk of the cork. Say the boat is 16ft. long, and the measurement round the gunwales will be 32ft. A tube 32ft. long to contain $17\frac{1}{2}$ cubic feet would require to be 10 $\frac{1}{2}$ inches in diameter. [The contents of a tube are found by multiplying its length by the area of one end. This area is found by taking the square of the diameter and multiplying it by $\cdot 78$ (see "Areas of Circles").] The $17\frac{1}{2}$ cubic feet of cork would weigh $(17\cdot 5 \times 15)$ 262 $\frac{1}{2}$ lb. equal to 4 cubic feet of salt water, and so an addition would have to be made to the tubing to that extent. Thus, in round numbers, 22 cubic feet of cork would be required to support

10cwt. net. A tube 32ft. long and 11in. in diameter would contain 22·0 cubic feet. The tubes that contain the cork are usually made of canvas and painted. The weight of the canvas tube would have to be added to the general weight to be supported. Solid cork should be used, and not cork shavings, for filling the tubes; cork shavings get more or less saturated, and lose their buoyancy, and generally have less buoyancy than solid cork, in consequence of the multitude of spaces between the shavings which would admit water.

The accompanying sketch shows a small boat with a cork belting round under her gunwales.

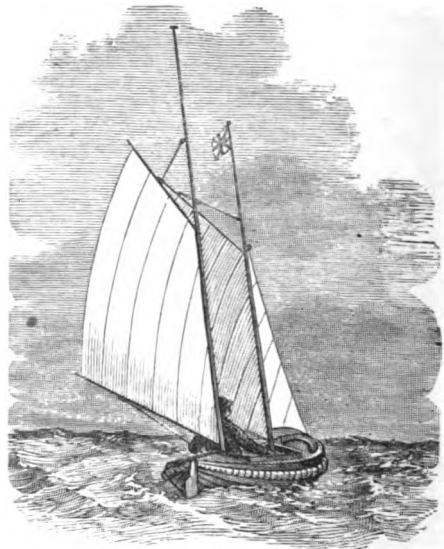

FIG. 189.

A-Lee.—To leeward. The helm is a-lee when it is put down to leeward. Hard a-lee means that the helm must be put as far to leeward as it can be got. (See "Helm's a-lee.")

All.—A prefix put to many words to show that the whole is included, as "all aback," meaning all the sails are aback; "all-a-taunto," meaning that the ship is fully rigged and fitted out, with everything in its place; "all hands," the whole ship's company; "all standing," with everything in its place—nothing being shifted, &c.

All Aback For'ard.—A cry raised when a vessel is sailed so near to wind that the head sails lift or shake.

Alley.—The channel made in the after part of a steamship for the propeller shaft is termed the shaft alley.

Aloft.—Up the mast; overhead. "Aloft there!" is a manner of hailing seamen who may be aloft on the mast, tops, yards, &c.

Along the Wind.—Sailing along the wind means to sail with the wind from a point to four points free, or with the wind abeam.

Along the Land.—To lay along the land is when a vessel can hug or keep close to the land without tacking.

Along Shore.—Close to the shore, by the shore, or on the shore.

Alongside.—By the side of the ship. "The gig is alongside, sir," is a common way of informing the owner, master, or other officers that the boat is manned and by the gangway, in readiness to take people off; also said when a boat is brought to the gangway so that passengers can embark.

Amateur.—See "Corinthian."

Amidships.—The middle part of a ship. The middle part of anything. To put the helm amidships is to bring it in a line with the keel. Generally the word has reference to the middle fore-and-aft line of the ship, and to a middle athwartship part of a ship.

Anchor for Small Boats.—For small open boats the anchor should weigh 1lb. for every foot of length up to 20ft. length; but if the boat be ballasted another $\frac{1}{2}$ lb. per foot of length should be added. Anchors for small boats should be long in the shank, and of the old-fashioned pattern.

Anchor Shackle.—A shackle which connects the chain with the anchor.

Anchor, Tripping an.—If an anchor is let go on very firm holding-ground, or on ground where the anchor is likely to get foul, a tripping line is made fast to the crown of the anchor; to the other end of the line a buoy is made fast, and when the anchor is "wanted" it can be broken out of the ground by hauling on the tripping line if it cannot be got by hauling on the cable.

Another plan is to "scow" the anchor by bending the end of the cable to the crown instead of to the ring or shackle. The cable is then "stopped" to the ring by a yarn. When the cable is hauled upon the stop breaks, and, of course, the cable being fast to the crown, the anchor is readily broken out of the ground. A boat should not be left moored with her anchor "scowed," as, if any unusual strain came upon the cable, the stop would break, and the boat would probably go adrift. The trip line should be used in such cases. (See "Scowing.")

Anchor Watch.—A watch kept constantly on deck when a ship is at anchor, to be ready to veer out or take in chain, or to slip, make sail, give warning to the hands below, &c., if the vessel be in danger of collision or other mishaps. One hand may keep an anchor watch, and call up the officers and crew if necessary.

Anchor, Winch for Raising a Boat's.—Very neat and small winches are now made for almost any sized boat that has a deck forward, but a winch is not readily fitted to an open boat, and fishermen have a very simple contrivance to obtain the necessary power. Get a short piece of hard wood about 4in. in diameter, and of a length equal to the width of the boat at the gunwale, where it is to be

fitted to serve as the barrel of a winch (termed a "wink" by the fishermen). In either end drive an iron pin to form an axle, and to keep the wood from opening fit an iron band on either end (all the iron should be galvanised). On each gunwale fit an iron band on either end (all the iron should be galvanised). On each gunwale fit an iron plate—a round hole in one plate and a hole and slot (opening aft) in the other. A hole must be bored through the wood to receive a short bar of tough wood or iron three or four feet long, to serve as a lever, or three or four pegs can be inserted, as is shown in the

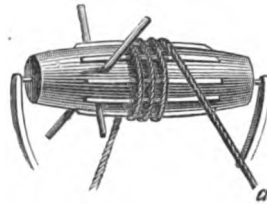

FIG. 190.

sketch. The end of the cable will be fast to the wink, and as the latter is hove round the cable will be wound up. If there be two hands in the boat the cable need not be fast to the wink, but one hand can heave whilst the other holds on to the cable and coils away. A ratchet and pawl are sometimes fitted to the wink. Messrs. Pascal Atkey and Son, Cowes, manufacture a suitable ratchet windlass for small yachts.

Anchors (Cole's).—This is an anchor something like the "old bay." It has a very long shank and sharp clean flukes. The crown is fitted to the shank and kept in its place by a pin. The advantage of this anchor is its great holding power, and the quickness with which it gets a hold even in hard ground. In letting go very little chain is required to bring a vessel up, but if the vessel has much way on a good scope should be given, as the anchor is a dangerous one to snub. The parts of the anchor are very light, and generally the weight required is 25 per cent. less than the weight of other anchors.

Anchors (Liardet's).

—The peculiarity of this anchor is that the stock is provided with flukes the same as the arms. The arms and stock are so fitted that they can move within a range of 45°. When stowed, the arms and stock lie in a line with the shank. There is a shackle for the cable and another near the crown for a buoy rope. The arms are shown by *a a* and the flukes by *b b* (Figs. 191 and 192). The

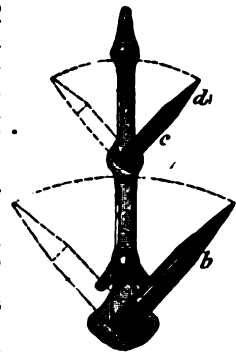

FIG. 191.

arms and flukes of the stock are similarly shown. The manner of securing the arms to the shank is shown at *e*. We are informed that the P. and O. Company and some other

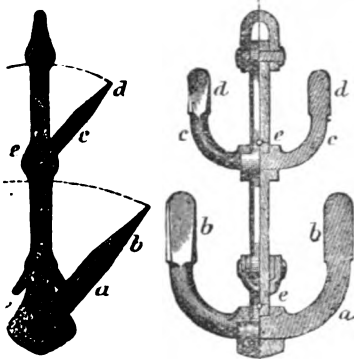

FIG. 192.

companies are using the anchor. The manufacturers are Messrs. Parkes and Ross, of Tipton (Staffordshire) and Liverpool. Mr. Andrew Thompson, of 5, Adelphi-terrace, is the London agent.

Anchors (Smith's Stockless).—This curious anchor is recommended by the patentees for the following reasons: It takes immediate hold; cannot foul; requires no stock; can be 20 per cent. lighter than other anchors;

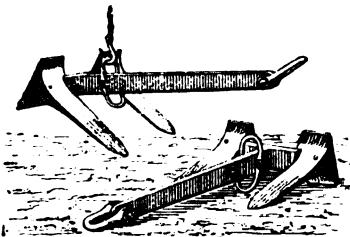

FIG. 193.

always cants properly; great strength; easily worked; lies flat on deck; stows in small space; easily tripped. The anchor is shown in the annexed cut, Fig. 193.

The sizes recommended for yachts are, for

SAILING YACHTS.	STREAM YACHTS.
250 tons 6½ cwt.	250 tons, 4½ cwt.
200 " 5½ "	200 " 4 "
150 " 4½ "	150 " 3½ "
125 " 3½ "	100 " 2½ "
100 " 3 "	75 " 2 "
75 " 2½ "	50 " 1½ "
50 " 2 "	25 " 1 "
40 " 1½ "	12 " ¾ "
30 " 1¼ "	
20 " 1 "	
10 " ¾ "	
5 " ½ "	

The anchors are made by Mr. Wasteneys Smith, 58, Sandhill, Newcastle-on-Tyne.

Answer.—To repeat an order after an officer; thus, if the order be to the helmsman, "No more away," he will repeat, "No more away, sir;" or to the jib-sheetsman, "Check the jib-

sheet," he will answer, "Check the jib-sheet, sir." Thus the crew should always "answer" every order to show that they comprehend.

Answer Her Helm.—A vessel is said to answer her helm when she moves quickly in obedience to a movement of the rudder. Long, deep vessels are slow to answer their helm. A vessel cannot "answer her helm" if she has not steerage way.

A 1.—The highest class obtainable at Lloyd's. Formerly (from about 1760) all new ships were classed "A" with a term of years according to their port of building; after this term expired the ship was degraded to the E or I class, and so frequently it happened that a bad ship got a long term and a good one a short term; and perhaps the short-termed ship when repaired for the class E was better than the long-termed one was when first built. Such an absurd way of classing formed no useful guide for underwriters or insurance brokers, and in 1824 the present well-known committee of "Lloyd's Register" was established, by which ships are classed and given a term, according as they are built, in compliance with certain rules. A 1 is the highest class. "A" denotes that the hull is built of good materials, in accordance with certain rules, "1" is the symbol that the rigging and general equipment of the ship are in every way perfect. The number of years assigned to a ship as her term depends upon the quality of the materials used and the mode of construction, and may vary from eight to eighteen years. A well-built ship upon being restored may be retained in the A class. "A in red" are ships that have passed their term, or ships that were not classed when built. Class \mathcal{A} applies to ships fit only for short voyages. Class E and I are similar to \mathcal{A} , but denote that the ships are not fit to carry perishable goods on any voyage. It is seldom that any number is assigned but 1, and generally the classes will be found distinguished by A 1 15 years, A 1 (in red) 7 years, \mathcal{A} 1; the classes \mathcal{A} , E and I, are subject to annual inspection (see Lloyd's Yacht Register).

A-Peak or Peak.—An anchor is said to be a-peak when the cable has been so much hove in as to form a line with the forestay; "hove short" so that the vessel is over her anchor. Yards are a-peak when topped by opposite lifts.

Apostles.—Seaman's slang for knightheads, bollards, &c., for belaying warps to.

Apron.—A piece of timber fitted at the fore end of the keel at its intersection with the stem.

Arch Board.—The formation of the counter at its extreme aft end, being a continuation of the covering board, and covers the heads of the counter frames.

Ardent.—A vessel is said to be ardent when she grips or shows a tendency to come to against a weather helm.

Areas of Circles.—The area of a circle is found by multiplying the square of the diameter by the fraction 0.7854. The areas of small circles

in decimals of a foot are given in the following table :

Diameter in inches.	Equivalent diameter in decimals of a linear foot of 12 inches.	Area of circle in decimals of a square foot.	Circumference of the circle in inches.
1½	0.1	0.0078	3.92
2½	0.2	0.0314	7.46
3½	0.3	0.0706	11.38
4½	0.4	0.1253	14.92
6	0.5	0.1963	18.84
7½	0.6	0.2827	22.37
8½	0.7	0.3848	26.31
9½	0.8	0.5026	30.23
10½	0.9	0.6362	33.77
12	1.0	0.7840	37.99

The contents of a tube or cylinder can be found by the above table.

Thus, say a tube 30ft. long be 3½in. (equal to 0.3 of a foot) in diameter, then the area of one end of the tube will be .0706 sq. ft. The contents of the tube will be found by multiplying its length by the fraction .0706 (30 × .0706 = 2.118 cubic feet). If the tube were 6in. in diameter, then its contents would be 30 × 0.1963 = 5.889 cubic feet.

Arms.—The extremities of anything, as yard arms.

Ashore.—A vessel is said to be ashore when she is aground. To go ashore is to leave the ship for the land.

A-stay.—Synonymous with a-peak.

Astbury's Tanning for Sails.—This is a composition for tanning sails without altering their colour: it is said to preserve the canvas and render it waterproof. Messrs. Astbury's address is 48, King-street, Manchester.

Astern.—Towards the stern. To move astern; to launch astern; to drop astern. An object or vessel that is behind another vessel or object.

A-taunto.—With all the masts on end, and rigging completely fitted. (See "All-a-taunto.")

Athwart.—Transversely, at right angles to fore and aft; across the keel. Athwart-ship is thus across the ship from one side to the other. Athwart hawse is when one vessel gets across the stem of another.

A-trip.—When the anchor is broken out of the ground or is a-weigh. A topmast is said to be a-trip when it has been launched and unfitted.

Avast.—Stop, cease, hold, discontinue. As avast heaving (stop heaving), avast hauling (stop hauling), &c.

Awash.—Level with the surface of the water.

Away.—A general order to go, as "away aloft," for men to go into the rigging; "away aft," for the men to move aft, &c. "Gigs away there," or "cutters away there," or "dinghys away there," is the common way of giving the order to get the boats ready and manned. "Away with it," to run away with the fall of a tackle when hauling upon it. "Away she goes," said of a vessel when first she moves in launching. "Away to leeward," "away to windward," "away on the port bow," &c.

A-Weather.—The situation of the helm when it is hauled to windward. To haul a sail a-weather is to haul the sheet in to windward instead of to leeward, to form a back sail, to box a vessel's head off the wind or put stern way on her. Generally to windward.

A-Weigh.—Said of the anchor when it is a-trip or broken out of the ground. The anchor is weighed when hove up to the hawse pipe.

Axioms for Yachtsmen by an American.—Don't stand up in a boat; don't sit on the rail of a boat; don't let your garments trail overboard; don't step into a boat except in her middle; don't stand up in a boat before you are alongside; don't pull under the bows of a ship—it looks green, and the consequences might be fatal; don't forget to "in fenders" every time you shove off; don't forget that a loaded boat keeps headway longer than a light one; don't make fast with a hitch that will jam; don't lower away with the plug out; keep the plug on hand by a small lanyard to it, so that it cannot be "led astray" and have to be hunted up when needed. Do.—Do hoist your flags chock up—nothing betokens the landsman more than slovenly colours; do haul tant all your gear; do see that no "Irish pennants" are flying adrift aloft; do have a long scope out in a gale; do see that your crew keeps in its place and does not boss the quarter deck; do keep your men tidy and looking sailor-like; do keep to leeward of competing yachts when you are not in the match yourself.

Aye Aye, Sir.—The response made by seamen when an order or direction is given them, to show that they understand and will obey.

B.

Back.—To back a sail, is to haul the sheet to windward.

Back and fill.—To luff up in the wind, and then fill off again. Often a vessel is worked up a narrow channel with a weather tide by backing and filling: that is, the helm is put down slowly, and the vessel kept moving until she is nearly head to wind; the helm is then put smartly up, and the vessel filled again. Care must be always taken to fill before the vessel loses way. Figuratively, to back and fill is to blow hot and cold, or assent and dissent, or to go backwards and forwards with opinions.

Backing.—Timber fitted at the back of other timbers.

Backstays.—The stays that support the topmast with a beam or stern wind. The topmast shrouds or rigging (See "Shifting Backstay, and Preventer.")

Backwater.—The water thrown back when waves strike a wall or other solid object. The water that appears to follow under the stern of a ship. To back water is to move the cars of a boat, so that the boat moves astern instead of ahead.

Bafling Wind.—A wind that is continually shifting its direction, so that it is difficult to keep the sails full or steady.

Bag.—Sails are said to bag when they do not sit flatly.

Bagpipe.—To bring the sheet of an after-sail, such as the mizen, forward to the weather rigging, so that the sail forms a bag, or back sail: useful to put stern way on a vessel.

Balanc Lug.—A lug sail with a boom and yard. About one-sixth of the sail is on the fore side of the mast, and thus "balances" on the mast, requiring no dipping when going about. (See page 201.)

Balanc Reef.—In gaff sails a band with reef points or eyelet holes for lacing, sewn from the throat to the clew. The reef is taken in by lowering the jaws down to the boom and lacing the sail along the reef band to the boom. Sometimes the gaff end is lowered down to the boom end; in which case the reef band is laced along the gaff.

Bale.—To throw water out of a vessel or boat by buckets or balers.

Balk.—A hewn tree; a piece of timber for masts, &c.

Ballast.—A ship is said to be in ballast when she has no merchandise on board, but only sand, gravel, mud, or rubbish as ballast. A yacht in marine parlance is always "in ballast."

Ballast, To Keep Clean or Sweeten.—The ballast of an old vessel should be removed every other season, scrubbed, and whitewashed with hot lime, or coated with black varnish or red lead. The hold of the yacht should at the same time be thoroughly cleansed and black varnished, distempered, or red leaded. A mixture of two-thirds Stockholm tar and one-third coal tar boiled together will make a good composition for the ballast and the inside of a vessel below the floor. Some vessels are now regularly hauled up every year, and of course their ballast is taken out and stored. (See "Distemper," "Laying up," and "Limber Boards").

Ballast, Run, into a Vessel.—Several racing yachts have had ballast run into them, but the plan has fallen into disuse owing to the great labour of outting the lead out again in case alterations became necessary; and moreover with a little trouble ballast can be moulded to fit into every cavity, however small, between the floors and keel. Before the lead is run into a vessel the timbers and plank should be cemented or smeared with wet clay; the vessel should be caulked before the lead is run in.

Ballast, To Shift from Inside to the Keel.—The quantity of ballast that can be removed from inside the hull whilst the same stability is maintained by placing a certain amount of metal on the keel, can be ascertained as follows: before the vessel is hauled up to have the metal keel fixed, perform the following experiment: take a quantity of ballast (say 10cwt. for a 20 tonner)

from the hull and place it on one side of the deck; mark on the vessel's side the line to which she is heeled; after the metal keel has been fixed and the vessel launched, put exactly the same weight of ballast (taken from the hull) as before on the side of the deck in exactly the same place; then remove ballast from the inside until the vessel heels to the line she did before the metal keel was fixed. This experiment should always be made before sailing a vessel to a lighter load-line after fixing a metal keel or adding to one. The experiment should be performed in perfectly smooth water. (The result can be arrived at by calculation, as explained in "Yacht Designing," but the process requires too many figures to introduce here.)

Ballast, Shifting.—To put ballast in the weather side of a vessel during sailing. This practice is now strictly forbidden in yacht racing, and if a man were known to practise it he would be shunned as a thoroughly dishonest person.

Balloon Sails.—Balloon canvas is a term applied to sails of large dimensions, made of light canvas, and generally only used in yacht matches. A balloon jib fills up the whole space from the bowsprit end, mast-head, and mast at deck; a balloon foresail is hanked to the forestay, but the foot reaches some distance abaft the mast; a balloon topsail has a yard nearly as long as the yacht is long over all, and the foot extends beyond the gaff on a jack yard; a balloon maintopmast staysail, has an up and down weather leech extending below the lower corner of the sail, which is hanked to the maintopmast stay (see Fig. 3, page 30). A jib topsail is sometimes termed a balloon sail, but now it is generally considered a "working sail." Balloon jibs are going out of fashion, as "bowsprit spinnakers" are now more generally used, and are more easily handled. In cutters, jack yards for balloon topsails are generally dispensed with, but are still used in yawls and schooners; but the latter seldom now have a jack yard for fore topsail.

Bare Poles.—With no sail set. With all the sails furled or stowed at sea for scudding before a heavy gale, or sometimes for lying to.

Bargee.—A seaman employed on board a barge.

Bar Harbour.—A harbour that has a bank or bar of sand or gravel at its mouth, so that it can only be entered at certain hours of the tide.

Barque.—A ship without yards on her mizen mast.

Barquentine.—A vessel square rigged on her foremast, and fore-and-aft rigged on her two other masts.

Barra Boats.—Vessels common to the Western Isles of Scotland, with almost perfect V section.

Barrel.—The part of a capstan, windlass, or winch round which the cable or rope is wound whilst heaving. Sometimes termed the drum.

Base Line.—In naval architecture a level line near the keel, from which all heights are measured perpendicularly to it. Generally in yacht designs the load water-line is made the base line, and all depths and heights are measured perpendicularly or at right angles to the load water-line, as shown in the Sheer Plan.

Batten.—A long piece of wood used to lash to yards or booms to strengthen them. Thin pieces of hard wood fitted to spars to prevent their being chafed or cut. Thin splines of wood used by draughtsmen to make curved lines. Generally a thin strip of wood.

Batten Down.—Putting tarpaulins over hatches or skylights, and securing them by iron bars or battens.

Beach.—A Shore. To beach is to lay ashore, to strand.

Beach Boats.—Flat floored boats that can be readily beached. (See page 230.)

Beacon.—A stake, boom, or post put on a sand-bank or shoal as a warning for vessels.

Beacon Buoy.—A buoy with a kind of cross upon top of it.

Beadon's Safety Reel.—Used for belaying the main sheet. This was a contrivance invented in 1833 described in "Folkard's Sailing Boat." This reel is said to have been contrived without coggs or catches, and released the main sheet upon the boat being held to a certain angle (See "Cruikshank's Patent Cleats".)

Beam.—A timber that crosses a vessel transversely to support the deck. The breadth of a vessel. "Before the beam" is forward of the middle part of a ship. The wind is said to be before the beam when the ship makes a less angle than 90° with the wind. A beam wind is a wind that blows at right angles to a vessel's keel. "Aft the beam" is towards the stern.

Beam and Length.—The proportion a vessel's beam bears to her length. A quarter of a century ago, it was considered that this proportion had a great deal to do with speed, hence many builders set great store on the particular amount of beam to length they gave a vessel. A yacht was seldom made more than four times her beam in length, but now a common proportion is five times, or even five and a half times, the beam. It is generally contended that the builders' rule and Thames rule for ascertaining tonnage have a great deal to do with the diminishing of breadth in its proportion to length, and so no doubt it has, inasmuch as an owner finds that, if he builds, say, a yacht of 100ft. in length, he gets practically no more room in her, if he makes her 22ft. in breadth, than he would if she were only 21ft. It would of course be an advantage to the builder to make the yacht 22ft. in breadth, as her tonnage would be 189 tons, instead of 185; so he would be paid about 200l. more for the foot extra beam, and practically there would be nothing to show for it. In sailing yachts it is found that to take advantage of the ton-

nage rating the length should be about five or exceed five times the beam. For cruising, a better proportion is four and a half times the beam. A yacht that has a beam of one-fourth her length need be rather shallow, or she would have a very large displacement and would be slow; on the other hand, shallow vessels are not good sea boats. The comparatively deep and long-bodied vessels make the best sea boats. They are of a good weight, which tends to lessen the influence of the waves on their motions, and they are easier in their motions with a beam sea.

Beam Ends.—A vessel is said to be on her beam ends when she is hove down on her side by the wind or other force, so that the ends of her deck beams are on the water, or her deck beams perpendicular to the water. However, in sea parlance, a ship is said to be on her beam ends when knocked down to a squall to say 45°, so that when a ship is described as being on her "beam ends" the meaning need not be taken literally.

Bear, To.—The direction an object takes from a ship expressed in compass points or by points in the vessel; as in reference to another vessel she bears S.E. or W.S.W., &c., or on the port bow, or weather bow, port beam or weather beam, port quarter or weather quarter, &c.; or two points on the weather bow or port bow, &c.

Bear a Hand There!—An admonition to hurry.

Bear Away, or Bear Up.—To put the helm up and keep the vessel more off the wind. Generally used in close-hauled sailing when a vessel begins to alter her course by sailing off the wind. (See "Wear.")

Bearings.—The direction between one object and another; generally the direction of an object on land to a ship.—The widest part of a vessel which may either be above or below water. A vessel is said to be on her bearings when she is heeled over, so that her greatest breadth is in the water.

Bearings by Compass.—An object is said to bear so many points on the port or starboard bow, or port or starboard quarter, or port or starboard beam as the case may be; or an object may be said to bear E.N.E. or E. or W., &c., from the point of observation. The usual plan of taking a bearing is to stand directly over the binnacle, and notice which point on the compass card directly points to the object. A more accurate way of taking bearings may be followed thus: on each quarter-rail abreast of the binnacle, have a half compass plate of brass fixed, or mark off compass points on the rail, and let two opposite points (say north and south) be in direct line or parallel with the keel. A pointer or hand, eight or nine inches long, must be fitted to the plate, to ship and unship on a pivot; move the pointer until it points directly to the object, then read off the number of points it is from the direction of the ship's head. Next observe the direction of the ship's head by the binnacle compass; if the ship's

head points N., and the pointer showed the object to be, say, four points away westerly from the direction of the ship's head, then the object will bear N.W., and so on. If very great accuracy be required, and if the ship be yawing about, one hand should watch the binnacle compass, whilst another makes the observations with the pointer.

An object is said to bear "on the bow" if its direction in relation to the ship does not make a greater angle with the keel of the vessel than 45°. If the direction of the object makes a greater angle than that it would be said to bear "before the beam;" next on the beam, then abaft the beam, on the quarter, right astern.

Beat.—To beat to windward is to make way against the wind by a zigzag course, and frequent tacking. (See "Thrashing" and "Turning to Windward.")

Beating to Windward.—(See "Beat.")

Be calm.—To deprive a vessel of wind, as by one vessel passing to windward of another.

Be calmed.—In a calm; without wind.

Becket.—A piece of rope used to confine or secure spars, ropes, or tackles. Generally an eye is at one end; sometimes an eye at either end; or a knot at one end and an eye at the other.

Beef.—Strength; generally the weight of the men hauling on a rope. "More beef here" is a request for help when hauling.

Before the Beam.—Towards the bow or stem of a vessel.

Before the Mast.—A term used to describe the station of seamen as distinguished from officers. Thus a man before the mast means a common sailor, and not an officer. The term owes its origin to the fact that the seamen were berthed in the forecabin, which is usually "before the mast."

Before the Wind.—Running with the wind astern.

Behaviour.—The performance of a ship in a sea-way or under canvas is generally termed by sailors her "behaviour."

Belay That.—An order given whilst men are hauling on a rope, &c. Also slang for cease talking or fooling.

Belay, To.—To make fast a rope or fall of a tackle. In hauling upon a rope the signal to cease is usually, "Belay!" or "Belay there!" Belay that, or "Avast hauling! Belay!"

To belay the mainsheet in small boats where the sheet travels on a horse through a block. The block will travel on the horse by a thimble eye strop; the sheet will be spliced to the clew cringle in the sail and rove through the block. Bring the fall of the sheet down to the pin under the stern seat, round which pin take a single turn; then take a bight and jam it between the sheet and the seat, and a slight pull will release the sheet. The sheet can be belayed in the same fashion by a turn taken under a thole pin in the gunwale; or a bight of the fall can be taken and made fast round

the sheet above the block by a slippery hitch. A plan for belaying a single sheet is shown in the accompanying sketch. A pin is fitted into the transom as shown. The fall of the sheet

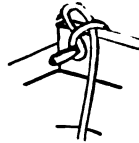

Fig. 194.

is brought round the pin outside the transom, then round the pin inside the transom, and a bight jammed in between the transom and sheet.

Belaying Pins.—Pins in racks, in cavel, spider hoops, &c., to make fast ropes to.

Belaying the Binnacle.—A slang term applied to a greenhorn who uses unseamanlike terms, or who does not know the duties of a seaman, &c.

Bell Buoy.—A buoy with an iron cage upon top of it, with a bell which is struck by a hammer or hammers moved by the heave of the sea.

Bells.—The manner of keeping time on board ship by striking a bell every half hour. Thus one bell is a half hour, as half-past twelve; two bells one o'clock; three bells half-past one, and so on until eight bells are struck, which would be four o'clock. One bell would then be begun again and proceed up to eight o'clock. Thus eight bells are struck every four hours, the duration of a watch (see "Watch"). (See page 121.)

Below.—A general term for the under-deck space. To go below is to descend from the deck to the cabin, or to under the deck. A seaman always goes "below," and never "downstairs." It is considered very green and landsman-like to hear a person on board a vessel speak of going "downstairs" for below, or upstairs for "on deck."

Below, or Below There!—A mode of hailing or attracting the attention of the crew below by those on deck.

Bend.—To fasten a rope to another; to fasten a rope to a spar; to bend a sail to a yard, &c. A knot, a mode of fastening a rope to a spar, &c.

Bends.—The wales of a ship. Stout planks on the side of a ship.

Beneaped.—Aground for want of water, owing to neap tides. The rise and fall of neap tides during quarter moons are less than during the full and change; consequently, if a vessel got ashore during a high water spring tide she might have to remain all through the neap period.

Bermudian Rig.—The mast of a Bermuda rigged boat is very long, and is placed far into the bow, which is usually very bluff. The mast rakes aft, and the sail set upon it is of the well-

known sliding gunter shape. The objection to the rig is the long heavy mast placed in the eyes of the boat, and although the sail stands well when hauled in on a wind, yet off the wind it causes some trouble, as it is almost impossible—except in very strong breezes—to keep the sail from falling on board.

Berth.—The situation of a ship when at anchor. A place to sleep in; a cabin. Employment.

Berthon's Collapsible Boats.—These boats were invented by the Rev. E. Berthon in 1851. They are made upon longitudinal frames with a double skin of stout canvas. When collapsed the gunwales fold outwards, back

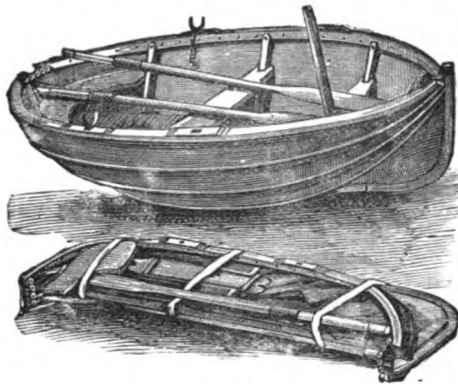

FIG. 195.

flat on the keel. (See Fig. 195.) A 7ft. dinghy which might suit a 5-ton yacht, will have 3ft. beam, and when folded only require space of 7ft. × 2ft. × 6in. The weight of such a boat is about 40lb.

A small boat 10ft. long weighs, with all the gear, about 80lb. A yacht's gig 26ft. long, 5cwt. The price of a boat 10ft. long is 14 guineas. The preceding sketch shows the boats open and collapsed. (See Water-proofing.)

From experiments made by the Admiralty (1878) with a 20ft. boat, intended for the use of troopships, a Berthon is not adapted to carry a great weight (60 "blue jackets" formed the weight), as after being rowed some distance the shores showed signs of straining, and it was anticipated that in a seaway the boat would have collapsed.

Berthon's Logs, or Speed Indicators.—A log invented by the Rev. E. Berthon. A tube passes through the keel, and the water rises in this tube in proportion to the speed of the vessel through the water. A simple mechanical contrivance of weight, line, and pulley serves to indicate the speed on a dial.

Bevel.—In shipbuilding, the departure from the square a timber is made to take to suit the inclination of a plank. An oblique edge of a piece of timber or plank.

Beveling Board.—A piece of wood used by ship builders on which the angle of the bevels for timbers are marked in lines.

Bibs.—Pieces of timbers fastened to the hounds of ships' masts to support the trestle trees.

Bight.—A loop or part of a rope doubled so as to form a loop, thus ∩.—The deepest part of a bay.

Bilge.—The round in a vessel's timbers where they begin to approach a vertical direction. (See page 116.)

Bilged.—A vessel is said to be bilged when her framing is broken in, or damaged along her bilge by grounding, or falling down when shored up by the side of a wharf.

Bilge Keels.—Pieces of timber fitted longitudinally on a vessel's bottom, so that she may take the ground readily and not damage her bottom. Bilge keels, however, now fulfil different offices and are fitted to large ships to assist in checking their rolling. The Brighton beach boats are fitted with bilge keels, and it has been argued that they prevent a boat making lee way; of course only the lee bilge keel can so operate, and the effectiveness of this one would be interfered with by the disturbed state of the water near it. Bilge keels, if very deep, would affect very greatly a boat's handiness in tacking; also the lee one would assist in heeling the boat to an extent dependent upon the force of the lee way, and the area of the bilge keel; on the other hand, bilge keels will tend to check the sudden heeling of a boat, for the same reason that they cause the process of rolling to be more slowly performed.

Bilge Kelsons.—Stout pieces of timber fitted inside a vessel in a fore-and-aft direction along the bilge to strengthen her.

Bilge Strakes.—Thick plank worked longitudinally in the ceiling of a vessel inside along the bilge to strengthen her—used instead of bilge kelsons, and through fastened.

Bilge Water.—The water inside a vessel, which in flat-floored crafts may rest in the bilge.

Bill.—A point of land; also the extreme points of the flukes of an anchor.

Bill Boards.—Pieces of wood fitted to the bow of a vessel to protect the plank from the fluke of the anchor.

Bill of Health.—A document wherein it is certified that the condition of the crew is healthy or otherwise. Hence a clean bill of health means that all the crew are free from disorders, and a foul bill of health the contrary.

Bill of Lading.—A document setting forth the cargo of a ship, certified by the master.

Bill of Sale.—A document by which a vessel is transferred from one owner to another. A "Bill of Sale" must be produced before a register can be transferred. Forms of Bill of Sale can be procured from Waterlow and Sons, printers and stationers, London.

Billy Buoy.—A bluff bowed vessel, common in the north, rigged with one mast, and commonly with a square topsail.

Binnacle.—A case wherein the compass is contained. (See "Compass" and "Fluid Compass.")

Bird's Nest.—(See "Crow's Nest.")

Birlin.—A rowing and sailing boat of the Hebrides.

Bitter End.—The end of a cable inside the bitts. The extreme end of a rope.

Bitts.—Stout pieces of timber fitted in the deck to receive the bowsprit; also stout pieces of timber fitted in the deck by the side of the mast, to which the halyards are usually belayed.

Black Book.—A book kept at the Admiralty, or said to be, wherein is recorded the offences of seamen. Several yacht clubs have kept "black books," but they have been of little use, as owners showed a disinclination to insist that no man should be engaged in his yacht who was on the "black book."

Black Paint.—A good mixture for the outside of a boat is thus made: to 6lb. of best black paint add half pint of good varnish and $\frac{1}{2}$ lb. of blue paint.

Or, Black 9lb.; raw linseed oil 1 quart; boiled linseed oil 1 quart; dryers $\frac{1}{2}$ lb.

For an iron yacht: 1cwt. of Astbury's oxide of paint; 6 gallons of boiled linseed oil; 1 gallon of turpentine; 3 gallons of varnish; 21lb. dryers. (Messrs Astbury's, King-street, Manchester.)



FIG. 196.

Blackening Down.—Painting or tarring the rigging, or sides of a ship.

Black Jack.—The black flag hoisted by pirates.

Blackwall Hitch.—A hitch used to jam the bight of a rope to a hook, &c. (Fig. 196.)

Blade.—The flat part of an oar.

Bleaching.—An American plan for bleaching sails is as follows:—Scrub with soap and fresh water on both sides, rinse well, then sprinkle with the following solution: slacked lime, 2 bushels; draw off lime water and mix with 120 gallons water and $\frac{1}{2}$ lb. blue vitriol. This also preserves the sails. (See "Mildew.")

Blind Harbour.—A harbour whose entrance cannot readily be made out from a distance.

Blisters.—Unsightly blisters on paint are generally caused by putting new paint upon the top of old, or using very thick paint. The old paint should be burnt or scraped off.

Block.—A pulley. A single block has one sheave; double, two; three-fold or treble, three; and so on. (See "Fiddle block.")

Block and Block.—Chock-a-block. When the blocks of a tackle are hauled close together. A vessel is said to take her main sheet block and block, when the boom is hauled so much aboard that the two blocks come close or nearly close together.

Blow, A.—A gale of wind.

Blue Jackets.—Sailors.

Blue Peter.—A blue flag with a white square in the centre; hoisted at the fore truck as a signal that the vessel is about to go to sea. Sometimes for brevity called Peter.

Blue Water.—The open sea or ocean.

Bluff.—A wall-like headland.

Bluff-bowsd.—Very full bowed, thus \cap .

Board.—In beating to windward a board is the time a vessel is on one tack and the distance she makes on that tack. Thus it may be a long board or a short board. Working to windward by a long board and a short board is when a vessel can more nearly lie her course on one tack than on another. Thus, suppose the wind be S.W., and the vessels' course from headland to headland S.S.W., and the vessel can lie four points from the wind; then on the starboard tack the vessel will head S., or two points off her course; on the port tack she will lie W., or six points off her course. The long board will be the one on the starboard tack. A vessel is said to make a good board when the wind frees her on one tack; a bad board when it heads her. A stern board is to get stern way on whilst tacking.—To board a ship is to enter upon her deck, generally supposed to mean without invitation.

"By the board." To fall close by the deck.

A mast is said to go by the board when it breaks by the deck and falls overboard.

Board and Board.—Vessels are said to work board and board when they keep in company and tack simultaneously.

Boat Building.—In the first place lay off the sections, keel and sternpost, and stem as described page 181 (see also the chapter on Canoes). [If the keel has a straight edge, top and bottom, it will not require to be laid off.] When the sections are laid off, proceed to make moulds to fit the curves; these moulds will be made of $\frac{1}{4}$ inch or $\frac{1}{2}$ inch deal or elm, any odd pieces of stuff will do, and there can be as many joints in a mould as may be found convenient: (See Fig. 197.) The cross piece A should be stout enough to keep the mould rigid. The diagonal braces D need not be used if the mould can be made rigid without them; in such case the joints in the mould should be secured by a doubling piece. The bar W.L.

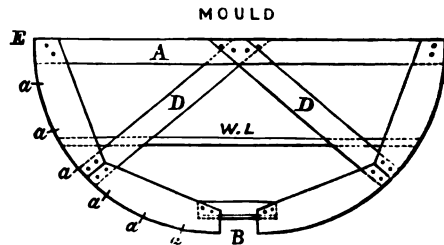

FIG. 197.

represents the load-water-line. B is the part that fits on the keel and represents the "joggle" in the floor-timber. The cross piece here should be securely attached and fixed so that the joggle is of the proper depth. A nail on each side of the mould, or a

Boat Building—continued.

couple of pieces of wood nailed to the keel, will keep the mould in position on the keel.

The outer edges of the mould must be planed up to fit the curve of the section as drawn on the mould loft. When floors or timbers have to be sawn out, and not steamed, the mould is laid over the timber and its shape marked on it by pencil or chalk.

The stem and sternpost are tenoned into mortices in the keel; but if the keel be not thick enough to take a tenon, the keel and stem, and keel and sternpost are box-scarped together by halves: that is, half the thickness of each is cut away.

In all the drawings of small boats given in the body of the book, the load-water-line is made the base-line, and therefore everything must be plumb to that.

Having got the stem, sternpost, and keel shaped and put together, proceed to fix them to the stocks. [A deal firmly fixed edgewise at a convenient distance from the floor—high enough to enable the builder to drive the nails up through the bottom of the boat—will make the stocks.] A straight edge or line must be fitted from stem to stern-post to represent the load-water-line as shown on the Sheer Plan: (See Plate II.)

Also a stout bar of wood must be nailed to stem-head and stern-post-head, above the one marking the L.W.L., to firmly connect the two; this bar will be found useful for nailing the mould stays to.

In fixing the keel stem and stern post frame on the stocks it must be wedged up forward until the line or straight edge representing the load-water-line is perfectly level or horizontal. A spirit level or plumb level can be used for this adjustment.

Fit the dead wood knee aft, and the stem knee or apron forward. Bore the holes for the through bolts with a long augur or gimlet. The heads of the bolts will be inside, and clenched outside over a ring: (See Plate II.)

Next the transom must be cut out from a mould and let into the sternpost and through bolted, as shown Plates II. and III. The edges of the transom will require to be bevelled to suit the fore-and-aft curve of the boat.

When the keel, stem and sternpost are on the stocks and in position (the stem and sternpost must be plumbed to see that they neither cant to port nor starboard), they must be secured by stays; the stays will be bars of wood and reach from the stemhead and head of sternpost to the floor or ceiling of the building-shed, and they must be securely nailed. The keel can be kept in its position by similar stays; or if the keel be quite straight on its underside it can be kept in its position by thumb cleats nailed to the deal forming the stocks.

The lower edge and upper edge of the rabbet in the keel, stem, and stern dead woods must be next set off, and cut out with a chisel. The aft dead wood will probably require some adzing away back to the rabbet.

Boat Building—continued.

The moulds must be next put into their proper places. Care must be taken that they are "square" to the keel (i.e., cross it at right-angles) that they are plumb (perpendicular) to the load-water-line, and that the bar W L (Fig. 197) is at the level of the line stretched between stem and stern-post to represent the load-water-line. The moulds must be kept in position by wood stays. A temporary gunwale can also be fixed round the moulds to assist in keeping them in position. Sometimes all the moulds are not fixed; but if there are no more than shown in Plate IV., they should be all fixed.

The planking will next be proceeded with. The width of the strakes will be in the widest part about $4\frac{1}{2}$ or 5 inches. Measure the half-girth of the midship mould (Fig. 197) from B to E by passing a tape or line round the outside curved edge. Divide this length into a number of equal intervals to represent the breadth of the strakes as *a, &c.* (see Fig. 197). Allowance must be made for about $\frac{1}{4}$ in. overlap of each plank which forms the lands.

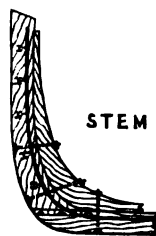

FIG. 198.

Count the number of intervals or strakes of plank, and set off the same number in equal intervals on the rabbet of the stem (see *a, a*, Fig. 198) and on the transom. These intervals will be much closer together than on the moulds, and will therefore show that the plank must taper towards the ends. The same number of intervals can also be set off on the intermediate moulds.

The garboard strake will be first fitted. This will be a strake quite straight on its upper edge before it is bent round the moulds from stem to stern post. The under edge will be cut to fit the rabbet in keel, and stem, and dead wood aft. When this plank has been fitted into the garboard and nailed at intervals of two or three inches to the keel, the next plank must be fitted. Take the board (out of which the plank is to be sawn) and hold it along as closely as possible outside the upper edge of the garboard strake. Mark a line along it to correspond with the top edge of the garboard. Remove the board and it will be found that the line is more or less curved. Saw down this curved line. Then fit the board to the garboard again, making it overlap (by its curved edge) the garboard by about $\frac{1}{4}$ of an inch. Now mark by spots on the upper edge of the board the next interval, representing the breadth of the

Boat Building—continued.

plank (see *a a*, Fig. 198) for each mould, including stem and dead wood or transom aft. Remove the board and run a line in through the spots representing the intersections *a a* on with the moulds; this will show the shape, or the curve of the upper edge, and the curve of the lower edge of the next strake. The plank may possibly be shaped like the sketch (Fig. 199), but the greatest curvature will be



PLANK
FIG. 199.

found as the bilge is reached. It is not absolutely necessary that the plank should accord with the spots *a a* at every mould, as the intervals are more as a guide to get the curve of the strake than to show the shape of the curve arbitrarily.

When the strake has been cut out it will be planed and then fitted to overlap the garboard; whilst it is being nailed it will be held in position by a number of clamps (at intervals of two or three feet.)

The clamps are made of two pieces of hard wood loosely connected by a screw bolt (see Fig. 200) and has a wedge. The bolt must

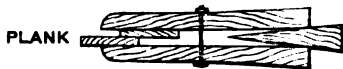

FIG. 200.

be allowed plenty of play, so that when the clamp grips the strakes it can be wedged up tightly as shewn.

The plank will be nailed together at intervals of 3 inches. The nails will be of copper, and will be rooved and clinched inside. At the stem and transom, the upper part of each strake is thinned away in order that the hood ends may fit into the rabbet flush.

To get the strakes round the bilge in a fair curve the upper outer edge of each strake is bevelled off (see Fig. 99, page 305), and sometimes the inner lower edge of the overlapping strake is also bevelled.

Holes should be bored for the copper nails by a sharp bradawl a little smaller than the nails. The roove having been put over the nail, the latter will be cut off by a pair of nippers, leaving about $\frac{1}{4}$ of an inch projecting above the roove. A "holder on" will be held to the head of the nail outside the boat, and the nail will then be clinched down over the roove inside the boat.

The boat being now planked up to the top strake, the floors and timbers must be put in. If the boat is a large one, such as the Brighton Beach boats (not the New Brighton boats, which are carvel built), the floors will be sawn out of timber of a suitable size (see page 229) and joggled (see Fig. 201) to fit in the lands of the plank; but joggles are objectionable as they weaken the floors. The floors should extend across the keel and into

Boat Building—continued.

the turn of the bilge; they will be fastened through the keel with a Munts-metal, or copper, or galvanised iron bolt, and, if thought necessary, clenched with ring. A copper nail will be driven through the plank (where two



FIG. 201.

strakes overlap), and be clenched on the top of the floor; frequently rooves are not used for these fastenings. A fastening is put through every overlap.

The timbers should be sawn out of a straight-grained piece of American elm, but sometimes English oak or ash is used; oak is generally preferred for the floors, and American elm for the timbers.

The timbers, having been sawn out, must be planed up, and will then require steaming to get them into their places. The timbers should extend from one gunwale across the keel to the other gunwale, but frequently, where stout floors are inserted, the timbers are not worked across the keel, and do not reach within 6in. of the keel; in such cases the timbers are in "halves."

A steam chest or kiln will have to be constructed (see Fig. 202). In length it should be a foot or so longer than the longest timber, and be a foot deep and a foot broad. It should be made of 1½in. deal. The end, *a*, is a door. Inside on the bottom should be nailed three or four cross pieces of wood, 2in. deep, for the timbers to rest upon, forming a kind of rack.

Steam can be generated in a common three-legged pot set up on bricks (see *k*). The pot should contain three or four gallons of water. The cover will be made of wood, cemented round with clay or mortar. *s* is a steam pipe (made of inch deal, inside size 3½in. by 3½in.); *p* is a plug for the water supply. The door, *a*, should fit inside the steam chest, and fillets

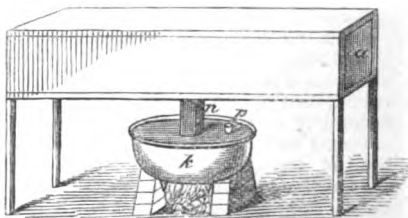

STEAM KILN

FIG. 202.

of inch deal must be nailed inside for the door to rest against. Before putting the door in its place, clay or mortar should be smeared round the fillets to keep the door from leaking. The door need not be hinged, but can

Boat Building—continued.

be kept in its place by a cross-bar of wood working through two staples driven into the ends of the chest.

The timbers will require steaming three or four hours before they are sufficiently pliable. They must be taken from the steam chest and fitted into the boat one by one; the first fastening to put in will be the one through or in the keel (a Muntz-metal dump is best for this). Press with the foot or hands the timber into the bilge, and put a fastening through it here (from the outside). The stations for the timbers should be previously marked across each plank strake, and the holes through the overlaps should be bored before putting the timber in.

If the timber has to be joggled to receive the inside edges of each strake (see Fig. 201), the fastenings must not be clinched as the timber will have to be removed for the joggles to be cut. The timbers, however, should not be removed until they are perfectly cool and rigid; they should be allowed to stay in the boat a day and night before removing. (If strength rather than neatness be required, the timbers should not be joggled.)

The gunwale must now be fitted (this is more properly termed the "in-wale," as it is the piece of timber which is fitted *inside* the top strake; it answers the purpose of the "clamp" used in larger boats). Having decided upon the size of the wale—its depth and thickness—it must be fitted. In the first place, the timber heads are cut down inside the top strake to the depth of the wale [one plan is not to cut the timbers so low as this by half an inch, and make joggles in the wale to receive the head of each timber; when this is done, however, the wale or clamp should be somewhat stouter, as it will be weakened by the joggles]. Usually the wale is flush with the top strake; but a better plan is to cut a rabbet in the wale (see Fig. 99, page 305) to fit over the top strake. A nail is put through the top strake and wale (from the outside), and rooved; or clinched without a roove, inside. A nail is put through about every 4, 5, or 6 inches. Forward, the wale top strake, stem, and apron are kept together by a breast-hook or >-shaped knee (see sketch A, Plate II., page 183). Aft, the wale and top strake are secured to the transom by a knee (see *m*, Half-breadth Plan, Plate II.). The thwarts will rest on the stringers (which are fastened through timbers and plank), as shown by *a a* and *b b*, Sheer Plan, Plate II. The thwarts are secured by knees, as shown Fig. 99, page 305. The knee is fastened through and out the wale and top strake, and with a long fastening through the overlap of strakes, and clenched with ring on the knee; there will also be fastenings through the thwart and knee.

In buying copper nails care must be taken that "land nails" are obtained for the plank fastenings, and "timber nails" for the timber fastenings. The rooves must match the nails.

Boat Building—continued.

A rooving iron (which is simply a kind of punch with a hole in its end) will be required to drive the rooves on whilst a hammer is held to the head of the nail. The sizes of the plank nails will depend upon the double thickness of the plank; about one-sixth of the double thickness should be added to the length of the nails for rooving and clenching.

If the boat is to be decked, a clamp or kind of shelf must be fitted to the timbers, and thoroughly fastened at each timber. The clamp will be fitted low enough for the beams to come flush with the top strake. The beams will be arched as required, and fastened through the shelf. The top strake should be of sufficient thickness to take the fastenings of the covering board. The covering board should be of hard wood, such as oak, and must be cut to fit the curve of the deck, as shown in the Half-breadth Plan.

The deck plank will be nailed to the beams by galvanised nails; not *through* the plank from the top downwards, but diagonally through the side edges of the plank into the beams.

The under edges of the plank will meet closely on the beams; but the upper edges will "gape," as shown, in an exaggerated way, by *a a*, Fig. 203; this is for the caulking. An eighth of an inch will give a wide enough



FIG. 203.

seam. The oakum or cotton thread (a couple of threads will be enough for inch plank) must be driven in tightly by the caulking chisel, and then payed with marine glue or stopped with putty (see articles on these subjects). Generally the arch of the beams will give the seam opening enough, as at *a a*; but, where it will not, the plank should be bevelled to the extent of a shaving. The seam round the covering board should be caulked and payed with extra care.

A hanging knee should be fitted on each side under the beam abreast of the mast or rigging. If the boat is wholly decked, three pairs of such hanging knees should be fitted.

If the boat is half-deck, waterways should be fitted. Short beams will be worked for these, and their inner ends will be butted into a fore-and-aft beam termed a carline, which fore-and-aft piece will in turn be butted into the full beams at either end. Two or three pairs of hanging knees (made of oak) will support the waterways.

Chain-plates for the rigging will be fitted as shown by Fig. 98, page 303.

The following are suitable sizes of timber or plank for a boat of these dimensions:—

Extreme length, 14ft. 2in.; beam, 5ft. 1in.; depth, 2ft.; elm plank, $\frac{1}{2}$ in. thickness;

Boat Building—continued.

American elm timbers, steamed, $\frac{1}{2}$ in. by $\frac{1}{2}$ in. ; all copper fastened, with copper stem-band, and rudder hangings; gunwales, American elm, $1\frac{1}{2}$ in. by 1 in. ; keel, elm, $2\frac{1}{2}$ in. wide, 4 in. deep below the garboard strake; false keel, 4 in. aft, running to 3 in. forward; three thwarts, the first from the stem 3 ft., second 5 ft. 11 in., third, 8 ft. 10 in. ; seats round the stern, width 1 ft., thickness all in, 1 in. ; ballast, when single-handed, three bags of beach gravel, length, 1 ft. 11 in., width, 1 ft. 5 in., weighing each about a hundredweight; with three hands on board one bag can be dispensed with, with four hands only one bag is in ordinary weather requisite; sails, sprit mizen, lug foresail, and jib. The following are the dimensions of the sails:—Jib, on the luff, 10 ft. 6 in. ; hoist or leach, 8 ft. ; foot, 6 ft. 6 in. ; standing lug-mainsail, 5 ft. 4 in. on the luff; head 9 ft. 6 in., leach 14 ft. 6 in., foot 9 ft. 4 in. ; a sprit mizen, measuring on the luff 5 ft., on leach 8 ft., on the foot 4 ft. ; length of sprit, 8 ft. 1 in. ; length of bowsprit, 7 ft. 10 in. ; diameter at outer end, 2 in. ; at heel, $2\frac{1}{2}$ in. Mast as long as can conveniently stow inside the boat on the thwarts; diameter at top, $2\frac{1}{2}$ in. ; at level of the thwarts, 3 in. ; distance of mast from the stem, 1 ft. 9 in., and stepped through a fore and aft thwart, fitted to the front thwart and extending forward until it butts against the apron piece at the back of the stem. The lug has a little boom, 2 in. diameter at the mast, and $1\frac{1}{2}$ in. at the after end. In lieu of jaws or gooseneck a hole is bored through the end where the jaws would be, to receive the tack of the lugsail, which is knotted below the boom, and thus keeps the boom in its place close to the mast; a hole is bored also through the thwart to receive the tack, one inch abaft the mast hole. The arrangement of the main sheet is as follows:—On the foreside of the after-thwart two wedge-shaped cleats are nailed amidship against the edge, which form a notch an inch deep. The mainsheet has a small thimble in it, 18 in. from one end, which is secured round the thwart and in the notch, hence it cannot slide from its position. Another thimble is seized by a grommet to the boom. The mainsheet is first rove through the boom thimble, and then through the first-named thimble, just above the level of the afterthwart. The mainsail thus works from side to side in going about, without the usual trouble of shifting the sheet from gunwale to gunwale. This arrangement is convenient for beating up channels, river sailing, or at sea when fishing, where a constant change of course is necessary every few minutes. For a freshwater lake or river it would be better to use fir or oak plank, as elm decays at the water-line in about three years. Elm is especially liable to decay, "between wind and water," but if entirely submerged will endure for ages.

Boat Chocks or Skids.—Pieces of wood with a score in them to take the keel of boats when they are lifted in upon deck.

Boats' Etiquette.—If the person in charge of a yacht's boat desires to salute a passing boat containing an admiral, captain, commodore, or other person of consequence, he directs the crew to lie on their oars as the boat passes, and to raise their hats or caps. The owner on leaving his yacht with a party is the last in the boat and the first out; and on leaving the shore is last to get into the boat and the first to board the yacht. This is the custom in the Royal Navy (the senior officer taking the place of the owner), in order that the admiral, captain, or other person might not be kept waiting alongside, which might be an unpleasant situation in bad weather. Thus the saying "the captain is the last in the first out of a boat." (See "Salutes" and "Ensign.")

Boat Hook.—A wood pole with a metal hook and prong at one end; sometimes with two hooks. A yacht's gig has two boat hooks—one for the use of the bowman, another for the stroke; by these means a boat is held alongside the steps of a jetty or by the gangway of a vessel, &c.

Boat Keeper.—The man left in charge of a boat when the other part of her crew go on shore.

Boat's Crew.—Men told off to always man a particular boat, such as the gig, cutter, or dinghy of a yacht.

Boatswain.—An officer who takes charge of a yacht's gear, and it is his duty to superintend all work done upon the spars, rigging, or sails. He also takes charge of all spare gear and sails, and sees that everything on deck and above deck is neat, clean, and ship-shape. He must in every sense of the word be a thorough seaman, and must know how all work upon rigging and sails should be done. As he has constantly to handle the sails and rigging, he necessarily has a knowledge of their condition, and it is his duty to report all defects in the same.

Boatswain's Call.—A whistle consisting of a hollow ball and a tube leading to a hole in it. By varying the sounds the men are "piped" to their work just the same as soldiers are ordered by the sound of a bugle. The pipe is seldom met with in English yachts, not even in those of large size, and the boatswain has little to do with giving orders.

Bobstay.—The bowsprit stay. (See page 27.)

Body.—Part of a vessel's hull, as fore-body, middle-body, and after-body. A vessel is said to be long-bodied when the tapering of the fore-and-aft lines are very gradual; short-bodied when the fore-and-aft lines taper very suddenly; a long-body thus means a great parallel length of middle-body. (See "Straight of Breadth.")

Body Plan.—A plan which contains the cross sections of a vessel. The midship section or largest section is generally shown on the right-hand side of the middle line of the body plan; sometimes on both sides.

Bollard.—A stout timber to fasten ropes and warps to.

Bollard Timbers.—The bollard timbers of a vessel are the same as the knightheads; originally the knightheads were carved figures of knights (fitted near the foremast to receive the windlass), hence the name knightheads. (See "Knightheads.")

Bolsters.—Pieces of hard wood bolted to the yoke or lower cap on the mast for the rigging to rest upon. They are sometimes covered with leather or sheepskin with the hair on, or raw hide, to prevent the rigging chafing. (See page 31.)

Bolt.—A fastening of metal. An eye bolt is a bolt with an eye in it used to hook blocks, &c., to. A ring bolt is a bolt with an eye and a ring in the eye. An ear bolt or lug bolt is a bolt with a kind of slot in it to receive the part of another bolt, a pin keeping the two together and forming a kind of joint (see C, Fig. 8, page 42). Bay bolts are bolts with jagged edges to prevent their drawing.

Bolt Rope.—The rope sewn round the edges of sails. It is made of the very best Biga Rhine hemp, dressed with Stockholm tar. A fore-and-aft sail is roped on port side, a square-sail on aft side. There is the weather (luff) rope, leech rope, foot rope, and head rope.

Booby Hatch.—A hatch on coamings used to give greater height in the cabin of small yachts, and which can be removed.

Boom.—A spar used to extend the foot of sails. To top the boom is to make sail and away. To boom off is to shove off a wharf, bank, &c., by the aid of spars. Stakes of wood used to denote a channel through shoal water are termed booms.

Boom Irons.—Iron bands on booms, with eyes, to which blocks or ropes may be hitched.

Boomkin.—A short boom of great strength, usually written "bumpkin."

Bonnet.—An addition to a sail by lacing a short piece to its foot; common in America, not often seen in British yachts.

Bore.—A sudden tide wave, which rolls along rapidly at certain times on some rivers, and makes a great noise.

Boreas.—The north wind. An old sailor's saying is, "as cold as Boreas with an iceberg in each pocket." Popularly the god that rules the wind, as Æolus is supposed to do.

Bore Away.—Did bear away. Said of a vessel that alters her course in a leewardly direction "as she bore away."

Bore by the Head.—A vessel is said to bore by the head when she, whilst passing through the water, is depressed by the head.

Boring.—When a vessel by bearing away or luffing forces another vessel to bear away or luff to avoid a collision.

Boss.—A slang American term for sailing master, or chief in command.

Both Sheets Aft.—When a square-rigged ship

has the wind dead aft, so that the sheets lead aft alike.

Bottom.—Usually understood as the part of a vessel below the bilge.

Bottomry.—The hull or bottom of a ship pledged as security for a loan. If the ship be lost the money is lost unless the lender has covered himself by other means.

Bound.—Encased with metal bands. Also referring to the destination of a vessel. Wind-bound means that a vessel is in a port or at an anchorage because the wind is unfavourable for her to proceed. Formerly square-rigged ships were everlastingly wind-bound, i.e., waiting in port because the wind was adverse; now they go out and look for a fair wind, and generally can sail so well on a wind that waiting for a fair wind would be considered an unpardonable piece of folly.

Bow.—The fore part of a vessel; forward of the greatest transverse section. In taking bearings an object is said to be on the bow if its direction does not make more than an angle of 45° with the line of the keel.

Bower Anchor.—The anchor in constant use.

Bow Fast.—A warp for holding the vessel by the bow.

Bowing the Sea.—Meeting the sea bow on or end on, or nearly end on, as in close-hauled sailing. When the sea runs true with the wind.

Bowline Haul.—The foremost man in hauling on a bowline sings out, "One! two!! three!!! haul!!!!" the weight of all the men being thrown on the rope when the "haul" is shouted out. This chant is sometimes varied, thus:

Heave on the bowlin'
When the ship's a rollin'—
One! two!! three!!! haul!

The origin of this probably is from the fact that when the ship takes her weather roll the sails lift and so some of the bowlines become slack and can be got in.

Bowline knot.—Formed thus: (Fig. 204.)

Bowlines.—Ropes made fast to oringles in the weather leech of squaresails, to pull them taut and steady when sailing on a wind. The bowlines usually lead into a bridle. Sailing on a bowline means sailing on a wind when the bowlines would be hauled taut; hence the phrase "sailing on a taut bowline." Sailing on an easy bowline means sailing with the sails well full, and the bowlines eased up a little, so that the vessel is not quite "on a wind" or close hauled.



FIG. 204.

Bow-lines.—Continuation of buttock lines, showing the outline of vertical fore-and-aft sections in the fore-body. (See "Buttock-lines.")

Bowse.—Hauling with a will upon a rope.

Bowsprit.—A spar projecting from the bow of a vessel. A running bowsprit is one that can easily be reefed in like a cutter's. Sometimes

- when a bowsprit is reefed in by the fids it is wrongly said to be housed; a bowsprit is housed when run close in to the crane iron. A standing bowsprit is one fitted in a bed and generally prolonged by a jibboom.
- Bowsprit Bitts.**—Timbers fitted into carlines on the deck to take the bowsprit. (See page 30.)
- Bowsprit Crane.**—The iron cap at the bowsprit end, to which the gear is hooked; in the case of the vessel having a jibboom the cap is a double one to take the jibboom.
- Bowsprit Shrouds.**—The horizontal stays of bowsprits. (See pp. 27 and 30.)
- Bozhauling.**—In tacking a ship to make her turn on her heel by hauling the head sheets a-weather, and getting stern-way on. Practised by square-rigged ships, sometimes in working narrow channels.
- Boxing off.**—Assisting to pay a vessel's head off the wind by hauling the head sheets a-weather.
- Box Scarph.**—A method of joining two pieces of timber by letting each into the other one-half its own thickness; sometimes termed a butt scarph.
- Box the Compass.**—To call over all the points of a compass in regular order. To understand the compass points and subdivisions. (See "Compass.")
- Braces.**—Copper, gunmetal, or brass straps fitted round the main piece of rudder or rudder-post and fastened to the sternpost. Strengthening pieces of iron or wood to bind together weak places in a vessel. Ropes used in working the yards of a ship.
- Braced Sharp Up.**—Said of a square-rigged ship when the weather braces are slacked up and the lee ones hauled in taut so as to trim the sails as close to wind as possible.
- Brace-up and Haul aft!**—The order to trim sails after a vessel has been hove to with sails slack.
- Brails.**—Ropes fast to the leeches of fore-and-aft sails and leading through blocks on the mast hoops; used to haul or truss the sail up to the mast instead of lowering it and stowing it.
- Breach.**—A breaking in of the sea. A clean breach is when a wave boards a vessel in solid form, and sometimes makes a clean sweep of the deck, taking crew, boats, and everything else overboard. To make a clean breach over a vessel is when the sea enters one side and pours out the other.
- Break Aboard.**—When the crest of a wave falls aboard on the deck of a vessel.
- Breakers.**—Caeks for containing water. Also the disturbed water over reefs, rocks, shoals, &c.
- Breakers Ahead!**—The cry when breakers are sighted close ahead.
- Break Off.**—In close-hauled sailing, when the wind comes more from ahead so as to cause the vessel's head to break to leeward of the course she had been sailing. Not to be confused with "fall off," which means that the vessel's head goes off farther away from the wind.
- Break tacks.**—When a vessel goes from one tack to the other.
- Breaming.**—Cleaning off a ship's bottom by burning the excrescences thereon. Sometimes when a vessel is not coppered small worms will eat into the plank. It is usual then to scrape her bottom, coal tar her, and then bream her off by fire in breaming irons.
- Breast Fast.**—A warp fastened to a vessel amidships to hold her.
- Breasthook.**—A strong >-shaped wood knee used forward to bind the stem, shelf, and frame of a vessel together. Breasthooks are also used in other parts of a vessel. They are now frequently made of wrought iron.
- Breeze, A.**—In sailor's parlance, a strong blow of wind; but generally a wind of no particular strength, as light breeze, gentle breeze, moderate breeze, strong breeze, &c. (See "Wind.")
- Breeze-up.**—The wind is said to "breeze-up" when it increases fast in strength from a light wind.
- Breezy Side.**—The windward side of an object.
- Bridles.**—The parts of moorings to hold on by; many ropes gathered into one.
- Brig.**—A two-masted vessel, square-rigged on both masts.
- Brigantine.**—A two-masted vessel, differing from a brig by being only square-rigged forward.
- Bring To, or Bring Her To.**—To luff or to come close to wind. To anchor. (See "Come To.")
- Bring to Wind.**—To luff a vessel close to the wind after she has been sailing off the wind.
- Bring Up.**—To come to anchor.
- Bring Up all Standing.**—To come to anchor, or to a stop suddenly without notice, or without any sail being lowered. To anchor without lowering sail.
- Bristol Fashion.**—In the best manner possible, Bristol shipbuilding and seamen formerly having a great reputation for excellence.
- Broach To.**—To come to against the wind and helm. (See page 103.)
- Broad Pennant.**—The swallow-tail flag of a commodore. (See "Burgee.")
- Broadside On.**—When a vessel moves sideways, or when she is approached by an object at right angles to her broadside.
- Broken Water.**—When waves lose their form by breaking over reefs, rocks, or shallows, or by meeting waves from another direction, termed a cross sea.
- Broom at the Masthead.**—A signal that a boat or vessel is for sale. The origin of the custom appears to be unknown; but it is ingeniously argued that brooms were hoisted as a signal that a man wanted to make a clean sweep of his vessel.
- Brought To.**—After a vessel has been sailing off a wind when she is brought to wind, or close to wind. Anchored.
- Brought Up.**—At anchor.
- Brought Up with a Round Turn.**—Figuratively, suddenly stopped; as for instance, when a

rope is being payed out rapidly, if a turn or bight catches round some object and checks the paying out of the rope.

Bucklers.—Blocks of wood used to stop the hawse pipes.

Builder's Certificate.—A document given by the builder of a vessel to the owner when she is handed over, setting forth the builder's name, the name of the ship, place of building, manner of building, rig, dimensions, tonnage, N.M., and concluding with the following declaration:—"This is to certify that [I or we] have built at _____, in the county of _____, in the year _____, the vessel _____. The measurement, tonnage, and description of which are given above.

As witness my hand, this _____ day of _____.

Signed,

This document must be produced when application is made for registration.

Builder's Measurement, or B. M.—(See "Tonnage.")

Bulkheads.—The athwartship partitions which separate a vessel into compartments, cabins, &c. Fore and aft partitions are also termed bulkheads.

Bull's Eye.—A block without a sheave, and with one hole in it. They are usually iron bound.

Bulwark.—The side of a vessel above the deck.

Bumboat.—A boat used by shore people to carry provisions on sale to ships.

Bumpkin.—(See "Boomkin.")

Bunk.—A bed or place to sleep in in a cabin.

Bunt.—The middle part of a sail. To gather up the bunt is take hold of the middle part of a sail and gather it up.

Bunting.—Woollen stuff of which flags are made.

Bunter.—A kind of tackle.

Bunt Lines.—Ropes attached to sails to haul them up by.

Buoy.—A floating mark.

Buoyancy.—The quality of floating or being supported or borne up by a fluid. A vessel is buoyant in proportion as she is bulk for bulk lighter than the fluid she is supported in.

Burden or Burthen.—Supposed to mean the quantity in tons of dead weight that a vessel will carry. The quantity would be the difference between the displacement of the ship when light and the displacement of the ship when she was laden as deeply as prudent.

Burgee.—A triangular flag flown at the truck as a kind of pennant. A commodore's pennant is a "swallow-tail" burgee. A vice-commodore's burgee has one white ball in the upper corner or canton of the hoist; a rear-commodore's, two balls.

Burgee, Etiquette of.—It is considered etiquette, if a yacht is on a station where there is a club established, and her owner is a member of the club, that the flag of that particular club should be hoisted as the yacht arrives on the station, although the owner may be the commodore, or vice, or rear-commodore of another club. Frequently, however, in such a case

the burgee is merely run up on arrival and then lowered and the commodore's pennant re-hoisted. If the yacht is a schooner, a flag-officer can fly his pennant at the main, and another club burgee at the fore. If several yachts are lying at an anchorage where there is no club, the yachts will fly the burgee of the senior flag-officer present; but if there be two flag-officers of equal rank present, then the flag of the one whose club is senior by virtue of the date of its Admiralty warrant will be flown. In the Royal Navy, if two or three ships are cruising in company, the title of commodore is given by courtesy to the senior captain present; but the rank does not seem very well defined, as, although an "appointed" commodore is said to rank next to a rear-admiral, yet he cannot fly his broad pennant in the presence of a "superior captain" without permission. In the case of the Yacht Navy, the senior officer would mean the one of highest rank; and where, in the case of clubs, the rank of the flag-officers is equal, seniority depends upon the date of the Admiralty warrant of the club which conferred the rank, and not upon the length of service of the officer; but a vice-commodore of a senior club does not take precedence of a commodore of a junior club. By the same rule, when several yachts are present belonging to clubs that have no Admiralty warrants, the date of the establishment of the several clubs would decide the seniority of flag-officers of equal rank, but clubs with Admiralty warrants always rank before those without. (See "Saluting," "Recognised Clubs," "Royal Clubs," "Admiralty Warrants," and "Ensigns.")

When the Royal Yacht Squadron was first established, members flew private signal flags, containing their crest or other device, at the truck. Owners of schooners in America fly such a flag at the fore when the owner is on board, club burgee always at the main. During meals American yachtsmen sometimes hoist a "dinner napkin," i.e., a square white flag at the fore. The Cambria in the Atlantic race flew her racing flag at the main, and the Royal Harwich Yacht Club burgee at the fore.

Burton.—A tackle composed of two single blocks; a double Spanish burton consists of two single and one double block.

Butcher's Cleaver Plate.—This plate has been devised to get a greater area of board im-

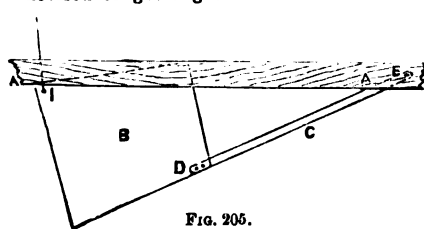

Fig. 205.

mersed without increasing its extreme dimensions, and thereby necessarily increasing the

size of the case inside the boat. The plate, instead of being pivoted at its fore end as usual, had an iron bar some two or three feet long riveted thereon; and the plate was then pivoted on this bar.

A is a portion of the keel of a boat 15ft. long.

B is the plate made of $\frac{3}{4}$ in. boiler iron 3ft. 6in. long, and 1ft. 4in. deep.

C is an iron bar $1\frac{1}{2}$ in. by $\frac{1}{2}$ in. riveted to the plate at D, and pivoted in the keel at E. The bar at D has "ears" or jaws, into which the plate is fitted and riveted.

The plate is lifted by a jointed bar bolted at I.

When the board is lifted the bar C fits into a groove made in the keel to receive it.

The probability is, as nearly half of the plate would be moving in disturbed water, that equally good results would be obtained from a triangular plate of half the area. It has been pointed out that the effective lateral resistance for any given plane would be considerably increased if one edge of the plane made a large angle with the direction of its motion; and for this reason a square plate of 3 square feet area would be not much more effective than a triangular one of $1\frac{1}{2}$ square feet area.

Butt.—The joining or meeting of two pieces of wood end-ways. Butt and butt means that two planks meet end to end, but do not overlap.

Butt End.—The biggest end of a spar.

Buttock.—The after-part of a vessel from her run upwards.

Buttock Lines.—Planes in a fore-and-aft direction, showing the outline of vertical fore-and-aft sections in the after-body.

By and Large.—Backing and filling, which see. (See also "Large.")

By the Head.—When the vessel is trimmed or depressed by the head so that her proper line of flotation is departed from.

By the Lee.—To bring a vessel by the lee is when nearly before the wind she falls off so much as to bring the wind on the other quarter; or the wind may shift from one quarter of the vessel to the other without the vessel altering her course ("See Lee"). (See page 103.)

By the Stern.—The contrary to being by the head.

By the Wind.—Close hauled; hauled by the wind.

By the Board.—Going or falling overboard.

C.

Cable.—A rope or chain by which a vessel is held at anchor.

Cable's Length.—A measure of one-tenth of a sea mile, 608 feet, or 101 fathoms, or 203 yards.

Caboose.—The cooking room or kitchen of a merchantman. Also the "galley fire" or cooking stove of a yacht or other vessel.

Cage Buoy.—A buoy with an iron framework upon the top. Formerly "cages" were put on poles in intricate channels, and for two

hours about the time of high water at night fires were lighted in them.

Call.—(See "Boatswain.")

Callipers.—An instrument consisting of a "straight edge" beam with two legs, used for measuring the breadth of yachts, packages of merchandises, &c. Metal bow-legged compasses called callipers are used for measuring the diameter of spars.

Cambered.—When the keel of a vessel has its ends lower than its middle, thus . Opposed to rockered.

Canoe, an unsinkable.—The following is a description of an unsinkable canoe built by a gentleman in Wales:

"This canoe could not, of course, compete in speed with an ordinary wooden one of its own weight in smooth water, but in a choppy sea has the great advantage of never requiring to be eased or turned to meet a sea, as she can take a sea on her beam without danger, being almost impossible to capsize, and three or four strokes will turn her round even in a heavy sea. In order to prove her buoyancy, we baled water into the cockpit (the only way we could fill it), till it would hold no more, the weight of water being about 3cwt. Then two men, about 11st each, got on outside, astride, one at each end, and the gunwale of the canoe and waterways were well out of water; this I think proves her practically unsinkable. I can confidently recommend this canoe for ladies' use, as one of mine has been constantly used by ladies this year, often in rough water, and has been approved of as "feeling safe," and keeping them dry. To insure the absolute safety of ladies canoeing, it is a good plan to have the back cushion separate from the seat, made of a small air cushion, covered with canvas, and strapped to the shoulders and belt by the corners. The appearance is the same as if an ordinary back cushion was used, which is a great point, as ladies invariably object to anything that looks like extra precaution for them.

Details of construction of zinc canoes, 11ft. 8in. long, 2ft. 10in. broad, 1ft. 1in. deep amidships, and 1ft. 5 $\frac{1}{2}$ in. at ends. Take two sheets of zinc of the usual size, 8ft. by 3ft.; get one and a half soldered together, making a sheet 12ft. by 3ft.; cut two strips of straight-grained deal, *free from knots*, 12ft. 6in. long, 2 $\frac{1}{2}$ in. broad, $\frac{1}{2}$ in. thick, to form strakes outside gunwale. Lay the zinc sheet on a level floor, placing the edges of the long sides on the strips of wood, care being taken that the edges correspond. Nail the zinc on the strip with half-inch tacks, put about $\frac{1}{2}$ in. apart (holes must be drilled in the zinc first with a pointed bradawl) in two rows, each row $\frac{1}{2}$ in. from the edge of the wooden strip, as shown at *a a a* in No. 1. This done, cut the ends of the zinc, as shown by dotted lines *b*, one of the edges thus cut being calculated to overlap the corresponding one by 1in. when they are brought together. Next cut the keelson out of a $\frac{1}{2}$ in. plank, 10ft. 5in. long by 6in. broad, the ends being

Canoe, an unsinkable—continued.

brought to a point, as shown, and screw the zinc firmly to it from the outside. No. 1 shows this part of the construction complete. Now take the end of the wooden strips, *a a*, *a a*, and join them together, lashing the overlapping ends firmly together with strong cord. No. 2 (*n n*) represents this stage. Cut out the bulkheads, as shown in No. 3, of strong deal, $\frac{1}{2}$ in. thick, and force them down at dotted lines *c c* in No. 2, and secure them with a single screw through each gunwale, thus forming the shape of the canoe at the gunwale. Next cut the stem and sternpost, as shown in No. 5, of $\frac{1}{2}$ in. deal, bevelling the outer edge almost sharp, and screw them on top of the ends of the kelson. Then bring the edges of the zinc *b b* together at bow end, No. 1, and screw with $\frac{1}{2}$ in. screws to the stem; turn down the overlapping edge, and screw firmly every $\frac{1}{2}$ in. up the stem. Proceed in the same way with the stern; cut off the overlapping end of the gunwale strips, and screw together with 2 in. screws. The whole skin of the canoe will take its shape with a little pressing in under the ends, to give it a tolerably sharp entrance whether the canoe be going ahead or astern. Now screw the bulkheads in their place with 1 in. screws, about 2 in. apart, and stop the joint round with white lead. To give strength to the bow or stern, raise one end of the canoe till it is at an angle of 45°, and pour a small quantity of boiling pitch on the joint of stem and kelson; allow it to set hard, and treat the other end in the same way. This will prevent the zinc yielding in case of a blow on the part where it is most liable to one.

“Now cut out roughly the decks for the compartments from bulkheads to bow and stern, and tack them on to the gunwales and bulkheads, first laying on strips of flannel soaked in white lead paint, a small support being nailed across half-way between bulkhead and end. Nail the deck with tacks $\frac{1}{2}$ in. apart, and screw every 6 in., and cut off the rough overlapping edges with a chisel, drawn sharply along the under side, guided by the gunwale strip.

“Cut the decks for the waterways outside the coaming, turning up the inner edge to join the coaming, and tack them on to the gunwales and bulkheads. These waterway decks must overlap the end compartment decks by 1 in. to form a strong joint when soldered. Cut the coamings of $\frac{1}{2}$ in. deal, 5 in. deep at

Canoe, an unsinkable—continued.

sides and foot, and 7 in. at back. Screw back and foot coamings on to bulkheads very firmly, fit side coamings inside, and screw to parts already fixed from outside of the latter, and fasten the waterway decks to side coamings by the edges turned up for the purpose. If required to make the sides under the waterways air-tight, take a piece of zinc the exact length of the cockpit, plus 2 in., and broad enough to reach from coaming to coaming. After forming a semi-circle to join the kelson, turn up 1 in. of each end, and cut small slits in the edge thus turned to enable it to bend,

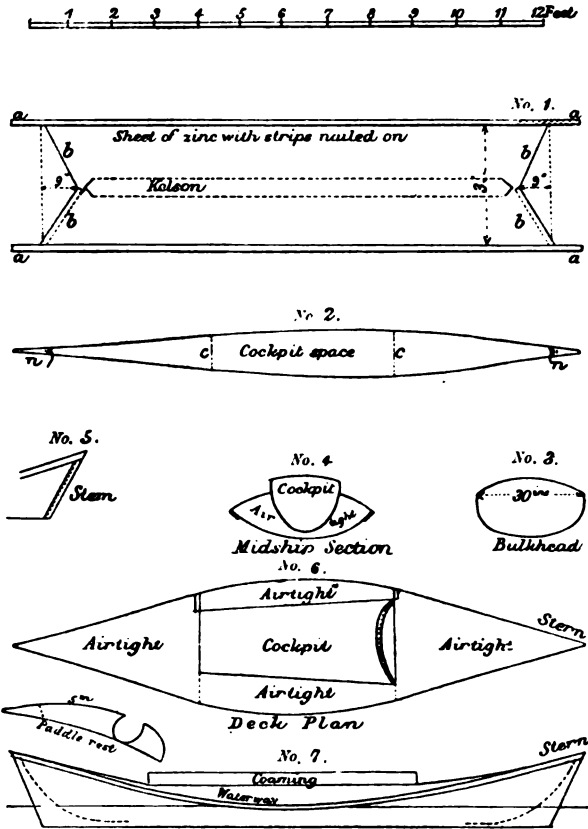

FIG. 206.

and screw inside coamings to kelson and bulkheads, leaving the cockpit semi-circular in section.

“To complete the canoe, solder all joints where zinc joins zinc, and white lead joints of wood and zinc. All screw heads must also be soldered over carefully. Paint first with two coats of white lead, and then according to taste. In case of a leak from any cause, it is the best plan to cut a plughole through the wooden gunwale into each compartment, and fit wooden plugs in to allow the water to drain out.

Canoe, an unsinkable—continued.

"Screw paddle rests on top of bulkheads outside coaming, and hinge the catch to retain paddle in rest on side of coaming. The paddle is jointed in the middle with an ordinary socket about 18in. long, so that the blades may be turned at right angles to each other in paddling against the wind. The seat is merely a cushion in the bottom of the cockpit. The apron is buttoned on studs outside the coaming; a strip of waterproofed canvas 6in. broad is tacked round inside the coaming at the back, and about 18in. down each side, to be turned up when going before a sea to keep spray out.

"The canoe, of which the description is given, has carried four persons (nearly 60wt.) with the cockpit full of water."

Canoe Hatch.—The double lines *c* are carlines, supposed to be seen through the hatch which is screwed to the two dotted ones; the ends of the latter are made to slide in a groove in the coamings. The middle carline is fastened to the deck and prevents the latter sliding too far, and stops the water getting into the well

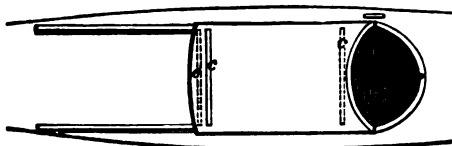

FIG. 207.

should any find its way under the hatch carline. A channel should be made round the rim of the well so that the person sitting therein could fit an apron or waterproof into it after the fashion of the Esquimaux.

A preferable plan is to have the hatch and the frame on which it slides separate, so that it will fit over the rabbets round the coamings; then if the canoe upsets, the hatch will float off and free the canoeist.

Cant Frames.—The frame in the bow and quarter of a vessel that are not square to the keel.

Canvas.—The weight of canvas used by Messrs. Laphorn and Ratsey for yachts' sails is as follows:

No. of canvas.	Width of canvas. in inches.	Weight of 60 yards in lbs.	Weight in lbs. per sq. foot when made up.	Size of yacht in tons.
0	18	61	0.270*	100 and upwards
1	18	57.5	0.255	40 to 60
2	18	54	0.240	20
3	18	50.5	0.225	15
4	18	47	0.210	10
5	18	43.5	0.195	7
6	18	40	0.182	5
7	18	36.8	0.165	3
1	12	40	0.265	40 to 60
2	12	37.2	0.250	20
3	12	34.4	0.235	15
4	12	31.6	0.220	10

* This includes the seams and tablings, but not roping, cringles, reef points, or lacing.

Canvas Back.—A term applied to boats covered with canvas to keep out the seas; also applied to yacht sailors who are fond of a salting.

Canvas-back Duck.—A wild duck common in America, and highly esteemed for the table.

Canvas Boats.—These are boats made of canvas and used by the Galway fishermen, particularly at Dingle. The ribs of the boats are made of wood hoop, such as may be got off oaks; outside the ribs battens are nailed in a fore-and-aft direction; a keel to which the ribs are also nailed is rounded up at the ends to form stem and stern post. The canvas is about two feet wide, and runs fore-and-aft. There is an inwale and gunwale as usual at the top of the ribs, the canvas going between the two. These boats are usually 20ft. by 4ft. They are very light, one man carrying them easily. They are manned by a crew of four, each man using a pair of oars. A lug sail is carried off the wind. These boats get through a great deal of rough water by aid of the eight oars they are propelled by.

The following directions for making canvas boats appeared in the *Field* :—

"For the keel get a piece of larch 15ft. long, 2½in. wide, and 2in. deep; the stem and stern posts, with rake according to fancy, may be mortised into the keel; these pieces must be bevelled off from the width of the keel, so as to have a cutwater of about half an inch, which will be sharp enough. Next get three good heavy blocks of wood, and lay them four feet apart in the place where you are going to build your boat; then take the keel with the stem and stern posts already in, and fix it perfectly true on the said blocks, using a spirit level for the purpose. The easiest temporary way of fastening the keel down is to nail short pieces of wood firmly to the blocks, just wide enough apart for the keel to jam between them, and drive a small nail through these pieces into the keel on each side; this will keep all firm, and prevent the keel from moving or twisting as you proceed with other work; it is an important point, and must not be omitted. This done, the next thing is to get a good stout spar, about 2in. or 3in. square, and longer than the boat; tack this on the top of the stem and stern posts; as it is necessary that this fore-and-aft piece should be stayed stiffly in its position, this can easily be done by tacking some rough pieces to it here and there, and nailing the other ends to the rafters of your shed. The uses of this spar are many and obvious. You will thus get your stem and stern posts true, and it will be useful afterwards to keep the moulds in their places, and for shoring out the timbers and ribbands or battens so as to keep them shapely to the eye as the work proceeds. Your next business is to make what shipwrights call "the moulds," which is to give the shape, beam, and depth. To make the moulds, first strike it out full size with a piece of chalk on the floor of some room. For a boat 15ft. in length, the width ought to be at least 4ft.,

Canvas Boats—continued.

the depth not less than 2ft. Do not let the curve of the sides be too sharp, but give her a good round side and a flattish bottom. Having made your moulds to the exact shape of the pattern chalked on the floor, nail a thin strip of wood across the upper (gunwale) ends, which will keep them stiff and true; next take the moulds and nail them on the keel in their proper places, fastening it above to the fore-and-aft piece. The moulds being now firmly fixed in their places, you may proceed to what in other boats would be called the planking. Saw out some thin strips of larch, about 20ft. long, 1in. wide, and a quarter of an inch thick. Six of these on each side would be sufficient. Having chamfered off a little from one of the ends to make it fit the stem of the boat, fasten it with two small copper nails; carry the ribband in your hand, and humour it gently round the moulds tacking it slightly there, and bring it on to the sternpost. You will probably find your piece too long; mark the required length, cut, and nail it in its place. In laying on these ribbands you must begin at the bottom of the boat, and work up. Having fixed your ribband both sides, get two long pieces the same width, only double the thickness, for gunwales, and fix them; fit a breast hook stem and stern, and rivet the gunwales securely to them. Saw out a lot of thin stuff for ribs, half an inch wide, and about the eighth of an inch thick; they will bend easily, and will not require steaming. Put these on about six inches apart, and rivet them to the battens. Next put in your thwarts, fixing them well down in the bottom of the boat, which will make her safer, the weight being near the keel. Get some copper, galvanised iron, or oak knees, with one leg long enough to reach from the gunwale down to the seat; rivet this well to the battens and gunwale, and nail the other part on the seat; there should be four to each thwart, as they help to strengthen the boat immensely. You may now take your boat off the stocks, and she will be ready for the next operation. Get some good new sail canvas, not too stout, and cover one side at a time; tack the edge of the canvas all along the bottom of the keel and pull it to the shape of the boat, tacking it neatly to the sides of the stem and stern posts. Where you find it does not sit well, you may sometimes avoid cutting by folding the spare stuff, and, with a sailor's needle and palm, sew it to the main body of the canvas. Do this on a warm day, as the canvas will then be quite supple, and more easy to handle. Nail a strip of wood half an inch thick on the bottom of the keel to keep all snug, and as an extra security drive a row of tacks through the canvas on each side of the keel. You must be careful to nail over the canvas some narrow strips of wood, as 'bilge pieces,' where you see she would take the ground when lying on her side, otherwise the pulling and dragging over the sand in launching, &c., would quickly wear the canvas through. With care, and

Canvas Boats—continued.

with an extra coat of paint now and then, a boat of this sort will last nine or ten years.

"The following suggestions will be found effective to prevent the puckering of the canvas skin of the proposed boat. A framework of 4ft. beam will require about three breadths of canvas on each side, and waste should be avoided by preparing paper patterns by which to cut out the canvas. To do this cut some old newspapers to the width of the canvas, and paste sufficient pieces together end to end to give the required length of the boat. Turn the frame of the boat upside down, and stay it in a horizontal position and upright. Lay the edge of the paper on the flat keel along the middle, place weights upon it, and measure off the distances from the middle line across the paper on the ribs, so as to keep the breadths horizontal from the middle to the stern and bow of the boat. Towards the bow and stern the breadths will be of course materially reduced. Remove the paper on to the floor, and draw a line from point to point marked on the paper at the crossings of the timbers. From this pattern you can easily cut out the two canvas strakes, one for each side of the boat against the keel, which are called the garboards. Replace the pattern; but, before doing so, mark the lower edge for the second breadth of paper, and, setting off the distances along the ribs to the width of the first pattern, you will be able to mark it out and cut it as the previous one. A double seam will be better than a single, as it will give great additional strength to the canvas, and the width of an inch and an eighth should be allowed for it. The lower edge of the third breadth can now be marked and cut out by the upper edge of the second, and if found to reach the gunwale, the top edge may be left uncut until the canvas is drawn over the framework. In applying the canvas to the keel, put plenty of thick paint on the inside to half the breadth of the keel, and nail the selvage with copper tacks along the middle line; then screw on with brass screws, at 6-inch intervals, a piece of elm plank $\frac{3}{4}$ ths of an inch thick, and exactly the same width and length as the keel. Between the 6-inch intervals drive copper tacks. A small strip of copper at the fore foot and heel will prevent this shoeing, as it is called, from catching in anything. To make a good finish at stem and stern, cut out the thickness of the stem and sternpost to the eighth of an inch from top to bottom, as in an ordinary boat, which will form a groove or rabbet, and when you come to this part fold the end of the canvas back. This will give additional strength for the nails, and at the same time make a very snug finish."

"A diagonal-framed canvas boat was built as long ago as 1844, and is still in existence. The canvas was stout, and it was very thickly painted when dry, and not wetted, as is frequently the case, to prevent the absorption of paint. The boat was built on three moulds,

Canvas Boats—continued.

the transom or stern board (for she is not canoe-formed at the stern) being one mould, the midship mould the second, and a third equi-distant between it and the bow. An inner keel or kelson having been connected with the stem and sternposts by mortices, this kelson was let into the moulds its own thickness, 1in., and secured. The moulds were steadied in their positions by the gunwales, of $\frac{1}{2}$ in. by 2in. yellow pine, nailed to the stern and transom board. The frame of yellow pine, $\frac{1}{2}$ in. by $\frac{1}{2}$ in., was then nailed on diagonally, leaving openings of 2 $\frac{1}{2}$ in. wide where crossing each other. The canvas, put on lengthways, was cut so as to run along the framework parallel with the kelson on each side; and the seams were sewn double, as sails are ordinarily made by sailmakers. There is one bottom and two side breadths, and, therefore, no join along the kelson. The canvas turns in over the gunwale, and is secured by a strip of the same wood. The framework is nailed with copper tacks. The canvas, being so well supported, is perfectly rigid, and the boat appears likely to last a number of years."

Canvas Coracle.—Such a boat (Fig. 208) was built by Capt. J. Richards, E.N., in 1878, for the river Avon, 12ft. long, 3ft. wide, and 15in. in depth. She has a frame of American elm, fastened with rove and clenched copper nails and wire; her floor is nearly flat, formed of $\frac{1}{2}$ in. white pine wood, lined inside with sheets of

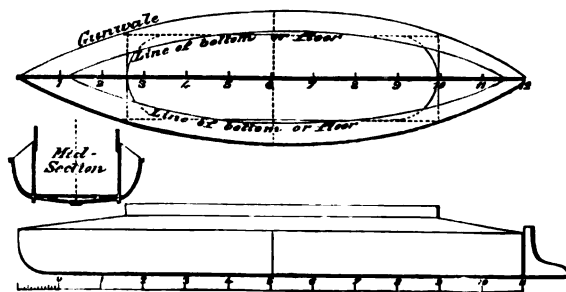

FIG. 208.

cork to fill up the spaces between the timbers, and form a level and solid platform within. Above the floor and outside the timbers (which are 6in. apart, and twenty-three in number), instead of the planking of an ordinary boat, there are stout fore-and-aft stringers of American elm three inches apart, outside all of which is stretched the thick No. 1 canvas skin of the outer boat. The principal materials required are keel of 1in. square ash; gunwale, 1in. square ash; cross-pieces of gunwales, 1in. square ash; keel chafing pieces, $\frac{1}{2}$ in. by $\frac{1}{2}$ in. ash; fore-and-aft stringers, $\frac{1}{2}$ in. by $\frac{1}{2}$ in.; bilge stringers, $\frac{1}{2}$ in. by $\frac{1}{2}$ in.; twenty-three timbers, $\frac{1}{2}$ in. square.

Within this structure and securely attached to it, although quite distinct from it, there is

Canvas Coracle—continued.

an inner canvas boat, 8ft. long and 2ft. wide (having a separate gunwale), in which the crew sit on the floor.

The deck space between the gunwale and coaming is entirely covered in by canvas, supported on a strong framework of wood and cane; and, being under ordinary circumstances quite secure from wet, was intended by Capt. Richards for the stowage of bedding, clothes, and provisions of the crew.

The gunwale and the coaming are strongly braced together, and the ends of the gunwale are additionally secured to the stem and sternpost by strong iron plates, with eye-bolts above, in which are rove stout ropes, to moor the boat with when afloat, or suspend her to trees like a hammock whenever her crew may desire to sleep in that position.

The coracle is fitted with a couple of small light wheels and iron axle (weighing only about 12lb., and movable at pleasure in about a couple of minutes), which when attached to her keel afford her the locomotive advantages of a porter's truck.

The twelve-foot coracle weighs about 90lb., and draws three inches water when light; but, with her crew of two men and her gear on board, at her late trial she drew five inches forward and seven aft. An inch of this, however, is due to her false keel, which, with bilge pieces, give ample lateral resistance when under sail in a seaway.

The entire structure was well saturated with boiled linseed oil, and then painted.

The inner boat can be disengaged at the gunwale, and removed altogether in about four minutes.

One of the principal advantages claimed for this "double-shell boat" consists in the fact that the outer boat may be stove in without rendering her unserviceable or wetting her crew; and so long as the outer boat is intact, a sea may be accidentally shipped in the inner boat without dangerously affecting the stability of the vessel; and should both the outer and inner boats be swamped with water, the cork floor and cushions will, nevertheless, still afford her the properties of a life buoy sufficient for her crew. (See "Coracle Lifeboat.")

The builders of these boats are Messrs. Hill, Canon's Marsh, Bristol. Price £6 10s. Carriage by rail 1d. per mile.

Cap.—A figure of 8 iron band fitted to the mast-head, bowsprit end, for jib-boom, &c. Sometimes the yoke is termed the lower cap.

Capful of Wind.—A puff of wind soon passing away.

Capstan.—A mechanical contrivance for raising the anchor. Capstans very compact in form are now made for yachts instead of the cumbersome windlass. The one most generally in use is manufactured by Harfield and Co.,

Mansion House Buildings, E.C. Cantelo, of Southampton, manufactures a capstan that can be used without capstan bars.

Capstan Bar.—Bars of wood by which the capstan is turned, and so made to wind up the anchor or raise any weight.

Capstan for a Trawl.—A capstan for a trawl for a yacht of twenty or more tons is made at the Mount's Bay Foundry, Cornwall.

Card.—The dial of a compass upon which the points are marked.

Cardinal Points.—The compass points, E., W., N., and S.

Careem.—To heel, to list, to lean over.

Carlines.—Pieces of timber fitted between the deck beams in a fore-and-aft direction.

Carry Away.—The breakage of a spar, rope, &c.

Carry Canvas.—A vessel is said to carry her canvas well if she does not heel much in strong breezes.

Carvel Built.—Built with the plank flush edge to edge, and the seams caulked and payed.

Cast.—Said of a ship when she fills on one tack or the other after being head to wind. Used generally in getting under way, as cast to port, &c. The word is variously used, as to cast anchor, to cast off a rope.

Catamaran.—A small raft common in the East Indies. A double boat in use in America. (See p. 354.)

Cat Block.—The block used in catting the anchor.

Cat Boat.—A boat with one sail, like a Una boat.

Catch a Turn.—To take a turn quickly with a rope round a belaying pin, or bitt, or cavel.

Cathead.—Timber or iron projection from the bow of a vessel by which the anchor is hoisted up to the rail, after it has been weighed to the hawse pipe.

Catspaws.—In calms, when the water is rippled here and there with passing airs of wind, it is said to be scratched by catspaws. A "catspaw" is also a bight double in a rope.

Caulking.—Driving oakum into the seams of a vessel. (See "Marine Glue.")

Caulking Iron.—A kind of blunt chisel used for driving oakum into the seams.

Caustic Soda.—A mixture of three-parts of soda to two of unslacked lime. The soda is boiled in the water, and then the lime added. The mixture should be applied hot, and be of the consistency of thick whitewash. In applying it great care should be exercised so as not to allow it to touch the hands. A brush of vegetable fibre should be used, as the composition will destroy hair. Caustic soda is used for cleaning off old paint or varnish; the mixture should be put on nine or ten hours before it is scraped off if a very clean job is desired. If it is a deck that has to be cleaned it is desirable to damp it with fresh water

before an application of the mixture; hence it is a good plan to apply it on a dewy morning. Mahogany should be scraped, and not cleaned with caustic soda. A mixture of two parts soda and one part soap, simmered together and applied hot, is sometimes used.

Carson's "Detergent" (La Belle Sauvageyard, London), is an excellent substitute for caustic soda, but care should be taken in using it for decks, as it injuriously affects marine glue. (See also "Soojee Moojee.")

Cavel (sometimes spelt "kavel" or "kevel").—Stout pieces of timber fixed horizontally to the stanchions on bitts for belaying ropes to.

Ceiling.—The inside planking of a vessel.

Centre-board (a Temporary).—Make a board of the shape of either of those in the sketch (Fig. 209) about one-third of the length of the boat. Three bolts will be on the upper edge of the board; the centre bolt will have a thread longer than the other two, and protrude through the keel. When the board is

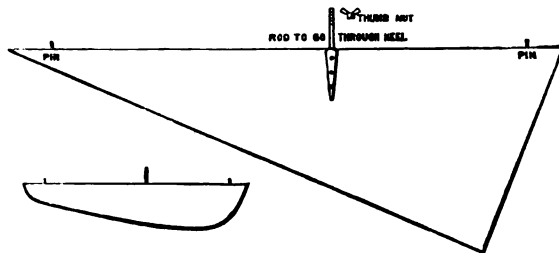

FIG. 209.

fitted under the keel, it will be held tight to the keel by a thumb nut on the centre bolt. To unship the board when afloat unscrew the thumb nut, push the board down, and it will float up alongside. A cork will be put into the bolt hole. Of course the board cannot be shifted when the boat is afloat. It would be unsafe to sail about in shallow water with such a contrivance; nor should the boat under any circumstances be allowed to take the ground with the board fixed.

Another form of temporary board (Fig. 210) has been fitted to an ordinary boat, 18ft. long.

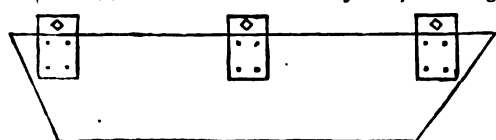

FIG. 210.

It consists of a board, to which are affixed iron clamps on either side, which admit of the main keel being inserted between them; through these are passed bolts with nuts, which firmly hold the two keels together.

The dimensions of a board for an 18ft. boat are 6ft. long, 1ft. 10in. deep, and 1½in. thick. The board is to be about 1ft. 6in. shorter on its under side than on its top side, the fore end sloping aft, and the aft end

- aloping forward; but the slope at the fore end is nearly double that at the aft end.
- Place the centre of the board a trifle in advance of the centre of the main keel; it can be fixed in five minutes when the boat is in the davits; only one word of caution is necessary, that is, not to tow her with the keel on behind the yacht when sailing, or in all probability she will take a sheer out and capsize.
- This plan was introduced by Mr. G. H. Harrison, of the *Siesta* schooner; but it is not quite so good as the American plan on the other page, because it cannot be unfitted or released whilst the boat is afloat; and, moreover, a triangular shape is to be preferred.
- Chain Pipe.**—Iron pipe on the deck through which the cables pass into the lockers.
- Chain Plates.**—Iron braces on the side of a ship to which long linked chains are attached with the dead eyes for the lanyards of the rigging above.
- Channel Plates.**—Braces secured to the sides of vessels and extended by pieces of timber termed channels. The lower dead eyes are bolted to the channel plates.
- Channels.**—Strong pieces of timber fixed on the side of a ship inside the chain plates to give greater spread to the rigging.
- Check, To.**—To check a sheet is to ease it a little. To check a vessel's way as by a warp, or by backing a sail. To check a tide is to keep a vessel from her course, in order to allow for the influence or drift of a tide. A vessel is said to check the tide when it throws her to windward. To check a vessel with the helm is to prevent her altering her course. (See "To Meet.")
- Cheek Blocks.**—A sheave fitted on a spar inside a sort of cleat, as the cheek block for top-sail sheet on the end of a gaff. (See pp. 59 and 66.)
- Cheeks of the Mast.**—The hounds.
- Cheering.**—The loud, deep, and sonorous "hip, hip, hurrahs!" which the crew of a vanquished yacht greet the victrix with. A custom much honoured. The crew of the vanquished yacht line the bulwarks and give three consecutive "hip, hip, hurrahs!" the winning crew then does the same; the vanquished crew then give a single "hip, hip, hurrah!" to "come up with," or finish off. (See "Man Ship.")
- Chill.**—In very light winds, if a cloud passes overhead and a puff comes out of it, it is called a chill—probably on account of its coldness.
- Chinese Lug.**—A lug sail with battens.
- Chips.**—A nickname for a ship's carpenter.
- Chock.**—A block or wedge of wood.
- Chock a Block.**—Said of two blocks when, in hoisting or hauling, the two blocks of a tackle are brought close together. Generally when two things are brought so close together that they cannot be got closer.
- Chock Full.**—Full to the brim. Frequently used in close-hauled sailing to let the helmsman know that the sails are full enough, and he need keep her no more off the wind.
- Chock Home.**—Close up.
- Chopping Sea.**—A short, steep sea, which makes a vessel continuously pitch and 'scend.
- Chuckle-headed.**—Full or bluff in the bow thickheaded.
- Chuck to Windward.**—A weather-going tide is said to chuck a vessel to windward, and the contrary a lee-going tide.
- Circumference of a Circle.**—The diameter multiplied by 3.14159; in algebra denoted by the Greek letter π .
- Clamp.**—A thick strake of wood worked inside a vessel under the shelf.
- Clamps.**—A kind of wedge vice, used in boat-building to hold the plank together. (See "Boat Building.")
- Clamps.**—Various contrivances of wood or metal used in fitting up a vessel or in fixing parts in her construction.
- Clap on Canvas.**—To put on more canvas. "Clap on here" is a request frequently made to idlers to assist in hauling on a rope.
- Claw.**—To hang well to windward, as to "claw off a lee shore."
- Claw to Windward.**—To beat to windward under difficulties. To claw off a lee shore is to beat off and avoid getting stranded.
- Clean Full.**—Barely close-hauled; when all the sails are full.
- Clear for Going About.**—A question often asked when work is being done on deck, and the vessel has to be put about: "Are ye all clear there for going about?"
- Cleats.**—Pieces of wood with one or more arms fastened to spars, &c., for belaying to, or to prevent ropes slipping, &c. (See "Thumb Cleats" and Cruickshanks' Patent Safety Cleats.)
- Clench Work** (spelt also "clencher," "clincher," and sometimes "clinker.")—In boat building when the edges of the plank overlap, forming lands.
- Clew.**—The lower corners of a square sail; in fore-and-aft sails only the lower after corner is called the clew.
- Clew Lines.**—Clew garnets. Ropes used for hauling up the clews of sails. (See page 27.)
- Clew Up.**—To haul up a sail by the clew lines for furling, &c. Also used as a slang term for shut up or cease.
- Clinch.**—To fasten a rope by a half hitch, and seize the end back to the other part; a method adopted with very large ropes or hawsers after they have to be bent to rings, &c., in a hurry. To clinch is also to beat the end of a bolt or rivet until it forms a head; or to turn the end of a nail in so that it will not draw.
- Clinometer.**—An instrument for measuring the angle of inclination or the extent of heel a ship has under canvas or whilst rolling.

Clip Hook.—A double hook (hinged to the eye) whose parts overlap when attached to a ring,



FIG. 211.

&c. A hook not much in favour, as it so frequently breaks or gets half detached.

Clipper.—A fine ship; first applied to the sharp-bowed ships that sailed out of Baltimore, U.S.

Clipper Stem or Bow.—An overhanging stem or prow.

Clock Calm.—So calm and still that the ticking of a clock could be heard.

Close Aboard.—Near to, as the land is said to be close aboard when a vessel has approached it very closely.

Close-hauled.—With all the sheets trimmed flat aft, and every rope that helps extend the sails hauled taut. Hauled as close to the wind as the sails will admit without shaking their luffs. When a square-rigged ship is close-hauled she is about from five to six points of the wind. A fore-and-aft schooner, with everything nicely trimmed for racing, will lie within four and a half points of the wind; a cutter within four and a quarter points. This, of course, supposes the water to be smooth and the wind of what is known as "wholesail strength." In rough water a vessel cannot be sailed so close; in the Atlantic race between the Cambria and Dauntless, the former, although she had head winds for a large part of the time, for two reasons was never hauled up closer than six points: generally there was too much sea to admit of it without being half hove to, and in such long passages it was thought better to sail her along hard on the chance of the wind freshing; or if it headed her she could have been put on the other tack. (See "Wind.")

Close Reefed.—When the last reef is taken in, generally the fourth reef; but some modern schooners with laced mainsails have only three reef bands, and it is thought that when the fourth reef is wanted that it is time to set the trysail.

Close to Wind.—Close hauled. As close to the wind as the sails will bear without lifting.

Clothes.—The outfit given to a yacht's crew by the owner, consisting of trousers, frocks, caps, shoes, and neckerchief. When the yacht is paid off the men take the clothes with them, but if a man is discharged for misconduct, he is made to leave his clothes behind. Under any circumstances the men have no legal right to the clothes if the owner chose to retain them, as it is only a kind of livery.

Clothes Lines.—A sail is said to be across a clothes line when it is girted by a rope. Lines used on board men-of-war for drying the sailors' clothes on washing days.

Cloth in the Wind, A.—When the foremost cloth or luff of a sail is shaking through the vessel being brought too near the wind. A man is said to be three cloths in the wind when intoxicated.

Clove Hitch.—(See "Scowing an Anchor.")

Club Hauling.—(See page 87.)

Coal, Consumption of.—With engines of the old type a steamer consumed from 4lb. to 6lb. of coal per indicated horse-power per hour. With compound engines the consumption is from 2lb. to 3lb. per horse-power per hour.

Coamings.—A raised frame fitted to and above the deck for the hatches, skylights, &c., to rest upon.

Coats.—Painted canvas used to cover sails when they are stowed.

Coated.—Sails stowed and covered up by the coats.

Coble.—A boat common on the Yorkshire coast. Said to run over a sea very dry. The pecu-



FIG. 212.

liar deep rudder makes them steer well in a sea. (See page 331.)

Cockpit.—In a man-of-war, part of the ship below water where the middies were berthed, and where the wounded were attended in time of action. A kind of well in the deck aft, common in American yachts and in some small ones in this country.

Coil.—Ropes packed up in rings one over the other. To coil away.

Cole's Anchors.—(See "Anchors.")

Collar.—An eye or bight of a shroud, stay or rope to go over the masthead as the collar of the forestay. Also a rim on a bolt.

Collier.—A vessel employed to carry coal.

Collision.—When one vessel comes into contact with another.

Colours.—Flags denoting nationality, ownership, or other identity.

Comb.—The crest part of a wave.

Comber.—A big surf-like wave.

Combings.—(See "Coamings.")

Come no Nearer.—An order to the helmsman not to bring the vessel nearer the wind.

Come on Board, Sir.—A seaman's laconic speech when he reports his arrival on board to an officer in charge after leave.

Come To.—To fly up in the wind; to come nearer or closer to the wind; to luff. Generally used when a vessel comes nearer the wind after having falling off the wind.

Come Up.—Generally to slack up. Whilst hauling on the fall of a tackle and the order comes, "Avaat hauling there," the hand that has to belay sings out, "Come up behind;" all hands instantly release the fall, so that the one who has to belay may catch the turn round the belaying pin or cavel without "losing any." (See "Hold on the Fore Side" and "Belay.") In slang an admonition to cease fooling.

Come Up, To.—A vessel is said to come up when the wind frees her so that she can head nearer her course, or look, or point her course. In beating, a helmsman in reporting the progress made by the vessel may say, "She has come up two points this tack, sir," according to the extent of the wind freeing; if the wind came more ahead, he might say she has broken off or fallen off two points, &c.

Come up With.—To overtake; also to finish off, as to "come up with a round turn," meaning as the crew left off hauling one had to take a sudden turn of the rope round the cavel, &c., to belay.

Commodore.—A rank conferred by clubs upon members; and there are Commodores, Vice-Commodores, and Rear-Commodores. Their duties are to see that the laws of the club, especially those that apply to matters afloat, are properly carried out. Commodores fly the broad pennant or swallow-tail burgee. (See "Burgee.")

Companion.—The entrance from the deck to the below cabins.

Compass Bowl.—The bowl within the binnacle containing the compass.

Compass Card.—A circle divided into 32 parts, called points; and each part is again divided into 4 parts, and the whole is divided into 360 degrees.

Courses.	Degrees.	Points.	Back Bearings.
N.	0 0 0	0 point	S.
N. † E.	2 48 45	†	S. † W.
E. † E.	5 37 30	†	S. † W.
N. † E.	8 26 15	†	S. † W.
N. by E.	11 15 0	1 point	S. by W.
N. by E. † E.	14 3 45	†	S. by W. † W.
N. by E. † E.	16 52 30	†	S. by W. † W.
N. by E. † E.	19 41 15	†	S. by W. † W.
N.N.E.	22 30 0	2 points	S.S.W.
N.E. by N. † N.	25 18 45	†	S.W. by S. † S.
N.E. by N. † N.	28 7 30	†	S.W. by S. † S.
N.E. by N. † N.	30 56 15	†	S.W. by S. † S.
N.E. by N.	33 45 0	3 points	S.W. by S.
N.E. † N.	36 33 45	†	S.W. † S.
N.E. † N.	39 22 30	†	S.W. † S.
N.E. † N.	42 11 15	†	S.W. † S.
N.E.	45 0 0	4 points	S.W.
N.E. † E.	47 48 45	†	S.W. † W.
N.E. † E.	50 37 30	†	S.W. † W.
N.E. † E.	53 26 15	†	S.W. † W.
N.E. by E.	56 15 0	5 points	S.W. by W.
N.E. by E. † E.	59 3 45	†	S.W. by W. † W.
N.E. by E. † E.	61 52 30	†	S.W. by W. † W.
N.E. by E. † E.	64 41 15	†	S.W. by W. † W.
E.N.E.	67 30 0	6 points	W.S.W.
E. by N. † N.	70 18 45	†	W. by S. † S.
E. by N. † N.	73 7 30	†	W. by S. † S.
E. by N. † N.	75 56 15	†	W. by S. † S.
E. by N.	78 45 0	7 points	W. by S.
E. † N.	81 33 45	†	W. † S.
E. † N.	84 22 30	†	W. † S.
E. † N.	87 11 15	†	W. † S.
E.	90 0 0	8 points	W.
E. by S.	92 48 45	†	W. by N.
and so on.			

* It is customary in the Royal Navy to call this N.N.E. † E.; N.N.E. † E.; N.N.E. † E., then N.E. by N. Either way is correct. Sometimes also E. by N. † N. is called E.N.E. † E.; or N.E. by E. † E. is called for shortness E.N.E. † N. The table, however, gives the more correct way. In calling off the points avoid such "lubberisms" as N.E. by E. † N. for N.E. † E., or S. by W. † S. for S. † W., &c.

It is commonly believed that the mariner's compass was introduced into Europe in the fifteenth century, but it seems to have been well known in a primitive form in the twelfth and thirteenth centuries. In one of the popular songs written in the time of King John, it is related that the sailors who went on long voyages to Friesland and the East, knew their way by observing the polar star, but, when the sky was covered with clouds, and they could no longer see the stars of heaven, they had a contrivance which consisted of a needle of iron put through a piece of cork so that one end remained out. This they rubbed with the loadstone, and then placed it in a vessel of water, and the needle pointed without error to the polar star. This formed a primitive but fairly perfect mariner's compass. If an ordinary needle be rubbed on a magnet and gently dropped into a glass of water it will float and point to the north. (See "Fluid Compass.")

Compass Point.—The 32nd part of 360 degrees, or practically 11¼ degrees.

Complement.—The full number; the whole ship's crew.

Composition for a Boat's Bottom.—Day's composition has been much used for coating the bottom of boats. It is said to prevent the growth of weeds, barnacles, &c. The boat should have a coat of common varnish first, and the composition should be applied before the varnish is quite dry. Only a part of the boat should be varnished at a time, or the varnish will dry before the composition can be put on. One gallon carefully put on will cover about 400 square feet or the immersed surface of a 10-tonner. The composition should be kept well stirred whilst being used, as the ingredients are heavy, and soon settle to the bottom. Day's address is Forest Hill, London. (See "Jesty's Composition.")

Peacock's composition has been used on iron ships with good effect. The composition can be obtained of Messrs. Peacock and Buchanan, Southampton. This composition should be applied in the same manner as Jesty's. Two, three, or four coats of black varnish, or coal tar, should be first put on. The plates of an iron yacht should be thoroughly cleaned of rust, &c., before applying the varnish. (See "Coal Tar or Black Varnish.")

The Protector Fluid Company, 8, Leadenhall-street, E.C., have a poisonous composition, said to very effectually prevent the growth of barnacles.

The following composition was patented by Mr. A. C. A. Holsappel, 15th March, 1879. The composition consists of:—(1) 5 parts coal tar or black varnish; (2) 25 parts methylated spirit; (3) 10 parts rosin; (4) 5 parts shellac; (5) 3 parts pine oil; (6) 32 parts colouring matter, amber, brown, and oxide of iron; (7) 2 parts chloride or oxide of mercury; (8) 12 parts sulphide of antimony; (9) 6 parts arsenic. Substances 8 and 4 are dissolved in 2; then 1, 5, and 6 added, and

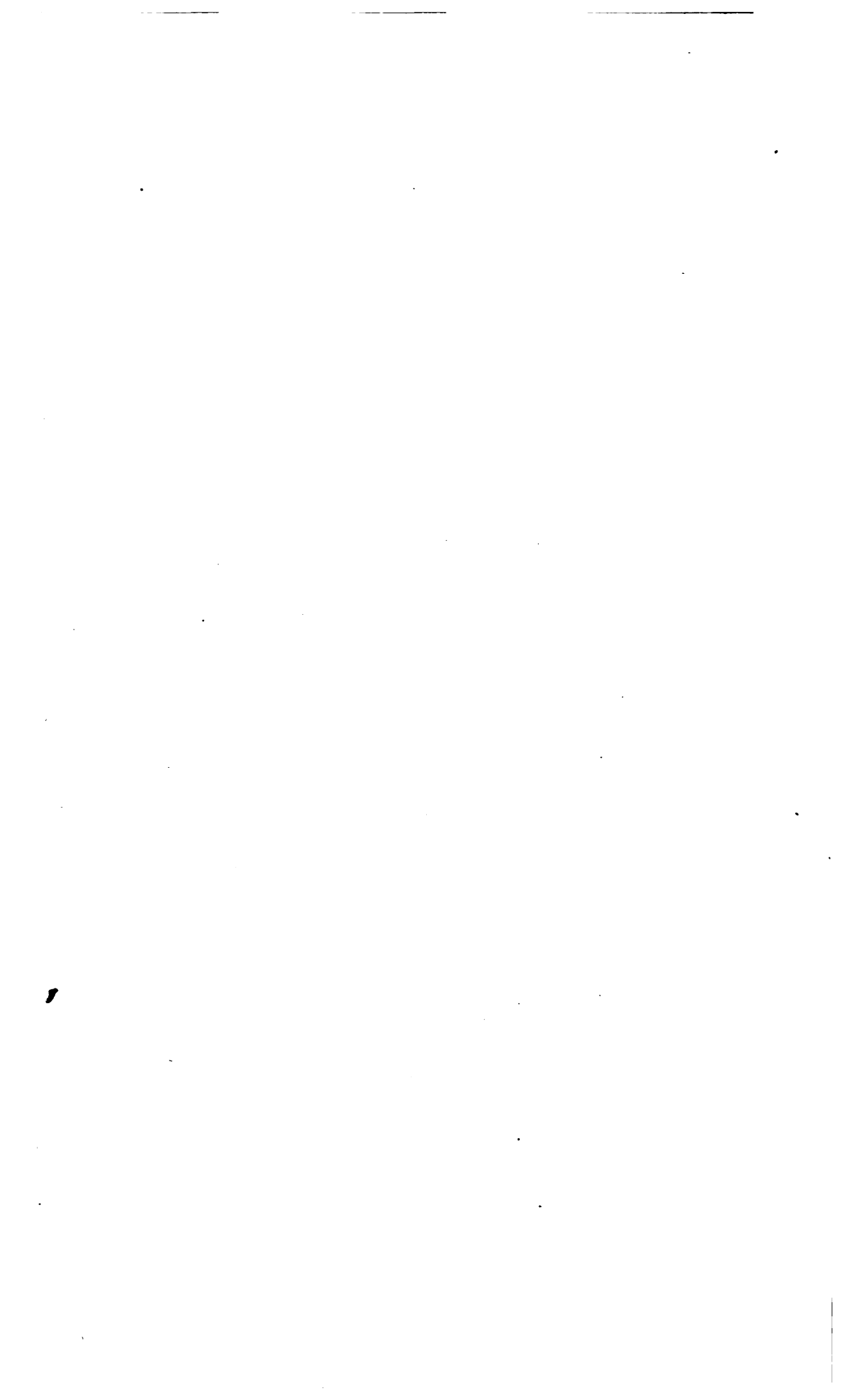

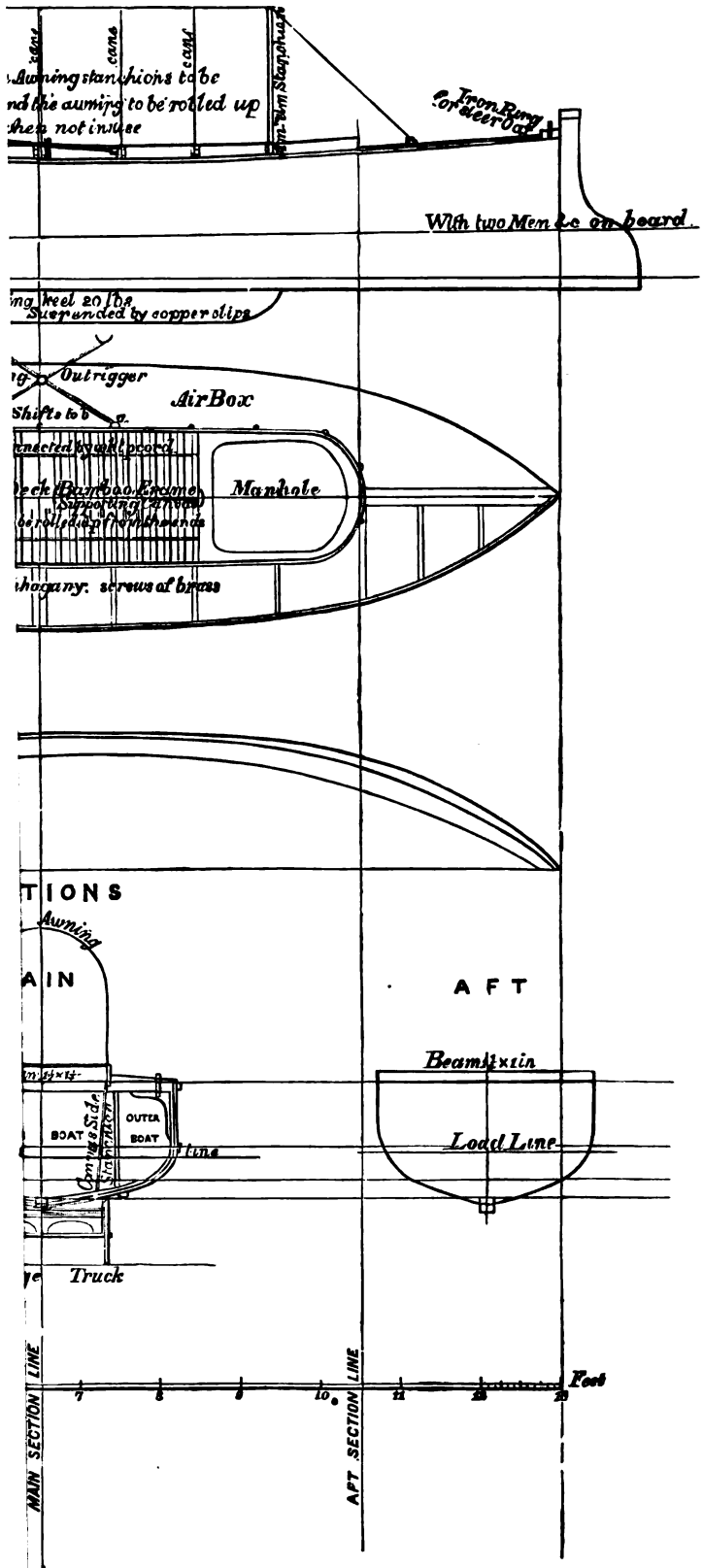

Lifeboat.

afterwards 7, 8, and 9, the mixture being allowed to stand twenty-four hours before filling into casks. We have not heard of this composition having been used, and unless anyone desired to make experiments, either Jesty's or Peacock's compositions can be recommended as fairly answering the purpose for which they are used.

Compressor.—A contrivance to prevent the chain cable being veered too quickly, or to stop its veering altogether.

Conduct Money.—Money kept back from a seaman's wages, but given up in whole at the end of an engagement if the seaman's conduct has been good; generally the amount kept back is 2s. per week, and a fine to that amount is levied for an offence.

Contrary Wind.—A wind that blows adversely down a vessel's course.

Copper Bottomed.—The bottom of a ship sheathed with copper. (See "Sheathing.")

Copper Fastened.—Fastened with copper bolts and nails.

Coracle.—A small boat used by the ancient Britons. (See "Canvas Boats.")

Coracle Lifeboat.—The following is a description of a lifeboat (Plate LXIV.) built by Capt. John Richards, R.N., of 4, Cotham-grove, Bristol:

"The coracle lifeboat was designed to accommodate two persons on a coasting cruise, as well as to carry their provisions, clothes, and necessaries, and furnish them with weatherproof and comfortable sleeping quarters at night. Several of these vessels have been built at Bristol and elsewhere, cost

Coracle Lifeboat—continued.

carries a stay foresail and a standing lug. The foresail is of stout material, intended for use as a storm-sail, as shown in the illustration. Her frame is similar to that of an ordinary boat, but stronger, although much lighter. The principal points of difference between the coracle and an ordinary boat consists in the light and partial planking of the former, and the substitution of a strong prepared canvas for the thin wooden skin now commonly used in our small pleasure boats and canoes, and which experience proves is very liable to break up in a heavy sea or when touching rough ground. The coracle is therefore elastic, and will yield to pressure, and recover her form immediately the pressure is removed. The coracle has none of the heavy fittings of ordinary boats, as thwarts, head and stern sheets, bottom boards, &c., which add materially to weight. Light basket seats are used instead of thwarts; and, as the floor of the coracle is constructed solid and even, bottom boards are not required. The coracle is partially decked with wood. A space or well is left in the middle, 7ft. long, by 2ft. wide, for the crew to sit. A strong wooden gunwale or combing bounds this space, and a groove running round the inside of it is formed to receive the gunwale of the inner boat. The outer and inner gunwales are firmly strutted and braced together. The inner boat is an oblong canvas box, 7ft. long by 2ft. wide, the upper edge of which is secured to a brass-bound wooden batten of the same shape as the inner gunwale or combing, a groove in the latter (as already stated) being out for its reception, and in which it is placed and firmly held by twelve brass buttons. The lower edges of this canvas box are bound with rope, and laced to battens secured to the floor of the vessel. By this arrangement the coracle is divided into two nearly equal parts, the connection between the two being made at the gunwale, which thus forms a nearly water-tight joint, similar to the metal cinchure bands connecting the upper and lower portions of Capt. Boyton's marine dress. By this means the entire space of the vessel may be utilised at pleasure for sleeping accommodation without forfeiting the desirable properties of the lifeboat. Further to add to the security of the coracle, one half of the space inclosed between the outer and inner boats is occupied by three lightly-constructed box floats. One of these occupies the entire fore-

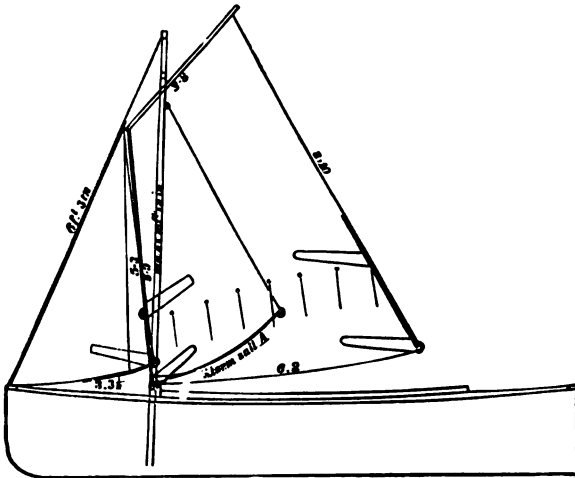

FIG. 213.

part of the vessel, and the two others fill up the vacant spaces on each side of the after part. These floats, together with a thin plate iron sliding keel, would keep the coracle upright and stable with her crew on board, in the unlikely event of the entire vessel being swamped by a sea.

about 1l. per foot for building, and perhaps about 10s. additional for fitting out. She is 13ft. long, 40in. beam, and 17½in. deep. She weighs 135lb., but when complete for sea, with all her gear on board, 356lb. She is propelled by oars working on reversible outriggers. She is fitted with one mast, which

Coracle Lifeboat—continued.

The floats are removed to the outside at pleasure, and the iron keel is usually carried inside when navigating shoal water. The iron keel is suspended to an iron keel band by clips. The keel band is a thin plate of galvanised iron, 1½ in. wide, and it is screwed on to the keel of the coracle. A small pair of wheels and axle is also fitted with iron clips to take the keel band. This renders the coracle easily transportable by land. A flying deck, constructed of pieces of bamboo, running across the inner gunwale and strung together, and covered with oil-cloth, having two manholes in it, enables the crew of the coracle to shut out the rain or sea from the interior; and, when they are equipped in their sou'westers and short oil-skin jackets, the coracle and her crew are proof against any sort of weather. A rain-awning, constructed of stout cloth, with canes sewn into it, and fitted something like the cover of a waggon, has been found to be a capital contrivance for excluding rain and wind.

The size of the coracle was arranged so that with her crew and their effects on board, she should be in good sailing trim. She carried in addition, however, about 70 lb. of trimming ballast, in the shape of two stout water bags of india rubber, measuring 2 ft. by 7 in. by 5 in. These served the crew for pillows at night, and formed our reserve stock of fresh water." (See "Canvas Coracle.")

Cordage.—A general term used to denote the rope used in the rigging of a ship.

Corinthian.—A term in yacht parlance synonymous with amateur. The term Corinthian half a century ago was commonly applied to the aristocratic patrons of sports, some of which, such as pugilism, are not now the fashion. No doubt the name originated with the supposed similarity between the fast young men of the Greek Empire who emulated the feats of athletes, &c., and their modern prototypes.

The qualifications of a "Corinthian" sailor are variously defined. The Royal Alfred Yacht Club enjoins that in all matches the amateur element shall consist of "members of the club, their sons, or members of a royal, foreign, or recognised yacht club, or naval officers." Any one not being a mechanic or menial is generally regarded as a qualified amateur. Some clubs only allow yachts of 15 tons and under one paid hand, who is not permitted to touch the tiller. A later and more suitable plan is to have paid hands in the proportion set forth in the table, page 133. In all cases an amateur must steer.

Corinthian Rule of Measurement.—A tonnage measurement adopted by the Corinthian Yacht Club. It is simply the shipbuilder's rule for roughly estimating the register tonnage of a vessel, thus $\frac{L \times B \times D}{200}$, where L length, B breadth, and D depth, amidships from deck to underside of keel. This rule was also adopted by the New Thames Yacht

Club in 1875, but after a trial of two years it was abandoned, as the general opinion appeared to be that the rule would have an injurious influence on yacht designing.

Cot.—(See "Wexford Flat-bottomed Boats.")

Counter.—The projecting part of a vessel abaft the sternpost.

Course.—Direction; the direction in which a vessel moves; the direction from one point to another point which a vessel has to reach. The distance yachts have to sail in a match at a regatta.

Courses.—The lower squaresails of a ship.

Covering Board.—The outside deck plank fitted over the timber heads. See "Plank sheer."

Coxswain.—The man who steers and has charge of a boat and her crew. Pronounced "cox'n."

Crabbing.—When a vessel tumbles down under a heavy press of canvas, or when she sags to leeward badly.

Cracking on.—Carrying a large quantity of sail.

Cracks in a Mast or other Spars, To Stop.—When the spar is quite dry run in marine glue; when the glue is hard, scrape out some of it, and stop with putty, coloured to imitate the colour of the wood.

Craft.—A vessel; also used in the plural, thus a number of craft, or a lot of craft, means a number of vessels.

Crank.—Not stiff under canvas; a boat that can be heeled or listed very easily; generally a dangerous boat.

Cranse.—An iron hoop band, with eyes fitted to bowsprit ends or the ends of other spars. (See pages 55 and 303.)

Creek.—An inlet of the sea.

Crests.—The top edges of waves.

Crew.—A ship's complement, and including every man employed on board in any capacity whatsoever, distinct from passengers.

Crimps.—Agents for engaging seaman: a vocation not in high repute.

Cringle.—A metal thimble worked into the corners and leeches of sails.

Cripple, A.—A vessel that does not carry her canvas stiffly.

Cross Chocks.—Pieces of wood used for filling in between lower futtocks where their heels do not meet on the top of the keel.

Cross-jack.—Cross-jack-yard is the lowest yard on the mizen mast. Pronounced "cro'-jack."

Cross Sea.—Waves that come from divers directions, usually caused by sudden shifts of wind when it is blowing heavily.

Cross-trees.—See p. 28, &c.

Crow-foot.—A number of lines attached to one line, and spreading out something like a bird's claw.

Crown of an Anchor.—The part of an anchor where the arms are joined to the shank.

Crow's Nest.—A place of shelter at the top-gallant mast-head for a look out man, used by whalers in Northern latitudes.

Cruikshank's Patent Cleats.—This is a contrivance for jamming the mainsheet without any turns or bights, so that when a certain pressure is put on the sail the sheet unreeves. The cleat was invented with a view of preventing boats being capsized when struck by sudden squalls. The objection to such cleats is that they may possibly foul, and moreover the pressure which if applied steadily would just cause the sheet to unreeve, might if applied suddenly capsize the boat long before the sheet would run through the jammers. (See page 110.) With a "breeze of wind" there is generally some sea, and then it is not so frequently a sudden accession of wind or squall that causes the boat to capsize as her position among the waves. If she gets so placed as to lurch or roll to leeward from the effect of a wave crest passing underneath her, she may upset without any increase in the pressure of wind; that is to say, if her safe angle of heel under canvas is 20 degrees, and she be permanently heeled by the wind pressure to that angle, then, if the action of the waves caused her to heel further—say 10 degrees—she would capsize unless skilfully handled by the steersman. As there need be no increase of wind pressure to bring about such a catastrophe, the "safety cleat" would be of no avail under such circumstances. In smooth water it would never be prudent or safe to wait for a squall to strike a boat, as, if the squall were heavy enough to cause the boat to heel to the capsizing point, the safety cleat could not relieve the sheet fast enough to prevent such heeling. The squall must be "met," the boat thrown head to wind, and the sheet released, before the squall strikes. Sometimes in small boats, with the wind abeam or abaft the beam, it may be more prudent to run them off the wind; but scarcely in any case, either in a sea or in smooth water, could the safety cleat save a boat from being capsized if the helmsman or crew carelessly handled her when she is in danger of such a catastrophe. Mr. Cruikshank's cleat is provided with a releasing line, which is to be held in the hand, and if the break does not allow the sheet to be released fast enough, the line is to be pulled. Manifestly it would be safer and give less trouble to hold the sheet itself in the hand. (See "Beadon's Safety Reel.")

Crutch.—An iron support for a boom when the sail is stowed something in this form Y; the upright part fits into a socket on the taffrail. Crutches are sometimes made of two cross pieces of wood, thus X; in schooners the crutch for the fore boom is generally so formed; also a similar crutch is used to put the tiller in when the vessel is moored to keep it from flying about, and when by lashing the tiller lines across the vessel to either rail the passage fore and aft would be inconveniently obstructed. An X crutch is used

to support the middle of the boom when the sail is stowed and not along by the peak halyards. A crutch is also the metal fork used instead of tholes in a row boat.

Cubic Measure of Water.—One gallon contains 277·274 cubic inches, or 0·16 of a cubic foot. One cubic foot contains 1728 cubic inches, or 6·233 gallons. One ton of salt water contains 35 cubic feet. One ton of fresh water contains 35·9 cubic feet. A ton weight is equal to 2240lb. See "Decimal Equivalents." (See "Water.")

Cuddy.—A small cabin, a deck house, the space under the half deck of a boat.

Cunt-line.—The space between four casks when they are stowed bilge to bilge.

Cutter.—A boat heavier than a gig, and used in bad weather when the lighter boat might get swamped.

Cutter.—A vessel with one mast rigged with mainsail, foresail, jib and topsail, as shown in the accompanying sketch, known as the national rig.

A cutter's sails are termed "fore-and-aft" sails, because they are tacked and sheeted in

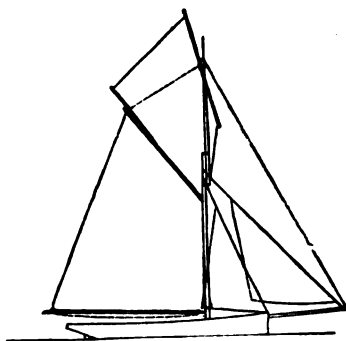

FIG. 214.

a fore-and-aft direction in contradistinction to sails which are tacked and sheeted as squaresails are.

D.

Dagger knee.—A piece of timber crossing the frames diagonally.

Dandy.—A cutter rigged vessel with lug mizen aft set on a jigger-mast.

Darning the Water.—When a vessel keeps sailing backwards and forwards, as before a bar harbour or pier, waiting for water or orders, &c.

Davit Guys.—The stays or ropes used to keep the davits steady.

Davits.—Strong iron arms used for hoisting boats, &c.

Day's Paint.—(See "Composition.")

Dead Calm.—Without a breath of wind.

Deaden-her-way.—To stop a vessel's way by backing and filling, or by hauling a sail aback, or by yawing her about with the helm, &c.

Dead Eye.—A circular block, with three holes in it (crow-foot fashion) without sheaves, used to reeve the lanyards through for setting up the rigging. (See page 40.)

Dead Flat.—The midship section. The term is applied to the middle flat of a ship, where she gets no broader and no narrower; that is, where the cross sections for some distance amidships are of the same size and form: thus the side will present a "dead flat" for some distance. (See "Straight of breadth.")

Dead Lights.—Strong shutters made to fit the outside of cabin windows—closed in bad weather. In yachts small circular lights are generally fitted, and without the shutters.

Dead on end.—Said of the wind, when it blows straight down the course a vessel wishes to make. (See "Nose-ender," "Muzzler.")

Dead Reckoning.—The calculation of a ship's position by the log, the courses she has made, lee way, set of currents, &c., without an observation.

Dead Rise.—The approach the floor timbers of a vessel makes to a perpendicular. In the case of ships, the frames in the after body are called the dead-risings, because they only rise from the keel at a sharp angle, all the middle frames starting nearly horizontally from the keel. A yacht is said to have considerable dead rise on a very rising floor, when she is more or less of the ∇ form, but really vessels of the Γ form have the greatest dead rise, as the heels of the floors forming the framing to take the garboards, do rise nearly perpendicularly to the keel.

Dead water.—The water in a vessel's wake, close to her rudder, that does not appear to move with such rapidity as the water along a ship's side.

Dead weight.—Concentrated weight in a vessel's bottom, such as a heavy cargo of ore or ballast.

Dead wood.—The solid wood worked on top of the keel forward and aft (See page 27).

Decimal Equivalents—

In.	OF A FOOT.				OF A TON			
	—	$\frac{1}{2}$	$\frac{3}{4}$	$\frac{4}{5}$	Cwt.	Ton.	Cwt.	Ton.
0	.000	.021	.042	.062	1	.05	11	.55
1	.083	.104	.125	.146	2	.10	12	.60
2	.167	.187	.208	.229	3	.15	13	.65
3	.250	.271	.292	.312	4	.20	14	.70
4	.333	.354	.375	.396	5	.25	15	.75
5	.417	.437	.458	.479	6	.30	16	.80
6	.500	.521	.542	.562	7	.35	17	.85
7	.583	.604	.625	.646	8	.40	18	.90
8	.667	.687	.708	.729	9	.45	19	.95
9	.750	.771	.792	.812	10	.50	20	1.00
10	.833	.854	.875	.896				
11	.916	.937	.958	.979				
12	1.000	1.021	1.042	1.062				

Deck.—The platforms supported on the beams of ships. The old three deckers had upper deck, main deck, middle deck, lower deck, and

orlop deck, no guns being carried on the latter. Below the orlop deck were the hold platforms, or decks. Yachts usually are said to have only one deck, i.e. the upper deck open to the sky; some large yachts, however, have a lower deck, laid and caulked. Smaller yachts have platform beams upon which the platform rests. The platform is the cabin floor.

Deck Caulking and Stopping.—(See "Marine Glue.")

Deck, to Whiten.—Make a mixture of 1lb. oxalic acid to 1 gallon of water. Damp the deck with this and wash off.

Deep sea lead (pronounced "dipsey lead").—A lead of 28lb. weight attached to a line of 200 fathoms. Now, automatically recording machines are generally used for deep sea soundings. (See "Lead.")

Delivery.—The quarter wash of a vessel. A yacht is said to have a good delivery if on passing through the water no waves are raised at and about the quarters; she is then said to leave the water clean, to have a clean wake, clean delivery, or to run the water very clean aft.

Demurrage.—Compensation paid to the owner of a ship when she has been detained longer than reasonable by a freighter at a port.

Depth of a Yacht, to measure.—Very frequently it is necessary to know accurately the external depth of a yacht from rail to keel, or her draught from load line to keel. The following simple plan is a ready means of obtaining such depth and draught: To obtain the depth take a straight-edged bar of wood (see *e e*, Fig. 215) will be placed

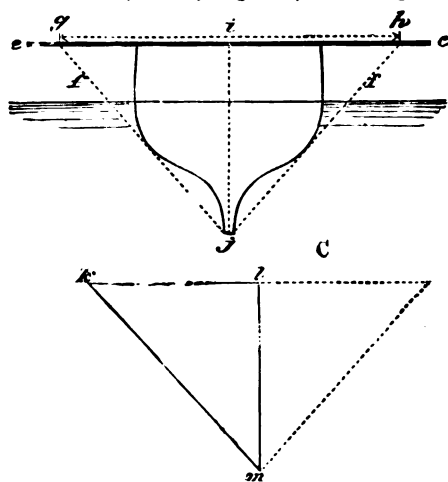

FIG. 215.

across the rail, at right angles to the keel. A small chain, *f f*, will be passed under the bottom of the yacht, and one end will be made fast on the bar at *g*, so that the chain just touches the bilge; the chain will be drawn tight, and the other end made fast to

Depth of a Yacht—continued.

bar at *h*. The distance *g h* must be accurately measured on the bar, as also, when removed, must the length of the chain which passed from *g* under the yacht to *h*. (To obtain the points for the measurement of the chain, it would be found convenient to fasten a small piece of cord or yarn at the points *g* and *h*, immediately under the bar, before the chain is cast off.)

Having obtained these measurements, it will be an easy matter to find the depth *i j*. The distance *g h* can be laid off to scale, divided in the centre by a perpendicular, *i j*: half the length of the chain will then be laid off from *g* and *h* to intersect the perpendicular, as at *j*; the distance from *i* to *j* on the bar, measured by the scale, will be the depth required.

The draught of water of the yacht will of course be found by subtracting her height out of water, from load line to rail, at the points where the depth was taken.

If no scale be at hand, the depth can readily be found by calculation. Take half the length *g h*, which call *k l* (Fig. 215), and half the length of the chain, which call *k m*; subtract *l* from *k m*; multiply the remainder by the sum of *k m* and *k l* added together; the square root of the product will be the required depth. Expressed in algebraic language:

$$\sqrt{(k m + k l) \times (k m - k l)}$$

Say *k m* is 10ft., added to *k l* 7ft., make 17ft.; next 7 subtracted from 10 leave 3, and 3 multiplied by 17 make 51. The square root of 51 is 7.1, which would be the required depth.

The mean draught would be found by taking the actual draught at several (say 4) equidistant intervals, commencing at the heel of the sternpost and ending at the stem; add these draughts together, and divide the sum by the number of measurements taken, including those at stem and sternpost. If the fore foot is very much rounded away, the measurement at the stem will be 0, but in counting the number of measurements, that for the stem must be included.

The Barrow Corinthian Yacht Club formerly included mean depth in their tonnage rule, and adopted, on the suggestion of Mr. R. S. White, the following plan for obtaining depth at any point without calculation. (See Fig. 216.)

A is the keel batten, graduated from centre, in feet and tenths, with slots marked C, at each end, to slide the side or depth battens to the exact beam of yacht.

BB. Side or depth battens, graduated at upper part in feet and tenths from top of keel batten, and secured to keel batten with thumb-screws marked D.

Modus operandi: Having obtained exact

Depth of a Yacht—continued.

beam of yacht, set the depth battens BB at this distance apart on keel batten A, by means of thumb-screws D tightly screwed up. Dip the keel batten under keel until opposite marks on gunwale, where depth is required to be taken; then bring it close up to keel, and take readings off depth battens BB, until they correspond on each side—this being depth of yacht, keel to gunwale, in vertical line, as shown in sketch.

If the measurements have to be taken in a tideway, the batten A must be kept close up to keel to prevent its driving aft.

Depth of Hold.—In a single-deck vessel, the height between the keelson and deck.

Derelict.—A vessel abandoned at sea. It is said that an owner's rights are not also abandoned if any live animal be left and found on board.

Derrick.—A kind of crane.

Deviation.—A movement of the compass needle due to local attraction, principally met with in iron or composite ships, and distinct from variation.

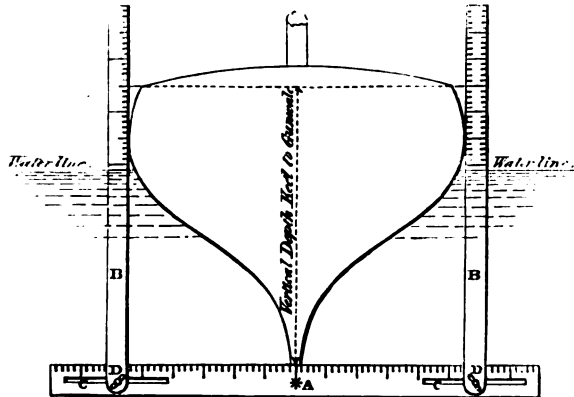

FIG. 216.

Dhow.—A large Arab vessel, usually lateen-rigged.

Diagonal Braces.—Strengthening straps of iron that cross the frames of a vessel diagonally.

Diagonal Lines.—Lines which cross the sections of a vessel shown in the body plan, in a diagonal direction with the middle vertical line.

Diameter of Circle.—Circumference multiplied by 0.31831.

Diminishing Strakes.—The strakes immediately above and below wales being the thickness of the wale on one edge, and diminishing to the thickness of the plank on the other.

Dinghy.—A small boat of Bombay, with a settee sail. Also a small skiff, or punt, carried by yachts. (See "Portable Dinghy.")

Dinghy-man.—The man who has charge of the dinghy of a yacht, whose duty it is to go on shore on errands, &c.

Dip.—The inclination the compass needle makes towards the earth in high latitudes.

Dip the Ensign, To.—To lower the ensign as a salute, or token of respect. (See "Dipping the Ensign.")

Dipping Lug Sail.—A sail hoisted by a halyard and mast hoop traveller. The sail is set to leeward of the mast, and the tack is usually fast to the stem or on the weather bow. In tacking or gybing the sail has to be lowered and the yard shifted to the other side of the mast. A plan has been proposed to perform this dipping by the aid of a topping and tripping line instead of by lowering the sail (see the sketch, Fig. 217); but the balance lug, which requires no dipping what-

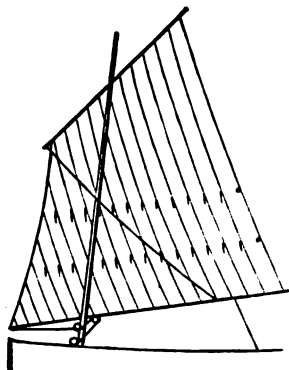

FIG. 217.

soever in tacking, is to be preferred to the best dipping arrangement. (See "Penzance Luggers" and "Split Lug.")

Dipping the Ensign.—The ensign is lowered or dipped as a means of saluting a commodore, &c., or member of a club. The junior member should be the first to dip. Sometimes, if no ensign is flying, the burgee is dipped. It is usual to "dip" on passing a man-of-war or royal yacht. A royal yacht never answers the salute by dipping her ensign. Strictly it is etiquette for the blue ensign to dip to the white; and red to the blue and white.

Discharge Ticket.—A formal document given to seamen when they are discharged.

Dismantled.—Unrigged: without sails or spars.

Dismasted.—When a vessel loses her mast by violence, or accident.

Displacement.—The quantity of water a vessel displaces, which, in weight, is always equal to her own weight.

Displacement per inch of immersion.—It is often necessary to know how much weight would have to be put into a yacht to sink her an inch or more deeper in the water or lighten her to a similar extent. Roughly, this can be ascertained by the following rule:—Multiply the length on the load line by the breadth on the load line and divide the product by 600. $\left(\frac{L \times B}{600}\right)$ The quotient will be the weight in tons or fractions of a ton. This rule would not hold good if the yacht were lightened more than

three or four inches or deepened to that extent. The rule is based on the assumption that the area of the load line is .7 of the circumscribing parallelogram. That is to say, the length and breadth multiplied together and again multiplied by .7 will (approximately) give the area of load line. Divide this product by 12, and the area is reduced to cubic feet, and divide again by 35 and the answer will be given in tons or fractions of a ton. By this rough rule the displacement per inch at any part of the hull of the vessel (if the measurements are taken at the part) can be found approximately $\left(\frac{L \times B \times .7}{12 \times 35}\right) = \left(\frac{L \times B}{600}\right)$

Distemper.—Red or white lead powder mixed in strong glue size and applied hot. Sometimes the part to be covered is first coated with lime whitewash. A yellow distemper for funnels is thus made: 6lb. glue made into size, and whilst hot added to $\frac{3}{4}$ cwt. yellow ochre, $\frac{1}{4}$ cwt. whiting, reduced to proper consistency by warm water.

Divisions.—The portions of a fleet; as the star-board, port, and centre divisions, the admiral in command always occupying the centre division. Prior to 1856, there were red, white and blue divisions, but now, as only the white or St. George's ensign is recognised, the divisions by colour have been done away with. (See "Admiral.")

Dock.—A basin into which a ship is floated and the gates closed upon her; the water is then pumped out and the ship left dry, supported on a framework and by shores. These are called dry docks.—A general name for a place to receive ships for repair or cleaning. A ship is said to dock herself when placed in a soft tidal bed of mud she buries herself in it more or less.

Dockyards.—Places where ships are built; usually, however, confined to government naval works.

Dog Shores.—Pieces of timber used in launching ships.

Dog Vane.—A light vane made of bunting or feathers, to show the direction of the wind, and sometimes put on the weather rail.

Dog Watches.—The divided watch between four and eight in the evening; thus the first dog watch is from four to six, and the second from six to eight. (See "Watches.")

Doldrums.—The state of being becalmed. Parts of the ocean where calms are prevalent.

Dolphins.—Stout timbers or stone pillars placed on wharfs to make fast warps to.

Dolphin Striker.—The perpendicular spar under the bowprit end by which more spread is given to the stay of the jib-boom.

Dory.—A flat-bottomed deep boat much used by American fishing schooners.

Double-banked.—When men sit on the same thwart to row oars from different sides of a boat. Double-banked frigates were two deckers, with the upper deck ports disguised.

Double Block.—A block with two sheaves.

Double Gimbals.—See "Gimbals."

Doubling Plank.—To put one thickness of plank over the other.

Douse or Dowse.—To lower away suddenly, to take in a sail suddenly. "Douse the glim;" to put out a light.

Dove-tail Plates.—Plates in form like a dove's tail.

Dowell.—A hard wood or metal pin used for connecting timber or the edges of plank.

Downhaul.—A rope used for hauling sails down.

Down Helm.—An order to put the helm to leeward and cause the vessel to luff.

Down Oars.—The order given for the crew of a boat to let fall their oars after having them on end in the boat.

Down Wind.—Sailing in the direction of or with the wind; before the wind; with the wind astern.

Down Wind, Down Sea.—The sea will subside when the wind does.

Drag.—The increased draught of water aft compared with the draught forward.

Drag, To.—To scrape the bottom; to search the bottom with grapnels.

Draught of Water.—The depth of a vessel to the extreme underside of the keel measured from the load water line.

Draw.—A sail is said to draw when it is filled by the wind. To let draw is to ease up the weather sheet of a sail after it has been hauled windward, and trim the lee sheet aft.

Draw Her to.—An order to bring a vessel closer to wind.

Dress.—To dress ship is to hoist flags from deck to truck; or from bowsprit end to truck and taffrail.
To dress copper is to lay or smooth down wrinkles by going over it with a flat piece of hard wood and a hammer.

Drift.—To float about with the tide or current.

Drift.—The distance between two blocks of a tackle; the distance two parts of a thing are apart.

Drive.—To move to leeward by the force of the wind, or drive without control.

Dry-rot.—The decay timber is subject to, often through imperfect ventilation.

Duck.—Light canvas of which boat sails and balloon sails are made. To duck is to dive under water.

Ducks.—A sailor's white suit of duck.

Dumb Cleat.—A thumb cleat.

Dump.—A nail used in fastening plank to the timbers, as distinguished from a through-bolt.

Dungares or Dongares.—A blue linen or cotton cloth in use in India, now much used for the rough or working suits given to yacht sailors.

Dunnage.—Loose material such as cork, bamboo, shavings, ferns, coir, &c., used to jam in between a heavy cargo such as casks, iron, &c.

Dynamometer.—An instrument to measure forces.

E.

Earings.—Ropes used to fasten the corners of the heads of sails to the yards, by the cringles. The upper corners of sails are frequently termed earings. (See "Reef Earings.")

Ears of a Bolt.—The lugs or upper projections of a bolt with a score in it, into which another part is fitted and held by a through pin so as to form a joint like that of a gooseneck.

Ease Away.—The order to slacken a rope, &c.; to ease off a sheet, to ease up a sheet, are synonymous terms, and mean to slacken. (See "Check.")

Ease the Helm.—The order given when sailing against a head sea to ease the weather helm, and by luffing meet the sea bow on, and at the same time deaden the ship's way so that the sea and ship meet less violently. Generally to put the helm amidship, or more amidship after it has been put to port or starboard.

Eating a Vessel out of the Wind.—When two vessels are sailing in company, and if one soaks or settles out to windward of the other she is said to eat her out of the wind. In reality, to make less leeway than another vessel.

Eating to Windward.—A vessel is said to eat to windward when she apparently soaks out to windward of her wake.

Ebb.—The receding of the tide.

Eddy.—Water or currents of air apparently moving in circles.

Edge Away.—To gradually keep a vessel more off a wind after sailing close hauled.

Edge Down on a Vessel.—To bear away towards a vessel to leeward, so as to approach her in an oblique direction.

End for End.—To shift a spar, rope, &c., by reversing the direction of the ends.

End On.—Said of vessel when she has an object bearing in a line with the keel, directly ahead of the bow. On approaching a mark or buoy it is said to be end on if it is directly ahead of the vessel, the bowsprit will then point to the object, hence it is sometimes said that an object is "right on for the bowsprit end."

Ensign.—A flag flown as a distinguishing mark of nationality. The red ensign, with "Union Jack" in the upper corner of the hoist, is the English national flag; but the ensign of the Royal Navy is white with red St. George's cross in it besides the Jack in the corner; this is called "St. George's ensign." Prior to 1856 the red (highest in rank) white and blue ensigns were used in the Royal Navy, and there were Admirals of the Red, Admirals of the White, and Admirals of the Blue; and there were Vice and Rear Admirals of the red, white, and blue. A fleet was divided into red, white, and blue divisions, according to the rank of the Admirals who commanded. In 1855 the red ensign was allotted to the British Mercantile Marine, the blue ensign to the Royal Naval Reserve, and the white ensign to the Royal Navy. However, the white and

Ensign—continued.

blue ensign had always been reserved for the exclusive use of H.M.'s navy, and other vessels could not use either without an Admiralty warrant.

In the Royal Navy it was etiquette, when an Admiral was on board his ship, to fly the white ensign from the main truck, Vice-Admiral from the fore truck, and Rear-Admiral mizen truck. Admirals now fly St. George's Jack (which see) from the main, fore, or mizen, according to rank. A Union Jack is carried at the stem head or bowsprit end (all ships of the Royal Navy now so carry a Jack). When a council of war is being held on board a flag-ship, the white ensign is displayed in the main, fore, or mizen shrouds, according to the rank of the Admiral. If there is to be an execution after a Court Martial, the white ensign is hoisted on the main, fore, or mizen yard arm. Ships of the Royal Navy at the approach of Royalty, or whilst saluting, "dress" ship, by hoisting St. George's ensign at the fore, main, and mizen trucks.

If an ensign other than the red be flown by any vessel without a warrant from the Admiralty, a penalty of 500*l.* may be inflicted, and any Custom House or Consular officer or other officer in H.M.S. on full pay may board the vessel and seize the flag. Although the red ensign has been assigned to the mercantile marine, no device can be put in it other than the Jack without the permission of the Admiralty.

The jurisdiction of the Admiralty only extends to flags flown afloat, and any ensign can be hoisted on flagstuffs on shore.

When a warrant is granted to a club to fly the white, blue, or the red ensign with a device, this warrant does not of itself entitle a member of the club to fly either ensign on board his yacht; before he can legally do so he must also obtain a warrant from the Admiralty through the club secretary. As many warrants must be obtained as he belongs to clubs if he desires to fly the flag of each club. When the yacht is disposed of, the warrants must be returned through the club secretary to the Admiralty, and if the owner obtains a new yacht he must get fresh warrants.

Prior to 1858 the Royal Western Yacht Club of Ireland flew the white ensign with a wreath of shamrock in it. In 1847, the privilege of flying the white ensign was accorded to the Royal St. George's Yacht Club, Kingstown, but was afterwards rescinded upon a representation by the Royal Yacht Squadron that that club by its warrant of 1829—(prior to 1829, the R.Y.S. flew the red ensign)—had the exclusive privilege of flying the white ensign. In 1853 an application was made in Parliament to know if the R.Y.S. had that exclusive privilege. The first Lord of the Admiralty said it had not, inasmuch as the privilege had also been extended to the Royal Western of Ireland in 1832, and was still enjoyed by that club. (But it does not appear that the Royal Western ever applied for a separate warrant for a yacht to fly

Ensign—continued.

the white ensign.) In 1858 the Royal St. George's Yacht Club (also the Holyhead) again applied for permission to fly the white ensign; the permission was not granted, and the Admiralty informed the Royal Western that they were no longer to use it; on making search at the Admiralty, it was found that in 1842 a decision was come to restricting the white ensign to the Royal Yacht Squadron; and the clubs affected by the decision were informed of it accordingly, but the Royal Western of Ireland was not interfered with, because up to that time no application for separate warrants from the club for yachts to fly the ensign had been received; and further in 1853, the Royal Western obtained permission to continue to use the ensign. However, in 1858, the Admiralty revoked that permission, and since that date no club excepting the R.Y.S. has been permitted to fly the St. George's ensign. It would be much better if the Admiralty only issued warrants to fly the red ensign with a club device or badge if desired. (See "Admiralty Warrants," "Royal and Recognised Clubs," "Burgee.")

Ensign for Hired Transports.—The blue ensign with admiralty anchor (yellow) in the fly.

Ensign, Hoisting of.—Ensigns and burgees are hoisted every morning at eight o'clock (9 a.m. from September 30 to March 31), and hauled down at sunset. It is a slovenly habit to hoist and haul down colours at irregular hours. At sea it is only usual to hoist colours when passing another vessel.

Ensign of the Colonies.—The blue ensign with arms or badge of colony in it.

Ensign of the Customs.—The blue ensign.

Ensign of Naval Reserve.—The blue ensign.

Entrance.—The fore part of a vessel, the bow. A good entrance into the water means a long well-formed bow.

Entrance Money.—The money demanded by clubs from yacht owners, who enter their vessels for match sailing at regattas.

Entry.—The record that a yacht is engaged for a particular match.

Equipment.—The complete outfit of a vessel including everything used in her handling, working, and accommodation. The inventory comprises the equipment.

Even Keel.—Said of a vessel when she is not heeled either to port or starboard, also when her keel is horizontal, that is when she is so trimmed that her draught forward is the same as aft.

Every Stitch of Canvas Set.—When all available canvas that will draw is set.

Extreme Breadth.—The greatest breadth of a vessel from the outside of the plank on one side to the outside of the plank on the other side, wales and doubling planks being included and measured in the breadth.

Eye Bolt.—(See "Bolts.")

Eyelet Holes.—Small holes worked in sails for lacing, &c., to be rove through.

Eyes of Her.—The extreme fore end of the ship near the hawse pipes, which are the "eyes of her."

Eyes of the Rigging.—The loops spliced into the ends of shrouds to go over the mast, and dead eyes.

Eye Splice.—The end of a rope turned in so as to form an eye.

F.

Fag End. When there is "nothing left of the rope but the end." The frayed-out end of a rope.

Fairing a Drawing.—A process by which the intersections of curved lines with other lines in the body plan, half-breadth plan, and sheer plan are made to correspond. A fair curve is a curved line which has no abrupt or unfair inflexions in it.

Fair Lead.—When the fall of a rope leads fairly, without obstruction, from the sheave hole. Also a "lead" made for a rope through a sheave hole or through any other hole.

Fair Leaders.—Holes in plank, &c., for ropes to lead through, so that they lead fairly and are not nipped or formed into a bight.

Fairway.—The ships' course in a channel. The navigable channel of a harbour as distinct from an anchorage in a harbour. A harbour master's duty is to see that the fairway is kept clear, and that no vessels improperly anchor in it. A fair way is generally buoyed.

Fair Wind.—A wind by which a vessel can proceed on her course without tacking; it may range from close-hauled point to dead aft.

Fake, A.—One of the rings formed in coiling a rope. The folds of a cable when ranged on deck. To fake is to arrange in folds.

Fall.—The loose end of the rope of a tackle, the hauling part of a tackle; also applied generally to the tackle of the bobstay and the topmast backstays.

Fall Aboard.—One ship sailing or driving into another. A sail is said to fall aboard when the wind is so light that it will not stay blown out.

Fall Astern.—The same as drop astern. When two vessels are sailing together, if one fails to keep company with the other by not sailing so fast.

Fall Off.—To drop away from the wind; when a vessel is hove to she is said to fall off if her head falls to leeward, in opposition to coming to; also when a vessel yaws to windward of her course and then falls off to her course or to leeward of it. Not used in the sense of breaking off, which means when the wind comes more ahead and causes an alteration in the direction of a vessel's head to leeward of a course she had previously been sailing.

Fall To.—To join in hauling, to commence work.

Falling Tide.—The ebbing tide.

False Keel.—A piece of timber fitted under the main keel to deepen it or protect it when taking the ground.

False Tack.—A trick sometimes practised in yacht racing when two vessels are working close hauled together, and one has been "weather bowing" the other every time they went about. To be rid of this attention the crew of the vessel under the lee quarter of the other makes a sudden move as if about to tack; the helm is put down and the vessel shot up in wind; the other vessel does the same and probably goes on the opposite tack; if she does so the former vessel fills off on her original tack, and the two part company. To shoot up in the wind and fill off on the same tack again.

Fashion Timbers.—The timbers which form the shape or fashion of the stern.

Fast.—Made fast by belaying. (See "Breast Fast," "Bow Fast," "Quarter Fast.")

Fastenings.—The bolts, nails, &c., by which the framing and planking of a vessel are held together.

Fathom.—A sea measure of six feet. To fathom a thing is to arrive at the bottom of it, to understand it.

Fay, To.—To join pieces of timber together very closely. Plank is said to fay the timbers when it fits closely to it.

Feather Edge.—When a plank or timber tapers to a very thin edge, "tapering to nothing."

Feathering.—Turning an oar over on its blade as it comes out of the water.

Feeling her Way.—Proceeding by sounding with the hand lead.

Feel the Helm.—In close hauled sailing when a vessel begins to gripe or carry weather helm. Also, generally, when a vessel begins to gather head way, so that she can be steered, or "feel her helm."

Feint.—To pretend to tack. (See "False Tack.")

Fender.—A sort of buffer made of rope, wood, matting, or other material to hang over the side of a vessel when she is about to come into contact with another vessel or object.

Fend Off.—To ward off the effects of a collision by placing a fender between the vessel and the object which is going to be struck.

Fetch Away.—To slip or move without intention. To fetch sternway or headway is when a vessel begins to move ahead or astern.

Fetch.—In close hauled sailing when a vessel arrives at or to windward of any point or object, as "she will fetch that buoy in two more boards," or "she will fetch the mark this tack," &c.

Fid.—A bar of wood or iron used to keep topmasts and bowsprits in their places. (See pp. 31 and 49.)

A plan of fid is used by the south coast fishermen as shown in the annexed sketch: *a* is the topmast; *y y* the yoke or lower cap; *s* is an iron fid, one end being loaded as shown. The fid is pivoted nearly in

the centre, the shorter arm being the lighter. *m* and *n* are slots cut in the topmast. *k* is a small line passing up through a hole in the heel of the topmast, and attached to the fid. To unfid the topmast haul on the heel rope until, by pulling on the line *k* the fid is brought into an oblique position in the slots *m* and *n*; the topmast can then be lowered through the cap. In sending the topmast up the line *k* must of course be kept taut.

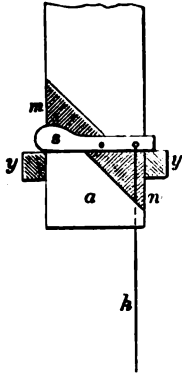

FIG. 218.

The plan recommended on page 51, and illustrated thereon by Fig. 14, is to be preferred; as if anything happened to this line *k* some one would have to go aloft to unfid. As the advantage of such contrivances depends almost entirely on being able to unfid without going aloft, the plan referred to on page 51 is to be recommended in preference to the one here given.

Fidded.—When the fid has secured the topmast or bowsprit in its proper place.

Fiddle Block.—A long block with one sheave above another.

Fiddle Head.—The curved part of the knee at the upper fore part of the stem in schooners, turned upwards aft like the curly part of a fiddle head. A scroll head turns downwards.

Fill, To.—When a vessel has been sailed so close to wind that the sails have shaken, and the helm being put up the sails are "filled" with wind. In getting underway after being hove to a vessel is said to fill, or to have been "filled upon."

Fillings or Filling Timbers.—Pieces of wood or timbers used to fill various spaces that may occur in ship building.

Fine.—To sail a vessel "fine" is to keep her so close to the wind that her sails are on the point of shaking; considered sometimes good sailing if done with great watchfulness. Too fine means too near the wind.

Fire Escape.—A term applied to chaplains by sailors. (See "Sky Pilot.")

Fish, To.—To strengthen or repair a damaged spar by lashing a batten or another spar to it.

Fisherman's Bend.—(See "Knots.")

Fisherman's Walk.—When there is very little deck room, "Three steps and overboard."

Fishing Tackle.—The lines, hooks, sinkers, &c., used by fishermen. Messrs. Hearder and Son, of 195, Union-street, Plymouth, publish a book giving a full description of all the lines, nets, &c., necessary for a yacht, with instructions for using the same. The book can be had on application to Messrs. Hearder.

Fitting Out.—Getting a ship's rigging, sails, &c. into place after she has been dismantled.

Fitted Out.—When a vessel is "all-a-taunto," which see. A vessel ready to proceed to sea.

Flag Officer.—An Admiral, Vice-Admiral, or Rear-Admiral; also the Commodore, Vice-Commodore, or Rear-Commodore of a club.

Flags.—Pieces of bunting of various forms, colours, and devices, such as ensigns, jacks, burgees, &c.

Flags, the size of.—The size of the racing flags usually carried is as under :

Tons.	ft.	in.	ft.	in.	Tons.	ft.	in.	ft.	in.				
5	1	6	by	1	0	60	3	0	by	2	3
10	1	9	by	1	2	100	3	6	by	2	9
20	2	3	by	1	9	150	4	0	by	3	3
40	2	9	by	2	0	200	4	6	by	3	9

and above 200 tons the same.

The burgee of a yacht 45ft. long over all would be 2ft. 6in. in the fly, and $\frac{3}{4}$ in. for every foot of length of the yacht up to 130ft. over all. The ensign would be 6ft. for a 45ft. yacht, and 1in. for every additional foot of length of the yacht up to 130ft. over all.

Flare.—To project outwards, contrary to tumbling home.

Flat Aback.—In square rigged ships when all the yards are trimmed across the ship, with the wind ahead so as to produce sternway.

Flat Aft.—When sheets are trimmed in as close as the vessel will bear for close hauled sailing.

Flat Floored.—When the bottom timbers or floors of a vessel project from the keel in a more or less horizontal direction.

Flatten in Sheets.—To haul in the sheets.

Fleet, To.—To overhaul a tackle or separate the blocks after they have been hauled close together.

Float.—To rest on the surface of the water, contrary to sinking.

Floating Anchor.—Although floating anchors are continually referred to in old writings as a means whereby many ships have been enabled to ride out very heavy gales in comparative ease, we seldom hear of their being used now. No doubt many a ship has been lost through getting broadside on to the sea, whereas they might have kept bowing the sea by such a simple contrivance as a floating anchor. However, masters, it would seem, prefer to heave-to, as they like to keep their vessels under command. In a very heavy sea and gale a floating anchor may be of very great service, and no doubt if a vessel can be kept bow to the sea, she will feel the violence of it in a much less degree than she would if hove-to

Floating Anchor—continued.

when she might be continually flying-to against the sea after falling off.

Many plans for floating anchors have been used, the simplest being thus made; three spars, in length about two-thirds the beam of

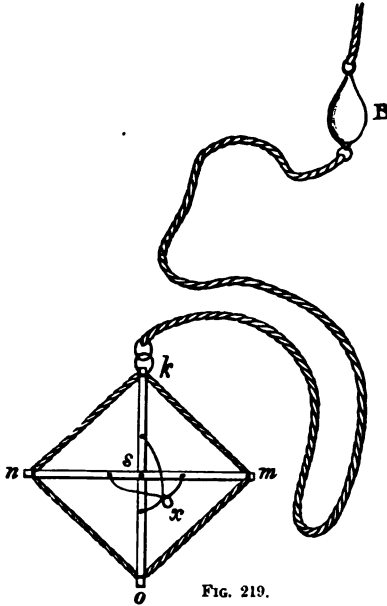

FIG. 219.

the vessel, were lashed together by their ends in the form of a triangle; over this triangle a jib made of stout canvas was lashed. Then to each corner of the triangle a rope was made fast; the ends of these ropes were then

Floating Anchor—continued.

The most approved plan of making a floating anchor is shown by the diagram; *k, m, n, o*, are the ends of two iron bars formed into a cross, and connected by a stout bolt, nut, and pin at their intersections *s*. At each end of the bars is a hole through which a strong rope is rove, hauled taut, and well secured. Thus a square is formed, and over the square a piece of stout canvas is laced to the roping. Four stout ropes are made fast to the iron bars, and make a sort of bridle or crow foot, the other ends being bent to a ring *x*. The ends should be well seized or "clinched." The hawser is bent to this ring to ride by. To prevent the anchor sinking a buoy, *B*, is made fast attached to one corner with 6 or 7 fathoms of drift; this buoy will also prevent the anchor "diving" (as it would, like a kite flies into the air) when a strain is brought upon it. The buoy rope *p* should lead on board; *h* is the hawser to which the vessel is riding, *A* is the anchor, and *B* the buoy.

To get the anchor on board haul in on the line *p*; this will bring the anchor edgewise, and it can then be readily hauled in.

Floating Dock.—Upon lakes, where there are no tides, and no convenience for hauling a yacht up, a floating dock may be of service to get at a yacht's bottom. The dock would be rectangular in form, of which [] might be a transverse section, and its size would depend upon the weight of the yacht that had to be docked. The weight of the yacht can roughly be arrived at thus: length on load line, multiplied by beam on load line, multiplied by draught of water to rabbet of keel; the product in turn being multiplied by the fraction 0.3. The decimal .3 is used, as that

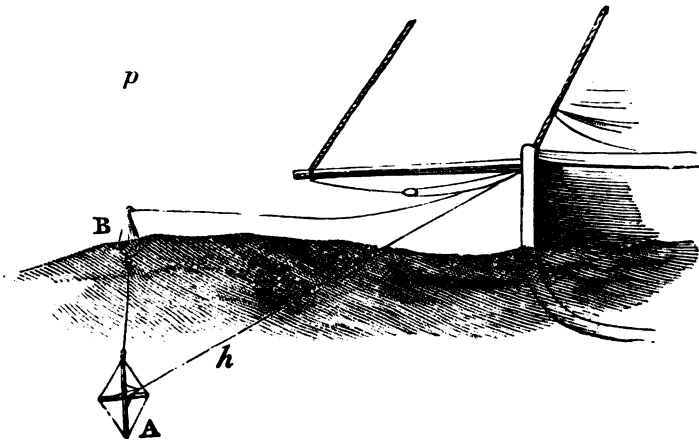

FIG. 220.

bent to a hawser, and thus formed a kind of bridle. A weight was attached to one corner of the triangle to keep it in a vertical position; veer out the hawser and ride to 30, 50, or 70 fathoms, according to the sea.

fairly allows for the quantity cut away from the cube in modelling. Say the yacht is 40ft. long, 8ft. broad, and 6ft. deep to the rabbet in the keel, then $40 \times 8 \times 6$, equal to 1920 cubic feet. 1920 multiplied by 0.3 is equal

to 576 cubic feet. There are 35 cubic feet of salt water to one ton, and 576 divided by 35 is equal to 16.4 tons. (There are 36 cubic feet of fresh water to one ton.) A dock 50ft. long, 16ft. broad, and immersed 2ft., would (omitting of course the reduction by the factor '3, as the dock would be a cube) be equal to 45 tons; the weight of the dock made of 4-inch deal, would be, if the sides were 10ft. deep, about 20 tons; this would leave a margin of 25 tons for floating at 2ft. draught. A false bottom and sides 2ft. deep would have to be made in the dock; also a door at one end hinged from its lower edge, level with the top of the false bottom, and rabbeted at the sides. To get the yacht in the dock lower the door and fill the false bottom and sides with water until the dock sank low enough to be hauled under the keel of the yacht; then close the valve which lets the water in, shut the door and pump the water out of the false bottom and sides (a hose for the pump should be used in case the dock sank). The yacht should be shored up from the sides of the dock before she took any list. With caution such a contrivance could be used for floating a deep draught yacht over shallows from one lake to another, or through canals; in such cases, if the draught of water for going over the shallows were not limited to 2ft., it would be well to keep the false bottom full or partially full of water.

Flood Tide.—The rising tide, contrary to ebb.

Floors.—The bottom timbers of a vessel.

Flotsam.—The cargo of a wreck that may be floating about or liberated from the wreck.

Flowing sheet.—In sailing free, when the sheets are eased up or slackened off.

Flowing tide.—The rising tide, the flood tide.

Fluid compass.—A compass card in a basin of fluid, usually spirit, used in rough weather because the card should not jump about. In a small yacht a good and steady compass is an essential part of the outfit, and if there be



FIG. 221.

any sea on the usual compass card and bowl are perfectly useless to steer by. The fluid compass then becomes necessary, and frequently a "life boat" compass, which costs about 5*l.*, is used. A more yacht-like looking

liquid compass, however, is one sold by Mr. C. Wilson, 157, Leadenhall-street, price 6*l.* 6*s.*, shown by Fig. 190. The extreme height is only 1ft. 2in., and the card remains steady under the most trying circumstances of pitching and rolling. (See "Binnacle and Compass.")

Flukes.—(Pronounced "fines" by seamen). The barb-shaped extremities of the arms of an anchor.

Flush deck.—When the deck has no raised or sunken part.

Fly.—The part of a flag which blows out; the opposite side to the hoist; the halyards are bent to the hoist.

Flying jib.—A jib set in vessels on the flying jib-boom. There is then the jib, the outer jib and flying jib or inner jib, jib and flying jib; probably called flying jib because unlike the others it is not set on a stay.

Flying light.—Said of a vessel when she has been lightened in ballast so as to float with her proper load-line out of water.

Flying start.—In match sailing a start made underway. (See page 141.)

Flying to.—When a vessel in sailing free, luffs suddenly, or comes to suddenly; also after tacking, if a vessel's head is kept much off the wind, and the helm be put amidships, the vessel will fly to, i.e. fly to the wind quickly. A vessel that carries a hard weather helm will fly to directly the tiller is released.

Fly up in the Wind.—When a vessel is allowed to come head to wind suddenly.

Foot.—The lower edge of a sail.

Fore.—Front; the contrary of aft; the forward part.

Fore-and-aft.—Running from forward aft, in a line with the keel.

Fore-and-aft rig.—Like a cutter or schooner; without yards, with all the sails tacked and sheeted in a line with the keel.

Fore-body.—The fore part of a ship which is forward of the greatest transverse section.

Forecastle.—The space under deck before the mast allotted to the seamen.

Fore Deck.—The deck before the mast.

Fore Foot.—The foremost part of the keel at its intersection with the stem under water.

Fore Guy.—The stay of a squaresail boom or spinnaker boom which leads forward.

Foremast.—The mast which occupies the most forward position in a vessel.

Fore Peak.—The fore-castle, a space decked over forward in a small boat to stow gear in.

Fore-rake.—The rake the stem has forward beyond a perpendicular dropped to the fore end of the keel.

Fore-reach.—When one vessel reaches past or sails past another; generally applied in close-hauled sailing. Thus it is frequently said that one vessel "fore-reaches but does not hold so good a wind as the other;" meaning that she passes through the water faster but does not

or cannot keep so close to the wind. A vessel is said to fore-reach or head-reach fast that is noted for great speed when sailing by the wind. (See "Head Reach.")

Foresail.—In square rigged ships the large lower-sail set on the foremast; in cutters the triangular sail or jib foresail set on the fore-stay; in fore-and-aft schooners the gaff sail set abaft the foremast.

Fore-staysail.—The jib foresail set on the fore-stay of schooners; properly "stay-foresail."

Foresheet.—The sheet of the foresail.

Foresheet horse.—An iron bar for the foresheet to work upon.

Fore-topman.—In a schooner yacht a man stationed aloft to work the fore-topsail tack and sheet in going about.

Fore-topmast.—The topmast over the foremast.

Foreyard.—The yard on the foremast for setting the foresail in square-rigged ships.

Forge ahead.—When a vessel that is hove to gathers way; generally when a vessel moves past another.

Foul.—Entangled, not clear.

Foul Anchor.—When an anchor gets a turn of the cable round its arms or stock; when imbedded among rocks, &c., so that it cannot be readily recovered.

Foul Berth.—When two vessels that are anchored or moored have not room to swing without fouling each other. If a vessel is properly moored and another comes and fouls her berth she is held liable for any damage which may ensue.

Foul bottom.—A rocky bottom; also the bottom of a ship when it is covered with weeds, &c.

Frames.—The timbers or ribs of a vessel.

Frapping.—A rope put round the parts of a tackle or other ropes which are some distance apart, to draw them together and increase their tension or prevent them overhauling. Frequently a frapping is put on the parts of the head sheets of a yacht, especially on the jib topsail sheets, to draw them down to the rail, and thus bring a strain on the leech and foot.

Frapping a ship.—Passing a cable or hawser round the hull of a ship to keep her from falling to pieces when she is straining in a heavy sea.

Free.—Not close hauled. When a vessel is sailing with a point or two to come and go upon. The wind is said to free a vessel when it enables her to check sheets so as to be no longer close hauled. Also when it enables a vessel that is close hauled to lie nearer her course.

Freeboard.—The side of a vessel which is above water.

French Nautical Terms—

Keel.....	Quille.
Stem.....	Etrave.
Sternpost	Etambot.
Rudder	Gouvernail.
Bulwarks	Parois.

French Nautical Terms—continued.

SPARS.	ESPARS.
Mainmast	Grand mât.
Topmast	Mât de flèche.
Bowprit	Beaupré.
Mizen mast.....	Mât de tapecul.
Main boom	Bôme ou guy.
Gaff peak	Corne ou pic.
Main yard	Vergue de tapecul.
Bumpkin	Bout dehors de tapecul.
Topsail yard	Vergue de flèche.
Spinnaker boom	Tangon de spinnaker ou de vent-arrière.

STANDING RIGGING.	MANGUYRES DORMANTES.
Forestay	Grand étai.
Topmast stay	Etai de mât de flèche.
Shrouds	Haubans.
Topmast shrouds.....	Galhaubans.
Banner tackle	Bastaque.
Bobstay	Sous-barbe.
Backstay	Pataras ou galhaubans volants.

RUNNING RIGGING.	MANGUYRES COURANTES
Boom topping lifts	Balancines.
Sheets	Ecoutes.
Main or throat halyards...	Drisee de mât.
Peak halyards	Drisee de pic.
Spinnaker boom brace ...	Bras du tangon.
Spinnaker boom guy	Botenue du tangon.
Spinnaker boom topping lifts	Balancine du tangon.
Davits	Pistolets.

SAILS.	VOILES.
Main sail	Grand voile.
Gaff topsail	Flèche.
Jib topsail or flying jib ...	Clin-Foc.
Jib	Foc.
Foresail	Trinquette.
Mizen	Tapacul.

MAINSAIL.	GRAND VOILE.
Mainmast	Mât.
Gaff	Corne.
Boom	Bôme ou guy.
Luff or weather leach.....	Guindant.
Head	Tête.
Leach or after leach	Chute arrière.
Foot or roach of sail	Bordant.
Tack	Point d'amure.
Clew or clue	Point d'écoute.
Throat.....	Empouture du mât.
Peak earing	Empouture du pic.
First, second, third, and close reef cringles	Cosses d'empoutures des 1 ^{re} , 2 ^e , 3 ^e , 4 ^e ris.
Beef knifes or points ...	Hanets ou garettes de ris.

GAFF TOPSAIL.	FLECHE POINTU.
Leach	Chute.
Halyards.....	Drisee.
Gaff topsail boom.....	Balestron.
Clew	Point d'écoute.
Tack	Point d'amure.
Truss	Collier de rascage.
Weather leach	Guindant.
Yard.....	Vergue.
Backstay	Etai de flèche.
Foot	Bordant.

SQUARE TOPSAIL.	FLECHE CARRE.
Yard and head	Vergue de flèche et ra-lingue de tête.
Leach	Chute arrière.
Luff	Chute avant.
Foot	Bordant.
Tack	Point d'amure.
Clew	Point d'écoute.
Head	Point de drisee.
Tack pendant	Pantoire d'amure.
Sheet pendant	Pantoire d'écoute.
Clew-line.....	Cargue.
Traveller	Rocambeau.
Bowline bridle	Patte de bouline.
Bowline	Bouline.

HULL.	COQUE D'UN BATEAU
Keel	Quille.
Keelson	Carlingue.
Stem.....	Etrave.
Forefoot	Briou.
Sternpost	Etambot.
Arch board.....	Barre d'hourdi.

French Nautical Terms—continued.

Long stern timbers	{ Allonges de voûte. de tableau.
Budder	{ Du gouvern.
" Afterpiece	" Safran.
" Spindle	" Mèche.
" Helm	" Barre.
Helm-port	Tron de jaumière.
Beam	Barrots ou baux.
Deck	Pont.
Bits	Bittes.
Windlass	Guindeau.
Partners	Etambrai.
Strep	Emplanture.
Frame	Des membres.
" Floor timbers	" Varangue.
" Timbers	" Genou.
" Futtock	" Allonge.
Stanchions	Jambette.
Rail	Lisse.
Knees	Courbe.
Gunwale	Plat-bord.
Scuppers	Dalots.
Planking	Bordages.
Wales or bends	Précointe ou carreau.
Channel	Forte-hauban.
Chain plates	Cadène de hauban.
Garboard strake	Gabord.
Rabbit	Bablure.
Inboard plank	Vaigrage.
Clamp	Bauquière.
Bulwarks	Favols.
Flooring	Plancher.
Bending strake	Hiloire.
Skylight	Claire-voie.
JIBS.	
Jib	Foc.
Foresail	Trinquette.
Flying jib or topsail jib ..	Foc volant ou foc en l'air.
Spinnaker	Spinnaker.
Halyards	Drisses.
Head	Points de drisse.
Clw or clue	Points d'écoute.
Tack	Points d'amure.
Sheet pennant and blocks	Fantoire et poulies d'écoute.
Jib purchase	Etarque de foc.
Flying jib tack	Amure de foc volant.
Sheets	Écoutes.
Main stay and hanks	Grand étai, servant de draille, et bagues.
Topmast stay	Etai du mât de flèche
Foresail bowline	Bouline de trinquette.
Inhaul of the traveller ..	Hâle-à-bord.
Foresail downhaul	Hâle-bas de trinquette.
Bobstay and tackle	Sous-barbe et son palan.
Bowsprit shrouds	Haubans de beaupré.
Foresail tack tackle	Palan d'amure de trinquette.
MAINMAST.	
Iron cap	Blin.
Top rope sheave	Clan de guinderesse.
Eye-bolt	Pitons de poulies (pic).
Jib halyard clamp	Lâte de drisse de foc.
Gallows bitt	Potence.
Yoke	Chouque.
Crosstrees	Bare de hune.
Tressle trees	Elongis.
Cheeks	Jottereaux.
Topping lift clamp	Galoche de balancine.
Spider hoop	Cercle du mât.
Mast coat	Brale.
Masthead	Ton.
BOOM.	
Boom	Bôme ou GUI.
Boom iron	Bôme.
Main tack	Ferrure.
Main tack cleat	Amure de grand-voile.
Beef tackle cleat	Taquet d'amure de grand-voile.
Main sheet strop	Taquets d'Itagues de ris.
Beef tackle cleat	Estrope de grande écoute, ou d'écoute de guy.
Topping lift strop	Estrope de balancine.
Beef earing bee blocks ..	Violons de ris.
Clw traveller on the boom	Rocambeau d'écoute.
Main sheet clamp	Clan d'écoute de grand-voile.

French Nautical Terms—continued.

TOPMAST.	
Heel	Caisse.
Fid	Clef.
Top rope sheave	Clan de guinderess
Traveller	Rocambeau.
Halyard sheaves	Clans de drisses.
Top rigging	Capelages.
Pole	Fusée.
Truck	Pomme.
BOWSPRIT.	
Bowsprit heel	BOUT DEHORS OU BEAUPRÉ.
Fidd	Talon.
Traveller	Clef.
Ironwork	Rocambeau
Jib tack	Frette.
GAFF OR PEAK.	
Throat	CORNE OU PIC.
Truss	Mâchoire.
Sheet sheave	Collier de racage.
Peak halyard strop	Clan d'écoute de flèche.
MISCELLANEOUS.	
Forward	De l'avant.
Aft	De l'arrière.
Fore and aft	De l'avant à l'arrière
Athwart	Par le travers.
Starboard	Tribord.
Port	Babord.
Below	En bas.
Aloft	En haut.
Avast	Tenez bon.
Crew	Equipage.
Boatswain	Maitre d'équipage.
Sailmaker	Voilier.
Carpenter	Charpentier.
Steward	Commis aux vivres.
Cook	Cuisinier.
Seaman	Matelot.
Boy	Mousse.
Belay!	Amarrez!
Let go!	Larguez!
Hoist away!	Hissez!
Lower away!	Amez!
Haul!	Halez!
Handsomely	Doucement
Hold on	Tenez.
Heave away	Virez.
Slack	Filez.
Bear a hand	Vite.
Foul	Embroullé.
Weather gage	Dessus le vent.
Windward	Au vent.
Leeward	Sous le vent.
Catch hold	Atrappez.
Look out	Être en Vigie.
All right	Tout droit.
Ready about	Paré à virer.
Hard up the helm!	La barre au vent.
Steady the helm!	Comme cela!
Let go the anchor	Mouillez.
Pay out the cable	Filez de la chaîne.
Right the helm	Dressez la barre.

Fresh Breeze.—(See "Wind.")

Freshen.—To alter the strain upon a rope.

Freshen Hawse.—To veer out or heave cable, so that a different part will take the chafe of the hawse pipe.

Freshen the Nip.—To shift a rope, &c., so that its nip, or short turn, or bight, may come in another part. In slang, to quench a desire for drink.

Full.—When all the sails are filled with the wind and quite steady.

Full Aft.—When a vessel is said not to taper sufficiently aft.

Full and By.—Sailing by the wind or close hauled, yet at the same time keeping all the sails full so that they do not shake through being too close to wind. Generally a vessel does better to windward when kept a "good full and bye" than when nipped or starved of wind.

Full and Change.—(See "High Water.")
Full bowed.—The same as bluff bowed.
Furl.—To roll a sail up on a yard, &c.
Futtocks.—The timbers which abut above the floors called first, second, and third futtocks. This should properly be written foothooks.

G.

Gaff.—The yard to which the head of a fore-and-aft sail is bent. (See "Jaws.")
Gaff Topsail.—The topsail set over a gaff sail, such as the topsail set over a cutter's mainsail. Sometimes the sail has a head yard, and sometimes not. (See "Jib-Headed Topsail.")
Galley.—A long narrow rowing boat propelled by six or eight oars. A boat a little longer and heavier than a yacht's gig.
Galley or Galley Fire.—The caboose, or kitchen of a vessel.
Gammoning.—The lashings which secure the bowsprit to the stem piece, and are passed backward and forwards in the form of an X, over the bowsprit. Now, generally chain is used. In yachts, an iron band or hoop, called the gammoning iron or span-shackle, is fitted to the stem, through which the bowsprit passes.
Gammon Iron.—An iron hoop fitted to the side of the stem, or on top of the stem, as a span-shackle, to receive and hold the bowsprit.
Gangway.—The opening in the bulwarks, or side, through which persons enter or leave a vessel. Generally a passage, or thoroughfare of any kind. "Don't block up the gangway," is a common admonition to thoughtless people who stand about in passages or thoroughfares, to the impediment of passers.
Gangway Ladder.—The steps hung from the gangway outside the vessel. Sometimes there is also a board, or kind of platform, called the "Gangway Board."
Gant-line.—A whip purchase; a single block with a rope rove through it. A Gant-line is used to hoist the rigging to the masthead on beginning to fit out.
Garboard.—The strake of plank next above the keel into which it is rabbeted and bolted.
Garland.—A strop put round spars when they are hoisted on board.
Garnet.—A kind of tackle used for hoisting things out of the hold of vessels; also used for clusing up squaresails.
Gaskets.—Pieces of rope, sometimes plaited, by which sails when furled are kept to the yards. The pieces of rope by which sails are secured when furled, such as the tyers of the mainsail, by which that sail when rolled up on the boom, is secured. (See "Tyers.")
Gather Way.—When a vessel begins to move through the water, under the influence of the wind on her sails, or under the influence of steam. (See "Steerage Way.")
Gawlor.—An open boat which can either be rowed or sailed, common to Portsmouth watermen. They are very skilfully handled by the water-

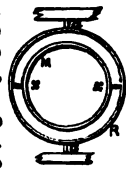
men, and go backwards and forwards to Spithead and elsewhere in all kinds of weather, and seldom meet with mishaps. They are sharp sterned, like the bow, and are rigged with sprit, main, and mizen, and jib-foresail. They have no boom to the mainsail.
Get a Pull.—To haul on a sheet or tack or fall of a tackle.
Getting Soundings Aboard.—Running aground.
Gig.—A long boat of four or six oars kept for the owner of a yacht. In gig races a boat should not be considered a gig if she has less than 1ft. of breadth for every 7ft. of length, and $\frac{1}{2}$ in. depth amidships for every foot of length. At the regatta held at Itchen-ferry by yacht-masters a "gig must not exceed 28ft. in length, and be in the proportions of 28ft. long, 4ft. broad, and 1ft. 8in. deep." A boat could be shorter if these proportions were maintained.
Gilling.—To gill a vessel along is to sail her very near the wind, so that very little of the weight of the wind is felt by the sails. The sails are kept lifting, and only bare steerage way kept on the vessel. A vessel is generally "gilled" through heavy squalls or through very broken water.
Gimbals.—The cross axes by which compasses, lamps, &c., are swung on board ship. Generally called "double gimbals." In Fig. 222 *a a* are the axes of the outer ring B, and *x x* of the inner ring M.

Girt.—To moor a vessel so that she cannot swing by tide or wind. To draw a sail into puckers; to divide the belly of a sail into bags as by a rope, such as the topping lift of boom.
Girt-line.—(See "Gant-line.")
Give Her.—A general prefix to an order, as "Give her sheet;" "Give her the jib-headed topsail;" "Give her chain," &c.
Give her the weight of it.—An admonition to a helmsman to sail a vessel a good heavy full when close-hauled.
Give Way.—The order to a boat's crew to commence rowing or to pull with more force or more quickly.
Giving the Keel.—Heeling over suddenly and bringing the keel near the surface; vessels that are not very stiff under canvas are said to "give the keel."
Glass.—The term by which a sailor knows the barometer. Also a telescope, and the sand glass used to denote half-hours on board ship, or the half-minute or quarter-minute glass used when heaving the log.
Glass Calm.—When it is so calm that the sea looks like a sheet of glass.
Glue for Paper.—For joining paper, cardboard, or model work, or similar articles, a good glue can be made thus: dissolve 2oz. of the best transparent glue in $\frac{1}{2}$ pt. of strong cider vinegar. Let it simmer slowly by placing the dish containing it in a dish of boiling water.

- When it has become liquid, add 1oz. of highest proof alcohol, and keep it tightly corked. If cold, heat in hot water when needed for use.
- Go About.**—To tack.
- Go Ahead!**—The order to the engineer of a steam vessel. Also "Go astern;" "Easy ahead;" "Easy astern;" "Stop her!"
- Go Down.**—To sink. To go down below.
- Going Large.**—The same as sailing with the wind free. (See "Large.")
- Going Through Her Lee.**—When one vessel overtakes and passes another vessel to leeward; considered to be a very smart thing for a vessel to do if they are close together and of equal size.
- Good Conduct Money.**—A douceur of one shilling or more a week given to men at the end of a season for good behaviour, and withheld for the week in which any offence or offences were committed. (See "Conduct Money.")
- Good Full.**—Same as "Clean Full," or little fuller than "Full and By."
- Goose-neck.**—An iron jointed bolt used to fix the end of booms to the mast, &c. (See Fig. 27, p. 77.)
- Goose Wing.**—A schooner "goose wings" when dead before the wind by booming out the gaff foresail on the opposite side to the mainsail. A practice not now in much use in racing, as the introduction of large squaresails and subsequently of spinnakers have made it unnecessary, but in America, where such sails are not allowed in matches, "goose-winging" is always resorted to. To goose-wing is to gybe the gaff foresail of a schooner to the opposite side to the mainsail. (See "Wing and Wing.")
- Graduated Sail.**—A sail whose cloths taper towards the head from the foot upwards; so that a whole cloth forms the luff as well as the leech. Manufactured by Gordon, of Southampton, and Summers and Hewitt, of Cowes.
- Granny Knot.**—An insecure knot which a seaman never ties, but which a landsman is sometimes seen to do when trying his hand at reef knots. (See "Knots.")
- Grapple.**—A grappling iron with four claws used to moor small boats by or to reach the bed of the sea.
- Gratings.**—Open woodwork put in the bottom of boats, in gangways, &c.
- Graving.**—Cleaning a vessel's bottom.
- Graving Dock.**—A dock which can be emptied of water by opening the gates as the tide falls, and its return prevented as the tide rises by closing the gates. Used for clearing the bottoms of vessels, repairing the same, &c.
- Gravity.**—Weight. The centre of gravity is the common centre of a weight or weights.
- Great Guns.**—A heavy wind is said to "blow great guns."
- Green Hand.**—A landsman shipped on board a vessel, and who has yet to learn his duties.
- Green Horn.**—A conceited simpleton, incapable of learning the duties of a seaman.

Green Sea.—The unbroken mass of water that will sometimes break on board a vessel as distinct from the mere buckets full of water or spray that may fly over her. Such bodies of water always have a green appearance, while smaller quantities look grey, hence we suppose the term.

Gridiron.—A large cross framing over which a vessel is placed at high water in order that her bottom may be examined as the tide falls.

Grin.—A vessel is said to grin when she dives head and shoulders into a sea and comes up streaming with water.

Gripe.—The forepart of the dead wood of a vessel; the fore foot.

Gripe, To.—A vessel is said to gripe when she has a tendency to fly up in the wind, and requires weather helm to check or "pay off" the tendency. (See "Weather helm.")

Grommet or Grummet.—A ring formed of a single strand of rope laid over three times. Used for straps, &c.



FIG. 223.

Grounding.—The act of getting aground or taking the ground as the tide falls.

Ground Sea, Ground Swell.—The swell that may be seen along shore sometimes, whilst in the offing the sea is calm.

Ground Tackle.—The moorings, anchors, chains, &c., used in securing a vessel.

Ground Ways.—The blocks on which a vessel is supported whilst she is being built.

Gudgeons.—Metal eye bolts fitted to the stern post to receive the pintles of the rudder. (See "Braces.")

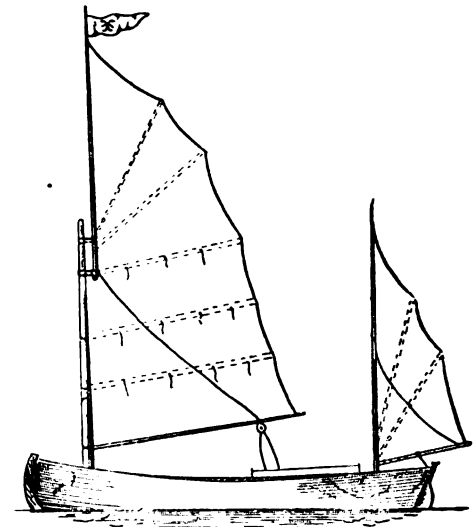

FIG. 224.

Gunter Rig.—A sliding gunter rig with battens has been in use since 1876, as shown in Fig. 225. A is the mast; B, topmast or yard;

C and D, irons with a sheave at C; E, connecting rod; F, halyard fast to B, and rove through a sheave in the masthead; G, a

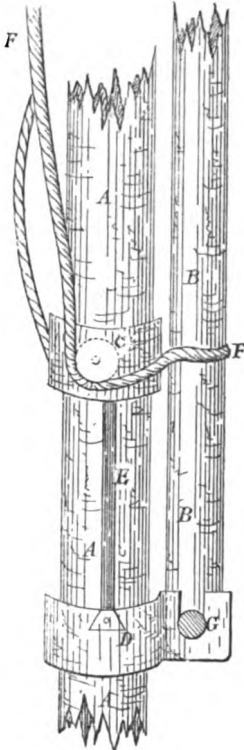

FIG. 225.

socket and pivot for the heel of the yard to allow the peak of the sail to be lowered.

Gunwale.—In small boats the timber which fits over the timber heads, and is fastened to the top strake. (See "Inwale.")

Gunwale Under.—Heeling until the lee gunwale is in the water.

Guy.—A rope used to steady a spar or keep it in its position.

Gybing (also spelt jibing and jib-bing).—To keep a vessel so much off the wind that at last it blows on the opposite quarter and causes the sails to shift over. The opposite of tacking, which is to come to the wind until it blows on the opposite bow of the vessel to the one on which it has been blowing.

H.

Hail.—To speak to a ship at sea by signals or otherwise. To attract the attention of a ship by singing out "Ship ahoy!" or "Neptune ahoy." To "hail from" a locality is to belong to a particular place by birthright.

Half-breadth Plan.—A drawing showing the horizontal sections or water-lines of a vessel by halves.

Half-breadths.—The width of horizontal sections at particular points.

Half-mast High.—Hoisting a burgee or ensign only halfway up as a mark of respect to a person who has recently died.

Halyards or Hallkards, or Haulyards.—Ropes or tackles for hauling up sails, yards, &c., by.

Hammock.—A canvas bed swung underneath the deck beams.

Hand.—To hand a sail is to stow, furl, or take in; hence a sail is said to be "handed" when either of these operations has been performed upon it.

Hand.—A man. A member of a ship's crew.

Hand Lead.—(See "Lead.")

Handle Her.—An admonition to the crew to be smart in working the sheets in tacking or gybing. Also a steamboat master is said to "handle" his vessel in bringing her alongside a wharf, pier, &c.

Hand over Hand.—Hauling on a rope by one hand at a time and passing one hand rapidly over the other to haul. A very rapid way of hauling, hence anything done rapidly is said to be done "hand over hand."

Hand over Fist.—(See "Hand over Hand.")

Hand Sail.—(See "Sailing on Skates.")

Handsomely.—Steadily; with care. Not too fast nor yet too slow, but with great care; cleverly. As "Lower away handsomely." In easing up a sheet, if the man is likely to let it fly, the master or mate will sing out, "Handsomely there!" meaning that the man is to ease up the sheet carefully, not letting too much run out nor yet letting it come up with a jerk nor yet allowing it to run away with him.

Handspike.—A bar of wood, usually of ash, used as a lever.

Hand Taut.—As tight or taut as a rope can be got by the hand without swigging upon it.

Handy.—A vessel is said to be handy when she answers her helm quickly, and will turn in a small circle, or go from one tack to the other quickly.

Handy Billy.—A watch tackle kept on deck for general use to get a pull on whatever is required, such as sheets, tacks, or halyards.

Hang.—To lean towards. To hang to windward is to make but little leeway. "Hang on here!" an order for men to assist in hauling on a rope.

Hanging Compass.—A compass suspended under the beams so that it hangs with the face of the card downwards; termed also a "Tell-tale Compass."

Hanging Knee.—Knees that help keep the beams and frame together; one arm is bolted to the under side of a beam, the other to the frame.

Hank for Hank.—Slang for "tack for tack."

Hanks.—Rings or hooks made of rope, wood, or iron for fastening the luff of sails to stays. Iron rings are usually used for the stay foresail; iron hooks for the balloon foresail and jib topsail.

Harbour Master.—An officer whose duty it is to see that vessels are properly berthed and moored in harbours. His authority cannot be disputed with impunity, as, in nine cases out of ten, if a dispute with a harbour master gets into court the decision will be for the harbour master.

Harbour Watch.—The watch kept on board a vessel at night when she is riding to an anchor in harbour; the anchor watch.

Hard.—A landing place usually made of gravel, piles, &c., across mud, as the "Common Hard," Portsea, where the small boats land and take in passengers.

Hard Down.—The order to put the helm hard-alee. Also the tiller may be put hard-a-port; hard-a-starboard; hard-a-weather; hard up.

Hard Up.—The tiller as far to windward as it can be got for bearing away.

Hard In.—Sheets are said to be hard in when a vessel is close-hauled.

Harpings.—Pieces of timber or battens that are fitted around the frames of a vessel in an unbroken line to keep the frames in their places before the plank is put on.

Hatches.—The coverings for hatchways or openings in the deck.

Hatchway Coamings.—The raised frame above the deck upon which the hatches rest.

Haul.—To pull on a rope.

Haul Aboard the Boom!—An order to get the main boom hauled in on the quarter for close-hauled sailing.

Haul Aft the Sheets.—The order to haul in the sheets for close-hauled sailing.

Haul Her Wind.—To become close-hauled after sailing free. Generally to sail closer to the wind when sailing free. Haul to the wind. Haul on the wind.

Haul Round a Mark, Point, &c.—When a vessel in sailing free has to come closer to the wind as her course alters round a point, buoy, &c. By hauling in the sheets the vessel will sometimes luff sufficiently without any help from the helm.

Haul Up.—To hoist a sail. A vessel is said to "haul up" when she comes, or is brought nearer the wind or nearer her course if she has been sailing to leeward of it. Haul up a point, haul up to windward of that buoy, &c.

Hawse Pipe.—The pipes in the hawseholes in the bow through which the cables pass.

Hawser.—A large rope laid up with the sun or right-handed.

Hawse Timbers.—The large timbers in the bow of ships in which the hawseholes are cut.

Head.—The fore part of a vessel. The upper part of a sail. "By the head" means pressed or trimmed down by the head, in contradistinction of "by the stern." To head is to pass ahead of another vessel.

Head Earings.—The earings of the upper part of a squaresail, &c.

Heading.—The direction of a vessel's head when sailing. Generally used when sailing close hauled, as "she headed S.E. on port tack, and N.E. on starboard tack." In such cases it is never said she "steered S.E.," &c., as practically the vessel is not steered, but her course alters with the wind. A vessel "steers" such and such a course when she is sailing large.

Headland.—A high cliff or point.

Headmost.—The first in order.

Head Reach.—In sailing by the wind when a vessel passes another either to windward or to leeward. A vessel is said to "head-reach" when she is hove to, but forges ahead a knot or two an hour. (See "Fore-reach.")

Head Rope.—The rope to which the head of a sail is sewn.

Head Sails.—A general name for all sails set forward of the foremost mast.

Head Sea.—The sea met when sailing close-hauled. In the case of a steamship she may meet the sea stem on.

Head Sheets.—The sheets of the head sails.

Head to Wind.—When a vessel is so situated that the wind blows no more on one bow than the other; when her head is directly pointed to the wind.

Head Way.—When a vessel moves ahead through the water.

Head Wind.—A wind that blows directly down the course a vessel is desired to sail. A foul wind. To be headed by the wind is when the wind shifts so that a vessel cannot lie her course, or puts her head off to leeward of the course she had been heading.

Heart.—A sort of dead-eye made of lignum vitae with one large hole in it to pass a lanyard through turn after turn instead of through three holes, as in an ordinary dead-eye. They are something like a heart in shape, and the lower one is iron bound; the stay goes round the upper one either by a spliced eye or an eye seizing.

Heart Thimble.—A thimble shaped like a heart put in the eye splices of ropes.

Heave.—To bring a strain or drag upon a capstan bar, purchase, &c. To throw, as "heave over-board."

Heave About.—To go into stays to tack.

Heave Ahead.—To draw a vessel ahead by heaving on her cable, warp, &c.

Heave-and-Away.—The last heave of the capstan that breaks the anchor out.

Heave in Stays.—The same as heave about.

Heave Short.—To heave on the cable until the vessel is over the anchor, or the cable taut in a line with the forestay, so that with another heave, or by the action of the sails, the anchor will be broken out of the ground.

Heave To.—To so trim a vessel's sails aback that she does not move ahead. The same as "lie to" or "lay to" as sailors call it.

Heave the Lead.—The order to cast the lead for sounding.

Heave the Log.—The order to throw the log ship overboard to test the rate of sailing.

Heel.—The lower after end of anything, as heel of the keel, heel of the mast (the fore part of the lower end of a mast is called the toe), heel of a yard, heel of the bowsprit. The amount of list a vessel has.

Heeler.—A heavy puff that makes a boat heel.

Heel Rope.—The rope by which a running bowsprit is launched out.

Heel, To.—To incline, to careen, to list over, to depart from the upright.

Height.—A distance measured in a vertical direction, as height of freeboard, &c.

Helm.—The apparatus for steering a vessel, usually applied only to the tiller. The word is derived from *helma* or *healma*, a rudder; German *helm*, a handle and a rudder.

Helm's A-lee.—The usual call made in tacking or in going about, as a signal for the crew to work the sheets, &c. The helm is a-lee when the tiller is "put down" or to leeward. (See "Lee Helm" and "Weather Helm.")

Helm Port.—The rudder trunk in the counter.

Helm, to Port the.—To put the helm or tiller to the port side, and thereby bring the vessel's head round to starboard. If a wheel is used besides a tiller the action of turning the wheel to port brings the vessel's head round to port, as the tiller is moved by the chains to starboard. Thus with a wheel, when the order is given to port the wheel is turned to starboard. The rule observed in French war ships and merchant ships, since 1876, is this: The order to "port" means to turn the vessel's head to port; and the order to "starboard" to turn the vessel's head to starboard.

Helm, to Put Down the.—To put the tiller to leeward, and thereby bring the vessel to the wind, or luff; the contrary action to putting up the helm.

Helm, to Put Up the.—To bring the tiller to windward, so that the rudder is turned to leeward, and consequently the head of the vessel goes off to leeward or "off the wind."

Helm, to Starboard the.—To put the tiller the way opposite to port.

Helm, to Steady the.—To bring the helm or tiller amidships after it has been moved to port or starboard, as the case may be.

Helmsman.—The man who steers a vessel. If a man can sail a vessel well on a wind he is generally termed a good "helmsman," and not steersman.

Hermaphrodite Brig.—A two-masted vessel, square-rigged forward, and fore-and-aft canvas only on mainmast.

High and Dry.—The situation of a vessel that is ashore when the ebb tide leaves her dry.

High Water: Full and Change.—On all coast charts the time of high water at the full moon and new moon is set down, the time of high water at the full moon and new moon always occurring at the same hour throughout the year; therefore, if the time of high water at

full and change (new moon) is known, and the age of the moon, the time of high water for any particular day can be roughly calculated, about twenty-five minutes being allowed for each tide.

Hipping.—To make a vessel broader on the beam about the water-line. It is an American term, and became generally known in England in connection with the celebrated American yacht *Sappho*. After her defeat by the English yacht *Cambria*, in the match round the Isle of Wight in 1868, she was taken to New York and hipped; that is, her planking was stripped off amidships, and each frame backed with timber, so that the vessel might be made to have more beam about the water-line. The backing is "faired" to the frames and then planked over. Sometimes, if it is not sought to give the vessel more than five or six inches more beam, the hipping is accomplished by a doubling of plank; in such cases a rabbet is cut for the edges of the new plank in the old plank; the seam is then caulked and payed. If the new planks were worked to a feather edge water would get underneath, and it might soon bring about decay.

Hire of a Yacht.—The hire of yachts varies from 30s. per ton per month to 40s. per ton. Usually the owner pays all wages, excepting those of the steward and cook; also often provides for the mess of the master and mate. The crew always provision themselves; the owner clothes the crew. The hirer pays insurance, and contributes to laying-up expenses. The exact details of hiring are usually a matter of special arrangement. Sometimes at the end of a season, if a yacht is already fitted out, she may be hired for a less price per month. When a yacht is wanted on hire, the best plan is to advertise.

Hitch.—A mode of fastening a rope. There are many kind of "hitches," such as Blackwall hitch, timber hitch, clove hitch, rolling hitch, &c. A hitch is also a short tack or board made in close-hauled sailing.

Hogged.—The situation of a vessel when she rises higher in the middle part than at the ends; the opposite of sagged.

Hogging Piece.—A piece of timber worked upon top of the keel to prevent its hogging or rising in the middle.

Hoist.—The length of the luff of a fore-and-aft sail, or the space it requires for hoisting. The hoist of a flag is the edge to which the roping is stitched.

Hoist, To.—To raise anything by halyards or tackles, &c.

Hoisting the Pennant.—A commodore is said to hoist his pennant when he goes on board the first time, as his pennant is then hoisted.

Hold.—The interior of a ship; generally understood to mean the space in which cargo, &c., is stowed away.

Hold-a-wind.—To sail close to the wind.

- Hold her Head Up.**—A vessel is said to "hold her head up" well that does not show a tendency to fall off.
- Holding On.**—To continue sailing without altering a course or shifting sail.
- Holding On to the Land.**—To keep the land aboard in sailing; not departing from the land.
- Holding Water.**—Resting with the blades of the oars in water to check a boat's way or stop her.
- Hold On.**—The order given after hauling on a rope not to slack any up, as "Hold on all that."
- Hold On the Fore Side.**—If, when hauling on the fall of a tackle, some of the hands have hold of it on the tackle side of the belaying pin, the hand that has to belay sings out, "Hold on the fore side" to those in front of him, and "Come up behind" to those behind. The hands on the fore side thus hold the fall and keep it from running through the blocks whilst it is being belayed. (See "Come Up.")
- Hollow Lines.**—The horizontal lines of a vessel that have inflections.
- Hollow Sea.**—When the waves have a short, steep, and deep trough.
- Home.**—Any operation that is completely performed, as "sheeted home" when the clew of a sail is hauled out to the last inch, &c. An anchor is said to come home when it breaks out of the ground.
- Hood.**—A covering for skylights, sails, &c.
- Hood Ends.**—The ends of the plank which are fitted into the rabbet of the stem or stern post; termed also the hooded ends, meaning probably that they are "housed" or covered in by the rabbet.
- Hooker.**—A small coasting craft.
- Hoop.**—(See "Mast Hoop" and "Spider Hoop.")
- Horizontal Lines.**—The curved lines on the Half-breadth Plan which show the water sections, the plane of each section being parallel to the horizon.
- Horizontal Keel.**—A plate of iron fitted to the underside of a boat's keel, a fore-and-aft view showing thus . The plate should be made of iron plate of from $\frac{1}{2}$ in. to $\frac{3}{4}$ in. in thickness. For a boat 12ft. long the plate should be 8in. wide at the middle (so as to project about 3in. on either side of the keel), and 8ft. long, tapering each end to the width of the wood keel, to the underside of which it is screwed. The wood keel should extend at least 3in. below the garboards to render the plate effective. It is necessary that the plate should be kept horizontal, or in other words, in the same plane as the horizon; inasmuch as if the keel dips forward or aft the tendency of the plate will be to draw the boat either by the head or stern. A horizontal keel will increase a boat's weatherliness, but not to the extent of a centre board. The deeper the wood keel of the boat is the more effective the horizontal plate will be, as it will clear the eddy water along the garboards, and prevent the possibility of the bilge of the boat as she heels over being lower than the keel. However, if a very deep keel is necessary to make the horizontal plate effective, it may be as well to have another inch or so, and dispense with the plate altogether. The plan does not appear to have met with much favour.
- Horns.**—The projections which form the jaws of gaffs or booms. The outer ends of the cross-trees are sometimes termed horns.
- Horse.**—A bar of iron or wood, or a rope for some part of a vessel's rigging to travel upon.
- Hounds.**—The projections on a mast which support the lower cap and rigging. (See pages 27 and 29.)
- House.**—To lower a topmast down within the cap. A snug house is when very little of the topmast shows above the upper cap. Sometimes in a racing yacht a topmast is fitted with one reef to shorten it about 3 feet, the same as a bowsprit. This plan has been adopted to be able to set a very large balloon topsail, but has very little to recommend it.
- Housing of a Mast.**—The part under the deck.
- Hove Down.**—Said of a vessel that is very much careened or heeled by the wind or other cause.
- Hove her Keel Out.**—Said of a vessel that heels over, so as to show her keel. (Generally used only as a figure of speech.)
- Hove in Sight.**—To come into view; said of a sail that appears above the horizon or round a headland; also of the anchor when it comes above water.
- Hove in Stays.**—Said of a vessel when she tacks, often meaning that a vessel tacks suddenly.
- Hove Short.**—When the cable is hove in so that there is but little more length out than the depth of water.
- Hove-to.**—The condition of a vessel with her head sails aback, so as to deprive her of way. Vessels hove-to on port tack should fill or get way on, if approached by a vessel on the starboard tack; but if the vessel on port tack can, by hailing or otherwise, make the other vessel understand the situation, the latter should give way; this is the custom of the sea, but there is no statutory regulations concerning the point.
- Hoy.**—A small vessel. An abbreviation of "Ahoy."
- Hug the Land.**—To sail along as close to a weather shore as possible.
- Hug the Wind.**—To keep very close, or too close to the wind.
- Hulk.**—A vessel whose seagoing days are over, but is still useful as a store ship, &c.
- Hull.**—The ship, as distinct from her masts and rigging.
- Hull, To.**—To strike the hull with shot, &c.
- Hull Down.**—On the sea when only a vessel's spars appear above the horizon.
- Hull-to, or A-hull.**—With all sails furled and the helm lashed to leeward, leaving the waves to do their worst.

PLATE LXV.



Ice Boat of the Sea of Azoff.

I.

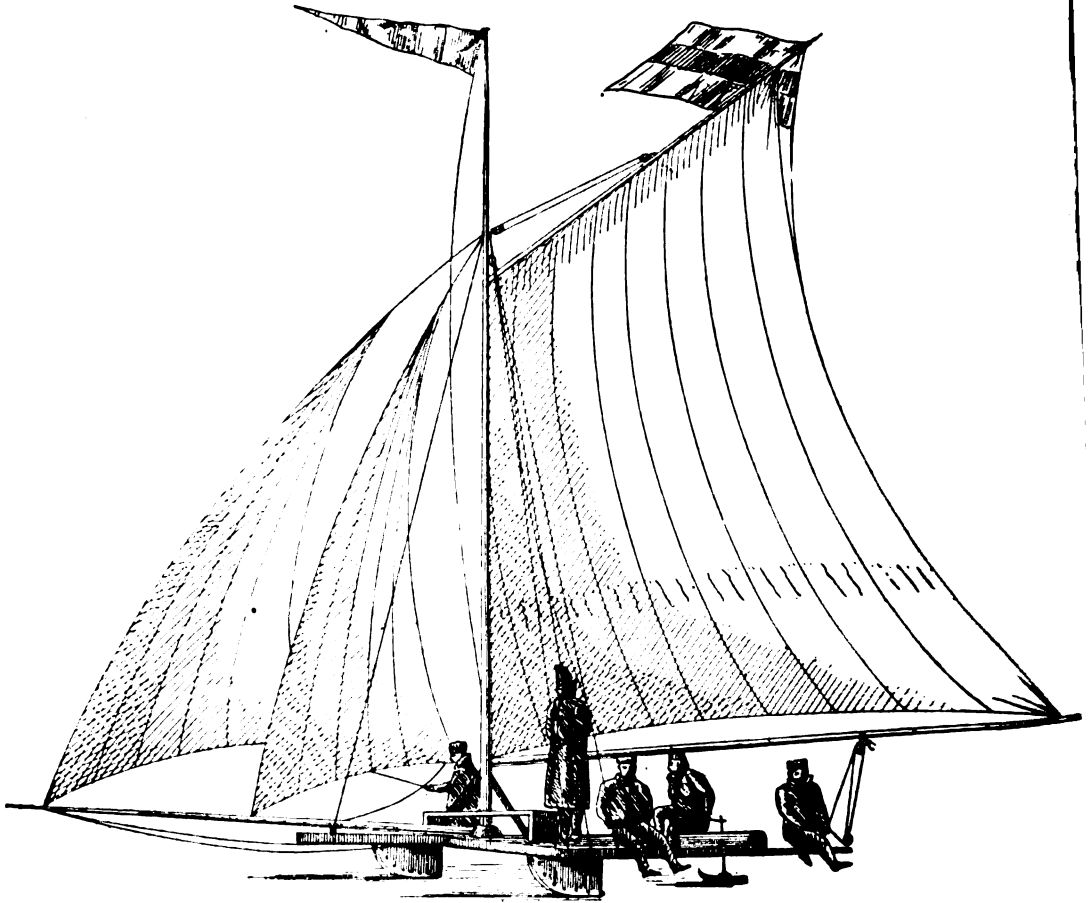
Ice Yachts.—A description of the ice yachts used by the Americans is given in the body of the book, and the following account of similar craft to be met with in Russia has been supplied by Mr. John Yeames, of Taganrog. Mr. Yeames thinks that the American ice boats are not built sufficiently strong for the rough

Ice Yachts—continued.

winds cause the water to rise with a S. wind and fall with a N., with a difference of 12ft. to 15ft. between the two extremes. The floes get knocked together, and the broken ice of the edges is forced down to the bottom of the sea—which is not very deep—and piece piled upon piece until the pile rises to about 1ft. to 3ft. above the level of the floes, which then

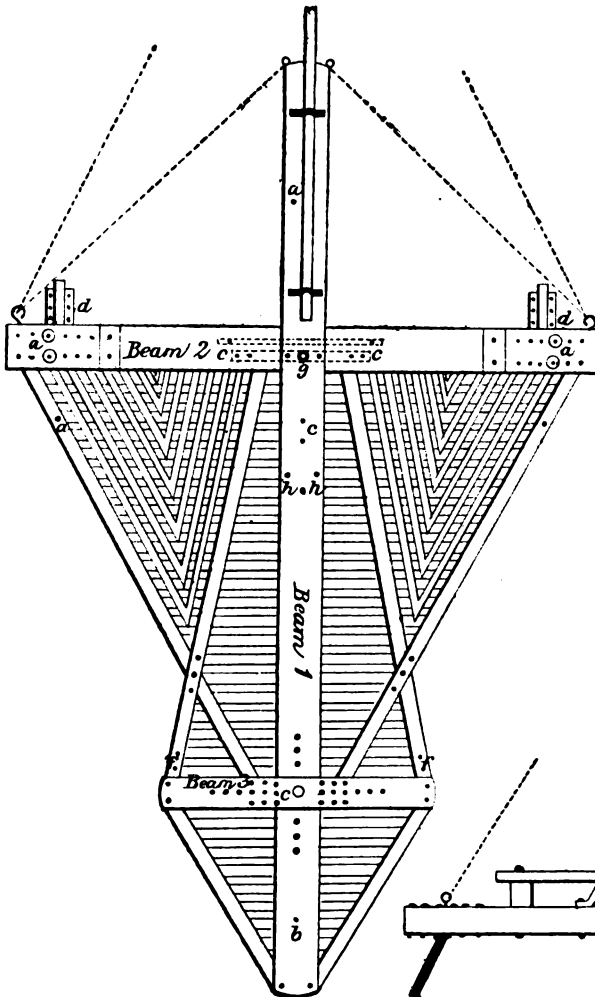
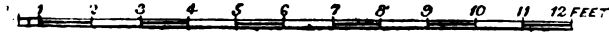

FIG. 226.

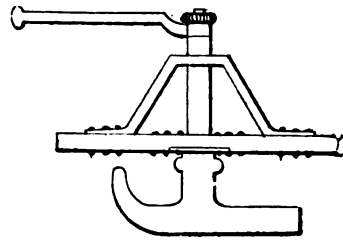

FIG. 227

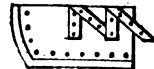

FIG. 228.

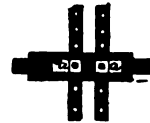

FIG. 229.

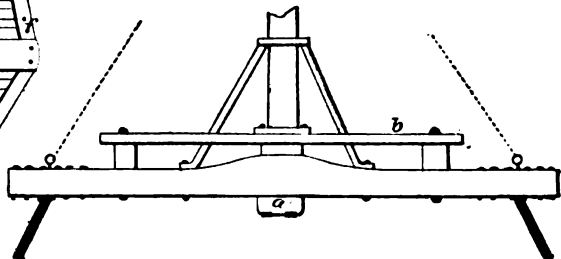

FIG. 230.

ice of the sea of Azoff, where ice-yacht sailing is practised. He says:

"The Azoff Sea naturally has not such a smooth frozen surface as a river, for, until the ice is of great thickness, it is continually split into big floes by the variations in the level of the water, caused by changes of wind. There is no tide in the Azoff, but N. and S.

freeze to these piles, which stretch for great distances, and, in fact, form a network in all directions. They are most numerous in shallow water, where the rise and fall of the water has the greatest effect. In parts where great forces have been at work the ice is piled in bergs of 30ft. to 60ft. in height.

"With my present yacht we charge over

Ice Yachts—continued.

broken ice which is not higher than 18in., and of course the breadth which we can rush at depends upon the force of the wind. Above 18in. and up to 3ft. we dare charge a narrow line, but above that height we are obliged to circumvent it. However, I do not think any boat could charge a greater height than one built on the plan of my present one.

"Fig. 226. General bird's-eye view of yacht. The three main beams are of oak, and the remainder of the framework of ash. The lattice work is of deal, made much lighter in the stern than forwards.

GENERAL DIMENSIONS.

Beam 1—Bowsprit, 6ft.; mast to rudder, 10ft.; rudder to stern, 4ft. = length, 20ft.; breadth, 10½in.; thickness, 3½in.

Beam 2—Length, 12ft.; breadth, 10½in.; thickness, 3½in., thickening to 7in. in centre.

Beam 3—Length, 6ft.; breadth, 5½in.; thickness, 3½in. The remaining beams are all—breadth, 3in.; thickness, 3½in.; but the two stern ones might be made lighter.

EXPLANATIONS.

- a Bolts with rings for rigging.
- b Bolt with rings for mainsail sheet.
- c Strong bolts fastening iron supports of mast.
- d Two main skates.
- e Rudder hole.
- f Supports for steersman's bench, about 1ft. above deck.
- g Mast.
- h Bolts to fasten iron bands.
- i Chains to stiffen bowsprit.

"Fig. 230 is a front view, showing the position of the skates, which are drawn at rather too great an angle, the bridge and mast supports; a, block of wood and two iron bands, which keep the bowsprit down; b, the bridge.

"Fig. 227, the rudder. This has been drawn rather too thick; but it is an error on the right side, as the extra weight would help to keep the rudder firmer on the ice. At present we always have a couple of men sitting on the stern in order to keep it down when charging.

"Fig. 228. Side view of front skate.

"Dimensions: Length above, 32in.; length below, 24in.; breadth on top, 7in.; breadth of fluted part, ½in.; height of skate from ice, 1ft. 3in.

"Fig. 229. Bird's-eye view of front skate; a, two strong holdfasts going right through beam 2, with rings for stays to mast.

"As will be seen from the plans, both the skates and the rudder supports, as well as those of the mast, have been firmly fastened with iron bands and bolts, and all mortices and joints have been strengthened in the same manner. Any boat built according to this plan ought to stand anything; but she weighs probably more than a ton herself, and when sailing, what with the pressure of the wind and the weight of ten or twelve persons—which is our usual number—her weight will be greatly increased. We have found that, as a rule, seven inches of ice are sufficient. The rudder must be entirely of iron, edged with steel, and fluted. The fore skates should also be of iron, if charging has to be resorted to. I have a very fine pair of wrought-iron ones, fluted and edged with steel. The greatest difficulty was that the main beam

Ice Yachts—continued.

split from the strain of the mast when charging; but the plan of stepping the mast upon an ash bridge is a perfect success. This is well shown in Fig. 230. Of course she could be constructed much lighter, if not required for very rough ice.

"She is cutter rig, and the following are the length of her spars: Height of mast to gaff, 16ft. 6in.; length of boom, 20ft.; length of gaff, 13ft. 6in.; length of jibboom, 16ft. The boom swings 3ft. above the deck, to give room to move; but perhaps it could be lowered. (See Plate LXIV.) She is quite open all round, not planked round the stern, as the American ones are. We generally sail with ten to twelve persons, with all but one or two on the windward side, so as to keep the boat as level as possible.

"With regard to the speed on good smooth ice, with only six or seven persons for ballast, the Russian ice boat is not far behind the American, and on rough ice would take a lot of beating, for they have run across several lines of broken ice, a distance of twenty-eight to thirty miles, in forty minutes."

Immersed.—Under water. The opposite of emersed, which means taken out of water. The "wedge of immersion" is the part of a vessel put into the water when she heels over. The wedge of emersion is the part taken out of the water. Sometimes termed the "in" and "out" wedges.

In.—The prefix to a curt order to take in a sail, as "In spinnaker," "In squaresail," or "In boats," &c.

In and Out Bolts.—Bolts that pass through the skin and frame of a vessel through and through.

In Board.—Inside a vessel's bulwarks, being the opposite to outboard.

In Bow.—In rowing, the order to the bow man to throw up his oar and be ready with the boat hook, to help bring the boat alongside.

Inclination.—Heeling from an upright position. Synonymous with careening and listing.

Inner Jib.—The jib next the forestay sail in schooners where two jibs are carried.

Inner Post.—A piece of timber sometimes worked inside the sternpost.

In Haul.—A rope used to haul sails on board, as the inhaul of a jib or spinnaker.

In Irons.—A vessel is said to be in irons when she is brought head to wind, and, having lost her way, will not fall off on one tack or the other.

Initial Stability.—The resistance a vessel at the first moment offers to being heeled from the upright position, as distinct from the resistance she may offer to being further heeled when inclined to considerable angles. Thus beamy boats are said to have great initial stability, because they resist powerfully, being heeled to small angles; narrow vessels, on the other hand, are readily heeled at first, but may offer greater resistance, as they

are farther heeled, whereas a beamy boat's resistance may rapidly decrease as she gets over to large angles of say 30°.

Inlet.—A creek. A pipe to admit water to the hold.

Inshore.—Close to the shore.

In the Wind.—When sailing close hauled, if a vessel comes to nearly head to wind she is said to be "all in the wind."

In wale.—The clamp or strake of timber inside the top strake of a small boat, generally termed the gunwale.

Irish Pennants.—Loose ends of ropes, &c., hanging about a vessel's rigging or sails.

Iron Moulds.—Diluted oxalic acid will remove iron moulds from sails; but the instant the iron mould is removed the part should be well rinsed or soaked in fresh water, or it will be rendered rotten.

J.

Jack.—The Union Jack. The typical British flag that has "braved a thousand years, the battle and the breeze." It originally only had the red St. George's cross on a white field. Upon the accession of the Scotch King James to the English throne, St. Andrew's cross on a blue ground was added, and the flag was thereupon termed the "Union Jack" and National Flag, "For the Protestant religion and liberty." The red cross of St. Patrick was added (over the white St. Andrew's cross) upon the union with Ireland 1801. (See St. George's Jack.)

Jack in the Basket.—A boom or pole with a cage on the top used to mark a shoal or bank.

Jack Screw.—A powerful screw used for moving heavy weights.

Jack Stay.—A rod of iron, or rope, usually wire rope, for sails or yards to travel on. Also the wire rope stay on the boom of laced sails, round which the lacing is passed.

Jack Yard.—The small yard on the foot of balloon topsails to extend them beyond the gaff. Termed also jenny yards and foot yards.

Jam.—In belaying or making fast a rope to close up or jam the turns together. To clinch the hitch of a rope by passing the end through a bight.

Jaws of a Gaff.—The horns at the end of the gaff which half encircle the mast. A rope called a "jaw rope," or jaw parrel, is fitted to the ends of the horns, and, passing round the mast, keeps the gaff in its place. Wood beads are rove on the rope to make it slide easily on the mast.

Jenny Yard.—(See "Jack Yard.")

Jesty's Composition.—This is a composition in great request for coating the bottoms of iron and wooden ships. Before applying it

give the vessels one or two coats of coal tar thinned with turpentine; when this has dried on apply a couple of coats of the composition; a priming of black varnish made by Mr. Jesty is sometimes used instead of coal tar. The composition should not be put on over paint. It must be kept well stirred in the pot whilst it is being applied, as some of its ingredients are very heavy. The Jesty manufactory is at Gosport, Hants. (See "Composition.")

Jetson.—Goods thrown overboard in heavy weather to lighten the ship. (See "Flotsam.")

Jib.—The outer triangular sail set on the bowsprit. A cutter usually carries six jibs—balloon jib, No. 1, 2, 3, 4, and 5 jib, the latter being the storm or spitfire jib.

Jibb or Jiba.—(See "Gybe.")

Jib-boom.—The spar beyond the bowsprit in schooners upon which the outer jib is set.

Jib Foresail.—In schooners the stay-foresail. (See "Fore-staysail.")

Jib Stay.—In schooners the stay to which jibs are hanked.

Jib Topsail.—A triangular sail made of duck set upon the topmast stay.

Jib Traveller.—The iron hook-hoop on the bowsprit to which the jib tack cringle is hooked.

Jigger Mast.—The mizen mast of yawl or dandy.

Joggles.—Notches cut in timber.

Join Ship.—To come on board a vessel, or to enter as a seaman on board.

Jolly Boat.—A boat larger than a dinghy, and not so large as a cutter.

Jumpers.—A short frock made of duck worn by sailors. The triatic stays of schooners when they are double.

Junk.—Old rope. Also old salt beef as tough and hard as old rope. Also a Chinese ship.

Jury.—A makeshift or temporary contrivance, as jurymast, jury rudder, jury bowsprit, &c., which may be fitted when either has been lost or carried away.

K.

Kamsin.—A south-westerly wind which is said to blow on the Nile for fifty days during March and April. The simoom.

Kedge.—The smallest anchor a yacht carries, used for anchoring temporarily by a hawser or warp. To kedge is to anchor by the kedge, or to carry the kedge anchor out in a boat and warp ahead by it.

Keg.—A small cask, or breaker.

Keel.—The fore-and-aft timber in a vessel to which the frames and garboard strake are fastened.

Keel.—An awkward-looking north-country boat with one lugsail forward.

Keel Haul.—A mode of punishment formerly in use in the Royal Navy. A rope, passed underneath the bottom of the ship, was made fast to each yard-arm. A man with a weight fast to his feet was made fast to one part of the rope and hauled from one yard-arm to the other, passing underneath the bottom of ship. Keel hauling now, in punning language, means "undergoing a great hardship" of some kind.

Keelson or Kelson.—An inside keel fitted over the throats of the floors.

Keep her Full.—When close hauled, an admonition not to keep too close to the wind.

Keep her Off.—An order to sail more off the wind; to put the helm up. To keep off is to keep away from the wind.

Keep your Luff.—An admonition to keep close to the wind. In match sailing, an order given when a vessel is being overtaken by one coming up from astern not to give way and allow the vessel to pass to windward. It is an old maxim in close-hauled sailing, "keep your luff and never look astern," meaning that if you sail as close to the wind as possible the overtaking vessel must take her passage to leeward or risk a collision by trying to force a passage to windward.

Kentledge.—Pig iron used as ballast.

Ketch.—A two-masted vessel, something like a yawl, but with the mizen stepped ahead of the stern post, and not abaft it as a yawl has it. Ketches were formerly common in the Royal Navy for yachts and bomb boats. A rig now seldom used except by coasters; it has all the disadvantages of the schooner or yawl rig, and none of the advantages.

Kevel or Cavel.—Large pieces of timber used for belaying ropes to such as the horizontal piece which is bolted to the stanchions aft to belay the main sheet to.

Key Model.—A model made by horizontal layers or vertical blocks, showing either the water lines or vertical sections of a vessel.

Kit.—A sailor's belongings in the way of clothes, &c., which he carries in his bag or keeps in his locker.

Kittiwake.—A kind of seagull.

Knees.—Pieces of timber or iron shaped thus L, used to strengthen particular parts of a ship. A hanging knee is the one fitted under the beams (see *n* in Fig. 25, page 105); a lodging knee is a knee fitted horizontally to the beams and shelf, or to the mast partners or deck beams. Floor knees are V-shaped, like breast-hooks.

Knight Heads.—Strong pieces of timber fitted inside and close to the stem to bear the strain of the bowsprit. Called also "bollard timbers." The name is said to be derived from the windlass bits, the heads of which formerly were carved to represent the heads of knights.

Knot.—A geographical mile, or sixtieth part of a degree, termed also a sea mile or nautical

mile. The Admiralty knot or mile is 6080ft., a statute mile is 5280ft. A sea mile = 1.1515 statute mile; a statute mile = .86842 sea mile.

KNOTS PER HOUR CONVERTED INTO FEET PER SECOND.

Knots per hour.	Feet per second.	Knots per hour.	Feet per second.	Knots per hour.	Feet per second.
1	1.688	11	18.57	21	35.45
2	3.376	12	20.26	22	37.14
3	5.064	13	21.94	23	38.82
4	6.752	14	23.63	24	40.51
5	8.44	15	25.32	25	42.20
6	10.13	16	27.01	26	43.89
7	11.82	17	28.70	27	45.58
8	13.50	18	30.38	28	47.26
9	15.19	19	32.07	29	48.95
10	16.88	20	33.76	30	50.64

Knots and Splices.—A Short Splice: Unlay the strands to an equal distance from each end of the rope. Intertwine the ends as shown in Fig. 231, and draw all close up together.



FIG. 231.

Take one end of the rope in the left hand close up to the unlayed strands, and with it the unlayed strands of the other end of the rope; grasp these firmly, or, if more convenient, stop them with a piece of yarn. Take one of the strands (which are free), pass it over the strand (belonging to the other end of the rope) next to it, under the next strand and out, and haul taut. Pass each of the three strands in the same way, and then the three other strands, and the splice will be made as shown in Fig. 232. The



FIG. 232.



FIG. 233.



FIG. 234.

operation can be repeated, or the ends can be seized with spun yarn round the rope. If the ends are stuck again, it is usual to taper each strand so as to make a neater job of it.

An Eye Splice: Unlay the strands of the rope and bring a part of the rope between the strands so as to form an eye (see Fig. 233). Put one end through the unlayed strand of the rope next to it; the succeeding end passes in

Knots and Splices—continued.

an opposite direction over the strand and through under the next strand. The remaining end goes under the strand on the other side. Taper the ends and work them through the strands again, and serve.

Single Wall Knot (Fig. 234): Unlay the end of a rope, hold it in the left hand, take a strand A, and form into a bight, holding it tight in the left hand to the standing part of the rope. Pass B round A, C round B, and up through the bight of A; haul taut. To crown, lay one end over the top of the knot, the second over that, the third over the first, and then under the bight of the first.

Sheet Bend, or Common Bend (see Fig. 235): Useful for bending two ropes together, or

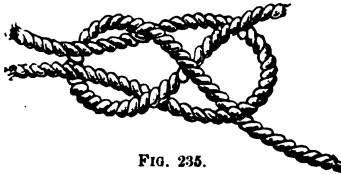

FIG. 235.

bending a rope to a cringle (see also Fig. 25, page 73).

Bend for Hawser (Fig. 236).



FIG. 236.

Magnus Hitch (see Fig. 237).—Useful for bending ropes to spars, &c.

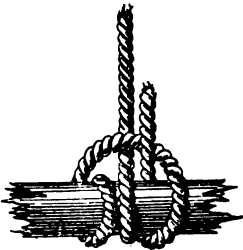

FIG. 237.

Bowline Knot (Fig. 238): Take a convenient part of the end of a rope and form the bight A, then the large bight B; pass the end through



FIG. 238.

the bight A, then round the standing part E, and down through the bight A, and haul taut.

Knots and Splices—continued.

Running Bowline Knot (Fig. 239): After the bight A is made, take the bight B round E (which is the standing part), then up through

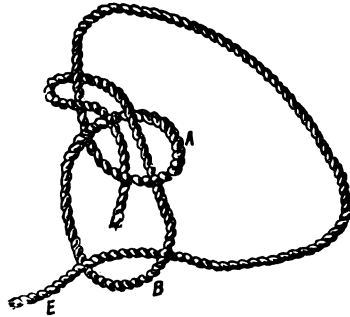

FIG. 239.

A, round the standing part, and down through A as before (see also "Clove Hitch," "Fisherman's Bend," "Timber Hitch," and "Black-wall Hitch").

L.

Labour.—A ship is said to labour when she pitches and rolls heavily, causing her frame to work.

Lace.—To pass a rope in and out.

Laid.—The make of a rope, as cable laid, hawser laid, single laid, laid with the sun, &c.

Land.—To go from a vessel to the shore; also to place anything. The outer edge of the plank of a clincher-built boat. The term "land" is used to mean the coast.

Land Boats.—Carriages propelled by sails on land. The following account of land boats appeared

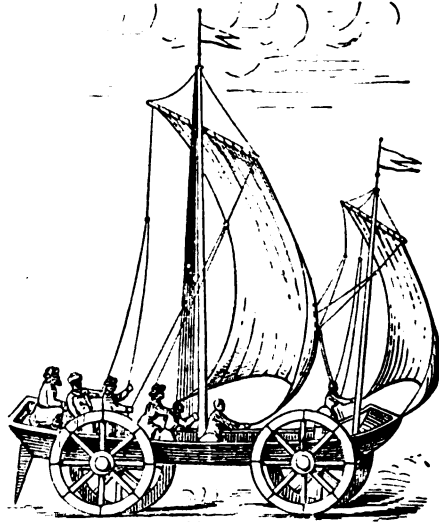

FIG. 240.—SAILING CHARIOT.

in the *Scientific American*: "The force of wind in the motion of sails may be applied

Land Boats—continued.

also to the driving of the chariot, by which a man may sail on the land, as well as by a ship on the water,' remarks Bishop Wilkins, in the second book of his 'Mathematical Magick,' printed in London in 1648. Such chariots, he goes on to explain, have been used from time immemorial on the plains of China and also in Spain, but their most remarkable success has, says the learned author, been achieved in Holland, where 'it did far exceed the speed of any ship, though we should suppose it to be carried in the open sea with never so prosperous wind; and that in some few hours space it would convey six or ten persons twenty or thirty German miles, and all this with very little labour of him that sitteth at the stern, who may easily guide the course of it as he pleaseth.'

"The astonishment of the good bishop and his contemporaries at the speed attained may well be realised when it appears that Dutch sailing carriages, constructed as shown in Fig. 240, page 545, accomplished a distance of

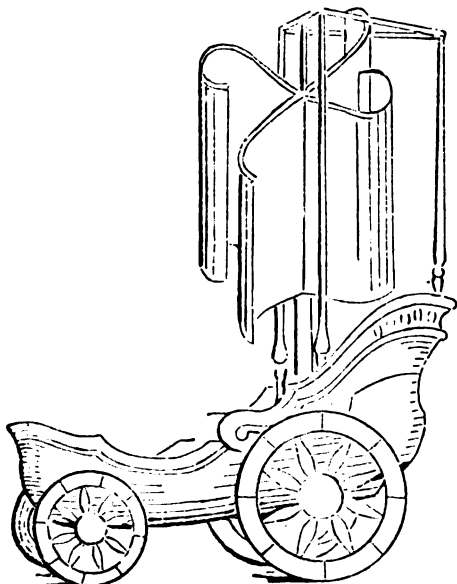

FIG. 241.—BISHOP WILKINS' CHARIOT.

forty-two miles in two hours. This was an unheard of speed in those days for any means of locomotion. 'Men ran before it seeming to go backwards, things which seem at a great distance being presently overtaken and left behind.' Until railroads were invented, without doubt the wind carriage outstripped all other means of travelling; and it is perhaps a little anomalous that more efforts were not made towards its improvement. Bishop Wilkins himself made an effort in that direction by rigging a windmill in the vehicle, whereby 'the sails are so contrived, that the wind from any coast will have a force upon them to turn them about,' and he

Land Boats—continued.

proposed to gear this contrivance with his wheels, and 'consequently carry on the chariot itself to any place (though fully against the wind) whither it shall be directed.' This same thing was reinvented a couple of years ago in this country, as we noted at the time, and perhaps it might be uncharitably inferred that if, after the labour of two and a quarter centuries, our inventors could do no better than reproduce the venerable bishop's notion, the *ultima Thule* of originality in wind carriages must be close at hand. Yet in reality the ice boat is probably the offspring of the wind-impelled land vehicle; and the little carriages to be drawn along by huge kites, such as many an ingenious school boy has constructed, are allied to it.

"It is curious to note, however, that while to the railroad is owing the abandonment of the wind carriage, to the same agency it now seems likely that its rejuvenation will be due. Wind vehicles are already in use on the long stretches of tracks which extend over the Western prairies, and the speed attained is said to rival that of the fast express train.

The engraving (Fig. 242) of a sailing car was devised by Mr. C. J. Bascom, of the Kansas Pacific Railroad. The vehicle is said to average a speed of thirty miles per hour, and, with a strong breeze, to travel at the rate of forty miles in the same period. This last speed was reached with the wind right abeam. A distance of eighty-four miles has been passed over in four hours, the car sailing part of this time close hauled and over a disadvantageously curved track.

"The vehicle has four wheels, each 30in. in diameter, is 6ft. in length, and weighs 600lb. The sail was two booms, respectively 14ft. and 15ft. in length, and an area of about 18 square feet. The mast is 11ft. high, tapering from 4in. square at the heel to 2in. at the truck. It will be obvious that many of the laws applying to the ice boat apply equally well to the sailing car. A little consideration will show that when the latter is sailing at forty miles per hour it is travelling faster than the wind that impels it, and this is constantly the case in ice boat sailing. On the other hand, ice boats always sail best close hauled, in fact the sheet is almost constantly kept flat aft; the sailing car, as stated above, goes fastest with the wind directly on the beam or side. Of course the difference is due to the greater resistance offered by the larger and more elevated surfaces of the car body and its occupants, and to the friction of the axle journals, which probably, under ordinary condition, is sufficient to prevent the sailing car ever attaining the ice boat's speed.

"Mr. Bascom states that his car has been in active operation on the Kansas Pacific Railway for the past three years, being employed to convey repairing parties to pumps, telegraph lines, &c., along the route. It is of course exceedingly cheap to

Land Boats—continued.

construct and maintain, and saves the labour involved in running a hand car."

Land Boats are to be met with on the flat sands of the Lancashire coasts, and were thus described by Mr. B. W. Hancock, of Leeds, in the *Mechanics' Magazine*: "A A, Fig. 243, is the deck, B B B B are seats with cushions, C C are boards for the feet, D D is an iron rail round the seats, E is the steering wheel, F a seat for the man who attends to the sheet, &c., G the hole where the mast is stepped, H H are steps with handrail, I I I I are the wheels, J is the nut which secures the pivot of front wheels. The dotted lines K on

Land Boats—continued.

after him, forming a seat. H is the side step with hand-rail, I I are the wheels, L L is the rail round deck, Q is a belaying pin, also M at back of carriage. O at front is the hook for jib sail, P is the end of iron bar for ring on jib sail to slip. E R are the ropes for steering, S S are supports for the axle of steering wheel, on which there is a great strain, T T is perforated zinc, U is iron ring to support boom.

"The deck, &c., should be made of light but strong wood, well put together, as it has to stand a deal of shaking and jerking. The wheels are also made of wood, they should be

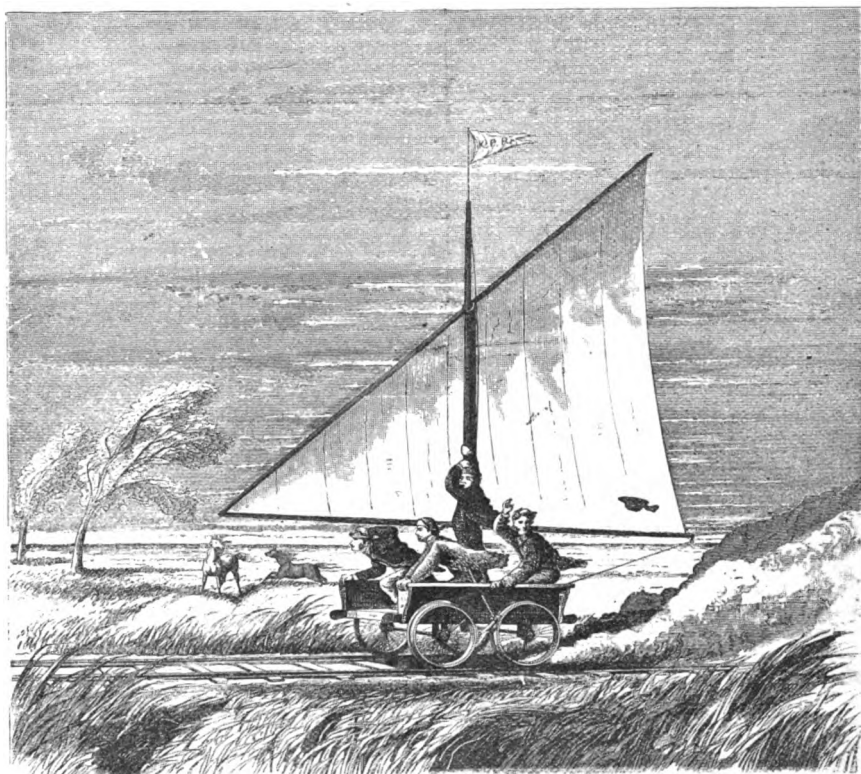

FIG. 242.

deck show the course of the steering gear and axle of front wheels, L L L is a rail about 1ft. high, just to keep anything from shaking off, M M M M are belaying pins, also M M at back of carriage; N in the centre of middle seat is made of wrought iron, to give the mast a good hold, O at front of carriage a hook to secure jib sail, P P is an iron bar for the ring of jib sail to slip on.

"In Fig. 244, A A is the edge of deck, B B sides of seats, D D the iron rail round the seats, E steering wheel, F the seat for man. In its position as a step, it works on hinges; the man can thus get up and pull the step up

about 3ft. diameter, 1ft. wide. Narrow wheels would sink in the sand and impede the progress of the carriage. The axles are wood cased with iron on the bearing parts; it is also advisable to put iron round the wheels. The steering gear will be best understood by referring to Fig. 243, where the dotted lines show the course of the rope or chain from one end of the axle to the steering wheel, where it is wrapped two or three times round the axle shown at S, and then back to the other end of front axle, in this way you have complete control over the carriage. The mast shown at X should be carried through the deck and

Land Boats—continued.

secured underneath, otherwise the deck will probably be torn up in a strong wind. The height of sails should be about twice the length of carriage, but space will not permit

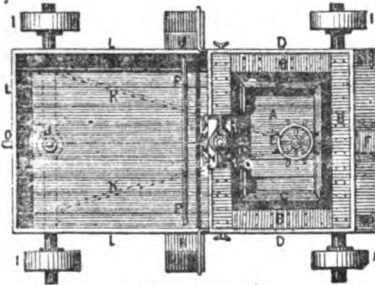

FIG. 243.

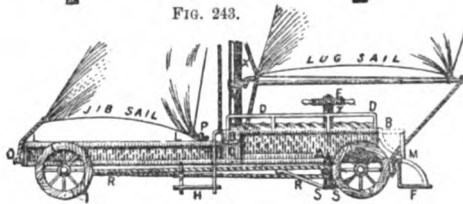

FIG. 244.

of their being shown here. The ordinary lug and jib sail, as shown, are by far the most manageable. As the wind changes they can be turned from side to side without difficulty."

A railway sail car was in use some years ago on Herne Bay Pier.

Land Fall.—The point or part of a coast a vessel first sights after being at sea. To make a good land-fall is to sight the land at the point calculated.

Land Lubber.—A person unacquainted with the duties of a seaman, and one never likely to learn them.

Landsman.—Men who have just joined a ship to train as seamen.

Lane.—A lane of wind is a current of air that travels in a narrow space and does not spread. On board ship the order to "Make a lane there," when a lot of men are standing together, is for them to stand on one side so that others can pass. Steamship lane is a track usually taken by steamships in crossing an ocean.

Lanyards or Laniards.—Ropes rove through dead eyes, &c., by which shrouds and stays are set up.

Larboard.—The left side. In consequence of frequent blunders occurring through "larboard" being misunderstood for "starboard" or *vice versa*, "port," as a distinctive sound, was introduced instead of larboard.

Larbolins.—The men composing the port watch. (See "Starbolins.")

Large.—With the wind abeam or abaft the beam. "She is sailing along large" means that the ship has the wind abeam or between the beam and the quarter.

Lash.—To lace, to bind together with a rope.

Lashing.—A lacing or rope to bind two spars together, &c.

Lateen Sail.—A large triangular sail, with the luff bent to a yard. It really has no head.

Lateral Resistance.—The resistance a vessel offers to being pressed broadside on through the water. This resistance is assumed to be governed by the area of the plane bounded by the stem, keel, and rudder.

Launch.—The largest boat carried by a ship. To launch is to move an object, as "launch a spar forward," to launch a ship.

Launching a Boat Across a Flat Shore.—In making a truck to launch or beach a boat on a sandy or loose gravelly shore, the truck should run on rollers in preference to wheels, as the latter will sink into the sand or gravel, and render the transit very labourousome.

Laveer.—An obsolete sea term used to denote beating to windward.

Lay.—Used by sailors instead of the neuter verb "to lie:" as "lay to" for lie to, "lay her course" for lie her course, "lay up" for lie up, &c., or "she lays S.W." for lies S.W. This use of the active verb is sometimes justified by an appeal to the well-known naval song—

'Twas in Trafalgar's Bay
We saw the Frenchmen lay.

But, whether right or wrong, a sailor will never be brought to say, "there she lies" for "there she lays, or "she's going to lie up" for "she's going to lay up."

Lay along the Land.—When a vessel can just keep along a weather shore close-hauled.

Lay her Course.—A vessel is said to lay her course when sailing close-hauled, if her head points nothing to leeward of it.

Lay in Oars.—An order given to a boat's crew to toss their oars aboard; generally curtly spoken "Oars." To "lay on your oars" is an order for the men to cease rowing, but not to toss their oars up; to rest on their oars.

Lay of a Rope.—The way the strands of a rope are laid up.

Lay Off.—To transfer the design of a vessel to the mould loft full size. This is never written or spoken "lie off."

Lay Out.—To move, as to lay out on a yard-arm.

Laying Up.—Dismantling a yacht after a cruise has been brought to a termination. It is always much the best plan to have a mud dock dug for the yacht to lie in, as then the bottom will not foul, and if the vessel be coppered, she will haul out quite clean; on the other hand, if she lies afloat, weeds and barnacles will accumulate on the bottom. It is much the practice now to haul vessels up high and dry during the winter months; this is an excellent plan, and greatly assists in preserving the hull. The ballast is removed, and the inside of the hull below the platform coated with red lead, black varnish, or a mixture of two-thirds Stockholm tar to one-third of coal tar; black varnish or red lead

is, however, to be preferred. The mast should be taken out before the vessel is hauled up, and with the other spars housed. In case the mast be not removed, all the rigging should be lifted over the mast, and the yoke taken off as well, so that no accumulation of damp may rot the masthead. The copper should be scrubbed and coated with a mineral oil such as paraffin. (See "Limber Boards.")

Lazy Guy.—The guy used to prevent the main boom falling aboard when a vessel is rolling.

Lazy Tack.—A running bight put on the tack cringle of a sail, and round a stay to keep the sail from blowing away whilst it is hoisted.

Lead.—A long weight or "sinker" of 7lb., 14lb., or 28lb. The line is "marked" thus:

Fathoms.		
2	a piece of leather in two strips.	
3	" leather three strips.	
5	" white calico.	
7	" red bunting.	
10	" leather with a hole in it.	
13	" blue serge.	
15	" white calico.	
17	" red bunting.	
20	" two knots.	

There are usually 5 fathoms beyond this unmarked. In heaving the lead, if the vessel has headway, the lead must be cast ahead, so that when it touches the bottom the vessel is directly over it. If the first white mark is just awash when the lead is on the bottom, the leadsman sings out, "By the mark five." If it is less than five, say $4\frac{1}{2}$, he sings out "Quarter less five," And not $4\frac{1}{4}$. If $\frac{1}{2}$ or $\frac{3}{4}$ more than five, he sings out "and a quarter five," &c. There are no marks for 1, 4, 6, 8, 9, 11, 12, 14, 16, 18, and 19 fathoms, and these numbers are called "deeps;" in sounding, the leadsman has to estimate the depth, as, for instance, between 5 and 7 marks, and will sing out, "By the deep 6." The deep-sea lead, pronounced "dipsea lead," weighs from 28lb. to 35lb., and has a much longer line. Up to 20 fathoms it is marked the same as the hand lead—at 30 fathoms 3 knots, at 40 fathoms 4 knots, and so on; the intermediate "fives" being marked by a piece of leather or a small strand with a knot in it; 100 fathoms is marked by a piece of bunting, and then commence the knots again—1 knot 10 fathoms, and so on. In sounding with the deep-sea lead the vessel is usually hoive to.

Lead Ballast.—Bricks of lead cast from moulds to fit inside the frames of a vessel without resting on the plank. Sometimes lead has been run into a vessel hot. When this has been done, the frame and plank have been first smeared with wet clay in order that the wood might not be injured. The objection to running lead into a vessel is the extreme difficulty of getting it out again. The vessel should be well calked before the lead is run in. In casting a lead or iron keel, $\frac{1}{2}$ in. per foot is allowed each way for shrinking.

Lee.—The opposite side to that from which the wind blows.

Lee Board.—A very old-fashioned contrivance to check leeway. The board is usually trapeziform, and hung from the gunwale on either side. The board in length should be about one-fifth the length of the boat, and at its broadest part two-thirds its own length in breadth, and its narrowest one-third its own length. If the board is fixed to an open boat, the gunwale should be strengthened at the point of attachment by a piece of timber worked inside at the back of the boat's timbers. For a boat 17ft. long this strengthening piece should be at least 5ft. in length by 6in. in depth, and be of $1\frac{1}{2}$ in. thickness. The board will be pivoted at its narrow end by an inch bolt; the neck of the bolt which passes through the board should be square, and a square iron plate should be fitted each side of the board, through which plates the bolt will pass. The round part of the bolt will pass through the gunwale and strengthening piece; the bolt will be tightened up by a thumb nut, and, to prevent the latter working into the strengthening piece, it will be best to have an iron plate inside over the hole in the gunwale. The board should be made of inch stuff, with two through bolts of $\frac{3}{4}$ in. galvanised iron rod.

A very good plan for a lee board was recommended in the *Field* a short time ago. It consists of a board about 16in. by 2ft., suspended over the side of the boat (the top

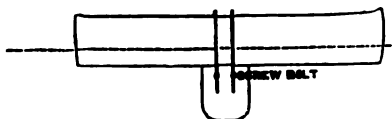

FIG. 245.

of the board being level with the keel) by two irons, which reach up the side over the gunwale, and are turned up along the midship thwart, to which they are fastened by means

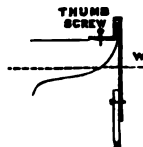

FIG. 246.

of two thumb screws; at the lower end two screw bolts connect the irons with the board; if necessary, one might be fitted on each side of the boat.

The advantages over the ordinary lee-board are that it is not unsightly, is always held parallel to the keel without straining the side, and two turns of the thumb screws will disconnect it in a moment from the boat. By unscrewing the irons, they, with the board, take up no room in the bottom of the boat. If these irons be fixed to different thwarts, a long board might be fitted in the same way; but most men would

- prefer a deep to a long one for going to windward.
- Lee, By the.**—In running nearly before the wind, when a vessel runs off her helm so much as to bring the wind on the quarter over which the boom is; a very dangerous proceeding, as if there be no boom guy a sudden gybe, or a gybe "all standing," may be the result. For safety, the helm should be put down the instant a vessel begins to run off. In match sailing, in running for a mark, yachts are often brought by the lee through a shift of wind, and frequently they are kept so, if a spinnaker or squaresail be set, and if near the mark, to save a gybe, every precaution being of course taken to prevent the main boom coming over, by hauling on the guy or pressing against the boom; this risk, however, should only be run in very light winds.
- Lee-going Tide.**—The tide that is running to leeward in the direction of the wind. The opposite to weather-going tide, which see.
- Lee Helm.**—The helm put to leeward to keep a vessel to or by the wind. Synonymous with slack helm. If the centre of effort of the sails is much forward of the centre of lateral resistance, the vessel will have a tendency to fall off, and will require the helm to be put to leeward to keep her close to wind. The tendency can be checked by reducing the head sail, or by hardening in the sheets of the after sail and easing the sheets of the head sail. A vessel that requires lee helm will be an awkward one, and in a heavy sea a dangerous one to work to windward. The contrary to "weather helm," which see.
- Lee Scuppers.**—Inside the lee bulwarks by the scupper holes. To be always in the lee scuppers is to be always in disgrace.
- Lead a Hand Here.**—An order to a person to assist.
- Let go and Haul.**—In tacking a square rigged vessel the order given to let go the lee braces and haul in on the others.
- Let Her Feel the Weight of It.**—An order to keep a vessel more off the wind, and not allow her sails to shake.
- Life Belts.**—Appliances for support in the water. The cork life belts of the National Lifeboat Institution (6s. each), John-street, Adelphi, are the most highly recommended.
- Lights.**—The lights which all vessels must exhibit between sundown and sunrise. (See "Side Light.")
- Limber Boards.**—Plank covering the floors of a vessel near the keelson. These should be removed when a yacht is laid up, so that the hold may be thoroughly cleansed of all bilge water accumulations. In yachts built with iron knee floors as shown on page 78 and 79, it is a common practice to fill up all cavities along the keel or hogging piece, fore dead-wood and apron, and dead-wood aft, with cement, first carefully coating the wood with Stockholm tar.
- Limber Clearer.**—A small chain which is kept rove through the limber holes in the floors at the side of the keelson, to allow the bilge water to flow freely to the pumps; occasionally the chain is worked backwards and forwards to clear the holes. This contrivance is seldom met with in yachts.
- Line.**—A general name for a rope, or cordage.
- Liner.**—A line-of-battle ship. An old name for ships of the first and second rate, as three deckers and two deckers. We believe the term is not applied to fighting ships of the present day.
- Lines.**—A general term applied to the drawing or design of a vessel as depicted by fore-and-aft lines. A vessel is said to have "fine lines" when she is very sharp fore-and-aft.
- List.**—A vessel is said to list when from some cause—shifting of ballast or cargo or weights—she heels over.
- Listing.**—A narrow strip of plank, usually 4in. in width, cut out of the plank in ship throughout her whole length, in order that the condition of her frames or timbers may be examined.
- Lizard.**—A piece of rope with a thimble eye spliced in one end, used in setting squaresails; sometimes the lizard is of two or more parts with a thimble in each, the whole being spliced into one tail.
- Lloyd's Register.**—The committee appointed in 1824 by "Lloyd's Society of Underwriters for the insurance of ships," to classify and regulate the building of, and keep a registry of all ships. (See "Underwriter.")
- Lloyd's Yacht Register.**—A register of yachts founded by Lloyd's, 1878, in which the build, age, condition, &c., of each yacht is set forth. The published register also contains rules and tables of scantling for the building of yachts. The offices are White Lion Court, Cornhill.
- Load-water-line.**—The line of flotation when a vessel is properly laden or ballasted.
- Load-water section.**—The horizontal plane at the line of flotation.
- Lob Sided.**—Larger or heavier on one side than on the other.
- Locker.**—A small cabin, or cupboard, or cavity to stow articles in.
- Log Board or Log Slate.**—The slate on which the hourly occurrences in navigating a ship—her speed, canvas, courses, the strength of wind, direction of wind, and general condition of weather—are set down.
- Log Line and Ship.**—An ancient contrivance for testing the speed of a ship by throwing a line overboard with a piece of board called "the ship," at one end, and then by noting the time (usually done by a sand glass) it takes to run so much line out. Massey's or Walker's log are now constantly towed, but the log line and ship are regularly used on board large steamers.
- Log Official.**—See "Official Log."
- Long Boat.**—A ship's launch; usually carvel built.

Long Leg and a Short One.—In beating to windward, when a vessel can sail nearer her intended course on one tack than another. Thus, say her course is E. and the wind

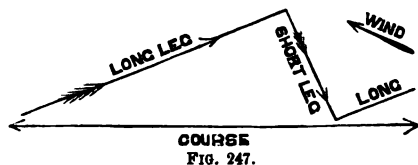

S. E. by E. she would lie E. by N. one tack, which would be the long leg, and S. by E. on the other, which would be the short leg.

Long Shore.—A contraction of along shore.

Long Tackle Blocks.—A double block with one sheave above the other, as a fiddle block, which see.

Look-out, The.—The men stationed on the bow, &c., to watch the approach of other ships or to seek the land, &c.

Loose.—Adrift; to unloose to unfurl; to loose tyers of a sail, &c.

Lose her Way.—Said of a vessel when she loses motion or gradually comes to a stop.

Lose His Number at Mess.—(See Number.)

Lower.—To cause a thing to descend—as to “lower the topsail,” &c. An order given to ease up halyards, as “lower,” “lower away!”

Lower Masts.—The masts that are next the deck.

Lubber's Hole.—The opening in a masthead cap, by which seamen get into the top instead of by the futtock shrouds.

Lubber's Point.—The black line or stroke in the front part of a compass basin, by which the direction of a vessel's head is told. The lubber's point is always in a direct line with the vessel's keel, or stem and sternpost.

Lucky Puff.—A puff that “frees” a vessel in close hauled sailing.

Luff.—To come nearer the wind. To “spring your luff” is to luff all the ship is capable of, without making her sails shake.

Luff and Touch Her.—To bring the vessel so near the wind that the head sails begin to shake a little.

Luff of a Sail.—The weather cloth in a sail. (See “Weather Cloth.”)

Luff Tackle.—A tackle composed of a single and double block, the standing part of the rope being fast to the single block.

Luff upon Luff.—One luff tackle hitched to the fall of another so as to make a double purchase.

Lugger.—A vessel rigged with lug sails like the fishing boats of this country and France.

Lug-Sail.—A sail set on a yard. (See “Dipping Lug.”)

Lurch.—When a vessel is left unsupported at the bow, stern, or amidships, so that she makes a sudden dive forward, or by the stern, or a heavy weather or lee roll.

Lutings.—Stoppings of white lead, putty, tar, &c. for seams and joins in planks, &c.

Lying To.—The condition of a ship when hove to.

M.

Mackerel Sky.—A sky streaked with fine clouds, something in the manner of the stripes on the back of a mackerel.

Mackerel Tailed.—A boat with a very sharp or fine after body. “Cod's head and mackerel's tail” or “full forward and fine aft,” once supposed to represent the solid of least resistance; now the order is reversed.

Made.—Built, as built mast, &c., meaning that the mast is not made of one piece of timber, but by several pieces bound together.

Main.—The open ocean. The principal, as main mast, main boom, main stay, main sail, &c.

Main Breadth.—The extreme breadth of a vessel.

Main Course.—The main sail of a square rigged ship.

Main Keel.—The keel proper, and not the keelson or false keel.

Mainsheet.—The rope or tackle which holds the aft clew of the mainsail. A good arrangement of mainsheet for a small boat with boom to the sail is to make fast one end of the sheet to one end of the after thwart, or near thereto (so that the sheet is clear of the helmsman) take the other end through a thimble eye in a strop round the boom and down through another thimble eye strop at the other end of the thwart; the hauling part can be made fast by a turn and bight above the latter thimble. This arrangement would do for a 10ft. or 12ft. boat, but in one of larger size a block should be stropped to the boom and thwart instead of the thimbles. (See “Belay.”)

Mainsheet Horse.—A mainsheet horse is frequently used in small boats, and in America in large yachts as well. Less mainsheet is required on a wind when the lower block travels on a horse, and therefore the boom cannot lift so much and assist in throwing the sail in a bag. In a seaway, however, there is some advantage in having more drift between the blocks than would be very likely given if a horse were used. For small boats to obviate the shifting of the mainsheet from side to side in tacking the horse is of advantage. The foresheet can also be made to travel on a horse if the boat be decked or half decked.

Maintopman.—The man whose duty it is to go to the mainmast head of a schooner to pass the lacing of a topsail, keep the topsail yard clear, &c.

Make Fast.—To securely belay a rope or join two ropes.

Make Ready There.—An order sometimes given to prepare to tack or lower a sail, as “Make ready for going about there,” the “there” referring to the crew.

Make Sail.—To set sails. To add to sails already set. To shake out reefs.

Make Stern Way.—To drive astern as a vessel sometimes will in tacking by getting in irons or through the head sails being thrown aback.

Make the Land.—After losing sight of the land to approach and sight it.

Making Water.—Leaking. A vessel is said to make no water if she is so tight that none ever gets through her seams, &c., into the hold.

Man.—To apply manual power to anything, as "Man the capstan," "Man the boat," &c.

Man Overboard.—A shout of alarm made on board ship when a man gets overboard by accident. In such cases it is not usual to wait for orders, but everyone joins in if he sees he can be of service in throwing a life-buoy, helping to launch a boat, jumping overboard, &c.

Mansard.—An American term for a booby hatch.

Man Ship.—An old-fashioned custom in the Navy of mustering the crew along the bulwarks to cheer upon parting company or meeting another ship. Losing yachts generally man the bulwarks and cheer a victorious yacht, a custom probably derived from the practice in "fighting days" of one war ship cheering another that was an enemy. (See "Cheering.")

Marine Glue.—This composition, said to be composed of 1 part india-rubber, 12 mineral naphtha or coal tar heated gently, and 20 parts of shellac, mixed with it. The composition is now usually employed to stop the seams of decks after they are caulked. The old fashioned plan was to use white lead putty for the stopping and indeed it is at this present time occasionally used; the objection to it is that it dries as hard as a cement and cracks, the result being that water gets into the caulking, rots it, and then leaky decks are the consequence. Moreover, hard putty is very difficult to get out of the seams without damaging the edges of the plank, and then in re-stopping ragged ugly seams are the result. Marine glue, on the other hand, if it does dry and crack can easily be renewed, and the edges of the plank remain uninjured.

In using marine glue the following practice should be observed: In driving the oakum or cotton thread (the latter is sometimes preferred as it can be laid in finer strands, a matter of consideration, if the plank is closely laid) into the seams, the caulking iron should be dipped in naphtha, and not in oil, as, if the sides of the plank are touched with the latter the glue will not adhere; naphtha on the other hand dissolves the glue and assists in closely cementing the seams. The plank should be quite dry when the glue is applied, or it will not adhere to the sides of the seams. The glue should be dissolved in a pot, and applied by lip ladles used for paying, two being kept going; or the glue can be melted in the lip ladles. Great care must be taken that the glue is melted slowly, as if it be melted over too

fierce a fire it will be spoilt. A little of the liquid glue can be usefully mixed with the other as it assists in keeping it dissolved. The glue that runs over the sides of the seams should be cleaned off with a broad sharp chisel and remelted. It is not advisable to scrape the surplus glue off the seams, as it cannot be so removed without leaving a ragged unsightly surface. The manufacturer of this marine glue is Mr. Jeffrey, Limehouse.

Another marine glue, not easily spoilt in melting, and much cheaper, is made by the Waterproof Glue Company, Landport, Hants.

Mariner.—A sailor. Two hundred years ago it was spelt "maryner," and appears to have only been applied to men who were perfect as seamen. Thus, from a muster roll made in the seventeenth century, we find so many men set down as "maryners" and so many as "seafaring men."

Marks.—The pieces of leather, &c., on a lead-line (see "Lead.") In sounding it is usual to say, "By the mark," &c., if the depth of water accords to a mark; if there be no "mark," as between three and five fathoms, the leadman says, "By the deep four," &c. (See "Lead.")

Marls.—To hitoh spun yarn round a rope to secure its parts, or round a hank of yarn to secure it. (See "Selvages.")

Marline Spike.—An iron implement tapering to a sharp point used to open the strands of rope for splicing, to turn eye-bolts, &c.

Martingale.—A stay spread by a "dolphin striker" to help secure the jibboom, the same as a bobstay does the bowsprit.

Mast Carlines or Carlines.—Pieces of timber fitted fore and aft between the beams to support the mast.

Master.—The chief officer of a ship. (See "Seaman.")

Master Mariner.—A master of a vessel who has a master's certificate of competency. An old-fashioned term. A "master mariner" is popularly known as a "captain" among yacht sailors; but a master is only a self-dubbed captain. Master is the correct term, and the only recognised one in law. A few yacht masters have obtained the Board of Trade certificate of competency, and are skilled navigators; the majority, however, barely understand the use of charts and the methods of keeping a dead reckoning.

Masthead.—The part of a mast above the hounds.

Masthead Light.—The white light which steam vessels are required to exhibit at the masthead when under way. (See "Side Lights.")

Masthead Man.—In yacht parlance, the man who goes aloft to lace a topsail, &c.

Masthead Pendants.—The pendants and runners which help support the mast.

Mast Hoops.—The hoops to which the luff of fore and aft sails are seized to keep the sail to the mast.

Mast Rope.—The heel rope by which a topmast

is sent up and lowered; not, however, termed heel rope.

Match.—In competition as yachts in a race. Formerly all contests between yachts were termed matches. Of late years the term race has been more generally applied to such encounters.

Mate.—An officer next in command to a master.

Maul.—A heavy hammer used by shipwrights.

Meaking Iron.—An implement used to extract old caulking from seams.

Measurement.—Generally written admeasurement. The computation of a vessel's tonnage by certain rules. (See "Tonnage.")

Meet Her.—When a vessel begins to fly to or run off the wind, to stop her doing so by the helm. Generally to check a vessel's tendency to yaw by aid of the helm.

Meet, To.—To meet a vessel with the helm is after the helm has been put one way to alter her course to put it the other way to stop the course being altered any further. This is also called "checking with the helm."

Mess.—The number of officers or men who eat together. Disorder; entanglement.

Middle Body.—The middle third of a vessel's length.

Middle Watch.—The watch between midnight and 4 a.m. (See page 120.)

Mildew.—Sails if rolled up when they are damp frequently mildew, and it is almost impossible to get the stains out entirely. New sails suffer most in this respect, as the "dressing" not being entirely washed or worked out of them will ferment and cause the mildew. The stains can be partly removed by scrubbing the sail with fresh water and soap; then rub the sail with soap and sprinkle or rub whiting over it; leave the sail to dry and bleach in the sun, and repeat the process more than once if necessary. Both sides of the sail should be scrubbed. Chloride of lime and other caustics and acids would remove mildew, but would almost certainly make the canvas rotten. If chloride of lime be used only the clear liquor should be allowed to touch the sail, and the latter should be well rinsed in fresh water afterwards (see "Bleaching"). If sails are stowed whilst damp or wet, they should be hoisted again as soon as possible for drying or airing.

Mile.—(See "Knot.")

Missing Stays.—To fail in an attempt to tack. (See page 85.)

Mizen Bumpkin.—A short spar that extends from the taffrail aft for the lower block of the mizen sheet to be hooked to. East country yachts have this bumpkin generally crooked downwards, the reason given being that the downward crook shows up the sheer of the yacht. A more practical reason, however, can be given, and that is, if a bobstay is used, a more effective purchase is obtained for it.

Mizenmast.—In a ship the after mast. So also in a yawl or ketch.

Mizen Staysail.—A sail set "flying" from a yawl's mizenmast head to an eye bolt on deck forward of the mizenmast. Generally set with a quarterly wind.

Moment.—A weight or force multiplied by the length of the lever upon which it acts. Sail moment generally means the area of sails and the pressure of wind upon them multiplied by the distance the centre of effort is above the centre of lateral resistance, which represents the length of lever.

Momentum.—A force represented by a weight and the velocity with which it is moved.

Moon.—Sailors say there will be a moon at such and such a date, meaning that there will be a new moon or full moon, from which the time of high water is calculated.

Moor.—To anchor by two cables.

Mooring Rings.—The rings by which the chain is attached to large stones used for moorings. Sometimes the bolts that hold these rings pass clean through the stone, and are secured underneath, but a more secure plan than this is that known as a "Lewis." In the engraving *a* is the ring or shackle, *b* a bolt with a

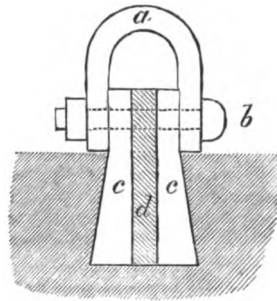

FIG. 248.

screw nut and linch pin; *c c* movable parts of the bolt; *d* the key or wedge. When the key is in its place the cavities, if any, can be filled with lead or sulphur.

Morning Watch.—The watch from 4 a.m. to 8 a.m.

Moulded.—The depth a timber is made between its curved surfaces as distinct from its siding, which is the thickness between its flat surfaces.

Moulded Breadth.—The greatest breadth of a vessel without the plank.

Moulds.—Curves used by draughtsmen. The skeleton frames made by shipwrights to cut the frames by.

Mourning Ribbon.—A blue ribbon or stripe run round a yacht's side, instead of a gold or white one, to denote mourning. Mourning is also denoted by flying an ensign or burgee half-mast.

Mousings.—Yarns wound round hooks to prevent them becoming detached. Indiarubber rings were in use a few years ago as mousings for cliphooks, but are never met with now.

'Mudian Rig.—A contraction of "Bermudian rig."

Muslin.—A slang term given to the sails: generally applied to balloon sails.

Muzzler.—A strong wind that blows directly down a vessel's intended course. Synonymous with "nose ender."

N.

Nail-sick Clench-built Boat.—This is when the nail fastenings have become loose in a boat so that she leaks. Mr. J. C. Wilcocks recommends that the boat should have the whole of her ballast taken out; let her then be thoroughly cleaned out and laid on her sides, with sufficient weight to keep her so until the water begins to come over the gunwale. A man should be inside with some ohalk or white paint, and mark every leak which becomes visible, first on one side, then on the other; or the boat can be hauled up and filled with water and marked outside. If the boat be decked, any recesses behind bulkheads or in the counter must be carefully examined, and marked in the same manner. After all the leaks have been discovered, let her be dried, and every nail examined; the lands or joinings of the planks should also be tried with the blade of a very thin knife. Any rivets which have worked very loose must be put out, and replaced with nails and rooves of a larger size, and through the chief parts of the bottom it will probably be necessary to put an additional nail between every two originally driven. Many of the old nails which are only a little slack should again be hardened by a few taps on the inside, a boy holding on against the head of the nail on the outside. After this work has been thus gone through, melt a pound of pitch in a gallon of boiling Stockholm tar, and give her a good coat inside up to the level of the inside of the lockers—that is to say, as high as it can be done not to interfere with the paint. The garboard strake fastenings, and also those of the hood ends, must also be examined, and will be certain to require careful caulking. In tarring the boat inside, the ledges or lands should be quite filled up with the boiling stuff.

Neaped.—The situation of a vessel that gets ashore during high water at spring tides, and as the tides get shorter every day towards the neap tides she cannot be floated off till the next spring tides. Generally termed be-neaped.

Neap Tides.—The tides which occur between new and full moon; spring tides being at or near the new and full moon.

Near.—Very close to the wind, so that the sails shake or lift.

Near the Wind.—Close to wind; generally used in a sense to convey the meaning that the vessel is too near the wind, as "She's near forward," meaning that the head sails are shaking or lifting. (See "Nip.")

Nettles.—Small lines or ropes used to support hammocks when they are slung under the beams. Also reef points are sometimes termed nettles.

News.—The intimation conveyed sternly to the watch below to turn up when they do not obey the first summons, as "Do you hear the news there, sleepers?"

Niggling.—Sailing close to the wind or too close.

Nip.—A short bight in a rope, such as the part that goes round a sheave, &c. To nip a vessel is to sail her very close, or too close, to the wind.

Nipping.—Joining a rope by cross turns.

No Nearer.—An order given to a steersman not to luff any more, or not to bring the vessel any closer to wind. When sailing free a course is frequently given to the steersman thus, W.S.W. and no nearer, or S.E. and no nearer, which may be varied "Nothing to windward of W.S.W.," or whatever the compass course may be.

Nosebag.—A name given to a jib, generally meaning a jib that is too big for the after sail; or a jib that bellies out into a bag.

Nose-ender.—Dead on end. A wind which blows directly down a vessel's intended course, involving a dead beat. (See "Muzzler.")

Noose.—A slip knot or running bight in a rope.

Number.—The number of a ship in the registry kept by the Registrar-General of Shipping; hence when a ship "makes her number" she hoists the signal flag denoting her number so that her name may be read. Also the number of a seaman on a ship's book. "To lose the number of the mess" is to fail to appear at mess through drowning or sudden death.

O.

Oars!—An order given to cease rowing and toss up the oars. (See "Lay in Oars;" and page 115.)

Off.—The opposite to near (which see), as "Off the wind." "Nothing off" is an order given to a helmsman to steer nothing to leeward of a particular course, or to sail nothing off the wind, but to keep the vessel full and bye. (See "No Nearer.")

Off and On.—Beating along a shore by a board off and then a board on.

Official Log.—The record of a voyage containing all matters relating to the crew, &c., which the law requires to be kept.

Offing.—Away from the land, seaward. To make an offing is to sail away clear of the land.

"Off She Goes!"—The shout raised when a vessel begins to move at launching.

On.—In the direction of, as "on the bow," "on the beam," "on the quarter," "on for that buoy," &c.

On a Bowline.—Close-hauled. Generally applied to the square rig when a ship has her bowlines hauled taut to keep the leeches of the sails from shaking when she is close-hauled.

On End.—A mast is said to be on end when in its place; literally, standing on its end. Generally applied to topmasts.

On a Wind.—Close-hauled; not off the wind.

On an Easy Bowline.—Not quite close-hauled; a good full.

One, Two, Three, Haul!—A cry raised by the foremost hand in hauling on a tackle. All hands throw their whole weight and strength on the rope or fall at the word "Haul!"

Open.—Upon sailing round a point or headland when an object comes into view.

Opposite Tacks.—When of two vessels one is on the port tack and the other on starboard tack. Cross tacks.

Ordinary Seaman.—On board a man-of-war a young sailor not yet efficient in his duties so as to entitle him to the rank of A.B.

Outer and Inner Turns.—In bending a sail to a yard, the outer turns haul the sail out taut along the yard, the inner turns secure the sail.

Outhaul.—A rope or tackle by which a sail is hauled out on a spar, as distinct from an inhaul by which it is hauled inboard.

Outrigger.—A contrivance of some sort for extending a sail or stay outboard. A name for a kind of row-boat which has the rowlocks extended beyond the boat's side.

Over-canvassed.—Too much canvas.

Overfalls.—The rough water caused by the tide pouring over a rough or precipitous bottom.

Overhang.—The "knee of the head" or the curved piece of wood fitted to the stem to form a graceful or ornamental curve. Also the inclination the stem has outwards from the end of the water-line forward; also the overhanging part of the counter aft. Anything that projects beyond the base.

Overhaul.—To overtake another vessel; to loosen the parts of a tackle; to ease up, to slacken, or free the fall of a tackle; to slacken or "lighten up" a rope.

Overlap.—When any part, spars and sails included, of one vessel covers or overlaps any part of another vessel. Generally when anything partly covers another thing.

Over-masted.—Masts that are too large or long for a vessel.

Over-rigged.—Generally more rigging, spars, and canvas than a vessel will properly bear.

Over-set.—To cause a capsizes.

Overshoot a Mark.—To go up to a mark with too much way on so that the vessel shoots past it.

Over-reach.—To stand so long on a reach that upon tacking the vessel can fetch much farther to windward of a mark than was necessary or desirable.

Over-stand.—In beating to windward to stand on a board so long that the yacht is able to clear a mark farther to windward than desired; overstood. (See "Over-reach.")

Overtake.—To approach a vessel that is sailing ahead. The "rule of the road" is that an overtaking vessel must keep clear of the vessel she overtakes; the vessel so overtaken must, however, keep her course steadily. In competitive yacht sailing this rule is somewhat different, as it allows the vessel that is overtaken to alter her course to windward to prevent the other passing her to windward; she must not, however, alter her course to leeward to prevent the overtaking vessel passing.

P.

Paint.—(See "Black Paint.")

Painter.—A rope spliced to a ring bolt in the bow of a boat to make fast by. "To let go the painter" is figuratively to depart.

Palm.—The guard and thimble used by sail makers. Also the fluke of an anchor.

Paltry.—A wind is said to be paltry that is light and intermittent, or varying a great deal in direction; baffling.

Parbuckles.—To roll a spar, cask, &c., by placing it in the bight of a rope, one end of which is fast, the other hauled upon. (See page 104.)

Parcel.—To cover a rope with strips of canvas painted or otherwise. The canvas is wound round the rope and stitched or "served" with spun yarn.

Parrel or Parral.—Ropes or irons used to secure yards at the slings to the mast; rope parrels are commonly rove through balls of wood, so that they hoist easily on the mast. Parrels are used on the jaws of a gaff. An eye is usually spliced in either end of a parrel.

Partners.—A strong frame of timber fixed between the deck beams to receive and support the mast.

Pass.—To reeve. Also to hand a thing one from another.

Passage.—A voyage. To carry a person from one place to another is to give a passage.

Paul or Pawl.—An iron bar used to prevent the back recoil of the barrel of a windlass, &c.

Pawl Bitt.—A long timber from the deck to the keelson forming one of the bowsprit bitts.

Pay.—To run hot pitch and tar, or marine glue, &c., into seams after they are caulked.

Pay Off.—When a vessel's head goes off to leeward by virtue of the head sails being put aback or the helm being put up.

Pay Out.—To veer or slack out chain or rope.

Peak.—The upper after corner of gaff sails, gaff topsails, lugsails, &c. A sail is said to have a great deal of peak when the gaff or yard makes a small angle with a vertical. A low peak means a flat-headed sail.

Peak Downhaul.—A rope rove through a single block at the gaff end to haul upon when lowering the mainsail.

Peak Halyards.—The halyards by which the peak of a sail is hoisted.

Peak Purchase.—A tackle attached to one end of the peak halyards.

Pendant.—A stout rope to which tackles are attached.

Pennant or Pendant.—A long white streamer with a St. George's cross at the hoist, used only by ships of the Royal Navy. It is said to owe its origin to the following incident: a Dutch Admiral hoisted a broom at his masthead as a symbol that he would sweep the English from the sea; the English Admiral retorted by hoisting a long streamer to denote that he would whip the Dutch off the sea; the English Admiral more nearly succeeded in his object than the Dutchman did. A Commodore has a broad pennant or swallow tail flag. (See "Burgee," "Hoisting Pennant," and "Irish Pennants.")

Peter.—(See "Blue Peter.")

Peter Boat.—A small fishing boat, sharp at both ends, common at the mouth of the Thames and Medway.

Petticoat Trousers.—An ancient garment worn by sailors, now only used by fishermen; a kind of kilt.

Pig.—A heavy mass of iron or lead.

Pile Driving.—Pitching heavily and frequently in a short steep sea.

Pilot.—A person who takes charge of a ship in narrow or dangerous channels, and, who from his local knowledge of the same can, or ought to avoid the dangers of stranding.

Pinbles.—The metal hooks by which rudders are attached to the gudgeons.

Pipe.—To summons men to duty by a whistle from the boatswain's call.

Pipe up.—The wind is said to pipe up when it increases in strength suddenly.

Pitching.—The plunging motion of a vessel when she dives by the head; the opposite motion to 'ascending, which is rising by the head and sinking by the stern.

Planking.—The outside skin of a vessel; plank laid on the frames or beams of a vessel whether inside or outside.

Plank Sheer.—The outside plank at the deck edge which covers in the timber heads, and shows the sheer of the vessel. The same as covering board.

Platform.—The floor of a cabin. (See "Deck.")

Ply to Windward.—Plying to windward is synonymous with beating to windward.

Points.—(See "Reef Points.")

Pole.—The part of a topmast about the shoulders.

Pole Mast.—A long mast without a topmast, but with a long "pole" or piece above the hounds.

Poop.—The raised part of a vessel at her extreme after end. To be pooped is when running before the wind a sea breaks in over the stern.

Poor John.—Dried hake, a coarse fish caught on the west coast.

Port.—The left hand side, the opposite to starboard. Formerly termed larboard, which see.

To port the helm is to put the tiller to port so that the vessel's head goes to starboard.

Portable Dinghies.—Numerous plans have been suggested for the construction of portable dinghies for small yachts, the best known perhaps being one adopted by Biffen, the well-known boat builder, in 1858. The boat was divided longitudinally into halves, each half being a complete boat, the longitudinal bulk heads coming as high as the thwarts; three iron clamps were fitted to one half of the keel, into which the other half of the keel was fitted. The top part of the bulkheads were kept together by thumb-screws inserted above the water line. The boat was 9ft. long, and 4ft. broad; in shape she did not differ from an ordinary dinghy when put together. She was used in a 6 tonner, and when not in use one half was stowed on either side of the cabin below. It was said that this boat could be put together in half a minute. In 1862 Biffen built a similar boat which was not so well recommended, on account of the multiplicity of fastenings. The obvious objection to such contrivances is of course the trouble of putting the parts together when the boat has to be used. (See "Berthon's Collapsible Boats.")

Ports and Portholes.—Square holes in the side of a ship for the guns, &c.

Port Sills.—The bottom framing of a port hole to which the lower half-port or shutter is hinged, also the frame to which the upper half-port is attached.

Preserving a Boat.—All small boats, if possible, should be hauled out of water or beached when not in use. Varnish preserves the wood from water absorption better than paint. Whenever the varnish becomes worn, the boat should be re-coated.

Press of Sail.—All the sail a vessel dare carry.

Preventers.—Additional ropes, stays, tackles, &c., used to prevent spars being carried away if their proper stays give out, as preventer backstays for the topmast (see page 27), preventer bobstay, &c. A preventer is also any rope or lashing used to prevent something giving way.

Preventive Man.—An old fashioned name for a coastguard man, whose duty it is to prevent or detect the landing of smuggled goods.

Privateer's Flag.—The Union Jack with a red border.

Protest.—A declaration that a yacht has not conformed to sailing rules.

Puff.—A gust of wind. A free puff is when it enables a vessel to luff; a foul puff when it breaks her off.

Punt.—A small boat or dinghy.

Punt Building.—The following directions for building a fishing punt were given in the *Field* some time since:—Take for the sides two 1in. planks 18in. wide and 14ft. long; for the ends use 2in. plank. Cut the stern-piece 30in. long at bottom, and 40in. at top; cut the bow piece 12in. long at bottom, and 20in. at top;

then cut a centre-piece 12in. wide, 40in. long at bottom, and 50in. long at top; put these pieces in position, and securely nail the sides to them; this can be readily done by bringing the planks into place by means of a rope, twisted by a short lever. After the sides are thus secured true up the bottom edges, and plank crosswise with three-quarter inch plank one-eighth of an inch apart; caulk these seams with oakum or cotton, and pitch the whole bottom, and 2in. or 3in. up the sides. A keel 1in., 2in., or 3in. deep can then be nailed on, depending on the depth of the water where the boat is to be used. For seats nail a plank across each end, and one for the rower over the middle piece; two rowlocks,

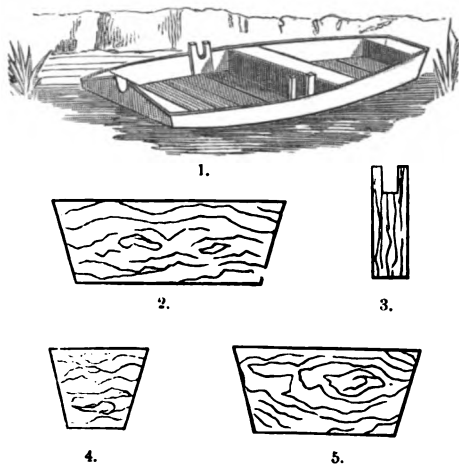

FIG. 249.

about 6in. above the sides of the boat, complete the job. These can be made of plank, set up on end, and fastened to the inside of the boat. A common carpenter can make such a boat in about two days, and, if planed and painted, it looks well. The ends ought to incline outwards about 3in. to the foot. No. 1 shows the skiff completed, but with a stern piece adapted for steering with an oar; No. 5 is a diagram of the stern piece; No. 4 the bow piece; No. 2 the middle piece, and No. 3 the rowlock. By putting in two pieces in the middle the required distance apart, and perforating the cross planking between them, a well would be readily formed.

Purchase.—A tackle; any contrivance for increasing mechanical power.

Put About.—To tack.

Put In.—To call at a port or harbour.

Put Off.—To leave, as to leave a ship's side or the shore.

Pykar.—An ancient English boat used for fishing.

Q.

Quarter Deck.—The deck abaft the main mast where the crew are never seen unless duty calls them there.

Quarter Fast.—A warp or rope made fast to the quarter; a quarter spring.

Quarter Master.—An officer who sees that the orders of the mate or master are properly executed, &c.

Quarter Timbers.—Large pieces of timber secured to the transom frame, which support the counter.

Quarter Watch.—When the two watches are subdivided into four watches, so that only one quarter of the crew is on deck at one time; sometimes observed in light weather.

Quarter Wind.—The wind that blows on the quarter, or four or more points abaft the beam, but not dead aft. (See "Compass.")

Quarters.—That part of a yacht or ship nearest the stern.

R.

Rabbet or Rebate.—An angular channel or groove cut in the keel, stem, or sternpost, &c, to receive the edges or ends of the plank.

Race.—A competition between yachts. A strong current or tide running over a pit-like bottom producing overfalls. (See "Overfalls.")

Racing Flags.—The size of racing flags will be found under the head of "Flags."

Racking.—A rope or seizing used to lash the parts of a tackle together, by taking several turns, so as to keep them from running through the blocks, whilst the fall is cast off for some purpose, or whilst one hand belays the fall made fast to some fixture by one end and then passed round and round a rope to hold the latter by. (See pp. 41 and 69.)

Raffee.—The square topsail set flying on the fore-topmast of schooners, and formerly often set on cutters and ketches above the squaresail. Sometimes this topsail is triangular in shape, like a scraper.

Rail.—The timber fitted on to the heads of the bulwark stanchions. Called also "top rail."

Raising a Boat's Anchor.—(See "Anchor.")

Raising Iron.—A sort of chisel for removing the paying and caulking from seams.

Raising Tacks and Sheets.—To lift the clews of lower squaresails previous to tacking or wearing.

Rake.—To lean forward or aft from the vertical, as raking masts, raking sternposts, raking stem, &c.

Rakish.—A vessel that has a look of speed about her, probably originating from the fast schooners of former days that had raking masts.

Ramp.—In close-hauled sailing, to sail a vessel along a heavy full without easing up the sheets.

Ramping Full.—Barely close-hauled.

Range.—Scope. To range is to arrange: to range the cable, to place a lot on deck in fakes ready for veering out.—To give a range of cable is to veer out enough in letting go the anchor to bring the vessel up without causing much

- strain to come on the bitts.—To sail near to, as to range up to windward, to range up alongside, to range along the coast, &c.
- Rap Full.*—The same as ramping full. By no means near the wind.
- Rate of a Chronometer.*—The daily loss or gain of a chronometer in relation to mean time.
- Ratlines.*—The small lines which cross the shrouds horizontally, and form the rungs of a ladder. Not generally used in yachts of 40 tons and under.
- Rattle Down.*—To fix ratlines to the shrouds.
- Reaching.*—Sailing by the wind. A "reach" is the distance sailed between tacks, and means the same as board. To "reach" another vessel is to pass her. In reaching a schooner of 150 tons, say, will pass a cutter of 100 tons; that is, will "fore-reach" her, but the cutter holding a better wind will generally keep the weather gauge. A "reach" is the distance a yacht can sail from point to point without tacking, and often such a reach does not require the yacht to be quite close-hauled. A reach is also the distance from bend to bend in a river or channel. (See "Head Reach," and "Fore Reach.")
- Ready About!*—The order given to prepare for tacking.
- Ready, All.*—Everybody make ready.
- Rear Commodore.*—The third flag officer of a yacht club, who has no duties in the presence of the Commodore or Vice-Commodore. He has two white balls in the upper corner of his pennant.
- Rear Guard.*—(See "After Guard.")
- Recognised Yacht Club.*—A term very frequently used in yacht rules; formerly it was a general condition that "a member of a Royal yacht club shall be on board" each yacht competing in a match, who is responsible for the due observance of the sailing rules. Often the rule required that a member of the particular club under whose auspices the match was being sailed should be on board. All clubs, however, have not the right to be styled "royal," and the word "recognised" yacht club became introduced as an equivalent for "royal." Since the establishment of the Yacht Racing Association the term "recognised" is alone contained in the rule. No one seems to know exactly what "recognised" means; strictly it should mean a club with an Admiralty warrant, but any "yacht club" is considered "recognised" which is organised by yacht owners for the promotion of properly conducted yacht matches. (See "Admiralty Warrant," "Royal Yacht Club," "Burgess," and "Ensign.")
- Reef.*—To shorten sail by reefing. Also to shorten a spar, as to take a reef in the bowsprit. The topmasts of some yachts are made with one reef in them. In such cases a thimble eye is seized to the backstays for the blocks of the falls to be hooked to when the

reef is taken in. The depth of such a reef is usually about one-sixth the length of topmast from first fid to sheave hole. When the topmast is lowered to second fid it is called reefing, not housing.

Reef Band.—A strip of canvas sewn across the sail in which the eyelet holes are worked to receive the reef points. Not always met with in yacht sails.

Reef Cringles.—The large cringles in the leeches of sails through which the reef pendants are rove and tacks or sheets hooked. (See p. 27.)

Reef Earing.—(See "Reef Pendant.")

Reef Knot.—(See Fig. 22, p. 69.)

Reef Pendant (called also "reef earing").—A short and strong rope (with a Matthew Walker knot in one end). One end of the pendant is passed up through a hole in the cleat on one side of the boom and stopped by the knot in the end. The other end is then passed through the reef cringle in the sail and down through the sheave hole on the other side of the boom. (See pages 26 and 69.) Reef pendants are rove on opposite sides.

Reef Points.—Short pieces of rope attached to sails to secure the folds rolled up when reefing. (See page 26.)

Reef Tackle.—The tackle hooked to the reef pendants.

Register.—A certificate of a vessel's register granted by the Registrar-General of Shipping. It is not a document of title.

Registry.—A register of all British ships kept by the Registrar-General of Shipping. When a ship is registered, the following documents must be produced: (1) Certificate of Custom House measuring officer. (2) Certificate of Board of Trade Surveyor; in the case of yachts this certificate is not required. (3) Builder's certificate, or if the builder's certificate cannot be obtained, a document setting forth all that is known of the vessel. (4) Declaration of ownership. All vessels, yachts, or otherwise of 15 tons N.M. and over must be registered. Yachts, however, of less than 15 tons can be registered, and it is advisable to have them so registered for the sake of holding the register, obtaining the Admiralty warrant, and being able to prove nationality when visiting foreign parts. The name of a vessel once registered cannot be altered except with the sanction of the Board of Trade. A quantity of useful information on the registry of ships will be found in a little book by Mr. Miles Stapylton, published by Oliver, St. Dunstan's Hill, E.C., and called the "Imperial Guide to Registry of British Shipping." (See also "Yachts" at the end of the Appendix.)

Render.—To slacken or ease up. A rope is said to render when it slackens without warning.

Reeve.—To put a rope through a hole of any kind.

Resistance.—According to Beaufoy, a plane moved normally at a rate of 10ft. per second meets with a resistance of 112·5lb. per square foot. The resistance varies as the square of the velocity. Generally understood to mean the resistance a vessel meets with from the friction of the water on her copper and the waves she makes. (See "Salt and Fresh Water.")

Ribbands.—Long pieces of plank or timber, usually three-sided, and sometimes called harpings, secured to the frames of a vessel in a fore-and-aft direction, when she is building, and representing the dividing lines or geodetic lines.

Ribs.—The frames or timbers of a ship or boat.

Ride.—To rest at anchor, or to be held by an anchor.

Ridge Ropes.—The ropes rove through the eyes of metal stanchions fitted in the top rail.

Riding Down.—When men go aloft and hang on the halyards and assist by their weight in hoisting sails.

Riding Light.—The white globular lantern hung on the forestay of vessels when riding at anchor.

Rig.—The arrangement of a vessel's spars, rigging, and sails, as schooner rig, cutter rig, lugger rig, &c. To rig is to fit the spars with rigging, &c. To rig out is to fit out.

Right Away.—In the direction of. An American term for quickly out of land, or move ahead.

Right Hand Rope.—Rope laid up or twisted with the sun.

Ring Bolt.—A bolt with an eye and a ring through the eye.

Ring Tail.—The studding sail of a gaff sail. (See page 79.)

Rings.—Rooves for bolt or nail clinching.

Rising Floor.—Distinct from flat floored, or flat bottomed; Sharp bottomed. (See "Dead Rise.")

Risings.—Stringers fitted inside small boats to strengthen them and support the thwarts.

Roach.—The curved part of the foot of a sail.

Roadstead.—An open anchorage.

Rockered Keel.—A keel whose ends curve upwards thus . (See "Cambered.")

Rolling.—The transverse motions of a ship when amongst waves.

Rolling Hitch.—A way of fastening a rope to a spar, &c. (See "Strop.")

Room and Space.—The distance from the centre of one frame to the centre of another.

Roove.—(See "Ruff.")

Rope.—Ropes are of three kinds; three-strand, four-strand, and cable-laid. A number of yarns twisted together forms a strand. Three-strand rope (see Fig. 250) is laid right-

handed, or with the sun (sometimes termed hawser-laid). Four-strand rope (see Fig. 251) is also laid with the sun (sometimes termed strand-laid). Four-strand rope is usually used for sheets and shrouds, pennants, and

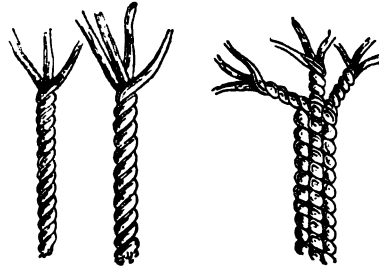

FIG. 250. FIG. 251.

FIG. 252.

generally for standing rigging. All rope comes under the general term of cordage. Cable-laid rope (see Fig. 252) consists of three "three-strand" right-hand laid ropes laid up together into one; these ropes are laid left-handed against the sun. Right-hand laid rope must be coiled with the sun; cable-laid rope is coiled against the sun.

Rough-tree Rail.—The top rail fitted to the stanchions.

Round In.—To haul in on a rope.

Round To.—To bring by the wind. To come up head to wind. A vessel is said to "go round" when she goes about.

Round Turn.—To pass a rope twice round a pin or cleat so as to make a complete circle.

Rove.—The condition of a rope that has been passed through a sheave hole or through any aperture.

Rowlocks.—The fittings on the gunwale to receive the tholes or crutches for the oars.

Royal.—The sail next above the topgallant sail.

Royal Standard.—The flag of the Sovereign and Royal family. It is always flown at the main. When the Sovereign is on board, the standard is flown at the main, and the Admiralty flag (a red ground with fouled anchor) at the fore, and Union Jack at the mizen.

Royal Yacht Club.—A club that has obtained permission from the Home Office to use the prefix "royal." An Admiralty warrant obtained from the Admiralty does not confer the title; but a royal yacht club that has not also the Admiralty warrant can only fly the red ensign, and this can have no device. A club with an Admiralty warrant takes precedence of a club that has only a Royal warrant. (See "Recognised Club.")

Rudder Board, A.—Capt. Lowther, R.N., introduced the following plan for increasing the area of rudders of shallow boats. This idea is not a new one. In 1780 Capt. Schank proposed a similar contrivance, and the plan is illustrated in Channock's "History of

Marine Architecture," vol. iii., p. 409. The rudder was invented to use in conjunction with the centre-board shallow craft which

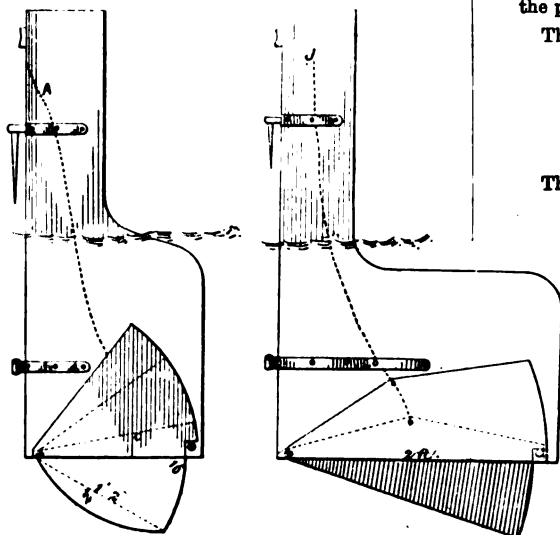

FIG. 263.

Capt. Schank built for the navy. In January, 1880, Mr. Charles Stewart proposed a slide for rudders in the *Shipping Gazette and Iron*.

Rudder Trunk.—The trunk fitted in the counter to receive the rudder post into which the tiller is fitted.

Ruff or Roove.—A small ring or square plate placed over copper nails before clinching in boat building.

Rules of the Road.—Certain rules framed under the provisions of the Merchant Shipping Act.

On Sept. 1, 1880, the following Steering and Sailing Rules (by Order in Council, held at Osborne, Aug. 14, 1879), came into force:

Art. 14. When two sailing ships are approaching one another so as to involve risk of collision, one of them shall keep out of the way of the other as follows, viz. :—

- (a.) A ship which is running free shall keep out of the way of a ship which is close-hauled.
- (b.) A ship which is close-hauled on the port tack shall keep out of the way of a ship which is close-hauled on the starboard tack.
- (c.) When both are running free with the wind on different sides, the ship which has the wind on the port side shall keep out of the way of the other.
- (d.) When both are running free with the wind on the same side, the ship which is to windward shall keep out of the way of the ship which is to leeward.
- (e.) A ship which has the wind aft shall keep out of the way of the other ship.

Art. 15. If two ships under steam are meeting end on, or nearly end on, so as to

Rules of the Road—continued.

involve risk of collision, each shall alter her course to starboard, so that each may pass on the port side of the other.

This Article only applies to cases where ships are meeting end on, or nearly end on, in such a manner as to involve risk of collision, and does not apply to two ships which must, if both keep on their respective courses, pass clear of each other.

The only cases to which it does apply are, when each of the two ships is end on, or nearly end on, to the other; in other words, the cases in which, by day, each ship sees the masts of the other in a line, or nearly in a line, with her own; and by night, to cases in which each ship is in such a position as to see both the side lights of the other.

It does not apply by day to cases in which a ship sees another ahead crossing her own course; or by night, to cases where the red light of one ship is opposed to the red light of the other, or where the green light of one ship is opposed to the green light of the other, or where a red light without a green light, or a green light without a red light, is seen ahead, or where both green and red lights are seen anywhere but ahead.

Art. 16. If two ships under steam are crossing so as to involve risk of collision, the ship which has the other on her own starboard side shall keep out of the way of the other.

Art. 17. If two ships, one of which is a sailing ship and the other a steamship, are proceeding in such directions as to involve risk of collision, the steamship shall keep out of the way of the sailing ship.

Art. 18. Every steamship, when approaching another ship so as to involve risk of collision, shall slacken her speed or stop and reverse if necessary.

Art. 19. In taking any course authorised or required by these regulations, a steamship underway may indicate that course to any other ship which she has in sight by the following signals on her steam whistle, viz. :—

One short blast to mean "I am directing my course to starboard."

Two short blasts to mean "I am directing my course to port."

Three short blasts to mean "I am going full speed astern."

The use of these signals is optional; but if they are used, the course of the ship must be in accordance with the signal made.

Art. 20. Notwithstanding anything contained in a preceding Article, every ship, whether a sailing ship or a steamship, overtaking any other shall keep out of the way of the overtaken ship.

Art. 21. In narrow channels every steamship shall, when it is safe and practicable, keep to that side of the fairway or mid-channel which lies on the starboard side of such ship.

Rules of the Road—continued.

Art. 22. Where by the above rules one or two ships is to keep out of the way, the other shall keep her course.

Art. 23. In obeying and construing these rules due regard shall be had to all dangers of navigation; and to any special circumstances which may render a departure from the above rules necessary in order to avoid immediate danger.

A SHIP, UNDER ANY CIRCUMSTANCES, NOT TO NEGLECT PROPER PRECAUTIONS.

Art. 24. Nothing in these rules shall exonerate a ship, or the owner or master, or crew thereof, from the consequences of any neglect to carry lights or signals, or of any neglect to keep a proper look-out, or of the neglect of any precaution which may be required by the ordinary practice of seamen, or by the special circumstances of the case.

RESERVATION OF RULES FOR HARBOURS AND INLAND NAVIGATION.

Art. 25. Nothing in these rules shall interfere with the operation of a special rule, duly made by local authority, relative to the navigation of any harbour, river, or inland navigation.

Run.—The under part of a vessel aft defined by the buttock lines and water lines.

Run.—To sail before the wind. To come down by the run is to lower or overhaul without warning, or suddenly. To run away with a rope is to take hold of a fall and haul on it by running along the deck.

Run Down.—To foul a vessel or other object wrongfully or by accident.

Run Foul Of.—To get into collision with a vessel or other object.

Run Out.—To veer out a warp or cable.

Run Over.—The same as run down. Generally denoting carelessness in bringing about a collision.

Runners.—A rope passed through a single block on a pendant with a purchase at one end.

Running Bowsprit.—A bowsprit that is fitted to run in and out and "reef" like a cutter's. Since 1856 most schooners have their bowsprits fitted in this way.

Running by the Lee.—To run with the boom on one quarter when the wind is blowing on the other quarter. A dangerous proceeding. (See "By the Lee.")

Running Off her Helm.—Said of a vessel if, when sailing, her stern flies up to windward (her head apparently going off to leeward) and giving her lee helm does not readily bring her to.

S.

Saddle.—A projection on a spar to support another spar, as the saddle on the mast for the jaws of the boom to rest upon.

Safety Cleats.—(See "Cruckshank's Cleats.")

Sagging.—Bending or curved downwards; the opposite of hogging. Sagging to leeward is to make a great deal of leeway.

Sail Coats.—Covers for sails, usually made of painted canvas. A yacht master named Carey introduced the following plan, but it has not been adopted: The sail covers fit tight round the blocks, and by the parts overlapping one another at a *a* (Fig. 254) it is quite im-

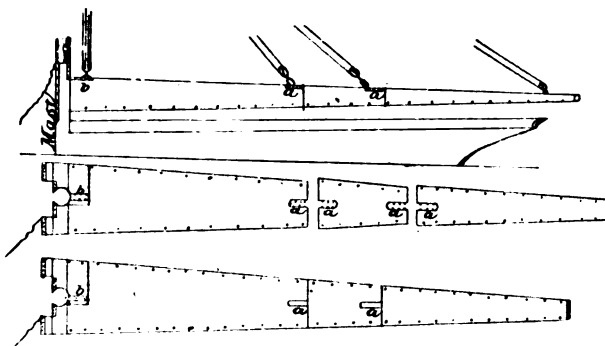

FIG. 254.

possible that any wet should ever touch the sail; *b* shows the opening for the throat halyard block overlapped and laced. Capt. Carey has his coats on board the *Onyx* made in this manner, and it answers perfectly.

Sail Her Along.—In close-hauled sailing, an order given to the helmsman when he is keeping the vessel too close to wind, meaning that he is to keep her a little off; sail her fuller or harder or "give her the whole weight of it," meaning the wind, and keep her passing through the water as fast as possible.

Sail Her.—When lying to if way has to be got on again, the order is to "Sail her;" or, "Let the head sheets draw and sail her!" Also "Sail her" is a general admonition to a helmsman to be very careful in his steering.

Sailing Directions.—Books of pilotage which accompany charts.

Sailing on Skates.—In 1879 a gentleman, under the signature of "Glacianant," published in *The Field* a description of a sail he had contrived for sailing on skates on ice. The sail is made of a piece of unbleached calico, with slightly rounded ends; each end is attached (either by a lacing, as in the case of a cutter's topsail, or by a wide hem, such as is common in window blinds) to a light stick or yard, of sufficient length to stretch the ends of the sail. The sail is spread by a central main-yard, long enough to project 9 in. beyond the sail at each end; this must be strong, stiff, and light, and must be fitted at each extremity with two stout eyes, smooth on the inside. A

Sailing on Skates—continued.

piece of stout line as a "lanyard" is made fast to the centre of each of the small yards, and rove through the eyes at the ends of the mainyard, then round the small yard, and through the eye again, finishing up with a "figure of eight seizing" round the main and small yards at the points where they cross one another. One lanyard is first rove and made fast, the other is then used as a purchase to strain the sail taut. The use of the rounded ends to the sail is now seen, as the small yards buckle when the strain of the purchase comes on them. To prevent the leaches of the sail from flapping, and to relieve the small yards, a light stay is led from each end of them to the extremity of the mainyard, and made fast to the second pair of eyes already mentioned. The size of sail for a gale is 6ft. by 3ft., 9ft. by 6ft. for light wind; 7ft. 6in. by 5ft. is a good size for one skater to handle in ordinary wind. Two people can manage a sail together with great comfort. The 9ft. by 6ft. sail is none too large, and tall men could manage a larger one. Two rows of reef points would be a

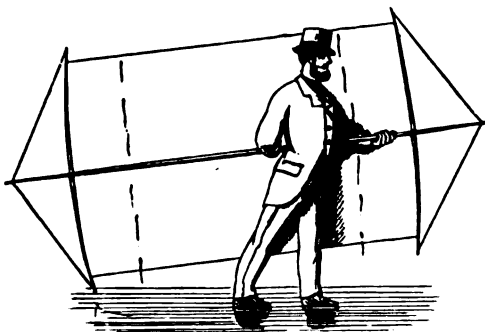

FIG. 255.

great addition, and might very easily be arranged. The sail must stand perfectly flat, and the yards and gear must be stout enough to bear the strain of setting everything up taut. In sailing alone, the skater should keep the greater part of his sail behind him; otherwise he will infallibly be taken aback if the wind is before the beam. Running before the wind needs no comment, but to work to windward satisfactorily and tack smoothly requires some practice.

When two go together, the sail is under perfect control. The front skater steers, and the hinder one, who is in command, trims the canvas correctly by the wind. It is equally easy to gybe or tack, and one can always stop immediately by coming head to wind.

Tacking may be accomplished in two different ways:—When close hauled, say, on the starboard tack, the sail being on the leeward side of the man, the right or weather foot will be in front, the other in a line behind it, the left hand will be forward, and the right (which answers to main sheet) holding the yard behind his back. When it becomes

Sailing on Skates—continued.

necessary to go about, by a slight inclination of his skates the skater luffs sharply, the sail shakes, the feet are changed, the hands remaining in the same position as before; the sail rapidly fills on the other side, and the skater shoots away smoothly on the port tack with his sail to windward of him. In moderate weather, the more smartly this is done the better. When blowing hard, it is necessary to take a wide sweep and shoot farther to windward in stays, running a little off the wind for a moment after filling away on the fresh tack. When tacking in this manner the yard will be alternately to windward and to leeward of the sail. In the former of these positions, the strain on it becomes very great; and for this, as well as other reasons, it may be desirable to tack in the other way, as follows:

When close hauled with the sail to windward of the man, and desiring to go about without bringing the wind on the other side of the sail, the skater, instead of luffing, turns his skates to leeward, keeping the sail spread behind his back, and running for a moment right before the wind. While in this position he rapidly shifts his hands along the yard until he reaches the point at which the balance of his head and after canvas becomes correct (this is a most important consideration). What was the after hand on the other tack becomes the fore hand now, and what was the leach now becomes the luff of the sail. With a slight turning of his skates to windward, and trimming his canvas accordingly, the skater hauls his wind in a moment, and shoots away on the fresh tack with unhindered velocity, and, if the manoeuvre has been skilfully performed, with a loss of only a yard or two to leeward. This plan is recommended for sailing single-handed, and the former when two people are going together.

Changing feet is perfectly easy; one foot can be slid in front of the other at any time.

Any skates that are sure not to come off (as Acme often do) will answer equally well.

When close hauled, the skater keeps by far the greater portion of the sail behind him; when reaching, he pushes it more forward. This answers to setting a big jib; and when running, he stands right in the middle.

The following description of a hand sail for sailing on ice appeared in the *New York Spirit of the Times*, Feb. 21, 1880:

"The first thing to be done after obtaining the sail, spars, &c., is to procure a strap about 1½ in. wide, with a loop to act as a step for the mast; secure it round the ankle of the left foot, then step the mast, after which pass the left arm around the mast at A (Fig. 256) and hold it firmly to the body, then hold the yard with the right hand at B. This is done for the purpose of handling the sail, instead of sheet ropes at C, which could not be used. The boom and yard do not need to be connected at D, but merely held together by means of the stops on the sail. The boom and yard may be secured to the mast with small pieces

Sailing on Skates—continued.

of cord, or any other way the operator may think fit, for conveniently stowing his miniature sail while in transit. The spars should be of pine, thus making them much lighter to carry. The sail may be made of strong factory or twill cotton, and can be bent on the

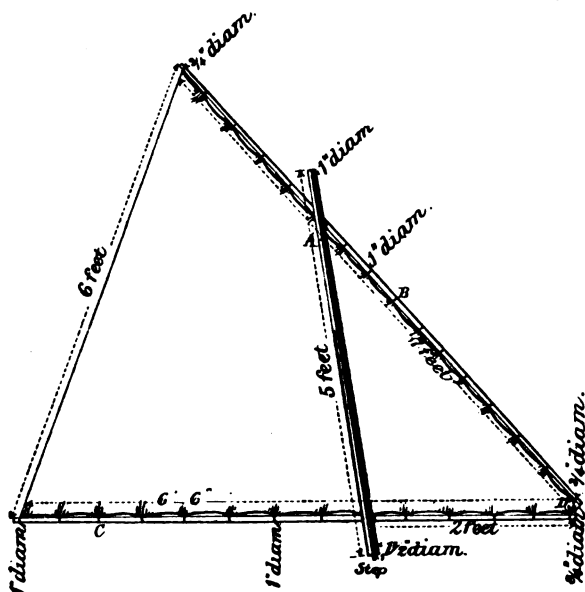

FIG. 266.

spars in the ordinary manner, with stops. It is not necessary to change the sail from one side of the body to the other when sailing on the port or starboard tacks, as the operator can more easily handle the yard with the right hand.

“It is usual when sailing to put one foot in front of the other, but the rule is not absolutely necessary. The strap around the ankle should be placed about one foot above the ice, or wherever the operator finds it more convenient for his height.”

Sails.—Sails in this country are usually made of flax in the form of canvas. In America nothing but cotton canvas has been used; but this year, 1882, several suits of flax canvas have been sent to America by Messrs. Laphorn. This is a curious incident. In 1851 the yacht *America* came here, and the superiority of the cut, make, and sit of her canvas revolutionised sail making in England. In 1881 the cutter *Madge* visited America, and her sails were considered so superior to those of American yachts, that her success was partly ascribed to her English suit of Laphorn sails. It was even said that sail-making had become a lost art in America. Cotton stretches less than flax; but the objection to it is that in case of rain it takes up so much water as to become exceedingly heavy and so hard as to be almost unmanageable with the hands. Information on the cutting out

and making of yacht and boat sails will be found in Kipping's treatise on "Sail Making," 2s. 6d., Weale's Series.

St. Andrew's Flag.—A blue flag with white diagonal cross, thus ×

St. George's Jack.—A white square flag with red St. George's cross (right angled, thus +), used by admirals in the Royal Navy. A vice-admiral's flag has one red ball, and rear-admiral's two. An admiral flies his flag from the main, vice from the fore, rear from mizen. St. George's Jack was the English flag before the union with Scotland and Ireland. (See "Jack.")

St. Patrick's Cross.—A red diagonal cross, ×.

Salt and Fresh Water.—A cubic foot of salt water weighs 64lb.; a ton contains 35 cubic feet. A cubic foot of fresh water weighs 62.5lb.; a ton contains 36 cubic feet: hence salt water bulk for bulk will sustain a greater weight. When a vessel goes from salt water to fresh she is sometimes lightened in ballast, in order that she may present the same surface for friction. There will be a loss of stability, and on the whole the practice is of doubtful utility. Regarding the case inversely, if a vessel be loaded down in salt water to the same depth that

she has been floating at in fresh water, and driven at the same speed, the resistance will increase in ratio to the superior density of salt water. No exact experiments have been made to ascertain whether a vessel, by floating somewhat lighter in salt than in fresh water, meets with a decrease of resistance. The comparison would be always attended with difficulty, as, if there were a difference in the resistance, it would be a very complicated matter unravelling it, as it would be necessary to know how much of the resistance depended on skin friction, and how much on wave making. We are inclined to think that the resistance (taking weight for weight) is a trifle less in salt water than in fresh. By removing weight, so as to float at the same load line as in salt water, the resistance in fresh water would be less, but the question of diminished stability, which removing weight involves, is such a serious matter that removing weight for river sailing cannot be advised. (See "Yacht Designing," page 93.)

Salute.—A salvo of cannon fired as a mark of respect and honour to a royal personage, commodore, vice or rear commodore, flag, &c. A Royal Salute is twenty-one guns; admiral of the fleet, seventeen; admiral, fifteen; vice-admiral, thirteen; rear-admiral, eleven; commodore (no senior captain being present. See "Burgee."), nine; captains or other

Salute—continued.

officers are not saluted. A captain or other officers' salute is returned with seven guns.

Among yacht clubs it is usual to salute a flag officer on his first hoisting his flag (swallow-tail burgee) on a club station at the beginning of a season, on his shifting his flag or on his promotion, and when he hauls it down at the end of a season, by eleven guns for a commodore, nine for a vice-commodore, and seven for a rear-commodore respectively. The club ensign is hoisted on the club flag-staff during the salute. It is unusual to salute a vice or rear commodore in the presence of a commodore, and if the commodore and vice or rear arrive together, the latter are not saluted. The Royal Cork Yacht Club has, however, a rule that a vice or rear can be saluted after a commodore has returned his salute. A commodore replies to a club salute, or to a salute by a squadron, with one salute of the number of guns he is entitled to. He returns a vice or rear commodore's salute with the guns each is entitled to, unless he receives a salute from both, then he returns with the number of guns he himself is entitled to. Strictly, however, the rear should not salute the commodore in the presence of the vice unless he obtains permission from the vice to do so. The regulation of the Royal Navy is that no salute is to be fired without permission of the senior officer present, except salutes to the senior officer himself; and further, if a salute has to be fired, only the senior officer of two or more yachts in company is to fire the salute. It is etiquette for a flag-officer of a club to return a salute, but a royal personage does not do so. The practice used to be for a yacht to "salute the flag" on arriving at a station; this practice is still in vogue in America, a junior always saluting first. If a winning yacht is saluted, it should be with five guns. A duke is saluted with fifteen guns, and any other nobleman thirteen. Merchant ships are supposed to salute H.M.S. by striking topsails or any upper sail, such as a royal or top-gallant sail; but the practice is now little observed except by old-fashioned seamen, the dipping of an ensign being all that is done. In the old Queen's regulations for salutes we find the following obsolete instructions:

"If any of Her Majesty's subjects shall so far forget their duty as to attempt to pass any of Her Majesty's ships without striking their topsails, the names of the ship and the master, the port to which they belong, the place from which they came, and that to which they are bound, together with affidavits of the fact, are to be sent to the secretary of the Admiralty, in order to their being proceeded against in the Admiralty Court."

If a merchant ship salutes a naval officer with the guns he is entitled to, the naval officer responds with five guns; or seven if there are several merchant ships. A merchant ship now usually salutes a man-of-war by dipping the ensign; the ensign is dipped (almost hauled down) and kept down until the man-

Salute—continued.

of-war responds. This is repeated three times; but some merchant ships only trouble to dip once, and then of course the man-of-war only responds once. (See "Dipping the Ensign;" see also the "Queen's Regulations for the Royal Navy," to be obtained of Messrs. Harrison and Sons, St. Martin's-lane.)

Save All.—A water sail; a sail set underneath booms in light weather.

Scant.—When the wind is very bare; when the wind comes so that a vessel will barely lie her course.

Scantlings.—The dimensions of all kinds of timber used in the construction of a vessel.

Scarp or Scarf, or Scarve.—A method of joining pieces of wood by tapering their ends. A box scarp is when the ends are not tapered, but a half thickness cut out of each part so that when put together the parts form only one thickness.

Schooner.—A fore-and-aft rigged vessel. A top-sail schooner has yards on her foremast, and sometimes on her mainmast, but no courses.

Scope.—Length or drift of rope or cable.

Score.—A groove to receive a rope or strop, &c.

Scowing an Anchor.—When small boats have to anchor on ground known or suspected to be foul, it will always be prudent to scow the anchor. Unbend the cable from the ring, and make the end fast round the crown, shank, and flukes with a clove hitch, and bring the end a back to *s*, and stop it round the cable with spun yarn or hitches; take the cable back to the shackle and stop it as at *b*; when the cable is hauled upon by the part *o* the stop at *b* will break, and the fluke of the anchor can be readily lifted out of its bed. Sometimes,

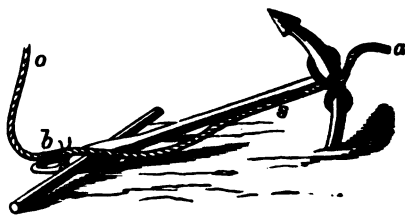

FIG. 257.

instead of scowing the anchor a trip line is bent to the crown and buoyed. (See "Anchor.")

Screens.—The wood shelves and screens painted red for port side, and green for starboard, in which a vessel's side lights are carried. (See "Side lights.")

Scroll Head.—The outward curved part of the knee at the upper fore part of the stem, called volute.

Scud.—To run before a gale of wind with very little canvas set, or "under bare poles."

Scull.—An oar. To scull is to propel a boat by working an oar over the centre of the transom on the principle of the screw.

Scuppers.—Apertures cut in the bulwarks or waterways to clear the deck of water.

Sea, A.—A wave. A heavy sea is when the waves are large and steep. When a quantity of water falls aboard a vessel it is said that "she shipped a sea."

Sea Boat.—A vessel fit to go to sea. A good sea boat is a relative term, and means a vessel that does not pitch badly or labour in a sea, or does not ship much water, and is, above all things, handy in a sea.

Sea, Depth of.—The soundings taken during the voyage of the "Challenger" added greatly to our knowledge of the sea depth. The following conclusions are stated in Moseley's Notes by a Naturalist on the "Challenger":

We are apt to form an erroneous impression as to the actual shapes and distributions of the elevations and depressions on the earth's surface, because only the very tops of the elevation stand above water. The outlines of the various continents and islands with which we are familiar on maps are merely lines marking the height to which the water reaches up. A very small proportion of the elevated masses projects above water, hence from an ordinary map we gain no truer impression of the form of the sculpturing of the surface of the earth itself than we should of a range of mountains if we viewed it when all but its summits were hidden by a flood.

So small a proportion does the mass of dry land elevated above the sea level bear to the hollows on the earth's surface beneath this level, that the cavities now occupied by the sea would contain three times the volume of the earth existing above the sea surface.

If the surface of the land and the sea bottom were brought to a complete level, the waters of the sea covering its even face would still have a depth of 1700 fathoms, being reduced in depth by the process only about 800 fathoms.

Although the depth of the ocean is so small in proportion to the vastness of its expanse, the depth is, nevertheless, so great as to be difficult of adequate realisation. The greatest depth as yet ascertained by sounding occurs in the North-west Pacific Ocean; it amounts to about five miles and a quarter.

The average depth of the ocean between 60° N. and 60° S. is about three miles, or 2500 fathoms. The great depth of five miles occurs only exceptionally over very small areas.

No sunlight penetrates the deep sea; probably all is dark below 200 fathoms, at least excepting in so far as light is given out by phosphorescent animals.

At depths of 2000 fathoms and upward the temperature of the water is never many degrees above the freezing point. The conditions under which life exists in the deep sea are very remarkable. The pressure exerted by the water at great depths is enormous,

amounting roughly to a ton weight on the square inch for every 1500 fathoms of depth. Sir C. Wyville Thompson ("Voyage of the Challenger," vol. ii., p. 352, London, 1877) gives, among the conclusions arrived at, after the first general survey of the deep sea collections of the expedition, that animal life is present on the bottom of the ocean at all depths, but is not nearly so abundant at extreme as at more moderate depths. Moseley mentions the dredging of a fish from 2500 fathoms, which had a deep-sea shrimp in its stomach.

Seam.—The line formed by the meeting of two planks; overlapping parts of canvas in a sail.

Seaman.—A man trained in the art of sailing, rigging, and general management of a ship. To make a good seaman a man must have practised the multitudinous details of his art with great diligence, and is then described as an "able seaman" or A.B. To say a man is a "seaman" means that he is thoroughly conversant with every duty of a sailor's life, and can not only "hand, reef, and steer," but can do every kind of work upon rigging, and even use the needle and palm.

The statutes relating to seamen are very numerous, and many of them affect, or can be made to affect, yacht sailors; however, many of the provisions of the Merchant Shipping Acts are rendered inoperative so far as yacht sailors go, because the signing of articles is not imperative.

SAILING MASTERS.

The master, mate, or engineer of a yacht need not possess a Board of Trade certificate, as sect. 136 of the Act of 1854 and sect. 5 of the Act of 1862, which, in effect, provides that no home-trade passenger ship or foreign-going ship, shall proceed to sea without having certificated master and mates, does not in any way apply to pleasure yachts. The Board of Trade have, however, instituted voluntary examinations for persons who command their own pleasure yachts, not, be it observed, for those who are not yacht owners but who may be desirous of taking charge of a yacht. A yacht owner, passing a satisfactory examination in navigation and seamanship, will be presented by the Board of Trade with a certificate entitling him to command his own yacht, which is a useless privilege, as he can take command of his yacht with or without the examination or certificate. The practical value set upon these very useless certificates by the Board of Trade may be gathered from one of the conditions: "The certificate will not entitle the holder to command any vessel except the pleasure yacht of which he may be, at the time, owner."

If no articles are signed, the rights, remedies, and duties of the owner of a yacht, his sailing master, and crew, are governed by ordinary master and servant law. When a man has once engaged to serve on board a yacht, as sailing master or in any other capacity, he will render himself liable to an

Seaman—continued.

action for breach of contract if, without a sufficient reason, he should refuse to enter upon his duty. Thus, a person agreed with a firm of shipowners to go in their ship as surgeon, but subsequently refused to go, the shipowners succeeded in an action against him, recovering as damages the difference between the sum they would have paid the defendant and the sum they had to pay another surgeon: ("Richards v. Hayward," 2 Manning & Granger, 574.) So, too, should the owner of a yacht refuse to receive a man into his service after having promised to do so, the owner will be liable to an action at the suit of the man: ("Clarke v. Allatt," 4 C.B. 335).

So long as anyone employed on board a yacht retains his situation, he is bound to obey the lawful commands of his employer, and to act in accordance with the terms of the contract of hiring; but circumstances may often arise which may render a discharge necessary, although nothing may have been done which would warrant a summary dismissal. Under such circumstances the question arises, what notice must be given? The answer must depend upon the position held by the persons to be dismissed, for the same rule would not necessarily hold good in the cases of the sailing master and a seaman. The law nowhere says what notice is to be given or required to put an end to a contract of hiring and service, for it assumes, as in all other contracts, that both parties will fulfil the terms of the contract into which they have entered, and that the service will endure for the time agreed upon; or, if no time has been specified, then the hiring is general and in contemplation of law one for a year, which can only be terminated by reasonable notice expiring at the end of some completed year's service: ("Forgan v. Burke," 4 Ir. C. & R. 495.) It is the duty of a jury to decide what is reasonable notice in each particular case. As a matter of fact, however, the custom of different callings so far controls the strict law, that there are now but few trades or professions in which a contract cannot be terminated by giving that notice which from continual adoption has grown to be the "custom of the trade." It is well that it should be so, for, as Chief Justice Erle has said ("Nicoll v. Graves," 33 L. J., C. P. 259), "Where the duties of the servant are such that he is required to be frequently near his employer, if any ill-feeling should arise between them, the presence of that servant would be a constant source of irritation to the employer; and, on the other hand, it may happen that a well-intentioned servant may have a dissatisfied employer constantly finding fault with him, and the sooner he is free from such service the greater will be his happiness." With regard to domestic or menial servants, it is a well-established custom that their contract of service may be determined at any time by giving a month's warning or paying a month's wages; and there have been several cases in

Seaman—continued.

which the courts have taken judicial notice of customs held to be proved in different callings, and subject to which the parties are taken to have contracted. So far as is known, it has never yet been decided in a superior court what is the customary notice in the yachting world in the case of a master of a yacht; but, as he is generally a yearly servant, it is probable that the courts would hold a three months' notice sufficient in any case. But something might turn upon the time of year at which the notice expired; for if the three months ended in the middle of the yachting season, it might be difficult for a master to obtain another berth before the commencement of the next season. But this remark only holds good in the absence of any express stipulation or usage. If either side can bring evidence of a custom—which must be proved to be generally known and acted upon—the decision would be in accordance with that custom.

All yacht servants, from the master to the boy, may be dismissed without wages for:

1. *Wilful disobedience* of any lawful command of the owner—"an offence," said Sir William Scott, "of the grossest kind: The Court would be particularly attentive to preserve that subordination and discipline on board of ship which is so indispensably necessary for the preservation of the whole service, and of every person in it. It would not, therefore, be a peremptory or harsh tone. . . that will ever be held by the Court to justify resistance." In "Spain v. Arnott" (2 Starkie, 256), a farm servant was dismissed because he refused to go to a place a mile off before dinner, dinner being then ready. Lord Ellenborough said: "If the servant persisted in refusing to obey his employer's orders, I think he was warranted in turning him away. . . It would be exceedingly inconvenient if the servant were to be permitted to set himself up to control his employer in his domestic regulations. . . After a refusal on the part of the servant to perform his work, the employer is not bound to keep him on as a burdensome and useless servant." So, too, a regimental messman, having once refused to serve up dinner until threatened with arrest, was held to have been rightly dismissed, although he offered an apology next morning: ("Churchward v. Chambers," 2 F. & F. 229.) Again, where a man agreed (under 5 & 6 Will. 4, c. 19) to serve as carpenter's mate of a vessel during a South Sea voyage, but refused to work except to an English port, the court held him to have been rightly discharged: ("Benno v. Bennett," 3 Q. B. 768.) And, lastly, it has been decided that an employer was warranted in dismissing a servant who persisted, contrary to the employer's orders, in going to visit a relation believed by her to be in a dying state: ("Turner v. Mason," 14 M. & W. 112.) In the case of a master of a yacht, it may be doubted whether the refusal to obey an order involving unnecessary danger would be a good ground of discharge;

Seaman—continued.

nor, it is apprehended, would the failure to comply strictly with a command warrant a summary course of procedure; as, for instance, if an owner ordered the master to make fast to one buoy, and he, perhaps for what he considered a good reason, made fast to another near at hand.

2. *Gross moral misconduct*, such as robbery, violence, continued insolence, or drunkenness: ("Cunningham v. Fonblanque," 6 C. & P. 49; "Speck v. Phillips," 5 M. & W. 279; "Wire v. Wilson," 1 C. & R. 662.) On these matters Sir W. Scott said: "Drunkenness, neglect of duty, and disobedience are offences of a high nature, fully sufficient to justify discharge without notice. Drunkenness is an offence particularly obnoxious on board ship, where the sober vigilant attention of every man is required. At the same time the Court cannot entirely forget that in a mode of life peculiarly exposed to severe peril and exertion, and therefore admitting in seasons of repose something of indulgence and refreshment, that indulgence and refreshment are naturally enough sought for by such persons in grosser pleasures of that kind; and therefore proof of a single act of intemperance, committed in port, is no conclusive proof of disability for general maritime employment:" ("The Exeter," 2 C. Robinson, 263.)

3. *Incompetence*.—When a man ships on board a yacht, there is on his part an implied warranty that he possesses sufficient skill for the work he undertakes. No express promise that he has the requisite skill is necessary, and should he be found incompetent he may be discharged without notice: ("Harmer v. Cornelius," 28 L. J., C. P. 85.) But the incompetence must be closely connected with the work he undertakes; for example, a master employed to take charge of a sailing yacht could not be summarily discharged because he happened to be unacquainted with the management of a steam yacht, or *vice versa*; or because he did not know how to manage a trawl, &c.

4. *Permanent illness* is, according to the best authority, a ground of dismissal, "for there is no difference between a servant who will not, and a servant who cannot, perform the duty for which he was hired" ("Harmer v. Cornelius," *ante*; "Cuckson v. Stones," 28 L. J., Q.B. 25), but mere temporary indisposition will not justify discharge. If a master receives injury in the performance of his duties, he, like the crew, can claim medical attendance until he is cured or dies, and no deduction can be made from wages.

Should the master be *rightfully* discharged for misconduct while the yacht is away cruising, the owner is under no liability to pay his passage either to his home or to the place at which he was engaged; for the dismissal was brought about by the man's own misconduct, which is not to be a tax on the employer: ("Turner v. Robinson," 5 B. and Adolphus 789.) Should the offender refuse

Seaman—continued.

to leave the vessel, he may be removed by force, but the services of a policeman should be sought for, as, if unnecessary violence be employed, it will amount to an assault on the man.

On the subject of clothes the law is that the property in them is in the yacht owner; when, therefore, the servant is dismissed for misconduct, he cannot claim to take his clothes. If, however, he be hired expressly for the season, or for a year, at stated wages and his clothes, he then becomes entitled to them at the expiration of the season, or of the year, as the case may be: ("Crocker v. Molyneux," 3 C. & P. 470.) Should a servant be guilty of returning the clothes supplied to him to the tailor or draper in exchange for money or private clothes, a yacht owner is only liable to pay for the garments actually supplied, and not for those given in exchange, and is entitled to set off against a subsequent account for clothes, the price of those supplied and paid for, but subsequently taken back by the tradesman: ("Hunter v. Berkeley," 7 C. & P. 413.) See cases tried in County Courts—Dublin, August, 1874; Torquay, Nov. 17, 1877; Newport, Isle of Wight, Aug. 6, 1878; Southampton, Dec. 10, 1878.

The strictly legal side of the question only has been dealt with; the questions of expediency and bounty are left to individual taste.

Agreement.—A form of agreement suitable for an owner and master to enter into is herewith appended.

Memorandum of Agreement entered into this day of _____, one thousand eight hundred _____, between _____ of _____, and hereinafter termed the owner, on the one part, and _____ mariner of _____, and hereinafter termed the master, on the other part.

The owner agrees to engage the master to serve in that capacity on board the yacht _____, and to pay him as wages the sum of _____ per _____, the said wages to be paid [here insert "weekly," "monthly," "quarterly," as the case may be]; and the owner agrees to supply the master each year the yacht is in commission during this agreement with _____ suits of clothes complete, as usually found for the master of a yacht; and the owner agrees that the said clothes shall be the property of the master, unless the master is discharged for misconduct, or discharges himself during any period that the owner's yacht is in commission; and the owner agrees to find the sailing master in food and a reasonable quantity of beer or other drink, or the equivalent in money of such food and drink, for the period the owner's yacht is in commission during this agreement; and the said sailing master, on his part, agrees to enter and abide in the service of the owner for the wages and other considerations aforesaid, and to the best of his ability to maintain discipline, strict sobriety, cleanliness, and general good con-

Seaman—continued.

duct in the crew on board the owner's yacht, and to keep the owner's yacht in a smart, tidy, clean, and yacht-like condition, and to incur no expense for the maintenance of the hull or equipment of the owner's yacht further than lawfully authorised by the owner, and to willingly, carefully, and skilfully take the owner's yacht to such places as the owner may desire her to be taken, either on the coasts of the British Isles or the coasts of _____, between _____ and _____; and when the yacht is put out of commission during this agreement the master agrees to dismantle her and carefully store all her equipment as directed and to frequently visit the owner's yacht for the purpose of ventilating, pumping, and generally preserving and taking care of her and her equipment in the period she is out of commission during this agreement; and it is further jointly agreed between the owner and master that the wages shall commence to be paid and continue to be paid on and after the day of _____, one thousand eight hundred and _____; and it is further jointly agreed between the owner and master that this agreement shall terminate upon either the owner or master giving _____ notice thereof, but the owner may summarily cancel the agreement and dismiss the master should the master wilfully disregard any of the owner's reasonable commands, or be guilty of any misconduct, such as drunkenness, quarrelsomeness, violence of conduct, smuggling, continued absence, or neglect of duty, breaches of this agreement, gross carelessness, extravagance, or incompetence.

(Signed) _____ Owner.
Sailing Master.

Witness,

COOKS AND STEWARDS.

A curious point might arise with regard to cooks and stewards. On shore, both these functionaries would most certainly fall within the category of domestic servants, and would, therefore, be entitled to a month's warning, or payment of a month's wages; but where the duration of the contract can only be inferred from the fact that the wages are paid weekly, it would be taken to be a weekly hiring, in which case a week's notice would suffice; or, again, owing to the fact that they cannot obtain situations as readily as shore servants, it is just possible that they might be held entitled to the same notice as the master, if they were hired on the same terms by the year and paid at the same intervals.

What has been said only applies when there has been no special stipulation at the commencement of the service, or no proof of custom. If an agreement has been made, the parties are bound by it; as there are no reported cases deciding what the custom is, the question is still in abeyance. Every yacht owner knows what he believes to be the custom, but until his idea has been

Seaman—continued.

supported in a court of law it is only a surmise.

CREWS UNDER THE MERCHANT SHIPPING ACTS.

Mercantile marine offices (formerly known as shipping offices), under the care of superintendents and deputy-superintendents, have been established for the purpose of affording facilities for engaging seamen by keeping registries of their names and characters, and for securing the presence on board at the proper time of the seamen engaged (sect. 124 of Act 1854). These offices are established at every seaport in the United Kingdom in which there is a local marine board, and the Board of Trade secures premises and arranges for the carrying on of the general business. In the absence of other premises, the business of the offices may be transacted at Custom Houses (sect. 128), and mercantile marine offices may be established in London at sailors' homes (sect. 129). As these sections are not among the excepted ones, they apply to pleasure yachts; but obviously they are more adapted to the requirements of merchant shipping than to yachting.

By sect. 272 of the Act of 1854 the Registrar-General of shipping and seamen is to keep a register of all persons who serve in ships "subject to the provisions of this Act." That section applies to yachts, and therefore every yacht owner should comply with the terms of sect. 273, and make out and sign a list in a form sanctioned by the Board of Trade, stating, amongst other information, (1) the number and date of the yacht's register, and her registered tonnage; (2) the length and general nature of the voyage; (3) the names, ages, and places of birth of the crew, including the master, and their occupation on board; (4) the names of any members of the crew who have died or otherwise ceased to belong to the ship, with the times, places, causes, and circumstances thereof; (5) the names of any members of the crew who have been maimed or hurt, with the times, places, causes, and circumstances thereof, and some other matters shown in the form, but with which yachtmen will not often be concerned.

By the Merchant Shipping Act, 1867 (30 & 31 Vict. c. 124), sect. 4, the owner of every ship—in which, it must be remembered, pleasure yachts are included—navigating between the United Kingdom and any place out of the same shall, unless exempted by the Board of Trade, provide, and keep on the ship, a supply of medicines and medical stores, in accordance with the scale appropriate to the ship. Lime or lemon juice, obtained from a bonded warehouse, and containing 15 per cent. proof spirit, is also to be kept on board. The lime or lemon juice is to be served out to the crew, as soon as they have been at sea ten days (except during the time the ship is in harbour and the crew supplied with fresh provisions), at the rate of an ounce per man per day. By the 4th sub-

Seaman—continued.

section lime juice need not be carried on ships bound to European ports, or to ports in the Mediterranean Sea, or to ports on the Eastern coast of America north of the 35th degree of north latitude, and to islands or places in the Atlantic north of the same limit.

With regard to the expenses attendant on illness and death, sect. 228 of the Act of 1854, which is one of the sections of the third part of the Act to which pleasure yachts are made subject by the Act of 1862, provides (1) that the expense of providing the necessary surgical and medical advice, with attendance and medicine, for any member of the crew, including the master, receiving any hurt or injury in the service of the ship, and the expense of his burial, shall be borne by the owner of the ship, without any deduction from the man's wages. (2) If a man is, on account of any illness, temporarily removed from the ship to prevent infection, or otherwise for the convenience of the ship, and subsequently returns to the ship, the expenses shall be defrayed by the owner of the vessel. (3) The owner of the vessel is to pay for all medicines and advice. (4) In all other cases any reasonable expense incurred by the owner for any seaman in respect of illness shall, if duly proved, be deducted from the seaman's wages. By sect. 8 of the Merchant Shipping Act, 1867, where a seaman is by reason of illness incapable of performing his duty, and it is proved that his illness, and consequent incapacity to work, arises through his own fault, then he is not entitled to his wages for the time during which he is incapacitated.

Having noticed how far what may be called the general provisions of the Merchant Shipping Acts affect yachtsmen, we must now direct attention to such of the provisions of those Acts as bear more particularly on the relationship between the yacht owner and his crew, and the maintenance of discipline on board; and for that reason are of importance in every case where a yacht is fitted out, for however short a time.

II. *Maintenance of discipline where no written articles or agreement is signed.*—The common and statute law, having regard to the innumerable difficulties that might arise on board a ship unless the government were, so to say, despotic, has clothed the master of a ship with a very wide authority; and even if his conduct should, in exceptional cases, have been harsher than circumstances absolutely required, courts of law having jurisdiction in the matter will require very strong proof that the master has abused his authority, before they will allow that his conduct is any justification for a seaman's misconduct. As we have already stated, sect. 13 of the Merchant Shipping Act of 1862 extends the operation of the third part of the Act of 1854 to yachts, so far as the provisions are applicable, and with the exception of certain sections. Amongst the enactments so rendered applicable to yachts are those contained in the

Seaman—continued.

third part of the Merchant Shipping Act, 1854, for the maintenance of discipline, although no agreement has been signed. In speaking of a master's authority over the crew, the author of Boyd's "Merchant Shipping Laws" says: "The rule of law is that a captain's authority over the crew . . . is, in the strict sense of the word, undefined; or, as it has been termed, despotic. He may, in short, inflict any punishment which is reasonable; that is, any punishment which is necessary to insure obedience to his command in all lawful matters relating to the navigation of the ship, and the preservation of good order . . . The question must be one of fact, viz., whether the captain has used his power immoderately. The law is very favourable for captains, their power is most extensive, and they are only liable to punishment if they exercise it wrongly."

The following are some of the more important provisions of the Act of 1854 for maintaining discipline: Any master, seaman, or apprentice—who, by virtue of the interpretation clause of the Act of 1854, and sect. 13 of the Act of 1862, includes every person (except masters, pilots, or duly indentured apprentices employed in any capacity on board any sea-going pleasure yacht)—who "by wilful breach of duty, or by neglect of duty, or by reason of drunkenness," does any act tending to the immediate loss, destruction, or serious damage of such ship, or tending immediately to endanger the life or limb of any person on board, or, by neglect of duty or drunkenness, refuses or omits to do any lawful act proper or requisite to be done by him for preserving the ship from immediate loss, destruction, or damage, shall be guilty of a misdemeanor, and is in consequence liable to be proceeded against in a criminal court (sect. 239 of the Act of 1854). In the words of Lord Stowell, drunkenness is "an offence peculiarly noxious on board ship, where the sober and vigilant attention of every man, and particularly of officers, is required. At the same time the Court cannot entirely forget that, in a mode of life particularly exposed to severe peril and exertion, and therefore admitting, in seasons of repose, something of indulgence and refreshment; that indulgence and refreshment is naturally enough sought by such persons in grosser pleasures of that kind, and therefore that the proof of a single act of intemperance, committed in port, is no conclusive proof of disability for general maritime employment:" (The *Exeter*, 2 Robinson's Rep., p. 264.) So, too, in another case (wherein it was proved that a steward had been drunk once or twice during a nine months' voyage), the same judge said that the court would not "countenance any criminal excess of that kind; yet it cannot so far blind itself to the ordinary habits of men, living for such a length of time in a frequent condition of extreme peril and fatigue, as to feel much surprise that a seaman . . . should have been betrayed into

Seaman—continued.

two acts of indulgence of that nature; nor can it consider them as sinking him below the common average of a seaman's morality:" (The Lady Campbell, 2 Hagg. 5.) These two extracts, if not over-complimentary to seamen, show at any rate that they will not be judged too hardly. Thus it has been held that occasional drunkenness, in cases where no damage has ensued to the shipowner, is no cause of forfeiture of wages. But in the case of the Macleod (L. R. 5 Probate Division, p. 254), Sir Robert Phillimore, after quoting with approval the above extracts, held that the master of a ship, who had been habitually drunk during his employment, could not maintain an action for wages.

When a yacht owner takes or sends his yacht into foreign waters, one of the inconveniences he is open to is the desertion of one or more members of his crew; and this and other offences are dealt with in sect. 243 of the Merchant Shipping Act, 1854, which, not being one of the excepted sections, applies to seagoing pleasure yachts, whether articles are signed or not. The Act of 1854 authorised imprisonment for desertion and kindred offences, but by the Merchant Seaman Act of 1880 (43 & 44 Vict. c. 16) imprisonment has been abolished for desertion, for neglect or refusal to join ship after, and absence without, leave; and the worst that can now befall a yacht sailor deserting, in addition to the liability to forfeit his clothes, effects, and wages, is that, subject to any proceedings which may be taken against him to recover damages at common law, or under the Employers and Workmen Act, 1875—which indeed would probably have no effective result—he may be conveyed on board again; while, if a yacht sailor gives forty-eight hours' notice of his intention to leave his ship, or to absent himself from duty, any court before whom he may be taken will not be justified in treating him as a deserter or absent without leave. In order to be guilty of desertion, a man must quit his ship with the intention of not returning. As, for instance, when a man leaves a yacht, and ships on board some other vessel other than a Queen's ship, or where, having obtained permission to go ashore, he refuses to return. Where a man goes on shore, gets drunk, and is left behind through being drunk, or through being locked up, he will not be held to have been guilty of desertion. If a *bonâ fide* deserter can be caught, and is brought before "any court," the court may, if the master requires, cause him to be conveyed on board, and any costs and expenses incurred by the owner or master of the yacht by reason of the desertion are to be paid by the offender, and, if necessary, deducted from any wages due or to become due to him.

For neglecting or refusing without reasonable cause to join his ship, or to proceed to sea in his ship, or for absence without leave at any time within twenty-four hours of the ship sailing from any port, either at the com-

Seaman—continued.

mencement or during the progress of any voyage, or for absence without leave at any time not amounting to desertion, and not treated as such by the master, a seaman (which term, as we have seen above, includes every person other than a master, pilot, or indentured apprentice employed in any capacity on board any sea-going yacht) is, if he has been lawfully engaged, liable to forfeit out of his wages a sum not exceeding the amount of two days' pay, and, in addition, for every twenty hours of absence either a sum not exceeding six days' pay, or any expenses which have been properly incurred in hiring a substitute.

A yachtman who leaves any sea-going yacht on which he is employed, for the purpose of entering on board a Queen's ship, does not commit any offence.

For wilful disobedience to any lawful command, a seaman shall be liable to imprisonment for any term not exceeding four weeks, with or without hard labour, and also, at the discretion of the court, to forfeit out of his wages a sum not exceeding two days' pay.

For continued wilful disobedience to lawful commands, or continued wilful neglect of duty, he shall be liable to imprisonment for any period not exceeding twelve weeks, with or without hard labour; and also, at the discretion of the court to forfeit for every twenty-four hours' continuance of such disobedience or neglect, either a sum not exceeding six days' pay, or any expenses properly incurred in hiring a substitute.

The powers of a master of a ship are so great, that any roughness in giving an order, or the giving of an unnecessary order, will not justify a seaman, whether he is one of the crew of a yacht or of a trading vessel, in refusing to execute it. So too, in allotting work amongst the crew, although matters requiring the neatest work are in ordinary course given to the most experienced hands, yet no seaman may refuse to do even boys' work, if it should seem fit to the master so to order.

It is a general rule that any member of the crew of a ship is obliged to obey the order of the master or his superior officer, asking no questions, and making no objection, whether the duty to which he is ordered be that which properly belongs to an able seaman or not: (see Dana's Manual, 14th ed., pp. 153-158.) But, of course, a master ought not to order a man to exercise skill in some line in which he professed no skill at the time of shipping. For example, if a carpenter does not ship as seaman as well as carpenter, no nautical skill can be required of him; although he would have, when all hands are called, or if ordered by the master, to do any ordinary work, such as tailing on to a halyard (Dana's Manual, p. 149), or any one shipping as a seaman he need not be expected to understand the repairing of fishing nets. "Disobedience to lawful command," said Lord Stowell (The Exeter, 2 Robinson, p. 264), "is an offence of the grossest kind; the

Seaman—continued.

court would be particularly attentive to preserve that subordination and discipline on board of ship, which is so indispensably necessary for the preservation of the whole service, and of every person concerned in it. It would not, therefore, be a peremptory or harsh tone, or an overcharged manner in the exercise of authority, that will ever be held by this court to justify resistance. The nature of the service requires that those persons who engage in it should accommodate themselves to the circumstances attending it; and those circumstances are not unfrequently urgent, and create strong sensations, which naturally find their way in strong expressions and violent demeanour. The persons subject to this species of authority are not to be captious, or to take exception to the want of a formal and ceremonious observance of behaviour."

It is further provided by the 243rd section of the Merchant Shipping Act, 1854, that for assaulting any master or mate, a "seaman" shall be liable to imprisonment for any period not exceeding twelve weeks, with or without hard labour. The same section provides that for combining with any other or others of the crew to disobey lawful commands, or to neglect duty, or to impede the navigation of the ship, or progress of the voyage, a "seaman" shall be liable to imprisonment for any period not exceeding twelve weeks, with or without hard labour.

For wilfully damaging the ship, or embezzling or wilfully damaging any of her stores or cargo, he shall be liable to forfeit out of his wages a sum equal in amount to the loss sustained, and also, at the direction of the court, to imprisonment for any period not exceeding twelve weeks, with or without hard labour.

For any act of smuggling, of which he is convicted, and whereby loss or damage is occasioned to the master or owner, the seaman shall be liable to pay to such master or owner such a sum as is sufficient to reimburse them for such loss or damage; and the whole, or a proportionate part of the man's wages, may be retained in satisfaction or on account of such liability, without prejudice to any further remedy. It will thus be seen that, irrespective of any contract or agreement with the seaman, the statute law of this country has entrusted the owner and master of a sea-going yacht with important powers for the preservation of discipline amongst the crew on board.

Inasmuch as the "master" is the person by whom the provisions of the above sections are usually put in force; and as, moreover, the common law has vested, as we have already noticed, in him such extensive powers over all on board his ship, it is important that yacht owners should not, as a general rule, enter into any arrangement whereby the legal status of the master is conferred on any person other than themselves. The word "master" is defined in the Merchant Shipping Act, 1854, as including every

Seaman—continued.

person (except a pilot) having command or charge of any ship; whilst, in yachting parlance, the master is understood to be the person engaged to navigate and manage the yacht under the orders and as required by the yacht owner.

It may be a question of doubt in some cases whether, notwithstanding that a sailing master may be employed, the owner of any unregistered yacht may not, when he is on board his yacht, be her "master" within the above definition in the Merchant Shipping Act, 1854, more especially if, as is generally the case, he takes any part in the working of the yacht; but with respect to British registered yachts no such question of doubt can arise, for the 44th section of the Merchant Shipping Act, 1854, requires that there shall be inserted in the ship's certificate of registry, amongst other details, the name of her "master," under the provisions of the 46th section of the same Act referred to on a previous occasion. Whenever the master of a British registered vessel is changed, the name of the new master must be indorsed on the ship's certificate of registry; and all officers of customs within the Queen's dominions may refuse to recognise any person as "master" whose name is not so inserted in or indorsed on the certificate of registry. Having regard to the provisions of these two last-mentioned sections, the owner of a British registered yacht should have his own name inserted in or indorsed on the yacht's certificate of registry as "master," not that of his captain or sailing master.

To say nothing of the legal proof thus afforded for all official purposes as to the person entitled to the status of "master" on board, or the express provisions of the 46th section of the Act of 1854 with reference to matters arising with the Customs, or questions affecting the revenue or quarantine, in all cases where the owner's name appears on the certificate of registry as master, the crew are, of course, precluded from denying his authority as "master," whilst at the same time they cannot refuse to obey the orders of the sailing master, who has the same power under the control of the master as the officers of a trading vessel.

Whenever any of the offences enumerated above are committed, an entry should be made in the form of log book approved by the Board of Trade, which on board foreign cruising yachts should always be carefully kept, and the entry should be signed by the master and also by the sailing master, the mate, or one of the crew; and the offender, if still in the yacht, should, before the yacht arrives at the next port, either have a copy of the entry or have it read over to him; and, in any subsequent legal proceeding the entries shall, if practicable, be produced or proved, and, in default of such production or proof, the court may, at its discretion, refuse to receive evidence of the offence: (Sect. 244 of the Act 1854.)

Seaman—continued.

The crew being servants paid weekly, can be discharged as any ordinary servant upon giving a week's notice, and can claim their discharge upon giving similar notice. When a member of a crew is discharged for no definite offence, he can claim his passage money to the port of shipment, but not if he discharges himself.

By the Merchant Seamen Act, 1880, additional facility is given for the settlement of disputes as to wages, &c., by extending the operation of the Employers and Workmen Act, 1875, so as to include seamen. Under the last-named Act, in any proceeding before a County Court in relation to any dispute between an employer and a seaman, arising out of or incidental to their relation as such, the County Court may (1) adjust and set off one against the other all claims found by the court to be subsisting between the parties; (2) may rescind any contract between the employer and seaman; (3) take security from a defendant for the due performance of a contract, instead of awarding damages for a breach thereof.

SIGNING ARTICLES.

We now come to the third part of our subject, namely, the position of master and crew and the maintenance of discipline when articles under the Merchant Shipping Acts are signed; or, in other words, when master and crew sign an agreement drawn up in a form sanctioned by the Board of Trade.

Section 149 of the Merchant Shipping Act of 1854, taken by itself, provides in effect that the master of every ship (except coasting vessels of less than 80 tons) shall enter into an agreement with every one of the crew in the form sanctioned by the Board of Trade, and the agreement must be signed by the master and all hands—whence the phrase signing articles. This section is one of the excepted sections of the third part of the Merchant Shipping Act, 1854, which does not apply to pleasure yachts, and therefore a yacht owner is not bound to enter into such an agreement with his crew. But if he likes to insist on a Board of Trade agreement, he can do so, although of course he must be prepared to find some yacht sailors refusing to ship with him on those terms. So long as a yacht only cruises in the home waters, Board of Trade agreements are not of much use, and it is only when she becomes a "foreign-going ship" that they are of such importance. By the interpretation clause of the Merchant Shipping Act, 1854, a foreign-going ship is interpreted as including anyone that proceeds between some place or places in the United Kingdom, and some place or places situate beyond the coasts of the United Kingdom, the Channel Islands, and the continent of Europe, between the river Elbe and Brest, inclusive. When, therefore, a yacht's voyage exceeds the above limits, the agreement should, with any necessary alterations, follow the form sanctioned by the Board of Trade for foreign-going ships. If a Board of

Seaman—continued.

Trade agreement is agreed to and adopted without alteration, it must contain the following particulars as to terms:

1. The nature, and as far as practicable, the duration of the intended voyage. Or by a later statute (36 & 37 Vict. c. 85, s. 7) it may state the maximum period of the voyage or engagement and the places (if any) to which the voyage or engagement is not to extend. The statement under this head must be sufficiently plain to enable a man to understand the nature of the work for which he contemplates an engagement.

2. The number and description of the crew, specifying how many are engaged as sailors.

3. The time at which each seaman is to be on board or to begin work.

4. The capacity in which each seaman is to serve.

5. The amount of wages which each seaman is to receive.

6. A scale of the provisions which are to be furnished to each seaman.

7. Any regulations as to conduct on board, and as to fines, short allowance of provisions, or other lawful punishments for misconduct, which have been sanctioned by the Board of Trade as regulations proper to be adopted, and which the parties agree to adopt; and the agreement shall be so framed as to admit of stipulations on the part of the employer and the employed which are not contrary to law.

These agreement forms can be obtained at the Mercantile Marine offices, and from the Board of Trade; they are printed, and spaces are left for filling in the signatures of the different stipulations.

Of course yacht owners may make any special written agreements which their crews will sign; but the Board of Trade form, having official sanction given to it, should be adhered to as much as possible. In the interpretation clause of the Merchant Shipping Act, 1854, the word "seaman," is to include "every person (except masters, pilots, and apprentices duly indentured and registered) employed or engaged in any capacity on board any ship." In steam yachts, therefore, the engineers and firemen would be seamen; as also would be on every yacht the cook and steward. It may be observed that a yacht owner, though he should adopt the forms of agreement signed by the Board of Trade, or a modification of them, is not compelled to require that all the persons engaged on board his yacht should sign them. He may, for instance, engage his cook and steward on the same terms as would be the case if their service would be performed on shore. Still, it will be found advisable that the authority of the master should be secured over all on board alike, by the medium of a written agreement.

The agreement is to be signed by all parties to it, the master signing first; and the document dates from the time of his signature. In order to avoid any technical difficulties that might arise, the yacht owner

Seaman—continued.

should sign as master, and the regular sailing master as mate; and in order to enable the crew to refer to the agreement at any time, the master should at the commencement of the voyage have a legible copy (omitting the signatures) placed in some part of the vessel to which the men have access.

In the agreement to be signed, the crew contract as follows:

"The several persons whose names are hereto subscribed, and whose descriptions are contained below, and of whom [here insert number] are engaged as sailors, hereby agree to serve on board the said yacht in the several capacities expressed against their names until the said yacht shall be paid off [here insert the voyage or cruise to be made], and to conduct themselves in an orderly, faithful, honest, and sober manner, and to be at all times diligent in their respective duties, and to be obedient to the lawful commands of the said master or of any person who shall lawfully succeed him, and of their superior officers in everything relating to the said yacht whether on board, in boats, or on shore. In consideration of which services to be duly performed, the said master hereby agrees to pay the said crew as wages the sums set against their names respectively expressed. And it is hereby agreed that any embezzlement or wilful or negligent destruction of any part of the yacht's stores shall be made good to the owner out of the wages of the person guilty of the same. And if any person enters himself as qualified for a duty which he proves incompetent to perform, his wages shall be reduced in proportion to his incompetency. And it is also agreed that the regulations authorised by the Board of Trade, which in the paper hereto annexed are numbered [here insert the numbers of the regulations], are adopted by the parties hereto, and shall be considered as embodied in this agreement. And it is also agreed that if any member of the crew considers himself to be aggrieved by any breach of the agreement or otherwise, he shall represent the same to the master or officer in charge of the ship in a quiet and orderly manner, who shall thereupon take such steps as the case may require. And it is also agreed that any man guilty of misconduct shall be liable to be discharged by the master at any port in Great Britain or Ireland. That the voyage shall be considered as terminated when the yacht is paid off. Every A.B. who conducts himself to the satisfaction of the master shall receive shillings per week conduct money when discharged. [Here insert any other stipulations which may be agreed upon, and which are not contrary to law.] In witness whereof the said parties have subscribed their names, &c. Signed master, and the day of 18 . . ."

This passage gives a very fair idea of a seaman's duty, and the only difficulty is in deciding when a man ceases to be honest, orderly, faithful, or sober. The due per-

Seaman—continued.

formance of duty entitles the man to proper accommodation, food, treatment, &c.

The following are the regulations for the preservation of discipline. They are distinct from and in addition to the statutable punishments for the offences previously set out:

1. Not being on board at the time fixed by the agreement—two days' pay.
2. Not returning on board at the expiration of leave—one day's pay.
3. Insolence or contemptuous language or behaviour towards the master or any mate . . .—one day's pay.
4. Striking or assaulting any person on board or belonging to the ship—two days' pay.
5. Quarrelling or provoking to quarrel—one day's pay.
6. Swearing or using improper language—one day's pay.
7. Bringing or having on board spirituous liquors—three days' pay.
8. Carrying a sheath knife—one day's pay.
9. Drunkenness, first offence—two and a half days' provisions; second offence—two days' pay.
10. Neglect on part of officer of watch to place the look-out properly—two days' pay.
11. Sleeping or gross negligence while on the look out—two days' pay.
12. Not extinguishing lights at the times ordered—one day's pay.
13. Smoking below—one day's pay.
14. Neglecting to bring up, open out, and air bedding, when ordered—half day's pay.
15. (For the cook.) Not having any meal of the crew ready at appointed time—one day's pay.
16. Not attending Divine service on Sunday, unless prevented by sickness or duty—one day's pay.
17. Interrupting Divine service by indecorous conduct—one day's pay.
18. Not being cleaned, shaved, and washed on Sundays—one day's pay.
19. Washing clothes on Sundays—one day's pay.
20. Secreting contraband goods on board with intent to smuggle—one month's pay.
21. Destroying or defacing the copy of the agreement which is made accessible to the crew—one day's pay.
22. Officers guilty of above offences shall be liable to fine of twice the number of days' pay which would be exacted from a seaman for like offence.

It does not, however, follow that the above table is to be adopted *in toto*. There is a blank space left in the agreement form, wherein is to be inserted the numbers of the above regulations which are mutually agreed upon. For example, smoking below is 13th on the list, and if the yacht owner wished to make smoking below a breach of discipline he would put 13 in the blank space in the agreement form, and so on.

For the purpose of legally enforcing any of the foregoing fines, the same course must be adopted as in the enforcement of the statutable penalties; that is to say, as soon

Seaman—continued.

as the offence is committed a memorandum of it should be inserted in the official log-book which should, for technical reasons, always be kept when the yacht is on a foreign cruise. The entry in the log-book must be signed by the master, mate, or one of the crew, and a copy of the entry must be read over to the offender before the ship reaches port, or departs from the port at which she may be, and if the offender is discharged before a mercantile marine superintendent the entry should be shown, and if the superintendent is satisfied the fine should be deducted from the wages and paid over to the superintendent.

The following are the Queen's Regulations for the Royal Navy as to smoking:

"The hours when smoking is to be permitted, providing it does not interfere with the carrying on of duty, are as follows:

- I. During the meal hours of the ship's company, and after quarters to 8 p.m. at sea and 9 p.m. in harbour.
- II. On Sundays, and also on Thursdays, when it does not interfere with the duties of the ship, in the afternoons until the pipe "clear up decks."
- III. The captain may also permit (if he sees fit) smoking during the night watches for a short period, not exceeding one hour in each watch.
- IV. Smoking in the boats is prohibited when on duty, unless the boats are detached for any length of time on service, in which case smoking may be allowed within the hours prescribed on board ship."

By section 181 of the Merchant Shipping Act, 1854, a seaman's right to wages and provisions begins either at the time at which he commences work, or at the time specified in the agreement for his arrival on board, whichever first happens, so that if a seaman goes on board and works sooner than he need have done, his right to wages does not necessarily date from the time he went on board.

When a seaman is desirous of having not more than half his wages paid to his wife and family during his absence, or placed in a savings bank, the stipulation to that effect may be inserted in the proper place in the agreement signed by the master and crew (Merchant Shipping Act, 1854, sect. 168); but it will in that case be necessary for the yacht owner to make provision for the amounts allowed being regularly paid on shore. In the case of merchant shipping, this is done by the owners or owners' agents. As advance notes are now illegal, the payments to the seaman's relations, under an allotment note, will not begin until the expiration of one month, or, if the money is to be placed in a savings bank, at the expiration of three months from the date of the agreement, because the payments are only to be made out of wages already earned. (Merchant Seamen's Act, 1880, sect. 3.)

Speaking generally, so long as a seaman only does his duty, although he may throw

Seaman—continued.

into the performance of it an extraordinary amount of zeal, he cannot maintain any claim for extra remuneration; and any promise by the master to pay something additional under ordinary circumstances is void; just as in hiring cabs licensed by the commissioners of police in London, a cabman can only claim his legal fare, although the hirer may have promised a larger sum for the journey. But if the circumstances are such that the men would be justified in refusing to proceed to sea—as for instance, if the vessel were unseaworthy, or dangerously short-handed—then, in the words of Lord Campbell, the sailors would be in the condition of freemen, and free to make a new contract, and in that case they would be entitled to claim whatever extra sum the master might agree to give ("Hartley v. Ponsonby," 7 Ell. & Bl. 872).

As regards the payment of wages, the seaman is entitled, by the Merchant Seaman Act, 1880, at the time of leaving the ship, to 2*l.*, or quarter of the sum due to him, which ever is the least, and the balance must be paid by the master within two clear days (exclusive of Sunday and Bank Holidays) after the seaman leave the ship; but this provision is scarcely in practice applicable to seamen on board yachts.

As we have already stated, the Employers and Workmen Act, 1875, now applies to seamen, and gives County Courts an extended jurisdiction in proceedings between a yacht owner and a member of the crew. The Act provides also that a dispute may be heard and determined before justices, but they may exercise jurisdiction where the amount claimed exceeds 10*l.*; nor can they make an order for the payment of any sum exceeding 10*l.*, exclusive of costs; nor can they require security for more than 10*l.* from a defendant or his sureties. Should a yacht sailor find it necessary to sue for his wages, he will do either before justices in a County Court having Admiralty jurisdiction, or under the Employers and Workmen Act.

Sea Mile.—The sixtieth part of a degree; the same as a geographical mile or nautical mile. (See "Knot.")

Sea Pie.—A dish made up of all sorts in layers.

Sea Way.—Generally used in the sense of waves in an open sea, meaning a disturbed sea.

Seaworthy.—In every respect fit to go to sea. In chartering a ship it is insisted that she must be "tight, staunch and strong, and well equipped, manned with an adequate crew, provisions, &c."

Second Topsail.—A gaff topsail between the largest (the latter not being a ballooner) and the jib-headed topsail.

Seising.—A way of securing a bight of a rope by a lashing so as to form an eye, or of securing any parts of ropes together. A seising is thus passed: an eye is spliced in a piece of small cordage which is to form the seising (Fig. 258), and the seising is then passed through its eye and round the rope as

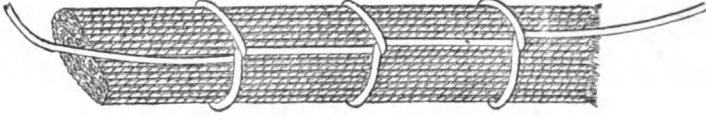

Fig. 261.

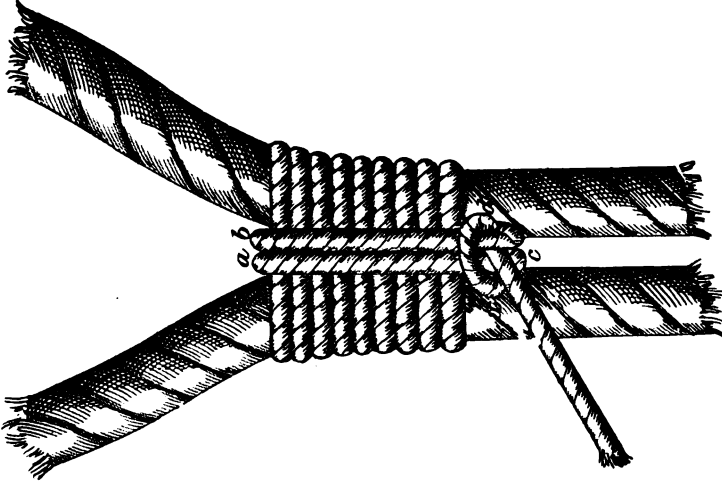

Fig. 269.

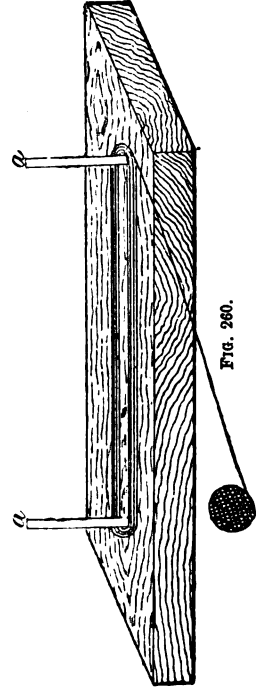

Fig. 260.

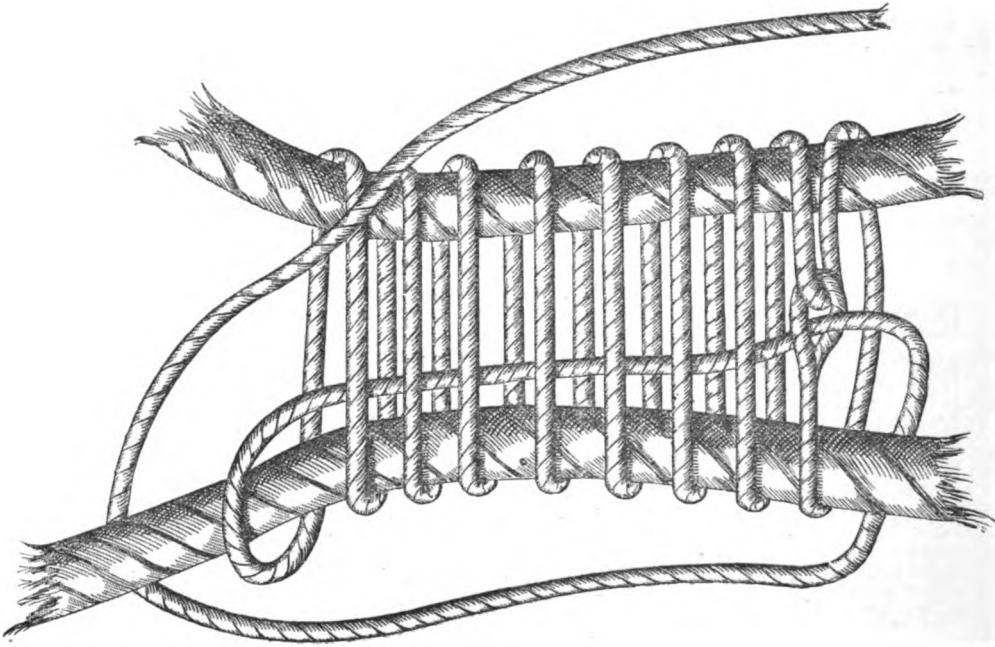

Fig. 268.

shown; the end is brought down through the turns and through the eye splice (or not, as preferred). It is then brought over at *a* (Fig. 259, which is the back view of Fig. 258), round and over again at *b*; the end is then passed under *a* at *c* (by aid of a marling spike), out at *x*, and hitched under *b* at *d* as shown. Sometimes the cross turns are not taken, but the end of the seizing made fast to a part of the large rope; in such a case riding turns are usually taken; that is, the seizing is passed twice round—once over itself.

Selvage Strop.—A strop made of spun yarn laid up in coils and marled; a board has two pegs, *a a* (Fig. 260), inserted at intervals suitable to the required length of the strop. Layers of spun yarn are put round these pegs, and when enough turns have been taken the marling is passed by single hitches as shown in Fig. 261. (See "Strop.")

Serve.—To cover a rope with spun yarn called "service."

Serving Mallet.—The mallet which riggers use to wind service round ropes and bind it up tightly together.

Set.—To hoist or make sail. This word is sometimes improperly confused with "sit" in reference to the way a sail stands.

Set Flying.—Not set on a stay or bent by a lacing; a jib in a cutter is set flying.

Set of the Tide.—Direction of the current.

Setting Up.—Purchasing up or hauling rigging taut.

Sewed or Sued.—The condition of a vessel that grounds and on the return of the tide is not floated. If the tide does not lift her by 2ft. she is said to be "sewed" 2ft. If the tide on falling does not leave her quite dry, she is said to "sew" 1ft., 2ft., 3ft., or more, as the case may be.

Shackle.—A U-shaped crook with an eye in each end, through which a screw bolt is passed. Various used, and are often preferred to hooks. (Fig. 262.) There is a shackle at every fifteen fathoms of cable, so that by unshackling it



FIG. 262.

the cable can be divided into many parts. Useful if the cable has to be slipped.

Shadow Sail.—This was a contrivance patented by Messrs. Harvey and Fryer, of Wivenhoe, in 1874, as an improvement on the spinnaker. It consisted of a gaff, goose-necked to the fore side of the masthead, and a boom to the fore side of the mast at deck. When the spars were in their places (the gaff being set up by halyards similar to the peak halyards of the mainsail), the sail was hoisted by its peak earing and throat, and hauled out by its clew to the boom end. Above the gaff a jib-headed topsail was hoisted. There were an after-brace for the gaff, an aft and a fore guy and topping

lift for the boom. The sails were nearly of the dimensions of the main sails. (See Fig. 263.) Practically it was found that there was too much gear for the sail to be got out in a

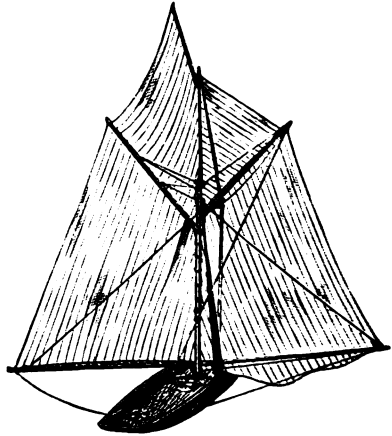

FIG. 263.

hurry, and in a strong wind the spars and gear would not have borne the strain of such large sails; and so the spinnaker remains in use. We believe Messrs. Harvey and Fryer's patent



FIG. 264.

has only been fitted to one vessel, the *Seabelle*, and she only tried it once in a match.

The plan appears to have been invented by Mr. N. M. Cummins, as that gentleman had a "shadow" fitted to his yacht *Electra* in 1869. Fig. 264 is a sketch of the *Electra* under the shadow or "cloud," as Mr. Cummins termed it.

Shake, To.—To sail a vessel so close to wind that the weather cloths of the sails shake; the head sails generally are the first to shake, and if the helmsman does not notice it someone who does sings out, "All shaking forward;" or "Near forward."

Shake Out a Reef.—To untie the reef points and unroll a reef.

Shallow Bodied.—With a very limited depth of hold.

Shape a Course.—To steer a particular course.

Sharp Bottomed or Sharp Floored.—A vessel with V-shaped sections.

Sharp Bowed.—With a very fine entrance or a bow whose two sides form a very acute angle.

Sharp Sterned.—A stern shaped something like the fore end or bow, thus <.

Sheathing.—The copper sheets put on the bottom of a vessel. 16oz. and 20oz. copper is generally used for yachts. Sometimes 20oz. copper at the load line, and 16oz. below. The sizes and weight of sheathing are usually as follows:—48in. by 20in., and more commonly for yachts 48in. by 14in. The weight per sheet of the 48in. by 20in. is 7.5lb., there being 18oz. to the square foot. The weight per sheet of the 48in. by 14in. is as under:

16oz.	4.67lb.	28oz.	11.67lb.
20 "	5.83 "	32 "	12.33 "

160 nails to a sheet, or 1cwt. nails to every 100 sheets. The allowance made for old copper is generally one-eighth less the price paid for new. That is, if the price of new copper be 80l. per ton, the price of old will be 70l. per ton. This price is subject to another deduction of 5lb. per cwt. for dross, &c. Copper is usually put on so that the edges overlap, but in the case of a few yachts the edges of the copper have been butted: that is, the edges were laid edge to edge and the nails were counter sunk and scoured down. Of course this plan entails enormous trouble, but the superior surface it presents can be considered as a compensation. Many yacht builders obtain the copper sheathing of Messrs. Neville, Druce, and Co., 13, Sherborne-lane, E.C.

Sheave.—The wheel within a block or in the sheave hole of a spar over which ropes pass.

Sheepshank.—A plan of shortening a rope by taking up a part and folding it into two loops



FIG. 265.

or bights, and then putting a half hitch of each standing part over a bight.

Sheer.—The fore-and-aft curve of a vessel's deck or bulwarks.

To sheer is to put the rudder over when a vessel is at anchor, so as to cause her to move laterally and ride clear of her anchor. A vessel is said to break her sheer when she departs from the sheer that has been given her.

Sheer Hulk.—An old vessel fitted with sheers, whereby masts are lifted into other vessels. Sometimes used in the sense that nothing but the hulk remains.

Sheer Mast.—Two masts fitted in the form of a triangle, termed sheers.

Sheer Plan or Sheer Draught.—A drawing showing a longitudinal vertical section or profile of a vessel. (See Plate III.)

Sheers.—Two spars erected in the form of a triangle (apex uppermost), to raise or lift heavy spars by.

Shelf.—A strong piece of timber running the whole length of the vessel inside the timber heads, binding the timbers together; the deck beams rest on and are fastened to the shelf.

Sheet.—A rope or chain by which the lower after corners of sails are secured.

Sheet Bends.—Fig. 266 is a single sheet bend, and Fig. 267 a double sheet bend.



FIG. 266.

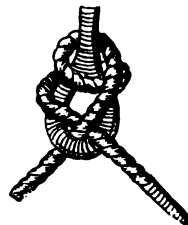

FIG. 267.

Sheet Home.—To strain or haul on a sheet until the foot of a sail is as straight or taut as it can be got. When the clew of a gaff topsail is hauled close out to the check block on the gaff. In practice, a gaff topsail sheet, however, is seldom sheeted home, as when once home no further strain could be brought on it; a few inches drift is therefore usually allowed. In square-rigged vessels a sail is said to be sheeted home when the after clews are hauled close out to the sheet blocks or sheave holes in the yard. This no doubt is the origin of the term.

Shifting Backstays.—The backstays that are only temporarily set up and shifted every time a vessel is put about or gybed. (See "Pre-venter.")

Shifting Ballast.—Ballast carried for shifting to windward to add to stiffness. A practice severely condemned in yacht racing.

Shifting her Berth.—When a vessel removes from an anchorage, &c.

Shift of Plank.—The distance one plank overlaps another.

Shift Ports, To.—To proceed from one port to another.

Shift Tacks, To.—To go from one tack to the other.

Shift the Helm.—To move the tiller from one side to the other; thus, if it is put to port, an order to shift the helm means put it to starboard.

Shift of Wind.—A change of wind.

Shin Up.—To climb up the shrouds by the hands and shins, when they are not rattled down.

Ship, To.—To put anything in position. To engage as one of the crew of a vessel. To ship a sea, to ship a crutch, to ship a seaman, &c.

Ship Shape.—Done in a proper and unimpeachable manner.

Ships' Papers.—These include builders' certificate, register (in case of not being an original owner, bill of sale as well), bill of lading, bill of health, &c. Also in the case of a yacht her Admiralty warrant.

Shiver.—To luff up and cause the sails to shiver or lift.

Shiver the Mizzen.—To luff up until the mizen lifts or shivers.

Shoe or Shod.—Iron plates rivetted to the ends of wire rigging to receive shackle bolts.

Shore.—The land. A support of wood or iron, a prop.

Short Tacks or Short Boards.—Beating or working to windward by frequent tacking.

Shorten.—The wind is said to shorten when it comes more ahead. To shorten sail, to take in sail.

Shoot.—To move through the water after the means of propulsion is withdrawn.

Shy.—The wind is said to shy when it comes from ahead or breaks a vessel off.

Side Kelsons.—Stout pieces of timber fitted fore and aft on either side of the keel.

Side Lights.—The red (port) and green (starboard) lights carried by vessels when under way. Small yachts during bad weather are not required to have their side lights fixed, but must always have them ready on deck on their proper sides ready to show. Open boats must carry lights, and if the usual side lights are not used they must have lanterns fitted with green and red slides, to show when required. Steam yachts and steam launches, in addition to the usual side lights, must carry a white light at the masthead. Steam vessels when towing must carry two white lights (vertically) at the masthead. All vessels when at anchor are required to exhibit after sundown a white light at a height not exceeding 20ft. above the hull. This light must be visible one mile, and show all round the horizon. It is usual to put this light on the forestay. Pilot vessels carry a white masthead light, and exhibit a "flare up" every fifteen minutes. Fishing vessels and open boats, when riding to nets, carry a white light and show a flare up occasionally. If drift netting, a fishing boat must carry two red lights vertically. A ship which is being overtaken by another ship must show a white light or flare up over her stern. Previous to 1847 there had been no regulation as to the carrying of lights; the custom being for ships to exhibit a light over their sides when approaching each other at night; but in 1847 the Admiralty were empowered to make regulations respecting lights, and steamers

were ordered to exhibit a white light at the masthead, a green light to starboard, and a red light to port, and vessels at anchor a bright light. And sailing ships were ordered to show, when required, a green light on the starboard side and a red to port. As between steamships and sailing vessels, the latter were required to present a light to the former where there was any danger of collision. The Admiralty Court acted upon the Admiralty Rules. The Order in Council issued in pursuance of the Act, and dated June 29, 1848, and the Act 1852, re-affirmed the former regulations as to steamers, and recommended all sailing vessels to be provided with red and green shaded lanterns, and lights to be shown on the port or starboard bow, according to the side a vessel might be approaching. Section 295 of the Merchant Shipping Act, 1854, confirmed the powers of the Admiralty to the same extent as before. The Merchant Shipping Act, 1862, did not alter the law with respect to steamers, but made it compulsory on sailing ships to keep their side lights fixed instead of displaying red or green lights by hand lamps. (See "Lights.")

Siding or Sided.—The size of a timber, &c., between its two-plane sides. (See "Moulding.")

Sight the Anchor.—To heave up the anchor.

Signal of Distress.—An ensign hoisted jack downwards.

Sit.—Sails are said to "sit" well when they do not girt, pucker, belly, or shake. This word is sometimes wrongly written "set."

Skeet.—An instrument (usually a horn on a stick) for wetting sails. In old yacht club rules skeeting to windward only was allowed, as it was thought the skeet might be used as a means of propulsion. "Fire engines" were occasionally used for skeeting, but the practice has gone out of fashion.

Skids.—Pieces of timber put under a boat's bottom for resting her on deck, or when launching off.

Skiff.—A small boat used by coast watermen for the conveyance of passengers.

Skin.—The outside or inside planking of a vessel.

Skinning.—In stowing a mainsail lifting the outside part up time after time, the bunt forming a kind of bag.

Skin Resistance.—The resistance a vessel meets with owing to the friction of the water on her plank or sheathing. (See "Resistance.")

Skipper.—A slang term for the master of a yacht or other vessel.

Skysail.—A square sail set above the royals.

Sky Scraper.—A triangular sail set above the skysail. Sometimes the sail next above the skysail is a square sail; then it is termed a moonsail, and the sail above that a star-gazer.

Sky Pilot.—A term applied by sailors to chaplains. (See "Fire Escape.")

Slab Line.—A rope used to brail up the foot of courses.

Slab Reef.—A kind of half-reef in a mainsail below the first reef, it takes up the foot or slab of the sail.

Slack.—Not taut. To slack up a rope or fall of a tackle is to ease it.

Slack Helm.—When a vessel carries very little, if any, weather helm.

Slack Tide.—The tide between the two streams when it runs neither one way nor the other. There is high-water slack, and low-water slack.

Slack in Stays.—Slow in coming head to wind, and still slower in paying off.

Slant of Wind.—A favouring wind. A wind that frees a vessel when close-hauled.

Sleep, or All Asleep.—When the sails are full and do not flap or shiver.

Sliding Keel.—(See page 173.)

Slings.—Ropes or strops used to support or sling yards, &c.

Slip.—To let go, as to slip the cable.

Sloop.—A fore-and-aft rigged vessel something like a cutter, but usually has a standing bowsprit. Small sloops have only one head sail set on a stay. (See pp. 176 and 252.)

Slot.—An aperture generally for a pin or bolt to travel in.

Smack.—A small trading vessel usually cutter rigged. A fishing cutter.

Small Helm.—Said of a vessel when she carries weather helm.

Snatch Block.—A block with an opening in the

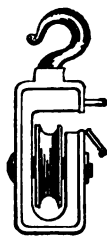

FIG. 268.

shell so that a rope can be put over the sheave without reeving it. (See Fig. 268.)

Sneak Boat.—A shallow and beamy boat in use on the Ohio and Mississippi.

Snotter.—An eye strop used to support the heel of a sprit.

Snub.—To bring a vessel up suddenly when she has way on and only a short range of cable to veer out. Sometimes necessary if the vessel must be stopped at all costs, but a practice likely to break the fluke of an anchor if it is a good and quick holder.

Snug.—Comfortably canvassed to suit the weather. Anything made neat, or stowed compactly.

So!—An order to cease, often given instead of "belay" when men are hauling on a rope.

Soldiers' Wind.—A wind so that a vessel can lie her course all through to her destination without tacking or any display of seamanship.

Soojee Moojee.—A caustic composition sold by

yacht fitters for cleaning off old paint, varnish, &c.

Sounding.—(See "Lead.")

Soundings.—To be near enough to land for the deep sea lead to find a bottom.

Spales.—Cross shores used to keep the frame of a vessel in position whilst building.

Span.—A rope made fast by either end to a spar or stay, usually for the purpose of hooking a tackle to. Spans are now commonly fitted to gaffs to hook the peak halyards to. (See page 57.)

Spanish Burton.—A purchase composed of three single blocks. A double Spanish Burton consists of one double and two single blocks.

Spanish Reef.—A knot tied in the head of a jib-headed sail to shorten the hoist or reduce the area of the sail.

Spanker.—The fore-and-aft sail set with boom and gaff on the mizen of a square-rigged ship; termed also the driver.

Span Shackle.—A bolt with a triangular shackle. The gammon iron that encircles the bowsprit at the stem. When it is directly over the stem the forestay is shackled to it.

Spars.—The masts, booms, gaffs, yards, bowsprit, &c., of a vessel.

Spars, Mensuration of.—Cubical contents of a spar can thus be found. Find the area of each end (see "Area of Circles"); add the areas of the circles together and halve the sum. Multiply the half by the length of the spar. If the spar tapers towards each end, the area of each end and the middle area should be taken, added together and divided by 3. And the plan is as follows: take the girth (see circumference "Areas of Circles") of the spar at each end and halve it. Find the square of the half, and multiply it by the length of the spar. If the spar tapers at both ends, find the girths at three places, halve and divide by 3; find the square of the quotient, and multiply it by the length of the spar. The weight of spars can be found by multiplying their solid contents by the weight in pounds of a cubic foot of the wood the spar is made of. Thus a cubic foot of red pine will weigh from 32 to 40lb., and a cubic foot of oak from 53 to 60lb. (See "Weight and Bulk of Substances.")

Speed Indicators.—The log-line, log-ship, and sand-glass have done service to test the rate of speed for more than two hundred years; but they make at the best a clumsy contrivance, and it is not surprising that many attempts have been made to supersede it. Of these perhaps Maasey's and Walker's logs are the best known, and, with certain limitations, the most reliable; but one objection to these has been that they do not show at a glance the rate of sailing, and, if anything fouls the log, the record of the distance sailed through the water is imperfect. Another disadvantage—although, it must be confessed, it is a small one—is that, before the distance run can be ascertained, the log has to be hauled in. Some eight years ago we recollect witnessing

Speed Indicators—continued.

some experiments in America with a fantail log attached to a small wire, which necessarily turned with the log. The wire was attached to some clock-like machinery on the poop, and a dial recorded the number of miles sailed. This instrument was said to have kept a true record of distances in a voyage to the West Indies and back; but, as it does not appear to have come into general use, it may be presumed that it was subject to mishaps. Reynolds's "pendent log" is similar to the American contrivance, inasmuch as it registers on board the miles run.

The speed indicators which most resemble the line and log-ship in its results are those which only show the rate of sailing per hour, and do not record the distance traversed. Of these perhaps Berthon's log, or adaptation of it, is the most in favour, and if properly adjusted, marks very accurately the speed per hour at any moment. Berthon's log consists of a tube, which passes through the keel, or any immersed part of the hull, and, as the water will rise in this tube in accordance with the speed through the water, it was not a difficult matter to adjust a speed indicator in connection with the tube. Another kind of log, on the dynamic principle, is one invented by the late Mr. Joseph Maudslay. This was a very simple contrivance, and consisted of an ordinary Salter's spring balance, a line, and small weight.

The line was 25 fathoms long, and 1 inch in circumference. The lead weight was 6 inches long, $1\frac{1}{4}$ inches in diameter, and weighed about $2\frac{1}{2}$ lb. The ends of the lead were rounded off. A hole was made through the lead from end to end, through which the line was passed and secured by a knot. With 12 fathoms of this line and lead immersed the resistance at two knots per hour was found to be 1 lb., and for other speeds the resistance increased nearly as the square of the speed; thus at two knots the resistance is 1 lb.; at ten knots, or five times greater speed, the resistance is 25 lb., as $5 \times 5 = 25$. We some years ago tested this log with Berthon's, and on different occasions on the measured mile, and found the speed pretty accurately indicated so long as the water was smooth; but when it came to rough water, the lead jumped about so that it was impossible to arrive at the exact speed.

The lead weight can be dispensed with; without it the line will not jump out of the water, and so a constant or steady pull can be obtained. We tried an experiment by towing a rope astern of a steam launch, and found the resistance at various speeds as set forth in the middle column. The rope forming the "log" was 13 fathoms long, the whole of which was permanently immersed. The rope was four stranded, "water-laid," and one inch and a quarter ($1\frac{1}{4}$ inch) in circumference. A smaller line was spliced to the other as a tow line, as much of this being payed out as was sufficient to keep the larger rope immersed, or to prevent any part of the thirteen fathoms

Speed Indicators—continued.

being towed out of water. At the splice, and on the larger piece of rope, was a piece of lead pipe about a foot long (with an inside diameter equal to the diameter of the rope). This served the double purpose of showing at a glance if the whole of the larger rope was not immersed, and helped to maintain the immersion. The after end of the larger rope should be whipped. The log patented by Mr. Clark Russell is similar to this arrangement.

On the face of the spring balance the numbers of the knots should be engraved opposite the resistance in pounds as set forth in the table.

In all cases speed indicators or logs only show the speed through the water; and to calculate the distance made to the good over the ground the tide must be eliminated.

Knots.	Resistance of Pro-posed Log in lbs.	Resistance of Maudslay's Log in lbs.
2	1 $\frac{1}{2}$	1
3	2 $\frac{1}{4}$	2 $\frac{1}{2}$
4	4 $\frac{1}{4}$	4
5	7 $\frac{1}{4}$	6 $\frac{1}{2}$
6	11	9
7	15	12 $\frac{1}{2}$
8	19 $\frac{1}{4}$	16-2oz.
9	24 $\frac{1}{4}$	20 $\frac{1}{2}$
10	30 $\frac{1}{4}$	25
11	37	30 $\frac{1}{2}$
12	44	36
13	51 $\frac{1}{4}$	42 $\frac{1}{2}$
14	60	49
15	69	56 $\frac{1}{2}$

Speed of Yachts.—No doubt very exaggerated opinions prevail as to the speed an English yacht is capable of. Very frequently there is a mistake made about the distance sailed in a certain time; no allowance has been made for tide, or the speed has been inaccurately judged. So far as our experience goes, the following table gives the extreme speed sailing yachts of certain length and tonnage have attained:

Length.	Equivalent Tonnage.	Knots per hour.	Time per mile.
ft.			Min. sec.
9	0 $\frac{1}{2}$	3-75	16 0
16	1 $\frac{1}{4}$	5-00	12 0
25	4 $\frac{1}{4}$	6-25	9 36
36	6	7-50	8 0
41	10	8-	7 30
49	20	8-75	6 51
64	40	10-	6 0
81	100	11-25	5 20
100	190	12-50	4 48
121	320	13-75	4 21
144	400	15-00	4 0

These observed speeds correspond with the theory that speed varies as the square roots of the length on load water-line. But there are some apparently well-authenticated reports that yachts of 121 ft. on the load-line have reached a speed of 16 knots per hour. The American yacht, Sappho, is said to have made such a speed; and as doubts have at various times been thrown upon the state-

Speed of Yachts—continued.

ment, it will be well to re-publish the following extract from her log, taken whilst crossing the Atlantic in 1869. The *Sappho* left Sandy Hook Lightship 7 a.m. July 28, and arrived Queenstown Harbour 9 p.m. Aug. 9, Queenstown time, making the run in 12 days 9 hours 36 min. (two hours less to the Old Head of Kinsale).

It will be seen that the strong wind was on the quarter the whole way, and as the sea was exceptionally smooth, more favourable conditions for attaining high speed could not have been had. As a rule, with a strong wind, there is a great deal of sea, and this, of course, is an unfavourable condition for the attainment of high speeds.

Spell.—The term of work allotted to any of the men in a watch. Thus there is the spell at the helm termed "trick;" spell at the mast-head to look out, &c. When a man's time comes to be relieved and the one who has to take his place lags, the former sings out "Spell O!" (See "Trick.")

Spencer.—A fore-and-aft sail set with gaffs in square-rigged ships, as trysails on the fore and main mast.

Spider Hoop or Spider Band.—An iron band encircling the mast with iron belaying pins in it.

Spiling.—Marking on a bar of wood the distances that a curved line (say that of a frame) is from a straight line.

	LAT. N.			LONG. W.			MILES.	COURSE.	WIND.	REMARKS.	
	D.	M.	S.	D.	M.	S.					
July 28	40	29	32	73	21	00	27	E. † S.	S.W.	Fine breeze.	
" 29	40	32	38	67	27	0	279	E. † S.	S.	{ Fresh breeze, making 9 to 14 knots thick fog; ran 47 miles in 3 hours.	
" 30	41	23	38	61	32	0	273	E. † S.	S. by W.	{ Making 16 knots, wind died out to calm, foggy.	
" 31	43	32	00	56	55	0	229	E.	W.S.W.	{ Light breeze and fog; got a glimpse of sun for latitude.	
Aug. 1	44	41	39	54	26	15	112	E. by S. † S.	W.N.W.	{ Light breeze; dense fog 8 p.m., nearly calm.	
" 2	45	20	23	51	25	15	134	E. by S.	W. by S.	{ Nearly calm, only going 1 knot sometimes; dense fog.	
" 3	46	25	17	47	10	15	192	E. by S.	W.S.W.	{ Dense fog; moderate breeze; fog lifted 6 p.m.	
" 4	47	36	49	41	52	45	238	E. by S.	S.	Fine breeze, clear weather.	
" 5	49	31	18	35	21	15	315*	E. by S.	S.S.W.	Fresh breeze; very smooth, sea like a lake.	
" 6	50	53	56	29	33	15	244	E.S.E.	S.W.	Fog and rain; moderate breeze.	
" 7	50	56	49	24	14	30	192	S.E. by E.	W.S.W.	Fresh breeze, with swell.	
" 8	51	07	30	17	06	00	271	S.E. by E. † E.	N.W. by N.	Fine breeze.	
" 9	50	42	25	10	12	15	255	S.E. by E. † E.	N.W. by N.	{ Overcast; fresh breeze, increasing to fresh gale; sighted land 4.15 p.m.	
							96	E. by N. † N.	N. by E.		
	Total miles						2857				

* The run of 315 miles on Aug. 5 was an average of 13.1 knots an hour.

It is equally well authenticated that the American yacht *Meteor* (which was lost in the Mediterranean in 1869), in a passage from Cowes to Lisbon, logged 319 miles in 24 hours, with a strong quarterly double-reef wind. During some portion of the 24 hours the *Meteor* logged 16 knots. The *Cambria*, in the Atlantic yacht race 1870 only attained a speed of 11½ knots, but there was a heavy quarter sea whenever she had a strong fair wind. The greatest sustained speed that we have ever been witnesses to in a match was in a race between the *Livonia* (106ft.) and *Columbia* (98ft.) in America. The *Livonia* did the distance between the S.W. Spit buoy and Sandy Hook Lightship, 8½ nautical miles, in 40 minutes, or at the rate of 13 knots an hour; and no doubt that some part of the time she was going 13½ knots. The tide was not strong, and abeam. We do not think this speed has been much exceeded by English yachts, but Mr. Thellusson states that the *Guinevere* has logged 14 knots. It is recorded that the American clipper ship *Sovereign of the Seas* in 1852 averaged 300 miles a day for eleven consecutive days, and 333 miles for four consecutive days. Her greatest distance any day, noon to noon, was 362 miles. Every one will agree that this was most extraordinary sailing. (See "Time Allowance by Length.")

Spinnaker.—A jib-headed sail reaching from the topmast head to the deck, first introduced in yacht racing in 1865 by Mr. William Gordon in the *Niobe*, and hence for some time termed a "Niobe." The term "spinnaker" appears to have been applied to it as a kind of nickname, without "rhyme or reason." In 1866 Mr. Herbert Maudslay had a similar sail made for his yacht *Sphinx*, and it was first used in a match of the Royal Victoria Yacht Club at Hyde. The men called the yacht "Spinks," and hence it is said that the sail became known as a spinker, the spinniker, or, as now written, "spinnaker." Mr. MacMullen in his "Down Channel" says that he had a similar sail in 1852.

Spindle Model.—A name given to a cylindrical model tapering at the ends.

Spirkettling.—Timber worked inside a vessel under the shelf in a fore-and-aft direction.

Spitfire.—The smallest storm jib.

Splice.—To join the ends of rope together by interweaving the untwisted strands. An eye splice is formed by interweaving the untwisted end of a rope in the lay of the strands.

Split Lug.—A lugsail in two parts (Fig. 269); the fore part is sheeted like a foresail, and in going about the tack is never cast off, nor is the tack of the after part of the sail. The up

and down lines on the sail show where it is divided and where the mast comes. To heave to, the clew (after oringle) of the fore part of the lug would be hauled up to the mast or to windward of it, easing the main-sheet as required. The split lug is not in much favour. The standing lug (or even balance lug) and foresail rig has all the advantages of the split lug without so much

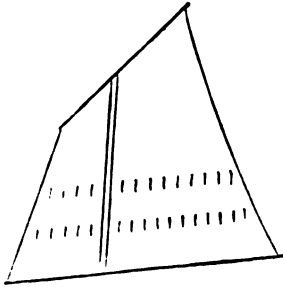

FIG. 269.

yard forward of the mast and without the disadvantage of not being able to lower the fore part or foresail. The most that can be said in favour of the split lug is that it points out the advantages of a main and foresail in preference to one sail.

Spoken.—Said when one ship has spoken to another by signal.

Spokes.—The bars of the wheel of a ship radiating from the boss. "To give her a spoke" is to move the wheel to the extent of the distance between spoke and spoke.

Sponson.—The platform ahead and abaft paddle wheels, usually outside the bulwarks, but sometimes inclosed.

Spoon Drift.—Spray blown from the crests of waves.

Spring.—A warp or hawser or rope.

Spring a Mast.—To crack or splinter a mast.

Spring her Luff.—To ease the weather tiller lines so that a vessel will luff to a free puff.

Sprit Sail.—A four-sided sail stretched by a pole termed a sprit (Fig. 270). This is a time-honoured contrivance for setting a sail that has no boom, but a gaff is preferred if the sail has a boom. (See page 216.)

Strung.—Damaged by cracking or splintering. (See "Spring a Mast.")

Spun Yarn.—Small rope or cord used for serving, &c.

Square.—Said of sails when they are trimmed at right angles to the keel. A ship is said to have square yards when there is little difference between the lengths of upper and lower, or when her yards are very long.

Square the Yards.—To brace them across at right angles to the keel. Square the boom

is to haul it out at right angles to the keel.

Squeeze.—A vessel is said to be squeezed when she is sailed very close to the wind in order that she may weather some point or object.

Stains on Deck.—Iron moulds, &c., can be removed from a deck by a solution of one part muriatic acid, three parts water.

Stand.—A term variously employed; as to stand on the shore, to stand E.S.E., and so on, to stand on without tacking. A sail is said to stand when it does not lift or shake.

Standard.—(See "Royal Standard.")

Stand By.—The order to make ready; as "Stand by to lower the topsail."

Standing Part.—The part permanently made fast to something, and not hauled upon.

Standing Rigging.—The rigging that is kept permanently in its place. (See pages 39 and 42.)

Stand Up.—A vessel is said to stand up well that carries her canvas without heeling much.

Starboard.—The right hand side. The opposite to port.

Starbolins.—The men and "Watches" who compose the starboard watch. (See "Larbolins.")

Start, To.—To move, as to slacken a sheet or tack. To start a butt is to cause a plank to shift at its butt or end.

Started neither Tack nor Sheet.—Said when a vessel sails a long course without a shift of wind, so that there is no occasion for her to alter the trim of her sails.

Starved of Wind.—When a vessel is sailed so near the wind that she does not have enough of it, or feel the weight of it.

Stay, To.—To tack.

Stay Rope.—The luff or weather bolt rope of a jib or other sail.

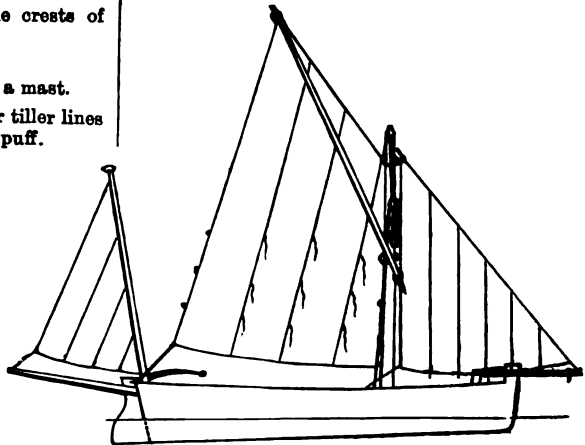

FIG. 270.

Stays.—Ropes for supporting masts and other spars. A vessel is said to be in stays when she is going through the operation of tacking. To stay is to tack. (See "Missing Stays.")

Steady!—An order to put the helm amidships, or not to move it about.

Steerage.—In a yacht the space between the after athwartship bulkhead of the main cabin and the athwartship bulkhead of the after cabin. (The latter is generally known as the ladies' cabin.) Usually the term steerage is limited to the fore and aft passage and berths therein.

Steerage Way.—When a vessel moves through the water so that she can be steered. In simply drifting or moving with the tide a vessel has no steerage way on, and cannot be steered; therefore steerage way means that a vessel relatively to the water moves ahead and passes the water.

Steersman.—A helmsman.

Steeve.—The upward inclination or rake which a bowsprit has, or which the plank sheer has forward. The running bowsprit has usually a steeve corresponding with the sheer forward; a standing bowsprit has generally considerably more.

Stem.—The timber at the fore end of a vessel into which the ends of the plank are butted. To stem is to make headway, as against a current.

Stemson.—A piece of timber worked inside the stem.

Step.—A piece of timber or metal to receive a vessel's mast, &c. To step is to put a thing into its step.

Stern-board.—The name given to the three-cornered board aft in an open boat. (See "Stern Sheets.")

Stern Board.—A movement of a vessel sternwards.

Stern Way.—Moving astern: to make a stern-board.

Stern Post.—The strong timber to which the rudder is hung.

Stern Sheets.—The seat in the aft end of a boat. Sometimes the three-cornered bottom board is termed the stern sheet. This board in a yacht's gig is usually a wood grating. In small fishing boats the stern sheet is the platform on which the fisherman coils away his nets, lines, &c.

Stiff.—Not easily heeled; having great stability.

Stock of an Anchor.—The crossbar near the shackle.

Stocks.—The framework upon which a vessel rests whilst she is being built.

Stopper.—A rope or lashing used to prevent a rope or chain surging or slipping, as cable stopper, rigging stoppers, &c. The latter is usually a short piece of rope put on as a kind of racking to prevent the rigging or its tackles rendering. A stopper is sometimes put on with a hitch, as shown by Fig. 276. (See "Racking.")

Stops.—Yarns or short pieces of rope by which sails are secured when rolled up or stowed. Also the short lines by which sails are tied to yards when they are not laced.

Storm Sails.—The storm trysail and storm jib set in bad weather.

Stove in.—Broken in.

Stow.—To roll up. To pack away.

Straight of Breadth.—The distance where the breadth of a ship is equal amidships; now generally termed parallel length of middle body, because the two sides of a ship may be for some distance parallel to each other. A straight of breadth is seldom found in a yacht excepting in some long steam yachts; these frequently are of the same breadth for some distance amidships. (See "Body" and "Dead Flat.")

Strake or Streak.—A breadth of plank.

Strand.—Yarns twisted together and they then make the parts or strands of a rope.

Stranded.—Said of a rope when one or more of its strands have burst. Cast ashore.

Strands.—Yarns when unlaidd and used as "stops" are sometimes called strands.

Strop.—(See "Strop.")

Stream.—The direction of the flood tide and ebb tide. The tides in the Channel are usually referred to as the eastern stream for the flood and western stream for the ebb.

Stretch.—A course sailed. Also the elasticity of canvas or rope.

Strike.—To lower, as to strike the topmast, &c. Also to strike the bottom, &c.

Striking Topsails.—(See "Saluting.")

Stringers.—Strengthening strakes of plank or iron inside a vessel's frame.

Strop or Strap.—A sort of hoop made of rope yarn, wire, or iron, used to put round spars, rigging, &c., to hook tackles to.

Fig. 271 shows a salvagee strop. (See also "Salvagee.")

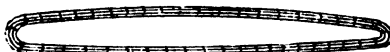

FIG. 271.

A salvagee strop is put on to a rope to hook a block or tackle to, as shown in Fig. 272, the whole of the strop being used up in the cross turns.

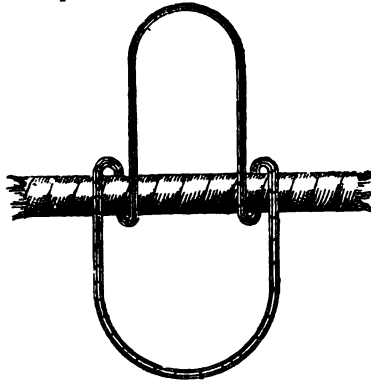

FIG. 272.

Another way of putting a strop on a Fig. 272, block is shown in Fig. 273. The bights

are passed through and through, round the rope until used up; the tackle is then hooked to the bights as in Fig. 272. A strop is usually put on a wire rope in this way, as it is less likely to slip.

Studding Sails.—Sails set outside the courses, topsail, &c., in square-rigged ships; called by sailors "stu'n's'la."

Stuff.—Slang for sails, as, "Give her the stuff," meaning more sail. Also small rope, and picked hemp or cotton waste.

Surge.—When a rope renders round a belaying pin, &c.

Swansea Pilot Boats.—A very snugly rigged kind of schooner met with in the Bristol channel. The rig comprises mainmast, foremast, and running bowsprit; the mainmast is stepped exactly in the middle of the boat, and has a great rake aft, so that the head of the

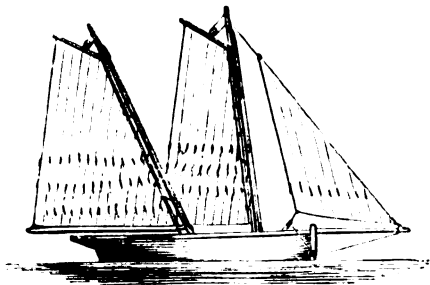

FIG. 274.

mast plumbs over the after part of the cockpit, two sheaves are cut in it, through which the halyards are rove. The foremast is upright, with sheaves like the mainmast, and a block on the fore part under the sheave holes for the jib halyards. These masts require no rigging or stays, and are pole masts without any topmasts. The gaffs are short, being for a boat of 25 to 30 tons only about 6ft. long, and only require one halyard. One end of the halyard is spliced to a single block; the other end being passed over the first sheave in the mast, then through a single block, which is hooked on to the gaff, and finally through the upper sheave in the mast. This end is belayed. A purchase is formed by a rope passed through the block on the halyard and through a block on deck. The fore halyards are rigged the same way, and the jib halyards are of the ordinary kind. The sails consist of mainsail, foresail, and jib; the two former being laced round the mast. These sails can be taken in in about one minute and a half, and set in about two and a half. The outhaul of the jib is passed under a sheave on the stem, and acts as a bobstay; there are no shrouds to bowsprit. The advantages of this rig are said to be that one man can handle a boat of 25 tons himself, and the boats are equally as handy with the foresail as without it, likewise the mainsail. They will stay or do anything

either way, and with only the foresail and jib a boat can be sailed on a wind.

Swell.—Long waves with unbroken crests, usually met with after heavy winds have subsided.

Sweep.—A long bend. To sweep is to impel by sweeps or large oars; formerly, vessels as large as 300 tons used sweeps, and by hard work could make three knots an hour. Sweeps are not permitted in yacht racing.

Sweeps.—Large oars.

Swig, To.—The fall of a tackle is put under a cleat or pin, and is held firmly by one or more of the crew; another man (or men) then takes hold of the part of the fall between the cleat and the block and throws his whole weight on it; as he comes up the other hand takes in the slack. By swigging on a tackle a couple of hands can often get in all that is required, where by steady hauling they might not have moved the blocks an inch.—To drink.

Swimming.—If a person who cannot swim falls overboard, he should turn his face towards the sky, and press his chest forward; he cannot then sink. He should keep the legs down as much as possible. He should keep composed, and strike out slowly with the hands. A person could soon learn to swim by walking into the water breast high, and then striking out, holding the face well up towards the sky.

Swivel Hook.—A hook that revolves by a pivot inserted in a socket and clinched.

T.

Tabernacle.—A strong trunk used in barges to step the mast in on deck so that the mast can be lowered for going under bridges. It is in fact a lengthening of the mast, the trunk being the housed part with a hinge or joint on deck. In small boats that have no deck the mast is generally stepped at the bottom of the tabernacle, and not on the top. (See pages 210, 390, 437, &c.)

Tabling.—The strengthening pieces of canvas sewn to the edges of sails where the roping goes on.

Tack.—The lower fore-corner of a sail. To tack is to go about or shift from one tack to another. The side on which the wind blows on the sails, as starboard tack or port tack. This term probably originated with the square rig, as "port tacks" aboard means that the lower port corners of the sail are now hauled in-board, whereas when the wind was on the other side these corners had been hauled out-board by the sheets.

Tackle.—An arrangement of ropes and pulleys for increasing power; a purchase. (Pronounced "tay-kle" by sailors.)

Tackle-fall.—The hauling part of the rope of a tackle.

Tack Tackles.—The tackles employed to set down the tacks of sails.

Taffrail.—The continuation of the top rail round the aft side of the counter.

Tail Block.—A block with a tail or piece of rope stropped to it for making fast the block instead of a hook.

A tail block is put on to a rope by a rolling hitch, as shown in Fig. 275. The hitches are jammed up close together. The end of the tail can be seized back to the rope if required.

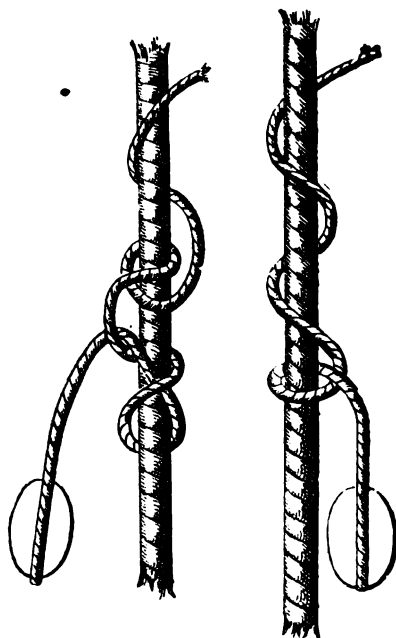

FIG. 275.

FIG. 276.

Often when in a hurry only one hitch is taken (Fig. 276), the tail being gripped round the rope with the hand. A tail tackle is put on to a rope in the same manner as a tail block.

Tail on.—An order to take hold of a rope and help haul.

Tail Tackle.—A watch tackle; that is, a double and single block. The single block has a hook; the double block a rope tail, which can be hitched to ropes or parts of rigging, &c.

Take In or Take Off.—To hand or furl a sail.

Take, To.—A jib is said to take when a vessel has been head to wind and the jib fills on one side or the other.

Take Up.—To shrink; to tighten up.

Tanning a Sail.—No tanning will entirely prevent mildew, if the canvas is left unopened and unaired an unlimited time. For a 20ft. boat boil in a furnace of 15 gallons 28lb. of catechu, until thoroughly dissolved; put in such sails as convenient, and let them soak a night; then spread and mop them over both sides with the mixture. If required very dark indeed, double the amount of catechu. Sails too large for a furnace or vat are mopped only on a floor of asphalt, or cement with the mixture. Sails are sometimes "tanned" in a tan yard.

Taunt.—Tall, high, towering. (See "A-taunto.")

Taut.—Tight: stretched as tightly as possible.

Taut Bowline.—A ship is said to be on a taut bowline when the bowlines on the leeches of the sail are hauled as taut as possible for sailing near the wind. With everything stretched as flat as possible for close-hauled sailing.

Tend.—To attend to a sheet and watch it to see if it requires hauling in or slacking out; generally to attend to any work on board ship.

Tenon.—A sort of tongue cut at the end of a piece of timber to fit into a mortise.

Thick Stuff.—Timber above 4in. thick.

Thimble.—A ring, pear shaped or circular, with a groove outside for ropes to fit in. When the thimble is pear-shaped it is usually termed a "heart thimble or thimble heart." These thimbles are used for the eye splices in ropes, whilst circular thimbles are mostly used for the cringles of sails, &c.

Thimble Eyes.—Eyes spliced in rigging round a thimble. A thimble seized in a strop.

Tholes.—Pins fitted into the holes in rowlocks for oars to work in.

Thread.—A vessel is said to thread her way when she weaves in and out among other vessels, or through a narrow channel.

Throat.—The deepest part of the hollow of the jaws of a gaff, or the hollow of a V shaped knee, or the hollow of a floor. The throat halyards are those which are attached to the throat of a gaff. The upper weather corner of a gaff-sail is often called the throat, because it is attached to the throat of the gaff.

Through Bolt, or Through Fastening.—A bolt that passes through timber and plank.

Thumb Cleat.—Pieces of wood put on spars, &c., to prevent ropes or strops from slipping.

Thwarts.—The transverse seats in a boat. (See "Athwartships.")

Tidal Harbour.—A harbour that can only be entered on certain stages of the tide.

Tides.—Usually the rise and fall or flow and ebb of the sea around the coast. The highest tides occur at the new moon and full moon. Tides in estuaries, harbours, and bays vary a great deal.

Tight.—Impervious to water; well caulked; not leaky. Never applied to the tension of ropes, &c., which are always "taut." (See "Taut.")

Tiller.—The piece of timber inserted in the rudder head for steering; usually termed the helm.

Tiller Lines.—The lines attached to the tiller to move it by. Generally in yachts of 40 tons and over, a tackle is used. In large yachts a second tackle is sometimes used, if the yacht carries much weather helm or is hard to steer: these second tackles are usually termed relieving tackles.

Tiller Ropes.—The ropes attached to the short tiller when a wheel is used for steering. The

ropes pass round the drum on the same axis as the wheel. In large vessels the tiller ropes are frequently made of raw hide.

Timber-heads.—The heads or upper ends of the frames.

Timber Hitch.—A quick way of bending a rope to a spar. A loop or bight is formed by twisting the end of a rope round its standing part, thus :



FIG. 277.

The end of the rope is shown on the right, and the standing part passing through the bight on the left.

Timbers.—The frames or ribs of a vessel.

Time Allowance.—In small boat sailing, an allowance of 1sec. per inch for every excess inch of length for every mile sailed, is a good allowance. Where length and breadth are multiplied together, 1sec. per square foot for every mile makes a good allowance. Where length and breadth are added together, the allowance might be 1½ second per inch per mile. These allowances are only adapted for boats that do not differ much in length. Where the difference in length much exceeds a foot, the boats should be classed as a 20ft. class, 25ft. class, &c., unless the graduated table of allowance for length given on page 564 be used.—The allowance made by one yacht to another in competitive sailing, proportional to the size of the yachts and the distance sailed. The Y.R.A. Scale founded on that of the Royal Alfred Club, which in turn was adapted from a scale prepared for the Royal Yacht Squadron, is the one in use in match sailing.

The principles assumed in computing the Y.R.A. time tables are that the allowance of time given by a larger to a smaller vessel should be *directly* proportional to the distance sailed, and *inversely* proportional to the size of the vessels; that is to say,

If a larger can allow a smaller vessel one minute on a particular length of course, she can allow her two minutes on a course of twice the length.

And with respect to the element of size, the assumption is that if a vessel, of say 50 tons, can allow a smaller one any given time per ton of difference, a vessel of twice the size, or 100 tons, can only allow half the time, or the same for two tons that the vessel of 50 tons allows for one ton.

The allowance of time for each ton will consequently be obtained from the relation $t = \frac{k l}{T}$ where t is the allowance of time per ton in seconds, k a number, whose value in the table is taken as 30, on the supposition that a vessel of 30 tons can allow one of 29 tons one second per mile, l the length of the course in miles, and T the tonnage of the vessel.

For a course of 50 miles the formula therefore is $t = \frac{30 \times 50}{T}$

The Y.R.A. time scales have been com-

Time Allowance—continued.

puted for courses of 50, 10, and 8 nautical miles. For 50 miles, the time per ton is $\frac{30 \times 50}{31} = 49$ seconds, and between 31 tons and 32 tons $\frac{30 \times 50}{32} = 47$ seconds, which, added together, is equal to 96 seconds, the time 32 tons allows 30 tons. The formula only gives the time per ton between any two vessels which are of one ton difference for fifty miles; the time allowed between any two, say between a yacht of 40 tons and 30 tons, is the sum of the time the intermediate yachts would allow each other in regular succession, or $(\frac{30 \times 50}{31}) + (\frac{30 \times 50}{32}) + (\frac{30 \times 50}{33}) + (\frac{30 \times 50}{34}) + (\frac{30 \times 50}{35})$, and so on.

[The New Thames Yacht Club scale was calculated on the assumption that on a fifty miles course a yacht should receive fifteen minutes from one of double tonnage, and so the allowance per ton is always the ratio 1 : 2 where the tonnage is in that ratio, and the allowance per ton for other tonnages is in proportion.]

The Y.R.A. scale for ten miles is given on the next page.

To use the table, take the times placed opposite to the tonnages of any two vessels; the difference between these times will be the time the larger vessel is to allow the smaller one over a course of ten miles.

If the course be twenty miles, the time allowance would be double; if thirty miles, treble, and so on.

If the course be an odd number of miles, like twenty-seven, the time can be found between any two yachts by a simple proportion sum.

Thus, it can be assumed that one yacht is 78 tons, and the other 42 tons. The time opposite these tonnages are

	m. s.
78 tons	13 17
42 tons	10 13
Allowance for ten miles	3 4
Multiply by	27 miles.
Divide by 10 miles.....	10)82 48
	8 16·8

That is, if the time between the two yachts were 3 min. 4 secs. for ten miles, it would be 8 min. 16 secs. (or taking in the fraction '8 it would be more correctly 8 min. 17 sec.) for twenty-seven miles.

When time has to be allowed on tons and tenths of a ton, it is computed as follows according to the Y.R.A. rule: Multiply the tons and fractions by 10, and apply the tables of time allowance to the tons so found: thus, say the tonnage of one yacht is 5·24 tons, and that of another 4·64 tons—5·24 × 10 = 52·4, and 4·64 × 10 = 46·4. As a fraction counts as a ton, the tonnage of these two yachts would be taken as 53 tons and 47 tons respectively. The time set down for 53 tons in the 10 miles table is 11min. 22sec., and for 47 tons 10min. 46sec.; the difference is 36sec., which would be the time between these two over a ten miles course.

TIME FOR A COURSE OF TEN NAUTICAL MILES.

Table with 4 columns: Ton., Min., Sec., Ton., Min., Sec. showing sailing times for vessels from 5 to 93 tons.

TIME FOR TEN MILES—continued.

Table with 4 columns: Ton., Min., Sec., Ton., Min., Sec. showing sailing times for vessels from 272 to 314 tons.

NOTE.—By the rule passed in 1882 time in the classes of 10 tons and under has in all cases to be calculated by tons and tenths of a ton; but, of course, if a 10-tonner were sailing against yachts above 10 tons this would not apply.

The Thames Sailing Club, to meet the conditions of up-river sailing, makes the allowance per mile five seconds instead of one second between any two vessels, one of which is one-thirtieth smaller than the other, and further applies the rule to Statute instead of to Nautical miles.

The table is constructed by separately calculating the allowance which each size of boat should give to the size immediately below it, the steps being by tons and tenths of tons.

For the purpose of the Thames Sailing Club Table, l was left out of the formula, being 1 (the table applies to one mile only), and the result was multiplied by 5; the formula will then be t = (30 / T) x 5, where T is the tonnage in tenths of tons.

As an example, a boat of 2 tons (20-tenths) allows a boat of 1.9 tons (19-tenths) 7.5 seconds per mile, because

t = (30 / T) x 5 = (30 / 20) x 5 = 7.5

—as appears by the Table.

TABLE SHOWING, IN SECONDS, THE ALLOWANCE PER STATUTE MILE OF THE COURSE, TO BE MADE BY BOATS OF ALL SIZES UP TO 5 TONS, TO A BOAT MEASURING HALF-A-TON.

Tonnage.	Allowance per Statute Mile of the course, to a boat measuring 5-10ths of a ton.	Seconds.	Tonnage.	Allowance per Statute Mile of the course, to a boat measuring 5-10ths of a ton.	Seconds.
.5	0	246.6	2.8	0	246.6
.6	25	251.7	2.9	25	251.7
.7	46.4	256.7	3	46.4	256.7
.8	65.2	261.6	3.1	65.2	261.6
.9	81.8	266.3	3.2	81.8	266.3
1	96.8	270.8	3.3	96.8	270.8
1.1	110.5	275.2	3.4	110.5	275.2
1.2	123	279.5	3.5	123	279.5
1.3	134.5	283.7	3.6	134.5	283.7
1.4	145.2	287.7	3.7	145.2	287.7
1.5	155.2	291.7	3.8	155.2	291.7
1.6	164.6	295.5	3.9	164.6	295.5
1.7	173.4	299.3	4	173.4	299.3
1.8	181.8	302.9	4.1	181.8	302.9
1.9	189.7	306.5	4.2	189.7	306.5
2	197.2	310	4.3	197.2	310
2.1	204.3	313.4	4.4	204.3	313.4
2.2	211.1	316.7	4.5	211.1	316.7
2.3	217.6	320	4.6	217.6	320
2.4	223.9	323.2	4.7	223.9	323.2
2.5	229.9	326.3	4.8	229.9	326.3
2.6	235.7	329.4	4.9	235.7	329.4
2.7	241.2	332.4	5	241.2	332.4

The allowance to be made by any boat to a smaller boat, per statute mile of the course, is ascertained by deducting the allowance given in the above table opposite to the tonnage of the smaller boat, from that placed opposite to the tonnage of the larger boat. The remainder is the required allowance.

TIME ALLOWANCE BY LENGTH.

Rating yachts by length, in competitive sailing, has been practised since the early days of yacht racing, so far at least as small yachts are concerned; but the practice has not become general, for the principal reason that one yacht, say of 40ft. length, owing to greater beam, might be capable of carrying a larger quantity of sail than another yacht of 40ft. length, and so have greater speed. If sails were not the means of propulsion this would be of little consequence, as, length for length, vessels of varied proportions of beam might, if well modelled, be of equal speed; and the speed of vessels of different lengths will be found to vary nearly as the square roots of their lengths, unless there be some extraordinary variance in their general form. It is not, therefore, surprising to find that the roots of the linear dimensions of yachts have been many times suggested as a proper basis for a time allowance; and, indeed, the Boston Yacht (U.S.) Club, some twelve years ago, had a time scale founded on the assumption that the greatest speed of a yacht is equal to $2\frac{1}{2}$ times the cube root of her length;

thus $2\frac{1}{2} \left(\frac{S}{\sqrt[3]{L}} \right) = \left(\frac{S \times 0.4}{\sqrt[3]{L}} \right)$ where S is the number (3600) of seconds in an hour, and L the length on the load water-line. 3600 seconds multiplied by .4 yield 1440 seconds, and so the formula can be simplified to $\left(\frac{1440}{\sqrt[3]{L}} \right)$ and

Time Allowance—continued.

the time per mile allowed by one yacht to some other would be expressed in seconds—

$$\left(\frac{1440}{\sqrt[3]{L}} \right) \text{ minus } \left(\frac{1400}{\sqrt[3]{L_2}} \right) \text{ (} L_2 \text{ of course means}$$

some other yacht): or, say the length of one yacht is 27ft., and that of the other 64ft. The cube root of 27 is 3, and the cube root of 64 is 4; the time per mile between these two would be $\left(\frac{1440}{3} \right) - \left(\frac{1440}{4} \right) = 120 \text{secs.}$

The allowance would be 72 seconds per mile under the Y.R.A. time scale between yachts of the lengths given. And it would be difficult to say which would be the fairer allowance, taking into consideration the very different circumstances under which matches are sailed.

But the speed of yachts varies more nearly as the square roots of their length than as the cube roots, other things being equal. On this assumption, and, in order that a properly graduated scale should be available instead of the clumsy contrivance of "so much a foot," we have computed a scale for yachts of all lengths from 9ft. to 200ft.

A common practice for allowing time over courses of any given distance is to make the allowance 1 min. per foot. This works very well so long as the boats are arranged in classes of say from 20ft. to 22ft., 22ft. to 25ft., and so on; but the rule would be misleading if there was as much difference of say 5ft. in the length of the boats.

So far as our experience goes, the speed of yachts of different sizes accords with those set out in the table below; and these speeds also agree with the assumption that the speed varies as the square root of the length.

Length.	Equivalent Tonnage.	Knots per hour.	Time per mile.
ft.			Min. sec.
9	0.1	3.75	16 0
16	1.4	5.00	12 0
25	4.1	6.25	9 36
36	6	7.50	8 0
41	10	8	7 30
49	20	8.75	6 51
64	40	10	6 0
81	100	11.25	5 20
100	190	12.50	4 48
121	320	13.75	4 21
144	400	15.00	4 0

Thus, in the table it has been assumed that a yacht 64ft. long can sail one mile in six minutes; and that the time of other yachts per mile will vary as the square root of their respective lengths. Therefore, on this assumption, a yacht 9ft. long will sail a mile in sixteen minutes (or 960 seconds), and the time between a yacht 9ft. long and any other larger yacht will, therefore be found by the equation

$$960 - \left(\frac{960 \times \sqrt{9}}{\sqrt{L}} \right)$$

The letter L in the equation is, of course, some other yacht.

This formula assumes that the full speed of the yachts would be maintained; but in yacht racing we know that full speed is seldom kept up; and practice teaches us

Time Allowance—continued.

that an allowance based on the assumption that full speed would be maintained from start to finish, would be nearly always double what the larger yacht is capable of giving the smaller. Consequently, in the table which follows, only half the full-speed allowance has been given.

The table has been computed for a course of five miles; for ten miles the time would be doubled; and for fifteen miles trebled; and so on. Or the time can be found for any number of miles by a simple proportion sum. Say one yacht is 49ft. long and the other 64ft. The times opposite these lengths are as under:

	Min. sec.
64ft.....	25 0
49ft.....	22 51

2 9 = Time for five miles.

That is, 64ft. allows 49ft. 2min. 9sec. (or 129 seconds) for five miles. The time for any other length, of course (say twenty-three-miles), can be found thus:

129 ... seconds.
23 ... miles.

387
258

5)2967

593 = Time for twenty-three miles.

That is, the time for twenty-three miles would be 593 seconds, or 9min. 53sec.

NOTE.—When the rating is to be by length on load water line, the length is obtained in this manner, the yacht being afloat in sailing trim: the measurement over all is first obtained on deck from stem to taffrail. A heavy plumb is then dropped over the stern in the centre of the taffrail; a rod is then floated from the plumb line in to the stern end of the load line (not including rudder post, unless the same be inside the stern end of load line—in other words, not unless a portion of the counter is immersed). The distance from the plumb line measured along the rod to the stern end of load line is subtracted from the length over all; if there is an overhang of stem forward the operation has to be repeated at that end of the vessel. The overhang of counter and stem (if any) deducted from the length over all gives the length on load water line.

TIME SCALE FOR LENGTH FOR A COURSE OF FIVE MILES.

ft. in.	min. sec.	ft. in.	min. sec.	ft. in.	min. sec.
9 0	0 0	18 6	12 6	28 0	17 21
9 6	1 3	19 0	12 20	28 6	17 33
10 0	2 2	19 6	12 50	28 0	17 45
10 6	3 58	20 0	13 10	28 6	17 57
11 0	4 38	20 6	13 29	30 0	18 8
11 6	5 36	21 0	13 48	30 6	18 18
12 0	6 20	21 6	14 7	31 0	18 28
12 6	7 8	22 0	14 25	31 6	18 38
13 0	8 40	22 6	14 42	32 0	18 48
13 6	9 21	23 0	14 58	32 6	18 58
14 0	10 55	23 6	15 14	33 0	19 7
14 6	11 35	24 0	15 30	33 6	19 16
15 0	12 2	24 6	15 45	34 0	19 25
15 6	13 32	25 0	16 0	34 6	19 34
16 0	14 10	25 6	16 14	35 0	19 43
16 6	15 28	26 0	16 28	35 6	19 52
17 0	16 54	26 6	16 42	36 0	20 0
17 6	18 19	27 0	16 55	36 6	20 8
18 0	19 42	27 6	17 8	37 0	20 16

TIME SCALE FOR A COURSE OF FIVE MILES—continued.

ft. in.	min. sec.	ft. in.	min. sec.	ft. in.	min. sec.
37 6	20 24	81 6	26 44	125 6	29 23
38 0	20 32	82 0	26 47	126 0	29 24
38 6	20 40	82 6	26 50	126 6	29 25
39 0	20 48	83 0	26 52	127 0	29 26
39 6	20 55	83 6	26 54	127 6	29 27
40 0	21 2	84 0	26 56	128 0	29 28
40 6	21 9	84 6	26 58	128 6	29 29
41 0	21 16	85 0	27 0	129 0	29 30
41 6	21 23	85 6	27 2	129 6	29 31
42 0	21 30	86 0	27 4	130 0	29 32
42 6	21 37	86 6	27 6	130 6	29 33
43 0	21 43	87 0	27 8	131 0	29 34
43 6	21 49	87 6	27 10	131 6	29 35
44 0	21 55	88 0	27 12	132 0	29 36
44 6	22 1	88 6	27 14	132 6	29 37
45 0	22 7	89 0	27 16	133 0	29 38
45 6	22 13	89 6	27 18	133 6	29 39
46 0	22 19	90 0	27 20	134 0	29 40
46 6	22 25	90 6	27 22	134 6	29 41
47 0	22 31	91 0	27 24	135 0	29 42
47 6	22 36	91 6	27 26	135 6	29 43
48 0	22 41	92 0	27 28	136 0	29 44
48 6	22 46	92 6	27 30	136 6	29 45
49 0	22 51	93 0	27 32	137 0	29 46
49 6	22 56	93 6	27 34	137 6	29 47
50 0	23 1	94 0	27 36	138 0	29 48
50 6	23 6	94 6	27 38	138 6	29 49
51 0	23 11	95 0	27 40	139 0	29 50
51 6	23 16	95 6	27 42	139 6	29 51
52 0	23 20	96 0	27 44	140 0	29 52
52 6	23 26	96 6	27 46	140 6	29 53
53 0	23 31	97 0	27 48	141 0	29 54
53 6	23 36	97 6	27 50	141 6	29 55
54 0	23 41	98 0	27 52	142 0	29 56
54 6	23 45	98 6	27 54	142 6	29 57
55 0	23 49	99 0	27 56	143 0	29 58
55 6	23 53	99 6	27 58	143 6	29 59
56 0	23 57	100 0	28 0	144 0	30 0
56 6	24 1	100 6	28 2	144 6	30 1
57 0	24 5	101 0	28 4	145 0	30 2
57 6	24 9	101 6	28 6	145 6	30 3
58 0	24 13	102 0	28 8	146 0	30 4
58 6	24 17	102 6	28 10	146 6	30 5
59 0	24 21	103 0	28 12	147 0	30 6
59 6	24 25	103 6	28 14	147 6	30 7
60 0	24 29	104 0	28 16	148 0	30 8
60 6	24 33	104 6	28 18	148 6	30 9
61 0	24 37	105 0	28 20	149 0	30 10
61 6	24 41	105 6	28 22	149 6	30 11
62 0	24 45	106 0	28 24	150 0	30 12
62 6	24 49	106 6	28 26	150 6	30 13
63 0	24 53	107 0	28 28	151 0	30 14
63 6	24 57	107 6	28 30	151 6	30 15
64 0	25 0	108 0	28 32	152 0	30 16
64 6	25 3	108 6	28 34	152 6	30 17
65 0	25 6	109 0	28 36	153 0	30 18
65 6	25 9	109 6	28 38	153 6	30 19
66 0	25 12	110 0	28 40	154 0	30 20
66 6	25 15	110 6	28 42	154 6	30 21
67 0	25 18	111 0	28 44	155 0	30 22
67 6	25 21	111 6	28 46	155 6	30 23
68 0	25 24	112 0	28 48	156 0	30 24
68 6	25 27	112 6	28 50	156 6	30 25
69 0	25 30	113 0	28 52	157 0	30 26
69 6	25 33	113 6	28 54	157 6	30 27
70 0	25 36	114 0	28 56	158 0	30 28
70 6	25 39	114 6	28 58	158 6	30 29
71 0	25 42	115 0	29 0	159 0	30 30
71 6	25 45	115 6	29 2	159 6	30 31
72 0	25 48	116 0	29 4	160 0	30 32
72 6	25 51	116 6	29 6	160 6	30 33
73 0	25 54	117 0	29 8	161 0	30 34
73 6	25 57	117 6	29 7	161 6	30 35
74 0	26 0	118 0	29 8	162 0	30 36
74 6	26 3	118 6	29 9	162 6	30 37
75 0	26 6	119 0	29 10	163 0	30 38
75 6	26 9	119 6	29 11	163 6	30 39
76 0	26 12	120 0	29 12	164 0	30 40
76 6	26 15	120 6	29 13	164 6	30 41
77 0	26 18	121 0	29 14	165 0	30 42
77 6	26 21	121 6	29 15	165 6	30 43
78 0	26 24	122 0	29 16	166 0	30 44
78 6	26 27	122 6	29 17	166 6	30 45
79 0	26 30	123 0	29 18	167 0	30 46
79 6	26 33	123 6	29 19	167 6	30 47
80 0	26 36	124 0	29 20	168 0	30 48
80 6	26 38	124 6	29 21	168 6	30 49
81 0	26 41	125 0	29 22	169 0	30 50

TIME SCALE FOR A COURSE OF FIVE MILES—continued.

ft.	in.	min.	sec.	ft.	in.	min.	sec.	ft.	in.	min.	sec.
169	6	30	51	176	0	31	5	188	0	31	19
170	0	30	52	176	6	31	6	189	0	31	20
170	6	30	53	177	0	31	7	190	0	31	21
171	0	30	54	177	6	31	8	191	0	31	22
171	6	30	56	178	0	31	9	192	0	31	23
172	0	30	57	179	0	31	10	193	0	31	24
172	6	30	58	180	0	31	11	194	0	31	25
173	0	30	59	181	0	31	12	195	0	31	26
173	6	31	0	182	0	31	13	196	0	31	27
174	0	31	1	183	0	31	14	197	0	31	28
174	6	31	2	184	0	31	15	198	0	31	29
175	0	31	3	185	0	31	16	199	0	31	30
175	6	31	4	186	0	31	17	200	0	31	31
				187	0	31	18				

TIME ALLOWANCE BY SAIL AREA AND LENGTH.

In 1880 Mr. Kemp devised the following rule for calculating time allowance by length and sail area. In 1882 the rule was adopted by the Seawanhaka Yacht Club in America, and the Bangor (Ireland) Corinthian Yacht Club.

In Fig. 278 measure the length from *a* to *c* and the height from *a* to *b*. Multiply the height by the length, and divide by two, and the quotient will be the quantity of sail in square feet that can be set as head sail. Next measure the length of the main boom *d e* and gaff *f g*, and multiply two-fifths of these lengths by the height *a b*. The product will pretty accurately give the quantity in square feet of canvas that can be set abaft the mast, including topsail. But a rougher rule than this can be used, with very little variation in the result.

Take the extreme length from bowsprit end to boom end; to this length add the length of the gaffs. Multiply the sum by the height

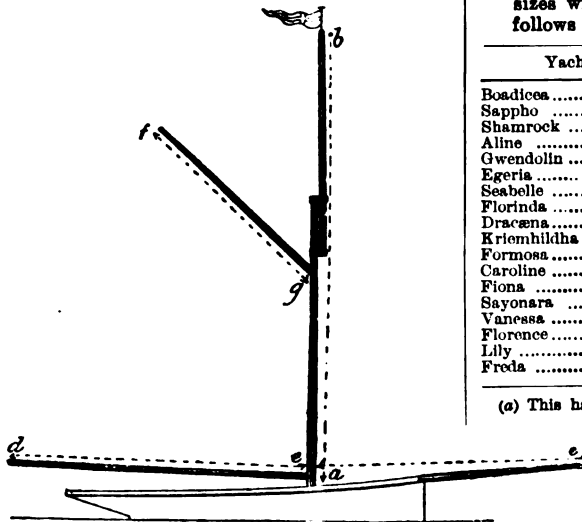

FIG. 278.

from deck to hounds of topmast, and divide the product by two. The quotient will be the sail area.

In the case of a schooner, the extreme length from bowsprit end or jibboom end to

Time Allowance—continued.

the main boom would be taken; to this add the length of fore and main gaff, and multiply by the mean of the height from deck to main and fore-topmast hounds.

A yawl's mizen would be separately calculated. Add the boom and yard together and multiply by half the height, deck to hounds.

Rule.—Multiply the sail area by the length of the yacht on the load water-line, and divide the product by 7000. The quotient will be the sail tonnage.

By cancelling the three right-hand figures the divisor becomes 7 instead of 7000.

Applying the rule to Egeria, the following is the sum :

Length, bowsprit end to boom end.....	158ft.
Length of main gaff	37
Length of fore gaff	28
	223
Mean height.....	89
	2007
Main height... 94.5	1784
Fore height... 83.5	
	2)19847
	9923
Mean height... 89	Length on load-line 94
	89692
	89307
	7982762
	Sail-tons 132.0

Actual sail area could of course be used, but the division would in that case have to be somewhat smaller.

The effect of the rule on yachts of various sizes will be found in the table which here follows (Y.R.A. Time Scale) :

Yacht.	Y.R.A. Tons.	Sail-Tons.
Boadicea	364	338 (a)
Sappho	366	271 (b)
Shamrock	280	176 (c)
Aline	200	168
Gwendolin	186	162
Egeria	147	133
Seabelle	126	122
Florida	124	114
Dracena	110	80 (d)
Kriemhilda	104	92
Formosa	101	95
Caroline	81	65 (e)
Fiona	77	70
Sayonara	90	22
Vanessa	19	20
Florence	10	13
Lily	10	11
Freda	5	64

(a) This has been calculated from Boadicea's original sail plan, which has been much reduced.

(b) Sappho has very short topmasts.

(c) Is rigged for cruising.

(d) The distance between Dracena's masts has been assumed.

(e) Caroline is rigged for cruising.

Timing.—In timing vessels passing marks to finish a race or otherwise, the fairest plan is to take the time as each vessel's stem reaches the mark. In timing yachts that have to gybe or tack round marks, time must be taken when in the opinion of the timekeeper the yacht is

fairly at or round the mark; this especially in the case of gybing.

Toggle.—A short rope with an eye at one end and a small piece of wood at the other, to insert in the eye and form a kind of strop or becket.

Ton.—A weight of 2240lb. avoirdupois. In hydraulics 35 cubic feet of sea water, represent a ton or 36ft. of fresh water.

Tonnage.—The nominal size or capacity of a ship, variously estimated. The tonnage of a merchant ship is her internal space or cubical contents expressed in 100 cubic feet to the ton, after making deductions for engine room and crew space. This is termed new measurement (N.M.) Builder's measurement (B.M.) or as it is sometimes termed old measurement (O.M.) is thus expressed.

$$\frac{(L - \frac{1}{2} B) \times (\frac{B^2}{2})}{94}$$

94

where L is length, and B breadth.

According to builders' measurement, length is taken along the keel from the sternpost to a perpendicular or plumb line dropped from the stem-head on deck. By raking the sternpost the length of keel was shortened, and in order to prevent evasions in this way, the Royal London Yacht Club in 1854 passed a rule that the length should be taken on deck instead of along the keel. The tonnage of the vessels with very raking sternposts was, of course, much increased, and in order to let them off a little more easily, the whole beam was ordered to be subtracted from the length instead of $\frac{1}{2}$ ths of the beam. The rule then read

$$\frac{(L - B) \times (B \times \frac{1}{2} B)}{94}$$

94

(Multiplying by beam, then by half beam, is the same as multiplying by the half square of the beam, as above.)

This is the rule known as the "Thames Rule," adopted by the Y.R.A. in 1875.

In 1879 the Y.R.A. altered the rule to length on load line.

In 1881 the Y.R.A. adopted a new rule, which came into operation in the following

year (1882). The rule is $\frac{(L+B)^2 \times B}{1730}$; that

is, add the breadth to the length, and multiply the sum thus obtained by itself, and then by the breadth. The product is divided by 1730.

Top.—In square rigged ships, the stage at the lower mast heads to give additional spread to the topmast rigging, and to form a kind of gallery for riflemen in war ships. There are fore top, main top, and mizen top. To top is to raise one end of a boom or yard by the topping lifts. (See Plate I., and page 115.)

Top Gallant Bulwarks.—Bulwarks fitted above the rail to afford additional shelter on deck.

Topgallant Mast.—The mast next above the topmast in square-rigged ships.

Top Hamper.—Any real or supposed unnecessary weight carried on deck or on the masts.

Topmast Hoops.—Occasionally hoops are used for jib-headed topsails. The hoops when not in use rest on the masthead. In hoisting the topsail the lacing is passed through an eyelet hole in the luff of the sail and through a hoop, and so on. When the sail is hoisted chook-a-block the lacing is hauled taut; in lowering the lacing is slackened. Hoops facilitate the hoisting and lowering of the sail, and admit of its being lowered and hoisted without a man going aloft.

Topping Lifts.—Ropes or tackles used to raise or support booms or yards. (See pages 31 and 58.)

Top Rail.—The rail fitted on the stanchions as a finish to the bulwarks.

Topsails.—Racing yachts usually are supplied with various topsails, viz., balloon topsail, No. 1 topsail, No. 2 topsail, jib-headed topsail, and jib topsail. Formerly a square topsail was carried as well, but spinnakers have superseded squaresails. A cruising yacht usually carries one square-headed topsail and one jib-headed topsail. American yachts usually carry one balloon topsail (called a club topsail—see Fig. 43, page 175) and one jib-headed topsail, called a working topsail, and a jib topsail. Schooners, both British and American, carry as well a main topmast staysail.

Topsail Schooner.—(See "Square Topsail Schooner.")

Topside.—That part of a vessel above the wales; now in yachts sometimes understood as the part between the water-line and deck, or the freeboard.

Top Timbers.—The upper parts of the framing of a vessel.

Top Your Boom and Sail Large.—To leave in a hurry.

Toss the Oars.—To throw them out of the rowlocks and rest them perpendicularly, blades uppermost.

Toss up the Boom.—To raise the boom by the lifts.

Touching the Wind.—Luffing into the wind so that the sails shake. (See "Luff and Touch Her.")

To Whip.—To bind the ends of rope with twine to prevent their fraying.

Tow Rope or Tow Line.—The rope or hawser used in towing.

Track.—The course or wake of a ship.

Trade Wind.—Winds that blow in one direction a considerable time, admitting of traders making expeditious voyages.

Trail Boards.—Carved boards formerly fitted on the bow and stem of schooners.

Transom.—The frame at the sternpost of a vessel. In boats the transverse board at the

stern, which gives shape to the quarters and forms the stern end of the boat.

Transverse.—Athwartships. At right-angles to the line of the keel.

Trapezium.—A four-sided figure with two sides parallel, as a ship's square sail.

Trapezoid.—A four-sided figure whose sides do not form parallel lines, such as a cutter's mainsail.

Traveller.—An iron ring, thimble, or strop which travels on a spar, bar, or rope.

Traveller, Jointed.—The fishermen on the S.W. coast use a jointed mast traveller. The iron hoop is in two half moons, each end has an eye turned in; the two halves are connected by

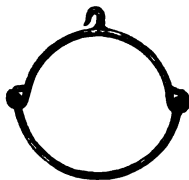

FIG. 279.

these eyes. The object in having a jointed traveller is to facilitate lowering. (See "Penance Luggers.")

Trenails.—Bolts or plugs of wood used to fasten plank to the timbers of vessels. Originally spelt treenail. Pronounced "trennel."

Trestle Trees.—In ships long pieces of timber fitted at the masthead in a fore-and-aft direction to support the cross trees.

Triatic Stay.—(See page 30 and 52.)

Trick.—The time a man is stationed at the helm. (See "Spell.")

Trim.—The position of a ship in the water in a fore-and-aft direction. To trim a vessel is to set her in a particular position, by the head or stern. The term is sometimes erroneously used to represent the shifting of ballast transversely. To trim the sails is to sheet and tack them so that they are disposed in the best manner possible, in relation to the force of the wind.

Trip.—A passage. Sometimes used to denote a board made in beating to windward. To trip a spar is to cant it. To trip an anchor is to break it out of the ground; an anchor is a-trip when one of its flukes is on, but not in, the ground. (See "Anchor" and "Scowing")

Trip or Tripping Line.—A rope used to cant a spar, as trip halyards for a topsail, or the line bent to the crown of an anchor to trip it or break it out of the ground.

Trough.—The hollow between wave-crest and wave-crest.

Trucks.—The wooden caps fitted on the upper mastheads to reeve the signal halyards through.

True Wind.—A wind that does not vary; the prevailing wind in contradistinction to eddies or baffling puffs.

Trying.—To "try" is when a vessel is hove to, if her sails are so trimmed that she may gather headway and make something to the good.

Trysail.—A small sort of gaff sail set in heavy weather. The sail set on the fore and main mast of square rigged ships similar to the spanker on the mizen. The meaning of try-sail is probably that under it in heavy weather a vessel can try to sail.

Tuck.—The form of the hollow in the quarter by the transom or stern-post.

Tug.—A towing boat. To tug is to tow.

Tumble In or Tumble Home.—When the sides of a ship near the deck incline inwards; the opposite to flaring.

Tumbler.—A piece of wood pivoted in the jaws of a gaff which is always in the plane of the mast.

Tumbler-rod.—(See pages 49 and 51.)

Turk's-head.—A knot made to finish off the end of a rope.

Turn.—A circle made by a rope round a pin, &c. "Turn O!" is an order to belay. To catch a turn is to put the fall of a tackle or part of any rope round a belaying pin, stanchion, &c.

Turn in.—To secure the end of a rope by seizing.

Turning to Windward.—Working or beating for a point or object by short boards. Generally beating to windward. To turn is to tack.

Turn of the Tide.—When the tide changes from flood to ebb, or the contrary.

'Tween Decks.—Under a deck.

Twice Laid Rope.—Rope re-made from old rope.

Twiddling Stick.—The tiller, hence "twiddling lines" are the tiller lines.

Two-blocks.—Said when a tackle has been used so that its two blocks come close together. (See Chock-a-block.)

Tye.—A runner to which a tackle is hooked, used for hoisting lug-sails and squaresails.

Tyers.—Ropes or gaskets used to secure the mainsail of a fore-and-aft vessel when furled or stowed to the boom. The tyer that takes up the middle of the sail is termed the bunt tyer. (See "Gasket and Buntline.")

U.

Una Boat.—This is a centre-board boat with one sail introduced from America, where they are known as "cat boats." The mast is stepped close to the stem (sometimes with a rake aft), and the sail is laced to a boom and gaff. The name Una was given them because the first boat introduced at Cowes, from America, was so named. These boats vary from twice to three times their beam in length, and are very shallow. If handled with care, they are safe enough, very fast, and in smooth water very weatherly and handy. In squalls they

should always be luffed up in good time, or they might be blown over.

Unbend.—To cast loose a sail from its gaff, yard, &c. The opposite of bend.

Under Bowing the Sea.—When a vessel is close-hauled sailing in a cross sea, and gets the worst of it on the lee bow.

Under Canvas.—Proceeding by means of sail. With sail set.

Under Deck.—Below.

Under Hatches.—Below deck.

Under Run.—To follow up a rope, chain hawser, or cable, by hauling it in from a boat which moves in the direction that the cable, &c., is laid out.

Under Sail.—(See "Under Canvas.")

Under Shore.—Close to the shore or land.

Under the Lee.—Sheltered from the wind by the sails of another vessel. Under the lee of the land, sheltered from the full force of the wind by the land.

Under-way.—Moving through the water under the influence of the wind, steam, or oars. Sometimes written under-weigh. It is said a vessel may be under-weigh when she is getting her anchor; but even then it would be the anchor, and not the vessel, that would be under-weigh.

In Admiral Smyth's "Sailor's Word Book," (edition revised by Admiral Sir E. Belcher, 1867), is the following:—"UNDERWAY.—A ship beginning to move under canvas after her anchor is started; some have written this *underweigh*, but improperly. A ship is underweigh when she has weighed her anchor; she may be with or without canvas, or have to. As soon as she gathers way she is *underway*. This is a moot point with old seamen."

The obvious objections to using *underweigh* in this limited sense is that a man might find himself saying, "We got *underweigh* at noon, but were not *underway* until two hours later." The fact is, underweigh is never written by seamen except through carelessness; but the odd thing is that greenhorns take to the word more kindly than they do to *underway*, probably because they have enough knowledge to know that to get under way the anchor must be weighed. The best naval writers never describe the operation of getting the anchor as getting *underweigh*; but always write "she weighed," or "she weighed anchor," or we weighed," &c. To get under way is by them used in the sense of making preparation to get way on; and when the anchor is aweigh the ship may have way on or not. Dana (who may be taken as an unimpeachable authority) does not admit the word *underweigh* in his Seaman's Manual (revised edition by the Registrar-General British Shipping); but in the instructions for making sail, &c., *underway* is always used thus: "Getting under way from a single anchor," "getting under way, riding head to wind," &c. So also *underway* is the term used in the Merchant Shipping Act.

Under-way—continued.

In William Falconer's Marine Dictionary (published more than one hundred years ago) *underweigh* is not to be found, but we come upon the following sections:

"UNDERWAY.—If it be in a tide way and with a leading wind, so that the ship can stem the tide, let it be a rule when the tide serves to get under way and sail against the flood, which gives time to clear a ship of her moorings, and affords a more powerful effect to the helm to clear of other ships, &c.

"WAY.—The course or progress a ship makes in the water under sail. Thus, when she begins her motion she is said to be under way, &c."

William Falconer, besides being a distinguished author, was a thorough seaman, and after long service in H.M.'s Navy, was lost in the shipwreck of the Aurora, 1769, at the age of 39.

Underwriter.—A person who attaches his name to a policy of insurance by the side of the amount he will share of the risk. The under part of some policies may have two or three hundred names attached, as the principle of underwriting is to have very little at stake on any one ship. To become an underwriter at Lloyd's a deposit of 5000*l.* is required by the committee, for which a percentage of interest is paid annually. This deposit must be in cash, or in property (sureties will not do.) The entrance fee is 100*l.*, and the subscription is 12*l.* 12*s.* per year, together with 5*l.* 5*s.* for a seat in the rooms—total subscription annually, 17 guineas. Fifteen hundred or two thousand might be profitably employed if a person has a good knowledge of underwriting, &c., or it might not.

Union Down.—An ensign with the jack downwards, hoisted as a signal of distress.

Union Jack.—A flag composed of St. George's, St. Andrew's, and St. Patrick's crosses. (See "Jack.")

Unmoored.—With anchors a-weigh. A vessel is also said to be "unmoored" when she is riding to a single anchor, as to be moored, two anchors must be down.

Unreeve.—To haul out a rope from a hole, &c.

Unrig.—To dismantle a ship or any part of her, as to unrig a spinnaker boom, to unrig a bowsprit, &c.

Unship.—To remove a thing from its lodgment. The opposite of "to ship."

Up and down.—Vertically. The wind is sometimes said to be up and down the mast, when there is none at all, like Paddy's hurricane.

Upper Mast—*Upper Stick.*—A topmast, a topgallant mast, &c.

Upper Strake.—The top strake running round a vessel at the deck edge under the covering board, usually stouter than the general planking, and almost always of hard wood to better hold fastenings.

Usages of the Sea.—Customs of the sea in relation to commercial pursuits, which are held in law to be binding.

V.

Van.—The advanced part of a fleet.

Vane.—(See "Dog Vane.")

Vang.—A rope used to keep in the gaff of a schooner's foresail. The foresail of a schooner has usually very little peak, and consequently the halyards will not keep it from going off to leeward. A block is lashed to the mainmast head, through which the vang is rove and made fast to the fore gaff end; the fall of the rope leads to the deck. In square-rigged ships vangs are generally used on the spanker gaff. Sprit sail barges also use vangs.

Variation of the Compass.—The departure the compass needle shows from true North at certain parts of the globe. The difference between magnetic and true North usually expressed in degrees on charts. The variation widely differs, thus: in the English Channel it is about 23°, at New York only 5°. The deviation of the compass is due to local attraction. A chart called a "Variation Chart," shows by curved lines the changing variations of the compass needle for different parts of the globe. Variation must not be confused with the deviation due to local attraction in iron and composite ships.

Varnish.—Black Japan: 1oz. lamp black, 2oz. bitumen, ½oz. acetate lead, ½oz. Turkey amber, ½oz. Venice turpentine, 12oz. boiled oil. Dissolve the oil in turpentine; powder the other ingredients, and stir in gradually. Simmer on slow fire ten minutes.

Copal Varnish: Copal 30oz., drying linseed oil 18oz., spirits of turpentine 50oz. Briskly fuse the copal; heat the oil to close on boiling point, and pour it hot on the copal; mix thoroughly; allow the mixture to cool a little and add the turpentine, mix thoroughly. Allow the mixture to further cool, and strain for use.

A Quick-drying Varnish: 7lb. copal (fused), hot linseed ½gall., hot turpentine 1½gall. Carefully stir and boil together.

Oak Varnish: 7lb. pale resin dissolved in 2gall. oil of turpentine.

Varnish for Metals: Powder 1lb. of copal and dissolve in 2lb. of strongest alcohol. A very quick-drying varnish.

Varnish for Iron: Mastic (clear grains) 10lb., camphor 5lb., sandarach 15lb., elemi 5lb. Dissolve in sufficient alcohol.

Black Varnish or Polish for Iron: Resin 4oz., lamp black 2oz., beeswax 3oz., shellac 2oz., linseed oil 1qt. Boil together one hour, and then stir in ½pt. turpentine.

Tar Varnish for Iron: Coal tar 1pt., lamp black 1oz., heel ball ½oz., spirits turpentine ½pt., beeswax 1oz. Dissolve the heel ball and beeswax in the turpentine, add the lamp

black and tar, warm and mix it thoroughly. This mixture should be applied hot.

Tar Varnish for Wood or Iron: 1gall. coal tar, 2oz. oil of vitriol; mix thoroughly, and add ½pt. of turpentine; mix, and apply immediately. This dries very quickly, and only small quantities sufficient for use should be made.

Varnishing a bright Boat.—Oil the planks, &c., and when the oil is dried in put on two coats of copal varnish. If size is used instead of oil, the varnish will peel off. To clean off varnish: take a mixture of soda (2lb.), soap (1lb.), boiled together, it will remove varnish from spars, &c. It should be applied hot. (See also "Caustic Soda.")

Veer.—To pay out chain. Veer is also used in the sense of wearing or gybing. The wind is said to veer when it changes in direction with the sun; to back when it changes against the sun. On board a ship, the wind is said to veer when it draws more aft. To haul when it comes more ahead.

Veer and Haul.—To slacken up a rope, and then haul on it suddenly, in order that those who are hauling on it may acquire a momentum. Pulling by jerks.

Veer away the Cable.—The order to pay or slack out cable.

Veering a Buoy in a Vessel's Wake.—Throwing overboard a buoy in the wake of a ship when a man has fallen overboard, in the hope that he may get to it, and pick it up.

Vertical.—At right angles to the horizon, or perpendicular to the horizon.

Vessel.—A name for all kinds of craft, from a canoe to a three-decker.

Vice Commodore.—(See "Commodore.")

Victual.—To supply with provisions for a voyage, &c.

Voyage.—The passage of a vessel by sea. A short voyage is called a trip or a cast.

W.

Waist.—The middle part of a vessel's decks.

Waisters.—Green hands, or old decrepid seamen, who are stationed about in the waist of a vessel to haul upon ropes, &c.

Wake.—The peculiar eddying water that appears after a ship has passed. Vessels are said to leave a clean wake that do not cause waves to form astern.

Wales.—Thick strakes of plank.

Walk Away with It.—(See "Run Away.")

Wall Knot.—A knot formed at the end of a rope by unlaying the strands, and weaving them in and out.

Wall Sided.—Up and down sides of a vessel that neither tumble home nor flare out.

Wallow.—To lie in the trough of a sea and roll heavily; to roll under the sea.

Warrants.—(See "Admiralty Warrants.")

Wash Strake.—A movable strake of plank fitted to the gunwale of an open boat to increase her height out of water whilst sailing or otherwise.

Watch and Watch.—The arrangement whereby one half of the crew is on deck for four hours, then the other half for four hours. (See "Watches.")

Watch.—An anchor buoy or mooring buoy is said to watch when it keeps above water.

Watches.—The divisions of time for work on board a vessel. The crew of a ship is divided for this work into two watches, port and starboard, each watch being alternately on deck, excepting in emergencies, when both watches may be called on deck. Watches are thus divided: From 8 p.m. to midnight is the "First Watch." From midnight to 4 a.m. is the "Middle Watch." From 4 a.m. to 8 a.m. is the "Morning Watch." From 8 a.m. to noon is the "Fore-noon Watch." From noon to 4 p.m. the "Afternoon Watch." From 4 p.m. to 8 p.m. the two "Dog Watches." (See p. 196.)

Watching for a Smooth.—In a sea way looking out for a time when the waves are smaller to tack in, &c.

Watch Tackle.—A tackle consisting of single and double block; the single block has a hook, the double a tail.

Water.—One cubic foot fresh water '0279 ton or 62'39lbs.; one gallon '0045 ton. A ton fresh water equal to 223'76 gallons. One cubic foot salt water '0286 ton or 64'05lbs.; one gallon '0046 ton; ton 217'95 gallons. A ton of fresh water is usually taken as 36 cubic feet; a ton of salt water as 35 cubic feet. (See "Cubic Measure of Water.")

Water Ballast.—Water carried in tanks or breakers as ballast. The tanks or breakers if intended to act as ballast should be kept full.

Water Borne.—Not resting on the ground, but being in the condition of floating.

Water Line.—A horizontal plane passing through a vessel longitudinally. A line shown in the half-breadth plan of a ship drawing. Length on load water-line means the length in a straight line from the fore side of the stem to the aft side of the stern-post at the water level.

Water Logged.—The condition of a vessel, that although her hold is full of water, she does not sink, owing to the buoyant nature of her cargo, or from other causes.

Waterproofing.—Boil 12oz. of beeswax in 1gall. of linseed oil for two hours; paint the cloth with this mixture twice or thrice. If black is required, add the necessary quantity of black for the second and third coat.

Waterproofing Sail Cloth.—The recipe used by Mr. Berthon to render the canvas of his collapsing boats airproof and waterproof, and believed to be similar to that used in H.M. dockyards for hammock cloths, is as follows: To 6oz. of hard yellow soap add 1½ pint of

water, and when boiling, add 5lb. of ground spruce ochre, ¼lb. patent driers, and 5lb. of boiled linseed oil. For waterproofing sheets, the ochre should be omitted, as it adds to the weight, lessens the flexibility, and is unnecessary. Existing coverings are made temporarily airproof and waterproof by preparations of indiarubber, oil, paint, &c. Fabrics coated with preparations of indiarubber are not proof against the effects of climate or rough usage, are not easily repaired, and, compared with those coated with the Chinese and other preparations, are very heavy, and, if the same dimensions, expensive. The recipe for "waterproofing" stout calico used by the Chinese, is given by the late Mr P. Le Neve Foster, in his recent report on life-saving apparatus in the "Journal" of the Society of Arts. He states that it is perfectly efficient, alike in the hottest and coldest climates, is believed to be composed of boiled oil one quart, soft soap 1oz., and beeswax 1oz.; the whole boiled until reduced to three-quarters of its previous quantity; but experiments are required satisfactorily to test the above proportions.

The following plan is recommended in America: To waterproof cotton drilling boil a mixture of 6oz. hard yellow soap, 1½ pint water, ¼lb. patent driers, 5lb. boiled linseed oil.

Waves.—The formation of waves is a subject which has received much attention of late, but no completely satisfactory theory as to their genesis has yet been evolved. The general theory is, that the smooth sea is acted upon by the impact and friction of the moving air or wind, and that the waves increase in size and speed, until the wind force is incapable of further developing them. Deep sea waves vary much in length, even under similar influences of wind pressure, and its continuation. Captain Motter of the French Navy, measured a wave in the North Atlantic, 2720ft., or half a mile from crest to crest, and Sir James Ross, one 1920ft. long. In the Bay of Biscay, where the sea is usually turbulent, waves have been seen of 1300ft. in length. Such waves however, are seldom met with, and Dr. Scoresby, who measured the lengths of some Atlantic storm waves he observed, had lengths of from 500ft. to 600ft. Measuring the heights of waves is a more difficult matter than measuring their lengths, and there has been much exaggeration under this head. The late Sir E. Belcher, at the Institute of Naval Architects in 1862, mentioned a wave he had observed rise to 100ft. Professor Rankine in his work on Naval Architecture, speaks of waves on rocky coasts rising to 150ft., and waves have been known to fly over the Eddystone Lighthouse. However, the greatest heights of deep sea waves as measured by Dr. Scoresby, and other accurate observers, have been 48ft., but it is rare to meet with waves exceeding 30ft. in height. Ordinary storm waves such as met with in the Atlantic of about 200ft. in length, have a height of about

Waves—continued.

one-twentieth of their length, but the ratio becomes lower as the length of the waves increase, and waves of 1000ft. in length have been observed with but a height of 10ft. On the other hand, waves of 600ft. in length have been observed of unusual steepness, and with heights one-eighth of their lengths. A long series of observations made by M. Bertin on the heights and lengths of waves, would seem to prove that the average height of deep sea waves is as 1 to 25 of their length. This of course is applied to single waves only. In what is termed a "confused sea," where a long wave may overtake and pass through a short one, the general height becomes increased, almost to the extent of the combined heights of both waves, and the wave form under such circumstances, is more or less "confused." In the English channel, superposed waves are common, and the waves generally being short and steep, heights are met with of about one eighth the length of the waves. (A wave length is the length from crest to crest, and wave height, the height from hollow to crest.)

The speed of waves are generally proportional to their length. Thus a wave 20ft. long, will travel 6 miles an hour, and one 50ft. long, 9 miles; 120ft., 15 miles; 200ft., 19 miles; 400ft., 27 miles; 600ft., 32 miles; 1000ft., 42 miles. It must be understood that it is only the *wave motion*, and not the water that travels, and no substance resting on the water is carried forward by the advance of waves further than the force of gravity may give a substance an alternate forward and backward motion, as it became differently situated on the sides of waves. Thus a ship will simply rise and fall with the waves and not be carried forward by them, and an unbroken wave would do a ship no harm in the sense of an impact due to the wave striking her. The danger from waves arises when they break over a ship, or when a ship by intercepting a wave causes it to break. (The best article in a popular form on Waves, and oscillations of ships among them is in Mr. W. H. White's "Manual of Naval Architecture.")

Way.—Motion through the water, as under-way, head way, stern way, steerage way, lee way, &c.

Ways.—Balks of timber arranged in a kind of shute to haul vessels upon or to launch them off.

Wear.—To bring the wind on the other side of a vessel by putting the helm up so that the vessel's head goes round away from the wind instead of towards the wind as in tacking. (See "Gybe.")

Weather.—The windward or "breezy" side of an object. The side on which the "weather" is felt; not to leeward. To weather is to pass on the windward side of an object. In cross tacking the vessel "weathers" another that crosses ahead of her. To weather on another vessel is to gain on her in a windward direction by holding a better wind than she does—to eat her out of the wind.

Weather Board.—On the weather side of a vessel. Sometimes in working to windward by a long board and a short one the short one is called "weather board."

Weather Boards.—Pieces of boards fitted over open ports to turn water or rain off.

Weather Cloth.—The cloth in a sail next the luff. The "weather" of a sail is the luff.

Weather Cloths.—Pieces of canvas fitted on ridge ropes and stanchions of yachts above the bulwarks; also the tarpaulins used to cover the hammocks when stowed in the nettings.

Weather Gauge.—The condition of a vessel that is to windward of another one. In slang, to possess an advantage.

Weather Helm.—The helm or tiller hauled to windward when a vessel owing to too much after sail has an inclination to fly up in the wind. If the centre of effort of the sails is much abaft the centre of lateral resistance, a vessel will require weather helm to keep her out of the wind. The tendency to fly up in the wind can be remedied by reducing the after sail, or setting more head sail, or by easing the main sheet. However, all vessels should carry a little weather helm. (The contrary to "Lee Helm," which see.) It has been frequently argued that the effect of the water pressure on the rudder when the helm is to windward (that is the rudder to leeward), is to press the vessel bodily to windward, and no doubt there is some truth in this, although the influence of the rudder in this respect could be only small.

Weathering.—A relative term used in sailing to define the action of one vessel that is eating to windward of another, thus, if a vessel is said to be weathering on another she is eating her out of the wind, or closing up to her from the leeward, or departing from her in a windward direction. Weathering an object is passing on its windward side.

Weather Lurch.—A weather roll or a roll to windward. In running with the main boom well off, it should be always secured with a guy, or it may fall to the opposite side during a weather roll, and cause some damage.

Weather Tide, or Weather-going Tide.—The tide that makes to windward or against the wind. (See "Lee-going tide.")

Wedges of Immerston and Emersion.—(See "Immersed.")

Wedging Up.—Lifting a vessel by driving wedges under her keel to take her weight off the building blocks before launching.

Weepings.—The exudations of damp or water through the seams or cracks of planks, &c.

Weigh.—To raise a thing, as weighing the anchor.

Weight (of Wire Rope).—The weight, elasticity, and strength of iron and steel wire rope and hemp rope vary very considerably, according to the quality of the iron, steel, or hemp used in its manufacture. The following table of the weight of different sizes rope of iron, hemp, &c., was compiled by the well-known civil engineer Mr. G. L. Molesworth

Hemp.		Iron Wire.		Steel Wire.		Equivalent Strength.	
Circumference.	Pounds weight per Fathom.	Circumference.	Pounds weight per Fathom.	Circumference.	Pounds weight per Fathom.	Working Load in Ows.	Breaking strain in Tons.
2½	2	1	1	6	2
3	3	1½	1½	1	1	9	3
3½	4	1¾	2	12	4
4	5	2	2½	1½	1½	15	5
4½	6	2¼	3	2	2	18	6
5	7	2½	3½	1¾	2	21	7
5½	8	2¾	4	2	2½	24	8
6	9	3	4½	27	9
6½	10	3¼	5	2½	3	30	10
7	12	3½	6	3	3½	33	11
7½	14	3¾	6½	2	4	36	12
8	16	4	7	2½	4½	39	13
8½	18	4¼	7½	3	5	42	14
9	20	4½	8	45	15
9½	22	4¾	8½	2½	5½	48	16
10	25	5	9	3	6	51	17
10½	28	5¼	10	3½	6½	54	18
11	30	5½	10½	4	7	60	20
11½	33	5¾	11	4½	7½	66	22
12	36	6	12	72	24
12½	40	6¼	13	5	8	78	26
13	45	6½	14	84	28
13½	50	6¾	15	5½	9	90	30
14	55	7	16	96	32
14½	60	7¼	18	6	10	108	36
15	66	7½	20	6½	12	120	40

Manilla rope, if not dried up and chafed, is slightly stronger size for size than hemp.

WEIGHT OF A SUPERFICIAL FOOT OF PLATES, OF DIFFERENT METALS, IN LBS.

Thickness.	Iron.	Steel.	Brass.	Copper.	Lead.	Zinc.
in.	lb.	lb.	lb.	lb.	lb.	lb.
1/8	2.5	2.6	2.7	2.9	8.7	2.3
1/4	5	5.2	5.5	5.8	7.4	4.7
3/8	7.5	7.8	8.2	8.7	11.1	7.0
1/2	10	10.4	11.0	11.6	14.8	9.4
5/8	12.5	13	13.7	14.5	18.5	11.7
3/4	15	15.6	16.4	17.2	22.2	14.0
7/8	17.5	18.2	19.2	20.0	25.9	16.4
1	20	20.8	21.9	22.9	29.5	18.7
1 1/8	22.5	23.4	24.6	25.8	33.2	21.1
1 1/4	25	26	27.4	28.6	36.9	23.4
1 1/2	27.5	28.6	30.1	31.4	40.6	25.7
1 3/4	30	31.2	32.9	34.3	44.3	28.1
1 7/8	32.5	33.8	35.6	37.2	48.0	30.4
2	35	36.4	38.3	40.0	51.7	32.8
2 1/8	37.5	39	41.2	42.9	55.4	35.1
2 1/4	40	41.6	43.9	45.8	59.1	37.5

WEIGHT OF CHAINS.

Chains.		Chain Cables.	
Diameter in inches.	Weight per Fathom in lbs.	Diameter in inches.	Weight per Fathom in lbs.
1/4	5½	1/4	18½
3/8	8	3/8	22
1/2	14	1/2	30
5/8	22	5/8	42
3/4	32	3/4	55
7/8	43	7/8	68
1	56	1	84
1 1/8	71	1 1/8	102
1 1/4	87	1 1/4	120
1 3/8	106	1 3/8	148
1 1/2		1 1/2	180

WEIGHT AND BULK OF SUBSTANCES.

Names of Substances.	Weight of Cubic foot in pounds.	Cubic feet in ton.
Cast iron	450.5	4.97
Wrought iron	486.6	4.60
Steel	489.8	4.67
Copper	565	4.08
Lead	707.7	3.16
Brass	537.7	4.16
Tin	456	4.91
Gold	1013	2.21
Silver	561	4.07
Pine, white	29.56	75.6
" yellow	33.81	66.2
" Dantzic	40	55
" red	38	60
English elm	35	64
American "	45	50
Teak	50	44
Mahogany	66.4	33.8
Oak, live (American)	70	32.0
" white	45.2	49.5
" " (English)	53	42
Marble, common	141.0	15.9
Millstone	180	17.2
Clay	101.3	22.1
Sand	94.5	23.7
Granite	165	13.5
Earth, loose	78.6	28.5
Water, salt (sea)	64.3	34.8
" fresh	62.5	35.9
Ice	58.08	38.56

Well.—A sunken part of the deck aft, termed cockpit sometimes. In small vessels there is usually a well aft in which the steersman sits; the cabin of a small boat is usually entered from the well. The cabin of most American yachts, large or small, is usually entered from the cockpit aft.

Well That! Well There!—An order to cease hauling and belay.

Weyford Flat Bottom Boats.—These boats are built for the herring fishery, and are generally termed "cots." The fishing season lasts from about the middle of October to Christmas, and very often the boats are not put into the water for the rest of the year.

They are suitable to any coast without quays or shelter, and where there is often a heavy surf, making it necessary to haul boats above high-water mark every time they are used. Thus described in the *Field*:

The beam of the boat, that is of the larger sort, is about one fourth of its length, say 6ft. beam to 24ft. in length, built of the undermentioned woods, viz.: the bottom and the beams of either white or yellow pine, the strakes of yellow pine, and the stem and stern posts, and the timbers of elm grown in the country.



FIG. 280.

The accompanying sketch shows a boat turned over on its side exhibiting the bottom.

The bottom boards are of wood, not less than an inch and a half thick; they are laid

Wexford Boats—continued.

down on heavy pieces of squared wood, and the elm timbers, which are sawn out of wood having the necessary bend, so as to reach from a few inches beyond the centre of the bottom to the top of the gunwale, are about two inches square—they cross one another; the bottom boards are then pegged to these timbers by driving pegs three-quarters of an inch thick and some eight in length through the timbers and boards; the ends are left to be cut off after the boat has been finished and turned over. These pegs are secured by cutting out a wedge from the lower end with a chisel, and then driving the wedge into the place from which it has been cut, thus filling the peg-hole more tightly. No nails are used for the bottom except to attach the short piece of keel at the stern, say four feet; and the heads of these nails are sunk in the keel. These wooden pegs never move, and wear even with the bottom; breadth at bottom, 4½ft. The stem and stern are alike, no transom being required. The end of a short keel extends some two inches beyond the bottom of the sternpost to protect the rudder. The stem and stern posts are then morticed for the ends of the bottom boards, and, as it is well to have them strong, there is a good lot of dead wood.

The first strake is three-quarters of an inch thick, and often an inch; but before fastening this on the beam of wood under the centre of the boat is either removed or sunk in the ground, say, three inches, and heavy weights of stones usually are placed on the bottom, near the centre, to bend the bottom boards, as it is considered that they do not row or sail so well on quite an even bottom.

The rest of the strakes are half an inch thick, and fastened on both to the timbers and themselves with iron nails, galvanised if procurable. Twelve-pennies are used to fix to the bottom boards and timbers, and six-penny nails to the strakes. Of course these boats are all clincher built, and are rather heavy, weighing three and a half or four hundredweight. They require four men generally to run them down and haul them up upon rollers. These are some 6in. in diameter if the sand is heavy. They place long boards or the sprits under the rollers. The sails are usually two or three sprit sails (see sketch), and sometimes a foresail. No

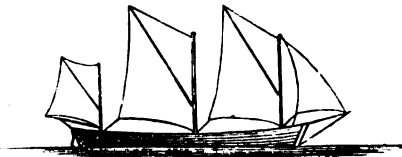

FIG. 281.

keel boats are ever used, owing to the great advantage of a flat bottom when they ground.

Accidents seldom take place with these boats, but, like all shallow boats, they require very skilful handling.

Wexford Boats—continued.

The centre-board now remains to be described. It runs in a frame or sheath formed for it in the centre of the boat. These, when let down, draw about 3ft. below the bottom of the boat, and are about 2ft. broad. The board is about 1in. thick; no iron is used for them. When they near the shore they are hauled up. They are not required when the sails are not used. The depth of these boats is about 2ft. to the top of the gunwale, and they generally pull four oars. They are too broad for one man to scull. Of course they will not carry so much sail as a keeled boat, nor will they sail so near the wind.

The ballast used consists of large stones. The fishermen hereabouts are a bold and hardy race, and they need be, for herring fishing on a December night is desperately cold work; but it is their harvest of the sea, and when four men can take from twelve to twenty mace of herrings in the night (the mace is 500, and worth from 15s. to 20s.), it pays them well. It is a pretty sight to see forty or fifty boats out of a night; but it is very cold work, and none but those brought up to it could stand it.

Wheel.—Used to give motion to the rudder by chains which pass over a barrel and lead through blocks to the tiller. When the tiller points *forward* the chain is put *over* the barrel first; when the tiller points *aft* the chain is put *under* the barrel first.

Where Away?—When an object is sighted, a question as to its bearing.

Wherry.—A small boat for rowing and sailing, usual rig a spritsail, main, and mizen, and foresail. (French "Houari.")

Whip.—A purchase consisting of one single block. A pennant vane.

Whip, To.—To bind the ends of rope with twine to prevent their fraying.

Whiskers.—(See page 30.)

Whistling for Wind.—In calms or light winds sailors sometimes amuse themselves by whistling in the hope that it will bring a breeze. They also scratch the boom for a breeze, or to make the vessel go faster. During heavy weather the superstition is all the other way, and no whistling or boom scratching is permitted.

Whole Sail Strength.—A wind of such strength so that a yacht can just carry all her canvas, including her "best" (not ballooner) gaff topsail, to windward.

Winch.—A drum with crank handles, pawl, &c., fitted to the mast to get in the topsail sheet, &c.

Wind.—(See "Winds.")

Wind Bound.—(See "Bound.")

Windfall.—An unexpected advantage or acquisition of treasure.

Windlass.—A horizontal barrel revolved by cranks or handspikes, used for getting the anchor. In yachts a small neat capstan is now generally used.

Winds.—Winds have been arranged according to the following table.

Velocity of wind in knots.	Pressure in lb. per sq. ft.	No. of force 0 to 12	Description of wind.	Sail Carried.	
1. ...	·067	}	1. Light air	All balloon canvas.	
2. ...	·077				
3. ...	·080				
4. ...	·107		}	2. Light wind	"
5. ...	·167				
6. ...	·240				
7. ...	·327		}	3. Light breeze	"
8. ...	·427				
9. ...	·540				
10. ...	·687		}	4. Moderate breeze.	Whole sail, including first topsail.
11. ...	·807				
12. ...	·980				
13. ...	1·13	}		5. Fresh breeze	Jib headed top-sail.
14. ...	1·31				
15. ...	1·50				
16. ...	1·71	}	6. Strong breeze ...	One reef.	
17. ...	1·93				
18. ...	2·16				
19. ...	2·41		}	7. Moderate gale ...	Three reefs, or close reefs.
20. ...	2·67				
22. ...	3·23				
24. ...	3·84	}	8. Fresh gale	Trysail.	
26. ...	4·51				
28. ...	5·23				
30. ...	6·00		}	9. Strong gale	Reefed trysail.
32. ...	6·83				
34. ...	7·71				
36. ...	8·64	}	10. Heavy gale	Storm trysail.	
38. ...	9·63				
40. ...	10·7				
50. ...	18·7		}	11. Storm	Whatever small sail could be got to hold together.
60. ...	24·0				
70. ...	32·7				
80. ...	42·7	}	12. Hurricane	No canvas made strong enough to stand such a force.	
90. ...	54·0				
100. ...	66·7				

Windsail.—A canvas shaft or tube for conveying air to or from below deck.

Wing and Wing.—A schooner before the wind with the main sail off the lee quarter, and the foresail boomed out to windward. Sometimes termed goose winged. (See "Goose Wing.")

Wings of a Ship.—That part of a ship below water near the load line.

Wink.—A west country term for a kind of winch used in the bow of a boat by fishermen to raise the anchor. (See "Anchor.")

Winning Flag or Crowning Flag.—The racing flag which is hoisted after a race to denote that a yacht has won a prize. It is hoisted immediately below and on the same halyards as the burgee. When a regatta is concluded a yacht hoists under her burgee as many racing flags as she has won prizes at the regatta. On arriving at a port, fresh from a regatta where she has been successful, she, in a like manner, hoists as many racing flags as she has won prizes; and if she calls at her own port she hoists as many flags as she has won prizes up to date. When she has sailed her last match she hoists as many racing flags as she has won prizes during the season. These are also hoisted when she returns to her own port. If a yacht has won more prizes than she has racing flags, it is usual to make up the deficiency with code signal flags or burgees.

Wiring.—A stringer or ledge running fore and aft in a boat to support the thwarts. (See "Clyde Sailing Boats.")

Wisby Laws.—A code of maritime laws which, with the rules of Oleron, for many centuries formed the basis of all regulations relating to seamen and ships. Wisby is a seaport of Gothland in the Baltic, and a port famous so long back as the 13th century.

Woof.—The threads or texture of any kind of cloth or canvas, &c.

Work.—A vessel is said to work when the different parts of her frame, planking, &c., are not securely bound together so that the various parts relative to each other alter their positions.

Working to Windward.—Proceeding by short tacks. Beating to windward. To work up to a vessel is to get nearer to her or catch her whilst beating to windward.

Wrinkle.—Something worth knowing; a piece of valuable experience.

Wrinkles in copper are generally a sign of severe strains in vessels, or that the vessel "works," or that her frame and plank shifts when she is underway in a sea.

Y.

Yacht.—Generally any kind of vessel which is permanently fitted out and used by her owner for pleasure. This is a word said to be of Dutch origin. In the time of Elizabeth a "yacht" was kept for the use of the Sovereign, and since that date every succeeding monarch has had more than one yacht. The "Bat of Wight" was built at Cowes in 1588, and Cowes appears from that early date to have been the head-quarters of yachting. But the Thames was early associated with yachting; in 1661, Charles II. sailed in a yacht on the Thames from Greenwich to Gravesend against a yacht in which sailed his brother the Duke of York. Pepys says "the King lost it going, the wind being contrary, but saved stakes in returning, his majesty sometimes steering himself." This probably is the first record of a yacht match, and likewise the first record of an amateur helmsman. Various yachts were built at Cowes during the eighteenth century, but to Cork apparently belongs the honour of originating yachting as a national pastime. In 1720 the "Cork Harbour Water Club" was established; but the yachts were small; and not until about 1783 did any private person build a yacht of any considerable size. This yacht was built at Itchen for the Duke of Richmond, and between that date and 1812 various yachts were built at Cowes, Fishbourne, and Southampton. In 1810 a club was started at Cowes (the club seal of the Royal Yacht Squadron bears date 1812), and thenceforward yachting made very rapid strides. In 1812 there were probably fifty yachts afloat, and these belonged exclusively to noblemen or to country gentlemen. In 1850 the number of yachts reached 500, and the pastime of cruising and

Yacht—continued.

racing had taken a firm hold of all branches of the community. From this time forward the growth in the number of yachts became very rapid, as will be gleaned from the table which follows. The rigs are separated, and it will be seen that yawls have only become an important class since 1864. This has not been at the expense of cutters, as the numbers in that rig have increased in a steady ratio. The schooners have been the sufferers; and, as the labour of racing a schooner is so very much greater and so much more expensive than racing a cutter or yawl, there is small hope of the schooners coming into favour again.

NUMBER OF YACHTS.

	1850.	1864.	1878.
Under 5 tons	4	62	160
5 tons, and not exceeding 9 tons	50	137	300
10 " " "	19	127	403
20 " " "	29	85	180
30 " " "	39	59	96
40 " " "	50	41	89
50 " " "	60	27	50
60 " " "	80	40	88
80 " " "	100	15	60
100 " " "	150	33	87
150 " " "	200	9	48
Above	200	10	15
Steam Yachts	3	33	282
Total	503	895	1883

RIGS.

	1850.	1864.	1878.
Cutters	372	574	754
Schooners	76	207	328
Yawls	45	64	328
Other Rigs	7	27	25
Steamers	3	33	282

TONNAGE.

	1850.	1864.	1878.
Average Tonnage	44	44	47
Gross Tonnage	22,141	39,485	89,420

Between 1878 and 1882 the number of steam yachts largely increased, as the following table will show :

	No.	Tonnage.
Not exceeding 100 tons...	275	7,300
Not exceeding 200 tons...	40	5,200
Not exceeding 300 tons...	23	5,200
Not exceeding 400 tons...	23	7,300
Not exceeding 500 tons...	12	5,000
Exceeding 500 tons.....	12	7,000
Total.....	384	37,000

It must be noticed that in the Acts of Parliament relating to maritime affairs, yachts are not generally referred to as a special class. The enactments refer to "every ship," "every British ship," "every seaman," as the case may be, and only occasionally to "pleasure yachts," and where these expressions are used yachts and yacht sailors are included, unless they are excepted in express terms. Moreover, it will be found in some cases that the Legislature has, by an express proviso, rendered pleasure yachts subject to the liabilities, and entitled to the privileges of trading vessels.

In 1854, the Merchant Shipping Act of that year (17 & 18 Vict. c. 104) repealed

Yacht—continued.

and consolidated into one Act, with amendments, very many previous enactments relating to the subject of British shipping. This Act came into force in 1855, and has in succeeding years been amended by later Acts which have repealed or modified certain sections of the principal Act; and these new provisions, which, in the case of nearly every Act, are to be read with the Act of 1854, will be noticed in their proper place.

The Merchant Shipping Act, 1854 consists of 548 sections, and is divided in eleven parts. The first treats of the Board of Trade and its general functions; the second of British ships, their ownership, measurement, and registry; the third of masters and seamen; the fifth part to pilotage; the ninth to the liability of shipowners; the tenth to the procedure under the Act, and the remaining parts to matters beyond the scope of these remarks.

1. With respect to the first and second parts of the Merchant Shipping Act, 1854, the provisions in them, speaking generally, apply to pleasure yachts, except where such vessels are expressly excepted by the terms of each particular section. By sect. 19 of the Act of 1854 every British owner of a yacht, whether used for pleasure (as yachts belonging to yacht clubs) or otherwise (as the yachts belonging to the Trinity House and the light-house boards), must register his yacht, unless she was registered before the provisions of the Act of 1854 came into operation; or unless she be of less burden than 15 tons register, and be used solely for navigation on the rivers or coasts of the United Kingdom. If a yacht belonging to a British owner is under 15 tons register, and is substantially used for cruising or racing in foreign waters, she comes within the enactment, and must be registered; but if she never ventures beyond coasting voyages, registration under the Act is, in her case, optional. It seems that, on the question whether a coasting pleasure yacht under 15 tons could be refused registration, there was no uniformity of practice at the Custom House at the outports; and accordingly, by a general order issued by the Board of Customs in 1880 to the registrars of British ships, it was directed in effect that any yacht was to be admitted to registration on the application of the owner, without requiring any statement that the vessel was to be employed for cruising in foreign waters. The yacht, if the owner resides in the United Kingdom, should be registered at the Custom House in London, or at one of the outports, and the owner's name should be indorsed as master on the certificate of registry, for the reasons given later on. If a yacht required to be registered under the Act is not registered, she will not be recognised as a British ship, and will not be entitled to any benefits, privileges, advantages, or protection usually enjoyed by British ships, nor to use the British flag; but, so far as regards the payment of dues, the liability to pains and penalties, and the punishment of offences committed on

Yacht—continued.

board the ship, or by any persons belonging to her, she will be dealt with as though she were a recognised British ship. In other words, an unregistered yacht of more than 15 tons has none of the advantages, and all the liabilities, of a registered ship (sect. 106). Further, by sect. 84 of the Act of 1854, whenever any registered ship is so altered as not to correspond with the particulars relating to her tonnage or description contained in the register book, then, if the alteration is made at a port where there is a registrar, the registrar of that port, but, if made elsewhere, the registrar of the first port having a registrar at which the ship arrives after her alteration, shall, on application made to him, and on the receipt of a certificate from the proper surveyor specifying the nature of the alteration, either retain the old certificate of registry, and grant a new one containing a description of the ship as altered, or indorse on the existing certificate a memorandum of the alteration, and put his name to the indorsement.

By the Merchant Shipping Act, 1873 (36 & 37 Vict. c. 85, s. 3), the Board of Trade may exempt any class of ships from being marked in the manner provided by the Act on the stem, stern, and main beam; and accordingly the Board of Trade have issued the following instructions: "Pleasure yachts, barges other than sailing barges, pilot vessels, and vessels employed solely in river navigation, are to be exempted from the requirements of having the name marked on each of the bows, and of having a scale of feet marked on the stem and sternpost; but in these vessels the other requirements of the law are to be observed, viz.: those that require the name and port of registry to be marked on the stern, and the official number and the number denoting the tonnage to be marked on the main beam, except in the case of yachts used for pleasure only, which, on special application in each case from the owner to the board, may be exempted from the observance of the regulations which require the name and port of registry to be marked on the stern, upon proof to the board's satisfaction that the owner is entitled to the privilege asked for. Yachts of the following clubs and pilot vessels have been exempted from the provisions of having the name and port of registry marked on the stern, namely." Then follows a list of Royal Yacht Clubs.

A provision is contained in the second part of the Merchant Shipping Act, 1854, which is most material with reference to the flags which British yachts may lawfully carry on the high seas. The 105th section of the Act provides in effect that anyone within the jurisdiction of the Admiralty, i.e., on the high seas, flying any colours representing those worn by the Queen's ships, or any distinctive national colours (except the red ensign, or the union jack with a white border), without a warrant from Her Majesty or the Admiralty, shall be liable to a penalty not exceeding the amount of 500*l.* It should here be mentioned

Yacht—continued.

that the Admiralty Court has from ancient times exercised a jurisdiction *in rem* in cases where illegal colours have been carried. This jurisdiction the Admiralty Division of the High Court of Justice still preserves, independently of the provision of sect. 105 just referred to. As it is not the practice to issue Admiralty warrants to unregistered yachts, the white or blue ensign cannot be used on an unregistered yacht, nor can any yacht fly colours other than those allowed by the club or clubs to which the owner belongs.

The above provisions with respect to the registration of British yachts and the colours to be carried by them, are contained in the first and second parts of the Act of 1854; but part 3 of that Act is the most important to the yachtman, as it deals, *inter alia*, with the maintenance of discipline amongst the crew, and with other regulations material to their engagement, conduct during the voyage, and discharge. By the Merchant Shipping Act, 1862 (25 & 26 Vict. c. 63, s. 13) it is enacted that "sea-going ships, being pleasure yachts," shall be subject to the whole of the third part of the Act of 1854, except certain sections, twenty-nine in number, relating for the most part to things in which yachtmen are not concerned, except sect. 149, which will be specially noticed when considering the effect of signing articles.

Yacht Club.—A club formed with the ostensible object of associating yacht owners, and promoting a fondness for the sea. (See "Recognised Yacht Club.")

Yachting Etiquette.—British yacht owners follow the regulations of the Royal Navy as far as possible in saluting, &c. (See "Saluting;" see also the "Queen's Regulations for the Royal Navy," which can be obtained from Messrs. Harrison and Sons, price 2*s.* 6*d.*) The New York Yacht Club this year (1882) drew up the following code for the guidance of young yachtmen:

Yachts in commission should hoist their colours at 8 o'clock a.m. and haul them down at sunset, taking time from the senior officer present.

Between sunset and colours they should carry a night pennant.

No guns should be fired on setting or hauling down the colours, except by the yacht giving the time; nor between sunset and colours, nor on Sunday.

The senior officer in port should be in command, and should make colours and sunset, make and return salutes and visits, &c.

His yacht should remain the station vessel until a senior to him in rank arrives, when such senior should assume the duties of the anchorage.

Flag officers should display their pennants while in commission, except when absent for more than forty-eight hours. In such case their private signal should be hoisted.

Owners when not on board should display a blue rectangular flag at the starboard spreader.

Single-masted vessels should display their private signal when entering a home port of this club, or when approaching other yachts at sea.

A white rectangular flag should be displayed at the main starboard spreader on schooners, and the starboard spreader on single-masted vessels, during the meal hours of the owner.

A red pennant at the fore port spreader on schooners, and the port spreader on single-masted vessels, during the meal hours of the crew.

The Commodore, when on board at night, should

Yachting Etiquette—continued.

display two blue lights perpendicularly at the stern; when absent, one blue light should be displayed.

The Vice-Commodore, red lights, as above.

The Rear-Commodore, white lights, as above.

Captains, when on board, a white light under the boom, and over the quarterdeck or cockpit.

All salutes should be returned in kind.

Yachts, passing one another, should always exchange salutes, juniors saluting first.

Flag officers, on entering port, should be saluted on rounding to, by the yachts present.

Captains should salute the yachts at anchor.

These rules should not apply to yachts leaving for, or returning from, a day's sail.

All visits should be made according to rank.

Salutes between yachts passing at sea should be made by dipping the ensign three times, or by firing a gun, followed by the dipping of the ensign.

By dipping the ensign, or by firing a single gun, on letting go anchor.

By dipping the ensign, or by firing a single gun when they let go anchor.

By firing a single gun, with the flag of the foreign club displayed—schooners and steamers at the fore, single-masted vessels at the topmast head—or, in the absence of such flag, by half-masting the club flag while firing a gun. When the salute shall have been returned or a reasonable time for its return allowed, the flag should be hauled down and the club flag hoisted.

This salute from or to yachts arriving after sunset or on Sunday should be made immediately after hoisting the colours on the following morning.

When a flag officer makes an official visit, a gun should be fired, and his pennant displayed at the fore, in schooners, and at the topmast head in single-masted vessels, while he remains on board.

Owners of yachts should signal their intentions to the officer in command. If too distant to signal, and they proceed with the squadron into port, they should report to him on anchoring; if they part company, as above, they should notify him, on reaching whatever port they make, of the entry they have made, and of their immediate plans.

If they join the squadron at anchor, they should report to the commanding officer; and should obtain his permission before leaving it.

When under sail, with the squadron, firing guns and signalling should be avoided, except when joining or parting company, or when repeating for information signals made from the flag-ship.

When squadrons of different clubs meet at sea, salutes should be exchanged only by the commanding officers.

Salutes from single yachts at sea should only be answered from the flag-ship.

Single-masted vessels should display their private signals when under sail with the squadron. When at anchor the club flag.

When a foreign yacht arrives, the senior officer present should send on board, without regard to rank, a tender of the civilities of the club.

Yachts should salute on entering port in the home waters of a foreign club, where any of its fleet are lying. After the tender of civilities has been made, owners of the entering yachts should visit the officer in command of the anchorage. All other visits should be made according to rank, visits to their equals in rank being made by the owner of the entering yachts.

If the squadron of this club be at anchor also, the salute should be made to its commanding officer, unless it be a senior flag-officer entering, when he should be saluted by the squadron, and should in his turn salute the foreign fleet.

Colours and sunset in the home waters of a foreign club should be made with its senior flag-officer.

The term "foreign" should be understood as applying to all clubs outside of the waters of New York and Newport harbours and Long Island Sound.

Seniors should precede, boarding yachts, and landing.

Juniors, leaving yachts or landings, should enter first. Flag officers should display their pennants, and captains their private signals, when in their boats; members, the club signal.

Salutes should only be made to boats displaying flags, as above.

Junior flag officers, captains, and members in charge of boats, should lie on their oars to the commodore's boat, and raise the cap. Passing one another, they should salute according to rank, by raising the cap.

Yachting Etiquette—continued.

Sailing-masters, under officers, and crew, should lie on their oars to all boats displaying flags, as above, and raise the cap. The salute from boats under sail, laden or in tow, should be made by raising the cap.

All boats approaching a yacht at night, should be hailed.

The answer for the commodore, when intending to board, should be "Commodore;" for junior flag officers, "Flag;" for captains and members, "Aye, aye;" for captains returning on board, the name of their yacht? for visitors, "Visitors;" for sailing masters, &c., "No, no," using the port side; for passing boats, "Passing."

Yacht Racing Association.—An association of yachtsmen founded in 1875 in order to provide one code of sailing rules for use in all matches, and to decide such disputes as might be referred to the Council of the Association. The Association and Council are constituted similarly to the Jockey Club. The following are the Y.R.A. sailing rules, as sanctioned for 1892:—

1. *Management of Races.*—All races, and all yachts sailing therein, shall be under the direction of the flag officers or Sailing Committee of the club under whose auspices the races are being sailed. All matters shall be subject to their approval and control; and all doubts, questions, and disputes which may arise shall be subject to their decision. Their decisions shall be based upon these rules so far as they will apply, but as no rules can be devised capable of meeting every incident and accident of sailing, the Sailing Committee should keep in view the ordinary customs of the sea, and discourage all attempts to win a race by other means than fair sailing and superior speed and skill. The decisions of the Sailing Committee shall be final, unless they think fit, on the application of the parties interested, or otherwise, to refer the questions at issue for the decision of the Council of the Yacht Racing Association. No member of the Sailing Committee or Council shall take part in the decision upon any disputed question in which he is directly interested. The Sailing Committee, or any officer appointed to take charge for the day, shall award the prizes, subject to rule 29. If any yacht be disqualified, the next in order shall be awarded the prize.

2. *Postponement of Races.*—The Sailing Committee, or officer in charge for the day, shall have power to postpone any race, should unfavourable weather render such a course desirable.

3. *Measurement for tonnage.*—The tonnage of every yacht entered to sail in a race shall be ascertained in the manner following: the length shall be taken in a straight line from the fore-end to the after-end of the load water-line, provided always that if any part of the stem or stern-post, or other part of the vessel below the load water-line project beyond the length taken as mentioned, such projection or projections shall, for the purposes of finding the tonnage, be added to the length taken as stated; the breadth shall be taken from outside to outside of the planking, in the broadest part of the yacht, and no allowance shall be made for wales, doubling planks,

Yacht Racing Association—continued.

or mouldings of any kind: add the breadth to the length and multiply the sum thus obtained by itself and by the breadth, except in the classes of 10 tons and under; then divide the product by 1730 and the quotient shall be the tonnage in tons and hundredths of a ton; a fraction shall count as a ton: but in the case of yachts built prior to August, 1881, to compete in the 40 tons class which exceed their class tonnage under the foregoing rule, the fraction shall be disregarded if such fraction does not exceed the class tonnage by more than half a ton; and in the case of the fraction exceeding the class tonnage by more than half a ton, up to one ton, yachts shall be allowed to compete in their class by allowing time on one ton; and yachts built prior to August, 1881, to compete in the 20 tons and 15 tons classes, which exceed their class tonnage under the foregoing rule by not more than half a ton, shall be allowed to compete in their respective classes by allowing time on half a ton; and yachts built prior to August, 1881, to compete in the classes of 10 tons and under which now exceed their class tonnage, under the foregoing rule, by not more than half a ton, shall be allowed to compete in their respective classes by allowing time. If, from any peculiarity in the construction of a yacht, or other cause, the measurer shall be of opinion that this rule will not measure the yacht fairly, he shall report the circumstances to the council or sailing committee, who, after making such inquiries as they consider necessary, shall award a certificate of tonnage accordingly. The certificate of tonnage of the Yacht Racing Association shall be deemed a yacht's true racing tonnage, so long as she remains unaltered.

4. *Time allowance.*—Time shall be allowed on arrival for difference in tonnage, according to the annexed scale, increased or decreased in proportion to the length of different courses. In all cases where time has to be allowed for difference of tonnage in the classes of 10 tons and under, it shall be computed by tons and tenths of a ton.

Shortening Course.—If it is necessary during a race to shorten the course, the signal flag denoting the race hoisted under the white Peter, or in case of fog or darkness two guns fired shall show that the race is to finish with the round about to be completed, and the time allowance shall be reduced in proportion. (See "Time Allowance.")

5. *Entries.*—Entries shall be made with the Secretary at least forty-eight hours previous to noon of the day appointed for starting each race. In case of a Sunday intervening, twenty-four hours shall be added. Entries may be made by telegram, and it shall be deemed sufficient that the same shall have been dispatched before noon of the day on which the entries close, subject to the provision as to Sundays. A sailing committee, may, if they think it expedient, refuse any entry.

Yacht Racing Association—continued.

Form of Entry.—Form of entry to be signed by the owner, or his representative, previous to the race:—

Please to enter the _____ Yacht for the
 race at _____ on the _____ Her
 distinguishing flag is _____; her rig is _____;
 and her tonnage, in accordance with Rule 3,
 is _____ tons. I undertake that while sailing
 under this entry she shall not have on board
any bags of shot; that all her ballast shall be
 properly stowed under the platform or in
 lockers, and shall not be *shifted or trimmed*
in any way whatever; and that I will obey
 and be bound by the Sailing Rules of the
 Yacht Racing Association.
 Signed this _____ day of _____.

Races re-sailed.—Should any yacht duly entered for a race not start, or having started should she give up, or be disabled during the race, such yacht shall, in the event of the race being resailed, be entitled to start; but no new entries shall be received under any circumstances whatever for a postponed race.

6. *Ownership.*—Each yacht entered for a race must be the *bonâ fide* property of the person or persons in whose name or names she is entered, who must be a member or members of a recognised yacht club.

7. *Only one Yacht of same Owner.*—No owner shall be allowed to enter more than one yacht in a race, except in cases in which a prize is given for each rig, when one yacht of each rig may be entered, nor shall he be entitled to enter the same yacht under different rigs for any race.

8. *Sliding Keels.*—No yachts which are fitted to shift keels, or to otherwise alter their form, shall be permitted to enter.

9. *Member on Board, and Declaration.*—Every yacht sailing in a race shall have on board a member of a recognised yacht club, who, before the prize is awarded, shall sign a declaration that the yacht under his charge has strictly conformed to all the sailing regulations, as follows:—

I hereby declare that the _____ yacht
 whilst sailing in the _____ race this day,
 has strictly observed the sailing rules and
 regulations.

(Signed) _____

Date _____

10. *Distinguishing Flags.*—Each yacht must carry, at her main topmast head, a rectangular distinguishing flag of a suitable size, which must not be hauled down unless she gives up the race. If the topmast be lowered on deck or carried away, the flag must be rehoisted in a conspicuous place as soon as possible.

11. *Instructions.*—Every yacht entered for a race shall, at the time of entry, or as soon after as possible, be supplied with written or printed instructions as to the conditions of

Yacht Racing Association—continued.

the race, the course to be sailed, marks, &c. Nothing shall be considered as a mark in the course unless specially named as such in these instructions.

Distinguishing numbers.—Each yacht shall be given a number with the sailing directions, and should any yacht cross the line before the signal for the start has been made, her distinguishing numeral shall be exhibited as soon as conveniently may be as a recall, and kept displayed until the said yacht shall have either returned and recrossed the line to the satisfaction of the sailing committee, or have given up the race. [The numbers to be in white on a black ground and the figures not less than 2ft. 6in. in height.]

12. *Sails.*—There shall be no restrictions as to sails, or the manner of setting and working them; but steam power must not be used for hoisting sails.

13. *Crew and Friends.*—There shall be no limit as to the number of paid hands, and no restrictions as to the number of friends, or to their working. No paid hand shall join or leave a yacht after the signal to start, except in case of accident or injury to any person on board. [This rule is not intended to apply to Corinthian matches.]

14. *Fittings and Ballast.*—All yachts exceeding five tons shall be fitted below deck with the ordinary fittings of a yacht, including two transverse bulkheads of wood, and their platforms shall be kept down, and bulkheads standing. No water shall be started from or taken into the tanks after the signal to start has been made. No more than the usual anchors and chains shall be carried during a race, which must not be used as shifting ballast, or for altering the trim of the yacht. No bags of shot shall be on board, and all ballast shall be properly stowed under the platform or in lockers, and shall not be shifted or trimmed in any way whatever during a race. No ballast shall be shipped or unshipped after nine p.m. of the day previous to the race. A race resailed shall, so far as regards this rule, be considered a new race.

15. *Boats and Life Buoys.*—Every yacht exceeding thirty and under seventy tons, shall carry a boat on deck not less than ten feet in length and three feet six inches beam, and every yacht of seventy tons and over, one of not less than twelve feet in length, and three feet six inches beam, with oars lashed in them, ready for immediate use. Each yacht shall carry one life buoy on deck ready for use.

16. *Starting.*—The yachts shall start from moorings, anchors, or under-way, as directed by the Sailing Committee. Half-an-hour before the time of starting one of the following flags of the Commercial Code shall be hoisted as a preparative flag for the yachts of each successive race; in case of a start from anchors or moorings to take up their stations for the start with headsails down, or all sails down, as the Sailing Committee may direct;

Yacht Racing Association—continued.

or in case the start be a flying one, to approach the starting line, viz :—

B of Commercial Code for the	
Yachts of the.....	1st Race.
C.....	2nd "
D.....	3rd "
F.....	4th "

and so on.

Five minutes before the start the preparative flag shall be lowered and a blue peter hoisted, and a gun fired; after which, the yachts in the race shall be amenable to the rules. At the expiration of five minutes *exactly* the blue peter shall be hauled down and a second gun fired as a signal to start. If the start is to be made from anchors or moorings, lots shall be drawn for stations, and springs shall be allowed on the same bridle or anchor chain or warp as the bowfasts, but are not to be carried to a buoy, pier, other vessel, or fixed object. If any yacht lets go or parts her bridle before the signal to start, or if she drags any moorings or anchor to which she is made fast for the purpose of starting, she shall be liable to be disqualified, unless such parting or dragging be explained to the satisfaction of the Committee, or unless she has returned, after the signal to start, within the line of starting buoys, so as not to obtain any advantage by the accident. In a flying start if any yacht or any part of her hull, spars, or other equipment, be on, or across the line before the signal to start is made, she must return and recross the line; a yacht so returning or one working into position from the wrong side of the line after the signal to start has been made, must keep clear of all competing yachts. Should the gun miss fire, the lowering of the blue peter shall be the signal to start.

17. When two yachts are approaching one another, so as to involve risk of collision, one of them shall keep out of the way of the other as follows, viz :

A yacht which is running free shall keep out of the way of a yacht which is close-hauled.

A yacht which is close-hauled on the port tack shall keep out of the way of a yacht which is close-hauled on the star-board tack.

When both are running free with the wind on different sides, the yacht which has the wind on the port side shall keep out of the way of the other.

When both are running free with the wind on the same side, the yacht which is to windward shall keep out of the way of the yacht which is to leeward.

A yacht which has the wind aft shall keep out of the way of the other yacht.

18. *Overtaking, Rounding Marks, &c.*—

When rounding any buoy or vessel need to mark out the course, if two yachts are not clear of each other at the time the leading yacht is close to, and actually rounding the mark, the outside yacht must give the other

Yacht Racing Association—continued.

room to pass clear of it, whether it be the lee or weather yacht which is in danger of fouling the mark. No yacht shall be considered clear of another yacht, unless so much ahead as to give a free choice to the other on which side she will pass. An overtaking yacht shall not, however, be justified in attempting to establish an overlap, and thus force a passage between the leading yacht and the mark after the latter yacht has altered her helm for the purpose of rounding.

19. *Obstructions to Sea Room.*—When passing a pier, shoal, rock, vessel, or other obstruction to sea room, should yachts not be clear of each other, the outside yacht or yachts must give room to the yacht in danger of fouling such obstruction, whether she be the weather or the leeward yacht; provided always that an overlap has been established before an obstruction is actually reached.

20. *Luffing and Bearing Away.*—A yacht overtaking any other shall keep out of the way of the overtaken yacht; and a yacht may luff as she pleases to prevent another yacht passing to windward, but must never bear away out of her course to hinder the other passing to leeward—the lee side to be considered that on which the leading yacht of the two carries her main boom. The overtaking vessel, if to leeward, must not luff until she has drawn clear ahead of the yacht she has overtaken.

21. *Close-hauled Approaching Shore.*—If two yachts are standing towards a shore or shoal, or towards any buoy, boat, or vessel, and the yacht to leeward is likely to run aground, or foul of such buoy, boat, or vessel (a mark vessel excepted), and is not able to tack without coming into collision with the yacht to windward, the latter shall at once tack on being hailed to do so by the owner of the leeward yacht, or the person acting as his representative, who shall be bound to see that his own vessel tacks at the same time.

22. *Running Aground, &c.*—Any yacht running on shore, or foul of a buoy, vessel, or other obstruction, may use her own anchors, boats, warps, &c., to get off, but may not receive any assistance except from the crew of the vessel fouled. Any anchor, boat, or warp used must be taken on board again before she continues the race.

23. *Fouling Yachts, Marks, &c.*—Each yacht must go fairly round the course; and must not touch any buoy, boat, or vessel used to mark it out, but shall not be disqualified if wrongfully compelled to do so by another yacht. Any yacht causing a mark vessel to in any way shift her position to avoid being fouled by such yacht, shall be disqualified. If a yacht, in consequence of her neglect of any of these rules, shall foul another yacht, or compel other yachts to foul, she shall forfeit all claim to the prize, and shall pay all damages.

24. *Means of Propulsion.*—No towing, sweeping, poling, or pushing, or any mode of propulsion except sails, shall be allowed.

Yacht Racing Association—continued.

25. *Anchoring.*—A yacht may anchor during a race, but must weigh her anchor again, and not slip. No yacht shall during a race make fast to any buoy, stage, or pier, or send an anchor out in a boat, except for the purpose of rule 24.

26. *Sounding.*—No other means of sounding than the lead and line allowed.

27. *Side Lights.*—All yachts sailing in a race at night shall observe the Board of Trade rule as to the carrying of side lights.

28. *Man Overboard.*—In case of a man falling overboard from a competing yacht, all other yachts in a position to do so shall use their utmost endeavours to render assistance; and if it should appear that any yacht was thereby prevented winning the race, the committee shall have power to order it to be resailed between any yacht or yachts so prevented and the actual winner.

29. *Protests.*—Should the owner of any yacht, or the person acting as his representative, consider that he has a fair ground of complaint against another for foul sailing, or any violation of these rules, he must, if it arise during the race, signify the same on first passing the committee vessel, by showing an ensign conspicuously in the main rigging. The protest shall be made in writing, and under such regulations (if any) as the sailing committee may have determined, within twelve hours of the arrival of the protesting yacht, and shall be heard by the sailing committee and decided, after such inquiries as they may consider necessary. A protest made in writing shall not be withdrawn. A sailing committee shall also, without a protest, disqualify any yacht, should it come to their knowledge that she has committed a breach of the rules.

30. *Removal of Flag Boat.*—Should any flag vessel, or other mark, be removed from its proper position, either by accident or design, the race shall be sailed over again, or not, at the discretion of the sailing committee.

31. *Disqualification.*—Any yacht disobeying or infringing any of these rules, which shall apply to all yachts whether sailing in the same or different races, shall be disqualified from receiving any prize she would otherwise have won, and her owner shall be liable for all damages arising therefrom.

32. *Penalty for disobeying rules.*—Should a flagrant breach or infringement of any of these rules be proved against the owner of any yacht he may be disqualified by the council, for such time as the council may think fit, from sailing his yacht in any race held under the rules of the Yacht Racing Association; and should a flagrant breach of these rules be proved against any sailing master he may be disqualified by the council, for such time as the council may think fit, from sailing in any race held under the rules of the Yacht Racing Association.

Yacht Racing Association—continued.

33. *Cruising Trim.*—When yachts are ordered to sail in cruising trim, the following rules are to be strictly observed:—

1. No doors, tables, cabin skylights, or other cabin or deck fittings (davits excepted) shall be removed from their places before or during the race.
2. No sails or other gear shall be put into the main cabin in yachts exceeding forty tons.
3. Anchors and chains suitable to the size of the yacht shall be carried, one at the cathead (or in yachts of forty tons and under, at the usual place on the bow), which anchor shall not be unshackled from the chain before or during the race.
4. Every yacht exceeding thirty and under seventy tons, shall carry a boat on deck not less than ten feet in length and three feet six inches beam—a yacht of seventy tons and over, her usual cutter and dinghy.
5. No extra hands, except a pilot, beyond the regular crew of the yacht shall be allowed.

In the Appendix the Yacht Racing Association further recommend for the consideration of Sailing Committees:—

1. *Allowance to Schooners and Yawls.*—That as mixed races are no satisfactory test of the relative speed of yachts, the different rigs should, whenever practicable, be kept separate; but when mixed races are unavoidable, the following rule shall be observed:—

The tonnage of schooners and yawls to be reckoned for time allowance as follows, viz., schooners at three-fifths, and yawls at four-fifths of their actual tonnage; provided that in case of a yawl, her main boom when in its place and parallel to the deck, does not extend more than two-fifths her extreme beam abaft the stern end of her load water-line. In calculating the deduction for difference of rig, the tonnage by certificate to the exact fraction to be used. The time allowances to be calculated from each vessel's reduced tonnage. Schooners and yawls shall not be allowed to enter in classes of forty tons and under at the reduced tonnage.

2. *One yacht entitled to sail over.*—That when a prize has been offered for competition, any yacht, duly entered, should be allowed to sail over the course and be entitled to the prize; subject, however, to Rule 2.

3. *Flying Starts.*—That flying starts should be adopted when practicable, but no time should be allowed for delay in starting.

4. *No Limit to Race.*—That any limit to the time for concluding a race should be avoided as far as possible.

5. *Classification.*—That the classification of yachts should, when practicable, be as follows:—

Yacht Racing Association—continued.

Of or under	3 Tons.
Not exceeding	5 "
Above 5 tons and not exceeding 10 ..	"
" 10 " " " 15 ..	"
" 15 " " " 20 ..	"
" 20 " " " 40 ..	"
" 40 " " " 80 ..	"
" 80 ..	"

6. *Courses.*—That as distance is an important element in the calculation of time allowance, the marks and flag boats should be placed so as to mark as accurately as possible the length of the course, for which time is allowed.

7. *Rounding Marks.*—That in heavy weather it should be arranged, if practicable, for yachts to stay instead of gybe round marks.

8. *Room at Starting.*—Sailing Committees should be particularly careful to provide ample room between the points marking the starting line.

Yacht Register.—A book compiled by the well known committee of Lloyd's Society, at the request of yacht owners. Hitherto difficulty was experienced in arriving at the age and condition of a yacht, but the Register contains all the particulars an intending purchaser need know. Owners will derive benefit from having their yachts surveyed and classed at Lloyd's, and special facilities now exist for making such surveys and assigning characters. The Register contains the following particulars: Names of yachts; official number, number in the Register; signal letters; rig; sailmaker's name; registered tonnage, N.M.; Thames tonnage; dimensions (length, breadth, and depth); repairs to yacht, and date thereof; nature of repairs; class; materials used in her construction; builder's name; date of building; port; port of survey; fastenings; sheathing; description of engines; builders of engines, &c. The first part of the Register contains the rules and regulations for building for classification. These rules and regulations relate to wood, iron, and composite yachts; and tables of scantlings, fastenings, &c., are given for each, together with a table for anchors, chains, &c., for sailing yachts and steam yachts. This part of the book is most valuable, and will be a large help to builders who have little experience of the particular work required in a yacht, and will as well be found of great use to the more experienced builders. A yacht can be built of any material and fastened in almost any way an owner or builder may desire, and still she can be admitted with a grade into the book. Existing yachts can be surveyed, and, if approved, assigned the A 1 class for fourteen years, or any other grade, according to their construction, condition, and age. The Register also contains full information as to the manner of having a survey effected; list of surveyors and their addresses; list of owners and their addresses; list of subscribers and their addresses. The offices are Lloyd's

Register of British and Foreign Shipping, White Lion Court, Cornhill, E.C. (See Lloyd's.)

Yard.—A spar used to extend a sail.

Yard Arm.—The extremities of yards.

Yarn.—A yarn is generally understood to mean one of the parts of a strand of a rope. The strands of old rope are separated and used as stops for temporarily securing sails when rolled up, &c. A narrative, a tale, a long story, or discourse. (See "Strands.")

Yaw.—When a vessel's head flies from one direction to another; generally when a vessel does not steer a straight or steady course.

Yawl.—A cutter-rigged vessel with a mizen mast stepped in her counter.

Yellow Flag.—The quarantine or fever flag.

Yoke.—The lower cap on the masthead. It is cut out of solid wood, and either strengthened by an iron plate over the whole of its top, or an iron band round its entire edge. The cross trees are fitted on the yoke. (See page 31.) A yoke is also the crossbar put on the rudder-head of small boats, to which lines, termed yoke lines, are attached for steering.

Z.

Zig-Zag.—Working to windward.

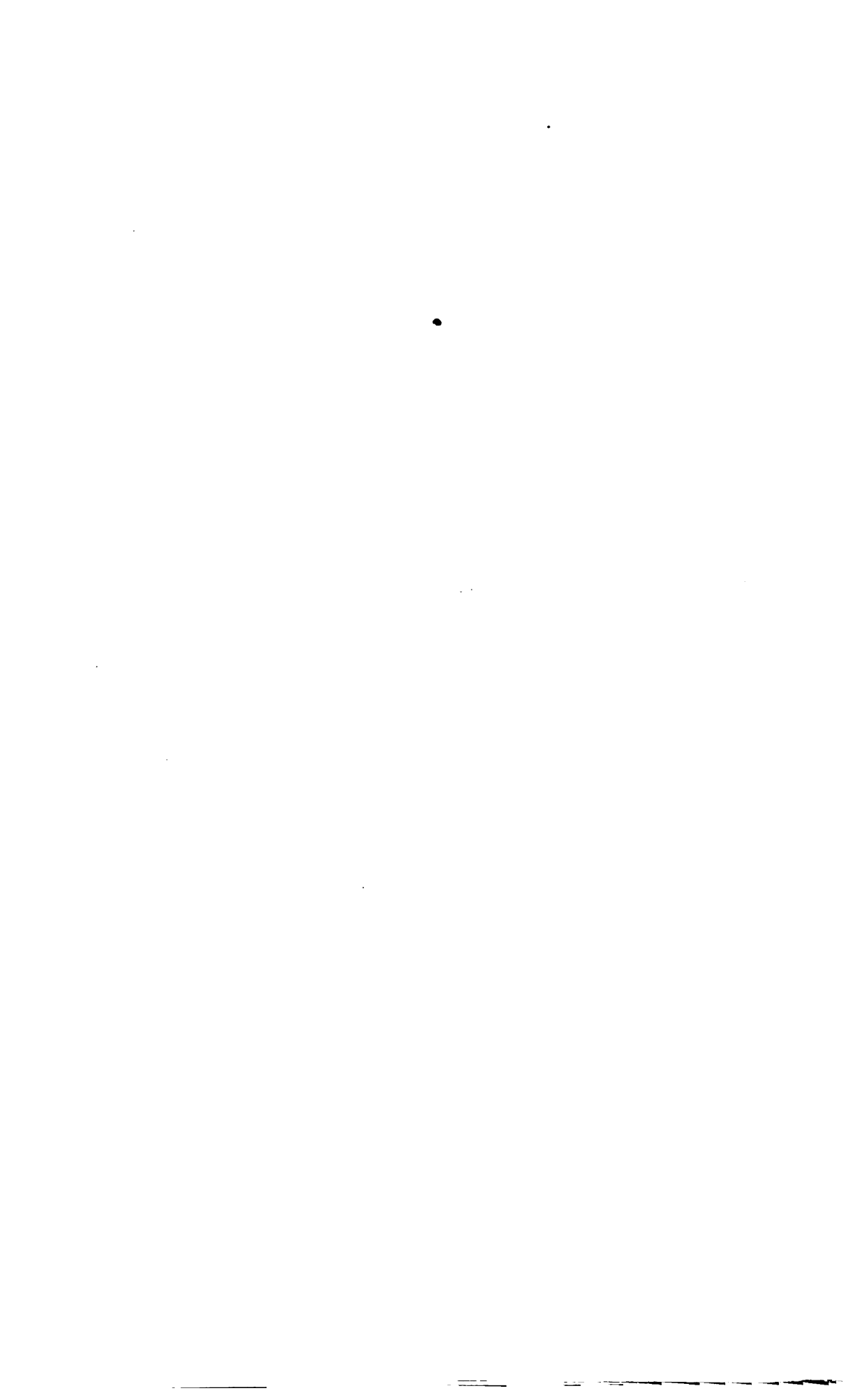

INDEX.

<p style="text-align: center;">A.</p> <p>Agreements with crewpage 125</p> <p>Alert, centre-board sloop 233</p> <p>Algoa Bay lateens 224</p> <p>Amateur canoe building 482</p> <p>American canoes..... 473</p> <p style="padding-left: 20px;">catamaran John Gilpin 352</p> <p style="padding-left: 20px;">river canoe 476</p> <p style="padding-left: 20px;">sharpies and sneak boats 254</p> <p style="padding-left: 20px;">sloop Parole 253</p> <p style="padding-left: 20px;">Una boats 247</p> <p>Anchoring during a yacht match 171</p> <p style="padding-left: 20px;">or mooring under various conditions of wind, tide, &c. 106-108</p> <p>Approaching a shore in yacht racing, and requiring a yacht to tack 162</p> <p>Arrow, yacht on Norfolk Broads..... 282</p> <p style="text-align: center;">B.</p> <p>Balance lug sail 201</p> <p>Balleners, whale boat 339</p> <p>Balloon foresail, to set 71</p> <p>Bearing away in match sailing..... 154, 164</p> <p>Belfast yawls 335</p> <p>Bells, striking of..... 120</p> <p>Blocks, examination of, for defects 17</p> <p style="padding-left: 20px;">for yachts of all sizes 32, 34, 35, 36</p> <p>Board wages 127</p> <p>Boat for rowing and sailing, with design..... 181</p> <p style="padding-left: 20px;">with centre-board, built by Mr. E. C. Carline 195</p> <p style="padding-left: 20px;">sailing, the art of 112 117</p> <p>Boats, capsizing of..... 109</p> <p style="padding-left: 20px;">construction of 183</p> <p style="padding-left: 20px;">double 348</p> <p style="padding-left: 20px;">management of New Brighton 267</p> <p style="padding-left: 20px;">open, the management of 108</p> <p style="padding-left: 20px;">qualities of open 108</p> <p style="padding-left: 20px;">rowing or sailing, for ships 335</p> <p style="padding-left: 20px;">tacking of 268</p> <p>Boatswain, duties of 120</p> <p style="padding-left: 20px;">wages of 127</p> <p>Bobstay, carrying away 104</p> <p style="padding-left: 20px;">fitting of 54</p> <p style="padding-left: 20px;">stretching of 81</p> <p>Bolsters 31</p> <p>Bowsprit, carrying away 104</p> <p style="padding-left: 20px;">fittings..... 55</p> <p style="padding-left: 20px;">shrouds 53</p> <p style="padding-left: 20px;">spinnaker 78</p> <p style="padding-left: 20px;">to reef 80</p> <p>Brighton Beach Boats 229</p> <p>Broach to 103</p> <p>Buenos Ayres whale boat Balleners 339</p>	<p>Building a yacht.....page 19</p> <p style="padding-left: 20px;">canoes 482</p> <p>Butler, Thomas, his topmast funnel 46</p> <p>Buttercup, 10-tonner..... 323</p> <p>By the lee 103</p> <p>By the wind, the art of sailing..... 90</p> <p style="text-align: center;">C.</p> <p>Canoe building 482</p> <p style="padding-left: 20px;">cooking apparatus 468</p> <p style="padding-left: 20px;">hammock 471</p> <p style="padding-left: 20px;">sails 406</p> <p>Canoes 375</p> <p style="padding-left: 20px;">American 473</p> <p style="padding-left: 20px;">American river 476</p> <p style="padding-left: 20px;">general management of 478</p> <p style="padding-left: 20px;">getting into one, after capsizing 480</p> <p style="padding-left: 20px;">Clyde canoes and Clyde canoe sails 455-467</p> <p style="padding-left: 40px;">canoe tent 468</p> <p style="padding-left: 40px;">sailing boats 298</p> <p style="padding-left: 20px;">Irish 258</p> <p style="padding-left: 20px;">Jersey Blue..... 474</p> <p style="padding-left: 20px;">Mersey..... 468</p> <p style="padding-left: 20px;">Nautilus 375</p> <p style="padding-left: 40px;">building 376</p> <p style="padding-left: 40px;">racing 393-395</p> <p style="padding-left: 40px;">sails of..... 406</p> <p style="padding-left: 40px;">travelling..... 400</p> <p style="padding-left: 20px;">Pearl 424</p> <p>Carpenter, duties of 120</p> <p>Catamaran John Gilpin..... 353</p> <p>Centre-board boat built by Mr. Carline 195</p> <p style="padding-left: 20px;">fans 178</p> <p style="padding-left: 20px;">boats for rowing and sailing..... 181-194</p> <p style="padding-left: 20px;">Mr. Forwood's 179</p> <p style="padding-left: 20px;">sails for 196</p> <p style="padding-left: 20px;">sloop 233</p> <p>Centre-boards and their cases, construction of 184</p> <p style="padding-left: 20px;">dagger 258, 474</p> <p style="padding-left: 20px;">double 176</p> <p style="padding-left: 20px;">for canoes 383</p> <p style="padding-left: 20px;">their history 173</p> <p>Charm, Chinese yacht 214</p> <p>Cheeks of mast 31</p> <p>Chinese lug sails 209, 213, 214</p> <p>Close-hauled sailing and approaching a shore 162</p> <p style="padding-left: 20px;">sailing in a match 167</p> <p>Clothes of crew 127</p> <p>Club hauling 87</p> <p>Cobles 331</p> <p>Cocker, 5-tonner..... 317</p> <p>Collisions..... 149</p> <p>Composite yachts 22</p> <p>Cook, wages of 127</p>
---	---

- | | | | |
|--|---------------|--|--|
| Cooking stove for canoes | page 468 | | |
| Copper, corrosion and exfoliation of | 23 | | |
| Cordage for yachts of all sizes | 33, 34, 37 | | |
| Cost of yacht racing | 134 | | |
| Counters, immersion of | 341 | | |
| Cowes Una boats | 246 | | |
| Coxswain, duties of | 120 | | |
| wages of | 128 | | |
| Crew, clothes of | 127 | | |
| food of | 127 | | |
| Crews of racing yachts | 133 | | |
| of steam yachts | 358 | | |
| of yachts, the discipline of | 120 | | |
| wages of | 127 | | |
| Cross tacking | 148 | | |
| Crosthrees | 31 | | |
| Customs on board yachts | 118 | | |
| Cutters, advantages of | 6 | | |
| and yawls | 4 | | |
| 40-tonners | 9 | | |
| Kriemhilda, Samona, Vanduara | 9 | | |
| to tack | 82 | | |
| 20 to 5 tons | 10 | | |
| D. | | | |
| Dagger centre-boards | 258, 474 | | |
| Dead eyes | 40 | | |
| Dimensions of various yachts | 38 | | |
| Dinghy man, duties of | 120 | | |
| Discipline on board a yacht | 118 | | |
| Dog watches | 121 | | |
| Double boats | 348 | | |
| Drogue for boats to ride to in heavy sea | 114 | | |
| E. | | | |
| Earing, to pass | 66 | | |
| Elaine, New Brighton sailing boat | 259 | | |
| Elastic lanyards | 42 | | |
| Engineers of steam yachts | 361 | | |
| Entries for yacht matches | 139 | | |
| Equipment of a yacht | 26 | | |
| Expenses of steam yachting | 357 | | |
| F. | | | |
| Falmouth lug sails | 222 | | |
| Fastenings of yachts | 21 | | |
| Fids of all kinds | 48 | | |
| Five-tonners | 317 | | |
| Flags of racing | 139 | | |
| Fore halyards, fore tack, and fore sheets,
the fitting of | 56 | | |
| Foresail, to reef | 71 | | |
| to set | 71 | | |
| Forestay, carrying away | 106 | | |
| fitting of | 52 | | |
| Frames of yachts | 13 | | |
| Freda, 5-tonner | 317 | | |
| Funnels for topmasts | 46 | | |
| G. | | | |
| Galway Hooker | 334 | | |
| Pookhaun | 334 | | |
| Gordon's double-hulled yacht | 352 | | |
| Grub money | 135 | | |
| Gunter, sliding | 220 | | |
| Gybing or wearing | 86 | | |
| H. | | | |
| Hammock for canoe | page 471 | | |
| Head-reaching | 146 | | |
| and sagging to leeward | 148 | | |
| Heaving to | 87, 88, 89 | | |
| Heavy sea, sailing a yacht in | 97, 102, 103 | | |
| Helm and the crew | 120 | | |
| Helmman; sailing a yacht under various
conditions | 90 | | |
| Hooker of Galway | 334 | | |
| Hounds of mast | 31 | | |
| Hove-to on port tack | 153 | | |
| I. | | | |
| Ice yachts | 363 | | |
| of Windermere | 371 | | |
| Immersed counters | 341 | | |
| Instructions for owners of racing yachts | 140 | | |
| Itchen sailing boats | 285 | | |
| punts | 297 | | |
| J. | | | |
| Jersey Blue American canoe | 474 | | |
| Jesty's coating for yachts' bottoms | 23 | | |
| Jib halyards, fitting of | 55 | | |
| sheets, fitting of | 55 | | |
| tack, fitting of | 55 | | |
| topsail, to set and stow | 75 | | |
| to set and shift or stow | 71 | | |
| Jibs, to carry with whole or reefed mainsail | 69 | | |
| John, W., his report on wire and hemp rigging | 42 | | |
| Jullanar yacht | 340 | | |
| Jury mast | 105 | | |
| K. | | | |
| Keels, double | 179, 180 | | |
| Keene, his elastic lanyards | 42 | | |
| Ketch rig | 6 | | |
| Kilkee canoes | 258 | | |
| Kingstown boats | 311 | | |
| L. | | | |
| Lacing, to pass | 66 | | |
| Lalage, coble | 333 | | |
| Lanyards, elastic | 42 | | |
| fitting of | 40 | | |
| Lateen sails | 218, 224 | | |
| Lateens: Capt. Horner's | 296 | | |
| Leaving a yacht during a match | 171 | | |
| Lee; to get by the lee | 103 | | |
| Le Lison, French lateen sloop | 206 | | |
| Liberty to crew | 124 | | |
| Life in a 5-tonner | 2 | | |
| Lights; yachts to carry side lights after
dark in a match | 169 | | |
| Lily, her scantling | 13 | | |
| Lloyd's surveyors | 11 | | |
| Lorelei, 5-tonner | 317 | | |
| Lough Erne centre-board yachts | 245 | | |
| Luffing and bearing away in a match | 164 | | |
| Lugsail, balance | 201 | | |
| standing | 205 | | |
| Lugsails, Chinese | 209, 213, 214 | | |
| Falmouth | 222 | | |
| Penzance | 327 | | |

M.

Mackenzie's double-hulled yachtpage 350

Main and peak halyards, main tack, main-sheet and main outhaul, the fitting of

 halyard blocks 31

Mainsail, to bend 65

 to reef 68

 to scandalise 90

 to set 67

 to stow 70

Main-topmast staysail, to set 76

Management of a yacht's crew, &c..... 118

Management of canoes 478

Markboat, to cause one to move her position 161

Marks, rounding of, in a yacht match 156, 158

Mast, carrying away 105

 to rig a jury 105

Master and ship chandlers 129

 of a yacht, his duties..... 118

 wages of 127

Masthead, yoke cap, &c. 31

Matches, postponement of 139

 re-sailed 139

 the management of under Y. R. A. rules..... 137

Mate, duties of 120

Meeting end on in a match 168

Melling's double-hulled yacht 348

Mersey canoes 468

Missing stays 85

Mizen of yawl..... 29

Munts metal, corrosion and exfoliation of ... 23

N.

Nautilus canoes and Nautilus canoe sails 375 to 424

New Brighton boats, management of 267

 sailing boats 259

Norfolk Broads, yachts of 282

Norwegian pilot boat 337

O.

Oimara as a yawl 4

Outhaul for clew of mainsail 58

Over-reaching 153

Overtaking in a yacht match 164, 166

Owner of yacht and master 118

P.

Parbuckling 104

Parole, American sloop 253

Peacock's composition for yachts' bottoms... 22

Peak halyard blocks 31

Pearl canoe sails and tents 421 to 455

Pendants and runners, fittings of..... 51

Penzance luggers 327

Pilot boats of Norway 338

Pollywog, centre-board sloop 240

Pookhaun 334

Pooping 103

Port and starboard tacks 148

Post entries 139

Powell, Baden, his topmast funnel 46

Preventer backstays 45

R.

Races, postponement ofpage 139

Racing flags..... 139

 money 136

 yacht, the expenses of 134

 the crews of 132

Racking 41

Reef-earing, to bend to tackle 69

 to pass and secure 69

Reef knot..... 69

Richardson, A., his scantling for Lily..... 13

Rigging a yacht 39

 examination of, for defects 17

 of a yacht 26

Ringtail, to set, &c. 79

River canoe 476

Rope for yachts of all sizes 33, 34, 37

Rounding marks in a yacht match 157, 158

Runner, carrying away 106

Runners and pendants 51

Running rigging, the fitting of 55

S.

Sail areas of various yachts 38

 plan of a yacht 27

Sails, examination of, for defects 17

 for centre-board boats 197

 material for canoe sails 470

 sprit..... 215

Sailing along a weather shore in a match ... 166

 a yacht in a heavy sea 97

 before the wind in a match 163

 by the wind, the art of 91

 close-hauled in a match 167

 free in a match 167, 169

 off the wind..... 100

Scandalise a mainsail..... 90

Scantling of yachts 13

Schank, Capt., the inventor of centre-boards 178

Schooner, to tack 84

Schooner's fore topsail, to work, &c. 75

 spar, rigging, and sail plan 30

Schooners and yawls 2

Sculling the rudder in a sailing match to aid steering 170

Seamanship, comprising the art of handing, setting, and taking in sail; management of fore-and-aft craft, &c. 65

Sharpies 254

Ship chandlers and commissions 129

Shoe keel..... 178

Shrouds, bowsprit 53

 carrying away 104

 fitting of..... 39

Side lights in yacht racing 169

Slack rigging, disadvantages of 43

Sliding gunter sails 220

Sloop rig 206

Sloops with centre-boards 233

Smith, Assheton, and wave lines 24

Sneak boats 256

Sounding during a yacht match 171

Spar for gaff, the fitting of 58

Spar plan of a yacht 27

 of schooner 30

Spars, a table of dimensions of yacht's 38

 examination of, for defects 16

 relative weight of cutters' and yawls'... 4

Spinnaker boom, the fitting of	page 61		
to shift	79		
Spinnaker, halyards, outhaul sheet, &c., the fitting of	61		
sailing before the wind	163		
to set, hand, &c.	77		
Spritsail of Norwegian pilot boat.....	337		
Spritsails	215		
Squalls	89		
Squaresail, to set, &c.	76		
Standing lugsail	205		
rigging	39		
Starting yacht matches.....	141		
Stay foresail, to set	71		
Stays, to miss	85		
Staysail, a schooner's maintopmast staysail, to set, &c.	76		
Steam yachting	357		
Sternway in tacking	84		
Steward, wages of	127		
Surbiton gig and balance lugsails	201		
sloops	233		
Surveying a yacht	11		
T.			
Tacking a boat	268		
Tack, to, a cutter, yawl, or schooner	82-84		
Tent of Mersey canoe	470		
of Nautilus canoe	391		
of Pearl canoe.....	452		
Three-tonners	313		
Tonnage cheaters	341		
Topmast backstay, carrying away	106		
carrying away	105		
funnels.....	46		
rigging	44		
to house	80		
to send up	80		
Topping lifts, fitting of	53		
Topsail, a schooner's fore.....	75		
halyards, sheets, and tacks, the fitting of	59		
to bend	73		
sheet, to bend.....	73		
whip and block, the fitting of	60		
sheeting home	146		
to set and take in	73, 74		
Triatic stay, fitting of	52		
carrying away.....	106		
Truant, centre-board yacht	176		
Trysail, to set.....	70		
Tumbler fids	48		
U.			
Una boats	247		
centre-board yacht.....	175		
Under way, to get under way under various conditions of wind and tide	81		
W.			
Wages of crew	page 127		
Watches	120		
Waves, length and motion of	103		
Wearing or gybing.....	86		
Weather-bowling.....	154		
Weathering	146		
Webb, Beavor, his topmast funnel	46		
Weld, Mr. Joseph, as a yacht designer	24		
Whale boat, Ballenera, of Buenos Ayres ...	339		
Wideawake's shoe keel	178		
Windermere ice yachts	371		
Windermere yachts	273		
Wind, sailing before the	163		
Winning and losing money	136		
Wire rope, strength, stretch, and elasticity of	42		
Witch, Lough Erne yacht.....	245		
Work on board a racing yacht.....	137		
Y.			
Yacht becalmed in hollow of waves.....	103		
designs.....	24		
hove to on port tack	153		
Jullanar	340		
racing	131		
the cost of	134		
the right of yachts in different matches	170		
under Y.R.A. rules.....	137		
requiring a, to tack on approaching a shore	162		
the work on board a racing	137		
Yachts amenable to Y.R.A. rules after first gun	172		
and racing crews	132		
dimensions of	38		
examination of, for defects	12		
of 3-tons	313		
of 5-tons	317		
of 10-tons	322		
old	12		
sail areas of	38		
scantling of	13		
table of dimensions of spars of	38		
work, discipline, and customs on board	118		
Yawl for cruising	3		
to tack.....	83		
Yawls and cutters	4		
and schooners.....	2		
mizen	29		
Yoke of mast	31		
Y.R.A. rules, amenable to, after the first gun	172		
Z.			
Zinc, corrosion and exfoliation of	23		

