

THE SAILOR'S HANDY BOOK AND YACHTSMAN'S MANUAL

By E. F. QUALTROUGH, Master, U. S. Navy

With Colored Plates, and many Illustrations

Blue roan, red edges, square 16mo, 620 pages, \$3.50

The American naval service and merchant marine, and that very large class of Americans who are interested in yachting or in some form of seamanship, have hitherto lacked one convenience—almost a necessity, indeed. There has been no one book which, not aiming to replace abstruse scientific and theoretical treatises on seamanship, should bring together in a convenient form the really practical knowledge necessary for a sailor; which should give him, immediately at hand, a compendium of those thousand details prompt and thorough acquaintance with which makes the difference between the good and the incompetent seaman.

This want Lieutenant Qualtrough, of the United States Navy, has now filled by a book which is the most exhaustive and practical that could be planned. Its completeness can best be understood by a summary of its contents; and its publishers announce with pleasure what they believe will be a standard work among American sailors for many years to come.

Sent post-paid, on receipt of price, by

CHARLES SCRIBNER'S SONS, Publishers,
153-157 Fifth Avenue, New York.

THE
BOAT SAILER'S MANUAL

A

*COMPLETE TREATISE ON THE MANAGEMENT OF SAILING
BOATS OF ALL KINDS, AND UNDER ALL
CONDITIONS OF WEATHER*

CONTAINING ALSO

*CONCISE DESCRIPTIONS OF THE VARIOUS RIGS IN GENERAL
USE, AT HOME AND ABROAD, DIRECTIONS FOR HANDLING
SAILING CANOES, AND "THE RUDIMENTS OF
CUTTER AND SLOOP SAILING"*

WITH NUMEROUS PLATES AND ILLUSTRATIONS.

BY

EDWARD F. QUALTROUGH

LIEUTENANT UNITED STATES NAVY

AUTHOR OF "THE SAILOR'S HANDY BOOK" AND "YACHTSMAN'S MANUAL"

REVISED EDITION

NEW YORK
CHARLES SCRIBNER'S SONS

1896

KC 8030



0447219

**COPYRIGHT, 1936, 1896, BY
CHARLES SCRIBNER'S SONS**

**TROW'S
PRINTING AND BOOKBINDING COMPANY,
NEW YORK.**

PREFACE.

SINCE the publication of "THE SAILOR'S HANDY BOOK," I have arrived at the opinion that a more elementary work, and one which should chiefly treat of the handling and rigging of small craft, would prove very acceptable to a large class of persons, who, while not aspiring to the designation of yachtsmen, take considerable pleasure in the possession and management of Sailing-boats.

The material used in the compilation of this little manual has been gleaned from the very highest sources, and every effort has been made to "winnow the chaff from the grain," and to arrange the valuable matter selected in such form as to set forth clearly and concisely "The Art of Boat-sailing."

My special acknowledgments are due to Mr. W. P. Stephens and the *Forest and Stream* Publishing Co. for permission to avail myself of certain plates from "Small Yachts;" and sincere thanks are tendered to my professional and other friends whose valuable suggestions have been incorporated in "THE BOAT SAILER'S MANUAL."

EDWARD F. QUALTROUGH,
Lieutenant U. S. Navy.

WASHINGTON, D. C.

CONTENTS.

	PAGE
SECTION I.	
INTRODUCTORY REMARKS. FLOTATION. STABILITY, AND LATERAL RESISTANCE. ACTION OF RUDDER, AND EFFECT OF THE WIND. BALLAST. MATERIALS FOR AND ARRANGEMENT OF SAME. REMARKS ON THE POINTS OF SAILING. TRIMMING THE BOOM, ETC. PRELIMINARY DEFINITIONS, AND NAUTICAL EXPRESSIONS. MARLINSPIKE SEAMANSHIP. KNOTS, HITCHES, BENDS, AND SPLICES. WORMING, PARCELLING, AND SERVING. SLINGING CASKS AND BALES.....	1
SECTION II.	
THE MOST SERVICEABLE TYPE OF BOAT. STIFFNESS OF OPEN BOATS. CAT-BOATS. FORBES CAT RIG. NEWPORT AND EASTERN CAT-BOATS. KEEL CAT-BOATS. THE BALANCE LUG SAIL. CENTREBOARD BOATS FOR ROWING AND SAILING. ANCHORS, ETC. SAIL AREAS, ETC. THE BEGINNER'S FIRST SAIL. HINTS AND CAUTIONS FOR PERSONS SAILING SMALL BOATS.....	35
SECTION III.	
JIB AND MAINSAIL BOATS. PAROLE AND CRUISER. JIB AND SPRIT RIG. SLIDING GUNTER. FRENCH GUNTER RIG. LEG OF MUTTON. SHARPIE AND NONPAREIL. BERMUDA BOATS. MAIN-AND-MIZZEN RIG. BATTENED SAILS. LATTEEN RIG, SHEERMASTS, ETC. LUG SAILS, CLYDE LUG-SAIL BOATS. SETTEE SAILS. NEW BRIGHTON BOATS. REMARKS ON THE DOUBLE HEAD-SAIL.....	69

SECTION IV.

PAGE

THE MANAGEMENT OF SAILING-BOATS HAVING MORE THAN ONE SAIL. GETTING UNDER WAY. SAILING TO WINDWARD. TACKING, ETC. SAILING FREE AND RUNNING BEFORE THE WIND. REEFING. SQUALLS. SAILING ALONG SHORE, ETC. REMARKS ON CAPSIZING, SAILING AMONGST WAVES, ETC. HANDLING BOATS IN A GALE. ANCHORING, STOWING THE SAILS, ETC. BOAT RACING. RULES AND ALLOWANCES	105
---	-----

SECTION V.

CANOE SAILING. CLASSIFICATION OF CANOES. SAIL-CARRYING POWER, ETC. SAILS AND RIGGING. VARIETY OF SAILS IN COMMON USE. HANDLING CANOES UNDER SAIL. CANOE FITTINGS	143
--	-----

SECTION VI.

THE CUTTER AND SLOOP RIGS. THE CUTTERS DAISY, CARMITA, AND MIGNONETTE. THE CENTREBOARD SLOOP GLEAM, AND THE KEEL SLOOP ALICE. WINDERMERE AND NORFOLK SLOOPS. THE RUDIMENTS OF CUTTER AND SLOOP SAILING. THE YAWL AND DANDY. QUESTIONS IN FORE-AND-AFT SEAMANSHIP. NAVY BOATS. RIGS FOR NAVY BOATS. HANDLING MAN-OF-WAR BOATS UNDER SAIL. MANAGEMENT OF NAVY BOATS UNDER OARS. BOARDING A WRECK OR VESSEL IN A HEAVY SEA	195
---	-----

SECTION VII.

WEATHER INDICATIONS, ETC. SOME USEFUL RECIPES. HINTS TO BATHERS. INSTRUCTIONS FOR SAVING DROWNING PERSONS. TREATMENT OF THE APPARENTLY DROWNED. ACCIDENTS. INJURIES AND POISONS. COOKERY. COOKERY FOR THE SICK. SOME NAUTICAL TERMS IN COMMON USE.	231
--	-----

Section 1.

INTRODUCTORY REMARKS.

**FLOTATION. STABILITY, AND LATERAL
RESISTANCE.**

ACTION OF RUDDER, AND EFFECT OF THE WIND.

**BALLAST. MATERIALS FOR AND
ARRANGEMENT OF SAME.**

**REMARKS ON THE POINTS OF SAILING.
TRIMMING THE BOOM, ETC.**

**PRELIMINARY DEFINITIONS AND NAUTICAL
EXPRESSIONS.**

MARLINSPIKE SEAMANSHIP.

KNOTS, HITCHES, BENDS, AND SPLICES.

WORMING, PARCELLING, AND SERVING.

SLINGING CASKS AND BALES.

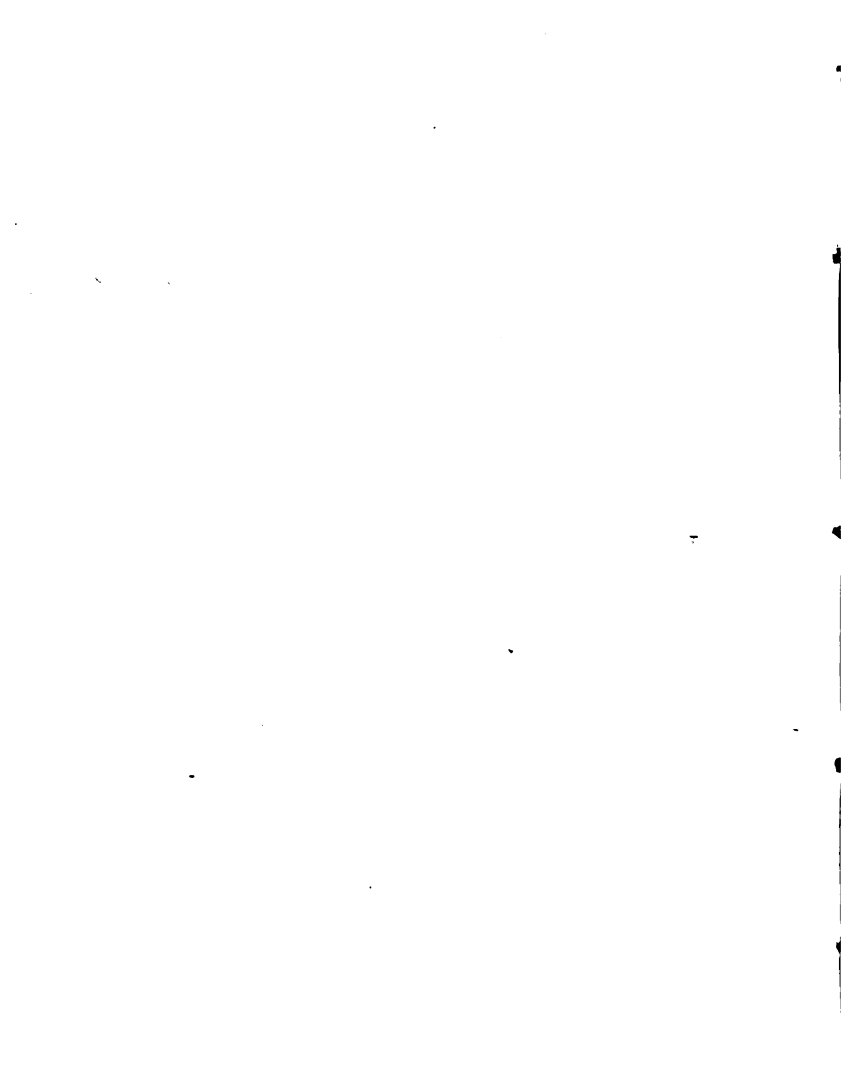

INTRODUCTORY REMARKS.

SOME preliminary preparation is very desirable before any young man should attempt the actual practice of boat sailing.

There is one acquirement necessary at the very outset. *Learn to swim* before you venture sailing. Many a life has been lost for the lack of the ability to swim a few rods, or to support a friend for a short time in the water.

Coolness, caution, and judgment are qualities absolutely essential to all persons who expect to become expert boat-sailors. Many young men appear to consider it very dashing and sailor-like to carry on recklessly, but in reality it is both foolish and dangerous, and is also very unfair to the boat itself, which, in the hands of a careful and skilful boatman, seems to become in very truth "a thing of life."

FLOTATION, STABILITY, AND LATERAL RESISTANCE.

BOATS ordinarily float on the surface of the water, and it will be our endeavor to explain this floating-power as clearly and concisely as possible.

The weight of a cubic foot of fresh water is $62\frac{1}{2}$ pounds. Any substance of exactly the same weight for bulk would sink in water until it was covered, but would not go to the bottom unless forced there. If the substance were heavier than the corresponding bulk of water, it would sink with greater rapidity. If it were lighter it would float, with more or less of it above the surface.

The rule may be stated as follows :

Any body which, bulk for bulk, is lighter than water will displace a quantity of water equal to its own weight. The space which it occupies beneath the surface will contain a quantity of water just equal to the total weight of the boat and everything on board at the time.

Thus a boat weighing a ton will displace exactly a ton of

water, and if a man weighing one hundred and fifty pounds gets into the boat, one hundred and fifty pounds of water will be displaced by the additional weight added by him.

The wind has two principal effects upon the sails of a boat ; one tending to propel the boat, and the other tending to heel or upset it. While the propelling effect must be encouraged, the heeling effect must be resisted.

The effect of the upsetting force of the wind on the sails of a boat is resisted by *stability*.

A boat may have sufficient stability arising from her form alone, or, as is generally the case, she may require to be given greater stability by the addition of extra weight.

Next in order to stability must be considered *lateral resistance*.

When sailing in any direction, except before the wind, there is a sidewise pressure exerted by the wind, as well as a forward pressure. This lateral pressure must be resisted as much as possible, so that the boat may sail in the direction she points, and may not drift sideways, or make *leeway*.

Boats are so formed that there is but little resistance to their forward passage, and as much as possible to their being forced sidewise through the water.

The lateral resistance is obtained, either by the depth of immersion and keel, or by the addition of a centreboard, which is a piece of wood, or metal, let down through the boat's bottom, and working in a water-tight casing.

THE ACTION OF THE RUDDER.

THE rudder is the agent by which the boat may be turned to one side or the other of the course she is sailing, or may be kept pursuing a straight course when the opposing effect of the wind or waves tends to throw her out of it.

When the rudder is put at an angle with the keel, the water pressing against it carries it off in the opposite direction, and the stern of the boat with it. Therefore, the effect of moving the rudder to one side or the other is to push the *stern* of the

boat to the opposite side, and the bow is made to point in a different direction.

THE EFFECT OF THE WIND.

THE action of the wind on the sails has a tendency to force the boat so that the bow will turn toward the wind, and the rudder is used to counteract this tendency, by being turned until the pressure of the water against it has sufficient effect to balance the turning pressure of the wind upon the sails.

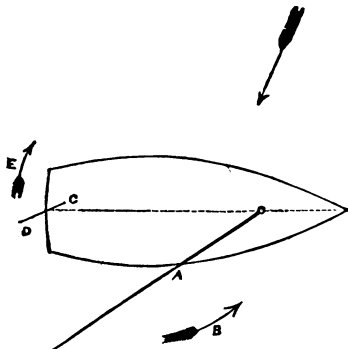

Fig. 1.

Fig. 1 shows a vessel with the wind on the port, or left side, blowing in the direction of the straight arrow upon the sail (A).

In addition to the propelling force of the wind there is the tendency to turn the sail, and with it the boat, in the direction of the curved arrow (B). To counteract this and keep the vessel in the course she is heading, the tiller (C) is pushed over to port, and the rudder (D) of necessity goes to starboard. The impact of the water tends to force the rudder, and with it

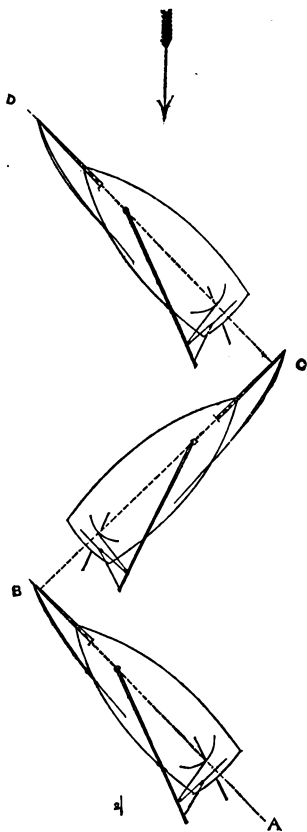

Fig. 2.

the stern of the boat, in the direction of the curved arrow (E), and the forces E and B equalling each other, the boat is steered straight. The effect of the wind on the sails and the principle of sailing close hauled, that is, in a direction against the wind, are very difficult things to explain in a short and plain manner. It is easy enough to understand how a vessel can sail before the wind—she is simply blown along; but how is it she can sail in a contrary direction?

Suppose the wind to be blowing from the top to the bottom of this page, a vessel can yet sail from the bottom to the top. To do so, however, she would have to tack, and her progress would be a zigzag one, as shown in Fig. 2.

Upon looking at Fig. 3 you will see that the sail (A) is trimmed at such an angle with the keel that it will be just full of wind. The wind strikes it and glances off in the direction of the dotted lines.

Now, if you were to put a billiard ball at the same angle it would fly off, not in the direction of the stroke, but in another at an angle with it. So in case of the wind. The force is resolved into other forces operating in the direction of the strokes on the op-

posite side of the sail. The sail cannot be blown sideways toward B, because of the great lateral resistance of the water, so that the force that way is lost—save to blow the vessel over (a result which her stability strives to prevent); but the forward forces in the direction of C have a minimum of resistance offered to them, so the sail and the vessel it propels progress in that direction.

To return to Fig. 2. A boat will sail against the wind at about the angles shown. By reference to a compass, it will be

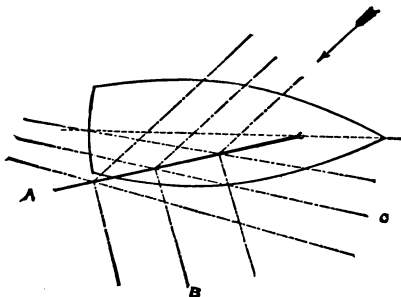

Fig. 3.

seen that the vessel sails about 4 to 4½ points from the wind. In the figures from A to B she is on the starboard tack—that is, the wind is on the right or starboard side; from B to C she is on the port tack, the wind being on the port side; and from C to D she is on the starboard tack again.

At the points B and C she has the helm put down—that is, to leeward—so that the rudder goes to windward and turns her head round, and the wind comes on the other side. This operation is called tacking. The flatter the sails the more perfect will be the effect of the wind upon them.

From what has been said about stability, it will be seen that

upon it depends the power to carry sail, and upon the power of a vessel to carry sail depends, in a great measure, her speed.

BALLAST. MATERIALS FOR AND ARRANGEMENT OF SAME.

NEARLY all boats require some heavy material added to them to give them sufficient stability to enable them to carry sail properly. This material is known as *ballast*.

The ballast for boats in which rowing is to play a prominent part should generally be inside, and be easily removable. Bags of sand or shot are very convenient, and water in small flat kegs or breakers is sometimes used.

Where sailing is the principal consideration, a certain proportion of the ballast should be placed on the keel, if possible, either in the shape of an iron or lead keel. Lead requires less space than iron, and is the best metal for ballast on the keel, but it is very expensive.

Pigs of iron ; water contained in specially fitted tanks, which can be discharged and renewed by means of a pump ; shingle from the sea-shore, and various other kinds of ballast are frequently used.

Lead is often placed inside also, either on the keelson, or moulded so as to fit the spaces between the floor.

The position of the ballast affects the steering qualities of the boat and also the speed.

If it be too far forward she will have a tendency to "yaw" about considerably when before the wind, and will be difficult to tack. Trimming a boat "by the stern" too much by means of the ballast is, perhaps, preferable to bringing her by the head, yet a loss of speed will result from either of them. As a rule small craft should be "trimmed a trifle by the stern ;" that is, the ballast should be so placed that the stern sinks deeper than the bow. The difference between the draught of water forward and that aft is known as the "drag."

The more ballast a boat carries the deeper she will sink, the

greater resistance she will experience, and the greater will be the area of sail required to drive her. Not, however, in the same proportion, and the boat which can, by the assistance of ballast or by breadth of beam, carry the most sail, is generally the fastest.

Weight causes a boat to retain her way better in tacking, and is a great advantage when beating to windward against a current or tidal set.

REMARKS ON THE POINTS OF SAILING. TRIMMING THE BOOM, ETC.

Close Hauled.—A boat is said to be “close hauled” when she is brought as near to the wind as possible, so as to advance through the water; for it should be understood that if the main-boom were brought directly over the line of the keel, and the boat jammed as near to the wind as she would lie and keep the sail full, she would not progress, but would simply be forced to leeward. To give her way through the water the boom must be at an angle with the keel line, and, therefore, the boom in sailing is always kept over one quarter or the other, and close hauled simply means that it is brought as far toward the fore-and-aft line as experience has proved to be beneficial for good speed through the water.

The closer the boom can be trimmed to the fore-and-aft line, and good headway be preserved, the nearer the wind the boat will be said to sail.

The majority of fore-and-aft vessels will lie within four points and a half of the wind and sail well, but there are craft that from their model and balance of sail will lie nearer than this, and seem to “eat up into the wind.”

As a rule, the sheets can be trimmed flatter in light weather and smooth water than in heavy weather and a rough sea. Usually with reefed sails a boat cannot lie as near the wind as before.

It will be found that most boats require the main-boom trimmed at about the angle shown in Fig. 4.

To know when a boat is as near the wind as she will sail properly, push the helm slowly to leeward, and, as she comes to the wind, a little shake will begin near the head of the sail and begin to agitate the luff. This tremble is caused by the wind getting on both sides of the sail, and, if the helm be kept down, the boat will lose headway, and the sail shake and flap. Practice will enable one to see this beginning, and at the first symptom the helm must be reversed and the boat kept away until the sail stands just full.

There are many other signs, such as the angle of the wind striking the face, the direction of the ripple on the waters, and the line of the vane, or flag, any one of which will do for the sailor equally as well as luffing up and shaking the sail.

If a boat be steered so as to keep just the suspicion of a tremble below the throat of the sail, she will then be "close hauled," or "full-and-by."

Sailing Free.—With a favoring wind, and when the boat will lay her course without having to beat toward her destination, the sails are trimmed in a different manner, the sheet is eased and the boom is swung out over the side in such proportion as the wind may require, till completely out at right angles to the keel, which is the position for the wind directly aft.

With the wind forward of the beam the boom will be trimmed about as in Fig. 5; with the wind directly abeam Fig. 6 shows the angle of the boom; Fig. 7 represents the wind abaft the beam; in Fig. 8 the wind is on the quarter; and, finally, the boom is at right angles with the keel line in Fig. 9, where the boat is before the wind.

Running before the Wind.—The steering is very difficult when the wind is aft, especially in rough water. The seas lift the boat's stern and neutralize the effect of the rudder for a time, and the speed being variable the effect of the rudder must alter also.

In running before the wind, the principal care should be to

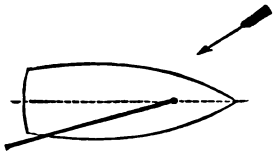

WIND AHEAD,
CLOSE HAULS.

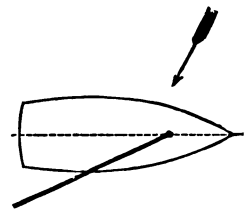

WIND FORWARD
OF THE BEAM.

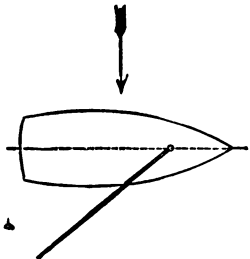

WIND ABEAM.

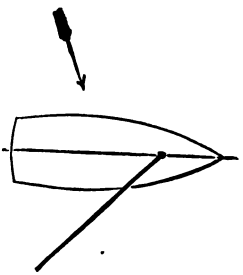

WIND AFT
THE BEAM.

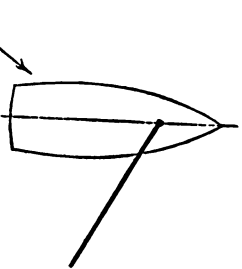

WIND ON
THE QUARTER.

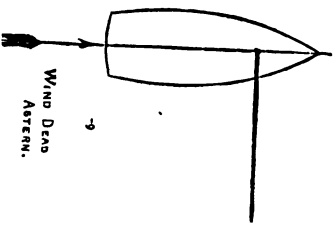

WIND DEAD
ASTERN.

prevent the sail from *gybing* over, from the wind catching it on the forward side. If the sea is heavy, or the boat steers wildly, the best plan is to haul her up so that she will have the wind on one quarter, and run on that course for some distance, and then by careful *gybing* bring the wind on the other quarter, and so on.

PRELIMINARY DEFINITIONS AND NAUTICAL EXPRESSIONS.

EVERY boat-sailer ought to be able to splice a rope, strap a block, pass seizings, and make all the ordinary knots, hitches, and bends in a neat, seamanlike manner.

A rope is composed of three or more strands ; each strand is made up of a number of yarns twisted together.

Bolt rope is made of the finest yarns, and is generally the most pliable and the best quality of rope.

Manila rope is cheaper than hemp of the same quality, is clean-looking, and is much used in this country for shipping, yachts, and pleasure-boats. It requires to be well stretched when new, in order that all tendency to kink may be eliminated.

Spun-yarn is made of the short fibres or toppings of hemp, laid up loosely, left-handed, and well tarred and rubbed down. It is known as 2, 3, 4, and 6 yarn spun-yarn.

Marline is made of two finely dressed hemp yarns, and is also laid up left-handed.

The *standing rigging* is composed of those ropes which are stationary and seldom require alteration, as shrouds and stays. It is now generally made of iron or steel wire rope and is very durable.

The *running rigging* consists of those ropes which reeve or work through blocks and fairleaders, as halliards, sheets, down-hauls, etc.

Shrouds and stays are usually *wormed*, which consists in winding marline or spun-yarn round the rope between the strands ;

by which means the divisions of the strands are hidden, and the rope given a smoother appearance. As a complete finish these ropes are also done over with *parcelling* and *served*. The former operation consists in wrapping them neatly with tarred canvas, and the latter in winding marline or spun-yarn over all, the turns being close together, and the whole, when finished, presenting a neat, hard surface.

Splicing a rope is joining the two ends together by weaving the strands, one between the others, and it cannot be properly performed without considerable practice.

Sails are made of canvas, duck, or some other material, and are generally extended by yards or gaffs.

The upper part of a sail is called the *head*; the lower part, the *foot*; the forward border, the *luff*; the after edge, the *leech*; the forward upper corner, the *throat*; the after upper corner, the *peak*; the lower forward corner, the *tack*; and the lower after corner, the *clew*.

The *main-sheet* is a rope by which the mainsail is hauled in, or eased off, and is made fast at the clew of the sail, or the outer portion of the main-boom. It is generally considered the most important rope in a boat when under way.

The *jib-sheets* are ropes of similar use attached to the clew of the jib. The jib-sheets are termed also the *head-sheets*.

Blocks are mechanical contrivances possessing the properties of pulleys. A block consists of the *shell*, *sheave*, *pin*, and *strap* (or strop). The shell is the frame or case. The sheave is the roller over which the rope turns, and it has a hole in the centre to receive the pin, which may be of iron or hardened copper. The sheave is usually of metal or lignum-vitæ. In what are known as *patent blocks* the sheave contains friction rollers.

The strap, or strop, is the rope or band around the shell by which it is strengthened, and attached to its particular place.

Blocks are *single*, *double*, *treble*, or *fourfold*, according to the number of sheaves contained within the shell.

The size of a block is determined by the length of the shell.

Cheek-blocks are half shells which bolt against a mast or spar.

Sister-blocks are formed of one shell and two sheaves, one above the other.

Tail-blocks are blocks strapped so as to have a rope tail at one end, two or three feet long, for hitching to rigging, rings, etc.

Snatch-blocks are blocks having a hook or tail at one end and a clasp at the side, which may be opened to admit the bight of a rope.

When not metal strapped, blocks are fitted with rope straps, which should invariably be well stretched. The rope should be in circumference about one-third the length of the block. Once and a half the round of the block is a good measure for a common strap.

A *tackle* is a purchase, for moving or raising weights, formed of two or more blocks and ropes.

A *whip purchase* has a single block only.

A *gun-tackle purchase* consists of two single blocks with a rope run through them, one end being fast to the strap of the upper block.

A *luff-tackle* purchase has a single and a double block, one end of the rope being fast to the single block, and the *fall* or hauling end leading from the double block.

The *standing part* of a tackle is so much of the rope as remains between the sheave and the end which is secured; the *running part* is that portion that works between the sheaves; the *fall* is the part laid hold of in hauling.

The *weather side* of a boat is that side against which the wind blows.

The *lee side* is the opposite to the weather side.

The *port side* is the left hand side of the boat, looking forward from the stern.

The *starboard side* is the right hand side of the boat, looking forward from the stern.

The *starboard tack*. A boat is on the starboard tack when sailing with the wind blowing on the starboard side.

The *port tack*. A boat is on the port tack when sailing with the wind blowing on the port side.

To *starboard the helm* is to put the tiller over to the starboard side. To *port the helm* is to put it over to the port side.

Carrying a weather helm implies that, in steering a straight course, close hauled, the helm has to be kept a little to the windward side.

Close hauled, on-a-wind, or by-the-wind are terms which signify sailing as close to the direction from which the wind blows as possible.

Sailing large, going free, or off the wind are terms which imply sailing with the wind between close hauled and astern, as with the wind abeam or on the quarter.

To *luff* is to bring the boat's bow closer to the point from which the wind is blowing, which is done by putting the helm down, or toward the lee side.

To *bear up, or keep her away*, is to alter the boat's course by turning her bow farther from the direction of the wind, to do which the helm is put up, or to windward.

To *weather* a vessel or object is to pass to windward of it.

To *tack, go about, or go in stays*, signifies to turn the boat's head past the direction from which the wind is blowing, so that it blows on the other side of the sail.

To *gybe* is to turn the boat's head from the wind until the boom and sail which were extended on one side are caused to sway over to the other.

To *wear* signifies to turn the boat's head from near the wind on one tack to near the wind on the other, by turning from the wind, gybing the sail, and coming to the wind on the other tack.

Beating, working, or turning to windward, is to proceed as close to the wind as possible, and by tacking at intervals to work ahead in the direction from which the wind is blowing.

Lying-to or laying to. Keeping the bow of the boat close to the wind with very little sail, and so making very little progress.

Hove-to means to keep the vessel as nearly stationary as possible, by hauling one or more sails a-weather so that a portion of

the sails act against the rest, and the vessel's progress is arrested.

To *box off* is to haul a head-sail a-weather, so as to pay the boat's head off when she is too near the wind.

To *weigh the anchor*. To raise it from the bottom and get it on board.

Under way. A boat is under way when moving ahead.

MARLINSPIKE SEAMANSHIP. KNOTS, HITCHES, BENDS, AND SPLICES.

THERE are many simple methods of making ropes fast to each other, to spars, rings, warping posts, etc., in use among sailors, and known as Bends, Hitches, Knots, and Splices.

The boat-sailer should make himself acquainted with the principal ones and those most in use as soon as possible, as on many occasions he will be called upon to use them under circumstances of considerable importance, life itself, perhaps, depending upon the security of the work.

In the explanations which follow, the *standing part* of a rope must be understood to mean the principal part or long portion, which is worked upon with the end to form a hitch or bend; the loop or eye formed when the end is doubled round will be termed the *bight*, and the part which is used in forming the hitches, knots, etc., will be called the *end*.

In order that the amateur may understand the directions which follow, let him refer to Fig. 10.

The loose ends of ropes should always be securely *whipped*, to prevent the strands from unlaying.

To make such a whipping, Fig. 11, proceed as follows: Lay the end of the twine used about an inch from the rope's end, pass the twine about half a dozen times around the rope, keeping the end under the first turns in order to secure it; then make a large loop with the free thread, bringing it back to the rope and laying it on it. Continue the lapping for four turns round both rope and free end of twine, and finally draw the loop tight by hauling on the free end. The surplus twine may now be cut off.

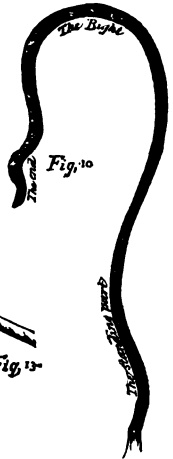
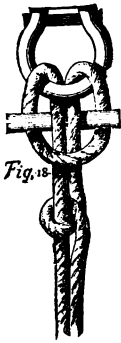

Fig. 17



Fig. 15



Figs. 12 and 13 show loops or *cuckold's necks*; if seizings be put on them at the cross they become *clinches*. The majority of hitches, bends, etc., begin with a loop.

OVERHAND KNOT. To make this knot pass the end of a rope over the standing part and through the bight so formed. Fig. 14 shows the knot commenced, and Fig. 15 shows it completed.

FIGURE OF EIGHT KNOT. Pass the end of a rope round the standing part, under its own part, and then through the lower bight. Fig. 16 shows the knot commenced, and the knot complete is delineated in Fig. 17.

A LARK'S HEAD. This knot, shown in Fig. 18, is a useful slip knot, as it can be readily cleared by withdrawing the toggle. Figs. 19 and 20 represent other boat knots.

A SLIPPERY HITCH. Fig. 21 clearly shows this simple knot.

REEF OR SQUARE KNOT, Fig. 22. This is used to tie reef points, secure sails, and for many other purposes. To make it, take one end of a rope in each hand, pass the left over and under the right, then the right over and under the left. Remember the formula—left over, right over.

GRANNY KNOT. This knot is often the result of an attempt by a novice to make a reef knot. An inspection of Fig. 23 will explain how the knot appears.

BOWLINE KNOT, Fig. 24. Take the end of a rope in your right hand and the standing part in the left, lay the end over the standing part; then with the left hand turn the bight of the standing part over the end part, so as to form a *cuckold's neck* on the standing part; next lead the end round the standing part above and stick it down through the *cuckold's neck*.

RUNNING BOWLINE. Pass the end of a rope round the standing part, through the bight, and make a single bowline upon the running part. Fig. 25 shows this knot.

BOWLINE ON A BIGHT. Take a doubled rope at about three feet from the bight in the left hand, holding the two parts of the bight together in the right, make a kink or *cuckold's neck* as at A; then pass the bight B up through the eye A; open out the bight B, and then throw it over the large loop C, and

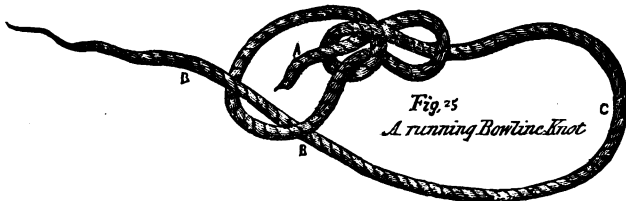
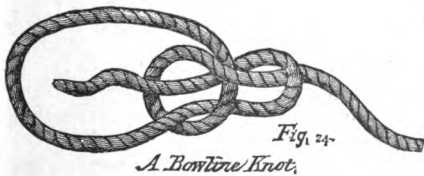
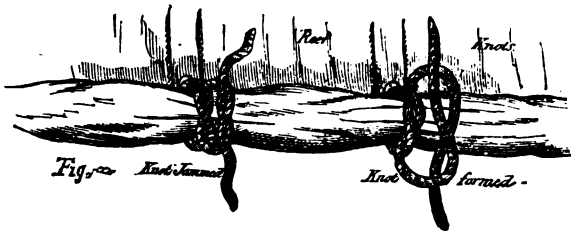

bring it up round the standing parts at D. Jam it there and the knot will appear as in Fig. 26.

TIMBER HITCH, Fig. 27. Pass the end of a rope round a spar, round the standing part, and then pass it three times under and over its own part. This hitch is sometimes used to bend a tow-line to a spar; or, after making the timber hitch, a half hitch may be taken with the tow-line, a couple of feet farther along the spar, which obviates all danger of slipping.

Two **HALF HITCHES** are very useful for bending gear and temporary lines. Fig. 28 shows them.

Pass the end of a rope round the standing part and bring it up through the bight, this forms one *half hitch*; two of these, one above the other, complete the knot.

A **CLOVE HITCH**, Fig. 29, is used to secure ratlines to shrouds, and buoy-ropes to anchors. It is found to be very useful in other places also.

A **BLACKWALL HITCH**, Fig. 30, is made with the end of a rope, or the fall of a tackle, on the hook of a tackle. It is very useful in setting up rigging, when the end of the shroud lanyard is thus made fast round the tackle-hook.

A **MAGNUS HITCH**, Fig. 31, is made on the shackle of an anchor, a spar, or a rope, by taking two round turns round the ring or spar, passing the end over the standing part of the line, round the rope and spar again, and up through the bight.

A **CATSPAW**, Fig. 32, is very useful for the same purpose as a Blackwall Hitch. To make it, lay the bight of a rope over the end and standing part, then with a bight in each hand take three turns in them by twisting from you; bring the bights together and hook on.

MIDSHIPMAN'S HITCH, Fig. 33, is useful for securing gear at times. It is made with a half hitch over the standing part, and a round turn above the hitch which jams it.

A **SHEET** or **BECKET BEND** is used for fastening two ropes together, or for bending a rope to the becket of a block. Make a bight with the end of one rope, and pass the end of the other

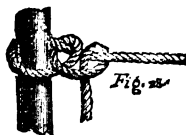
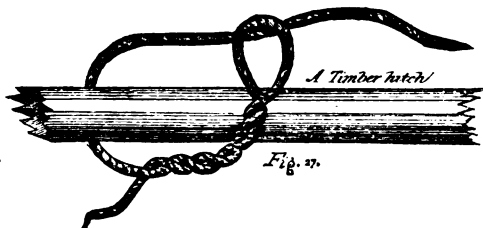

AND HALF BUCKLE



A Blackwall hitch

Fig. 30-

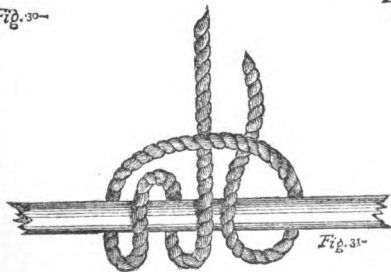

A Magnus hitch

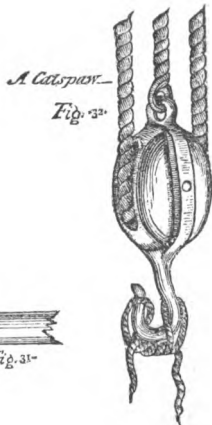

A Colspier

Fig. 32-

rope through this bight, from beneath, round both parts, and then shove the end under its own standing part and jam.

FISHERMAN'S BEND, Fig. 34. This bend is very useful for securing hawsers and warping lines, and also for bending halliards to yards. With the end of a rope take two round turns through a ring or around a spar; take a half-hitch round the standing part and under all parts of the turns, then a half-hitch round the standing part above all, and to make all secure stop the end to the standing part.

ROLLING BEND, Fig. 35. Take two round turns round a spar, and two half-hitches round the standing part.

GAFF TOPSAIL HALLIARD BEND, Fig. 36. Pass two turns of the halliard round the yard, and coming up on the third turn pass over both turns, over its own part and one of the turns, and stick the end under the first turn.

A neat manner of bending topsail halliards is with a strap and toggle, Fig. 37. No. 1 is the end of the halliard into which an eye is neatly turned and leathered. No. 2 is the strap with its toggle A, which may be made of wood, but in this instance it consists of a man-rope knot, made large enough to jam in the eye of the halliard at B. C shows the strap through its eye, and the toggle jammed in the eye of the topsail halliard. D exhibits the halliard bent to the yard. This mode of bending gaff topsail halliards has the merit of being neat, simple, and very expeditious.

GAFF TOPSAIL SHEET BEND, Fig. 38. This bend may be used to bend the topsail sheet, but many persons prefer to use clip-or sister-hooks, as shown in Fig. 39. A represents the clip-hooks with a seizing, B, attached, and C exhibits them hooked and seized. The seizing, or mousing, as it is termed, serves to prevent the hooks opening when the sail flaps.

REEF PENDANT BEND. It is important to know how to make fast a reef pendant round the boom, when the reef is hardened down with the reef tackle. The crew hang on to the reef pendant, in order that the reef tackle may be unhooked; you then pass the pendant smartly round the boom, as in the sketch

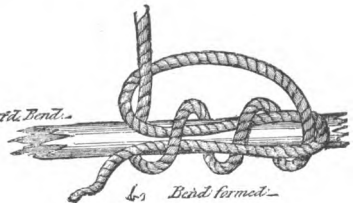
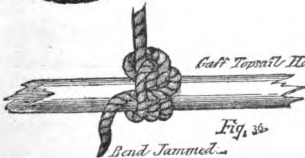
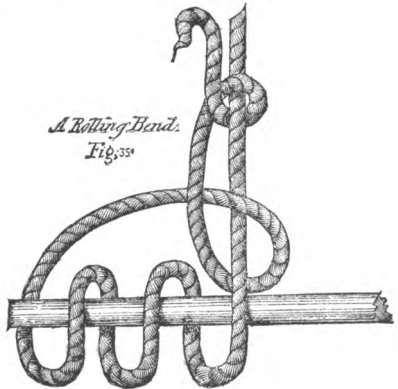
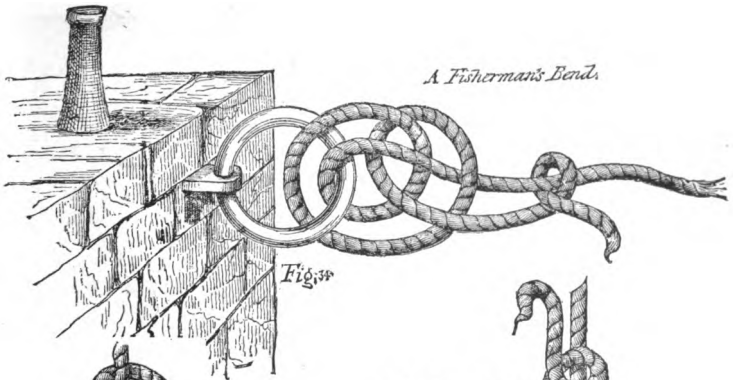

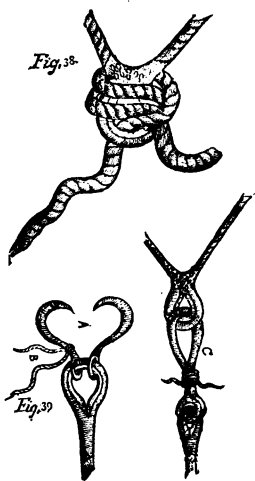
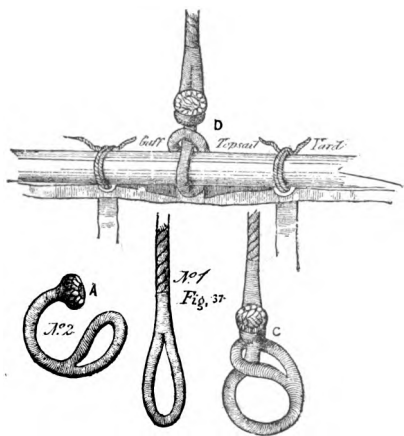

Reef Pennant Bend.

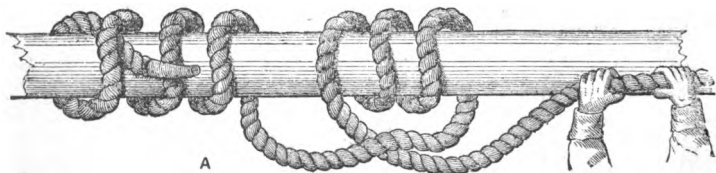

Bend formed.

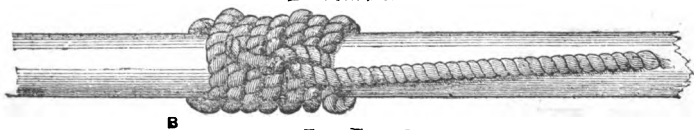

Bend Jammed

Fig. 40, A; jam the bend as shown in B, and the reef pendant is passed.

A CARRICK BEND, Fig. 41. This is a very useful and secure method of bending two lawasers or tow-lines together. The ends may be seized to the standing parts also if desired. Form a bight by laying the end of a rope on top of, and crossing the standing part; take the end of a second rope and reeve it down through the bight, up and over the cross, and pass it down through the bight again, so as to come out on the opposite side to the other end, thus bringing one on top and the other underneath, as in the figure.

A hawser may be bent to an anchor by either of the methods shown in Figs. 42 and 43.

SINGLE WALL KNOT, Fig. 44. Unlay the end of a rope. Take one strand and form a bight; take a second strand and bring it round the end of the first; and finally pass the third strand round the end of the second and up through the bight of the first, forming the wall as in the figure.

SINGLE WALL AND CROWN, Fig. 45. After making a single wall, if it be desired to crown it, lay one of the ends over the top of the knot, lay a second over the first, and lay the third over the second and pass it through the bight of the first, and the crown is made.

DOUBLE WALL AND DOUBLE CROWN, Fig. 46. Form a single wall knot, keeping the strands slack, crown it and then pass the ends "under" and "up" through the bights of the slack single walling, and then push the ends "by the side" of those in the single crown, pushing them through the same bight in the crown and downward through the walling. The ends should finally be cut off closely.

This knot is known as a **MAN-ROPE KNOT**. Whenever the strands are opened out to form these knots a whipping should be put round the rope where the knot is to be when formed.

MATTHEW WALKER KNOT. Put a whipping on the rope; open the strands to the whipping and pass one end, A, Fig. 47, round the rope and through its own bight, the strand B underneath

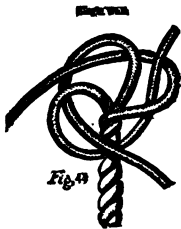

and through the bight of A and through its own bight, and the strand C underneath and through all three bights. Haul the ends through, work the turns round, and the knot will be formed.

TURK'S HEAD, Fig. 48 *a, b, c, d*.—This is used to ornament man-ropes, yoke-lines, ridge-ropes, etc. Pass two round turns with small stuff around the rope to be ornamented; pass the upper bight down through the lower, and reeve the upper end down through it; then pass the bight up again, and pass the end over the lower bight and up between it and the upper bight. Dip the upper bight again through the lower one and pass the end over what is now the upper bight, and between it and the lower. Work round in this manner to the right until the other end is met, when the other part is followed round until a plait of two, three, or more lays, according to your desire, is complete.

WORMING, PARCELLING, AND SERVING.

GET the rope on a stretch, making one end fast to the bits, or any convenient place, and hook one block of a tackle to an eye-bolt, or to a strap at some timber-head, and the other block to the rope by means of a selvagee strap, then bowse well taut, and the rope is ready for the operation, which may easily be understood by reference to Fig. 49.

Worming is performed with a ball of spunyarn, the yarn being laid tightly into the divisions between the strands, so as to fill up the inequalities, and render the surface smooth for parcelling (see No. 1, Fig. 49).

Parcelling is done by wrapping narrow strips of canvas, a couple of inches wide, round the rope "with the lay," or in the direction of the strands; these pieces of canvas should be well tarred (see No. 2, Fig. 49).

Serving is the last operation, and is done with a wooden serving mallet which has a score cut in the underneath part to fit the rope.

Spunyarn is wound round the rope over the parcelling and "against the lay" (see No. 3, Fig. 49).



Fig. 46



THE CAPTURE OF QUEBEC, 1759, &c.

FROM CORRESPONDENCE AND DOCUMENTS PRESERVED AT RAYNHAM, CONTAINING INFORMATION NOT HITHERTO PUBLISHED.

By Lieut.-Colonel C. V. F. TOWNSHEND, C.B., D.S.O.,
Royal Fusiliers.

With Plans and Illustrations.

Demy 8vo. 16s.



Sermons to Young Boys.

A hand passes the ball of yarn, keeping the turns out of it, at a short distance in advance of the man who is serving the rope. When the required length of service is on the rope, the end of the spunyarn is put underneath the last two turns, hauled taut, and trimmed off close. Worming, parcelling, and serving are performed on all parts of the standing rigging liable to be chafed.

SERVAGEE STRAP (or Strop), Fig. 50. Drive two spikes or pins into a piece of plank at a distance apart equal to the length you intend to have the strap. Take a ball of spunyarn or rope-yarn, secure the end to one pin and pass it round the other, continuing to take turns around the pins, hauling them taut as passed, until the strap reaches the required size. Marl it down with spunyarn or marline.

GROMMET, Fig. 51, is a useful ring of rope, and may readily be made as follows: Take a strand of rope, sufficiently long for the sized grommet it is desired to make; lay one end over the other at the size required, and with the long end follow the lay round until it forms a ring, with three parts of the strand all round, finish it by dividing the ends, overhand knotting, and passing them underneath the neighboring parts.

INSTRUMENTS USED. The instruments used in the various manipulations of rope, and especially in splicing, are Fids, Marlinspikes, and Prickers.

Fids are made of various sizes, of hard wood or iron, and are tapered gradually from one end to the other.

Marlinspikes are of iron, of similar form, and generally have an eye in the large end. A lanyard is fitted to this eye, in order to sling it round the neck.

Prickers are only used for light work, and are made of hard wood or metal, and have sharp points.

TO MAKE A SHORT SPLICE. Unlay the ends of the ropes it is proposed to join, A, A, Fig. 52, grease the strands well, and place them together as in B, B. Next take a marlinspike, grease it, and open strand No. 1, C, C, through which shove strand *a* of the other rope, and so on, raising the alternate strands, on both

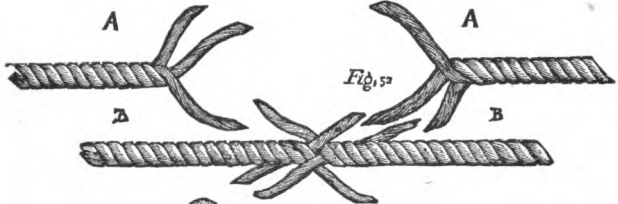

ropes' ends, and working in the strands that have been unlaid. The splice, after the ends have been once stuck through the strands, presents the appearance of D.

Unlay the ends of the strands, cut out one-half the yarns, and pass the remainder again, being careful to pass the upper half, for neatness. The loose ends are then cut off close to the rope.

Sometimes the strands are passed once whole strand, once two-thirds, and once one-third, which makes a neat tapering splice.

A LONG SPLICE, Fig. 53. This is much used where the rope has to reeve through blocks after being spliced.

Unlay the ends of the ropes about four times as much as for a short splice, or say from four to five feet; unlay one strand in each rope's-end for half the same length additional, place the middle strands together as A in the sketch, then the additionally unlaid strands will appear as at B and C, and the spiral groove left by them will appear as D, D, and E, E.

Take off the centre strands F and G and lay them into the vacant scores D, D, E, E, until they meet B and C at 1 and 2; then take off the strands H and J, divide the yarns each in half, make an overhand knot with the opposite strands and stick the ends, as in a short splice.

Perform exactly the same operation with the unlaid strands B and C, and F and G laid up to them, dividing, knotting, and sticking the half strands in the same manner.

Finally get the rope on a good stretch, and see that the splice is well taut and the knotted half-strands buried in their scores, then cut off all the ends neatly, and the splice is completed.

AN EYE SPLICE, Fig. 54, is made by unlaying the end of a rope laying it back over the standing part and sticking in the strands, once whole strand, once two-thirds, and once one-third.

It is very useful for turning in blocks, thimbles, etc.

(In case of a four-stranded rope one of the strands goes under two strands).

AN ARTIFICIAL EYE, Fig. 55, is made in a similar manner to a

long splice. One strand of a rope's-end is unlaid somewhat more than the size of the eye it is intended to form, then the two remaining strands are laid back to the standing part as at No. 1, the unlaid strand passed across, as at A, and laid up in its former score, B, B, around the eye, until it reaches its old berth under the two laid strands, then the three ends are stuck as in an eye splice, or the yarns halved and tapered down, marled and served over.

A CUT SPLICE, Fig. 56, is used to form an eye in any part of a rope. Place the unlaid ends of each piece of rope on the standing part of the other, and stick the ends as in a short splice. A cut splice is often used for the eyes of shrouds. A small piece of rope may be used when preferable, and both its ends spliced into the lay of the longer rope.

SPLICING WIRE ROPE.—Proceed as for a short splice, sticking once whole strand, once two-thirds strand, and once one-third strand; get it on a stretch, break off the wires, by working them smartly backward and forward, and finally red-lead, parcel, and serve.

A *long splice* of wire is made as follows: Open out the strands, and lay them up in the manner described for ordinary ropes. Instead of knotting, however, separate the strands into two parts, and cross each opposite part, tucking the ends under and over the laid-up strands until expended, worm, parcel, and serve, and the splice will last as long as the rope.

To make an eye splice, allow more end for splicing than with hemp or manilla. Each wire must be passed separately. Stick once whole strand, once two-thirds, and once one-third strand. Put a good strap round all parts after sticking each time, in order to keep them close together.

Set it up and stretch it well. Break off the yarns, and parcel and serve over.

Always serve over the required length for an eye, in wire, before splicing it.

Thimbles may be spliced in wire-rope as follows: Red-lead, parcel, and serve the rope the length of the round of thimble.

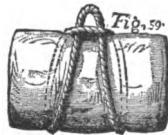
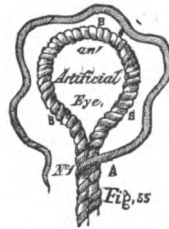
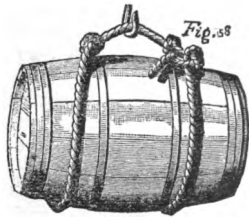

Break or bend the rope around the thimble and secure it in a vise or bench-screw ; stop the parts together, and pass seizings through the thimble and around the rope on each quarter ; open out the strands and splice, passing each wire separately. Wire is always cut on the straight. Having secured one end, clap a tackle on the rope beyond the mark for cutting, on both sides of which mark put a good whipping. Lay an axe under the rope at the mark and beat it down with a mallet or hammer.

Three-quarter inch wire rope is about equal in strength to two inch hemp. One inch wire equals two and three-quarters inch hemp. Two inch wire equals five inch hemp, and so on in the same proportion.

Numerous other knots, splices, etc., are known to sailors, but a knowledge of those mentioned will doubtless be quite sufficient to enable the boat-sailer to tide over any and all difficulties which he may encounter.

A HORSE, represented in Fig. 57, is used in sailing craft generally, for sheets to travel upon. The one delineated is for a main-sheet, and has india-rubber collars at each end to relieve the shock when the lower sheet block shifts over suddenly.

SLINGING CASKS AND BALES.

FIGS. 58, 59, and 60 represent respectively a CASK SLING, BALE SLING, and BARREL SLING. These are usually employed for the purpose of slinging stores and water, for hoisting on board vessels, but will also be found very useful for many other purposes.

Section 2.

THE MOST SERVICEABLE TYPE OF BOAT.

STIFFNESS OF OPEN BOATS.

CAT-BOATS.

**FORBES CAT RIG. NEWPORT AND EASTERN CAT-
BOATS. KEEL CAT-BOATS.**

THE BALANCE LUG SAIL.

CENTREBOARD BOATS FOR ROWING AND SAILING.

ANCHORS, ETC. SAIL AREAS, ETC.

THE BEGINNER'S FIRST SAIL.

**HINTS AND CAUTIONS FOR PERSONS SAILING
SMALL BOATS.**

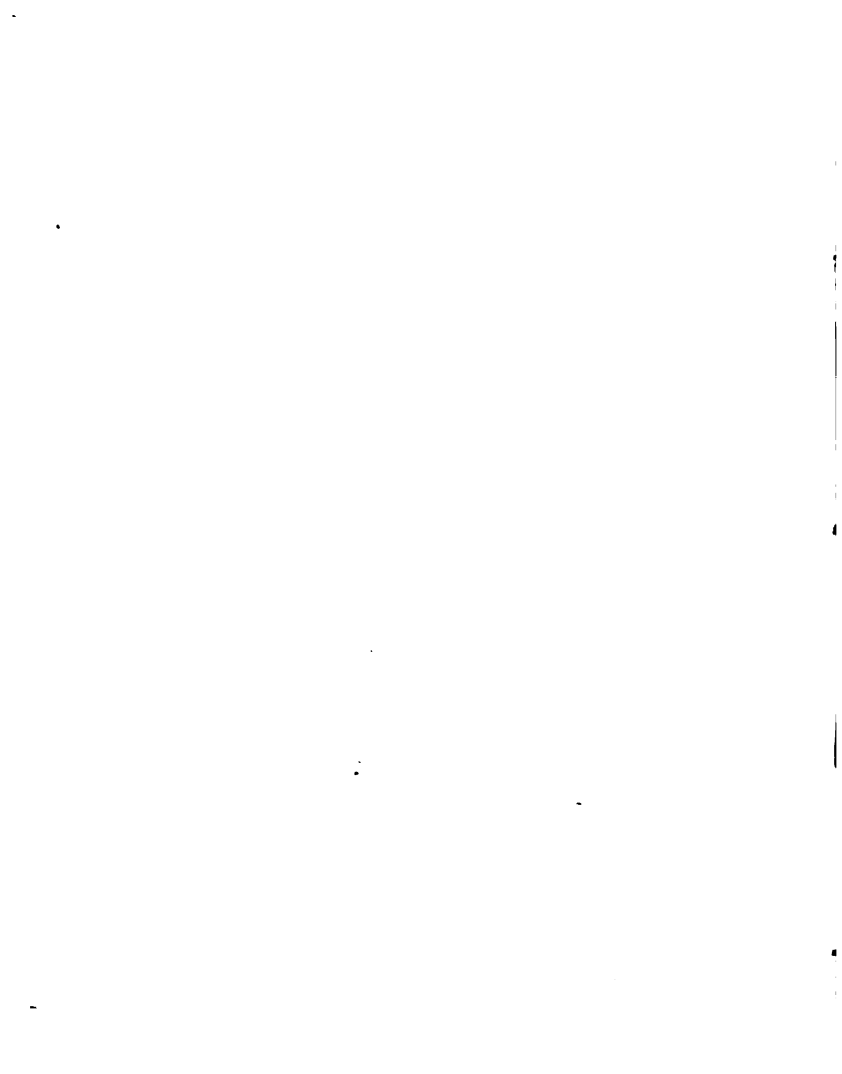

THE MOST SERVICEABLE TYPE OF BOAT.

A SAILING-BOAT, to be safe and serviceable, must be adapted to the waters and locality in which it is to be employed ; the most useful and reliable, perhaps, being that in general use by the resident boatmen, the form and rig of which will usually be found to possess some special advantages with reference to the nature of the waters and coast in the locality ; and generally such advantages are the result of years of practical experience.

Therefore the size, rig, and model of a boat should be defined by the local custom obtaining in the waters on which it is to be sailed. A boat constructed and rigged for sailing on smooth inland waters would be illy suited to the rough waters of the sea-coast, and *vice versâ*. And, as some parts of the coast are more dangerous than others, it may be found that the ingenuity of the resident boatmen has enabled them, from long experience, to design a form of boat admirably adapted to the locality and purposes required.

For rivers and small lakes, the sailing boat should always be of good beam, light draught of water, and small sail area, on account of the frequency of puffs of wind from unexpected quarters of the neighboring hillsides. The "leg-of-mutton" sail is one of the safest sails that can be used on inland waters, and the "balance lug," "sliding gunter," "gaff," and "sprit" sails, fitted singly, are all handy for small craft.

For bays, sounds, and lakes the type of boat selected should be of good model, and fitted with either the "balance-lug," gaff-sail, jib-and-mainsail, main-and-mizzen, or cutter rigs.

Boats which have frequently to run alongside vessels should carry all their sail inboard ; there should not be any bowsprit, on account of the liability to foul it, and snap it off.

The question of centreboard or keel seems to be mainly one of adaptability. If the boat is intended for shallow waters, she must be of light draught, and to such boats the centreboard properly belongs, and should be fitted, as the keel will not an-

swer so well. If, however, the waters upon which the boat is to sail will admit a deep model, the keel may be found to be preferable to the board.

Between the two extreme types a neutral zone exists, and within its limits the keel and centreboard seem to give equally good results.

For outside work, or in places where the currents are strong, or where the wind may kick up a nasty "jump of a sea," the deep keel boat will be preferable. Sailing boats for sea-going purposes should have high bows, and the ballast should be trimmed somewhat aft. A capital rig will be a gaff-mainsail, fore-staysail, and jib, but either the lugger rig, main-and-mizzen, jib-and-mainsail, sloop, cutter, or yawl rig will be found to answer very well.

Of course the size of the boat will be considered in selecting the rig, and also the purposes for which she is to be used, whether for cruising, pleasure sailing, or racing.

Very small boats, which are intended for rowing and sailing purposes, need not be decked, as more room is gained for rowing or moving about in the boat; but they will be much safer if air-chambers are fitted at the ends, and a locker is very desirable in any boat. Such boats are necessarily intended for use in smooth water.

The large boats which have to encounter rougher water, on lakes or the sea, will be safer if fully decked, and should have at least a half deck forward, and waterways around the open portion fitted with a coaming three or four inches high.

STIFFNESS OF OPEN BOATS.

OPEN boats should never be treated as if they possessed the qualities of deep and well-ballasted yachts. They should not be sailed "gunwale under," as a yacht often is, and the squall which a decked boat may be sailed through with safety will necessitate the open boat being luffed up with head-sheets flown, or run off the wind with after-sheet slacked.

No system of ballasting will much increase the range of stability of an open boat, and it should be clearly understood that it is not the stiffness of the boat at small angles of heel upon which her safety depends, but upon her *range of stability*, that is to say, upon the amount of power she has to recover herself when heeled to great angles, when the gunwale might be pressed under water. For racing, a boat to succeed should have great *initial stability*, so as to be able to carry a very large area of canvas without heeling more than to a point midway between the water-line and gunwale. This stiffness is dependent more upon breadth of beam than upon the weight of low placed ballast, and a novice finding the boat very stiff at first might be tempted to press her beyond the danger-point. Again, depth of hull of itself does not add to stability, but by ballasting it does, and increases the range of stability so that a boat may have great righting power at any angle of heel, provided she does not fill with water.

High freeboard increases a boat's range of stability, and therefore the higher, in reason, a boat's side is out of the water, the safer she will be.

CAT-BOATS.

THE cat rig has always been a great favorite in this country, especially in Newport, Boston, and the Eastern ports, and the boats enjoy a great reputation for handiness and speed in smooth water. The impudence with which a cat-boat will point into the wind's eye is simply marvellous, and many American boat-sailors consider it even more handy than the balance lug.

The rig is represented in Fig. 61, and will be seen to be very simple.

The sail, as shown, hoists by a single halliard, the standing part of which is made fast on the gaff at *a*, then leads through a double block, *j*, on the mast, through a single block, *s*, near the jaws of the gaff, up through the double block again, and down to the deck, where the fall passes through a block, *n*, and leads

aft, belaying to a cleat on the after end of the centreboard case. The fall being handy, the helmsman can, in case of necessity, lower the sail without leaving the tiller.

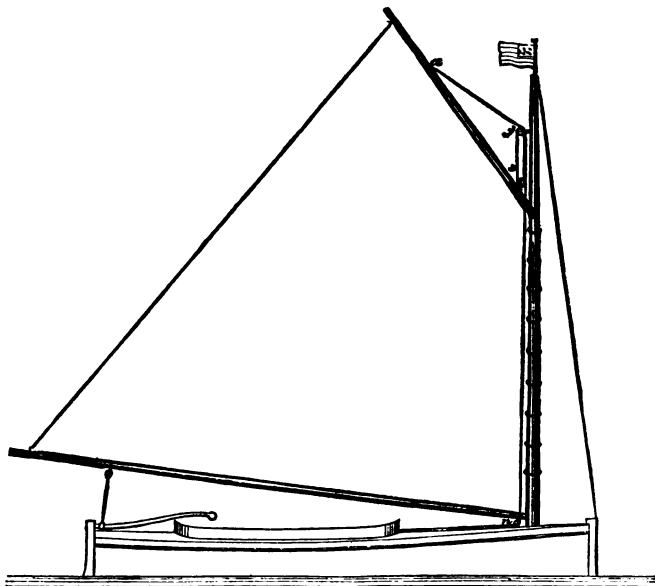

Fig. 61.

A down-haul is sometimes fitted, but the sail will lower readily without it.

Vanderdecken gives an ingenious method of preventing the hoops, by which the luff of the sail is held to the mast, from jamming in hoisting or lowering. A line is fastened to the

forward side of the top hoop, and thence to every hoop in turn down the mast to the bottom one; then when the halliard is pulled up, the fore sides of all the hoops feel the lift, and go up parallel with the after sides.

The mast should be occasionally touched up with a little grease, in order that the hoops may slide easily.

The main-sheet is frequently fitted as follows: The standing part is fast to an eye-bolt on one quarter, and the sheet then leads through a block on the boom, and through a block on the other quarter, the fall leading into the cockpit to the hand.

Some boats are fitted with topping-lifts, which, after passing through a block at the foot of the mast, lead aft to belay. The boom can then readily be topped without leaving the tiller, when running before a stiff breeze.

There is very little doubt that the single sail is the best for handiness and weatherly qualities, if there be no sea and if all the work is to windward. In a jump of a sea, however, the heavy mast, stepped well forward, causes the boat to bury too much.

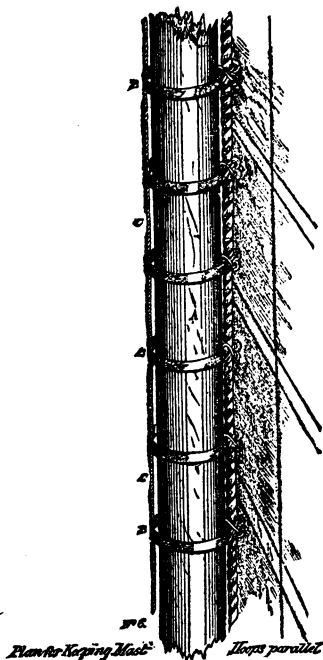

Fig. 62.

Off the wind the shallow cat-boats are somewhat wild, and have considerable tendency to "broach to," a fault com-

mon to almost all light-draught boats under like circumstances.

Some boat-sailers have used a small jib on a short bowsprit when sailing "off the wind;" the bowsprit being run out through an iron on the stem-head, and its heel secured to the mast. The jib-sheets lead aft for convenience in slacking when luffing up in squalls. The stiffness of cat-boats, up to a certain point, is proverbial, but when they are heeled so that the water sweeps along the waterways, they require very careful handling.

They may be considered safe enough, however, in skilful hands, and are certainly not so dangerous as most open boats of the same length. They should always be luffed to squalls before the deck is in danger of being immersed, and, if it should be necessary to bring the boat head to wind, a foot or two of the main-sheet should be eased.

The main-sheet should not be let go altogether, with any boom sail, as the sail will not spill readily, and the boom may get into the water, which will be dangerous.

A cat-boat known as the *Una* was taken to England in 1852, and excited great interest at Cowes, where her performance was looked upon as something wonderful. She was so handy and showed such speed that in a very short time there was quite a fleet of cat-boats about the Solent. The type was there named *Una*, after the original *Una* imported, and to the present day the boats are great favorites for smooth-water sailing.

The *Una* was 16 feet in length, had 6 feet 6 inches beam, and drew 14 inches without centreboard.

The mast was 16 feet long, boom 18 feet, and gaff 9 feet 3 inches. Step for mast 2 feet from stem.

Sail 12 feet on luff, 19 feet on leech, 17 feet 6 inches on foot, and 9 feet on head.

NOTE.—In addition to the mast, boom, gaff, sail, rudder, and tiller, every cat-boat should have one pair of oars, one sail-cover, one hatch-cover, one baler, two rowlocks, four blocks, and some pigs of lead ballast. As a general thing these boats are not heavily ballasted.

FORBES CAT RIG.

THE adaptation of the cat and gunter rigs represented in Fig. 63 is by Mr. R. B. Forbes.

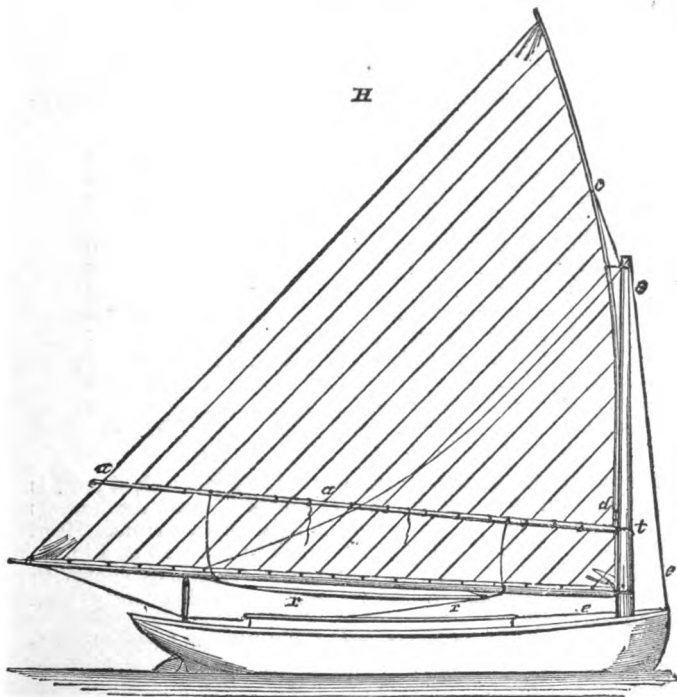

Fig. 63.

The boom *a* is laced to the sail, and is used for reefing, being hauled down by the tackle *r*. The upper halliard *c* comes down to, and belays to a cleat on the heel of the yard at *d*, close to the traveller. By slacking the lower halliard *e*, and hauling on the reefing-tackle, the reef is taken in.

NEWPORT AND EASTERN CAT-BOATS.

The dimensions of a typical Newport cat-boat are as follows :

	Feet.	Inches.
Length on water-line.....	20	0
Beam on water-line.....	6	8
Beam, extreme.....	7	9
Draught, without board.....	1	2½
Draught, with board.....	5	0
Mast over all.....	27	6
“ from stem.....	1	3
“ rake in one foot.....	0	0¼
“ diameter at deck.....	0	6
“ diameter at truck.....	0	2½
Boom length.....	24	0
“ diameter at slings.....	0	4½
Gaff length.....	11	
“ diameter at slings.....	0	2½

The rise of boom at after end above the gooseneck at mast is 2 ft. 6 in. Sail area, 350 sq. ft. The material used for the sails is 8-oz. duck, lightly roped and fitted with two reefs. Head of sail, 7 ft. 3 in.; luff, 16 ft. 9 in.; tack to peak, 25 ft. 4 in.

A small jib set flying to a boomkin is sometimes shown in quartering winds, and a light spinnaker is frequently used before the wind.

These boats possess great initial stability and considerable buoyancy. They have long tapering runs, raking midship section, and easy lines.

Cat-boats in Eastern waters are generally of an abler type than

those for smooth-water service, and are distinguished by greater draught, fuller lines, and higher bows. Like many of the Newport boats, a small cuddy with sliding hatch gives some stowage under cover, and in larger boats the chance for a low berth into which the belated cruiser may creep.

The dimensions of a typical boat are as follows :

	Feet.	Inches.
Length on water-line.....	15	0
Extreme beam.....	5	6
Beam at load water-line.....	5	0
Draught, without board.....	1	5
Draught, with board.....	4	0
Mast from fore side stem.....	1	11
Mast over all.....	20	0
Diameter at deck.....	0	4½
Boom over all.....	18	6
Diameter in slings.....	0	3½
Gaff over all.....	8	0
Diameter of gaff.....	0	2
Luff of sail.....	14	6
Cruising sail.....	250	sq. ft.

KEEL CAT-BOATS.

In the endeavor to obtain a boat which should not only be uncapsizable, but unsinkable, some keel cat-boats have been built. The cockpits are shoal, the companion hatch narrow, and the sill of cabin doors kept high. Bulkheads have also been arranged in the bow, stern, and at the sides.

The dimensions and particulars of one of these keel boats, represented in Figure 64, and which has proved very weatherly, are as follows :

Length over all.....	20 ft.
“ on water-line.....	17 ft. 6 in.
Beam, extreme.....	8 ft. 5 in.

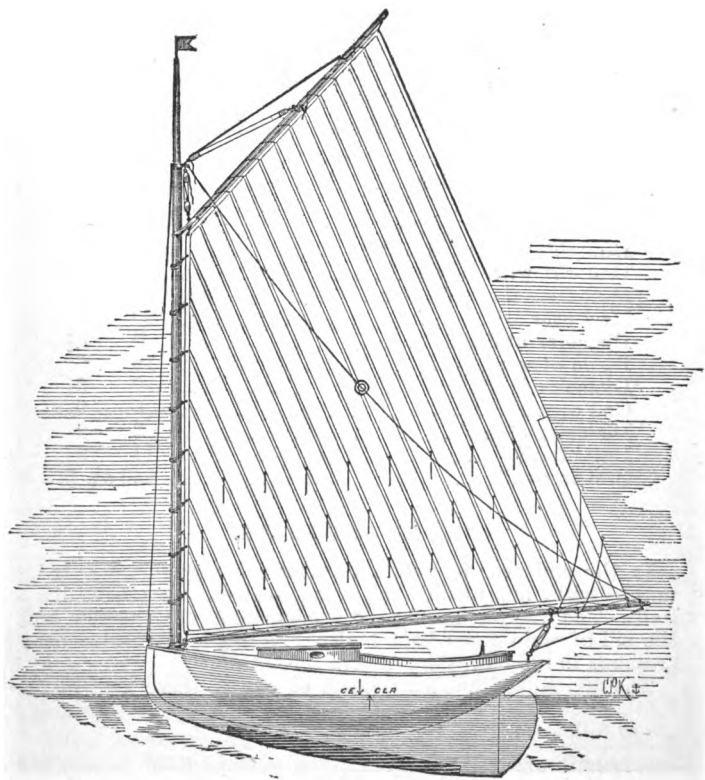

Fig. 64.

Draught, extreme.....	4 ft.
Freeboard, least.....	13 in.
Displacement.....	5,750 lbs.
Ballast, inside lead.....	1,000 lbs.
“ on keel.....	856 lbs.
Ratio of ballast to displacement.....	32 per cent.
Centre of mast from stem.....	18 in.
Mast, deck to hounds.....	24 ft.
“ diameter at deck.....	6½ in.
“ “ “ hounds.....	5 in.
Boom over all.....	23 ft.
“ diameter at slings.....	4 in.
“ “ “ end.....	2½ in.
Gaff over all.....	15 ft.
“ diameter, oval section.....	3½ in. by 2½ in.

Hoist of sail, 20 ft.; head, 14 ft.; foot, 22 ft.; leech, 31 ft. Sail area, 415 sq. ft.

All the gear leads to the cockpit.

Examples of the rigs of other keel cat-boats of various dimensions are as follows :

Length on water-line.	Beam.	Hoist.	Head.	Foot.
10 ft. 8 in.	4 ft. 10 in.	11 ft.	6 ft.	12 ft.
10 “ 6 “	8 “ 7 “	20 “	14 “	22 “
21 “ 0 “	9 “ 0 “	21 “	16 “	27 “

THE BALANCE LUG SAIL.

THE balance lug sail is so arranged that it lies on the mast on one tack, and away from it on the other. It requires no “dipping” in going about, and in this respect it resembles what is termed the “standing lug,” but it has the advantage of a larger piece forward of the mast to balance the after part of the sail (Fig. 65).

The boom and mast are about the same length, and the

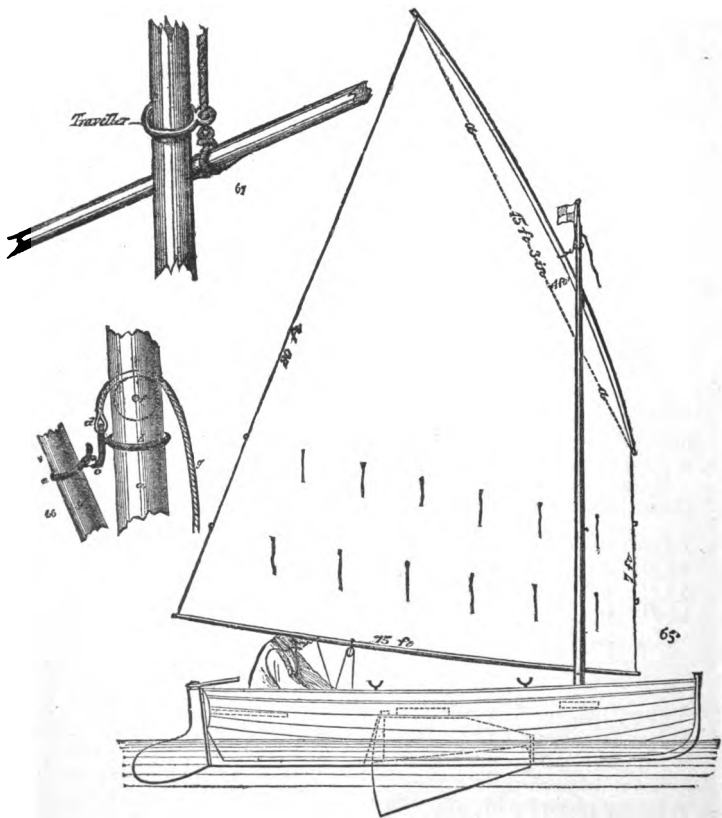

Fig. 65.

length of the latter is, in a measure, governed by the amount of peak given to the head of the sail.

The sail is generally cut with great peak, and it is found that such a sail stands better than a flat-headed sail.

About one-seventh of the foot of a balance lug should be forward of the mast, and in slinging the yard and bending the tack care should be taken that this proportion is not much exceeded. A capital place for the slings of a well-peaked yard will be about one-tenth the length of the yard below its middle.

A single halliard is used to hoist the sail, one end of which is bent to the yard, passes over a sheave in the masthead, and has a block turned into the end; a rope is rove through this block, the standing part being secured at the foot of the mast, and the hauling part rove through a block and led aft.

When the iron mast-traveller is used, the halliard is bent to an eye on the iron, and the latter is hooked to a thimble-eye stop on the yard (Fig. 61). Another style is shown in Fig. 62.

If a parrel is preferred to the iron, the yard will be slung a trifle lower down, and the mast may be a little shorter.

The tack should be made fast to the boom, and led through a block, either on the mast thwart or on deck, as may be most convenient.

A down-haul should be bent to the yard.

When topping-lifts are used, one part should be made fast at the masthead, then lead across the sail, and through a thimble seized under the boom, thence up on the opposite side of the sail, through a block at the masthead, and down on deck.

A wire forestay is sometimes set up at the stem head by a purchase, and the mast (sails and all) may be lowered thereby, for passing under bridges, etc. The mast must be stepped in a "tabernacle,"* in the event of its being desirable to have it

* A *tabernacle* is a perpendicular trunk, made to take the lower part of the mast. The mast is pivoted on a bolt passing athwartships through the sides of the tabernacle.

In an open boat the mast can be pivoted near the bottom of the tabernacle, but in some boats and canoes it is stepped on deck, pivoting on a bolt passing through the sides of the tabernacle above the deck.

fitted to lower and hoist readily. This may be fitted in the after side of the mast thwart and open on the after side.

A single wire shroud is sometimes fitted and set up to neat chain plates fitted to the gunwales.

The main-sheet is led as follows: The standing part is made fast to the boom, led through a single block on one quarter, through a block on the boom, and belays on the other quarter. For small boats thimbles or bull's-eyes may be used instead of blocks.

Instead of being belayed at the quarter, the sheet may be led through a block or fairleader there, and held in the hand, which is always a good plan.

The blocks should generally be fitted *inside* the gunwale so that they will not prevent the boom from being hauled in flat enough when sailing close hauled.

Another plan is to have the standing part of the sheet fast to the extreme end of the boom; then reeve through a double block travelling on a horse; next through a single block on the boom; back through the double block, and belayed, if desired, by hitching the fall round the parts of the sheet above the double block.

Still another way of leading the main-sheet is as follows: The sheet is fast to a single block on the boom, then leads through a single block on a horse, back through the block on the boom, through a block on deck a little ahead of the horse, and is then belayed.

Hardly any rig is handier for tacking than the balance lug, and, should a boat so rigged show a tendency to miss stays, her head can be easily paid off by holding the foot of the sail over to what is to be the weather side.

The sail should not be kept a-weather a moment longer than necessary, however, and if the boat does not gather way again quickly after the boom has been put over on the lee quarter, the main-sheet must be eased a bit.

CENTREBOARD BOATS FOR ROWING AND SAILING.

A BOAT in general demand is one for rowing and sailing, sometimes termed centreboard gig, which is admirably contrived for those who like the exercise of rowing and the pleasure of dodging the wind between the banks of a river.

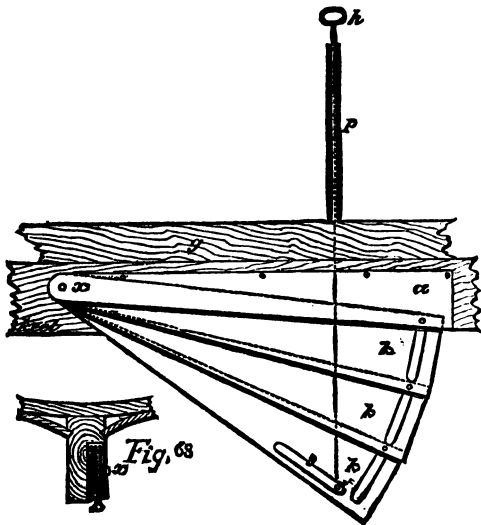

Fig. 69.

But the person who has one should limit his cruises to the waters upon which she is intended to sail, for a light centreboard boat is not fit for open water where there may be a yeasty sea.

For this description of boat no rig is handier or safer than the

single balance lug, though the gaff-sail, and sprit-sail are often fitted.

This boat as generally built is from 10 ft. to 18 ft. in length, with a beam of from $4\frac{1}{2}$ to 6 ft.

A centreboard of wood or galvanized iron is fitted; if the latter material is used it should be about $\frac{3}{8}$ in. in thickness.

A capital plan is in use for dispensing with the inside housing of the board, and is illustrated in Fig. 69.

It consists of plates of metal pivoted at the forward ends, and made to rest on one side of the keel when hauled up.

The leaves of the fan are pivoted to the side of the keel, which is cut away and a plate, *a*, bolted over the chamber so as to form a case to take the leaves when the fan is shut. The leaves *k, k, k*, are connected at their after ends by studs working in slots.

The fan is closed by a bar, working in a pipe, *p*; the bar being attached to the lower leaf by a stud, which works in a fore-and-aft slot, *s*. The bar is usually jointed, so that when the leaves are closed, the handle part, *h*, will fold down by the side of the pipe.*

The following proportions of ballast, for open boats of the ordinary model, may serve as a guide to the amateur:

For a boat of ten feet in length, about one hundred pounds; of twelve feet, about two hundred pounds; of fourteen feet, about four hundred pounds; sixteen feet, about six hundred pounds; and of twenty feet, about half a ton. These weights are approximate and should be corrected by experiment.

The combination row- and sail-boats made by Joyner & Sons, of Glenn's Falls, N. Y., are said to give general satisfaction. The boats are partially decked, and have a waterway around the cockpit; either keel or centreboard as desired, and ballasted if preferred. A typical boat is represented in Fig. 69 *a* and *b*.

* Other varieties of folding-boards are the Radix and Atwood boards, which have patent contrivances for raising and lowering the leaves of the fan.

The dimensions of one of the latest boats are as follows :
Length over all, 18 ft. ; length on water-line, 15 ft. ; beam,



Fig. 69 a.

extreme, 5 ft. ; overhang, 3 ft. There are three air-chambers and an after locker. The mast steps in a metal socket.

A canvas hatch-hood, which stows below when not in use, is furnished to cover the cockpit when at anchor, or in case of heavy seas or stormy weather.

A fan or folding centreboard is fitted. Where the ordinary centreboard is preferred $\frac{1}{2}$ -inch galvanized iron is used, weighing about sixty pounds. The sail generally fitted is a gaff-sail

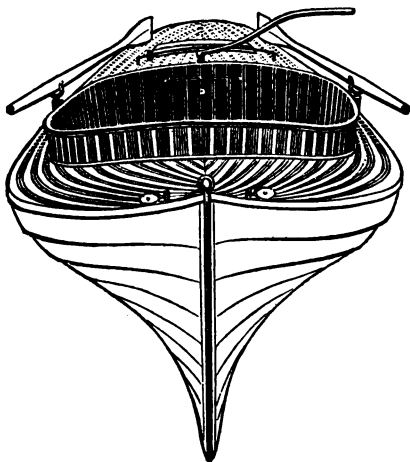

Fig. 69 b.

of about the following dimensions: Head, 7 ft. 3 in.; luff, 10 ft.; foot, 15 ft.; leech, 15 ft. 6 in.

A capital sail for these boats would be either the balance lug or the Mohican canoe sail, both of which admit of readily unbending from the mast, and of being compactly stowed for rowing.

A cheap and easily obtainable ballast for light boats is gravel, which should be carried in canvas bags holding from thirty to forty pounds. The rudder is of metal. There is one

twenty-pound anchor, and one set nine-foot oars. The prices of these boats fully equipped range from \$200 to \$300, according to finish and the quality of the fittings.

A small portable boat designed by Mr. H. W. Easton, of New York, has a length of 10 ft. and a beam of 5 ft. The mast is 12 ft. long, and is stepped 1 ft. from stem, and its diameter is $2\frac{1}{2}$ in. at deck, and $1\frac{1}{4}$ in. at truck. The sail is a standing lug, the boom having jaws to take the mast. The boom is 11 ft. 6 in. long,

and its greatest diameter is 2 in. The yard is 5 ft. 6 in. long and has a diameter of $1\frac{1}{4}$ in. The sail area is 76 sq. ft. The material of the sail is heavy 27-inch muslin, bighted every six inches, and hemmed with duck, stitched with three seams.

Ballast required thirty pounds, with one hand on board. Total cost, \$150.

ANCHORS, ETC.

ALL boats should have an anchor, and every boat over twenty-five feet in length should have two, at least. A short length of chain cable should be added when practicable, as rope is easily cut through.

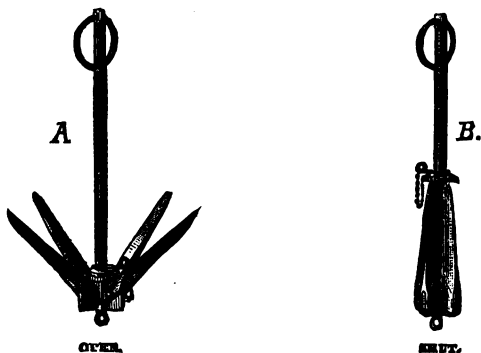

Fig. 70.

Anchors for boats should weigh at least $1\frac{1}{4}$ lbs. per foot of water-line. When two anchors are carried, the second one may be given 1 lb. per foot of water-line.

The Chester Anchor, Fig. 70, seems to be very suitable for small boats. Its great advantage consists in its compactness and the small space it occupies when not in use.

A represents the anchor open and ready for use ; B shows it closed up and ready to be stowed away.

The anchor has a straight, stockless shank, to the lower end of which are attached the four arms, or flukes ; these arms have a flat inner surface extending nearly to the point, giving the maximum holding power. On the shank is a ring, which slides down over the points of the arms, to hold them in position when folded, where it is retained by a pin.

When it is desired to unfold the anchor the pin is removed, the ring is raised to clear the arms, and the latter unfold and spread apart, dropping to the position indicated in Fig. 1 ; the ring slides down the shank until it brings up against the unfolded arms, and at a point in the shank just above the top of the ring, when in this position, is a second hole, in which the locking pin is inserted, so as to hold the ring down upon the arms, which are thus held securely open.

Rope cables are very convenient for boats, but are more reliable with a short length of chain at the anchor.

To mark them, run short pieces of cod-line through the strands at intervals of two or more fathoms, making one knot in the first piece, two knots in the second, etc. the amount of cable out may then be readily determined.

SAIL AREAS OF OPEN BOATS.

SAIL areas of open boats vary considerably, and in proportion to the length of boats multiplied by the breadth range from 1 to 3. Thus we find some cruising gigs, 17 feet long by $5\frac{1}{2}$ feet beam (equal to 93.5 sq. ft.), with about 94 square feet of canvas in their sails ; while other boats, only 14 ft. by 5 ft. (equal to 70 sq. ft.), that are intended for racing, have sail areas of 180 sq. ft., or $2\frac{1}{2}$ times the area found by multiplying the length into the breadth.

For ordinary boat sailing and cruising the sail area, especially if a single sail is used, should not much exceed the length of a boat multiplied by its extreme breadth.

If the boat is to be rigged for racing, a sail spread of over three times that area may be given, but this enormous proportion will only be safe in the hands of a clever boat-sailer, and the boat will require dexterous handling.

As a general rule boats will conveniently carry a greater area of canvas if divided into two or more sails than if planned all in a single sail.

THE BEGINNER'S FIRST SAIL.

FOR a novice the 14-foot centreboard boat, rigged with a single "balance lug," is a very suitable craft for schooling, and if he be so fortunate as to be located near shallow waters, he may find out considerable about boat sailing without an instructor.

To prepare for a sail: The boat is moored to the dock. The sail is a single balance lug, so called because it is "balanced" on the mast, a part of the sail being forward and part abaft the mast.

The halliard is bent to the yard, and then passes through a sheave in the masthead.

We get on board and see that there are oars and rowlocks handy, that there is a baler and sponge provided, and that there is a life-buoy or belt for use in case of accident.

The tack of the sail is a loop bent to the boom and hooked to a hook on the mast. This must be made fast before hauling on the halliard.

Now "a long pull and a strong pull" and the sail goes up taut. Catch a turn of the halliard once round the cleat, and *swig it up*, to take in any slackness aloft, hauling the slack round the cleat, and belaying it with three or four turns, figure-eight fashion, round the cleat.

The yard is kept in to the mast by the mast-iron, or *traveller*, which is the method in general use. The halliard fall is now coiled up neatly at the foot of the mast, and the coil turned upside down so that the running part may lead from its top.

Next overhaul the sheet and see it clear. In this case this important rope is fitted with one end fast to an eyebolt at the stern, then leads through a block on the boom, and the hauling part leads inboard to the hand.

In a small boat this sheet should never be made fast, and to avoid any temptation to belay it there should be no cleat handy.

Let it be supposed that there is a side wind blowing across the river so that we can sail either way. It blows from the left, or *port* side. Lower the centreboard to its full depth, and prepare to start.

Cast off the *painter*, by which the boat was secured, and hold the boom over to the *weather* side, that is, the side toward the wind. This makes a *back-sail* and cants the boat's head from shore.

As she pays off, let the boom go over, and slack off the sheet until the sail is nearly at right angles to the boat.

Grasp the tiller and press it toward you, as you sit on the weather side of the boat.

She is *under way*, and is skipping along at a fine pace up the river, and you feel the exquisite charm of controlling her movements by a light, firm touch upon the tiller.

Soon a bend in the river is approached; it turns to the left, or to windward, and as you come round it the main-sheet must be hauled in. In order to sail up this reach without tacking, you will find it necessary to sail *close hauled*. So get the sheet well in and the boom just over the lee quarter.

If the wind is puffy, the boat must be luffed as the gusts strike the sail; that is, allow the pressure of the wind to force the boat's bow up a bit closer to the wind, which will spill some of the wind out of the sail, and cause the heeling tendency to be reduced. If the helm be slightly eased, the boat will tend to point up into the *wind's eye*.

Observe not to luff up too much, however, as the wind will be thrown out of the sail, and the *way* will be deadened, or perhaps lost.

Ah! here comes a strong puff. And you have arrived so close to the weather shore, that you cannot luff without running on shore; so ease off the sheet smartly and spill the wind out of the sail in this manner. Be spryer the next time, my lad, for the lee gunwale was pressed down to the water.

Haul in the sheet again as soon as the puff has passed.

Now the river makes a turn to the right, which is to *leeward*.

As you near the bend, *bear up* and sail her *free*, or not so near the wind. To do this, *put the helm up*, which is accomplished by pushing the tiller up to windward.

(To put the *helm down* the tiller is pressed down to leeward, and the boat is caused to luff.)

A sharp bend to the left appears, and it will be necessary to tack up the next reach.

Observe not to keep the boat too close to the wind, but sail her a *good full* so that she may have plenty of headway. As the bank is neared, *go about*. Put the helm down steadily and the boat will luff head to wind, with the sail shaking. If she appears to lose headway, shove the helm *hard over* sharply, and she will turn quickly and the wind will catch her on the other bow and fill the sail on the other tack.

Let the boat gather good headway with the sheet eased a trifle, and, as soon as she has a good start, trim the sheet carefully and sail her *by the wind*.

Repeat the evolution when the opposite shore is approached, and you will then be *tacking*, or working to windward.

Ah! you have carelessly jammed the tiller down too suddenly in tacking, which has stopped her way and she has *missed stays*, and lies dead in the water. The boom must now be shoved well over to windward by hand, which will *box* her head around.

As there's a good breeze, you have perhaps found that by sitting on the weather side you could add to the boat's stiffness under sail, but you should be careful to change over each tack. And it may be well to remember that there is no objection to shifting *live* ballast in racing, though shifting dead ballast is generally forbidden.

The wind is freshening and we will take in a reef. On the river we can, of course, run her bow into the bank while we do so, but on more open waters it would be necessary to bring her head to wind.

Lower the sail partially, or wholly if desirable, and lash the reef cringle on the luff or forward edge of the sail to the boom (the line used for this purpose is called a reef earing); then pass the earing of the cringle on the leech, or after edge of the sail, stretching the foot of the sail as taut as possible. The earings well secured, roll up the foot of the sail neatly and tie all the reef points with square knots, or if eyelet holes and a lacing are used, pass the lacing and bring them down snugly to the boom. Hoist the sail up taut.

We will now turn back and see how she sails before the wind. Put the helm up, ease off the sheet, and away she goes before the wind at a good pace. Perhaps, thinking that all hard work is over, you make fast the sheet and begin to take your ease. Crack! the sail has gybed, and it took you unawares, knocked your hat into the water, and shook things up generally. Served you exactly right. *There should not be a moment's negligence in a sail-boat.* The wind down the last reach was a little on the starboard quarter, which kept the sail extended on the port side; but as the course of the river was followed the wind came a little on the port quarter. Although there was little difference in the feel to your back the more sensitive sail was affected and began to shiver, the boom began to lift and finally flew over with a vigorous jerk. In a light breeze the jerk might not be severe enough to matter and the sail might be permitted to gybe without bothering yourself, excepting to meet her with the helm and counteract the tendency to fly round as the pressure is suddenly applied on the other side.

With a fresh breeze, however, it becomes necessary to "rally" in the sheet rapidly before the boom goes over, catch a turn, to prevent the great shock, and slack off the sheet steadily as the boom goes out on the other side.

We are back to our starting-point. Take a good sweep round

and bring the boat up head to wind, so that she loses her way just as she grazes the bank, or reaches the moorings.

Lower the sail, roll it up neatly, and put the waterproof cover on, raise the centreboard, and leave everything neat and tidy.

NOTE.—Although the centreboard has been kept down all the time, the amateur will be careful, as he becomes more of an adept in boat sailing, to raise it, and so lessen the resistance when the wind is aft, or nearly so.

HINTS AND CAUTIONS FOR PERSONS SAILING SMALL BOATS.

BEFORE leaving the moorings, see everything about the boat and gear in order, especially the tack, sheet, halliard, and reefing gear.

Remember that the boat is not liable to capsize unless the sail is confined by the sheet being fast. If the sail and boom are free to move in a direction parallel to the wind, the boat cannot be upset by any ordinary puff.

To insure safety the person handling a boat should never betray the sheet, but keep it in hand so as to be able to slack it at a moment's notice. If desired, one turn may be taken round the cleat, and in puffy weather it is well to do so, and the end should be then held in the hand so that it may readily be eased to the puffs and allowed to render round the cleat.

It does not follow, however, because the slacking of the sheet is a safe thing to do, that it should always be done. With skilful boat-sailors it is seldom done; for they can obtain the same result with the rudder by bringing the boat up into the wind until the sail shakes with the sheet fast.

In a sudden squall a modification of both of these methods may be used; *i.e.*, slack a foot or two of the sheet, and luff the boat up to the wind.

Unless the squall is very severe, there is no necessity to luff so as to shake the sail to any great extent.

The slightest movement of the tiller will keep the sail just

quivering, the boat still advancing, and retaining steerage way, and being under perfect control.

It is very important to keep steerage way on the boat, and it is only in the utmost emergency that the sheet should be slacked roundly, and the headway lost.

In small boats on ponds or lakes, when a thunder-shower is seen coming up, it is, as a rule, much the safest plan to take the boat promptly toward the nearest land, unless inaccessible ; in which case furl all sail, and anchor, paying out a long scope of cable so that the boat will ride easily.

The safest position in an open boat, when preparing for an approaching squall, is for all except the helmsman to sit in the bottom of the boat near amidships. No rising up in the boat should be permitted.

The helmsman should always sit to windward of the helm, so that it can be put down quickly in case of necessity.

Keep the halliards and sheet clear for running, by neatly coiling them down, and up-ending the coil so that the rope may render freely from the top of the coil.

If a compass can be procured, carry one with you whenever sailing in open waters.

Never sail strange waters without a pilot or a chart.

A lead-line, with the first fathom marked in feet, should be a part of the outfit of all deep-draught boats.

Bear in mind that "on the wind," the *starboard* tack has the right of way over the port, and that a boat sailing *close hauled* has the right of way over one sailing free.

Avoid tide-rips and whirls.

Keep cool in emergencies.

If sailing with passengers, do not permit them to distract your attention from the management of the boat.

Always have an eye to windward, watching the horizon and the surface of the water for the approach of puffs of wind.

Boats of the cat-boat type should be kept well down by the stern, as if at all down by the head they *gripe*, or fly to windward, and it will require a strong weather helm to keep them away.

In tacking, the helm must always be eased down steadily so as not to deaden the boat's way. With a single sail, haul the boom aboard as the helm goes down, and keep it to windward until she pays off.

Never attempt to tack with a big wave coming in on the weather bow, but wait for a "smooth."

Remember that a boat can always be helped round with an oar.

Some boats come about with such marvellous celerity that in a breeze it is necessary to pop over spryly to avoid becoming "lee ballast."

As a rule it is preferable to tack than to gybe.

Never gybe a sail when the wind is blowing fresh, unless actually necessary. If you must gybe, do so with the peak settled, or the sail reduced.

Never gybe a boat with the sheet well out. Trim the sheet in smartly, as the helm goes up, catch a turn round the cleat, and ease the sheet out as the boom goes over.

In running before the wind, be careful not to gybe. If the wind is fresh-run with the peak settled.

In rough water, watch out that the boom does not catch in the crest of a sea, trail aft, and gybe the boat. This is known as "tripping," and may be avoided by using the helm so as to bring the wind on the quarter opposite to the boom, and keeping the latter topped up.

A mistake frequently made is to neglect to reef till it is too late. It is easy to take in a reef while there is time, but sometimes it becomes almost impossible if too long delayed.

To reef, take in sail, trim the sheet flat aft and secure it. Haul out the clew and make the pendant fast. Tie down the tack and then tie the reef-points with square knots.

In shaking out a reef reverse this process, casting off the reef-points first. Reef to windward of the sail.

Whenever, from a heavy sea, a boat refuses to mind her helm and misses stays, it may become necessary to *wear* to get her on the other tack. *Wearing* is performed by settling the peak of the

sail and following the directions already given for gybing. Once gybed, hoist the peak, trim in the sheet, and bring her to her course with the helm.

In heavy winds and rough water a boat will sail better and be safer with the sheet started a little.

Never luff a small boat in rough water and high wind so as to stop her way. When puffs come along too strong for safety, ease the sheet.

Boats which lose way under the foregoing circumstances are very liable to upset after the helm is put up to fill away again.

If the boat has lost way, slack off the sheet, put up the helm and let her fall off. When the sail is full down helm carefully and trim in the sheet.

Whenever struck by a squall in a boat running free, put the helm down at once, keeping the sheet free.

The main-sheet should never be let go altogether with any boom sail, as the sail will not spill readily, and the boom may get in the water, which will be dangerous.

With reefed sails, and a safe and powerful boat, she may be "sailed narrow" through summer squalls, that is, very close to the wind, the luff of the sail quivering in the eye of the wind.

When overtaken by a heavy squall, sailing before the wind, settle the sail at once, and furl it if possible to make all secure, waiting until you have felt the weight of the squall before attempting to make sail. If the squall promises to be continuous and severe, it may be well to come to an anchor, if on soundings.

Lifting the centreboard when scudding will cause the boat to steer better as a general thing.

If seas are liable to comb over on your stern or quarter, a bucket or a couple of oars lashed together may be towed about five fathoms astern to break the seas. This drag will also steady the boat and prevent her steering wildly. For riding out gales of wind, the *sea anchor* is invaluable.

A drag formed by lashing spars and sails together, the sails being left partially loose and the whole being held by a line and

thrown overboard, so that the boat may ride to leeward of them in comparatively smooth water, should always be used when it becomes necessary to ride out heavy weather.

When racing in small open boats, the crew should sit as low down in the boat as possible; if on the floor so much the better.

In very light boats, where a very essential element for speed is to keep the crew quiet, and if necessary to lay well up to windward, the men may be required to get one leg and part of the body over the weather side, and if the spare spars and sails are lashed up to the sides of the boat, they will assist the crew maintaining this position.

For racing purposes, the hulls of small craft are often carefully pumice-stoned outside and then black-leaded.

The practice of going into the lee bow of a boat as the helm is put down to assist her in going about is a very good one; by immersing the lee bow the pressure of the water is increased there and the boat's head is forced to the wind.

The man who goes into the lee bow to help the boat into the wind should not remain there too long, but should move aft to the opposite quarter to assist the boat's head in falling off.

The mast and spars of boats should be neither larger nor heavier than absolutely requisite, for it is better to carry away a spar now and again than to upset the boat by using those which are too stout and heavy.

When there is too much sail on a boat, something must give way; an accident is inevitable unless the sheet is let go, or the sail smartly lowered. If the mast is slender it may "go by the board," all sail standing; there the damage generally ends, and there is no upset and no danger of loss of life.

It is a good plan to fit the masthead with an iron hoop having several small eyes, in which little metal blocks may be hooked to receive the halliards and other gear.

It is generally considered better to reeve the halliards of a small boat through a block than through a sheave in the mast.

Whenever shrouds are fitted in sailing boats, they should be

set up a little abaft the mast, in order to serve also as back-stays.

Narrow boats are not recommended for sailing purposes. They are well adapted for rowing, but are not so safe for sailing as the wider boats.

In open boats the jib-sheet should not be fitted to work on a horse.

By placing reef-points close up to the cringles, the ends of the sail will be made so neat and snug that the reefed sail will appear as if it had been changed for a smaller one.

Boats which are intended to make frequent visits alongside shipping, or to land often at wharves, should be fitted with some rig not requiring a bowsprit.

Great care should always be taken when passing under the lee of a ship at anchor or other large object, if there is anything like a breeze, as when the boat draws clear she will have but little way on, and to be met then by the full blast of the breeze will cause her to heel more than if she were moving at her best speed ; or, if she has to go under the lee of a passing or meeting vessel, she will equally get becalmed, though not for so long a time ; she will, however, get the breeze again much more suddenly than if the passing ship had been at anchor, and may consequently be knocked down more. None of the crew of a boat should sit on the weather gunwale when passing under the lee of a ship, as the sudden loss of wind will bring the boat upright, and so much weight on one side may cause the crew to be pitched into the water, or possibly if the boat gets caught aback as she heels to windward she may capsize.

The first best thing to do is to give all objects such a wide berth that the boat cannot be becalmed by them. If the boat is beating to windward, and would have to bear up very much to clear the ship at anchor, it would be better to make a board and weather the ship ; this can also be done, if managed in good time, to weather a ship that is meeting the boat, *i.e.*, is running before the wind ; but a boat should never be put across a vessel unless so far ahead as to render collision impossible.

If in the attempt to weather a ship there seems a doubt about doing it, do not commence squeezing ; ramp the boat along, and tack or bear up in good time and go under the ship's stern if both are beating, and under her lee if the ship is free.

If there be no choice, and the boat has to pass under the lee of the ship, then have the main-sheet cast off and held ready and clear to run out ; if the boat has nearly lost her way before she gets the breeze again she will scarcely answer her helm to luff ; and if she is knocked down to near the gunwale edge let the sheet fly without hesitation.

If the passing vessel be a steamer going at a great speed she will leave a considerable wash, and small boats should avoid this, although it is the delight of some bold sailors to get into it and ship "green water," as they love to call it.

If capsized in a squall, try and crawl over the weather gunwale, so as not to get caught *underneath* the boat. Cling to the bottom of the boat, which will be sure to float.

NEVER let go the tiller or jump about in a boat.

NEVER sit on the gunwale or climb the mast.

NEVER let your garments trail overboard.

NEVER forget that a heavy boat holds headway longer than a light one.

NEVER trust a squall that cannot be seen through.

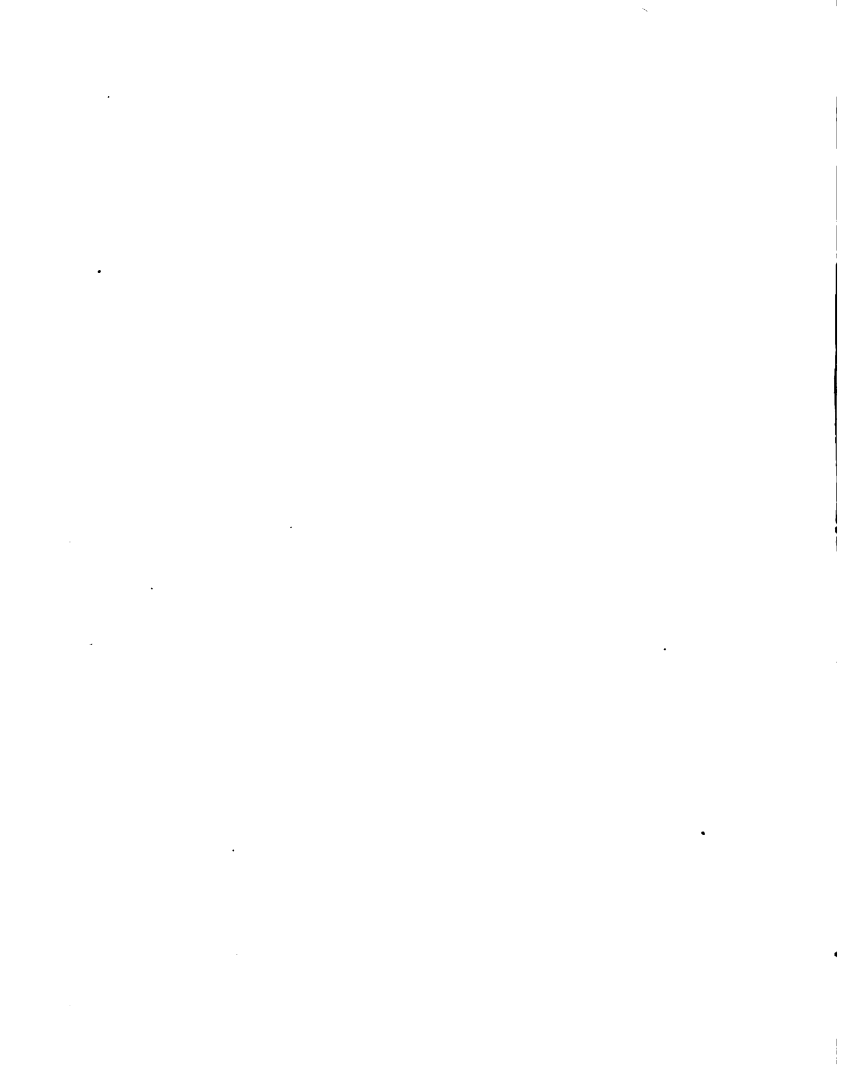

Section 3.

JIB AND MAINSAIL BOATS.

PAROLE AND CRUISER.

JIB AND SPRIT-RIG. SLIDING GUNTER.

FRENCH GUNTER RIG.

LEG OF MUTTON. SHARPIE AND NONPAREIL.

BERMUDA BOATS.

MAIN-AND-MIZZEN RIG. BATTENED SAILS.

LATEEN RIG, SHEERMASTS, ETC.

LUG SAILS, CLYDE LUG-SAIL BOATS.

SETTEE SAILS. NEW BRIGHTON BOATS.

REMARKS ON THE DOUBLE HEAD-SAIL.

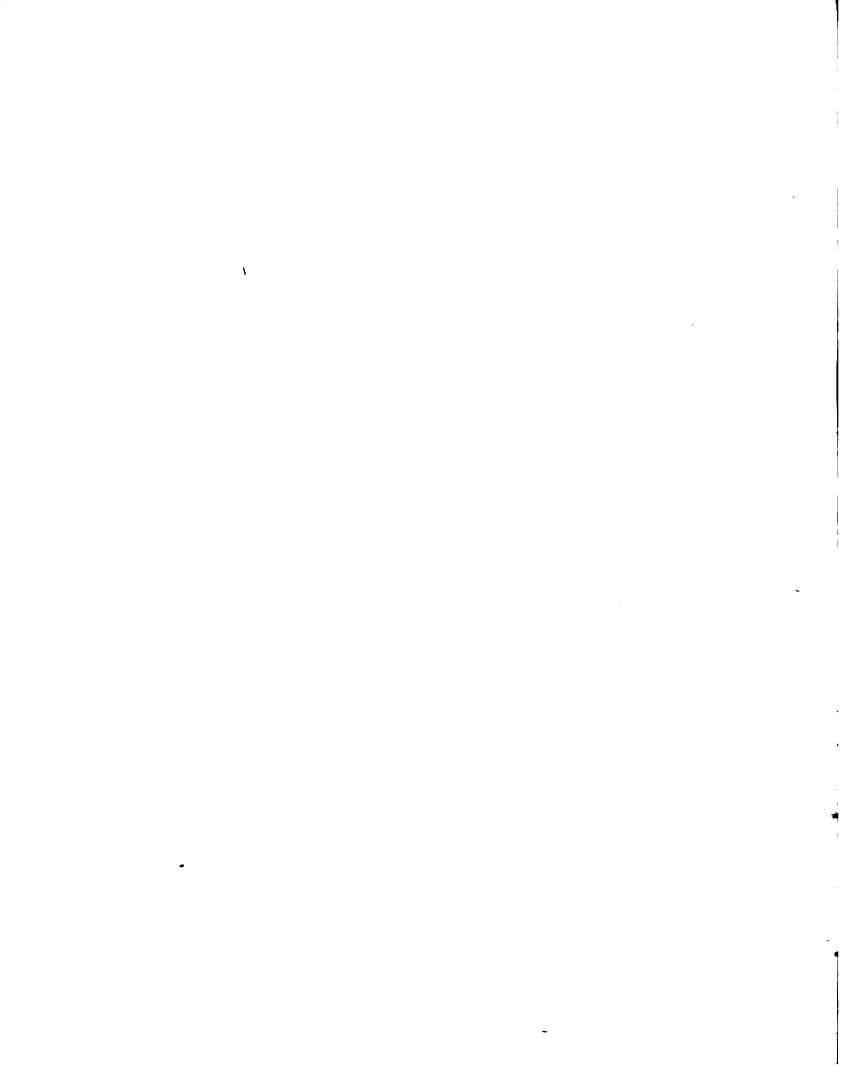

JIB AND MAINSAIL BOATS.

THESE boats are deservedly popular in the United States, and may be seen in great numbers about the harbors on the Atlantic seaboard, and on the great lakes along our northern border.

When the highest rate of speed and best balance of sail are sought in preference to simplicity in gear the single sail naturally gives place to the mainsail and jib.

Larger area is obtained on a given weight of spars, the mast is stepped in a more favorable position, and two sails admit the quick adjustment of the balance on all points of sailing, and allow the easy reduction in area necessary in strong winds. What is lost in simplicity of gear is gained in greater handiness of manipulation.

PAROLE AND CRUISER.

FIG. 71 shows the sail plan of PAROLE, one of the fastest clippers built by Mr. Jacob Schmidt, of Staten Island.

TABLE OF DIMENSIONS, ETC., OF PAROLE.

Length on load water-line	27 ft.
Breadth, extreme	11 ft. 3 in.
Breadth, load water-line	10 ft.
Draught of water	1 ft. 8 in.
Draught with board	7 ft. 3 in.
Displacement	4.5 tons.
Centre of effort of sails abaft centre of lateral resistance	0.4 ft.
Area of immersed board	25 sq. ft.
Mast, deck to cap	38 ft. 3 in.
Fore side of mast from fore side of stem .	8 ft. 2 in.
Bowsprit, outboard	22 ft. 1 in.
Area of mainsail	1,056 sq. ft.
Area of jib	484 sq. ft.

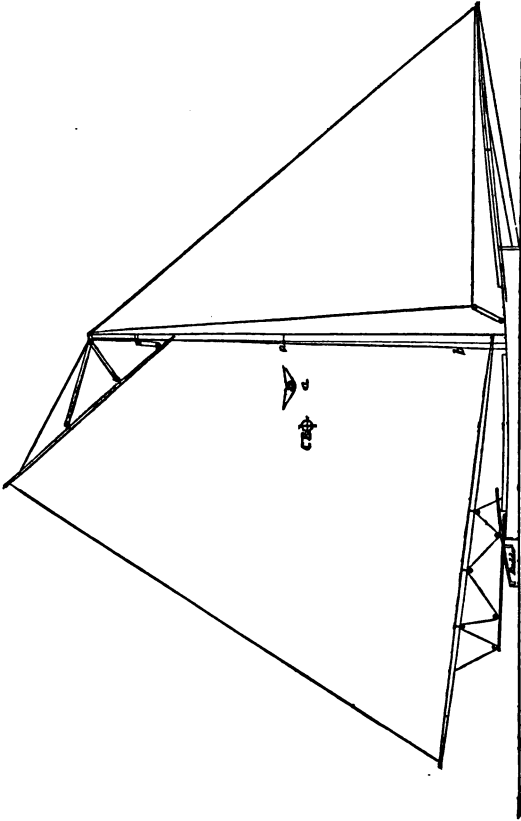

Fig. 71.

TABLE OF DIMENSIONS, ETC., OF PAROLE.—*Continued.*

Total sail area	1,540 sq. ft.
Luff of mainsail	30 ft.
Leech of mainsail	48 ft.
Foot of mainsail	38 ft. 6 in.
Tack to peak	46 ft. 6 in.
Clew to throat	46 ft. 6 in.
Luff of jib	46 ft.
Leech of jib	35 ft.
Foot of jib	27 ft. 6 in.

The ballast carried is about 1½ tons.

The mast is 10 in. in diameter at the deck, and 5½ in. at the truck. It has one shroud each side, with a "spreader" about half way up. A spreader is also used for the bowsprit shrouds.

The main-sheet leads through two blocks, on outriggers over the stern, and through a block traversing on a horse. The inner block on the boom is only used in match sailing when on a wind.

Fig. 72 represents the CRUISER, of Boston.

Her particulars are as follows :

Length over all	20 ft. 8 in.
" on water-line	20 ft. 8 in.
Beam extreme	9 ft. 8 in.
Least freeboard	1 ft.
Draught without board	1 ft. 4 in.
" with board	6 ft.
Length of board	6 ft. 8 in.
Area racing mainsail	527 sq. ft.
" racing jib	272 sq. ft.

With racing sails 25 sand-bags of 50 lbs. each are carried in the weather gangway and shifted in stays. The jib can be dispensed with, and the mast shifted to a step 20 inches from stem if desired. The dotted lines indicate the smaller mainsail

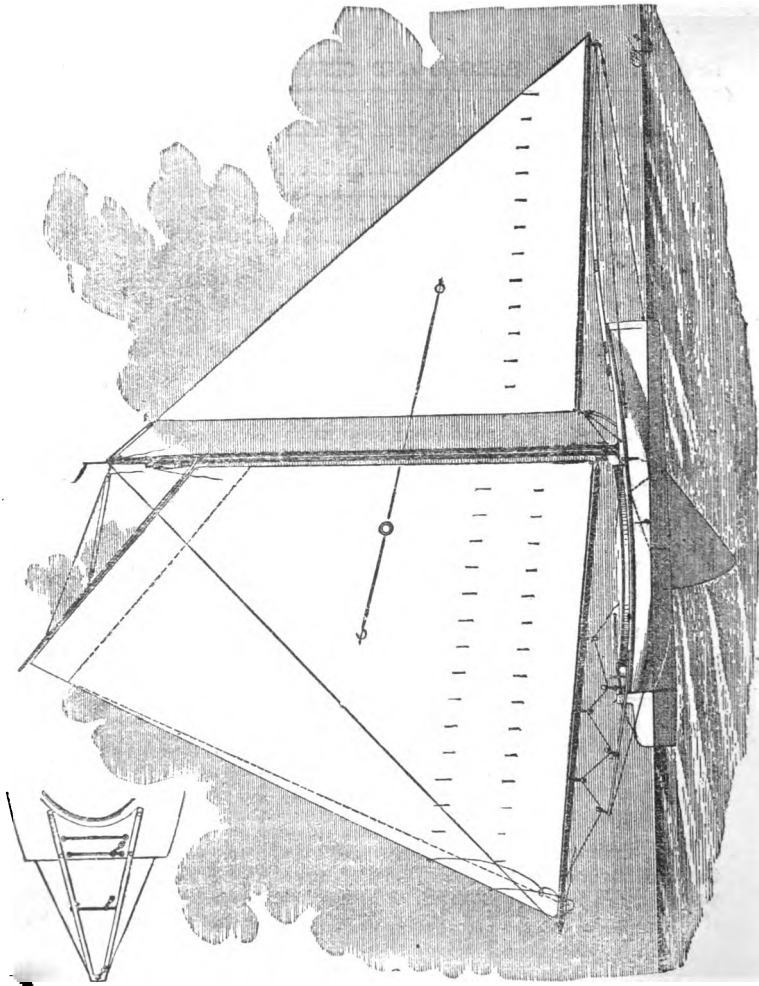

Fig. 72.

generally carried when she races with fixed ballast and a crew of five hands, the latter sitting on the weather rail.

The jib is set on its own luff. The tiller passes through the rudder-head, and secures to the rudder to prevent buckling of the latter.

The mast, for small rig measures, keel to truck, 28 ft. 4 in., and deck to hounds, 24 ft. 3 in., and has a diameter of 6 in.; boom, 25 ft. long and 4½ in. in diameter; gaff, 15 ft. long and 2¼ in. in diameter; bowsprit, outboard, 14 ft. 6 in.; jib-boom, 21 ft. 6 in. Hoist of mainsail, 19 ft. 6 in. Jib, on luff, 32 ft.; leech, 22 ft. 6 in.

For the large rig the particulars are as follows :

	Fect.	Inches.
Mast, heel to truck.....	31	0
“ deck to hounds.....	26	8
“ from end water-line.....	7	4
“ diameter at deck.....	0	6½
Boom, over all.....	27	0
“ diameter at slings.....	0	4½
Gaff, over all.....	15	0
“ diameter.....	0	2¼
Bowsprit, outboard.....	16	0
Jib-boom.....	21	6
Hoist of mainsail.....	22	6
Jib, on luff.....	32	0
“ leech.....	23	6

Two iron travellers extend over the tiller across the quarters, and a cleat is secured to the forward one for catching a turn with the main-sheet.

On a wind the sheet is entered in a snatch-block on the boom and the fall attended by hand.

JIB AND SPRIT RIG.

SPRIT-SAILS have fallen somewhat into disuse lately, but are still seen among watermen and fishermen, who claim for them certain advantages. The sprit, by crossing the sail diagonally,

takes up all the slack canvas in the middle, even if it be an old sail. On the other hand, however, a sprit is an awkward spar

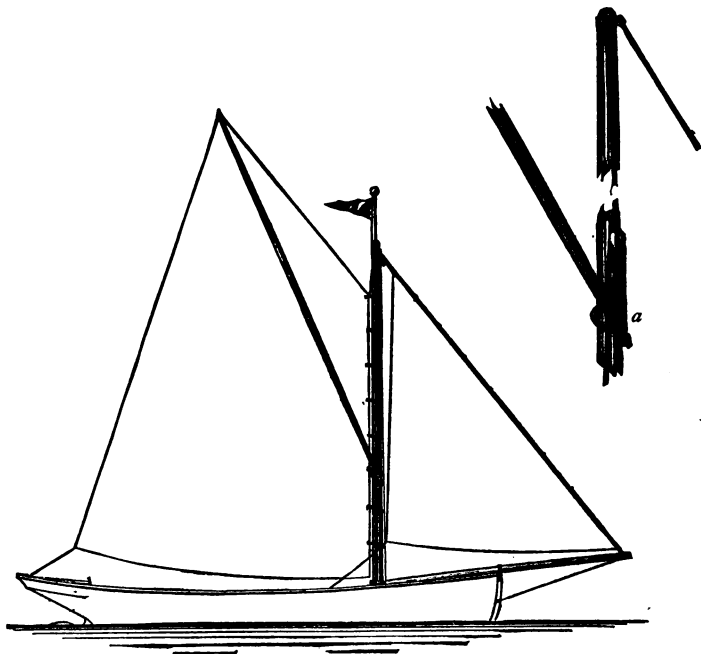

Fig. 73.

to handle, and to set similar sails it must be longer and heavier than a gaff.

In small boats the luff of the sail is usually laced to the mast

through eyelet holes about eighteen inches apart, and the throat is secured to an iron traveller. In large sails galvanized iron mast-hoops are used. Fig. 73 shows a jib and sprit rig.

The tack lashes to an eye-bolt in the mast. The sail is hoisted by a single halliard, which is belayed to a cleat on the gunwale to serve as a shroud. The jib halliard is also single, and belays to the opposite gunwale.

The sprit is supported on the mast by a strap called a *snorter* (*a*, Fig. 73); this is a piece of rope having an eye in each end; it is passed round the mast, and one end rove through the eye in the other end; the heel of the sprit is inserted in the remaining eye. After the sail is hoisted, the upper end of the sprit is slipped into the loop at the peak of the sail, and then shoved up and the heel inserted in the snorter.

The sail is peaked by pushing the snorter and heel of sprit as high as possible, after which the sheet is trimmed. A traveller and whip purchase are used with large sails (masthead plan). A pendant having a running eye is fitted over the masthead; * at the lower end of this pendant is a block, through which the hauling part is rove, one end being fast on deck.

The following are suitable dimensions for a sprit-sail and jib for an open boat, about fourteen feet in length by four feet six inches in breadth.

	Feet.	Inches.
Hoist of mainsail	7	6
Head " "	8	3
Leech " "	12	0
Foot " "	9	0
Length of sprit.....	16	0
Luff of jib.....	10	6
Leech "	7	10
Foot "	5	9

The jib may be dispensed with in strong winds.

* An iron band is fitted in the figure in place of a running eye.

THE SLIDING GUNTER RIG.

In this rig the mast is in two pieces, the upper part or topmast sliding on the lowermast by means of two metal rings or travellers (Fig. 74). These rings should be of brass or galvanized iron and are sometimes connected by one or two metal braces or stiffeners, but these are not necessary and may be dispensed with.

The sail should be laced to the topmast and its lower part kept to the lowermast by hoops or rings, which may be covered with leather and should be kept greased.

The gunter rings are fitted solidly to the topmast and slide freely on the lowermast, so as not to jam in lowering.

The topmast hoists by a single halliard, which is made fast at the neck of the upper gunter ring, and passes over a sheave in the masthead.

This rig is frequently applied to boats with two masts, a jib being used forward.

Jib-headed sails, although excellent for working to windward, are not in general favor for running before the wind. For localities where the weather is very changeable and unsettled, and where it may become necessary to reduce sail and top hamper quickly, this rig has many advantages.

Almost all the ship's boats belonging to the vessels of the United States Navy are at present fitted with the sliding gunter rig. The only exceptions are the sailing launches, which are generally rigged with jib and mainsail, and the dingies, which have a single sprit-sail.

FRENCH GUNTER RIG.

The rig shown in Fig. 75 has attained some popularity in France.

The mast steps in a "tabernacle" and can be readily lowered. The heel of the yard is denoted by *a*, and a wire-rope span extends from *c* to *d* on the yard, passing through a block, *k*.

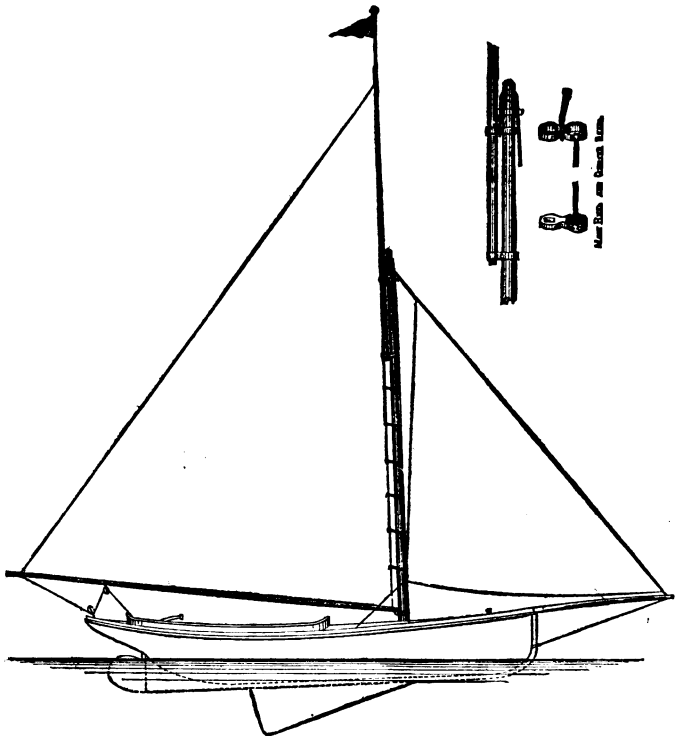

Fig. 74.

In A, α is an iron traveller on the mast, into the arms of

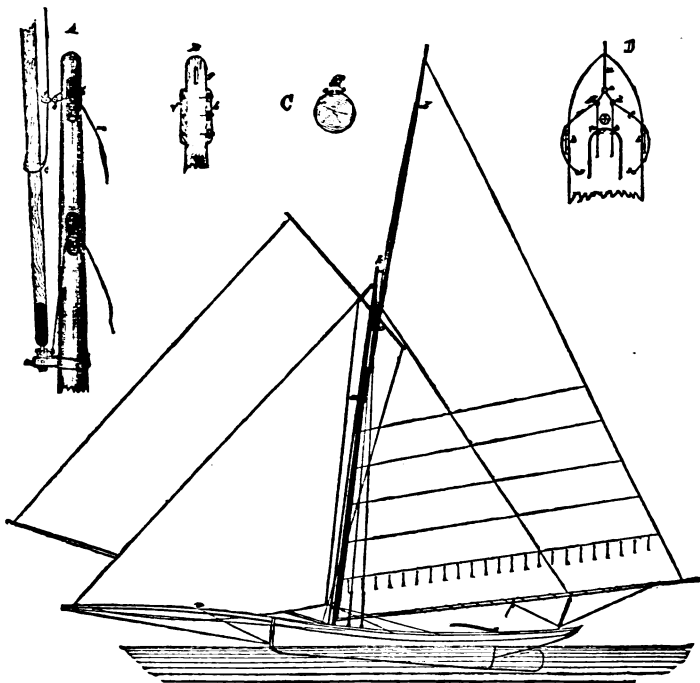

Fig. 75.

which the heel of the yard is inserted, and hinged so as to form a universal joint.

The hoisting halliard, *n*, is fast to an eye in the traveller, and reeves through a cheek-block on the mast. A whip purchase may be used on the fall.

There is an eye splice, *c*, in the end of the wire span, kept from slipping by a cleat; this span passes through a metal block, *j*, to which another block, *k*, is seized; and through the latter the rope *m* is rove. The rope *m*, in the first place, is rove through a cheek on the mast *B*, *f*; then through *k*, and over the sheave in *h*. The end at *f* is kept from unreeving by a wall-knot. In small craft the block *k* may be dispensed with, the end of the rope being made fast to *j*, and rove single. The upper sheave above *h*, in Fig. B, is used for the jib-halliard; one end of the halliard being stopped by a wall-knot after being rove through the hole above *f*; the other end is passed through a block hooked to the head of the jib and over the sheave above *h*.

The sheave below *h* is used for a topping-lift, one end of which is stopped at the hole below *f*; the other passes through a thimble on the under side of main-boom, and thence up over the sheave below *h*.

The large sheave-hole at *g*, Fig. B, is used for the spinnaker-halliards.

The sail is kept in to the mast by a number of metal travellers, *C*, working in a channel-way on the after side of the mast. These travellers have eyes to which the eyelet holes in the luff of the sail are seized. A traveller, made with a socket to receive the gooseneck on the end of the yard, is also inserted in the channel.

The bobstay is of wire, and has an eye in one end which encircles the bowsprit at *v*; it passes through a fairleader on the stem near the water-line, and through a block on bowsprit end, and is set up by a tackle. The standing part of the main-sheet is fast at the boom end, and leads through a double block on deck, a single block on the boom, back through the block on deck, thence through another single block on the boom, and in on deck.

The jib-sheets are very handily arranged. In diagram D, *a* delineates the line of the foot of the jib, *c* being the clew-*cringle*. Two short pieces of rope are spliced to this *cringle*, having also *thimble-eyes* at *d, d*. Each of the jib-sheets is fast to an eye-bolt at *s*, and thence passes, outside the channels, through the *thimble d*, and through the coamings of the well at *x*, after which it is belayed.

THE LEG-OF-MUTTON RIG.

THE leg-of-mutton requires no yard, and the mast should be a light, tapering spar.

The halliards are usually of small-sized rope, and reeve through a small block at the masthead, and are bent to the peak of the sail.

The sail may lace to the mast, or preferably be kept to it by small hoops or grommets; but if a jib be carried, these should not extend higher up than the jib-halliard block, which should be seized to the mast about four-fifths its height from the deck. A light boom may be used for the mainsail, and the jib should be cut narrow unless for a stiff boat, in which case a broad and powerful jib may be planned.

Fig. 76 represents a jib and leg-of-mutton sail. The advantages of this rig are that the heavy sway of sprit or gaff is avoided; and that on reefing the sail the widest part is taken off the boat, while the light, tapering peak is still retained.

A boat may be rigged with either one or two leg-of-mutton sails, and a jib may be added if desired. Boats so fitted sail fairly well, are easily handled, and quickly reefed. Brails are generally fitted to leg-of-mutton sails.

The approximate dimensions for a single leg-of-mutton sail for an open boat fourteen feet long and four feet six inches beam are as follows: Hoist, 14 ft.; after leech, 16½ ft.; foot, 12 ft. The mast should be stepped well forward, and the luff of the sail fitted with ten hoops. Reef-points 30 in. from foot of the sail.

The foot of the sail may be laced to a boom, connected to

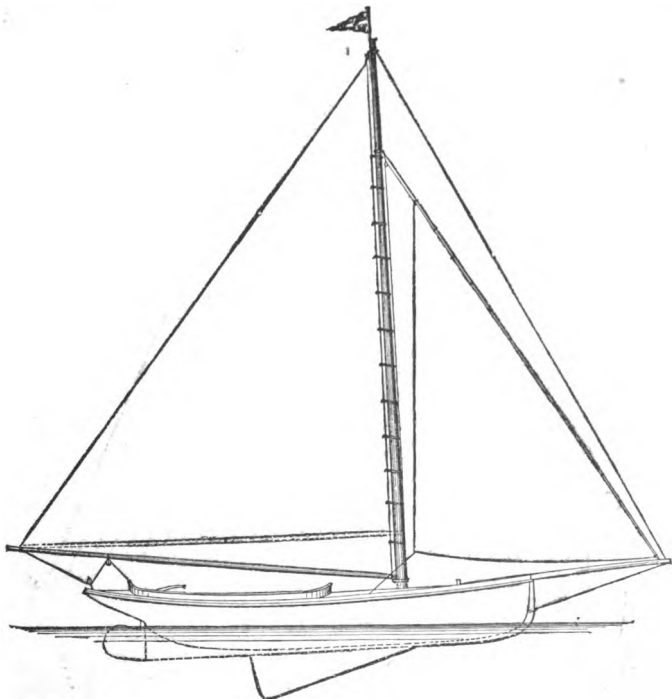

Fig. 76.

the mast by jaws or a gooseneck, so that the sail may readily
brail up.

Boats are sometimes fitted with two leg-of-mutton sails having horizontal sprits in place of booms, one end fitting into a grommet-eye at the clew of the sail, and the other into a grommet or bridle on the mast.

THE SHARPIE AND NONPAREIL.

THE sharpie is supposed to owe its origin to the oystermen, and its existence can be traced back to 1835.

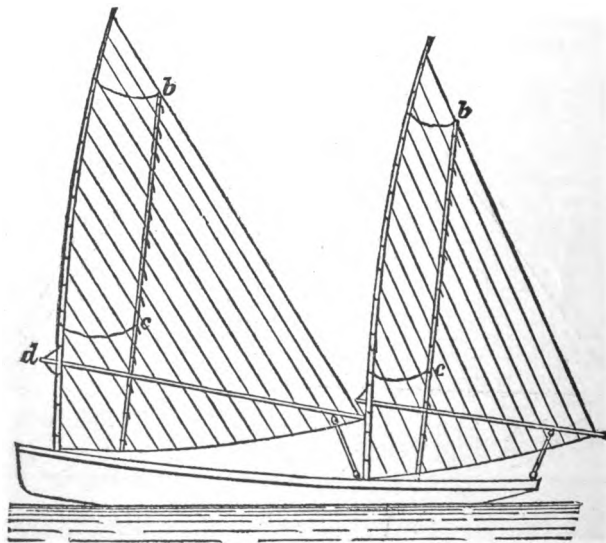

Fig. 77.

The floor of a true sharpie is generally rockered, or rounded up at both ends, but Mr. Thomas Clapham, of Roslyn, L. I.,

has introduced a form of the skipjack which he terms the "Nonpareil," in which the bow end is immersed with a view of doing away with the "spanking" of the flat floor when the boats are driven in lumpy water.

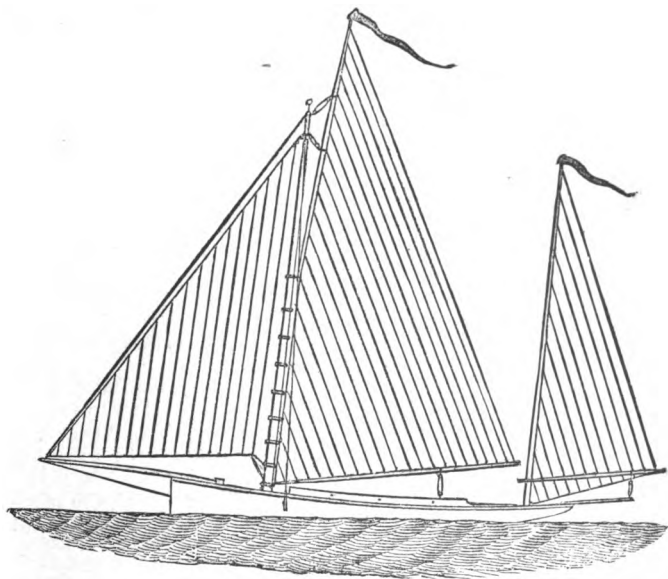

Fig. 78.

Sharpies vary in their proportions of length to beam from four to five, but those of five beams in length are said to be the faster.

The sides flare out three or four inches for each foot of depth,

and, while the bow end is sharp, the stern has usually a square transom. As a rule, the ends of the boats are decked, and in the larger craft a cabin is built.

In the rig delineated in Fig. 77 the mainmast is usually about five and one-half times the beam in height, and the foremast a trifle longer, or about six times the beam. Both masts are light, tapering spars, having considerable spring. The sails are leg-of-mutton shaped, extended by a horizontal sprit, a tackle on the mast being used for purchasing the sprit; *b* and *c* are brails used for reefing the sail.

The centreboard and rudder are large, and the latter is generally of the balance type, one-third being forward of the rudder-post.

The ballast usually consists of sand-bags.

With skilful management these boats can be sailed in lumpy water, but they heel very easily, and great quickness and dexterity are required to handle them in anything of a breeze.

A special adaptation of the principles of the yawl rig has been applied to a number of the nonpareils (Fig. 78).

Mr. Thomas Clapham gives the following description of a proposed nonpareil cruiser:

Length over all, 45 ft.; beam, 11 ft. 6 in.; depth at stem, 5 ft.; depth amidships, 4 ft.; draught with board up, 12 to 15 in.

The stem, apron, and stern are of oak; keel and keelson of oak, 6 × 10 in.; timbers of oak, 2 × 2 and 15 in. apart; planking and decks of clear white pine; centreboard of oak, 15 ft. long; house, 9 ft. by 15 ft.; masts and spars of spruce. Rig, the regular sharpie schooner style. Four berths in cabin. Cost of all complete, \$800.

BERMUDA BOATS.

THE waters of the Bermuda Islands are navigated by a style of boat the look of which is no doubt familiar to many people who have never been to Bermuda. They are short, broad, deep, handy little vessels, and are admirably suited to those waters where there is generally a smooth sea and a fresh breeze.

One remarkable quality of the Bermuda boats is their power of shooting to windward—they take a wonderful “fore reach” in stays; and it is not an uncommon thing to see one of them, with good weight on her, shoot head to wind through a channel of considerable length, and so narrow that she could not possibly beat through it.

The mast in these boats is stepped very far forward and rakes considerably, it is very stout at the partners, and tapers off toward the masthead; there is scarcely any rigging, generally only one small shroud on each side, and these appear to be more for ornament than use.

The Bermudians lace the mainsail to the mast when they are going to race; it is laced taut up and down from tack to head, and the mast being tapered, the sail cannot be lowered when once laced; thus they cannot reef, and if a boat starts for a race with a whole sail she must carry it or swamp.

The Bermudian races are generally “beating to windward;” this is what they appear to think the one thing needful in a boat. On the morning of the race two marks are laid down in the Great Sound, the only open piece of water there; one of these marks is dead in the wind’s eye of the other, three miles distant. The boats start from the lee mark, and go twice to windward, and once to leeward, winning at the weather mark on the second round. Their boats are slow “off the wind” and run very badly, completely burying themselves in a strong breeze; they are also dangerous to gybe; in fact, a Bermudian will not gybe his boat in a fresh breeze; he will in preference put his helm down, and come to the wind, and get the wind on the other quarter by tacking and then bearing away.

There is a peculiar plan used in these boats for making the mainsail set flat; the main-boom, instead of being fitted with jaws, has an eye-bolt in the foremost end of it, which end projects considerably before the mast; the after end of the boom is secured to the clew of the sail, and the boom is then roused taut aft with a small tackle taken from the eye-bolt to a strop round the mast. This produces a wonderfully flat sail. The strop

round the mast is three or four feet above the deck, whereas

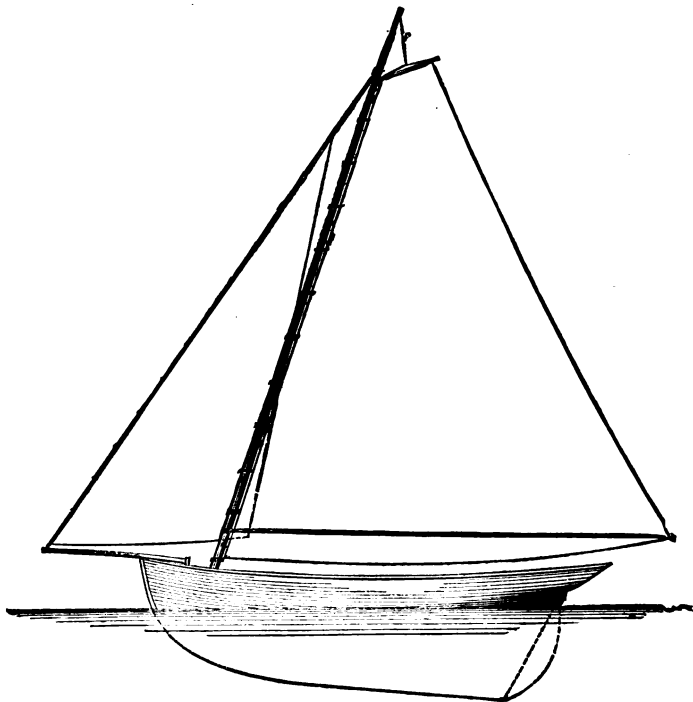

Fig. 79.

the tack of the mainsail comes close down, and this arrangement prevents the after end of the boom from cocking up.

MAIN-AND-MIZZEN RIG.

THIS rig is represented in Fig. 80. The mainsail is generally a balance lug, and the mizzen may be either a lug, sprit-sail, or leg-of-mutton sail.

If there is no counter, a boomkin projects from the stern, to which the mizzen sheet leads before passing inboard to belay.

Where not intended for single-hand sailing, the boomkin for the sheet may be a prolongation of the tiller, as shown in the drawing. When the tiller is put down the sail goes to windward, and the boat turns like a top. When the helm is put up the mizzen is eased, and the boat pays off cheerfully.

After reeving at the end, the sheet should pass through an eye on the rudder-head, and belay to a cleat, near the hand, on the tiller.

BATTENED SAILS.

FIG. 80 also shows the arrangement of battens for lug-sails. The mainsail is fitted with a yard, boom, and three battens, the sail being lashed to yard and boom.

The battens are passed through a horizontal seam on the sail, and the ends are seized to the luff and leech. The battens are of pine, about 1½ in. in diameter at the middle, and smaller at the ends. The battens and yard are kept in to the mast by toggles and becket parrels.

The reef earings reeve through thimbles on the boom, and belay to cleats thereon.

The halliard toggles to a becket on the yard.

The tack is single, and leads from the cockpit to a block at the foot of the mast; then toggles to a becket on the boom, one-eighth from the end.

The sail has great peak to clear the forestay, by which the mast, which works in a tabernacle, is supported and may be lowered. A topping-lift is fitted, with the standing part at the masthead, then passes down one side of the sail, through sheet-

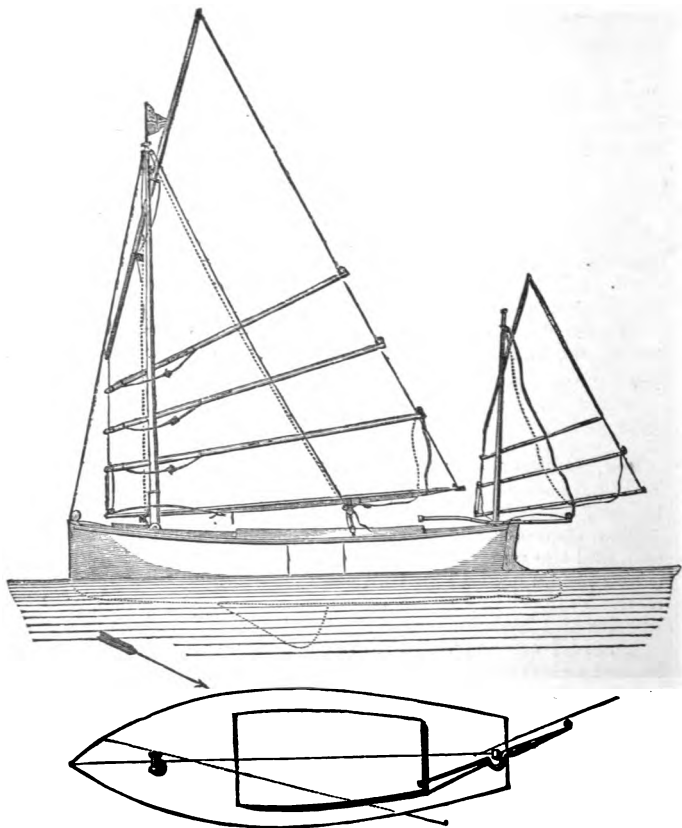

Fig. 80.

block thimble, up other side of sail through masthead block, and down to the deck. -

A *gathering line*, or *lazy guy*, is fitted to keep the sail clear of the deck when it is lowered.

The part of the tiller on fore side of the rudder has a U bend in it to allow it to work clear of the mizzen mast. A battened sail can be reefed in stays without checking the boat's way, as it is not necessary to tie the points.

Mr. W. Baden Powell found, in canoe sailing, that with battens he could carry more sail (in the ratio of 5 to 7), and that the sail was flatter and steadier.

THE LATEEN RIG, SHEERMASTS, ETC.

LATEEN sails are met with all over the world, and are very popular on the African coast and in the Mediterranean Sea.

They are usually cut with great peak, although they are sometimes planned with a longer boom and the yard carried more across the mast.

The main boom is retained at the mast by a clutch or a parrel, or traveller.

At the Cape of Good Hope, a plan of hoisting the sail on sheermasts has been adopted; the same contrivance is common to the Prahus of the Eastern seas.

Two short poles are fitted triangle fashion, and secured to each side of the boat with goosenecks, so as to move forward or aft (Fig. 81). The heads of the poles fit into metal sockets, *s, s* (diagram A), which are kept from opening at the throat by a transverse bar, *j*. A small bolt, *a, a*, runs through for further security. The upper socket holds a flagstaff.

The forestay is secured to each mast by means of a bridle, and the runner and pendants are fast to a mast on either side. A double block with tail, *o*, is secured round the neck of the socket for the halliards. Wire rope is used for the stay and pendants. No dipping is necessary, everything can be quickly lowered, and the masts and sails snugly stowed for rowing.

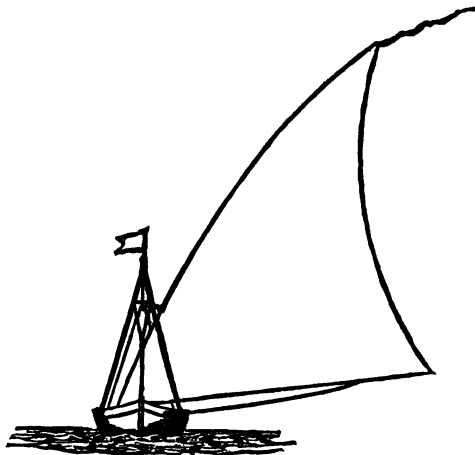
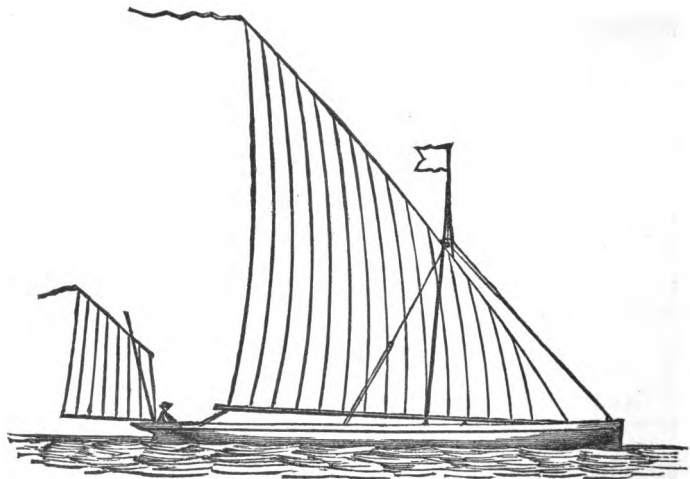

Fig. 81.

LUG-SAILS.

LUG-SAILS have always been very popular for open boats among foreign pilots and fishermen.

The lug-sail requires little gear, and the halliard serves as a support to the mast.

Sail may be rapidly shortened in luggers, and the spars are comparatively light and may be quickly struck, thus relieving the boat of a portion of the top hamper—quite a consideration in heavy weather.

During the last ten years, open-boat sailing has attained a wonderful popularity on the Clyde, where special opportunities are offered for this fascinating sport.

Fairly smooth water, little run of tide, snug anchorages, and the best of facilities by rail and steamboat for readily getting from the city to the water, induce most young men who have any nautical inclination to keep a sailing boat; and during the bright summer evenings a fleet of little vessels may be seen fitting along the shore, near every coast village, and lying over to the land breeze.

Saturdays are set apart for racing purposes, and almost every week there are two or three matches for the little craft.

CLYDE LUG-SAIL BOATS.

THE boats are divided for racing into three classes, 17 ft., 19 ft., and 22 ft. in length. The illustration, Fig. 82, shows a 19-foot boat.

The Y. R. A. rule has lately been adopted, the classes being fixed at $1\frac{1}{2}$, $2\frac{1}{2}$, and $3\frac{1}{2}$ tons, so as not to throw out existing boats.

The boats have plenty of freeboard, the average being 22 in. for a 19-foot boat, which is none too much for the heavy sea which a souwester tumbles up in that locality.

Pumps are fitted on the thwarts with discharge to both sides. The 17-foot boat, hull, spars, sails, etc., complete, weighs usu-

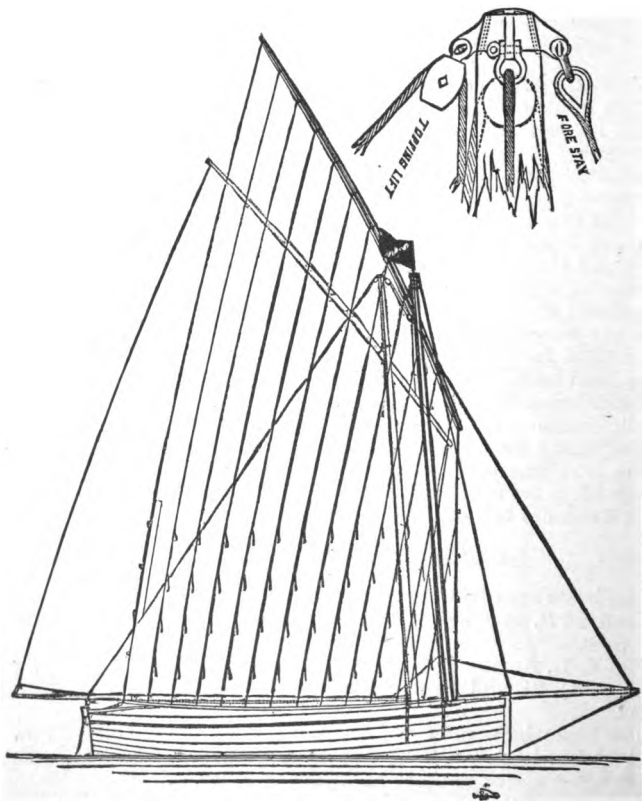

Fig. 82.

ally about a thousand pounds, and a 22-foot boat from eighteen hundred to twenty-four hundred pounds.

The usual rig for the boats of 17 and 19 feet in length is a single standing lug, as shown in Fig. 82; but for racing, in some of the clubs, a standing lug with boom on the foot, and short bowsprit with jib are used; these are indicated by the dotted lines in the plan.

For the single lug the mast is stepped one-seventh the boat's length from the stem, and for the lug and jib about eighteen inches further aft.

The mast is supported by $1\frac{1}{4}$ -inch steel-wire shrouds and a forestay, which are shackled to the crane at the masthead and are set up with laniards.

The yard hoists with a halliard of 2-inch rope, spliced into the eye of a mast-traveller, and having a purchase on the lower end.

The tack slips over a hook in the mast-beam, the purchase on the halliards serving to bring enough strain on the luff to peak the sail.

The main-sheet is a gun-tackle purchase, the lower block working on a horse.

The spars and sails carried by these boats are very large; one 19-foot boat having a mast 21 ft. in length, deck to hounds. The general proportions of sails carried, however, are:

Nineteen-foot boats: Luff, 12 ft. 6 in.; head, 16 ft.; foot, 14 ft. 6 in.; leech, 25 ft. 6 in.

Seventeen-foot boats: Luff, 12 ft.; head, 14 ft.; foot, 13 ft. 6 in.; leech, 23 ft.

All the modern boats have metal keels, 3 cwt. to 5 cwt. in weight. In some of them all of the internal ballast is lead also; but whether lead or iron, it is neatly cast in blocks which fit close down to the skin and hang on the floor timbers and keel.

Many of the boats are fitted with a shelf for stowing weather ballast in each bilge, which also makes a capital seat for the crew well up to windward.

Where shifting ballast is allowed the weight is sometimes gotten still further to windward by slinging a portion of it outside.

The crews are generally limited to three in the smaller boats and four in the 22-foot boats, so as to limit the use of "live ballast."

The 22-foot boats are now generally cutter rigged, and carry a small topsail on the pole mast. They also have balloon canvas for running.

SETTEE SAILS.

THE settee sail is a modification of the lateen and lug sails. It is a species of "standing lug."

The yard does not reach quite as low as the tack, and a short up and down luff is thus obtained up to the second reef. As the tack is close to the mast very little canvas is exhibited forward of the mast.

A 17-foot boat fitted with settee sails is shown in Fig. 83, the particulars of the sails being as follows :

	Head.	Leech.	Foot.	Luff.	Tack to peak.	Round of head.
	ft. in.	ft. in.	ft. in.	ft. in.	ft. in.	ft. in.
Mainsail	15 0	18 0	11 9	3 3	17 0	1 4
Mizzen	9 0	9 6	6 6	2 6	10 6
Jib	8 6	6 6	10 9

	Sq. ft.
Area mainsail	119
Area mizzen	38
Area jib	27
Total sail area	184

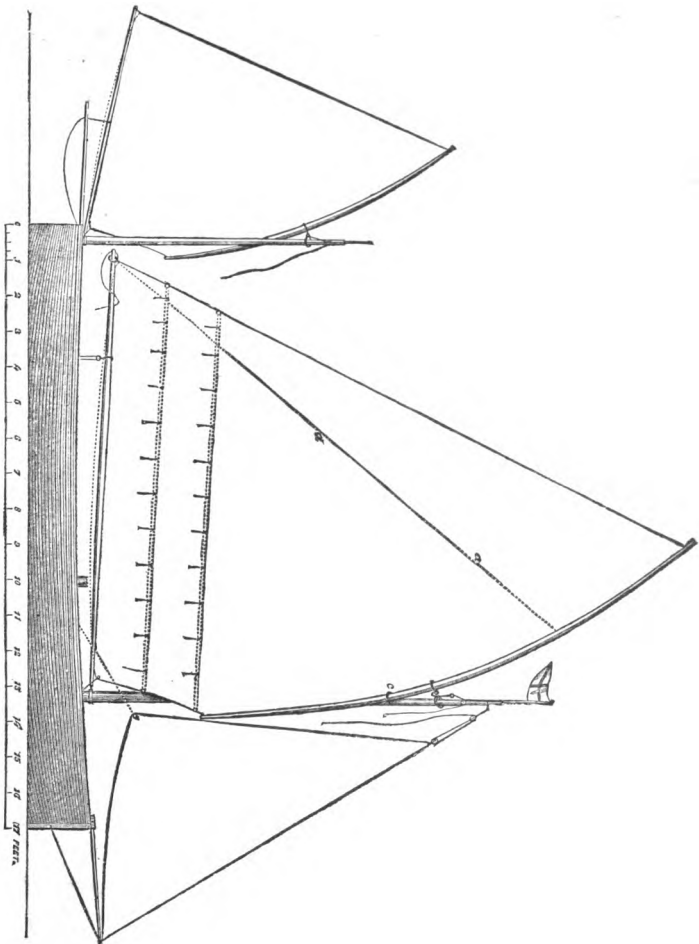

FIG. 83.

For single-hand sailing the mainsail should be smaller, as shown by the dotted line *a, a*. The jib should also be two feet shorter in hoist, and six inches smaller on the foot. The mizzen should measure two feet less on the head. Area of reduced mainsail for single-hand sailing, 85 sq. ft. The yard must be 4 ft. 6 in. shorter.

NEW BRIGHTON BOATS.

THE modern boats are built with counters, which enable them to have longer buttock lines, and make them handier when pressed by a wind forward of the beam; they also run before a sea drier, and some additional room is gained for working after sails. They are decked forward only.

The ELAINE, a very successful boat, is presented in Fig. 84.

Her length is 23 ft. 3 in.; greatest breadth, 6 ft. 4 in.; and draught aft, with six hands on board, is 3 ft. She carries 6 cwt. of iron on the keel and 2 cwt. inside. Displacement, 2 tons.

Her sails are cut very round at the head, the fore-lug having 19 in. rounding, and the yard being bent to nearly fit the sail.

The yard is $3\frac{1}{4}$ in. in diameter at the centre and tapers to the ends. An elm batten 1 in. thick, tapering to ends, is made to fit the yard by grooving and extends nearly its whole length, being neatly seized to it.

The foremast is 4 in. in diameter, and is held in step by a clamp at the after side of the fore thwart. It has two light wire shrouds.

The fore halliard is fast to a traveller and leads through a sheave in the mast.

The tack is hauled well down by a gun-tackle purchase, leading to an eye-bolt in the keelson.

The boom has a gooseneck at the mast, and the fall of the tack purchase is ordinarily belayed round the boom at the mast.

The sheet is a gun-tackle purchase.

The clew of the sail is kept free while the tack is bowsed

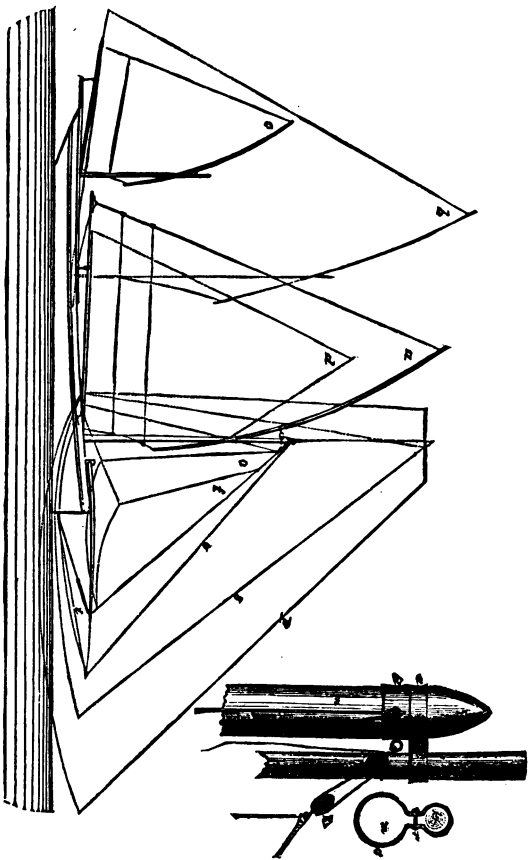

Fig. 84.

down ; the clew is then hauled out on the boom, to which it is connected by a traveller. The mizzen is hoisted the same as the mainsail, but the tack and clew are lashed to the boom.

The Elaine's topmast is fitted as shown in Fig. 84. A metal cap is fitted to the topmast, *k*, and remains on it as a fixture ; when the latter is got on end it is shoved up and shipped by putting the part, *a*, of the cap over the masthead, *m*. The heel of the topmast is then lashed. The jib halliards, *h*, are hooked to an eye in the fore side of the hoop.

The Elaine's topmast is 20 ft. long, with the cap in the centre of length.

The bowsprit ships through an iron hoop on the stem head, and the heel fits into a socket on the mooring-bit about one foot ahead of the mast.

All of these boats have jib-booms for carrying balloon jibs.

The standing part of the mizzen sheet is fast to the end of a short boomkin, which projects about three feet beyond the taffrail, and is fitted to unship ; the sheet then leads through a block on the boom, down through a sheet at the boomkin end, and from there leads inboard.

The main-sheet works on an iron horse about fourteen inches long, secured to a thwart about two-thirds the length of the boom from the mast. The standing part of the sheet is fast to a single block on the traveller ; it then leads through a single block on the boom, back through the block on the traveller, and the fall is hitched round all parts.

The jib-sheets pass through an eye-bolt inside the gunwale, and lead well aft, being belayed to a pin in the centre of a thwart.

The dimensions of the Elaine's spars and sails are as follows :

	Feet.	Inches.
Mainmast from heel (stepped on top of keel)		
to sheave-hole.....	20	0
Foremast ditto.....	17	0
Diameter mainmast.....	0	3½

	Feet.	Inches.
Diameter foremast.....	0	4½
Fore-yard.....	21	8
“ “ diameter.....	0	3½
Fore-boom (mast to outhaul sheave).....	16	6
“ “ diameter.....	0	4
Topmast.....	20	0
“ above cap.....	10	0
“ diameter.....	0	2½
Bowsprit, outside.....	7	0
“ diameter.....	0	3½
Mizzenmast.....	10	9
“ diameter.....	0	3½
Two spinnaker booms.....	21 ft. and 7 ft.	

	Luff.	Leech.	Head.	Foot.	Tack to peak earing.	Clew to throat weather earing.
	ft. in.	ft. in.	ft. in.	ft. in.	ft. in.	ft. in.
Foresail, <i>a</i>	5 0	26 0	21 6	16 0	25 0	17 0
Mainsail, <i>b</i> , for running.....	10 0	28 6	18 6	18 0	27 6	21 0
Mizzen, <i>c</i>	3 0	14 0	18 0	9 0	15 0	9 6
Small sprit-foresail, <i>d</i>	10 0	20 0	10 0	14 0	19 0	17 0
Balloon jib, <i>e</i>	20 0	14 0	18 6
Working jib, <i>o</i>	16 6	12 6	10 6
Small jib, <i>f</i>	15 0	10 0	7 6
Spinnaker, <i>s</i>	29 0	23 6	22 0
Big spinnaker, <i>p</i>	33 0	23 6	4 6	30 0

‡ Bobstay of jib-boom. The reference letters refer to sail-plain.

The jib is the first sail set, to act as a fore-stay. The sail hauls out with an outhaul, and hoists with a gun-tackle purchase.

When the jib and mizzen are set the boat is manageable, and can be freed from her moorings, the foresail being the last sail set.

When the latter is hoisted the tack is bowsed down, and

finally the clew is hooked to the boom traveller, hauled out, and the fall belayed to a cleat on the boom.

In tacking, the jib sheet is sometimes eased at the time the helm goes down, and then, if the boat shows signs of refusing stays, a hand going into the lee bow tends to bring her head to wind. This hand can also hold the jib to windward, and so force her head round.

It is advisable in racing to haul in the last inch of the mizzen sheet, just as the helm is put down, thereby helping her to come to quickly; and then to ease it off, and not haul it in again until the boat has gathered good headway.

The mizzen-yard may be easily pushed to the lee side of the mast, by the helmsman, but the fore lug requires more care: the best way to get it over is by means of a couple of light ropes, about a fathom long made fast to the foot of the yard, with the ends falling free at each side of the boom. The weather one is hauled in just before the boat comes upright in stays, the yard bends slightly, passes around the mast and flies into position to leeward.

In reefing the foresail, the halliards are lowered the required distance, then the tack tackle-block is hooked into the reef cringle in the luff and bowsed down; the clew traveller is then hooked into the reef cringle in the leach, and hauled out; finally the foot of the sail is rolled up and the reef-points tied.

Reefing the mizzen, and changing jibs is also often necessary.

The sheeting-lug for running (see *b*) is kept in the boat, with the head laced to the yard, and foot to a boom; the running lug mast is the full length of the boat inside, and is shipped into a thwart, about two-thirds the distance aft, between the fore and mizzen masts. A single backstay is used; the yard is hoisted with single halliards and the tack hauled down with a light line. The sheet is led over a fairleader aft in the counter, and then inboard. The mizzen may be brailed up, to allow the big sail to receive all the wind. Topping-lifts are fitted to the working lugs for handiness.

The balloon jib is hoisted by a ready rove single halliard; the

jib-boom is shipped with the outhaul ready rove ; the sheet is passed well aft, outside of all rigging, to leeward, then, when the halliards are hoisted, the sail is set.

In setting the spinnaker, the topmast having been got on end, the backstay is first taken aft and secured ; the guy is passed outside the rigging ; the halliards and sail are on the fore side of the shrouds and hoisted chock-a-block ; the sheet is secured to the bowsprit or lee gunwale ; the guy is bent to a cringle in the tack of the sail which is of sufficient size to take the point of the spinnaker-boom ; this boom is then pushed forward, and the gooseneck at the inner end shipped into a socket on the mast or gunwale. A hand is told off to sit on the boom to keep it down.

A topping-lift is used for large spinnaker-booms, in which case the boom is shipped into place before the sail is hoisted, care being taken that the outhaul is outside the topping-lift and clear of the guy.

In the club races the boats generally make a flying start, being allowed to pass the line as soon as they can, after the second gun.

REMARKS ON THE DOUBLE HEAD-SAIL.

WHILE the jib and mainsail is a very effective rig, still further advantage in handiness may be obtained, excepting in very small craft, by fitting two head-sails, and hoisting the inner, or fore-staysail, on a stay extending from the masthead to the stem.

The forestaysail-sheet will give no trouble in working if rove off as a traveller or span.

The standing part is made fast at one side of the mast, and the sheet then leads through a small block at the clew of the sail, and through a block at the other side of the mast, only one hauling part leading aft.

The foot of the sail may be laced to a light boom if desired.

The staysail may generally be kept flat, and the jib only

“lighted up.” The head-sail may be quickly reduced without reefing.

There is also great facility for conveniently shifting to balloon sails in racing, besides a lighter bowsprit, and more security for the mast.

The outer sail may be set “flying,” that is, upon its own luff without the aid of a stay, the foot hauling out on the boom by an outhaul, and the luff stretched taut by the halliards. The inner sail is bent and worked like an ordinary sloop’s jib.

The advantages of setting the jib flying are mainly the possibility of shifting to sails of different sizes to suit the strength of the wind, and the immunity from laying out on the bowsprit in rough water.

Some persons, however, prefer to abide by the usual jib-stay, with the sail bent to hanks or rings, in which case the jib is managed like the ordinary single jib. Whichever arrangement be chosen the bowsprit may be fixed, unless it is intended to cruise in rough waters, when it should be arranged to run in, or “reef,” and the jib must be set flying.

Kunhardt says: “The considerations dictating single or double jibs are wholly of a practical kind.

In boats having the mast stepped well in the eyes, there may be lack of room for sufficient foot to double jibs, as they cannot be narrowed with out stint. But with enough drift between mast and bowsprit end, does not hold.”

“The superior handiness of double head-sail is, of course, accompanied by addition to gear. While the difference in cost is too immaterial to deserve notice, some persons lay great stress upon simplicity, and they will naturally prefer a single sail. Others, seeing less to complain of in the extra gear, deem the advantages of double head-sail more than an offset.”

“Personal fancy must decide between the two plans, though it should be added that the multiplicity of gear is more apparent than real, inasmuch as all the gear need not be manned at one and the same time, but in rotation.”

Section 4.

THE MANAGEMENT OF SAILING-BOATS HAVING
MORE THAN ONE SAIL.

GETTING UNDER WAY. SAILING TO WINDWARD.
TACKING, ETC.

SAILING FREE AND RUNNING BEFORE THE WIND.
REEFING. SQUALLS.

SAILING ALONG SHORE, ETC.

REMARKS ON CAPSIZING, SAILING AMONGST
WAVES, ETC.

HANDLING BOATS IN A GALE.

ANCHORING, STOWING THE SAILS, ETC.

BOAT RACING. RULES AND ALLOWANCES.

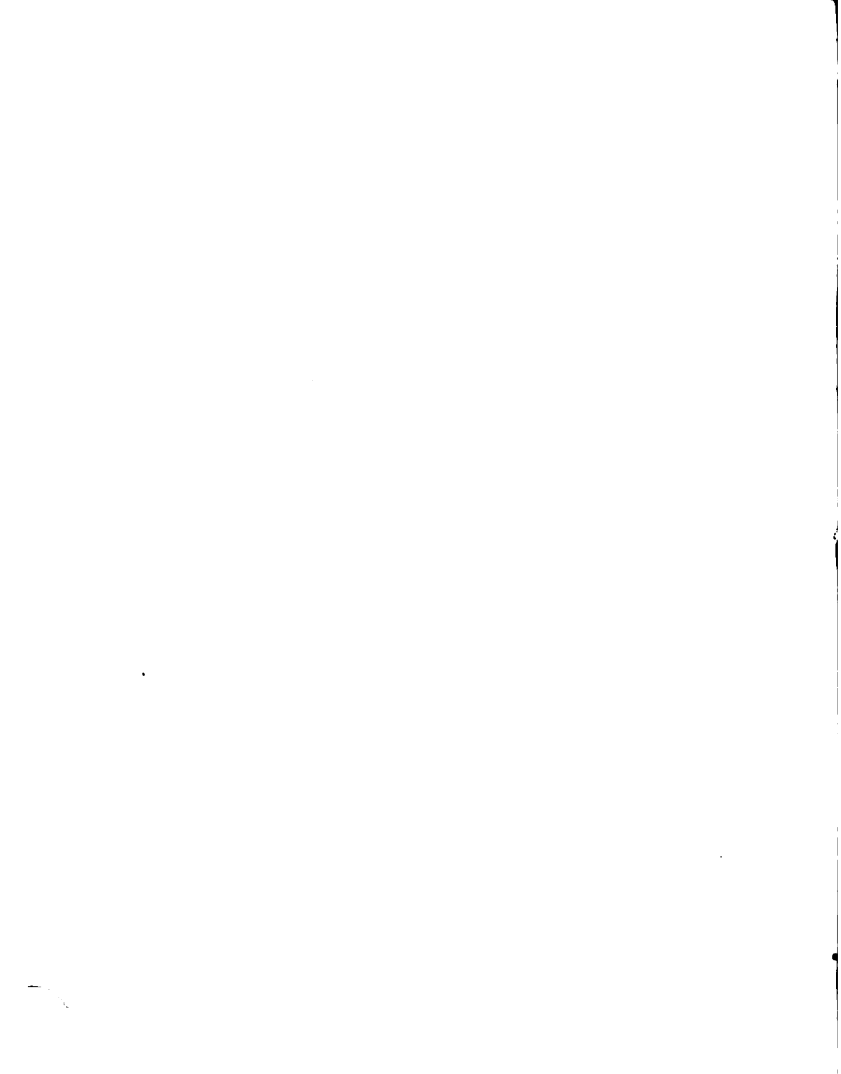

THE PRACTICAL MANAGEMENT OF SAILING-BOATS HAVING MORE THAN ONE SAIL.

Prefatory Note.—The prevalence of jib-and-mainsail boats in this country has been considered in the adaptation of the text of much of the following section for that rig, but the double head-sail has also received a certain amount of attention, especially where sea work is touched upon.

E. F. Q.

MAKING SAIL AND GETTING UNDER WAY.

Loose the sails and look to the sheets and halliards to see them all clear for service.

Set the mainsail, and have the jib all ready for hoisting. Heave away on the cable until the anchor is almost broken out, or until the cable is "up and down;" then by means of the rudder, if there be sufficient current, cast the boat's head toward the direction in which you wish to proceed; weigh the anchor and run up the jib.

If there is no tide or current to act upon the rudder, the jib must be set before the anchor is broken out, and the sheet trimmed flat aft to cast her.

For example, if it be desired to cast the boat on the starboard tack, trim down the *starboard* jib-sheet, and push the main boom out over the port quarter; then, when the boat has a good sheer, weigh the anchor; and, when she has paid off sufficiently, let go the starboard jib-sheet and trim aft the port one; haul in the main-sheet and sail your course.

To get under way from moorings, the mainsail and jib may be set as before, and then the moorings slipped.

Among crowded shipping, it may be necessary to turn in a very small space, which may be accomplished by hauling the jib a-weather, dropping the main-peak, easing the main-sheet and putting the helm hard up. Or a spring may be used to cant her round smartly.

When away clear swig the sails up taut ; have a look round, and coil all gear clear for running, and ready for letting go should occasion demand it.

SAILING TO WINDWARD.

SEVERAL writers on nautical subjects appear to imagine that *sailing on a bowline* and *reaching* are synonymous terms, which is not the case.

A bowline is a rope made fast to a cringle on the leech of a square sail, to haul the weather leech well forward and keep it steady, *when on a wind*.

Sailing on a bowline means, in nautical parlance, sailing on a wind, or close hauled, when the bowlines would be hauled taut ; hence the phrase "sailing on a taut bowline." "Sailing on an easy bowline" means sailing with the sails well full, and the vessel not jammed up into the wind.

Sailing, beating, or turning to windward is one of the most interesting performances connected with the practice of boat sailing.

The art of sailing against the wind by making sundry zig-zag courses is one which requires careful attention, a watchful eye, and constant practice ; for although its rudiments may be learned in a short time, the art itself, which may be said to be the perfection of boat-sailing, can only be acquired from frequent practice and long experience.

The principal thing to attend to is to watch the fore leech, or luff, of the mainsail. The boat should be kept as close to the wind as she will point without shaking this part of the sail, which will always be the first to give warning of too close a luff.

Many sailors prefer to steer by a vane at the masthead and others by the jib, but the young boat-sailer will find the fore-leech of the mainsail his best guide.

It sometimes happens that the wind is flawy and unsteady, blowing strong for some minutes, and immediately afterward

becoming very light. On such occasions considerable advantage may be gained by carefully noting the changes in the effect of the wind upon the luff of the mainsail; for the boat may be sailed a couple of points nearer at some times than at others, and then is the time for the expert boat-sailer to wedge his way to windward.

The greater the force of the wind, the closer a boat may be sailed, if in smooth water; and in match sailing, a fine helmsman will watch the wind so narrowly, that, should the slightest variation occur, he will be sure to gain some advantage by sailing his boat up to it with the greatest precision, but never so high as to cause any shivering in the sails. In sailing to windward care should always be taken to "keep her full," for a shaking sail is of no assistance to a boat. When beating to windward in a narrow channel, it is well not to carry too much head-sail. As a general rule a boat will work to windward better with a small jib than with a large one, and considerable judgment is required to determine the proper size of jib to carry. The effect of too large a jib is to cause the boat to sag to leeward, particularly when she has but little headway. Many races have been lost through carrying too much head-sail when beating to windward.

TACKING, ETC.

A BOAT is said to be "in stays" after the helm has been put down to tack her, and when the sails are shaking in the wind's eye; but as soon as the head-sail has "paid her head off" she is about and on the new tack. In squally weather, to be in stays is a very critical position for a boat, for should the sail be taken aback by a squall, a capsize may readily result. We will suppose that the boat is sailing along on the starboard tack, carrying the main boom over the port quarter, the port head-sheets trimmed aft, and "sailing close to the wind."

When desiring to tack, sing out *Ready about!* to warn the crew. Keep her a good full, and, when ready, press the tiller

over gradually to port and bring her head into the wind's eye, calling out *Helm's a-lee!* as she comes to.

The jib-sheet should be in hand and flown at the order *Let go the jib-sheet!* which should follow quickly the announcement of "*Helm's a-lee.*"

The main boom is hauled flat aft, and pushed toward the starboard quarter to help her round. The port jib-sheet should be trimmed down again as the boat gets head to wind, the order given being *Trim down the port jib-sheet!* This trims the sail flat by the same sheet that has just been flown, and causes the port side of the sail to be acted upon by the wind, and to assist in boxing her head off to starboard. When the wind fills the mainsail on the new tack, the command *Let draw!* is given, at which the port jib-sheet is let go and the starboard sheet is trimmed aft for the new tack.

In light weather and smooth water, with a quick working boat, all of the foregoing may not be necessary. Some boats will work without starting the head-sheets at all until they are round; and some always get sternway, and require the helm shifted to bring them about.

Missing Stays implies a failure of the boat to "come about," or to obey her helm when it is put down to bring her head past the wind's eye. In light winds there is seldom any danger attending it, but in a fresh breeze, or a squall, or in a rough sea, there is always considerable risk, for the boat when in stays has little or no headway and is not under the control of her helm.

Should the boat miss stays in a squall, the main-sheet must be slacked roundly, the peak lowered if possible, and the jib-sheet kept a-weather, after which if the squall heels her dangerously, let go the halliards to avoid a capsize.

Boats which seldom miss stays in smooth water may do so in a heavy sea, when the stern is occasionally out of the water and the rudder powerless.

To steer a boat when she is going stern first through the water, the tiller must be put over in the same direction as that in which the boat's head is required to turn.

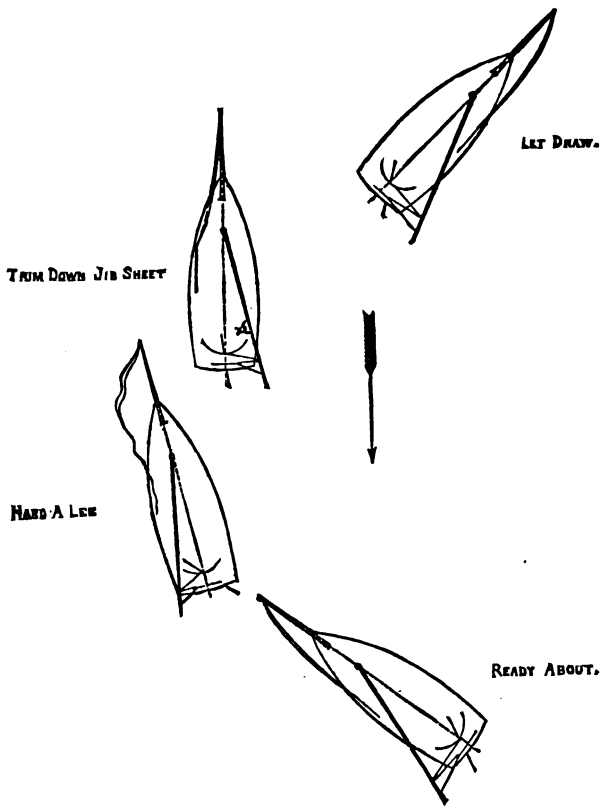

Fig. 85.

Half Board or Pilot's Luff.—In close-hauled sailing an obstacle sometimes appears directly ahead which might compel a tack but which if passed will allow of keeping away. In such a case if the tide is favorable and the wind brisk, resort may be had to a manœuvre called a "half board." Bring the boat quickly head to wind and shake the sails, allowing her to shoot dead to windward, and then before headway is lost, keep her away again until everything draws well, after which, if desired, the evolution may be again executed, each time gaining something to windward. This manœuvre is often invaluable in rounding marks when racing.

SAILING FREE, OR REACHING.

REACHING is sailing with a side wind. A boat may be said to be reaching when the wind is about abeam, and the sheets are eased off a bit so that the sails all draw in an effective manner.

The sheets should always be trimmed to a nicety, when sailing with the wind free, so that every inch of canvas will be doing its utmost by the boat.

Should the boat be struck by a squall when reaching, she should be instantly luffed; but if the squall be very sudden, or there is not sufficient sea room for luffing, the main-sheet should be roundly slacked and if necessary the halliards should be let go.

Balloon-jibs are of considerable service in reaching.

RUNNING BEFORE THE WIND, OR SCUDDING.

RUNNING before the wind requires very careful steering, especially in a strong wind, or in squally weather, and is considered the most perilous point of sailing, because of the risk of the mainsail suddenly gybing.

A backstay should be fitted, to support the mast when sailing in strong winds.

When before the wind, the main-sheet should be paid out,

the running tackle set up to windward, and the main tack cast off (if the sail is not laced to the boom). A careful watch must be kept upon the sail, and attention paid to the direction of the wind; for should the boom gybe suddenly when the sheet is all out, the mast may be carried away, or the boat capsized. Should the sail show the slightest wavering to leeward, the helm should be promptly put down a bit, so as to prevent a gybe.

The person steering a boat should always give timely warning when the boom is coming over, as if it swings across suddenly it is apt to knock overboard any one who is not on the lookout. As straight a course as possible should be steered. The jib will be of no use when directly before the wind unless boomed out.

With a fresh and squally breeze it is well to lower the peak of the mainsail, or to trice up the main-tack, either of which will greatly relieve the mast.

A safe plan is to reef the mainsail and set a smaller jib.

Should a squall strike the sails when before the wind the boat may be eased by dropping the peak, or, if already down, lowering the mainsail and sailing her under a small jib.

Scudding among Waves.—Scudding before a strong wind and heavy sea is exceedingly dangerous, and many a boat has been lost in attempting to “run away from the sea.”

The two principal dangers will arise from “getting brought by the lee,” and “broaching-to;” the boat’s head will be most likely to fall off to leeward, or rather her stern to be thrown to windward as a wave passes under her. But with equal peril she might have “broached-to,” as the wave-crest lifted her bow, the boat’s head would be turned toward the wind, and then, if she be not expertly handled, she will get broadside on to the waves, and the next roller will inevitably swamp her.

If the rig should be jib, mainsail, and mizzen, the latter should come in before the boat is put before the wind; the lee jib-sheet should be belayed slack, and the weather one led aft. As the boat begins to fly to, haul the weather jib-sheet flat

and put the helm up. Frequently, however, the helm is of little use under such circumstances, as the boat will be carried along on the back of a comber.

It sometimes happens that a boat that has successfully battled with the waves in the open sea comes to grief as she gets among the surf rollers, to endeavor to effect a landing, or to run over a bar into a harbor. In running through a surf an oar will be found much more effective for steering than the rudder.

A small boat, if there be much wind and sea, should not be run dead before the wind, but with the wind a little on the quarter; then, after running some distance, should be gybed over and run with the wind on the other quarter, to make the destination.

REEFING.

REEFING should generally be done in anticipation of a strong wind or heavy sea; it should always be begun in time, and carefully yet smartly performed, for moments lost in fair weather are difficult to regain in foul.

When about to reef, luff the boat up, but not so high as to allow her to come about. Haul the jib a-weather and belay the sheet; haul the main-sheet in flat, and the boat will be "lying-to."

Lower the peak and throat sufficiently for the number of reefs it is proposed to take in, and cast off the main-tack (if the sail be not laced to the boom). Haul down the reef and secure the earings to the boom; make fast the tack and tie the reef-points with square-knots. When completed set up the throat, and peak; reef the jib or set a smaller jib; slack the main-sheet, trim the jib-sheets, and the boat will resume her course under a single-reefed mainsail and reduced jib. A second or a third reef may be hauled down in a similar manner.

Never tie the points of a second or third reef until the points of the preceding reefs have been secured; the reefs may then be shaken out, one at a time, as the weather moderates.

SQUALLS.

SIGNS of a squall may generally be seen on the surface of the water some moments before it strikes the sails, in which case there will be plenty of time for shortening sail before its effects are felt, but in rivers, and when sailing close along the land, squalls frequently rush down upon a boat with marvellous suddenness.

The main-sheet should always be ready to let go in an instant, whenever sailing under the land, for many disasters have resulted from sudden puffs sweeping down a valley or ravine with great force, and catching boats just as they emerge from the comparatively calm weather under the lee of some cliff or high land.

If a squall be descried approaching, the peak of the mainsail should be dropped. If the squall seems very light it may be allowed to just reach the sails, and then the boat luffed carefully to it, but not so as to lose headway; she must be kept going in order that she may answer her helm readily.

A light squall usually flits over the water like a passing cloud, but a heavy one is generally accompanied with some fierce white crests upon the tops of the waves. With reefed sails a good boat may be "sailed narrow" through squalls of ordinary strength, that is, so close to the wind that the luffs of the sails tremble, and with judicious handling there will be little risk.

When threatened with a severe squall, lower the jib and drop the peak of the mainsail. A smaller jib may be set if deemed desirable.

SAILING ALONG SHORE.

Sailing along a Weather Shore.—With a boom mainsail it is generally preferable to luff up in the wind and ease the jib-sheet, in puffs, than to ease the main-sheet and attempt to relieve the boat without deviating much from the course; however, if a weather shore, as the bank of a river, be close aboard

there will be considerable risk of going stem on into the bank, if this course be adopted. While going into the bank might be preferable to capsizing, yet if the puffs do not come too heavy the mainsail may generally be eased and the boat relieved in that manner.

In racing much valuable time might be lost by luffing up, and the boat may be kept going by judiciously easing the main-sheet.

Always bear in mind, in the case of squalls, that, "he who hesitates is lost," and determine early on the course it will be best to pursue, whether the boat shall be luffed at the risk of beaching her, or whether the main-sheet shall be eased.

Sailing along a Lee Shore.—When sailing along a lee shore in squally weather, which should never be done from choice, luff up smartly for squalls, in preference to easing the main-sheet to keep the boat going.

If the squall be very severe, the jib-sheet should be flown to bring the boat's head to wind quickly.

Easing the main-sheet in squalls should be avoided, if possible, when sailing along the lee bank of a river, or by the side of mud flats.

Generally a boat will luff to quickly enough without easing the jib-sheet; but, if the squall looks heavy, ease the sheet and luff to in good time; then stand by to lower the mainsail, if necessary. In lowering a sail in a squall care should be taken to spill the sail as it comes down.

REMARKS ON CAPSIZING.

Boats are not more frequently capsized by reason of strong winds and heavy seas than they are from carelessness or mismanagement.

Among the principal causes of boats upsetting may be mentioned the following: Negligence regarding the main and jib sheets; faulty adjustment of the sails; disproportionate spars; improper trim; insufficient ballast; shifting of ballast; ill-

fitting blocks ; the entanglement of some rope ; carrying sail recklessly ; overcrowding with passengers ; standing up in the boat ; leaning over the gunwale ; and generally, careless handling.

Every person who goes in a sailing-boat should know that the most important rope, and that on which the safety of the boat frequently depends, is the *main-sheet* ; next in importance come the head-sheets, or jib-sheets. Every rope should be laid in a separate coil, so as to run out clear in case of emergency.

It is well never to belay the main-sheet, and care should always be taken that it is not hidden from view, or entangled in any way.

When struck by a squall a jammed sheet, if not instantly cleared, will be certain to cause a capsize. The most effectual way of clearing the sheet in such a case would be to cut it ; a measure which has, before now, saved boat and crew from impending disaster, even after the boat has been forced on her beam ends with the water pouring over the gunwale.

During a steady breeze, with a clear sky, and when there are no signs of squalls, boat-sailers are frequently inclined to take a "slippery hitch" in the sheet ; this is effected by twisting the bight of the rope once round its own part.

It sometimes becomes desirable, in light winds or a foul tide, to row and sail at the same time, but such a proceeding is very incautious, if the sheet is made fast and no one left in charge at the helm. A more prudent course would be either to lower the sails, or to dispense with the use of oars.

Generally when oars are used to assist the sails they should be worked on the weather side of the boat, as there is some risk of lee oars catching under water, if the boat suddenly lays over.

Boat-sailers should always be very cautious when passing under the lee of large vessels in squally weather. The sheets should be in hand, and ready for slacking instantly.

REMARKS ON SAILING AMONGST WAVES.

BOATS are frequently capsized in disturbed water, and the cause is generally ascribed to a sudden squall, or to the fact that some of the loose ballast shifted to leeward. But a boat among waves might be capsized without any accession of wind or shifting of ballast.

Let it be supposed that a boat is sailing with a beam wind, and sea on the beam, and that her inclination, due to the pressure on her sail is fifteen degrees. If she should get into the situation shown in Fig. 86, she would practically be inclined thirty degrees and would probably capsize. If the boat had no sail set she would not be liable to get into such a position, as she would accommodate herself to the wave-surface, and her mast would correspond to the perpendicular to that surface.

Even with sail set the boat would somewhat accommodate herself to the wave surface, minus her steady angle of heel; but the increased pressure on the sail due to the righting moment of the boat would prevent her recovering herself entirely. If the boat be heeled to fifteen degrees, and a wave came to leeward as shown, she would have a heel of thirty degrees relative to the perpendicular to the wave-surface; but inasmuch as the wind-pressure is only capable of heeling her to fifteen degrees, the boat would ultimately recover herself to that extent, and her mast would be represented by the vertical line. However, long before a boat could so recover herself she might be swamped.

With a beam sea a boat will roll considerably, and this condition is a prolific source of accidents. If she is being sailed at a permanent heel of fifteen degrees, and by the action of the waves she is caused to roll another fifteen degrees, she will frequently be in the position of thirty degrees of heel; and if the extreme part of the roll should occur conjointly with such a position as shown in the illustration the boat would inevitably upset.

Next let it be supposed that a boat is being sailed at a per-

manent angle of heel of fifteen degrees, that she has a maximum roll of fifteen degrees, and that there comes a sudden squall. If the extreme leeward roll, and the squall occur together, when in the position shown by Fig. 86, she will be certain to blow over.

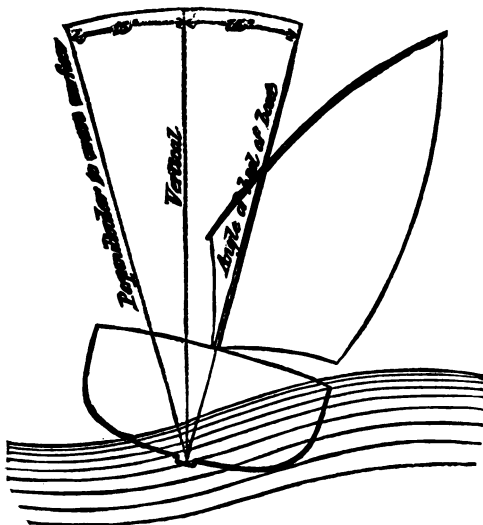

Fig. 86.

She may even be blown over if not in such a position as that depicted; for example, if the boat has fifteen degrees heel and an extreme leeward roll of fifteen degrees, then if the extreme roll and the squall occur together the boat will be upset, whatever may be her actual position with regard to the waves.

Furthermore it must be understood that a force of wind which will, if applied steadily, heel a boat to fifteen degrees, will, if applied suddenly, heel her to double that angle ; therefore it is not so much the force of the squall as the suddenness of its application which constitutes the danger.

When a boat is among waves, especially with a beam wind, ballast should not be trimmed to windward, nor should the passengers sit on the weather gunwale, as a boat, after being in the position shown in Fig. 86, will take a very heavy weather roll, possibly fly up in the wind, be caught aback, and upset. The sail that will give a permanent heel of fifteen degrees may be carried well enough in smooth water with a beam wind, but the case is vastly different among waves, and so much canvas should not then be carried. Many boats are annually lost through recklessness in carrying sail in rough water ; and although a boat may be among waves many times without being subject to the coincident conditions described, yet she may at last ; therefore impunity is not necessarily immunity.

In sailing a boat among waves, the ballast should be well secured, the passengers should sit in the bottom of the boat, and the main-sheet should be kept ready for slacking instantly.

It may occasionally be unavoidable that a boat in pointing for her destination must take the wind and sea right abeam ; this is a most critical position, as it will require a yaw of eight points to bring her end on to the sea, and there will hardly be time to do that in order to avoid a heavy breaking sea. The boat must be very closely watched, and if a bigger wave than usual rolls in on the weather beam, the sheet must be eased and the boat run off, the wave will then in all probability pass harmlessly under the boat. She should not be luffed with a beam wind and sea, and the main-sheet should always be eased in keeping away.

A capital course to pursue, if there be plenty of sea room, with a sea which would be dangerous if taken abeam, is to "quarter the sea," somewhat after the manner of a horse drag-

ging a load up hill, only it may not be necessary to make a large number of zigzags, probably one will be sufficient.

For example, if desiring to make from A to B, with the wind and sea in the direction indicated by the arrow, the boat may be sailed to C and thence to B, and thereby be kept always in such position with regard to the waves as to enable her to meet any particularly heavy sea with a yaw of only four points of the compass.*

In sailing by the wind, the danger of being blown over will be much less, but it must not be assumed that because an expert boat-sailer sails a small boat safely about among waves that an inexperienced person could do so.

Suppose the boat to be sailing by the wind, and the helmsman sees an ugly breaking sea coming curling along on his weather bow; just before it reaches him he should put his helm down and luff right up into it, so as to take it end on or nearly so, as this is the best position for a boat to ride safely over a breaking wave. The instant the wave has passed, however, he must put his helm up and fill the sails to avoid losing headway.

In sailing close hauled the main-sheet might be belayed with a slippery hitch, with the fall resting across the knee, and close to the hand, and the jib-sheet should also lead aft close to the hand. When there is much sea the main-sheet should not be too flat. The jib may be sheeted pretty flat, however, to assist in paying her head off.

In puffs the boat should be luffed up and the jib-sheet eased, before the gunwale gets under; as when the gunwale goes under the boat soon loses way, and then the power of luffing will be lost, and she may perhaps swamp.

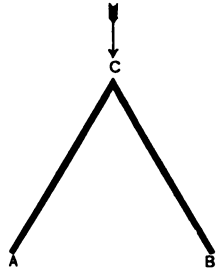

* The same "wrinkle" is frequently made use of, even when there is no danger of swamping the boat, but simply to keep the passengers dry and to avoid shipping a large quantity of water.

If a boat does not come to quickly and relieve the pressure of wind, slack the main-sheet and ease her in that manner, but above all do promptly whatever is to be done.

In luffing for squalls, should the boat get head to wind, haul the jib-sheet a-weather, jam the helm up, ease off the main-sheet and press down what is to be the lee quarter. If the boat has only one sail, haul the boom to what is to be the weather side, and shove the tiller over to the opposite side; as the boat gathers sternway she will pay off, then right the helm and ease over the boom. If the boat has a mizzen as well as mainsail, the mizzen-sheet should be eased while the boom is held over.

If an oar is handy, the boat may be helped off the wind by a "back water" stroke or two, off the lee quarter.

Generally in luffing for squalls the main sheet need not be eased, but the jib-sheet should be, to allow the boat to luff to readily.

If the boat has only a mainsail and mizzen, ease the main sheet in luffing to heavy squalls and leave the mizzen to bring her to.

A boat need not be thrown head to wind for every little cats-paw or small sea, however, and the boat-sailer should, while being careful that his boat is not filled by shipping water or upset by a puff, sail his craft boldly and keep her "a good full" or she will be sure to sag to leeward.

If sailing across a weather-going tide the boat may be "squeezed" a trifle, but not so much as to allow the sails to lift.

The Drogue.—A drogue is of great assistance to a boat in a sea-way, and serves to keep it end on to the waves, and to prevent "broaching to"

The drogue consists of a hinge-jointed iron ring, about two feet in diameter, to which a conical canvas bag is sewn, and roped, as shown in the sketch, Fig. 87. A bridle of four parts is fitted to the ring, to which the towing-line is bent; *d* is a tripping line and *b* a cork buoy to keep the drogue from diving.

When cast overboard the mouth *a* of the drogue opens, fills with water, and draws heavily.

To get it on board the tripping-line must be hauled upon.

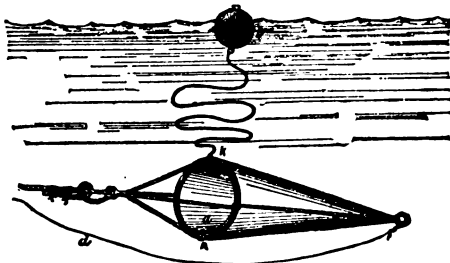

Fig. 87.

When not in use the ring folds together and the bag is stowed around it.

When riding to a drogue it may be well to keep a reefed or small mizzen set.

HANDLING BOATS IN A GALE.

WHEN signs of an approaching gale are detected, the sails must be close-reefed promptly, and all the canvas that can be dispensed with should be taken in. It will be advisable to draw the bowsprit inboard to avoid losing it when the boat pitches.

If the boat requires a jib, the very smallest and stoutest head-sail available should be chosen. If the rig be a two masted one, or if there be a mizzen, the mainsail should be lowered, and the boat may be sailed under a fore-staysail and mizzen; or, if preferred, these may both be lowered and the little craft may be sailed under a close-reefed mainsail, or a trysail if there be one on board.

Careful attention should be given to the boat's trim, and there should be no weight permitted in the bows, nor any in the extreme end of the stern. The ballast should always be judiciously disposed amidships, and firmly secured so that no part of it can possibly shift, though the boat should lurch ever so heavily.

In heavy weather the boat must not be sailed too close to the wind, nor the sails trimmed too flat. It is in heavy seas that the advantage of being able to trice up the main-tack is most apparent, and the boat may be greatly eased by so doing.

Let us suppose a crew of six persons in a boat, caught in a gale of wind, and no harbor available, except one some miles dead to windward.

The rig of the boat is mainsail, fore-staysail, and jib, a very serviceable rig for sea service.

As there are indications of an increasing gale, take in the fore-staysail, luff up, and close reef the mainsail, putting in each reef separately, and tying the points singly.

The jib-sheet must be hauled a-weather while reefing the mainsail; after which run in the bowsprit and set the very smallest jib available.

The man at the main-sheet should keep it clear and be ready to slack it in an instant.

The waves are now running high and the boat pitching heavily. Try her cautiously to windward, easing or luffing her a bit as the approaching waves meet her. Have a hand by the main-sheet and another by the jib-sheet, while the others are down on the boat's floor, to windward, excepting the skipper, who remains at the helm, carefully watching the threatening seas.

In luffing to the heavy seas the least motion of the tiller will suffice; be very careful not to allow all headway to be lost or the boat will not obey the helm; take advantage of the smooth, which usually follows three heavy seas, to get good headway on; keep her full and at it, and only ease the helm on the approach of a heavy sea, that threatens to engulf the bows;

then luff into the very crest of the wave, which will check the boat's way for a moment, and headway must be regained by instantly bearing up a trifle to fill the sails and prevent the boat getting into the trough of the sea. No one should give orders but the man at the helm, who can see exactly what the boat requires, and his orders should be given distinctly and obeyed instantly.

Riding out a Gale.—Should the gale come on very weighty, and the sea increase so much that the waves are likely to break into the boat, it will not be prudent to continue working to windward, and the boat must be “laid-to.”

A drogue should be used or a sea-anchor rigged, to break the force of the sea and make a lee for the boat to ride in.

Either the jib and fore-staysail, or the jib alone, according to the type of boat, may be used to “lay-to” under. Some boats lay to nicely under a close-reefed mainsail, with, perhaps, a small piece of the fore-staysail showing just to windward of the mast.

As a general rule any attempt to force the boat ahead will be very dangerous, and the attention must be directed to keeping her afloat. A raft may be made of spars, oars, and sails, the latter only loosely bound to the spars, and the whole attached to the boat's painter. This raft being cast overboard, the line should be veered out, say ten or fifteen fathoms, and the boat allowed to ride to leeward of it. With good sea room a boat may thus ride out a severe gale of, perhaps, several days' duration.

It is marvellous how a raft of this description will break the force of the sea, and form a “smooth” for the boat, and this contrivance may be made use of whether the boat be laid-to under small sail or without any sail. If a weight be suspended from the clew of one of the sails, the drift of the boat will be resisted.

In shallow water the raft may be anchored and the boat will still ride in safety.

When all has been done to keep the boat afloat, and to ride

out the gale, the crew should button their coats, harden their hearts, and patiently await the return of good weather.

NOTE.—The best sails to lay to under must be determined for each particular type of boat by experiment. A ship's long boat has been known to lay to under a close-reefed mainsail, with a bucket veered out twenty fathoms ahead, and ride out a gale of seven days.

The Use of Oil to break the Force of Wave-crests.—It has been conclusively demonstrated that oil applied to the water has a marvellous effect upon the force and break of dangerous topping waves.

To obtain the greatest benefit from its use, the boat should be "laid to," so as to remain nearly stationary. A bag containing the oil should be suspended over the lee-bow, and the oil should be allowed to drip slowly into the water, through small holes punctured in the bottom of the bag.

As the boat forges ahead but slowly, and is carried bodily to leeward with the waves, she remains within the limits of the calm oasis caused by the floating oil.

In the event of being compelled to run before dangerous seas, in order to make a harbor, the wave-crests may be prevented from breaking over the stern, by allowing the oil to drip from two bags, one suspended from each bow.

ANCHORING.

To Anchor on a Lee Shore.—If caught in a gale on a lee shore, and the sea is too heavy to "claw off," the only safe plan will be to anchor.

When all is ready, bring the boat to the wind, and shake the sails, and, as soon as she gets stern way, let go the anchor, taking care not to snub her too quickly, but let a fair scope of cable run out before checking it; catch a turn or two around the bits before the strain comes on, and be prepared to give her the cable as she needs it. As soon as the first anchor bites

and the boat comes head to wind let go the second anchor and pay out on both cables, keeping the strain alike on each.

Always let go both anchors under the foregoing circumstances; and, if the weather be very bad indeed, when about half the cable of the second anchor is out lash to it a kedge or some other convenient weight to "back it." Of course, as the boat comes head to wind the jib comes down, and when anchored take in and stow the mainsail.

Grounding, etc.—If the boat takes the ground and is left by the tide, get out an anchor in the direction of the wind, and heave taut; then lighten the boat and be ready to float off as the tide returns.

Kedging.—When there is no wind and it is desirable to get into a certain position; run out a light anchor by means of a dinky, and warp your boat up to it, repeating the operation till the desired position is attained.

Every boat of any size should have an anchor, and all boats over twenty-five feet in length should be provided with two, and a light kedge.

To Bring up at Moorings.—Bringing up at moorings in a crowded harbor is a very neat performance when well executed, and nothing looks worse than getting into a muddle with a sailing-boat in the endeavor to "bring her to" in a particular spot.

Bungling hands sometimes manage to foul neighboring boats, keep hoisting and lowering the sails, hauling over the boom, jamming their fingers, getting entangled in the gear, and working themselves up into a state of excitement, to the amusement and ridicule of lookers on, whose jeers at such lubberly seamanship go far to increase the embarrassment of the unskilful boat-sailers.

An expert boatman, however, will bring up at moorings or drop his boat between two vessels with as much ease and grace as a skilful driver stops a carriage at any desired door.

A boat's moorings usually consist of a strong mooring-chain or line, the two ends of which are fast to anchors laid out in

different directions. A smaller line or chain, called a bridle, is bent to the mooring-chain, about midway from the ends, and has a buoy attached to its upper end, to mark the spot where the moorings are arranged.

The greater the boat's length, the more sweep will be required in coming round.

On approaching moorings the distance required for the sweep should be measured by the eye, and if in a tideway sufficient allowance made for the strength of the current. The boat should be luffed boldly into the wind, and after a little practice, it should be easy to bring her to her berth or alongside a landing-place with the sails standing and shivering in the wind's eye.

The jib may be hauled down, or it may be kept up with the sheet flown, until just before grappling the moorings, so as to be ready for hauling a-weather to pay the boat off for a second trial, in case of a failure in the evolution.

If from any cause it becomes necessary to approach the berth *before the wind*, lower all sail except the jib, and sail the boat slowly; get the buoy and make fast quickly.

When drifting in a tideway the after part of the boat, being deeper than the bow, will have a tendency to drift faster, in which case the boat may be kept under control by reducing the after-sail and carrying more head-sail.

STOWING THE SAILS.

THE mainsail is furled as follows: The sail being lowered, place the gaff on top of the boom; then lift the flap of the sail over the boom, and lay the leech over the flap, hauling it taut from the gaff end; the loose sail is then rolled up snugly close to the gaff. Pass several lashings or gaskets around sail, boom, and gaff, and secure them, after which a waterproof cover should be put on.

A spritsail is usually furled by rolling it up snugly after

removing the sprit ; the jib, if any, being rolled up inside the mainsail.

When a jib traverses on the stay by means of hanks, it should be lowered, rolled up, and secured with stops, and a cover put on. When the jib sets flying, the tack should be unhooked, and the sail furled in the mainsail.

Wet sails should be loosely furled, unless they can first be spread out to dry.

Sails should be loosed and exposed to the air as often as possible to prevent mildewing.

BOAT-RACING.

In a sailing-match there should always be the greatest activity and readiness on the part of every member of the crew, and skill and daring are indispensable at the helm of any boat which is expected to win a hard-fought race, especially in a strong wind and heavy sea.

Only those who have taken an active part in a lively sailing-race can fully appreciate the pleasure and exhilaration of a contest on the watery race-course, where every inch of vantage is as closely contested as if life and death were pending the issue.

When once the race has begun, there can be no "heaving to" to repair damages, or to make any important alterations without a strong probability of losing the match ; it is therefore most unadvisable to come to the starting-line without having previously tried the boat and her fittings thoroughly on all the points of sailing, found her best trim, both in smooth water and among waves ; set and taken in the "running sails" with the wind right astern and on either quarter ; and also drilled the crew at tacking, gybing, and reefing ; as it is generally impossible to foresee the kind of weather which will be experienced on the day of the race, and it may be necessary to reef in the middle of the contest.

It is advisable to carry along some spare articles for use in

case of accidents ; some spare rope, a couple of spare blocks, a ball of spunyarn, a hatchet, spare balers, and anything else which may be likely to come in handy. A pair of binocular glasses will be found of service for picking up the position of a mark-boat or buoy which has to be rounded in the race, and which may be more or less masked by being in line with land, or amongst shipping. Many a race has been lost through not seeing, or mistaking a turning-mark.

The boat's gear should all receive a careful examination, before starting for a race, to see that there are no sprung sailing thwarts or spars, no rotten ropes, ripped sails, half straightened hooks, etc., and that nothing connected with the gear is at all likely to fail you during the race.

Avoid, however, a practice which is almost as bad as starting with worn-out gear, and which is too prevalent, that of reeving a lot of brand-new ropes just on the eve of a race. If you do so without having had them previously well stretched and given a little work, they will be extremely liable to "kink" and jam in the blocks, and to sell you out just at the critical moment when your men are anxious and excited, and when you desire everything to work particularly smooth and clear.

Next, as to trim ; you will not be able to beat to windward properly if your boat is out of trim. A good practical method of regulating a boat's trim is to get her "on a wind" with sail well set and sheets aft and then trim her with ballast and crew, until she carries just sufficient weather helm to insure that she will come up to the wind directly the tiller is let go.

Much will depend upon the skill of the helmsman, and when it is remembered how light a touch of the tiller will throw a well-trimmed boat out of her course, it is easy to understand how races may be won or lost through superior skill on the one hand and the least inattention or lack of skill on the other.

Before the starting-gun is fired every man should be at his post, ready to perform his allotted duty ; for after the signal every moment's delay is a moment lost. Frequently in a hard-fought time race the chances are greatly in favor of the boat

that first gets away and takes the lead. The boat that can sail fastest to windward is generally considered to be the best boat in sailing matches.

All preliminaries as to making sail smartly, canting round for windward berth, etc., should be learned and well practised.

Every man who aspires to the helm in a sailing-match should be an expert in the art of boat-sailing. When putting the boat about the helm should be eased down slowly and steadily, so that the boat may shoot ahead in stays.

Many races have been lost by carrying too large a jib on a wind, and as many more by carrying large topsails, when with a jib-headed topsail and a smaller jib the boat would have eaten to windward in a creditable manner.

In reaching, sailing large, or running, however, a boat should be allowed all the sail she can stagger under; so set balloon-jibs and topsails as large as the weather will allow, always having a judicious regard for the safety of the spars. As soon as the sails are properly set, sheets trimmed, and the gear coiled clear for running, every man on board a racing-boat should sit or lie down, and should so remain until ordered to move by the skipper.

In working to windward in a race, considerable advantage may sometimes be obtained by the execution of various little nautical manœuvres, which can be learned best by practical experience, and cannot readily be acquired from books. When there is abundance of sea room there is less chance for the display of skill in manœuvring, but in rivers, narrow channels, and tideways every move of the opponents should be carefully watched, and every chance for gain embraced.

If two boats be standing on the same tack, and the sternmost cannot pass her opponent to windward, by skilfully tacking an instant before her opponent goes about, the next leg may, if the boat be quick in stays, reverse the order of things.

When beating against a lee-going tide, the boat should be kept out of the strength of the current as much as possible,

especially when going about ; but in a favoring tide the boat should be kept in it and tacked where there is the strongest set.

In dry weather the sails become soft and expansive, and a wetting not only fills the pores of the canvas and causes it to hold a better wind, but also has the property of making the sails stand flatter.

When on a wind the skipper who watches the wind and the sails the closest, is sure to obtain some advantage ; for there are frequently variations in the force and direction of the wind, of more or less account, and at some moments he will be enabled to lay a much more advantageous course than at others.

He should be quick to take advantage of all such slants and endeavor to wedge his way to windward, creeping as close to the wind as he possibly can without causing the sails to shiver.

In sailing by the wind the primary object is to make the boat progress at her best speed through the water, and in a direction as near to the wind's eye as possible.

If the sheets are hauled very flat aft and the boat sailed close to the wind ("jammed up" as it is termed), she may "look" higher than another boat which is being properly sailed, but she will not go through the water as fast and will make considerable leeway ; and if, on the other hand, the sheets are not trimmed flat enough, and the boat is sailed too much "off," she will have more speed through the water, but will not gain sufficiently to windward.

The perfection of the art of sailing consists in striking the happy medium between these two extremes, watching every puff of wind, and seizing every opportunity to luff a trifle to windward, at the same time keeping the boat "speeding" and never deadening her way through jamming her in the wind.

Considerable judgment must be given to the trim of the sheets throughout the race. An inch too much on the jib-sheet when on a wind will render the sail far less effective, and instead of acting as a powerful drawing sail, it then becomes something of a "lee driver."

When sailing free and reaching great care should be taken

that the sheets are so trimmed that every inch of canvas draws so as to assist the boat in the most effective manner.

When running before the wind, the main sheet should be well out, the jib boomed out a-weather, and all the sails so arranged as to pull powerfully.

Let us now suppose that all the boats have arrived at the starting line, have their sails down, and are moored by their sterns to a hawser.* This is a method which has been much used for starting boats, and the first run is generally made to leeward to give the boats a chance of getting well clear of each other, and to avoid a ruck at the first mark-boat, where there is often a general fouling match, through boats attempting to cut each other out while rounding the mark.

The boat should be kept to the hawser by a "slip-rope," attended by a cool-headed hand who is not likely to lose his head in the excitement, and let go at the wrong moment.

The men should be stationed for making sail, and each man must thoroughly understand what he is to do, in order that there shall be no hurry or confusion incident to getting away.

Do not be disheartened at the loss of a trifle at the start, for, as a matter of fact, it is found that it is seldom that the first boat round the lee mark-boat wins the race, for it is almost always the best boat at working to windward, and not the fastest boat off the wind, that wins.

Observe to keep your temper, keep your head cool, look

* "Flying Starts" are now generally used in yacht races, and are coming much into favor for boat races also.

An imaginary line is taken between two marks at right angles to the course the vessels must take to reach the first mark-boat.

Two guns are fired, *exactly* five minutes apart, and the competing vessels are required to keep behind the line until after the second gun-fire.

The object is to cross the line with good "way" on as soon as possible after the second gun-fire, and this requires nice judgment, because in the event of getting over the line too soon it will be necessary to go back and recross it.

The gun-fires must be timed with the greatest accuracy.

If this method of starting be adopted the boats will have all or the greater part of their canvas aloft before crossing the line, and therefore the directions hereafter given for making sail will not apply. It has been deemed best to describe the other start with canvas down, however, for the benefit of those who still adhere to the old method.

well where you are going, and don't run into your competitors at the mark-boats. A foul is always unfortunate; even if you are on the right tack, it is better to give way than to have a collision. The adversary may err through ignorance, and although he would be disqualified, yet that would be of little satisfaction to you, if he also carried away some of your spars and put you out of the race.

Now then, "Stand by!" "Bang!" goes the gun, and away we all go before a fine wholesail breeze; out go the spinnakers, and up go the "kites," for there is always considerable advantage in these running sails when they do not interfere in any way with the working canvas.

We have now run down to leeward and are drawing near the lee mark-boat in company with a crowd of boats. Let us imagine that there are three or four boats ahead of you, and several behind, while there is one boat right alongside, which has been running neck and neck with you all the way, and now the question is, which of the two is to cut the other out rounding the mark-boat, and find himself on his rival's weather quarter when both are round and close-hauled for the thrash to windward.

Suppose the mark has to be left on the port hand, that you are dead before the wind, and that you have to haul close to the wind directly you round the mark. Under these circumstances use every effort to get *outside* your rival; do not steer straight for the mark, but steer a course which would take you two or three boats lengths to the right of it; and then if your rival steers so as to pass close to the mark before he puts his helm down for rounding it, you will have no difficulty in getting the better of him. If the boats are exactly even you must get your boat clear *astern* of the other by jamming the helm hard over or flattening aft the sheets and so deadening her way.

It is evident from the following diagram, Fig. 88, that although A was astern of B at the first position, he has got the best of him at the second, and the reason is this: *A made his*

turn before he got to the mark boat, and passed close to leeward of it. B having passed close to the mark boat while before the wind, had to run to leeward, while making his turn, and thus A finds himself on B's weather quarter, which I need hardly say is a very advantageous position, as he will now very probably pass B to windward, for B's helmsman will be apt to sail his boat as close to the wind as possible, and try to "claw to windward," and prevent A from "blanketing" him, though in this case he would be wrong and his proper course would be to sail his boat "rap full" and forereach all he can, in order to get clear of A's lee; but whichever course he adopts, A has the advantage, and if B takes the first mentioned course, of sailing his boat close, A will sail a good clean full, and if the boats are at all equal in speed and weatherly qualities, he will pass B with ease, leaving him astern and to leeward.

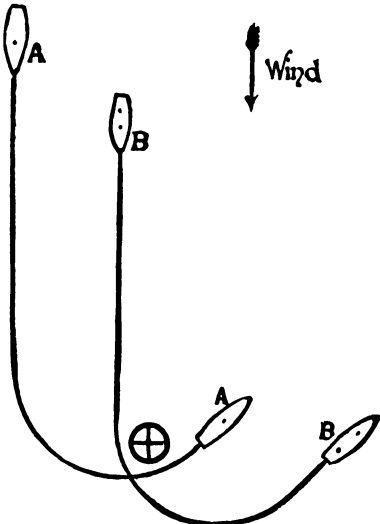

Fig. 88.

Remember to round a lee mark-boat with small helm, working the sheets cleverly, and thus bring the boat to the wind with good way on.

Having passed the lee mark, we are settling down for a good thrash to windward, of two or three miles, we will say. If the

wind is steady and there are no flukes or accidents, the best boat, skilfully handled, must win the race.

Everybody should sit down as low as possible in the boat, and there should be nothing visible above the gunwale except the steersman's head, and one pair of eyes looking out to leeward ; there is no advantage in exhibiting yourself on the weather gunwale with a rope round the tiller ; and if the rope slips you may turn an undignified back somersault into the water. The lower the helmsman sits the better will be his outlook under the sail to leeward.

Now look out for the boat that you consider likely to be your most dangerous rival ; go for her and get on the same tack with her, and try conclusions at once. If you find that you can beat her, and that none of the others are dangerous, then stick to her, never let her get away from you, tack whenever she tacks, stick on her weather-beam, and don't give her the chance of a fluke, or of benefiting by a shift of wind, which might put her to windward and you to leeward, if you were on opposite tacks ; but while you are doing this be careful to keep a look out and see that a third boat is not beating the pair of you, while you are engaged in jockeying each other.

On the other hand, if you find that the same dangerous rival can beat you on even terms, then do all in your power to get away from her, and shake her off. If she tries to stick to you, worry her by tacking frequently, perhaps your boat may be quicker in stays than she is, and you may thus gain an advantage. If you do manage to shake her off and get away on a different tack, and then the wind should shift a point or two, it is obvious that it will either put you well to windward, or, in case it shifts the wrong way, leave you only a trifle farther to leeward than you were before ; thus you utilize your only chance of beating a faster boat.

Another plan for shaking off a boat that is sticking on your weather-beam, which may sometimes be practised when racing in a harbor or roadstead, where there are ships about, is as follows : Look out for a good long ship, and when her stern bears a

little abaft your weather beam, so that you will *just* clear her astern, then tack; the boat on your weather beam tacks also, and then when you reach the ship, unless he is a very long distance to windward of you, he will either have to bear up and run under the ship's stern, and give up his advantage, or else tack and go away on the opposite tack to you. Perhaps he will try to weather the ship and come to grief in the attempt: so that the trap you have laid for him may spoil his chance of winning.

Captain Fitzgerald tells an amusing and somewhat apposite story of a clever Cowes skipper humbugging an adversary. The two leading yachts were sailing a close race, and running for the finish with the wind abeam; they both had jib-topsails set, with a freshening wind, and they were burying themselves with the large amount of canvas they were carrying.

The skipper's craft was a trifle ahead, and one of the amateurs on board ventured the remark to old Ben that his jib-topsail was doing more harm than good. "I knows that," replied old Ben, "I knows that as well as you do, but t'other chap's a young hand, and he is watching me and will do the same as I do; if I takes in my jib-taup's'l he'll take in his'n, and his'n 's doing him more harm nor mine 's doing me."

So Ben continued to carry his jib-topsail, and his 'cuteness was rewarded by winning the race.

If several of your rivals are faster than you are, then your chance of winning is very small. The only thing to do is to cut out a line of your own; it is useless to do the same as the other boats do. Stand off on an opposite tack to them, the wind may shift, and while your rivals are jockeying each other, with a failing breeze in one direction, you may come out from under a point of land in the opposite direction with a slashing fine breeze, and snatch the honors from them with an inferior boat. Where there is much high land about, the wind is uncertain and a fluke is worth trying for when you have no other chance.

A common error when working to windward in a race for the

purpose of rounding a weather mark-boat reach herself, that is to say, stand on fast weathering the mark. This frequently ing boat, which has no other boat to then number two, profiting by her rival's just to weather neatly, robs number one perhaps beating her on the run in, wins t.

The endeavor should be made to utilize possible when racing, as an apparently very marked effect, either in lifting you to you to leeward, according to the manner. A tide under the lee bow is particularly a boat to claw to windward; and you will sailing your boat very close to the wind, it just "underbow" the tide, as it will hoist ward in a wonderful manner.

Regulate your sail according to the amount, being, if in doubt, that it is easier to share take one in. The amount of ballast should be regulated according to the wind to be expected.

Remember that the ballast should be carried as possible amidships, and kept out of the out of the bow.

Sailing Allowances.—The New England regulation adopted in 1884 a comparison by length being obtained by adding one fifth of the length of the load water line.

Time for difference in such "sailing according to the "Herreshoff Table," which is to reduce a yacht's "actual time" over a course time," by which the relative merit is determined the number of minutes and seconds of "sailing length" of the vessel, and multiplied sailed in miles. Subtract this product from which the course was made.

country."

—Regarding population, surely never in times of peace has any other country had such a record as Ireland. A preliminary report of last April's census has appeared. (Parl. Paper Cd.—613). The population has within the past ten years declined 248,204 to 4,456,546. In 1841 it stood at 8,196,597. Scotland has now run ahead of her. Her population is less than it was a century ago, when it was about half the population of Great Britain—now perhaps one-tenth. Dublin proper, without some suburbs, is now smaller than Belfast, though, with its suburbs, it is slightly larger. Three counties—Dublin, Down, and Antrim—have increased in population from 7.3 to 7 per cent. The others have decreased, from Monaghan (13.6 per cent.) to Derry (5.1 per cent.). By provinces, Connaught has decreased 9.7 Munster 8.4, Leinster 3.5, Ulster 2.4 per cent. Of the total population, 74.3 are Catholics 13.0 Episcopalians, 10.0 Presbyterians, 1.0 Methodists, 1.3 other denominations. Methodists, Jews, and "others" alone show an increase. The Jews, 200 thirty years ago are now nearly 2,000. The Protestant and foreign element increases decade by decade slightly in proportion. Meanwhile, the amount of drink consumed and the number of public houses increase; also, the number of persons in poorhouses and in insane asylums. Consequent on the complication

equal utility were beaver skins, the value of which was more difficult to determine. In 1677 a beaver was reckoned at 8 guilders, in 1698 a merchantable beaver was counted as 100 shillings. More complicated is a present

HERRESHOFF TABLE OF ALLOWANCES.

139

Length.	Allow- ance.	Length.	Allow- ance.	Length.	Allow- ance.	Length.	Allow- ance.	Length.	Allow- ance.	Length.	Allow- ance.	Length.	Allow- ance.
1	29.0	16	4 31.5	20	3 50.5	24	3 19.2	28	2 54.2	32	2 33.5	36	2 16.1
1	27.4	1	4 30.5	1	3 49.7	1	3 18.6	1	2 53.7	1	2 33.1	1	2 15.7
2	26.0	2	4 29.5	2	3 49.0	2	3 18.0	2	2 53.2	2	2 32.7	2	2 15.3
3	23.2	3	4 28.5	3	3 48.3	3	3 17.5	3	2 52.8	3	2 32.3	3	2 15.0
4	21.8	4	4 27.5	4	3 47.5	4	3 16.9	4	2 52.3	4	2 31.9	4	2 14.7
5	20.5	5	4 26.5	5	3 46.8	5	3 16.3	5	2 51.8	5	2 31.5	5	2 14.4
6	19.1	6	4 25.6	6	3 46.1	6	3 15.8	6	2 51.4	6	2 31.2	6	2 14.1
7	17.7	7	4 24.6	7	3 45.4	7	3 15.2	7	2 50.9	7	2 30.8	7	2 13.7
8	16.4	8	4 23.7	8	3 44.7	8	3 14.6	8	2 50.4	8	2 30.4	8	2 13.3
9	15.0	9	4 22.8	9	3 44.0	9	3 14.1	9	2 50.0	9	2 30.0	9	2 13.6
10	13.7	10	4 21.8	10	3 43.3	10	3 13.5	10	2 49.5	10	2 29.6	10	2 12.7
11		11	4 20.9	11	3 42.6	11	3 12.9	11	2 49.0	11	2 29.2	11	2 12.4
13	5 12.4	17	4 20.0	21	3 41.9	25	3 12.4	29	2 48.6	33	2 28.9	37	2 12.1
1	5 11.1	1	4 19.1	1	3 41.2	1	3 11.8	1	2 48.0	1	2 28.5	1	2 11.7
2	5 9.8	2	4 18.2	2	3 40.5	2	3 11.3	2	2 47.7	2	2 28.1	2	2 11.4
3	5 8.6	3	4 17.3	3	3 39.9	3	3 10.8	3	2 47.3	3	2 27.7	3	2 11.1
4	5 7.3	4	4 16.4	4	3 39.2	4	3 10.2	4	2 46.8	4	2 27.3	4	2 10.8
5	6 6.0	5	4 15.5	5	3 38.5	5	3 9.7	5	2 46.4	5	2 27.0	5	2 10.5
6	5 4.8	6	4 14.6	6	3 37.9	6	3 9.2	6	2 46.0	6	2 26.7	6	2 10.2
7	5 3.5	7	4 13.7	7	3 37.2	7	3 8.6	7	2 45.5	7	2 26.3	7	2 9.8
8	5 2.3	8	4 12.8	8	3 36.5	8	3 8.1	8	2 45.1	8	2 25.9	8	2 9.5
9	5 1.1	9	4 12.0	9	3 35.9	9	3 7.6	9	2 44.7	9	2 25.5	9	2 9.2
10	4 59.9	10	4 11.1	10	3 35.2	10	3 7.0	10	2 44.2	10	2 25.1	10	2 8.9
11	4 58.7	11	4 10.3	11	3 34.5	11	3 6.5	11	2 43.8	11	2 24.8	11	2 8.6
14	4 57.5	18	4 9.5	22	3 33.9	26	3 6.0	30	2 43.4	34	2 24.5	38	2 16.1
1	4 56.3	1	4 8.6	1	3 33.2	1	3 5.5	1	2 42.9	1	2 24.1	1	2 15.7
2	4 55.1	2	4 7.8	2	3 32.6	2	3 5.0	2	2 42.5	2	2 23.7	2	2 15.3
3	4 53.9	3	4 7.0	3	3 32.0	3	3 4.5	3	2 42.1	3	2 23.3	3	2 15.0
4	4 52.7	4	4 6.1	4	3 31.3	4	3 4.0	4	2 41.7	4	2 22.9	4	2 14.7
5	4 51.6	5	4 5.3	5	3 30.7	5	3 3.5	5	2 41.3	5	2 22.6	5	2 14.4
6	4 50.5	6	4 4.5	6	3 30.1	6	3 3.0	6	2 40.9	6	2 22.3	6	2 14.1
7	4 49.4	7	4 3.6	7	3 29.4	7	3 2.5	7	2 40.4	7	2 21.9	7	2 13.7
8	4 48.3	8	4 2.8	8	3 28.8	8	3 2.0	8	2 40.0	8	2 21.5	8	2 13.3
9	4 47.2	9	4 2.0	9	3 28.2	9	3 1.5	9	2 39.6	9	2 21.1	9	2 13.0
10	4 46.1	10	4 1.2	10	3 27.5	10	3 1.0	10	2 39.2	10	2 20.8	10	2 12.7
11	4 45.0	11	4 0.4	11	3 26.9	11	3 0.5	11	2 38.8	11	2 20.5	11	2 12.4
15	4 43.9	19	3 59.6	23	3 26.3	27	3 0.0	31	2 38.4	35	2 20.2	39	2 12.1
1	4 42.8	1	3 58.8	1	3 25.7	1	2 59.5	1	2 37.9	1	2 19.8	1	2 11.7
2	4 41.7	2	3 58.0	2	3 25.1	2	2 59.0	2	2 37.5	2	2 19.4	2	2 11.4
3	4 40.7	3	3 57.3	3	3 24.5	3	2 58.5	3	2 37.1	3	2 19.0	3	2 11.1
4	4 39.6	4	3 56.5	4	3 23.9	4	2 58.0	4	2 36.7	4	2 18.7	4	2 10.8
5	4 38.6	5	3 55.7	5	3 23.3	5	2 57.5	5	2 36.3	5	2 18.4	5	2 10.5
6	4 37.6	6	3 55.0	6	3 22.7	6	2 57.0	6	2 35.9	6	2 18.1	6	2 10.2
7	4 36.5	7	3 54.2	7	3 22.1	7	2 56.5	7	2 35.5	7	2 17.7	7	2 9.8
8	4 35.5	8	3 53.4	8	3 21.5	8	2 56.0	8	2 35.1	8	2 17.3	8	2 9.5
9	4 34.5	9	3 52.7	9	2 20.9	9	2 55.6	9	2 34.7	9	2 17.0	9	2 9.2
10	4 33.5	10	3 51.9	10	3 20.3	10	2 55.1	10	2 34.3	10	2 16.7	10	2 8.9
11	4 32.5	11	3 51.2	11	3 19.7	11	2 54.6	11	2 33.9	11	2 16.4	11	2 8.6

purpose of rounding a weather mark-boat, is for a boat to overreach herself, that is to say, stand on farther than necessary for weathering the mark. This frequently happens with the leading boat, which has no other boat to serve as a guide; and then number two, profiting by her rival's experience, tacks so as just to weather neatly, robs number one of her advantage, and perhaps beating her on the run in, wins the race.

The endeavor should be made to utilize the tide as much as possible when racing, as an apparently small tide will have a very marked effect, either in lifting you to windward or setting you to leeward, according to the manner in which you work it. A tide under the lee bow is particularly favorable for assisting a boat to claw to windward; and you will often be justified in sailing your boat *very* close to the wind, if by doing so you can just "underbow" the tide, as it will hoist your craft to windward in a wonderful manner.

Regulate your sail according to the amount of wind, remembering, if in doubt, that it is easier to shake out a reef than to take one in. The amount of ballast should also be carefully regulated according to the wind to be expected.

Remember that the ballast should be concentrated as much as possible amidships, and kept out of the ends, particularly out of the bow.

Sailing Allowances.—The New England Yacht Racing Association adopted in 1884 a comparison by length, the length used being obtained by adding *one fifth* of the after overhang to the length of the *load water line*.

Time for difference in such "sailing length" is allowed according to the "Herreshoff Table," which is printed on next page. To reduce a yacht's "actual time" over a course to "corrected time," by which the relative merit is determined, find in the table the number of minutes and seconds corresponding to the "sailing length" of the vessel, and multiply it by the distance sailed in miles. Subtract this product from the actual time in which the course was made.

HERRESHOFF TABLE OF ALLOWANCES.

Length.	Allow- ance.	Length.	Allow- ance.	Length.	Allow- ance.	Length.	Allow- ance.	Length.	Allow- ance.	Length.	Allow- ance.	Length.	Allow- ance.	Length.	Allow- ance.
12	5 29.0	16	4 31.5	20	3 50.5	24	3 19.2	28	2 54.2	32	2 33.5	36	2 16.1		
1	5 27.4	1	4 30.5	1	3 49.7	1	3 18.6	1	2 53.7	1	2 33.1	1	2 15.7		
2	5 26.0	2	4 29.5	2	3 49.0	2	3 18.0	2	2 53.2	2	2 32.7	2	2 15.3		
3	5 23.2	3	4 28.5	3	3 48.3	3	3 17.5	3	2 52.8	3	2 32.3	3	2 15.0		
4	5 21.8	4	4 27.5	4	3 47.5	4	3 16.9	4	2 52.3	4	2 31.9	4	2 14.7		
5	5 20.5	5	4 26.5	5	3 46.8	5	3 16.3	5	2 51.8	5	2 31.5	5	2 14.4		
6	5 19.1	6	4 25.6	6	3 46.1	6	3 15.8	6	2 51.4	6	2 31.2	6	2 14.1		
7	5 17.7	7	4 24.6	7	3 45.4	7	3 15.2	7	2 50.9	7	2 30.8	7	2 13.7		
8	5 16.4	8	4 23.7	8	3 44.7	8	3 14.6	8	2 50.4	8	2 30.4	8	2 13.3		
9	5 15.0	9	4 22.8	9	3 44.0	9	3 14.1	9	2 50.0	9	2 30.0	9	2 13.6		
10	5 13.7	10	4 21.8	10	3 43.3	10	3 13.5	10	2 49.5	10	2 29.6	10	2 12.7		
11		11	4 20.9	11	3 42.6	11	3 12.9	11	2 49.0	11	2 29.2	11	2 12.4		
13	5 12.4	17	4 20.0	21	3 41.9	25	3 12.4	29	2 48.6	33	2 28.9	37	2 12.1		
1	5 11.1	1	4 19.1	1	3 41.2	1	3 11.8	1	2 48.0	1	2 28.5	1	2 11.7		
2	5 9.8	2	4 18.2	2	3 40.5	2	3 11.3	2	2 47.7	2	2 28.1	2	2 11.4		
3	5 8.6	3	4 17.3	3	3 39.9	3	3 10.8	3	2 47.3	3	2 27.7	3	2 11.1		
4	5 7.3	4	4 16.4	4	3 39.2	4	3 10.2	4	2 46.8	4	2 27.3	4	2 10.8		
5	6 6.0	5	4 15.5	5	3 38.5	5	3 9.7	5	2 46.4	5	2 27.0	5	2 10.5		
6	5 4.8	6	4 14.6	6	3 37.9	6	3 9.2	6	2 46.0	6	2 26.7	6	2 10.2		
7	5 3.5	7	4 13.7	7	3 37.2	7	3 8.6	7	2 45.5	7	2 26.3	7	2 9.8		
8	5 2.3	8	4 12.8	8	3 36.5	8	3 8.1	8	2 45.1	8	2 25.9	8	2 9.5		
9	5 1.1	9	4 12.0	9	3 35.9	9	3 7.6	9	2 44.7	9	2 25.5	9	2 9.2		
10	4 59.9	10	4 11.1	10	3 35.2	10	3 7.0	10	2 44.2	10	2 25.1	10	2 8.9		
11	4 58.7	11	4 10.3	11	3 34.5	11	3 6.5	11	2 43.8	11	2 24.8	11	2 8.6		
14	4 57.5	18	4 9.5	22	3 33.9	26	3 6.0	30	2 43.4	34	2 24.5	38	2 16.1		
1	4 56.3	1	4 8.6	1	3 33.2	1	3 5.5	1	2 42.9	1	2 24.1	1	2 15.7		
2	4 55.1	2	4 7.8	2	3 32.6	2	3 5.0	2	2 42.5	2	2 23.7	2	2 15.3		
3	4 53.9	3	4 7.0	3	3 32.0	3	3 4.5	3	2 42.1	3	2 23.3	3	2 15.0		
4	4 52.7	4	4 6.1	4	3 31.3	4	3 4.0	4	2 41.7	4	2 22.9	4	2 14.7		
5	4 51.6	5	4 5.3	5	3 30.7	5	3 3.5	5	2 41.3	5	2 22.6	5	2 14.4		
6	4 50.5	6	4 4.5	6	3 30.1	6	3 3.0	6	2 40.9	6	2 22.3	6	2 14.1		
7	4 49.4	7	4 3.6	7	3 29.4	7	3 2.5	7	2 40.4	7	2 21.9	7	2 13.7		
8	4 48.3	8	4 2.8	8	3 28.8	8	3 2.0	8	2 40.0	8	2 21.5	8	2 13.3		
9	4 47.2	9	4 2.0	9	3 28.2	9	3 1.5	9	2 39.6	9	2 21.1	9	2 13.0		
10	4 46.1	10	4 1.2	10	3 27.5	10	3 1.0	10	2 39.2	10	2 20.8	10	2 12.7		
11	4 45.0	11	4 0.4	11	3 26.9	11	3 0.5	11	2 38.8	11	2 20.5	11	2 12.4		
15	4 43.9	19	3 59.6	23	3 26.3	27	3 0.0	31	2 38.4	35	2 20.2	39	2 12.1		
1	4 42.8	1	3 58.8	1	3 25.7	1	2 59.5	1	2 37.9	1	2 19.8	1	2 11.7		
2	4 41.7	2	3 58.0	2	3 25.1	2	2 59.0	2	2 37.5	2	2 19.4	2	2 11.4		
3	4 40.7	3	3 57.3	3	3 24.5	3	2 58.5	3	2 37.1	3	2 19.0	3	2 11.1		
4	4 39.6	4	3 56.5	4	3 23.9	4	2 58.0	4	2 36.7	4	2 18.7	4	2 10.8		
5	4 38.6	5	3 55.7	5	3 23.3	5	2 57.5	5	2 36.3	5	2 18.4	5	2 10.5		
6	4 37.6	6	3 55.0	6	3 22.7	6	2 57.0	6	2 35.9	6	2 18.1	6	2 10.2		
7	4 36.5	7	3 54.2	7	3 22.1	7	2 56.5	7	2 35.5	7	2 17.7	7	2 9.8		
8	4 35.5	8	3 53.4	8	3 21.5	8	2 56.0	8	2 35.1	8	2 17.3	8	2 9.5		
9	4 34.5	9	3 52.7	9	2 20.9	9	2 55.6	9	2 34.7	9	2 17.0	9	2 9.2		
10	4 33.5	10	3 51.9	10	3 20.3	10	2 55.1	10	2 34.3	10	2 16.7	10	2 8.9		
11	4 32.5	11	3 51.2	11	3 19.7	11	2 54.6	11	2 33.9	11	2 16.4	11	2 8.6		

The following rules for sailing matches may serve as a guide to those arranging regattas, etc.

SUGGESTED RULES FOR SAILING BOAT-MATCHES.

ENTRIES.

1. Entries for regattas to be made in writing to the chairman of the Regatta Committee, before 5 o'clock P.M., on the day previous to the race. Should any boat duly entered not start, or, having started, withdraw from the race, such boat shall, in the event of the race being resailed, be entitled to start.

CLASSIFICATION, COURSE, AND START.

2. Classification, course, manner of starting, and limit of time to be designated by the Regatta Committee in a circular. Lots may be drawn for choice of stations.

SAILS.

3. No restrictions as to size, number, or shape of sails.

TIME ALLOWANCE.

4. Time allowance to be according to Herreshoff Table.*

PRIZES.

5. No first prize to be awarded unless two boats start, and no second prize unless three start. No prize will be awarded unless the course be made within the limit of time.

DISTINGUISHING FLAG, ETC.

6. Every boat sailing in a regatta should carry her private signal at the main-peak. A number on cloth should be furnished each boat, which will be her official number, and must be displayed in a conspicuous position on crossing the line.

CREW.

7. Boats contending for prizes may carry one man for each three feet of length on water-line. No person shall be allowed

* Any other system may be adopted.

to go aboard or leave a boat during the race for any purpose whatever, except in the case of getting aground, when all who jump overboard must return again into the boat.

FITTINGS AND BALLAST.

8. Every boat shall carry two serviceable life-buoys ready for immediate use. Only the usual anchors and chains shall be carried, and they must not be used as shifting ballast. All boats sailing in a race at night shall carry the proper side-lights.

MEETING, ETC.

9. Boats sailing free must give way to those on a wind.

Boats on the port tack must give way to those on the star-board tack.

OVERTAKING, ROUNDING, ETC.

10. A boat overtaking another shall keep out of her way, but when rounding any mark, if the two boats are not clear of each other at the time the leading boat is actually rounding the mark the outside boat must allow the other room to pass clear of the mark.

Each boat to go fairly round the stake-boats * or mark-buoys without touching the same, the boat nearest thereto to be considered the headmost.

LUFFING AND BEARING AWAY.

11. A boat may luff as she pleases to prevent another boat passing to windward, but must not bear away out of her course to prevent the other passing to leeward; the lee side to be taken to be that on which the leading boat of the two carries her main-boom. The overtaking boat, if to leeward, must not luff until she is clear of the boat she has overtaken.

CLOSE-HAULED NEARING SHORE.

12. If two or more boats (by the wind) are approaching the shore or any other obstruction, and are so close to each other

* The rules should specify the side on which the mark-boat or buoy is to be left by the competing boats in rounding.

that the leewardmost cannot tack clear of the weathermost, and by standing on would risk running foul or on shore, the boat to windward, on being requested to put about is immediately to do so, but the boat making the request must also tack at the same time.

FOULING.

13. Any boat fouling another, either from design or negligence, shall forfeit all claim to the prize.

MEANS OF PROPULSION, SOUNDING, ETC.

14. No means of propulsion except sails shall be allowed. Nothing but a hand-line and lead shall be used for sounding.

MAN OVERBOARD.

15. In case of the capsizing of a boat, or of a man falling overboard, all boats in a position to do so should make the utmost efforts to render assistance; and if it shall appear that any boat was thereby prevented from winning the race, the boat or boats so prevented shall have an opportunity of sailing the winner.

ANCHORING.

16. No anchoring allowed during the race except to prevent accident, in which case the anchor shall be weighed and taken on board again.

PROTESTS.

17. Any boat desiring to enter a protest must show the club or other signal conspicuously in her rigging, and keep it flying. All protests to be delivered in writing to the person or persons appointed to receive the same within three hours after the race.

PENALTIES.

18. Should a breach of any of these rules be proved against any boat, that boat shall forfeit all claim to the prize, and may be disqualified by the Regatta Committee, for such time as they deem proper, from sailing in the club matches.

Section 5.

CANOE SAILING.

**CLASSIFICATION OF CANOES. SAIL-CARRYING
POWER, ETC.**

SAILS AND RIGGING.

VARIETIES OF SAILS IN COMMON USE.

HANDLING CANOES UNDER SAIL.

CANOE FITTINGS.

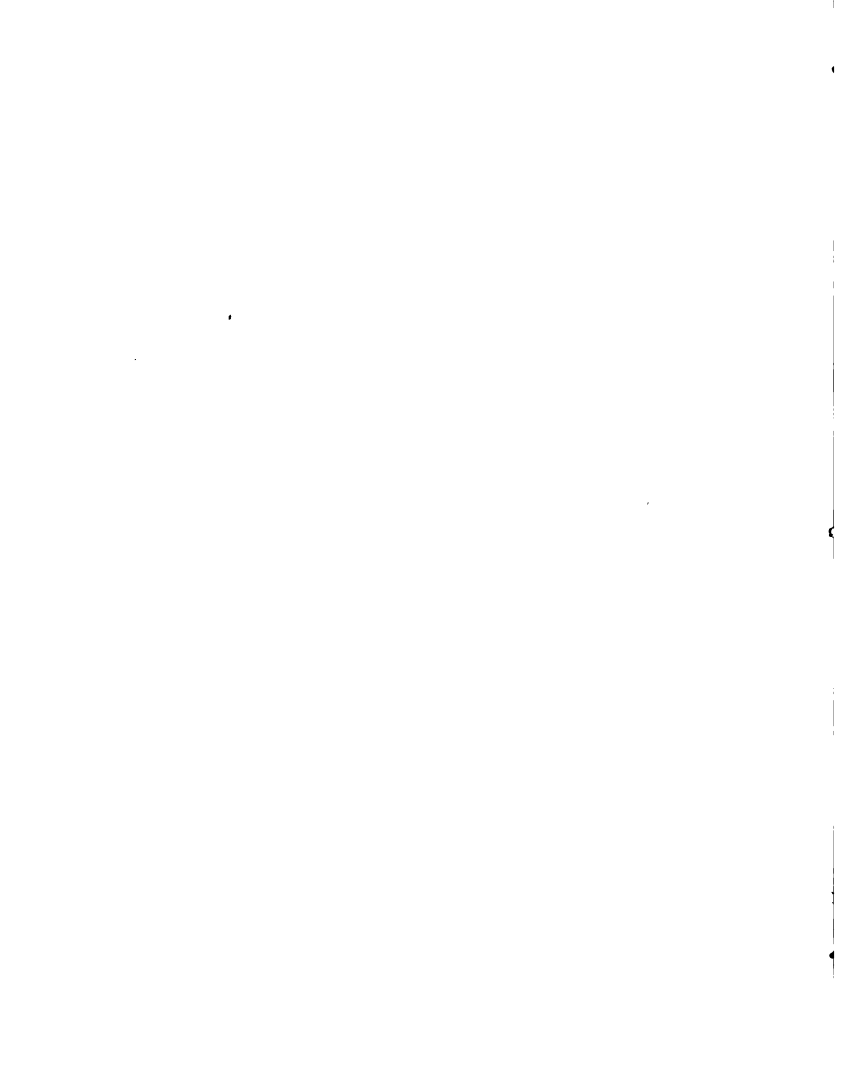

CANOE SAILING.

Introductory.—It has been found that sails will nearly double the travelling power of a canoe, and enable her to accomplish journeys in a day which would be almost impossible with the paddle.

In addition to giving the rudiments of sailing the following pages will, perhaps, assist the beginner in selecting from the numerous inventions in use those which may be advantageously adopted for general purposes.

A person may learn to paddle a canoe quite well in a couple of days, and by practice will soon be able to paddle long and rapidly. But for real cruising one should be able to sail as well, and even this may readily be acquired by a little explanation and a couple of days' coaching afloat. Of course, all the niceties of sailing cannot be appreciated in such a short time, but it will suffice for a man of ordinary activity and nerve to learn to handle a canoe under sail sufficiently well to make one of a party "on a cruise," during which he will be continually adding to his skill and experience.

The beginner should first learn to paddle the canoe, with single and with double paddle, and to steer with the foot-gear.

The next step should be to learn the principles of sailing, how the sheets must be hauled in when close hauled, and eased off before the wind, etc., which may be accomplished in a very short time.

Finally he should get on board, and in a light steady breeze start on a sail. The main and mizzen-rig, if used, will prove more instructive, perhaps, than a single-sail rig. The mizzen should be so small, however, that it may be neglected in puffs, and if the canoe have a centre-board, it should be lowered and kept down.

The coach may paddle or sail alongside, and give his explanations when necessary.

As soon as sailing by the wind is mastered, the instructions for staying should be given and the canoe tacked. Next try

the wind quartering, when the use of the downhaul should be learned, as the sheet should no longer be eased for puffs.

Careful attention should be given to running before the wind, and steering so as to avoid gybing.

A burgee may be permitted to serve as a guide for the beginner at first, but he should learn to do without this aid as soon as possible.

CLASSIFICATION OF CANOES.

CANOES may be divided for convenience into five classes, as follows:

CLASS I. *Paddling Canoes*, in which the paddle is the sole method of propulsion.

CLASS II. *Sailable Paddling*, sail being used as auxiliary.

CLASS III. *Sailing and Paddling*, both qualities being about equal.

CLASS IV. *Paddleable Sailing*, fitted mainly for sailing, the paddle being auxiliary.

CLASS V. *Sailing*, large canoes intended for sailing, as the Mersey canoes.

For racing purposes a different classification has been adopted by the American Canoe Association.

The remarks contained in the following pages will relate almost exclusively to the last four classes, and be confined mainly to the sailing properties of canoes.

NOTE.—For a description of the various types of canoes in use, and the fittings of the same, the reader is referred to "Canoe and Boat-Building," by W. P. Stephens, New York.

For general cruising work, using both sail and paddle, a canoe 14 feet long by 30 inches breadth, with good bearings, nearly upright sternpost, full model, and keel of three inches, or a weighted centreboard, will be found suitable.

For large rivers, lakes, and open waters, a canoe 14 or 15 feet in length, by 33 or 31½ inches beam, fitted with a weighted centreboard, should be selected.

As a general rule the well should be as small as it can conveniently be made, so that very little water can get below. The boat will also be stronger and there will be more stowage-room.

There should, however, be sufficient opening to allow sleeping, stowing spars, and to give easy access to hatches below decks.

Ballast is generally carried in canoes intended principally for sailing, but for cruising and travelling the stores and luggage may serve as ballast. The best ballast for canoes is shot, in twenty-five-pound bags; such a weight is easily handled, and can be shifted to regulate trim and placed to windward to prevent excessive heeling when close-hauled.

SAIL-CARRYING POWER OF CANOES.

SAILING demands a lowering of the weights as much as possible, and consequently a reclining position of the body; and further, when running before a strong wind, under a press of sail, even though a spinnaker be carried, the head of the lug may get forward of abeam and cause violent rolling.

Comfort and safety will be promoted under these circumstances by lying back and wedging the shoulders between the sides of the after well-coamings.

A sailing canoe, especially if of racing build and equipment, is a very delicate craft to handle. Her sail-carrying power almost entirely depends on the artificial shifting of her centre of gravity to windward, by moving the ballast and crew.

The small depth of body and keel, coupled with the necessarily large proportion and weight of crew, spars, and sails to the small hull, cause a much higher position of centre of gravity in a canoe than will be found in any other vessel.

The beam being very small for sailing purposes, the "righting couple" will be very short at any angle of heel, unless the weights are moved rapidly to windward as the canoe heels; consequently, righting force will be limited to small angles of heel, and there will be a point at which stability will vanish and the canoe capsize.

As soon as the canoe begins to heel, the weather bilge rises out of water, and a large bulk of body is immersed on the lee side, and the centre of buoyancy is rapidly shifted out to leeward.

If, then, the weights remain amidships, there will be a gradually increasing righting power, till the deck is awash, or the angle of heel is about twenty-five degrees, Fig. 89; but the centre of gravity is now being raised, and some of the weights,

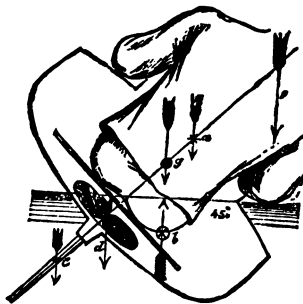

Fig. 89.

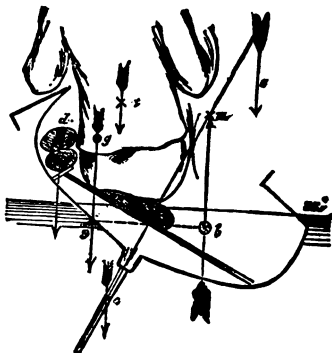

Fig. 90.

such as the man's body, are coming into the vertical, in which is the centre of buoyancy, and that of the spars and sails is shifting out to leeward. This is rapidly shortening the righting lever, and therefore the canoe is nearing the capsizing point, and at forty-five degrees this will be reached and then an upset must follow.

But before this point is reached, the man's balancing power, aided by that of ballast trimmed to windward, comes into play, and the craft receives a new lease of stability, as in Fig. 90 the only danger then remaining is that of the lee well-coaming get-

ting under water, or of the weights suddenly slipping to leeward.

In the Figures the positions of the centres are exaggerated, for the sake of clearness: b represents the centre of buoyancy (through which a force acts upward at right angles to the water's surface); g is the mean centre of gravity of all the weights, such as ballast, crew, spars, sails, centreboard, and hull; a force acts downward, vertically through g .

Each of these two forces is exactly equal to the weight of the canoe and its contents.

The horizontal distance between the verticals of g and b is the "righting couple," and so long as g has any horizontal distance to windward of b , the canoe has stability; but in Fig. 89, g and b have been brought into the same vertical line, the metacentre has been made to coincide with the centre of gravity, consequently the vessel is in equilibrium, and a touch either way will settle the question of capsizing or right.

The centre of gravity of the separate parts are represented individually in the Figures, a being that of the man, d of the ballast, c of the centreboard, and s that of the spars and top-hamper.

The stability of a canoe in which the ballast is not shifted and the man's position not altered would rapidly decline after a heel of about twenty-five degrees, and vanish entirely at about forty-five degrees; but if the man and ballast both shift up to windward, the canoe will be safe, even though a puff should suddenly force her over to forty-five degrees.

Suppose a canoe to be sailing, and heeled over to an angle of about twenty degrees, and working short tacks where there is no time to trim ballast over, and where the wind is coming in sudden puffs: it will often be found necessary to do a multitude of things at the same moment; such as to sit over to windward, to luff sharply before steerage-way has been lost in consequence of the sails banging about, to ease off the head-sheet and flatten in the mizzen, and perhaps to lift the centreboard for shoal water; and then have to go about suddenly, and perform much

of the same thing on the other tack, with perhaps the addition of taking in or shaking out a reef or two.

The necessity of performing the operations quickly in a canoe suggests certain fittings and arrangements; for example, sitting up to windward can be better performed when the craft has been fitted with side deck-flaps; to luff or bear away at the same moment that one's hands are busy with the gear, suggests steering with the feet. To work the sails conveniently, smartly and safely, it is essential that the chief sail should be forward of the man, and the various ropes and centreboard lifting gear must all be at hand.

To allow a sufficient margin for heeling and for rough water, the free board in sailing canoes is seldom less than six inches, and will often be found to be eight inches. Taking this as a margin, the depth of the canoe's body from water-line to garboards will be six inches. The weights of boat, gear, and man may not put the canoe down to its depth of immersion, consequently ballast must be added in until she has come to her marks. The arrangement of this ballast will be a question of how it can be handled in working, the heavy man will possibly require no more ballast to put his boat down to her designed load-line than he can conveniently handle as shifting ballast; whereas the light weight may have much more than he could possibly shift and consequently must stow some below the floor.

Having arrived at the correct weights and the most useful way of stowing them, the next question will be as to how much sail the canoe so weighted and balanced will stand.

SAILS AND RIGGING.

THE success of the sailing canoe greatly depends on the proportioning of the sails, on their proper fitting, and on the arrangement of the details of the rigging.

Before deciding on the shape of the sails, it will be well to determine how much sail you will carry, which can best be de-

cided by a comparison with other canoes and their rig. As the personal qualities of the canoeist, his skill, activity, and good judgment, enter largely into the problem, and the character of the locality where the sailing is to be done must also be considered, it will be best to determine the average cruising rig by a comparison with similar canoes, and afterward the canoeist will be able to make such additions to it as experience may show to be desirable.

VARIETIES OF SAILS IN COMMON USE.

ALMOST every conceivable rig and sail has been tested on canoes; gaff sails, dipping lugs, standing lugs, balance lugs, Chinese lugs, lateen sails, settee sails, spritsails, sliding gunter, gunter sprits, and leg-of-mutton sails have all been tried.

The sails which have proved the best suited for canoes and are now in general use are leg-of-mutton, standing lugs, balance lugs, lateen, settee, and various modifications of one or more of them. The spritsail is sometimes used as a mizzen, and the sliding gunter is still in use abroad.

The standing, or working lug, has its tack made fast at the foot of the mast, while the balance lug has it forward of the mast.

A canoe should have a boom with any description of sail.

The main and mizzen rig is very handy and efficient on all points of sailing and for working. "Before the wind" both sails draw effectively, and when "by the wind" in squalls, the mizzen acts to luff the canoe, and the pressure is eased by spilling the large sail. The centre of gravity of the mainsail is forward of the centre of lateral resistance, and consequently, by spilling the mainsail, the centre of effort of sail is carried aft and the canoe luffs smartly; or for "bearing away," the main-sheet is kept flat, and the mizzen eased, the centre of effort being thereby carried forward, and the canoe goes off the wind cheerfully. Both the foregoing evolutions may, of course, be greatly facilitated by the judicious use of helm and centre-board.

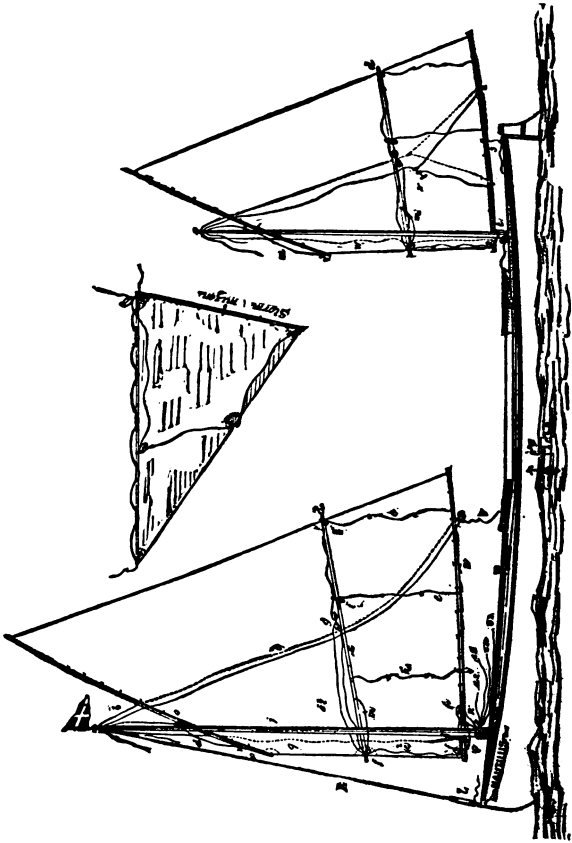

FIG. 94

For racing, the balance-lug main and mizzen rig is a great favorite; and, with the addition of a spinnaker for running, appears to give the best all round results.

Balance-lug Cruising and Travelling Sails.—In planning sails the centre of effort must be kept as low as possible, and, where a large area is desired, it should rather be obtained by long boom and yard, than by a lofty mast and narrow sail. The spars must be kept short for facility of stowage, and, when the masts are near the ends of the canoe, it will be found necessary to carry quite a large mizzen. If a good balance of sail is to be designed combining these requisites, a low centre of effort, good sail area, easy stowage of spars, and an efficient working balance, the sail plan of the Nautilus travelling canoe, delineated in Figs. 91 and 92, may well be adopted.

The main and mizzen lugs are intended to be used in all weathers up to a "fresh breeze," and for stronger winds the mizzen lug is to be set on the mainmast, and the storm mizzen shown aft.

The total lug sail area is 52 square feet, of which 32.5 are in the mainsail, and 19.5 square feet in the mizzen. The storm mizzen has an area of 9.5 square feet.

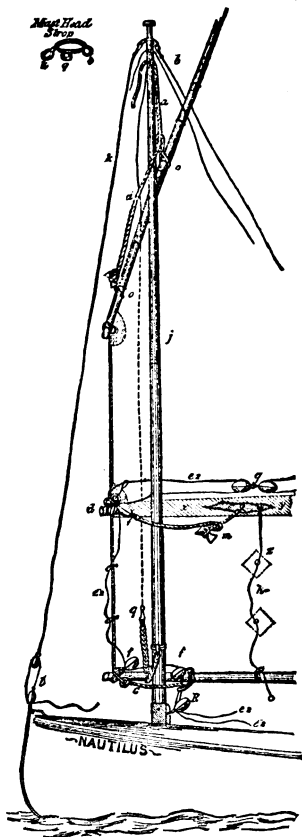

Fig. 92.

The chief fittings are denoted by the following letters :

- a*, Main halliards.
- a* 2, Hauling part of same.
- b*, Main topping-lift.
- b* 2, Main topping-lift, hauling part.
- c*, Tack parrel.
- c* 2, Main tack.
- d*, Reef batten.
- e*, Reef earing.
- e* 2, Hauling part of reef earing.
- f*, Reef earing blocks and fairleaders.
- g*, Reef sister-blocks.
- h*, Hand reef-line.
- i*, Main-sheet.
- j*, Mast joint ferrule.
- k*, Forestay.
- l*, Stay tackle.
- m*, Mast parrel on batten.
- n*, Cleat on boom for hand reef-line.
- o*, Yard grommets.
- p*, Main-sheet grommet.
- q*, Main jackstay (dotted).
- r*, Main-blocks.
- s*, Mizzen sheet.
- t*, Mizzen tack.
- u*, Mizzen halliards.
- v*, Mizzen topping-lift.
- w*, Mizzen jackstay (dotted).
- x*, Main and mizzen reef-bands.
- y*, Buttonhole slit in band.
- z*, Patches on sails for rings.

The gear at the masthead is snap-hooked to a masthead strop, *k q b*, so as to be easily taken off for the various shifts of sail. The main halliards pass from the deck block *R* up to the sheave in the masthead, reeve through from forward aft, and

the standing part *a* is rove through a grommet (seized to yard two feet from fore end), and then taken on the opposite side of the mast to that on which the yard hangs, and toggled to a grommet on the yard at six inches from the fore end. Another plan is to have a flat sennit parrel from the fore end of the yard rove through the inner grommet and ending in an eye just above the grommet to which the halliard is toggled. A jackstay toggled at the masthead leads down on the starboard side of the sail, and snap-hooks to a sennit band, which passes under the boom and up on the port side, and is seized to the mast about a foot above the deck; this jackstay is useful in keeping the sail steady when being lowered or hoisted. The batten parrel *m* is either made of flat sennit or four-strand line; the fore end of fore part is seized or spliced into the reef-block strop *f*, and the after end is finished off with an eye; the after part toggles to this eye, and the after end is seized to the reef-batten, so that when toggled the parrel binds the batten to the mast. The main tack parrel *c* is also flat sennit, with an eye at each end, the fore end is seized on to the boom, about three inches from fore end of boom, and it then passes on the opposite side of the mast to that on which the boom lies and is rove through a grommet or ring, which is seized to the boom, about nine inches from fore end; to the after eye of the parrel the tack hauling part *c* 2 is toggled and rove through the deck block *R*. The stay is snap-hooked or toggled to the masthead strop at *k*, and its tackle is shown at *l*. The topping-lift is toggled to the masthead strop at *b*; then, passing down the starboard side of the sail, is rove through the main-sheet thimble where the main-sheet is spliced into a snap-hook, which hooks to the grommet at *p* on the boom; it then leads up the port side of the sail and is rove either through a block toggled to a fourth eye (not shown in the sketch) in the mast-strop, or through a sheave in the masthead above the halliards and down through block *R* and into hand.

The reefing gear is arranged as follows:

The after part of the earing is fastened to the boom by seiz-

ing the end back to the standing part, and afterward seizing the eye to the boom. Then lead the after reef earing up through brass rings which are stitched on the sail and through the block *f* at after end of the batten *d*; next through a thimble or ring stropped in above the next *f* block in on the batten; then through the sister-block *g*, back through the last-mentioned *f* block, down through the rings *e*, and fasten to the boom. When the sail is fully hoisted the sister-block *g* should rest nearly against *f* block. Next reeve the forward reef earing. Make the standing part, *c* 2, fast by clinching it through the cringle in the luff of the sail at *d* (rigging plan); then take it aft in line with the batten, and reeve it through the block *g*; lead forward again through *f* at fore end of batten, then down through the rings, through block *f* at fore end of boom; next along the boom through the fair leader block *f* abaft the mast, and then through *R* and into hand. The hand-reef line *h* is fast to the batten *d*, leads down through rings on the sail and a ring on the boom, and is finished off by having a ring spliced into its end. This line is used for snugging that part of the sail where the reef-gear does not come, and the ring at the end of *h* is in such case taken hold of by means of a boat-hook till brought into hand, and is then hitched to the cleat *n* on the boom.

The gear on the mizzen is fitted in the same way, except the topping-lift. It has been found in practice that a crow's-foot form of topping-lift is best to keep the sail and reef-gear clear of the rudder yoke when the sail is lowered; but as the mizzen lug is to be shiftable, so as to set as a mainsail, it is necessary to be able to detach the topping-lift; therefore, the standing part is fast to the masthead on the starboard side, and the lift leads down that side of the sail, and at about two feet above the boom it divides into two parts. These two branches go under the boom, and each end in an eye-splice. The hauling part, which is rove through a sheave or block at the masthead, comes down and toggles into these two eyes (*v*). The sheet is a single line, which is toggled to the boom at *s*, reeves through an eye-bolt in the sternpost, and leads into hand.

When the lug mizzen is used as a mainsail, the storm mizzen is rigged by gathering the lacing together in clear turns and dropping them over the mizzen masthead; then the end of the tack is hitched below the halliard block, leaving sufficient play for gybing, etc.; next hitch the head earing through the masthead sheave-hole and toggle the sheet to the strop. The brail is kept on the sail; a line fast to the clew leading through a ring on the leech at two feet four inches up, then to a block on the luff at five feet eight inches up, and down to a block at the tack. This sail should be roped all around, and a light bamboo boom laced on the foot.

The reef-band (*x*) is made of wide tape, stitched on slack—*i.e.*, the tape will not stretch, but the sail will, so the band is put on slack to avoid girding the sail. The batten (*z*) is passed into this pocket formed by the sail and tape band, and is seized to the sail cringles at each end. At the stations on the batten where the reef-blocks are lashed the band is slit and button-hole-stitched (*y*).

The yard and boom should be of bamboo, which, if possible, should have a "knot" at each end when cut to the right length. The mast may be of yellow pine; a "grown stick" is best, though apt to buckle and kink.

With regard to the mainsail, where complete stowage is desired the sail may be kept on the upper mast—that is, keeping the halliards fast, let go the tack, pull close upon the topping-lift and lower away the mast by slacking up *l* till the sail comes to hand, then unhook main-blocks *R* either by hand or by boat-hook, and roll them and all rope bights and ends into the sail, keeping tack and batten parrels on the mast above the mast-joint. Unclip the forestay at masthead, and the jackstay at lower end, and unship the upper mast; pass the sheet round all, and stow below. If only to be stowed for a short time, when the sail is set let go the tack, haul down the reef, lowering halliards at the same time; tie the sail by gaskets, pull it "up and down" by the topping-lift and halliard, and lower the mast half down.

The foregoing sails are intended for a cruising and travelling canoe of the following general dimensions: Length over all, 14 feet, beam extreme, 2 feet 6 inches. Depth, under side of deck to garboards, at the fore end of well, 13 inches.

Sailing and paddling are considered to be about equal in importance in this design.

Balance Lugs for General Sailing and Racing.—The rig shown in Fig. 93 is considered to be a moderately well-proportioned sailing rig.

In the sail plan the numbers refer to the gear and blocks; 1 being the tack; 2, the main halliard; (2) the snorter; 3, the peak halliard, also serving as forestay; 4, peak halliard span; 5, topping-lift; 6, main-sheet; 7, reef earings; (7), ends of earings; 8, spinnaker halliard block.

Fig. II. delineates the masthead and slinging plan, and Fig. III. the details of main-sheet plan.

The principal dimensions are as follows:

	Mainsail.	Mizzen.
Tack to peak.....	14 ft. 10 in.	7 ft. 3 in.
Clew to throat.....	11 " 0 "	4 " 11 "
Head.....	8 " 9 "	4 " 4 "
Foot.....	9 " 4 "	4 " 5 "
Luff.....	6 " 4 "	3 " 0 "
Leech.....	15 " 4 "	7 " 4 "
Head rounding.....	0 " 2½ "	0 " 1 "

Area mainsail, 76.2 sq. ft.; area mizzen, 16.5 sq. ft.; total area, 92.7 sq. ft.

This area will be amply sufficient in from light to moderate breezes. The first reef taken in the mainsail will leave a total area of 71.5 sq. ft., which will be found to be as much sail as can well be carried in a good steady sailing wind, and there is always the reef extra for light weather.

The centre of effort of the full sail plan is four inches abaft amidships, and that of whole mizzen and single-reefed mainsail nine inches abaft amidships.

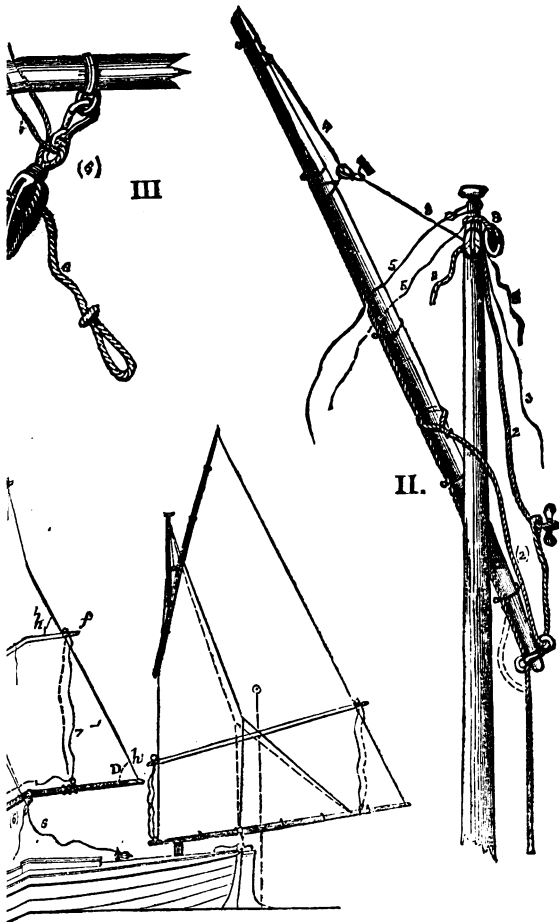

Fig. 93.

For running in light weather a spinnaker may be carried, which will require a boom about eight feet long. It may be formed by adding a joint to the boat-hook. The spinnaker halliard is usually kept on the main boom, and runs through a block aloft and one at the foot of the mast. Some canoeists use one of the topping-lifts for this purpose.

The spinnaker sheet is also kept on the boom and leads through a block at its forward end. The outhaul, or after-guy, is generally kept on the sail.

For the foregoing rig the spinnaker luff would be twelve feet, and the foot seven feet in length—area 36 sq. ft.

A capital plan for fitting the main tack is that in which a short piece of rope is fitted to the boom abaft the mast, and passes round the opposite side of the mast to that on which the boom lies, then reeves through a thimble on the under side of the boom, and finishes with an eye; the tack pendant toggles to this eye, and passes through an eye-bolt in the deck forward of the mast, and thence to the well. It may be fitted with a whip, if necessary.

The main-sheet, as fitted, has a large eye at one end, the splice ends of which are worked into a knot, to prevent the sheet from unreeving. The sheet is used single when running free, and when close-hauled, the eye is slipped over a hook on deck abaft the well, and the sheet thereby doubled.

Another plan is to have the sheet block travel on a wire span under the boom, to distribute the strain, and render less sheet necessary in running. The sheet may have a ring at each end; then, when before the wind, one of these rings may be allowed to run up to the block, the other being dropped over a hook on the lee side of the deck. By the wind, the rings should both be hooked on deck, one each side, and the sail "humored" with the slack.

The reefing gear is fitted as follows: the standing part of each reef line is fast to the boom, then leads through rings on the bolt rope, and the after one through rings on the sail, next passing through thimbles on the top of the batten and down

the opposite side of the sail, through rings, to and through a thimble on the boom ; both parts are brought to the after side of a thimble on the boom, abreast the mast, and, when the sail is up, are spliced together, the single part then leading through the thimble and to a cleat at the well. On lowering the halliard and hauling on this reef-line, the reef comes in as the sail lowers, and the points may afterward be secured.

The mizzen is an ordinary balance lug, fitted with standing tack and branched topping-lift.

The mizzen halliard has a toggle in the end ; two grommet eyes are fitted to the yard, one at mid-length and the other at the fore end ; the halliard is rove through the upper eye, passed round the mast, and toggled to the eye at the fore end of the yard.

The mizzen sheet may lead to a boomkin, to the sternpost head, or to the rudder, as preferred. If the latter, the standing part is secured to the after edge of the rudder near the water, rove through a block on the boom and led to the well.

The drawing exhibits the yard slung with main and peak halliards. With this fitting, when the peak halliard is let go, the peak will drop as with a gaff sail, which is sometimes handy in squalls.

The fitting is shown in the masthead Plan II. ; (2) is the snorter of rope or sennit, which is secured to the yard and leads round the mast and through a thimble at the fore end of the yard ; it ends in an eye to which the main halliard toggles.

The peak span (4) is usually made of copper wire. It distributes the strain on the yard, and allows the peak halliard to shift upward when the sail is reefed. A thimble, with a rope grommet to which the peak halliard toggles, travels on the span.

The peak halliards may lead down to a block on the stem-head, or at side of mast, and thence to the well. With large sails a forestay should be used to keep the masthead forward when by the wind.

A mast jackstay is also useful. One end is fast at the mast-

head, and the other having passed down outside the sail on the side opposite to the mast, goes under the boom and belays round the mast, about six inches above the boom. When the sail is lowered, it is snugly gathered in by the jackstay and the topping-lift.

The standing part of the topping-lift (5) is fitted with a running eye round the masthead; the topping-lift then passes down one side of the sail, and reeves through a thimble in the sheet block strop, then leads up the other side of the sail and reeves through its block at masthead, after which it passes down to a deck block at the side of mast, and to the well.

The sail is shown slung on the port side of the mast. The jackstay, which is not shown, comes down on the port side of the sail.

For spars yellow pine is generally used, although for light sails bamboo has some advantages.

The mainmast should, if possible, be a "grown" fir spar, straight and tapering. Length from deck to shoulder, 12 ft., squared at lower portion, $2\frac{1}{4}$ in. in diameter at deck, and tapering below to $1\frac{1}{4}$ in. rounding; and to 1 in. at head. The mainmast should be fitted to lower; in which case the mast may be pivoted to a tabernacle above the deck, and a small hatchway will be necessary on the fore side of mast to allow the heel to come up. The mast will be held upright either by a forestay or a heel tackle. There are many ways in use for fitting the heel and lowering gear, any of which may be selected, observing, however, to have the deck and mast case fittings good and strong. The sails should be made of stout sheeting in one width, the selvage being taken for the leech. Narrow binding tape should be stitched all round, except on the leech, and the stuff should be cut outside the tape and turned in. Eyelet holes should be made for lacing, etc., and the sail should be roped on the luff and head corner patches. After being made, the sail should be bent and hoisted, after which it should be thoroughly wetted and allowed to dry before putting on the reef and batten bands.

A $1\frac{1}{2}$ inch double block and a single block, fitted with strop and

thimble, should be seized to the mast just above the deck, the double block at the after side, and the single one on the starboard side; a brass ring seized on the port side will act as a fairleader for the topping-lift.

At the masthead there must be a sheave-hole for the main halliards, and three single $1\frac{1}{4}$ -inch blocks, fitted with strop and thimble, seized on above the shoulder, one each side and one on the fore side, to take the peak and spinnaker halliards and the topping-lift. A truck and short brass flag-rod finish the masthead. All spars, blocks, and seizings should be varnished, the mast being sand-papered and oiled afterward. Boxwood blocks with metal sheaves are the neatest. The foregoing rig is designed for a canoe of 13 ft. total length; extreme beam 2 ft. $10\frac{1}{4}$ in.; depth deck to garboard, fore end of well, $15\frac{1}{4}$ in.; and having a keel of about 2 in. and a centreboard of $\frac{3}{8}$ -inch galvanized boiler plate or composition.

In this craft sailing is intended to be the chief mode of propulsion, and so long as any wind exists sailing will be the most successful mode of making progress.

Racing Sails.—The sail plan, as shown in Fig. 93, is identical with that of the Nautilus racing canoe, except as to dimensions, the principal difference being that the racing mizzen is much larger in proportion to the mainsail, or about half the size of that sail.

The racing outfit consists of five sails: a racing mainsail, No. 1 and No. 2 mizzens, and No. 1 and No. 2 spinnakers.

The mainsail, which is 100 sq. ft. in area, has a bamboo yard and three battens, and a pine boom. The yard is 9 ft. and the boom and spinnaker boom each 11 ft. in length.

The racing reefing gear is made of woven cord, dressed with boiled oil, and is both simple and effective (Fig. 94).

The leech earing has one end fast to the boom at *a*, leads through rings to block *b*, and along the batten through a brass fairleader, through one sheave of a sister-block, back through a block seized to the brass fairleader, down through brass rings *c* on the sail, and secures to the boom at *d*.

The luff earing is fast at *e*, passes through rings, through a block *f*, thence along batten and through forward sheave of the sister-block, back to a block on the batten at *g*, thence to a block, *h*, on the mast, and the hauling part leads aft to a cleat.

This gear is usually arranged for the first two reefs. The boom being held by the jackstay and topping-lift, a reef is taken in by lowering the halliard until the batten comes down,

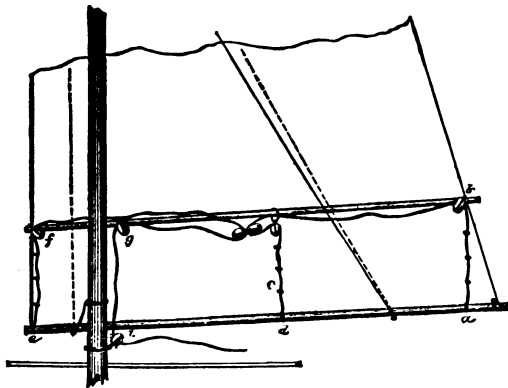

Fig. 94.

hauling taut the reef-line. If desired the reef may also be secured by points.

The mizzen may be fitted with a similar reefing gear. The No. 1 mizzen has 50 sq. ft. and No. 2 mizzen 25 sq. ft. area; each having one batten reef. No. 1 spinnaker has 60 sq. ft., and the boom has a ferrule joint, one third out, for facility of stowage, and for shortening for No. 2 spinnaker.

The mainmast is a white-pine stick, 15 ft. 6 in. from deck to truck, and 2½ in. in diameter at deck, tapering to 1½ in. at the head.

The mizzenmast is 8 ft. from deck to head, and $1\frac{1}{4}$ in. diameter at the deck.

Preventer backstays are useful with the long racing masts in use. They are sometimes fitted with a bridle, which hauls one forward as the other comes aft, and an india-rubber spring on this bridle carries them both forward to the mast when let go.

The boom should be cut about 10 ft. long, and reduced at the after end after the sail has attained its shape. It should be $1\frac{1}{4}$ in. in diameter at the centre, taper to 1 in. at the fore end, and $\frac{1}{2}$ in. at the after end.

The yard should be cut 9 ft. 6 in. long, and have a little less diameter than the boom, or it may be a light spar with a fish batten of elm on its upper side.

The reef battens may be of pine or bamboo, should be stoutest at one-third from the fore end, and be paralalled to the mast by a snorter with eye and toggle. When cut to their length, the ends of bamboo battens should be bound with wire, plugged with soft wood and well varnished. Seizings of hard twine are sometimes used, and in some

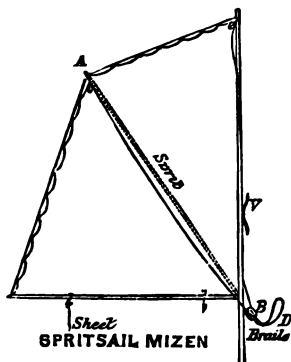

Fig. 95.

cases the ends are lightly ferruled with brass.

The cords for running gear should be of the very best quality of four-strand line, except for reef-lines, which should be of plaited line.

The Sprit Mizzen.—This mizzen, which may be found more convenient for general cruising work than a lug mizzen, is shown in Fig. 95. It is fitted with a brail from the boom end, through rings on the leech, and a block at the sprithead *A*. It then passes down the sprit, through a double block *B*, at foot of mast, and a bight of a couple of feet is left there, after which

the line passes through the other sheave of the double block, up to the masthead, through rings along the head of the sail to the sprit-head, and is there made fast.

By pulling on the bight *D* of the brail, the sheet being slacked, the sail may be snugly brailed up; or by pulling on the head part only, the sail can be reduced into a jib-headed mizzen.

A furling-line from the masthead serves to bind the sail and sprit to the mast when brailed up. It fastens to a cleat *V*. The sprit should pass through a tape pocket to insure a flat surface when reduced.

The Roller Mizzen.—Mr. Tredwen has used a batten lug for a mizzen, which has an ingenious arrangement for reefing.

The boom is double, the upper part being fitted with a reel like a window-curtain roller. To this the halliard is fastened so that when the sail is hoisted the line is wound upon the roller. By pulling on one part of the line the sail may be wound down on the upper boom. The bight of the halliard is led forward through sheaves and kept taut by a strong india-rubber spring.

Stoddard and Mohican Sails.—The Stoddard and Mohican sails are simply balance lugs with the yard brought down to the forward end of the first batten, which transforms them into lateen sails when reefed. Fig. 96 represents the Mohican sail.

The following description of the Mohican sail will do for both: In shape the sail is an ordinary balance lug, cut off at the first reef, thus leaving a short luff. The sail is hoisted by a halliard, *d*, which is made fast to a brass ring, *a*, on the mast, thence leads through a snatch-block, *c*, on the yard, through a block, *b*, on the masthead down through a block, *m*, on deck, and returns through a block, *j*, ending in a brass hook. The downhaul, *e*, is fast to the batten *i*, and runs down through rings on the sail to brass ring *n*, lashed to the mast. The two reef-lines *ff* are double, one on each side of the sail, reeving through blocks on the

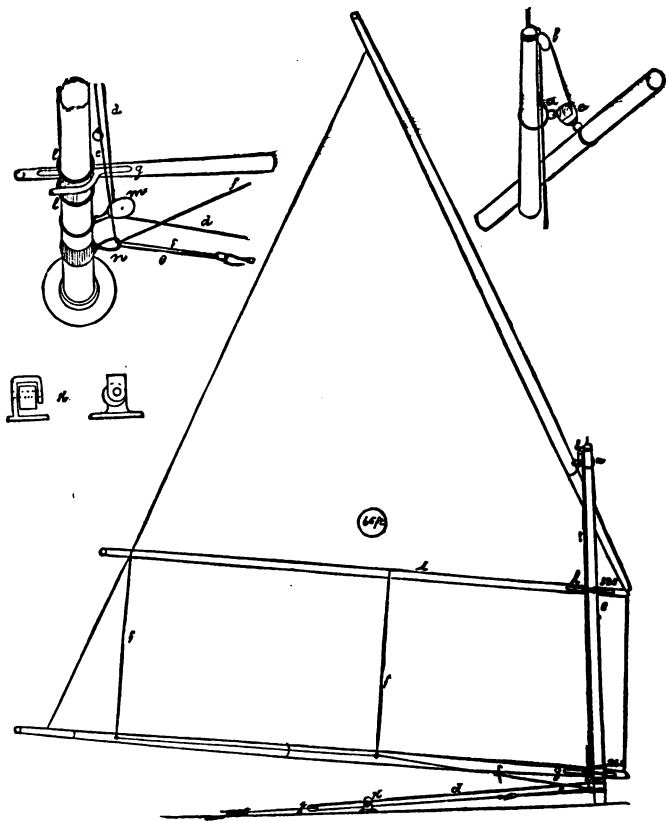

Fig. 96.

boom, and uniting in a single line, which is also part of *e*, so that the three lines from batten to boom at middle, fore, and after ends really run through *n* as a single line, the small ring in the bight into which the halliard hooks serving to equalize the strain.

The boom is held to the mast by a brass jaw, *g*, above and below which are leather collars which prevent the boom rising or falling, and render a tack-line unnecessary. A parrel or a jaw may be used on the batten. The tension on the halliard and reef-lines is obtained by the line on block *j*, by which all are hauled taut.

To set the sail the jaws are placed around the mast (*g* being between the collars), the bight of the halliard next to the ring is slipped into the snatch-block *c*, the downhaul and reef-lines *e f* are passed through the ring *n*, and the end of the halliard hooked into the ring. Next the block *j* is drawn aft and its line belayed, putting a tension on the halliard and downhaul. The sail is now ready to hoist. The halliard with block *m* always remains on the mast; in stowing the latter the block *j* is cast off, leaving the halliard free. To take in a reef, that part of the halliard to which *e* and *f* are attached is hauled aft, thus slacking away the other part and at the same time taking in the reef neatly, with no ends to attend to. It is found in practice that the halliard will slip a little, letting the sail down. To prevent this a little brass cam-clutch, *k*, is screwed to the deck, the halliard *d* being slipped into it. The roller will jam the cord as it pulls forward, but a pull aft will instantly release it. The end of this line is fast at the tack, it is then rove through rings on the sail, and the other end made fast on the leech; the slack is taken in by hooking the cord over a screw-eye, *e*, on the boom forward, and another aft.

The dimensions of the sail shown are as follows: Head, 10 ft.; foot, 9 ft. 6 in.; leech, 12 ft. 6 in.; luff, 3 ft.; tack to peak, 12 ft. 6 in.; clew to throat, 9 ft. 10 in.; area, 65 ft.; reefed, 38½ ft.

The Dot Reefing Gear.—Three holes are made through sail

and batten, 1, 2, 3, Fig. 97. Thimbles are lashed on the boom at 4, 5, 6, directly under 1, 2, 3, or cheek-blocks on the boom may be used.

A line is led through the thimble 4, passes up on the left side of the sail to the batten, through the hole and down the right side of the sail to the boom, thence through the same thimble. The line, passing thus down each side of the sail, Reeves double through the thimble from forward aft. Both

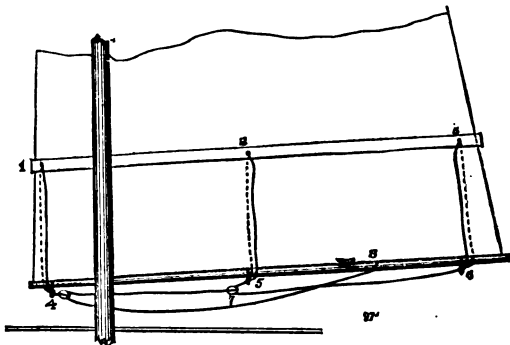

Fig. 97.

lines are cut about four inches from the thimble and secured to a block.

Another line passes through the thimble at 6, entering from forward, passes up the left side of the sail to 3, through the hole, down the right side of the sail, and back through the thimble. The end is then lashed to the standing part forming a loop, which includes within it the batten, boom, and cloth between 3 and 6. This line continues along the boom to the forward end of the thimble at 5. It is left a trifle slack between 5 and 6, and before entering the thimble it is run through a

block 7, which is left free to play along it. Passing through the thimble from forward aft, it leads up the sail to 2, through the hole and down the other side of the sail to after end of thimble, through it, and passes a couple inches beyond; it is here cut, and the end lashed to the main part of the line as before; forming another loop about batten, boom, and cloth between 2 and 5.

A line secured to block 7 leads forward and through the block at 4, after which it passes clear of all to the point 8 on the boom, where it makes fast. A cleat is fast to the boom near 8 to which the reef-line secures when the reef is hauled down.

Slacking the halliard and hauling on the reef-line brings batten and boom together, and the cloth is also gathered in by the loops.

By shifting this rig "end for end" 1, and 4 where 3 and 6 now are, and adding a block on the boom by the mast, and one at the foot of the mast, the reef-line can be carried down and along the deck.

The reef-line for the mizzen must come at least as far forward as the tack, so as to be within easy reach of the skipper. Two loops only need be fitted to the mizzen.

The Standing Lug.—The accompanying illustration, Fig. 98, represents a standing lug fitted with battens, having a maximum length of 7 ft. 6 in., which would suit a canoe able to stow 8-foot spars.

The dimensions are as follows:

	Feet.	Inches.
Luff	4	0
Head	7	6
Foot	7	6
Length on lower batten	7	4
On second and third battens.....	6	9
Hoist	6	4
Yard (slung from weather earing).....	3	0
Clew to peak.....	11	2
Area	47	sq. ft.

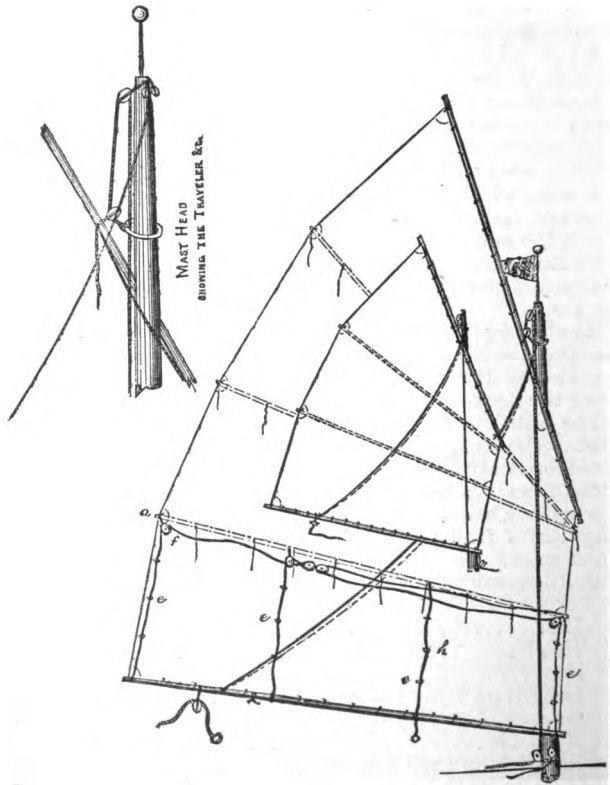

Fig. 98.

The following gear is required for this sail : Sheet, halliard, tack, topping-lift, reefing gear, hand reef-line, jackstay, downhaul, etc., and for the mizzen the same, less one reef-line and perhaps downhaul. The halliard should be fast to hollow brass-traveller on the mast. The halliard then passes through a block at masthead, and a cheek-block on the side of mast-foot and aft to haul.

The sketch shows this and the masthead arrangements. The halliard-block should be fixed aloft by a wire strop round the masthead, kept from slipping down by a chock on the fore side. A brass screw-eye above the strop keeps it from falling off when the mast is stowed away.

The tack should be toggled to the boom near the fore end, and lead aft through a block. The topping-lifts are toggled to the boom, lead through two small blocks at the masthead, and down and aft like the halliard. The sail is here shown with the *Nautilus* reefing gear, which has already been described. The downhaul secures to the sling of the yard, and leads through a block on deck two feet abaft mast.

The "jackstay" leads from the masthead to the boom, and keeps the latter from falling on deck when the sail is lowered. It may be led under the boom and made fast to the mast a few inches higher. There should be two rings on it, through one of which the tack is led ; this prevents the jackstay from getting over the end of the boom. The two rings are seized together in a figure-of-eight.

Another plan is to have a ring, like the traveller, round the lower part of the mast, prevented from slipping by chocks. To this the jackstay is fastened, and the tack rove through a thimble seized to the ring.

Thus rigged, the sail can be taken off the mast from aft and replaced with equal ease.

The Batswing Sliding Gunter, Fig. 99.—This is a pretty rig, but cannot be readily taken off the mast. It consists of an ordinary sliding-gunter mast and topmast, carrying a sail containing nearly one-quarter more area than a triangle of the same

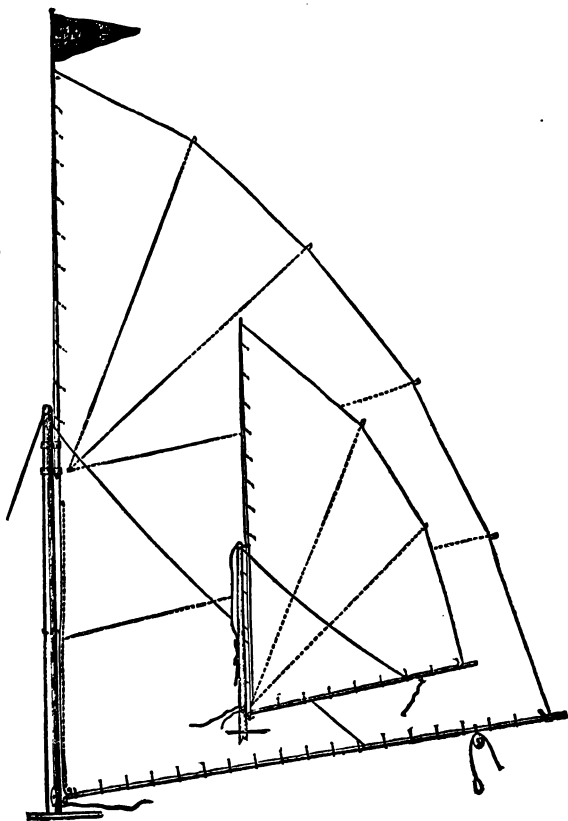

Fig. 99.

height and base. There is a batten at each reef of which there may be two or three, and one or more battens in the head dividing the leech equally.

A downhaul should be fitted to the gunter-brass and another

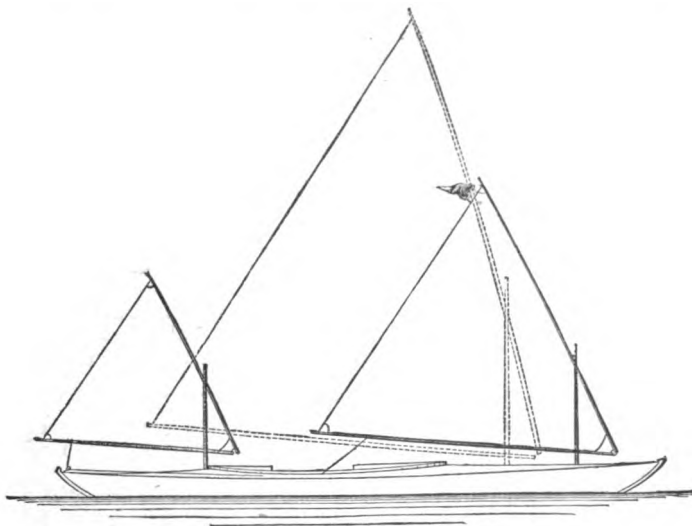

Fig. 100.

to each reef ; or patent reefing-gear may be fitted if preferred. When the topmast has been lowered, the boom may be topped up to the mast, which for light airs is a sufficiently snug method, but in stronger winds something further is required.

When lowered, the masthead will fall right in front of the canoeist, and, by taking off the collar which holds forestay, the

mast can be drawn aft and stowed below, leaving nothing on deck but the stay; and it can be stepped again with equal ease. The heel of mast must be made to pull out of the tabernacle when down. In the illustration, Fig. 99, the rig is shown with two reefs, besides which a balance reef may be made by lacing the third batten to the boom. The dimensions for a fifteen-foot canoe are: Mainmast above deck, 5 ft. 8 in.; including topmast, 10 ft. 9 in.; mainsail luff, 10 ft. 6 in.; foot, 6 ft. 9 in.; clew to peak, 12 ft. 6 in.; mizzen luff, 5 ft. 6 in.; foot, 3 ft. 9 in.; clew to peak, 6 ft. 3 in.; area of mainsail, 44 sq. ft.; area of mizzen, $11\frac{1}{4}$ sq. ft.; total area, $55\frac{1}{4}$ sq. ft. First reef, $14\frac{1}{4}$ sq. ft.; second, $12\frac{1}{4}$; area of close-reefed sail, 17 sq. ft.

This rig would hardly suit very large areas, or be good for racing against lugs, but for all round work in light and narrow canoes seems to be easy-working, safe, and light.

Lateen Sails.—The lateen rigs have the advantage of a short mast, low centre of effort, and simple gear. A halliard, sheet, and topping-lift are all the strings necessary. A tack may be added, or the boom may be held to the mast by a crutch.

In the Cincinnati lateen the yard peaks up almost into the position of a topmast. It is in general use in the Cincinnati Canoe Club.

The cruising main-and-mizzen rig is shown in Fig. 100. The mainsail is sometimes carried alone, the mast being stepped in the second tube. For racing one large sail is in general use.

In this country the ordinary lateen yard is often hung to a spike or hook on the mast by means of a ring. The boom and yard are jointed together at the tack, and a crutch or jaw is fixed to the boom a short distance from the fore end. On setting the sail the yard is lifted until the ring can be hooked over the spike on the mast, then the boom is drawn back raising the yard, and the crutch is allowed to take round the mast, the operation being reversed in taking in sail.

Another method of slinging the yard is shown in Fig. 101. A halliard reeves through a sheave at the masthead and has a

hook in its end. The yard is hung to this hook, and a parrel, with toggle and eye, passes round the mast.

This plan enables the sail to be reefed from the foot, and keeps the yard to the mast.

General Oliver, of the Mohican C. C., has devised a method of reefing lateen sails, by which a triangular reef may be hauled in. The end of the reef-line is fast at the tack and reeves through rings on the sail, in a line with each other, to a point about one-fifth the distance up the leech, above the boom, where

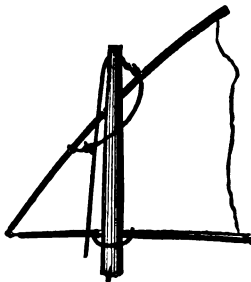

Fig. 101.

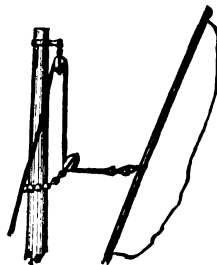

Fig. 102.

the end is made fast. The reef is taken in by hooking the line over screw-eyes on the boom.

The same gentleman has planned a sail intended to combine the short mast of the lateen with the short boom and facility in reefing of the balance lug.

Leg-of-Mutton Sails.—A simple rig for a canoe is the leg-of-mutton, consisting of two triangular sails, requiring only mast, boom, halliard, and sheet, and on a narrow boat, where but a small area can be carried, this rig will answer very well, but where a large spread is needed, the spars will be so long as to be unmanageable. For instance, to spread sixty square feet, with an

eight-foot boom, would require a mast sixteen feet above the deck.

A first-rate rig for a beginner consists of a main-and-mizzen, each resembling the mizzen shown with the sliding-gunter. No halliards are required, and the only gear consists of sheet and brail. A small triangular reef can be taken in each sail, and for stronger winds the mizzen may be shifted forward and a very small mizzen set.

To take off the sail, lower the mast and all. The mizzen is also fitted to lower into a crutch fitted for the purpose on deck.

A canoe fitted with this rig had sails of the following dimensions : Luff of mainsail, 7 ft. 9 in. ; foot of mainsail, 7 ft. 6 in. ; mizzen luff, 4 ft. 6 in. ; mizzen foot, 4 ft. 4½ in. The leech of both sails was well rounded.

An arrangement which is said to combine the advantages of the sliding-gunter and the handy single-halliard yard sail, requiring only a short mast, is shown in Fig. 102. As the sail is hoisted it is brought close to the mast, the traveller sliding up as the halliards are hauled upon.

HANDLING CANOES UNDER SAIL.

Position when Sailing.—English canoe-sailers generally take a reclining position, either when sailing on the wind or free. They depend mainly upon lead ballast, a weighted centreboard, and their own weight kept low down for stability.

In this country, however, stability is obtained when sailing near the wind, by the weight of the canoeist on deck to windward, and, except before the wind, the deck position is now taken almost universally for sailing in races.

To Make Sail.—If from paddling : Unjoint the paddle, keeping half on deck secured and ready for use.

Get the mast on deck, heel forward, and insert the heel into its tabernacle. Put over the forestay collar ; ship the flagstaff ; set up the stay, and the mast goes up.

Pass the halliards and lines through their screw-eyes, and turn a "figure-of-eight" knot in the end.

Next get up the sail; toggle on the tack, halliard, and topping-lift; haul it forward by the tack and halliard, guiding the sail between the mast and jackstay; secure the sheet, set taut the topping-lift, and hoist away.

The mizzen should be set first if head to wind. All of its gear should be kept on it except the sheet, which should remain on deck, the ends within easy reach of the hand.

Toggle the sheet and step the mast by hand.

If the mainsail stows with its mast follow the directions for setting up the mast and the sail will go up with it.

If from shore: Have the masts ready; shove off; run up the mizzen, belay the halliard, trim the sheet, and let the canoe swing head to wind.

Hoist the mainsail, getting the boom on the side on which the sail is to fill when under way.

Slack mizzen-sheet, and hold the main-boom to windward, to allow the bow to fall off to the course, when let the boom go over, trim the mainsail and mizzen to the course, and belay the mizzen-sheet.

Get on deck to windward, with the left hand on the tiller and the main-sheet in the right.

To Take in Sail.—To take in mast and all: Lower the sail; lower the mast almost down, and pass a line round mast, sail, and gear, so that all will be retained clear for resetting when desired.

Cast off the lines from the cleats and unreeve them from the screw-eyes.

Lower the mast down; unship the flagstaff and stay; draw the mast aft and stow it below.

For a gunter mainsail, top the boom up to the mast and proceed as for a lug.

To take in a lug mizzen: Lower the sail, slack the sheet, secure the topping-lift, etc., to the mast, unstep mast, untoggle the sheet, roll all up together and stow.

For a sprit-mizzen and similar sails, brail up, unstep the mast, and proceed as before mentioned.

Making and taking in sail may be done at anchor or under way, as may be most convenient.

To Shift Sails.—Take in one sail according to the foregoing directions and set the other.

Sometimes it is necessary to step a mizzen forward by stepping the mizzenmast in a step near the step for the mainmast.

Bend on a sheet, but do not unreeve the proper mizzen-sheet, and see the halliards, brails, etc., rove to lead aft.

Lower the mainsail and let her lie head to wind.

Shift mizzen smartly, and get the large mizzen forward and set it as mainsail.

The canoe, though lying close, will be going astern more or less rapidly, so the mizzen should be kept drawing as much as possible by putting the helm up.

To Reef.—With reefing gear: Top the boom up about a foot, slack the halliard, and haul upon the reef-line until the reef comes down. Secure the reef-line, set taut the halliard, ease the lifts, and the reef is in.

Without reefing gear: Luff up, top up the boom, slack the halliard, and haul down the reef-pendant. Tie the after points first, then the others.

Off the wind, if it blows too strong to haul in the boom, and it is inconvenient to luff up for tying the points, lower the sail nearly down, trim aft the sheet, and tie the points.

To Shake out Reefs.—Let go the reefing gear, reef-points, and pendant, and hoist the sail.

Sailing by the Wind.—American canoe-sailers generally sit on the weather deck in windward sailing, the feet being braced under the lee deck, the body leaning to windward, and the steering being done by means of a tiller.

A canoe should be so sparred and rigged that in a light breeze she will carry a very light weather helm, and, on the helm being eased, will come readily to the wind. If her weather helm is excessive after-sail must be reduced; if she

carries lee helm a larger mizzen, the mizzen farther aft, or less mainsail, is required. As the wind increases in force the canoe will carry more weather helm, which may be moderated by reefing the mizzen. As the battened sails will trim closer to the wind than a boat can advantageously sail, the shaking of the sail should not be relied upon as a guide to steering.

In light airs a well-rigged canoe will point within three points of the wind, but will make very little speed, and such a course would only be valuable for a short distance, as to clear an obstacle in racing, etc. If, in smooth water, a canoe makes good a course on one tack at right angles to that on the other she is doing well to windward. Every change in the force or direction of the wind should be taken advantage of, keeping away to a good full if the wind hauls ahead, and luffing carefully as it draws aft; luffing up also to puffs if necessary, to relieve the canoe, and shoot to windward, but observing always to keep good headway on her.

The sail area should always be kept down, by reefing, to a spread that can be easily carried, to the end that you may be able to hold your course as much as possible and sail steadily with a good full. In strong breezes no canoe should carry more sail than, in the true force of the wind, she can bear without forcing her gunwale under water. In luffing to squalls, the headway is so much deadened that it is sometimes well to ease the sheet a trifle, in preference to luffing too much.

If the canoe gets "knocked down," so that the sheet cannot be let go without the sail going into the water, there will be great difficulty in averting a capsize. The position on the weather coaming will then be very advantageous to assist the boat to right, and will also be a capital position if she upsets. From this position let go the main halliard, and top the boom up as much as possible.

It is under such circumstances as the foregoing that the advantages of the main-and-mizzen rig are conspicuous.

In a sudden squall, with the two-sail rig, the main-sheet can be "flown," and the mizzen will keep way on the canoe, and

help her to luff; the windage of the top-hamper forward being sufficient to keep her from getting into the wind.

For sailing among waves, the sail should be reefed down below what the canoe would safely carry in smooth water, and the boat should be luffed to the heavy seas. As soon as the sea is met, the helm must be put up, and the canoe allowed to gather way again, so that she will slide down the back of the wave, and be prepared for the next one. If you have been too late in preparing to meet a sea, and it is about to break on the bow, let fly the sheet and throw all your weight to windward.

Tacking.—Some canoes tack freely, especially those which are well ballasted and carry a good way in stays. Long canoes stay less rapidly and certainly than short ones, as they turn more slowly and their headway is exhausted before they get round.

In tacking a long light canoe, slack the mizzen-sheet when the canoe is head to wind; and as she falls off on the other tack, trim the mainsail flat, after which trim the mizzen to the course. Throwing the weight of the body forward and to leeward will also help a canoe to tack, shifting over as she passes the wind's eye.

With a handy canoe, all that is necessary is to get good way on her, with the mizzen well flattened in, under which conditions she will carry a good weather helm. Ease down the helm, and she will fly up into the wind, the helm being put harder over until she pays off.

Missing Stays.—If the canoe gets "in irons," *i. e.*, comes to the wind and refuses to pass the wind's eye, shove the main boom to windward, and slack the mizzen-sheet to get her round, shifting the helm if she gets sternway.

In working to windward with a favoring current, always tack in the strength of the current. In beating up-stream, on the contrary, endeavor to tack in the slack water, or in the eddy current near the bank.

In strong winds and rough water, under reduced sail, a canoe will not tack readily, and a "smooth" should be selected for

putting her about, and every endeavor made to help her round.

Reaching, or Sailing with a Beam Wind.—When reaching in squally weather, it is considered better to ease the sheet a trifle than to be continually luffing for the puffs. If the boom end threatens to go into the water, the sail must be reefed.

In lumpy water, sail as straight a course as possible, and the worst seas will seem to break before meeting you, or will pass a length or so astern. In case of an approaching sea that means mischief, luff to it in good time, or if the wind should be at all abaft the beam, keep her away before it.

Sailing among the sharp little waves formed by a fresh breeze in narrow waters is very wet work. As they are too small to be dealt with separately the best plan is to disregard them, and by battening down and putting on a water-proof coat to keep as dry as possible.

Handling a Spinnaker.—It is desirable that the canoeist should be able to set a spinnaker without leaving his seat, and it may be accomplished by the following plan :

The corners of the sail are fitted with swivels to avoid all twisting, and the halliards and tack may fasten with clip-hooks. When the sail is not set, the halliard hooks to the topping-lift thimble on the main boom and the other end leads through an eye-bolt on deck near the hand.

The tack leads through a thimble on the fore end of the boom, and both ends are made fast to an eye-bolt in the side-deck near the hand.

When the sail is rolled up, for stowing, the three corners are left out ready for bending the gear. For convenience of stowage the spinnaker-boom should be jointed. The outer end has a hook which travels out along the sheet to the corner of the sail as the sheet is hauled taut. The inner boom end is fitted with a boat-hook head, which hooks to a grommet attached to an eye on deck (Fig. 103).

If the mainsail should gybe over to the spinnaker, the inner end of the boom must be unhooked from its grommet, the sheet permitted to slip clear of the hook in the outer end,

passed round the mast by means of the boat-hook, and hauled in on the other side. The sheet is again slipped in the hook at the boom end, which is run forward until it reaches the corner of the sail. The boat-hook end is again looped to the deck and the sheet trimmed.

As the wind draws toward the beam, the spinnaker may be made to sit well by using a guy to the boom, led through an eye on the weather gunwale and aft to a cleat. When taut it acts as a "jumper" to keep the boom from lifting.

Running Before the Wind.—It is on this point of sailing that the value of the downhaul, topping-lifts, etc., is appreciated.

The boom should be well squared away when before the wind, and if there be any rolling it must be topped up a foot or more. The head of the sail should not be permitted to get forward of the mast.

If any tendency to bury the bow appears, sail should be promptly reduced.

When it is desired to gybe, haul the boom steadily in as the helm is put up, and ease it out steadily as the sail goes over, throwing the weight of the body to the other side. In a heavy breeze ease the halliards and haul the yard down by the close-reef line or the downhaul, gybe over, and hoist the sail. The boom should be well topped up before attempting to gybe under these circumstances.

In strong winds and rough water the mizzen should not be carried, but in moderate breezes it may be carried on the opposite side to the mainsail, which is termed "wing-and-wing." If it becomes necessary to take in sail, or to reef, when before the wind, with a rig in which topping-lifts, downhaul, reefing gear, etc., have been omitted, the canoe must be rounded to and brought to the wind, at considerable risk. With sails completely fitted with these important accessories, however,

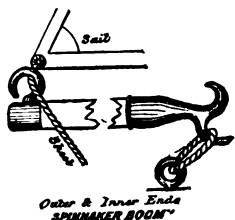

Fig. 103.

the boom may be topped, the sail lowered and hauled inboard, and stowed or reefed at leisure.

If caught in a heavy thunder-squall and a port cannot be made, take in all sail and stow it away below ; lower masts and lash the spars to the deck ; then paddle into the wind head on.

How to Manage when Capsized.—When a sailing canoe capsizes, immediately clamber over, instead of diving under her, and thus avoid the risk of getting “netted” by the loose gear.

Hang on athwart the boat's side ; let go main halliards, haul on downhaul, and get mainsail in to deck ; and, if necessary, the mizzen also. Cut away any foul gear.

When she rights get in and set the mizzen. Bale out and sail her.

Some kind of a life-buoy or belt is advisable. A large swimming-collar is a very convenient support, and may readily be carried on deck.

To board a canoe from swimming, crawl on to the after deck as far as possible forward of the mizzen-mast with your head aft. Turn on your back and get a hand on each coaming. Then lift your feet quickly but quietly into the well.

Another method is to unship the mizzen, get hold of the stern and push it between your legs ; creep forward till near the well, then sit up astride of the boat and lift your feet into the well.

Always carry a sponge and baler and have a knife in your belt to cut away any obnoxious gear.

Never bathe from a canoe under way without lowering the mainsail and so arranging matters that she cannot sail away from you.

Coast Sailing.—To make extended cruises along the sea-coast it is well to be something of a sailor as well as an expert canoeist.

Settled weather should always be selected for coasting, and the chart should be carefully studied before starting, to avoid too frequent recurrence to it while afloat.

Local information as to tides, etc., should be carefully utilized, and combined with that in the tide-tables.

Courses should be judiciously shaped according to the prevailing winds, and so as to have a refuge to leeward whenever possible.

A good compass should be on board, as a matter of course, and should be hung in gimbals.

A light lead and few fathoms of line wound on a stick should likewise be a part of the equipment.

A small aneroid barometer should also be carried.

Coasting demands a strong canoe snugly rigged with good fittings, and tough keel and bilge-pieces.

In navigable waters, a lamp, preferably with red and green lights, should always be carried at night.

Always give steamers a wide berth, considering not only the danger of being run down, but that it is unreasonable for pleasure craft to interfere with important traffic.

To Come to Anchor.—The painter should lead through a hole in the stem, and both the ends come aft, a large thimble being turned into one of them. The cable must be passed through the thimble, a couple of fathoms overhauled, and the end bent to the ring of the anchor. The painter should now be hauled on, until the thimble runs out to the bow, and then be made fast. Drop the anchor over the side and haul on the cable, to get it under the bows.

Luff up head to wind, and, as soon as she loses headway and begins to go astern, ease down the anchor and veer to about four times as much cable as there is depth of water.

If there be any current lower the sails before anchoring.

Weighing the Anchor.—Make all preparations, heave short, and set the sails, if the tide will permit; then heave up the anchor to the bow. Ease the painter and the anchor will readily come on board amidships. Wash the "ground tackle" and put everything to rights. If on bad holding ground, the anchor should be backed with some weight a few feet above it on the cable.

Where there is any danger of the anchor becoming hooked under rocks or moorings, the cable should be secured to the crown of the anchor, and stopped to the ring with a light seizing. In case of the anchor catching, a strong heave will part the seizing, and the anchor may be readily broken out.

Whenever practicable it will be better to secure to moorings than to anchor. Keep head to the tide in grappling the buoy, and get hold of the mooring line, which may be secured to the painter and hauled to the bow.

To run alongside a float: Steer a little to leeward of it, and luff up into the wind just as you come abreast it, allowing the canoe to run up to windward till headway is about gone before coming alongside. If doubtful about being able to make a good landing, luff up a short distance out in the stream, drop the mainsail, and paddle in.

To Beach a Canoe.—This operation is very easy in smooth water, but if the water is rough, it requires considerable skill.

Get the centreboard well up. Take in all sail, trice up the rudder, and take off hatch and cover.

If there be assistance at hand, a couple of men may catch the fore end of the well, and another hand take hold of the painter, and run her up, with her skipper in her, all safe and dry.

If alone, you must get wet in beaching the canoe. On a shelving beach, jump out with the painter, when the water shoals to a couple of feet, and haul her along. In case of a steep beach, jump out just before she can touch, choosing a rising wave to put her on the beach. Get ashore and haul up the canoe smartly.

To Get off a Beach.—Get a couple of men to launch the canoe carefully with you on board, and well battened down, paddle through the surf and then make sail. In moderately smooth water, on a favorable beach, one can easily get off alone, wading beside the boat to a couple of feet of water, and jumping in.

Remarks on the Handling of Canoes.—There are a few maxims on which the handling of a canoe in a seaway is founded,

and being very short and simple they can easily be called to mind.

Unless in a well-ballasted sailing canoe, never keep sail on when the seas begin to break and come on board.

Never allow the canoe to be broadside on to the seas even for a moment, unless it be absolutely necessary, as in the act of turning.

To work safely through really heavy water a zigzag course *must* be steered; the seas should be dodged as much as possible; but when it becomes necessary to "take" a sea, put her at it end on, or nearly so, with plenty of way; then, as soon as the crest is passed, let her glide sidewise down the back of it.

When about to reef in rough water, do not put the canoe head on to the seas, but keep some way on her; lower away the halliards, haul the boom in, and reef the mainsail, then shift the mizzen, and so be prepared to shift the mainsail if necessary.

When running before a sea, remove the backboard and assume a reclining position, haul down the mizzen, and as breakers approach check headway by back strokes of the paddle to prevent over-ending or broaching-to. If she runs her bows under a sea, let go the halliards at once, and allow the bows to lift again.

In running for shore, before getting into the breakers, turn the canoe head to sea, and back in during the smooths, paddling ahead to meet each heavy breaking sea.

The paddle should always be ready for use in a seaway.

Never go to sea, even for an hour's sail, without a compass.

Before going on an extended cruise carefully test all fittings and gear.

Have a life-belt on whenever there is risk of an upset.

VARIOUS CANOE FITTINGS.

Mast-Tabernacles, and Trunks.—As the bow of a canoe is frequently immersed when working in rough water, it is desirable not to have any opening in the deck.

The tabernacle for lowering the mast may be fitted as follows (Fig. 104): Two pieces of oak, *c*, are secured at the heels by a block, (G), and pass up through a blocking piece, *a*, and through the deck, *b*. The heads of the oak pieces are each $3\frac{1}{2}$ in. high by $2\frac{1}{2}$ in. wide, fore and aft, and half an inch thick, the heels being tapered down.

A blocking-piece, (*c'*), is bolted between the uprights, and let through the deck and deck-block, and against this the mast-heel lodges. The mast-heel should be an inch and three-quarters square, from heel to half an inch above the tabernacle; then rounded and tapered to one inch at head.

The mast bolts between the heads at *d*, and at *e* is a bolt to which the halliard-block hooks.

The mast-heel and sides of tabernacle-heads should be brass-plated, and a small piece of rubber should be screwed to the heel as a buffer, *g*.

The mast is set up with a wire forestay, from the swivel-clip at the thimble at masthead down to a single block, which, when the mast is on end, comes about four inches above the stem-head. The fall secures to stem-head and reeves through the block, and then through a cheek-sheave at stem and to a cleat near the well.

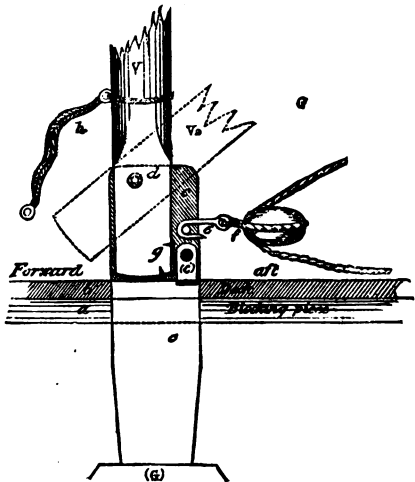

Fig. 104.

The mast may be fitted with a ferrule-joint four feet six inches above the tabernacle pin, and if the upper portion be four feet long, including a six-inch ferrule to ship over lower mast, the mast will have a length of eight feet six inches, pin to truck.

The gear excepting the forestay remains on the masthead,

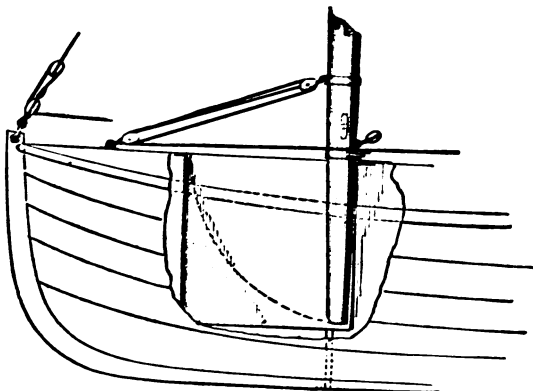

Fig. 105.

and the sail is kept on the upper mast with its halliards and parrels bent on.

Mr. Tredwen has two modes of fitting a lowering mast, one of which has a trunk, as shown by Fig. 105, in which the mast is stepped. The trunk is lined with copper to prevent water getting into the canoe, and a drain-pipe through the keel empties water from the trunk. The mast has a brass ferrule, at the level of the deck, to the after side of which is secured a cross-bar on which the mast pivots when raised or

lowered. The cross-bar turns in two hooks, or crutches, screwed to the deck. The mast can be raised and held in position either by a forestay leading to the stem-head, or by a tackle.

The Pearl of 1882 has been fitted with another contrivance, which is shown in Fig. 106. The length fore and aft is about 17 in., depth 1 ft., and breadth $2\frac{1}{2}$ in., at the deck, tapering to 2 in. at the bottom. The case is lined with copper, and a drain-pipe runs off any water.

A piece of wood about two inches shorter than the tabernacle, dropped into it, serves as a chock to keep the heel of the mast forward, and the mast is raised by a tackle hooked on to an eye, on a ferrule about six inches above the deck. The fore part of the mast-heel is rounded away,

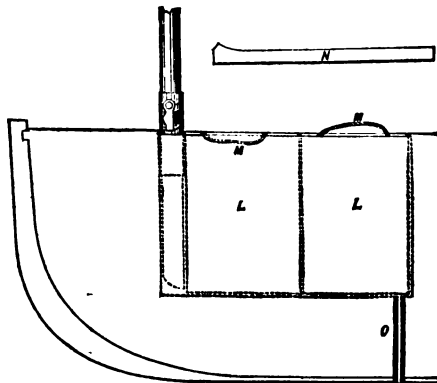

Fig. 106.

so that, as the mast is hauled up by the tackle, the heel can slide down the fore end of the tabernacle in front of the wooden chock lying at the bottom, N.

When it is desired to step the mast at the after end of the tabernacle the wooden chock is not required. The mast then pivots on the cross-bar, which is held by the crutches screwed to the deck at the after end of the tabernacle. The mast may be stepped in any part of the tabernacle by means of two light wooden boxes made to fit into and fill the spaces on the fore

side and the after side of the mast. When the mast is not required to be lowered, the hoisting-tackle and chock are unnecessary, and the mast may be lowered by lifting out the boxes and handing it down.

Steering Gear.—There are so many ways of fitting the foot-steering gear that it would only be confusing to consider each kind.

In some cases the yoke-lines are led direct to a foot-yoke, and in others to a deck-yoke which is connected to the foot-yoke.

In the deck-yoke plan, as fitted by Mr. Baden Powell, the rudder-yoke fits over the rudder-head and has an eye in each end. The foot-yoke, about sixteen inches wide, is made strong enough to serve as a stretcher for the feet. A steel rod, enclosed in a brass tube, has its heel stepped in a block on the top of the centreboard case, the upper end passing up through a hole in the deck; a brass shoulder, with a squaring of one and a half inch above it, is soldered to the rod, and to this the foot-yoke is clamped. It should be at such distance from the lower end of the rod as will bring the foot-yoke about eight inches above the surface on which the man's heels are to rest. The head of the rod should project an inch and a half above the deck. At a quarter of an inch above the deck the rod is squared to receive the deck-yoke, and the last half-inch of the rod is formed into a screw on which a thumb-nut is screwed as a fore-lock.

The deck-yoke is of metal, about eighteen inches long, and has an eye in each end.

The yoke lines are of brass or copper wire, and fitted as follows:

Having fitted a brass thimble into each of the eyes of the rudder and deck-yokes, pass the ends of the two wires round the thimbles in the rudder-yoke, and secure them; then at the forward ends fit in a similar manner to two thimbles, making the wires of the proper length to bring these two thimbles about one foot from the eyes of the deck-yoke. A small line is

secured to each of the forward ends of the wire, and rove through the yoke thimbles and the wire thimbles, say three turns, which completes the steering-gear.

In the case of the foot-yoke only, the wires are fitted in much the same way, but before being fitted at the forward end they must be passed through coaming and bulkhead to get a fair lead to the foot-yoke.

In this country, where the canoe-sailer is often seated on the deck, the foot-gear is out of reach. To steer from the deck a tiller is used, which is attached to a yoke pivoted on the deck just abaft the hatch, and within easy reach of the hand. Two short lines connect the deck and rudder-yokes.

The steering gear should frequently be examined, the parts oiled, and all parts kept in perfect working order.

Mr. W. P. Stephens, in his valuable work, "Canoe and Boat Sailing," gives descriptions of several of the foot-steering gears which have been tried in this country.

Centreboards.—In the great majority of the canoes used in America sailing qualities are considered as of more importance than paddling, and therefore a fixed keel, or a centreboard, or both, become necessary to obtain the required lateral resistance.

In England the double centreboard is in general use, and many advantages are claimed for it, but it does not seem to have found much favor here.

On the position, form, and area of the centreboard, or boards, and rudder depends to a great extent the successful sailing of the canoe.

The position of the sails in a canoe does not admit of much variation. The centre of effort of the main-and-mizzen rig, which has almost superseded all others, will be ordinarily at mid-length, or a few inches abaft it; then the canoe being of light draught, the rudder, to be effective, must have a good area, and this carries the centre of lateral resistance somewhat aft; therefore, to bring this centre forward and near to the centre of effort of the sails, the centreboard must be placed slightly forward of mid-length.

As to area, two square feet has been found amply sufficient, even in racing; and whether this area is given in one large board or two small ones is immaterial as far as counteracting leeway is concerned, but in relation to turning and manœuvring there is something to be said on both sides.

The single board appears to be the best by the wind, and the double board seems to have the advantage off the wind, and is undoubtedly a very powerful aid in manœuvring when skilfully handled. The experienced canoe-sailer will use the two boards, by alternate lifting and dropping, when near the wind, in conjunction with his rudder; in fact, the working of the boards will be attended to with as much care as the working of the sheets. The facility of shifting the centre of lateral resistance forward or aft of the centre of effort of the sails places within his grasp a power of turning quickly which is of prime importance in racing.

If any accident occurs to the mizzen, the after board may be hauled up and the canoe will be handy under the mainsail; and if caught in a squall the canoe may be laid-to under mizzen and fore board.

When sailing close-hauled, if the after board be raised the canoe will fly to at once, which can be augmented by easing main-sheet and pulling helm down; and for quick bearing away the fore board may be lifted, the mizzen eased, and the helm put up.

The single board requires less attention, and when on a wind need not be touched, except for shoal-water.

Fan centreboards, which collapse into a case which does not come above the floor-boards, have come into use for canoes, and much of the internal space formerly occupied by the case is saved for other purposes.

When two centreboards are fitted, the after one may be of zinc or copper, one-eighth inch thick, and from fifteen to eighteen inches long.

The heavy forward board is usually of plate-iron, or Muntz metal, from a quarter to half an inch thick, and ranges in weight

up to about sixty pounds. Boards as heavy as sixty-eight pounds are sometimes carried for racing.

Single boards may be of galvanized iron plate, or composition, from three-eighths to five-eighths inch in thickness.

A special form of board has a framework of wrought iron, with sides of sheet iron, and a space inside for inserting a plate of lead. By this device a light or heavy board may be had.

Canoe boards are often fitted to lift out.

Light boards are raised and lowered by a single line of braided cord, and for the heavier boards a purchase is used. The board is generally housed when running free, and dropped for windward sailing. It is sometimes lowered part way when running free in a seaway, to steady the canoe.

Rudders.—In rough water, the stern of the canoe sometimes rises, and it is therefore well to have a rudder so planned as to drop well down, and so have a hold on the water even when the canoe is pitching among waves.

It should be hung on a rod and have sufficient play to rise and avoid damage in shoal-water.

A rudder of sheet brass, in two parts, in which the drop may be regulated, has lately come into use.

Aprons.—In rainy weather, or a seaway, it is necessary to cover the well entirely, either by hatches, or by an apron fitting closely around the body.

A form of apron well adapted to the pointed coamings is a cover of water-proof cloth, cut to the shape of the coaming, and turned down at the edges, to button over screw-heads in the latter, near the deck. It extends aft about six inches over the deck behind the back. A hole is cut for the canoeist, and around the edge a piece six inches wide is stitched, so as to be drawn around the body. The piece is long enough to lap and button at one side. The part of the apron around the body is held down by a cord made fast to screw-eyes on the deck. A light shifting beam forward of the body keeps the apron arched so as to shed water.

The material is stout muslin, which is made up, stretched,

dampened with water, and coated with a mixture of three parts boiled oil, six parts raw oil, and one part turpentine; put on very thin. A second coat is given when the first is dry.

Coat.—To complete the outfit a water-proof coat is necessary, opening about eight inches at the top, the sleeves being gathered in at the wrists with elastic.

The coat should have a flounce outside, just under the arms and long enough to fasten over the coamings, or hinged pieces of the deck side-flaps, if the latter are used, the coat being sufficiently full to admit of opening them inside it.

Deck Side-flap.—In mentioning the fittings of sailing canoes the deck side-flap, which is a great favorite in England, must not be omitted. This is to allow the canoeist to sit up to windward, and should be easy to open and shut, and yet be water-tight.

The flap being just abreast the body, the hands are often placed heavily upon it in getting into or out of the canoe; which demands good supports under the main deck.

Miscellaneous Outfit.—Among the articles comprised in the equipment of cruising canoes may be mentioned the following: Camp axe, compass, hunting-knife, stove and cuisine, charts, lantern, pail, provisions, water in breaker, toilet necessaries, medicines, fishing lines, blankets, tent, and changes of clothing.

Pumping and Baling Gear.—For river or lake work a sponge and baler may be sufficient, but for sea cruising an effective pump should be fitted.

It should be of small size and very light weight, and if possible capable of pumping at both bilge and keelson.

Both hull and gear should always be kept ship-shape. No rope's ends should be flying about, no unsightly temporary hitches in the rigging, but neat splices properly tapered and served.

Section 6.

THE CUTTER AND SLOOP RIGS.

THE CUTTERS DAISY, CARMITA, AND MIGNONETTE.

THE CENTREBOARD SLOOP GLEAM, AND THE KEEL SLOOP ALICE.

WINDERMERE AND NORFOLK SLOOPS.

THE RUDIMENTS OF CUTTER AND SLOOP SAILING.

THE YAWL AND DANDY.

QUESTIONS IN FORE-AND-AFT SEAMANSHIP.

NAVY BOATS.

RIGS FOR NAVY BOATS.

HANDLING MAN-OF-WAR BOATS UNDER SAIL.

MANAGEMENT OF NAVY BOATS UNDER OARS.

BOARDING A WRECK OR VESSEL IN A HEAVY SEA.

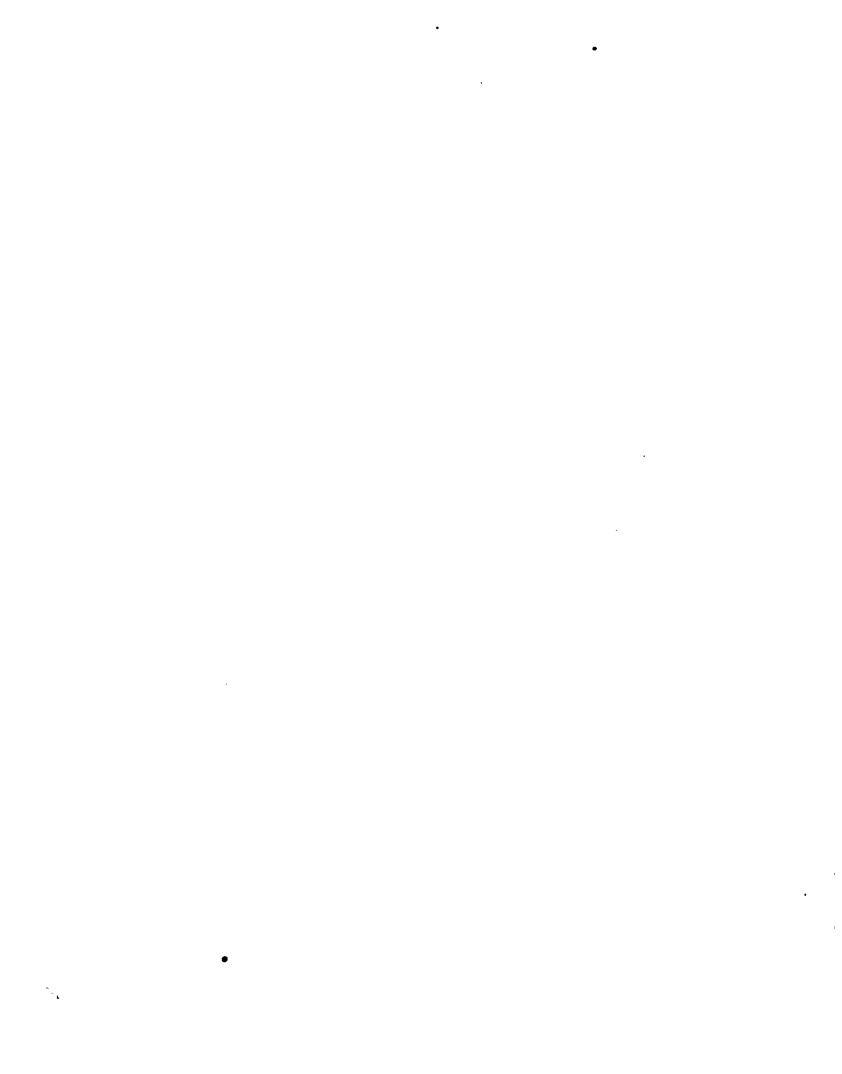

THE CUTTER AND SLOOP RIGS.

THE cutter is, perhaps, taking all points into consideration, the best rig for sea-going yachts up to a certain tonnage. The rigging is somewhat more complicated than that of a sloop, but every inch of rope has its practical use, and the management of a smart cutter may well be likened to riding to hounds, being very easy to do when experience has shown you the way.

The bowsprit of the cutter is usually fitted to "reef," or run in, and is arranged for fidding at various lengths.

The bobstay in cutters is generally set up so as to be readily adjusted for changes in the length of the bowsprit, while those in sloops are often fixed bars, set up with turnbuckles.

From the masthead on each side are *runners* and *pendants* which also set up by means of tackles. These act as backstays to the mast, and are often convenient for other purposes.*

The topmast is generally arranged to lower and hoist, and works through two caps, or bands, on the foreside of the masthead. It hoists by means of a rope working over a sheave in the masthead,† and when up is secured by a fid. The topmast stay leads from the topmast head to the bowsprit end.

The shrouds at each side are given more spread by iron outriggers, called cross-trees, projecting from the masthead on either side. The topmast has also a preventer backstay on each side, which leads aft, and when in use the weather one is kept hooked and set taut.

The topmast rigging is generally cut short, and has thimbles spliced in the ends, to which the tackles for setting up may be hooked. When the topmast is sent aloft, short lengths of rope fitted with clip-hooks are added, in order to give the necessary length.

* Small cutters and sloops frequently have standing or pole topmasts.

† If the sheave in the masthead over which the tie runs, for hoisting the topmast, be cut quartering, or midway between the fore-and-aft and athwartship diameters, the rope then leading from the heel of the topmast to the fore quarter of the masthead, and the fall coming out on the after quarter, it will have a lead clear of all eye-bolts and blocks.

The boom may have either a gooseneck fitting or jaws, as preferred. It has a topping-lift leading from the boom end through a block at the masthead and down on deck, where a tackle may be attached for topping up. In large cutters there is a topping-lift each side, and the lee one is carried slack.

The gaff has jaws and a parrel. The main halliards pass through a double block at the masthead and a double or a single one at the throat of the gaff, and belay to the mast bits or cleats.

The standing part of the peak halliard is fast at the masthead and leads through two blocks on the gaff, and two on the mast-head.

A peak line reeves through a small block on the gaff and serves to hoist the ensign.

The mainsail hauls out to the boom end by an outhaul; the tack is set up by a gun-tackle purchase; the head of the sail is laced to the gaff; and the luff is seized to the mast hoops.

The foresail is attached to hanks or rings travelling on the forestay.

The *tack tricing-line* is fast to the masthead, passes through a block on the tack of the sail, up through a block on the mast, and down on deck.

In some modern cutters, there is neither tack tackle, nor tricing tackle. The tack is lashed or shackled and the foot of the sail is laced to the boom.

The topsail is laced to a yard, to which the halliard is bent at a point determined by experiment. Its tack-line leads down the mast, and the sheet reeves through a block at the gaff end and another at the throat. A jib-headed, or working topsail has no yard, the head going to a peak.

Cutter yachts usually carry several jibs, of different sizes, which can be shifted to suit the weather (see Fig. 107).

The smallest, or storm-jib, is termed the "spitfire."

Small racing cutters are generally fitted with three backstays on each side, two of which are led athwartships (one lodged into a cleat or ram's-horn at the after side of the cross-tree) and

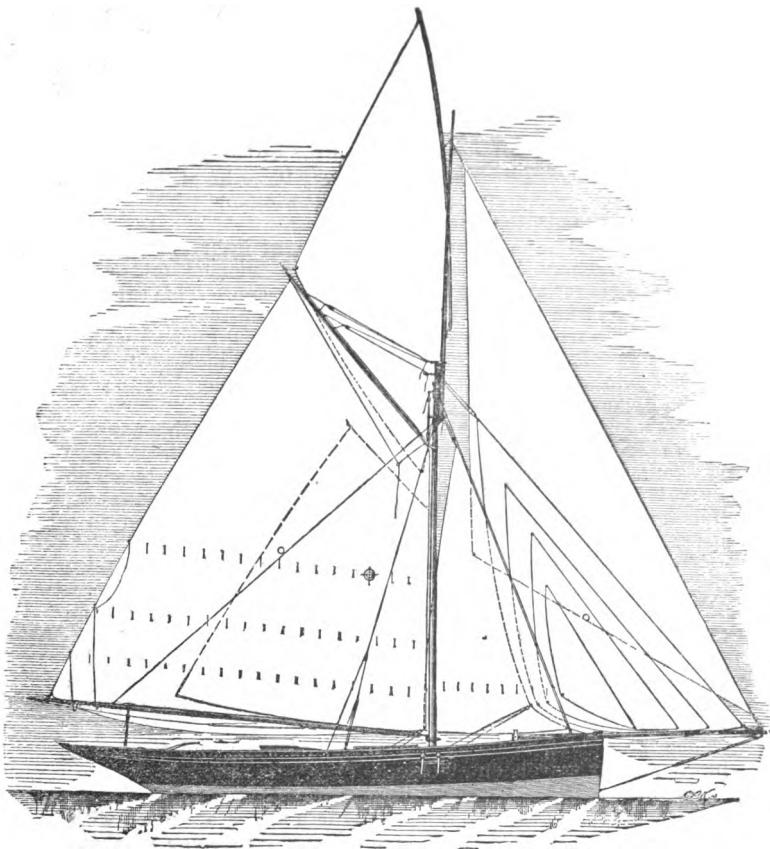

Fig. 107.

the third kept secured to an eye-bolt in the channel when not in use, but led aft and set up to an eye-bolt, about opposite the rudder-head, when the boat is running with the wind aft or nearly so. All backstays and the fore-and-aft stay set up with tackles.

The extra backstay may be omitted for cruising rigs.

Balloon Sails.—*The balloon jib* is a very large jib of light material, used only when going free, in light winds.

It often extends abaft the main rigging.

The spinnaker is a large triangular sail, of light material, set from the topmast head to the deck, and boomed out on the windward side when the wind is abaft the beam. This sail may also be used as a balloon jib in light beam winds.

Balloon Topsail.—A jack-yard is now invariably used with a balloon topsail, which is generally given a very high peak.

A balloon foresail and a balloon jib-topsail complete the list of the balloon canvas in general use.

The sloop rig has always been a great favorite in this country for small yachts. In its usual form the rig consists of a gaff mainsail, having generally a short gaff and long boom, to which the sail is laced; a jib extending to the end of a fixed bowsprit, hoisting on a stay, and sometimes having its foot laced to a boom, and a topsail.

The mast is stepped somewhat nearer the stem than the mast in the cutter.

The boom end fits into a gooseneck joint at the mast, and the gaff has jaws and a parrel.

The sail being laced to the boom, and kept to the mast by hoops, the topping-lift may be used to get the sail as flat as possible by easing it after the sail is set, and allowing the sail to have the weight of the boom.

The main-sheet is fitted in a variety of ways, and the lower block usually travels on a horse.

Balloon canvas is carried in light weather.

For handiness in cruising many modern sloops are fitted with two head-sails, a fore-staysail and a jib, and in some of them the jib hauls out on the boom by a traveller.

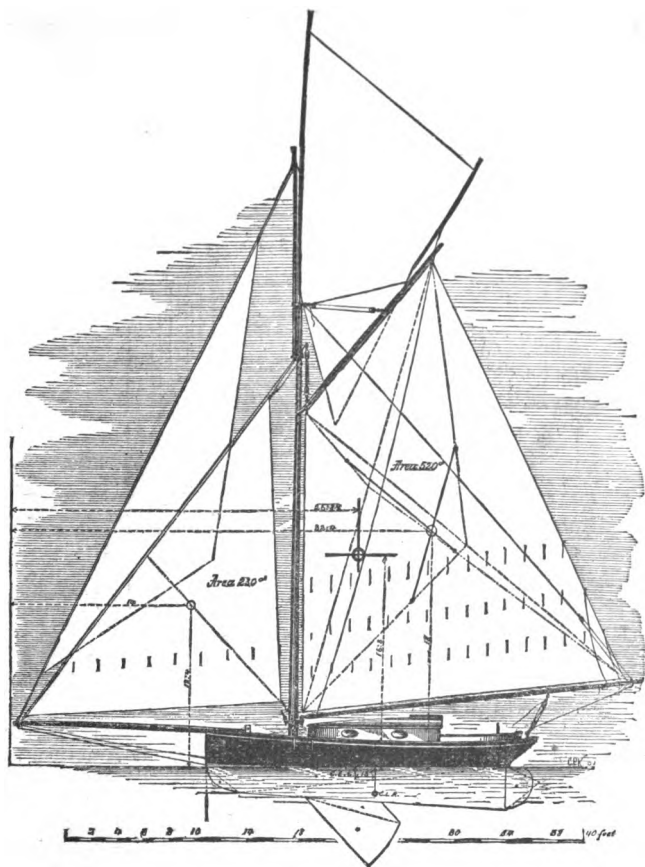

9*

Fig. 108.

Many other peculiarities of the cutter rig have been adopted, until there is very little difference in rig between some of the latest American sloops and the English cutters, although the difference in model is very marked.

The impression that lacing sails to booms enables greater

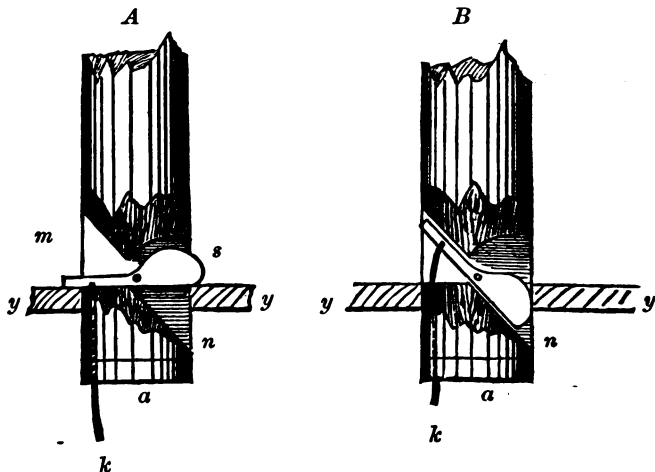

Fig. 109.

flatness to be obtained has been almost universal in this country, since the historic victories of the yacht *America*, at Cowes, in the year 1851.

While the superior cut and fit of her sails had, perhaps, considerable to do with their flat set, the lacing has, however, since been adopted on this side of the Atlantic, as absolutely necessary to having the proper flatness of the canvas.

As trials abroad failed to fully sustain the superiority claimed, a return to the method of hauling out to the boom end succeeded, and by improving the cut of the sails, they are now made to set very flat without lacing.

The latter plan has some advantages for sea-cruising, as the tack may be readily triced up, or the mainsail scandalized; but the boom must be somewhat heavier in proportion than that for the laced sail, to prevent buckling.

Various plans have been devised for fidding and unfidding topmasts without going aloft, and the "tumbler" plan, in one form or another, has been in fashion for some time.

The most approved plan of self-unfidding topmast is shown by Fig. 109. a is the topmast, y the yoke, s is an iron tumbler fid, pivoted by a bolt shown above a ; m and n are slots cut in the topmast, k is a line attached to the fid and passed up through a hole in the heel of the topmast.

To unfid, hoist on the tie or mast-rope until the tumbler falls into the slot n , then lower away.

To fid, hoist the topmast until the slot n is above the yoke. Then haul on the line k until the fid is in the horizontal position and lower until it takes the weight of the mast.

PARTICULARS OF THE CUTTER DAISY.

THE Daisy was built by Fay & Co., of Southampton, England.

Length over all.....	32 ft.
" on load line.....	25. ft
Beam, water line.....	8 ft. 6 in.
Draught, greatest.....	5 ft. 9 in.
Freeboard, least.....	2 ft.
Displacement, long tons.....	7.86 tons.
Ballast, on keel.....	4.38 tons.
" inside.....	0.25 ton.
Ratio of ballast to displacement.....	59 per cent.

SPARS.

Mast, deck to hounds.....	23 ft. 6 in.
“ from stem.....	10 ft. 6 in.
Masthead.....	5 ft. 6 in.
Topmast, cap to shoulder.....	14 ft.
Bowsprit, outboard.....	15 ft.
Main boom, over all.....	26 ft.
Gaff, over all.....	20 ft. 9 in.
Trysail gaff.....	9 ft.
Spinnaker boom.....	30 ft. 4 in.
First topsail-yard.....	23 ft. 6 in.
Second “.....	17 ft. 6 in.
Jack-yard.....	15 ft. 6 in.

SAILS.—There is one mainsail, two sizes working foresail, and one balloon foresail, three shifting jibs, one club topsail, two sizes yard topsails, and one jib-headed working topsail, one jib-topsail, one spinnaker, and one trysail.

The dimensions of the mainsail, No. 1 jib, large working foresail, and No. 1 yard topsail are as follows :

Mainsail on head.....	19 ft. 8 in.
“ “ foot.....	24 ft. 3 in.
“ “ luff.....	21 ft.
“ “ leech.....	37 ft. 3 in.
“ roach to foot.....	16 in.
“ area.....	542 sq. ft.
Foresail on foot.....	14 ft.
“ “ luff.....	23 ft.
“ “ leech.....	20 ft. 4 in.
“ roach to foot.....	8 in.
“ area.....	145 sq. ft.
Jib on foot.....	15 ft.
“ luff.....	31 ft. 9 in.
“ leech.....	24 ft.
“ roach to foot.....	8 in.
Area jib.....	175 sq. ft.
“ lower sails.....	862 sq. ft.

THE CUTTER CARMITA.

THIS yacht was designed by Mr. J. H. Keating, of Marblehead, Mass., and was launched in 1882. She is intended to be un-capsizable and unsinkable, and has 53 cubic ft. of air-tanks, having a floating capacity of 3,000 lbs. She is intended for deep-sea cruising and is said to behave splendidly.

Her particulars are as follows :

Length over all	24 ft. 8 in.
“ on water-line	20 ft. 6 in.
Beam, extreme	7 ft. 11 in.
Draught, greatest	3 ft. 7 in.
Freeboard, least	1 ft. 7 in.
Displacement	7,735 lbs.
Ballast, inside	2,650 lbs.
“ on keel	1,150 lbs.
Ratio of ballast to displacement	48 per cent.
Sail-area, three lower sails	430 sq. ft.
Mast, deck to hounds	17 ft. 6 in.
“ from end load-line	7 ft. 4 in.
Main boom, over all	18 ft.
Gaff over all	16 ft.
Bowsprit, outboard	9 ft.
Hoist of mainsail	15 ft.
Foot of foresail	8 ft.
“ jib	10 ft. 6 in.

THE LIGHT-DRAUGHT CUTTER MIGNONETTE.

THIS vessel was built in 1884 by Wallin & Gorman, of Brooklyn. She is the product of ingrafting sufficient beam upon the ordinary cutter type, to be able to cruise along the Eastern coast in all weathers.

She is considered un-capsizable and unsinkable.

The floor of the cockpit is 12 in. below the deck level, and measures 6 by 3½ ft., with 14 in. of deck utilized for seats,

the coaming being set back from the well that distance. The volume of water which can be shipped is thus reduced to a harmless amount, and the cabin door-sill being almost at deck-height, no seas can get below.

Length on deck	25 ft. 10 in.
" on water-line	20 ft. 10 in.
Beam, extreme	7 ft. 9 in.
" water-line	7 ft. 3 in.
Greatest draught	4 ft.
Least freeboard	1 ft. 9 in.
Displacement	8,350 lbs.
" short tons	4,175
Ballast, inside	2,350 lbs.
" on keel	1,500 lbs.
Ratio ballast to displacement	46 per cent.
Area of three lower sails	460 sq. ft.
" mainsail	279 sq. ft.
" foresail	91 sq. ft.
" large jib	93 sq. ft.
Hoist of mainsail	15 ft.
Foresail on foot	11 ft. 3 in.
Jib on foot	12 ft.
Mast, deck to hounds	19 ft.
" from end load-line	8 ft. 6 in.
Boom, over all	19 ft.
Gaff over all	12 ft.
Bowsprit outboard	9 ft. 6 in.

THE CENTREBOARD SLOOP GLEAM.

THIS sloop was built by John Mumm, of Brooklyn.

Length over all	25 ft. 10 in.
" on water-line	23 ft.
Beam, extreme	9 ft. 6 in.
" on water-line	9 ft.

Draught without board.....	3 ft. 3 in.
“ with board.....	7 ft. 9 in.
Freeboard, least.....	1 ft. 9 in.
Displacement.....	12,000 lbs.
Ballast, inside.....	4,500 lbs.
“ on keel.....	1,700 lbs.
Area lower sails.....	788 sq. ft.
Hoist mainsail.....	23 ft.
Jib on luff.....	31 ft.
“ on foot.....	20 ft.
Mast, deck to hounds.....	29 ft.
Topmast, over all.....	16 ft.
Boom, over all.....	26 ft.
Gaff, over all.....	16 ft.
Bowsprit, outboard.....	15 ft.

Sails of 10-oz. duck, double bighted. Club topsail of 8-oz. duck. A storm-jib of heavy duck is also carried.

THE KEEL SLOOP ALICE.

THE Alice was built in 1885 by Mr. F. C. Smith, of New Bedford. The rig is that of a pole-mast sloop.

	Feet.	Inches.
Length on deck.....	24	0
“ on water-line.....	21	6
Beam, extreme.....	10	0
“ water-line.....	9	0
Hoist of mainsail.....	19	0
Mast, deck to truck.....	33	0
“ “ hounds.....	24	0
“ from stem.....	7	0
Bowsprit, outboard.....	13	0
Boom, over all.....	27	0
Gaff, over all.....	17	0
Draught.....	3	6

Ballast, 2 tons inside. She has a storm-jib to set flying in bad weather.

SLOOPS OF LAKE WINDERMERE.

THE peculiarity of these vessels is their long immersed counters, as shown in the accompanying sketch, Fig. 110.

The fashion of immersing the counter rose some years ago out of an intended evasion of the rule of measurement.

These boats are noted for their fine weatherly qualities, and their advocates assert that no other craft in the world of similar length are so good to windward. A feature that should command the attention of the amateur is their almost absolute safety. They are really uncapsizable, and when wholly decked

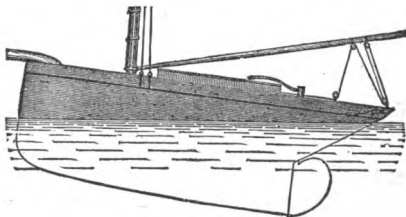

Fig. 110.

no mishap, further than the carrying away of spars or gear, is likely to occur. They may be worked single-handed. Naturally, if carelessly sailed, these boats might get knocked down, but directly the pressure on the sails had passed they would right themselves.

The sloop rig is used with pole masts, that is, the lowermast and topmast in one, and one large jib is carried.

As the boats are very sensitive, they require careful steering, and the jib is generally taken as a guide by the helmsman.

They are usually sailed through the squalls which sweep down from the mountains, being luffed a trifle to ease the pressure. If a squall be very heavy the jib-sheet is eased, but the main-sheet is never started.

There are waterways and coamings to the cockpit, and the boats are sometimes sailed so that water is taken in over the coamings. They are said to do their best when about two inches of the deck is immersed. When sailing free and run-

ning, the crew are generally brought aft on the counter to counteract any tendency to bury the bows, and the speed is said

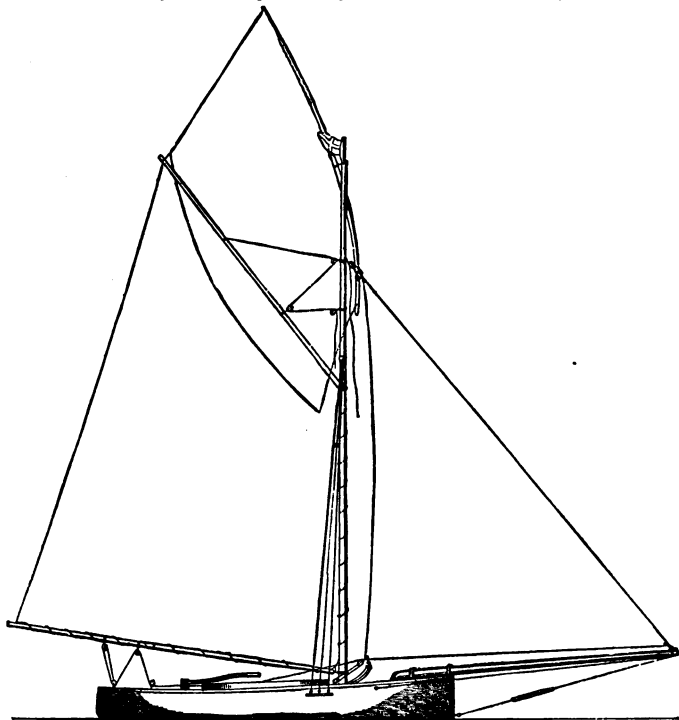

Fig. 111.

to be greatly improved thereby. The sail plan is represented in Fig. 111.

SLOOPS OF NORFOLK.

THESE vessels have light draught, on account of the shallowness of some portions of the rivers, good beam, a large sail area, and carry considerable ballast.

The modern boats are all sloop rigged, and range from four to ten tons in size.

The smaller boats draw about three and one-half feet, and the larger ones from five to six feet of water.

All the Norfolk boats have large counters, in many cases quite one-third of the length over all.

Their bowsprits are very long, extending outboard usually more than the length from stem to stern-post. The rudders are very large and effective, and the boats will turn with marvellous celerity.

The Arrow, of the Yare Sailing Club, designed and built by Dixon Kemp, Esq., is said to be one of the best, and she certainly is one of the handsomest of these craft.

She is represented in Fig. 112.

Her dimensions are as follows :

Length over all.....	38 ft. 6 in.
Length, stem to sternpost.....	29 ft. 6 in.
Length of counter.....	9 ft.
Length on water-line.....	34 ft.
Greatest beam.....	10 ft.
Beam on water-line.....	9 ft. 9 in.
Draught.....	6 ft.
Depth inside.....	6 ft. 7½ in.
Rudder.....	4 ft.
Weight of lead on keel.....	2½ tons
“ inside ballast.....	4½ tons
Mast stepped from stem.....	9 ft. 9 in.
Mast, deck to upper cap.....	36 ft.
Topmast above upper cap.....	21 ft. 2 in.
Bowsprit outboard.....	26 ft. 2 in.

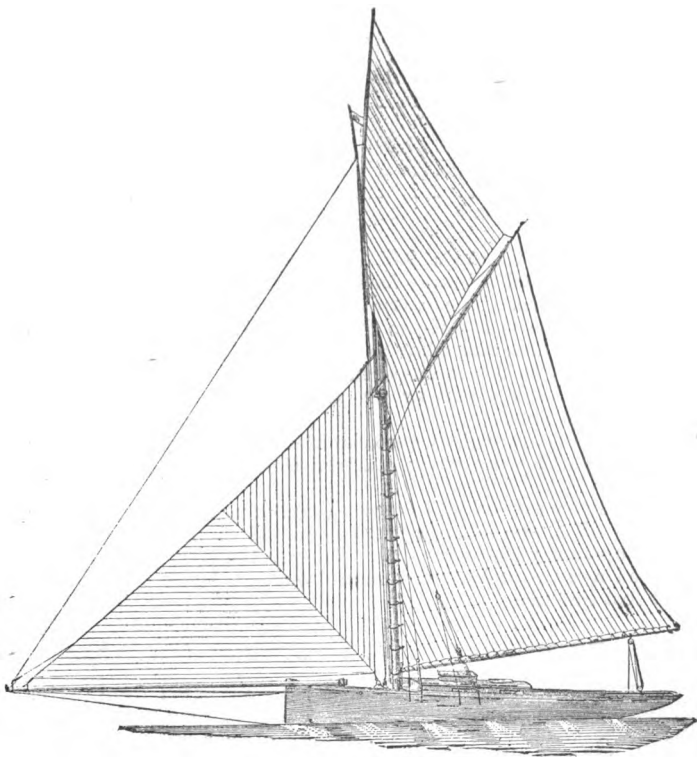

Fig. 112.

Length of boom	31 ft. 4 in.
" gaff	26 ft.
" topsail yard	32 ft.
Leech of mainsail	42 ft.
Luff " 	24 ft. 6 in.
Luff of jib	42 ft.
Foot of jib	35 ft.
Leech of jib	30 ft.
" topsail	25 ft.

She has a main cabin, 9 ft. long, with 5 ft. 3 in. head room; a fore cabin, and a roomy forecabin. The fittings are of polished pitch-pine. The cockpit is large and roomy.

Her tonnage is about ten tons by the Y. R. A. rule, and she requires two men and a boy to handle her properly.

In August, 1878, she sailed in a race from Lowestoft to Yarmouth and back, about twenty miles, in a good bit of a sea, and a stiff breeze.

The other competitors were the *Merle* and *Kismet*, sea-going ten-tonners of some note; and the *Gem*, a fast smooth-water yacht.

The *Arrow* carried all lower sail, and after a pretty pounding arrived off Lowestoft considerably ahead of the other boats, and apparently an easy winner. There, however, her bowsprit carried away close to the gammon-iron, in a jump of a sea, and she lost the race.

THE RUDIMENTS OF CUTTER AND SLOOP SAILING.

PORTIONS of the following remarks are extracted from "The Sailor's Handy Book and Yachtsman's Manual," to which work the amateur is referred for any further information, regarding the handling of cutters and sloops, which he may desire.

The management of modern sloops, with the double headsail, is almost identical with that of cutters, and will be so considered in the text.

We will imagine a yacht at single anchor, and that there is a light breeze, in which a topsail may be carried with advantage.

Getting Under Way.—Take off the covers and loose the sails. Hook the main and peak-halliards; and top the boom a couple of feet, a hand overhauling the main-sheet to permit the boom to rise.

Hoist away on main and peak-halliards together, so that the gaff rises nearly horizontal. Belay the peak and purchase the main-halliards until the throat is well up, when belay them, and set up on the peak-halliard until there is a slight wrinkle at the throat of the sail.

Set up the runners and tackles; haul taut and belay the main-sheet, coil down the slack of it, and capsize the coil clear for running.

The topsail may be set either when under way or while at anchor. If the latter, send it aloft after the mainsail is set.

Having set the after canvas, proceed to clear the ground tackle. Heave in upon the cable until it is nearly "up and down," having a hand at the stem-head to cleanse it before it enters the hawse-hole.

See that the bobstay is well down and that the bowsprit shrouds are well taut.

Hoist the foresail and jib, and see their sheets clear. Haul the fore-sheet a-weather to cant her head to the side you wish to cast. When "all ready," ship the tiller, ease the main-sheet. Trip the anchor and get it inboard, and as soon as she pays off trim the sheets according to the course.

With a laced mainsail always ease the topping-lift to make the sail set flat.

Cruising.—Avoid sailing too close to the wind, as what is gained by travelling a shorter distance is more than lost by the reduction in speed.

Of course, there are occasions when, to clear some object, without tacking, it will be advisable to jam her up as close as possible, and with a favoring tide she may be squeezed almost into the wind's eye.

In sailing "close hauled" some men steer by the jib, some by the luff of the mainsail, and many tyros by the flag. The mainsail will, perhaps, be the best general guide for the amateur, although the eddy wind from the foressail and jib will often cause quite a tremble in its luff.

Be careful, no matter how fine the weather may be, to have the downhauls bent, reef-earring rove, and halliards clear for running. For a loose-footed mainsail have a main-tack tricing-line bent.

Have a look all round, as soon as you are fairly under way, and take heed that all halliards and sheets are neatly coiled down, and the coils upset clear for running.

You are now sailing along nicely with every sail telling and a moderate sea on. The tiller is pressing against your hand with a tremulous vibration. We will suppose you are on the port tack and desire to go about.

Tacking.—When ready sing out "Ready about!" Upon getting the word "All ready, sir!" from forward, ease down the helm, calling out "Helm's a-lee!" Haul in the main-sheet as she comes to, if desired, although most yachts will tack without touching the main-sheet.

The jib-sheet is slacked, and the fore-sheet in hand ready for slacking at the proper time.

Care should be taken to get the lee jib-sheet aft just at the proper instant, and the fore-sheet should not be kept a-weather too long.

Shift the main-tack tackle (if there be one) to-windward of the boom and bowse the tack down.

The gaff topsail should be trimmed while in stays if it requires any alterations.

When fairly about, see that the head-sheets are trimmed so that the sails are a good clean full, and that all the sails stand at the same effective angle.

To Bear Away, after sailing close to the wind, put the helm up, and ease off the main-sheet, then ease off the head-sheets a trifle.

Gybing requires care, and a yacht should never be sailed so that the boom may come over without warning, or the topmast may "go by the board," and the loose parts of the sheet will be apt to carry somebody, or something, overboard.

That which was the weather-runner must be eased, and the opposite one set up, and the same attention must be given to the preventer backstay, if in use, and smartly too. In anything but light airs, the fall of the main-sheet must be rallied in smartly, and the jerk, as the boom goes over, prevented by allowing the parts to render slowly through the blocks.

In a fresh breeze the peak may be lowered, or the tack triced up, or both, in order to ease the pressure.

In light airs, when there is so much motion as to render gybing imminent, a lazy-guy may be used to the boom from forward.

Reducing Sail, etc., Preparations for Bad Weather.—If there are indications of bad weather, take in and stow the topsail. Haul the foresail a-weather; luff up; haul in the main-sheet; cast off the tack tackle and trice up the main-tack (if so fitted). The vessel is now "hove to." Shift the jib for a smaller one and proceed to reef.

Reefing.—Man the topping-lifts and top well up, easing the main-sheet as necessary. Lower on main and peak-halliards sufficiently. The reef-pendant has a knot in one end and passes through the fairleader on one side of the boom, up through the reef-cringle on the sail, and down through the sheave on the other side of the boom. Bowse down the reef-cringle to the boom by the pendant and tackle, and secure the earing; roll up the sail and tie the reef-points; hook tackle to the next cringle, hoist the sail, and bowse down the tack. If the sail is laced to the boom, the tack-lashing should be secured first.

Send down or house the topmast, and when ready trim the sheets and sail the vessel, which is now under single-reefed mainsail, foresail, and small jib. If the weather gets worse, take in the foresail and sail her under reefed mainsail and jib.

If it is necessary to beat to windward to reach port, get a reef in the foresail, shift the sheets and tack and set it, hauling the sheet a-weather and heaving her to. Haul down a second reef in the mainsail, and then sail her again. If she plunges much, ease in the jib until the sheet just clears the forestay, and trice up the main-tack.

Should the wind still increase, take in the close-reef in the mainsail; take in the jib, unfid and close-reef the bowsprit; set up the bobstay and stay, and set the storm-jib. Close-reef and reset the foresail; trim aft the head-sheets; batten down everything, and hammer her at it.

NOTE.—For information concerning the handling of yachts in a gale of wind, and the storm canvas used, the reader is referred to "The Sailor's Handy Book," the space available in this little work not being sufficient to admit of going into the subject any further.

Anchoring and Mooring.—When sailing on a wind, keep her pointed in the wind's eye, lower the head-sails, and when she loses headway let go the anchor and pay out the cable to a safe scope, three or four times the depth of water.

When going free, lower the headsails, drop the peak of the mainsail, put the helm down, and haul in the main-sheet until she is head to wind and has lost headway, when let go the anchor.

Moorings may be taken in the same way, but it is well to keep some sail set until the buoy-rope is grappled, so that, in case of a miss, you may sail up to it again.

When safely moored the sails should be lowered and furled, and the covers put on. The weight of the boom is received by a *crutch*, set up on the counter.

THE YAWL RIG.

THE Yawl rig proper consists of a gaff mainsail, somewhat narrower than that of a cutter, and with or without a boom, a stay-foresail, jib, topsail, and lug mizzen. The balloon canvas is the same as that used in cutters and sloops.

There has always been considerable discussion as to the comparative merits of the cutter and yawl rigs, and the general opinion at present appears to be that, with yachts of equal tonnage, the cutter is the faster, but, by reason of the large mair-

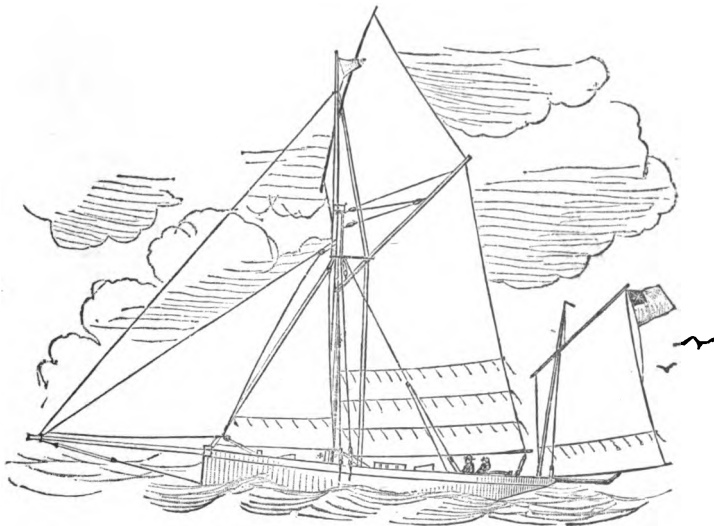

Fig. 113.

sail and lengthy boom, is more difficult to handle ; while the yawl, having the sails more subdivided may, be effectively worked with fewer hands.

With regard to safety and efficiency, the yawl rig certainly has many advantages.

With jib and mizzen alone the boat will be under command,

if there be sufficient area in these sails for working canvas, and this will be found very handy in getting under way and coming to.

The yawl may be sailed through squalls with jib and mizzen, by flowing the main-sheet. If the squall comes too heavy the mainsail may be lowered until it passes by.

Reefing may be delayed until the last moment, and then the mainsail being settled to reef, the vessel may be kept right on her course, and the operation be performed at leisure and all inboard.

There is no immense boom to take charge of the deck in bad weather, or to dip in the waves and "trip" when running before the wind. The sails may be carried wing-and-wing, if desired, and the yawl may be gybed with great ease.

The yacht can be sailed without the mizzen by setting smaller head-sails, and thus the same advantage obtained as if a good reef had been put in.

When tacking a yawl, it is advisable to haul in the mizzen as flat as possible, to assist her head round; and in beating in narrow channels it should be kept sheeted perfectly flat.

To back out of a slip, between wharves, bring the mizzen square across and put the helm hard over.

The mizzen should always be given sufficient area to allow of working to windward properly with the assistance of the jib.

For sea-cruising short-handed, the yawl rig is to be commended.

THE DANDY RIG.

THE Dandy rig bears a striking resemblance to the yawl rig, the principal difference being in the mizzen-sail, which in the Dandy rig is jib-headed and set without yard or gaff.

The advantages claimed for this rig are the same as those of the yawl rig; the mainsail swings clear of the mizzen, and is worked without a boom, whereby the inconvenience of that heavy spar swaying overhead is avoided—a matter of considerable importance in a boat loaded with passengers.

On the south coast of England some of the large open pleasure-boats so rigged are nearly fifty feet in length, by fourteen in breadth, and are capable of carrying thirty persons without crowding. Although so large and capacious, these boats are safely managed in ordinary weather by two persons.

QUESTIONS IN FORE-AND-AFT SEAMANSHIP.

Q. How would you take in a gaff topsail?

A. Lower the halliards and haul on the downhaul until the head of the sail is down to the cap, then slack the sheet and brail up. When clewed up, lower away the halliards and haul the sail down by the tack and down haul.

Q. How would you reef a mainsail?

A. Lower peak and throat sufficiently to take in the required reef. Hook the tackle to reef pendant, and bouse the reef cringle down to the boom. Pass the tack earing, tie the points, and reset the sail.

Q. What is scandalizing the mainsail?

A. Tricing up the tack and dropping the peak.

Q. What is a balloon jib?

A. A large jib of very light material, used only in light breezes when going free. It extends from the end of the bowsprit to the main rigging.

Q. What is a spit-fire jib?

A. A very small jib of strong canvas for stormy weather.

Q. In a gale, with a heavy sea, what is the best canvas to reach under?

A. Trysail, or balance-reefed mainsail, double-reefed foresail and storm jib.

Q. Under what canvas would you heave to in a gale?

A. Trysail and storm jib; topmast on deck.

Q. Running before the wind and sea and wishing to gybe, what precautions are necessary?

A. In a light breeze and smooth water the whole mainsail

may be carried, but in a strong breeze, the tack of the mainsail may be triced up, the boom being topped well up; the peak and throat should be eased down, the wind brought on the quarter and the main sheet hauled in, unhook the boom guy before putting the helm up, and gather in as much as possible of the sheet as the vessel pays off, and the boom goes over. When the wing gets on the other quarter, hook the guy, slack the main sheet, trim and make sail.

Q. Bowsprit shroud carried away, what would you do?

A. Luff and keep her easily to the wind, ease in the jib half way, hoist it well up, and trim aft the sheet, after securing the shroud with a shroud knot.

Q. Being on a wind, heave to in order to receive a boat alongside?

A. Haul in main sheet, and haul both fore and jib sheets to windward. In a fresh breeze ease off the jib sheet and trice up main lock.

Q. Being close hauled on the port tack, a man falls overboard, what would you do?

A. Put the helm down; heave a life buoy, grating, oar, or anything that will float, toward the man. Then go about, stand toward him and pick him up.

Q. Suppose you are running in a strong breeze and a man falls overboard?

A. Down helm, haul in main sheet, up main lock, round-to and get the boat in the water smartly, heaving life buoy as in the first case.

NAVY BOATS.

THE boats carried by naval vessels are intended for use either under oars or sails, or both.

They are known as single-banked or double-banked according as they have one or two rowers to a thwart.

Sailing launches, barges, and cutters are double-banked gigs. Whale boats and dingies are single-banked. Launches range

from 34 to 28 feet in length; barges from 32 to 30 feet; cutters from 30 to 26 feet; whale boats and gigs from 30 to 26 feet, and dingies from 20 to 18 feet.

Boat Equipment.—Every navy boat is supplied with the following articles :

1st. The plug. 2d. A breaker of water. 3d. A rudder with laniard and tiller, or yoke. 4th. Two or three boat hooks. 5th. A full set of oars, and two spare oars. 6th. An outfit of sails and spars. 7th. A bailer. 8th. A boat compass. 9th. A tool and supply chest, known as a boat box. 10th. A set of fenders. 11th. An anchor and cable. 12th. A rope painter. The plug is secured to the keelson by a laniard. The water-breaker is fitted with a spigot and laniard and its bung-hole with a leather lip.

If a steering-oar is supplied to steer with at times in place of a rudder, a patent crutch is fitted in which it may be shipped.

A painted canvas cover is provided for the sails.

There are also a set of stretchers for the feet of the rowers; short chain slings for hooking on; and an ensign and staff.

RIGS FOR NAVY BOATS.

NAVY or man-of-war boats are usually rigged as follows :

Launches are sloop-rigged.

Barges, cutters, and whaleboats with two sliding gunter sails, or two lug sails, with the addition in some cases of a jib.

Lug-sails are either *standing* or *dipping* lugs.

The halliards of a standing lug are bent to the yard a trifle inside of the forward end, and the tack secures just abaft the mast.

In the case of a dipping lug the halliards are bent at two-fifths the length of the yard from its forward end; the tack hooks well forward of the mast, to an eye-bolt on either bow in the case of the fore-tack.

In tacking or wearing with this rig, the after yard-arm must

be dipped around the mast from aft forward. In tacking, the wind coming on the former lee-bow, the halliards are lowered enough to allow the after yard-arm to be passed around the mast, a hand bears out the forepart of the sail, others gather the clew of the sail forward and pass it around the mast.

The sheet is unhooked as soon as the sail is spilled and rehooked when the clew is passed aft on the other side. The unengaged portion of the crew hand along the foot of the sail and assist in rehoisting. The fore-tack is shifted to the weather-bow.

In wearing, the sail is dipped just before the wind gets aft, and hoisted when the wind comes on the other quarter. The halliards are always belayed to windward.

Three quarter lugs are occasionally seen in which the halliards are bent about one-quarter the length of the yard from the forward end, and which are dipped by passing the forward yard-arm abaft the mast.

A *split* lug is used in some foreign boats. There is one mast, the yard being slung at two-fifths its length from the forward end.

The sail is split in the wake of the mast and has also a tack-hook or lashing for the after portion. A lacing is provided to join the two portions of the sail when required. With the lacing unrove, and the tack secured, the after-portion sets as a standing lug, and the forward part acts as a jib, being fitted with a short sheet.

Dingies are usually fitted with sprit-sails.

Masts step in boxes, and clamp to the thwarts.

Haliards should always be rove before stepping. If accidentally unrove the mast should always be unstepped to rectify matters.

As a rule a jib should be set before setting the foresail when the jib acts as a fore-stay, to avoid the head of the mast sagging aft and causing a slack after leech. If obliged to reverse this

order, ease the fore-sheet when setting the jib, to allow the masthead to go to place.

HANDLING MAN-OF-WAR BOATS UNDER SAIL.

HAVE all the crew sit down. When the ship is not head to wind pull clear of her before making sail. If the ship is broad-side to the wind sail may be made from the lee gangway. If head to wind: *Shove off! In fenders! Hoist the jib! Up foresail!* If to sail by the wind hoist the mainsail also. If bound to leeward let the boat pay off to her course, then *hoist mainsail!* Ease off fore and jib sheets and proceed.

When a pull on the halliards is necessary, slack the sheet until it is obtained.

All gear should be kept clean for running, the crew quiet and in their places, and the sheets retained in hand and not belayed.

If going free and about to round-to, remember that less sail should be carried on a wind than before it, and reduce in time.

Running dead to leeward in a stiff breeze in a single-masted boat is dangerous. It is better to bring the wind a little on one quarter for a portion of the distance, then lower, shift over the sail, and head for your destination with the wind on the other quarter.

Putting the rudder right across the stern deadens the way; about 42° is the extreme of efficiency.

When a boat is tied by the stern—as in towing with a tow-line fast to the stern ring-bolt—the rudder has no turning effect.

Endeavor by trimming sails and the disposition of weights to reduce the boat to a “small helm” to avoid retarding way by dragging the rudder too much across the stern.

Weather-helm may be induced by allowing the boat to be pressed by the head, which may be caused by the bowmen sit-

ting well forward, or by press of sail, or a combination of the two.

If the bow is deep and the stern light, the former is not so readily blown from the wind, but if, on the contrary, the stern be deep and the bow light, the bow will readily be thrown to leeward by the action of the wind and sea.

In the first of these cases the boat would probably carry weather helm, and in the latter case lee helm, but in either case her way would be diminished. The drag of cross helm might be reduced by decreasing sail at one of the extremities, but at the expense of speed, whereas, by trimming weights all sail might be carried and speed increased.

Tacking.—Assume the boat to be a barge or cutter fitted with jib and sliding gunters. Keep her a good full for stays, then *Ready about!* Ease down the helm, *Ease off jib sheet!* (In a quick-working boat the jib sheet may be kept fast.) Haul the main boom handsomely amidships, when head to wind, *shift over fore-sheet!* being careful not to make the foresail a back sail. Bear the jib to windward until the boat's head pays off sufficiently to fill the foresail, when *draw jib!* Trim the jib and foresheets, right the helm and trim the main sheet.

Wearing.—Put the helm up, ease off the main sheet, or in a very fresh breeze brail up the mainsail, slack off the fore and jib sheets as she pays off. When the wind is well on the quarter shift over the foresheet; shift over the main boom, with the wind on the new weather quarter, haul aft the main sheet, or set the mainsail if it has been brailed up; haul aft the foresheet and, when nearly by the wind, trim aft the jib sheet, and right the helm.

Heaving to.—Put the helm down, haul the main boom amidships, brail up the foresail and haul the jib sheet to windward.

Reefing.—Sliding gunter sails are easily reefed, but in using lug sails, two men haul down on the luff and shift the tack, hands lowering the halliards and others tending the sheets. The crew then tie the reef-points and shift the sheet block at

the clews. The sheets should be checked and the halliards lowered sufficiently to tie the points, keeping in the foresheet so that the foot of the sail can be reached. When the points are tied and the tacks and sheets shifted, hoist the sails and trim aft the sheets.

Hoist the foresail first, then the mainsail.

A sliding gunter is managed in much the same way, except that it is unnecessary to haul down on the luff of the sail.

Always reef when the boat commences to bury her lee gunwale or shows signs of being crpnk.

Squalls, etc.—Sailing on a wind in light squalls, ease the sheets a trifle, keeping enough steerage way to bring her into the wind if the squall comes on heavy.

If caught in a hard and sudden squall, put the helm down, let fly foresheet, and if necessary lower the sail. With wind abeam a squall may be received with sheets flowing and halliards in hand clear for running. If it becomes very heavy brail up mainsail, up helm and lower and reef the foresail.

If obliged to run before a very fresh breeze, do it under a reefed foresail, being careful to carry sufficient canvas to keep ahead of the seas. An empty breaker or spar towed astern may be used to break the seas and prevent their coming on board.

If blown out to sea, or unable to fetch the ship in a gale, lash the spars and sails together, reserving half the oars for use if necessary, bend a rope span to the opposite ends of the largest spar, and make fast the end of the boat's painter to this span, loose all the sails, and launch the whole affair overboard to serve as a sea anchor and breakwater. Ride to leeward of it with a long scope.

Going Alongside.—If under sail, in a fresh breeze, round-to ahead, reduce sail, down masts, out oars, and drop down; or shoot up under the stern and down sail and masts before getting under the quarter boats.

In case the ship is riding head to wind, and there is no tide, keep the main yard end on until near the gangway, then down

jib (rig in bowsprit if carried), and, when with sufficient way to fetch the gangway, brail up foresail, put helm down and haul main boom amidships.

Brail up the mainsail when alongside.

If there be a current allow for it by heading further forward or aft, as the case may be.

If the ship be riding to a windward tide, and the approach made from abaft the beam, the foresail should be taken in and the mainsail used to bring the boat alongside. Approaching from forward the beam, unstep masts and use the oars.

It is a good plan to douse masts in approaching a vessel under way, and to avoid boarding or shoving off from a vessel having sternway.

When going alongside a vessel riding to her anchor or under way, round-to so that the bow of the boat will be in the same direction as the ship's head.

MANAGEMENT OF NAVY BOATS UNDER OARS.

A DOUBLE-BANKED boat as a barge or cutter being manned and lying alongside ready to shove off: The coxswain orders: *Up oars!*

The crew with the exception of the bowmen seize their oars and raise them briskly to a vertical position directly in front of their bodies, keeping the blades fore and aft; the starboard rowers with right hands, and the port rowers with left hands down and grasping the handles.

The bowmen are standing up, facing forward, handling the boat-hooks or heaving lines. In a strong tideway the after-oarsmen may also assist in holding the boat at the gangway, and handling boat-hooks in shoving off.

At command *shove off!*

Bowmen cast off line, if used, handle boat-hooks, and shove the bow clear, the coxswain seeing that the ensign staff and

quarter go clear of the gangway. When well clear, the order is given : *Let fall !*

The oars are let fall easily into the rowlocks and levelled at the height of the gunwale ; the fenders are taken in, each man being responsible for his own. In single-banked boats each man takes care of the fender of the next man abaft him.

Having shoved the boat clear the bowmen take their seats, lay aside their boat-hooks, and having hauled in the painter, if adrift, seize their oars, throw the blades forward on the bows until the booms and handles can be grasped, raise them together to the vertical, lapping the blades, then drop them into the rowlocks.

In the meantime the boat has been pointed in the desired direction, by ordering the proper oars to be backed or given way on, and when ready the coxswain commands : *Give way together !*

The after-oarsmen give the stroke, the others following their movements. Each oar is lifted as high as the gunwale, and feathered by dropping the wrist until the blade is horizontal. When the blade is thrown forward as far as the rowlock will admit, it is dropped into the water easily and without splashing.

On nearing the desired place of landing, the boat being properly pointed, and just as the oars are leaving the water, the coxswain commands : *In bows !* The bowmen take one stroke and tossing their oars simultaneously to the vertical, lightly touch the blades together and lower them into the boat, passing the handles underneath, the oars still in motion. They then seize their boat-hooks, stand up, face forward, and hold the boat-hooks up and down. When with sufficient headway to reach the landing, and while the oar-blades are in the water, the command is given : *Way enough !*

The crew, regarding the motions of the stroke oarsmen, finish the uncompleted stroke and give one additional stroke, then

toss their oars simultaneously and lay them carefully in the boat. The fenders are then thrown out.

The stroke oarsmen then handle their boat-hooks, if necessary, retaining their seats, and assisting in holding the boat to the landing-place.

In stopping to hail or salute passing boats, or for any other reason, to check headway, it may become necessary to lay on the oars : to do this command : *Stand by to lay on oars!* when ready, *Oars!* The stroke is finished and the blades of the oars are feathered and raised in line with the gunwale.

At the order *Give way!* the pulling is resumed, taking the time from the stroke oarsman. Wishing to toss oars, the first command is : *Stand by to toss!* followed by *Toss!* The stroke is completed and the oars tossed up to a vertical position together in front of the bodies of the rowers, blades fore and aft.

In single-banked boats oars are usually trailed. To trail, order : *Stand by to trail!* *Trai!* At the second order the oars are thrown out of the rowlocks and allowed to trail alongside either by the trail lines, or being held by the handles.

To stop a boat's headway order *Oars!* followed by *Hold water!* and if necessary *Stern all!* At the first order, lay on the oars, at the second, drop the blades in the water to check headway, and at the third row backward, keeping stroke with the after oars.

To turn a boat quickly, order, *Give way starboard!* (or port), *Back port!* (or starboard), *oars!* Both backing and pulling oars keeping stroke with the after oar on their side.

Boat Salutes.—Boats not laden nor engaged in towing, when encountering other boats observe the following ceremonies :

To a boat flying the flag of an admiral or commodore, boats carrying commanding officers, and staff officers of the relative rank of captains or commanders, will lie on oars, or let fly sheets if under sail, and all other boats toss oars or lower the sails.

Officers in boats passing a captain or commander salute by

lying on oars or letting fly sheets, and, generally, officers junior in grade to any commanding officer salute in the same manner.

Coxswains of boats salute all commissioned officers by standing and touching their caps, and all warrant officers by touching the cap alone.

The officer to whom a salute is tendered acknowledges the same by touching the cap, and in all cases the salute by touching the cap is mutually made, but first by the junior in rank or seniority.

Officers and coxswains of loaded boats and boats engaged in towing, salute flag officers by standing and touching their caps; to all other officers the boat officer salutes merely by touching the cap.

Instead of tossing single-banked boats trail the oars.

A junior never passes his senior when pulling in the same direction except when on urgent duty.

When boats are approaching the same landing or vessel, junior is always to yield the way to a senior in rank.

In entering a boat a junior goes first, and in leaving a boat the senior precedes.

BOARDING A WRECK OR VESSEL IN A HEAVY SEA.

GENERALLY speaking a vessel whether stranded or afloat should be boarded to *leeward*, to avoid colliding against the side of the vessel or being swamped by the rebound of the sea.

In boarding a stranded vessel on the lee side, if broadside to the sea, danger may be apprehended from the falling of the masts or collision with the wreckage alongside. Under such circumstances it may be necessary to take a wrecked crew into a life-boat from the bow or stern.

On flat shores or shoals boats may anchor to windward and veer down toward a wreck from a safe distance until near enough to heave a line on board.

In all cases it is important that the lines by which a boat is made fast to the vessel should be of sufficient length to allow her to rise and fall freely with the sea, and they should also be kept in hand and ready to slip or cut at once in case of necessity.

Vessels of low freeboard, such as small schooners, etc., are sometimes boarded on the weather quarter to avoid being stove by the boom or chains.

Section 7.

WEATHER INDICATIONS, ETC.

SOME USEFUL RECIPES.

HINTS TO BATHERS.

INSTRUCTIONS FOR SAVING DROWNING PERSONS.

TREATMENT OF THE APPARENTLY DROWNED.

ACCIDENTS. INJURIES AND POISONS.

COOKERY. COOKERY FOR THE SICK.

SOME NAUTICAL TERMS IN COMMON USE.



WEATHER INDICATIONS.

THE boat-sailer should have some competent knowledge of weather indications, and this may be acquired by the study of certain rules that have been laid down by good authorities.

A pocket aneroid should be consulted. These instruments are made so portable that a boatman may carry one in his pocket as he does his watch, and thus provided, can have warning if bad weather be impending.

The probable changes of weather indicated by barometric changes are set forth in the following rules.

Rules for Foretelling Weather adapted for Aneroid Barometers.—A “rapid” rise indicates unsettled weather.

A “gradual” rise indicates settled weather.

A “rise,” with dry air and increasing cold in summer, indicates wind from northward; and if rain has fallen better weather is to be expected.

A “rise,” with moist air and a low temperature, indicates wind and rain from northward.

A “rise,” with southerly wind, indicates fine weather.

A steady barometer, with dry and seasonable temperature, indicates a continuance of fine weather.

A “rapid” fall indicates stormy weather.

A “rapid” fall, with westerly wind, indicates stormy weather from northward.

More than usual twinkling of stars, indistinctness or apparent multiplication of the moon's horns, halos, “wind-dogs,” and the rainbow are more or less significant of increasing wind, if not approaching rain with or without wind.

The barometer rises for northerly wind (including from north-west, by north, to the eastward), for dry, or less wet weather, for less wind—or for more than one of these changes; except on a few occasions when rain, hail, or snow comes from the northward with strong wind.

The barometer falls for southerly wind (including from south-east, by the south, to the westward), for wet weather, for stronger

wind, or for more than one of these changes ; except on a few occasions when moderate wind with rain (or snow) comes from the northward.

The thermometer falls for *change* of wind toward northerly directions.

The thermometer rises for *change* of wind toward southerly directions.

“ When the wind shifts against the sun
Trust it not, for *back* it will run.”

“ First rise after very low
Indicates a stronger blow.
Long foretold—long last,
Short notice—soon past.”

A “ fall,” with northerly wind, indicates storm, with rain, hail, or snow.

A “ fall,” with dry air and increasing cold (in winter), indicates snow.

A “ fall,” after very calm, warm weather, indicates rain, with squally weather.

The following are a few of the more marked signs of weather :

Whether clear or cloudy, a rosy sky at sunset presages fine weather ; a sickly-looking greenish hue, wind and rain ; a dark-red, rain ; a red sky in the morning, bad weather or wind ; a gray sky in the morning, fine weather ; a high dawn, wind ; a low dawn, fair weather. A “ high dawn ” is when the first indications of daylight are seen above a bank of clouds. A “ low dawn ” is when the day breaks on or near the horizon, the first streaks of light being low down.

Soft-looking or delicate clouds foretell fine weather with moderate or light breezes ; hard-edged, oily-looking clouds, wind. A dark, gloomy-blue sky is windy, but a light, bright-blue sky indicates fine weather.

A bright-yellow sky at sunset presages wind, a pale-yellow,

wet ; therefore, by the prevalence and kind of red, yellow, or other tints, the coming weather may be foretold very nearly ; indeed, if aided by instruments, almost exactly.

Small inky-looking clouds foretell rain ; light scud clouds driving across heavy masses show wind and rain ; but if alone, may indicate wind only.

High upper clouds crossing the sun, moon, or stars, in a direction different from that of the lower clouds, or the wind then felt below, foretell a change of wind toward their direction.

After fine clear weather, the first signs in the sky of a coming change are usually light streaks, curls, wisps, or mottled patches of white distant clouds, which increase, and are followed by an overcasting of murky vapor that grows into cloudiness. This appearance, more or less oily or watery as wind or rain will prevail, is an infallible sign.

Light, delicate, quiet tints or colors, with soft, undefined forms of clouds, indicate and accompany fine weather ; but unusual or gaudy hues, with hard, definitely-outlined clouds, foretell rain, and probably strong wind.

Misty clouds, forming or hanging on heights, show wind and rain coming if they remain, increase, or descend. If they rise or disperse the weather will improve or become fine.

Dew is an indication of fine weather, so is fog. Neither of these two formations occurs under an overcast sky, or when there is much wind.

Remarkable clearness of atmosphere near the horizon, distant objects, such as hills, unusually visible or raised (by refraction)—and what is called “a good hearing day”—may be mentioned among signs of wet, if not wind, to be expected.

SOME USEFUL RECIPES.

To Water-proof Canvas.—To one quart of boiled oil add one ounce yellow soap, and one ounce beeswax. Boil together until reduced to the consistency of thick paint.

Another method is as follows : Take of pulverized potash,

alum, and crushed acetate of lead, each twenty parts, bicarbonate of potassium and Glauber's salts, each twelve parts, and pour over this mixture three thousand parts of soft water, all by weight. Also dissolve separately in soft water nine parts of oleine soap, and then mix both solutions. Leave the canvas in this solution until thoroughly saturated, allow it to drain, dry it, and finally press it.

To Prevent Mildew.—Dissolve in fresh water one pound of finely-powdered alum and two ounces finely-powdered sugar of lead. Steep the canvas for eight or ten hours and allow it to dry slowly.

Black Stain.—Four ounces copperas, some small pieces of old rusty iron, one gallon of vinegar, one-half pound lampblack, and some oak-shavings.

Black Varnish for Tarpaulins, etc.—One gallon spirits of turpentine, twenty ounces of resin, twenty ounces of lampblack, and one quart of linseed oil. Boil slowly for half an hour.

Protective Coatings for Ballast.—Varnish with the foregoing black varnish, whitewash put on hot, or paint with red lead and then with white lead.

To Remove Old Paint.—Either soften carefully with a charcoal brazier, and then scrape, or apply the following mixture: one part pearl-ash to three parts quick stone-lime slacked in water. Lay it over the paint and allow it to remain about fifteen hours, when the paint may be readily scraped off. Do not soil the hands with the compound.

To Varnish Bright.—Sandpaper or scrape with glass. Stop all cracks with wood filler. Then apply a light coat of spar composition. When dry lay on second coat. Do not expose to sun.

Bottom Paint.—Use copper paint, or Rathjen's German Paint.

To Bleach Sails.—Mix one barrel of salt water, three pounds chloride of lime, three pounds soda-ash, two pounds of whiting, and three pounds of salt. Scrub the sail with a broom on both sides, and allow it to dry on the beach.

Another plan is to scrub both sides lightly with soap and

water, then rinse and sprinkle with solution consisting of the water drawn off from slacking a bushel of lime, and to which has been added sixty gallons of fresh water and one-quarter of a pound of blue vitriol.

To Whiten Decks.—Boil five pounds of American potash in one gallon of water. Test the solution by applying it to a piece of pine wood. If it turns the wood red, add water until it has no such effect.

Lay on evenly after sunset and allow it to remain over night. Before sunrise scrub with water and then scour with sand. This will remove all dirt, grease, or varnish, after which allow the deck to dry.

Then dissolve one pound oxalic acid in a gallon of water, and apply it to the dry deck, and after washing with water the decks should be of snowy whiteness.

(Extracted from "THE SAILOR'S HANDY BOOK AND YACHTSMAN'S MANUAL.")

HINTS TO BATHERS.

AVOID bathing within two hours after a meal.

AVOID bathing when exhausted by fatigue or any other cause. **AVOID** bathing when the body is cooling after perspiration; but bathe when the body is warm, provided no time is lost in getting into the water.

AVOID chilling the body by sitting or standing **NAKED** on the banks or in boats after having been in the water.

AVOID remaining too long in the water—leave the water immediately there is the slightest feeling of chilliness.

AVOID bathing altogether in the open air, if after having been a short time in the water there is a sense of chilliness, with numbness of the hands and feet.

The vigorous and strong may bathe early in the morning on an empty stomach; the young and those who are weak had better bathe three hours after a meal—the best time for such is from two to three hours after breakfast.

ALL that is necessary to keep a person from drowning in deep

water is to keep the water out of the lungs. Suppose yourself a bottle—your nose is the mouth of the bottle, and must be kept out of the water ; if it goes under, do not breathe at all till it comes out ; keep legs, arms, all under but your nose ; do that, and you cannot sink in any depth of water. All you need do to secure this is to clasp your hands behind your back, point your nose upward toward the heavens, and keep perfectly still. Your nose will never go under water unless you raise your chin, hand, knee, or foot above it.

INSTRUCTIONS FOR SAVING DROWNING PERSONS BY SWIMMING TO THEIR RELIEF.

FIRST.—When you approach a drowning person in the water, assure him with a loud and firm voice that he is safe.

SECOND.—Before jumping in, divest yourself, as far and as quickly as possible, of all clothes—tear them off if necessary ; but, if there is no time, loose, at all events, the foot of your drawers if they are tied, as if you do not do so they fill with water and drag you.

THIRD.—On swimming to a person in the sea, if he be struggling, do not seize him then, but keep off for a few seconds till he gets quiet, for it is sheer madness to take hold of a man when he is struggling in the water ; if you do, you run a great risk.

FOURTH.—Then get close to him and take fast hold of the hair of the head, turn him as quickly as possible on his back, give him a sudden pull, and this will cause him to float ; then throw yourself on your back also and swim for the shore, both hands having hold of his hair, you on your back and he also on his, and of course his back to your stomach. In this way you will get sooner and safer ashore than by any other means, and you can easily thus swim with two or three persons. One great advantage of this method is that it enables you to keep your head up, and also to hold the person's head up you are trying to save. It is of primary importance that you take fast hold of the hair, and throw both the person and yourself on your

backs. After many experiments it is usually found preferable to all other methods. You can in this manner float nearly as long as you please, or until a boat or other help can be obtained.

FIFTH.—It is believed there is no such thing as a *death-grasp*; at least, it is very unusual to witness it. As soon as drowning persons begin to get feeble and to lose recollection, they gradually slacken their hold until they quit it altogether. No apprehension need therefore be felt on that head when attempting to rescue a drowning person.

SIXTH.—After a person has sunk to the bottom, if the water be smooth, the exact position where the body lies may be known by the air-bubbles which will occasionally rise to the surface, allowance being of course made for the motion of the water if in a tideway or stream, which will carry the bubbles out of the perpendicular course in rising to the surface. A body may be often regained from the bottom before too late for recovery, by diving for it in the direction indicated by these bubbles.

SEVENTH.—On rescuing a person by diving to the bottom, the hair of the head should be seized by one hand only, and the other used in conjunction with the feet in raising yourself and the drowning person to the surface.

EIGHTH.—If in the sea, it may sometimes be a great error to try and get to land. If there be a strong "outsetting" tide and you are swimming, either by yourself or having hold of a person who cannot swim, then get on your back and float till help comes.

NINTH.—These instructions apply alike to all circumstances, whether the roughest sea or smooth water.

TREATMENT OF THE APPARENTLY DROWNED.

The following Directions for Restoring the Apparently Drowned are from the Latest Instructions issued by our Life-Saving Service; they are those of DR. HOWARD.

WHERE you can do so, send immediately for a regular medical practitioner.

RULE I.—*Arouse the Patient.*—Unless in danger of freezing, do not move the patient, but instantly expose the face to a current of fresh air, wipe dry the mouth and nostrils, rip the clothing, so as to expose the chest and waist, and give two or three quick smarting slaps on the stomach and chest with the open hand. If the patient does not revive, proceed thus :

RULE II.—*To Draw off Water, etc., from the Stomach and Chest.*—If the jaws are clenched, separate them, and keep the mouth open by placing between the teeth a cork, or small bit of wood ; turn the patient on the face, a large bundle of tightly rolled clothing being placed beneath the stomach, and press heavily over it for half a minute, or so long as fluids flow freely from the mouth.

RULE III.—*To Produce Breathing.*—Clear the mouth and throat of mucus by introducing into the throat the corner of a handkerchief wrapped closely around the forefinger ; turn the patient on the back, the roll of clothing being so placed as to raise the pit of the stomach above the level of any other portion of the body. If there be another person present, let him, with a piece of dry cloth, hold the tip of the tongue out of one corner of the mouth (this prevents the tongue from pulling back and obstructing the windpipe), and with the other hand grasp both wrists, and keep the arms forcibly stretched back above the head, thereby increasing the prominence of the ribs, which tends to enlarge the chest. The two last-named positions are not, however, essential to success. Kneel beside or astride the patient's hips, and with the balls of the thumbs resting on either side of the pit of the stomach, let the fingers fall into the grooves between the short ribs, so as to afford the best grasp of the waist. Now, using your knees as a pivot, throw all your weight forward on your hands, and at the same time squeeze the waist between them, as if you wished to force everything in the chest upward out of the mouth ; deepen the pressure while you can count slowly one, two, three ; then suddenly let go with a final push, which springs you back on your first kneeling position. Remain erect on your knees while you can count

one, two, three; then repeat the same motions as before, at a rate gradually increased from four or five to fifteen times in a minute, and continue thus this bellows movement, with the same regularity that is observable in the natural motions of breathing which you are imitating. If natural breathing be not restored after a trial of the bellows movement for three or four minutes, then, without interrupting the artificial respiration, turn the patient a second time on the stomach, as directed in Rule II., rolling the body in the opposite direction from that in which it was first turned, for the purpose of freeing the air-passages from any remaining water. Continue the artificial respiration from one to four hours, or until the patient breathes; and for a while after the appearance of returning life carefully aid the first short gasps until deepened into full breaths. Continue the drying and rubbing, which should have been unceasingly practised from the beginning, taking care not to interfere with the means employed to produce breathing. Thus, the limbs of the patient should be rubbed, always in an upward direction toward the body, with firm grasping pressure and energy, using the bare hands, dry flannels or handkerchiefs, and continuing the friction under the blankets or over the dry clothing. The warmth of the body can also be promoted by the application of hot flannels to the stomach and armpits, bottles or bladders of hot water, heated bricks, stones, etc., to the limbs and soles of the feet.

RULE IV.—*After-treatment.*—*Externally:* As soon as breathing is established, let the patient be stripped of all wet clothing, wrapped in blankets only, put to bed comfortably warm, but with a free circulation of fresh air, and left to perfect rest. *Internally:* Give a little brandy and hot water, or other stimulant at hand, every ten or fifteen minutes during the first hour, and as often thereafter as may seem expedient. *Later Manifestations:* After reaction is fully established there is great danger of congestion of the lungs, and if perfect rest is not maintained for at least forty-eight hours, it sometimes occurs that the patient is seized with great difficulty of breathing, and death is

liable to follow unless immediate relief is afforded. In such cases apply a large mustard plaster over the breast. If the patient gasps for breath before the mustard plaster takes effect, assist the breathing by carefully repeating the artificial respiration.

ACCIDENTS, INJURIES, AND POISONS.

Rules to be followed where Surgical Assistance cannot be at once Obtained.

The dangers to be feared are : *Shock, loss of blood, and suffering* in moving the patient.

In **shock** the injured person lies pale, faint, and sometimes insensible. A person with such symptoms should, if possible, be placed flat on the back, with the head and shoulders *slightly* raised. The cravat and collar should be loosened or removed. If the injury is slight, reaction will soon come on after giving a little spirits and water, or aromatic spirits of ammonia and water, every couple of minutes. External warmth should be applied to the limbs and the pit of stomach, and the body well wrapped in blankets to assist reaction. Bottles of hot water, or hot bricks, may also be wrapped in cloths, and placed along the sides and between the legs.

Food, in the shape of strong soup, should be given now and then.

If the weather is hot, a palm-leaf fan will assist greatly ; also a little eau-de-cologne on a handkerchief, applied to the nostrils.

Loss of Blood.—To check the flow of blood from a wound, the principle to be acted upon is to check the flow of blood to the part. Should the bleeding be from an artery, in which case it comes forth in spurts and is of a bright-red color, *pressure* must be made on the main artery of the limb, *above* the wound, on the side of the wound nearest the heart.

If the blood be from a wounded vein, it flows in a stream and is of a dark color ; in this case pressure must be made *below* the

wound for a short time, after which a small pad of lint and a bandage over the wound will suffice.

To check the current of blood in the main artery of the arms or legs, feel for the artery on the inner side of the limbs, where it will be recognized by its pulsations; lay a firm compress across the course of the artery, pass a handkerchief around the limb and compress; pass a stick under the handkerchief, on the outer side of the limb, and twist it until sufficient tightness is produced to arrest the bleeding; then secure the stick to prevent its untwisting.

The arteries will be found coursing toward the inner side of both limbs. In applying the tourniquet or handkerchief, the pad should be on the inner side, the screw or knot on the outer side, of the limb. A compress or pad may be made of a piece of wood, a cork, or round stone wrapped in cloth. Care should be taken to examine the limb from time to time, and to lessen the constriction if it becomes very cold or purple; tighten the tourniquet if the bleeding begins afresh.

Elevation of the wounded part above the rest of the body will contribute much to check the bleeding.

The application of cold is good when the bleeding is from several points scattered over a large surface; it is conveniently applied by letting cold water drip from a sponge upon the bleeding points, or by the application of ice in a rubber-bag.

When these immediate measures have been used, there is time to use what physicians call "hæmostatics," to stop the blood. Alum or gallic acid may be dusted on the part in powder, or poured over it in solution. Tincture of iron and nitrate of silver are also used.

Fractures.—If any of the limbs be fractured, they should be temporarily splintered with two or four pieces of light wood tied at each end with handkerchiefs passed twice round, like an old-fashioned necktie. If a broken limb be not splintered, the ends may be forced through the skin if the patient be carried.

To transport a wounded person, let the patient be laid on a

door or some firm support, properly covered. Have sufficient force to lift steadily, and the bearers should *not* keep step.

Dislocations.—Whenever a bone is dislocated, there is a deformity at joint and loss of motion.

The sufferer usually becomes faint. While this condition exists, an attempt should be made to reduce the bone into position. It is surprising how easily this may be done, if it be tried at once, by extension and counter-extension by jack-towels or sheets.

If, for example, the dislocation takes place at the shoulder-joint, a clove-hitch by towel should be applied above the elbow-joint, and steady traction made in the direction of the axis of the bone by a strong man, while two others make counter-extension by another towel or sheet in the armpit, crossed toward the sound shoulder. This may be held by two men, or made fast to a ring-bolt; or the heel may be placed in the armpit, while a towel is clove-hitched above the elbow-joint. The limb should be steadily pulled downward, while the heel assists to force the head of the dislocated bone outward and upward into its natural position. A loud snap is always heard when the bone returns into its socket.

Dislocation at Hip.—Clove-hitch above knee; second sheet on inside of thigh for counter-extension; and make fast to bolt on deck or ship's side.

Bruises.—Use hot fomentations at first. After inflammation has subsided, use stimulating applications, as vinegar and water, alcohol, etc.

Sprains.—Elevate the limb; keep the joint perfectly quiet; apply lukewarm lotions or fomentations. When inflammation has ceased apply stimulating liniments, as soap or camphor liniments, and bandages; shower the part with cold water, alternating with warm water, or the hot and cold douches.

Burns or Scalds.—Do not cut the bladder. The readiest application may be flour from the dredging-box, laid on thick as possible. Lime-water and oil in equal parts is excellent, covered with cotton wadding.

The object is to exclude the air and prevent suppuration. Do not change the dressing for four or five days unless there be profuse discharge or bad odor. Resinous ointment, spread on lint sprinkled with turpentine, is another excellent application. If the scald is extensive and on the body, *cold* applications are *not proper*. Keep the air from the wound; this can be done by the dressing already suggested for burns.

Sunstroke.—Take the patient immediately into the shade; place in a semi-recumbent position, head raised; loosen the clothes about neck and chest; apply immediately ice or cold wet cloths to the head and nape of the neck, changing them frequently. Then douche over head, spine, and chest, from a height of about three feet. Patient to be fanned to produce a cold current of air. Mustard to limbs and sides—stimulants.

Poisons.—In all cases of poisoning, the first step is to give the antidote, if known, and then evacuate the stomach. The last should be effected by a mustard emetic, a tablespoonful of mustard in a cup of water, or a tablespoonful or two of common salt in a tumbler of water. When vomiting has already taken place, copious draughts of warm water or warm mucilaginous drinks, soap and water, or oil, should be given to keep up the effect till the stomach has been thoroughly cleared.

ANTIDOTES.—*For any of the strong acids:* Common chalk, oil, or soapsuds.

For Arsenic: Magnesia, milk, raw eggs, powdered charcoal, oil, and lime-water.

For Prussic Acid: Cold affusion, brandy and ammonia.

For Opium: Keep patient walking, strong coffee, slap with flat ruler, sting with nettles, mustard emetics.

Asphyxia.—Asphyxia arises from carbonic acid, from charcoal fumes, and other gases interfering with the respiration. The face becomes turgid and livid, owing to the accumulation of impure blood. The patient in this case should be placed with the head high, so as to facilitate the flow of blood from the brain, which is congested; the clothes should be taken off, and he should be douched with cold water. Ammonia should

be applied to the nose, etc. ; the face and body should be sponged with brandy or vinegar and water ; friction all over ; and artificial respiration if recovery is not evident.

Fever and Ague.—Fever and Ague is always preceded by an ague fit : it has three stages, the cold, hot, and sweating stage.

First, the cold, when teeth chatter.

Second, the hot, with high fever.

Third, the sweating, when moisture appears, and feeling of health returns.

In the event of there being no physician : in cold stage give hot drinks, hot foot-bath, hot bottles to sides and limbs.

In hot stage, give cooling drinks, half teaspoonful of sweet spirits of nitre in water every two hours.

During sweating stage, rub with dry towels. In *intermission* give quinine in from two- to ten-grain doses every three hours, for a few doses : afterward give ten drops of tincture of iron three times a day for a week. Avoid the hot sun and damp evening and morning air. If ringing in the ears should come on while taking quinine, the dose should be either lessened or suspended altogether.

To Restore Persons Affected by Cold.—*For Frost-bite*: Bring about reaction gradually by friction. Rub with snow or other cold application, and place in cold water for a time. When sensation returns, administer brandy-and-water carefully in small quantities.

If Apparently Dead or Insensible.—Strip entirely of clothes, and cover body, except mouth and nostrils, with snow or ice, or place in cold water. When body is thawed, dry it, place it in a cold bed ; rub with warm hands under the cover ; continue this for hours. If life appears, give small injections of camphor and water ; put a drop of spirits of camphor on tongue ; then rub body with spirits and water, finally with spirits ; then give tea, coffee, or brandy and water.

Fainting.—When a person suddenly grows pale and faint, he should be immediately placed full length on the floor, the head being kept low. The face may be dashed with cold water. In

this position he will quickly recover—this owing to the head having been placed low so as to facilitate the flow of blood to the brain.

Drunkness.—Drunkness in a severe form may cause death by apoplexy; it is a poisoning by alcohol. The individual should be placed in a semi-recumbent position, with head on one side to favor vomiting, all the clothing about the neck being freely opened. A douche, from a height, of cold water on face, head, and neck, will probably rouse him. It is difficult to get an emetic to act in this state, yet a tablespoonful of mustard, in half a tumbler of water, had better be given, to excite vomiting. If the respiration becomes embarrassed, artificial respiration should be used, as directed in case of drowning. The preparation called acetate of ammonia (to be had at any apothecary's), taken in ounce doses every half-hour, is said to have a most magical effect in restoring drunken men to sobriety; about three doses ought to suffice.

Bite of a Mad Dog.—If possible, immediately apply a ligature on the side nearest the heart, bathe the wound in warm water, and apply caustic freely to the bottoms of the teeth-punctures. If no caustic be at hand, a hot iron wire may be used as an actual caustery, or gunpowder may be placed in the wounds and ignited. Give brandy and ammonia.

Marsh Poison.—When men are employed on detached service in boats, or are otherwise exposed in a swampy region, they should be supplied with quinine to guard them against the marsh poison. Four grains should be administered before starting in the morning and four on their return; but if they should be exposed for twelve hours, or if the exposure be over night, the quinine should be continued until they return on board, and for fourteen days afterward.

Strength for one dose:

Quinine	4 grains.
Dilute sulphuric acid	10 drops.
Water	2 ounces.
Rum	1 ounce.

By simple multiplication the above formula may be mixed for any number of men daily.

Thirst.—Thirst is a fever of the palate, which may be somewhat relieved by other means than drinking fluids.

The mouth is kept moist, and thirst is mitigated by exciting the saliva to flow. This may be done by chewing something, as a leaf, or by keeping in the mouth a bullet or a pebble.

A spoonful of fat or butter will act on the irritated membranes of the mouth and throat. Life may be prolonged without drinking by keeping the clothes and skin constantly wet, even if the water be salt.

Care must be taken on giving water to persons nearly dead from thirst. Give a little at a time, and keep the whole body wet.

Water.—In all localities where the quality of the water is suspicious, condensed water should, if possible, be used for drinking and cooking purposes. When this is not feasible, the water should be carefully filtered and boiled.

Two barrels, one inside the other, having a space of four or six inches clear all round between them, filled with layers of sand, gravel, and charcoal, form an excellent filter. The inside one, without a bottom, rests on three stones placed in layers of sand, charcoal, and coarse gravel; the water, flowing or being poured into the space between the two barrels, and having thus to force its way through the substances into the inner barrel, becomes purified.

The water should be drawn off by means of a pipe, running through the outer into the inner barrel. Animal charcoal is the best. When, after a time, it ceases to act, it should be removed and well dried. It can then be used again with advantage. It is impossible to use too much of it.

The popular French plan of purifying turbid water (*alumage de l'eau*) simply consists in the addition of a small quantity of alum. It clears the water very rapidly, but merely converts the lime carbonate into sulphate, which remains in solution.

COOKERY.

Boiling meat entails a loss in weight of about thirty per cent. The water should never be higher than 160° F.; if hotter the meat becomes hard and shrunken; the lower the temperature the better are the nutritive juices kept in. The larger the pieces of meat the better.

Put the meat into boiling water, let it boil for five minutes and then reduce the temperature of the water either by pouring in cold water, or by reducing the fire until it is about 160° F., that is, as hot as the finger can be put into it without scalding. Allow a quarter of an hour for every pound the meat weighs.

Roasting.—The loss is a little less than in boiling. The meat should be exposed at first to a great heat for the purpose of keeping in the juice. Allow a quarter of an hour to a pound.

Meat Soup.—Sixteen and one-half pounds meat, one pound onions, one pound flour, five ounces salt, one-fourth ounce pepper, five ounces sugar, small fagot of herbs, and three and one-half gallons water. Separate the *large* bone from the meat, also the gristle, cut the meat into pieces of about four ounces, take eight ounces of the fat and chop it up, slice the onions, put the fat in the boiler; when melted, add the onions, stir them well, so that they do not get brown; in five minutes add the meat, which keep stirring and turning over for five minutes longer; the meat ought to be warmed through. Then add the boiling water by degrees, let it simmer gently for an hour, mix the flour with cold water very smooth, add it to the soup with the salt, pepper, sugar, and herbs; simmer gently for thirty minutes, keep stirring it to prevent the flour from settling at the bottom. The great error commonly committed in making soup is doing it too rapidly, which renders the meat hard and tasteless. Bones and scraps of meat should be collected after every meal and put down to simmer for next day's soup.

Irish Stew.—Sixteen and one-half pounds meat, sixteen pounds potatoes, four pounds onions, six ounces salt, one ounce pepper,

one-fourth pound flour. Cut the meat away from the bone, and then into pieces of a quarter of a pound each, the loin and neck of mutton into chops; disjoint the shoulder and cut the blade bone into four pieces; if the leg, cut into slices, three-fourths inch thick; rub them with the salt, pepper, and flour, and place the meat in the boiler with some fat, brown it on both sides, then add the onions whole, and then the potatoes; stew gently for two hours; keep the fire down and well covered during the cooking.

How to Soak and Plain-boil Rations of Salt Meat.—To each pound of meat allow one-half pint of water, or a pint if handy; do not let the pieces weigh more than three or four pounds each. Let them soak about eight hours, or all night if possible. Wash each piece with the hand to extract as much salt as possible; it is then ready for cooking. If less time is allowed cut the pieces smaller or parboil the meat for twenty minutes in the above quantity of water, which throw off, and add more; simmer gently for three hours and serve. Vegetables or dumplings can be boiled with it.

Salt Meat, to Prepare Hurriedly.—Warm it slightly on both sides—this makes the salt draw to the outside—then rinse it well in a pannikin of water. This process is found to extract a great deal of salt, and to leave the meat in a fit state for cooking.

How to Stew Fresh Beef, Pork, Mutton, and Veal.—Cut or chop two pounds of fresh meat into ten or twelve pieces, put these into a saucepan with a teaspoonful and a half of salt, a teaspoonful and a half of sugar, half a teaspoonful of pepper, two middle-sized onions sliced, half a pint of water. Set on the fire for ten minutes until forming a thick gravy. Add a tablespoonful of flour, stir on the fire a few minutes; add a quart and a half of water; let the whole simmer until the meat is tender. Beef will take from two hours and a half to three hours; mutton and pork about two hours; veal an hour and a quarter to an hour and a half. If onions, sugar, and pepper are not to be had, meat thus prepared will even then make a good dish with half a pound of sliced potatoes

or two ounces of preserved potatoes ; ration vegetables may be added, also a small dumpling.

For a hurried dinner cut your rations into pieces about the size of a penny, but three or four times thicker ; skewer them on a piece of iron wire or hard stick. A few minutes will cook them if hung before the fire.

Vegetables must be carefully washed and cleaned from insects.

Green vegetables must be boiled fast in plenty of water, and drained at once when done. They sink when sufficiently cooked. *Potatoes* take from twenty to thirty minutes boiling ; they show signs of breaking when they are done, which can be ascertained by sticking a fork into them. *Carrots* and *parsnips* take from twenty to forty-five minutes boiling. Young nettles, sweet docks, turnip-tops, or the young leaves of mangel-wurtzel, make good green food : a little pepper and salt should be added to season them. Dandelion leaves, especially when young, make a most agreeable salad.

Dried and compressed vegetables of all kinds should be soaked from four to six hours in pure water, and then boiled slowly ; if there is any bad taste from putrefaction having commenced, a little chloride of lime will remove it. The "*mixed compressed vegetables*" should be boiled in a little water for about half an hour ; the *cabbage* to be boiled in sufficient water for half an hour ; the *carrots* and *turnips* to be boiled for about fifteen minutes ; *potatoes* to be boiled in sufficient water for half an hour. *Rice* should be washed and soaked, and then boiled in plenty of water, *without salt*, for twenty or twenty-five minutes ; then some salt should be thrown in, and the water drained off. Each grain will then be separate.

To Make Tea.—Before the tea is made the kettle must be well washed, and heated with a little hot water and well rinsed. The water for the tea should then be put in, and boiled before the tea is put in, care to be taken that the water is boiling fast when this is done. If possible the boiling water should be poured from one kettle into another containing the dry tea. The lid should then be put on, and the pot placed beside (but

not on) the fire for four or five minutes before serving it out. Much depends on the softness of the water; if the water is hard add, when possible, half a teaspoonful of carbonate of soda to the camp-kettleful (for five men).

To Make Coffee.—The same rules apply, as regards cleanliness and the description of water, as in making tea. Sometimes there is only time to prepare it by boiling; but, if possible, it is better to heat the coffee in the lid of the kettle; then put it in a kettle, and pour the boiling water on it, leaving it to stand near the fire for five minutes, when it will be fit for use. When there is time to do so, it should be strained through a cloth of some sort; when made the dregs should be collected and well boiled. If this decoction is poured over fresh coffee the result of the second making will be found strong and aromatic. To clear coffee, some cold water should be poured in from a height. The cold water sinks through the coffee, and carries down the suspended particles.

COOKERY FOR THE SICK.

Arrowroot.—Take a small tablespoonful of arrowroot, mix or blend it smoothly in two tablespoonfuls of cold water. Then add half a pint of boiling water, and stir it until it thickens; add sugar. A little wine will render it more agreeable.

Water-gruel.—Rub a tablespoonful of oaten meal smooth in a little cold water, add this to a pint of boiling water (on the fire), stir gently for a quarter of an hour. Let it settle; pour off from dregs, and add a little salt and butter.

Barley-water.—Wash a handful of barley and simmer in three pints of water. A little lemon-peel will flavor it.

Beef-tea.—Take one pound of rump steak, mince it fine, and mix it with one pint of cold water; place it by the fire to heat *very* slowly. It may stand two or three hours before it is allowed to simmer, then boil for fifteen minutes; skim and serve. Good in fever and debility.

SOME NAUTICAL TERMS IN COMMON USE.

- ABACK.** A sail is aback when its fore side is acted upon by the wind.
- ABEFT.** A position toward the stern from any stated point.
- ABEAM.** Bearing at right-angles to the line of the keel.
- ABOUT.** To pass from one tack to the opposite one.
- ADRIFT.** Broken loose, as a boat from her moorings.
- AFT.** Toward the stern.
- A-LEE.** To the side of a vessel opposite to the wind. The helm is a-lee when the tiller is put over to the lee side.
- ALL IN THE WIND.** When the sails receive the wind on both sides and shake.
- AMIDSHIPS.** In the middle ; in line with the keel.
- ATHWARTSHIPS.** Across ; at right angles with the keel.
- AVAST.** An order to discontinue.
- A-WEATHER.** The side toward the wind.
- BACKSTAYS.** Ropes leading aft to support a mast, or topmast.
- BEAR UP.** To turn from the wind.
- BECALMED.** Having no wind to fill the sails.
- BELAY.** To secure a rope to a cleat or pin.
- BEND.** To make fast ; a kind of knot.
- BERTH.** An anchorage ; a sleeping-bunk.
- BIGHT.** The noose, or slack part of a rope between the ends.
- BITTS.** Upright pieces of timber to which ropes are belayed.
- BLOCKS.** Contrivances with sheaves, or pulleys, used to lead ropes more advantageously.
- BLOCK-AND-BLOCK.** When the two blocks of a tackle have been brought close together (also called "Chock-a-block").
- BOARD.** The distance made on any one tack.
- BOBSTAY.** A rope from the cutwater to the bowsprit end to sustain it.
- BOLT-ROPE.** Rope sewn round the edges of sails to strengthen them.
- BOOM.** A round spar to spread the foot of a sail.
- BOW.** The forward end of a vessel.
- BOWLINE.** A line to extend the forward leech of a square-sail when close-hauled. To sail on a bowline is to sail close to the wind.
- BOWSPRIT.** A spar extending out over the stem.

- BOWSE.** To haul upon.
- BRAILS.** Ropes fitted to draw a sail close up to the mast.
- BRING-TO.** To come to an anchor.
- BULL'S-EYE.** A piece of wood with a hole in the centre to reeve a rope through.
- BY THE HEAD.** To be deeper in the water forward than aft.
- BY THE STERN.** The reverse of "by the head."
- BY THE WIND.** As near the wind as a boat will sail without the sails shaking; also called "full and by."
- CABLE.** The line, either rope or chain, by which a vessel is attached to an anchor.
- CAPSIZE.** To turn over.
- CARRY AWAY.** A spar is carried away when it is broken or disabled.
- CAST OFF.** To untie; to allow to go free.
- CASTING.** To pay a vessel off on the desired tack when getting under way.
- CAT'S PAW.** A light current of air seen upon the water.
- CENTREBOARD.** A movable keel that can be hoisted or lowered at pleasure.
- CLEAT.** A piece of wood or metal, with two horns, upon which ropes are belayed.
- CLEW.** The after corner of a fore-and-aft sail and the two lower corners of a square-sail.
- CLOSE-HAULED.** Sailing as near as possible to the wind.
- COCKPIT.** An open space in the after part of a yacht.
- COIL.** To gather a rope into circular rings one above another.
- COURSE.** The point of the compass on which a vessel sails; the direction she is going.
- CRANK.** Not stiff; unable to carry canvas well.
- CRINGLE.** A thimble or grommet worked into the bolt-rope of a sail.
- CROTCH.** Two crossed pieces of wood, or an iron stanchion in which the boom is supported when at anchor and the sail furled.
- CUTWATER.** Timber forming the stem or entrance of a vessel.
- DAVITS.** Bent iron stanchions extending over the side, to which boats are hoisted.
- DOWNHAUL.** A rope used to haul down sails.
- DOWSE.** To lower by the run. To extinguish.

- DRAUGHT.** Depth in the water.
- DRIFT.** To float with the tide or current.
- EARINGS.** Lines used to lash reef-criingles, heads of sails, etc.
- EASE-OFF.** To slacken.
- ENSIGN.** The national flag.
- ENTRANCE.** The lower part of a vessel's stem.
- FAG-END.** The end that is frayed.
- FALL OFF.** To move away from the wind.
- FATHOM.** A measurement of six feet.
- FID.** A tapered instrument used in splicing rope.
- FILL AWAY.** To have the wind fill the after surfaces of the sails and the vessel proceed on her course.
- FOUL.** To come into collision ; an entangled rope or sail.
- FORE-REACH.** To pass to windward of another vessel when close-hauled.
- FURL.** To stow a sail close to the mast, yard, or boom by means of gaskets.
- GAFF.** The spar that supports the head of a fore-and-aft sail.
- GANGWAY.** The place where persons usually come on board a vessel.
- GARBOARD-STRAKES.** The planks next the keel on either side.
- GASKET.** A lashing of rope, or canvas, used to secure furled sails, etc.
- GO ABOUT.** To tack.
- GOSENECK.** An iron joint connecting a boom with a mast.
- GRAPNEL.** An anchor with four arms, or claws.
- GROMMET.** A rope ring.
- GROUND-TACKLE.** Anchor, cable, and fittings.
- GRIPING.** Carrying too much weather helm.
- GYBE.** To pass the mainsail from one quarter to the other when running.
- HALLIARDS.** The ropes with which sails are hoisted.
- HAND-OVER-HAND.** To pass the hands alternately before one another when hauling.
- HANDSOMELY.** Carefully ; slowly.
- HANDY-BILLY.** A small snatch tackle used for clapping on a rope.
- HANKS.** Metal rings fitted to slide freely on stays, to which sails are seized.
- HEAVE-TO.** To stop a vessel's way by so arranging the sails that

she will lie nearly head to wind, and have no tendency to forge ahead.

HEELING. Inclining to one side.

HELM. A tiller or wheel which controls the rudder.

HITCH. A species of knot.

IN IRONS. When steerage-way is lost and the vessel will not obey her helm.

JACKSTAY. A small bar of iron, or rope-line reeving through staples on a spar, to which a sail is bent.

JAM. A rope is jammed when it refuses to pass a block by reason of a kink; a knot is jammed when it is difficult to untie.

JAWS. Gaff-horns which fit a mast.

JIB. Triangular sail set on the bowsprit.

JURYMAST. Temporary mast, used generally to replace one carried away.

KEDGE. A small anchor.

KEEL. That part of a vessel lowest in the water and upon which all the rest is erected.

KINK. A twist in a rope.

LANDFALL. Discovering the land.

LEECH. The after edge of a fore-and-aft sail.

LEeward. The direction toward which the wind is blowing.

LONG LEG. A long distance on one tack.

LOG. The record of a vessel's performance, etc., for each day of twenty-four hours, kept in a log-book; also an apparatus for measuring the speed.

LUBBER. A person who is not accustomed to the sea, a greenhorn or awkward sailor.

LUFF. To put the helm to leeward so that the vessel turns toward the wind; the forward border of a fore-and-aft sail.

LYING-TO. Heading close to the wind under very little sail and helm a-lee, to ease the vessel, in heavy weather.

MISSING STAYS. When the vessel refuses to tack.

MOOR. To secure by two or more cables and anchors.

MOORINGS. The place where a vessel is generally kept when at anchor.

MOUSE. To seize a piece of spun-yarn or twine around a hook, to prevent its becoming detached.

NEAR, TOO NEAR. Steering too close to the wind.

OFF-AND-ON. Approaching the land on one tack and leaving it on the other.

OFFING. Out to sea ; sea room.

OVERHAUL. To examine ; to slack up a rope and haul it through the blocks ; to overtake.

PAINTER. A rope attached to the bows of a boat, by which she may be secured.

PART. To tear asunder.

PAY. To paint with pitch or tar.

PAY OFF. To recede from the wind, as a boat when the jib is hauled to windward and the main-boom eased off.

PEAK UP. To elevate the after end of a sail or gaff.

PENDANT. A short piece of rope.

PENNANT. A long narrow flag, or streamer.

POOPED. Struck by a sea that tumbles on board over the stern.

PORT. Left hand, opposite to starboard.

PREVENTER. Anything to take off the strain, as preventer-sheet.

QUARTER. The part between the beam and stern.

RAKE. The leaning of a mast from the perpendicular.

REACHING. Sailing with the wind abeam.

REEF. To reduce sail by means of reef-points.

REEVE. To pass a rope through a block or fairleader.

ROOTING. Burying by the head.

RUN. The after end of a vessel underneath at each side of the keel.

SCANT. A wind is scant when a vessel can barely lay her course.

SCUD. To run before the wind.

SELVAGEE. A strap made of yarns loosely hitched.

SEIZE. To make fast or bind.

SHEAVE. The wheel in a block.

SHEER. To vary from a direct course ; line of planking under gunwale.

SHEET. The rope attached to the after-clew of a fore-and-aft sail by which it is held and worked.

SNORTER. A rope strop into which the heel of a sprit is slipped (sometimes improperly called snotter).

SOLDIER'S WIND. A wind abeam.

SPILL. To throw the wind out of a sail by easing the sheet or otherwise.

SPLICE. To join two parts of rope together by interweaving the strands.

SPRING. To crack or split a spar, is to spring it; a rope made fast to the cable, or some convenient place on shore, or to another vessel, and taken on board aft in order to haul a vessel's stern in any desired direction.

SPRIT. A light spar used to extend a spritsail.

SQUATTING. Settling by the stern.

STARBOARD. The side to the right looking forward.

STAY. A rope to support a mast. *In stays*, when a vessel is going about.

STERNBOARD. To sail backward, or stern first.

SWIG OFF. To catch a turn with a rope at a cleat, and then pull upon it sidewise, giving in suddenly, and hauling the lock round the cleat.

TACK. The lower forward corner of a fore-and-aft sail.

TACKING. Advancing by a series of zizzag courses toward the wind's eye; going about.

TACKLE. A purchase made up of blocks and ropes.

TAUNT. Lofty; long.

TAUT. Tight.

TILLER. The lever by which the rudder is controlled.

TURNING TO WINDWARD. Tacking.

UNBEND. To cast off; to release.

VEER. To pay out cable.

WAKE. The track left by a vessel on the water.

WATCH. A division of the crew.

WEAR. To turn a boat's head from the wind until she comes to the wind on the other tack.

WEATHER-HELM. When the tiller is pressed to windward to keep the boat from flying up into the wind.

WEATHERING. Getting to windward of a vessel by closer sailing.

WIND'S EYE. The exact direction from which the wind proceeds.

YACHT. A vessel used for pleasure, and generally built for comfort and speed.

YAW. To swerve violently from the course, despite the action of the rudder.

INDEX.

ACCIDENTS, injuries, etc., 244

- Action of rudder, etc., 4
- Ague, to treat, 246
- Alice, keel sloop, described, 207
- Allowances for boat racing, 138
- Anchorage, to bring up at, 127
- Anchoring canoes, 184
 - cutters and sloops, 216
 - directions for, 126
 - in matches, 142
 - on lee shore, 126
- Anchors, Chester's, etc., 55
 - for boats, 55
 - to weigh, defined, 16
- Aneroid barometer rules, 233
- Angle of boom in sailing, 9, 10
- Antidotes for poisons, 245
- Apparently drowned, to treat, 239
- Aprons for canoes, 193
- Area of canoe centreboards, 192
 - of canvas for canoes, 158
- Arrangement of ballast, 8
- Arrow, Norfolk sloop, 210
- Arrowroot, to prepare, 252
- Arsenic, antidote for, 245
- Artificial eye, to make, 31
- Asphyxia, treatment, 245

BALANCE lug-sail, described, 47

- Balance lug-sail fittings, 49
- Balance lug-sails for canoes, 153 to 158
- Bale slings, described, 34
- Ballast, arrangement of, 8
 - coatings for, 236
 - defined, etc., 8
 - for canoes, 147
 - for open boats, 52, 54, 55
 - influence of, on steering, etc., 8
 - materials for, 8

Ballast, to trim amongst waves, 120

- Balloon jib, described, 200, 218
 - sails, described, 200
 - topsail, described, 200
- Barley-water, to prepare, 252
- Barrel-sling, described, 34
- Bathers, hints for, 237
- Batswing sliding-gunter sails, 171
- Battened sails, described, 89, 91, 164
- Battens for sails, 89, 164
- Beaching a canoe, 185
- Bearing up, explained, 15
- Becket-bend, to make, 20
- Beef, to cook, 250
- Beef-tea, to make, 251
- Beginner's first sail, 57
- Bends, described, 16, 20
- Bermuda boats, described, 86
 - raees, 87
 - sails, 88
- Bight, of rope, defined, 16
- Black stain, to make, 236
 - varnish, to make, 236
- Blackwall hitch, to make, 20
- Bleaching sails, 256
- Blocks, description of, 13
- Block-straps, described, 13
- Boarding a canoe, 183
 - a wreck or vessel in a heavy sea, 229
- Boat-anchors, weights of, 55
- Boat, Easton's portable, 54
 - caught in gale, 124
 - for novices, 57
 - matches, rules for, 140
 - racing, position of crew, 65
 - racing, remarks on, 129
 - sailers, hints for, 61
 - sailing on Clyde, 93
 - sails, materials for, 13, 55

- Boat, decking of, 38**
 general management, 107
Boats, for outside work, 38
 for rowing and sailing, 38, 51
 stability of, 39
 rigs for, 39, 47, 71
 stiffness of, 38
 serviceable type of, 37
 to get under way, etc., 57
 to manage in squalls, 115
Boiling meat, directions for, 139
Bolt-rope, described, 12
Boom trimming, described, 9
 tripping, to avoid, 63
Box off, definition of, 16
Bowline, defined, 108
 knots, to make, 18
Broaching-to, described, 113
Bruises, treatment for, 244
Burns or scalds, treatment for, 244
By the wind, defined, 15
- CABLES for boats, etc., 56**
 Cables to mark, 56
Canoe anchoring, 184
 centreboards, 191
 disposition of weights in, 147
 fittings, 186
 for cruising, described, 146, 158
 handling under sail, 176
 main-sheet fittings, 159
 racing outfit, 162
 reefing gears, 155, 159, 162
 rig for beginners, 176
 rig for general work, 158
 rudders, 193
 sailing, 145
 sails and rigging, 150
 sails described, 150 to 175
 sails, fittings of, 154, 155
 sails for cruising, etc., 153
 sails for racing, etc., 158
 spars, 157, 161, 163
 steering gear, 190
Canoes, beaching, etc., 185
 classification of, 146
 free board of, 150
 sail-carrying power of, 147
 stability of, 146
 trunks for masts, 189
- Capsized boat, directions for, 67**
 canoe, directions, etc., 183
Capsizing, causes of, 116
Carmita, cutter yacht, described, 205
Carrick-bend, to make, 25
Cask and bale slings, 34
Casting, in getting under way, 107
Cat-boats, described, 39
 fittings, etc., 42
 remarks on, 42
 to trim, 62
 unsinkable, 45
Catspaw, to form, 20
Cautions for boat sailers, 61
Centreboard boats, etc., 51
 boats, rigs for, 52
 described, 51, 52, 54
 gig, described, 51
 sloop Gleam, 206
 versus keel, 37
Centreboards for canoes, 191
Chart, desirable, 62
Cheek-blocks, described, 18
Chester's anchor, described, 55
Cincinnati canoe sails, 174
Clew of sail, defined, 13
Classification of canoes, 146
Clinchee, described, 18
Close-hauled amongst waves, 121
 sailing, 6, 9, 15, 121
Clove-hitch, described, 20
Clyde boats and fittings, 93, 94
Coast sailing, equipment, 183
Coat for canoeist, 194
Coffee, to make, 252
Cold, remedy for effects, 246
Comparison of strength of rope, 34
Compass for boats, 62
Cookery, hints on, 249
Crew, allowance of, 141
 position during races, 136
Cruiser, described, 78 to 75
Cruising canoes, 146
 canoe sails, 153
 sail areas, 56
Cubic foot of water, weight of, 3
Cuckold's neck, described, 18
Cut-splice, described, 32
Cutter and sloop sailing, 212
 Carmita, particulars, 205
 Daisy, particulars, 203

Cutter Mignonette, particulars, 205
rig, described, 197

DAISY, particulars of, 203
Dandy rig, described, 218
Deck side-flaps, for canoes, 194
Decks, to whiten, 237
Definitions, etc., 12
Dislocations, treatment of, 244
Displacement of floating bodies, 8
Dot reefing-gear, described, 167, 168
Double centreboards, 192
head sails, remarks, 103
wall and crown, to make, 25
Drag, to construct, 64
Drogue, described, 123
Drowning persons, to save, 238
Drunkness, to treat, 247

EASTERN cat-boats, described, 44
Easton's portable boat, 54
Effect of wind on sails, 5
Elaine, particulars of, 98, 101
Entries, for matches, 140
Equipment of cutters, 197, 198
of sloops, 200
Eye-splices, to make, 31, 32

FAINTING, treatment for, 246
Fall of tackle, defined, 14
Fan centreboards, described, 52, 192
Fever, treatment of, 246
Fids, described, 29
Figure-of-eight knot, to make, 18
Fisherman's bend, to make, 22
Flags for matches, 141
Flotation, defined, 8
Flying starts for races, 133
Foot of sail, defined, 13
Forbes cat rig, described, 43
Fore-and-aft seamanship, questions in,
219
Fouling, remarks on, 134, 142
Fractures, treatment of, 243
Free board, remarks on, 39, 150
sailing, described, 10
French gunter rig, 78 to 81
Frost-bitc, to treat, 246
Full-and-by, to sail, 10

GAFF-sail, to rig, etc., 39, 40
Gaff-topsail halliard bend, 22
Gaff-topsail sheet bend, 22
Gale, preparations for, 123, 125, 219
to handle boats in, 123
Galvanized iron centreboards, 52, 53
Gathering-line, described, 91
Gear, for racing-boats, 130
Getting boats underway, 107
Gleam, centreboard sloop, 206
Going about, described, 15
free, explained, 15
alongside, described, 225
Granny knot, to make, 18
Grommet, to make, 29
Grounding, remarks on, 127
Gun-tackle, defined, 14
Gybing boats, described, 12, 15, 60, 63,
219
canoes, remarks on, 182
cutters and sloops, 215

HALF board, described, 112
Half hitches, to make, 20
Halliards, to bend, 22
Handiness of balance lug-sail, 50
Handling boats under sail, 56, 57, 107,
119, 121, 223
New Brighton boats, 102
sailing boats amongst waves, 119 to
121
sailing boats in gales, 123 to 125
sailing canoes, 176 to 186
sloops and cutters, 212
spinnakers in canoes, 181
yawls, 218
Head of sail, defined, 13
Heaving to man-of-war boats, 224
Helm, movements of, explained, 15
Herreshoff's time allowances, 139
Hints for boat sailers, 61
for bathers, 237
Hitches, described, 16, 20
Horse, described, 34
Hove to, defined, 15

INITIAL stability of boats, 39
Injuries, etc., treatment for, 242
Instruments, to work wire rope, 29

Irish stew, to make, 249
Iron ballast, remarks on, 8

JIB, in cat-boats, 18
Jib-and-mainsail boats, 71, 107
Jib-and-sprit rig, described, 71
Jib sheets, described, 18
Joyner's combination boats, 52

KEDGING, described, 127
Keel boats, when desirable, 38
Keel cat-boats, described, 45, 47
sloop Alice, described, 207
Keeping away, defined, 15
Knots, descriptions of, 16
Kunhardt, on two head sails, 104

LAKE Windermere sloops, 208
Landing, to run alongside, 61
Lark's head, to make, 18
Lateen sails for canoes, 174
Lateral resistance, defined, 4
Laying-to, defined, 15
Lead ballast, remarks on, 8
Lead-line for boats, 62
Leech of sail, defined, 13
Lee side, defined, 14
Leeway, definition of, 4
Leg-of-mutton sails, described, 82
rig for canoes, 175
Long splices, to make, 31, 32
Luffing, explained, 15
in matches, 141
Luff of sail, defined, 13
Luff-tackle purchase, defined, 14
Lug-sail, remarks on, 93
Lug-sails, for canoes, 169
for navy boats, 221
Lying-to, definition of, 15
in a gale of wind, 125

MAD dog bite, to treat, 247
Magnus hitch, to make, 20
Main- and mizzen rig, described, 89, 90
rig for canoes, 151
Main-sheet, remarks on, 13, 41, 50, 61,
117
fittings for canoes, 159
horse, described, 34

Main-tack, advantage of tricing up, 124
Making sail, remarks on, 107
in canoes, 176
Man-of-war boats under sail, 223
Manilla rope, described, 12
Man overboard, directions, 142, 220
Man-rope knot, to make, 25
Marks, rounding, etc., 134, 135
Marline, definition of, 12
Marlinspike, described, 29
seamanship, etc., 16
Marsh poison, to provide against, 247
Masthead fittings for canoes, 154, 160, 162
Mast-hoops, to keep parallel, 41
Mast-tabernacles, 49, 186, 187
Masts, to lower, 50
Mast-traveller, described, 49
Mast-trunks, etc., 189
Materials for ballast, 8
Mathew Walker knot, 25
Meat soup, to make, 249
Meat, to boil, etc., 240
Midshipman's hitch, to make, 20
Mignonette, cutter, described, 205
Missing stays, in boats, 59, 110
in canoes, 190
Mohican sail, described, 165, 167
Mooring, directions for, 127, 128

NAUTICAL expressions, etc., 12
Nautical terms, defined, 253 to 258
Nautilus travelling sails, 153
Navy boats, rigs for, 78, 220, 221, 222
salutes of, 228
under oars, management of, 226
New Brighton boats, etc., 98, 102
Newport cat-boats, described, 44
Nonpareils, remarks on, 85, 86
Norfolk sloops, described, 210

OARS, to use when sailing, 117
Off-the-wind, explained, 15
Oil, use of, on wave crests, 126
On-a-wind, explanation of, 15
Open boats, stiffness of, 38
Opium, antidotes for, 245
Overhand-knot, described, 18
Over-reaching, remarks on, 138
Overtaking, rules regarding, 141

PAINT for boats' bottoms, 236
 Paint, to remove, 236
 Parcelling ropes, method of, 12, 27
 Parole, description of, etc., 71, 73
 Peak of sail, defined, 13
 Pilot's-luff, described, 112
 Points of sailing, 9, 58
 Poisons, antidotes for, 242, 245
 Port side, defined, 14
 tack, defined, 7, 14, 15
 Position in canoes, 176
 Power to carry sail, 8
 Preliminary definitions, 12
 Prickers, described, 29
 Prizes, in matches, 141
 Protests, in matches, 142
 Prussic acid, antidote for, 245
 Pumping and baling gear, 194
 Purchases, described, 14

QUARTERING the sea, remarks on, 121

RACES, to prepare for, 129
 Racing, hints regarding, etc., 65, 93, 130, 131, etc.

Racing, reefing gear for canoes, 162
 sail area for boats, 57
 sails for canoes, 153, 153, 162
 Range of stability of boats, 39
 Reaching, remarks on, 112, 181
 Receipts for various purposes, 235
 Reefing, described, 60, 63, 114, 178, 215, 219

Reef knot, to make, 18
 pendant bend, to make, 22
 Reefs, to shake out, 63
 Reefing gear, for canoes, 155, 159, 162, 167, 168
 in canoes, 178
 lateen sails, described, 175
 in man-of-war boats, 224

Regatta committee, remarks on, 142
 Rice, to cook, 251
 Riding out gales, rules for, 125
 Rigging, materials for, etc., 12
 Rigs for boats, 39, 40, 71, 22
 Roasting meat, described, 139
 Roller mizzen, described, 165
 Rolling bend, to make, 22
 Rope cables, to mark, 56

Rope cables, description of, etc., 12
 sizes to reeve, etc., 14
 strength, of wire and hemp, 34
 to splice, whip, etc., 13, 16
 Rounding bends in rivers, 57
 marks, described, 134, 185
 Roalyn yawl, sails for, 85
 Rudder, action of, etc., 4
 Rudders for canoes, 193
 Rule for displacement, etc., 3
 of the road, 62
 Rules for boat racing, 140
 - for weather predictions, 233
 Running before the wind, 10, 112, 189
 bowline, to make, 13
 rigging, defined, 12

SAIL areas of boats, 44, 47, 56
 Sail carrying power, 8, 147
 Sailing allowances, 138
 along shore, 115, 116
 amongst waves, 118, 119, 180
 and rowing, 117
 boats, to select, 37
 canoes, remarks on, 145
 close-hauled, 6, 107, 178
 free, remarks on, 10, 112
 in heavy weather, 64, 123
 matches, preparations for, 129
 matches, rules for, 140
 on a bowline, 108
 the points of, etc., 9, 15
 preparations, 57
 through surf, 114
 to windward, 6, 108
 to leeward of vessels, 117
 Sails, allowed in matches, 140
 and rigging of canoes, 150, 155 to 175
 and spars of Elaine, 100
 described, 13
 for boats, 50, 55
 for canoes, 151, 158, 161
 laced versus unlaced, 202
 materials for, 13, 44, 61, 151 to 161
 of cutter Daisy, 204
 of New Brighton boats, 101
 of racing boats, 131
 to bleach, 236
 to stow, 128
 with battens, 89

Salutes of navy boats, 228
 Schooner rig, remarks on, 219
 Scudding, remarks on, 112, 113
 Sea anchor, to use, 64
 Seamanship, marlinspike, described, 16
 Selvage strap, to make, 29
 Serving ropes, described, 13, 27
 Settee sails, described, 96, 97
 Shaking out reefs in canoes, 178
 Sharpies, described, 84
 Sheermasts, described, 91
 Sheet bend, to make, 20
 fittings of Elaine, 100
 Sheets, main and jib, described, 13
 to trim during matches, 132
 trimming of, 9
 Shifting sails in canoes, 178
 Shrouds, to fit, 66
 Short splice, to make, 29
 Single sail, remarks on, 41
 wall-knot, etc., to make, 25
 Sister blocks, described, 14
 Sliding-gunter rig, described, 78, 79,
 171
 Slings for casks, bales, etc., 34
 for balance lug-yard, 49
 Slippery hitch, to make, 18
 Sloop and cutter sailing, 212
 Alice, described, 207
 Gleam, particulars of, 206
 rig, described, 200
 Sloops of Lake Windermere, 208
 of Norfolk, 210
 Snatch-blocks, described, 14
 Snorter, described, 77
 Soup, to make, 249
 Spars of cutter Daisy, 204
 Spinnaker, described, 200
 for canoes, 159, 181
 Splices, described, 13, 16, 29, 32
 Sprains, treatment for, 244
 Sprit-mizzen for canoes, 164
 Sprit-sails, described, 75, 76
 Spun-yarn, defined, 12
 Squalls, hints concerning, 61, 62, 64, 67,
 115, 179
 in canoe sailing, 179
 in man-of-war boat sailing, 225
 Square knot, to make, 15
 Stability of boats, 4, 39
 of canoes, 148

Standing lug-sail for canoes, 169
 rigging, defined, 12
 Starboard side, tack, etc., defined, 14
 Starting for races, remarks on, 133
 Steering boats, 12, 57, 110, 113
 during sternway, 110
 gear for canoes, 190
 Stew, to make, 249
 Stiffness of open boats, 38
 Stoddard sail for canoes, 165
 Stowing sails, 128
 Straps, or *strops*, to make, 13, 29
 Sunstroke, treatment of, 245
 Surf sailing, 114

TABERNACLE, described, 49, 186
 Tack, of sail, defined, 13
 Tacking boats, 15, 59, 109
 canoes, 180
 cutters and sloops, 214
 hints, etc., 63
 schooners, 219
 man-of-war boats, 224
 Tackle, defined, 14
 Tail block, described, 14
 Taking in sail, in canoes, 177
 Tea, to make, 251
 Thermometer, indications of, 234
 Thimbles, method of splicing in, 32
 Thirst, to relieve, 248
 Throat of a sail, defined, 13
 Thunder shower, to prepare for, 62
 Tide, to utilize, 138
 Timber-hitch, to make, 20
 Time allowances, 140
 Topmast fittings of Elaine, 100
 Topmasts, of cutters, 197
 self fiddling, 203
 Topping lifts for cat-boats, 41
 Topsail halliard bend, to make, 22
 sheet, to bend, 22
 Travelling canoe sails, 153
 Tredwen's mast trunks, 188
 Trimming the boom, 9
 Trim of boats, in matches, 130
 in heavy weather, 124
 Trunks, for masts, 186, 187
 Tumbler fids, for topmasts, 203
 Turk's head, to make, 27
 Turning to windward, defined, 15

UNA, cat-boat, described, 42
 Underway, defined, 16, 57
 Underway, to get, 107
 Useful recipes, 235

VARNISHING bright, 236
 Vegetables, to cook, 251

WALL-KNOTS, to make, 25
 Water, to purify, 248
 Water ballast, for boats, 8
 Water-gruel, to make, 252
 Waterproofing canvas, 235
 Waves, sailing amongst, 118
 Wearing a boat, 15, 64, 224
 Weather helm, to carry, 15
 indications, 233
 signs, 234
 Weathering objects, 15, 67
 Weighing anchor, defined, 16
 anchor in canoes, 184

Weight, advantage of, in boats, 9
 of anchor for boats, 55
 of cubic foot of water, 8
 Whipping a rope, 16
 Whip purchase, defined, 14
 Whitening decks, 237
 Wind, terms relating to, 10, 11
 effect of, on sails, 5
 propelling force of, 5
 Windermere sloops, 208
 Windward sailing, 15, 108, 181
 Wire rope, compared with hemp, 34
 to splice and work, 32
 Working to windward, defined, 15
 Worming rope, process of, 12, 27
 Wreck, boarding a, in a heavy sea, 299

YACHT Racing Association of New
 England, 138
 Yard slinging for canoe sailing, 174, 176
 Yawl rig, described, 216

