



**modern**  
sheet copper  
practices

for Architects  
Engineers  
Specification writers  
Sheet metal workers

THE AMERICAN BRASS COMPANY

A.I.A. No. 12

691.8  
A 512 m

University  
of Florida  
Libraries



The Gift of  
John L.R. Grand

# modern SHEET COPPER PRACTICES

C. H. -  
A-512M  
APR 14  
ALLIED ARTS  
R. P.

## *a guide for the correct uses of sheet copper*

These drawings and specifications are intended as a guide to the Architect, to the Specification Writer and to the Sheet Metalworker. They are not presumed to be a complete work in the application of sheet metal in building, but instead they represent a reissue of the best in construction detail. The drawings are original in type and modern in concept, and designed to be applied to present day materials and methods.

The details and the specifications embody the advanced knowledge of sheet copper work, whereby it is established that all of the copper that is soldered or otherwise anchored shall be of cornice temper. Also that the gage of the metal shall be heavy enough and in good proportion to the breadth and scale of the work, and finally that expansion joints and other provisions be made for freedom of movement wherever possible.



The American Brass Company  
Waterbury 20, Connecticut

See...

<b>table of contents</b>	<b>page no.</b>	<b>plate no.</b>
Preface	1	
Table of Contents	2, 3	
General Specifications	4, 5	
Standing seam roofing, roll method	6, 7	1
Standing seam roofing, pan method	8, 9	2
Standing seam roofing, pan forming details	10, 11	3
Batten seam roofing	12, 13	4
Covered dome	14, 15	5
Flat lock soldered seam roofing	16, 17	6
Expansible intersections	18, 19	7
Roof edgings	20, 21	8
Edgings for insulated built-up roofs	22, 23	9
Flashing at copings	24, 25	10
Flashing for dwarf parapet with scupper	26, 27	11
Flashing for monitor roof	28, 29	12
Flashing of roof curbs	30, 31	13
Protected valley flashing	32, 33	14
Built-in gutter for masonry building	34, 35	15
Built-in gutters	36, 37	16
Built-in gutter and copper coping	38, 39	17
Flashing of cornice and balustrade	40, 41	18
Apron for shingle roof	42, 43	19
Flashing at junction of flat and sloping roof	44, 45	20
Valley flashings	46, 47	21
Roofing — bay windows	48, 49	22
Through-wall flashing for cavity wall	50, 51	23
Water table flashing	52, 53	24
Window sill flashing	54, 55	25
Window head flashing	56, 57	26

	<b>page no.</b>	<b>plate no.</b>
Roof and parapet flashing	58, 59	27
Corner flashings	60, 61	28
Cornice and parapet flashing	62, 63	29
Gable and parapet flashing	64, 65	30
Through-wall flashing of pilasters	66, 67	31
Parapet flashing and sheathing	68, 69	32
Roofing and flashing at building setback	70, 71	33
Chimney flashing at ridge	72, 73	34
Chimney flashing, architectural design	74, 75	35
Chimney flashing in slope	76, 77	36
Chimney flashing in flat roof	78, 79	37
Flashing — construction and expansion joints	80, 81	38
Vertical and horizontal expansion joints	82, 83	39
Flashing intersection of structural expansion joints	84, 85	40
Expansion joint for floor and wall	86, 87	41
Expansion joint and base flashing	88, 89	42
Gable end parapet with straight line counter flashing	90, 91	43
Gable end to stucco wall flashing	92, 93	44
Coping covers and base flashing	94, 95	45
Snow guards	96, 97	46
Metal surrounds for windows	98, 99	47
Copper-covered sunshades and canopy	100, 101	48
Copper-faced sunshade	102, 103	49
Flashing sprayed or flooded built-up roof ...	104, 105	50
Copper-covered spires	106, 107	51
Curtain walls of metal	108, 109	52

# SUGGESTED SPECIFICATIONS

## sheet copper work

### general conditions

The general conditions as set forth and prescribed by the American Institute of Architects in Form A-2 shall be a part of this contract so far as they apply.

### scope of the work

Unless otherwise agreed, this contract shall include the furnishings of all materials and labor shown or called for on the drawings or in the specifications, and including the flashing or joining of materials not shown, but which are apparently intended or required to make a complete and satisfactory installation of sheet copper.

### materials

**SHEET COPPER**—The copper shall be standard electrolytic, tough pitch, A.S.T.M. Type "A" cold rolled to what is known as "cornice temper" having a yield strength of not less than 20,000 lbs. psi, measured at 0.5% extension under stress. Copper of roofing temper is permitted only for small flashing pieces where it can be installed without solder or direct nailing. The sheet copper shall be handled with due respect for the quality and beauty of the material. Imperfections such as holes, dents, creases or crinkles will be cause for rejection.

**NAILS**—The nails for fastening the copper cleats which in turn hold the sheet copper are to be flat head 7/8" No. 12 made from hard drawn copper wire or of an approved bronze.

**SCREWS, BOLTS AND EXPANSION SHIELDS**—All accessories for fastening the copper work are to be of copper, bronze or brass. Expansion shields may, however, be of lead or a combination of lead and bronze. The wood screws are to be No. 12 gage and the machine screws or bolts are to be 1/4" diameter.

**CLEATS**—Copper cleats for fastening the sheet copper work to the construction are to be at least 1½" wide and of the same gage of metal as that which is being fastened, except they need not be heavier than 16 oz. gage. The cleats shall be long enough to make at least a 1/2" interlock with the sheet copper and to allow sufficient metal in the cleat to fold over the nail heads.

**SOLDER**—The solder shall be in bar form of an approved brand consisting of 50% pig lead and 50% pure block tin.

## **materials (continued)**

**FLUX**—The flux may be rosin, cut muriatic acid or other approved soldering flux.

**ROOFING FELT**—Under all copper work in built-in gutters, roofs and on all other horizontal and sloping surfaces there shall be an underlay of 15# asphalt saturated felt, furnished under another specification. This contractor to provide a cushioning felt of rosin-sized or unsaturated building paper, weighing approximately 6 lbs. per 100 sq. ft. applied piece by piece as the copper is installed.

## **workmanship**

**PREPARATION**—The surfaces over which the copper is to be applied are to be smooth and free of defects. It is the responsibility of this contractor to report anything in the construction that would make it difficult or impossible to produce a first-class installation of sheet copper work. Any roughness in the concrete is to be made smooth. All nails in the sheathing are to be driven flush with the surface and the work is to be kept clean at all times.

**FORMING**—The sheet copper is to be formed on a bending brake. Shaping, trimming and hand seaming is to be done on the bench as far as practicable with the proper sheet metalworking tools. The angle of the bends and the folds for interlocking the metal shall be made with full regard for expansion and contraction to avoid buckling or fullness in the metal after it is in service.

**JOINING**—The metal, already partly formed is to be put in place and fastened to the structure by means of cleats. The dry lock joints, without solder, are to be closed tight, but not dented with the mallet, so as to permit slight adjustment of the sheets and yet to remain weather-tight.

**SOLDERING**—All of the sheet copper that is to have water-tight joints shall first be cleaned with steel wool or by other means, then pre-tinned and soldered. The clinch lock seams are to be closed gently with a block of wood and mallet, then fluxed and filled with molten solder. The work is to be done with sufficient heat to induce the solder to flow into the seams by capillarity, and thereby to make a joint that is secure and permanently water-tight. Lap seams in 16 oz. copper are to be at least 1" wide and correspondingly wider for heavier gage metal. The soldered lap joints are to be reinforced with  $\frac{1}{8}$ " copper rivets spaced not over 2" apart.

**CLEANING COPPER**—All soldered joints are to be wiped and washed clean to remove all traces of acid from the flux immediately after the joints are made. When the copper work is completed it is to be washed with soap and hot water or with a suitable washing powder, rinsed with cold water and wiped dry with a cloth.

## Standing seam roofing, roll method PLATE NO. 1

The roll method of applying standing seam copper roofing originated with the terne plate steel roofs that were popular some years ago. These roofs had locked and soldered cross seams and were painted after being installed. They were applied on roof decks having a slope ranging from 2" to 6" per ft.

The roll method of standing seam roofing has been used successfully with 10 oz. Economy Copper Roofing furnished in strips 16" wide by 72" long. The 10 oz. material lends itself particularly well to this method of construction because the gage is practically the same as that of terne steel roofing, and, the ductility of copper and its excellent forming qualities are advantages which mean savings in energy and time.

16-oz. copper of roofing temper can also be applied by the roll method, but the work is somewhat harder, therefore, the pan method of making standing seam roofs is preferred when 16-oz. copper is used.

The drawing shows the strips of copper joined together endwise with 3/4" clinch locks without solder. In order to keep the strips in alignment, indentations are made with a center punch at both edges of the cross seams. The strips which are loosely wound into rolls for easy handling are unrolled on the roof deck where the edges are turned up with edging tangs. One edge is 1/4" higher than the other to form the first fold of

the double lock standing seams. The seams are then completed with the seaming tongs or "kickers" except at the ridge and the eave where the work is done with hand seamers and regular sheet metal tools. The up-standing edges of the roof pans are 1" and 1/4" for a finished standing seam 3/4" high.

### Suggested Specification

Standing Seam Copper Roofing may be applied by the Roll Method using strips of sheet copper of the proper width. These strips are to be joined together endwise by means of a 3/4" clinch lock joint, temporarily kept in alignment by indenting the metal at the folds of the lock with a center punch. The strips so assembled shall extend from ridge to eave or to the valley. The edges are to be turned up with roofing tongs as shown on the drawing, to form a double lock standing seam. The smaller upstanding edge of the formed strip is to be anchored to the roof deck at 12" intervals with 1/2" x 3" copper cleats. The finish at the ridge and at the eave and valley is to be as shown in detail.

The copper is to be 10-oz. Economy Copper Roofing applied in sheets 16" x 72" having a slight temper.

Alternate: The copper shall be of 16-oz. gage in sheets 20" x 96".



Standing seam roofing, roll method

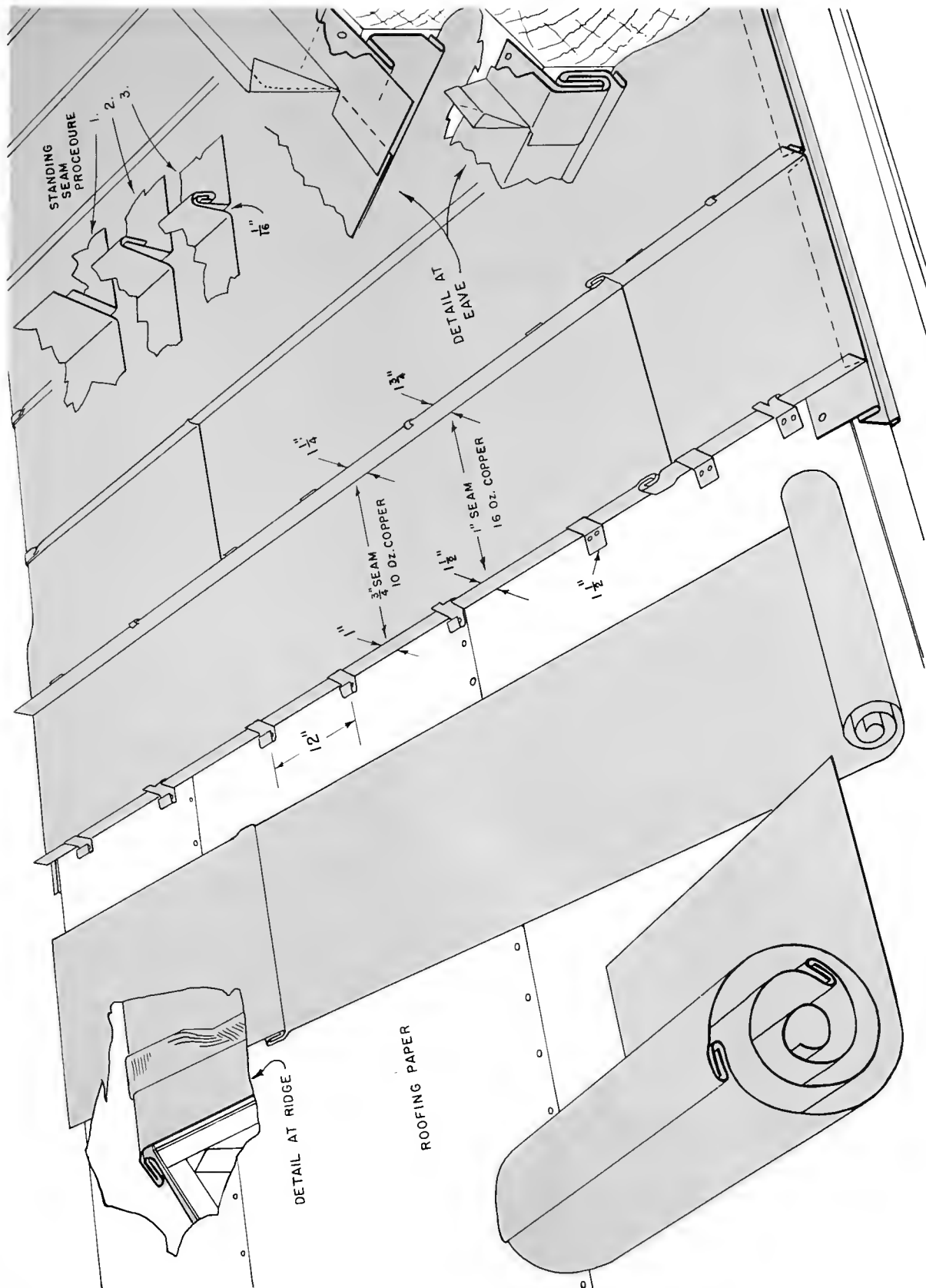

## Standing seam roofing, pan method PLATE NO. 2

In the early days of standing seam roofing it was customary to assemble the strips of copper endwise reaching from ridge to eave, then to form upstanding edges on these long strips with the aid of edging tongs. The channel shaped roofing strips were then moved into position, fastened to the roof deck, and the double lock standing seams were made with hand seamers or with special double seaming tongs known as "kickers." Some time later when the bending brake came into being it was found that a better job could be done by forming 8 ft. lengths of sheet copper into roofing pans with the help of that new device. In this procedure there is the advantage of forming the pans quite completely in the shop, making the work of installing on the roof very simple and relatively easy. It is only necessary to close the last two bends of the double lock standing seams with hand tools on the roof.

Standing seam copper roofing by the pan method is generally made of 16-oz. copper, the sheets measuring 20" wide by 96" long. The ends of the sheets are folded with 3/4" reverse bends so as to form a clinch lock when assembled end to end. The edges are then formed so as to finish with either a 3/4" or 1" standing seam.

The pan method has been used with 10-oz. Economy Copper Roofing consisting of sheets 16" wide by 72" long, intended principally for residential work. The technique of forming and applying is exactly the same as for 16-oz. copper. Economy Copper Roofing lends itself well to a 3/4" high seam for steep roofs. It is more

likely to remain straight and true, and produces a very attractive architectural shadow line.

The drawing illustrates a suggested method of applying copper roofing on a house by the pan method. The details show a 3/4" common clinch lock joint forming the cross seams. The clinch lock at the junction of the roof pans and valley is made up of 3/4" and 1 1/2" return bends thereby offering greater protection at the valley where there is a heavy flow of water. The valley has a comb or ridge in the center to interrupt the onrush of water from a wider slope, and to arrest and steady the flow at the center of the valley. This feature is only necessary where the lengths of slopes draining into the valley are unequal.

### Suggested Specification

Standing Seam Copper Roofing by the Pan Method shall consist of 16-oz. sheet copper measuring 20" x 96" formed into roof pans in the shop with a mechanical bending brake. These pans are to have reverse bends at the upper and lower ends to interlock with the adjoining metal. The longitudinal bends for the standing seams are to be formed on the brake, except for closing of the last two folds of the seams which is to be done on the roof. These pans are to be anchored to the roof deck at 12" spacings with copper cleats having 2 nails in each cleat. A tab on the cleat shall be bent back over the nail heads to prevent chafing. The finish at the ridge, eave and valley is to be as shown on the drawing.

**Standing seam roofing, pan method**

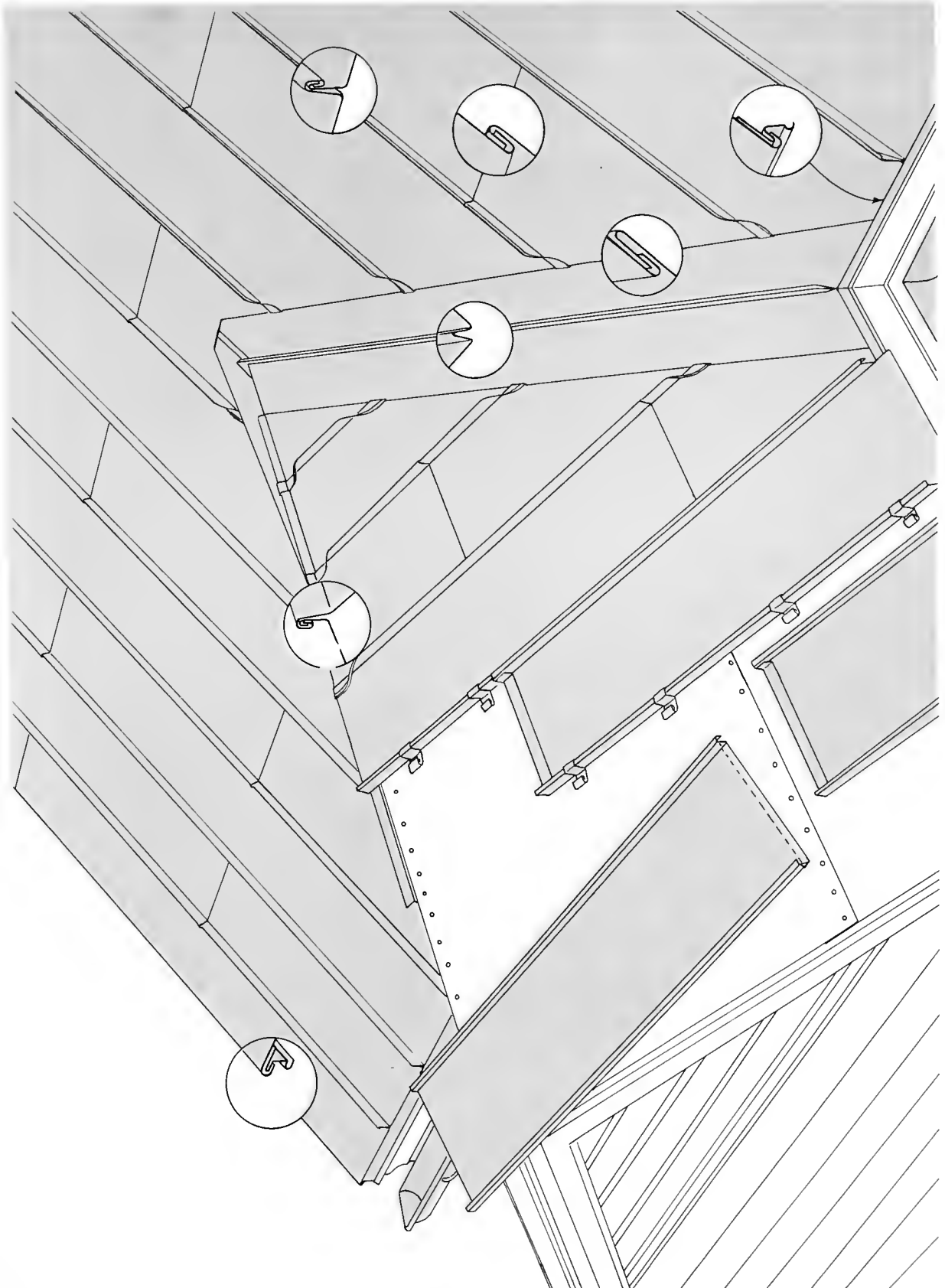

## Standing seam roofing, pan forming details PLATE NO. 3

This drawing shows the procedure in forming roof pans. Starting with a blank or plain sheet of copper, the corners are notched to cut away some of the metal that is not needed to make a weather-tight construction, and which would be troublesome in making the seams. This operation is followed by making the reverse bends at the top and bottom edges of the sheet, then turning up the sides with their additional small bends, thus forming pans that can easily be interlocked on the roof. There the standing seams are completed by simply clasping the last two bends with regular hand tools.

Many standing seam copper roofs have finished seams  $3/4$ " high like the copper roof on Christ Church in Philadelphia. This is the oldest metal roof in existence in the United States, well in its third century of service. In recent years, and particularly for roofs with a low pitch, architects have in many instances specified seams 1" high. Whether the seams are to be 1" high or  $3/4$ " high is largely a matter of taste, and is influenced by design, climatic conditions and pitch of roof.

The end locks of the roof pans as shown will form a simple single lock clinch joint. For roofs that have a pitch of less than 6" per ft., it is sometimes considered good judgment to make the reverse bend at the top of the pan  $1\frac{1}{2}$ " wide instead of  $3/4$ " so as to offer greater protection at the cross joints and to cushion the blasts of wind that could possibly force rain water into the joints. In that case it might also be considered wise to

finish the standing seam 1" high. The 1" seam is preferred on slopes having a pitch of less than 3" per ft., in which case the cross seams should be filled with white lead paste or caulking compound to prevent the infiltration of wind-driven rain or back-up water from ice or slushy snow. If blind soldering of cross joints is resorted to, copper of cornice temper must be used.

### Suggested Specification

Standing Seam Copper Roofing—Pan Forming Details: The roofing pans shall be made from a sheet or blank of copper of 16-oz. gage, measuring 20" x 96". This blank is to be notched at the corners, as shown on the drawing, to remove the excess metal that would otherwise fold into the double lock standing seam, making an unnecessarily bulky joint. This is followed by making reverse bends at the end of the sheet to interlock with the adjoining work. The sides of the roof pans are then formed on a standard bending brake, allowing a very slight taper from end to end so as to permit easy interlocking of the successive pans. These shop-made pans are completed on the brake, except for closing the last two folds of the double lock standing seams which is done on the roof. The upstanding edges are to be of a height that will make a finished seam  $3/4$ " or 1" high, as directed.

Alternate: The roofing pans shall be made from 10-oz. Economy Copper Roofing stock measuring 16" x 72".

Standing seam roofing, pan forming details

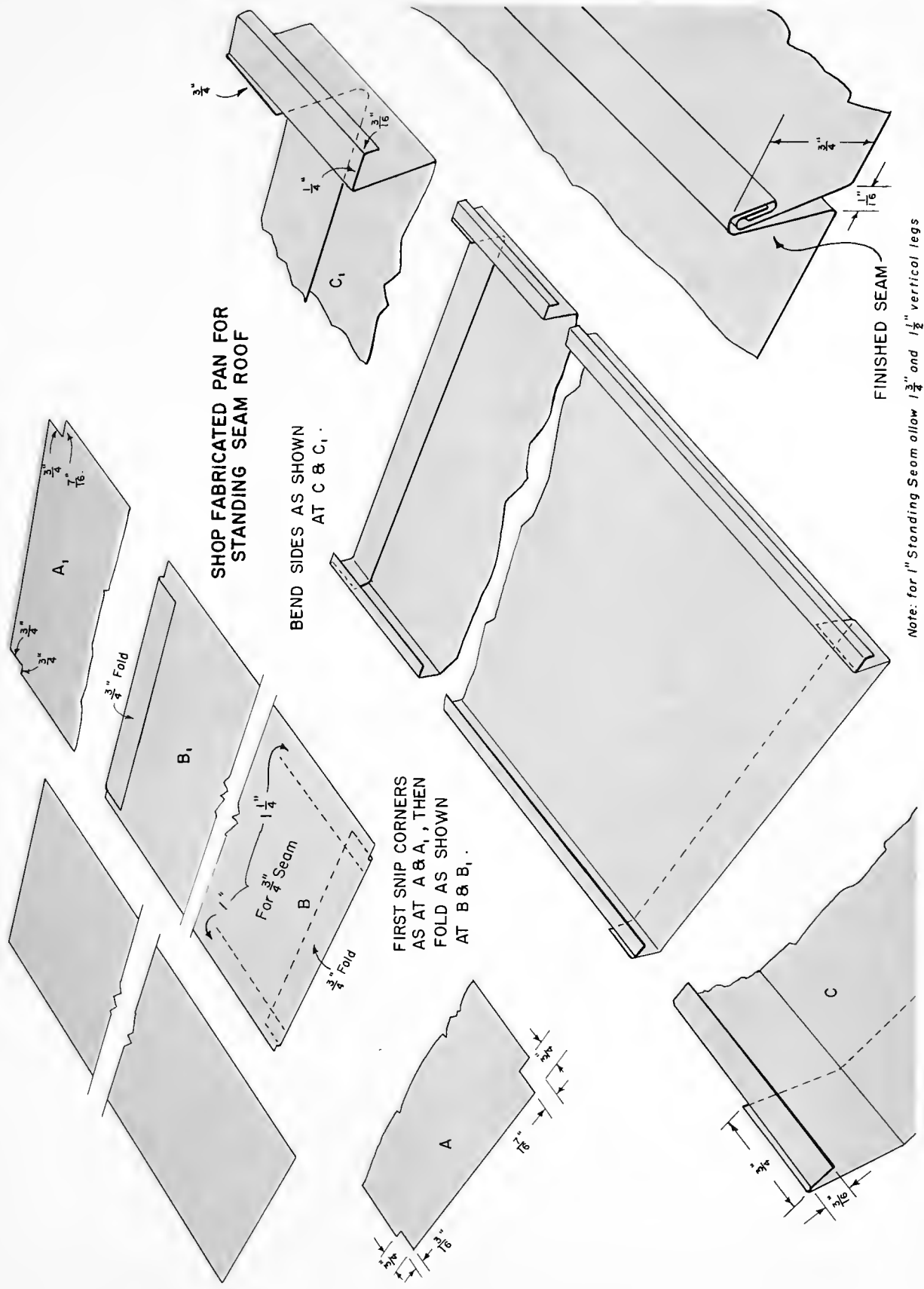

## Batten seam roofing PLATE NO. 4

The batten seam is the most popular type of copper roofing. It is commonly used for monumental buildings, and on structures where a long-lasting roof covering is required. This kind of roof provides weather-tight construction without the use of solder, and it enhances the beauty of the building not only by its color, but also by a proper proportion or spacing of the battens. In climates where there is much snow, such roofs are usually designed to be quite steep in order to shed the snow freely, thus avoiding heavy snow loads, as well as back-up troubles that may develop on uninsulated roofs with overhangs. Some of the finest batten seam copper roofs in Canada are of steep Norman design with 2" x 1" battens. In a more temperate climate the roofs are generally not so steep, and 3" x 2" or 2" x 1 1/8" battens are in order because of the likelihood of occasional deep slush or thin crusts of ice or snow which cause diversion or damming of the water in its course down the surface of the roof.

This drawing shows a rectangular batten, with the copper roof pans laid loosely between the battens allowing a 1/16" clearance at the base of the batten on each side. In making up the cross joints, the leading edge of the laid pan is raised above the top of the batten and the sides are flared outward so that the successive pan, with its bottom edge also flared, can be interlocked and the two worked back into place between the battens with a broad-faced tool. The cross joints are ordinarily left dry, without solder, and closed lightly with a block of wood and a mallet. For slopes that are less than 4" per ft., the cross joints should be filled with white lead paste or a suitable caulking compound before malleting. Blind soldering may be resorted to, but in that case the copper must be cornice temper.

For best appearance, batten seam roofing employs sheets

of copper that are 24" wide by 96" long, usually of 16-oz. or 20-oz. gage. The cross joints are ordinarily of the single lock type, having a 3/4" clinch lock. The copper of the roof is always secured with copper cleats, as illustrated, to allow for expansion and contraction. Where the roof pans on the slopes adjoin the valleys, or at an apron at the eaves, extra protection may be had by forming a clinch lock with a 1 1/2" turn-back on the underlying sheet and a 3/4" reverse bend at the bottom edge of the roof pans, as shown in detail. Where the roof pans butt against the ridge cap, the corners of the pans are folded in a manner as shown, which does not require cutting or soldering.

### Suggested Specification

Batten Seam Roofing shall be installed in accordance with recognized best practice in the trade, using 16-oz. sheet copper of cornice temper 24" x 96". The roof pans are to be formed on a standard bending brake, and there is to be no notching or soldering of the metal if it can be avoided. All joints are to be made with a simple clinch lock, closed gently with a block of wood and a mallet. The clinch lock at the batten covers is to be 1/2", at the cross seams and at the eave, 3/4", and at the valleys and apron, 1 1/2", as shown in detail. The ridge pole and the batten ends, as well as any other parts of the roof construction, are to be covered with copper to make a complete installation.

Alternate: . . . using 16-oz. sheet copper of roofing temper 24" x 96". It is imperative that the roof pans have an absolute clearance of at least 1/8" between the battens; also, under no circumstances shall the copper work be fastened by direct nailing through the sheet, nor is solder to be used with copper of roofing temper.

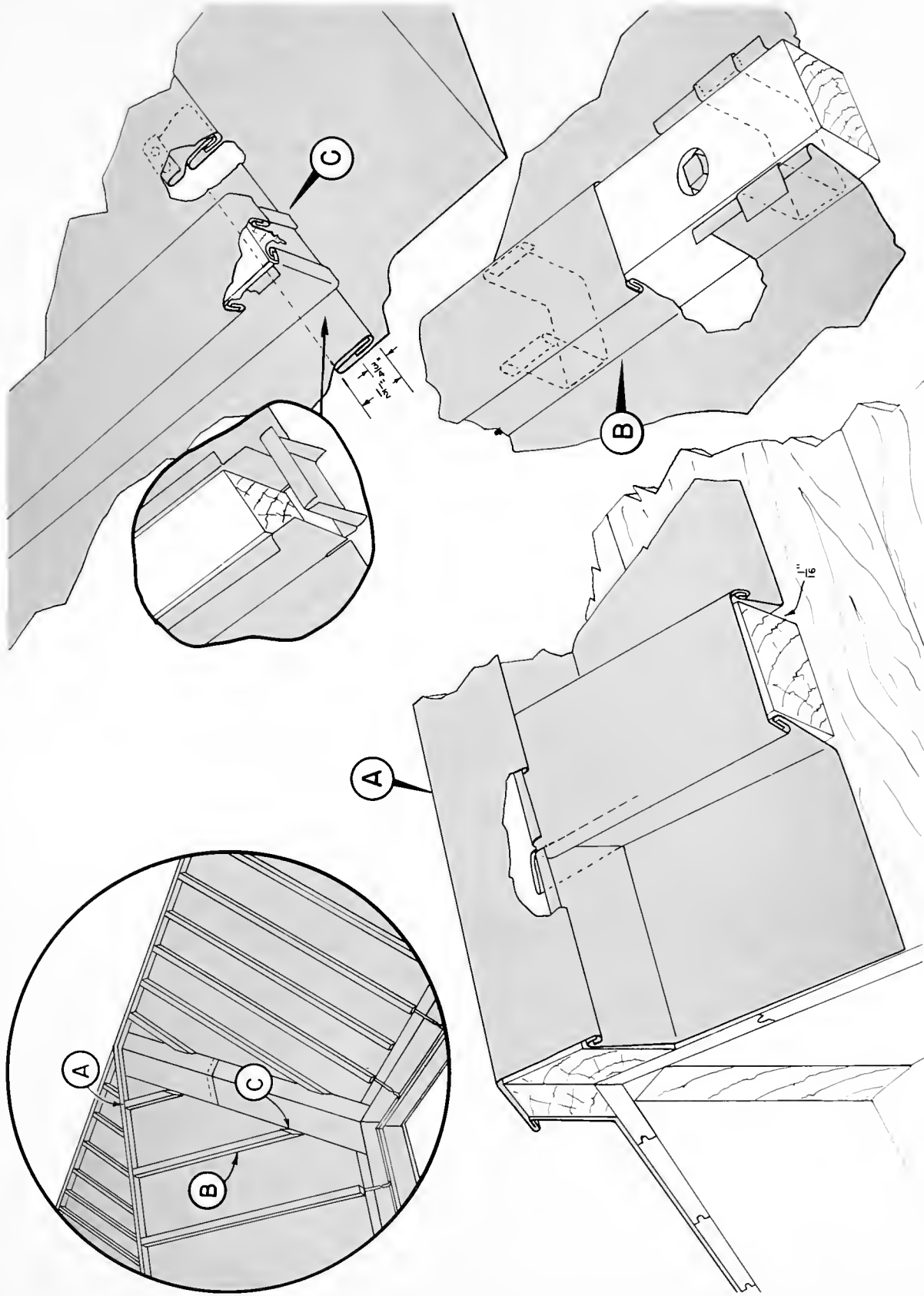

## Covered dome PLATE NO. 5

The dome was an important element of design in the architecture of old, and continues to be important in the architecture of today. It is a basic engineering form. Its beauty of line and inherent strength make the dome especially suitable and economical in covering large areas with wide spans where columns or posts would be objectionable.

Regardless of the architectural shape or proportions of the dome, there are certain basic principles of sheet metal work that must be observed if the copper covering is to give the best possible service. In general, any portion of the dome with a slope of less than 3" per ft. should be roofed with flat lock soldered seam roofing. The portion of the dome with a slope greater than 3" per ft. can be covered with 16-oz. copper applied either by the standing seam or batten seam method of construction. Dry lock clinch joints may even be used on steep domes with a minimum pitch of 12" per ft., provided the horizontal seams are not more than 24" apart and the vertical seams are filled with caulking compound or white lead paste.

This drawing shows a type of copper dome that may be used either in classic or modern design. It is characterized by bold, horizontal shadow lines and by radial striations produced by small battens formed of 1/2" x 1/2" inverted bronze channels. In general, the major portion of the roof is of regular batten seam construction. For this purpose, sheets of 16-oz. copper of cornice temper, 20" wide by 96" long, or 20-oz. copper of cornice temper, 24" wide by 96" long, are particularly suitable. For the crown, flat lock soldered seam construction with roofing squares 16" x 18" of 20-oz. copper of cornice temper with 1/2" pretinned edges should be specified. The built-in gutter and the expansion joints, as shown, should be of a gage ranging from 20-oz. to 32-oz. copper of cornice temper, depending upon the breadth

and size of the gutter. The inner and outer edge must be designed with freedom for movement, and the expansion joints should not be over 40' apart.

### Suggested Specification

Dome Roofing shall consist of sheets of 16-oz. copper of cornice temper in sizes not exceeding 24" x 96". The battens are to be formed of inverted bronze channels of a size and gage specified on the drawings. The battens are to be secured to the roof deck at intervals of not over 12" with No. 12 bronze wood screws, or No. 12 machine screws set into brass and lead expansion shields for fireproof construction. The cleats of 16-oz. copper which hold down the roof pans are to pass under the battens in stirrup fashion, at 12" spacings.

The roof pans are to be accurately formed on a bending brake so as to fit properly between the battens, with a 1/16" clearance between the bottom of the batten and the heel of the roof pan. The batten cover is to be of 16-oz. copper forming a clinch lock with the upstanding legs of the roof pans. All the work in the standing seam portion of the dome is to be in accordance with the drawings and details, and without solder. The crown of the dome, where the pitch is less than 3" per ft., is to be roofed by the flat lock solder seam method of construction, using 16" x 18" roofing squares of 20-oz. copper of cornice temper. The corners of these squares are to be snipped on a 45° angle, and the edges of the squares are to be tinned 1/2" wide. These roofing squares are to be laid with 3/4" clinch locks, soaked full with 50/50 lead-fin solder using cut muriatic acid as a flux. The roofing squares are to be secured to the roof deck with five 1/2" to 3" copper cleats in each of the roofing squares.



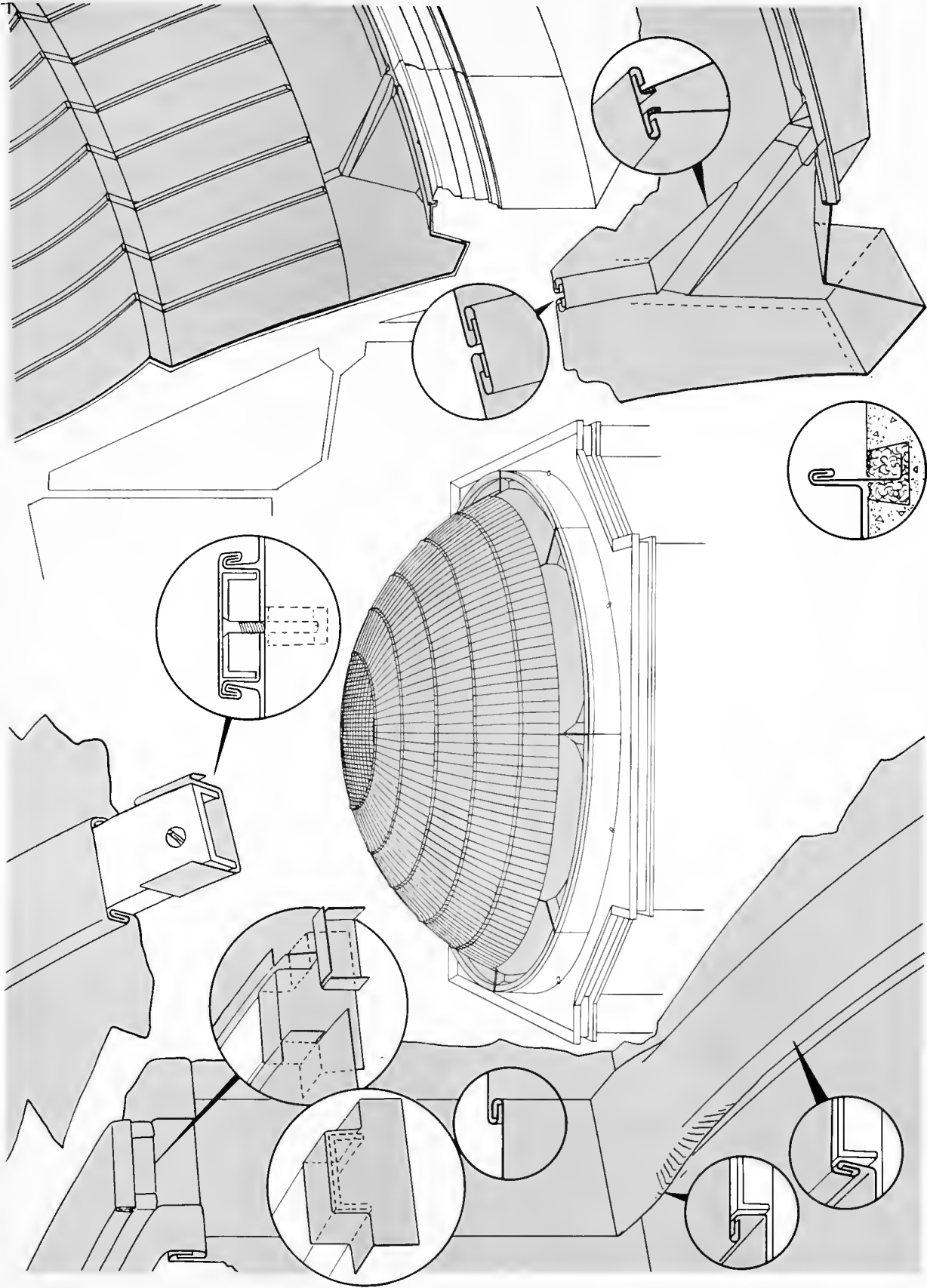

## Flat lock soldered seam roofing PLATE NO. 6

Except for vertical surfaces, church spires and the steep portion of domes, flat seam roofing must necessarily be soldered so as to be weather-tight and water-tight. Unlike other types of copper roofing in which the sheets of copper can expand and contract freely because of the dry lock joints, as with standing seams or batten seams, this kind of roofing with soldered joints becomes, in effect, a single sheet of copper over the entire roof or roof panel area. Therefore, unless copper of a proper thickness is used and suitable provision is made to allow for expansion, waves or buckles will form in the roofing squares in hot, sunny weather. In turn, during cold weather the metal will become stressed due to contraction, the force becoming increasingly greater outward from the center of the panel or roof area.

It has been learned from experience that long-lasting construction will result if the roof is divided into rectangles about 40' square, thereby creating a number of small roof areas isolated from one another by expansion battens. This drawing suggests such small roof areas surrounded by expansion battens with expansible intersections (1) so designed that all the copper can contract a reasonable amount in cold weather without excessively stressing the metal. For roofs that are to be sprayed or flooded with water, all joints must be soldered.

At the edge of the roof or at vertical extensions at parapet walls, the battens can be beveled on the top surface and the roofing copper or batten cover can be folded without cutting the metal, in a manner as shown on the drawing (2). Where the flat seam roofing adjoins a wall, it is finished with a base flashing of cold rolled copper with soldered cross seams, extending up behind a loose counter flashing in the usual way (3). Where the roof extends over a cornice, it can be finished with an edging strip forming a drip edge at the crown mould as shown

(4). For an overhang or sunshade, as in contemporary design, the roofing can finish at a point slightly back from the edge, with a canted edging strip (5).

For flat lock soldered seam roofing, as well as for all other soldered work, the copper must be of cornice temper of a suitable gage. Roofing squares of 20-oz. copper measuring 16" x 18" are the most economical.

The expansion battens, the edging strips and the base flashing should likewise be of 20-oz. copper of cornice temper. Generally, all soldered joints are to be pre-tinned, clinch locked 3/4" and filled with regular 50/50 solder.

### Suggested Specification

Flat Lock Soldered Seam Roofing shall consist of 20-oz. copper roofing squares, measuring 16" x 18", with soldered clinch lock joints. The copper is to be of cornice temper. The corners of the roofing squares are to be clipped to facilitate making reverse bends for a 3/4" clinch lock, and the edges are to be tinned 1/2" deep by dipping the squares in a bath of molten tin. The roofing squares are to be laid in rows parallel to their long dimension, braking joints in the other direction. Each square is to be fastened to the roof deck with 5 cleats of 16-oz. copper. The joints are to be closed with a block of wood and mallet, and soaked full with 50/50 solder.

Expansion battens and expansible intersections are to be made of 20-oz. copper of cornice temper and in accordance with the drawings. The edges of the copper at the joints are to be cleaned free of oxide, prefinished and soldered.

Flat lock soldered seam roofing

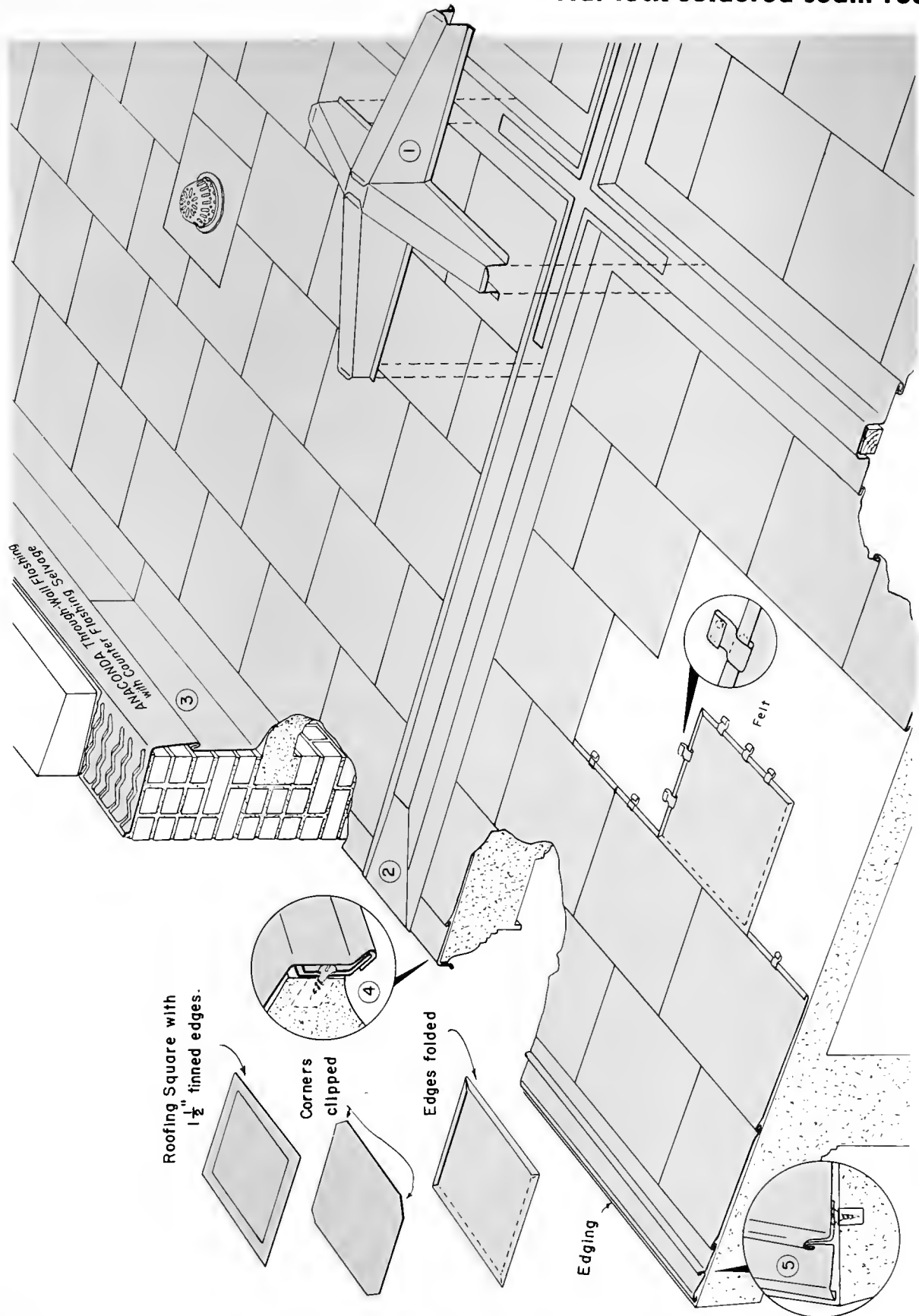

## Expansible intersections PLATE NO. 7

In dry lock seam construction, such as standing or batten seams, expansion and contraction of the metal are absorbed or compensated for by the bellows or hinge action made possible by the loose lock joints. On vertical walls with the proper proportioning of the squares of copper, even a clinch lock seam without solder may be suitable, since such work needs only to be weather-tight or safe against wind-driven rain.

On dead level roofs, or for roofs that are to be flooded, and for large tanks where there is an actual head of water, the joints in the copper work must be locked and soldered. For good and lasting construction this requires that the area be divided into rectangles not over 40' square, surrounded by expansion battens. The copper cover is to have a clearance on each side of the structural batten to allow a certain amount of leeway for expansion and contraction. For this type of construction, it is imperative that the copper be cornice temper and that it be of a gage upwards of 16-oz. per sq. ft.

Although the regular expansion batten makes a weather-tight and water-tight construction, and provides adequate freedom for adjustment of the copper within a 40-foot rectangle, it presents a problem at the point of intersection of two battens. This is particularly so on long roofs with expansion battens running the full length, because the contraction in such a length of batten could, possibly, cause a parting of the copper work at the ends.

The answer to that problem is in the design of expansible intersections. There are two types shown — one is for water-tight construction and the other for weather-tight construction. The former consists of a raised cover piece about 6" high which is soldered in place and

which, due to the fullness of metal in its design, can flatten and yield in every conceivable direction. This type, of course, is for a flooded condition. The other type has a sliding cover at the intersection. In each case the metal on top of the battens is cut away a distance of about 18" in four directions to allow the battens to shorten, by contraction, in cold weather. The sliding cover is only to make the cutaway section over the battens weather-tight. This type of expansible intersection is used on the crown of a vaulted roof or at the ridge of a roof with a low pitch where flat lock soldered seam construction is used.

The copper for all soldered work must be of cornice temper, because it is better able to withstand stress and strain. This is due to its greater stiffness and to other favorable characteristics. It also improves appearance in the finished work. For small areas where the rectangles are less than 40' square, 16-oz. copper is suitable, but for larger work on first-class buildings and for greater assurance of permanence, copper of 20-oz. gage for the roofing squares and for the battens is preferred.

### Suggested Specification

Expansible Intersections for expansion battens shall be made of 20-oz. copper of cornice temper in accordance with the drawings. At a ridge or at the crown of a barrel vault roof, the intersections can be of the sliding cover type. For dead level roofs that are to be sprayed or flooded with water, the full soldered type of expansible intersection with its raised cross piece is required. The copper shall have ample clearance in all directions and the seams are first to be cleaned, pretinned and soaked full with 50/50 solder.

Expansible intersections

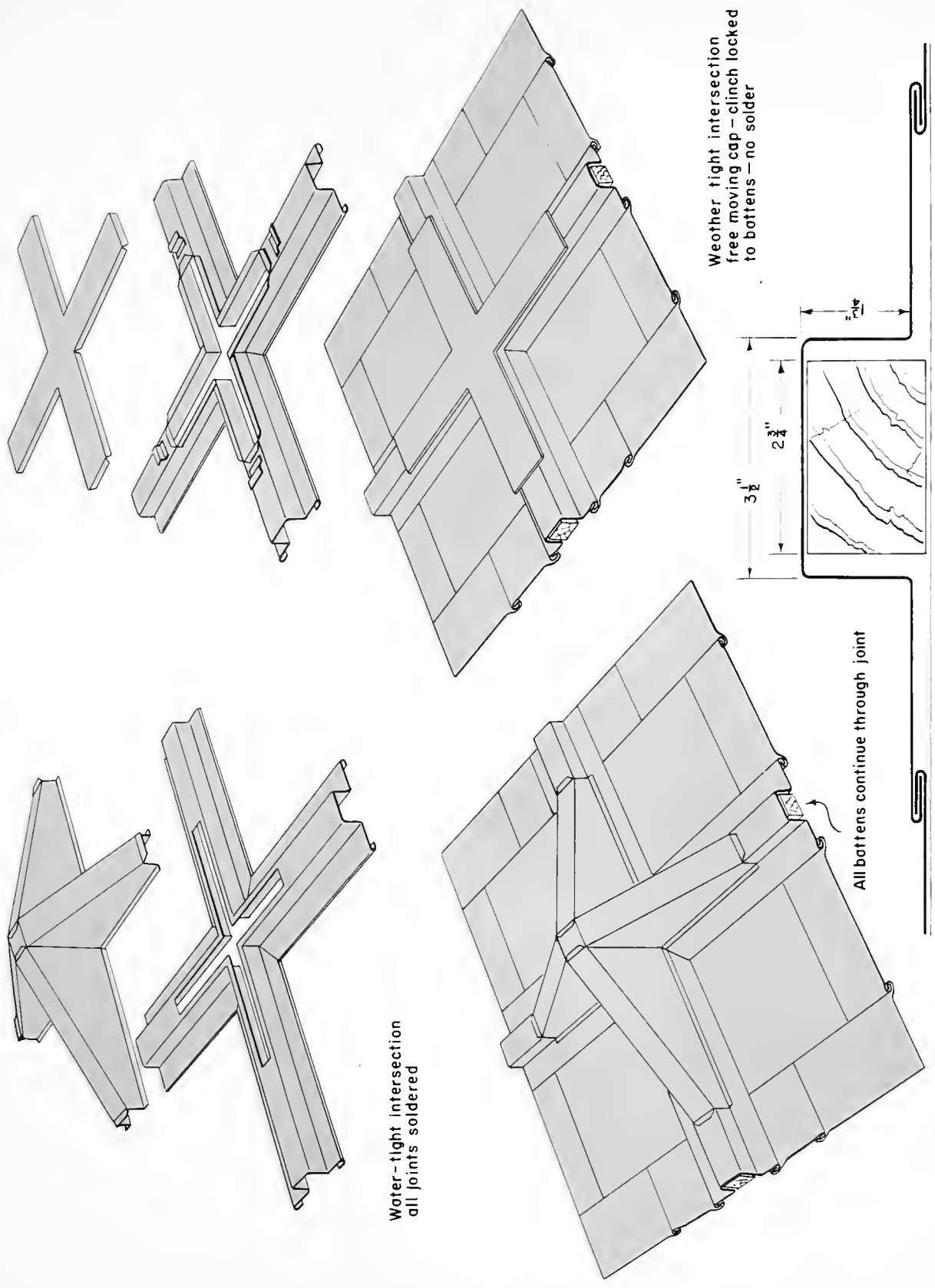

## Roof edgings PLATE NO. 8

All roofing materials, whether for flat roofs or for steep roofs, require edgings and flashings. The more durable edgings and flashings are of metal, and the most suitable metal is copper.

The detail drawing showing an edging at the overhang is for the simplest kind of construction with wood sheathing and built-up composition roofing. The copper edging has a 4" flashing flange, a 3/4" gravel stop, and a drip edge extending at least 1/4" below the bottom of the sheathing.

The edging at the fascia board is similar to that at the overhang, except that the outer face of the edging is slightly deeper for architectural effect, and the bottom edge is turned back to form a hem, canted outward to serve as a drip.

The drawing showing a separate gravel stop and edging for a built-up composition roof on a concrete deck is somewhat more decorative, and is designed to show a minimum of waviness or buckling. The facing strip is free to slide by virtue of the clinch lock seam at the top and bottom edges. The standing seam at the top is rolled toward the outside, and serves as a gravel stop for the flashing strip that is built into the plies of the composition roofing. The seam at the bottom is formed of a simple clinch lock, joining the fascia with a stiffening strip at the soffit to insure a trim appearance and to provide a drip edge at the bottom. The flashing strip, the cleats for holding the standing seam, and the strip at the soffit are all attached to the construction at intervals of about 12" with durable fastenings. The end joints of the flashing must be cleaned, tinned, locked and soldered, whereas the joints in the fascia can be soldered, or without solder, cleaned, clinch locked, and the horizontal portion at the top filled with solder, white lead paste or caulking compound.

For shingle roofs where workmanship is important and a neat finish is desired, an edging strip of copper as shown on the drawing for shingles is suggested. This edging strip assures alignment of the shingles at a gable and at the end of every slope. Such an edging provides a hard surface to resist the pressure of a ladder or damage from other causes in the care and maintenance of roofing.

### Suggested Specification

Copper Flashings and Edgings for built-up composition roofing are to be of 16-oz. copper of cornice temper. There is to be a 4" flashing flange extending into the plies of roofing with a 3/4" gravel stop and a vertical apron as shown in detail. Where there is a fascia of copper for architectural effect it shall be separate from the roof flashing, but the two are to be joined together with a dry lock joint rolled toward the outside so that any overflow will run off the edge of the roof. The seam is to be located back from the edge far enough so that it will not be noticeable from the ground. The bends in the architectural fascia are to be brake formed. The end joints are to be neatly made with a simple clinch lock or a 3" lap joint soldered on the level top surface only. The bottoms of all edgings are to have a drip edge that is formed by interlocking with a holding strip, or they may have a hem to make a finish and to facilitate fastening and holding in alignment by cleats. The copper edgings and flashings are to be fastened with 7/8" No. 12 copper nails on 3" centers. The fastenings in concrete shall occur at 12" intervals using 1/4" screws and expansion shields.

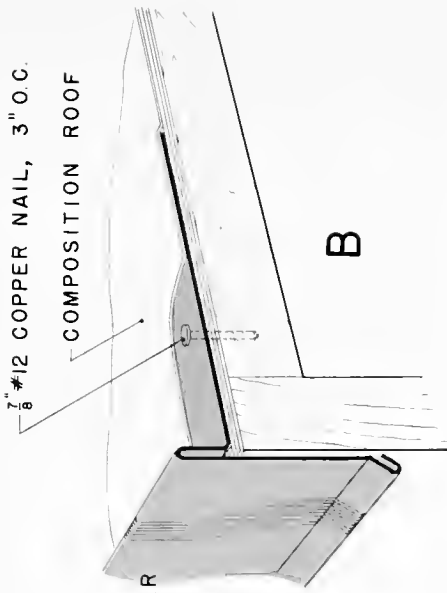

AT FASCIA BOARD

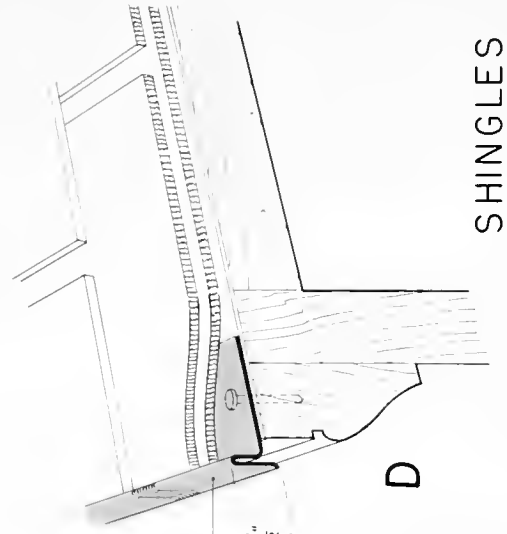

SHINGLES

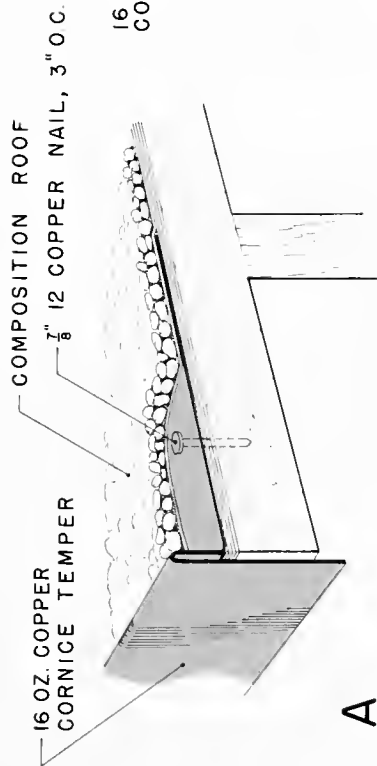

AT OVERHANG

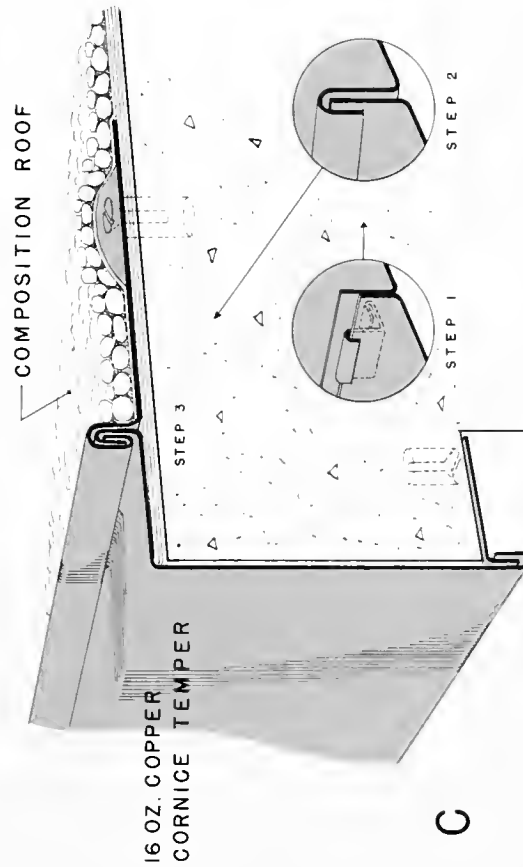

SEPARATE GRAVEL STOP & EDGING

## Edgings for insulated built-up roofs PLATE NO. 9

There are certain problems inherent with insulated built-up roofs which effect metal flashings and edgings. Probably the most difficult is that of obtaining a firm and secure fastening for the metal so that it will retain its bond with the built-up roofing, and that the construction will not be subjected to horizontal shear at the margin of the relatively soft cellular insulating material. This drawing shows details for such insulated roofs — one with nailers and sleepers of wood — the other of incombustible material. The sleepers form a hard edging which provides a means for nailing the copper edging and flashing, and holding it firmly in position in the built-up roofing so the two can not break the bond by moving separately during changes of temperature.

The drawing with wood nailers shows a type of edging which is canted upward slightly, and which has a gravel stop somewhat higher than the ordinary to prevent the tar and gravel from overflowing the brim and streaking the fascia, and the side of the building. This type of edging or gravel stop is designed to serve with a hanging gutter to receive the rain water that will drain over the edge. The copper edging is nailed through the roofing into wooden screeds at 3" intervals. The end joints may be lapped and soldered, or clinch locked and soldered on the roof side and lapped on the exposed outside face, the lower edge engaging a continuous cleat as indicated and locked at the bottom of the fascia.

The drawing with a metal channel for fastening and leveling is intended for fireproof construc-

tion. The channel is secured to the roof slab with expansion bolts and, in turn, the copper flashing and edging is fastened to the webbing of the channel with self-tapping screws or sheet metal screws at 6" spacing. The end joints in the copper are made with a 3" lap, pretinned and soldered on the roof side, but without solder on the outside face. The bottom edge of the fascia is held in place and brought to alignment by means of a continuous cleat, formed as shown.

All copper for flashings and edgings for built-up composition roofing should be at least 16-oz. gage (20-oz. preferred) cornice temper. In order that the joints shall function properly, the copper should be cleaned, pretinned, clinch locked and soldered wherever practicable.

### Suggested Specification

Edgings for Insulated Built-up Roofs are to be made, as shown on the drawing, of 20-oz. copper of cornice temper. The roof flange is to be built into the plies of roofing felt and fastened with nails or screws as shown, using 7/8" No. 12 nails at 3" spacing, or 1/4" screws at 12" spacing. The end joints are to be lapped 3" and soldered on the roof side, one of the roof fastenings being put through the lap. All bends are to be made with a bending brake, and particular care is to be exercised in making a neat and workmanlike finish at the exposed part of the edging. Unnecessary buckling and tool marks or other blemishes in the metal are not acceptable.



Edgings for insulated built-up roofs

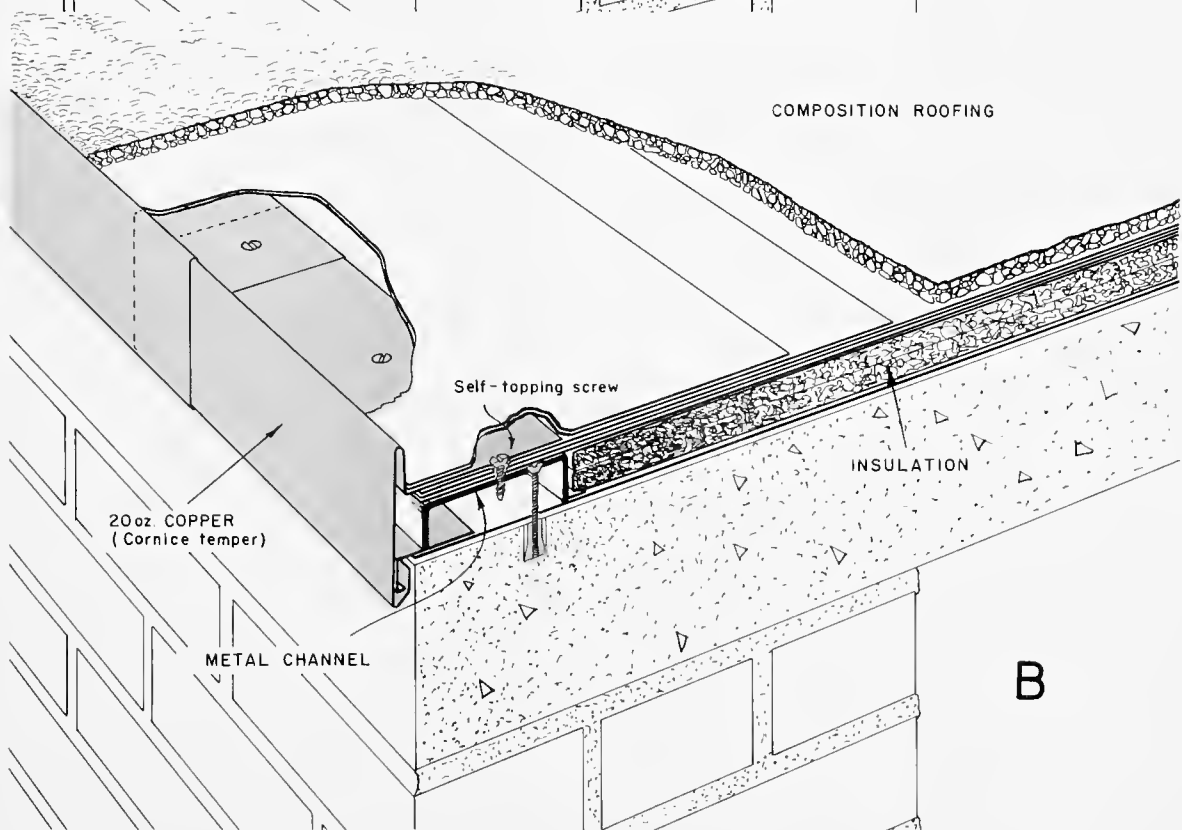
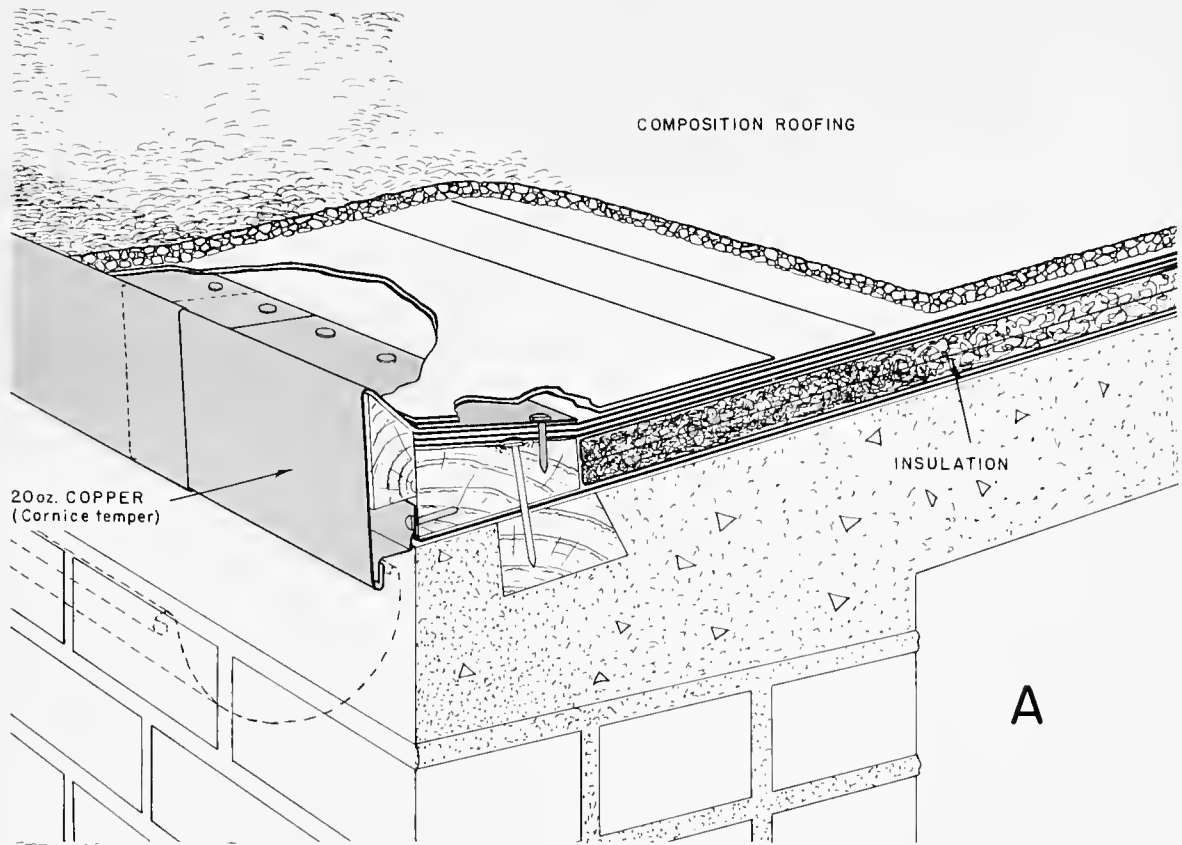

## Flashings at copings PLATE NO. 10

The austerity of modern or functional design in which the parapet wall has been eliminated has made it necessary to develop new details of construction at the junction of the roof and side wall. If the architecture is classic in design, the topmost piece or coping is usually of stone, but if the design is modern with considerable metal, including windows and trim, the coping too may well be of metal.

In flashing a stone coping, as shown on the drawing, it is desirable to cover the coping with copper, as much as possible, but it should not show from the street. Such a covering will minimize the problem of making the vertical joints in the stone coping weather-tight, which is generally conceded to be almost impossible.

The flashing, as shown, is of 24-oz. copper of cornice temper, because the broad plain surface needs this additional thickness and stiffness. With copper of such a gage, it is important that the flashing flange be fastened securely to the roof deck at intervals of not over 12" so as to avoid the possibility of breaking the bond between the copper and the brittle bituminous binder of the built-up roofing in cold weather. For additional security in this respect, the drawing shows holes in the flashing flange which allows the bitumen to bond through from top to underside, thereby obtaining the benefit of cohesion as well as adhesion.

The detail of an architectural bronze coping may be made to suit the designer, provided certain practical and extrusion-mill limitations are observed. In general, the cross-section of an extruded shape should fit inside a 6" diameter circle, and for a section of that size a 1/8" thickness is more or less standard. Extrusions of this kind can be obtained in lengths up to 20' or more, but are usually more easily handled in 10' or 12' lengths.

### Suggested Specification

Stone Coping "A": The copper which is to form a base flashing and a coping covering is to be of 24-oz. gage cornice temper. It shall be made up of sections 8' long, and joints are to be either with a 3/4" soldered clinch lock seam or a 1 1/2" soldered lap seam, with 1/8" copper rivets at 2" spacings. In either case, the copper is to be cleaned, prefinned and soldered with 50/50 lead-tin solder. The portion of copper that is built in to the plies of composition roofing is to have 1 1/2" diameter holes on 6" centers to improve the bond with the membrane roofing. The outer edge of the coping covering is to be made secure by interlocking the covering with a continuous cleat of 20-oz. copper. In addition, the joint is to be made weather-tight with an approved caulking compound.

Architectural Bronze Coping "B": The bronze coping will consist of 1/8" thick architectural bronze, in accordance with the detail drawing. The sections of convenient length, 12' or more, shall be brazed together endwise with silver-alloy brazing solder, using a backer strip so that the finished work will show only a hairline joint. There are to be bronze holding clips at spacings of not over 24" brazed or riveted to the bronze coping, and anchored to the roof so as to get a positively true alignment and a permanent anchorage. This bronze coping is to be flashed with 20-oz copper of cornice temper, which is also to serve as a base flashing for the built-up composition roofing. The flashing is to interlock with the bronze at the outer edge, and the 4" flange between the plies of roofing is to be fastened to the roof deck with copper nails or with screws at 3" or 12" spacings respectively.

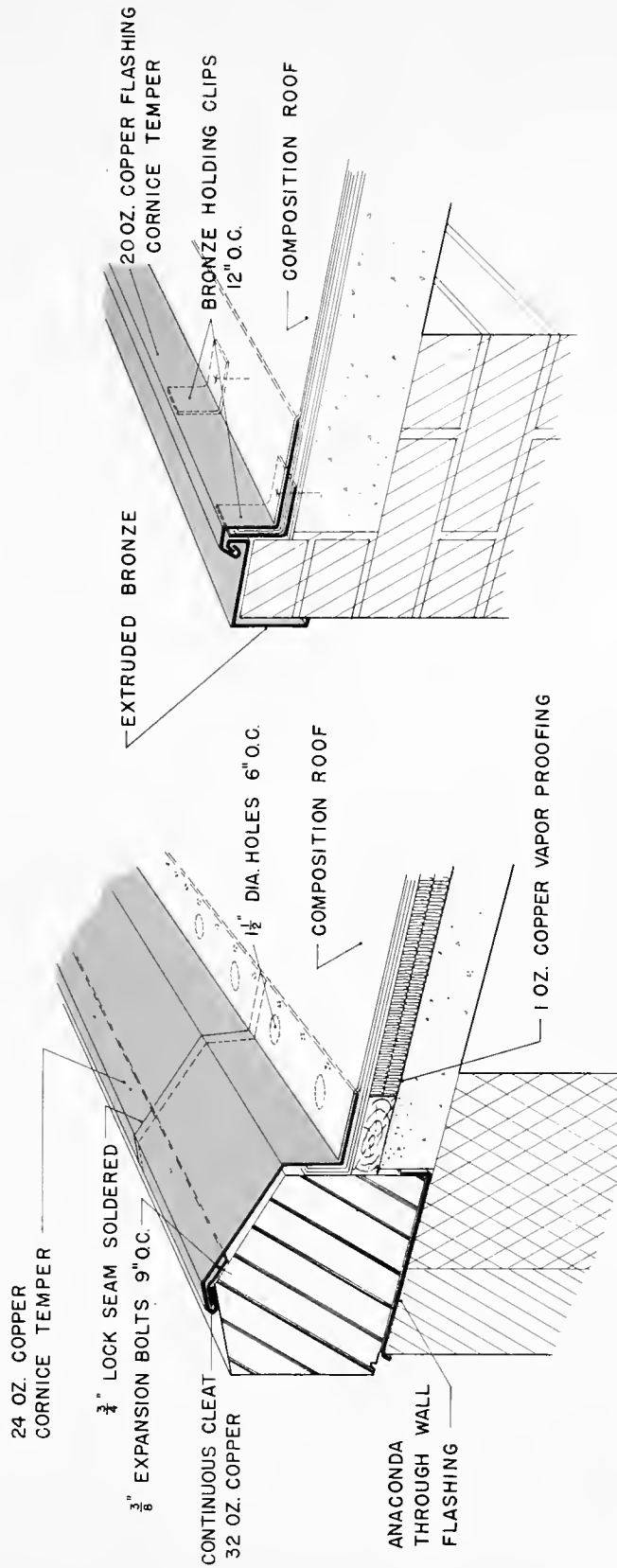

ARCHITECTURAL  
 BRONZE COPING  
 B

STONE COPING  
 A

## Flashing for dwarf parapet with scupper PLATE NO. 11

With contemporary architecture wherein the parapet above the roof is reduced to only a curb and where the winter climate is not too severe, architects may choose to use the least expensive method of disposing of rain water, that of causing the water to flow through scuppers into sheet copper leader heads and conductors on the outside of the walls. This is the simplest method of handling the water when there is no storm sewer available. Not only does the utility of this method of construction have an influence on the designer's choice, but also on the architecture, or character that is imparted to the design by properly proportioned leader heads and conductors.

This detail drawing shows a base flashing and scupper secured to the roof deck and made water-tight with solder. These parts should be made of cornice temper copper, 20-oz. or heavier, and should have expansion joints wherever expansion is provided for in the structure.

A copper coping connected to the base flashing with a loose clinch lock and without solder avoids the trouble that usually occurs with copings of bare stone or concrete having vertical joints. The additional cost for the copper is returned many times by saving maintenance expense that is inherent with copings that are not covered with metal. The copper coping should likewise be furnished in 16-oz. cornice temper. Neat, free sliding expansion joints that are simple and weather-tight should be located at 24' intervals along the length of the coping. The mitered corners of the coping and the base flashing with all of its end joints should be clinch locked and soldered.

The conductors, for reasons of economy should be of the standard variety of sizes and shapes, which are furnished only in 16-oz. copper, except on special order. The leader heads which are usually of the architect's individual design should be of cold rolled copper for trim appearance, and the gage should be 20-oz. or 24-oz. depending upon size and form. The means for fastening can be in the nature of regular conductor straps or they can be made of bar stock to suit the architect's design.

### Suggested Specification

Base Flashing and Coping Covering for the composition roofing, as well as the scuppers and the conductor heads are to be made of sheet copper of cornice temper, all of 20-oz. gage and from strips or sheets 96" long. The coping covering is to have longitudinal loose lock slip joints. The cross joints are to be clinched and soldered. The base flashing, scuppers and conductor heads are to have all joints clinched and soldered or lapped and soldered as shown. In every case the metal that is to be soldered must be cleaned with steel wool, pretinned, fluxed and soaked full with solder. The continuous holding straps at the outside of the coping covering and the base flashing of the composition roofing are to be firmly secured in place with nails or screws. Where there are nailers, nails of the proper length are to be used and spaced 3" on centers. In masonry, expansion bolts with brass screws and suitable shields are to be used on 12" centers. Miterers are to be clinch locked and blind soldered, and in all cases the soldering is to be done so as to provide a workmanlike appearance.

Flashing for dwarf parapet with scupper

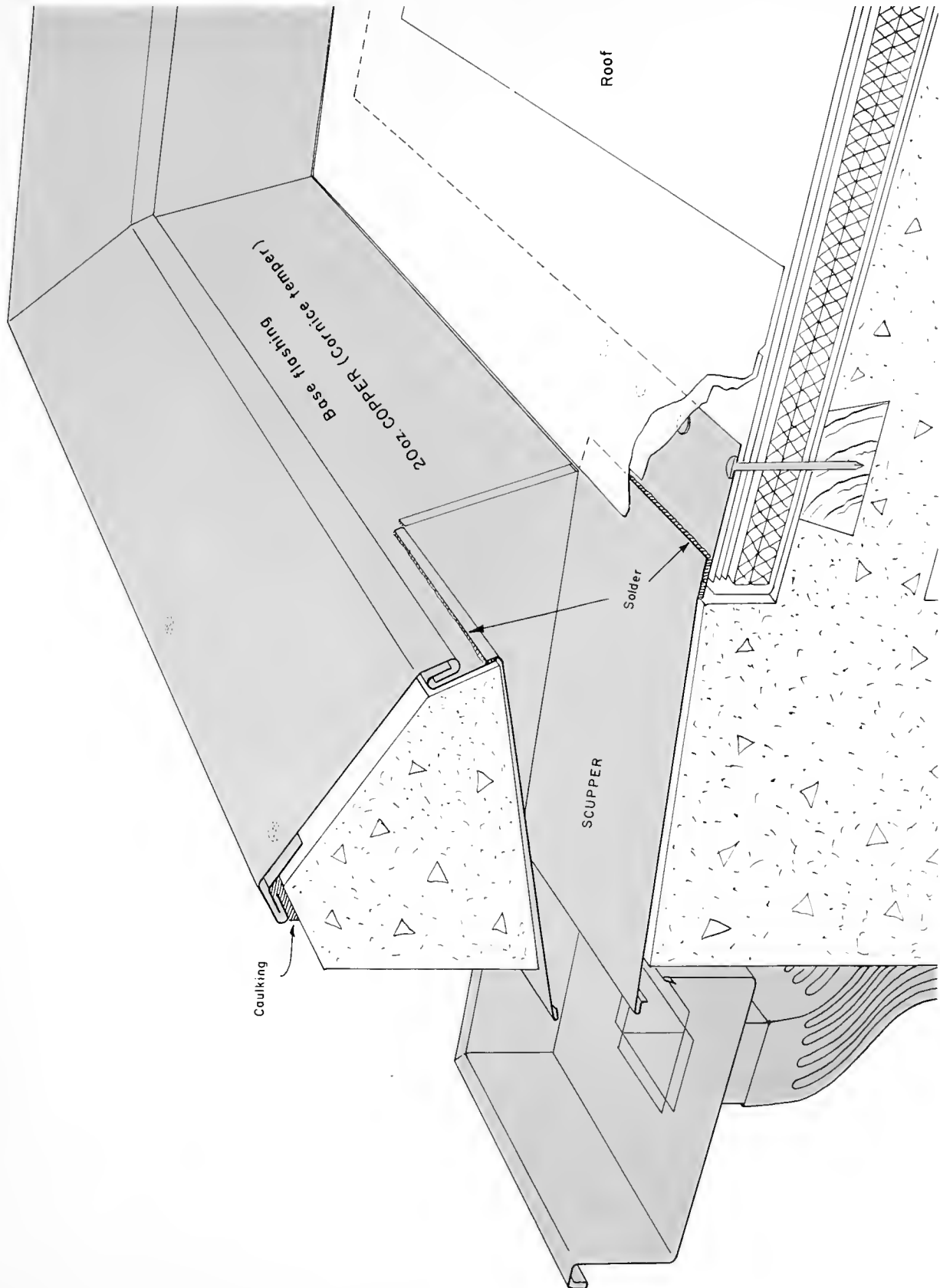

## Flashing for monitor roof PLATE NO. 12

Flashing requires special attention on monitors for long industrial buildings and on structures where there is a change in roof level, or where peculiar construction is involved. The part of the flashing which builds into composition roofing must be fastened securely to prevent movement lest the bond between the flashing and the brittle, bituminous adhesive be broken in cold weather. All other parts can have self-adjusting, dry clinch lock joints, except where solder is required to make the construction water-tight.

Expansion joints are always desirable but need not occur more frequently than the structural expansion joints in the building, which seldom, if ever, are more than 200' apart. In soldered work, a suitable substitute is to use copper of one or two gage size heavier than would be used if expansion joints could be conveniently installed at frequent intervals. The copper must be of cornice temper and of 16-oz. gage or better.

### Suggested Specification

Monitor Flashing shall be in three parts; roof flashing, fascia and edging. The roof flashing is to be of 16-oz. copper of cornice temper, having a 4" roof flange, of 3/4" gravel stop and a drop edge for interlocking with the fascia. The fascia of 20-oz. copper of cornice temper shall be brake formed in 8' lengths with sliding edges and end joints clinch locked and soldered. The lower edging is of 16-oz. copper, formed to receive the fascia, and with a drip or weather lip so the water will fall clear of the facing below.

All clinch locks are to be 3/4", and all exposed soldered joints are to be blind soldered or the solder shall be scraped away clean on the face of the work.

The roof flashing shall be fastened with copper nails at 3" spacings or with expansion bolts or approved other fastenings in fireproof construction.

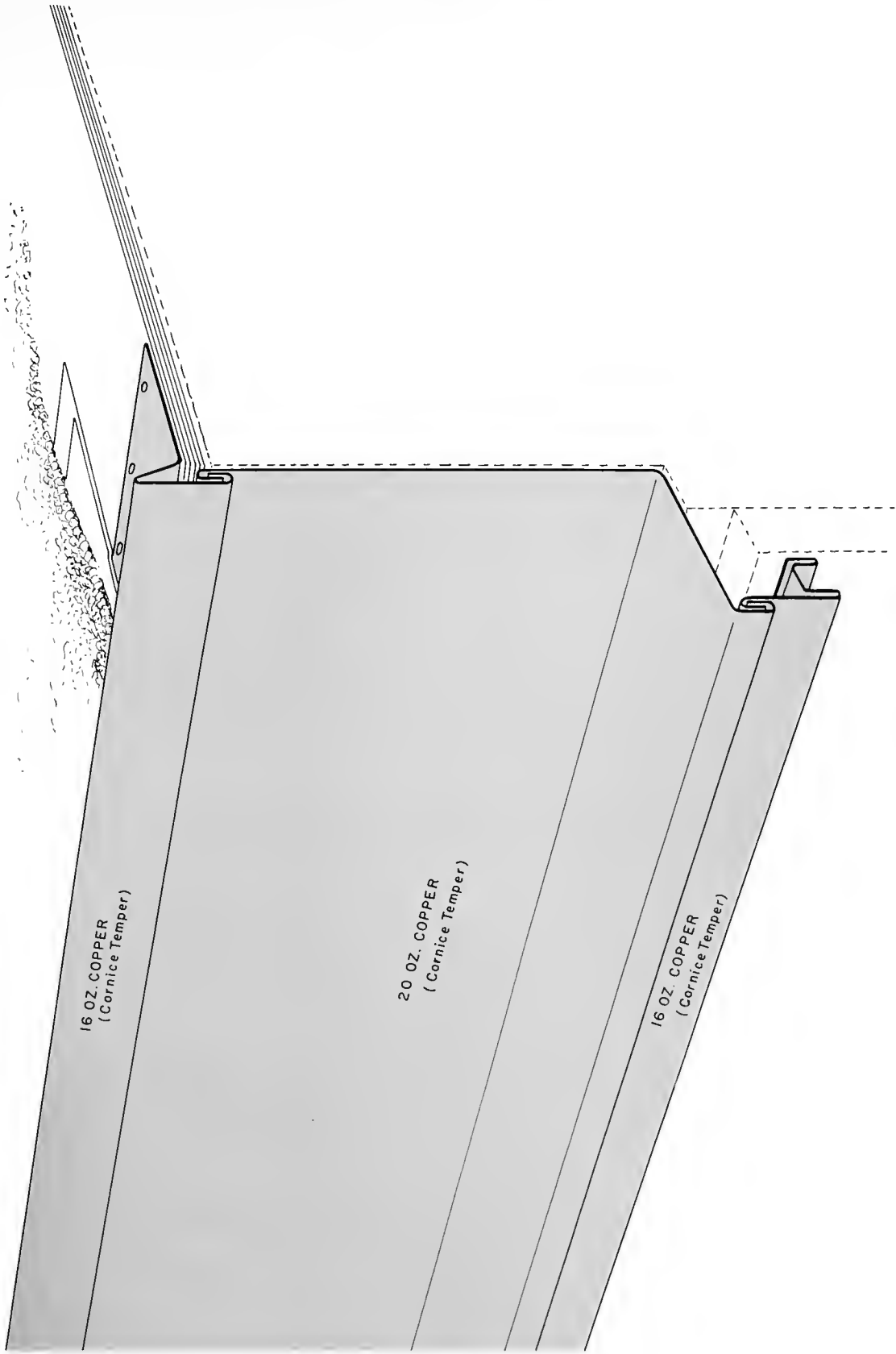

## Flashing of roof curbs PLATE NO. 13

On a modern building having a flat roof area there are several kinds of equipment and parts of construction that require a curb properly flashed so that water will not find its way into the interior.

Equipment and construction which may project through a roof include stair and elevator tower penthouses, scuttles, skylights, vent pipes for plumbing, flagpole bases, pedestals, stub columns for future extensions, banks of finned coils for heat pump evaporator-condensers, etc.

This drawing shows an assortment of curb flashing details for both fireproof and wood construction. It also shows the more difficult kind of flashing for a piece of equipment with a metal housing, such as might be the case with a roof fan, a dust collector, or an evaporative condenser. In this type of construction it is necessary to isolate unlike metals to avoid galvanic corrosion. You will note that the isolating of one active metal

from another is done with strips of lead and lead washers, which are neutral and electro-chemically inactive.

### Suggested Specification

Flashing of Roof Curbs shall be of 16-oz. copper of cornice temper, break formed in accordance with the detail drawing. All joints are to be clinch locked and soldered. Base flashing shall be anchored securely to the roof deck.

Pitch pockets are to be constructed of 16-oz. copper of cornice temper as shown and poured full of regular roofing pitch.

Lead strips 1/8" thick and of suitable width are to be placed between the copper flashing and the metal housing of mechanical equipment above the roof.



Flashing of roof curbs

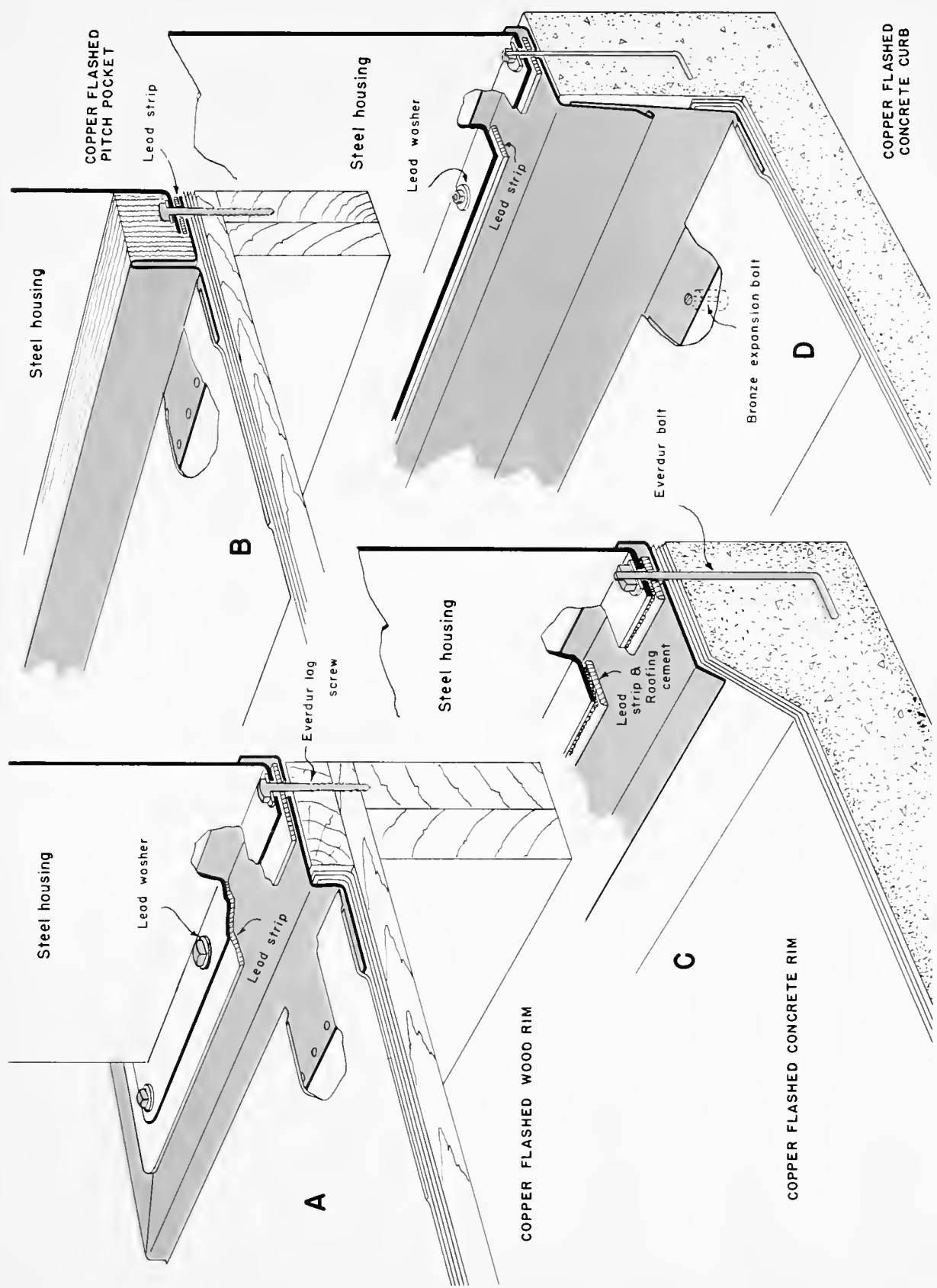

## Protected valley flashing PLATE NO. 14

The presence of sulphur in fuels burned in and around metropolitan areas forms large amounts of sulphur dioxide, which dissolves in atmospheric moisture and is oxidized by the air to form dilute sulphuric acid. When this acid, borne by fog, dew or rain, settles on a copper roof, it reacts with the copper and yields basic copper sulphate. Because this salt is sparingly soluble and adherent it acts as a protective film to inhibit further corrosion. The corrosive effect is extremely slight because it is spread over a large area and the moisture loses its corrosiveness by reacting with the copper.

On the other hand, this acid moisture is not neutralized if it falls on an inert roofing material, such as tile, slate, wood, asphalt or skylight glass. The run-off from a large inert area may be concentrated on a relatively small area of copper, such as a valley gutter. There is no opportunity for the protective coating of basic copper sulphate to form, and under severe conditions fairly rapid corrosion of the copper may occur. That condition has been found to be most pronounced at the edge line of the shingles in valleys, and at the drip line in gutters. For this reason, it is called line corrosion. This chemical action is accelerated in valleys where the edges of shingles are not raised, but are allowed to rest on the copper; in which case, they will retain a bead of the corrosive water, due to capillarity, allowing a greater length of time for attack.

It is fair to say that in the great majority of cases where copper is used this effect is negligible. There are, however, some localities where line corrosion presents a problem, particularly in manufacturing centers along the seacoast.

This drawing suggests the insertion of a strip of copper with an upturned edge at the bottom, placed over the copper valley lining, and so located at the edge line of the shingles that, if line corrosion should occur, the main copper valley lining would be spared. For renewing the protective reinforcing strip, a new strip with a 3/8" upstand and a 4" leg can be slipped into place and made fast by clinching with the upturned edge of the original reinforcing strip.

### Suggested Specification

Protection against line corrosion shall consist of a 16-oz. copper replaceable reinforcing strip as shown on detail. In general, the strip is about 4" wide with a reverse bend at the top edge and a 3/8" upstand at the bottom. This is to save the copper valley lining from attack by any sulphurous wash at the edge of the shingles. These strips are to be 8' long with a 4" end lap in the direction of flow.

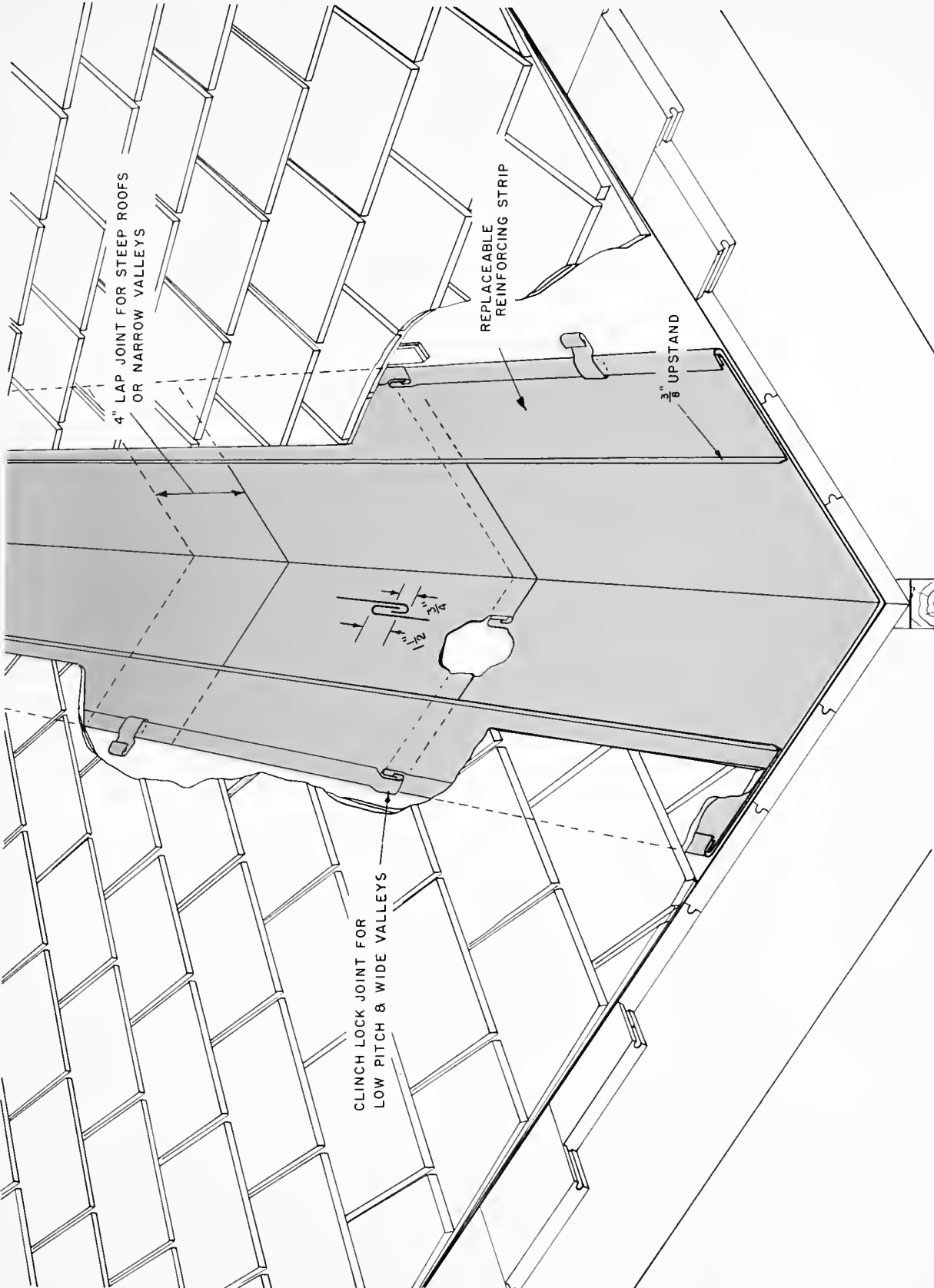

## Built-in gutter — stone cornice PLATE NO. 15

In buildings of classic design with steep roofs, the gutters for carrying off rain water are usually built into the top of the cornice in such a manner as to be concealed. It is important to prevent overflow and staining on the face of the cornice, so provision also must be made to handle sliding snow and slush.

Gutter linings must be of durable material and construction because damage from water can be excessive. Sheet copper of the proper gage and temper is the most suitable and economical material to use.

The gage of the copper depends on the shape and the length of the gutter, but more particularly on the widest flat surface. The broad surfaces tend to buckle and to produce objectionable kinks in the metal. The more nearly the gutter approaches the half circle in cross section the stiffer it is and the thinner the gage of metal required. The best metal for soldered gutter construction is cornice temper copper. The chart on PLATE NO. 15 is based on the foregoing information and will serve

as a guide in specifying the proper gage material for a gutter.

### Suggested Specification

The built-in gutter and the apron extending onto the roof shall be made of 24-oz. cornice temper copper. The sheets are to be 8' long if the girth of the gutter or the breadth of apron is less than 36". Otherwise the 36" wide sheets shall run crosswise of the gutter or apron. All joints are to be cleaned, pretinned, clinch locked and soldered.

Standard bulkhead and cover type expansion joints are to be built into the gutters midway between all downspouts. The outer edge of the gutter is to form a loose lock with a continuous copper cleat let into a reglet in the cornice. The cleat is to be held in place by lead plugs at 12" centers and the reglet filled with an approved caulking compound. The top edge of the apron is to be free sliding and fastened with copper cleats at 12" intervals.

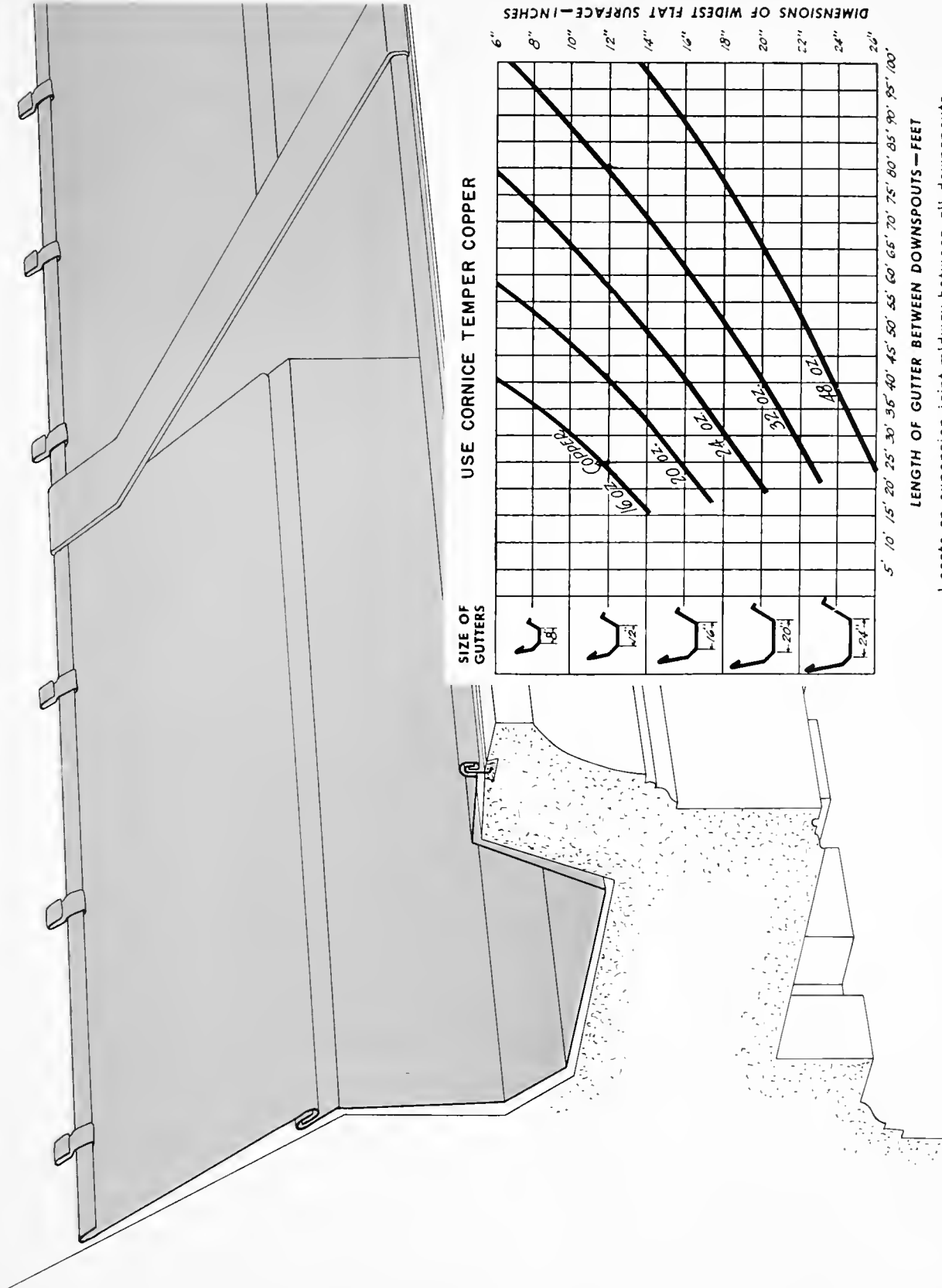

## Built-in gutters PLATE NO. 16

For improved appearance in buildings of classic design with projecting cornices, the gutters for collecting and disposing of rain water are usually built into and concealed behind the cornice. The copper linings for built-in gutters are likely to be subjected to rough usage and unusual stress because of their confinement in the trough of wood or concrete which forms the gutter. In the design and installation of built-in gutters of copper a certain procedure, learned from experience, should be followed. The copper should be of a gage corresponding to the scale of the work. A gutter like that shown on the drawing with a bottom 8" wide, a size commonly used for houses, can be of 16-oz. copper; one with a bottom 12", 20-oz. copper; 18" wide, 24-oz. copper; and for anything wider, 32-oz. copper.

It is of great importance that the copper be of cornice temper, and not of roofing temper. The stiffer the copper, within practical limits, the more able it is to distribute and to absorb stresses from expansion and contraction. All gutters must have free sliding edges, and expansion joints located midway between the downspouts. There are instances where otherwise perfectly good copper gutter linings were spoiled by stitching the outer edge with nails driven directly through the copper into the crown mold and by nailing the apron

extending up under the shingles directly through the metal instead of fastening with cleats.

Expansion joints across the gutter have the effect of cutting the gutter in two at the halfway point between the downspouts. This feature of construction is very effective in preventing longitudinal stresses in the copper gutter, provided the expansion joints are free to function and are not pinned down with solder as is sometimes carelessly done when the cover piece is put in place.

### Suggested Specification

Built-in Gutters are to be of sheet copper of cornice temper and of a gage as called for on the drawings. The inner and outer edges of the gutter are to be free sliding and there are to be expansion joints located midway between all downspouts. All fastenings are to be with clinch type copper cleats, either individual or continuous, made of 16-oz. copper. There are to be two copper nails in each individual cleat. Nails in continuous cleats shall be spaced 12" apart. All cross joints are to be cleaned, pretinned, clinch locked and soldered.

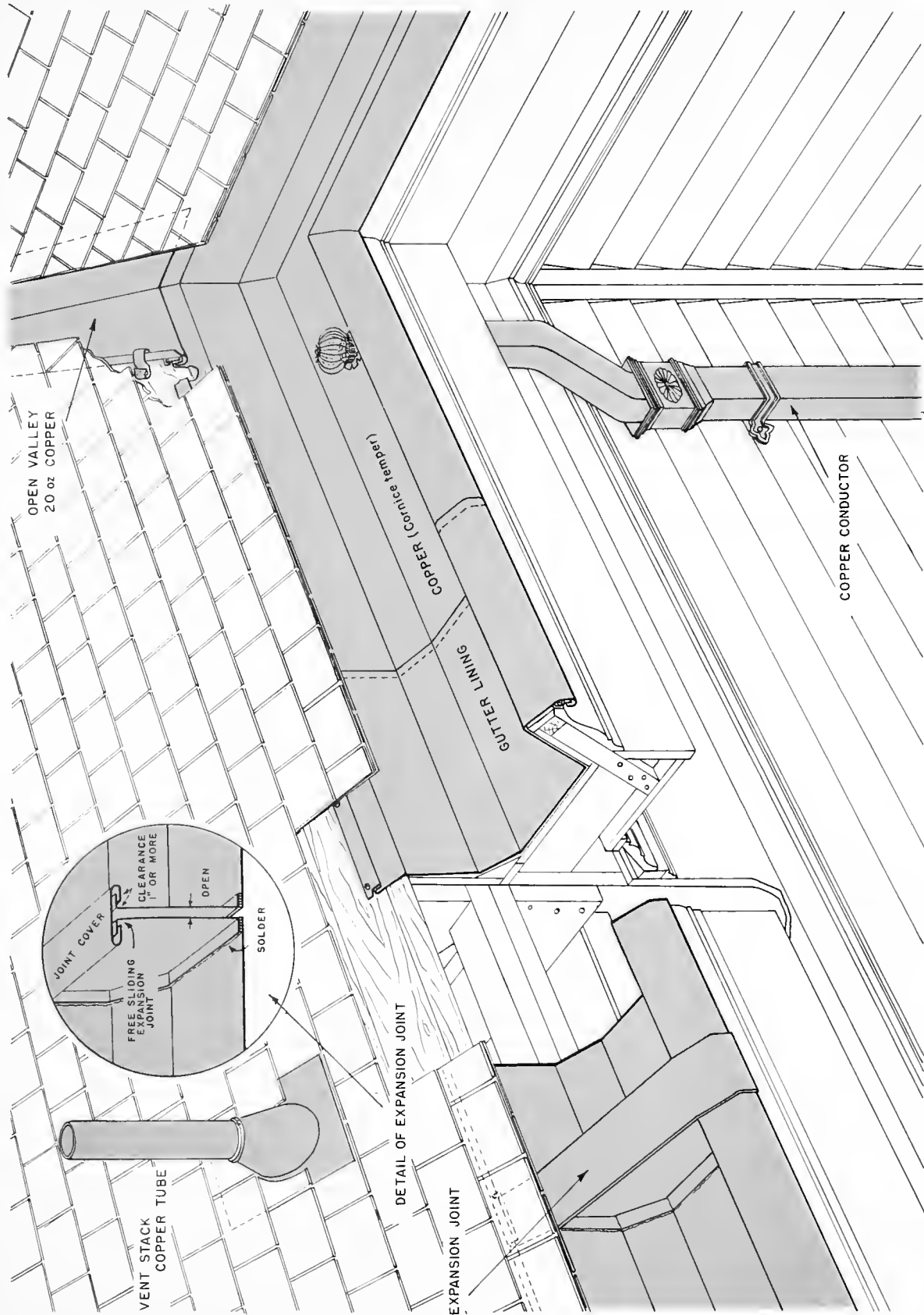

## **Built-in gutter and copper coping** PLATE NO. 17

This style of gutter with copper coping and a hip roof is particularly suitable for houses of Regency design and is also very adaptable to modern architecture. It provides a well defined roof line and has the advantage of an easily accessible gutter.

By being built into the roof, and located within the line of the outer wall, there is little likelihood of clogging or damming up with ice and snow. This is a great advantage as compared with box gutters that are built into the roof outside of the wall line, especially in buildings that are not well insulated. In the latter, any water from melting snow in contact with the roof may become chilled and freeze as it reaches the cold gutter which get no warmth from the building. Trouble from frozen gutters in cold climates is well known.

### **Suggested Specification**

The Built-in Gutter and Coping shall be made of 20-oz. copper of cornice temper and accurately formed on a bending brake. The bottom of the gutter shall be 1/4" narrower than the structural form into which it fits. The bottom of the gutter shall pitch slightly to the drain.

Conventional expansion joints shall be placed midway between all downspouts. All fastening shall be done with cleats and clinch lock joints. The cross joints in the gutter are to be clinch locked and soldered. Those in the coping are to be locked and blind soldered or the solder is to be scraped clean on the work that is exposed to view.



**Built-in gutter and copper coping**

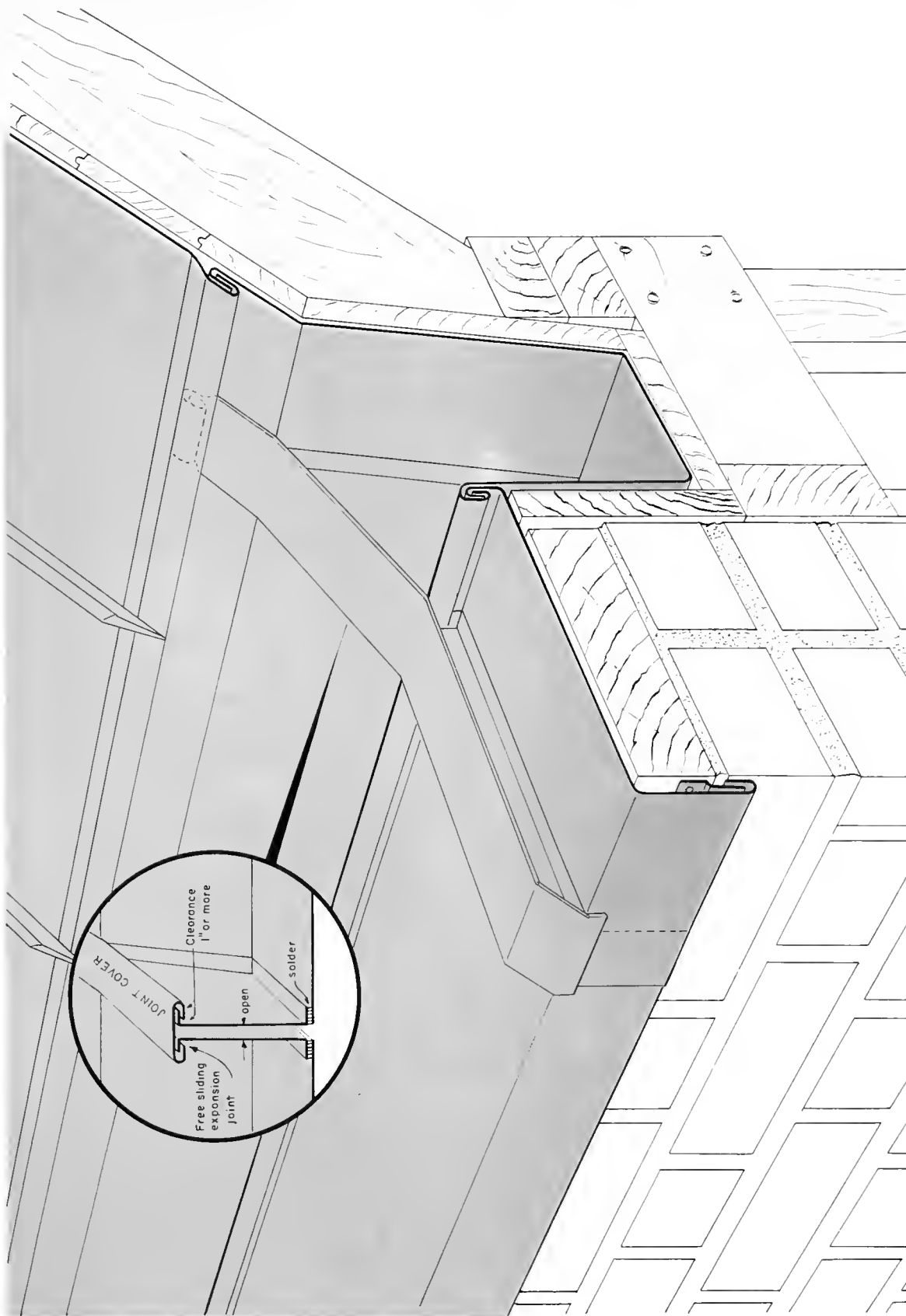

## Flashing of cornice and balustrade PLATE NO. 18

Classic architecture is always good and worthy of preservation. The Roman classic originated in a warm climate and the construction is somewhat delicate in detail. This type of design is prominent in the United States, and has been used with many churches, colleges and government buildings of the classic architecture known to us as Colonial or Georgian.

Whether the cornice and balustrade are of wood or stone, proper flashing and protection with copper is essential, and in the long run highly economical. Hardly anything is so damaging to a building as rain water flowing into the joints, particularly in cold climates where there is frost.

### Suggested Specification

The copper work at the cornice and balustrade is to be done as shown on the drawings. The cornice covering is to be of 20-oz. copper, the balustrade covering and flashing of 16-oz. copper and the built-in gutter of 24-oz. copper. All sheet copper except the through-wall flashing is to be of cornice temper. The leading edge of the copper is to have a hem or quirk to form a drip and shall be kept back from the face to avoid staining the materials composing the architecture.

PLATE NO. **18**  
**Flashing of cornice and balustrade**

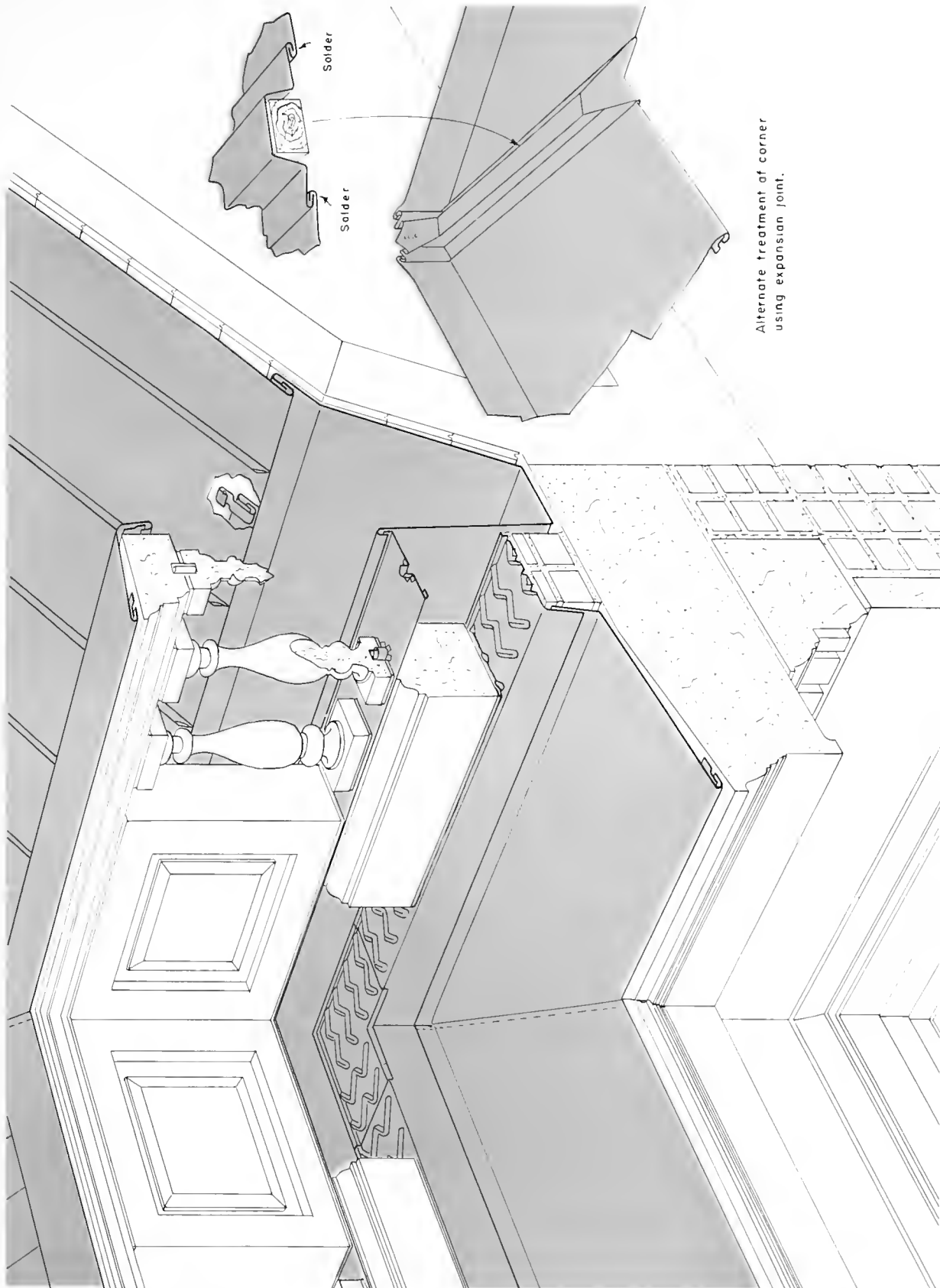

## Apron for shingle roof PLATE NO. 19

The part of roof which overhangs the outer wall at the eave becomes chilled because of exposure to the cold outdoor air at the top, bottom and front, whereas, the roof within the wall lines of the building becomes warmed by the heat which escapes through the ceiling. As a result the blanket of snow in contact with this roof area will slowly melt. The water will then flow downward until it reaches the cold overhang where, upon continual freezing it forms a dam, thus causing water to back up under the shingles and into the house.

A satisfactory safeguard or remedy is to build an apron of copper on the part of the roof which extends outside of the wall line of the building. Snow and ice will

not cling to the metal and if properly constructed the apron will not leak water.

### **Suggested Specification**

There is to be an apron of 16-oz. copper of cornice temper where shown and as detailed on the drawings. The sheets are to be endwise connected with blind soldered clinch lock joints. The edges are to be free sliding, fastened with individual or continuous copper cleats as required. The sheets of copper may be 8' long. Expansion joints of an approved type are to be used at intervals of 32'.

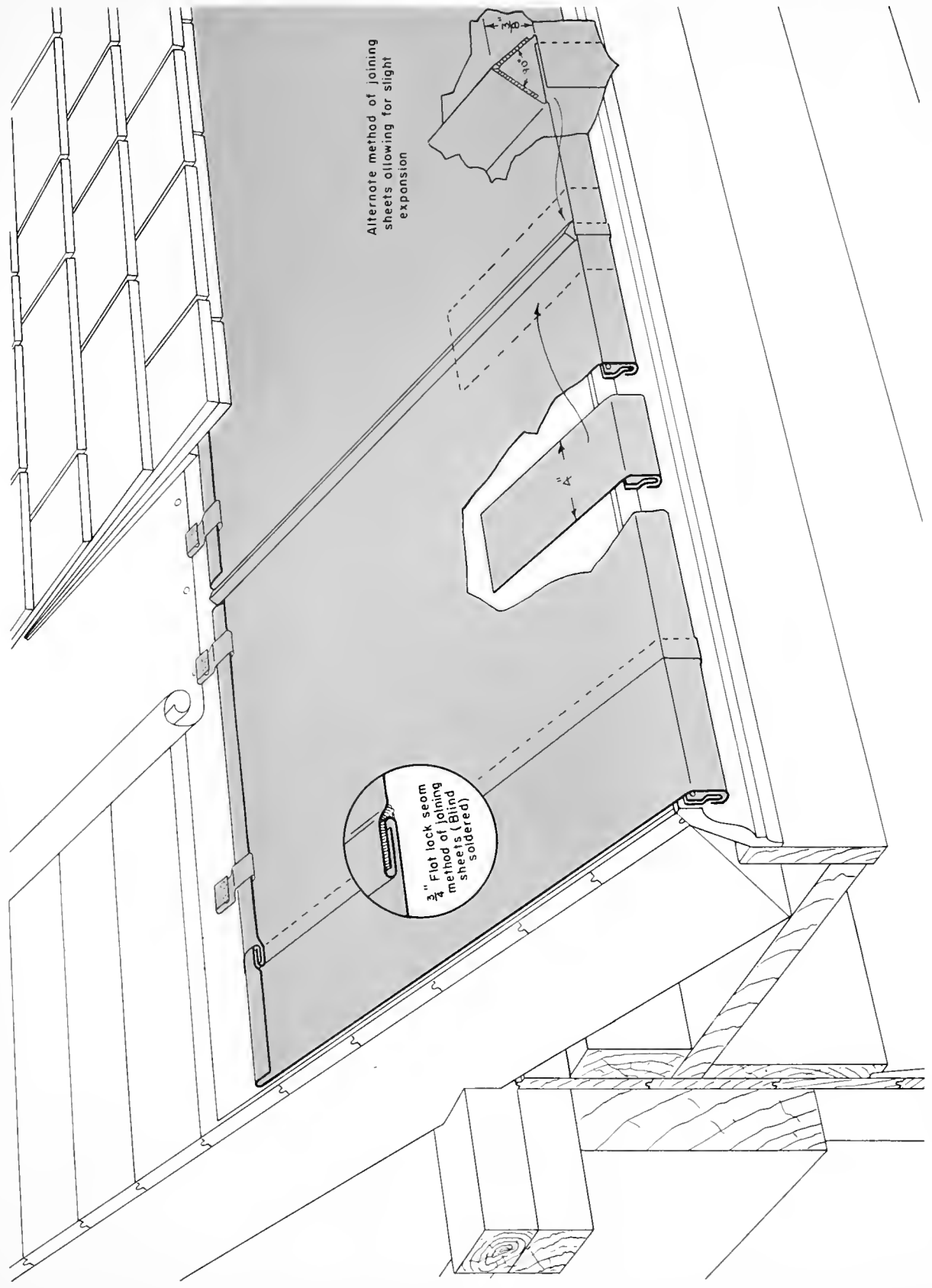

## Flashing at junction of flat and sloping roof PLATE NO. 20

The transition from a flat roof to a sloping roof requires proper flashing. The drawing shows a shallow curb of wood which facilitates joining the standing seam copper roofing with the flashing for the built-up roofing. The curb could very easily be formed to accommodate batten seam roofing on the steep slope by thickening the outer edge an amount equal to the height of the battens.

The curb should be high enough to prevent the wind from whipping any water on the flat deck, over and onto the sloping roof. This is to prevent staining and

disfiguring of the copper roofing. The flat deck should have an inside drain.

### Suggested Specification

The junction of the flat roof and the sloping roof is to be made with flashing of 20-oz. copper of cornice temper. The base flashing for the built-up roof is to have a 4" roof flange, locked and soldered end joints, and a free sliding clinch lock joint at the top edge, filled with white lead paste. The curb flashing is to have soldered end joints and 3/4" clinch lock, free sliding edges.

Flashing at junction of flat and sloping roof

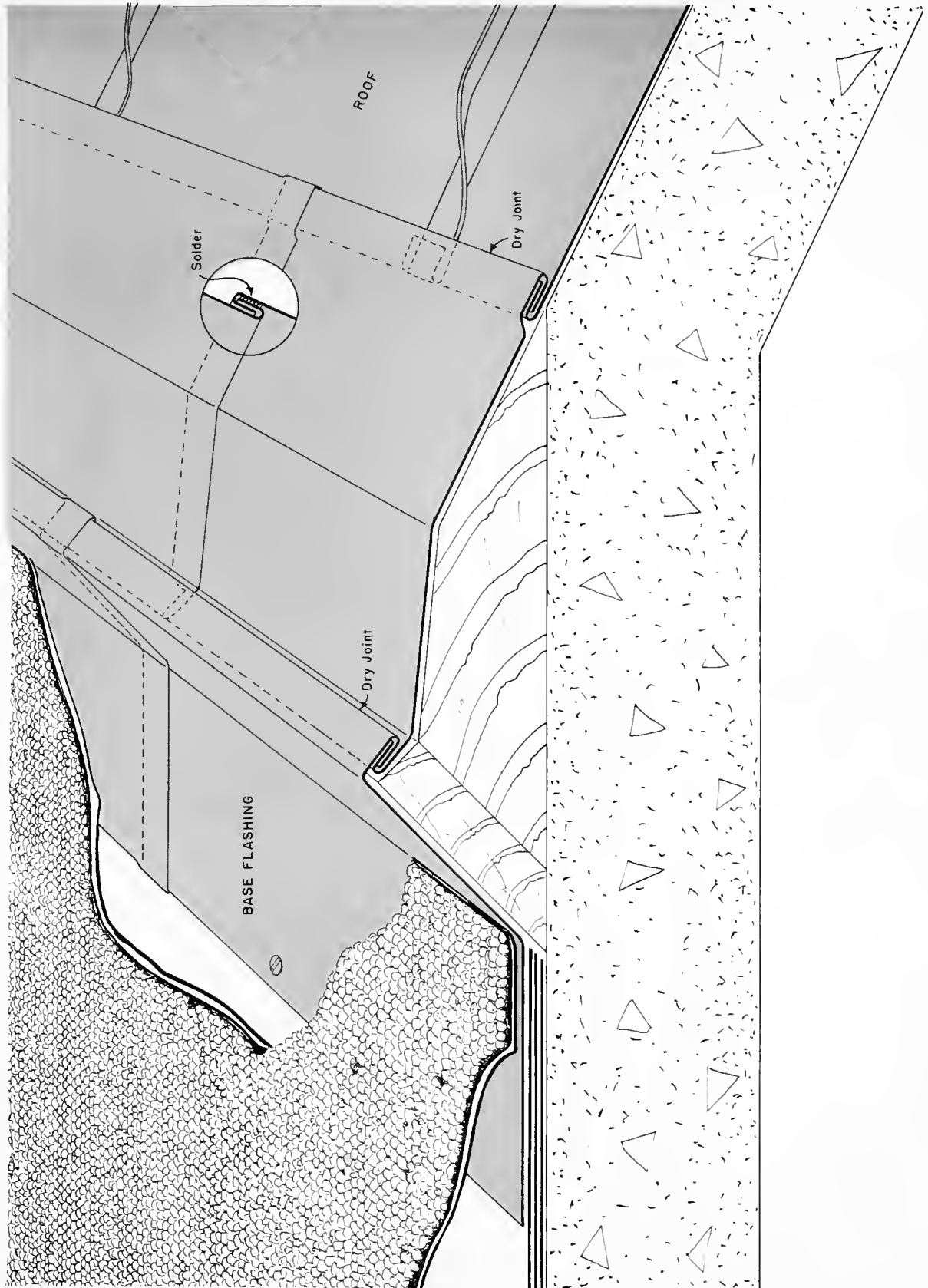

## Valley flashings PLATE NO. 21

There are two kinds of valley flashing in common use, open valley and closed valley. As the name implies, an open valley is one where the line of shingles or other roofing is kept back, leaving part of the valley flashing exposed for a free and easy flow of the water. A closed valley is one with the shingles brought to the center of the valley thereby concealing the flashing and producing an effect that is sometimes preferred in steep roofs on small buildings.

Nails securing the shingles should not be driven through the valley flashing, therefore the open valley becomes a necessity in roofs with a large water shed or for roofs with a low pitch, both of which require a relatively wide valley lining. The width is governed by the roof area that drains into the valley and by the pitch of the roof. A slight pitch drains slowly and allows more water to accumulate in the valley, thus requiring a wide valley lining, whereas, a steep roof sheds water more quickly

and can have a narrower valley flashing. The chart on PLATE NO. 21 will serve as a guide.

### Suggested Specification

**Open Valley:** Valley linings are to be of 16-oz. copper in 8' lengths. The ends are to lap 6" on slopes of 6" per ft. or steeper. On lesser slopes the end joints are to be clinch locked and filled with white lead paste. The re-turn bends for the clinch lock shall be 1½" at the top edge and ¾" at the bottom edge of the sheets of copper that make up the valley lining. The edges of the valley lining are to be turned back ¾" to facilitate fastening with copper cleats, which are to occur at 12" spacings. There shall be no nailing directly through the copper.

**Closed Valley:** Flashing squares of 16 oz. copper 9" square are to be inserted in each course of shingles at the valley. These are to be held in position by nailing at the top edge.



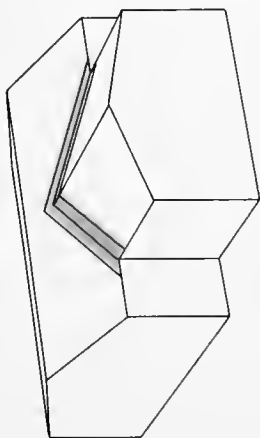
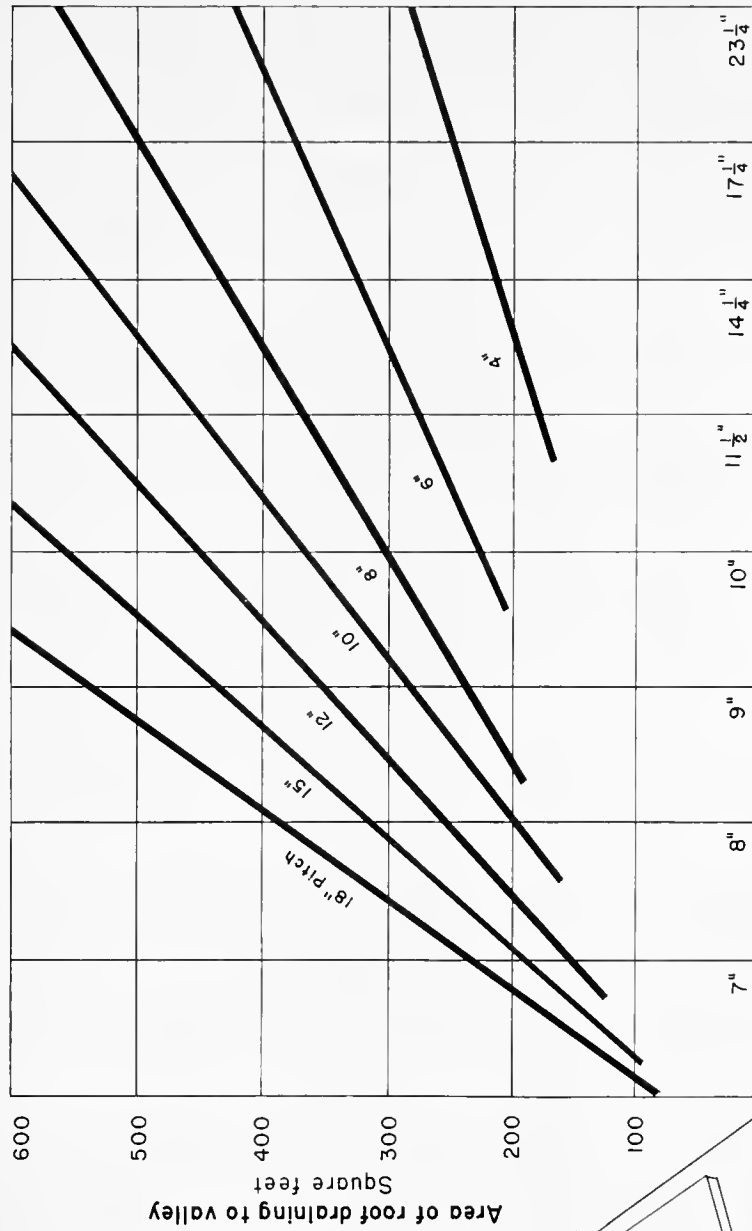

Low pitch roofs because of slow drainage require wide valleys of the open type

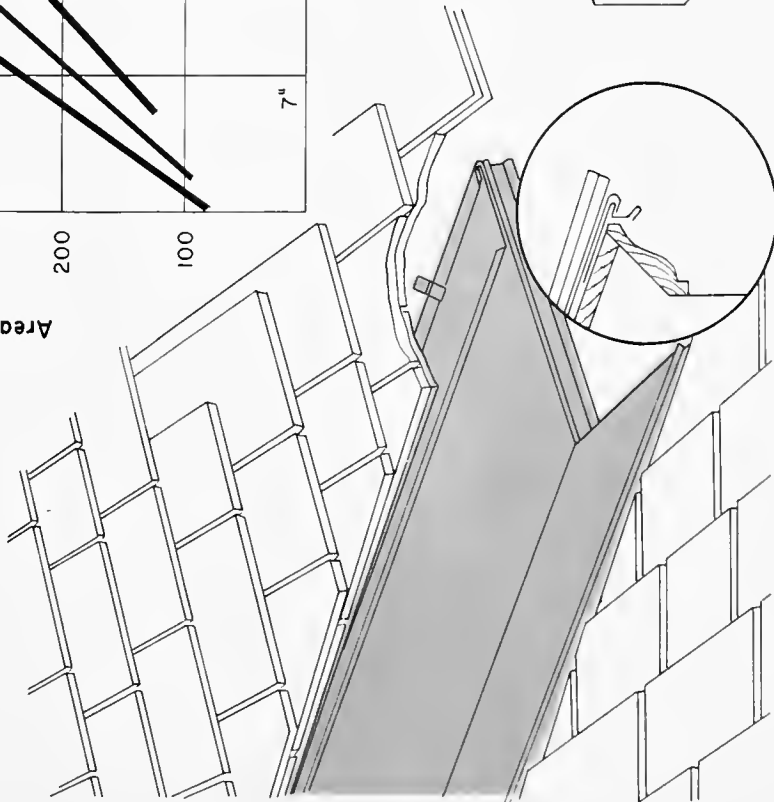

**Half width of valley**

Steep roofs need only a narrow valley lining because of the speed of flow. Closed valleys are the most common. They can consist of small flashing squares or of long sheets.

Medium pitch roof valleys can be open or closed. Open valleys are preferred, particularly when they serve large roof areas.

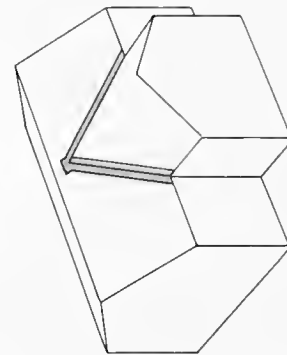
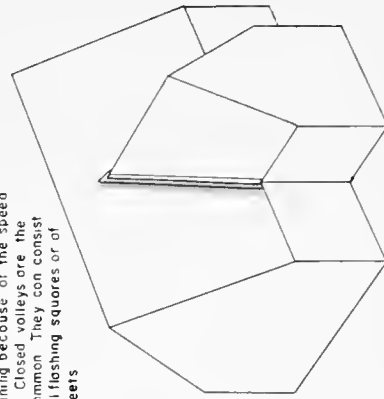

## Roofing — bay windows PLATE NO. 22

No building materials are so adaptable to curves as sheet metal, and copper is the most suitable because of its pliability and ease of joining and soldering. It is also the most attractive when it takes on the familiar green patina upon exposure to the weather.

Curved roofs and sweeps on bay windows, entrance hoods, conical turrets, etc. covered with sheet copper, look best with blind soldered joints, or with the double lock standing seam method of joining.

For neat appearance the copper should be of cornice temper. When an entire slope of a bay window or a hood is made of a single sheet of copper, it should be of 20-oz. or 24-oz. gage. If the work is to be done with the standing seam method of joining, copper sheets of 16-oz. gage or 10-oz. Economy Copper Roofing (16" x 72") is suitable. Often the 10-oz. copper with 3/4" standing seams and the narrower spacing between seams produces the best architectural effect. Also the closer seam spacing provides rigidity and wind resistance comparable to that obtained by using heavier sheets with a wider spacing between the standing seams. If the radius of the curvature is short, the uppermost edges of the upstanding legs of the roof pans should be crimped before the double lock seams are made.

The procedure in applying the standing seam roofing is quite regular, except that the work of flashing the vertical walls and finishing at the eave, as well as at the underside of the bay windows, is special and pecu-

liar to the requirements of the design. The eave may be provided with a drip edge or may have architectural or half round hanging gutters with suitable leaders to carry away the rain water. The designer should take special care that all drip edges are of generous proportion.

The copper on a hood or bay window roof may be left plain and allowed to weather, or it can be painted, if desired. The copper can be wiped with boiled or raw linseed oil if a deep bronze color is desired, but otherwise should be avoided so that the beautiful color of the natural patina can be acquired.

### Suggested Specification

Bay Window copper work is to be as shown on the drawings and the gage of metal shall be as indicated. Dry lock joints are to be used wherever it is possible to make the construction weather-tight without solder. Where soldering is necessary the copper is to be cleaned, pretinned and locked and soldered, or lapped and soldered for best appearance. Lap joints are to be at least 1" wide. Any exposed solder is to be scraped or wiped off, leaving the copper clean.

The flashings and edgings shall have drip edges or shall be formed so as to minimize the possibility of staining adjacent building material.

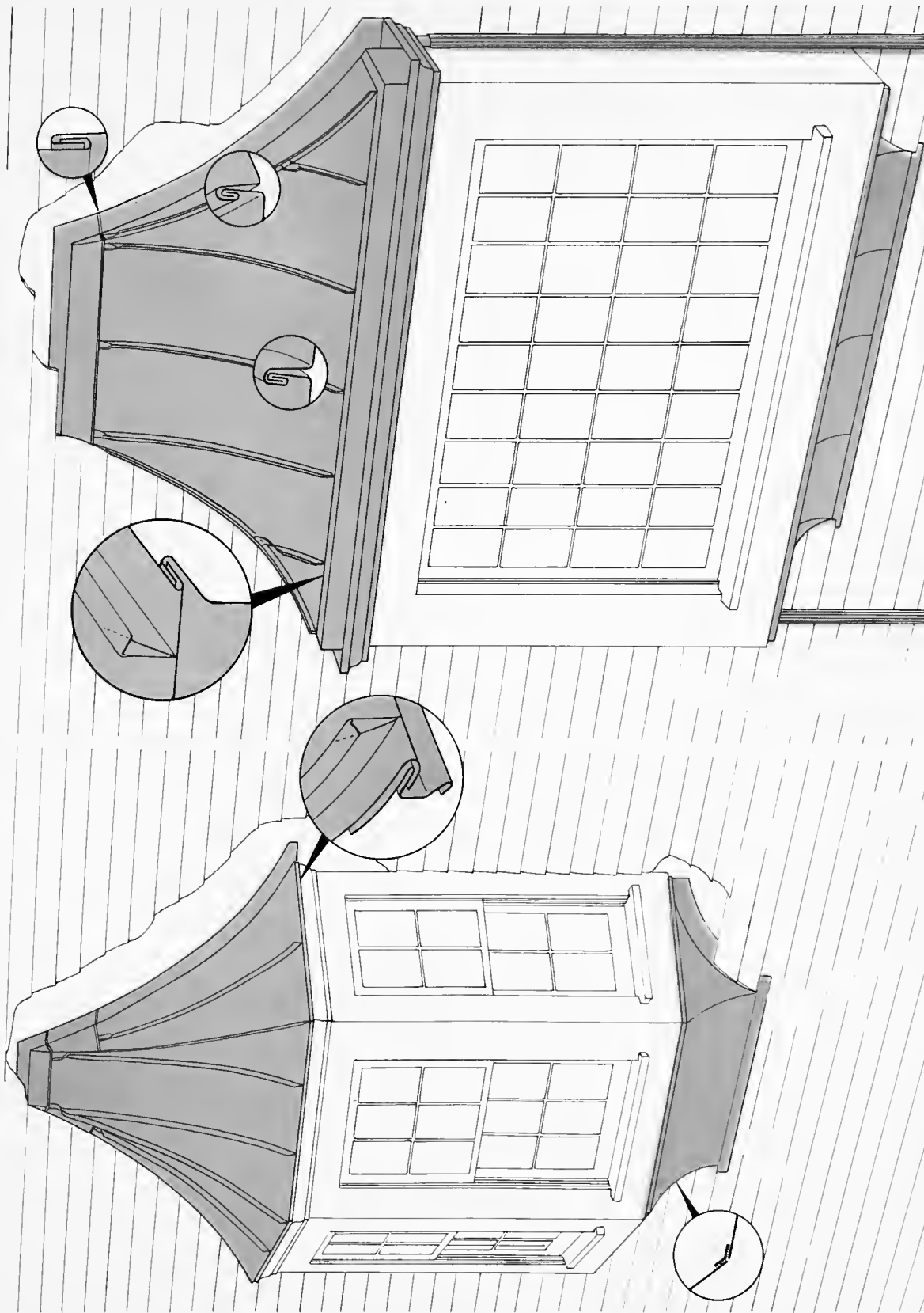

## Through-wall flashing for cavity wall PLATE NO. 23

A cavity wall consists of masonry, generally of brick, in which the outer facing is free standing and separated from the inner masonry of the wall by an air space, usually 2" wide. This air space is quite valuable in that it retards heat flow, both inward and outward through the wall. It also prevents the penetration of moisture from the outside to the interior, and thereby obviates the need of furring on the inside to protect the plaster that would otherwise become stained and damaged by such penetration.

Theoretically there would be little need for flashing, but for reasons of practical construction it is quite important that flashing of a permanent kind be built into the masonry in locations where there is likely to be an accumulation of water, such as at the water table or floor level, and at window and door sills. Window heads should also be flashed if there is not sufficient protection from an overhanging cornice or similar construction.

This drawing shows the standard Anaconda Through-Wall Flashing extending through the wall at the level of the top of the floor joists. The flashing tends to stiffen the construction, and will protect the joists and carrying timbers from the water which would otherwise reach them by filtering down through the masonry to cause decay and weakening of the structure. Such a through-wall flashing is very desirable. An important reason is that considerable mortar falls into the air space as the bricks of the inner and outer walls are laid. This mortar in effect creates a solid wall directly above the flashing and since the mortar is porous and absorbs

water, the flashing will collect any accumulation of water and will discharge it to the outside. There are also certain unavoidable connections between the outer and inner wall in the form of withes or metal wall ties which, with an accumulation of droppings of mortar, form sufficient contact to conduct moisture across the air space.

Anaconda Through-Wall Flashing because of its nesting and interlocking design, with one-piece corners, fits into place very readily and makes for good economical construction. This flashing is normally furnished in 16-oz. copper. Window head and sill flashing may also be of 16-oz. copper, or of 10-oz. copper. The latter is furnished in sheets 16" x 72" known as Economy Copper Roofing sheets, or in rolls 16" wide.

### Suggested Specification

Cavity Wall Flashing shall consist of a damp course on top of the foundation wall and through-wall flashing at about the floor line as shown on the drawings. There shall also be through flashing under all window sills and at door sills where required. Sill flashings shall extend 6" beyond the opening and the flashings in the wall are to lap 3".

The damp course flashing is to be of paper backed 2-oz. Electro-Sheet Copper and the formed through-wall flashing is to be of 16-oz. copper.

Through-wall flashing for cavity wall

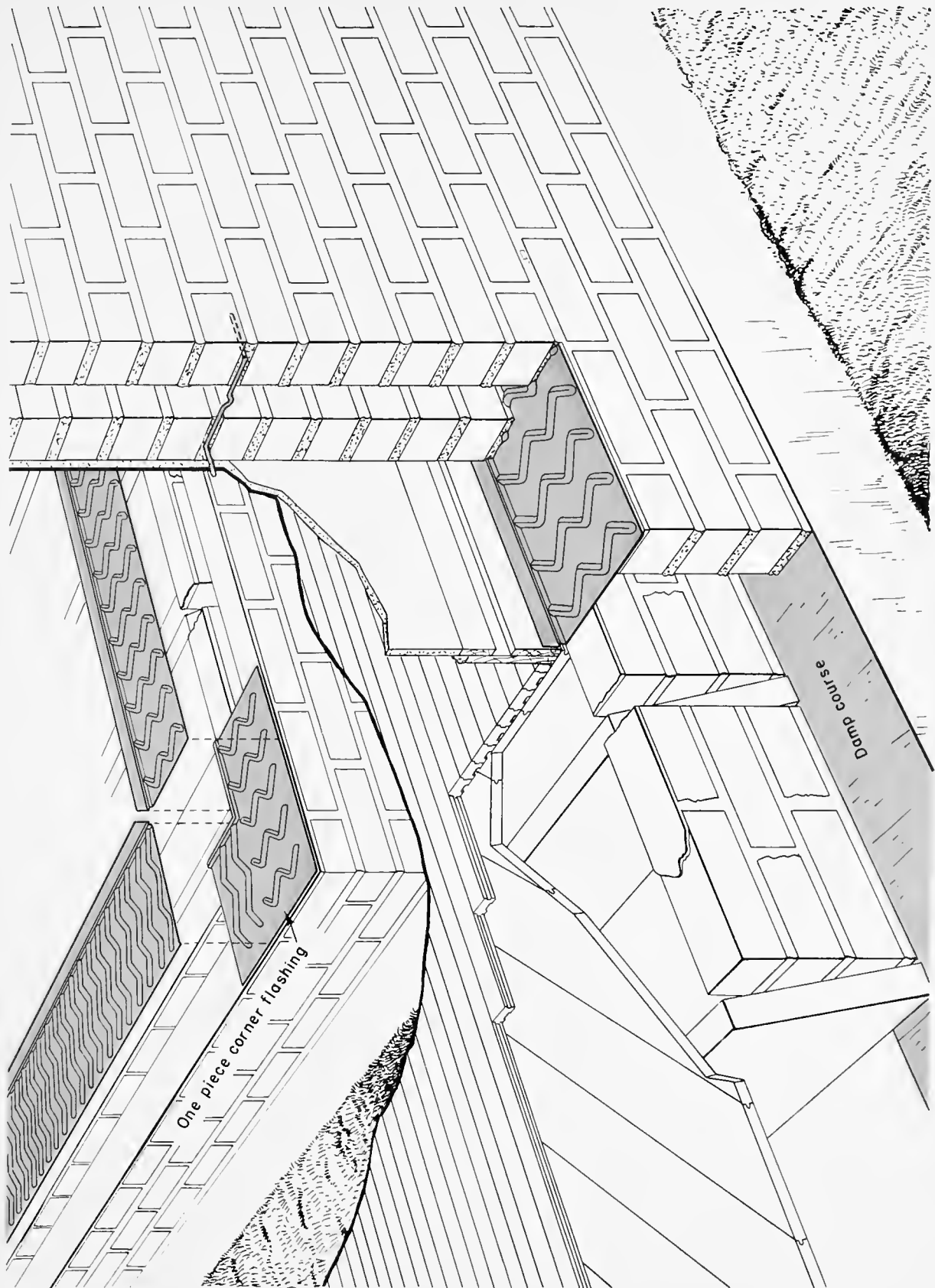

## **Water table flashing** PLATE NO. **24**

The water table at the first floor level usually extends beyond the wall line of the building to give the appearance of a heavy base or pedestal. Construction such as that with a top surface more or less level and exposed to the weather requires proper flashing.

Usually the through flashing rises from one level to another so as to pass under the stone water table and lies directly beneath the starting course of the masonry wall at the level of the first floor. The Anaconda Through-Wall Flashing with plain selvages on both the dam and the drain sides makes an ideal flashing when installed as shown on the drawing. The unevenness in height that will naturally occur between the two levels is absorbed by the weather lapped vertical flanges of the two pieces of flashing, so that a solid bearing is possible at both levels. The flashing

can be set so that the water will positively drain toward the outside.

Anaconda Through-Wall Flashing is furnished flat with a specified breadth of corrugation, and with plain selvages, to be brake formed in the shop or on the job.

### **Suggested Specification**

Water Table Flashing is to be in two parts as shown on the drawing. The horizontal portions of the flashing are to have corrugations at least  $3/16$ " high and at 3" spacings to interlock with the mortar. The plain selvages at the edges of the flashing shall be bent up or down as required for proper drainage to the outside. The 8' lengths are to have an end lap of 3" by nesting one corrugation over another.

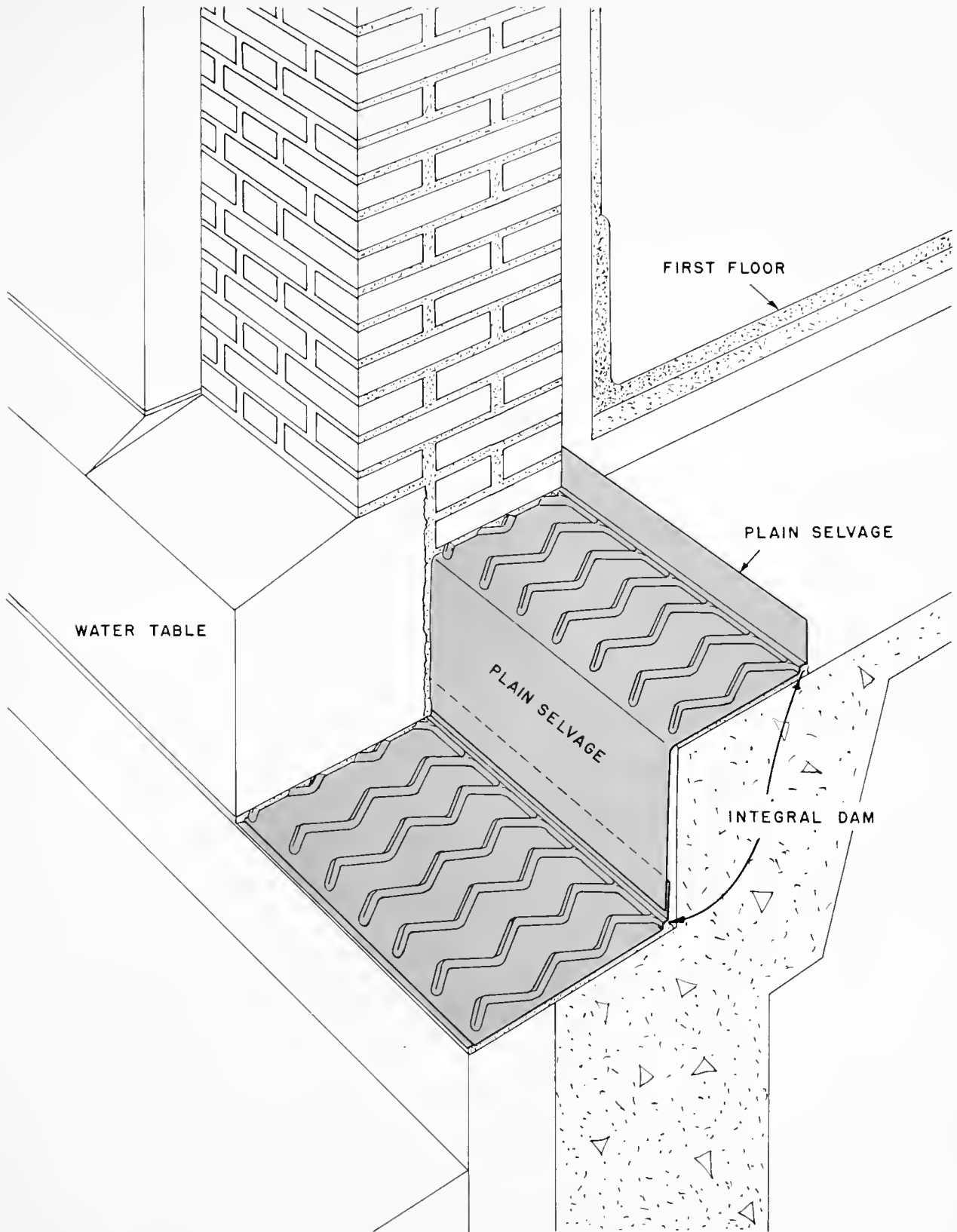

## Window sill flashing PLATE NO. 25

In the construction of window sills for masonry buildings the matter of shedding rain water is important. In the early days elaborate precautions were taken to prevent the water from getting through to the interior. It was customary to extend the sill 4" beyond the jamb forming a lug and to cut a wash into the top surface of the sill. It was also considered good practice to rabbet the stone sill and to insert a brass spline or water stop between the top of the stone sill and the underside of the wood sill of the window frame above. There was also the practice of extending the blind stop of the window frame into the jamb of the masonry to form a wind brake and to prevent the entering of wind driven rain.

Because of practical difficulties and added expense the lug sill of old has evolved to the slip sill of today which means that the sill is cut to fit between the jambs of the masonry with vertical mortar joints at the ends of the sill. The spline is usually replaced with elastic caulking compound and the joint around the window frame is likewise made storm-tight with caulking, whether the frame is made of wood or steel. All of this makes faster, simpler and less expensive construction, and requires only through-wall flashing which, when correctly installed, results in construction that is more waterproof than former methods, particularly at the sill.

The Anaconda Through-Wall Flashing with its integral dam and herringbone design corrugation is ideal for window sill flashing. It is available in copper of 16-oz. gage in various widths and plain selvages. The detail shows a regular flashing for a 12½" brick wall with a 2" up-standing flange on the inside. The purpose of this flange is to direct the water that may flow down the inner face of the brick wall to the mortar joint above the copper through-wall flashing, where it will find its way to the outer face of the wall, across the top surface of the flashing. The through-wall flashing is extended 6" beyond the jamb so as to offer positive protection under the vertical joint at the ends of the stone sill where rain water is quite certain to leak through in time. Leaks are most likely to occur at the jamb and bottom corners of the window frame, at the sash, in the joint under the wood sill, and between the sash and stool.

### Suggested Specification

Through-Wall Flashing at all sills shall be of 16-oz copper of the embossed type with corrugations on 3" centers and with a dam on one edge and a plain surface on the other. The flashing shall be so positioned that the water that is intercepted will be diverted to the outside. It is to be laid in a bed of mortar and shall extend 6" beyond the jamb of the opening. The outer edge of the flashing is to be placed 1/4" in from the face of the masonry.



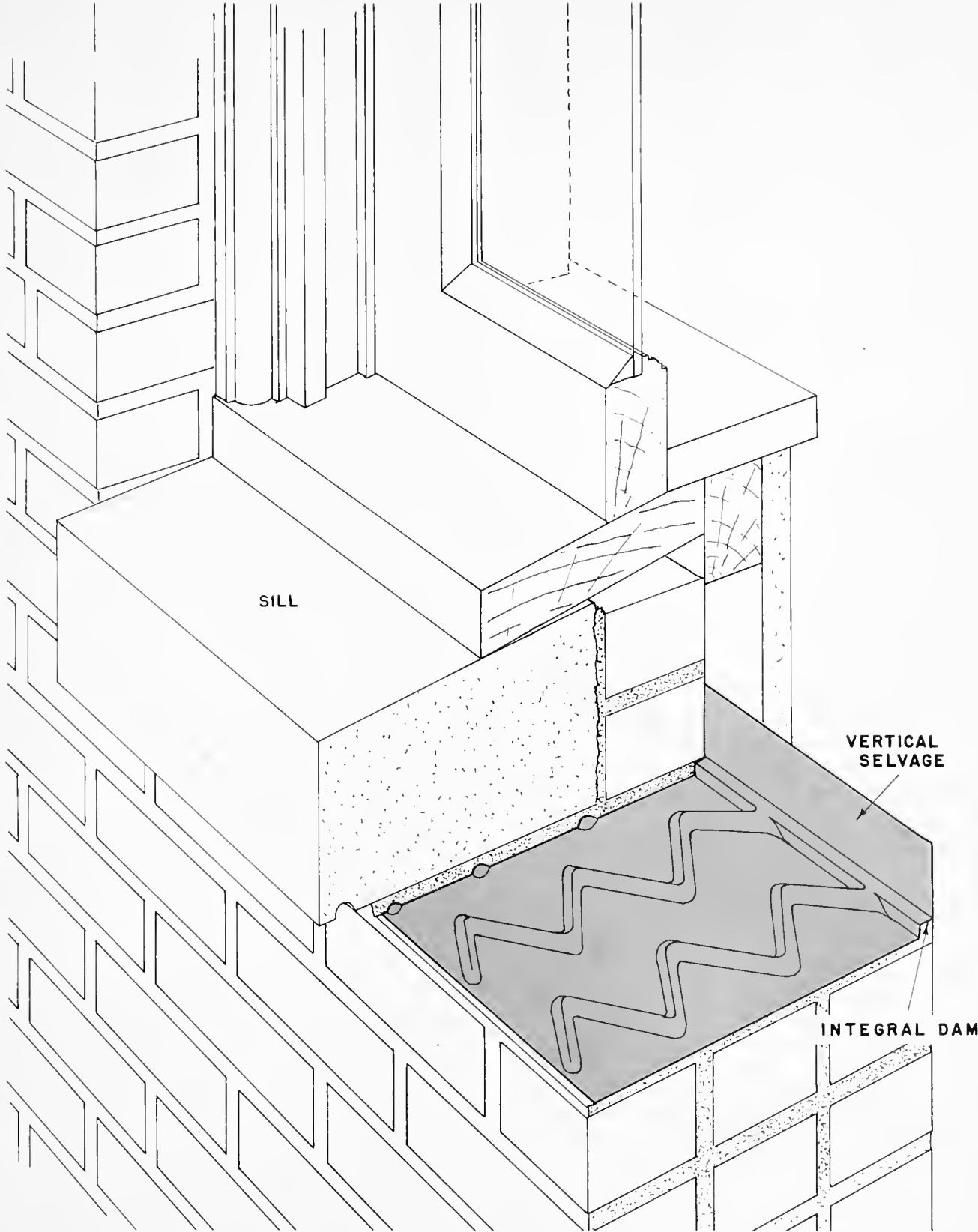

## **Window head flashing** PLATE NO. **26**

Leaking water at the window heads can prove very damaging and it is important that it be prevented with through-wall flashing.

In building walls of masonry nearly every opening has a steel lintel and some with a shelf angle to support an outer veneer of brick. There are also variations in detail, such as the window frame which may be of wood, steel or aluminum, and the lintel may be of stone as on this drawing, or it may be in the form of a spandrel made of brick, terra cotta, slate or marble. In any case it is vitally important to do a thorough job of flashing with copper.

The Anaconda Through-Wall Flashing with a 2" upstand formed of the plain selvage on the dam side, and with a wide plain selvage on the drain side can be easily shaped to conform to the masonry construction over the window and is

the most positive method of draining all of the water to the outside. Window head flashings for individual windows, like sill flashings, are extended 6" beyond the jamb. For wide openings or for band type windows, the flashings may be extended by lapping the 8' lengths 3", or 1 corrugation endwise.

### **Suggested Specification**

Window Head Flashing shall be standard through-wall flashing of 16-oz. copper with corrugations on 3" centers and with an integral dam. The selvage on the drain side is to drop vertically as shown on the drawing to protect the steel lintel and the window head. A weather lip is to be formed at the outer edge. Extend the flashing 6" beyond the jamb in all cases.

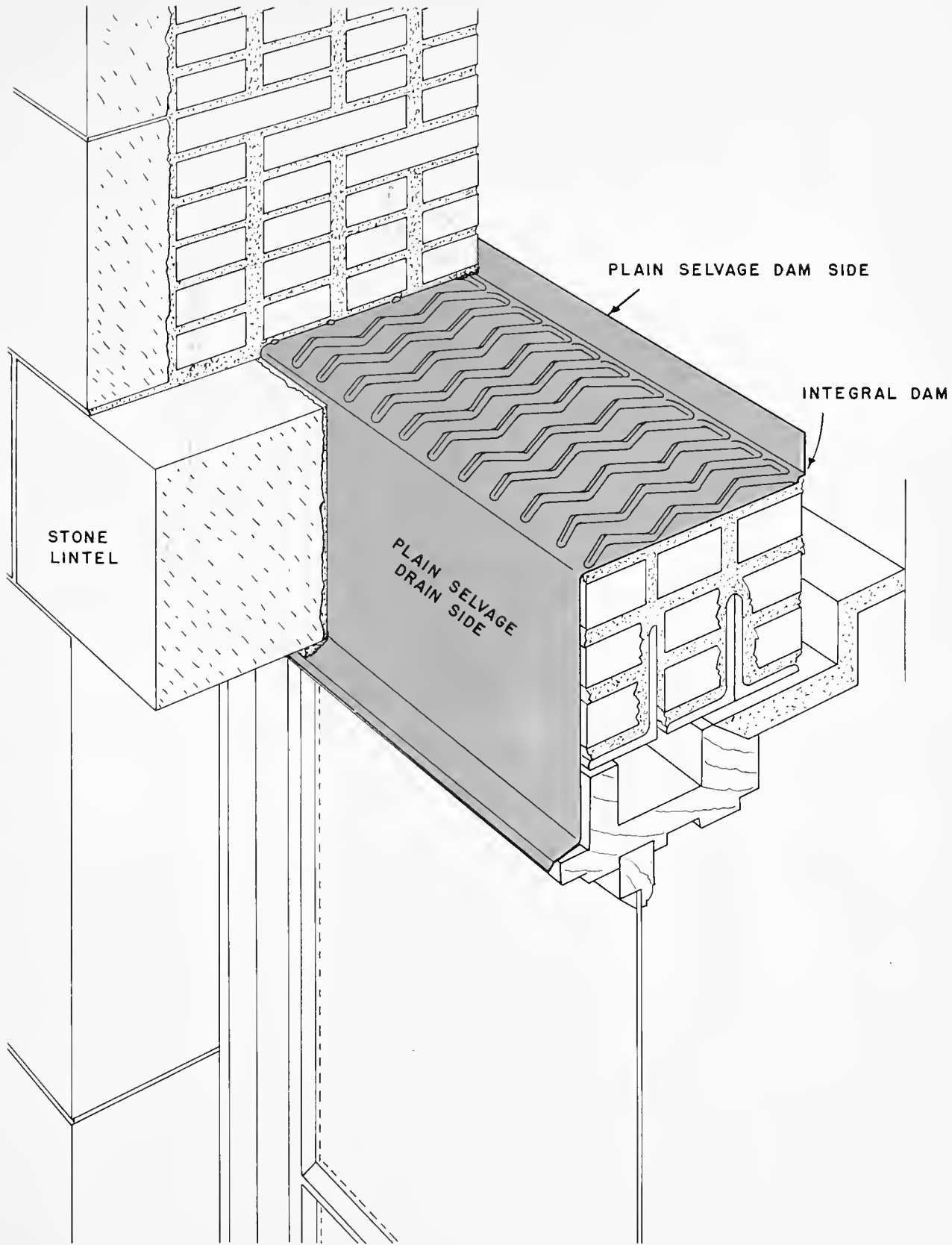

## Roof and parapet flashing PLATE NO. 27

### Base Flashing

The junction of the roof deck and the parapet is subject to movement by shrinkage, settlement, or expansion and contraction. It is important that a flashing material be used which is not only strong and durable, but of a kind that suits every practical need. Copper of cornice temper and of a gage suitable to the scale of the work meets these requirements better than any other material. It is extremely workable, has excellent soldering properties and a yield strength sufficiently high for the normal stresses in the adjustment of building materials and from climatic changes in temperature.

### Counter and Through-Wall Flashing

A masonry parapet which is exposed to the weather on both sides becomes saturated with water during heavy rains due to the double action of suction and pressure on the opposite sides of the wall caused by strong winds. Any water which penetrates the wall will percolate downward through the masonry to the interior. Thus, in addition to a good base flashing, a well designed junction of flat roof and parapet will also require a counter flashing and through-wall flashing of copper.

The best form of counter flashing is one that is integral with the through-wall flashing. Referring to the drawing you will note that the plain selvage of the Anaconda Through-Wall Flashing is easily bent down at a right

angle to form a neat, weather-tight counter flashing—but this is not the only advantage offered by the Anaconda flashing. It has a maximum bearing surface of plain copper and its embossed herringbone design offers the greatest resistance to horizontal shear in every direction. The dam is press formed in the flashing. The smooth selvage may be bent without distortion or humping—thus eliminating the forming of water pockets. The Anaconda Through-Wall Flashing drains dry on a level bed.

### Suggested Specification

Base Flashing shall be of 20-oz. copper of cornice temper and in 8' lengths. The roof flange is to be 4" wide and the vertical leg not over 12" high. The base flashing shall be secured to the roof deck in an approved manner, equal to nailing through the flashing and the built-up composition roofing with 7/8" #12 copper nails at 3" spacings. The end joints in the flashing shall be cleaned, pretinned, clinch laced and soldered.

Parapet Flashing shall consist of a one piece through-wall and counter flashing. This flashing shall be of 16-oz. copper, machine formed with corrugations and an integral dam. There is to be a 4" counter flashing drop with a stiffening edge at the bottom. End joints are to be made by lapping the flashing pieces 3" or one corrugation.

Roof and parapet flashing

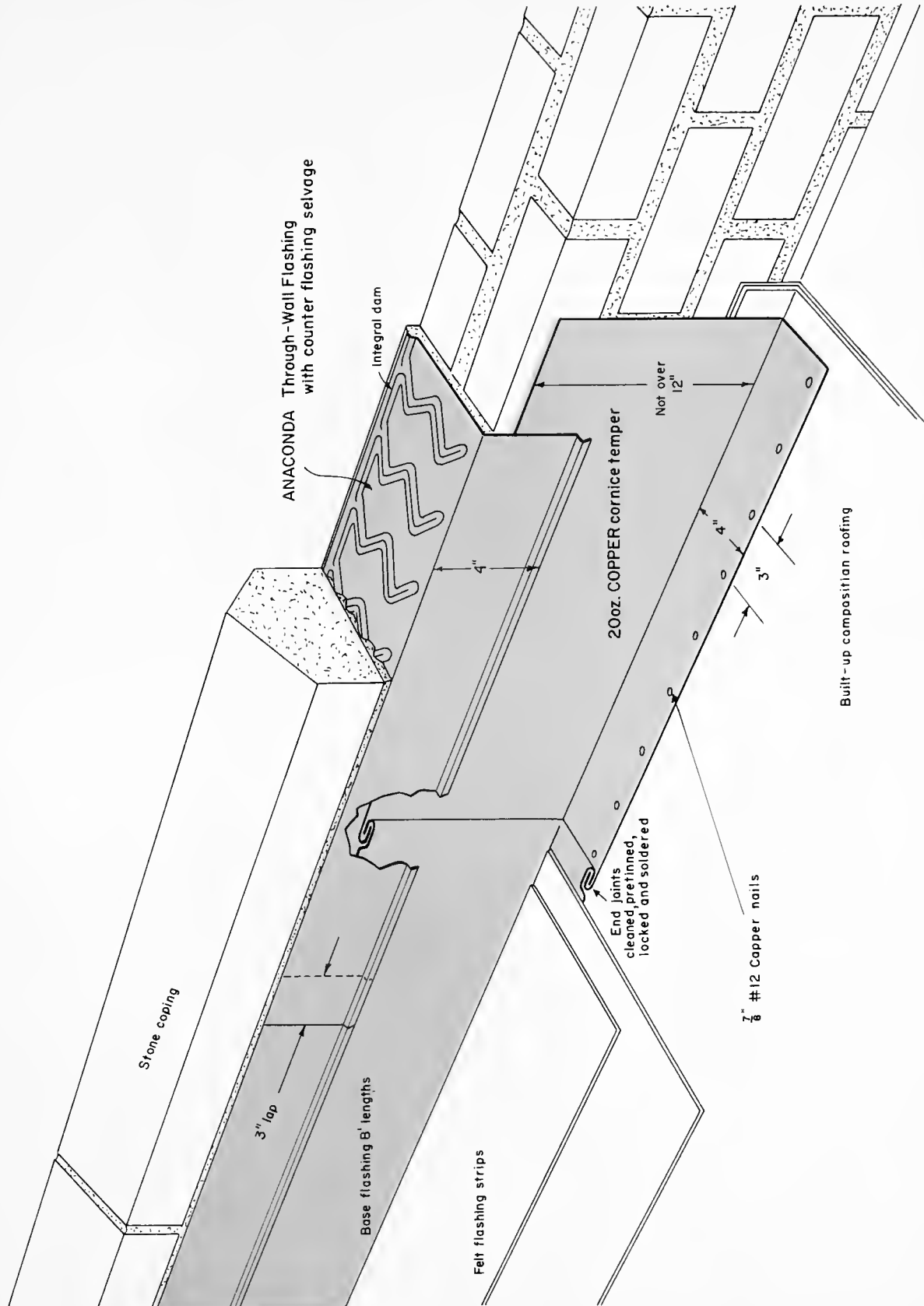

## Corner flashing PLATE NO. 28

Installing Anaconda Through-Wall Flashing at the corners offers no problem to the sheet metal worker as standard 8" and 12" one-piece Anaconda corner flashings are available for both outside (external angle) and inside (internal angle) corners.

In most through-wall flashings it is impossible to lap one flashing over the other without resulting in a "fat" mortar joint. In common brickwork this condition might be acceptable, but not with face brick or with stonework where the mortar joint may be only a 1/4" thick. Tailoring or mitering with snips and making a soldered joint is sometimes resorted to, but is often unsatisfactory and expensive.

Anaconda One-Piece Corner Flashings interlock and nest perfectly with the adjoining straight flashing. There is no building up of metal, except the additional thickness (.0216") of 16-oz copper at the lap, and the mortar joint at the corner can match the other masonry.

Anaconda outside corner flashings are precision stamped from a copper sheet to form a perfect dam on the outer edge and an integral weather lip on the drain side so that a weather-tight corner results when the adjacent lengths of straight flashing are properly placed. The Anaconda inside corner flashing is furnished flat

with an integral dam on the outside of the wall, and a plain selvage on the drain side. The selvage is formed into a drop counter flashing at the corner. When all the flashings are in place, including the base flashing, the counter flashing is made weather-tight at the corner by interlocking or lapping the vertical flanges and making them secure either by malleting or by saldering.

### Suggested Specification

Through-Wall Flashing shall be of 16-oz. copper with corrugations at least 3/16" high and at 3" spacings. The flashing is to have an integral dam on one edge to drain the water in the desired direction. This flashing is to be with or without selvage on the drain side as required by the drawings.

The corners are to be finished with one-piece corner flashings. These corner pieces are to have an integral dam in the right location for the inside and outside corner flashings, respectively. The corrugations of the corner flashings shall nest with the corrugations of the straight wall flashing so that there will be no piling-up of copper at the lap, which is to cover two corrugations of the straight flashing.

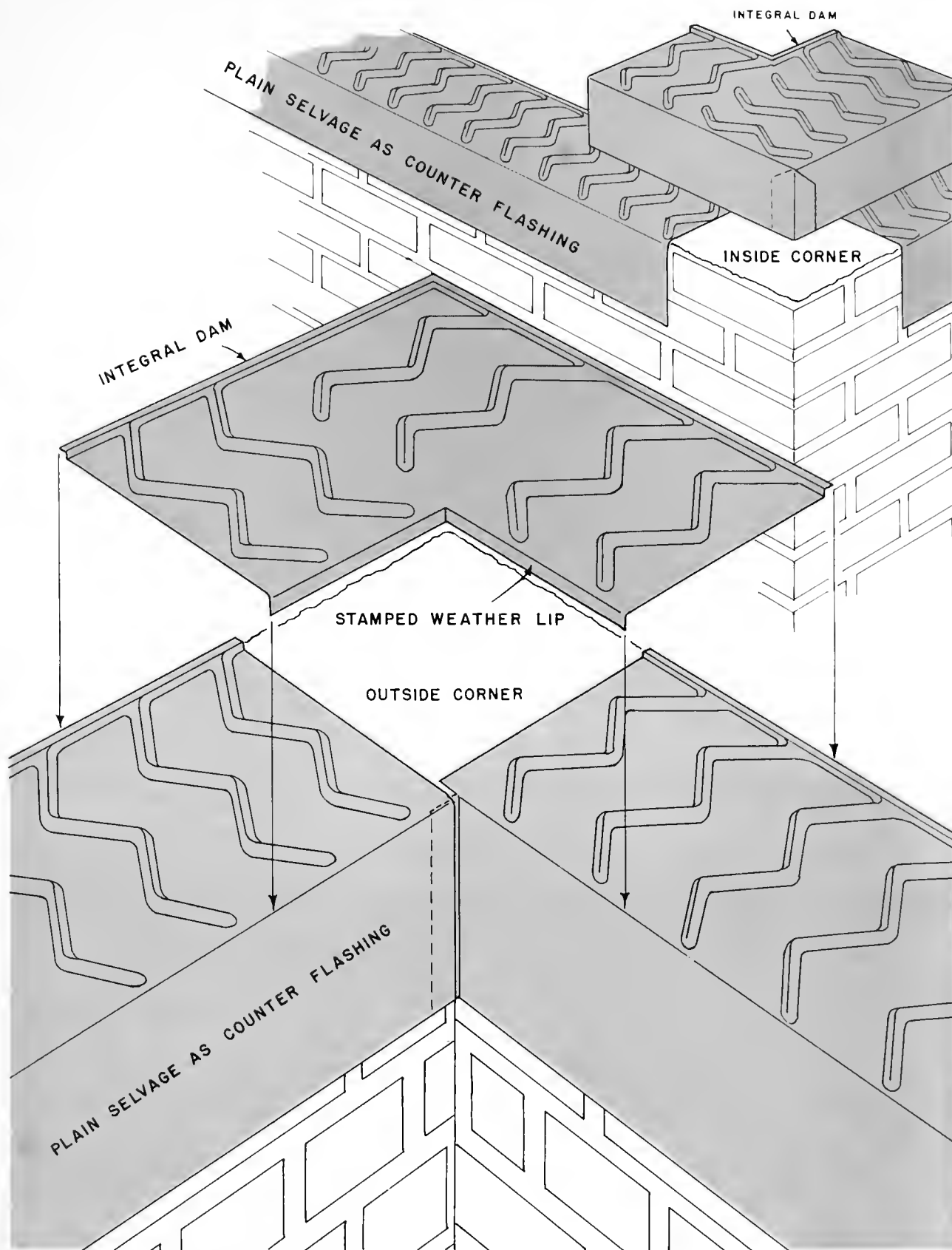

## Cornice and parapet flashing PLATE NO. 29

Masonry materials such as artificial stone, brick and terra cotta are all quite porous and absorptive and, after a length of time, will admit and flow water rather freely. A common brick may absorb as much as 35% of its weight in water, while artificial stone and terra cotta are designed for a 15% water absorption to insure a desirable amount of suction for a strong bond with the mortar. Even for masonry of granite, limestone or marble, copper flashing is necessary because it is impossible to make the mortar joints permanently water-tight.

Water absorption in a masonry wall is of concern in a warm climate because of the danger of damage to the interior. In cold climates there is the additional danger of damage to the construction caused by the freezing of any water that may find its way into the masonry. This usually becomes evident in the way of scaling on the face of natural stone and spalling or disintegrating of artificial stone. In brick work this destructive force manifests itself in breaking away parts of the mortar joints and destroying the cohesion of the particles that make up the brick, particularly so with common red brick. Sometimes there is a warning of such a situation in the form of white stains from efflorescence.

If the cornice and parapet are flashed with copper as shown on the accompanying drawing, the face of the building will, in all probability, require little repair. Anaconda Through-Wall Flashing installed under the coping so that the dam is on the outside edge will divert the absorbed water toward the roof. The lower course

of through-wall flashing protects the structure below from the water that usually saturates a parapet wall. Note that the Anaconda flashing can be obtained with a plain selvage on both drain and dam sides. On the drain side the selvage forms a counter flashing over the base flashing, and on the dam side this integral selvage serves as a counter flashing for the cornice flashing.

The top surface of a masonry cornice is particularly vulnerable to damage from wind-driven rain sweeping along the top and into the vertical joints. Plain sheet copper, cornice temper, installed as suggested in the drawing will protect the stone and mortar joints.

### Suggested Specification

Parapet and Cornice are to be flashed as shown on the drawing. The through-wall flashing under the coping is to have a 1/2" selvage on the drain side to bend down below the top edge of the underlying brick. The lower through flashing is to have a counter flashing selvage on the dam side and the drain side. Use 16-oz. copper.

The base flashing is to be of 20-oz. copper of cornice temper, with a 4" roof flange, fastened securely to the roof deck through the built-up roofing. The cornice cover is to be of 24-oz. copper of cornice temper, in 8' lengths.

Joints in the through flashing shall consist of a 3" end lap. All other joints are to be cleaned, pretinned, clinch locked and soldered.



Cornice and parapet flashing

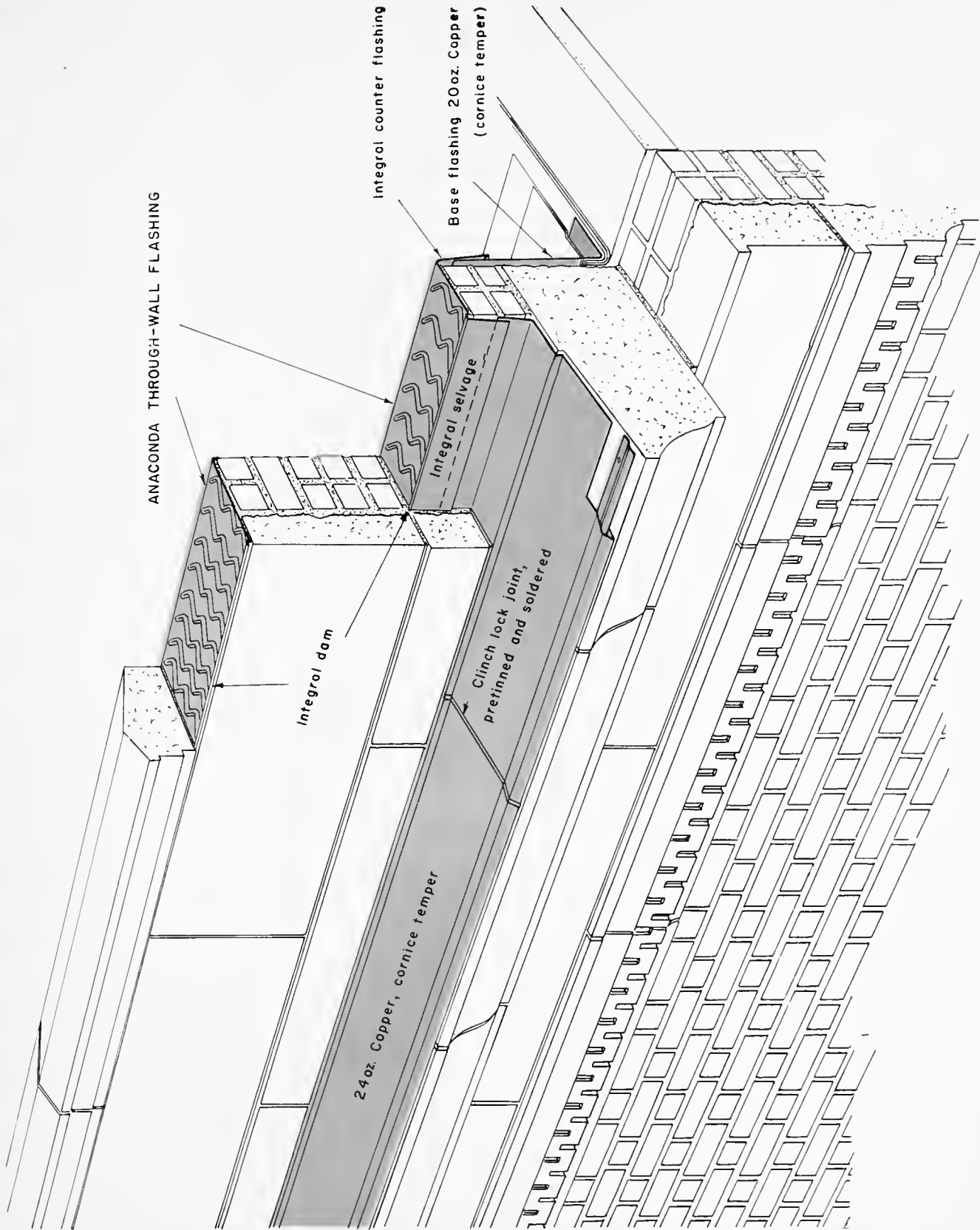

## **Gable and parapet flashing PLATE NO. 30**

To build a gable end and a parapet wall of cement blocks as shown on the accompanying drawing calls for a method of flashing that is considerably different from that commonly done with walls of brick where there are many horizontal and vertical joints into which the flashing can be built. The flashing as shown accommodates the regular cement block construction with 8" courses, allowing for breaking joints. The exposed ends of the blocks are closed and finished smooth by the manufacturer.

The copper through-wall and counter flashing shown is of two parts, making use of the counter flashing receiver feature that is particularly well suited to the Anaconda Through-Wall Flashing with its plain selvage. The base flashing in this plan is omitted because the built-up roofing is carried up over and above the cant strip. The counter flashing is held by a continuous cleat which can be lifted and the bottom of the flashing fastened down again whenever the roof covering needs to be renewed.

### **Suggested Specification**

Gable End and Parapet Flashing shall consist of an embossed through-wall flashing and a counter flashing of plain copper, both of 16-oz. gage. The latter is to be of cornice temper.

The through-wall flashing is to be installed in step fashion in each course of building blocks. The counter flashing will also be in steps as shown. All joints are to be without solder wherever possible for weather-tight construction. The connection of the through-wall and the counter flashing is by means of a reverse fold or French-lock. Other joints are to be a simple clinch lock, folded in the direction of flow. There is to be a hem at the bottom edge of the counter flashing which is to engage concealed holding clips of copper at 12" centers. The exposed vertical edge of the counter flashing is to turn the corner and to fold back so as to be held with concealed fastenings.

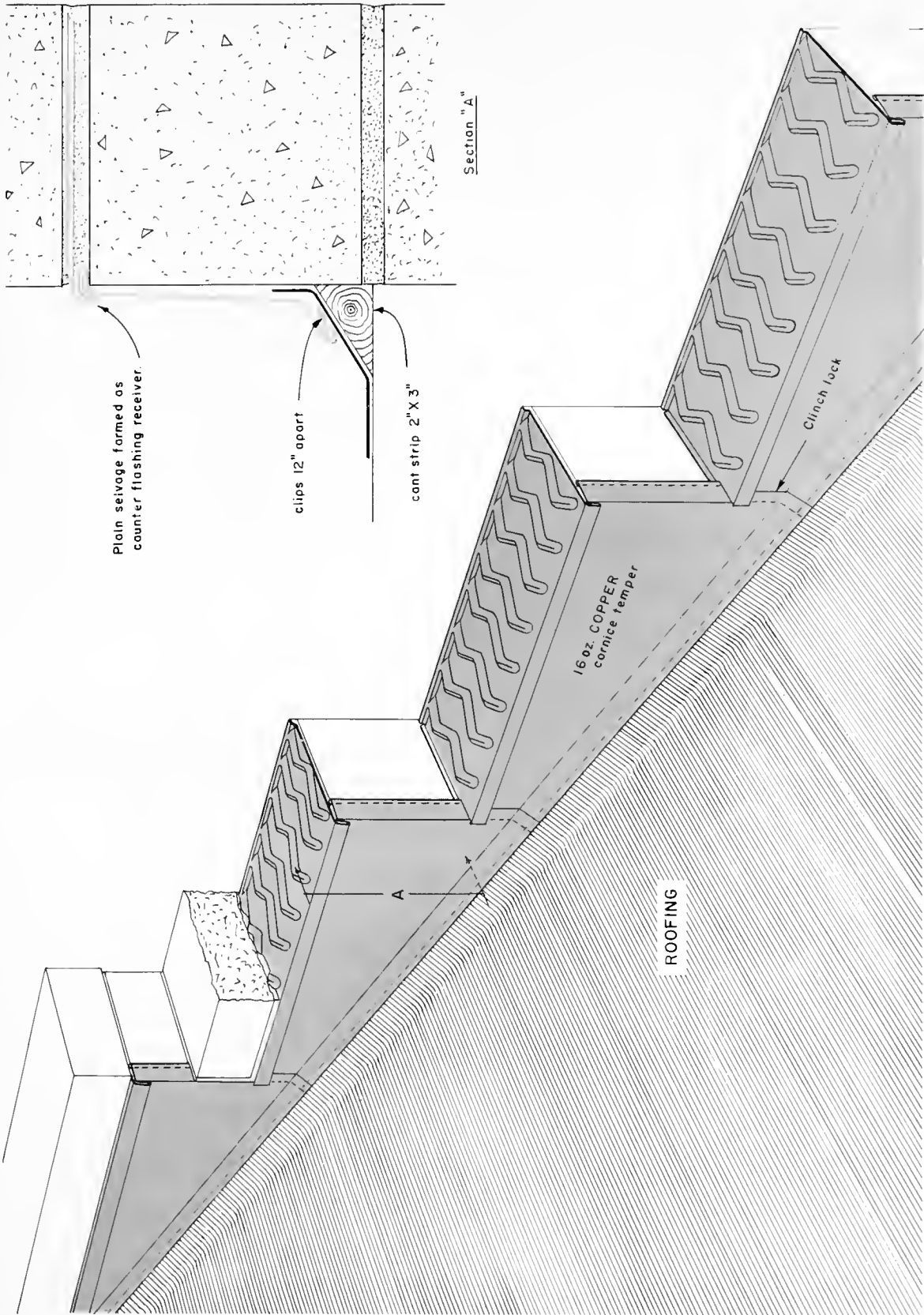

## Through-wall flashing of pilasters PLATE NO. 31

One of the great difficulties in the maintenance of masonry buildings is that of making the vertical joints between coping stones water-tight. No matter what is done hairline cracks will eventually develop, and the rain water will feed into the cracks by wind-driven rain and capillarity. There is also the porosity of artificial stone which with wide copings, as on pilasters, or as buttress caps permit a great deal of rain water to soak through to the masonry below. A simple and inexpensive protection against such an eventuality is to use through-wall flashing under all copings and possibly at the counter flashing level.

That walls of common brick are extremely porous and absorptive can not be proved more clearly than by the efflorescence that appears on the surface of such walls, usually in the spring of the year. The efflorescence which forms a white stain on the face of the bricks is the result of a chemical action between the iron oxide of the bricks and the lime sulphate of the mortar, producing a froth, which upon saturation of the masonry by rain water, flows to the outer surfaces where it becomes deposited in the form of mineral salts due to evaporation of the water. This condition is sometimes referred to as "salpeter." If the brickwork can be kept reasonably dry efflorescence will not appear.

This drawing shows a detail of construction with Anaconda Through-Wall Flashing under the coping. It makes use of the varied widths which are available in increments of 2" ranging from 8 $\frac{1}{4}$ " to 36 $\frac{1}{4}$ ". In this case the flashings have corrugations of 8 $\frac{1}{4}$ ", 10 $\frac{1}{4}$ " and 20 $\frac{1}{4}$ " with a plain selvage for counter flashing. The Anaconda flashing with its integral dam will divert rain water seepage toward the roof where it will discharge over an integral counter flashing of plain copper. In that way the water that would otherwise produce unsightly efflorescence is carried harmlessly away and delivered to the roof.

### Suggested Specification

Through - Wall Flashing shall be 16-oz. copper of various widths under the coping. The copper parapet flashing shall be made up of 16-oz. copper, cornice temper and 20-oz. cornice temper copper shall be used for the base flashing. The base flashing is to have soldered clinch lock end joints and shall be fastened securely to the roof deck. The parapet flashing shall consist of squares not larger than 18" x 24" with 3/4" dry lock joints all around.

Through-wall flashing of pilasters

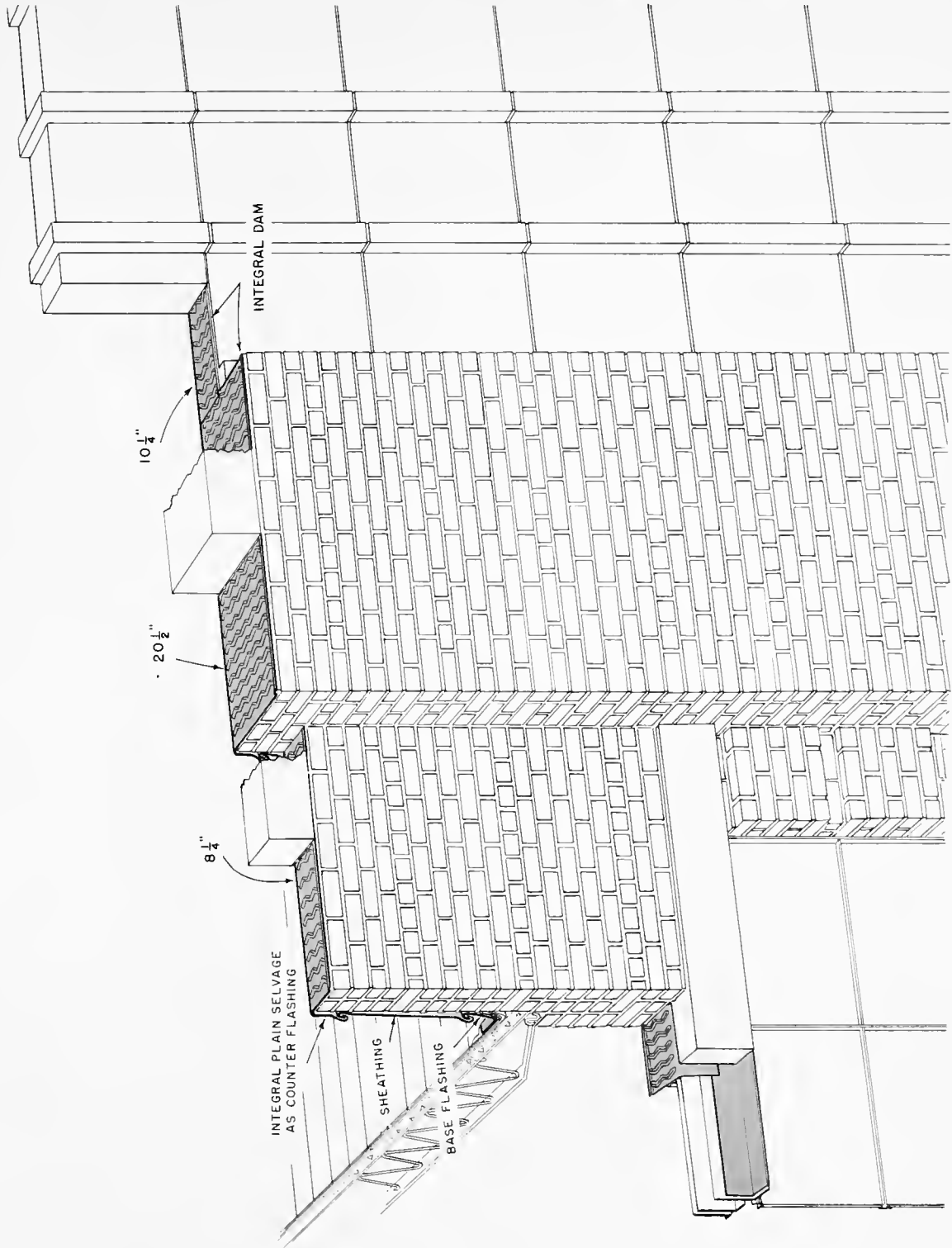

## Parapet flashing and sheathing PLATE NO. 32

To flash and sheath a parapet on the roof side with copper is quite important, particularly on buildings with high parapets and in localities that are subject to hurricanes or freezing temperatures. In a driving rain the parapet naturally becomes saturated much sooner than the wall below the roof line because of the double action of wind on one side and suction on the other. This becomes evident by way of leaks, excessive efflorescence, or even by spalling and disintegration of the masonry. The sheathing will nullify the suction and will thereby avoid all these undesirable effects.

It is very essential that a parapet sheathing allow the wall to "breathe". This means that the weatherproof sheathing must allow water vapor to escape, otherwise deterioration may ensue.

The most suitable parapet sheathing is one of sheet copper applied either by the standing seam or the ribbed methods of construction.

### Suggested Specification

**Parapet Sheathing:** The standing seam type sheathing shall be made of 10-oz Economy Copper Roofing material, in sheets 16" x 72". The pans are to be formed as shown, with the aid of a mechanical bending brake. There is to be a simple clinch lock joint at the top and at the bottom. The sheathing is to be secured to the wall with copper cleats at 12" spacings in the standing seams. Use 1/4" brass screws and expansion shields or other approved means for fastening.

**Parapet Sheathing:** Cover the roof side of the parapet wall from base flashing to coping flashing, with 16-oz. copper in a ribbed pattern as shown on the drawing. The copper is to be of cornice temper and the flutings are to be 3/8" deep and 4" wide, using a sheet of 30" width. Fastenings are to be by means of copper cleats at the leading edge, anchor bolts or stub nails at the top edge and semi-concealed holding clips at the bottom edge.

**Parapet flashing and sheathing**

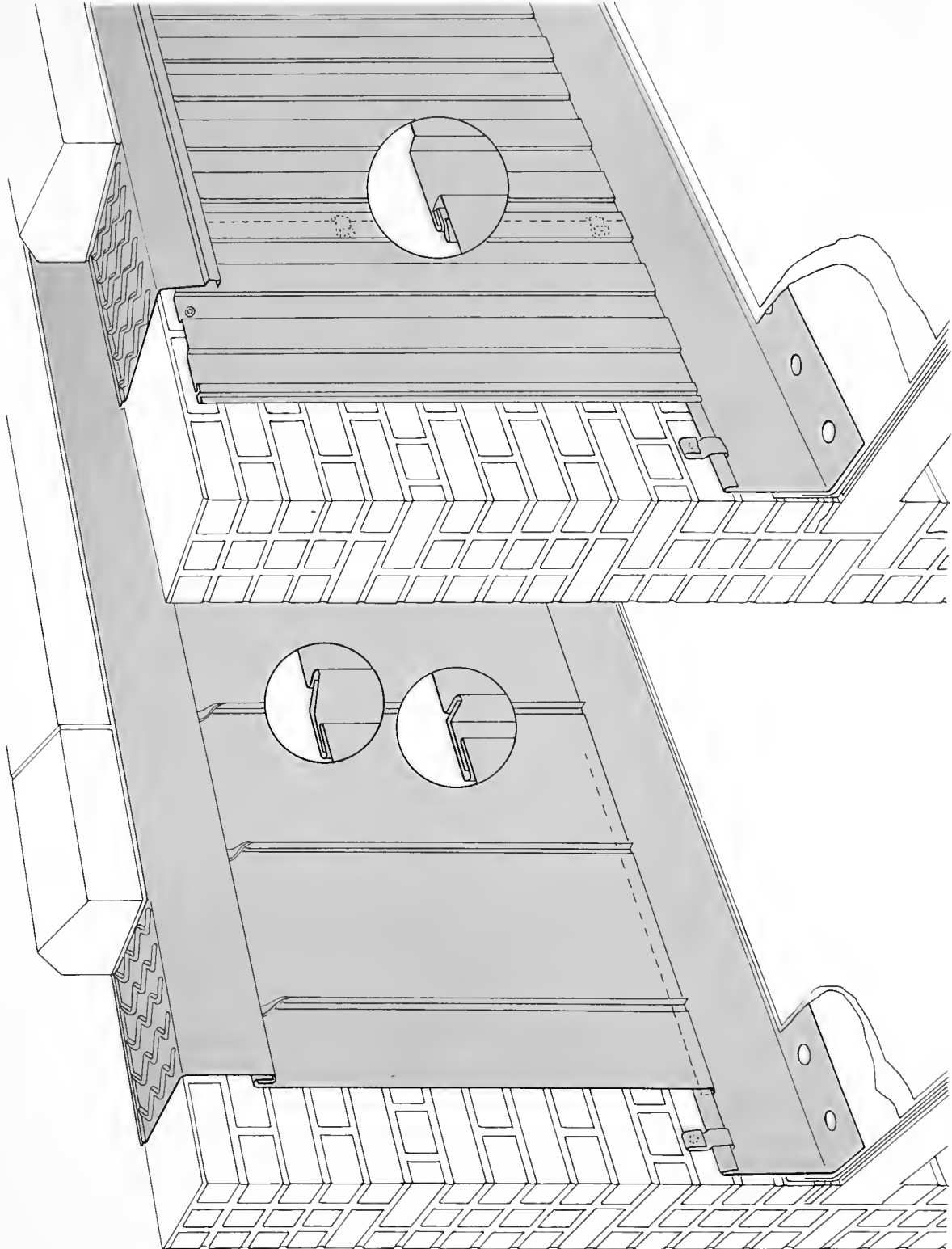

## Roofing and flashing at building setback

PLATE NO. 33

Setbacks, or the stepping back of outer walls of tall city buildings are generally required by law to admit light to the lower stories and to the street below. Setbacks are also used in architectural design. The roof for a setback can be located at any practical level in respect to the top of the coping on the outer wall. Some architects design only for a serviceable and easily accessible gutter near the top of the coping for drainage. Others prefer a parapet wall and promenade deck.

The roof covering at the setback should be of the best design and of a durable material because of the great difficulty and expense that is involved in renewing a roof in such a location. Copper is probably more suitable than any other material.

This drawing shows a flat lock soldered seam roof of 20-oz. copper of cornice temper over which a wearing surface of promenade tile is laid. There are water-tight expansion joints in the copper roofing extending across the deck at intervals of not over 40', intended to divide the total length of the promenade into relatively small isolated areas with a downspout, located midway between the expansion joints to carry off rain water. The expansion and contraction in the promenade tiling is absorbed by expansion joints of mastic around the outline where the tiling abuts either the vertical walls of masonry or the copper expansion joints.

The drawing also shows proper flashing for a promenade deck which in this case consists of the standard Anaconda Through-Wall Flashing with 12 $\frac{1}{4}$ " carriage-tion and integral selvage of plain copper on the drain side to serve as a counter flashing for the copper roof-

ing. The regular Anaconda Through-Wall Flashing without selvages is shown under the coping stone to receive and discharge the water that may flow into the vertical joints of the coping, as well as any rain water that might penetrate the coping stones. There is also an 8 $\frac{1}{4}$ " Anaconda Through-Wall Flashing with a 1" upstand located under the window sill and extending about 6" beyond the jamb. The upstand on the dam side of the flashing at the floor level is optional and depends somewhat upon the severity of exposure or an orientation of the building wall.

### Suggested Specification

The promenade deck of the building setback is to be roofed with copper, over which there is to be a wearing surface of other material. The copper roofing is to be of the flat lock soldered seam type of construction using 20-oz. copper of cornice temper. The roofing squares, with 3/4" reverse bends are to be made from sheets or blanks of copper 16" by 18" in size. These roofing squares are to be pretinned 1 $\frac{1}{2}$ " wide at the edges, clinch lapped and soldered in place. Each piece is to be fastened to the roof deck with at least three copper cleats.

Expansion joints and base flashings are to be of 20-oz. copper of cornice temper. All edges and end joints are to be cleaned, pretinned, clinch lapped and soldered. The copper roofing will be flashed at the walls with integral through-wall and counter flashing.



Roofing and flashing at building setback

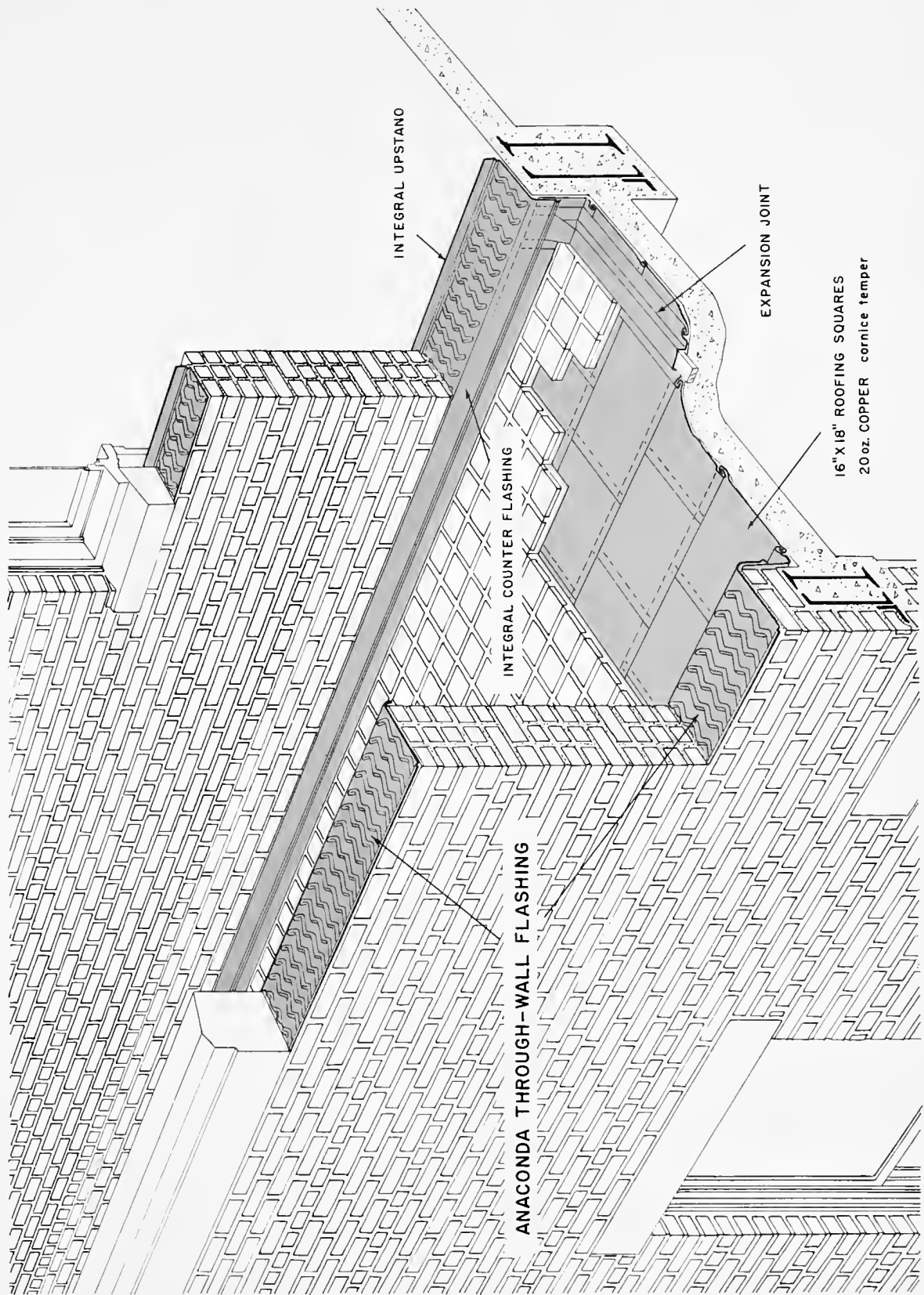

## Chimney flashing at ridge PLATE NO. 34

From the standpoint of appearance, as well as that of function, a chimney at the ridge is preferred. In that location it has the advantage of providing the best draft with the least amount of masonry extending above the roof. However, any chimney regardless of its location contributes something to an architectural composition. The designer is usually not too seriously concerned about the placing of the chimney, but instead lets it come where it may so long as the interior plan arrangement is good. Whether a chimney is at the ridge, or in the slope, or whether it is only partly in the roof, as in the gable, or at the outside wall, the problem, and the need for flashing is the same.

There is always the base flashing which on steep roofs consists of an apron at the lower edge of the chimney with soldered returns at the corners, and at the sides the ordinary 5" x 7" or 7" x 7" flashing squares are leafed into each course of shingles. The cap flashing is formed at the shop, in a manner as shown on the drawing. It is set in place over steps in the masonry to form a complete counter flashing, and is then built solidly into the brick or stonework of the chimney.

The finished appearance of the chimney flashing has considerable architectural value if the work is well done. The sheet metalworker should take care not to dent or

crease the copper and should wipe the metal clean of flux after applying solder so as to avoid ugly staining. Where appearance is important the copper should be cleaned by rubbing lightly with steel wool after the mason has completed the chimney. The copper can then be left in its natural color or it may be given a wiped or brush coating of linseed oil to bring about the russet brown or the bronze effect.

### Suggested Specification

The chimney flashing is to be of 16-oz. copper of cornice temper. There is to be a base flashing and a counter flashing, the latter extending through the masonry to the flue, with a 1" flange or upstand at the flue. There is to be a 1/2" hem at the bottom edge of the counter flashing for stiffness. All joints are to be without solder where possible, but where soldering is required the joint shall be scraped clean or blind soldered. The base flashing shall consist of an apron with soldered corners and a hem at the bottom for concealed copper clips to hold the exposed flashing flange down to the roof. There are to be 7" x 7" flashing squares woven into the successive courses of shingles, with 3" of copper extending vertically and 4" onto the roof.

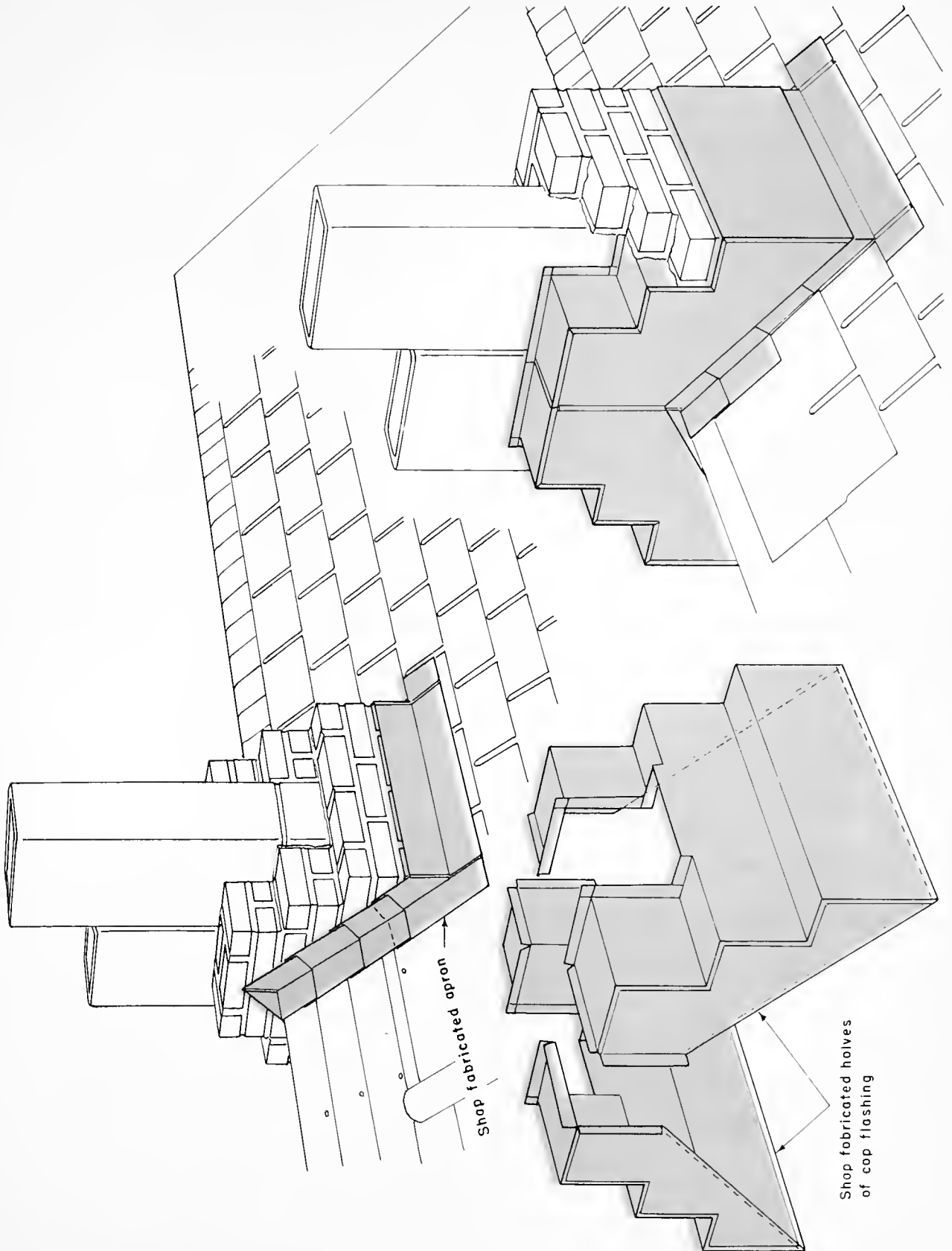

## **Chimney flashing, architectural design** PLATE NO. **35**

One might wonder why changes are necessary in the method of flashing chimneys when there are many homes built in Colonial days where the simplest chimney flashings are apparently serving quite well. This is so because chimneys built in Colonial times were usually massive, often measuring 4' to 6' at the roof and 20' square in the cellar. Moisture which penetrated the chimney above the roof was absorbed by this large bulk of masonry and did not reach the interior walls and ceilings. Moreover the lime mortar of years ago permeated the brick or stonework and after a time had somewhat of a waterproofing effect.

Thus the major function of chimney flashings at that time was to seal the openings between the chimney and roof. Strips of metal were leaded into the shingle courses and the ends of the strips tucked into the mortar joints of the chimney. Later as caulking compounds and roofing mastics became available these materials were used to close up the joints and holes against the passage of water. Today this is considered unsightly and not of first-class or permanent construction.

In modern chimneys, flue lined, masonry is kept to a minimum with the result that water which is absorbed above the roof level may very likely

find its way to interior partitions or ceilings. Furthermore, the cement rich mortar now commonly used does not have the sealing properties of lime mortar so that wind-driven rain more easily penetrates the masonry. It is therefore important that this water, which has been absorbed by the chimney, be intercepted and drained outward to the roof. A through-to-flue counter flashing of copper installed over a copper base flashing, as indicated by the drawing serves this purpose very well.

### **Suggested Specification**

The chimney flashing shall be of 16-oz. copper, consisting of a base flashing and counter flashing. The base flashing to be of 7" x 7" flashing squares leaded in between the courses of shingles. The head flashing and the apron are to be made up and soldered.

The counter flashing is to be of cornice temper and shall extend through the masonry turning up 1" at the flue. The exposed bottom edge is to have a hem for stiffness and all of the bends are to be made on a bending brake. The work is to be blind soldered wherever possible. Face soldering shall be washed and scraped clean.

# Chimney flashing, architectural design

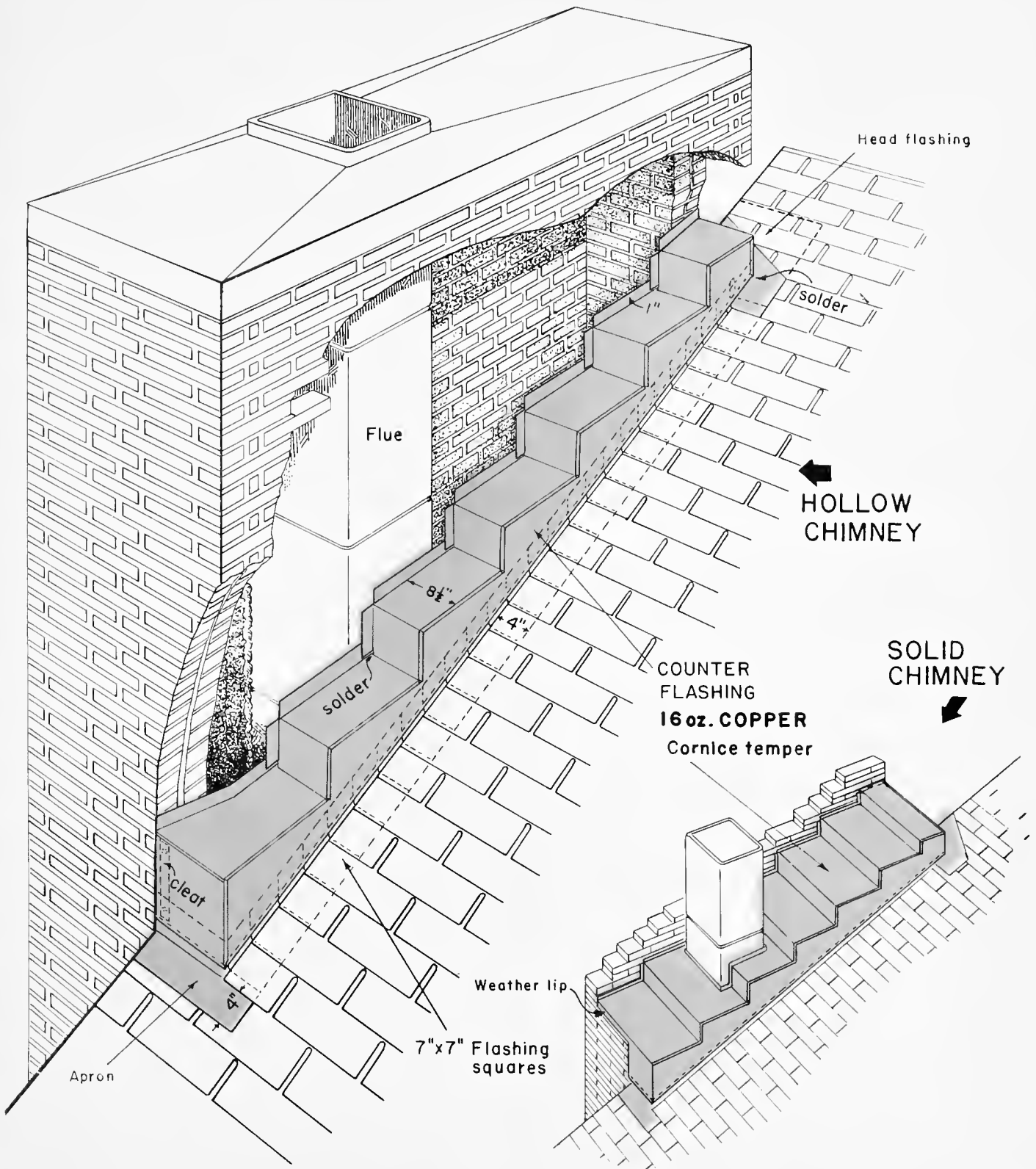

## Chimney flashing in slope PLATE NO. 36

This drawing shows a chimney on the slope of a roof. This style of chimney and flashing is particularly adaptable to low pitch roofs on bungalows and ranch houses and for buildings of contemporary design with a slope of 3" - 6" per ft. The chimney has a single flue 8½" x 13" and is flashed with 16-oz. copper of cornice temper. The base flashing is shown to be made up in the shop in the form of a flashing flange with an apron about 4" wide overlapping the shingles and a head flashing about 12" wide. There is no cricket behind the chimney. The flashing flange at the sides of the chimney is also shown to be about 4" wide so as to make certain that the rain water will flow downward beyond the chimney. This construction is considered satisfactory for the narrow side of a single flue chimney, particularly when the roof is steep, but for larger chimneys individual flashing squares should be built into the successive courses of shingles.

The cap flashing is shown to be shop fabricated of cornice temper copper, and in this case has a level top surface because of the gentle slope of the roof. In accordance with recognized good practice the copper is carried through the masonry to the flue and turned up about an inch to

make sure the rain water that is intercepted by the flashing will be diverted to the outer face of the flashing.

In laying out the flashing, the height of the up-standing leg of the base flashing at the back of the chimney should not be less than 4". On that basis, and without resorting to steps in the design of the cap flashing, a considerable breadth of copper will show, all of which is favorable provided the work is well done and nicely finished. Such a flashing when formed in the shop with the benefit of a bending brake, and other sheet metalworking tools and with proper and careful soldering, should result in a very satisfactory installation of flashing.

### Suggested Specification

Chimney Flashing shall be in two parts, a base flashing with a 4" roof flange and a 4" curb, and a hood or one-piece counter flashing with a hem at the bottom edge about 1" above the roof. The work shall be shapely and clean, and there shall be no solder on the face of the copper.

PLATE NO. **36**  
**Chimney flashing in slope**

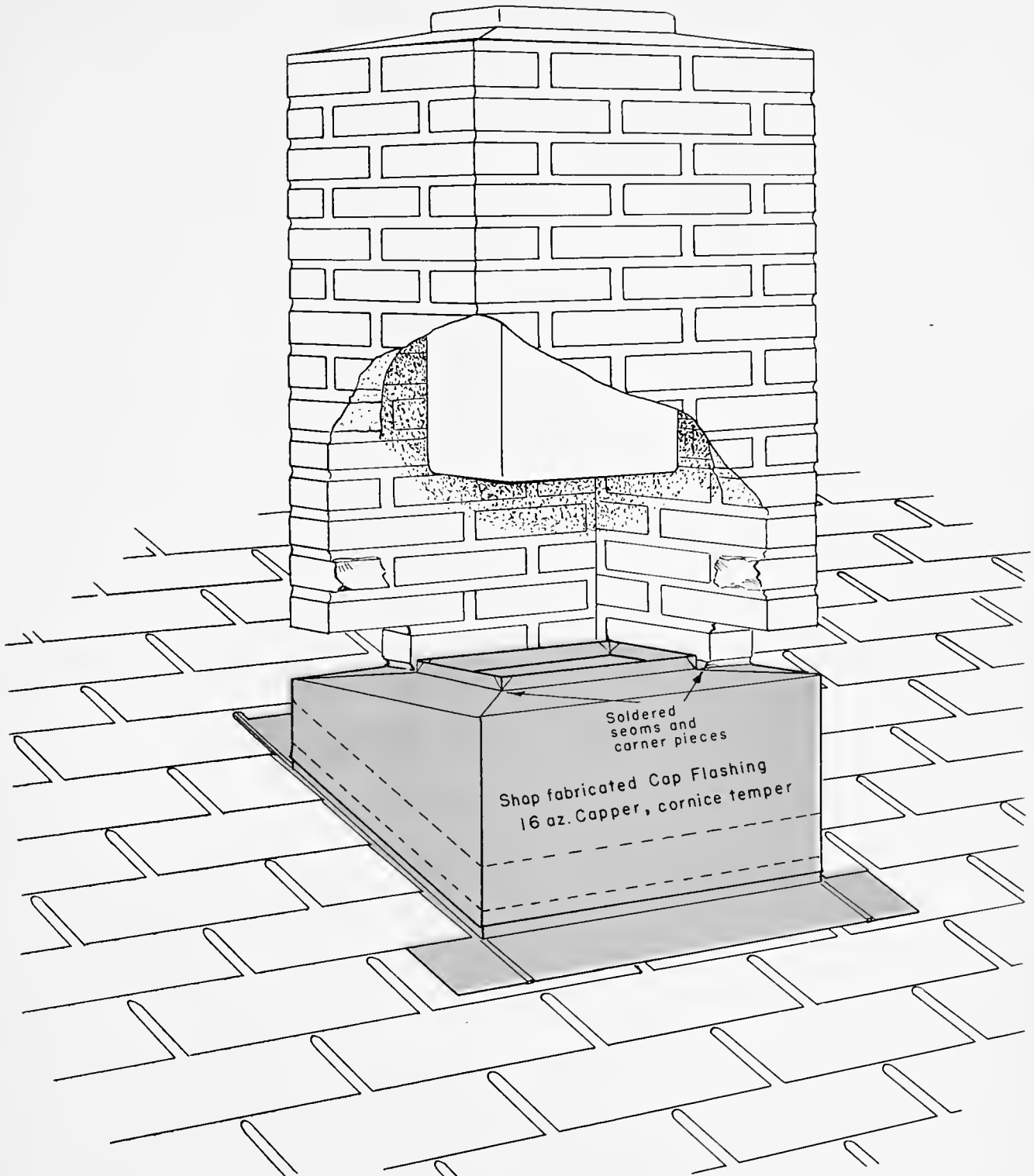

## **Chimney flashing in flat roof** PLATE NO. **37**

For houses of modern design or for apartment houses and commercial buildings the chimney may come through a roof with a pitch of less than 3" per ft., or what might be called a flat roof. The flashing for such a chimney can be quite simple and yet thorough.

Base flashings for chimneys on flat roofs must be soldered at all joints because the flashing has to be water-tight—not just weather-tight as in the case of the steep roof flashing. There is always the possibility that a roof drain may become clogged and that an actual head of water will develop around the chimney. An especially neat and workmanlike appearance will result from the use of copper of cornice temper.

Frequently, a chimney that rises above a flat roof has considerable height so as to avoid down draft. This necessitates an additional thickness of masonry around the flue, but whether the thickness is 4" or more it is important to carry the copper counter flashing through the masonry and to turn it up about an inch on the outer surface of the flue. This is particularly important because a large chimney, and one that is tall with heavy walls, will absorb a great deal of

rain water which, if allowed to gravitate downward within the masonry without being intercepted by flashing may cause serious damage. Many chimneys have been built with the counter flashing only tucked into the mortar joint an inch or so with the unhappy result that repairs were continually required and the fault cannot be remedied without taking down the entire chimney to the roof line and flashing it correctly.

### **Suggested Specification**

Chimney Flashing shall be of 16-oz. copper of cornice temper and shall be composed of a base flashing and counter flashing. The base flashing shall have a 4" roof flange and a curb, or vertical flashing 8" high. The counter flashing shall have a 4" vertical face and shall extend into the chimney horizontally through to the flue where it is to finish with a 1" upstand. The exposed bottom edge of the counter flashing is to have a hem or cant for stiffness. All joints are to be blind soldered wherever possible and the work is to be left clean.



PLATE NO. **37**  
**Chimney flashing in flat roof**

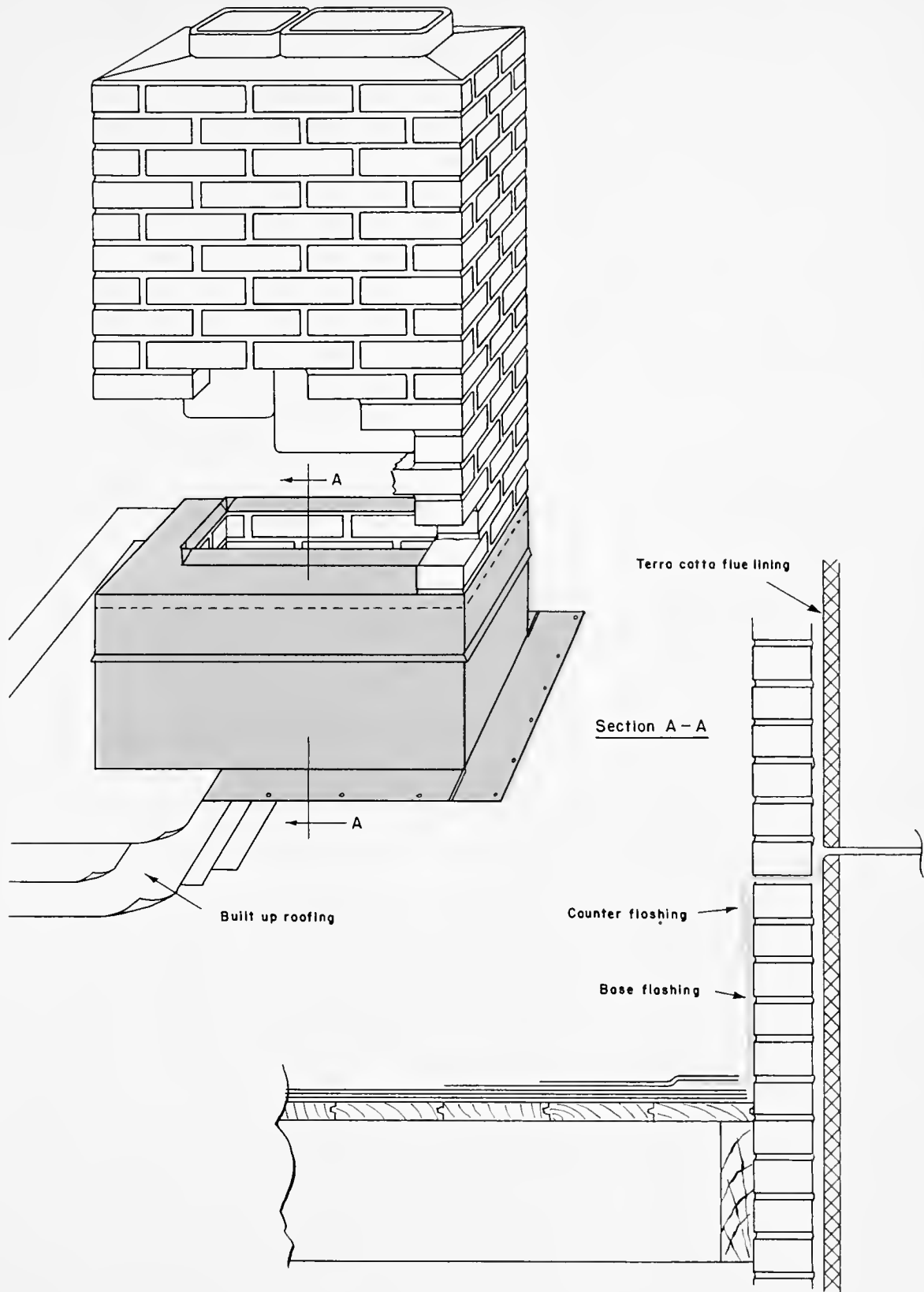

## Flashing - construction and expansion joints PLATE NO. 38

Whether it is to be a construction joint in concrete, an expansion joint in the brickwork of building walls, in masonry abutments, buttresses or retaining walls, the joint must be wind-tight and waterproof. This best can be accomplished through the use of copper flashing strips formed in a manner that will permit movement due to expansion and contraction without breaking the seal.

In pouring concrete the vertical finish line of a day's pour is certain to produce a seam or crack because of shrinkage and the lack of cohesion between new and old concrete. This can admit water, particularly ground water with some hydrostatic pressure. Horizontal construction joints have also a seam or cleavage line, but it is less likely to be troublesome because the seam is generally quite tight due to the weight of the concrete. All expansion joints and vertical construction joints in concrete should be flashed with copper as shown on the drawing.

In order to avoid cracks in long walls of brick masonry, vertical expansion joints are provided at intervals of not over 200', or as little as 20', depending upon the design of building, the height of the building wall, and whether or not there is a high parapet. Expansion and contraction in masonry walls are effected somewhat by

the surroundings and exposure. The movement is least at the ground where the masonry gets the cooling effect of the more or less uniform temperature of the earth. The temperature of the wall increases as it rises above the influence of the cool earth to a point several stories above the ground where expansion and contraction are governed entirely by climate, season, and conditions of the weather. Copper expansion joints and flashings built into the walls as shown on the drawing are the accepted method of making vertical joints safe from the penetration of water and minimizing the danger of damage by frost. For good appearance and to permit a certain amount of movement without being noticeable the exposed joints on the outer and inner face of the wall are filled with an elastic caulking compound.

### Suggested Specification

Expansion joint flashings of 16-oz. copper are to be built into the masonry where shown or called for on the drawings. They are to be of the V type, made from a 12" wide strip of copper. The V is to be 2½" deep and the flanges are to build into the masonry 3" with a hem or offset at the edge. The flanges are to have 1½" diameter perforations on 3" centers.

Flashing - construction and expansion joints

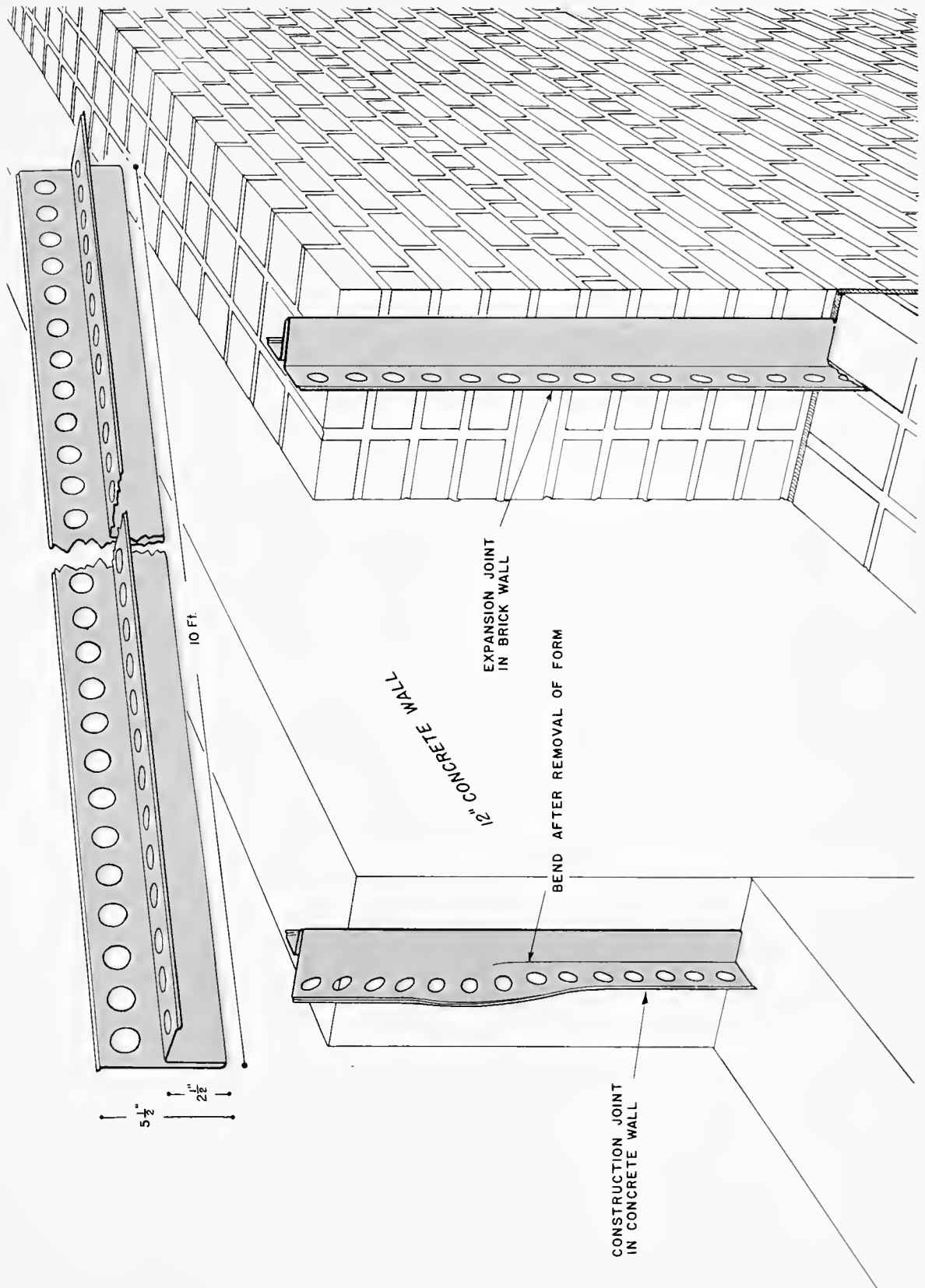

## Vertical and horizontal expansion joints PLATE NO. 39

All building materials are subject to dimensional change from expansion and contraction caused by differences in temperature. In the construction of small buildings the amount of movement is negligible, but in large buildings the matter of expansion and contraction becomes a structural problem. Temperature variations produce complex stresses within the walls and roof of a large building, particularly if the building is long and tall, or if it has a large plan area.

To counteract the effects of expansion and contraction on relatively brittle materials such as masonry of brick, stone and terra cotta, architects and engineers introduce structural cleavages in buildings by means of expansion joints, which isolate certain divisions of the plan area as independent structural units. Large buildings are usually divided into rectangles of about 200' square by expansion joints. The joints are designed with a clearance, ranging from 1/2" to 4", and are most commonly flashed or double flashed with copper.

The expansion joints are concealed on the inside with sliding covers so as not to be noticeable. On the outside, small joints are filled with a compressible fiber and faced with caulking compound of a suitable color. A wide joint is usually built-up neatly with masonry and allowed to show as an architectural chase or channel.

### Suggested Specification

The expansion joints are to be of the accordion fold or the double tongue and sheath type as shown on the drawings. The joints are to include flashing and counter flashing for the roofs and walls into which they are to be built. The copper for the base flashing, the counter flashing and the expansion joints shall be of 20-oz. gage, cornice temper. All cross joints are to be cleaned, pretinned, lapped 1", riveted and soldered.

# Vertical and horizontal expansion joints

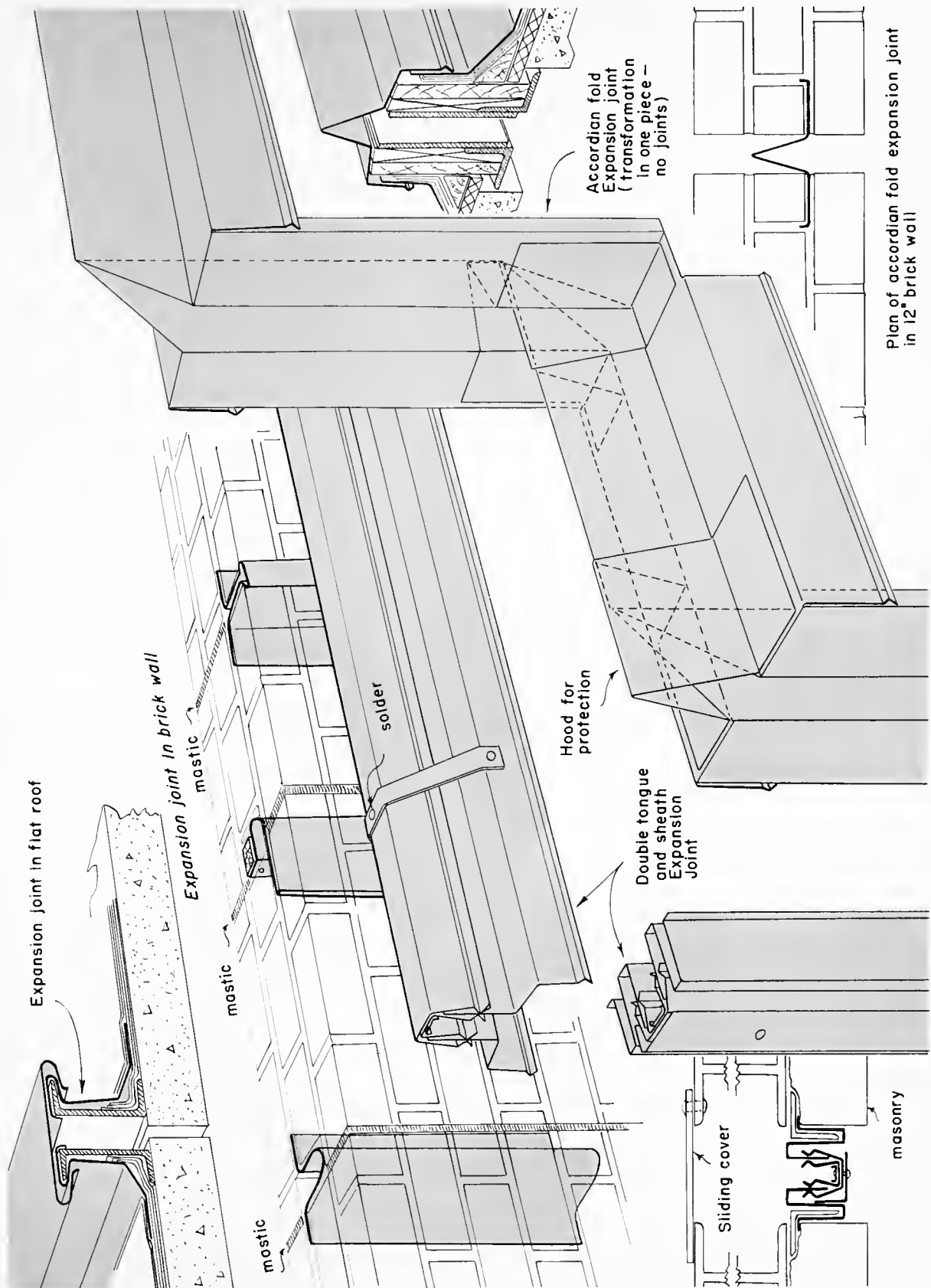

## Flashing intersection of structural expansion joints PLATE NO. 40

Structural expansion joints across a building are quite common, but joints that cross or bisect one another occur only on very large buildings. This point of intersection requires special attention so as to avoid unnecessary stress in the metal flashing of the joint. The metal of the expansion joint flashing may have sufficient strength, such as 16-oz. or 20-oz. cornice temper copper, but the fastenings may not be strong enough to hold.

A long straight run of metal without an expansion joint will tend to contract from the ends toward the middle point with a maximum force of about 24,000 pounds per square inch. That force is great enough to tear the work away at the ends of the building. Therefore expansion joints are very important.

The drawing shows a method of breaking the continuity of the expansion joint covering at the center line and weatherproofing the opening with a free moving cap. This limits the effect of expansion and contraction

to the distance between intersections, which is usually less than 200 feet.

### Suggested Specification

The top member of the expansion joint flashing is to be cut open as shown, for a distance of at least 18" from the point of intersection in each of the 4 directions. 1" x 1" angles are to be soldered to the up-standing legs of the expansion fold to receive the free sliding cap with return bends at the edges for a clinch lock joint. The entire intersection of copper is to be made up on the bench with shop tools and the best facilities for soldering. The underside of the copper is to be tinned 1" wide at the leading edges, and the whole assembly is set in place on the roof, then riveted and soldered. The soldering shall be neatly done and concealed wherever possible. All copper is to be of 20-oz. gage and of cornice temper.

Flashing intersection of structural expansion joints

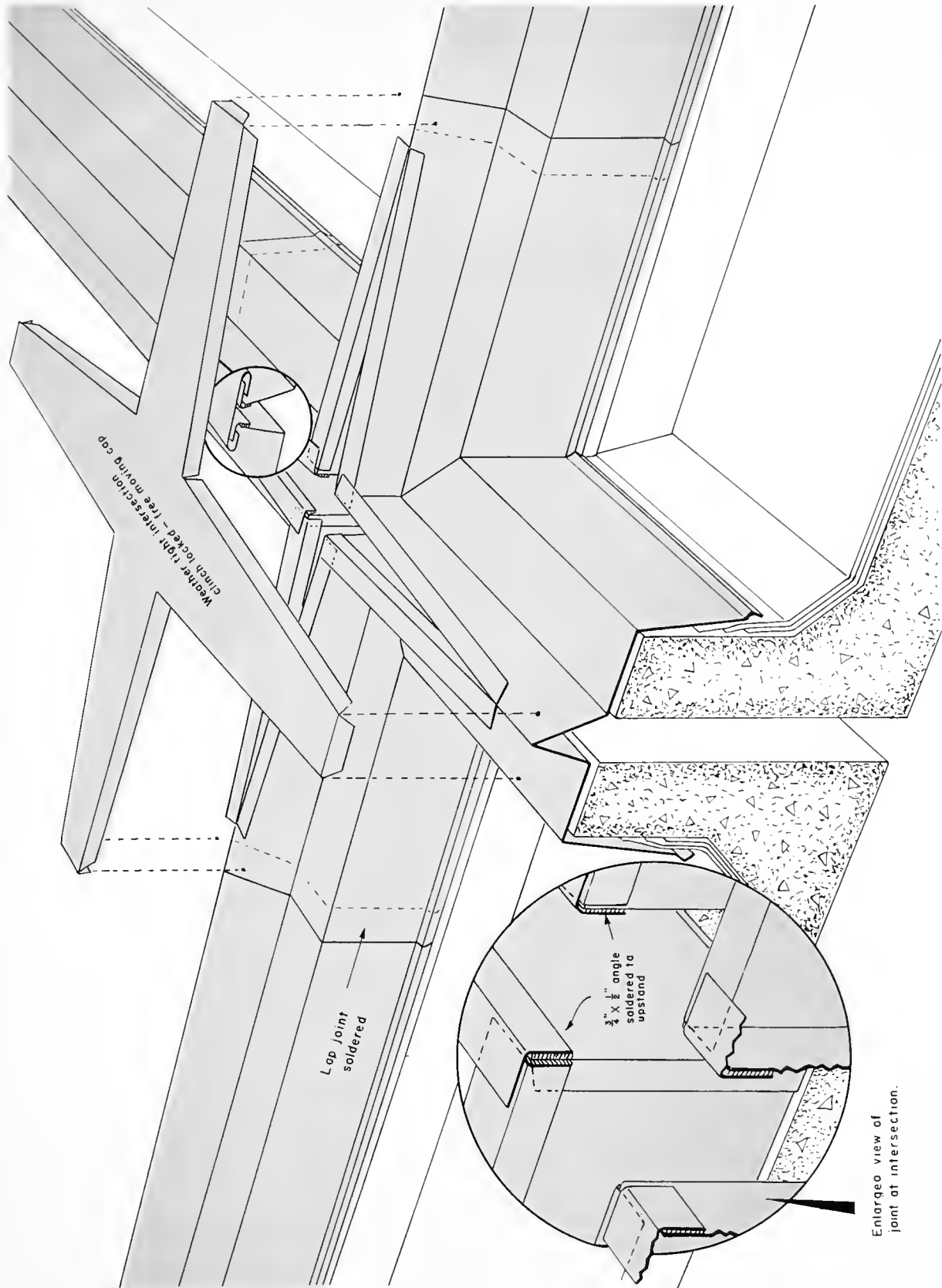

## Expansion joint for floor and wall PLATE NO. 41

Expansion joints in first class buildings require architectural treatment on the inside as well as on the outside of the building. Here one must contend with many kinds of wall and floor finishes, when the covering of the expansion joints is seen at close range.

The drawing shows a method of covering the joint with sliding plates of extruded architectural bronze. These are adaptable to practically every kind of interior decoration and have the advantage of being of a material that can be refinished or cleaned at any time to its original finish. The bronze will not rust or pit, nor is it affected by the usual cleaning compounds. Bronze joint cover can be painted if desired.

### **Suggested Specification**

The expansion joint covers at the floors and walls on the interior of the building are to be made up of ex-

truded architectural bronze as shown in detail, with a minimum thickness of  $1/8"$ . The material shall be of commercial grade and shall have a scratch brush finish.

The work is to be assembled in the shop so far as practicable. The joints are to be brazed wherever possible, using pieces of the parent metal for the purpose. Otherwise the parts may be fastened together by means of brass rivets or screws that can be ground flush and made unnoticeable.

The finished work shall be without marks or blemishes of any kind and shall be cleaned and given a spray coat of best quality outdoor lacquer.

The expansion joint covers at the ceiling are to be made of a size and shape to conform to the bronze expansion joint covers at the walls against which they abut. The ceiling covers are to be of sheet metal as shown, using No. 22 B&S gage commercial bronze, quarter hard.



**Expansion joint for floor and wall**

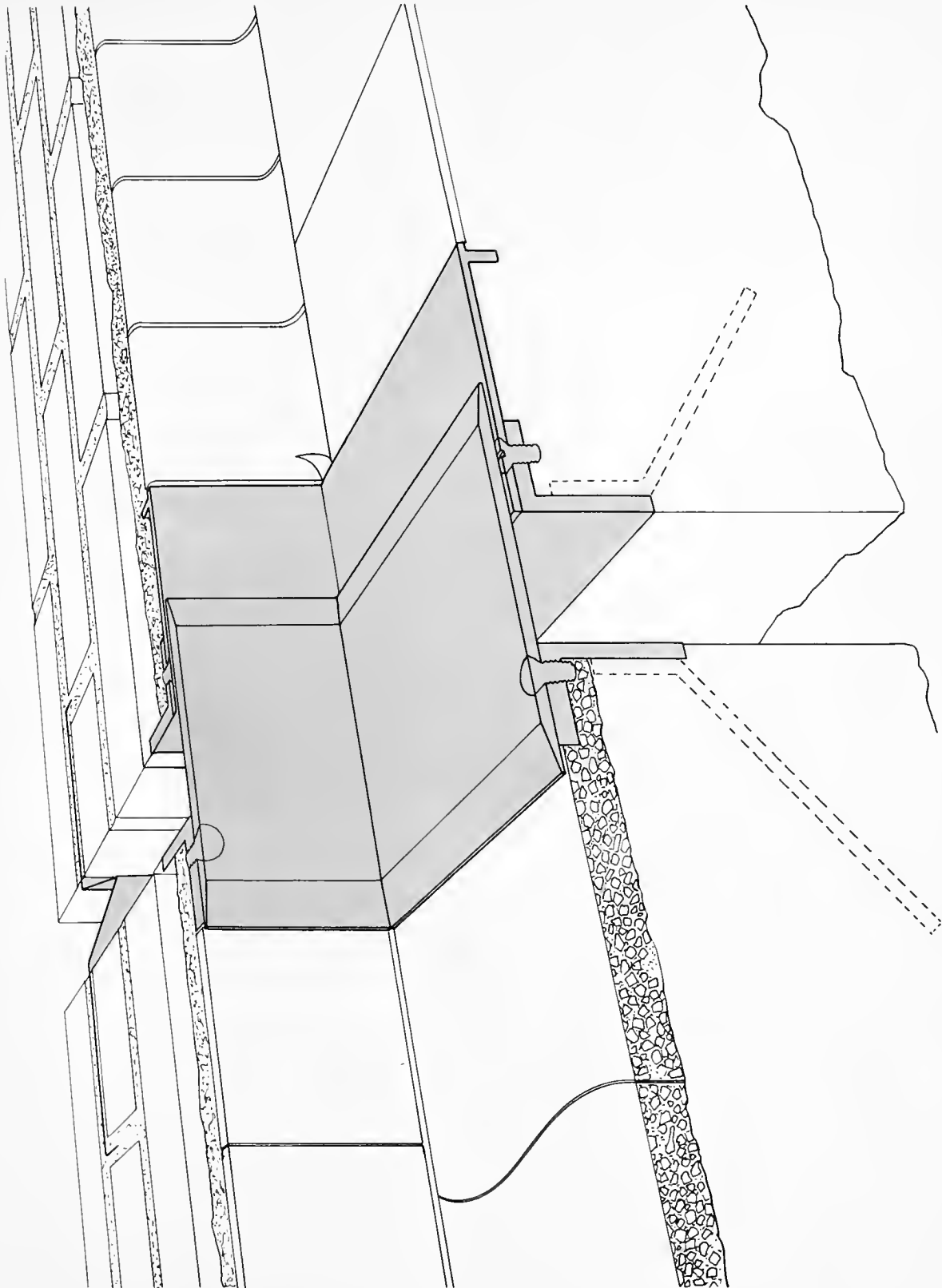

## Expansion joint and base flashing PLATE NO. 42

In large buildings and particularly those having considerable floor area it has become more or less common practice among engineers to divide the plan into rectangles about 200' square, and by complete separation to produce structurally independent sections of a building with a clearance up to 2" in width. The clearance is made weather-tight by means of copper expansion joints. In locating the expansion joints, the architect or engineer is likely to draw a line along the walls where a low portion of the building adjoins a taller portion.

This drawing shows an expansion joint for such a condition. It consists of standard Anaconda Through-Wall Flashing and a base flashing of sheet copper so arranged as to permit the necessary hinge action for the joint to open and close without stressing the copper. The vertical expansion joint flashing at the outer wall can be made weather-tight by coming up under the extended horizontal through-wall flashing, being secured with a loose clinch lock.

### Suggested Specification

Base Flashing shall be of 20-oz. copper of cornice temper. It is to have a 4" roof flange and a vertical leg not over 12" high. The roof flange is to be nailed to the roof deck with 7/8", #12 flat head copper nails at 3" intervals or fastened with brass screws and lead expansion shields at 12" spacings. The end joints of the base flashing are to be cleaned, pretinned, clinched and soldered.

The through-wall flashing is to be of 16-oz. copper with a 12 1/4" corrugation and 4" plain selvage on the drain side. This selvage is to form a loose fitting 1 1/2" clinch lock to allow for a certain amount of uneven shrinkage or settlement. The end joints in the through-wall flashing are made by simply lapping the pieces of flashing one corrugation. At the end of the building or at an intermediate vertical expansion joint, this flashing is to be tailored to make a wind and weather-tight connection.

Expansion joint and base flashing

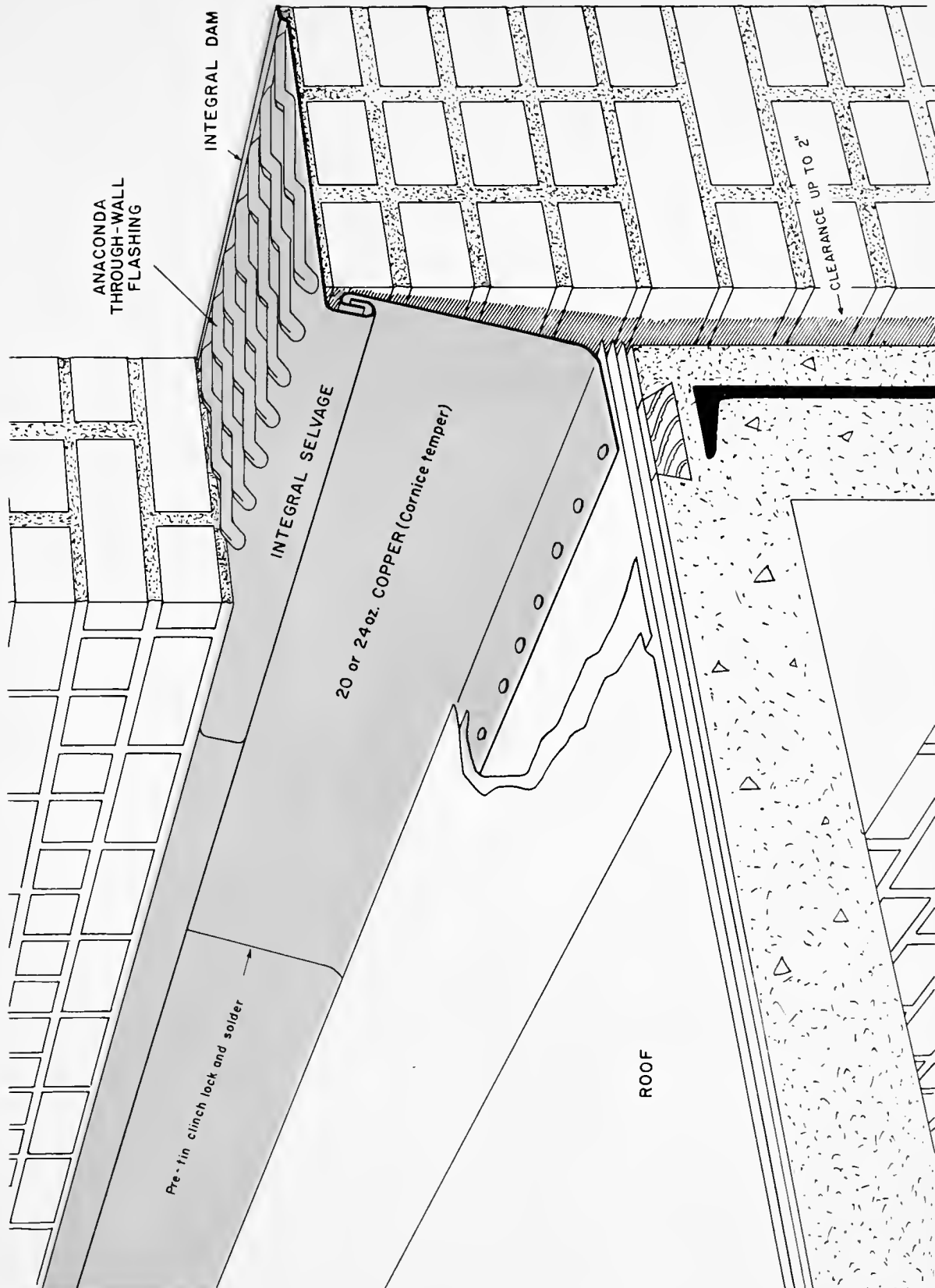

## Gable end parapet

### Straight line counter flashing PLATE NO. 43

The matter of flashing to a vertical wall of masonry along the slope of a steep roof has always been somewhat of a problem to the architect and the builder. If the wall is of brick it is common practice to step the counter flashing so as to conform to the rectangular lines and dimensions of the courses of brick. Work of that kind that is well done will serve its purpose indefinitely so far as protection against the weather is concerned, provided there is through-wall flashing at reasonable intervals. However, the step type of counter flashing has certain undesirable features. From a practical standpoint an installation of step flashing may easily develop into an unhappy result through insufficient care in laying out and doing the work. On a very steep roof the drop ears of the counter flashing become long and pointed and it is extremely difficult to avoid unpleasant shadow lines at the vertical laps and at the exposed edges where the flashing is supposed to lie against the brickwork. If tack soldering is resorted to, as is often done, the condition is aggravated because the sheet metal becomes bowed from elongation in hot weather.

For the trim effect that is typical of modern architecture a straight line counter flashing parallel to the rake of the roof is very desirable. The bricks need only to be cut to the line of the flashing. This is quite simple, particularly with common face brick. These bricks can be cut to a reasonably straight line with a brick set, and finished by rubbing with carborundum. Hard burned face brick can be molded or machine cut to the proper bevel.

This drawing shows the flashing of a steep roof at a gable end wall. There are individual flash-

ing squares for the successive courses of shingles with a counter flashing having a weather-proof base flashing receiver feature, and extending 4" into the wall. The roof and wall flashing is made additionally safe by the Anaconda Through-Wall Flashing installed under the parapet coping. By these flashings any seepage of rain water is intercepted and diverted to the roof side of the wall where it can flow onto the roof.

#### Suggested Specification

The counter flashing receiver for the roof flashing at the gable end parapet shall consist of 16-oz. copper. The receiver shall extend into the masonry wall 4" with a 1/2" upstand on the inner edge. A 4" selvage on the outer edge is to be fashioned into a reglet so as to receive the base flashing, after which the horizontally extended fold of the receiver is bent down to hold the base flashing and provide a weather lip.

The base flashing shall consist of individual flashing squares that are to be built into each course of shingles. These shall extend into the reglet 1/2" and drop vertically to the roof, where they are to extend from 3" to 4" under the shingles. The flashing squares are nailed at the top edge only.

The through-wall flashing of 16-oz. copper under the coping is to be installed in an approved manner. The 1/2" brass dowels, spaced not over 3' apart are to have sleeves of sheet copper soldered to the flashing.

**Gable end parapet with straight line counter flashing**

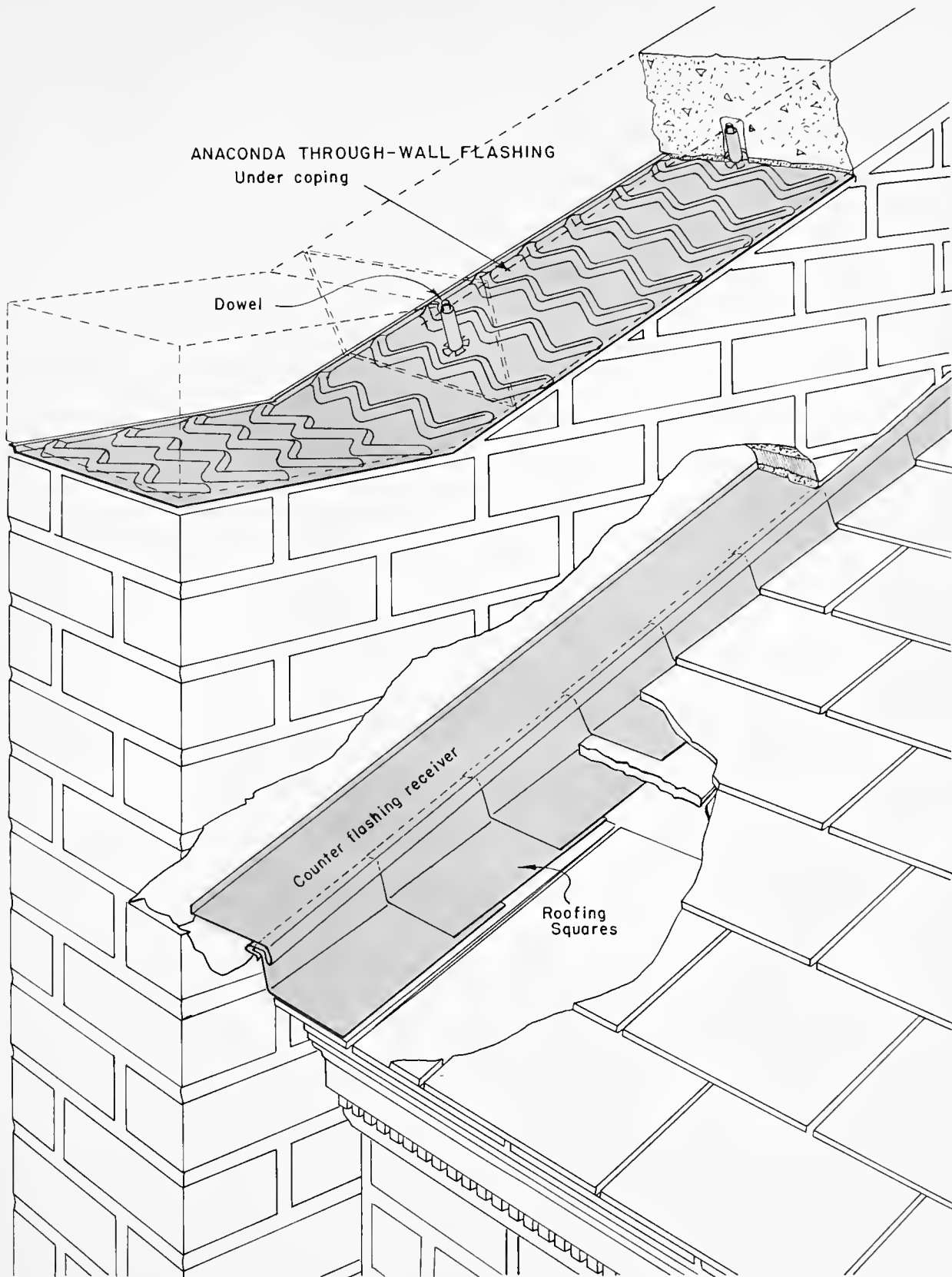

## Gable end stucco wall flashing PLATE NO. 44

In warm climates where there is no danger of damage to building materials from frost, stucco has been found to be a very desirable and economical exterior facing for buildings. Because of the plastic nature of stucco, and the ease of application, it is used extensively in certain localities. The widespread use of this material has had a great deal of influence on architecture. There are certain types of design that depend greatly upon stucco for their full architectural expression, including modern or contemporary architecture.

Stucco may be applied to walls of brick, terra cotta, or to cement blocks of the various kinds and to metal lath. With all of those backing materials, the problem of flashing is practically the same, and can be done best with copper, for unlike some other metals copper can be in contact with wet stucco without harm to either material.

Suitable drip edges should be provided to avoid the possibility of discoloring the stucco by spatter of the wash that may contain dust, soot, copper salts and other matter. This usually consists of a hemmed bottom edge on exposed vertical flashings, canted outward at

an angle of 45°. Some architects specify lead coated copper as an additional precaution.

### Suggested Specification

Counter Flashing at the junction of the gable roof and the stucco wall shall consist of 16-oz. cornice temper copper, formed as shown. The counter flashing is to be applied over a wood backing and secured to the masonry with 1/4" brass screws and expansion shields at 12" spacings. The top edge of the counter flashing is to be formed to suit, and the bottom edge of the vertical face is to have a 1/2" hem. End joints are to lap 3", without being soldered.

Base Flashing shall be in the form of single flashing squares 8" wide by 7" long for a 2" head lap. The horizontal leg shall weave into the shingle course a distance of 3" to 4" and the upstanding leg shall extend up under the counter flashing at least 3". The counter flashing shall be so positioned that the bottom edge will be about an inch above the top of the shingles.

Gable and stucco wall flashing

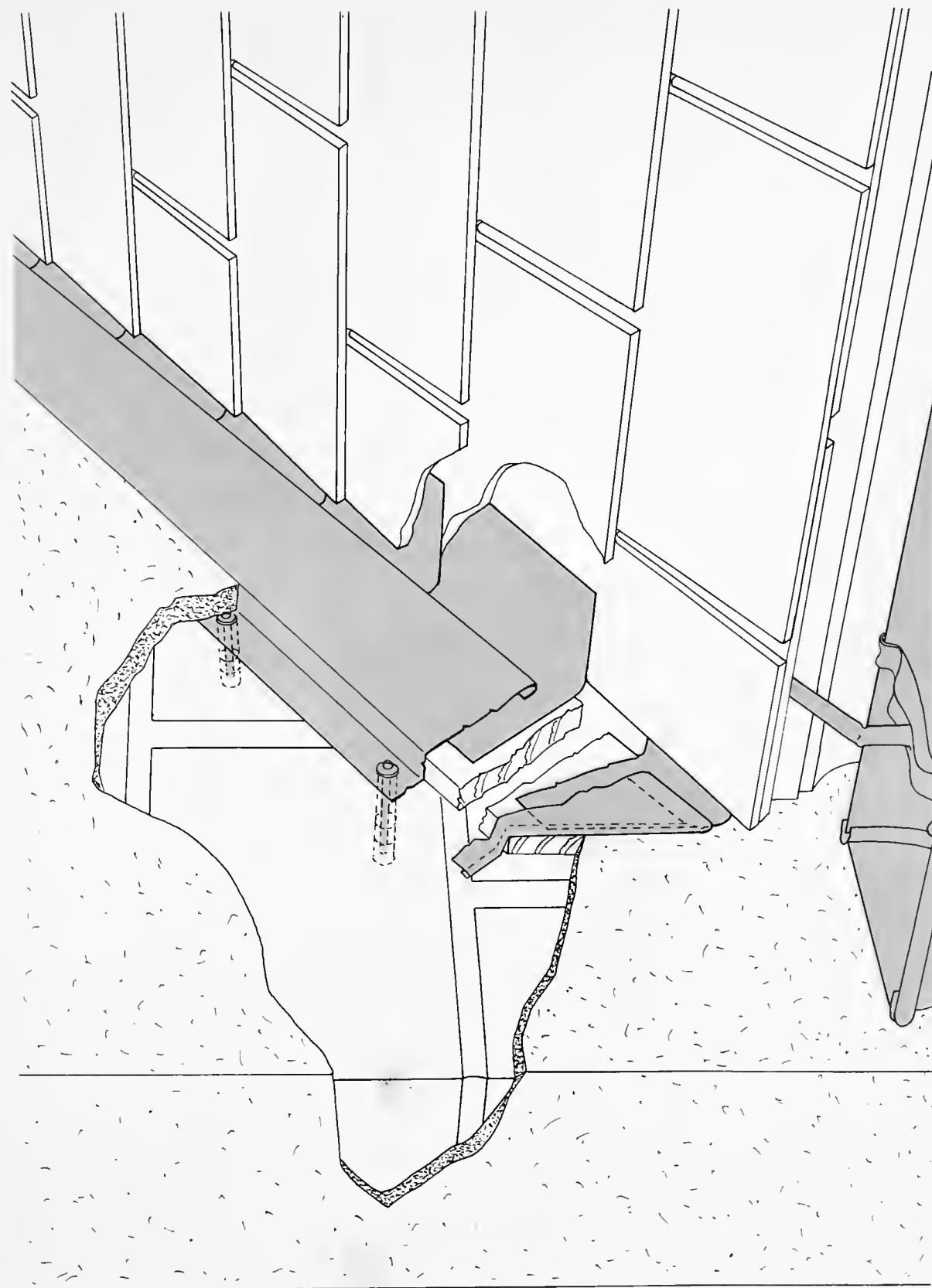

## Coping covers and base flashing PLATE NO. 45

In the maintenance of buildings there is nothing more troublesome than copings. With copings of masonry there is what appears to be the insurmountable difficulty of making joints that will prevent the infiltration of wind-driven rain and seepage from soaking rains and melting snow. The use of a durable metal such as copper for flashing and for covering copings eliminates such trouble.

**FIGURE #1**—Shows a combination of a coping cover and base flashing, both of copper. For work of that size or scale 20-oz. cornice temper copper should be used for both the base flashing and the coping. The edges of the coping cover are free to slide without straining the fastenings, and the base flashing is anchored securely in place to prevent movement.

**FIGURE #2**—The copper coping can be molded or plain. A coping such as this is applied over an existing artificial stone coping. Note the construction of the expansion joint.

**FIGURE #3**—This style of coping with a flush type expansion joint every 24' is one of the most common forms of coping and serves as a counter flashing on the side toward the roof. In some localities it is regular practice to connect the coping with the base flashing by means of a loose clinch lock joint which allows a reasonable amount of shrinkage or adjustment in the roof deck,

as well as permitting the coping to slide with changes in temperature, especially when the broad surface of the coping is exposed to the direct heat of the sun.

**FIGURE #4**—This style of coping is probably the least expensive and introduces another style of expansion joint which with the use of a strip of flashing called the tongue is reasonably weather-tight. In this coping, as well as with all copings of copper or of any other metal, it is of first importance that the metal be stiff, straight and of a gage sufficiently heavy to avoid visible buckling. Toward this end it is imperative that the edge fastenings be free to slide and that expansion joints be provided at intervals of not over 24'.

### Suggested Specification

The copings shall be covered with 20-oz. copper of cornice temper formed as shown on the drawings. The pieces are to be brake formed in 8' lengths with clinch lock and blind soldered end joints, and expansion joints at 24' intervals. The copper coping is to have free sliding edges at both sides of the wall. This may be accomplished through the use of continuous copper cleats or by interlocking with other copper work. The cleats are to be securely fastened at 12" spacings.



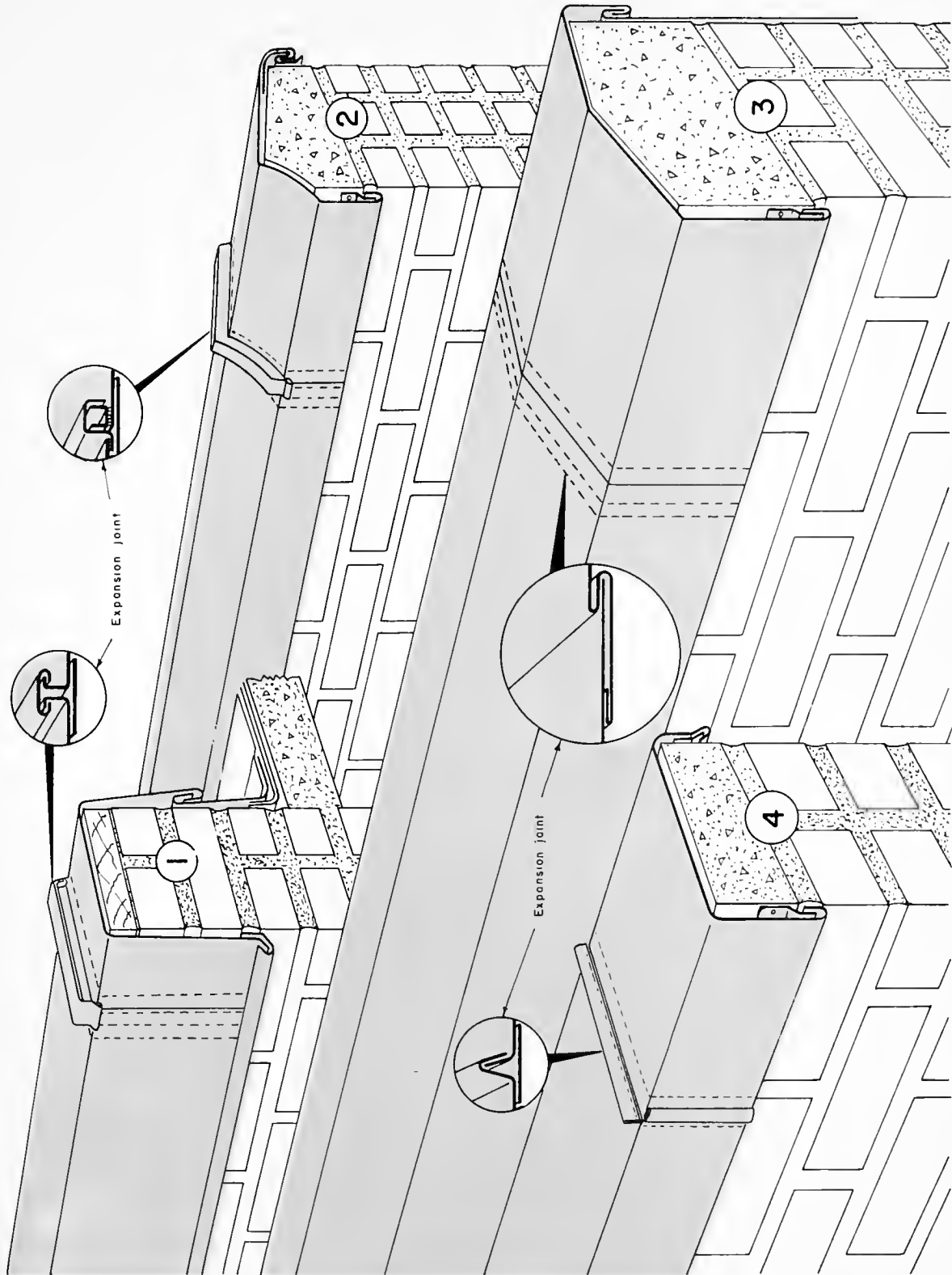

## Snow guards PLATE NO. 46

In climates where there is snow there is always a danger of damage to buildings and injury to persons from snow sliding off roofs. It has, therefore, become regular practice to provide snow guards for the parts of the roof where the snow might fall on a sidewalk, court, or a skylight. Snow guards may be desirable on all slopes because of the danger of damage to gutters.

Where there is an abundance of snow, architects usually design their roofs with considerable pitch to avoid heavy snow loads. Steep roofs shed the snow rather freely, therefore a minimum of snow guards is usually satisfactory.

The cleat type of snow guard is intended to keep a uniform snow cover on the roof, holding it there until it melts or turns to vapor. These cleats or snow guards usually occupy the lower portion of the roof extending from one-third to three-quarters the way up the slope so that the snow at the high part of the roof will not be able to gather enough momentum to push past the cleats.

The railing type snow guard is ideal for batten seam roofs because it can be mounted high on top of the battens. Brackets may be placed on every batten, as shown, for severe winter conditions, or at alternate battens and possibly with only two horizontal rails for conditions that are less extreme.

In cold climates it is always good practice to thoroughly insulate the attic either at the floor line or under the roof to minimize backing-up of snow.

### Suggested Specification

**Cleats:** Copper cleats for snow guards are to be of 16-oz. copper of cornice temper. These cleats shall be 2" wide and 1" high as shown in detail. They are to be soldered to the copper roofing in rows, with a 2' horizontal spacing and an 18" spacing along the slope, cleats staggered. The lower two-thirds of the roof area is to have snow guards.

**Railing:** The railing type snow guard shall consist of brackets made of copper bars and rails of copper tube. The brackets are to be formed as shown using 3/8" x 1 1/2" bar copper. The rails are to be of 3/4" Type K hard drawn copper water tube, flattened at the brackets and fastened with 5/16" brass stove bolts. The brackets are to be screwed to the tops of the battens with 1/2" copper silicon lag screws. The joints shall be made weather-tight with lead washers and with strips of lead under the legs of the brackets. The brackets shall not be over 4' apart.

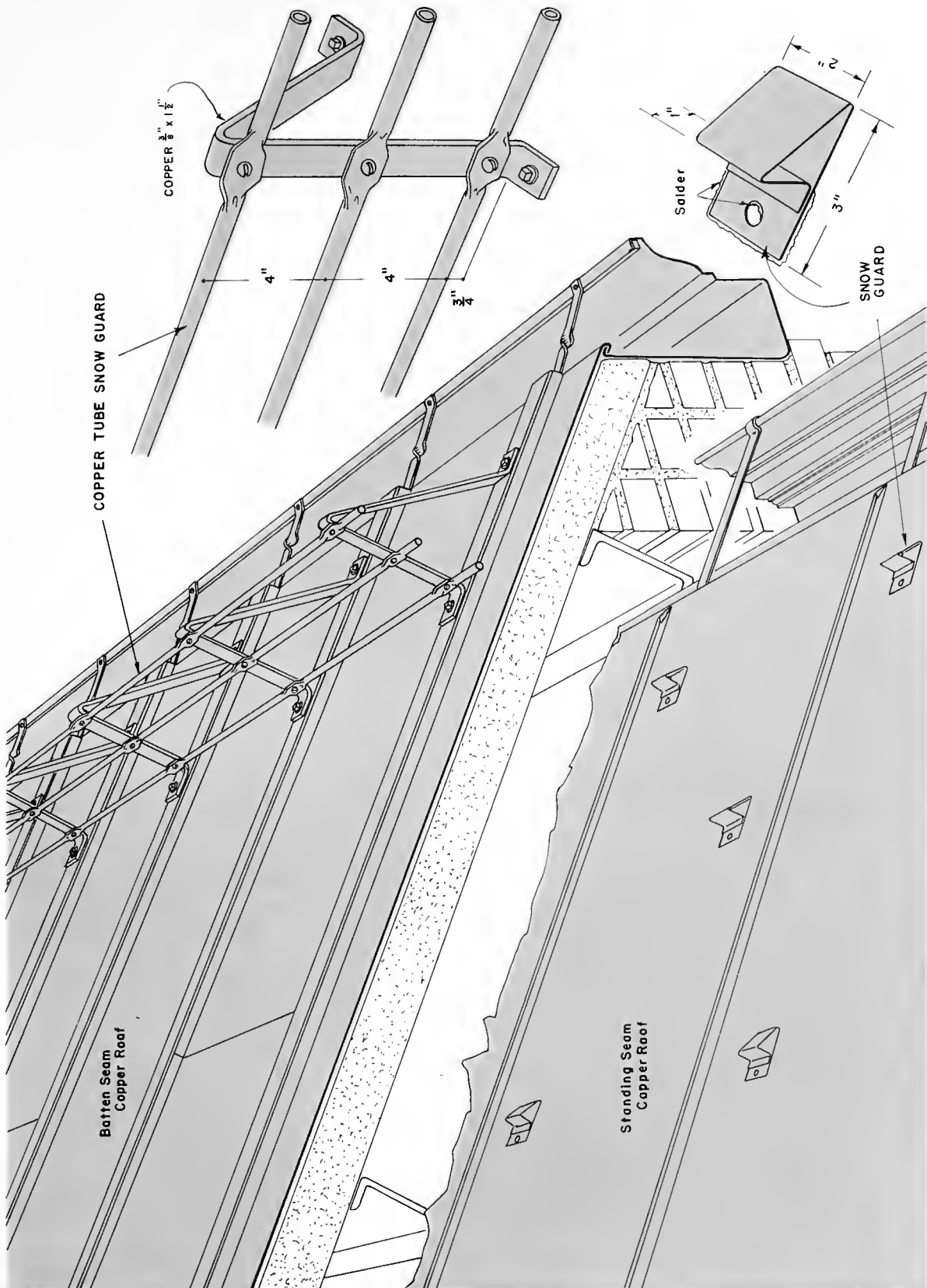

## Metal surrounds for windows PLATE NO. 47

In modern design with large windows, particularly of the band type, surrounds have been employed to produce a very pleasing effect by simulating a picture frame outlining the window opening.

The surround is a medium by which the window can be given a new look. By its use it is possible to avoid the deep socket of old and to bring the window glass to a plane, practically in line with the outer face of the building wall.

Surrounds can be made of several kinds of metal, but in any case they should be stiff enough to produce a neat and shapely appearance and not be easily damaged. This, of course, depends largely upon size and breadth of the plain surfaces, but in general should be of .032" gage or heavier with proper stiffening. The joints should be blind soldered and reinforced, or preferably silver soldered or brazed when the gage of metal is 1/16" thick or heavier. All exposed joints should be flush, of the hairline type, finished entirely smooth by grinding or by other means. The work should be finished by an acceptable method of cleaning, and with a spray coat of best quality outdoor lacquer, or with other finishes that may be desired.

Surrounds having the warmth of brass or copper are

particularly effective since the color and appearance of these metals combine very attractively with the vitalizing effect of glass. The brass looks its best with a mat or scratch brush finish, and copper with its salmon pink coloring looks richest when finished by rubbing with steel wool. Of course, there is also the possibility of having the antique effect produced with chemicals. If a white metal is desired for surrounds, a warm white can be obtained by using a nickel silver. Extrusions are possible in 10% and 13% nickel silver.

### Suggested Specification

Sheet metal surrounds shall be of .032" gage commercial bronze, formed on a power brake to the outline shown on the drawings. The joints are to be blind soldered and reinforced. The surrounds shall be made secure by means of brackets and bracing of the same material.

Extruded metal surrounds are to be of architectural bronze 1/8" thick. All joints and miters are to be brazed with pieces of the parent metal. Anchorage and supports shall consist of red brass or commercial bronze bar stock.

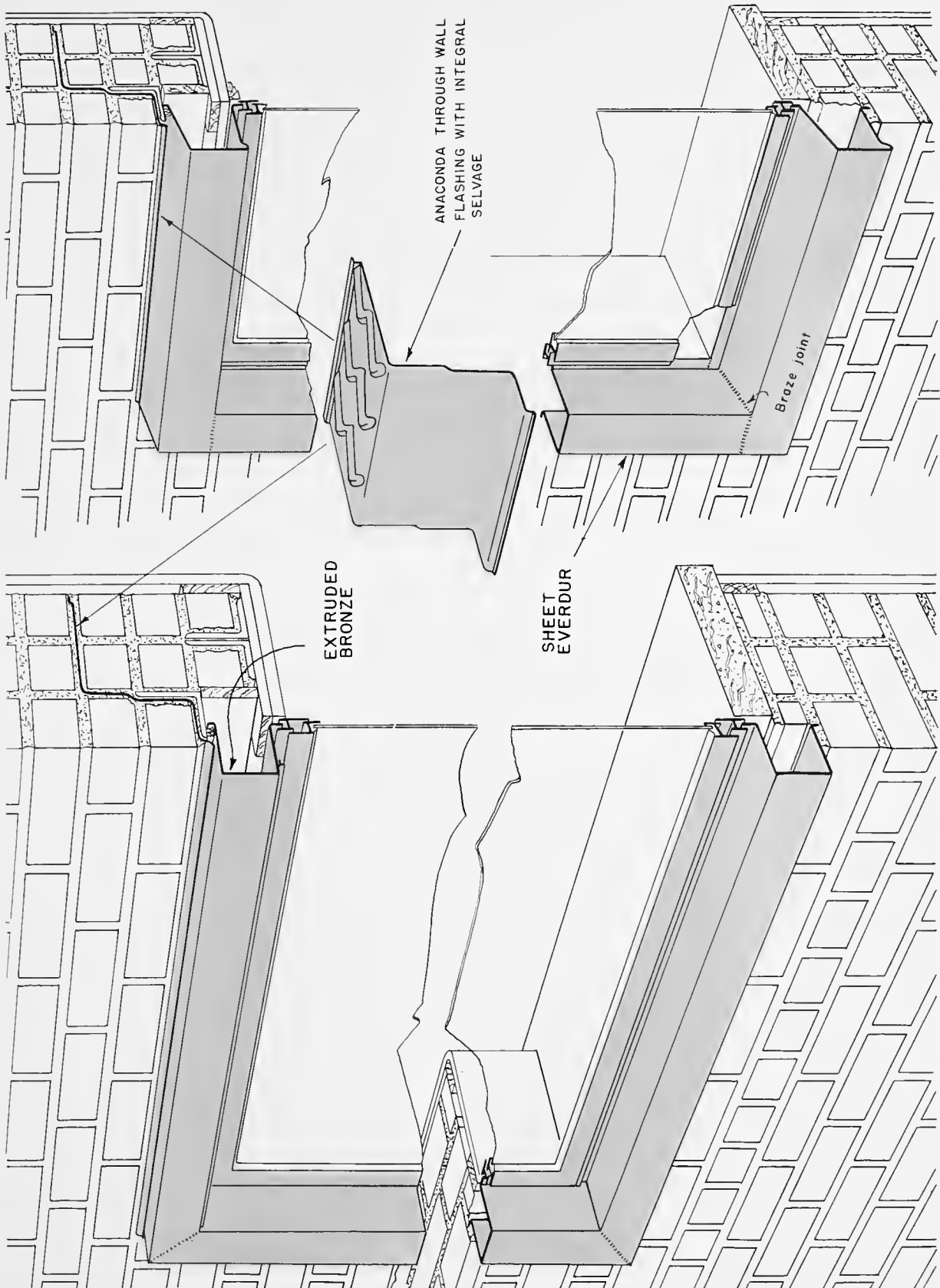

## Copper covered sunshades and canopy PLATE NO. 48

Buildings of contemporary design depend largely on horizontal or vertical projections in the form of slab type cornices, shadow bands, balconies and canopies for ornamentation or decoration. This kind of construction requires waterproofing of unprotected concrete where freezing temperatures occur, to prevent deterioration from the expansive force of frost. It is a comparatively simple matter to waterproof such projections with copper.

For small projections that are intended principally for architectural shadow lines as shown on drawing #1 for climates where there is no extreme cold weather, the Anaconda Through-Wall Flashing can be used to advantage. The 4" plain selvage on the drain side can be locked to a continuous cleat and sealed with white lead paste or caulking compound so that rain water will not flow into the building at the top side of the projecting slab.

For larger projections that serve the dual purpose of creating interesting shadows and, cutting down the cooling load by preventing direct sunlight from passing through the windows, it seems desirable to cover the entire top surface with copper. Such a method is shown on drawing #2 and is labeled "Sunshade." The object in this detail is to keep the copper covering back from the top edge of the projection, so as to leave that edge straight and clear as an architectural shadow line.

Drawing #3 of an entrance canopy is shown to be roofed with regular copper roofing squares, and with a drip edge around the outline. At the outer edge is a new method of fastening the copper edging. It involves placing a 1/2" copper tube in the form before the concrete is

poured, thereby casting the tube in the concrete to serve as a ground.

### Suggested Specification

**Shadow Band:** The masonry joint on top of the shadow band shall be waterproofed with 16-oz. copper through-wall flashing. The edge of the flashing at the inside of the wall is to have a dam at least 3/16" high, plus a 2" upstand. The outer edge of the flashing is to interlock with a continuous cleat of 16-oz. copper, securely fastened, and the joint is to be filled with an approved asphaltic roofing cement.

**Sunshade:** The sunshade is to be covered with a single breadth of 20-oz. copper of cornice temper. The outer edge is to interlock with a continuous copper cleat as shown and the inner edge shall form a clinch lock with a standard 16-oz. copper through-wall flashing located in the first mortar joint above the top of the sunshade. The end joints shall be cleaned, pretinned, clinched and soldered. Provide expansion joints at 24' intervals.

**Entrance Canopy:** The roof on the canopy shall be of flat lock soldered seam construction, using 16" x 18" roofing squares of 20-oz. copper of cornice temper. The edges of the roofing squares are to be cleaned, pretinned, locked and soldered. The edging of the canopy with a 4" margin and clinch lock on the roof is also to be of 20-oz. copper of cornice temper. The outer edge at the fascia is to form a clinch and weather lip with a continuous copper cleat as shown. The cleat is to be a double thickness of 16-oz. copper fastened to a tubular ground in the concrete with sheet metal screws. The ground shall be a 3/4" Type L copper tube.

# Copper covered sunshades and canopy

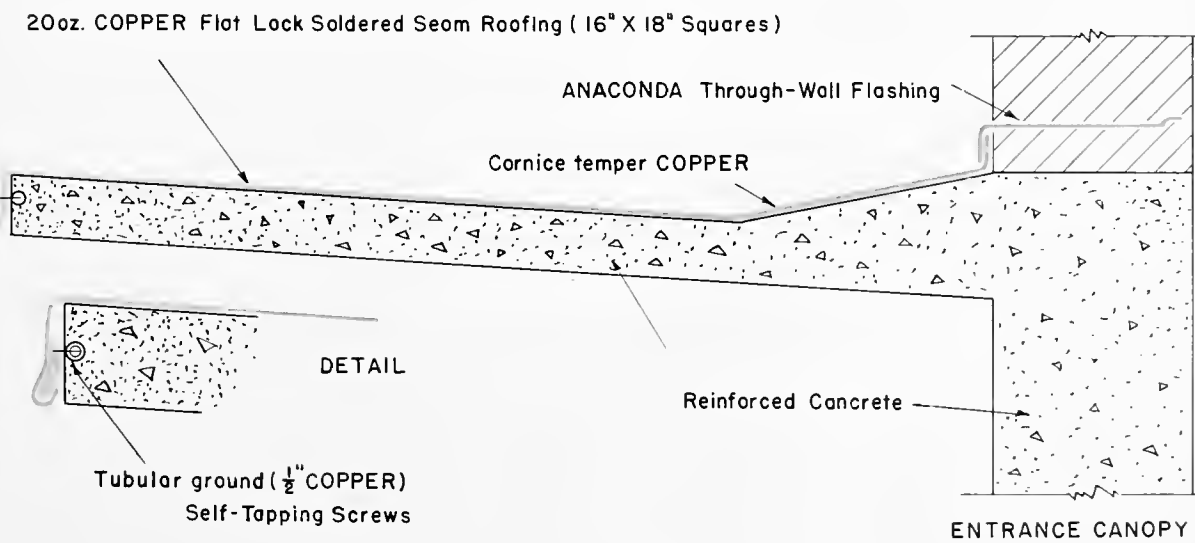
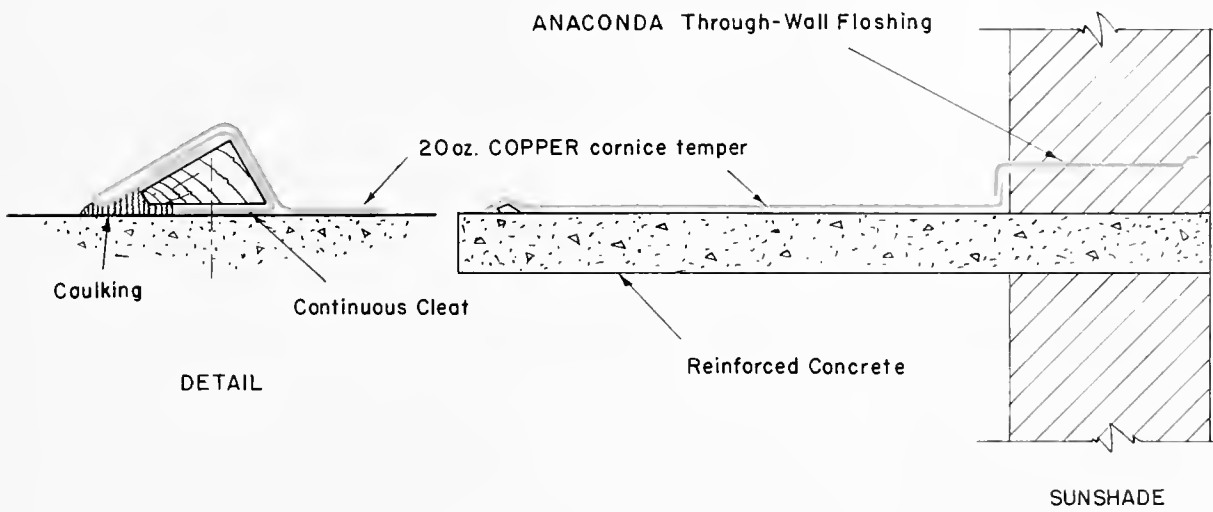
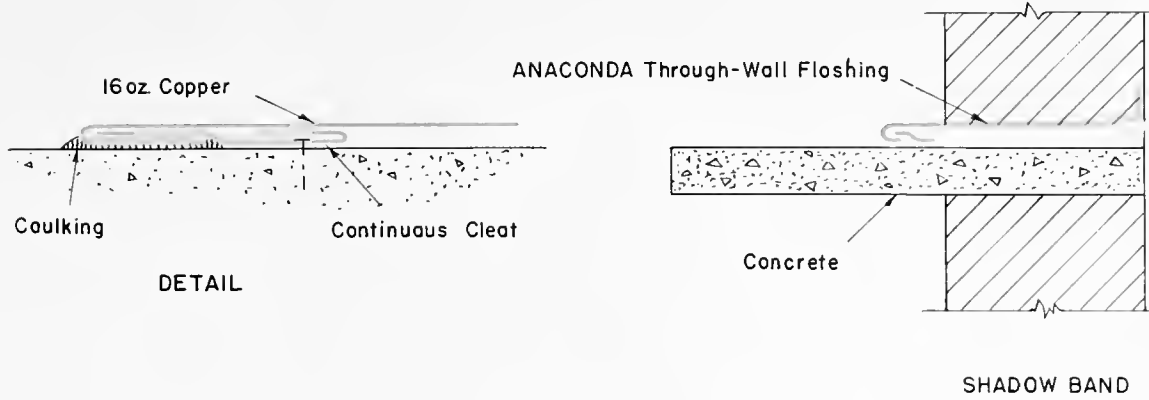

## Copper faced sunshade PLATE NO. 49

The sunshade for keeping down the cooling load is becoming a regular part of the architecture. In areas where freezing temperatures occur it is advisable to cover the sunshade with copper.

### **Suggested Specification**

The copper covering on the sunshade shall consist of 20-oz. copper of cornice temper in 8' lengths and single width. The inside edge is to interlock with the plain selvage of a standard 16-oz. copper through-wall flash-

ing having an 8 $\frac{1}{4}$ " corrugation and a 2" upstanding selvage on the inside. The outer edge is to form a clinch lock with the facing also of 20-oz. copper of cornice temper. The facing or fascia is to be held at the bottom edge with a continuous copper cleat. The end joints in the copper of the facing and the deck shall be cleaned, prefinished, locked and soldered, except that there are to be expansion joints at 24' intervals. The longitudinal joint between the facing and deck is to be soldered. Blind soldering is to be done wherever possible, otherwise the exposed solder joints are to be scraped clean.



PLATE NO. **49**  
**Copper faced sunshade**

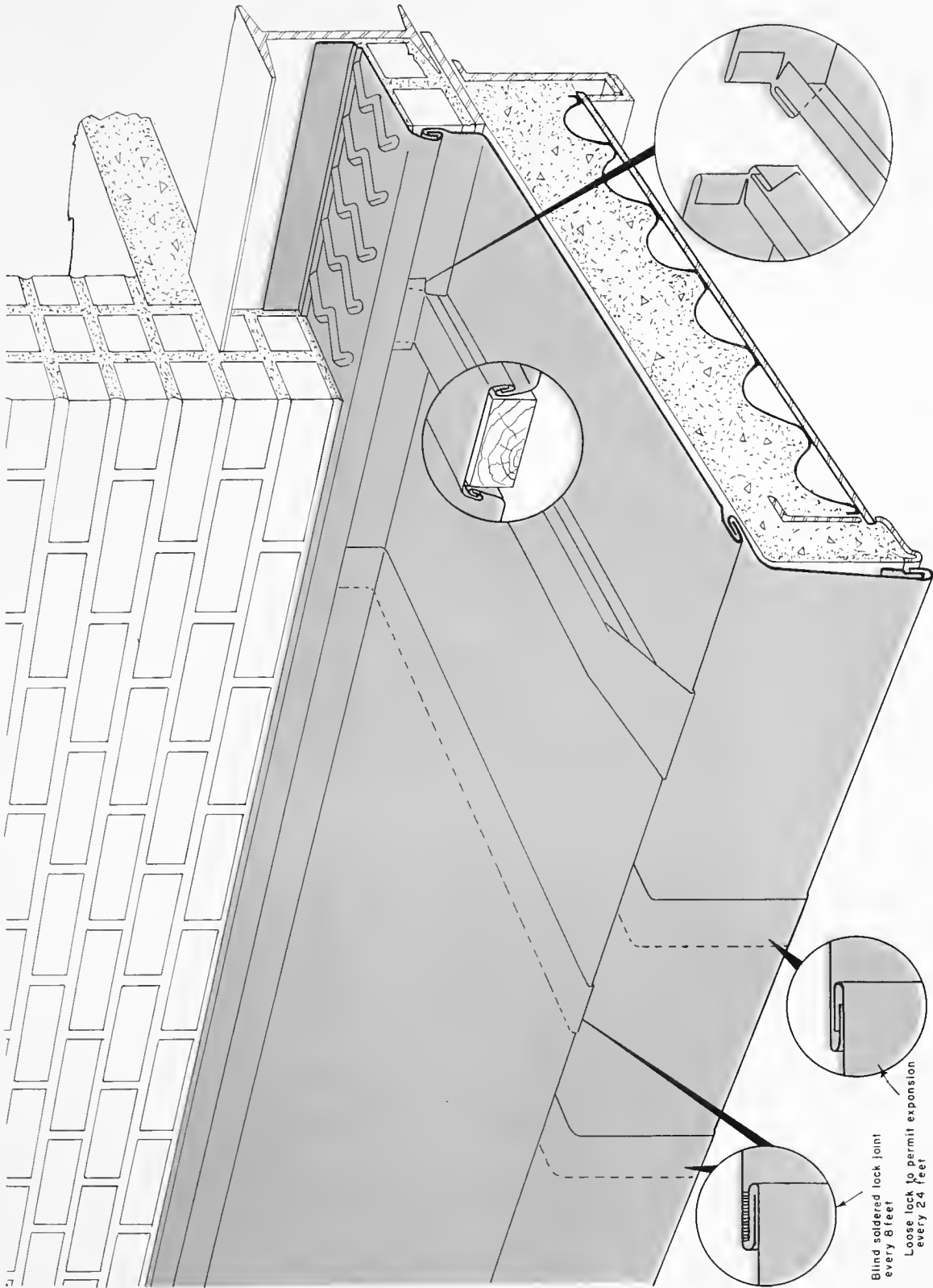

## Flashing sprayed or flooded built-up roofs PLATE NO. 50

A flooded roof should have copper flashings at all downspouts, at the collar or curbs of ventilators, and at other parts of the construction extending through or above the roof. There should be a sump with provision for high water overflow and complete drainage, also an automatic water feed. The sump should be lined and flashed to the roof, all with copper. Column stubs, or bases for the framework of advertising signs and other purposes should be encased and flashed with copper. If the framing is connected to the structure below the roof, pitch pockets of copper with upstanding edges and proper flashing may be resorted to. Because of continual dampness of a flooded roof, and possibly wind tossed spray, the roof side of the parapet should be sheathed with copper above a regular copper base

flashing, and the coping should likewise be copper for durable and trouble-free construction.

### **Suggested Specification**

All flashing for the built-up composition roof is to be of 16-oz. cornice temper copper, except the base flashings and the drainage pit which are to be of 20-oz. cornice temper copper. The horizontal leg of the flashing is to extend 4" into the roofing and fastened solidly to the roof deck. Circular flashings are to be made in 2 parts, soldered together. There is to be a gravel stop 2" high around the drainage pit. All plumbing connections will be made by the plumber.

Flashing sprayed or flooded built-up roofs

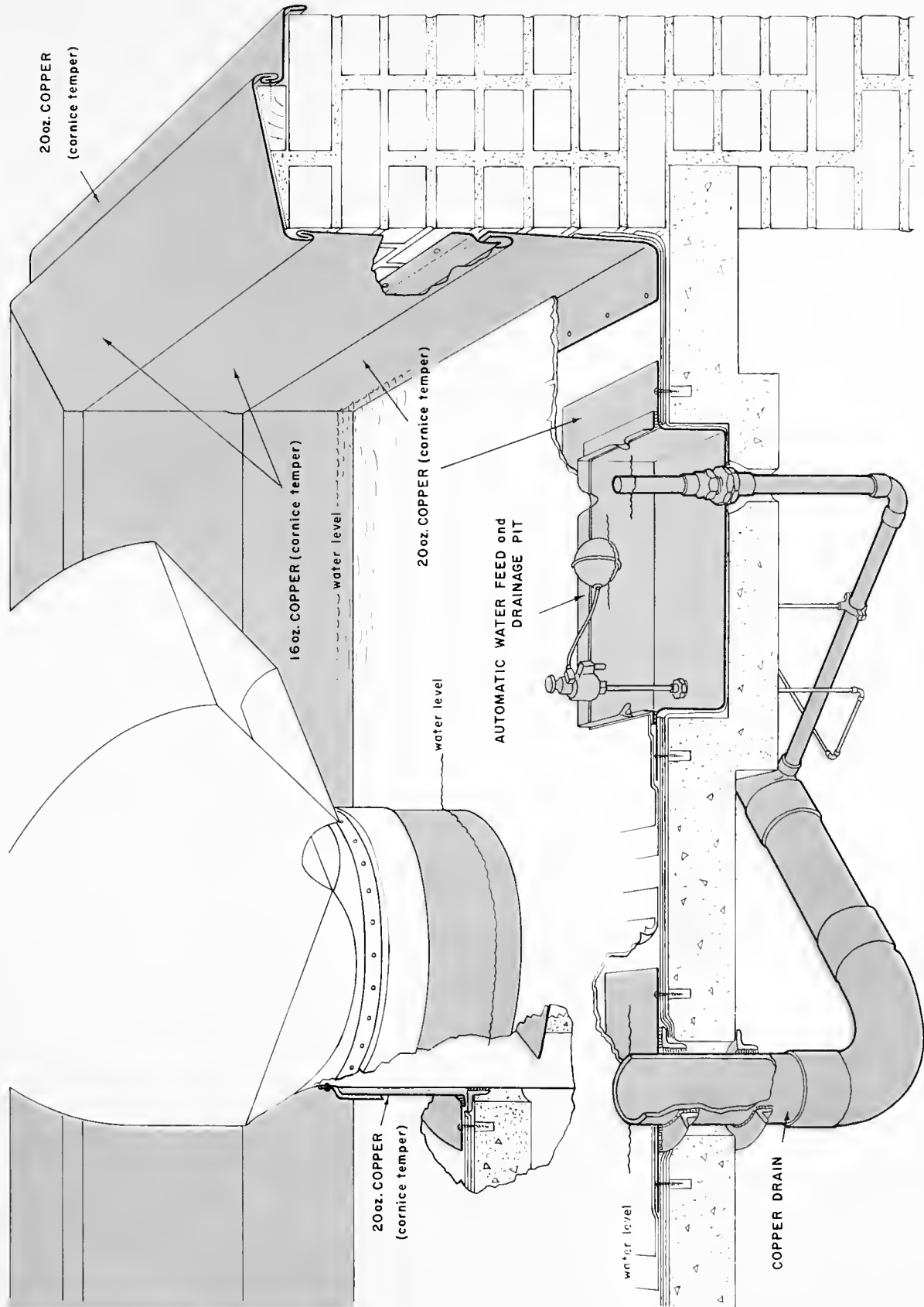

## Copper covered spires PLATE NO. 51

It is known from experience that it is difficult, particularly in cold climates, to build permanently waterproof masonry walls having a batter such as those of a spire. It is also uneconomical to maintain a spire that is made of materials that need paint for their protection and durability. The ideal would be a spire that would not require any outlay for maintenance. This possibly can be accomplished by covering the spire with copper somewhat in the manner as shown and in accordance with best practices in the trade.

The drawing shows a copper covered spire, octagonal in plan having battens at the eighth points, and horizontal courses of copper between the battens made weather-tight by means of dry clinch lock joining. In general, the technique for applying the copper is the same as that for batten seam roofing. The copper covering of the spire is built into the wood construction of the ventilating dormers at the base, and the details for edgings, etc. are simple. The drawing also shows alter-

nate types of battens or methods of joining at the corners of the octagonal spire. For spires of the ordinary size, 16-oz. copper of cornice temper should do very well. For large spires 20-oz. copper of cornice temper might be preferred because of the lesser likelihood of showing buckles in the metal.

### Suggested Specification

The copper roofing and flashing on the spire is to be of 16-oz. copper of cornice temper. There are to be copper covered battens at the eighth points of the spire and horizontal courses of roof pans between the battens. The roof pans shall not be over 18" high. All joints are to be of the clinch lock type and wherever possible they shall be made weather-tight without solder. The finial and the capping of the spire are to be made according to detail. All joints shall be blind soldered and the work reinforced with copper strapping where necessary.

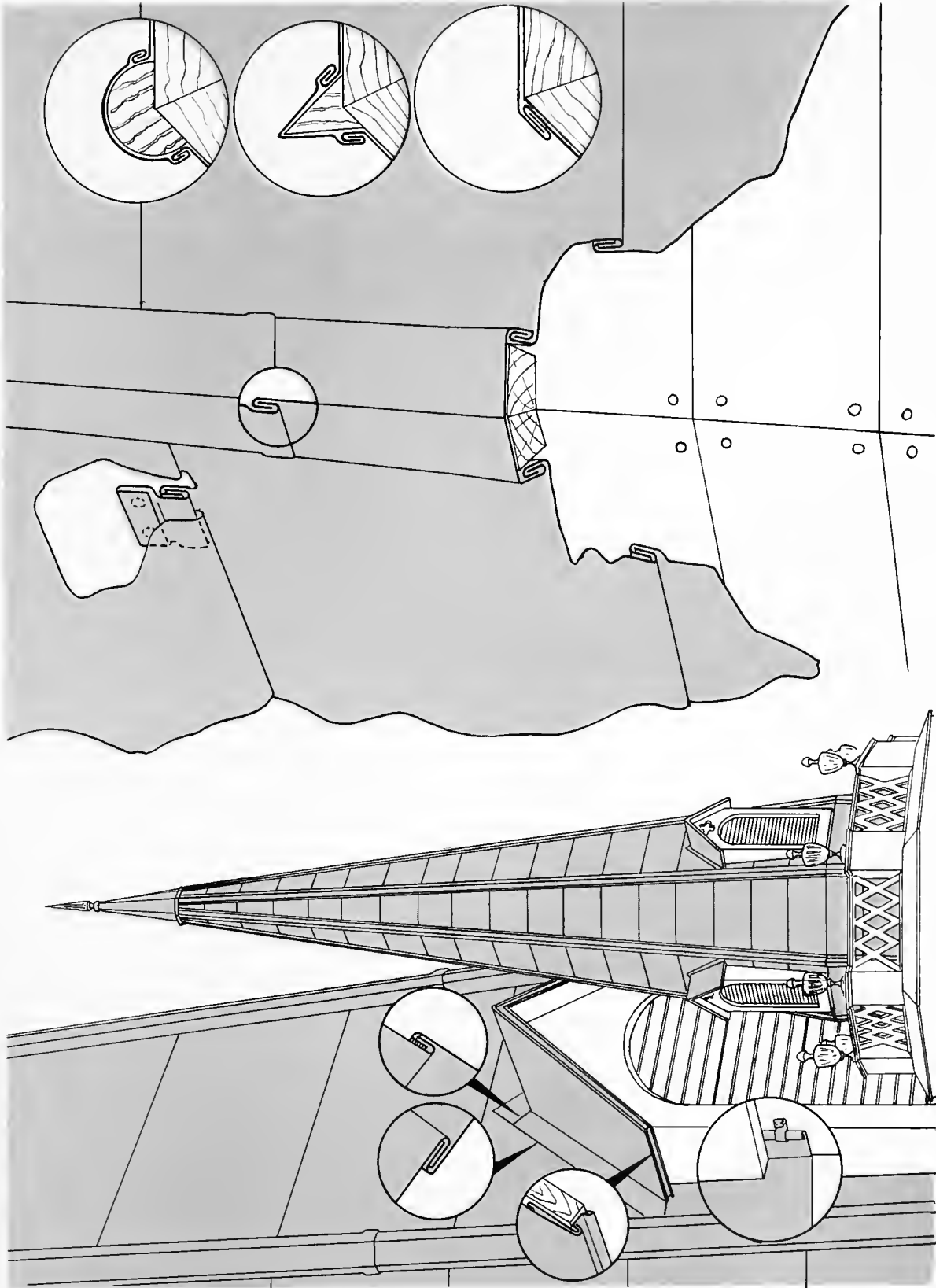

## Curtain walls of metal PLATE NO. 52

This drawing shows an exterior wall with metal facing. The wall consists of large sheets of metal reaching from floor to floor with vertical striations of a fine trough and reed type corrugation. The construction gives the architect the plain wall surface that is characteristic of conventional design. He has a choice of lacquered copper or bronze in the new color of the metal. Without special care he will obtain the russet brown and statuary bronze of the metal upon exposure to the weather, but with chemical treatment he can have copper with an artificial patina, either speckled or plain, preliminary to the natural patina that forms on copper after a number of years.

### **Suggested Specification**

The copper facing for the exterior walls shall be of 24-

oz. gage, of cornice temper, with fine corrugations  $1/4''$  deep as shown. The panels are to be made from sheets of copper 36'' wide by one story high plus 3'' for head lap. The corrugated panels are to be stiffened with 24-oz. copper holding cleats, at 2' intervals vertically spot welded on 3'' centers to the back of the panels. These cleats are to engage with continuous supporting cleats, also of 24-oz. copper which occur at 2' vertical spacings and rest on structural purlins. The supporting cleats are to be isolated from the steel with strips of lead, and fastened with  $5/16''$  bronze bolts with lead washers, spaced on 12'' centers along the purlins. A condensation gutter with weep holes is integral with the supporting cleats. The top supporting cleat should be fastened to the wall panel in the shop for easy erection on the job.

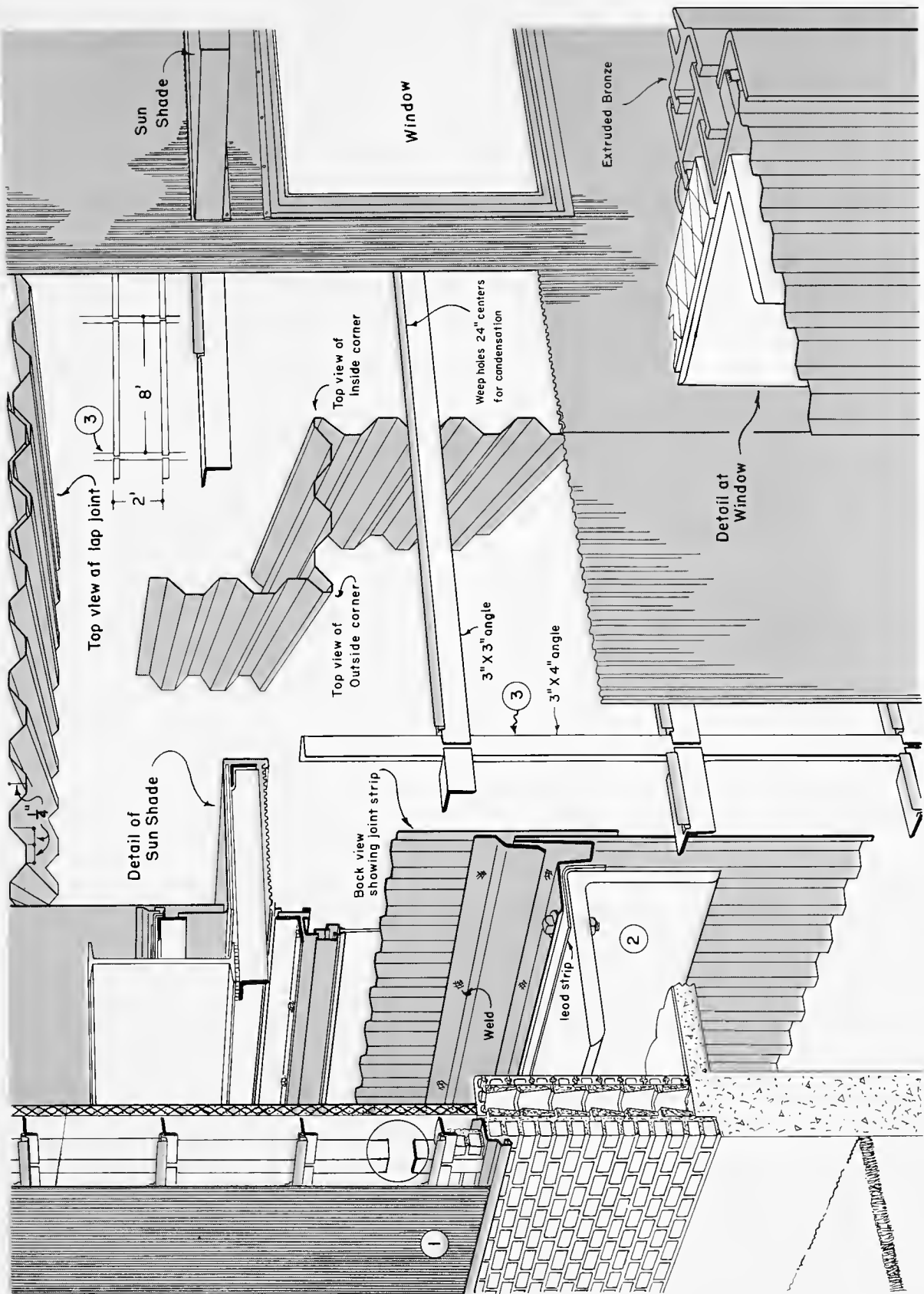





## N O T I C E

The statements and data contained in this publication are based on extensive investigation and practical experience and represent the best information available at time of printing, Jan., 1956. This information is subject to change at any time principally because of new developments and changes in practice. Since the Company does not control or supervise subsequent installations of its products, it cannot assume responsibility for performance in service.

# THE AMERICAN BRASS COMPANY



WATERBURY 20, CONNECTICUT

## MANUFACTURING PLANTS

### COPPER AND COPPER ALLOY MILL PRODUCTS

Ansonia, Conn. • Torrington, Conn. • Waterbury, Conn.  
Buffalo, N. Y. • Detroit, Mich. • Kenosha, Wis.  
New Toronto, Ontario, Canada

### SMALL DIAMETER SEAMLESS TUBES

French Small Tube Division, Waterbury, Conn.

### FLEXIBLE METAL HOSE AND TUBING

American Metal Hose Division, Waterbury, Conn.

### EYELETS, SHELLS, STAMPINGS, FERRULES

Waterbury Brass Goods Division, Waterbury, Conn.

## DISTRICT SALES OFFICES

Ansonia, Conn., 75 Liberty Street  
Atlanta 3, Ga., 161 Spring Street, N.W.  
Buffalo 5, N. Y., 70 Sayre Street  
Cambridge 42, Mass., 23B Main Street  
Cedar Rapids, Iowa, First Avenue Building  
Charlotte 2, North Carolina, Liberty Life Building  
Chicago 39, Ill., 4501 West North Avenue  
Cincinnati 2, Ohio, 101 West Fourth Street  
Cleveland 14, Ohio, 2906 Chester Avenue  
Columbus 15, Ohio, 214 Beggs Building  
Dallas 25, Texas, P. O. Box 12153, Preston Station  
Denver 2, Colo., 909 Seventeenth Street  
Detroit 31, Mich., 174 South Clark Avenue  
Houston 2, Texas, 1114 Texas Avenue Building  
Kenosha, Wis., 1420 Sixty-Third Street  
Los Angeles 17, Calif., 816 West Fifth Street  
Miami 30, Fla., 1514 Alfred I. duPont Building  
Milwaukee 4, Wis., 1033 West Bruce Street  
Minneapolis 2, Minn., 607 Marquette Avenue  
Newark 2, N. J., 744 Broad Street  
New York 16, N. Y., 99 Park Avenue  
Philadelphia 22, Pa., 111 West Norris Street  
Pittsburgh 19, Pa., 603 Grant Building  
Providence 3, R. I., 200 Chestnut Street  
Rochester 4, N. Y., 409 Clinton Building  
St. Louis 3, Mo., 1010 Shell Building  
San Francisco 4, Calif., 111 Sutter Building  
Seattle 1, Wash., 953 Stuart Building  
Syracuse 2, N. Y., 800 State Tower Building  
Torrington, Conn., 179 Water Street  
Washington 5, D. C., 1511 K Street, N.W.  
Waterbury 20, Conn., Crane Street, P. O. Box 1939

## WAREHOUSES

Chicago 39, Ill., 4501 West North Avenue  
Cleveland 14, Ohio, 2906 Chester Avenue  
Dallas 25, Texas, P. O. Box 12153, Preston Station  
Milwaukee 4, Wis., 1033 West Bruce Street  
Philadelphia 22, Pa., 111 West Norris Street  
Providence 3, R. I., 200 Chestnut Street

## IN CANADA:

ANACONDA AMERICAN BRASS LIMITED,  
General Offices, New Toronto, Ontario  
Montreal Office: 939 Dominion Square Building



