

EX LIBRIS





THE METALLURGY OF IRON AND STEEL

Published by the
McGraw-Hill Book Company
New York

Successors to the Book Departments of the
McGraw Publishing Company Hill Publishing Company

Publishers of Books for

Electrical World	The Engineering and Mining Journal
Engineering Record	Power and The Engineer
Electric Railway Journal	American Machinist
Metallurgical and Chemical Engineering	

THE METALLURGY OF IRON AND STEEL

BY

BRADLEY STOUGHTON, PH.B., B.S.

FIRST EDITION — FIFTH IMPRESSION

(With numerous revisions)

McGRAW-HILL BOOK COMPANY
239 WEST 39TH STREET, NEW YORK
6 BOUVERIE STREET, LONDON, E.C.
1908

T 14705
93

COPYRIGHT, 1908, BY THE HILL PUBLISHING COMPANY

ENTERED AT STATIONERS' HALL, LONDON, ENGLAND

TO THE
READER

222483

TO
PROFESSOR HENRY MARION HOWE, A.M., LL.D.,
BESSEMER MEDALLIST, KNIGHT OF THE ORDER OF
ST. STANISLAS, ETC., ETC.,
PRACTITIONER, INVESTIGATOR, AUTHOR, INTERPRETER,
EDUCATOR AND PHILOSOPHER, WHOM THE WORLD
OF SCIENCE DELIGHTS TO HONOR,
THIS VOLUME IS
AFFECTIONATELY DEDICATED



PREFACE

THE purpose of this book is to serve as a text-book, not only for college work, but for civil, mechanical, electrical, metallurgical, mining engineers and architects, and for those engaged in work allied to engineering or metallurgy. America now produces almost as much iron and steel as the rest of the world together, although less than eighteen years ago she held second rank in this industry. It seems fitting that the record of this progress should be brought together into one volume covering every branch of the art of extracting the metal from its ores and of altering its adaptable and ever-varying nature to serve the many requirements of civilized life.

I take pleasure in acknowledging here, with sincere thanks the assistance of many who have aided in the make-up of the volume, and especially The Adams Co. (Figs. 204-7), American Electric Furnace Co. (Figs. 303-4), American Sheet & Tinsplate Co. (Figs. 9, 11, 23, and 79), Bethlehem Steel Co. (Figs. 128-9), Brown Specialty Machinery Co. (Fig. 218), Connersville Blower Co. (Figs. 230-1), Crocker-Wheeler Co. (Figs. 155-6, 167), Francis G. Hall Esq. (Figs. 188-91, 196), Holland Linseed Oil Co. (Figs. 197-200), Chas. W. Hunt, Esq., Secretary, American Society of Civil Engineers (Fig. 284), Professor James F. Kemp (Fig. 8), Mackintosh, Hemphill & Co. (Figs. 136-7, 150, 152), Morgan Construction Co. (Figs. 111, 175, 179, 180), National Tube Co. (Fig. 171), S. Obermayer Co. (Figs. 194-5, 201, 203, 223-5, 270), J. W. Paxson Co. (Figs. 226-8), Henry E. Pridmore (Figs. 208-12), John A. Rathbone (Figs. 213-6, 219-20), each of whom have kindly loaned electrotypes. And of Dr. H. C. Boynton (for Fig. 289), the Brown Hoisting Machinery Co. (Fig. 14), Buffalo Furnace Works (Fig. 266), H. H. Campbell, Esq. (Figs. 115-6), Professor William Campbell (Fig. 290 and those on page 186), Carnegie Steel Co. (Figs. 1, 80, 160, 163-4, 172, 177), W. M. Carr, Esq. (Fig. 108), Central Iron & Steel Co. (Figs. 44, 46-7, 49, 51), Crucible Steel Company

of America (Fig. 59), Fiske & Robinson (Fig. 27), The Foundry (Fig. 117-8, 202), Harbison-Walker Refractories Co. (Figs. 100, 181, 229), Joseph Hartshorne, Esq. (Figs. 41, 43, 45, 48, 50), Professor Henry M. Howe (Figs. 18, 21, 36-7, 60, 67-70, 120-2, 125-6, 254, 283), Lackawanna Steel Co. (Figs. 13, 20, 65, 73-4), Marion Steam Shovel Co. (Fig. 10), Mesta Machine Co. (Figs. 17, 138, 143-4, 153, 187), Morgan Engineering Co. (Figs. 127, 147, 159), Professor A. H. Sexton (Fig. 56), Wm. Swindell & Bros. (Figs. 113-4), United Coke & Gas Co. (Figs. 2-6), United Engineering & Foundry Co. (Figs. 78, 81, 135, 141, 146, 148-9, 154, 170, 264), Wellman-Seaver-Morgan Co. (Figs. 92-3, 102-4, 107, 112), Whiting Foundry Equipment Co. (Figs. 271-3). And of O. S. Doolittle, Esq., for information upon the paint given on page 433, Frank E. Hall, Esq., for the analyses in Table XVIII, and W. J. Keep, Esq., for the figures in Table XXVI.

But especially I am indebted to the following gentlemen, each of whom has read a section of the book and made suggestions for its revision which have been very valuable to me: Messrs. W. Arthur Bostwick, Stanley G. Flagg, Jr., Alfred E. Hammer, Joseph Hartshorne, J. E. Johnson, Jr., Carleton S. Koch, Frank N. Speller, Herbert L. Sutton, and Hugh P. Tiemann.

January 20, 1908.

BRADLEY STOUGHTON.

TABLE OF CONTENTS

	PAGES
CHAPTER I. INTRODUCTION—IRON AND CARBON	3-10
Definitions, 6. General text-books, reference books and periodicals on the metallurgy of iron and steel, 8.	
CHAPTER II. THE MANUFACTURE OF PIG IRON	11-50
Blast-furnace fuels and fluxes, 11. Varieties and distribution of iron ores, 14. United States deposits and transportation, 16. Handling raw material at a modern furnace, 22. The blast furnace and accessories, 24. Smelting practice and products, 30. Calculating a blast-furnace charge, 46.	
CHAPTER III. THE PURIFICATION OF PIG IRON	51-73
Comparison of purification processes, 59. Distinguishing between the different products, 66. Miscellaneous purification processes, 67. General reference books on steel, 72.	
CHAPTER IV. THE MANUFACTURE OF WROUGHT IRON AND CRUCIBLE STEEL	74-94
The manufacture of wrought iron, 74. The carburization of wrought iron, 85. References on the manufacture of iron, 93.	
CHAPTER V. THE BESSEMER PROCESS	95-126
References on the Bessemer process, 125.	
CHAPTER VI. THE OPEN-HEARTH OR SIEMENS-MARTIN PROCESS	127-172
Open-hearth plant, 127. Open-hearth furnace, 132. Basic open-hearth practice, 145. Acid open-hearth practice, 153. Special open-hearth processes, 155. Open-hearth fuels, 160.	
CHAPTER VII. DEFECTS IN INGOTS AND OTHER CASTINGS . . .	173-184
References on defects in ingots, 183.	
CHAPTER VIII. THE MECHANICAL TREATMENT OF STEEL . . .	185-235
The forging of metals, 187. The reduction of metals in rolls, 193. Parts of rolling mills, 200. Rolling-mill practice, 215. Wire drawing, 224. Pressing, 227. Comparison of mechanical methods, 229. Heating furnaces, 229. References on mechanical treatment, 235.	
CHAPTER IX. IRON AND STEEL FOUNDRY	236-291
The making of molds, 237. Design of patterns, 260. Cupola melting of iron for castings, 262. Comparative cupola practice, 279. Other melting furnaces, 284. Melting steel for castings, 286. References on foundry practice, 291.	

	PAGES
CHAPTER X. THE SOLUTION THEORY OF IRON AND STEEL	292-315
The freezing of alloys of lead and tin, 295. The freezing of iron and steel, 304. The solid solution of iron and carbon, 308. The complete Roberts-Austen, Roozeboom diagram, 312. References, 315.	
CHAPTER XI. THE CONSTITUTION OF STEEL	316-332
The micro-constituents of steel, 316. The strength of steel, 324. Hardness and brittleness of steel, 328. Electric conductivity of steel, 329. Magnetic properties of steel, 330. References on the constitution of steel, 332.	
CHAPTER XII. THE CONSTITUTION OF CAST IRON	333-355
The effect of carbon on cast iron, 337. The effect of silicon, sulphur, phosphorus, and manganese on pig iron, 341. The properties of cast iron, 345. References on the constitution of cast iron, 355.	
CHAPTER XIII. MALLEABLE CAST IRON	356-369
References on malleable cast iron, 369.	
CHAPTER XIV. THE HEAT TREATMENT OF STEEL	370-395
Improper heating of steel, 370. Hardening of steel, 382. The constituents of hardened and tempered steels, 389. References on the heat treatment of steel, 395.	
CHAPTER XV. ALLOY STEELS	396-421
Nickel steels, 398. Manganese steel, 405. Chrome steel, 407. Self-hardening and high-speed tool steels, 408. Silicon steels, 413. Vanadium steels, 414. Titanium steels, 419. References on alloy steels, 419.	
CHAPTER XVI. THE CORROSION OF IRON AND STEEL	422-436
The cause and operation of corrosion, 422. Preservative coatings for iron and steel, 429. References on corrosion, 436.	
CHAPTER XVII. THE ELECTRO-METALLURGY OF IRON AND STEEL	437-447
Electro-thermic ore smelting, 438. Electro-thermic manufacture of steel, 442. Electrolytic refining of iron, 446. References on the electro-metallurgy of iron and steel, 447.	
CHAPTER XVIII. THE METALLOGRAPHY OF IRON AND STEEL	448-457
Preparation of samples for microscopic examination, 449. Developing the structure for examination, 452. Microscope and accessories, 454. Macroscopic metallography, 454. References on the metallography of iron and steel, 457.	
CHAPTER XIX. CHEMISTRY AND PHYSICS INTRODUCTORY TO METALLURGY	458-488
Oxygen, 462. Thermo-chemistry, 464. Chemical equations, 466. Hydrogen, 469. Elements, compounds, and radicals, 471. Chemical reactions and compounds, 475. Chemical solutions, 480. Some principles of physics, 482. Physical properties of metals, 484.	

THE METALLURGY OF IRON AND STEEL

THE
LIBRARY OF
CONGRESS

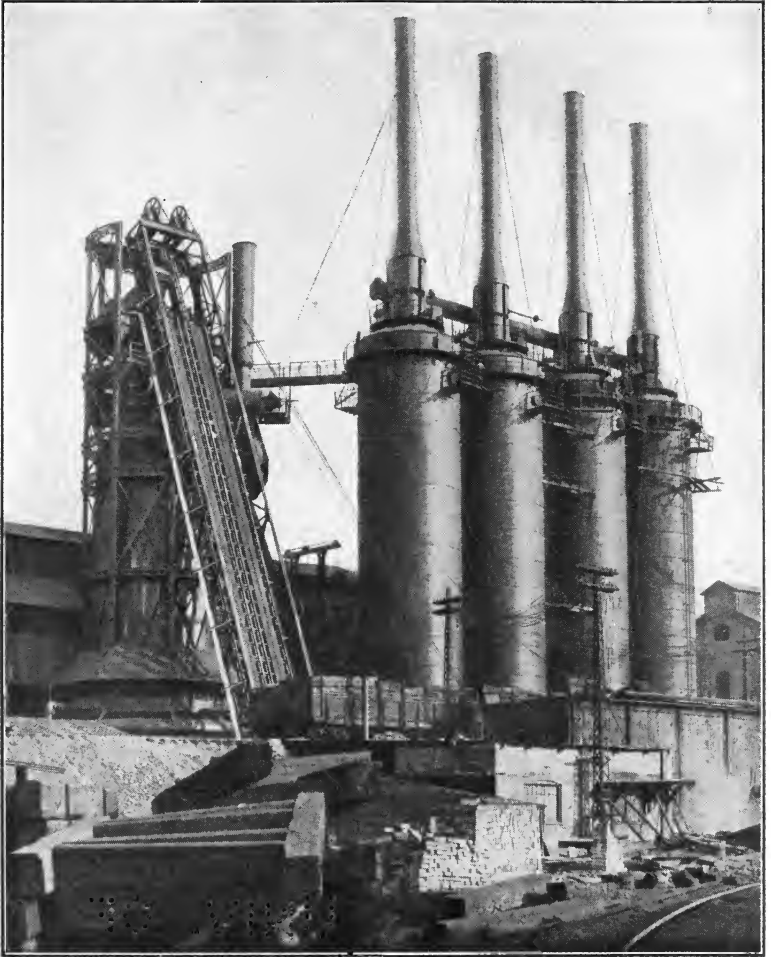

FIG. 4. — IRON BLAST FURNACE AND STOVES.



I

INTRODUCTION—IRON AND CARBON

This chapter is written for those students of iron and steel,—whether they be students engaged at some university, or in an engineering or metallurgical profession,—who have previously completed a course in chemistry and physics. For the benefit of those who have not had a technical education, Chapter XIX has been especially prepared, and it is hoped that, if they will read that chapter before beginning elsewhere in the book, all the subjects discussed in these pages will be readily intelligible to them.

The Ferrous Metals. — Iron and steel together form the largest manufactured product in the world, and each of them enters into every branch of industry and is a necessary factor in every phase of our modern civilization. Cast iron, because of the ease with which it can be melted, is produced in final form in almost every city in the United States, and only slightly less widely in other civilized countries. The manufacture of steel is more centralized, for economical reasons, but is several times as great as cast iron in volume. Wrought iron is lesser in amount than either of the others, but has its own importance and uses. These three products,—cast iron, steel, and wrought iron,—together comprise the whole of the so-called “ferrous group of metals”—that is, the group which we classify together under the name of “iron and steel.” They have two characteristics in common: First, that iron is present in all to the extent of at least 92 per cent.; and second, that carbon is their next most important ingredient, and regulates and controls their chief qualities. Their manufacture represents nearly 15 per cent. of all the world’s manufacturing wealth, and is far greater than any other like industry. (See Table I.)

Cast Iron. — Cast iron is impure, weak, and must be brought to its desired size and form by melting and casting in a mold. A

typical example would contain about 94 per cent. iron, 4 per cent. carbon, and 2 per cent. of other ingredients or impurities.

Pig iron is a raw form of cast iron, and malleable cast iron is a semipurified form.

Steel. — Steel is purer than cast iron, much stronger, and may be produced in the desired size and form either by melting and casting in a mold or by forging at a red heat. It usually contains about 98 per cent. or more of iron, and, in different samples, from 1.50 per cent. down to almost no carbon, together with small amounts of other ingredients or impurities.

Wrought Iron. — Wrought iron is almost the same as the very low-carbon steels, except that it is never produced by melting and casting in a mold, but is always forged to the desired size and form. It usually contains less than 0.12 per cent. of carbon. Its chief distinction from the low-carbon steels is that it is made by a process which finishes it in a pasty, instead of in a liquid form, and leaves about 1 or 2 per cent. of slag mechanically disseminated through it.

Iron. — Iron as such,—by which I mean pure iron,—does not exist as an article of commerce, but appears in service and in the market only in the form of cast iron, steel or wrought iron,—that is, when contaminated with carbon and other impurities. Some of these impurities are present because they cannot cheaply be gotten rid of, and others, because, like carbon for example, they benefit the metal by giving it strength or some other desirable property. Pure iron is a white metal and one of the chemical elements. It is with one exception the commonest and most abundant metal in the earth, and almost all rocks contain it in greater or less degree, from which we extract it if it is large enough in amount to pay for working. It practically never occurs in nature in the form of a metal, but is always united with oxygen to form either a blackish, brownish, reddish or yellowish substance. Indeed, if it should occur in metallic form it would very soon become oxidized by the action of air and moisture.

It is the abundance of iron in the earth which is the chief cause of its cheapness, and therefore one reason why it is used more than any other manufactured material. The other reason is the ease with which we can confer upon it at will some of the qualities most useful to man, of which the most valuable is probably its unequalled strength, and the most wonderful its magnet-

TABLE I.—THE WORLD'S PRODUCTION OF PIG IRON IN LONG TONS (2,240 POUNDS), 1865 TO 1906.

	United States	Great Britain	Germany	France	Belgium	Russia	Austria-Hungary	Sweden	Spain	Italy	Canada	Other Countries	Total
1865	843,410	4,897,971	988,191	1,203,710	470,767	299,438	101,403	226,619	68,037	9,099,666
1870	1,692,378	6,060,720	1,391,123	1,178,113	565,234	* 359,531	402,953	300,338	309,520	12,259,910
1875	2,056,750	6,469,219	2,029,389	1,448,272	541,805	427,187	463,063	350,539	316,078	14,102,222
1880	3,897,840	7,875,545	2,792,038	1,725,293	608,084	448,596	464,234	405,713	306,946	18,547,228
1881	4,211,980	8,513,915	2,913,009	1,886,350	624,736	470,052	543,641	430,042	114,394	27,800	302,354	20,038,273
1882	4,698,790	8,631,727	3,380,806	2,039,067	726,946	463,087	611,739	398,945	120,064	24,778	665,178	21,461,127
1883	4,670,570	8,628,614	3,469,718	2,069,430	783,433	482,274	698,857	422,627	139,920	341,729	21,707,172
1884	4,164,800	7,651,688	3,608,618	1,871,537	750,812	510,132	734,346	430,534	124,363	18,405	283,633	20,140,868
1885	4,110,660	7,368,842	3,687,434	1,630,648	712,876	528,170	714,787	464,737	159,225	15,991	398,583	19,791,893
1886	5,776,168	7,124,012	3,528,658	1,516,574	701,677	532,744	719,980	442,457	57,728	12,291	*20,138	*350,000	25,862,289
1887	6,521,973	6,982,738	4,023,953	1,567,622	755,781	613,184	704,530	456,625	288,634	12,265	22,529	*350,000	22,977,305
1888	6,595,735	8,129,047	4,337,121	1,683,349	826,850	667,737	790,227	457,052	252,116	12,538	19,781	264,136	24,015,908
1889	7,871,590	8,458,486	4,524,558	1,734,000	832,226	740,957	855,813	420,665	197,874	13,473	23,522	380,418	26,029,981
1890	9,353,020	8,033,052	4,658,451	1,962,196	787,836	927,581	965,382	456,103	170,782	14,346	301,959	27,630,712
1891	8,413,176	7,525,301	4,631,218	1,897,387	684,126	1,004,745	921,846	490,913	278,462	11,930	21,697	*350,000	26,230,081
1892	9,304,428	6,817,274	4,937,461	2,037,300	753,268	*919,614	940,284	485,664	247,329	12,729	38,514	*350,000	26,863,865
1893	7,239,806	7,089,318	4,986,030	2,003,100	745,264	1,160,737	982,707	453,421	260,450	8,038	50,750	*350,000	24,229,025
1894	6,757,248	7,364,745	5,559,322	2,077,647	810,940	1,312,760	1,054,520	459,132	260,000	10,329	45,327	*350,000	26,068,970
1895	5,997,449	8,022,006	5,788,798	2,005,889	829,135	1,454,298	1,075,000	455,200	206,430	*10,500	47,586	*375,000	29,867,591
1896	8,761,127	8,700,220	6,360,982	2,333,702	932,780	1,629,810	1,130,000	466,400	246,326	11,280	47,635	*395,000	31,015,302
1897	9,807,123	8,930,086	6,888,087	2,472,143	1,024,666	1,857,000	1,205,000	533,800	282,171	12,500	49,497	*450,000	33,513,073
1898	11,962,317	8,819,968	7,407,717	2,525,075	982,748	2,228,850	1,250,000	492,700	301,799	12,850	69,248	*545,000	36,658,272
1899	13,838,634	9,572,178	7,160,203	2,578,400	1,036,185	2,708,749	1,323,999	467,727	266,385	19,218	95,582	*625,000	39,722,560
1900	14,009,870	9,003,046	7,549,655	2,714,298	1,161,180	2,895,636	1,311,949	526,868	289,788	23,990	87,612	*625,000	40,198,892
1901	16,132,408	7,977,459	7,785,887	2,388,823	765,420	2,807,972	1,300,000	528,375	294,118	25,000	248,896	*635,000	40,889,358
1902	18,003,448	8,653,976	8,402,660	2,427,427	1,102,910	2,597,435	1,335,000	524,400	330,747	24,500	325,076	*615,000	44,342,579
1903	18,297,400	8,952,183	10,085,634	2,827,668	1,299,211	2,486,610	1,355,000	506,825	380,284	28,250	269,665	*625,000	47,113,730
1904	16,760,986	8,699,661	10,103,941	2,999,787	1,307,399	2,978,325	1,369,500	528,525	386,000	27,600	274,777	*633,000	46,069,501
1905	23,340,258	9,746,221	10,987,623	3,077,000	1,310,290	2,125,000	1,372,300	531,200	383,100	31,300	475,491	*655,000	54,054,783
1906	25,712,106	10,210,178	12,478,067	3,319,032	1,431,160	2,350,000	1,403,500	552,250	387,500	30,450	550,618	*650,000	59,074,861

* Estimated.

ism, in which it is not even approached by any other substance. What these two properties alone mean in modern structural and electrical engineering can scarcely be estimated.

Carbon. — Carbon is also a chemical element and familiar to everyone; graphite, lamp-black, charcoal, and diamond are the various allotropic forms in which it appears. It is a common substance and present in every form of organic matter, while its oxides, — carbon monoxide, CO; and carbon dioxide, CO₂ — are well known gases. Its chemical affinity for iron is very great; iron practically always contains some amount, and, if it is desired to remove it entirely, the last traces are eliminated only with extreme difficulty.

Iron and Carbon. — Carbon has the peculiarity of conferring on iron great strength, which, strange to say, it does not itself possess, and also hardness, which it possesses only in its diamond allotropic form. At the same time it takes away from the iron a part of its ductility, malleability, magnetism and electric conductivity. So important is the influence of carbon in regulating and controlling the characteristics of the ferrous metals, that they are individually and collectively classified according to the amount and condition of the carbon in them. The potent effect of carbon must be constantly borne in mind when we come to describe the manufacture of iron and steel and to discuss the methods of regulating the carbon.

DEFINITIONS

The following definitions are selected from the report of March 31, 1906, of the Committee on the Uniform Nomenclature of Iron and Steel of the International Association for Testing Materials, with slight changes:

Cast Iron. — Generically, iron containing so much carbon or its equivalent that it is not malleable at any temperature. Specifically, cast iron in the form of castings other than pigs, or remelted cast iron suitable for casting into such castings, as distinguished from pig iron, i. e., cast iron in pigs.

The committee recommends drawing the line between cast iron and steel at 2.20 per cent. carbon for the reason that this appears from the results of Carpenter and Keeling to be the critical percentage of carbon corresponding to the point "a" in the diagrams of Roberts-Austen and Roozeboom. (See page 314.)

Pig Iron. — Cast iron which has been cast into pigs direct from the blast furnace. This name is also applied to molten cast iron which is about to be so cast into pigs, or is in a condition in which it could readily be cast into pigs before it has ever been cast into any other form.

Gray Pig Iron and Gray Cast Iron. — Pig iron and cast iron in the fracture of which the iron itself is nearly or quite concealed by graphite, so that the fracture has the gray color of graphite.

White Pig Iron and White Cast Iron. — Pig iron and cast iron in the fracture of which little or no graphite is visible, so that their fracture is silvery and white.

Mottled Pig Iron and Mottled Cast Iron. — Pig iron and cast iron, the structure of which is mottled, with white parts in which no graphite is seen, and gray parts in which graphite is seen.

Malleable Cast Iron. — Iron which when first made is cast in the condition of cast iron, and is made malleable by subsequent treatment without fusion.

Malleable Iron. — The same as wrought iron. A name used in Great Britain, but not in the United States, except carelessly as meaning "Malleable cast iron."

Steel. — Iron which is malleable at least in some one range of temperature, and in addition is either (a) cast into an initially malleable mass; or (b) is capable of hardening greatly by sudden cooling; or (c) is both so cast and so capable of hardening.

Wrought Iron. — Slag-bearing, malleable iron, which does not harden materially when suddenly cooled.

In the definition of steel the first sentence ("is malleable at least in some one range of temperature") distinguishes steel from cast iron and pig iron; the second sentence ("is cast into an initially malleable mass") distinguishes it from malleable cast iron, and the third sentence ("is capable of hardening greatly by sudden cooling") distinguishes it from wrought iron. At the best, however, the definition of steel is in a shockingly bad condition, and has been brought to it by a series of events which shows the carelessness of the buying public and the greed of men who will appropriate the name for their product that will bring them the best price without regard to whether the name really fits or not.¹

¹See page 173 of reference No. 1, at the end of this chapter, and page 6 of No. 2.

GENERAL TEXT-BOOKS, REFERENCE BOOKS AND PERIODICALS ON
THE METALLURGY OF IRON AND STEEL

(For further references, see the end of Chapter III.)

1. Prof. H. M. Howe. "Iron, Steel, and Other Alloys," 1903. Published by Sauveur & Whiting, Boston, Mass. This book contains three chapters upon the "Manufacture of Iron and Steel" and ten chapters upon its constitution and properties, especially from the standpoint of metallography. Upon this latter subject it is without an equal and, like the same author's larger work, bids fair to remain the standard authority for many years to come.
2. H. H. Campbell. "The Manufacture and Properties of Iron and Steel." Fourth edition. New York and London. 1907. This is a great reference book by one of the best of the practical American metallurgical engineers. It is undoubtedly the best reference book upon the manufacture of iron and steel, but is not intended especially for beginners or those without technical education.
3. James M. Swank. "Directory to the Iron and Steel Works of the United States." Embracing the Blast Furnaces, Rolling Mills, Steel Works, Forges, and Bloomeries in Every State and Territory. Prepared and published by The American Iron and Steel Association. Philadelphia. The first edition of this book appeared in 1873, and the seventeenth edition in 1907. The data given are very complete and are classified for convenient reference.
4. James M. Swank. "History of the Manufacture of Iron in All Ages, and Particularly in the United States from 1585 to 1892." Philadelphia.
5. "Ryland's Colliery; Iron, Steel, Tin-Plate, Engineering and Allied Trades' Directory (For Great Britain only) with Brands and Trade Marks." 1906. Published by Eagland & Co., Ltd., London.
6. Andrew Alexander Blair. "The Chemical Analysis of Iron." A Complete Account of all the best known Methods for the Analysis of Iron, Steel, Pig Iron, Iron Ore, Limestone, Slag, Clay, Sand, Coal, Coke, and Furnace and Producer-Gases. Sixth edition. Philadelphia and London. 1906.

7. J. O. Arnold. "Steel Works Analysis." London and New York. 1895.
8. *The Journal of the Iron and Steel Institute*. Published in London. Vol. i, 1869; vol. lxxiii, 1907. This periodical appears twice a year and contains not only many original articles of very great value but also an almost complete collection of abstracts of the literature of iron and steel that is published anywhere, classified under headings for convenient reference. Anyone beginning the study of any branch of iron and steel metallurgy should commence with this journal, as soon as the text-books have been consulted.
9. *Stahl und Eisen*. Published in Duesseldorf. Vol. i, 1881; vol. xxvii, 1907. This is the best German periodical on iron and steel, and contains not only many valuable original articles and abstracts but also translations. I have found it particularly useful in this latter connection, because of its translations of many articles from the Swedish.
10. *Revue de Metallurgie*. Published in Paris. Vol. i, 1904; vol. iv, 1907. This is a very valuable periodical for those who read French, not only for its original articles but also for its abstracts. Upon the more scientific side of metallurgy, that is to say the properties and constitution of iron and steel, alloy steels, etc., it is without an equal.
11. *The Mineral Industry*. Its statistics, technical and trade. Published in New York. Vol. i, 1892; vol. xvi, 1907. This contains a review every year of the technology and trade of each of the metals listed alphabetically, as well as the statistics of production, price, etc. The articles usually include a review of the progress of the metallurgy during the year.
12. *The Iron Age*. Published in New York. Vol. i, 1869; vol. lxxix, 1907. This is the oldest and largest of the American iron and steel technical magazines, and deals not only with the scientific and technical side of the subject, but also acts as a sort of a weekly newspaper upon the condition of the iron trade and recent happenings of interest.
13. *Transactions of the American Institute of Mining Engineers*. Published in New York. Vol. i, 1871; vol. xxxviii, 1907. The American Institute of Mining Engineers is the leading

aggregation of both mining engineers and metallurgists in America. These transactions contain many original articles of value.

14. James M. Swank. *Annual Statistical Report of the Secretary of the American Iron and Steel Association*, containing detailed statistics of the American and foreign iron trade. Published in Philadelphia.
15. *Iron Trade Review*. Published in Cleveland, Ohio. Although this magazine aims to deal principally with iron trade conditions, it contains also a great many technical articles of importance.
16. *Metallurgie*. Published in Halle am See. Vol. i, 1904; vol. iv, 1907. This German magazine contains a great many original articles and abstracts.
17. *Annales des Mines*. Published in Paris. Vol. i, 1816. Tenth series. Vol. xi, 1907.
18. *Revue Universelle des Mines, de la Metallurgie des Travaux Publics, des Sciences et des Arts Appliqués à l'Industrie*. Vol. i, 1857; Fourth series, vol. xvii, 1907.
19. *Osterreichische Zeitschrift für Berg- und Hüttenwesen*. Published in Vienna. Vol. i, 1853; vol. lv, 1907.

II

THE MANUFACTURE OF PIG IRON

WHATEVER material we are to manufacture — cast iron, wrought iron, or steel — or for whatever purpose the metal is to be used, the first step in the operation is smelting iron ore in a blast furnace with fuel and flux, and obtaining cast iron or pig iron, terms used synonymously in the United States.¹ The pig iron thus produced is an impure grade of iron, containing usually 3 to 4 per cent. of carbon, up to 4 per cent. of silicon, up to 1 per cent. of manganese, and a few hundredths of 1 per cent. each of sulphur and phosphorus.² The amount of pig iron made exceeds that of any other product manufactured by man.

BLAST-FURNACE FUELS AND FLUXES

Fuels are impure forms of carbon. By their union with oxygen they furnish heat:

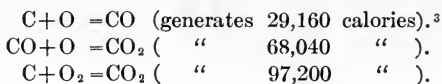

The temperatures necessary for smelting are obtained in this way. They also act as the chemical agents to separate the iron from the oxygen with which it is combined in ores:

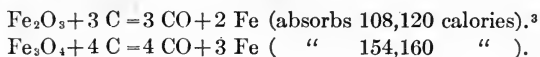

The carbon contained in the pig iron is also dissolved from the fuel, directly or indirectly.

¹ More strictly speaking, 'pig iron' applies to the virgin product of the blast furnace, and 'cast iron' designates pig iron that has been cast into molds of some final and useful shape, usually after a remelting.

² In foundry and basic pig irons, the impurities are higher than this.

³ All heat effects of chemical reactions are given in calories per molecular weight in grams throughout the book.

Charcoal. — The purer the carbon the better it serves the purposes mentioned. For this reason charcoal, which has the least amount of objectionable impurities, was once the great metallurgical fuel. Even to-day blast furnaces use charcoal for the production of pure pig relatively free from sulphur. Except in favored localities, charcoal is costly. Furthermore, its weakness permits it to crush easily; so charcoal furnaces are restricted to small sizes, and 'charcoal iron' is higher in price.

Anthracite. — Anthracite is purer than coke, but its denseness makes it offer a large resistance to the blast in furnaces having much height.

Coke. — Coke is the great blast-furnace fuel, and a near-by supply of this material makes Pittsburg, Chicago, Alabama, and Colorado the great smelting centers that they are. In the United

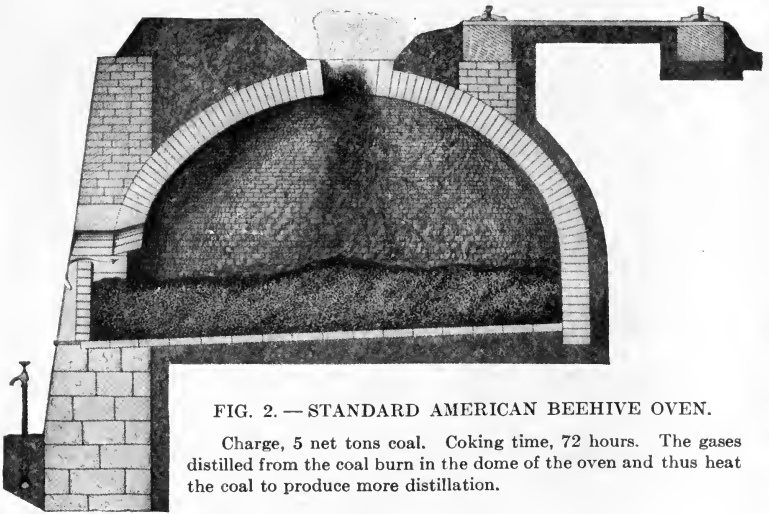

FIG. 2. — STANDARD AMERICAN BEEHIVE OVEN.

Charge, 5 net tons coal. Coking time, 72 hours. The gases distilled from the coal burn in the dome of the oven and thus heat the coal to produce more distillation.

States practically 94 per cent. of the pig iron is made with coke as fuel, 5 per cent. with anthracite as fuel, and 1 per cent. with charcoal.

A bituminous coking coal contains about 30 per cent. by weight of volatile matter. When this coal is heated, or 'coked,' the volatile matter is driven off, leaving a porous, spongy mass of a silvery gray color and good strength. This is coke, and an

analysis of a specimen from the famous Connellsville region near Pittsburg is: Volatile matter = 0.67 per cent.; fixed carbon = 87.05 per cent.; ash = 10.60 per cent.; sulphur = 0.74 per cent.; phosphorus = 0.016 per cent.

Fluxes. — The ash of fuels will not melt readily. By adding the correct amount of lime to them they are transformed into a fusible mass, which remains in a liquid form in the furnace and is easily removed by opening a hole in the side. This fusible ma-

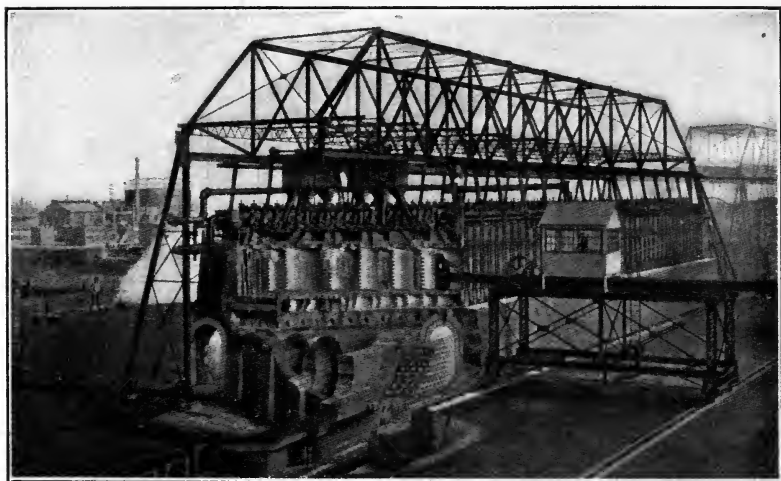

FIG. 3. — 50 OTTO-HOFFMANN BY-PRODUCT, OR RETORT, COKE OVENS.

terial is known as slag or cinder, and the added lime is known as flux. The flux is usually added in the form of limestone (CaCO_3), but the heat in the upper layers of the furnace drives off the carbonic acid, leaving lime (CaO).

The gangue of our iron ores consists usually of silica, alumina, etc., and, like the fuel ash, requires the addition of the correct amount of limestone flux to make it into a fusible slag. In the Pittsburg district we charge about 1200 lb. of limestone, 2200 lb. of coke, and 4000 lb. of ore for every long ton of pig iron made. The amount of each is increasing, however, from time to time, as the higher-grade ores are becoming exhausted and there are more impurities to be fluxed and melted.

VARIETIES AND DISTRIBUTION OF IRON ORES

The iron ores used for smelting consist of chemical compounds of iron and oxygen containing more or less water, either in the

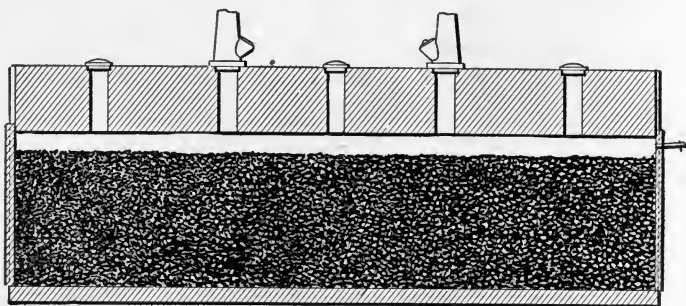

FIG. 4. — HORIZONTAL SECTION THROUGH A RETORT OF A BY-PRODUCT OVEN.

The gases from the coal burn in flues on the side of the retort which contains the coal.

form of moisture or chemically combined as water of crystallization.

Hematite (Fe_2O_3). — The best known of these ores is hematite, containing when pure 70 per cent. of iron. The red or brown

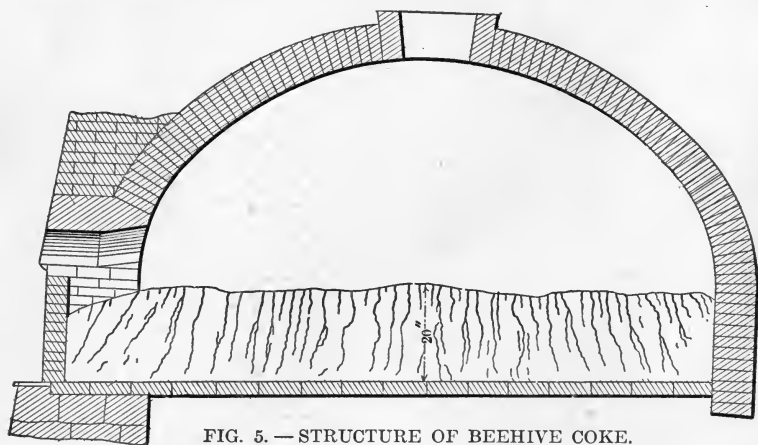

FIG. 5. — STRUCTURE OF BEEHIVE COKE.

hematites are the richer varieties (Lake Superior deposits, containing, in some cases, as much as 68 per cent. of iron), while the

hydrated hematites, or limonites, usually contain a good deal of water of crystallization and are consequently poorer in iron, not often yielding much more than 50 per cent. iron.

Oölitic hematite is a variety that exists in the form of spherical grains or nodules. It is important because it sometimes contains limestone and is, therefore, valuable not only for the iron but for the fluxing quality of the lime. The Minette ore of Lothringen (formerly Lorraine), Luxemburg, and France is an enormous deposit of this oölitic hematite, running from 30 to 35 per cent. iron and giving a pig iron containing about 2 per cent. of phosphorus. This ore is the basis of the iron industry of Germany, France, and Belgium, and, upon judicious mixing of varieties, when necessary, is self-fluxing.

Magnetite (Fe_3O_4). — Magnetite contains, when pure, enough iron (72.4 per cent.) to attract the magnet. In the United States it is often mixed with other impurities, such as silica, titanium, and phosphorus, so much so as to render the ore either too poor in iron to be smelted profitably, or too high in phosphorus to make good steel, or so high in titanium as to interfere with the blast-furnace smelting by producing sticky slags which are not easily handled.

The magnetite ores of Sweden are, however, the purest ores that exist in large quantities anywhere, and form one of the sources of the Swedish iron and steel, which is famous all over the world for its purity, that is, for its freedom from the objectionable elements sulphur and phosphorus. It is these Swedish products which supply the steel industry of Sheffield with pure material for its tool steel and cutlery.

Siderite (FeCO_3). — Another variety of iron ore is the so-called 'spathic' iron ore, or siderite, which is, however, without any importance in the United States. This forms the famous 'clay ironstone' of the Cleveland district in England. It is poor

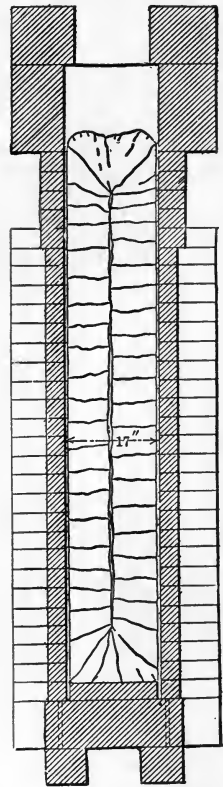

FIG. 6. — CROSS-SECTION OF RETORT.
Structure of By-product Coke.

in iron and is therefore no longer smelted in any quantity in the United States in competition with the rich hematites. This ore is

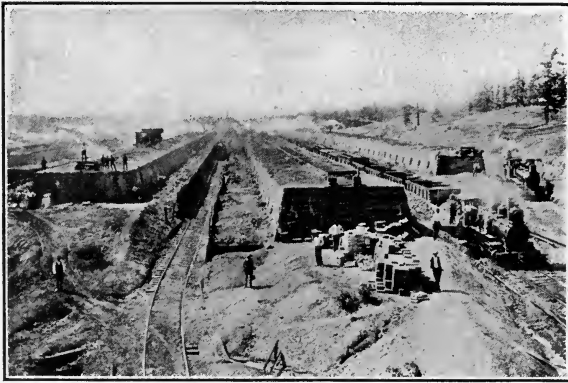

FIG. 7. — BATTERIES OF BEEHIVE OVENS.

almost always calcined before smelting to expel the carbonic acid, in order to save the blast furnace the extra work of this expulsion in its upper levels.

UNITED STATES DEPOSITS AND TRANSPORTATION

In the United States ores of iron are very widely distributed, as will be seen by reference to the map on page 17, the black spots on which represent notable deposits. The smelting of ore also shows a wide distribution. Blast furnaces are in operation in twenty-two states, including Washington, Minnesota, New York, and Massachusetts on the north; Colorado, Texas, and Alabama on the west and south. The great pig iron centers are: (1) The district that includes Western Pennsylvania and Ohio, which produces more than one-half of the pig iron of the country; (2) Illinois, and (3) Alabama.

It is not to be supposed that all the deposits marked on the map are extensively worked for their iron. The rich hematite deposits of the Lake Superior district furnish annually about 40,000,000 tons, which yield more than three-quarters of the pig-iron production of the country. The only other districts which produce more than 1,000,000 tons a year are in the states of Alabama and New York. Most of the other deposits are mined only for local

treatment. In addition, a total of nearly 1,000,000 tons of ore per year are imported from Cuba, Spain, and other foreign countries,

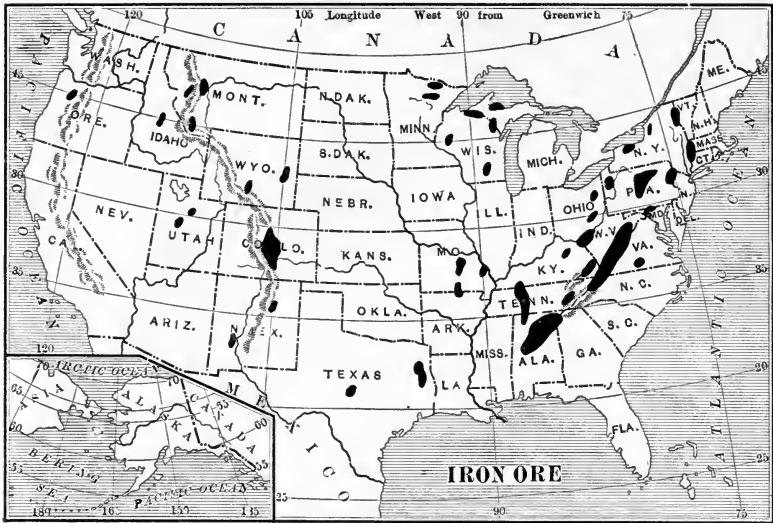

FIG. 8. — FROM KEMP'S "ORE DEPOSITS OF THE UNITED STATES."

principally for smelting by blast furnaces on or near the Atlantic coast.

Ore Transportation. — The peculiarity of the Lake Superior deposits is that almost none of the ore is smelted locally, but is transported a distance of 800 miles or more in order to bring it to



FIG. 9. — A LAKE SUPERIOR ORE MINE.

the coke. Thus, South Chicago, Western Pennsylvania, and Ohio receive the bulk of the ore shipped from the Lake Superior mines. Since the amount of coke used in the blast furnaces is only about one-half the weight of the ore, it might seem uneconomical to carry



FIG. 10. — STEAM SHOVEL LOADING SOFT ORE.

the latter to the former. But coke is bulky in proportion to its weight; furthermore, it suffers a good deal of waste in transportation in consequence of its friability and of the fact that so much of it is broken down into pieces less than an inch in diameter (technically known as 'breeze') which is not suitable for charging into the blast furnace. The ore, on the other hand, may be handled by the cheapest and most rapid labor-saving devices. Indeed, in

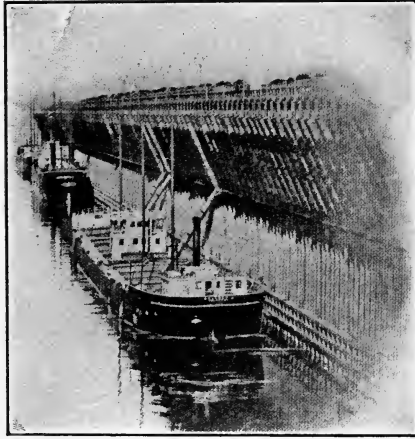

FIG. 11. — LOADING AN ORE BOAT.

many cases, the ore is never touched by shovels in the hands of man, but is mined, charged, and discharged in units of several tons each, and often by means of gravity.

The mining and transportation of this great amount of material is in itself a mighty industry, every advance in which has contributed in no small share to the increasing volume and importance of the iron, steel, and other industries of the United States.

Mining. — Some of the Lake Superior deposits lie near the surface and are therefore cheaply mined. This is especially true of the soft, earthy deposits of the Mesabi range, which are sometimes worked in great open cuts, the ore being loaded upon cars by mammoth steam shovels, or sometimes by the caving method, the ore falling by gravity into cars situated in underground tunnels. The massive, or rock, ores are more costly to extract, and the utmost skill of American blast-furnace men has been exercised to

employ as large a portion of the earthy ores as possible without choking up the furnace.

Transportation. — On reaching the shore of the lake the ore train is run out above a long line of ore bins supported on a wharf extending over the deep water of Lake Superior. Alongside of this wharf the ore boats, capable of taking a load of 10,000 or 13,000 tons of ore, are docked. The hatches of these great boats

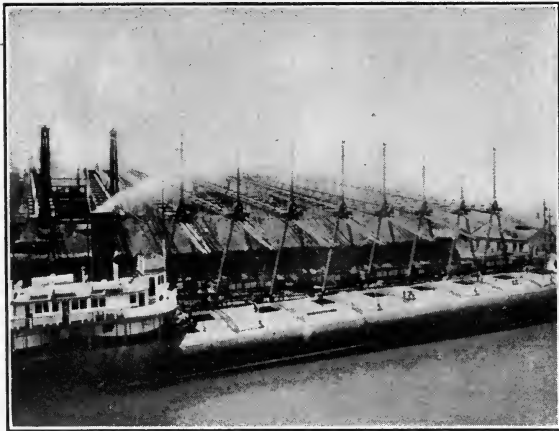

FIG. 12. — BROWN-HOIST APPARATUS UNLOADING AN ORE BOAT.

are placed such a distance apart that the hinged ore chutes of the bins may be swung down and, when the gates are opened, the ore allowed to flow directly into the hold of the vessel. In a few minutes the vessel has received her full cargo and is ready to start on its long journey down the chain of inland lakes.

Sometimes in long strings of three or four, in tow together, sometimes singly or in pairs, the boats travel from one end of Lake Superior to the other and come to the great canal of Sault Ste. Marie. This canal deserves a passing mention because of the enormous benefit which its construction has conferred upon the iron industry. It is two miles long, and for about three months of the year is closed to navigation by the ice; nevertheless, the total tonnage of the cargoes passing through it annually, by far the greater part of which consists of iron ore, amounts to nearly 55,000,000, a volume three times as great as that borne by the next greatest canal, namely, the Suez Canal, which forms the

great water highway from Europe and the Mediterranean to the East.

After passing through the one lock of the 'Soo' canal, the stream of ore divides into two parts. One part turns to the westward and supplies the great blast furnaces of Chicago and Milwaukee; but much the larger portion travels down Lake Huron and Lake St. Clair and is discharged at some one of the many great unloading points on the southern shore of Lake Erie, where it is either smelted near by or loaded on railroad cars for transportation to Pittsburg, Youngstown, or one of the other great blast-furnace centers.

Unloading. — The unloading of boats is accomplished with almost as great celerity as the loading, and by means of mechanical unloading machinery a steamer containing as much as 10,300 tons



FIG. 13. — HULETT ELECTRIC UNLOADER.

of ore has been completely discharged in 4 hours and 30 minutes. Nor is any time wasted in coaling the vessel for a second journey up the lakes and back. Great machines pick up whole railroad cars of fuel and empty them bodily into the chute which connects with the bunkers of the vessel, many of the ore steamers being so constructed that this wholesale loading of coal can go on at the same time that ore is being discharged.

HANDLING RAW MATERIAL AT A MODERN FURNACE

Behind the blast furnace are situated two long rows of storage bins, one of which is shown in elevation in Fig. 15. These bins are filled by bottom-dumping railroad cars which bring the ore to the furnaces, or by mechanical apparatus from the great piles of ore stored conveniently near. Between and under these two rows of bins runs a track on which little trains of ore larries are transferred back and forth, being first filled with a weighed amount of ore, limestone, or fuel, and then switched into a position from which they can deposit their contents into the loading skip of the blast furnace.

Loading the Furnace. — The next step in the handling of the raw material is to bring the ore, together with the necessary fuel and flux, into the mouth of the huge furnace that is to convert it into pig iron. In one of the big modern American furnaces, work-

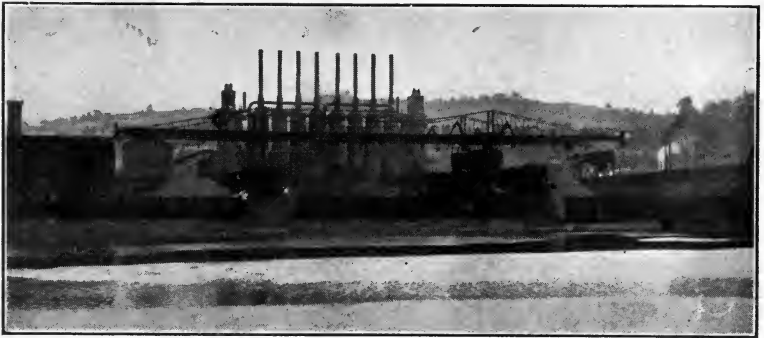

FIG. 14. — ORE-HANDLING MECHANISM AT BLAST FURNACE.

ing at top speed, the amount of material which must be dumped into the top during 24 hours will frequently exceed 2000 tons, and the charging must go on for 365 days a year with never a delay of more than a few hours at a time.

In the modern type of furnace this loading is accomplished altogether by mechanism operated and controlled from the ground level, and no men are required to work at the top of the furnace. In Fig. 15 is a section of such a furnace showing one method of loading, — a double, inclined skipway extending above the top of the furnace. One skip is seen discharging its load of ore, or fuel

and flux, into the hopper, while the second skip is at the bottom of the incline ready to be loaded with its charge.

Double Bell and Hopper. — The upper hopper of the furnace is closed at the bottom by an iron cone, known as a 'bell.' This bell

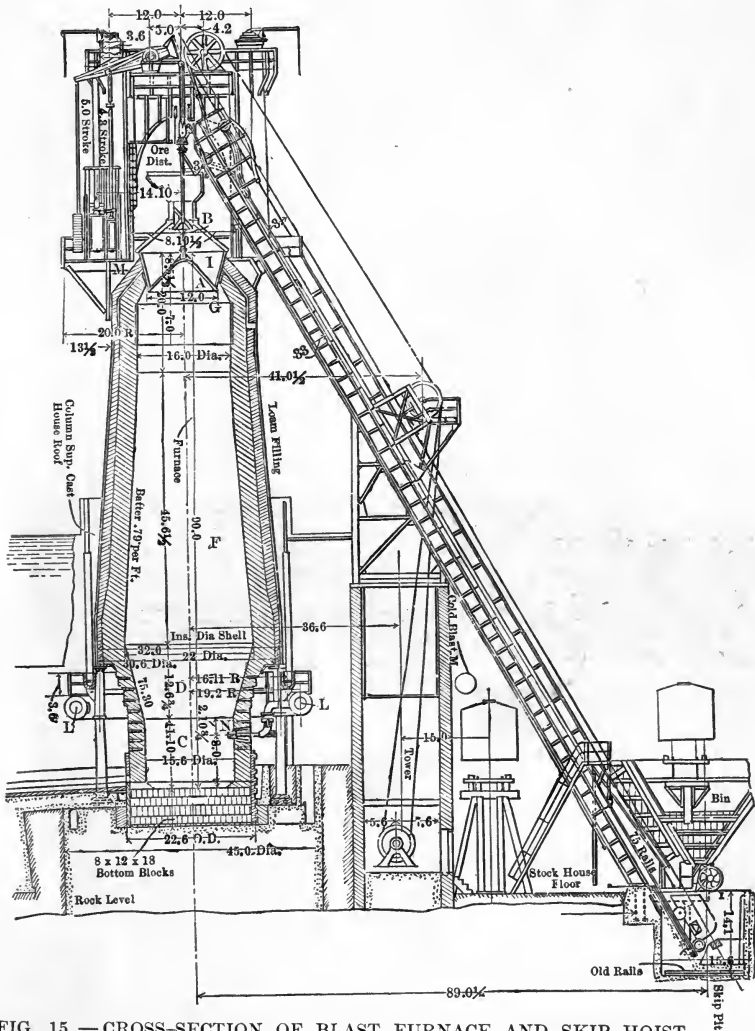

FIG. 15. — CROSS-SECTION OF BLAST FURNACE AND SKIP HOIST.

is pressed up against the bottom of the hopper by the lever of the counterweight, as shown, but may be lowered by operating the

cylinder *M*, to allow the charge to fall into the true hopper, *I*, of the blast furnace. In this way the true hopper of the furnace is progressively filled with ore, flux, and fuel. This hopper, *I*, is also closed at the bottom by a similar bell, *A*. The lowering of this bell is also controlled by mechanism operated from the ground level. At intervals this operation is effected and the contents of the hopper allowed to fall in an annular stream, distributing itself in a regular layer on top of the material already in the furnace and reaching to within a few feet of the bottom of the bell. As the upper bell, *B*, is now held up against the bottom of the upper hopper, there is never a direct opening from the interior of the blast furnace to the outer air, so that the escape of gas, resulting formerly in the long flame rising from the top of the blast furnace whenever material was dropped into the interior, no longer occurs at our modern plants.

This is not the only means of handling the raw material for the blast furnace. Several varieties of mechanism are extensively used, but the description given heretofore will serve to illustrate the general principles of labor-saving mechanisms in connection with charging the blast furnace. It will be seen that the ore is transferred from one receptacle to another by means of gravity wherever possible.

THE BLAST FURNACE AND ACCESSORIES

The blast furnace itself consists of a tall cylindrical stack lined with an acid (silicious) refractory fire-brick, the general form and dimensions being shown in Fig. 15. The hearth or crucible is the straight portion occupying the lower 8 ft. of the furnace. Above that extends the widening portion, called the bosh, which reaches to that portion in the furnace having the greatest diameter. The stack extends throughout the remainder of the furnace, from the bosh to the throat. The brickwork of the hearth is cooled by causing water to trickle over the outside surface.

Tuyeres. — Through the lining of the furnace, just at the top of the hearth, extend the tuyeres — 8 to 16 pipes having an internal diameter of 4 to 7 in., through which hot blast is driven to burn the coke and furnish the heat for the smelting operation. The 'tuyere notches,' or openings through which the tuyere pipes enter, as well as the tuyeres themselves, are surrounded by hollow

bronze rings set in the brickwork, through which cold water is constantly flowing to protect them from being melted off at the inner ends. The number and size of the tuyeres are in proportion to the diameter of the hearth, the volume and pressure of the blast, etc., the blast being given sufficient velocity to carry it, distributed as evenly as possible, to the very center of the furnace.

Discharge Holes. — On the side of the furnace, and 30 to 40 in. below the level of the tuyeres, the 'cinder notch' or 'monkey' is situated. This is protected by a water-cooled casting, and the hole is closed by chilling the iron in it with an iron plug.

In the front, or breast, at the very bottom level of the crucible, is the iron tap-hole, from which all the liquid contents of the

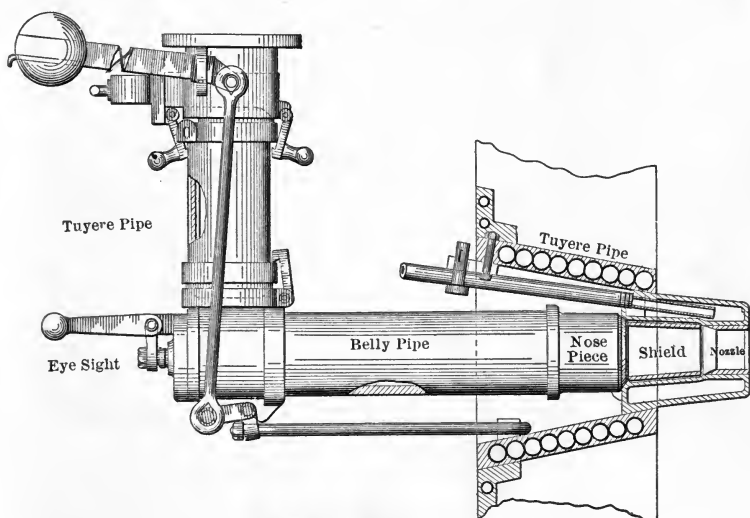

FIG. 16. — PARTS OF A BLAST FURNACE TUYERE.

furnace can be completely drained. This is a large hole in the brickwork, and is closed with several balls of clay.

Bosh. — The hottest part of the furnace is near the tuyeres and a few feet above them. In order to protect the brickwork of the bosh from this heat, a number of hollow wedge-shaped castings are placed therein, through which cold water circulates. The brickwork is furthermore protected by a deposition of a layer of carbon, similar to lampblack, on its internal surface, covered by a layer of a sort of slag, replacing part of the brickwork. This deposition of carbon comes about through the reaction of the

furnace operation itself, in the following manner: For the correct conduct of the smelting operation, and especially for the carrying off of the sulphur in the slag, it is necessary that a very powerful reducing influence must exist; this reducing influence is produced

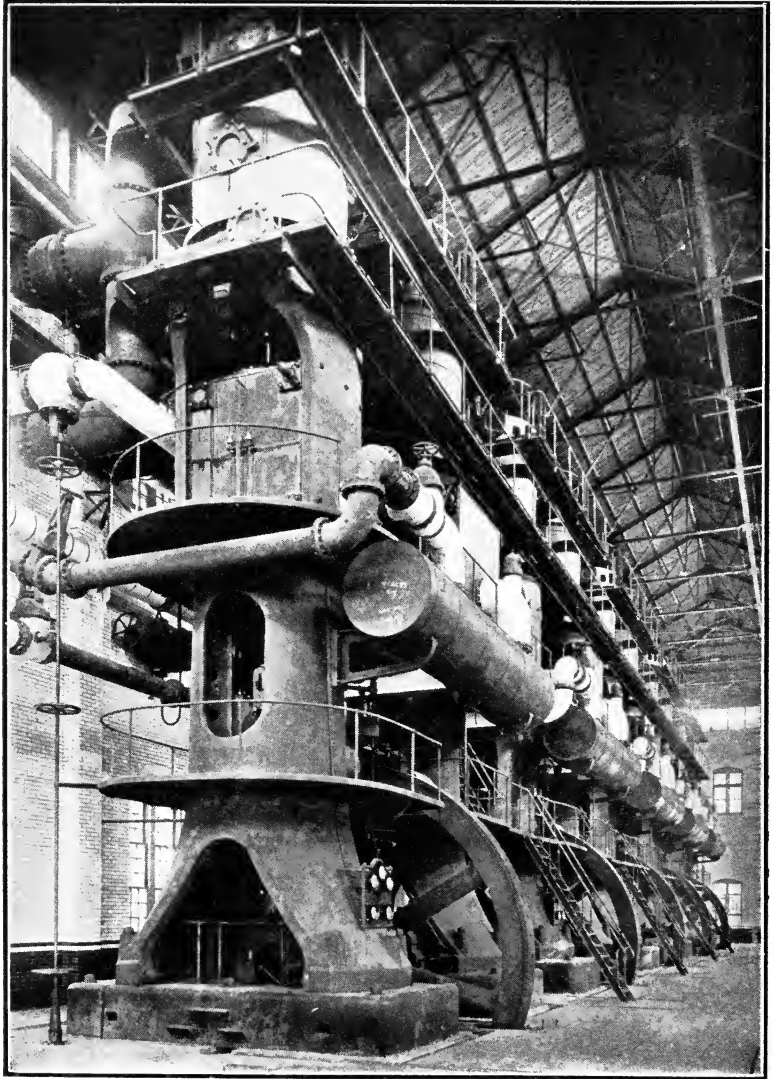

FIG. 17. — A BATTERY OF BLAST FURNACE BLOWING ENGINES.

by an excess of coke, and one of its results is the precipitation of finely divided carbon on the internal walls of the furnace. It is this thin layer of slag and carbon which is most effective in protecting the acid lining of the furnace from the corrosive action of the basic slag.

Hot Blast. — The air for smelting is driven into the furnace by immense blowing engines ranging up to 2500 H.P. each, and capable of compressing 50,000 to 65,000 cu. ft. (=4875 lb.¹) of free air per minute to a pressure of 15 to 30 lb. per sq. in., which is about what one furnace requires. It actually requires about 4 to 5 tons of air for each ton of iron produced in the furnace. After leaving the engines and before coming to the furnace, the air is heated to a temperature of 425 to 650° C. (800 to 1200° F.), by being made to pass through the hot-blast stoves.

Hot-blast Stoves. — Each furnace is connected with four stoves. These are cylindrical tanks of steel about 110 ft. high and 22 ft. in diameter, containing two fire-brick chambers. One of these chambers is open, and the other is filled with a number of small flues (see Fig. 18). Gas and air are received in the bottom of the open chamber, *B*, in which they burn and rise. They then pass downward through the several flues in the annular chamber surrounding *B*, and escape at the bottom to the chimney as waste products. In passing through the stove they give up the greater part of their heat to the brickwork. After this phase is ended, the stove is ready to heat the blast.

The blast from the blowing engine enters at the bottom of the flues, *E*, passes up through the outer chamber, and down through *B* to the furnace. In this passage it takes up the heat left in the brickwork by the burning gas and air. Sometimes there are three passes, instead of two as described. In a blast-furnace plant one stove is heating the blast while the other three are simultaneously in the preparation stage, burning gas and air. By changing once an hour a pretty regular blast-temperature is maintained. The gas used for the heating is the waste gas from the blast furnace itself, which amounts to about 90,000 cu. ft. per minute at a temperature of 235° C. (450° F.), and has a calorific power of about 85 to 95 B. T. U. per cubic foot. The latent and available heat of this gas is equivalent to approximately 50 per cent. of that of the fuel charged into

¹ At 70° F. and atmospheric pressure, each 1000 cu. ft. of air weighs 75 lb.

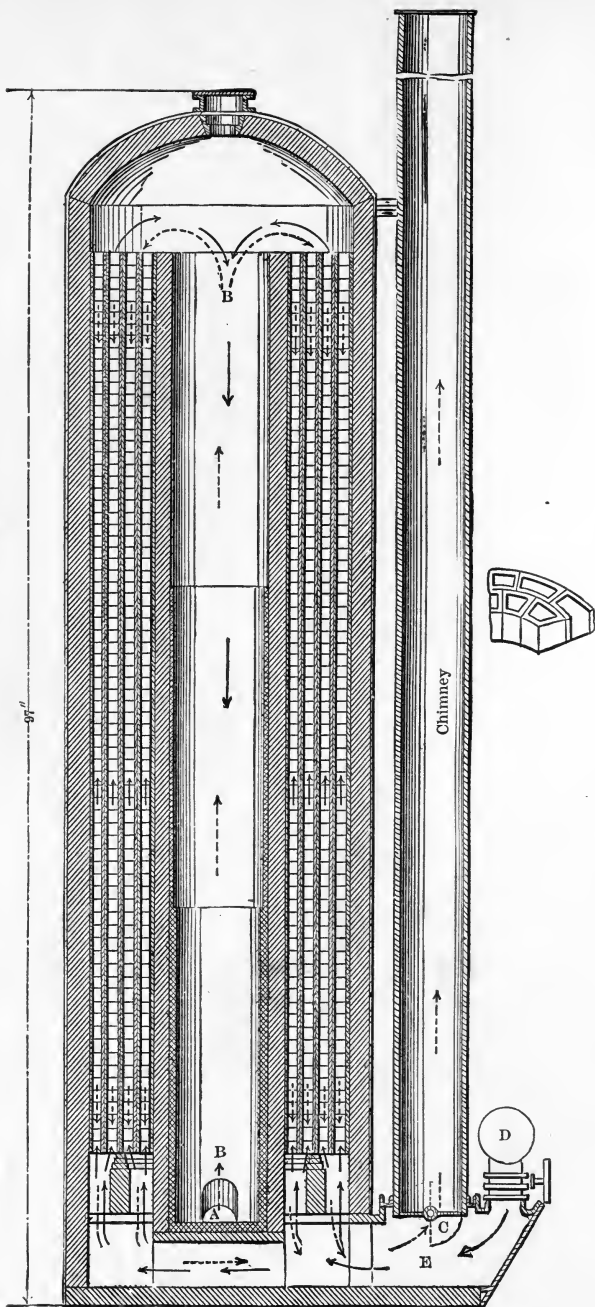

FIG. 18. — HOT-BLAST STOVE. From Howe, "Iron, Steel and other Alloys."

Solid arrows show passage of air that is heating. Broken arrows show passage of burning gas. This is but one of several types of stove.

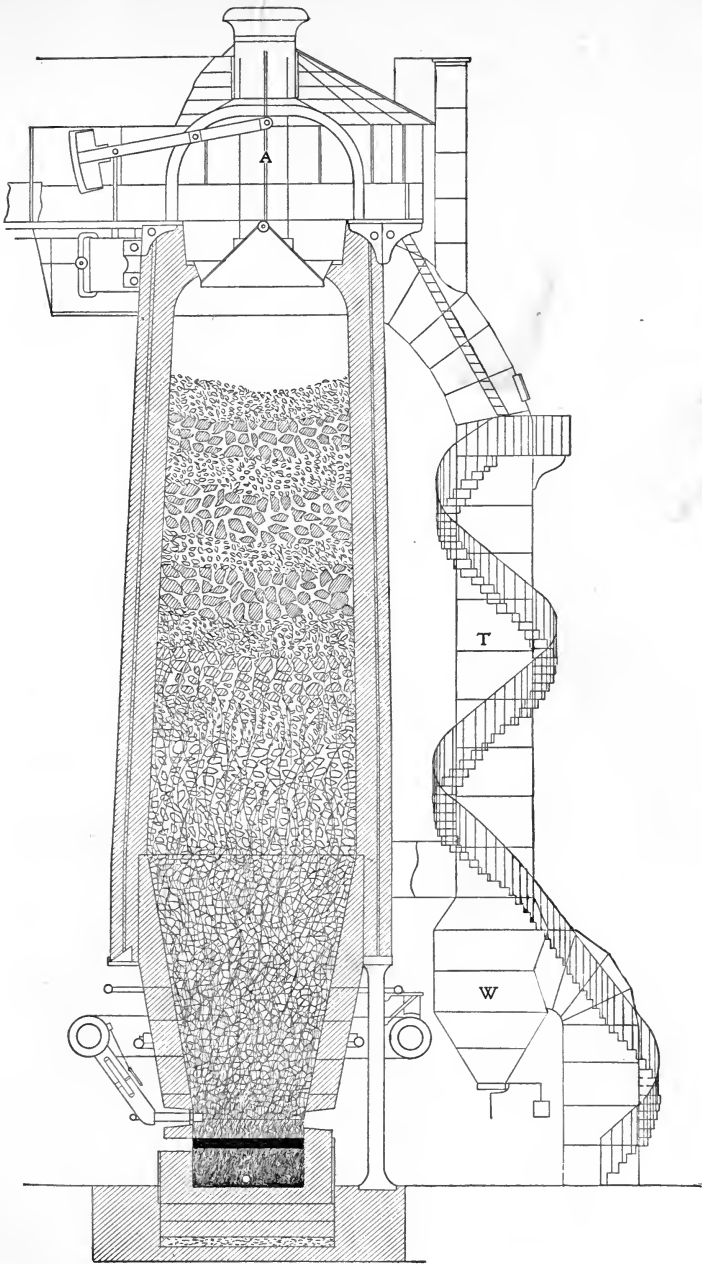

FIG. 19.

the furnace. Only about 30,000 cu. ft., or one-third of this gas, is needed for keeping the stoves hot, and the remaining two-thirds is used to produce power.

Power from Waste Gas. — The waste gas comes down the downcomer *T*, Fig. 19, settles out dirt in the dust-catcher *W*, and is then led to the stoves or power-producer. This gas varies in composition, but will average about 61 per cent. nitrogen, 10 to 17 per cent. CO_2 , and 22 to 27 per cent. CO . The latter can be burned with air to produce heat.

$\text{CO} + \text{O} - \text{CO}_2$ (generates 68,040 calories).

If burned under boilers, the available gas will generate enough power to operate the blowing engines, hoisting mechanism, and other machinery used in connection with the furnace. At several plants the gas available for power is cleaned carefully and utilized in gas engines, whereby much more power is obtained, the excess being usually converted into electricity and transmitted to more distant points.

SMELTING PRACTICE AND PRODUCTS

The furnace is filled with alternate layers of fuel, flux, and ore, down to the top of the smelting zone. The exact location of this zone will be dependent upon the volume and pressure of blast, size of furnace, character of slag made, etc., but will extend from the level of the tuyeres to a few feet above them, or about to the top of the bosh. It will require perhaps 15 hours for the material to descend from the top of the furnace to the smelting zone. During this descent, it is upheld partly by the resistance of the upward-rushing column of hot gases,¹ partly by its friction on the walls of the furnace, and partly by the loose column of coke which extends through the smelting zone and to the bottom of the furnace, and which alone resists melting in the intense heat of this zone. The blast, entering the furnace through the tuyeres, consists of 23 per cent. by weight of oxygen and 77 per cent. by weight of nitrogen, together with varying amounts of water vapor from moisture in the air (see page 38). The nitrogen is practically inert chemically and performs no function other than that of absorbing heat in the

¹ There is a great fall in the pressure of the blast between the tuyeres and the throat, which represents the work done by the air in helping to support the stock.

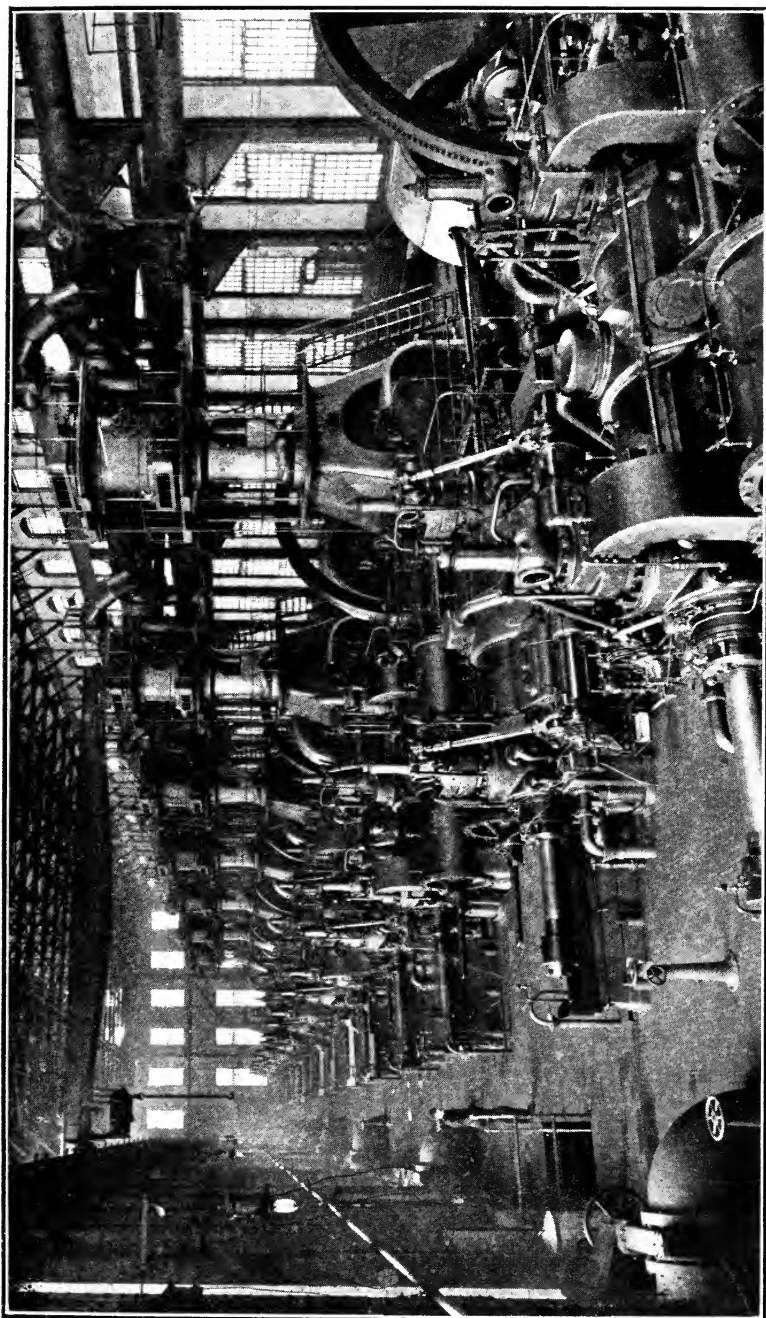
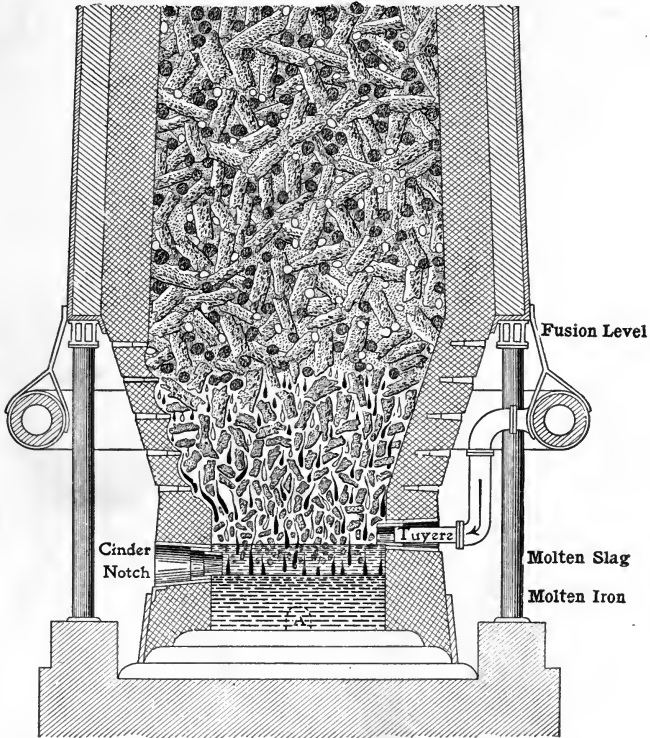

FIG. 20. — BLOWING ENGINE HOUSE OF THE LACKAWANNA STEEL COMPANY.

Engines driven by 2000 H.P. gas-engine units operated by blast-furnace gas.

smelting zone and giving it out at higher levels. The oxygen attacks all the coke in the smelting zone and as much of it below the level of the tuyeres as is not covered by accumulations of iron









- Legend: — Lumps of Coke 
- Lumps of Iron Ore 
- Lumps of Lime 
- Drops of Slag 
- Drops of Iron 
- Layer of Molten Slag 
- Layer of Molten Iron 

FIG. 21. From Howe, "Iron, Steel, and other Alloys."

and slag in the hearth, producing a large volume of carbon monoxide gas (CO) and a temperature of about 1510° C. (2750° F.).¹

¹ It is of minor importance whether the CO gas is formed directly or as a result of the two following reactions:

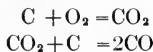

The CO and nitrogen pass up between the particles of solid material, to which they give up the greater part of their heat. The former also performs certain chemical reactions, and thus in both ways the rising column of gases prepares the charge for its final reduction in the smelting zone.

Chemical Reactions in the Upper Levels. — As soon as the iron ore enters the top of the furnace, two reactions begin to take place between it and the gases:

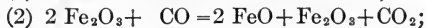
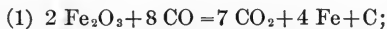

and this continues with increasing rapidity as the material becomes hotter. The carbon formed by reaction No. 1 deposits in a form similar to that of lampblack on the outside and in the interstices of the ore. This reaction, however, is opposed by two reactions with carbon dioxide gas:

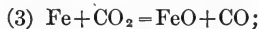

Reaction No. 3 begins at a temperature of about 300° C. (575° F.), which is met with about 3 or 4 ft. below the top level of the stock; and No. 4 begins at about 535° C. (1000° F.), or 20 ft. below the stock line. Reaction No. 4 is so rapid that the deposition of carbon ceases at a temperature of 590° C. (1100° F.). All the way down the ore is constantly losing a proportion of its oxygen to the gases. At higher temperatures than 590° C., FeO is stable, and practically all of the Fe₂O₃ (or Fe₃O₄ if magnetite is being smelted) has been reduced:

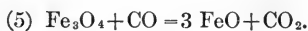

The reaction between iron oxide and solid carbon begins at 400° C. (750° F.).



At 700° C. (1300° F.) solid carbon begins to reduce even FeO:

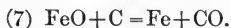

Practically all the iron is reduced to a spongy metallic form by the time the temperature of 800° C. (1475° F.) is reached. This is about 45 ft. from the stock line and less than 30 ft. above the tuyeres. At 800° C. the limestone begins to be decomposed by the heat, and only CaO comes to the smelting zone:

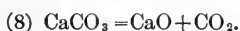

The foregoing facts are summarized in Fig. 22, which is adapted from H. H. Campbell, with certain changes.¹ It is not supposed that these figures are exactly correct for the different levels, and it is probable that they change from day to day and from furnace to furnace, but a general idea may be obtained from this sketch. It will be seen that the upper 15 or 20 ft. of the stock is a region of Fe_2O_3 and Fe_3O_4 , gradually being converted to FeO by CO gas, and forming quantities of CO_2 gas. If these reactions were the only ones, the top gases would contain no CO and would have no calorific power, but reaction No. 1 produces both metallic iron and carbon, both of which reduce CO_2 and waste much energy, as far as the blast furnace is concerned:

Reaction No. 3, $\text{Fe} + \text{CO}_2 = \text{FeO} + \text{CO}$, absorbs 2340 calories,
but wastes 68,040 calories.

Reaction No. 4, $\text{C} + \text{CO}_2 = 2 \text{CO}$, absorbs 38,880 calories.

From 20 to 35 ft. below the stock line is the region of FeO , gradually being converted to metallic iron sponge by carbon. On the lower level of this zone the limestone loses its CO_2 , which joins the other furnace gases. From 35 ft. down to the smelting zone is the region of metallic iron. This spongy iron is impregnated with deposited carbon which probably to some extent soaks into it and dissolves, in a manner like in nature but not in degree to the way ink soaks into blotting-paper. This carburization of the iron reduces its melting-point and causes it to become liquid at a higher point above the tuyeres than it otherwise would.

On reaching the smelting zone the iron melts and trickles quickly down over the column of coke, from which it completes its saturation with carbon. At a corresponding point the lime unites with the coke ash and impurities in the iron ore, forming a fusible slag which also trickles down and collects in the hearth. It is during this transit that the different impurities are reduced by the carbon, and the extent of this reduction determines the characteristics of the pig iron, for in this operation, as in all smelting, reduced elements are dissolved by the metal, while those in the oxidized form are dissolved by the slag. Only one exception occurs, namely, that iron will dissolve its own sulphide (FeS) and, to a less extent, that of manganese (MnS), but not that of other metals, as, for instance, CaS .

¹ See pp. 54 and 62 of Book No. 2, page 8.

Chemical Reactions in the Smelting Zone. — There is always a large amount of silica present in the coke ash, and some of this is reduced according to the reaction:

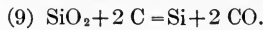

The extent of this reaction will depend on the length of time the iron takes to drop through the smelting zone, the relative intensity of the reducing influence, and the avidity with which the slag takes

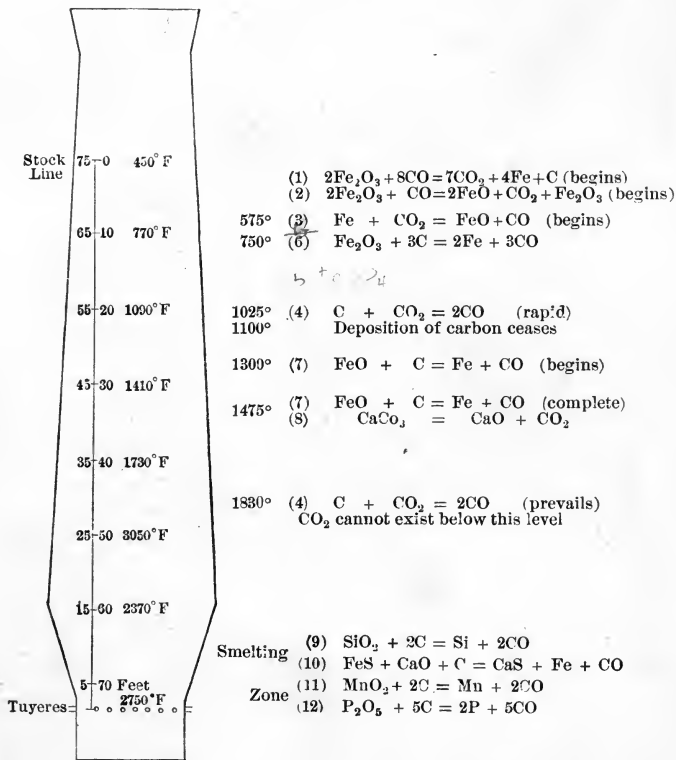
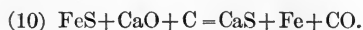

FIG. 22. — DIAGRAM SHOWING CHEMICAL ACTION IN BLAST FURNACE.

up silica. A slag with a high melting-point will trickle sluggishly through the smelting zone and cause the iron to do the same, to some extent, thus giving it more chance to take up silicon. A higher temperature in the smelting zone, which increases disproportionately the avidity of carbon for oxygen, will promote reaction No. 9. We can produce this higher temperature by supply-

ing hotter blast. A larger proportion of coke to burden¹ will further promote this reaction, because this not only increases the amount of the reducing agent, but also raises the temperature and, therefore, the chemical activity of this agent. Thus the coke has both a physical and a chemical influence in increasing the intensity of the reduction in the smelting zone. A basic slag, because of its avidity for silica, will oppose reaction No. 9; it is one of the principal means of making low-silicon pig iron. This is in spite of the fact that the basic slags are sluggish, and therefore trickle slowly through the smelting zone, thus exposing the silica longer to reducing influence, and also increasing the temperature of the materials in this zone (1) by causing them to pass through it more slowly and absorb more heat, and (2) by reducing the level of the smelting zone nearer to the tuyeres, which confines the intense temperature to the smaller area, or, in other words, diminishes the passage of heat upward.

Sulphur comes into the furnace chiefly in the coke. It is partly in the form of iron sulphide (FeS), and partly in the form of iron pyrites (FeS₂), which loses one atom of sulphur near the top of the stock and becomes FeS, which will dissolve in the iron unless converted to sulphide of calcium (CaS). This is brought about, according to the explanation of Professor Howe, by the following reaction:



CaS passes into the slag, and the odor of sulphur is very strong when the slag is running from the furnace. It is evident from reaction No. 10 that intense reduction, which increases the silicon in the iron, has the contrary effect on the sulphur, and this explains the common observation that iron high in silicon is liable to be low in sulphur. Indeed, this relation is so constant that it is almost a rule. There are two exceptions, however: (1) Increasing the proportion of coke has a doubly strong influence in putting silicon in the iron. As regards sulphur, on the other hand, it has a self-contradictory effect; by increasing the amount of sulphur in the charge it tends to increase it in the iron, which is partly or wholly counteracted by its effect in reaction No. 10. (2) A basic slag may hold silicon from the iron, and it also holds sulphur from the iron by dissolving CaS more readily. In other respects the conditions

¹The burden is the amount of material that the coke has to melt. We lighten the burden by increasing the amount of coke, and vice versa.

TABLE II.—COMPOSITION OF BLAST-FURNACE SLAGS

From H. H. Campbell. P. 50 of No. 2.

	SLAG							IRON		REMARKS	
	SiO ₂	Al ₂ O ₂	CaO	MgO	FeO	S	Total not including S	Si	S		
1	33.10	14.92	40.76	9.67	98.45	3.37	tr.	Cuban ore, Hot furnace	
2	32.27	14.57	41.02	10.30	98.16	3.18	tr.	" " " "	
3	24.26	11.53	40.25	13.28	98.32	4.81	.01	" " " "	
4	32.68	13.50	43.28	9.44	98.90	1.25	.06	" " Warm "	
5	32.28	9.38	46.95	9.52	98.13	0.70	.11	" " Cool "	
6	34.50	7.94	46.47	10.47	99.38	0.69	.05	" " " "	
7	34.98	12.05	41.33	9.62	97.98	2.60	.03	Spanish ore, Hot furnace	
8	34.70	11.44	41.27	9.96	97.37	2.32	.02	" " " "	
9	33.68	11.93	45.96	6.69	98.26	1.27	.02	" " " "	
10	29.86	12.04	45.20	11.41	98.51	1.27	.02	" " " "	
11	28.95	12.04	49.30	8.46	98.75	0.57	tr.	" " Cool "	
12	30.62	10.47	49.13	7.49	97.71	0.26	.02	" " " "	
13	32.55	11.13	47.16	6.61	97.45	0.15	.03	" " " "	
14	30.08	11.44	46.36	8.76	96.64	0.58	.03	" " " "	
15	31.46	11.50	44.85	10.41	98.22	0.20	.07	" " " "	
16	36.08	12.85	41.69	7.25	0.54	1.62	98.41	2.15	.020	Lake ore and part anthracite coal; mostly Connells-ville coke }	
17	37.19	12.65	35.47	11.32	0.90	1.70	97.53	1.92	.029		Hot furnace
18	36.86	10.74	42.46	6.62	0.63	1.54	97.31	1.50	.028		Fairly hot
19	32.06	11.97	42.46	10.25	0.63	1.76	97.37	1.59	.032		" "
20	33.57	10.65	44.11	8.55	0.81	1.74	97.69	0.94	.017		Normal
21	35.38	11.76	38.19	12.32	0.90	1.60	98.53	1.13	.040		"
22	36.35	10.21	40.10	10.95	0.99	1.28	98.60	0.66	.095		Cool
23	33.70	12.56	38.12	11.60	0.32	0.96	98.30	0.50	.101		"
24	35.11	14.21	22.48	22.38	100.12	1.37	.048		Lake ore and Con-nellsville coke }
25	35.10	14.75	27.95	22.28	100.08	1.85	.038		
26	35.84	14.34	32.71	17.46	100.35	1.60	.034	Av. of 7 wks	
Averages for hot furnaces:											
	33.21	13.67	40.68	11.08	98.64	3.79	tr.	Cuban ore.	
	34.84	11.75	41.30	9.79	97.68	2.46	.025	Spanish ore.	
	31.77	11.98	45.58	9.05	98.38	1.27	.020	" "	
	35.55	12.05	40.52	8.86	0.68	1.66	97.66	1.79	.027	Lake ore.	
Averages for moderate or cool furnace:											
	33.15	10.27	45.57	9.81	98.80	0.88	.07	Cuban ore.	
	30.73	11.32	47.36	8.35	97.75	0.35	.03	Spanish ore.	
	34.75	11.30	40.12	10.86	1.26	1.40	98.29	0.81	.063	Lake ore.	
	35.35	14.43	29.69	20.71	100.18	1.61	.040	" "	

which make for high silicon make also for low sulphur. Particularly is this true of a high temperature in the smelting zone, and the term 'hot iron' has come to be synonymous in the minds of blast-furnace foremen with iron high in silicon and low in sulphur.

Manganese is reduced by the following reaction:

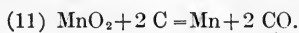

The amount of manganese in the iron is dependent, to a certain extent, upon the character of the ores charged, but it may be controlled somewhat by the character of slag made, because an acid slag will carry a large amount of manganese away in the form of silicate of manganese (MnSiO_3).

With a certain unimportant qualification, the amount of phosphorus in the iron is controlled by the character of the ores charged, and districts or countries having high-phosphorus ores must make high-phosphorus irons. This is not an insuperable objection, because the presence of phosphorus, even up to 1.5 per cent., is desired in certain irons for foundry use, and the basic processes for making steel can remove this element.

The chemical influence of the blast furnace is a strongly reducing one, and this is produced in order, first, to reduce the iron from the ore; second, to get rid of the sulphur, and third, to saturate the iron with carbon. Many attempts have been made to provide a process wherein the reducing influence was not so strong, and thus to produce a purer material than pig iron, because it is the intensity of the reduction which vitiates the iron with carbon and silicon. The great weakness of all such processes, however, is that they do not get rid of the sulphur, which is the most objectionable impurity that iron is liable to contain and which is not satisfactorily removed by any process after once it makes its way into the iron. Finally, to saturate the iron with carbon renders the blast-furnace operation very much cheaper, because pure iron melts at a temperature much higher than can readily be obtained in the furnace, and melted iron is handled much more cheaply than it could be if allowed to solidify. Even the presence of silicon is an advantage, as we shall see in Chapter XII.

Drying the Blast. — The water vapor blown into the furnace (derived from the moisture of the air) is equivalent to from $\frac{1}{3}$ to 2 gal. of water per 10,000 cu. ft. of blast, or $1\frac{1}{3}$ to 8 gal. per minute, depending on the humidity of the atmosphere. Though this steam is as hot as the blast, it materially cools the smelting zone of the furnace by dissociating there:

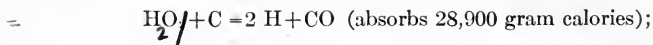

or 1 lb. of steam absorbs 7,110,000 calories. The hydrogen and oxygen reunite in a cooler part of the furnace and return the same amount of heat, but this does not compensate for that taken away from the smelting zone, where it is most needed. For this reason a few American plants, and at least one in England, have adopted James Gayley's expedient of drying the air by refrigeration before it is drawn into the blowing engine. This results in greater regularity of furnace working and valuable saving in fuel. In fact, so great is the economy shown in this respect that there was a tendency at first to receive the results with skepticism. J. E. Johnson, Jr., has explained this saving, however, in a very ingenious and skillful manner, by showing that every blast furnace has a certain 'critical temperature,' below which it will not perform any smelting, and that the theoretical temperature of combustion of the smelting zone is only a little above this 'critical temperature.' To increase this small interval between the two, therefore, greatly increases the 'available heat,' though the change in nominal temperature be small.¹

Slag Disposal. — On account of its lower specific gravity, the slag floats on top of the bath of iron in the hearth and accumulates, frequently until it reaches the bottom level of the tuyeres. Four or five times every six hours the plug in the cinder-notch is pierced with a steel rod and the cinder above this level allowed to run out. It flows down an inclined iron runner for a distance of 15 to 30 ft. and pours into an iron ladle on a standard-gage railroad track, whence it is drawn away by a locomotive and poured out on the slag dump. Slag varies in composition according to the will of the blast-furnace manager, and some typical analyses are given in Table II. Slags high in lime are sometimes treated with additional lime to make a good grade of Portland cement, known as 'Puzzolini.' The amount of cinder made will depend on the amount of silica, alumina, etc., in the ore, the amount of coke ash, and the amount of flux, which will also depend on the desired slag analysis. Under favorable circumstances, the slag may weigh slightly less than half the iron; under other conditions it may weigh nearly twice the iron.

¹ If further explanation of this argument is needed, it may be found in the following simile: Water boils at 212° F. If the temperature of a boiler is 262°, there is a certain pressure of steam; if we increase the temperature only 50°, we greatly increase the pressure; yet 50° appears small in comparison to 262°.

Weight of Slag. — The amount of slag may be calculated from the amount of lime (CaO) in the furnace, which may be calculated from the percentage of lime in the limestone and other materials charged into the furnace. Since all the lime charged goes into the slag, the amount of the latter will be equal to the weight of lime divided by the percentage of the lime in the slag. Thus, if we use per ton of iron 1300 lb. of limestone, containing 50 per cent. of lime, there will be 650 lb. of lime charged for every ton of iron made. If the slag made contains 40 per cent. lime, then the weight of slag will be $\frac{650}{.40} = 1625$ lb. per ton of iron made.

Iron Disposal. — Immediately after the last 'flushing,' i.e., removal of cinder, the tap hole or iron notch is opened by several men drilling a hole in it with a heavy, pointed steel bar. Out of



FIG. 23.

this notch flows 100 to 150 tons of liquid pig iron, with which is carried along 30 tons or so of slag. The 'skimmer' is situated about a dozen feet from the front of the furnace. It is an iron plate extending down almost to the bottom of the runner. The slag is deflected by this plate into a runner of its own, which leads it off to a slag ladle such as described before. The heavier pig iron flows under the skimmer and is distributed to six or seven brick-lined ladles on a standard-gage railroad track. It is then drawn

away to the steel works, or, if not wanted there, is poured into iron molds at the pig-casting machine.

Mechanical Pig-Molding Machine. — There are several types of molding machine, but a common form is illustrated in Figs. 24-5, and consists of a long continuous series of hollow metallic molds car-



FIG. 24. — UEHLING PIG-CASTING MACHINE.

ried on an endless chain. *D* is the pig-iron ladle pouring metal into the spout, from whence it overflows into the molds as they travel slowly past. The pig iron chills quickly against the metallic molds, and by the time it reaches the other end of the machine, it consists of a solid pig of iron which drops into the waiting railroad

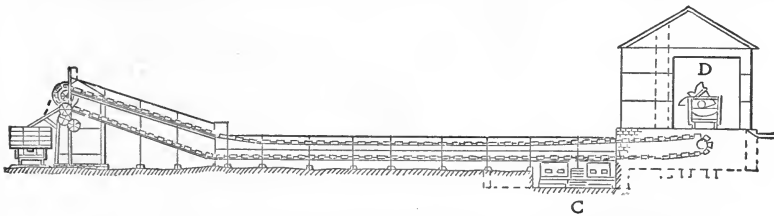

FIG. 25. — HEYL AND PATTERSON PIG-CASTING MACHINE.

car as the chain passes over the sheave. The pig iron is now in a form convenient for transportation or for storing until needed. The molds travel back toward the spout, underneath the machine and hollow side down. At the point *C* they are sprayed with whitewash, the water of which is quickly dried off by the heat of the mold, leaving a coating of lime inside to which the melted iron will

not stick. This mechanical casting is a great improvement over the former method of cooling iron in front of the blast furnace, because of the severity of the work which the former method involved and which, in hot weather, was well-nigh intolerable to human beings. It also gives pigs which are cleaner, i.e., freer from adhering sand. This silicious sand is objectionable, especially in the basic open-hearth furnace.

Sand-Casting. — This method is still used at some furnaces, because of the capital needed to install machines and their high cost for repairs. Moreover, foundrymen often prefer the sand-cast

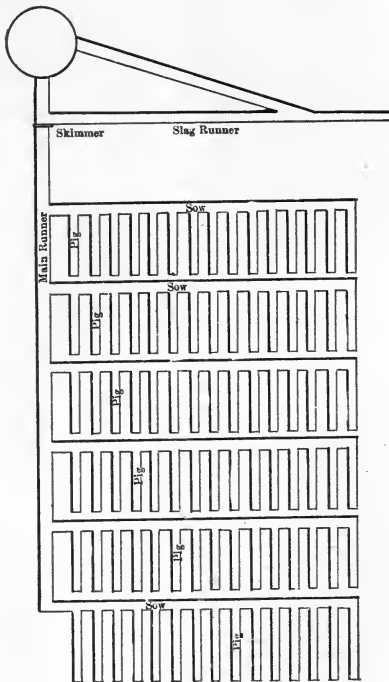

FIG. 26. — SAND-CASTING BED.

pig because they are able to tell by the appearance of its fracture what grade of castings it will make, which they cannot well do with iron cast in metal molds (see pages 336, 337). In the sand method, the cast house extends in front of the furnace and its floor is composed of silica sand, in which the molds or impressions to receive the liquid iron are made. The main runner extends from the taphole down the middle of the floor, and the space on either side of it is used alternately for alternate castings. The plan of the arrangement is shown in Fig. 26.

After cooling the iron, the pigs are broken away from the sows, which are also broken into pieces with a sledge, and then all is carried over and

thrown into a railroad car. In making 'basic iron,' — i.e., iron for the basic open-hearth steel process, — the molds for the sows and pigs are permanently made of metal, so that the iron will not carry acid sand into the basic hearth.

Irregularities in Blast-Furnace Working. — Although the management and control of the operation is in general as I have de-

scribed it, the blast furnace is by no means a perfect machine, and great difficulties arise in the working of the furnace and in maintaining a uniform grade of product. The chief of these difficulties

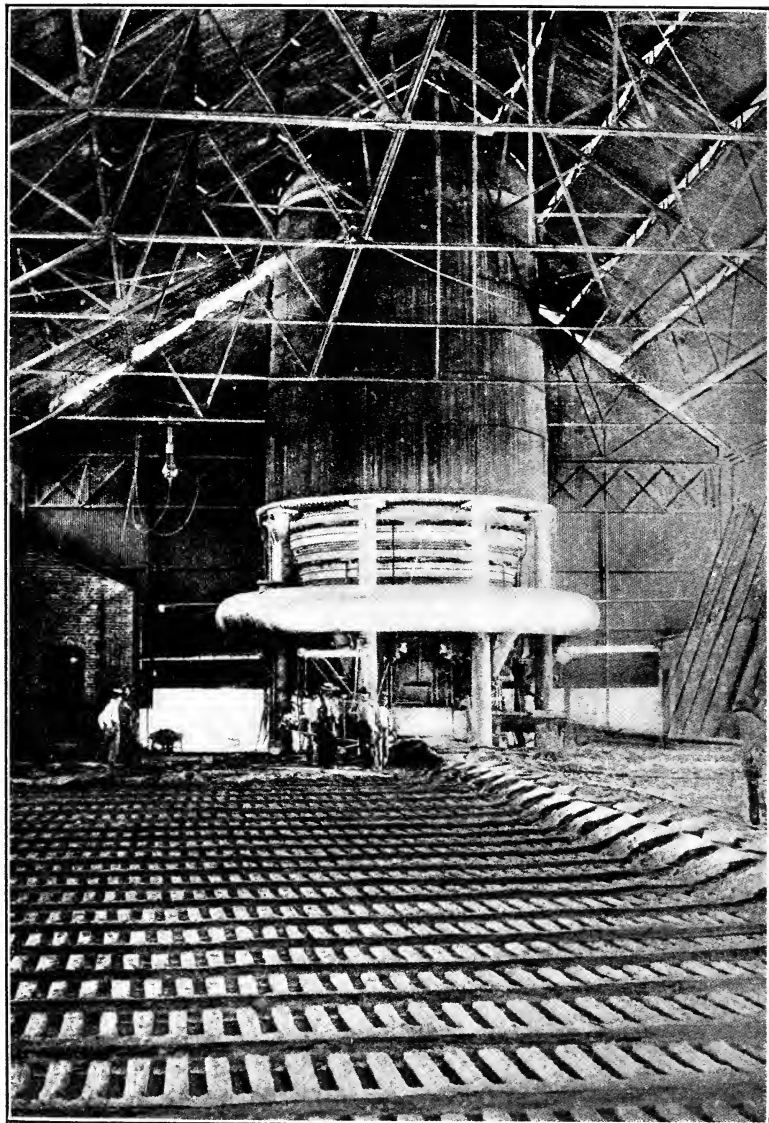

FIG. 27. — PIG BEDS.

result from localized chilling of the semi-molten charge. This is most liable to happen in the upper part of the smelting zone, where a little lump of pasty material may attach itself to the walls of the furnace. This has the effect of hindering the descent of that part of the charge above it and of deflecting the hot gases to other parts of the furnace. The result of the first action is to disarrange the order and evenness with which originally horizontal rings of stock come down into the hearth. The obstruction is also liable to receive chilled materials from above and to build itself out toward the center. When the furnace is working badly, these scaffolds may occur at two or more places at the same time and cantilever out toward the middle. This will cause a 'hanging' of the charge, and may become so bad as to cause a complete arch over the smelting zone, through which it is impossible to drive the blast. Sometimes the scaffold may be broken down by suddenly cutting off the blast pressure and allowing the full weight of material in the furnace to come upon the obstruction; but sometimes it is necessary to cut a hole in the wall of the furnace and melt it out with a blow-pipe burning oil or gas, or with some other form of heat.

The 'scaffolding' of a furnace and hanging of the charge is more liable to happen when large percentages of the earthy Mesabi ores are used, and in this type of practice localized hanging and slips are not infrequent. When the slip is extensive in character and a large amount of material is suddenly precipitated into the hearth, the upward rush of gases resembles an explosion inside the furnace and may do damage to the charging apparatus and throw a part of the stock out of the top of the furnace. Some furnaces are provided with explosion doors, which fly open under pressure and relieve the strain; while the practice in other instances is to fasten everything down as tight as possible and prevent the rapid escape of the gases.

There is also a large amount of hanging due to the action of the blast in tending to drive the stock before it up into the stack of the furnace and thus compress it. This action is more liable to take place with fine ores

Cooling of the charge, also, results in some cases in the freezing of material over the mouths of the tuyeres. The solid layer may sometimes be broken away with a bar, and the blow thus allowed to continue until more heat can be brought down into the hearth. Sometimes it is necessary to melt out the frozen material with a

blow-pipe, and in extreme cases it may even be necessary to break through it with explosives.

Another difficulty sometimes met with is the freezing up of the metal in the lower part of the hearth, so that it is impossible to open the tap-hole. Then a new tap-hole must be made by boring through the front of the furnace at a higher level, from which the iron is drained, and then the heat gradually worked down until the whole hearth is melted out and normal conditions reestablished. The bad work of a furnace is often cumulative in its effects, because irregularities in the smelting zone have an effect upon the top gases, which, in turn, derange the work of the stoves and hence impair the hot blast.

These irregularities in the smelting have a disturbing effect upon the character of the iron made, and the changes sometimes come suddenly and without warning. For instance, a sudden precipitation of cold material into the hearth will chill the smelting zone and cause the silicon in the iron to be low and the sulphur high. The same effect will be produced by the leakage of several gallons of water into the hearth through the burning out of a tuyere or the cooling-ring of one of the tuyeres.¹

Dimensions of Blast Furnace. — The size of a modern blast furnace is limited by the conditions of its work: the hearth may not be much more than 15 ft. in diameter, else the blast from the tuyeres will not be distributed evenly to the center; the batter of the bosh walls cannot be much more nor less than a certain amount, because they must give support to the charge above them, and yet allow the solid coke to slip down; the height of bosh is limited, because its top must be practically the same as the top of the smelting zone, — that is, no solid material except coke should descend into the bosh. These conditions therefore limit the diameter of the top of the bosh to not much more than 22 ft. From the bosh the stack walls must decrease in diameter upward in order that the descending charge, which swells in the reactions that take place from the throat downward, shall not become wedged in the stack;

¹ In my early days at the blast furnace I was once informed by the assistant manager that, on one occasion, he tapped several tons of water from the tap-hole with the iron. Whether he was himself deceived or whether he was merely trying to test me, I have never been able to decide; but the fact is worthy of mention in an elementary treatise to illustrate the character of the tales to which even the educated men around a plant will treat a novice.

as the throat must have a sufficiently large diameter to properly charge the materials, this limits the height of the stack. Modern furnaces are therefore usually built about 90 ft. in height, and the exceeding of that limit has resulted in some cases in a decrease, rather than an increase of fuel economy.

CALCULATING A BLAST-FURNACE CHARGE

This subject is of prime importance to young metallurgists, because the ability to calculate a charge is sometimes a cause of advancement, and the knowledge of the way to do so is not always obtainable from one's superior.

Assumptions. — Let us assume that we desire to produce a slag containing 55 per cent. lime, 15 per cent. alumina, and 30 per cent. silica, these proportions being determined by the experience of the manager, and that the materials from which the charge is to be made analyze according to Table III. Assume furthermore that the coke ash is equal to 10 per cent. of the coke, and that the iron we are going to make will contain about 1 per cent. silicon.

TABLE III

MATERIAL	Per cent. CaO	Per cent. MgO	Per cent. Al ₂ O ₃	Per cent. SiO ₂	Per cent. Fe ₂ O ₃	Per cent. Fe
Ore A.....	5	3	2	11	60
Ore B.....	2	12	16	50
Coke ash.....	20	18	50	10
Limestone.....	46	3	2	4	2

Silicon in the Iron. — This last assumption necessitates our allowing a corresponding amount of silica, because the silica reduced and absorbed by the iron will not be available for slag-making purposes. One per cent. of silicon is roughly equal to 2 per cent. of silica; we may therefore make the requisite allowance by subtracting from the silica in each material an amount equivalent to 2 per cent. of its iron content. Thus we begin to make up Table IV.

Magnesia. — In considering slags, magnesia is classified under the head of lime. We cannot do this, however, by a simple addition of the figures of the percentages, because 1 per cent. of mag-

nesia will do the chemical work of 1.4 per cent. of lime, on account of the difference in molecular weight ($\text{CaO} = 56$; $\text{MgO} = 40$). Thus:

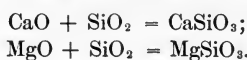

We thus multiply each percentage of magnesia by 1.4 and add the product thus obtained to the percentage of lime in each material, thus obtaining column 2 in Table IV.

TABLE IV

MATERIAL	Per cent. CaO	Per cent. Al_2O_3	Per cent. SiO_2
Ore A.....	9	2	10
Ore B.....	2	12	15
Coke ash.....	20	18	50
Limestone.....	50	2	4

Self fluxing of Materials. — It is evident that in so far as each of the materials in Table IV contains all the components of the slag, they will partially flux themselves. For example, the 2 per cent. of alumina in ore A will theoretically combine with 4 per cent. of the silica ($2 \text{ per cent.} \times \frac{3}{1} = 4 \text{ per cent.}$) and 7 per cent. of the lime ($2 \text{ per cent.} \times \frac{5}{5} = 7.3 \text{ per cent.}$) to make a slag of the desired proportions, leaving unfluxed percentages as per the first line of Table V. In the same manner we may use up all of the lime in ore B by uniting it with weights of alumina and silica in proportion to the percentages of these components in the slag. Similar simplifications in the analyses of coke ash and limestone may then be calculated, and Table V will be completed.

TABLE V

MATERIAL	Per cent. CaO	Per cent. Al_2O_3	Per cent. SiO_2
Ore A.....	2	6
Ore B.....	11.5	14
Coke ash.....	13.0	39
Limestone.....	43

Weight of Charge. — Let us assume that we are going to make one ton of pig iron for every ton of coke used in the charge, and that the coke will be put in in charges weighing 11,000 lb. each. This weight includes about 10 per cent. of moisture, dust, etc., so

we calculate with it as if it weighed only 10,000 lb. Now let us determine how much ore will be put in each charge: The ores average 55 per cent. of iron; therefore, $\frac{10000 \text{ lb.}}{55 \text{ per cent.}} = 18,000 \text{ lb.}$, the amount of ore that must be in each charge, according to the assumption of this paragraph.

Adjusting the Alumina and Silica. — Next adjust the different materials so that the weight of alumina shall be $\frac{1}{3}\frac{5}{6}$ of the weight of silica. In the first rough approximation of this we may neglect the coke ash, because the weight of this ash is so small in relation to the other materials. Therefore only the two ores need be apportioned, and we quickly find by trying a few mixtures at random that 60 per cent. of ore A mixed with 40 per cent. of ore B will give the desired relation:¹ 60 per cent. \times 6 + 40 per cent. \times 14 = 920 parts of silica; 60 per cent. \times 0 + 40 per cent. \times 11.5 = 460 parts alumina; $\frac{920}{460} = \frac{2}{1}\frac{5}{6}$. Now draw Table VI, and enter 10,800 lb. of ore A (= 60 per cent. of 18,000), 7200 lb. of ore B, 1000 lb. of coke ash (= 10 per cent. of 10,000), and the percentages from Table V. All the weights in this table may then be filled in except those of the limestone and total CaO.

To obtain the total number of pounds of lime:

$$\text{Al}_2\text{O}_3: 958 \times \frac{4}{3}\frac{5}{6} = 3513 \text{ lb.}$$

$$\text{SiO}_2: 2046 \times \frac{5}{3}\frac{5}{6} = 3751 \text{ lb.}$$

Average of 3515 and 3751 is 3632.

TABLE VI

MATERIAL		CaO		Al ₂ O ₃		SiO ₂	
		Per Cent.	Lb.	Per Cent.	Lb.	Per cent.	Lb.
Ore A	10,800	2	216	6	648
Ore B	7,200	11.5	828	14	1008
Coke ash	1,000	13.0	130	39	390
Limestone	7,940	43	3416
Total lb			A 3632	958	2046

¹ Try first 50 per cent. of each, and we see that there is too much alumina; therefore try less than 50 per cent. of the ore having the most alumina, and correspondingly more of the other, and we have it.

Adjusting for Lime. — It is now only necessary to determine the amount of total lime that shall bear the correct relation to the alumina and silica calculated. This we do by means of the method shown in the figures above Table VI. We enter this in the square 'A' of Table VI. The figures at the square 'B' are then obtained ($3632 - 216 = 3416$), and thence the weight of limestone to be used — ($3416 \div 43$ per cent. = 7940).

Checking the Calculations. — We now check up all the calculations by making up Table VII, in which we go back to the original percentages found by chemical analysis and given in Table III. In making up this final table, however, we use our experience in making slag calculations and estimate slight changes: For example, Table VI shows us that the alumina comes a little low in relation to silica; therefore we increase ore B, say, by 400 lb. and decrease ore A correspondingly. But ore A is high in lime; therefore we use a little more limestone to offset this reduction.

TABLE VII

MATERIAL		CaO + MgO		Al ₂ O ₃		SiO ₂		Fe	
		Per cent.	Lb.	Per cent.	Lb.	Per cent.	Lb.	Per cent.	Lb.
Ore A	10400	9	936	2	208	11	1144	60	6240
Ore B	7600	2	152	12	912	16	1216	50	3800
Coke ash	1000	20	200	18	180	50	500	10	100
Limestone	8200	50	4100	2	164	4	328	2	164
Total weights.....	5388	1464	3188.....	10,304	
		=54.8 per cent.		=14.9 per cent.		-206(=2% × 10,304)		2982 =30.3 per cent.	

These figures are much closer to those desired than the limit of accuracy in furnace operation. The chief difference is that we are making a little more iron with 10,000 lb. of coke than we intended. If any change seems necessary it is then well to reduce the weight of ore A to 10,000, leaving everything else the same. This will lighten the burden and bring the calculated lime, alumina and silica even closer to the desired figures.

Phosphorus and Manganese. — No account of the phosphorus has been taken in the calculation above. This is necessary some-

times. For example, if ore A happened to be very high in phosphorus we could not use so large a proportion of it. It would then be necessary either to secure another ore low in both phosphorus and alumina, or else to make a slag with less alumina. The same line of reasoning applies to manganese.

III

THE PURIFICATION OF PIG IRON

THE large amount of carbon in pig iron makes it both weak and brittle, so that it is unfit for most engineering purposes. It is used for castings that are to be subjected only to compression, or transverse or very slight tensile strains, as, for example, supporting columns, engine bed-plates, railroad car wheels, water mains, etc., but the relatively increasing amount of steel used shows the preference of engineers for the stronger and more ductile material. To-day three-fourths of the pig iron made in the United States is subsequently purified by either the Bessemer, open-hearth, or puddling process. Each of these will reduce the carbon to any desired point, while the silicon and manganese are eliminated as a necessary accompaniment of the reactions, — indeed, we might almost say as a condition precedent to carbon reduction. Phosphorus and sulphur are reduced by the puddling process, and by a special form of open-hearth process known as ‘the basic open-hearth process.’¹ The complete scheme of American iron and steel manufacture is given in Fig. 29.

Explanation of Fig. 29. — Practically all the iron ore mined is smelted in about 325 blast furnaces, producing annually 25,000,000 tons of pig iron. About 3 per cent.² of this pig iron is remelted and made into malleable cast iron; 20 per cent. is remelted and cast as gray cast iron; 52 per cent. is purified in 62 Bessemer converters to Bessemer steel; 20 per cent. is purified in 465 basic open-hearth furnaces; 2 per cent. is purified in 195 acid open-hearth furnaces, while the remaining 3 per cent. is purified in 3000 puddling furnaces to make wrought iron. The wrought iron may be used as such for pipe, blacksmith work, small structural shapes, etc., and

¹ The basic Bessemer process is not in operation in America.

² The numbers and percentages given in this figure will change slightly from time to time, but this will convey to a beginner an idea of the relative amounts of the different products made.

95 per cent. of it is so used; the other 5 per cent. is remelted in crucibles to make crucible steel. To sum up, about 23 per cent. of the pig iron made is used without purification,¹ and 77 per cent. is purified and converted into another form. In all cases of purification the impurities are removed by oxidizing them, and we must

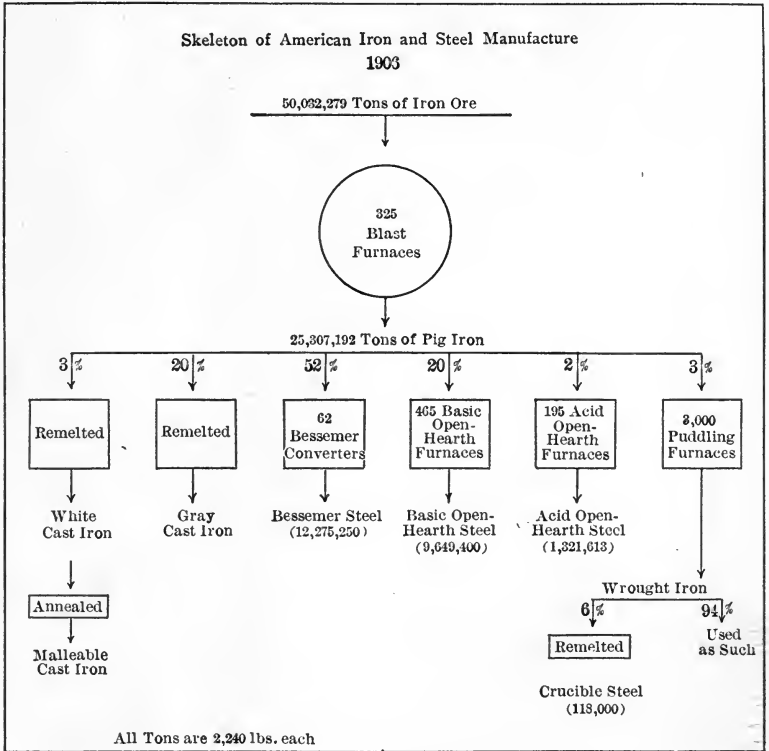

FIG. 29.

again emphasize the rule that unoxidized elements dissolve in the metal, while those in the oxidized condition pass into the slag, or, if there is no slag, form a slag for and of themselves. In considering the Bessemer, open-hearth, and puddling processes then, we have to do with oxidizing conditions, whereas the opposite was the

¹ It is true that the annealing process for malleable cast iron purifies the outer layers of the castings from carbon, and, if the castings are very thin, this purification may extend to the center; but this is not primarily a purification process and will be treated at length in another section.

case in the blast furnace. The oxidation is effected by means of the oxygen of the air or that of iron ore, Fe_2O_3 , or its equivalent, or of both air and oxide of iron.

There is not an exact relation between the amounts of pig iron used for the different purposes and the amounts of the resulting materials. In 1906 the following production was made:

PRODUCTION FOR 1906

	Cast Iron Used	Made
Malleable cast iron.....	600,000* tons	750,000* tons
Gray cast iron.....	5,100,000 "	6,000,000 "
Bessemer steel.....	13,150,000 "	12,275,250 "
Basic open-hearth steel.....	5,150,000 "	9,649,400 "
Acid open-hearth steel.....	500,000 "	1,321,613 "
Wrought iron.....	800,000 "	2,000,000* "
Crucible steel.....	118,000 "

* Estimated.

The reason for the discrepancy is found in the scrap iron or steel mixed with the pig iron in the manufacture of gray-iron castings and open-hearth steel. Perhaps an average of 25 per cent. of old scrap will be mixed with 75 per cent. of new pig iron for making iron castings, and 50 per cent. or so of steel scrap will be mixed with 50 per cent. or so of pig iron in the open-hearth process, while wrought iron is often made by the piling and rerolling of old wrought-iron scrap.

Bessemer Process. — In the Bessemer process, perhaps 10 tons of melted pig iron is poured into a hollow pear-shaped converter lined with silicious material. Through the molten material is then forced 25,000 cu. ft. of cold air per minute. In about four minutes the silicon and manganese are all oxidized by the oxygen of the air and have formed a slag. The carbon then begins to oxidize to carbon monoxide, CO , and this boils up through the metal and pours out of the mouth of the vessel in a long brilliant flame. After another six minutes the flame shortens or 'drops'; the operator knows that the carbon has been eliminated to the lowest practicable limit (say 0.04 per cent.) and the operation is stopped. So great has been the heat evolved by the oxidation of the impurities that the temperature is now higher than it was at the start, and we have a white-hot liquid mass of relatively pure metal. To this is added a carefully calculated amount of carbon to

produce the desired degree of strength or hardness, or both; also about 1.5 per cent. of manganese and 0.2 per cent. of silicon.¹ The manganese is added to remove from the bath the oxygen with which it has become charged during the operation and which would render the steel unfit for use. The silicon is added to get rid of the

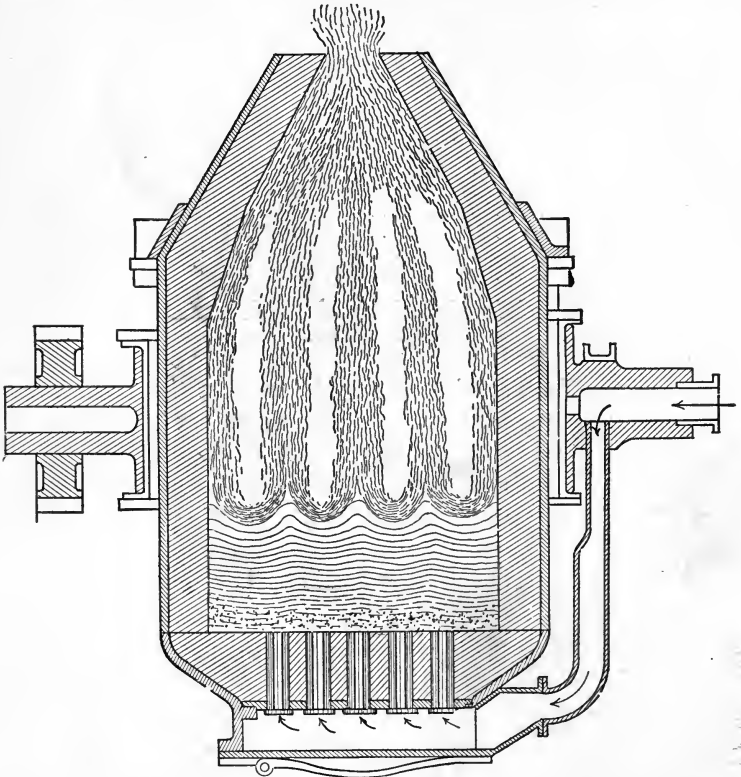

FIG. 30. — SECTION THROUGH BESSEMER CONVERTER WHILE BLOWING.

gases which are contained in the bath. After adding these materials, or 'recarburizing,' as it is called, the metal is poured into ingots, which are allowed to solidify and then rolled, while hot, into the desired size and form. The characteristics of the Bessemer process are: (a) Great rapidity of purification (say ten minutes per 'heat'); (b) no extraneous fuel is used; and (c) the metal is not melted in the furnace where the purification takes place.

¹ In the case of making rail steel.

Acid Open-hearth Process. — The acid open-hearth furnace is heated by burning within it gas and air, each of which has been highly preheated before it enters the combustion chamber. A section of the furnace is shown in Fig. 32. The metal lies in a shallow pool on the long hearth, composed of silicious material, and is heated by radiation from the intense flame produced as described. The impurities are oxidized by an excess of oxygen in the furnace gases over that necessary to burn the gas. This action is so slow, however, that the 3 to 4 per cent. of carbon in the pig

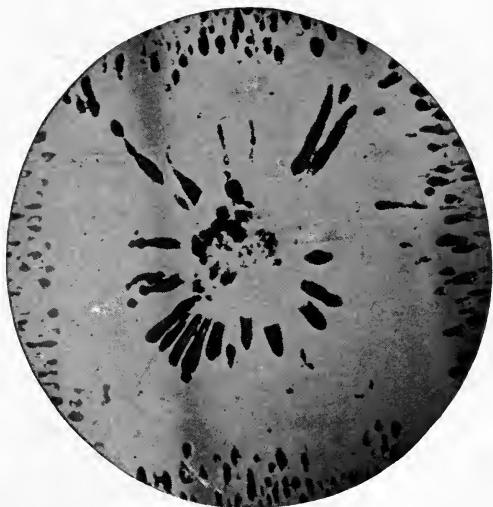

FIG. 31. — BLOWHOLES OR GAS-BUBBLES IN STEEL.

iron takes a long time for combustion. The operation is therefore hastened in two ways: (a) iron ore is added to the bath to produce the reaction



and (b) the carbon is diluted by adding varying amounts of cold steel scrap. The steel scrap is added to the furnace charge at the beginning of the process, and it takes about 6 to 10 hours to purify a charge, after which we recarburize and cast the metal into ingots. The characteristics of the open-hearth process are: (a) A long time occupied in purification; (b) large charges are treated in the furnace (the modern practice is usually 30 to 70 tons to a furnace); (c) at least a part of the charge is melted in the

purification furnace; and (d) the furnace is heated with preheated gas and air.

Basic Open-Hearth Process. — The basic open-hearth operation is similar to the acid open-hearth process, with the difference

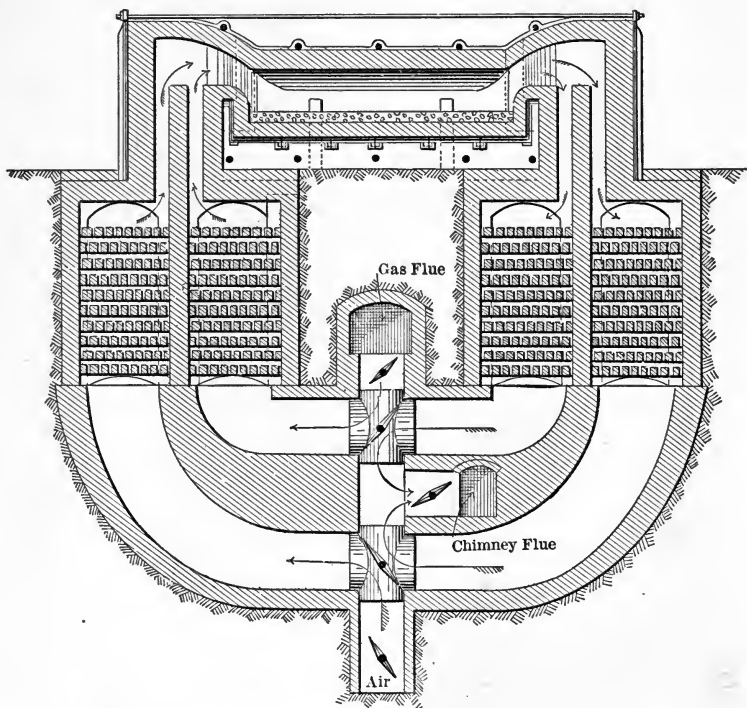

FIG. 32. — DIAGRAM OF REGENERATIVE OPEN-HEARTH FURNACE.

The four chambers below this furnace are filled with checkerwork of brick with horizontal and vertical channels through which the gas and air may pass. The gas enters the furnace through the inner regenerative chamber on one side and the air enters through the corresponding outer one. They meet and unite, passing through the furnace and thence dividing into proportional parts and passing to the chimney through the two regenerative chambers at the opposite end. In this way the brickwork in the chambers is heated up by the waste heat of the furnace. The current of gas, air, and products of combustion is changed every twenty minutes whereby all four regenerators are always kept hot. The gas and air enter in a highly preheated condition and thus give a greater temperature of combustion, while the products of combustion go out to the chimney at a relatively low heat and thus fuel economy is promoted.

that we add to the bath a sufficient amount of lime to form a very basic slag. This slag will dissolve all the phosphorus that is oxidized, which an acid slag will not do. We can oxidize the phos-

phorus in any of these processes, but in the acid Bessemer and the acid open-hearth furnaces the highly silicious slag rejects the phosphorus, and it is immediately deoxidized again and returns to the iron. The characteristics of the basic open-hearth process are the same as those of the acid open-hearth, with the addition of: (e) Lime is added to produce a basic slag; (f) the hearth is lined with basic, instead of silicious, material in order that it may not be eaten away by this slag; and (g) impure iron and scrap may be used, because phosphorus and, to a limited extent, sulphur can be removed in the operation.

Puddling Process. — Almost all the wrought iron to-day is made by the puddling process, invented by Henry Cort about 1780, with certain valuable improvements made by Joseph Hall fifty years later. In this process the pig iron is melted on the hearth of a reverberatory furnace lined with oxide of iron. During

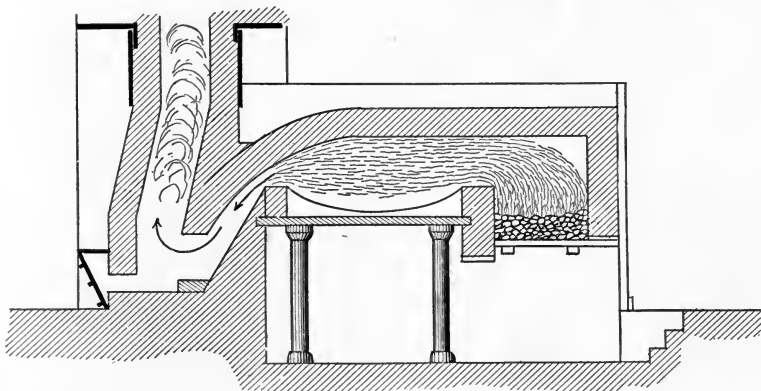

FIG. 33. — PUDDLING FURNACE.

the melting there is an elimination of silicon and manganese and the formation of a slag which automatically adjusts itself to a very high content of iron oxide by dissolving it from the lining. After melting, the heat is reduced and a reaction set up between the iron oxide of the slag and the silicon, manganese, carbon, phosphorus and sulphur of the bath, whereby the impurities are oxidized and all removed to a greater or less extent. The slag, because of its basicity (by iron oxide), will retain all the phosphorus oxidized, and therefore the greater part of this element is removed. The oxidation of all the impurities is produced chiefly by the iron

oxide in the slag and the lining of the furnace, although it is probable that excess oxygen in the furnace gases assists, the slag acting as a carrier of oxygen from it to the impurities.

The purification finally reaches that stage at which the utmost heat of the furnace is not sufficient to keep the charge molten, because iron, like almost every other metal, melts at a higher temperature the purer it is. The metal therefore 'comes to nature,' as it is called, that is to say, it assumes a pasty state. The iron is rolled up into several balls, weighing 125 to 180 lb. apiece, which are removed from the furnace, dripping with slag, and carried over to an apparatus, where they are squeezed into a much smaller size and a large amount of slag separated from them. The squeezed ball is then rolled between grooved rolls to a bar, whereby the slag is still further reduced, so that the bar contains at the end usually about 1 or 2 per cent. This puddled bar, or 'muck bar,' is cut into strips and piled up, as shown in Fig. 34,

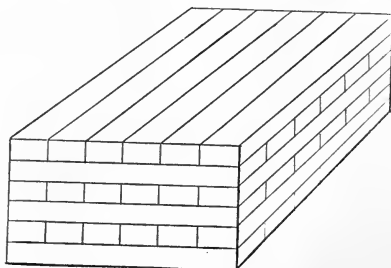

FIG. 34. — METHOD OF PILING MUCK BAR.

into a bundle of bars which are bound together by wire, raised to a welding heat, and again rolled into a smaller size. This rolled material is then known as 'merchant bar,' and all wrought iron, except that which is to be used for manufacture into crucible steel, is treated in this way before sale. The effect of the further rolling is to eject more slag, and also to make a cross network of fibers, instead of a line of fibers all running in the same direction, i.e., lengthwise of the bar. The fibers are produced by the action in rolling of drawing out the slag into strings, long fibers of metal also being produced, each of which is surrounded by an envelope of slag.

COMPARISON OF PURIFICATION PROCESSES

Acid with Basic Open-Hearth. — Acid open-hearth steel is believed by engineers to be better than basic, and is usually specified for in all important parts of structures, although not so rigidly to-day as a few years ago. This is in spite of the fact that phosphorus and sulphur, two very harmful elements, are lower in the basic steel. The basic process is much less expensive than the acid, because high phosphorus pig iron and scrap are cheap, and the lower cost of materials used more than balances the greater cost of the basic lining and the lime additions and the circumstance that the acid furnace has a higher output because the heats are shorter. The reasons for the preference of acid steel are as follows:

(a) A basic slag will dissolve silicon from the metal; we therefore recarburize in the basic process by adding the recarburizer to the steel after it has left the furnace, instead of in the furnace, as we do in the acid process. Should any basic slag be carried over with the metal, however, which is liable to happen, there is the danger that the ingots will be too low in silicon. They are then impregnated with gas bubbles, or 'blow holes.'

(b) Moreover, the recarburizer does not mix with the steel as well if it is not added in the furnace, and this sometimes produces irregularities.

(c) A basic slag is usually more highly oxidized than an acid one; therefore the metal at the end of the operation is more highly charged with oxygen. For this reason we add a larger amount of manganese in the recarburizer, but the remedy is never quite as good as prevention.

(d) Since we cannot remove the phosphorus from the bath in the acid process, it is necessary to use only picked iron and scrap, whereas, in the basic process, good steel can be made from almost any quality of material. Many engineers believe, however, that a better grade of steel results from using the picked material.

(e) It occasionally happens in the basic process that, after the phosphorus has all been oxidized in the slag and the operation is ended, some of it will get back into the metal again. This is especially liable to happen when basic slag is carried over into the ladle before the recarburizer is all in. If this occurs, and if the bath is very hot, a reaction may take place between the basic slag and

the acid lining of the ladle. In this way the slag will be enriched in silica and phosphorus will be forced out of it.

Basic Open-Hearth with Bessemer. — Basic open-hearth steel is better than Bessemer steel. The reasons for this are believed to be:

(a) The open-hearth process being slower, more attention and care can be given to each detail. This is particularly true of the ending of the process; for if the Bessemer process is continued only a second or so too long, the bath is highly charged with oxygen, to its detriment, and even under normal circumstances there is more oxygen in the metal at the end of the Bessemer process than at the end of the basic open-hearth, because there has been so intimate a mixture between metal and air.

(b) For the same reason the Bessemer metal is believed to contain more nitrogen and hydrogen,¹ which are thought to be deleterious.

(c) The heat of the Bessemer process is dependent upon the impurities in the pig iron, and especially upon the amount of the silicon, and can be controlled only to a limited extent by methods that are not perfect in their operation. Furthermore, the heat is regulated according to the judgment of the operator and his skill in estimating the temperature of the flame. Irregularities therefore result at times, and these produce an effect on the steel, because the temperature at which the ingots are cast should be neither too high nor too low. It is true that the temperature of the open-hearth steel is also regulated by the judgment of the operator, but more time is afforded for exercising this judgment and for controlling the heat.

(d) In the Bessemer process we must get rid of all the carbon first and then recarburize to the desired point. In the open-hearth process we may stop the operation at any desired amount of carbon, and then recarburize only a small amount. Therefore the open-hearth has the advantage of greater homogeneity when making high-carbon steel, since a very large amount of recarburizer may not distribute itself uniformly.

(e) In order to produce the best quality of steel, it must be cast into ingot molds within a certain limited range of temperature, which varies according to the amount of carbon, etc., that it contains. Therefore, in casting the very large heats of the open-

¹ From moisture in the blast.

hearth process, the ingots must be very large, else the first one will be too hot and the last one too cold for the best results. On the other hand, if the ingots are large, segregation is liable to be excessive (see page 180).

For nearly fifteen years the Bessemer process has been fighting a losing battle to maintain its supremacy against the inroads of the basic open-hearth, which have been possible because of the increasing cost of Bessemer pig iron, due to the exhaustion of the low phosphorus ores. The pig iron for the Bessemer process must contain so little phosphorus that, after allowing 10 per cent. loss of metal during the blow, the phosphorus in the steel shall be not over 0.100 per cent. Ores low enough in phosphorus to make this grade of metal have, therefore, come to be known as 'Bessemer ores.' The requirement of such an ore is that the percentage of iron in it must be 1000 times the percentage of phosphorus. During the year 1906, the Bessemer process in the United States yielded very much to the basic open-hearth, and it would seem as if there was no chance of its ever taking up so important a position again unless new iron ores low in phosphorus are discovered.

On account of its ability to make low carbon steel more readily than the basic open-hearth, the Bessemer process has a firm hold on the wire and welded steel-pipe industry, although even here the open-hearth process has encroached. For rolling very thin for tinplate, etc., we want a metal relatively high in phosphorus, and therefore the Bessemer process is largely used here, although in some cases ferrophosphorus is being added to basic open-hearth metal to accomplish the same result. The reason phosphorus is desired is because the plates are rolled very thin by doubling them up and putting several thicknesses through the rolls at the same time. Low phosphorus metal welds together too much under these circumstances.

The chief requisites of railroad rails are lack of brittleness and ability to withstand wear. The Bessemer process is able to provide such a material, and it works so well in conjunction with the rapid, continuous operation of the rail-rolling mill that it has a decided advantage. It produces a small tonnage of ingots at frequent intervals (say 15 tons every 7 minutes), while the open-hearth process provides a large tonnage of ingots, which may come at irregular intervals and thus alternately delay and overcrowd

the rail-mill operations. But notwithstanding these advantages, an increasing tonnage of basic open-hearth rails is made every year in the United States.

During 1907 this phase of the industry has attracted widespread interest, owing to reports of an alarming number of rail breakages and of the action of some railroads in blaming the Bessemer process therefor. It is true that every year there is a greater scarcity of Bessemer ores and therefore an increasing amount of phosphorus in the steel manufactured, so that it is no secret that many rails have been made within the past year containing more than the allowable 0.1 per cent. phosphorus. Phosphorus makes the steel brittle, especially under shock and in cold weather. It also makes the steel hard and more able to resist wear; but this hardness is better obtained by means of carbon, and low-phosphorus, high-carbon steel rails would undoubtedly break less often in the track. It is to be remembered that heavier trains are being run every year, and that this brings greater strains upon the rails, to meet which they have not been correspondingly increased in size. At the present time such a very large amount of capital is tied up in Bessemer-rail mills, and it would take so long to change them over into open-hearth mills, that there is no immediate liability of a great replacement. The acid- and basic-steel production of the principal countries of the world is shown in Tables IX and X, while the recent history of open-hearth steel-rail manufacture is shown briefly in Table VIII.

TABLE VIII.—AMERICAN RAILROAD RAIL MANUFACTURE

	Bessemer ¹ Gross Tons	Open-Hearth ² Gross Tons	Wrought Iron ³ Gross Tons	Total Gross Tons
1900.....	2,383,654	1,333	695	2,385,682
1901.....	2,870,816	2,093	1,730	2,874,639
1902.....	2,935,392	6,029	6,512	2,947,933
1903.....	2,946,756	45,054	667	2,992,477
1904.....	2,137,957	145,883	871	2,284,711
1905.....	3,188,675	183,264	318	3,372,257
1906.....	3,700,000*	250,000*

* Estimated.

¹ The first Bessemer rails were made commercially in 1867.

² In 1881, 22,515 gross tons of open-hearth rails were produced. The first open-hearth rails were made in 1878.

³ The maximum production of iron rails was 808,866 gross tons in 1872.

TABLE IX.—STEEL PRODUCTION OF PRINCIPAL COUNTRIES: 1906

	United States	Germany	Great Britain
Acid converter.....	12,275,253	407,688	1,307,149
Basic converter.....	6,772,804	600,189
Total converter.....	12,275,253	7,180,492	1,907,338
Acid open-hearth.....	1,321,613	230,668	3,378,691
Basic open-hearth.....	9,649,385	3,534,612	1,176,245
Total open-hearth.....	10,970,998	3,765,280	4,554,936
Crucible and special.....	118,500	189,313
Total.....	23,364,751	11,135,085	6,462,274
Proportion steel to pig iron.....	92.3	89.2	63.7

TABLE X.—MAKE OF ACID AND BASIC STEEL: 1906

	ACID		BASIC	
	Tons	Per cent.	Tons	Per cent.
United States.....	13,715,366	58.7	9,649,385	41.3
Germany.....	715,952	6.4	10,419,133	93.6
Great Britain.....	4,685,840	72.5	1,776,434	27.5
Total.....	19,117,158	46.7	21,844,952	53.3

Crucible Steel with Others. — Crucible steel is the most expensive of all and costs at least three times as much as the next in price — acid open-hearth steel. It is also the best quality of steel manufactured, and for very severe service, such as the points and edges of cutting tools, the highest grades of springs, armor-piercing projectiles, etc., it should always be employed. The reason for its superiority is believed to be because it is manufactured in a vessel which excludes the air and furnace gases, and is therefore freer from oxygen, hydrogen and nitrogen. Perhaps the fact that the process is in some ways under a little better control than any of the others, and receives more care, on account of being manufactured in small units, assists in raising its grade. Crucible steels are usually higher in carbon than Bessemer and open-hearth steels, because the special service to which the crucible steels are adapted is usually one requiring steel that can be hardened and tempered — for example, cutting tools, springs, etc., and only the high-carbon steels are capable of this hardening and tempering.

Wrought Iron with Low-Carbon Steel. — Wrought iron costs from 10 to 20 per cent. more than the cheapest steel. Its claim to superiority over dead-soft steel consists in its purity and the presence in it of slag. Just how much advantage the slag is has never been proven; it gives the metal a fibrous structure which, perhaps, increases its toughness and its resistance to breaking under bending or under a sudden blow or shock. Some think that the slag also assists in the welding of the material, but this is doubtful, and it is probable that the easy weldability of wrought iron is due alone to its being low in carbon. Some also believe that the slag assists the metal in resisting corrosion; hence one reason for the preference of engineers for wrought-iron pipe for boilers and other purposes. There are other qualities of wrought iron which may tend to make it corrode less than steel, chief among which are the absence of blowholes and possibly the absence of manganese, and the presence of phosphorus. It is now believed by many that manganese starts an electrolytic action which hastens corrosion. An advantage of wrought iron in this connection is its rough surface to which paint or other protective coatings will adhere more firmly than to the comparatively smooth surface of steel. Nevertheless the evidence goes to show that *properly made steel* corrodes no more than wrought iron, especially in boilers, pipe, and other articles which cannot be coated.

The properties of wrought iron are the nearest to those of pure iron of any commercial material, notwithstanding its slag. This is because the slag is mechanically mingled with the metal and does not interfere with its chemical or physical actions. Therefore wrought iron is greatly preferred for electrical conductivity purposes and as a metal with high magnetic power, for armatures of electromagnets, etc.

The advantages I have mentioned, the conservatism of engineers, and the capital previously invested in puddling furnaces are the chief factors in keeping alive the manufacture of wrought iron. It was freely predicted that the invention of the Bessemer and open-hearth processes would bring about the extinction of the puddling process, but these prophecies have never been fulfilled, although the importance of wrought iron has waned very greatly in fifty years. When under strain greater than it can withstand wrought iron stretches more uniformly over its entire length than steel, as shown by the following tests:

STRAIN TESTS ON WROUGHT IRON

	Elastic Limit	Ultimate Strength	Elongation per cent.		Reduction of Area
	Lb. per sq. in.	Lb. per sq. in.	In 12 in.	In 18 ft.	Per cent.
Wrought iron..	31,550	48,810	23	15.22	28.30
Steel	33,150	59,260	39	14.40	51.50

Summary. — In order of expense and of quality the different steels are arranged as follows: (1) Crucible, (2) acid open-hearth, (3) basic open-hearth, and (4) Bessemer. The amounts of the different kinds made in America to-day and ten years ago are shown in Table XI. Though I have not made a direct comparison between certain of the classes, e.g., acid open-hearth with Bessemer, their relations may be easily learned by collating the other comparisons given.

TABLE XI

	Bessemer		Open-Hearth		Crucible, etc.			
1906..	12,275,253	52%	9,649,385	41%	1,321,613	6%	118,500	1%
1896..	4,909,128	78%	776,256	12%	522,444	9%	68,524	1%

Many engineers will be interested in the uses to which the annual steel and wrought iron production of the United States is put, which are shown below:

TABLE XII.—USES OF STEEL AND WROUGHT IRON. 1906.

GROSS TONS, 1906	Steel, tons	Wrought Iron, tons
Railroad rails.....	3,977,872	15
Railroad rail splice bars.....	213,977	10,934
Plates and sheets.....	4,107,783	74,373
Structural shapes.....	2,114,053	4,719
Merchant bars*.....	2,510,852	1,481,348
Rods for wire and wire products.....	1,310,413	1,201
Rods for wire nails.....	560,000§
Plate for cut nails.....	37,032	17,179
Skelp†.....	1,137,068	391,517
Hoops, bands and cotton ties.....	579,018	1,332
Blooms and billets‡.....	205,648	462
All other rolled shapes.....	648,195	203,477
Castings.....	700,000§
Totals.....	18,101,911	2,186,557

* Merchant bars are small bars to be worked up into other forms.

† Skelp is welded into pipe.

‡ Blooms and billets are larger pieces to be worked up farther.

§ Estimated.

DISTINGUISHING BETWEEN THE DIFFERENT PRODUCTS

Low-carbon steel pipe, merchant bars, horseshoe blanks, etc., sometimes masquerade under the name of wrought-iron; high-carbon open-hearth and Bessemer-steel merchant bars, tool blanks, etc., sometimes masquerade as 'crucible steel,' or perhaps 'cast steel,' which is the trade name for crucible steel; other deceptions are not unknown; indeed, even malleable cast iron is sold oftentimes as 'steel castings.' It is therefore important for engineers to understand the essential differences between these materials, although care in the wording of contracts and specifications should be the important consideration and should precede watchfulness over the products. The definitions of iron and steel materials are in such a confused and unsettled condition that it does not do to rely upon them at all, especially where a lawsuit may be involved; and contracts in clear, simple language, free from legal and metallurgical phraseology, are the best safeguards. But even where it is entirely plain what material is called for, there is always a temptation to substitute steel for wrought iron, Bessemer for open-hearth, basic for acid, and Bessemer or open-hearth for crucible steel. In case one such substitution is suspected, there are means by which the material may be tested, aside from its strength and ductility, which may or may not be in the contract. The tests are somewhat delicate and usually require the judgment and experience of an expert—one who has standard samples of the different grades of material for comparison, because the details of manufacture vary from district to district, and still more so with the purposes for which the products are to be used.

Wrought iron may be distinguished from low-carbon steel by the fact that it contains slag. Usually, there is more than 1 per cent. of slag in iron and less than 0.2 per cent. of slag (including metallic oxides) in steel. The slag may be determined either by chemical or microscopical analysis. Normal wrought iron is practically free from manganese, while normal Bessemer and open-hearth steel will contain 0.5 per cent. or more. Wrought iron generally contains more than 0.1 per cent. phosphorus, while good steel should never do so.

Crucible steel normally has less than 0.4 per cent. manganese and more than 0.2 per cent. silicon, while open-hearth and Bessemer

steels normally have more than 0.4 per cent. manganese and less than 0.2 per cent. silicon. In the case of steel castings, however, this rule for silicon does not apply, as Bessemer and open-hearth steel castings are sometimes as high as 0.6 per cent. in silicon. It is possible to make both Bessemer and open-hearth steels low in manganese, but they cannot be made low in both manganese and silicon without great danger from blow-holes, while this difficulty is not met with to the same extent in crucible steel. When crucible steel, low in carbon, is ordered, there is a much greater temptation to substitute another steel for it.

Acid open-hearth steel may be distinguished from basic open-hearth steel by its being normally higher in silicon, and usually in phosphorus also, but lower in manganese. The same differences exist between acid and basic Bessemer steel.

Basic open-hearth steel may be distinguished from Bessemer steel by its lower manganese, silicon, phosphorus and (generally) sulphur, as well as by the fact that it dissolves much more slowly in dilute hydrochloric acid.

It is possible to place such physical specifications in a contract as to practically insure obtaining the grade of material ordered. For example, such a high degree of ductility may be demanded, especially the percentage elongation in ten or twenty feet, that nothing but wrought iron will give it; the strength and ductility may be put so high as to make it too dangerous to try to supply anything but crucible steel for the order; or they may be put a little lower so as practically to preclude Bessemer steel. The average physical difference between acid and basic open-hearth steels is not great enough to make this method of assurance so practicable, but it is possible in the case of basic and acid Bessemer steel in England, where alone both these kinds of steel are made in important quantities.

MISCELLANEOUS PURIFICATION PROCESSES

Bell-Krupp Process. — The late Sir I. Lowthian Bell devised a process in which liquid pig iron is violently stirred up with iron oxide, producing a slag which carries away more than 90 per cent. of the silicon and phosphorus in the metal in the course of from 7 to 10 minutes. As soon as carbon begins to burn the process is stopped, and therefore there is almost no change in this element. The

operation is conducted on the revolving hearth of a mechanical puddling furnace, into which the melted iron is poured while the hearth is rotating at about 11 revolutions per minute. The temperature is lower than that of the open-hearth process, in order that the elimination of phosphorus may be rapid.

The purified metal is used to some extent in the manufacture of crucible steel. During recent years, when the low phosphorus ores of America have become more scarce and the price of Bessemer pig iron is consequently increased, the metal has been bought to a limited extent by foundrymen using the acid open-hearth process or the baby Bessemer process for the production of steel castings.

Finery Fire. — This furnace is known under various names, such as 'refinery hearth,' 'running-out fire,' 'finery fire,' etc. It consists of a shallow, rectangular hearth, surrounded on the sides by water-cooled, hollow blocks of iron about 3 to 3½ ft. long by 2 ft. wide and 24 to 30 in. deep. In and above this hearth is built a fire of coke upon which is placed 500 or 600 lb. of pig iron. The coke is burned by a blast at 2 to 3 lb. pressure from 2 to 3 tuyeres on each side, and the pig iron gradually melts and sinks below it. When this takes place, more coke and pig iron is placed upon the top, and the operation repeated. A bath of pig iron forms in the hearth, and upon this the blast from the tuyeres impinges. This oxidizes the silicon in the metal, and also a large amount of iron, phosphorus, and sulphur. A slag high in iron oxide and therefore very basic is formed. As the temperature is low, phosphorus is eliminated without burning much carbon, and the result is the production of a purified iron still high in the latter element.

It takes about two hours to perform this purification, and then the metal is tapped out from the tap-hole in the front. It usually runs into the long, shallow trough, whence the name 'running-out fire'; but sometimes the refined metal is not allowed to cool, but is run directly into the furnace in which the purification is to be completed. The consumption of coke is about one-eighth of the metal produced, and the loss from 5 to 20 per cent., depending upon the purity of the iron treated.

The running-out fire is frequently used in connection with the charcoal finery known as the 'knobbling fire,' to produce knobbled charcoal-iron, which is employed especially for boiler tubes and to a less extent for boiler-plate, wire, rivets, etc. Running-out fires

for this purpose are often known as 'melting fineries,' because in them the pig iron is melted before it goes to the knobbling fire. There are usually two tuyeres in the back, and the melted metal, after the operation described just above, is run directly into two charcoal fineries, which are very similar in construction to the

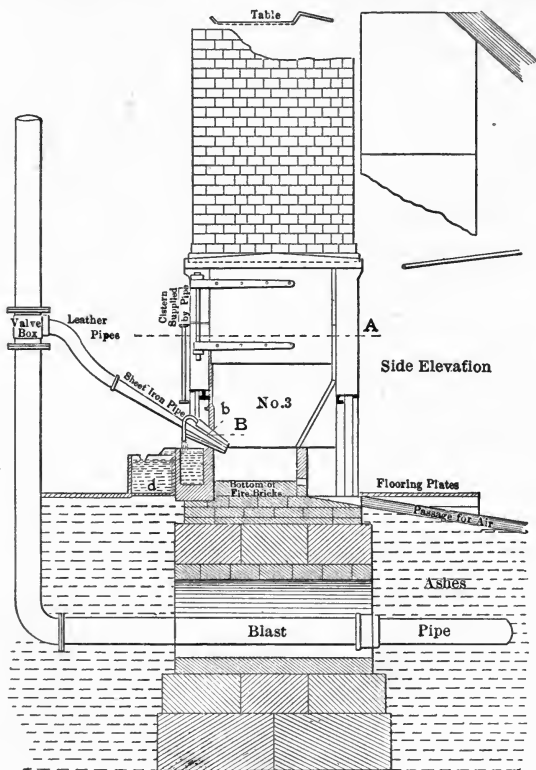

FIG. 35. — MELTING FINERY.

melting fineries, but have only one tuyere, situated in the back, and take a charge of 250 lb. apiece. During the transfer the slag is separated from the metal as well as possible, but some gets into the charcoal fineries; it is allowed to solidify and then is removed.

Knobbling Fire. — Upon the metal is now charged some damp charcoal. The cold blast is turned on and the metal constantly agitated and raised up from the bottom so as to bring it in contact with the blast. Charcoal is added from time to time and is kept

damp to avoid loss, and the slag is removed at intervals, but there must always be a layer of slag between the metal and charcoal. As the metal comes to nature, it is pressed together with the pointed bar, like a crowbar, which is used for the agitation and raising. At the end of about an hour and a half, the ball is withdrawn and hammered. The cinder from the knobbling fire is usually charged into the melting finery.

The great advantages of the knobbled iron as compared to puddled iron are its softness and relative freedom from slag. Tubes made of this material may be flanged out very extensively without showing any cracks, and rivets will flow easily when hammered cold.

The Lancashire Process. — In the Lancashire process, which some believe is a descendant in Sweden of the purification in the two fires last described, the same operations are performed in one hearth, which is made of iron plates, sometimes cooled with water, with a tap-hole in the front. The Swedish Lancashire process is

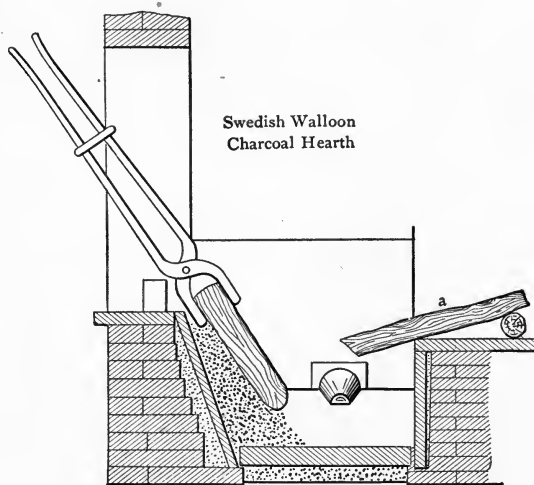

FIG. 36. From Howe, "The Metallurgy of Steel."

known as the 'Walloon process,' and is used in Sweden for making bar iron from the very pure pig iron reduced from Dannemora iron ore. This bar iron is used in Sheffield, England, for conversion into blister-steel, and some of the steelmakers pay a large price for it, in the belief that it has a certain intangible 'body' not

contained in wrought iron from any other process, and which makes a superior quality of steel. It is probable, however, that this body is wholly imaginary. The process consists of three stages:

1. The melting down, which is somewhat similar to the operation in the running-out fire or melting finery.
2. A purification period, during which the metal is nearly purified and comes to nature.
3. A remelting above the tuyere for further purification.

In America, pig iron heated red-hot in the chamber *H-C* (Fig. 37), during the working of a previous charge, is placed between two layers of charcoal and a little above the level of the

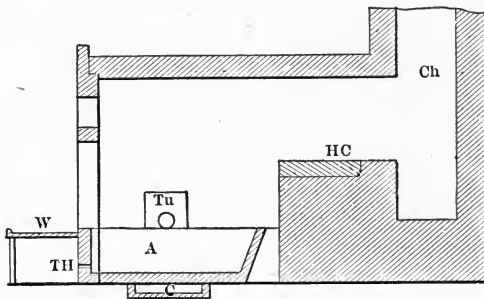

FIG. 37. — AMERICAN LANCASHIRE FURNACE. Tu = Tuyere. From Howe "The Metallurgy of Steel."

tuyere. It is thus quickly melted, the liquid drops being forced to trickle down through the blast and thus exposed to strongly oxidizing conditions.

The second period begins at the end of about 15 minutes, when the melted metal is all collected in the bottom. It becomes pasty in contact with the cold hearth, and is raised by a pointed bar and charcoal allowed to fall under it. Some slag at the same time is tapped off and some is mixed with the pasty lump, which produces a reaction between the two that assists in the purification. Toward the end of this period, which lasts 20 or 25 minutes, carbonic oxide comes off very rapidly, and when the metal becomes so stiff that great pressure is needed to raise it, and the slag has become thinner and whiter, the third period begins.

The metal is now broken into pieces and raised to its original position, the action of the first period being substantially repeated. During this period the workman is careful not to touch the mass

collecting in the bottom of the hearth lest he mix slag with it. By the time about two-thirds of the metal is melted, some rich iron oxide slag is added in order to keep enough in the bottom of the hearth to protect the metal from being carburized by the charcoal. When all the metal has melted and dropped down in front of the tuyere, the pasty ball is pried out of the hearth and hammered. The third period takes about 25 to 30 minutes.

Walloon Process. — In the Swedish Lancashire or Walloon process, the long pigs of metal are fed slowly down into the fire, so that it is not necessary to constantly pry them up with bars. The charges are smaller and the product is more liable to be heterogeneous, because the first melted metal is decarburized more than the last, and this heterogeneity is not removed by the remelting. (See Fig. 36.)

GENERAL REFERENCE BOOKS ON STEEL

30. Henry M. Howe. "The Metallurgy of Steel." Vol. i. 1890. New York. This is the recognized standard authority on the metallurgy of the Bessemer and crucible steel processes, and upon the properties of steel as far as they were known and understood at the time when this book was written. It will long remain a classic. There have been many editions of different dates, but no change in text since 1890.
31. F. W. Harbord. "The Metallurgy of Steel." 1905. London. With a Section on Mechanical Treatment by J. W. Hall. Next to No. 30, this is the most complete and thorough book on steel ever written, and, for English readers, will be the first source of reference for those desiring recent practice. The section on mechanical treatment is the best extant.
32. A. Ledebur. "Handbuch der Eisenhuettenkunde." Fourth edition. 1902. Leipzig. This is an excellent reference book for those who read German, and contains a very complete account of the metallurgy of both iron and steel, and of their properties. There are also classified lists of the literature upon each of the branches of the subject.
33. Hermann Wedding. "Ausfuehrliches Handbuch der Eisenhuettenkunde." Braunschweig. 1906. Four volumes. This is an edited translation of Percy's "Iron and Steel,"

brought up to date and greatly enlarged with especial reference to German practice, which is the second largest in the world.

34. H. Noble. "Fabrication de l'Acier." Paris, 1905. As its name indicates this book deals chiefly with the manufacture of steel, the section on properties being very small.
35. Léon Gages. "Traité de Métallurgie du Fer." In two volumes. Paris. 1898. The first volume covers the manufacture of iron and steel, and the second, foundry, mechanical treatment and properties.
36. Sir I. Lowthian Bell. "Principles of the Manufacture of Iron and Steel." London. 1884. This book well accomplishes its aim, namely, to elucidate the principles of iron and steel manufacture, and no man can be either so well informed or so ignorant as not to understand the metallurgy of these metals better after reading it.
37. John Percy. "Metallurgy. Iron and Steel." London. 1864. This classical book is now chiefly valuable for historical reasons, where its usefulness is often unexpectedly advantageous, as, for example, in patent litigations, but at the time it was written it was a model for wealth of information (although badly arranged).

IV

THE MANUFACTURE OF WROUGHT IRON AND CRUCIBLE STEEL

THE MANUFACTURE OF WROUGHT IRON

Pig Iron Used. — The pig iron employed is of the grade known as 'forge iron' or 'mill iron.' In the United States we prefer to have this contain about 1 per cent. of silicon, because the higher the silicon the larger will be the amount of slag made, while if it is too low the iron will be oxidized excessively. Manganese is usually about 0.50 per cent., although it varies anywhere from 0.25 per cent. to over 1 per cent., depending on what the blast furnace puts in the pig. Phosphorus is preferred to be less than 1 per cent., and sulphur not more than 0.10 per cent., because neither of these elements are entirely eliminated during the process. A large amount of phosphorus in wrought iron is not, however, as objectionable as it is in steel, because the slag mechanically mingled with the wrought iron hinders it from being brittle under shock, which is the chief damage caused by phosphorus. Pig iron containing 2.50 per cent. and even 3 per cent. of phosphorus, and as much as 0.35 per cent. of sulphur, is sometimes used. The larger the amount of impurities the larger the loss of metal in the process.

Puddling Furnaces. — There are many different varieties of puddling furnace, varying in capacity from 300 to 1500 lb. and even more, but the commonest is probably the 500-lb. furnace, built either single or in pairs, back to back, the latter arrangement having the advantage of reducing loss of heat by radiation, which is always a very large factor. Puddling furnaces are heated by gas or bituminous coal. The commonest method is a deep bituminous-coal fire, giving a long flame, and with a large area of grate in relation to the area of the hearth, in order that a high temperature may be maintained.

Fettling. — The hearth is lined or 'fettled' with oxide of iron in

the form of roll scale, or high-grade iron ore, or 'bulldog,' i.e., roasted puddle cinder, and this oxide, together with the metal

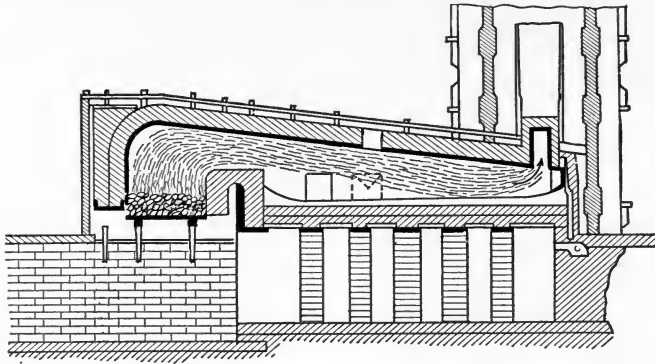

FIG. 40. — 500-LB. PUDDLING FURNACE.

oxidized during the melting, supplies the base which automatically maintains a very basic slag and also serves as the principal oxidiz-

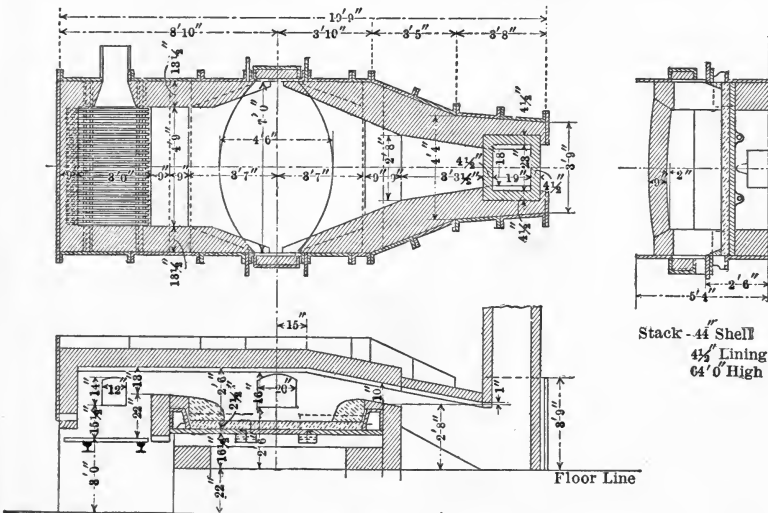

FIG. 41. — 1500-LB. PUDDLING FURNACE.

(Two work doors.)

ing agent of the impurities. The fettling is repaired between melts as often as is necessary, and suffers wear with each operation.

Squeezers. — A very common form of squeezer is that shown in Fig. 42, the distance between the inner and outer circle being

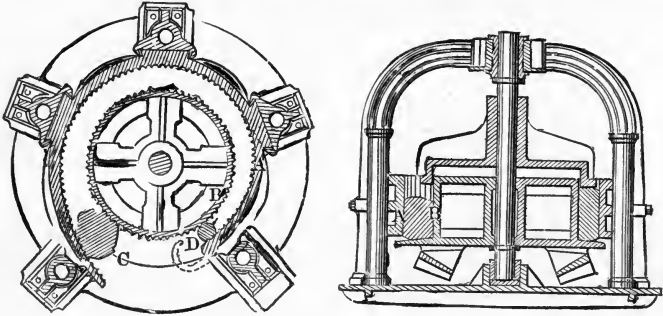

FIG. 42. — ROTARY SQUEEZER.

greater on the entering side than on the outgoing side. As the inner circle revolves, the corrugations on the surface carry the ball

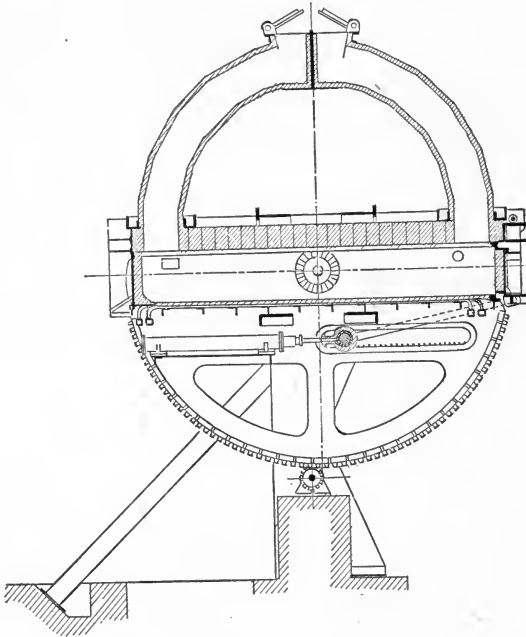

FIG. 43. — ROE MECHANICAL PUDDLING FURNACE.

around, giving it at the same time a movement of rotation. By the time the ball exits on the opposite side, it has been squeezed

and kneaded sufficiently to get rid of a large amount of slag. In European countries the squeezer is rarely used and the ball is 'shingled' — reduced under a hammer — to weld its particles together.

Mechanical Furnaces. — The labor in puddling is very severe on the men, and many attempts have been made to remedy this by mechanical furnaces which will work the charge without so much manual labor. Several forms of mechanical appliances and



FIG. 44. — CHARGING THE PUDDLING FURNACE.

of mechanical furnaces have been invented, but without any permanent success. However, the mechanical furnace shown in Fig. 43, devised by James P. Roe, of Pottstown, Pa., has given approximately satisfactory results. It is suspended on trunnions, and the water-cooled bottom and sides are lined with magnesite brick. The oil and blast for combustion enter through the two trunnions and the products of combustion escape through a stack at each end, which meet above the top of the furnace and discharge into the atmosphere as shown. The furnace is made to oscillate 65° each way from the vertical, which keeps the slag and bath uniformly

mixed and avoids the hand-rabbling of the ordinary puddling process. The whole charge, weighing about 4000 lb., is discharged in one ball by sliding it down the hearth of the furnace toward the end, and then out into a hydraulic squeezer of special design, in which it is compressed in three dimensions until it is a slab and ready for rolling.

Puddling. — The pig iron is usually charged by hand through the working doors of the furnace, and the puddler's assistant fires vigorously in order to melt it down as fast as possible, which usually takes about 30 to 35 minutes. As soon as melted, there follows a short stage of 7 to 10 minutes, during which iron oxide in the form of roll scale or very high-grade iron ore is added, in order to make a very basic slag, the charge being thoroughly mixed and



FIG. 45. — PUDDLING.

cooled, for which purpose the damper is put on and sometimes even water is thrown on to the bath. The object is to reduce the temperature to the point where the slag will commence to oxidize the impurities and especially the phosphorus and sulphur ahead of the carbon. As soon as the reaction is started, light flames begin to break through the covering of slag, produced by burning carbon monoxide from the oxidation of carbon:

1. $\text{Fe}_2\text{O}_3 + 3\text{C} = 3\text{CO} + 2\text{Fe}$;
2. $\text{CO} + \text{O} = \text{CO}_2$.

If the slag is not very basic at this time the CO will reduce phosphorus and sulphur and cause them to return to the metal.

As the carbon monoxide forms more and more abundantly, the charge is more violently agitated by its escape, and the 'boil' is in progress. The formation of gas in its interior causes the charge to swell greatly, and it thus rises in the furnace and a large amount of slag pours out of the slag-hole and into a waiting buggy. About one-half of all the slag produced during the process, and amounting to about one-eighth to one-quarter of the weight of the metal



FIG. 46. — THE BOIL.

(A removable iron shield down which water flows protects the puddler from the heat.)

charged to the furnace, is removed at this time. The boil continues from 20 to 25 minutes, and during this time the puddler stirs or 'rabbls' the charge vigorously with a long iron rabble, shaped like a hoe. Toward the end of the boil the metal begins to come to nature, and points of solid metal project through the cover of slag, while other pasty masses form on the bottom of the furnace. Both of these things must be corrected immediately by the



FIG. 47. — GETTING A HOLD OF THE BALL.

puddler, lest (1) the iron that is exposed to the furnace gases become too much oxidized, (2) lest the iron sticking to the cold bottom become too much chilled, or (3) lest the charge be not uniform



FIG. 48. — TAKING THE BALL OUT.

in composition. Finally, the whole charge comes to nature and the 'balling' period begins and occupies about 15 to 20 minutes. During this period the bath is divided into three or four portions, which are each rolled up into a ball, consisting of a large number of particles partially welded together. The balls are rolled up near the fire-bridge in order, first, to protect them from direct contact with the flame, and second, to keep them as hot as possible until the puddler can draw them, so that the slag may be fluid and thus



FIG. 49.—THE BALL ENTERING THE SQUEEZER.

more easily squeezed out of the metal. The balls are then squeezed in turn, and the furnace hearth repaired for another charge. The total time between operations is usually from 1 hour and 10 minutes to 1 hour and 40 minutes.

Chemistry of the Process. — The removal of the impurities during the puddling process are shown in Table XI, which is quoted because it records probably the first successful attempt ever made to study in this way the chemistry of an iron or

TABLE XI.—REMOVALS IN HAND PUDDLING

By Calvert and Johnson, *Phil. Mag.*, 1857.

Sample No.	Time after charging		C	Si	S	P
	Hrs.	Min.	Per cent.	Per cent.	Per cent.	Per cent.
1.....	0	0	2.275	2.720	0.301	0.645
" " 2.....	0	40	2.726	0.915
" " 3.....	1	00	2.905	0.197
" " 4.....	1	5	2.444	0.194
" " 5.....	1	20	2.305	0.182
" " 6.....	1	35	1.647	0.183
" " 7.....	1	40	1.206	0.163
" " 8.....	1	45	0.963	0.163
" " 9.....	1	50	0.772	0.168
Puddled bar.....	0.296	0.120	0.134	0.139

steel process. A similar study is graphically represented in Fig. 53.

During the melting-down stage, the silicon and manganese in the puddling charge are almost entirely eliminated, and these reactions are as complete as they will be by the end of the 'clearing' stage which follows it. Much phosphorus and sulphur are also

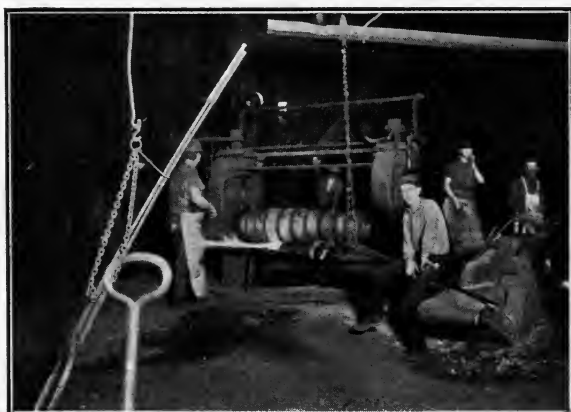

FIG. 50.—PUDDLE ROLLS.

removed. The boil period is, of course, the period during which the carbon escapes together with all the phosphorus and sulphur which was not removed during the first two periods.

Fuel. — The temperature of the puddling process is as high as can be obtained in furnaces of this type without preheating the air.¹ The result is a very large waste of heat up the



FIG. 51. — ROLLING PUDDLE BAR.

chimney, although some economy in this respect is obtained by placing boilers, or else furnaces to heat metal for the rolls, where they will receive the waste heat of the puddling furnaces. The two greatest items of expense in the puddling process are the fuel used and the excessive labor, which, on account of the strength and endurance demanded, receives a high price. The amount of fuel burned per ton of iron produced will usually be about one ton of a soft bituminous coal, or a little more, although better figures than this are obtained in some cases.

Losses. — The loss in the puddling process usually averages from 4 to 6 per cent. of the weight of the metal charged, although so much iron oxide is added or is reduced from the lining by the impurities in the metal, that in the Roe furnace the wrought iron produced will



FIG. 52. — WROUGHT IRON SHOWING STRINGS OF SLAG MAGNIFIED 50 DIAMETERS.

(Unetched.)

¹ Indeed, in some cases the air is preheated by the regenerative process, although this is not the usual practice.

actually weigh more than the pig iron charged. The following table gives a typical example of loss:

TABLE OF LOSSES IN HAND PUDDLING

	Percentage of Loss
Silicon burned.....	1.00
Carbon burned.....	3.50
Sulphur burned.....	.20
Phosphorus burned.....	.50
Manganese burned.....	.30
Total.....	5.50
Iron reduced from oxide ¹ = 1.00 per cent. gain	
Net loss.....	4.50

¹ There is much iron oxidized and carried off in the slag, but there is also much reduced by impurities. The figure here given represents the excess of reduction over oxidation; in some cases it runs as high as 6 per cent. or more.

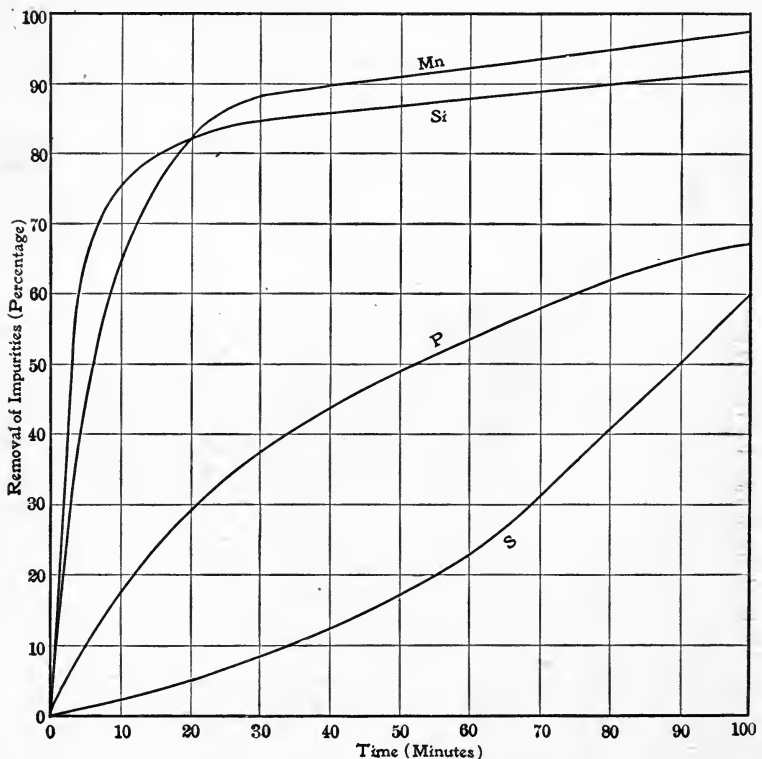

FIG. 53. — REMOVALS IN HAND PUDDLING.

Slag. — The slag which runs from the tap-hole during the boil is known as ‘boilings,’ while that tapped out at the end of the process is known as ‘tappings’ or ‘tap-cinder.’ The characteristics of the boilings are that they contain a larger amount of the phosphorus than the tappings, and also that globules of metallic iron are carried off in the violent agitation of the boil. An analysis of the two varieties, giving a mean composition from seven heats, is as follows: ¹

	Boilings	Tappings
Ferric oxide (Fe ₂ O ₃).....	6.94	12.90
Ferrous oxide (FeO).....	62.61	64.62
Silica (SiO ₂).....	19.45	15.47
Phosphoric anhydride (P ₂ O ₅).....	6.32	3.91
Not determined (MnO, S, CaO, etc.).....	4.68	3.10
	100.00	100.00
Total iron.....	53.55	59.29

The amount of slag will depend chiefly upon the amount of silicon in the pig iron. It will average in weight about one-half the weight of the charge, where the silicon is high, as in English practice (say 1.70 to 2 per cent.), and about one-quarter to one-third in American practice, where the silicon is about 1 per cent.

THE CARBURIZATION OF WROUGHT IRON

Wrought iron is converted into steel by the operation of carburizing, or the adding of carbon to it. This is to-day accomplished in two ways: (1) By the cementation, or steel conversion, process, in which carbon is allowed to soak into red-hot steel in a manner like in nature to the absorption of ink by blotting paper; and (2) by the crucible process, in which wrought iron is melted in a crucible with carbon, or with iron containing carbon, e.g., cast iron.

Cementation Process. — We have already observed in describing the blast-furnace process that iron at a bright-red heat will absorb carbon very slowly. The action appears to be a traveling of solid carbon into the interior of solid iron, forming with it a chemi-

¹ Page 297 of Number 40, page 93.

cal compound or carbide, Fe_3C , to which Professor Howe has given the name of 'cementite.' When the steel is at a proper heat, the rate of travel is approximately $\frac{3}{8}$ of an inch per 24 hours.

Steel Converting Furnace. — A section of the type of cementation-furnace used in Sheffield, England, is shown in Fig. 55. The superstructure, *e*, is a mere chimney for the purpose of carrying

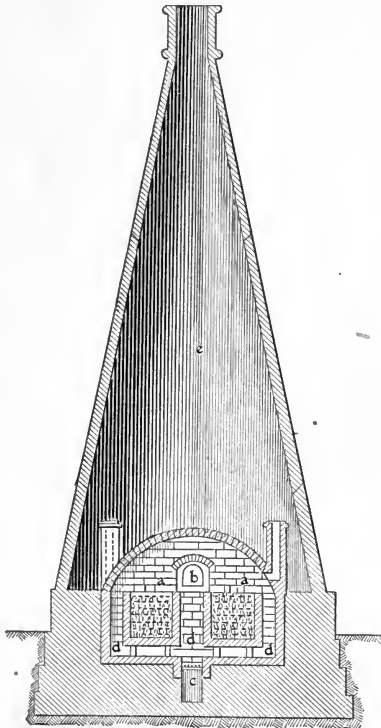

FIG. 55. — CEMENTATION FURNACE.

off the products of combustion from the fire at *c*, and for reducing loss of heat by radiation. The real furnace is the part underneath this superstructure or stack, and it has several small chimneys of its own. The two converting pots are shown underneath the points *a a*. In Sheffield they are built of stone and are $2\frac{1}{2}$ to 4 ft. wide and deep, and 8 to 15 ft. long. On the bottom of the pot is first placed a layer of charcoal in small pieces freed from dust. On this is laid a layer of the wrought-iron bars to be converted, which are 2 to 5 in. wide, $\frac{1}{2}$ to $\frac{3}{4}$ in. thick, and nearly as long as the pot. A little space is left (about $\frac{1}{2}$ in.) between each pair of bars in order that they may be completely surrounded by the charcoal.

On top of the layer of bars is then placed another layer of charcoal, and then a layer of bars, and so on until the pots are filled, each one containing from 10 to 30 tons of iron. The top of the pots is then luted air-tight and the fire lighted.

In about 2 days the temperature has reached a full red-heat of say 650° to 700° C. (1200° to 1300° F.), and this is maintained from 7 to 11 days longer, depending upon the grade of steel to be made. The names of the different grades of steel made in Sheffield are as follows:

No. 1.	Spring heat.....	0.50	per cent.	carbon
" 2.	Country heat.....	0.60	"	"
" 3.	Single-shear heat.....	0.75	"	"
" 4.	Double-shear heat.....	1.00	"	"
" 5.	Steel-through heat.....	1.25	"	"
" 6.	Melting heat.....	1.50	"	"

The product is controlled by a series of trial bars which are so placed that, beginning about 7 days from the full-red heat, they can be withdrawn from the furnace from time to time, broken, and examined. The appearance of the fracture denotes the extent of the cementation.

Discharging the Furnace. — When the cementation has proceeded to the desired point, the fire is withdrawn and the furnace is allowed to cool for about a week, when the pots are opened and the bars withdrawn through the door *b*.

Blister-Steel. — The product of the cementation process is known as 'blister-steel' because its surface is covered with blisters, due to the formation of gas by a reaction between the carbon of the cementite and the slag contained in the wrought iron:



The blister-steel has gained about 1 per cent. in weight over the wrought iron and the appearance of the fracture is entirely different, as the broken surface now shows large bright crystals.

Shear-Steel. — The bars of blister-steel are sometimes forged to a smaller size, piled up, and then the pile forged down again into a bar, which makes what is known as 'single shear-steel.' Single shear-steel may be again piled and forged into double shear-steel. In America, however, it is more common to melt the blister-steel in crucibles, which separates the metal from the slag it contains and produces the finest quality of cutlery and tool-steel that is made in America.

Crucible or Cast Steel. — The cementation process, on account of the length of time and the very large amount of fuel required, has now been largely superseded by the crucible process. In this process the wrought iron is cut up into small pieces and melted in covered crucibles, the desired amount of carbon being placed on top of the charge before the melting, together with any other alloying element desired, such as chromium, tungsten, manganese, etc.

Furnaces. — In Sheffield, England, coke-furnaces, or melting-holes, containing each two crucibles, are almost universally used,

while in America gas-furnaces, containing about 6 crucibles each, are the common type. In the gas-furnace it is necessary that the gas and air for combustion shall be preheated, in order that we may (1) obtain fuel economy and (2) reach the desired temperature for melting quickly.

Regenerative Furnace. — The operation of the regenerative-furnace is shown in Fig. 57. The gas enters the gas regenerative-chamber and passes up between the checker-work of bricks, laid

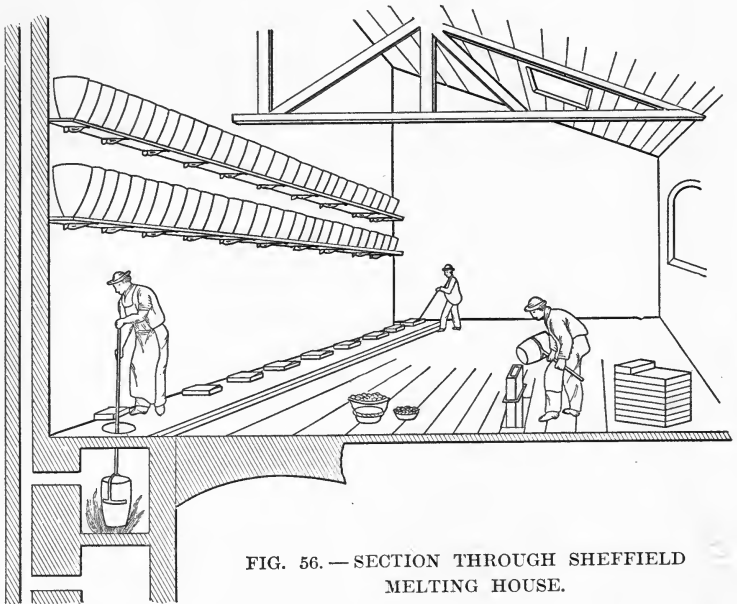

FIG. 56. — SECTION THROUGH SHEFFIELD MELTING HOUSE.

with many spaces between, and into the melting-hole. The air enters and passes up through its regenerative-chamber, meeting the gas above. They there combine and, passing through the melting-hole, divide into two parts and pass through the regenerative-chambers on the other side. Previous to beginning the operation, all of the brickwork in the regenerative-chambers has been heated red-hot by means of a wood fire. The gas and air have therefore absorbed a good deal of heat from the brickwork before they meet. As they pass down through the regenerators on the outgoing side, they will still further increase the heat of this brickwork, giving up their temperature to the checker-

work. This causes them to go to the stack at a relatively low temperature, and when the current of air and gas is reversed, each now entering from the other side, they become more highly pre-heated than before, and now serve to heat the opposite pair of

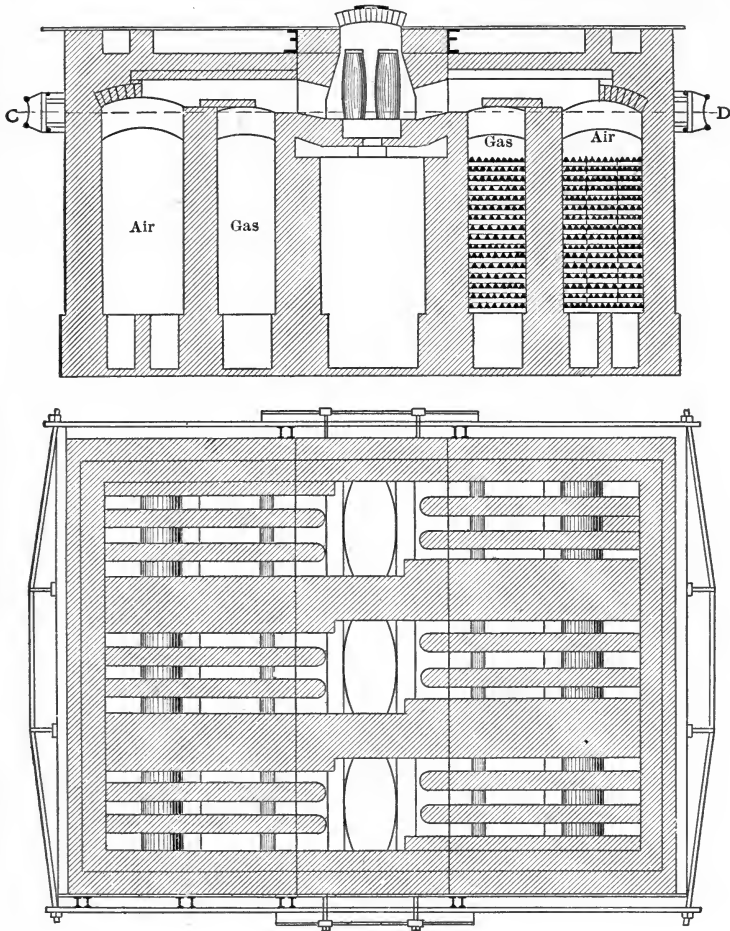

FIG. 57. — REGENERATIVE GAS CRUCIBLE FURNACE OR "MELTING-HOLE."

regenerators. When all four regenerators have been raised to a high temperature, the reversal of direction takes place every 20 minutes, and thus a uniformly high heat is obtained with low temperature of chimney gases and consequent fuel economy.

Crucibles. — In England, the crucibles are made of fire-clay. They are usually made by hand at the steel melting plants and are dried for one or two months, on a shelf next to the chimney of the melting-furnace. Before being used they are heated to redness in an annealing furnace and are then ready to receive a charge of 50 lb. of metal. The clay is deeply cut by the slag, and therefore the charge must be reduced to 44 lb. for the second melt and 38 lb. for the third, in order that the slag-line may be lower each time. After the third melt they are thrown away. The advantages of clay crucibles are that the first cost is lower, and that they do not give up any carbon to the metal, so that the composition of the final product may be regulated with greater exactness and a lower carbon steel may be made, if desired.

In America, the crucibles are made of a mixture approximating 50 per cent. graphite and 50 per cent. fire-clay. They are made and tempered by factories outside of the steel-works and are received by the latter ready for use. They last about six heats, after which the bottom is sawed off and used for the top of a new crucible. They hold almost 100 lb. of metal, because they are stronger than clay and can therefore stand greater strains.

Metal Used. — Although crucible steel is supposed to be made by the melting of pure wrought iron with charcoal, washed metal, ferromanganese and other 'physic,' it is not at all uncommon for the wrought iron to be diluted with varying amounts of cheaper scrap steel, which unquestionably lowers the quality of the product. The pieces of wrought iron are put into the crucible first, and on top of that is placed the charcoal or pig iron, ferromanganese or spiegel-eisen, and various physics, such as salt, potassium ferrocyanide, oxide of manganese, etc. The purpose of these physics is not entirely clear. Probably the salt and oxide of manganese make a more fluid slag; the ferromanganese puts a little manganese in the steel; and the ferrocyanide may, perhaps, favor the absorption of carbon by the steel.

In some cases the material is charged directly into a hot crucible from the previous melt, but when graphite crucibles are used, these are sometimes allowed to cool, in order to be examined for cracks, because the breaking of a crucible in the furnace, allowing the liquid mass to flow out upon the floor, is very objectionable. There is a hole in the middle of the floor of the furnace, so that if such an accident happens the metal may run down into a pit

underneath; and the floor is also covered with a few inches of coke-dust to absorb the metal in such a contingency.

Melting. — The crucibles are placed in the furnace and the gas and air turned on, in the case of a gas-furnace. In the case of a coke-furnace, the crucibles are placed upon their fire-clay stands and the coke packed around them upon the fire left from the last melt. At the end of about an hour, the coke fire has burned down



FIG. 58. — STAGES IN CRUCIBLE STEEL MELTING.

so low that it has to be poked down and more coke added. The melting takes on the average from two to three hours in both cases, and the charge is examined by removing the crucible cover, to make sure that it is entirely molten. The coke fire also requires further attention at this time, and care must be taken that no coke falls into the crucible when the cover is off.

Killing. — When the charge is entirely molten, it is kept in the furnace for one-half to an hour longer in order that it may teem 'dead,' that is, pour quietly without the evolution of gas, and yield solid ingots. If the 'killing' time is too long, the ingots will be solid, but the steel will be hard, brittle and weak, probably as a result of the absorption of too much silicon from the walls of the crucibles. Graphite crucibles probably yield more silicon than clay crucibles. Just what takes place during the killing of steel is not definitely known. Some have suggested that the gas contained in the steel is eliminated from it during this time, but the alternate suggestion that the principal effect of the killing is to cause the steel to absorb silicon, becoming sound on this account, is the more generally accepted one. The amount of silicon in the final steel will vary greatly, but will average perhaps from 0.10 to 0.50 per cent.

Pulling. — When, in the judgment of the melter, the steel has been properly killed, the crucibles are removed from the fire by the puller-out, who straddles the top of the furnace and grasps the

crucible with a pair of tongs, his legs and arms being swathed in wet cloths to protect him from the heat, and his eyes frequently being protected by heavy blue glasses. The puller-out then passes the crucible to the pourer, who pours it as shown in Fig. 59, the slag



FIG. 59. — POURING.

first being swabbed off with a ball of cold slag on the end of an iron rod. The total time of operations is $3\frac{1}{2}$ to $5\frac{1}{2}$ hours in England, and $3\frac{1}{2}$ to 4 hours in America.

Ingot Molds.

— Ingot molds are shown in Fig. 60, and as a usual thing each mold has a capacity to take the charge

from one crucible. The metal must be teemed into this with great care, so that the stream shall not touch the sides during pouring. In case a large ingot is to be poured, then several crucibles are poured at once into the same mold, care being taken that the metal shall be liquid as long as the pouring continues.

Grading. — The composition of the final metal is a matter of some uncertainty, especially as regards the carbon and silicon. The former is more easily adjusted when clay crucibles are used, because the amount of carbon dissolved from a graphite crucible will depend to a large extent upon the time and temperature of the operation, etc. The ingots are therefore always graded after they have cooled, by breaking off the upper part of them, which contains the pipe and is therefore useless, except when remelted, and examining the fracture with the eye. The skilled steel man can thus estimate the carbon within 0.10 per cent., and the ingots are put away in the pile



FIG. 60. — INGOT MOLD FOR CRUCIBLE STEEL. From Howe, "The Metallurgy of Steel."

with others of like analysis. At large American works, how-

ever, this grading by eye is always supplemented by chemical analysis.

Chemistry. — The chemistry of the crucible process is very simple, and consists principally in the elimination of the slag in the wrought iron and the absorption by the metal of carbon, silicon and manganese. There is also a very slight increase in sulphur, which perhaps comes from the pyrite in the clay or graphite, or from sulphurous gases which find their way under the cover of the crucible. Phosphorus also increases slightly, perhaps from the slag out of the wrought iron.

Loss. — The loss is due to the elimination of the slag and to some slight oxidation of metal by oxygen in the gas inside the crucible. It is counteracted to some extent by the absorption of carbon, silicon and manganese, and will average slightly more than 2 per cent. in clay crucibles and somewhat less than 2 per cent. in graphite crucibles, doubtless due to there being less oxidation in the presence of the graphite.

Fuel. — In coke fires, the amount of fuel used will be three to four times the weight of steel produced. In gas-fired furnaces the amount of fuel used to make producer gas will be equal to or slightly less in weight than the amount of steel produced. The high cost in making crucible steel is on account of the cost of crucibles, fuel, labor and raw material.

REFERENCES ON THE MANUFACTURE OF IRON

There is but one American book (No. 47) devoted either to the manufacture of pig iron or wrought iron. One should refer to Nos. 2, 32, 33, 35, 36, 37, and the list given below:

40. Thomas Turner. "The Metallurgy of Iron."* London, 1895.
41. A. de Vathaire. "Les Hautes Fourneaux." Paris.
42. H. Bauerman. "A Treatise on the Metallurgy of Iron."* London, 1868.
43. M. A. Pavlov. "Atlas of Plans for Blast Furnace Construction." Gekatermoslov (Russia), 1902. Although these drawings are lettered in Russian, one gets much valuable information from them even without being able to read the language.

* Starred books refer both to pig iron and wrought iron.

44. Frederick Overman. "The Manufacture of Iron." * Philadelphia, 1850.
45. W. Truran. "The Iron Manufacture of Great Britain." * London, 1865. Revised by J. Arthur Phillips and W. H. Dorman.
46. James P. Roe. "The Development of the Roe Puddling Process." *Journal, Iron and Steel Institute*, No. 111, 1906, pages 265-306.
47. Robert Forsythe. "The Blast Furnace and the Manufacture of Pig Iron."

* Starred books refer both to pig iron and wrought iron.

V

THE BESSEMER PROCESS

Pig Iron Used. — In the large American works, pig iron for the Bessemer process is preferred to have about 1 per cent. of silicon. This is the chief slag producer and also the chief heat producer. To keep it at a low figure limits the amount of slag made, which limits one of the sources of iron loss. Furthermore, the lower the silicon the shorter will be the time of blow; but it is usually risky to allow it to fall below 1 per cent., or the blow will be cold, and it is only by very rapid working and permitting the least possible delay between operations, so that the converter and ladles are kept very hot, that we are able to get along with as little as this. The manganese is below 0.8 per cent. This also furnishes heat;¹ but it is now an expensive ingredient of pig iron, and also has the effect of making very liquid slags, which cause a good deal of slopping or 'spitting' from the converter (i.e., ejection of the material by the blast), and also make the steel ingots dirty and spotted with oxide spots, due to slag carried over with the steel. Manganese of 1.50 per cent., with silicon of 1.00 to 0.90 per cent., gives a very 'wet' slag, which follows the metal into the ladle and boils up through it, oxidizing the manganese in the steel:

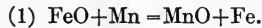

The phosphorus and sulphur must be below 0.10 and 0.08 per cent., respectively, in order that the steel may be salable, as neither of these elements is reduced in the acid Bessemer process.

Mixer. — It takes about two blast furnaces to supply one converter with metal, so that a modern plant of two to four converters will be operated in conjunction with a large blast-furnace plant. The product of each of these furnaces, if not too different from the

¹ Indeed, formerly, in the Swedish Bessemer practice, the pig iron contained 2 per cent. of manganese, and this element was relied upon as the chief source of heat, because silicon was necessarily low in the Swedish charcoal pig iron.



FIG. 65. — A BESSEMER BLOW.

desired analysis, will be poured into a huge reservoir, or 'mixer,' capable of holding 150 to 500 tons, which is then used as a source of supply for the converters.

The mixer serves several very useful purposes: (1) It equalizes the irregularities of pig iron composition by mixing the product of several furnaces, and also brings the composition somewhat under the control of the metallurgist of the Bessemer plant, because he not only can pick and choose from the different furnaces, but he

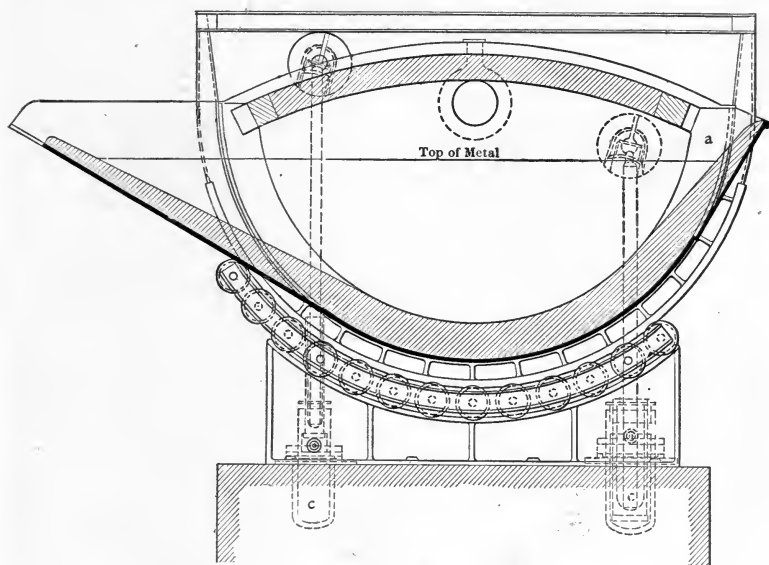

FIG. 66. — MIXER.

has a few large cupolas under his dominion in which he can melt iron of any desired analysis to pour into the mixer and help regulate its contents.

(2) Because of its large size, and the fact that it is continually in receipt of new fresh metal, the mixer can keep its contents molten for an indefinite length of time, whereas a ladle containing 15 tons of pig iron would chill up in a very few hours. Mixers are supplied with blowpipes which can contribute a small amount of heat to the charge, but it is not often necessary to use them.

(3) The capacity of the mixer is so large that a delay either at the blast furnace or at the steel-works will not discommode it greatly, and thus each operation is independent of the other.

serve for the passage of the blast. The shape of the converter is such that, when it is lying on its side, the metal will not cover any of these tuyere-holes. This is necessary, or the blast could never be turned off without having molten metal run down into the wind-box. The converter may have either an eccentric or a concentric shape. The advantage of the eccentric shape is that less heat can escape from the nose: the advantage of the concentric shape is that the vessel may contain its charge when turned on either of the sides.

Lining. — The lining is made of highly refractory acid material composed principally of silica. In England, a ganister rock

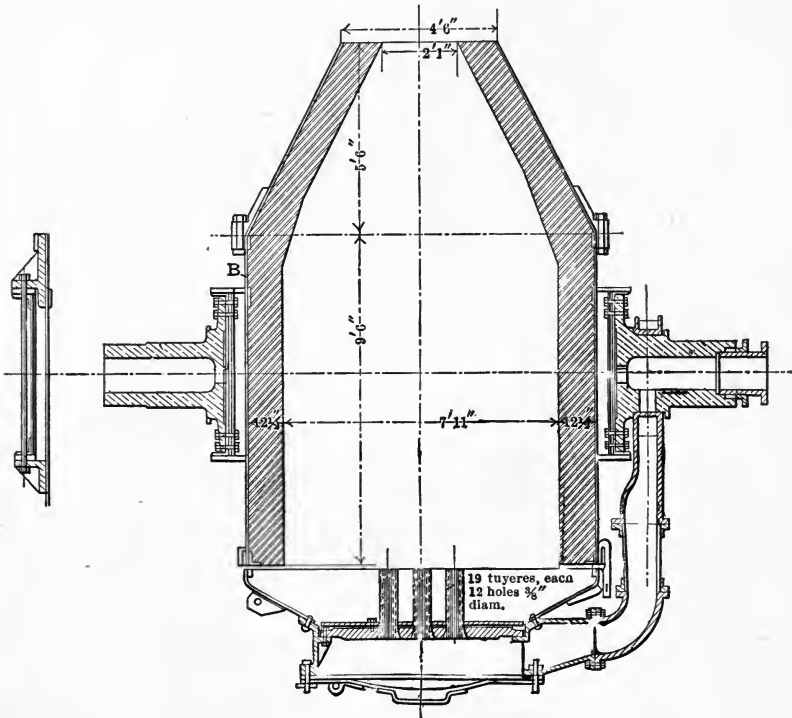

FIG. 68. — FIFTEEN-TON CONVERTER SECTION. From Howe, "The Metallurgy of Steel."

is used, or sometimes the lining is rammed up around a pattern and is composed of silicious material held together by a small amount of fire-clay. In America, it consists usually of blocks of ganister or of mica-schist (a silicious rock consisting of pseudo-

strata, or laminae, formed by tiny plates of mica) laid with a thin layer of refractory fire-clay between, and in such a manner that the edges of the laminae will be exposed to the wear to which it is subjected.¹ After a new lining is put in, it is carefully dried, and every Sunday afternoon, before the converter begins its operation for the week, a wood fire is kept in it for several hours in order to

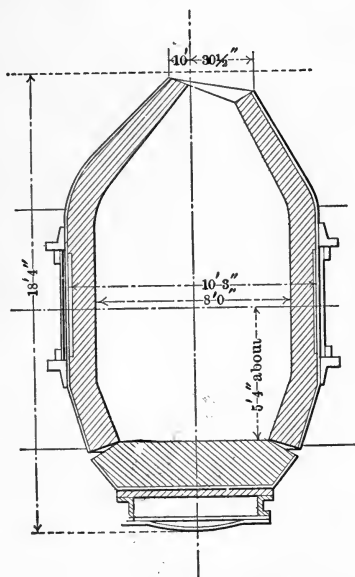

FIG. 69. From Howe, "The Metallurgy of Steel."

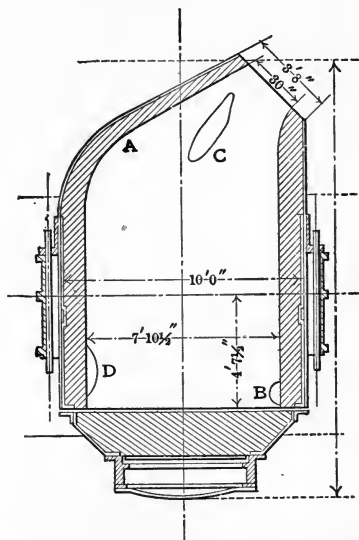

FIG. 70. — ECCENTRIC CONVERTER. From Howe, "The Metallurgy of Steel."

heat the lining to a red heat. Between the heats the lining is repaired, if necessary, with balls of silicious material and clay. On Sundays, and with an occasional lay-off for which one extra shell is provided, more extensive repairs are made, and in this way the lining is made to last several months, — say 10,000 to 20,000 heats. The converter slags are always high in silica and corrode the lining only slightly. If, however, any uncombined oxide of iron comes in contact with it, it is attacked very rapidly. For this reason the mouths of the tuyeres are rapidly eaten away, and this part of the converter lasts only about 20 to 25 blows. The bottom

¹ If we represent the blocks of mica-schist by big books, and lay these books in a horizontal position with the edges of the leaves exposed, it will illustrate the method employed.

is therefore fastened to the body with links and keys, so that it may be readily detached and replaced by a new one. Indeed, in some works bottoms are changed with an average delay to the operation of only about 20 minutes for each replacement.

Bottoms. — The lining of the bottom is made by placing the tuyere-bricks (see Fig. 68) in position and then filling in around them with refractory material consisting of damp silicious material held together with clay and containing usually some coke breeze, which seems to lessen the chemical activity of the corrosion. The details of lining vary so greatly that no general rules can be given. The number of tuyeres is from 18 to 30, the number of holes in each from 12 to 18, and the size of the holes $\frac{3}{8}$ in. (England) or $\frac{3}{8}$ to $\frac{5}{8}$ in. (America).¹ The correct lining is of the greatest

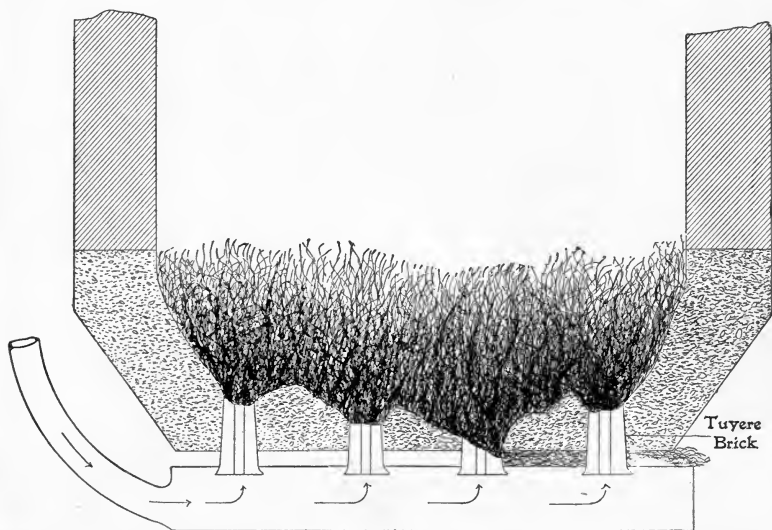

FIG. 71. — CORROSION OF THE BOTTOM LINING OF BESSEMER CONVERTER.

importance and is the most influential factor in determining the life of the bottom, which furthermore depends upon the care in drying, the temperature of blowing, the pressure of blast, and the composition of pig iron. A bottom should dry 36 hours or more. Its life is shortened by (1) hotter blows, (2) longer blows, (3) lower blast pressure (because the blast holds the metal away from the

¹ The acid Bessemer process finds its greatest importance in America, and next to that in England. Germany is the leader in basic Bessemer practice.

mouths of the tuyeres), and (4) more manganese in the pig iron (because a wet slag is more corrosive). Between heats, when the vessel is on its side receiving the recarburizer, pouring into a ladle, or receiving a new charge, the lining of the bottom can be repaired. For instance, if one tuyere eats away faster than its fellows, the excessive corrosion can be prevented by stopping it up with mud, because, if no air passes through the holes, no oxide of iron is formed at their mouths. Or a worn tuyere may be replaced by a new one, etc., etc. These repairs are chiefly made through the wind-box, the back plate of which is removable.

When a bottom is worn out, it is taken away and a new one brought on a car and placed under the converter, which is in the

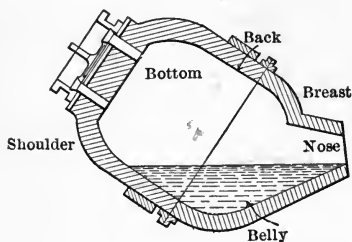

FIG. 72. — CONVERTER PARTS.

vertical position. Around the top is piled a ring of thick wet mud, and, as the bottom is forced up against the body by hydraulic pressure, the mud is squeezed into a firm joint. Lack of space prevents an account of some of the interesting expedients that are resorted to to stop an occasional leak in this joint without delaying the first heat, which

must be avoided if possible, as the first heat on a new bottom is already too liable to be a cold one.

Operation of the Converter. — Figs. 73 and 74 are sections through the converter plant at different points. In Fig. 73, *A* is the mixer, capable of containing, say, 300 tons of metal; *B* is the ladle carriage from the blast furnace, from which the ladle *C* has been raised to pour the metal into the mixer. Immediately above *D* is the ladle that is to take the metal from the mixer to the converter, for which it is transferred along a level track until it comes to *E* (Fig. 74), where it is poured into the vessel, now in the horizontal position, as shown by the dotted line. When the metal has been poured in, the wind is turned on and the vessel elevated into the vertical position. The blast now pours through the 18 inches or so of metal in the bottom of the converter in a wide spray of tiny bubbles until the impurities are oxidized, when it is turned again into the horizontal position and the wind cut off. In anticipation of this a predetermined quantity of spiegeleisen

has been tapped from the spiegel cupola into the ladle at *H* (Fig. 73). (For soft steel ferromanganese, not spiegeleisen, is used.)

Spiegeleisen is pig iron very high in manganese. Some analyses

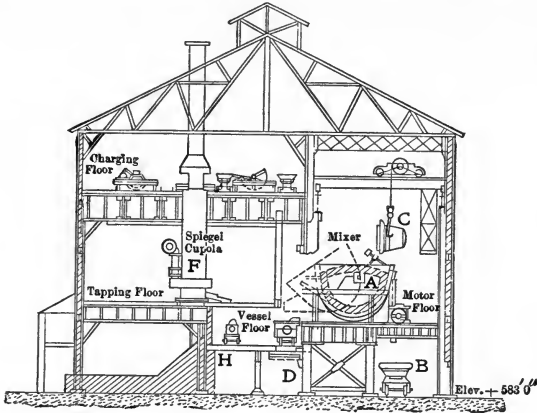

FIG. 73.

are given in Table XII. It is melted in the spiegel cupola together with a predetermined amount of high silicon pig iron, and is then used to recarburize the bath in the vessel, for which purpose the

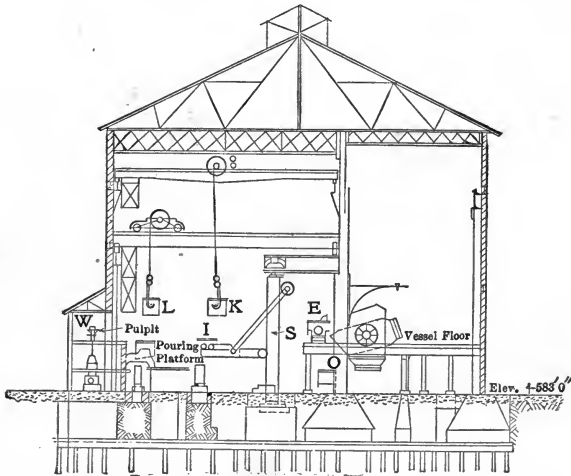

FIG. 74.

ladle is now run into the position *E* (Fig. 74) and its contents poured into the bath. The reactions that take place between the

TABLE XII.—ANALYSIS OF VARIOUS GRADES OF PIG IRON

NAME	Silicon Per cent.	Sulphur Per cent.	Phosphorus Per cent.	Manganese Per cent.	Carbon Per cent.	
Foundry Irons	No. 1.....	2.75	0.035	0.30 to 1.50	0.20 to 1.60	3.00 to 4.00
	No. 2.....	2.25	0.045	"	"	"
	No. 3.....	1.75	0.055	"	"	"
	No. 4.....	1.25	0.065	"	"	"
Forge.....	0.75 to 1.75	0.05 to 0.30	0.30 to 3.00	0.20 to 1.50	"	
Bessemer—Acid.....	0.80 to 2.00	0.03 to 0.08	under 0.10	0.30 to 0.50	3.50 to 4.00	
Bessemer—Basic.....	under 1.00	under 0.10	2.00 to 3.00	1.00 to 2.00	"	
Open-hearth—Acid.....	under 0.050	under 0.05	0.30 to 0.50	"	
Open-hearth—Basic.....	under 1.00	0.10 to 2.00	1.00 to 2.00	"	
Ferromanganese.....	0.50 to 1.00	under 0.03	0.10 to 1.00	80.00	5.00 to 7.00	
Ferromanganese.....	under 1.00	under 0.03	0.10 to 0.50	40.00	5.00 to 6.00	
Spiegeleisen.....	under 1.00	under 0.05	under 0.15	15.00 to 30.00	5.00 to 6.00	
Ferrosilicon.....	8.00 to 15.00	under 0.07	0.10 to 0.50	1.00 to 2.00	
Ferrosilicon.....	50.00	under 0.02	under 0.08	under 0.40	
Silico-Spiegel.....	8.00 to 15.00	under 0.01	under 0.15	15.00 to 20.00	1.00 to 1.50	

elements in the recarburizer and the impurities in the bath are as follows:

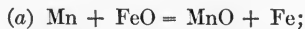

Reaction (b) produces a boil of the bath, which serves to stir it well and distribute the elements uniformly. Reaction (a) removes a

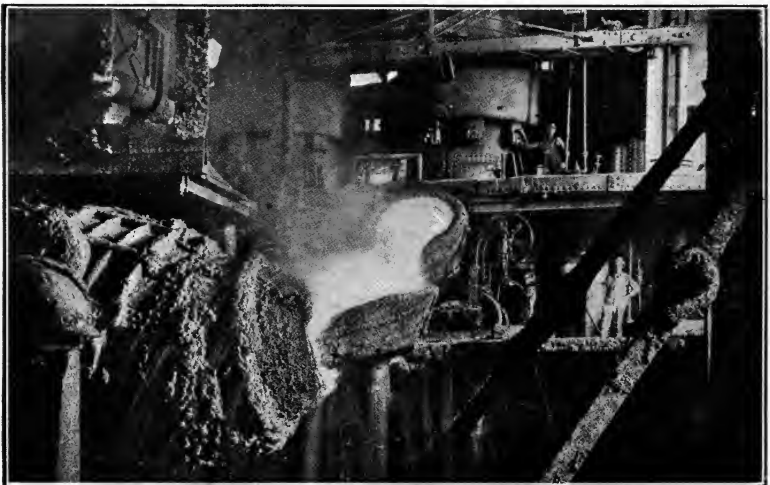

Converter.

Cupola.

Ladle.

Runner.

FIG. 75.—POURING METAL INTO THE CONVERTER.

large amount of oxygen from the metal and takes some of the manganese in the recarburizer into the vessel slag. There is also

a slight loss of silicon from the recarburizer by the following reaction:

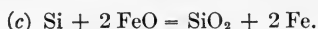

All of these losses are discounted in calculating the composition and amount of metal tapped from the spiegel cupola, so that there should be left in the steel the desired percentage of carbon, silicon, and manganese.

After the 'spiegel reaction' is completed, the steel is poured from the converter into a ladle held at the point *O* by the jib-crane *I*, or by one of the traveling cranes *K* or *L*. The ladle is then carried over to a position above the ingot molds into which the steel is to be teemed. In pouring the steel into the ladle, the slag is held back in the vessel as much as possible, because this not only furnishes heat for the next operation, but also makes it shorter by as much as 20 or 25 per cent., because the slag, being an oxidized substance, assists in oxidizing the impurities in the next charge.

The turning on and off of the blast and the rotation of the converter is all executed by the blower, who stands upon the pulpit at *W* and operates the various valves, and also judges by eye the progress of the purification from the appearance of the flame which issues from the mouth of the converter.

Every effort is made by him to so arrange the different operations of the converter, cranes, and ladles and to bring in both spiegeleisen and iron, that each step shall fit into the others without delay to the operation in any of the converters. He also has under his control means for lowering the temperature of the bath, if necessary: (*a*) By ordering an amount of cold steel scrap to be thrown into the mouth of the vessel during the blow¹ and (*b*) by admitting live steam into the converter with the blast. The decomposition of the steam very quickly reduces the heat of the blow. Attempts have been made to dispense with the blower, who, on account of the long training and experience necessary, is the most highly paid man in the plant, next to the foreman, by judging of the progress of the operation with the spectroscope; but when two or three vessels are blowing at the same time the reflected light from one interferes with the spectroscopic indications of the others. Furthermore, the spectroscope gives no indications of the temperature of the blow, and until the past two or

¹ Scrap is so valuable for use in the open-hearth process that (*b*) is now used much more than (*a*).

three years no reliable pyrometer existed which was suitable for this use.

Steel Ladles. — The ladles to receive the steel and teem it into molds are steel shells lined with a cheaper grade of acid refractory material, because the life of these ladles is limited to about six

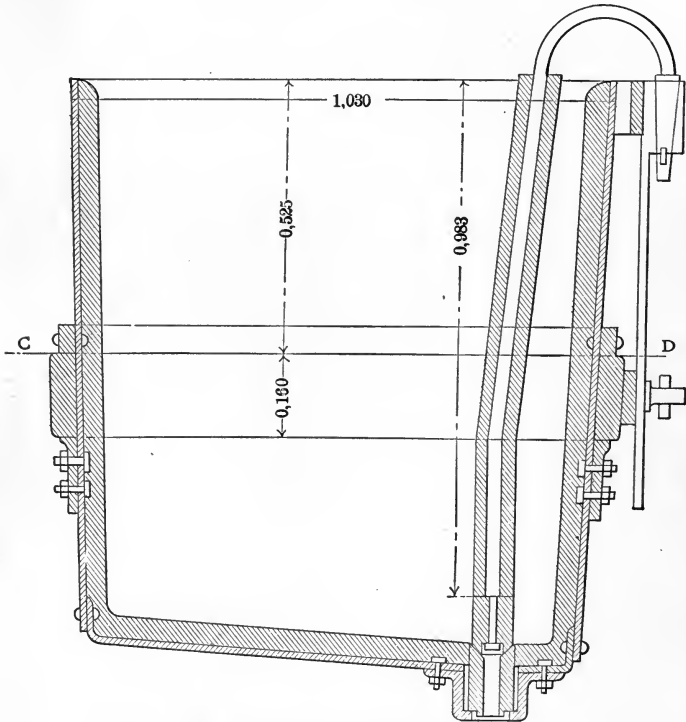

FIG. 76. — FIFTEEN-TON STEEL TEEMING LADLE.

heats by the wearing out of the nozzle, and therefore a more expensive lining would be wasted. The arrangements of nozzles, stoppers, and handle shown in Fig. 76 are provided in order that a thin stream of steel may be poured into the molds and may be interrupted when a new mold is being brought into place. The slag lies on top of the metal, and when this begins to come out of the nozzle the stopper is let down and the ladle carried over a slag car and turned upside down to dump out the slag. At this time the blower observes the lining of the ladle in order to tell whether the

steel was too hot or too cold. If there is a skull of metal frozen inside the ladle, the steel was too cold; if there is no frozen metal, it was too hot; but if there is a spot of metal here and there on the bottom, it was just right.

Ingot Molds, Stools and Cars. — The arrangement of the molds into which the ingots are to be cast is shown in Fig. 78, which also gives the dimensions of molds commonly used for railroad rails, wire, and pipe. Molds last about 100 heats, after which they are so cracked inside that they are with difficulty lifted off the solidified ingot of steel, and are also very liable to tear it, producing cracks which are not easily welded up later because they become



FIG. 77. — TEEMING INTO MOLDS.

oxidized on the interior. A continuous series of mold cars are fed into the steel-mill at one end and drawn out, with the ingot inside, at the other end. They should be heated so hot that the palm of the hand will not bear the heat on the outside, and are washed inside with a thin clay wash which prevents the liquid metal sticking to the cast iron. At the pouring platform they are moved

forward under the ladle by means of a little finger, which enters a notch in the side of the car and is itself carried on the rod of a hydraulic piston.

Stripping. — As soon as they can be run out to the stripping house; the ingots are solidified sufficiently on the outside for the mold to be removed, leaving the ingot standing on the car ready to be drawn to the rolling-mill. In the majority of cases it is only necessary to place the jaws of the stripping machine under the lugs on the mold, raise it up to a sufficient height, and then trans-



FIG. 78. — INGOT MOLDS, STOOL AND CAR.

5000-lb. molds: 7 ft. high, $15\frac{1}{2}$ in. square at top, $19\frac{1}{2}$ in. at bottom; about $2\frac{1}{2}$ in. thickness of cast iron.

fer it to a stool on a car in the second track of the stripping house. Sometimes the ingots do not come out so easily, however, and then the plunger is rested on top of the ingot, which is held down by the hydraulic pressure as the mold is drawn upward. Most stripping machines are actuated by hydraulic power, although electric

ones are common. The empty molds are stored in the yard until they are sufficiently cool to be drawn back to the steel-mill for another charge, and during the wait they are washed inside with clay water, which is quickly dried by the heat of the mold.

Chemistry of the Acid Bessemer Process. — If a stream of air be made to impinge upon a melted bath of iron, the metal and impurities will be immediately oxidized, about in proportion to the

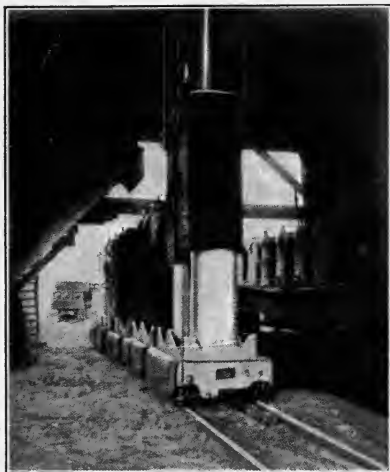

FIG. 79. — STRIPPING.

relative amounts of each present. We may therefore consider the chemistry of the Bessemer process as a union of the oxygen from the tuyeres with the first element it meets, irrespective of relative affinity, and a subsequent attack upon these oxidized elements by unoxidized ones for their oxygen. As iron is the predominant element, and as the oxides of iron are readily reduced, they especially serve as carriers of oxygen between the air and other impurities:

1. $\text{FeO} + \text{Mn} = \text{Fe} + \text{MnO}$.
2. $\text{FeO} + \text{C} = \text{Fe} + \text{CO}$.
3. $2\text{FeO} + \text{Si} = 2\text{Fe} + \text{SiO}_2$.

In the first part of the blow, the oxides of carbon also suffer reduction:

4. $2\text{CO} + \text{Si} = \text{SiO}_2 + 2\text{C}$.
5. $\text{CO}_2 + \text{Si} = \text{SiO}_2 + \text{C}$.
6. $\text{CO} + \text{Mn} = \text{MnO} + \text{C}$.

Equilibrium is therefore established by the elements which have the greatest chemical affinity for oxygen getting practically all of that agent, either directly or by robbing their neighbors. Some iron oxide survives, however, because it is so predominant in amount that its neighbors cannot rob it before a part of it has united with silica, which is either formed by the oxidation of silicon or else won from the lining:



The ferrous silicate forms a slag with manganese silicate, and this slag will dissolve oxides of iron. Even after the oxide of iron has been absorbed by the slag, it may be reduced by manganese and carbon, although not to the same extent. Practically no oxygen of the air escapes from the bath uncombined, even though it has but 18 in. of metal to pass through and amounts to more than 5000 cu. ft. per minute,¹ because the blast pressure is made high in order that the air may be broken up into a fine spray of bubbles as soon as it strikes the metal and thus offer a large surface of contact for chemical reaction.

Slag Formation. — Manganese oxide unites with silica:



and it is perhaps for this reason that manganese, unless very high (say over 2 per cent.), is removed early in the blow. The silicates of iron and manganese dissolve in each other and form a slag, and this slag will dissolve large amounts of iron oxide, manganese oxide, silica and alumina, the latter coming from the vessel lining. At all times the bath is so violently agitated that the metal and slag are intimately mixed, and the reducing effect of manganese, silicon and carbon on the iron oxide dissolved in the slag limits it in amount. The slag itself therefore serves as a carrier of oxygen to the impurities.

Critical Temperature. — As the temperature rises, chiefly on account of the oxidation of silicon, the chemical affinity of carbon for oxygen increases relatively more than that of the other impurities, and reaction No. 4 ceases and then reverses:

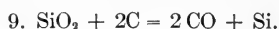

What the critical temperature of this reversal is has never been

¹ Air is composed of 20.8 parts, by volume, of oxygen and 79.2 parts of nitrogen, and the amount of blast per minute is 15,000 to 30,000 cu. ft.



FIG. 80. — SOAKING PIT HEATING FURNACES AT ROLLING MILL WHICH RECEIVE THE RED HOT, NEWLY STRIPPED INGOT.

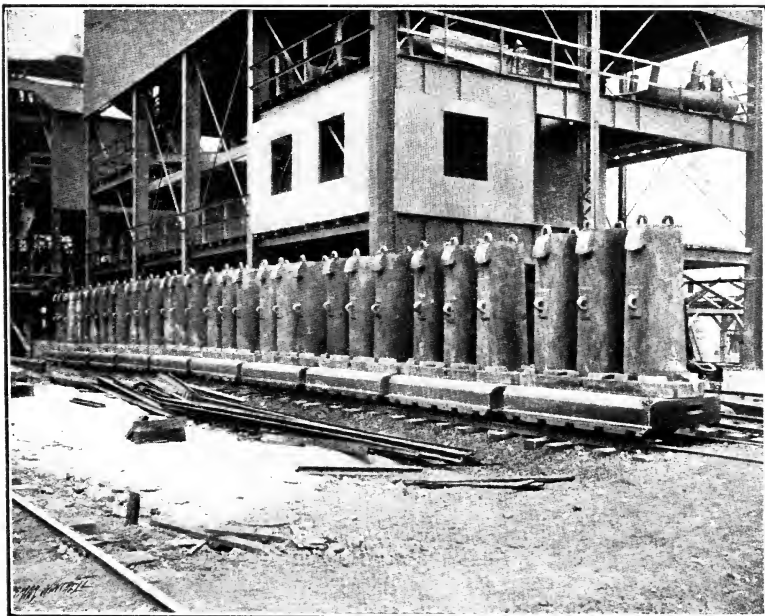

FIG. 81. — LINE OF COOLING INGOT MOLDS OUTSIDE BESSEMER MILL.

determined, but we may estimate it as being somewhere between 1450° and 1550° C. (2642° to 2822° F.), and unless the silicon is all oxidized before this temperature is reached, we shall have 'residual silicon' in the steel. In English Bessemer practice, where silicon is often above 2 per cent. of the pig iron, this is not

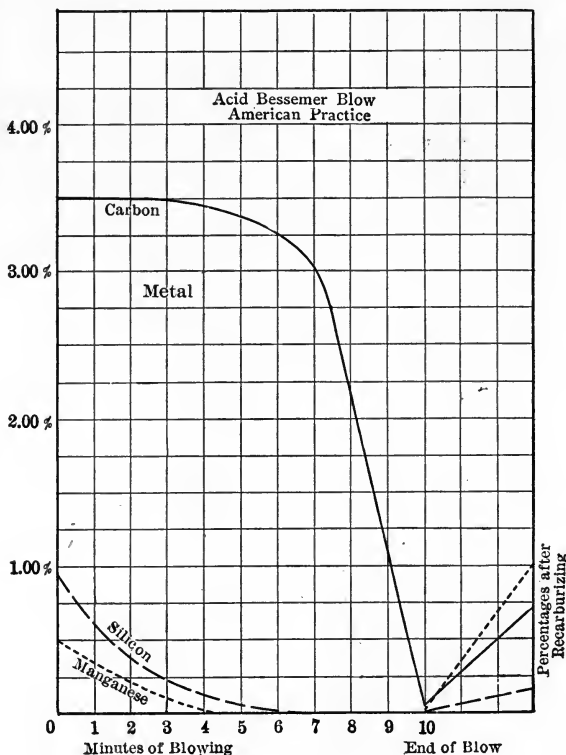
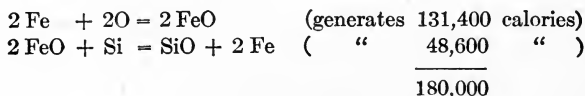

FIG. 82.

rare, because the high silicon takes longer to go and also increases the temperature:



¹ It is immaterial from the heat standpoint whether oxidation takes place directly or as a result of two reactions:



There is also a critical temperature for manganese oxidation, above which reaction No. 6 is reversed and residual manganese is left in the steel; but this happens only when the manganese in the pig iron is very high. No warning is given that the temperature is approaching these critical points, because no flame — nothing but sparks — comes from the mouth of the converter until carbon begins to burn, and therefore no indication is given to the operator of the degree of heat until too late.

Second Period. — The second period begins when the carbon commences to burn, which happens in America only after the

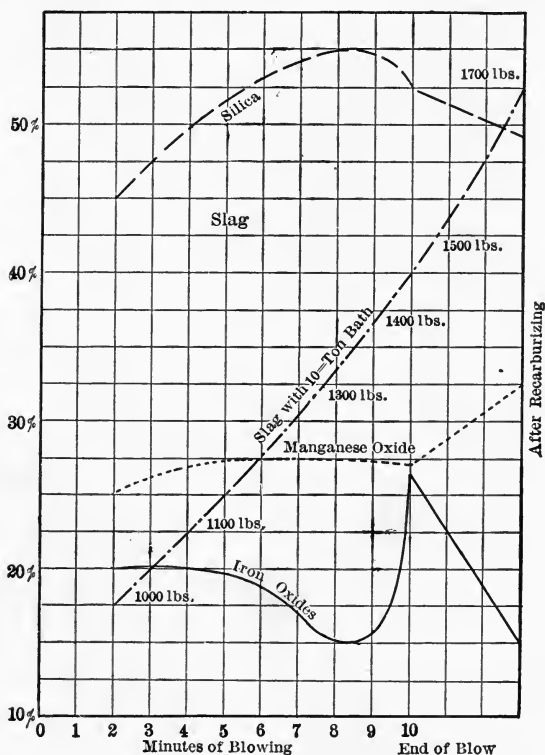

FIG. 83.

silicon and manganese have been almost eliminated, as shown by Tables XIII and XIV and Figs. 82 and 83. During this period the reactions consist principally of the oxidation of carbon, although a little silicon passes off at the same time. Further details will be

TABLE XIII.—REMOVAL OF IMPURITIES IN THE BESSEMER CONVERTER, WITH ACCOMPANYING SLAG-ANALYSES

TIME AFTER COMMENCEMENT OF BLOW		REMOVAL OF METALLOIDS—PER CENT.					Authority *	ANALYSIS OF CORRESPONDING SLAGS—PER CENT.											
		C	Si	Mn	P	S		SiO	Al ₂ O	FeO	Fe ₂ O ₃	Iron as Shots	MnO	CaO	MgO	P	S	Alkalies	
Min.	Sec.																		
Pig iron.		2.98	0.94	1.43	0.100	0.06	Howe, American 39	42.40	5.63	40.29	4.36	6.54	1.22	0.36	0.008	0.009	
2	0	2.94	0.63	0.09	0.104	0.06		50.26	5.13	34.24	0.96	7.90	0.91	0.34	0.008	0.009	
3	20	2.71	0.33	0.04	0.106	0.06		62.54	4.06	21.26	1.93	8.79	0.88	0.34	0.010	0.014	
6	3	1.72	0.03	0.03	0.106	0.06		63.56	3.01	21.39	2.63	8.88	0.90	0.36	0.014	0.008	
8	8	0.53	0.03	0.01	0.107	0.06													
9	10	0.04	0.02	0.01	0.108	0.06		62.20	.276	17.44	2.90	13.72	0.87	0.29	0.010	0.011	
Steel.		0.45	0.038	1.15	0.109	0.059			Al ₂ O ₃										
									&P ₂ O ₅										
Pig iron.		3.55	2.39	0.49	0.09		King, American 40	62.65	7.98	1.93	10.52	15.78	0.65	0.52
8	0	3.21	1.08	0.15			73.24	4.51	0.00	8.72	11.83	1.11	0.64
15	0	1.25	0.11	0.13	0.09	75.63		5.19	0.00	7.70	10.92	0.96	0.38	
17	0	0.207	0.06	0.13	0.08	61.30		4.24	13.47	9.12	10.82	0.75	0.29	
18	0	0.034	0.04	0.10	64.15		5.71	13.95	2.39	12.81	0.75	0.24	
Steel.		0.370	0.06	1.17	0.09			Al ₂ O ₃										
Pig iron.		3.93	1.96	3.46	0.040	0.018	Bell, English 41	40.95	8.70	0.60	2.18	30.35	16.31	0.01	0.34	0.32		
After slagging.		2.465	0.443	1.645	0.040	trace		46.78	4.65	6.78	37.00	2.98	1.53	0.03	0.04	trace		
End of boil.		0.949	0.112	0.429	0.045	"		51.75	2.98	5.50	37.90	1.76	0.45	0.02	trace	"		
End of blow.		0.087	0.028	0.113	0.045	"	46.75	2.80	16.86	32.23	1.19	0.52	0.01					
Pig iron.		4.00	1.02	1.83	Bangbro, Sw. 42	50.20	3.86	1.80	5.44	27.22	10.88		
3	0	4.30	0.03	0.22		55.26	2.86	14.20	26.31	0.62	0.22		
4	45	0.90	0.03	0.12		47.20	2.70	18.52	31.01	0.38	0.14		
5	45	0.10	0.03	0.09		40.50	2.24	31.19	25.43	0.32	0.11		
Pig iron.		3.94	1.14	0.64	Langlytt'n, Sw. 42	46.50	12.90	0.90	0.58	32.07	6.75		
2	15	4.20	0.04	0.12		48.76	0.78	34.72	13.95	2.60	0.24		
4	30	1.10	0.03	0.12		59.82	0.98	21.08	15.48	3.25	0.30		
5	0	0.05	0.01	0.06		48.48	0.72	35.82	12.29	2.35	0.21		
Pig iron.		4.49	1.08	0.83	Sandviken, Sw. 42	51.00	2.56	0.90	3.40	31.80	9.03		
3	0	3.87	0.03	0.11		53.44	1.84	20.24	23.90	0.44	trace		
5	0	1.30	0.03	0.09		57.80	1.94	17.04	22.80	0.46		
5	45	0.33	0.02	0.07		55.76	1.58	18.48	22.23	0.36		
Pig iron.		4.35	0.88	1.15	Ny Kroppa, Sw. 42	47.16	5.83	0.77	2.14	21.79	22.18		
2	30	4.10	0.10	0.15		53.26	2.28	13.50	29.76	0.42	0.23		
5	30	1.00	0.05	0.15		62.34	3.90	9.54	23.70	0.60	0.28		
6	30	0.08	0.04	0.08		44.52	2.14	30.60	21.39	0.38	0.21		
Pig iron.		4.22	1.06	5.12	West-tanfors, Sw. 42	46.72	4.36	0.70	11.16	19.10	18.37		
4	15	4.20	0.43	3.26		45.87	3.08	4.20	46.38	1.26	0.54		
8	35	1.30	0.12	0.85		39.07	2.49	6.24	52.26	0.70	0.29		
9	20	0.55	0.07	0.43		37.63	2.94	9.45	48.92	1.00	0.46		
Pig iron.		3.5	1.70	1.50	0.05	Basic, Bell, 41a	32.6	7.26	0.60	
3	0	3.6	0.80	1.50	0.05		42.6	2.57	0.15		
6	0	3.4	0.28	1.63	0.05		36.0	5.91	1.60		
9	0	2.4	0.05	1.43	0.05		35.6	6.17	2.61		
12	0	0.09	0.01	1.42	0.05		33.0	7.89	5.66		
14	30	0.075	0.0	1.20	0.05		15.6	13.43	15.06		
16	30	0.0	0.0	0.08	0.05													

* See No. 52, page 125.

TABLE XIV.—REMOVAL OF IMPURITIES IN THE BESSEMER PROCESS

TIME AFTER COMMENCEMENT OF BLOW	REMOVAL OF METALLOIDS—PER CENT.					References and Remarks
	C	Si	Mn	P	S	
Min. Sec.						
Pig iron.	3.52	3.00	1.25	German method. "Leaving Silicon in the Bath," <i>Stahl und Eisen</i> , vol. iii, pp. 262-264.
5 0	3.6	2.0	0.60	
10 0	3.3	1.25	0.20	
15 0	2.5	0.75	0.10	
20 0	1.0	0.65	trace	
25 0	trace	0.35	
Pig iron.	3.5	3.0	0.75	German method. Same reference.
5 0	3.6	1.75	0.25	
10 0	3.3	1.25	trace	
15 0	2.5	0.9	
20 0	1.0	0.7	
25 0	trace	0.5	
Pig iron.	3.52	1.85	1.93	German method. Carl Rott. 31
4 30	2.78	1.21	1.69	
13 0	0.43	0.93	1.00	
16 0	0.05	0.28	0.37	
Steel....	0.23	0.27	0.62	
Pig iron.	3.57	2.26	0.04	English method. Carl Rott. 31
6 0	3.95	0.95	trace	
12 0	1.64	0.47	"	
18 0	0.19	trace	"	
Steel....	0.37	"	0.54	
Pig iron.	3.270	1.952	0.086	0.048	0.014	English method. Snelus. See <i>Encyclopædia Britannica</i> , American ed., vol. xiii, p. 334.
6 0	2.170	0.795	trace	0.051	trace	
9 0	1.550	0.635	"	0.064	"	
13 0	0.097	0.020	"	0.067	"	
Steel....	0.519	0.033	0.309	0.053	"	
Pig iron.	3.5	2.25	1.0	<i>Stahl und Eisen</i> , vol. iii, pp. 262-264.
5 0	3.6	1.0	0.35	
10 0	3.3	0.5	0.2	
15 0	3.25	0.2	trace	
20 0	2.0	0.1	
25 0	trace	trace	
Pig iron.	3.50	1.50	0.71	1.57	0.16	"Basic Process," <i>Stahl und Eisen</i> , vol. iii, pp. 262-264.
5 0	3.55	0.50	0.56	1.60	0.14	
10 0	2.35	0.09	0.27	1.43	0.13	
15 0	0.07	trace	0.12	1.22	0.12	
18 0	trace	trace	0.08	0.10	
Pig iron.	2.97	0.53	0.61	1.22	0.15	"Basic Process," by Müller, at Hörde, <i>Encyc. Brit.</i> , p. 346.
4 30	2.480	0.009	0.247	1.250	0.206	
9 15	0.811	0.0	0.0	1.320	0.262	
11 15	0.049	0.0	0.0	0.786	0.262	
13 0	0.0	0.0	0.123	0.021	0.206	

learned from the tables and figures. It is interesting to note that the phosphorus and sulphur in the metal are not eliminated, because the acid slag will not dissolve them even if they become oxidized. For this reason the percentage of these impurities increases slightly during the blow, because their actual weight remains the same, while the weight of the bath decreases.

TABLE XV. — ANALYSES OF BOTTOM-BLOWN CONVERTER-GASES

TIME AFTER STARTING BLOW	PER CENT.					Reference *
	CO	CO ₂	O	H	N	
2 min.		10.71	0.92		88.37	} Sir Lothian Bell. 37
4 "	3.95	8.59		0.88	86.58	
6 "	4.52	8.20		2.00	85.28	
10 "	19.59	3.58		2.00	74.83	
12 "	29.30	2.30		2.16	66.24	
14 "	31.11	1.34		2.00	65.55	
18 "	End of blow.					
3 to 5 min.		9.127	4.762		86.111	} 38
9 to 10 " ...	17.555	5.998	1.699	0.908	73.840	
21 to 23 " ...	19.322	4.856	0.967	1.120	73.735	
26 to 27 " ...	14.311	1.853	0.550	1.699	81.587	
2 to 3 min.		6.608	7.256		86.137	} 38
8 to 10 " ...	15.579	5.613	1.296	1.112	76.400	
12 to 15 " ...	25.580	4.144	0.980	1.040	68.256	
17 to 19 " ...	25.606	2.995	1.318	1.120	68.961	

* See No. 52.

Gases. — In connection with Table XV it is interesting to note what a large proportion of the carbon is oxidized to the monoxide, and this is the more important because this formation generates only 29,160 calories, while the higher oxidation generates more than three times as much:



Thus a large amount of heat is wasted, and is generated only when the flame passes out of the mouth of the converter and unites with more oxygen. When the heat of a charge is too low, it is customary at some plants to tip the converter forward or backward, so that a few tuyere holes will be above the level of the bath and will blow free air into the interior of the converter. This results in a portion of the carbon monoxide being oxidized to carbon dioxide

inside the converter, and is a limited means of making the blow hotter. Oxidation of additional iron produces the same effect.

Slag. — In Table XIII the lime and magnesia in the slag come from a small amount of blast-furnace slag which finds its way to the converter through the mixer, in spite of efforts made to hold it back at all points when pouring. Because the blast-furnace slag is basic, it has the effect in the converter of making the slags wet and sloppy, and therefore increasing the loss. Although the iron as shot is only shown in one case, this is not because it is absent in the other cases, but merely because it was not determined. At all times the slag carries a great many pellets of iron, which should be added to the combined iron, since they represent a loss in the process. It is interesting to note how closely the amount of iron in the slag, after adding the spiegeleisen, approximates 15 per cent.,¹ and there seems to be a chemical balance which fixes this amount as a condition of equilibrium. When the silicon in the pig iron is higher, and therefore the amount of slag made is larger, there is a slightly lower percentage of iron oxide in it. The practice of 'side blowing for heating,' described above, has the effect of increasing the amount of iron oxide in the slag by increasing the oxidizing influences in the interior of the converter. The rise in manganous oxide in the slag during recarburizing is, of course, due to the formation of MnO by the action of the manganese on the oxygen of the bath, while the iron oxide in the slag is reduced at the same time by the action of manganese and carbon.

The weight of slag at different periods of the Bessemer process has been calculated by H. H. Campbell² from its analyses, with the following average results:

TABLE OF SLAG WEIGHTS IN BESSEMER PROCESS

Percentage of blow finished		Pounds of slag	Percentage of charge
20	Silicon flame	1035	4.5
36	Brightening	1146	5.1
66	Carbon flame	1255	5.5
89	Full carbon flame	1385	6.1

¹ Not including pellets, which average 6 to 8 per cent. of the slag.

² See page 158 of No. 2. Old edition, 1904, on page 8 herein.

The final amount of slag made will probably average about $7\frac{1}{2}$ to 8 per cent. of the weight of the metal produced, or, roughly, 7 per cent. of the weight of the pig iron charged.

Flame. — A flame is the result of burning gas, and as practically the only gas in this process is carbon monoxide, there is no flame except during the period when the carbon is burning. In the first part of the blow a large number of small sparks issue from the mouth of the converter, consisting mainly of pellets of iron and slag ejected by the blast. At the end of the first two or three minutes, a small tongue of reddish-yellow flame begins to pour from the mouth, showing that the carbon is beginning to be oxidized. This soon increases in size and brilliancy until a white-hot flame, 30 ft. in height, pours from the vessel with a loud roaring sound caused by the boiling of the bath and the passage of the blast and gas through it. This boil lasts until the end of the operation, and the bath is at all times violently agitated and intimately mixed with the slag, which greatly facilitates the reaction between the two. The process at this period presents a spectacle which is almost unmatched as a pyrotechnic display. Soon the flame begins to flicker or 'feather' at the edges, as a warning that the carbon is becoming low, and finally it shortens or drops, whereupon the converter is immediately turned down and the blast stopped. The carbon at this time will be about 0.03 to 0.10 per cent., depending on how 'young' or how 'full' was the blowing.

At all times there is a varying amount of slag and metal thrown out of the mouth, so that the converter may be likened to a fountain of sparks, the great bulk of which consists of slag. Throughout the blow there is also a constant stream of fume issuing with the flame. It is a brownish-red smoke, which rises to a good height and consists principally of oxide of iron and manganese. Dr. Charles F. Chandler, Professor of Chemistry at Columbia University, while observing this smoke at the Homestead steel-works, suggested to me that it might be due to the formation in the bath of iron carbonyl, a volatile compound of iron, carbon and oxygen ($\text{Fe}(\text{CO})_5$), and perhaps of manganese carbonyl.

Loss. — The difference in weight between the pig iron charged into the converter and the steel ingots made will be 8 per cent. in good practice, although running above that (say to 10 per cent.) in some mills. This is distributed as follows:

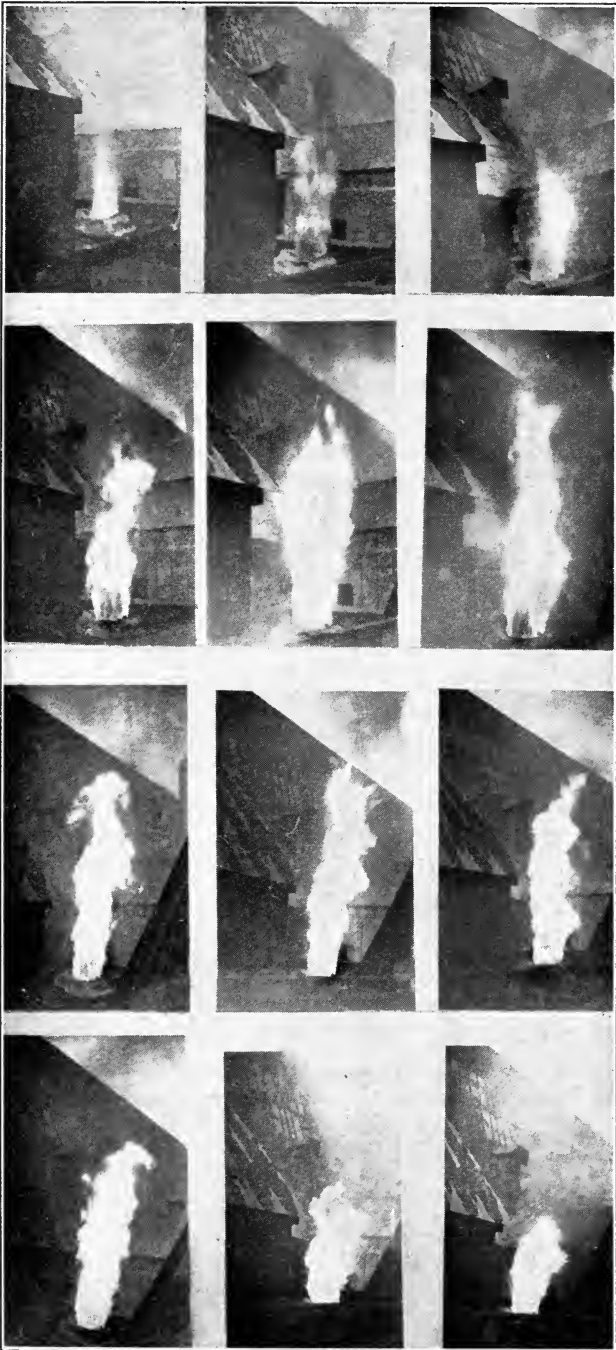

FIG. 84. — BESSEMER FLAMES DURING A BLOW.

Carbon burned.....	3.5	per cent.
Silicon burned.....	1.0	"
Manganese burned.....	0.5	"
7 per cent. slag @ 15 per cent. Fe.....	1.0	"
7 per cent. slag @ 7 per cent. iron pellets.....	0.5	"
Volatilized and ejected.....	1.5	"
	8.0	"

Recarburizing. — It might be thought that a more economical method could be found than that of burning up all of the carbon in the pig iron and then adding the desired amount, and in fact such a method is employed in Sweden, where the carbon is burned down to the desired point, as estimated by the appearance of the sparks issuing from the converter, the vessel being then turned down and the charge held until a hammer-test confirms this estimate. Such a complicated procedure, however, requires a hotter bath and very slow working, and it is much cheaper to burn the carbon until the drop of the flame and then add the requisite amount. In making rail-steel to contain about 0.50 per cent. carbon, we will add to 15 tons of blown metal about 3000 pounds of melted spiegeleisen, containing roughly 6 per cent. of carbon, 12 per cent. of manganese, and 1.50 per cent. of silicon. The mixture charged into the spiegel cupola for melting must be higher in manganese than this, as there is a loss into the cupola slag by oxidation.

In making dead-soft steel for wire, material to be welded, etc., we add ferromanganese as high in manganese as possible. This material will contain about 7 per cent. of carbon, 80 per cent. of manganese, and 13 per cent. of iron. It is only necessary to add about 500 pounds to a 15-ton bath, and therefore it will dissolve without being melted, although it is customary to heat it to a red heat in order to lessen the chilling of the metal. This dead-soft material will then have the requisite amount of manganese, but will be low in carbon and frequently less than 0.01 per cent. in silicon. It is not improbable that pure manganese metal, if it were readily obtainable, would be used in many cases instead of ferromanganese, in order that the carbon might be still lower. Ferromanganese and spiegeleisen are made in the blast furnaces by smelting very high manganese ores in a manner somewhat similar to the smelting of pig iron.

Calorific Equation of the Acid Bessemer Operation. — The predominant part that silicon plays in furnishing heat for the acid

Bessemer process is shown by a calorific calculation. In making this, let us assume that we have a charge of pig iron weighing 30,000 lb., and that we burn: silicon = 1.00 per cent.; manganese = 0.40 per cent.; carbon = 3.50 per cent.; iron = 2.00 per cent. And let us assume further that the average temperature during the operation will be 1500° C., and that the atmosphere is at 0° C. Then:

	Pound-calories	Surplus pound-calories
Si + 2O = SiO ₂ produces.....	1,900,000	
28.4 2 × 16		
300 lb. ¹ + 338 lb. = 638 lb.		
338 lb. of oxygen = 1470 lb. air.		
Specific heat air = 0.268 cal. per lb.		
1470 lb. × 1500° C. × 0.268 =	<u>591,000</u>	1,309,000
Mn + O = MnO produces.....	198,000	
55 16		
120 lb. ² + 35 lb. = 155 lb.		
35 lb. oxygen = 152 lb. air.		
152 lb. × 1500° C. × 0.268 =	<u>61,000</u>	137,000
C + O = CO produces.....	2,552,000	
12 16		
1050 lb. + 1400 lb. = 2450 lb.		
1400 lb. oxygen = 6087 lb. air.		
6087 lb. × 1500° C. × 0.268 =	<u>2,447,000</u>	105,000
Fe + O = FeO produces.....	704,000	
56 16		
600 lb. + 171 lb. = 771 lb.		
171 lb. oxygen = 743 lb. air.		
743 lb. × 1500° C. × 0.268 =	<u>299,000</u>	405,000
Total net heat from chemical reactions =		<u>1,956,000</u>

¹ 30,000 lb. × 1 per cent. = 300 lb.

² 30,000 lb. × 0.40 per cent. = 120 lb.

Now let us suppose that the specific heat of the metal is 0.20 calories per pound, per degree Centigrade; then how many degrees will it be raised by the heat produced in the chemical reactions of the blow?

30,000 lb. × 0.20 cal. = 6,000 cal. per 1° C.

1,956,000 cal. ÷ 6,000 cal. = 326° C. Answer.

This simple calculation neglects the heat lost by radiation through the vessel lining, and the heat necessary to raise the silicon, manganese and carbon of the bath from their temperature at the beginning of the blow, to 1500° C., and also leaves out of account the

heat produced by the combination of FeO and MnO with SiO₂ to form the slag. All these figures are relatively less important, but those who desire to calculate with greater delicacy should consult J. W. Richards' very thorough little book, No. 53, Part II, pages 307-354.

Basic Bessemer Process. — The basic vessel is almost the same as the acid, except that the lining is made of calcined dolomite held

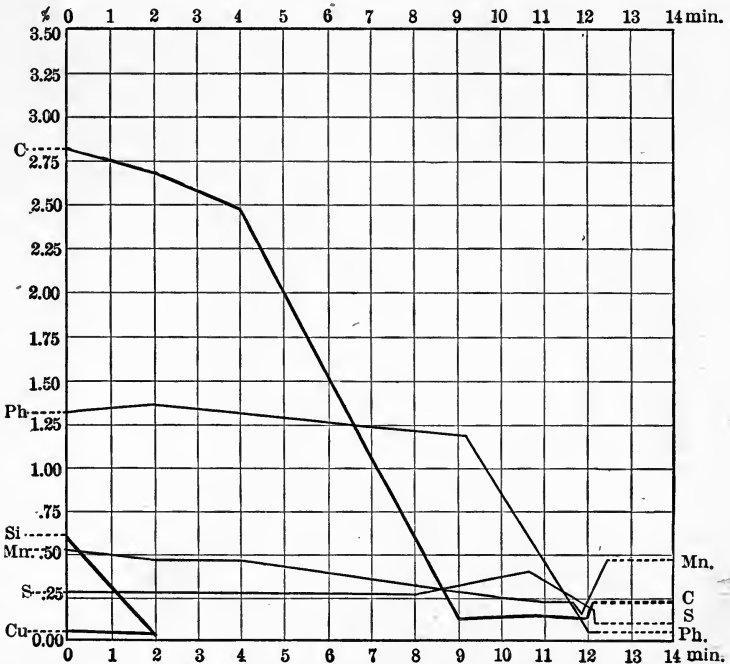

FIG. 85. — REMOVAL OF IMPURITIES IN BASIC BESSEMER PROCESS.

together by about 10 per cent. of tar and rammed in around a pattern while still warm. In ramming up the bottom wooden pins are rammed in with the lining, and when withdrawn they leave $\frac{1}{2}$ -in. tuyere-holes, through which the blast enters. The object of the lining is to resist the chemical action of the slag, and it is not desired to have it enter in any way into the chemical reaction. Before beginning the blowing, lime is added to the bath, equivalent in weight to 14 to 20 per cent. of the iron, in order that it may form a basic slag, take up all the silica formed, and prevent this uniting with the lining.

The basic blow is similar to the acid one up to the point where the carbon is eliminated and the flame drops, before which practically no phosphorus is oxidized, as its chemical affinity for oxygen is less than that of carbon. The blow is then continued for a few minutes to form what is known as an 'after-blow,' during which the phosphorus is oxidized and absorbed by the basic slag, probably in the form of calcium phosphate. There is also an elimination of sulphur at the same time, although this is never a very satisfactory action. The indication given by the flame during the after-blow is not a good guide, and the operation is usually controlled by continuing the blow for the given number of minutes, or the given number of revolutions of the blowing engine, after the drop of the flame which experience has proved will produce the desired dephosphorization. Before the recarburizer is added, a sample of metal is ladled out of the bath, quickly cooled, and broken, so that the appearance of its fracture may be used as a final estimation of the elimination of phosphorus.

Recarburization of the basic heat cannot take place in the converter, because the carbon monoxide formed at this time is liable to reduce phosphorus from the slag and cause rephosphorization of the metal. At the end of the blow the slag is therefore poured off the bath as completely as possible, and then the rest is held back in the vessel when the metal is poured into the ladle. The amount of basic slag made will be about 25 per cent. of the weight of iron charged and will contain about 9 per cent. of iron. The loss of metal will be much higher than in the acid process, averaging perhaps 13 to 17 per cent., a part of which is due to the fact that the pig iron used contains a larger amount of impurities to be oxidized:

Carbon.....	3.7 per cent.
Silicon.....	0.5 "
Manganese.....	1.5 "
Phosphorus.....	2.5 "
25 per cent. of slag @ 9 per cent. Fe.....	2.3 "
Pellets.....	1.0 "
Fume and ejected.....	1.5 "
	13.0 "

The demand for a given composition of pig iron for the basic process is even more rigid than for the acid process. The silicon is kept as low as possible in order to decrease the necessary lime addition, and also because the combustion of phosphorus is here

relied upon to furnish the greater part of the heat. The phosphorus is not less than 1.8 per cent., and the manganese is high in order to aid in the production of heat and the elimination of sulphur. The calorific equation for fourteen tons of metal is shown in Table XVI.

TABLE XVI. — CALORIFIC EQUATION OF THE BASIC BESSEMER PROCESS

Charge: 30,000 lb.

Analysis: 0.50 per cent. silicon burned; Temperature of atmosphere = 0° C.;
 1.60 per cent manganese burned; Specific heat of air = 0.268 pound-calories per 1° C.;
 3.50 per cent. carbon burned; Specific heat of metal = 0.20 pound-calories per 1° C.;
 2.50 per cent. phosphorus burned; Average temperature of blow = 1500° C.
 3.00 per cent. iron burned;

Principle of calculation same as in Acid Bessemer Operation, p. 121.

REACTIONS		Pound-calories	Surplus pound-calories
2 P + 5 O = P ₂ O ₅ produces.....	62 80	4,420,000	
750 lb. 968 lb.			
4209 lb. air × 1500° C. × 0.268 =		1,692,000	2,728,000
Si + 2 O = SiO ₂ produces.....	28.4 32	950,000	
150 lb. 169 lb.			
735 lb. air × 1500° C. × 0.268 =		295,000	655,000
Mn + O = MnO produces.....	55 16	794,000	
480 lb. 140 lb.			
608 lb. air × 1500° C. × 0.268 =		244,000	550,000
C. + O = CO produces.....	12 16	2,552,000	
1050 lb. 1400 lb.			
6078 lb. air × 1500° C. × 0.268 =		2,447,000	105,000
Fe + O = FeO produces.....	56 16	1,056,000	
900 lb. 257 lb.			
1118 lb. air × 1500° C. × 0.268 =		449,000	607,000
Total net heat from chemical reactions =			4,645,000

Thus, much more heat is generated in the basic process, but more is required because a large amount is absorbed by melting the additions of lime to form the basic slag, and also there is greater radiation because the blows are longer and the operation is slower.

The basic process is much more expensive to operate than the acid, on account of the longer time in blowing, delay at the end of the operation to test for dephosphorization, and greater cost for repairs, because (1) the basic lining costs more than the acid, and (2) it lasts but a fraction as long. To balance this expense we have the much decreased cost for the high phosphorus pig iron, and also the slight return from the sale of the slag, which is high enough in phosphorus to be used as a fertilizer. The process is no longer operated in America, and it seems improbable that it ever will be again. The high phosphorus ores of the Minette district produce a pig iron which is, however, especially adapted to the basic process, and the skill of the Germans in producing a high-grade structural steel by this method, which is the predominant one in Germany, excites the admiration of the other iron and steel countries.

REFERENCES ON THE BESSEMER PROCESS

See Nos. 2, 30, 31, 32, 36, and the following list:

50. Richard Akerman. "The Bessemer Process as Conducted in Sweden." Trans. American Institute of Mining Engineers. Vol. xxii, 1893, pages 277 et seq.
51. Henry M. Howe. "Notes on the Bessemer Process." *Journal*, Iron and Steel Institute, No. 11, 1890, pages 100 et seq.
52. Bradley Stoughton. "The Development of the Bessemer Process for Small Charges." Trans. American Institute of Mining Engineers. Vol. xxxiii, 1903, pages 846 et seq.
53. Joseph W. Richards. "Metallurgical Calculations." Part I, Introduction, Chemical and Thermal Principles, Problems in Combustion. 1906. Part II, Iron and Steel. 1907. These problems not only teach how to calculate many very important things in connection with furnaces and their efficiency, but give a good insight into the principles of the processes themselves.
54. Friedrich C. G. Müller. *Untersuchungen über den deutschen Bessemerprocess*. Zeitschrift des Vereines deutscher Ingenieure. Vol. xxii, 1878, pages 384-404 and 454-470.

This is one of the most comprehensive studies of the metallurgy of the Bessemer process in any language.

55. Hermann Wedding. "The Basic Bessemer, or Thomas, Process." Translated into English by William B. Phillips and Ernst Prochaska. New York, 1891. This is the fullest account of the basic Bessemer process.

VI

THE OPEN-HEARTH OR SIEMENS-MARTIN PROCESS

OPEN-HEARTH PLANT

THE arrangement of the open-hearth plant is not of such vital importance as that of the Bessemer, because the open-hearth process is so much slower that it is easier to arrange the different cycles so that one will not delay another and lessen the output of steel. The different open-hearth cycles are as follows:

1. Getting the stock to, and in, the furnace.
2. Supplying the furnace with fuel and air and preheating both of these.
3. Working the charge, repairing the furnace, etc.
4. Recarburizing.
5. Disposing of the steel and slag.
6. Repairing and preparing ladles, ingot molds, etc.

A plan and elevation of a typical open-hearth plant is shown in Figs. 90 and 91. It is not to be presumed that all plants are laid out in the same manner, but that shown is a modern type which is much favored in America. The furnaces are arranged in a long row, with often as many as ten in one house and with the level of the hearth several feet above the general ground-level of the plant.

Melting Platform. — On the same level as the hearth, and in front of the furnace, is the melting platform, or working platform, upon which are placed one or more charging machines, depending upon the number of furnaces to be served, running upon tracks extending the entire length of the working platform. The space above this is usually spanned by one or more electric traveling cranes which assist in repairs to the charging machines, in handling materials on the melting platform, and in pouring molten pig iron into the furnace where such practice prevails. The melting platform has a small extension around the back of the furnace to afford

10 Furnaces.

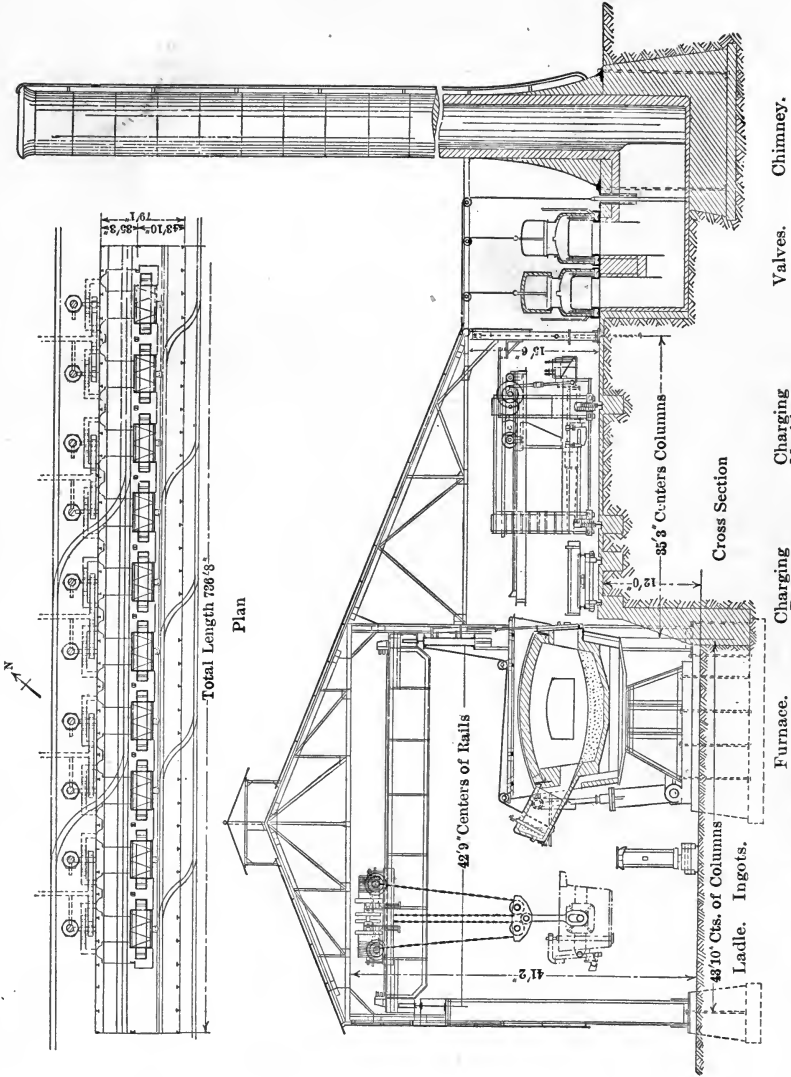

FIGS. 90 AND 91. — OPEN-HEARTH FURNACE PLANT.

access to the tap-hole and the ladle into which the steel is poured, and for putting the recarburizer into this ladle when necessary. Upon the working platform are the valve handles for regulating the admission of gas and air to the furnace and for reversing the current of these at the proper time.

Gas Producers. — The gas producers are situated outside of the furnace house and in a long line parallel to it. This arrangement has the great disadvantage of placing the men on the working plat-



FIG. 92.—OPEN-HEARTH MELTING PLATFORM AND CHARGING MACHINE.

form between the smoke of the gas producers and the heat of the furnace, but there seems to be no good way of avoiding it. As the regenerators are usually placed underneath the working platform, this situation of the producers gives the least possible distance which the gas has to be carried, and therefore the least possible loss by deposition of tarry components.

Stock. — The stock yards are oftentimes placed between the furnace house and the gas producers, but this nearness is not necessary and stock is frequently stored by the end of the house,

or even at some distance. For its transfer to the furnace, the stock is loaded into steel boxes similar to those in Fig. 93. Three or four boxes are supported on a little car, which is transferred in a train to the melting-floor, passing over a pair of scales on the way, where the weight is taken. Between the track of the charging machine and the line of furnaces runs the track upon which these cars are transferred, and if a constant supply of boxes is brought to the machine, it can empty them upon the hearth of the furnace at a rate of about 50 boxes (equivalent to about 125 tons) per hour.



FIG. 93.

Charging Machine. — A view of a Wellman charging machine is shown in Fig. 94. Its essential feature is a long charging-bar with a foot on the end which can be dropped into a socket on the charging-box. By this means the charging-box is raised off the car, thrust into the open door of the furnace, and turned upside down to empty its contents of pig iron, steel scrap, limestone, iron ore, or other material, upon the hearth. The operator is seated in a little cage, which moves backward and forward with the charging-bar, and has within his reach five levers: (1) To move the charg-

ing-bar inward and outward; (2) to move the charging machine backward and forward on its track in order to serve any of the furnaces, or to place itself opposite any of the doors of a single furnace, or to push the train of charging-boxes along by means of the charging-bar; (3) to lock the foot of the charging-bar in the socket of the charging-box; (4) to raise the charging-bar up and down; and (5) to turn the box over.

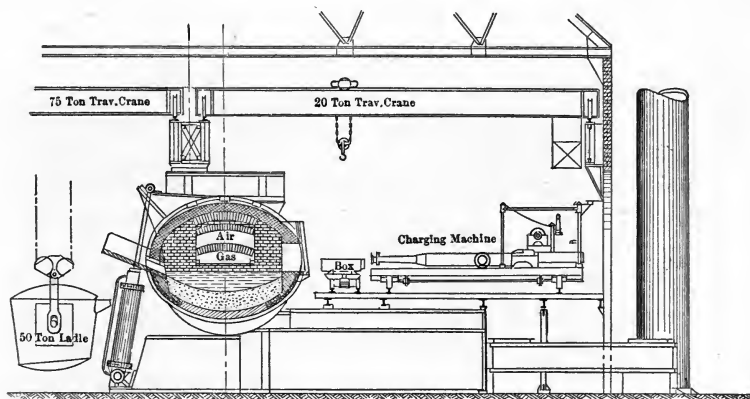

FIG. 94.

Casting-Pit. — The casting-pit extends all the way behind the furnaces; it is on the general ground-level of the plant and therefore several feet below the melting platform. This pit is spanned by one or more electric traveling cranes of large capacity, which are used to hold the ladles while the steel is running into them from the tap-hole of the furnace and while it is being teemed into the ingot molds. They are also used to serve the pit for several purposes, such as carrying away the slag, transferring empty ladles to and from the point where they are lined and dried, etc. Through the casting-pit extend 2 to 4 railroad tracks. One of these, and sometimes two, are used for the passage of the cars carrying the ingot molds, and they therefore run along the side of the teeming platforms upon which the ladleman stands to pour the ingots; another is used for the railroad cars into which the slag, dirt, and other waste material is dumped; and still another, if present, is kept clear for transfer purposes.

OPEN-HEARTH FURNACE

The form and dimensions of a modern 50-ton rolling open-hearth furnace is shown in Figs. 95 to 97. It consists of a long shallow hearth suitably enclosed in fire-brick and bound together with steel, and can be rolled forward in order to pour material out of the tap-hole. A stationary furnace is shown in Fig. 100. There are more stationary than tilting furnaces, but the general principles of the steel-making operation are the same in both.

Regenerators. — With the furnace are connected two pair of regenerators which preheat the gas and air for combustion. The internal volume of each of these chambers is equal to $\frac{3}{8}$ to $\frac{9}{10}$ of that of the working-chamber itself. The larger the chamber the greater will be the amount of heat intercepted in them, and therefore the lower the temperature of the gases that go to the stack. The amount of space actually occupied by the bricks, or checkerwork, is the important consideration, however, and this should be from 5000 to 10,000 cu. ft., total, for all four regenerators in a 50-ton furnace, the capacity of the two gas regenerators usually being less than that of the air regenerators, because the volume of gas used is less than that of the air, and also because the gas does not require to be preheated so much, since it is already somewhat warm from the gas producer. During the operation of the furnace more or less slag, dirt, and dust are carried over with the outgoing gases. To intercept this the slag-pockets or dirt-pockets *A A* (Fig. 97) are provided; but in spite of them the space between the bricks of the checkerwork becomes partially choked, and for this reason, as well as because the deposit of dust makes the surface of the bricks rough, the total area between the bricks must be much larger than the area of the ports, so that the velocity of the gas will not be lessened. The furnace must be laid off for repairs when the passages between the bricks are choked by dirt, but, on the other hand, the space is limited, because the bricks must be laid in such a way that the maximum amount of surface shall be exposed and the gases forced to the greatest possible contact with them. The modern construction makes the regenerators as tall as possible in order that incoming gas and air may be forced into the furnace by the draught, and also because this chimney effect causes the incoming gas and air to naturally seek the

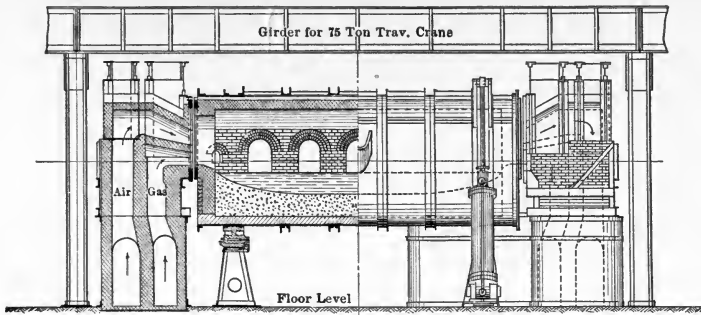

Longitudinal Section and Elevation

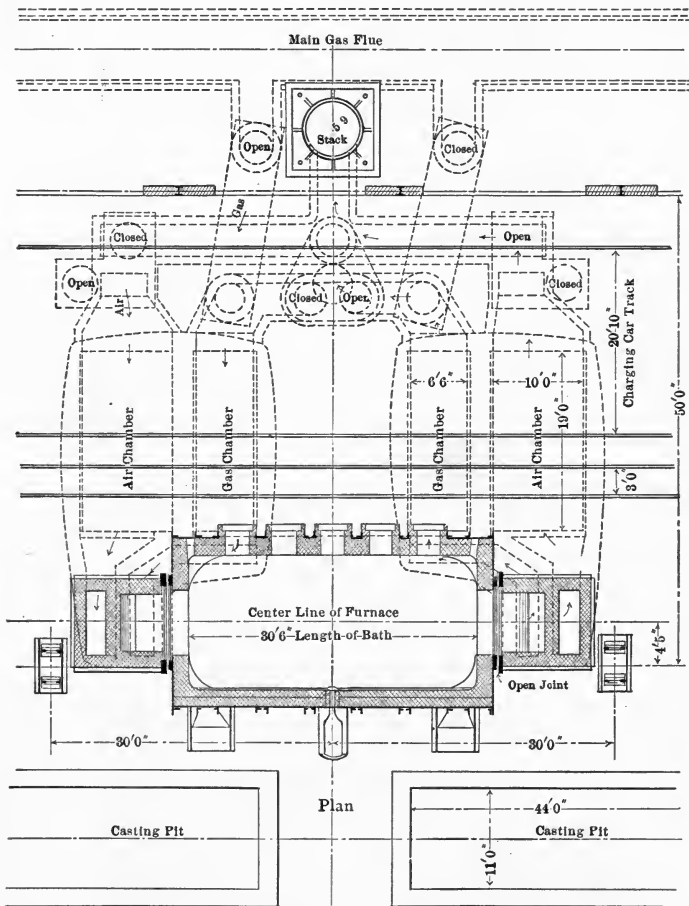

FIGS. 95 AND 96.

hottest places and the outgoing gas to naturally seek the coolest places, in this way equalizing the temperature in the different parts of the regenerators.

The space underneath the checkerwork should be so large that the incoming gas and air will distribute itself nearly uniformly through the different passages, and the temperature of the fire-

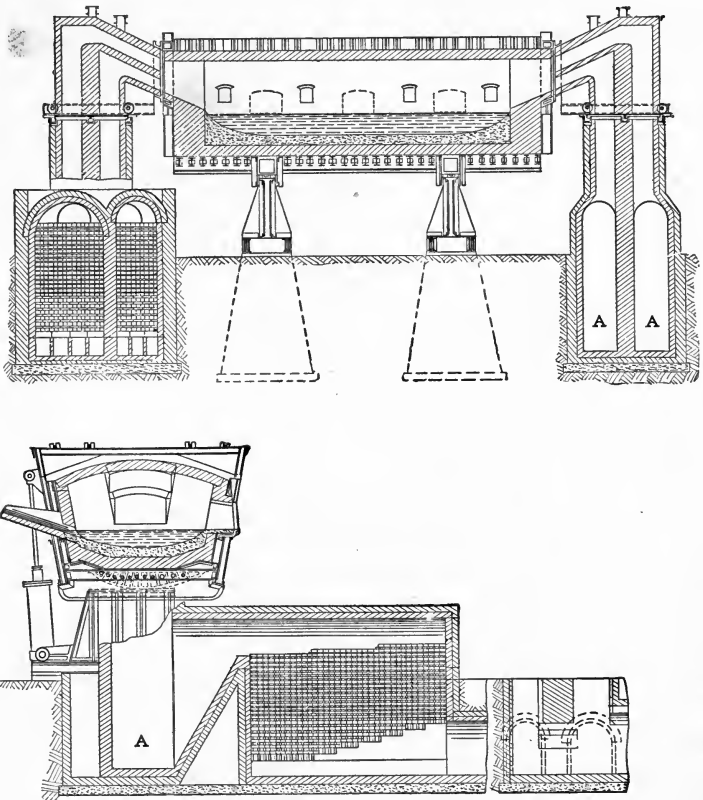

FIGS. 97 AND 98.

bricks at this lower part will be, say, 400° C. (752° F.), although varying, of course, at different furnaces and at different times. When the regenerator is receiving the waste gas from the furnace, the temperature of these bricks will be that of the gases that go to the chimney, say 400° to 600° C., and when the air or gas is passing through the regenerator on its way to the furnace, these bricks

will be somewhat cooler, depending upon the length of time that the regenerator has been in this phase of the operation. The temperature of the bricks at the top of the regenerator will be about 1000° C. (1832° F.), and therefore the air and gas entering the furnace will be the same.

Ports. — The ports are so arranged that the flame shall be deflected away from the roof and yet not impinge upon the bath, or impinge only very slightly, because the bath would thereby be oxidized excessively. The gas should be spread out all over the

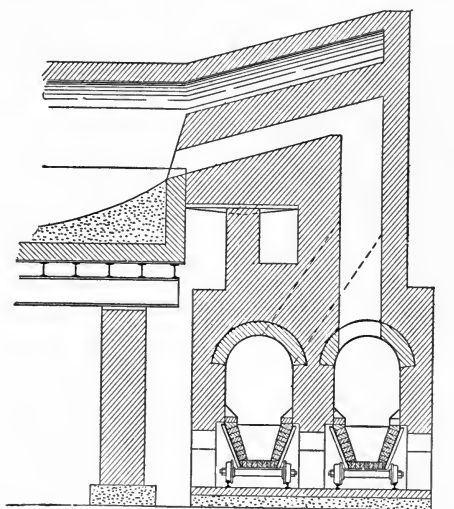

FIG. 99.—REMOVABLE BUGGIES TO CATCH SLAG IN SLAG POCKETS.

width of the hearth beneath the air, and the two should be brought together just before they enter the laboratory, or work-chamber. The air especially must be kept away from direct contact with the bath, and for this reason the gas-ports are placed below the air-ports, which arrangement has the further advantage of promoting a better mixing of the two, since the gas is lighter and therefore rises. In America the favorite arrangement is two gas-ports, above which is situated a long slit, extending almost the entire width of the furnace, which serves as an air-port. This is not universal practice, however, for in some cases there are two, or even three, air-ports. In one case the two gas-ports are built wide and low, so that they will deliver thin streams and get a better mix-

ing of the two materials for combustion. The area of the air-port in a 50-ton furnace should be about 18 sq. ft., and the combined area of all the gas-ports on one end should be from 8 to 10 sq. ft., depending upon the quality of gas used.

The roof must be protected from the direct impact of the flame, because even the most refractory silica bricks would be melted by the intense heat. The heat in the regenerators and uptakes gives the gas and air a velocity which causes them to enter the furnace with some force, and the construction of the ports directs the stream in the desired manner. The mouths of the ports are gradually melted away by the intense heat of combustion of the outgoing gases, until they finally cease to serve this purpose and it is impossible to get the proper mixing and the proper kind of a flame in the laboratory of the furnace. The ports must then be repaired, else the temperature cannot be maintained.

Draught and Chimney. — The draught must be sufficient to catch the flame about in the middle of the laboratory and drag it out through the ports on the opposite side from which it entered without allowing it either to drop down and touch the bath (as this is to be heated almost altogether by radiation) or to impinge upon the roof. This draught also has to do the work of overcoming the friction of the outgoing regenerators and flues. Its force will depend upon the height of the chimney and the temperature of the products of combustion after they have left the regenerators, which should be about 400° C. (752° F.), though even better economy (i.e., a lower temperature) than this is obtained in many cases. All the heat carried away by these flue gases is of course wasted, but the very great cost of the refractory bricks in the regenerative chambers makes it unwise to reduce the temperature of the flue gases too much by enlarging the checkerwork. The calculation of the amount of draught produced by any given height of chimney with any given temperature of flue gases, according to the method of Professor J. W. Richards, is given in Table XVII.

Roof. — The roof is made very thin and of the most refractory bricks that can be obtained, i.e., almost pure silica, with enough lime to hold it together in a compact mass. The walls are also thin, and the radiation from the furnace chamber is great, but this has to be endured, as thicker walls and roof produce endless trouble by expansion and contraction. The roof is arched and suspended from beams independent of the side walls.

TABLE XVII. — CALCULATION OF DRAUGHT OF CHIMNEYS

The draught in a chimney is produced by the gases within it being lighter than the air outside, and this lightness is due to their being hotter. In this calculation we assume the following data:

Data assumed	{	Air weighs 1.29 oz. per cu. ft. at 0° C. and 760 mm. pressure;
		Chimney gases weigh 1.03 times air at 0° C. and 760 mm. pressure;
		Water weighs 772 times air;
		Mercury weighs 13.6 times water;
		The friction of a chimney absorbs the equivalent of 0.1 in. of water on a water-gauge showing draught, for every 100 ft. height of chimney.

As the gases rise in the chimney they cool; therefore their average temperature will be about 50° C. cooler than their temperature at the foot of the chimney. Call this average temperature T° C. Then:

$$1.29 \text{ oz.} \times 1.03 \times \frac{273^\circ \text{ C.}}{T^\circ \text{ C.} + 273^\circ \text{ C.}} = \text{the weight of a cu. ft. of the chimney gases at the temperature } T^\circ \text{ C.}$$

Subtract this weight from 1.29 oz. and we get the difference in weight of air and the furnace gases at the temperature T° C. Then:

Height of chimney \times difference in weight = ounces draught pressure per square foot of chimney area.

$$\frac{\text{Ounces draught} \times 12 \text{ in.}}{1.29 \text{ oz.} \times 772} = \text{equivalent height of a water-gauge.}$$

From the height of a water-gauge so found, we must subtract the amount lost by friction, or 0.1 in. \times height of chimney \div 100.

For further modifications of this type of calculation see No. 53, Part I, pp. 164, 166, 194, 200, and 201.

Life of the Furnace. — The 'life' of an open-hearth furnace means the number of heats that it can make continuously without stopping for any more extensive repairs than can be made in the usual week's-end shut-down. No figure can be given for this except in the most general way. The life of the furnace will be ended usually in one of three ways: (1) The falling in of the roof, (2) the eating way of the ports, so that the flame can no longer be maintained properly, or (3) the giving out of the regenerators, which may occur either through the choking of the checkerwork, or through a crevice formed by the contraction and expansion of the bricks, so that there is a serious leak between the gas-chamber and the air-chamber, and premature combustion takes place. If a basic furnace makes 350 heats, it is considered good work, and we may perhaps tentatively consider this figure as the "three-score years and ten" of a furnace making steel for structural work and similar purposes. Three hundred and fifty heats would mean

about 18 to 24 weeks' work in America. An acid furnace will last about 1,000 heats.

Construction of Hearth and Bottom. — The hearth is made with a thickness of 18 to 24 in. inside the furnace shell, in the form of a shallow dish whose sides reach up to the level of the charging doors, and so constructed that the depth of the metal will be from 12 to 24 in. — the former figure in the case of a very small furnace, say 5 to 15 tons, and the latter in the case of one of 50-ton capacity. If the bath is too shallow the oxidation will be excessive and the wear of the lining by oxide of iron, with consequent production

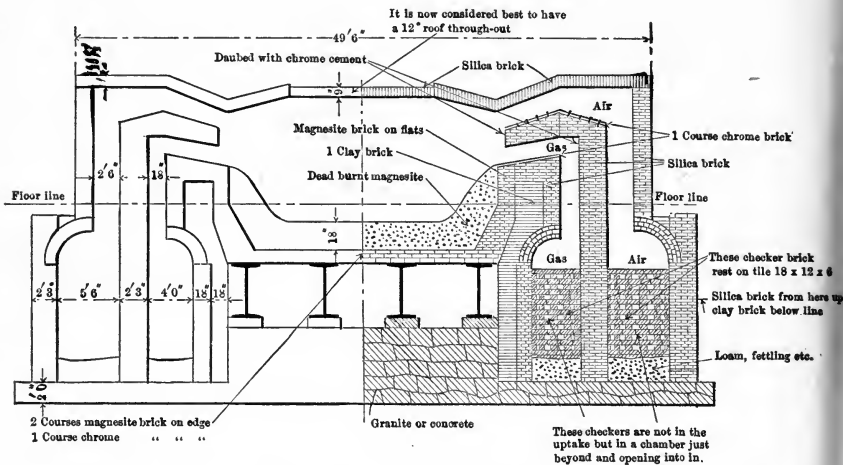

FIG. 100. — MATERIALS OF CONSTRUCTION AND LINING FOR BASIC OPEN-HEARTH FURNACE.

of slag, will be great;¹ if the bath is too deep, the melting and oxidation will be slow. In the case of an acid bottom, that portion of the lining next to the shell will be made up of refractory clay brick, and the upper portion will be formed by shoveling in silica sand, spreading it out in a thin layer about $\frac{1}{2}$ in. thick over the entire hearth, and then allowing it to sinter at the full heat of the furnace for about ten minutes, so as to set it firmly in place. Upon this layer will be set another layer in like manner, until the whole hearth is constructed, and then it will be 'washed' with

¹ In an open-hearth furnace the lining suffers the greatest wear at the side of the bath, where it is thin, because the oxidation of the metal is the greatest there.

a melted bath of old slag to fill up all crevices and give a glazed surface.

In the case of the basic hearth, the bottom is made of calcined dolomite,¹ held together with 10 per cent. or less of anhydrous tar. In this case the layer of brick next to the lining is very thin and the dolomite and tar are set in in layers by the heat of the furnace as in the case of the acid lining. The tar burns to a strong coke, which holds the mass together in a firm hard form. In some cases no tar is used, and the calcined dolomite is fritted slightly to hold it together; in other cases 15 per cent. of old slag is used as a bond. Pure magnesite gives a more permanent lining than dolomite, and is now much used since its longer life more than compensates for its greater expense. Even when magnesite is used for the bottom, the topmost layer, or working bottom, and the repairs, or 'fettling,' put in during the intervals of the furnace life, are made of dolomite, because this sets more quickly. As the sides and roof even of the basic furnace are made of silica bricks, it is customary, although not absolutely necessary, to put a layer of neutral material between these bricks and the basic hearth, and also to protect this joint from excessive heat. The neutral material commonly used is chromite bricks, which are made of ground chromite (FeO , Cr_2O_3), held together with tar and then burned to form a firm, hard mass.

Repairing Bottoms. — Between the heats, bottoms are repaired by filling up holes with acid or basic material, as the case may be, and by more extensive attention at the end of the week. In this way the bottom may be made to last almost indefinitely, unless a part of the charge works its way down a crevice and forces up whole sections of the bottom lining, which not infrequently happens; while sometimes the charge even works its way out through the bottom of the furnace. A sticky or viscous slag is also liable to bring the bottom up by sticking to it. In the tilting furnace, the bottom may be repaired along the point where the worst corrosion usually takes place — i.e., at the edge of slag line — even during the operation, by tipping the furnace until this place is uncovered.

Tap-Hole. — In the stationary furnace, the tap-hole is made according to the section in Fig. 101. During the operation this is

¹ Dolomite is a magnesia limestone, and after calcining consists of a mixture of lime and magnesite (CaO , MgO), with a little silica and other impurities.

closed by material rammed into it from the door of the furnace. It sets quickly into a solid mass, which is pierced with a pointed bar when it is desired to allow the metal to run out. After tapping, the hole must be entirely freed from metal, and then it is made up and filled anew, ready for the next operation. This always delays work to some extent, and occasionally the tap-hole causes trouble by the charge working through it prematurely, or, on the other hand, by its becoming so hard that a hole is pierced in it only after a long delay and much difficulty, during which the oxidation continues in the charge beyond the desired point. In the tilting furnace there is no tap-hole, strictly speaking, but the

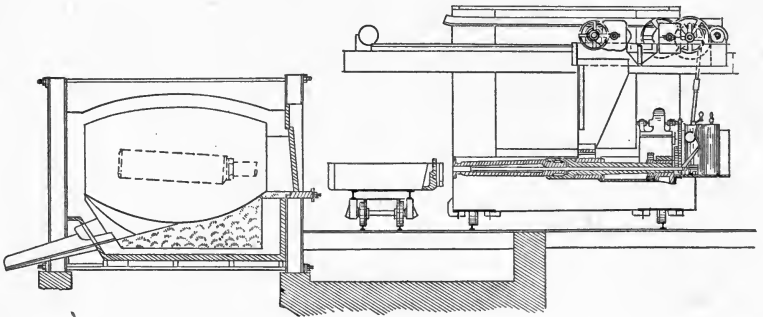

FIG. 101.

opening into the metal-spout is closed by loose material, which is scraped away before the furnace is tipped to pour the charge.

Tilting Compared with Stationary Furnaces. — Tilting furnaces are more expensive to install than stationary ones, and require repairs to the machinery and power to operate them. They also require special arrangements of ports and uptakes, to be described later, and means for cooling the junction between the movable and stationary parts of the furnace. Their advantages are that they do away with troubles and delays from the tap-hole, the slag can be poured off at any time, and the charge may be tapped at a moment's notice, which is especially advantageous when making steels within very narrow limits of composition. Furthermore, the back-wall of the bottom may be repaired more easily between heats when the furnace itself is still white hot. In the stationary furnace the angle of this back-wall will be about 60° or 70° from the horizontal, and loose material thrown in from

the front doors will not rest on this angle; but the tilting furnace can be tipped until the back-wall is more nearly horizontal, and then loose material will remain upon it until sintered into place.

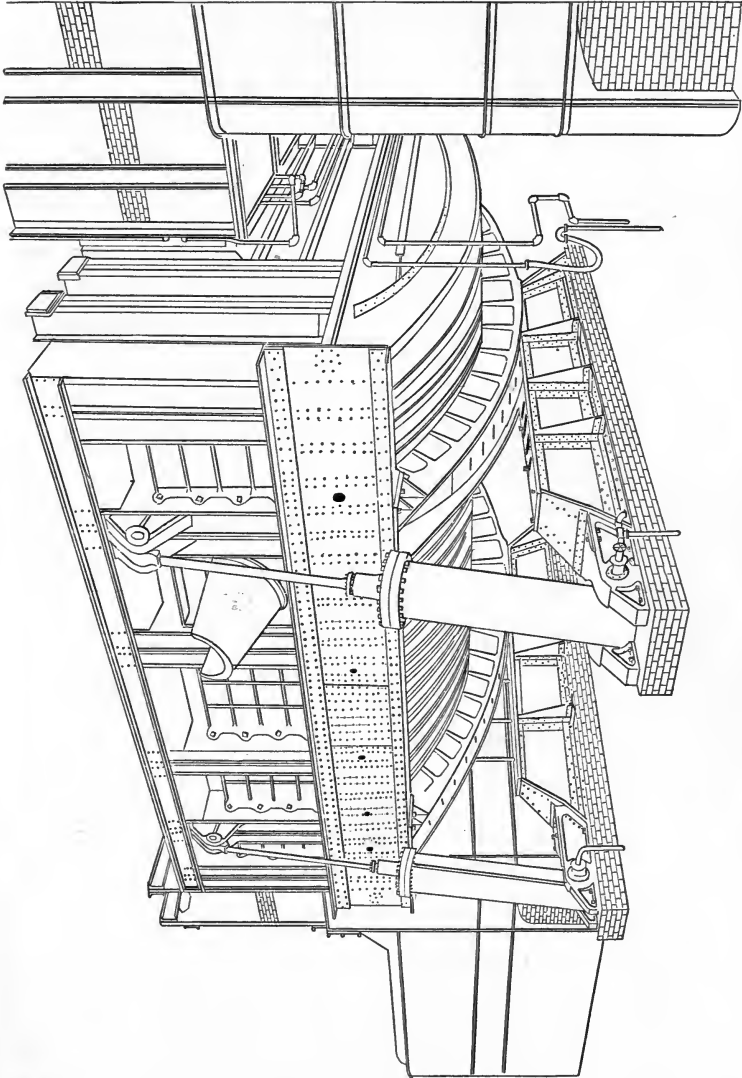

FIG. 102. — WELLMAN TILTING OPEN-HEARTH FURNACE, POURING SIDE, OR BACK.

The tilting type is of more advantage in the basic process than in the acid, because it enables the slag to be poured off at will, which is occasionally advantageous in basic practice.

Tilting Furnaces. — There are two types of tilting furnaces, known respectively as the Campbell and the Wellman. In the Campbell type the hearth of the furnace is arranged so that the center of tilting is coincident with the center of the ports, and therefore the furnace can be oscillated without cutting off the supply of gas and air. In order to facilitate this, there is a little clearance between the uptake and the furnace proper, and these parts are surrounded by water-cooled castings. In the Wellman



FIG. 103. — TILTING FURNACES.

type the gas and air supply must be cut off when the furnace is tilted. In tipping the Wellman furnace the ports move with the hearth, and they are therefore seated in a water-tank, which makes an air-tight connection with the regenerators when the furnace is in a horizontal position, but breaks it when it is tipped forward.

The Wellman type is not as expensive to build as the Campbell, and probably requires less repairs. The Campbell type has the advantage that the bottom can be repaired along the slag line without interrupting the operation, and that the bottom can be

sintered into place by the heat of the flame when the hearth is in any position. This is more important in the acid furnace than in the basic, where the mixture of dolomite and tar can be set by

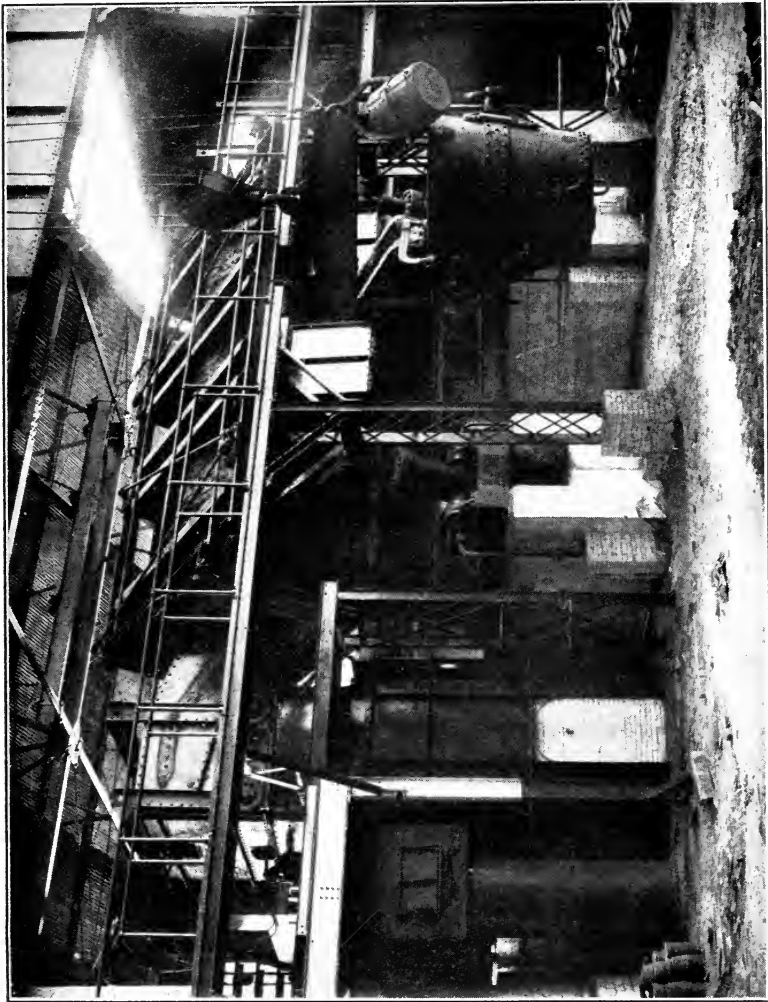

FIG. 104. — TAPPING AND POURING RECARBURIZER IN.

the heat contained in the furnace walls themselves. In the Wellman type, when the furnace is tipped for pouring, cold air can enter it through the port-holes, and may oxidize the manganese in the final product after recarburizing. Finally, a great advantage

of the Campbell type is the fact that a great deal of ore can be used during the operation, and although the boiling of the charge is violent on this account, metal does not flow out of the furnace doors, because the hearth can be tipped in the opposite direction. The slag which runs off during this period is allowed to pass through a hole in the bottom of the port-opening, at the joint between the fixed and the rotating portion, where it is continually exposed to the flame and therefore not liable to chill up.

Temperature Calculation. — There is almost no limit to the temperature that can be obtained in the open-hearth furnace by frequent reversing of the valves, except the danger of melting the roof. The temperature is controlled by reversing and by throttling the amount of gas and air admitted to the furnace. It is the almost universal practice to reverse the valves every twenty minutes, in order to maintain a uniform temperature of the regenerators. The melter endeavors to keep the charge always in a very liquid state, and at the same time to have a slight excess of air, in order that the atmosphere of the furnace may be slightly oxidizing to burn the impurities in the metal. Every excess of oxygen, however, causes a loss of heat, because each volume of oxygen in the air is accompanied by four volumes of nitrogen, which carries heat out of the furnace, but does not assist in any way in the reactions.

The actual temperature of the furnace will depend upon the length to which the decarburization is carried, because as the metal gets lower and lower in carbon, it requires a higher heat to keep it fluid. It will average about 1600° to 1700° C. (2912° to 3092° F.). An operation which is interrupted when the carbon is still 0.50 per cent. will take much less fuel than one in which dead-soft steel is manufactured. The amount of coal burned in the gas producers, per ton of steel produced, will therefore vary greatly, but will average perhaps 400 to 1000 lb. Figures for oil and natural gas fuel will be given on pages 167 and 169.

Size of Open-Hearth Furnace. — The so-called 'standard' open-hearth furnace has a capacity of 50 tons. The bath in such a furnace will have a length of about 30 to 35 ft., a width of about 12 to 15 ft., and a maximum depth of about 24 in. In America, however, there is now (1907) a tendency to increase the size to a capacity of 60 or even 75 tons. This innovation is due largely to Mr. T. S. Blair, Jr., of the Lackawanna Steel Company; some of the

furnaces under his control are 43 ft. between the ports. The result is a much better opportunity for complete combustion within the laboratory of the furnace, and therefore less deferred combustion as the gases escape through the ports and downtakes. This lengthens the life of the ports and promotes fuel economy.

The smallest practicable size of an open-hearth furnace is about 15 tons, and this is very expensive to operate. There are furnaces, however, as small as 5 tons capacity, but this is not good practice, even under the special circumstances which alone justify the use of the 15-ton furnace. The maximum practical size will not be far above 75 tons, and the real governing factor is the ability of the mechanical apparatus to handle the raw material and the product, besides which it is difficult to cast so much metal out of one ladle without having the casting temperature of the first metal too hot, or else that of the last metal too cold.

BASIC OPEN-HEARTH PRACTICE

Formerly, the open-hearth practice was divided into two types, known respectively as the 'pig-and-ore process' and the 'pig-and-scrap process.' In the pig-and-ore process the charge consisted entirely of pig iron, and the oxidation was hastened by the addition of as much ore as the charge would stand without boiling over; in the pig-and-scrap process the charge consisted of pig iron with large amounts of steel scrap, the proportion of the latter being so large in some cases that the operation became a mere remelting process, there being only enough pig iron for its silicon, manganese and carbon to protect the metal from excessive oxidation. At the present time the pig-and-ore process does not exist in its original form, but normal charges consist of pig iron and steel scrap, in proportions determined by financial considerations, and the operation is hastened by judicious additions of ore. The amount of steel scrap will vary all the way from 0 to 90 per cent., and will average not far from 50 per cent. in America (1906). By decreasing the proportion of impurities in the raw material in the charge the scrap enables the process to be completed in less time.

Charge. — A difference of opinion exists as to whether it is desirable to charge the steel scrap first upon the hearth and then cover it with the pig iron, in order that the impurities in the latter may lessen the oxidation of iron during the melting period, or

whether it is better to put the pig iron on the hearth and cover it with the steel, upon the theory that the hearth is in this way corroded less by oxide of iron. The former practice is in vogue at several American works, and the latter at some American and many English works. It is probable that the scrap, unless small in size, does not corrode the hearth much, and the practice of putting the pig iron on top is preferable. In acid open-hearth practice it is more common to charge all, or most, of the scrap on top; in basic practice we may charge, first limestone, then scrap, and lastly pig, or else, limestone, most of the scrap, most of the pig, and then a layer each of scrap and pig.

Composition of Pig Iron Used. — Basic pig should be free from adhering sand, and therefore only machine-cast metal will ordinarily be used, or else that cast in metal molds. Its silicon should be below 1 per cent., and its manganese above 1 per cent., though the price of manganese ore makes this ingredient an expensive luxury. It is desired because it makes the slag more fluid and aids in removing sulphur. The phosphorus will be almost any figure up to 2 per cent., but a regular supply of pig with more phosphorus than that would tempt the manager toward the basic Bessemer process. Silicon and phosphorus increase the amount of slag, lengthen the operation, and require lime to flux them.

Fluxes. — The function of the basic lining is to remain inert and serve simply as a container for the bath. In order that the slag may be at all times rich in lime (35 to 45 per cent. CaO ordinarily), from 5 to 30 per cent. of lime is added with the pig and scrap, the exact amount depending upon the purity of the metal charged. Especially if the charge is high in sulphur, the slag must be kept as rich in lime as possible without making it too infusible and therefore viscous, the limit being about 55 per cent. CaO in this respect. The lime is usually added in the form of calcined limestone, and, as already noted, the higher the silicon and phosphorus in the metal the greater must be the amount of lime used. It is also customary to charge ore with the pig and scrap, in order to increase the amount of oxidation that takes place during the melting. This ore has very little effect on the basic lining, although it would rapidly corrode a silicious one. Further additions are made during the operation if necessary. The average amount of ore added to a 50-ton charge will be between $\frac{1}{3}$ of a ton and $2\frac{1}{2}$ tons.

Chemistry. — It takes about 3 or 4 hours for the charge to melt, and during that time the silicon is almost entirely eliminated,

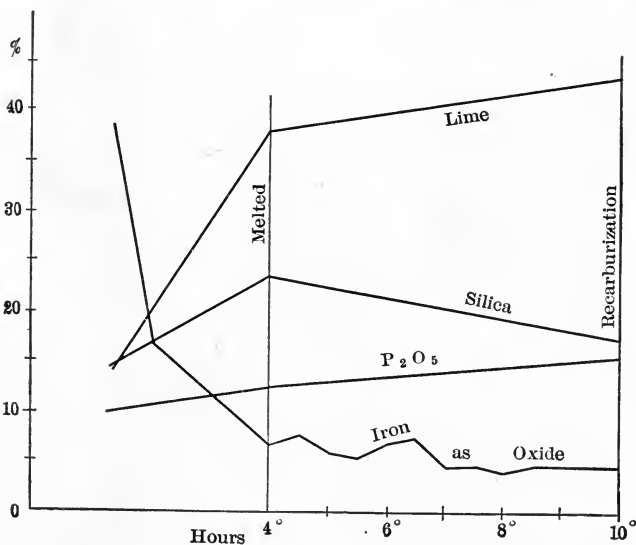
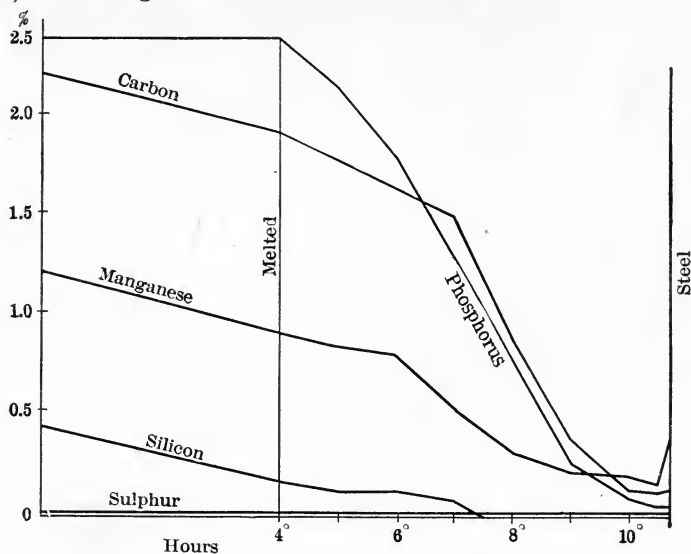

FIGS. 105 AND 106. — CHEMICAL CHANGES IN BATH AND SLAG IN A BASIC OPEN-HEARTH FURNACE.

while the proportion of carbon and manganese is somewhat reduced, as shown by Figs. 105 and 106, which also show the chemical

changes that take place during the entire operation. These reactions must be controlled by the melter, because it is necessary that the carbon shall be eliminated last, and therefore it is occasionally necessary to 'pig up' the charge, i.e., add pig iron in order to increase the amount of carbon. On the other hand, in case the phosphorus is being eliminated very fast, the oxidation of the carbon may be hastened by 'oreing down,' as it is called, i.e., adding ore to produce the reaction.



If the carbon is eliminated before the phosphorus, a great deal of iron will be oxidized, because the phosphorus does not protect it as much as the carbon.

When the charge is melted, and at intervals thereafter, the melter takes a spoon-ladle full of metal and pours it into an iron mold. As soon as this is set hard it is cooled in water, and from the appearance of its fracture the melter can estimate very closely the amount of carbon and phosphorus it contains. In many plants it is customary to tap heats on these estimates alone and astonishing accuracy can be obtained by these methods as to the amount of carbon contained in the bath of steel. In all large plants, however, the laboratory analysis is made for phosphorus and usually for carbon as well, and these determinations may be made in 20 minutes or less.

Functions of the Slag. — The functions of the slag are: (1) To absorb and retain the impurities in the metal, particularly silicon, manganese and phosphorus, and as much sulphur as possible; (2) to lie upon the top of the bath as a blanket and protect it from excessive oxidation by the furnace gases; and (3) to oxidize the impurities of the bath by means of its dissolved iron oxide, which serves as a carrier of oxygen from the furnace gases to the impurities in the metal.

For the retention of phosphorus and sulphur, the slag must be rich in bases. For the oxidizing it is necessary that the slag shall be fluid, so that it will mix easily with the bath, and therefore the content of lime must not be too high. During the boil, when the carbon is passing off, there is an intimate mixture of metal and slag, and there is even such a violent agitation of the bath that the metal itself is frequently uncovered in places and exposed to direct oxidation by the furnace gases.

The removal of sulphur is a variable quantity and cannot be altogether depended upon, but there is usually a large loss of this element during the operation, in spite of slight additions of sulphur from the coal through the gas. This sulphur reduction is greatly assisted if the slag is thinned out (i.e., its melting-point reduced) by the addition of calcium fluoride (CaF_2) just before the end of the operation. The higher the slag is in lime, provided it remains at the same time fluid, the more complete in general will be the sulphur elimination, but over 55 per cent. of lime usually makes the slag viscous, unless the calcium be added in the form of fluoride, or of chloride (CaCl_2). The latter agent was added in many cases by the recommendations of E. H. Saniter, but the practice was never general in the United States, and the use of calcium fluoride (known as fluorspar) answers most purposes, unless the sulphur in the charge is excessive.

It is of very great importance that the final slag in the open-hearth operation shall be a nonoxidizing one, lest the metal itself be full of oxide and very 'wild,' i.e., give off gas abundantly during solidification. Therefore no ore should be added within two or three hours of the finish of the operation. For this reason there is some difficulty in making steel of under 0.20 per cent. carbon by the open-hearth process, and the difficulty increases almost in geometric ratio as the carbon is reduced lower and lower, because iron retains with tremendous affinity the last traces of carbon, and it requires a most powerful influence to separate them. Open-hearth managers usually refuse to take orders for steel under 0.10 per cent. carbon, except where consumers own their own plant.

Slag.—Basic slags will contain:

10 to 20 per cent. SiO_2
45 to 55 per cent. CaO
10 to 25 per cent. FeO
5 to 15 per cent. P_2O_5 .

Weight of Slag. — The slag made will depend upon the silicon and phosphorus and dirt in the metal, and will average from 10 to 30 per cent. of the weight of metal. Since the slag takes practically all the lime charged into the furnace, its weight can be calculated with sufficient accuracy by the same formula given for calculating the blast-furnace slag: Divide the total lime (CaO) used

with the charge (plus 30 per cent. of itself to allow for wear of the lining) by the percentage of lime in the slag.

Loss. — The weight of steel produced will be a variable proportion of the weight of metal charged, depending upon the amount of pig iron in the charge, the amount of ore used, the extent to which the carbon was eliminated before tapping, etc., but it will average perhaps 93 to 96 per cent., the difference being made up as follows, in a typical example:

ANALYSIS OF CHARGE

(50 per cent. pig; 50 per cent. scrap)

	Pig Iron per cent.	Scrap per cent.	Average per cent.	Loss per cent.
Carbon.....	3.75	0.25	2.00	2.00
Silicon.....	0.70	0.06	0.38	0.38
Manganese.....	1.10	0.40	0.75	0.75
Phosphorus.....	1.30	0.04	0.67	0.67
Sulphur.....	0.37	0.03	0.20	0.20
20 per cent. slag @ 12½ per cent. Fe.....				2.50
				<hr/> 6.50
Iron reduced from ore.....				1.50 per cent. gain
Net loss.....				<hr/> 5.00

Recarburizing. — Steel must not be recarburized in the presence of a basic slag, lest the carbon, silicon, and manganese of the recarburizer reduce phosphorus from the slag and cause it to pass back into the metal:

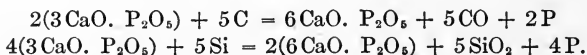

Therefore in basic practice the recarburizer is added to the stream of metal while it is pouring from the furnace into the ladle, and special arrangements are made for allowing the slag which floats on top of the metal to overflow at the top of the ladle and thus be gotten rid of in a large part. In careful practice 'rephosphorization' need not exceed 0.01 to 0.02 per cent. of the steel, although a much larger increase may take place through accident.

The recarburizer usually consists of ferromanganese, together with anthracite coal, charcoal or coke which is broken into small pieces and loaded into paper bags. About 45 per cent. of the broken coke is burned and the other 55 per cent. will be dissolved

by the steel. It is practically impossible to melt spiegeleisen in the cupola, because a cupola must be run continuously in order to do satisfactory work, while the open-hearth process is too slow and too irregular to use a continuous supply of molten recharburizer.

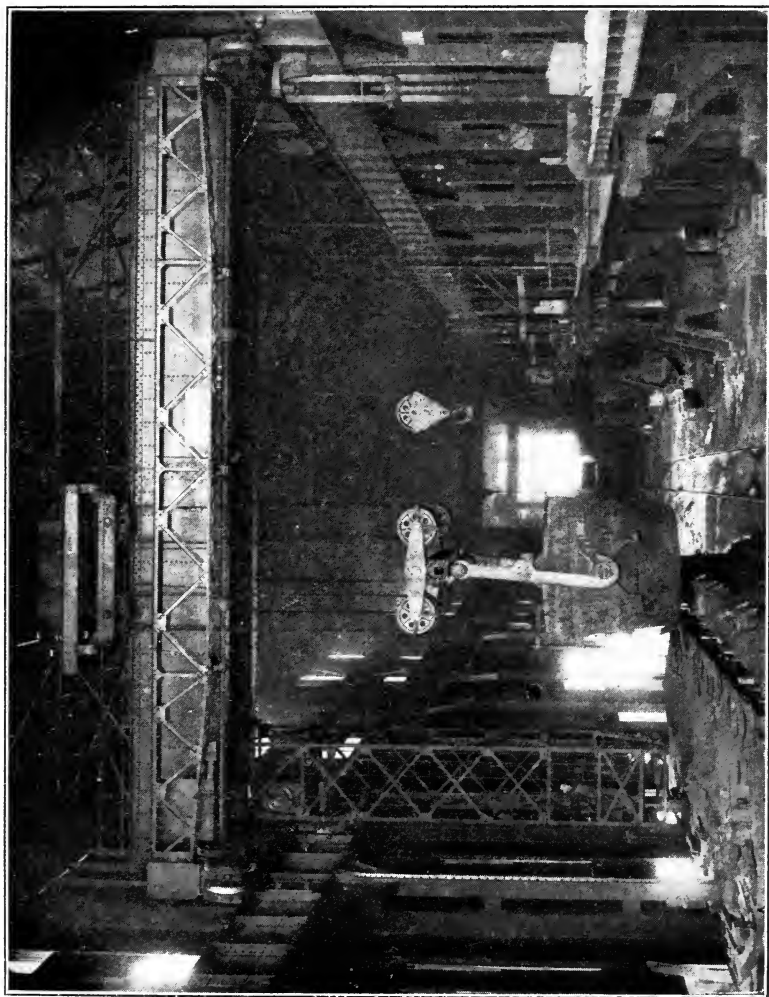

FIG. 107. — OPEN-HEARTH HEAT READY FOR TEEMING.

In making soft steel the carbon is reduced to about 0.10 or 0.15 per cent. in the bath, and then the necessary amount of recharburizer is added. In making high carbon steel, on the other hand, two

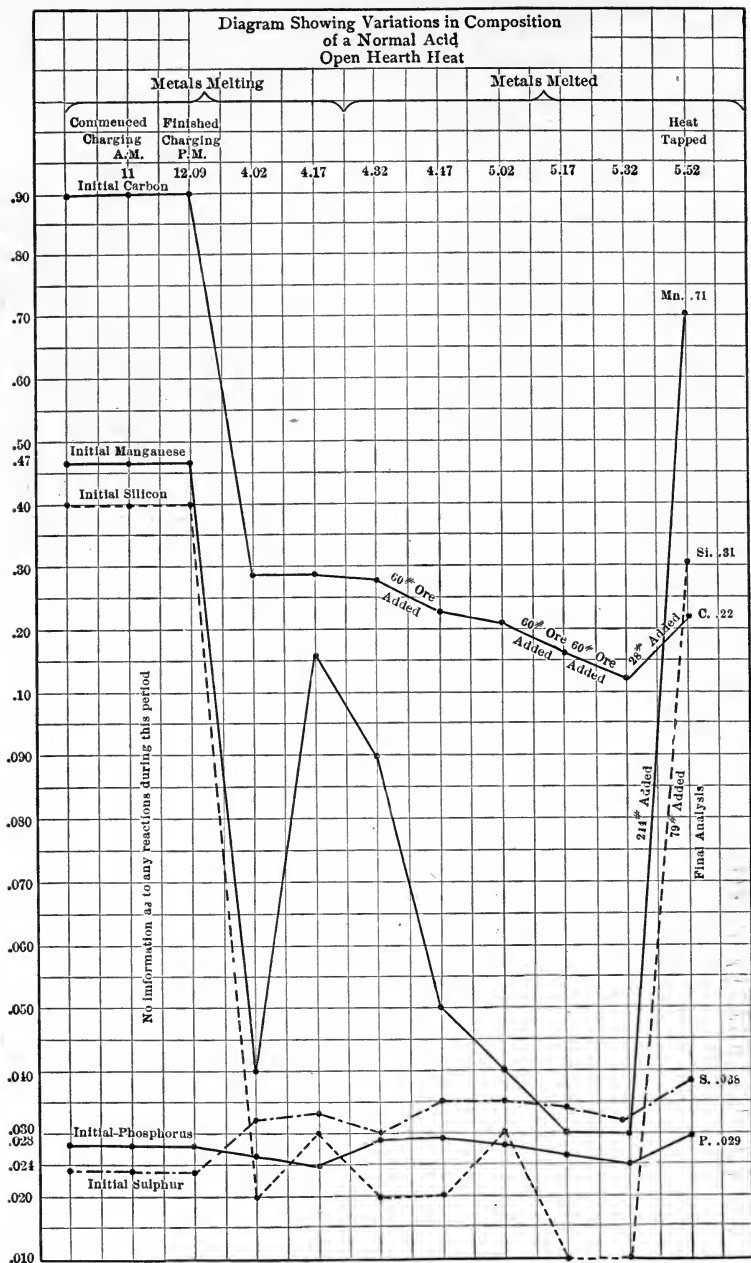

FIG. 108.

methods are possible: We may reduce the bath to 0.10 or 0.15 per cent. and then add sufficient recarburizer to bring the carbon up to the desired point, or we may bring the bath down to only slightly below the desired point and recarburize it to the desired percentage. The former practice usually frees the steel more completely from gas and therefore makes it less wild, besides reducing the danger of phosphorus being left in the steel.

ACID OPEN-HEARTH PRACTICE

Acid open-hearth practice is in many respects similar to basic, but the operations are shorter because: (1) a much larger proportion of steel scrap is used; (2) phosphorus is not removed; and (3), no fluxes are added, except in rare instances, when a little silica is charged at the beginning to prevent iron oxide cutting the lining.

Chemistry. — The chemistry of the acid process is much simpler, because neither phosphorus nor sulphur is removed; therefore it is necessary to start with pig iron and scrap low in both of these elements. The progress of the operation is shown in Fig. 108. The manganese in the pig iron for acid work is usually not so high as it is for basic work: (1) Because this element is sometimes costly; (2) because it increases the amount of slag made; (3) because it forms a base which requires silica for fluxing it; and (4) because it increases the waste, since all the manganese burned represents a loss in weight of metal purchased. Therefore the manganese, as well as the silicon in the bath, is usually reduced to only a trace by the time the charge is melted. H. H. Campbell has shown that the open-hearth slag at the end of the acid operation automatically adjusts itself to contain about 46 per cent. of bases ($\text{FeO} + \text{MnO}$), the remainder being principally silica, and that this ratio remains almost the same even when very varying amounts of iron oxide are added.

Loss. — The loss in the acid process will not be as large as in the basic, because the pig iron and scrap charged are not so impure, and because the amount of slag made and the amount of iron oxidized and retained by the slag are not so large. The loss will vary on an average from 3 to 5 per cent., so that the final metal will weigh 95 to 97 per cent. of the weight of the charge. The analysis of this difference is as shown on page 154.

ANALYSIS OF CHARGE

(50 per cent. pig; 50 per cent. scrap)

	Pig Iron per cent.	Scrap per cent.	Average per cent.	Loss per cent.
Carbon.	3.75	0.25	2.00	2.00
Silicon.....	0.90	0.10	0.50	0.50
Manganese.....	0.60	0.40	0.50	0.50
Phosphorus.....	0.035	0.045	0.04	0.00
Sulphur.....	0.028	0.032	0.03	0.00
8 per cent. slag @ 25 per cent. Fe. =				2.00
				5.00
Iron reduced from ore =				1.20 gain
Net loss.....				3.80

Recarburiz ng. — Recarburization may take place in the furnace in the acid process, if desired, because there is practically no phosphorus in the slag to be reduced and absorbed by the metal. This method has the advantage of the recarburizer being more thoroughly mixed with the bath, but it has the disadvantage of more



FIG. 109.

manganese being burned out of the metal after the recarburizer is added and before the charge is all run into the ladle. The recarburizer consists of ferromanganese, broken in pieces not larger

than a silver dollar. It is sometimes heated red-hot, but not always so, because the heat of the metal will readily melt it. As in the basic practice, recarburization of high carbon steel may be effected either by burning the bath down to a low point and then bringing it up again with carbon and ferromanganese, or by reducing it only slightly below the desired amount and then adding ferromanganese only.

In acid practice, if the carbon is burned to a low point and then brought back, it is customary to accomplish this by dissolving the requisite amount of pig iron in the bath before adding the ferromanganese. This could not be done in the basic furnace, because the impurities in the added pig iron would be liable to cause a rephosphorization of the metal from the slag.

Weight of Slag. — The weight of slag made in the acid process may be determined, according to the method of H. H. Campbell,¹ from the total amount of manganese in the furnace, which will include that put in with the charge (including any that may have been in the ore) and that added with the recarburizing. First we subtract from this total the amount of manganese in the metal tapped; the weight of the remainder is then divided by the percentage of the manganese in the slag, which gives the weight of the slag. The amount of acid slag will depend primarily upon the amount of silicon in the charge and will vary on the average from 6 to 18 per cent. of the weight of the metal charged, about three-fourths of which is formed during the melting period.²

Coal Burned. — The amount of fuel used per ton of steel made in the acid open-hearth furnace will be perhaps 50 to 100 lb. less than in the basic furnace, but will depend again upon many varying conditions, so that figures should be used only with caution. (See pages 144, 167, and 169).

SPECIAL OPEN-HEARTH PROCESSES

It might seem as if the use of molten pig iron direct from the blast furnace, or through the medium of a mixer, might be as advantageous in open-hearth practice as in Bessemer; but this is not so, because the metal in the open-hearth is subjected to oxidation at the same time that it is being melted, so that charging

¹ See page 275 of No. 2. Old edition, on page 8 herein.

² In the case of making structural steel (say 0.18 per cent. carbon).

molten material does not shorten the operation much. The time and labor cost for charging is less, but this advantage is partly neutralized by the scorification and wear of the hearth produced by the inpouring stream of melted metal. About one-half the open-hearth steel of America is made from molten pig. Where it is used the limestone is charged first, on top of that the steel scrap and any other cold metal, and finally the molten metal is poured in. In this way the hearth is protected as much as possible from being cut.

The old pig-and-ore process is abandoned very largely, because of the length of time required to burn off the impurities unless they are diluted by steel. It is difficult for a novice to understand why the reactions are not more rapid in the open-hearth furnace, when the entire purification of pig iron in the puddling-furnace is accomplished in an hour and a half, including melting; but the difference is due to the very shallow bath in the puddling operation and its extensive contact with the fettle. If we should attempt to purify under such strong oxidizing conditions in the open-hearth furnace, the molten metal would boil violently, because of the high temperature, and for the same reason would also become so charged with oxygen as to be worthless. Even at the low temperature of the puddling-furnace, the boiling is so violent as to increase the height of the bath, and this action would be proportionately increased at the temperature of the open-hearth furnace, which, at the end of an operation producing dead-soft steel, will be about 1650° to 1700° C. (3002° to 3092° F.). The increase in volume of the metal when carbon monoxide gas is escaping from it may be likened to that of champagne when the drawing of the cork allows a rapid escape of gas. There is another reason why the boil causes more of an increase in the volume of the bath in the open-hearth furnace than in the puddling-furnace: in the latter, the carbon monoxide has only molten metal and slag to bubble through, but in the open-hearth process, where cold ore is added to the charge, it produces a certain amount of chilling of the metal and slag adjacent to it, and the gas having to bubble through this somewhat pasty material causes a greater increase in its bulk. By the time the puddling charge becomes pasty, the carbon is largely gone and therefore there is not a violent action.

Various attempts have been made by different metallurgists to adapt the open-hearth process to the use of all pig iron rapidly

oxidized by iron ore or other agencies, and this has led to the Talbot and the Monell processes, each of which is carried on in a single furnace, molten pig iron being acted upon by a highly oxidized liquid slag, formed prior to the addition of the pig iron in the Talbot process and coincident with it in the Monell process. It has also led to the Duplex process, whereby a large proportion of the oxidation is effected in an acid Bessemer converter, the operation being completed in a basic open-hearth.

Talbot Process. — The Talbot process has a basic lining and contains a charge as high as 200 tons in some cases, as, for example, at the Jones & Laughlin plant, in Pittsburg, Pa. As the bath of metal is over 3 ft. deep, however, which is about twice that of an ordinary bath, the furnace is only as large in other dimensions as a 100-ton furnace. The tilting furnace is used in order that any desired quantity of metal or slag may be poured out at will. The operation is continuous and the furnace is drained of metal only once a week. After the charge has been worked down to the desired percentage of carbon, the great part of the slag is poured off, and then about one-third (52 tons) of the steel is poured into the ladle, recarburized, and teemed into the ingot molds in the usual way. To the charge of metal left in the bath is now added iron ore and limestone to produce a basic and highly oxidized slag, and through this slag is then poured an amount of pig iron equal to the steel removed. The reaction between the impurities in the pig iron and the iron oxide in the slag is very vigorous, but does not cause a frothing or foaming, because all the materials are in the liquid form and the gas bubbles through them without great difficulty.

The oxidation is so rapid that the silicon and manganese are said to be oxidized almost immediately, and then the phosphorus and carbon are worked off in the usual way, using more ore and limestone, if necessary. The temperature is low at first, in order that the phosphorus may be more readily burned. At the end of about four to six hours, the bath has again become purified, and 50 tons of metal are removed, the whole operation being then repeated. The yield of steel is 106 to 108 per cent. of the weight of the pig iron charged, because of the large amount of iron reduced from the ore by the impurities in the pig iron.



The advantages of the process are: We obtain three or four heats of 50 tons each in 24 hours without the use of steel scrap; the yield is large (though this advantage is somewhat neutralized by the cost of the iron ore used); and the temperature of the final metal can be more easily controlled. The disadvantages of the process are: The very large cost of furnaces¹ and the slightly higher cost for repairs.

Monell Process. — Mr. A. Monell, when metallurgist of the Carnegie Steel Company, developed a pig-and-ore process in which highly heated oxidizing and slag-making materials were made to react with the impurities in molten pig iron without the necessity of having a reservoir of metal into which to pour it. Upon a basic hearth he heats limestone and a relatively large amount of ore until they begin to melt, and then pours molten pig iron, equivalent to the capacity of the furnace, upon it. The temperature of the bath is necessarily low, since pig iron direct from a blast furnace or from a mixer will not be more than 200° or 300° C. above its melting-point, and therefore the phosphorus will be oxidized very rapidly. The slag foams up and pours out of a slag-notch that is provided for the purpose, and in an hour the bath is practically free from phosphorus, silicon, and manganese, and most of the slag is removed. The operation is then continued in the usual way to eliminate the carbon, and the metal is tapped when this has been reduced to the desired point. The American rights to the process are owned by the Carnegie Steel Company and they are operating it at many of their furnaces. No details are known generally, but it is to be presumed that the results are favorable. The apparent disadvantages of the process are excessive cutting of the hearth and a heavy loss of iron in the rich slag which flows off at the beginning of the operation. The Monell process has been used successfully in England, with pig iron containing up to 2 per cent. of phosphorus.

Duplex Process. — At Witkowitz, Austria, at Ensley, Alabama, at Monterey, Mexico, at Sidney, Nova Scotia, and at Pueblo, Colorado, the combined Bessemer and basic open-hearth process is in operation, an acid converter being used to oxidize the silicon, manganese, and most of the carbon, while the phosphorus and the

¹ It is stated that the first 200-ton furnace at the Jones & Laughlin works cost \$1,000,000 to build; but with the present experience they can be installed for about one-fourth of that sum.

remainder of the carbon is eliminated in a basic open-hearth furnace. In the different localities there are different ways of carrying out this combination, but these divide themselves into two general methods: In one method, the metal is blown in the converter until it is purified to the point where it is practically equivalent to so much high-phosphorus, molten steel scrap, which is then mixed with either liquid or solid pig iron in the open-hearth furnace and worked as any ordinary pig-and-scrap heat after melting. In another, and more common, method, the pig iron is blown in the converter until it contains about 1 per cent. or so of carbon, and this product, with little or no additional pig iron, is then dephosphorized and completely decarbonized in the open-hearth furnace. It is stated that the total time of the purification is less than if the ordinary basic open-hearth process were used (this is 4 to 7 hours in Alabama, while the open-hearth part of the process is about 3 hours at Witkowitz), and that the total loss is only 10 per cent.

At Alabama, the metal from two 20-ton converters is poured into a mixer furnace of 250 tons capacity, which supplies four 100-ton basic open-hearth furnaces with metal. The blown metal contains about 1 per cent. of carbon, about one-half the heats being blown 'full,' while the remainder are blown to about 1.75 to 2.50 per cent. carbon. In this connection it is interesting to note that, if the metal is blown to about 1.75 per cent. or so of carbon, there is less loss of iron as shots in the slag than if the carbon is higher.¹

Processes in Two Open-Hearth Furnaces. — At a low temperature, phosphorus is very easily oxidized and absorbed by a basic slag, even in the presence of carbon, but when the heat is high the oxidation of phosphorus is hindered by the carbon, for the reason already explained, — that the affinity of carbon for oxygen increases more rapidly with the temperature than the affinity of the other elements in the bath. This explains the rapid elimination of phosphorus in the puddling process, where the slag is strongly basic with oxide of iron and the temperature is low. We could obtain the same conditions in the beginning of the open-hearth process, but the operation would be extremely slow at this low heat, and the carbon would pass away slowly. These difficulties have been met by the Campbell No. 2 and Bertrand-Thiel processes, the former of which was developed at Steelton, Pa., and the latter at Kladno, Bohemia.

¹ For this information I am indebted to Mr. Hugh P. Tiemann.

Campbell No. 1 Process.—The pig-and-ore process using molten metal has long been in operation in the Campbell tilting furnace, and the frothing of the bath is taken care of by tipping the furnace backward so that no slag or metal will pour out of the door, though a large amount of the former flows from the slag-hole between the ends of the furnace and the ports. The operation is continued in this way for two or three hours, since, as already noted, the furnace can be tipped without cutting off the supply of gas and air, and the yield of steel is 104 to 106 per cent. of the pig iron charged.

Campbell No. 2 Process.—At the same plant there is also a combination process in which the charge, consisting of all pig iron, or of pig iron¹ and scrap, is placed in a basic open-hearth furnace, and the purification carried on at a high temperature until almost all the silicon and phosphorus and part of the sulphur and carbon are eliminated. The bath is then tapped from the basic furnace and poured into an acid-lined furnace, care being taken that none of the basic slag goes with it. At this period the metal is low in phosphorus and sulphur, and contains about the same amount of carbon that a cold charge would have contained as soon as melted. The conditions are therefore the same as if low-phosphorus low-sulphur material had been charged into an acid furnace and melted there, and the process is now continued at a higher temperature, in the usual way to make acid open-hearth steel. The disadvantage of this process is that the transferring of molten metal from one furnace to another is not an easy matter, nor, in fact, is it possible with the arrangements in many plants.

OPEN-HEARTH FUELS

The commonest fuel used in the open-hearth furnace is producer gas, because more heating power and more gas can be obtained for a dollar in this variety than in any other, except in those favored localities where natural gas is found.

Producer Gas.—If air be blown through red-hot carbon the following reaction takes place:

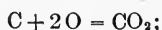

but if the bed of fuel is deep, the carbon dioxide enters into a further reaction, as follows:

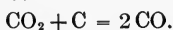

¹The pig iron charged may be either in the liquid or solid state.

In other words, if air be made to blow through a deep bed of red-hot carbon, there will be produced carbon monoxide gas which has combustible value:



Producer gas for open-hearth furnaces is usually made from bituminous coal, because the hydrocarbons contained in this coal enter into the gas and thus give it illuminating power, which makes it much more efficient in the furnace, because the heating takes place by radiation chiefly. Such a gas will contain 3 to 5 per cent. of hydrocarbons, 20 to 25 per cent. of CO, 55 to 60 per cent. of nitrogen, and 2 to 8 per cent. of carbon dioxide.

The two latter components produce no heat and are therefore worse than useless, because they carry heat away from the furnace up the chimney stack. The nitrogen comes from the air, of course, but the CO₂ is theoretically absent. Its presence is due to irregularities in the gas producer operation, such as vertical channels forming in the bed of fuel, up which the CO₂ gas passes without being brought into contact with carbon; or the rapid passage of the gas does not permit time for the reactions to be completed; or irregularities in the fuel bed, whereby the fuel will be red-hot much higher on one side than on the other.

The air is usually blown through the fuel by means of a steam-jet, which results in a certain amount of steam passing into the producer with the air; but this is rather an advantage than otherwise, as the steam is decomposed by the red-hot carbon and enriches the producer gas:

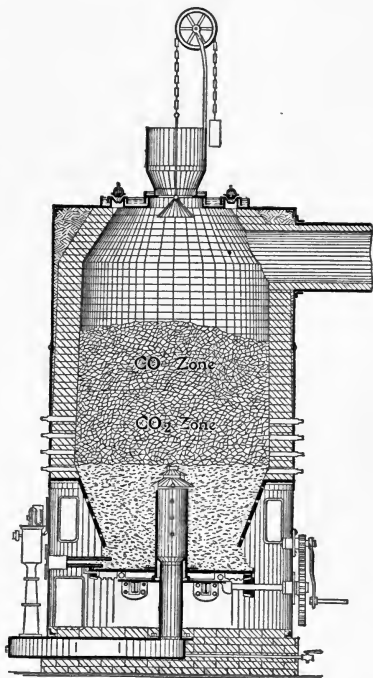
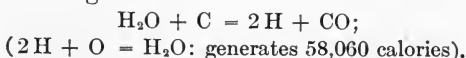

FIG. 110. — TAYLOR REVOLVING BOTTOM GAS PRODUCER.

Gas Producers. — The gas producers are the furnaces in which the fuel is contained while the air is passed through it. The main objects to be accomplished are: (1) To pass the air uniformly through the bed; (2) to remove ashes and charge fresh fuel without interrupting the production of gas; and (3) to preserve the deep bed of incandescent carbon, having level upper and lower surfaces. There are three horizontal zones in the gas producer: The first is the ash zone, which is deep in order that the air may be slightly preheated in passing through it and that any unburned carbon which gets into it may have a strong liability of being burned. Next above that is the CO_2 zone, in which the oxygen and carbons are first combined; and above that the CO zone, in which the CO_2 is reduced by more carbon. The top of this zone should be at a dull-red heat.

There are many different forms of producer, which are extensively used for open-hearth work, but these may be divided into two general types: In the first or water-sealed type, the bottom of the producer dips into a pool of water and thus the tools may be introduced for the removal of the ashes at will. In this type there are sometimes steel arms extending into the bed of fuel, either from the top or from a central shaft, by the rotation of which the bed is poked, lumps and channels are broken up, etc. The second type has a mechanical grate, by which the ashes can be scraped down into the chamber underneath without interrupting the producer operation for the purpose.

Grate Area. — The total grate area of all the producers supplying gas to a furnace should be about 3.5 sq. ft. per ton of furnace capacity; some producer plants run even higher than this, and up to 6.25 sq. ft. Another method of figuring the grate area is that 1 sq. ft. should be supplied for every 7.5 to 12.5 lb. of coal burned per hour, although with expert gas makers and good coal the combustion may be much greater than this, and higher values (to 22 lb.) are claimed by the makers of the gas producers.

Volume and Calorific Power. — The volume of producer gas obtained from a ton of coal will be about 150,000 to 170,000 cu. ft., having a calorific power of 33 to 36 Calories per cu. ft., or 130 to 145 B.t.u. per cu. ft.¹ These figures will, of course, depend upon the quality of the coal gasified, but the calorific power is no

¹ For calculation of this relation see page 171.

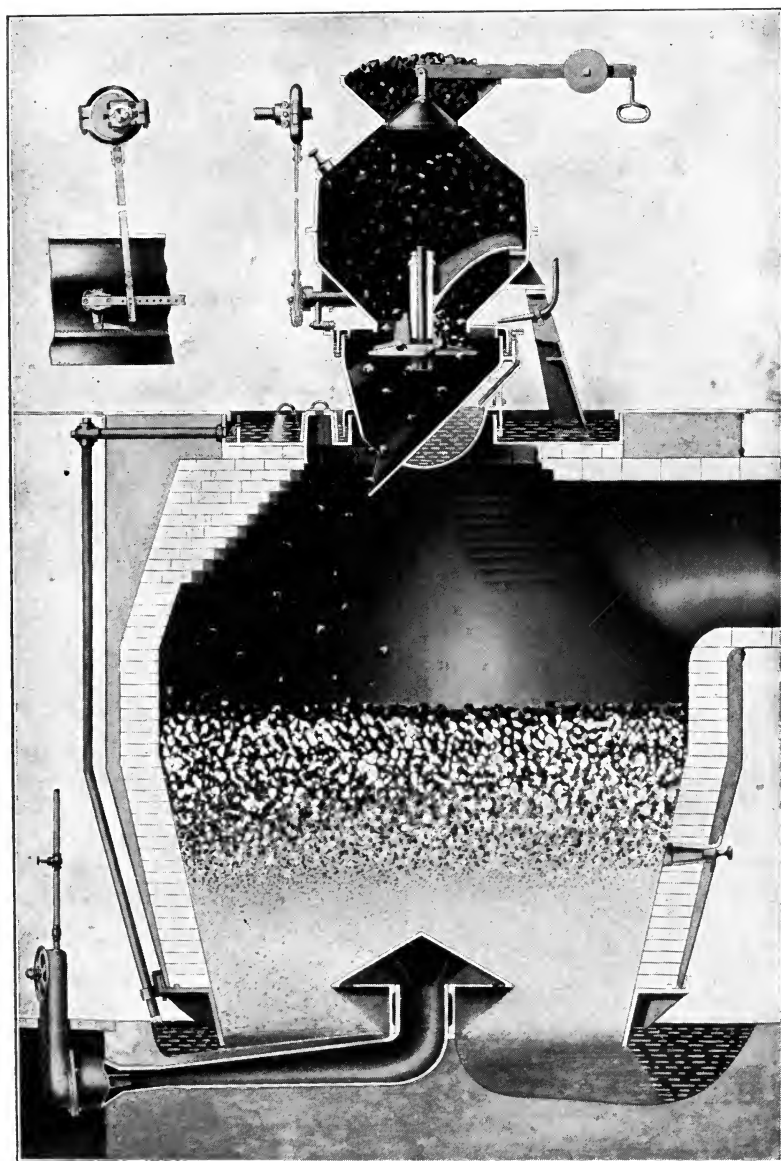

FIG. 111. — MORGAN WATER-SEALED GAS PRODUCER.

more important than the amount of heat that it will radiate, which depends upon the luminosity of the flame.

Luminosity. — The luminosity of flames depends upon the amount of hydrocarbons, and especially of heavy hydrocarbons,

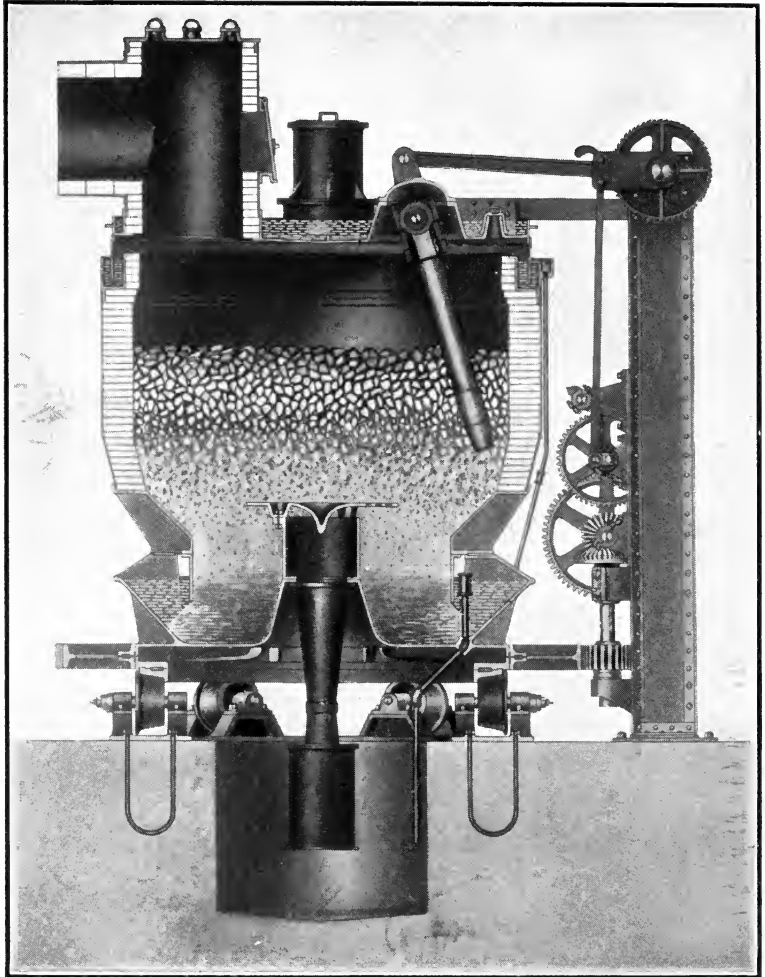

FIG. 112. — HUGHES MECHANICALLY POKED GAS PRODUCER.

burned to produce them. It is therefore necessary, if the producer gas is made from bituminous coal low in hydrocarbons or from coke or anthracite, to increase its illuminating power by

spraying oil into it. The luminosity is produced by the deposition of a myriad of tiny particles of carbon, which are heated to incandescence and then radiate energy in the form of light. It is probable that this action is produced by the relatively light hydrocarbons, such as methane (CH_4), breaking up first into ethylene (C_2H_4), and then into acetylene (C_2H_2), which deposits the carbon particles or soot. It is for this reason that the pure acetylene flame has such intense luminosity.

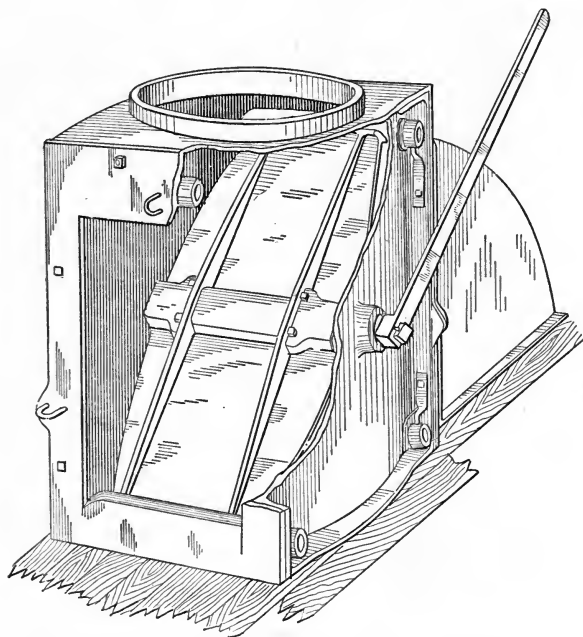

FIG 113. — BUTTERFLY REVERSING VALVE.

(See also Fig. 32, page 56.)

Gas Mains. — The gas mains leading from the producer plant to the open-hearth furnace should be lined with brick and be at least large enough for a man to pass through. Beyond this, a good rule is 1 sq. ft. of area of cross-section of gas main for every 8 sq. ft. of total combined area of gas-producer grates. The gas loses heat by radiation in the mains and deposits the tarry constituents, i.e., the nearly solid hydrocarbons, in both ways losing heating power.

Valves. — The reversing valves of the open-hearth furnace are a cause of large loss in producer gas, and sometimes the leak amounts to 10 or 20 per cent. Ordinary leaks may be prevented by having water-sealed valves, but sometimes the pressure of gas reaches the point where it overcomes the water pressure and escapes, causing a heavy loss. Moreover, water-sealed valves are open to serious objections: (1) The water may freeze, causing an endless amount of annoyance and trouble; (2) some water on the inside of the valve is vaporized and the vapor carried into the regenerator or into the furnace, where it absorbs heat; (3) the hoods are liable to warp with the heat; and (4) valves of this type are so heavy that elaborate mechanism is necessary to reverse them. The common butterfly valves burn out rapidly and warp badly. If water-

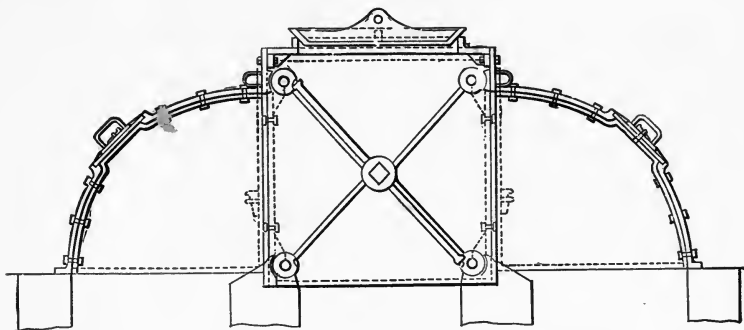

FIG. 114.

sealed, the hoods warp and leak. Lining the hoods with brick makes additional weight for shifting and adds very largely to the repairs. The mushroom type requires eight valves to a furnace and an elaborate arrangement for reversing them properly. They burn out badly unless water-cooled, when difficulty is met with from freezing.

Natural Gas. — In those districts, like Pittsburg, where natural gas occurs, it is a great boon to the open-hearth steel industry, because of its high calorific power and the cheapness with which it may be obtained, and about 80 wrought-iron plants and 90 steel plants in America use it. It is drawn from the earth, and has a calorific power of 970 to 1010 B.t.u. per cu. ft. (equivalent to 225 to 250 Calories per cu. ft. or 8600 to 9000 Calories per cu. meter).¹

¹ The calculation of this relation will be found on page 171.

In the Pittsburg district the amount of natural gas used per ton of steel made ranges from 4000 to 11,000 cu. ft., averaging about

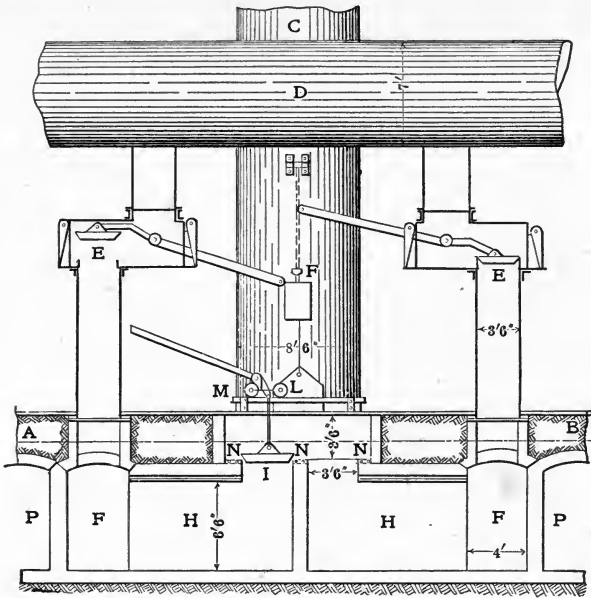

FIG. 115. — MUSHROOM REVERSING VALVE.

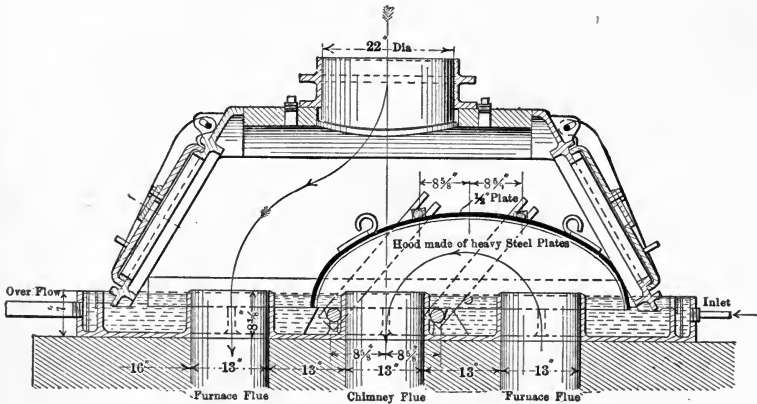

FIG. 116. — WATER-SEALED REVERSING VALVE.

5500. This includes the gas used in the furnace and the small amount necessary for heating the ladles. The natural gas is usu-

ally introduced through two pipes at each end of the furnace, which are located close to the bottom of the gas-ports and deliver the fuel about $3\frac{1}{2}$ feet back from the hearth. The natural gas is therefore applied without any loss in gas mains, reversing valves, regenerators, etc., and is cheaper in labor on the furnace floor itself. The Pittsburg natural gas averages about 70 to 90 per cent. of methane (CH_4) or marsh gas, the remainder being hydrogen with a fraction of a per cent. of carbon dioxide and a very few per cent. of nitrogen.

On account of its high calorific power, it is not necessary to pre-heat this gas, and this is the more fortunate, because the amount of

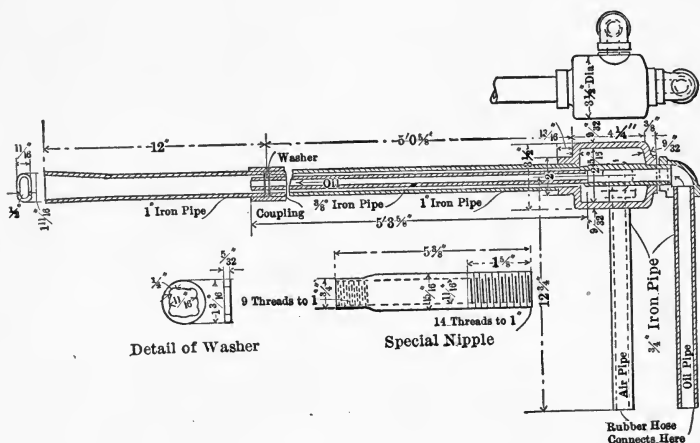

FIG. 117. — OIL BLOW-PIPE FOR OPEN-HEARTH FURNACE.

hydrocarbon is so great that if the gas be passed through regenerative chambers, it decomposes and deposits soot on the checkerwork. All the open-hearth furnaces in the Pittsburg district are so arranged that they can be put on producer gas in case it should become necessary, because the supply of natural gas has been decreasing for many years. In the early part of 1908, some furnace plants of a very important company in this district began the use of the manufactured gas, because of the increased cost of natural gas.

Oil. — On the continent of Europe, and in parts of the United States distant from the natural gas and bituminous coal regions, many open-hearth furnaces are heated by petroleum. The

United States has many deposits of fuel oil, besides which it is sometimes possible to obtain a refuse from the oil refineries which is excellent for this purpose. There are therefore many different grades employed, but they will usually average from 7.8 to 8.3 lb. per gallon, with a calorific power of 14,000 to 17,000 B.t.u. per pound. H. H. Campbell¹ states that a rough comparison may be made by assuming that 50 gallons of oil will give the same amount of heat as about 1000 pounds of soft coal, and he has had a valuable amount of experience with this kind of fuel. It would seem, however, as if this value for oil was somewhat high for safety in

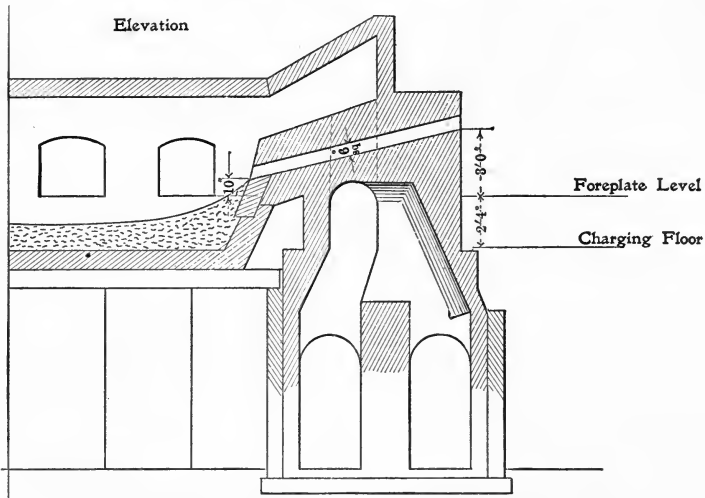

FIG. 118. — FURNACE ARRANGED TO USE OIL BLOW-PIPE.

making calculations, and that a more conservative estimate would be to say that from 35 to 60 gal. of oil would be required per ton of steel treated in the open-hearth furnace. Eight furnaces using oil averaged 38 to 42 gal. per ton of steel made.

The crude petroleum is vaporized by atomizing it with a jet of steam or compressed air, and it is not common practice in the United States to pass this vapor through a regenerative chamber. The usual method of application is by a blow-pipe introduced through the brickwork at the end of the furnace, as shown in Fig. 118, and a special form of blow-pipe is now on the market for this purpose. It is necessary to pump the oil to the blow-pipe or

¹ See page 247 of No. 2. Old edition, on page 8 herein.

else to store it in an overhead tank, from which gravity will carry it, but the labor in connection with this is much less than the labor on gas producers. In the rare cases when the oil vapor is preheated, it must be introduced into the hot part of the regenerative chamber, because if it cools it condenses. Moreover, when introduced into a cold furnace or with a cold charge in the furnace, combustion will be retarded.

Whether oil is used or not will depend principally upon freight, because it may be transported much more cheaply than any other form of fuel. It gives a longer flame than either natural or producer gas, and one very great advantage of using it is a saving of the roof of the furnace; the oil flame may be directed so accurately by means of the blow-pipe that it does not impinge directly on the roof, and the brickwork therefore lasts very much longer. On the other hand, it spreads out horizontally and causes a greater wear on the front and back walls of the furnace. It gives a more uniform heat, a more oxidizing flame, and no danger of losses or difficulties, in case there is a leak in the walls between the gas and air regenerators, which is not an infrequent occurrence with gas.

Water-Gas. — If steam be made to pass through a bed of red-hot carbon, the product is a gas containing slightly less than 50 per cent. each of hydrogen and carbon monoxide and having a high calorific power:

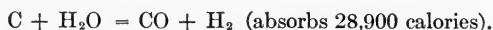

The result of this reaction is a reduction of the temperature of the fuel bed, which is rapidly reduced until another reaction begins to take place:



Therefore some means must be employed to raise the temperature at intervals, and this is ordinarily accomplished by interrupting the passage of steam and passing air through the fuel bed, which raises the temperature and at the same time forms producer gas which is used for other purposes. Usually, it is necessary to blow air through for 12 to 15 minutes, and then steam for 4 or 5 minutes. Consequently, the manufacture of water-gas is intermittent and the method is not very satisfactory for open-hearth work, although the gas is used to some extent on account of its high calorific power. This operation produces roughly 35,000 cu. ft. of water-gas and 80,000 cu. ft. of producer gas per

ton of coal. Water-gas has about 2600 Cals. per cu. meter, or, say, 290 to 300 B.t.u. per cubic foot.¹

Dellwik-Fleischer System. — The Dellwik-Fleischer system is a modification of the ordinary water-gas system, in that the amount of air blown through for heating up the fuel is so very large that carbon dioxide is produced instead of carbon monoxide. This

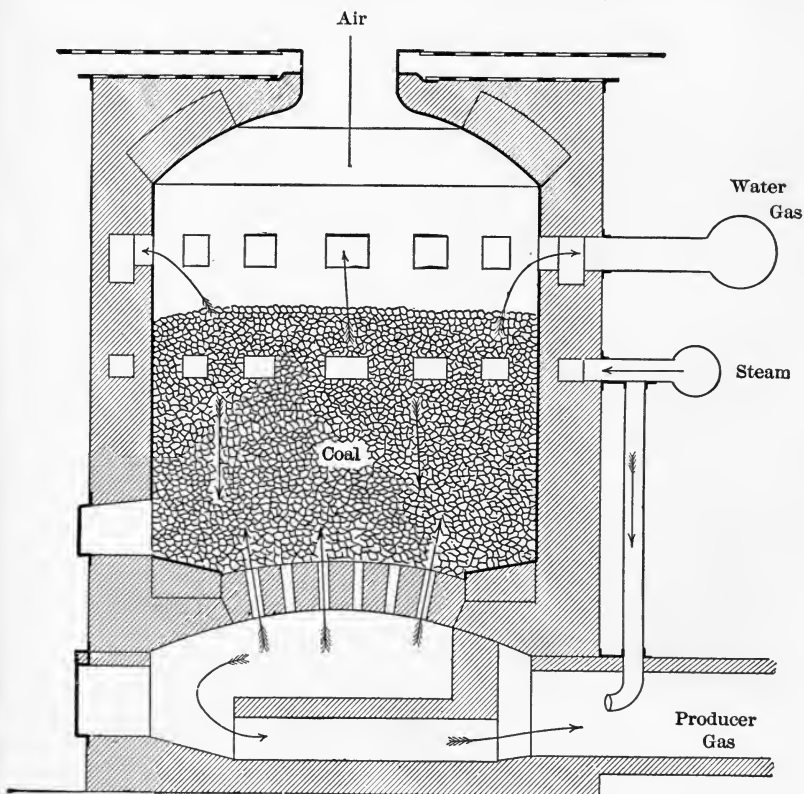

FIG. 119. — WATER-GAS PRODUCER.

gas is therefore altogether wasted, but the formation of carbon dioxide generates so much more heat that the blowing up does not take so long, and usually lasts from $1\frac{1}{2}$ to 2 minutes, after which water-gas is made for 8 to 12 minutes. In this way about

¹ One cubic meter = 35.3 cubic feet.

One Calorie = 3.968 B. t. u. (See page 466.)

One Calorie per cubic meter = 8.9 B. t. u. per cubic foot.

80 per cent. of the calorific value of the fuel is converted into water-gas, and several steel-works in Europe have adopted the method.

Mond Gas. — In the Mond process a mixture of water-gas and producer gas is made continuously. For every ton of fuel burned there is forced into the producer about 3 tons of air and 2.5 tons of steam, the latter being produced by absorbing the sensible heat of the gas in the boiler. It gives about 150,000 cu. ft. of gas per ton of fuel burned, containing about 25 per cent. of hydrogen, $12\frac{1}{2}$ per cent. of CO, 45 to 50 per cent. of nitrogen, and $12\frac{1}{2}$ per cent. of CO₂. This gives a slightly higher calorific power than ordinary producer gas, and is used in some steel-works.

REFERENCES ON THE OPEN-HEARTH PROCESS

61. M. A. Pavlov. "Album of Drawings Relating to the Manufacture of Open-Hearth Steel." St. Petersburg, 1908. (See also page 93.)
62. W. M. Carr. "Open-Hearth Steel Castings." 1907. This contains a concise, simple and readily intelligible discussion of the acid and basic open-hearth processes and practice.

VII

DEFECTS IN INGOTS AND OTHER CASTINGS

BESIDES the dangers already mentioned in connection with improper methods of manufacture, excessive amounts of impurities, etc., iron or steel may suffer from damage caused or developed during casting. The commonest defects which may appear at this time are: (1) Blow-holes, or gas bubbles enclosed in the body of the metal; (2) a pipe, or shrinkage cavity; (3) ingotism, or the formation of large-sized crystals; (4) segregation, or the concentration of impurities in localities; (5) checking or cracking of the casting because of strains produced when the metal is hot and tender. Avoiding these defects cannot make bad steel good, but their presence may make good steel bad, and therefore to guard against them is an important part of the processes.

Blow-holes. — Blow-holes are especially liable to occur in steel, particularly in low-carbon steel. When the metal is in a molten state, it readily dissolves certain gases, such as hydrogen, nitrogen, oxygen. Upon solidification these gases come out of their state of solution, but may become entangled in the steel and cause a gas bubble or cavity varying all the way in size from microscopic proportions up to an inch or more in length. The formation of these blow-holes is precisely similar to the formation of air bubbles in ice: water dissolves a good deal of air while in the liquid state and, as we all know, it is well-nigh impossible to freeze the water without obtaining a great many air bubbles in the ice, due to the separation of this air during freezing. The danger in the case of steel is not so great as in the case of ice, and it is by no means impossible to obtain steel absolutely free from this defect. Apparently, the reason for this difference is that the gas separates from steel a short time before solidification is complete, and thus the bubbles have some opportunity to escape before they are enclosed in the solid. Also, steel passes through a pasty stage during solidification, as we shall learn later, and therefore gives a better opportunity for the gas bubbles to pass away.

Another cause of blow-holes in steel is undoubtedly the presence of oxide of iron in the metal. This oxide of iron reacts with the carbon added in the recarburizer and forms carbon monoxide gas (CO), which may be produced during the entire solidification period and thus cause many blow-holes.

Prevention of Blow-holes. — That oxide of iron is one of the chief causes of blow-holes is shown by many things; for instance, (1) steel known to be highly oxidized is very liable to blow-holes; (2) cast iron, which from its chemical composition can never be much oxidized,¹ is never subject to blow-holes; and (3) the addition to steel of deoxidizers prevents the formation of blow-holes.

Chief among the deoxidizing elements which are added for this purpose are manganese, silicon, and aluminum. These elements seem to act partly by deoxidizing the iron and carbon, in both ways preventing the formation of carbon monoxide, and partly by increasing the solvent power of the solid metal for gases, so that a less amount separates. The amount of these deoxidizing substances necessary to be added will depend largely upon the extent to which we desire to prevent the formation of blow-holes. In the case of steel castings it is often necessary that blow-holes be entirely prevented, but in the case of ingots which are to be subsequently forged or rolled it is not necessary that blow-holes should be absent altogether, because they will be closed up under the pressure of the mechanical work and their sides welded together. Indeed, their presence is sometimes desired, because when they separate from the steel they occupy space, thereby counteracting to a certain extent the shrinkage of the metal during solidification and tending to reduce the volume of the shrinkage cavity or pipe. For this reason a small number in some harmless locality is often intentionally allowed to form in steel ingots. Mr. Brinell found in his steel-works that if the percentage of manganese plus 5.2 times the percentage of silicon is equal to 2.05 or more, the steel will be entirely free from blow-holes. In this case, however, the pipe will be large. If this sum is equal to 1.66, the steel will contain a harmless number of minute blow-holes, but the pipe will be small.

¹That cast iron is sometimes partially oxidized is claimed by several eminent authorities, and the evidence presented makes us hesitate to deny that a certain variety of wild cast iron owes its peculiar behavior to the presence of some partially oxidized constituent (perhaps the oxysulphide of iron, as suggested by J. E. Johnson, Jr.).

This figure is therefore about the correct amount for ingots under conditions similar to those of Mr. Brinell's experiments, and not far different in any event. Mr. Brinell also found that the addition to the steel of 0.0184 per cent. of aluminum will give approximately the same result as that given by the amount of manganese and silicon last mentioned, 1.66.

Location of Blow-holes. — The number and size of blow-holes is no more important, however, than the position they occupy in ingots in relation to the external surface. Even in castings, blow-holes, if present, should be deep-seated, as they are then less liable to be exposed by machine work performed on the surface. In the case of ingots the deep-seating is of still greater importance, because then the blow-holes may be closed up before they have an opportunity to break through to the surface and thus become oxidized on their interior. The normal gases in blow-holes are reducing in effect, and thus the interior surfaces of the holes are bright and silvery in appearance and readily weld together; but if they become oxidized they will never adhere firmly. For instance, a blow-hole near the surface, as in Figs. 120 and 122, is liable

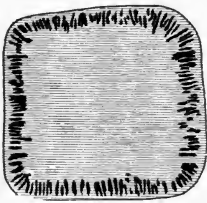

FIG. 120. — SKIN
BLOW-HOLES.

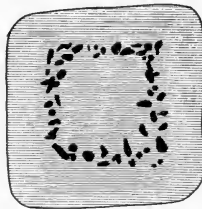

FIG. 121. — DEEP-SEATED
BLOW-HOLES.



FIG. 122.

to break through to the exterior when the ingot is put under pressure. This not only causes a crack in the steel but allows the air to oxidize the interior of the hole and thus prevent the crack being welded up by the rolling. It is not at all uncommon to see a number of these openings form during rolling when the blow-holes are near the surface.

As the percentage of manganese plus 5.2 times the percentage of silicon decreases from 1.66, the blow-holes become correspondingly deeper-seated. Finally when this sum becomes as low as 0.28, the blow-holes are harmlessly located in the interior. It is

usually impracticable, however, to get the manganese and silicon as low as this in steel, because manganese is needed to counteract the bad effect of sulphur and oxygen.

The location of the blow-holes is also very largely dependent upon the fluidity of the metal when first cast into the molds. The more fluid it is, other things being equal, the nearer will the blow-holes be to the surface of the solid ingot. On the other hand, if the casting temperature is too low there will be a dangerously large number of blow-holes in the steel (see Fig. 122), because it solidifies so quickly that very little opportunity is afforded for any part of the dissolved gases to escape. The fluidity of the steel depends partly upon its temperature and partly upon the amount of impurities in it. For instance, pig iron is fluid at a temperature at which steel is solid; high-carbon steel is fluid at a lower temperature than low-carbon steel. Therefore every different kind of steel has a different correct casting temperature; but we have already learned (p. 107) how to determine this by means of the skull left in the casting-ladle, and it is evident that this test applies equally well to all grades of steel. It is to be observed that low-carbon steel suffers greatly from blow-holes, because the more the carbon the less oxidized will be the steel.

Pipes. — When steel is poured into a mold, it forms almost immediately a thin skin of frozen metal against the cold surface of the sand or iron. The radiation of heat thereafter necessarily takes place through these surfaces, and therefore a casting will usually complete its solidification by the formation of thicker and thicker layers of solid metal around all the sides. The top, however, will usually remain molten longer than the rest because the hottest metal is usually at this point, having been the last to leave the ladle, and also because the heat is not conducted away by the air as fast as by the walls of the mold. This is especially true where the casting is poured into an iron mold—for example, in the case of ingots (see Fig. 123). But it is evident that at some period a stage will be reached when all the outside of the ingot, or casting, will be covered by a skin of solid metal while the interior will still be liquid. The liquid interior will continue to freeze and will, at the same time, contract. The result will be the shrinking of the molten mass away from the solid walls and consequently the formation of a cavity, known as a 'pipe,' in the interior. This pipe will be filled with the gases evolved by the steel during solidification.

Professor Howe has shown that the volume of the pipe is too large to be accounted for altogether by the shrinkage of the steel during solidification, and has shown that the rate of contraction of the inner walls of the ingot being greater than the rate of contraction of the outer walls, a virtual expansion of the outer walls is caused and a consequent enlargement of the pipe.¹

The portion of the steel containing the pipe is of course defective and should be discarded at some time subsequent to casting. In the casting of ingots the upper part, which contains the pipe, is

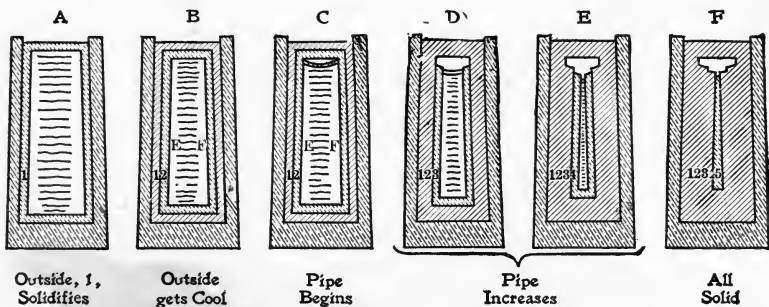

FIG. 123. — SOLIDIFICATION OF AN INGOT.

cut off during the rolling or forging and goes back to the furnace to be remelted as scrap. In the casting of steel castings there is a large adjunct to the castings situated above it, and so regulated in size and otherwise that it freezes after the casting itself, and thus always contains a supply of molten metal which runs down and fills any cavity that forms in the casting. This adjunct is cut off when the casting has cooled. In other words, the 'riser' or 'feeder,' as this extra part is called, serves the same purpose for a steel casting as the upper part of an ingot does for the ingot.

Cast-iron castings do not form a pipe under ordinary circumstances, because cast iron expands during solidification on account of the separation of graphite, as we shall learn later. Under certain circumstances, however, there may be enough difference in expansion between the inside and outside of cast-iron castings to produce a porous spot which, while not exactly a pipe, is due to similar causes. We shall discuss this matter further in Chapter XII.

¹ No. 71, page 183.

Lessening the Volume of the Pipe. — If the steel were poured into the mold so extremely slowly that it would solidify in layers from the bottom upward there would be no pipe. Therefore one method of lessening the volume of the pipe is by slow casting. We have already noted another method, namely, permitting a small number of blow-holes to form, which causes a certain amount of expansion of the steel during solidification and thus diminishes its shrinkage. Another way is to use wide ingots, because this reduces the difference in contraction between the inner and outer layers of the ingot, which, as I have already stated, caused a virtual expansion of the outer walls and thus enlarged the cavity. Casting in sand molds has the same effect, because radiation is not so rapid through sand as through metal. Still another method is to prevent the steel forming a solid skin over the top by constantly stirring and breaking it up with an iron rod. This method is often resorted to with the risers of steel castings, with very beneficial results.

Bottom Casting. — In the case of steel castings, and less frequently in the case of ingots, the metal is poured from the ladle into a runner which delivers it at the bottom of the casting (see Fig. 193, p. 241). With steel castings this is often necessary in order to prevent dirt getting into the casting. It also has a similar effect on ingots, because it prevents slag getting into the molds and also prevents metal from spattering up on the side of the mold and forming what is known as a 'cold-shut,' that is, a part of the metal which is not melted in with the rest. In both cases, however, this bottom casting has the effect of increasing the volume of the pipe and also of making the pipe extend deeper, because at the end of casting the hottest metal is at the bottom instead of at the top.

Casting with the Large End Up. — Risers on castings are almost always made with the top end larger than the bottom, in order that the pipe may be less in volume and shorter in depth. At steel-works, however, the ingot molds are always tapered slightly with the large end at the bottom, in order that the mold may be easily drawn off the top (see p. 109). This results in the large end of the ingot being down, and consequently in the pipe being larger in volume and very much greater in depth.¹ Because of this advantage Professor Howe has proposed certain mechanical ar-

¹ No. 72, page 184.

rangements by which the ingot may be cast with the large end upward.¹

Liquid Compression of Ingots. — If the pipe is caused by the difference in expansion between the inside and the outside of an ingot, it is evident that putting sufficient pressure upon the outside when the walls are solid but the interior is still liquid will prevent the formation of a pipe. Numerous processes have been devised for effecting this liquid 'compression,' some of which are in operation at steel-works and produce ingots that are entirely free from pipes. In Whitworth's system the ingot is raised and compressed lengthwise against a solid ram situated above it, during and shortly after solidification.² In Harmet's method the ingot is forced upward during solidification into its tapered mold.² This causes a large radial pressure on its sides. In Lilienberg's method the ingots are stripped and then run on their cars between a solid and movable wall. The movable wall is then pressed against one side of the ingots.³

Ingotism. — When iron and steel freeze they crystallize, and these crystals grow with great rapidity, so that if the passage through the solidification period is slow they will attain a very



FIG. 124. — INGOTISM.

large size. This formation of large crystals is known as 'ingotism.' It is especially liable to occur if the metal is cast at too high a temperature or is allowed to cool through the solidification period

¹ See No. 71, page 183. ² See page 373 of No. 1, page 8. ³ See No. 73, page 184.

at too slow a rate.¹ In the case of steel, ingotism may be detected by breaking the casting, when the large size of the crystal faces or facets may be observed.

Damage Due to Ingotism. — Large crystals always produce weakness and loss of ductility, for the large crystals do not adhere to one another as firmly as when there is a more intimate association; consequently steel that shows ingotism will be tender. In the case of steel castings, they will not give as good a result in the testing machine; in the case of ingots they will be liable to tear during rolling or under the hammer.

Remedy for Ingotism. — Ingots in which large crystals have formed during solidification may be brought to a high degree of strength and ductility by forging or rolling, because the mechanical work crushes the crystals and reduces them to a smaller size. The work must be done very carefully at first, however, or cracks will be formed that are not afterward welded up. Ingotism in steel castings is not so easy to cure; indeed, it is maintained by some authorities that its bad effects are never entirely obliterated. I am inclined to agree with this opinion, although annealing the steel at a proper temperature (see Chapter XIV) will produce a very beneficial effect.

Segregation. — When either iron or steel is molten, the various impurities are dissolved in it, and some of them, especially carbon, phosphorus, and sulphur, make the metal more fusible, that is, they lower its melting-point. But the impurities are not as soluble in the solid metal, and therefore tend to separate on solidification; so it can readily be conceived how each layer that freezes, beginning at the outside, rejects some of its impurities to be dissolved by the still liquid mass in the interior. When the next layer freezes that too will tend to reject a part of its impurities into the contiguous molten layer, and thus the concentration will proceed so that as a general thing the portion of the metal richest in impurities, especially in carbon, phosphorus, and sulphur, will be that which freezes last. With ingots, this will evidently be at a point just below the bottom of the pipe, and it is found to be so in the great majority of cases; but the location of the richest segregate is very

¹In the case of cast iron, large crystals formed during solidification produce what is known as an 'open grain'; we shall consider this more particularly in Chapter XII. The name 'ingotism' is not usually applied to this open grain in cast iron.

liable to vary, and rules can only be used for general guidance. For example, in Fig. 125,¹ the most impure metal is found at a point higher than the bottom of the pipe; and other unexpected exceptions occur. In the case of iron and steel castings, the most impure point will generally be near the top of the thickest section of metal. The riser is calculated to be the last portion to freeze and the richest segregate should be located in it.

In iron castings which contained on an average less than 1 per cent. phos-

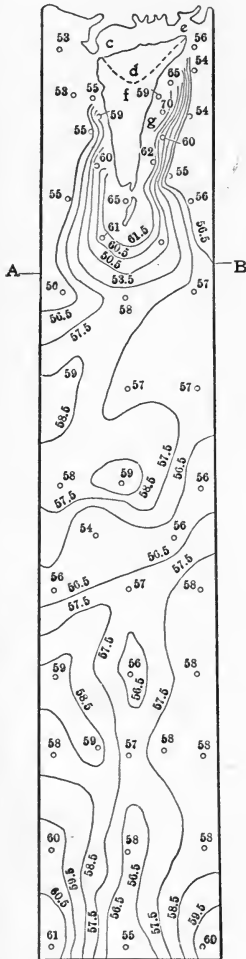

FIG. 125. — LINES OF EQUAL CARBON-PERCENTAGE IN A STEEL INGOT.

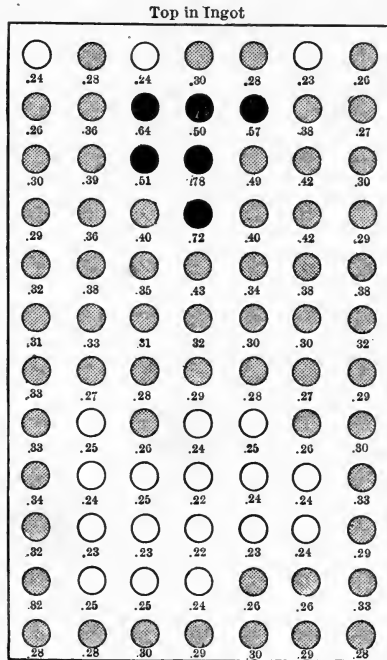

FIG. 126. — CARBON-PERCENTAGE AT DIFFERENT PARTS OF A STEEL INGOT.

phorus and 0.1 per cent. sulphur, I found on one occasion a segregated portion containing 1.856 per cent. phosphorus and

¹ From page 205 of No. 71, page 183.

0.144 per cent. sulphur; and on another occasion I found one containing 2.43 per cent. phosphorus and 0.236 per cent. sulphur. An extreme case of segregation in steel is shown in the following analysis:¹

	Carbon Per cent.	Silicon Per cent.	Manga- nese Per cent.	Phosphorus Per cent.	Sulphur Per cent.
Average.....	0.24	0.336	0.97	0.089	0.07
Segregate.....	1.27	0.41	1.08	0.753	0.418

Treatment of Segregated Steel. — Segregation cannot be prevented, although, of course, it seldom takes place to the degree shown in the extreme cases that I have cited above. Nevertheless, there are always certain portions of the ingot or casting which are richer in impurities than others. An attempt is made to get this richer portion into the upper part of an ingot, or into the riser of a casting, and then it is cut off when the ingot is rolled, or when the riser of the casting is removed. It is therefore advantageous to cause the segregate to go as high up in the ingot or casting as possible. Whatever tends to raise the whole pipe higher up in the casting would, in general, tend to raise the segregate also; but wide ingots, or ingots cast in walls with low conducting power, though they tend to decrease the volume of the pipe, would not necessarily raise the segregate to a higher point. Furthermore, wide ingots will probably have a much greater degree of segregation than narrow ingots, other things being equal, because the wider the ingot the greater will be the number of layers of solidification, and consequently the greater concentration of impurities in the center.

Lessening Segregation. — Benjamin Talbot² has shown that quieting the steel by adding aluminum to it will lessen the segregation. J. E. Stead³ argues that this result is due to the branches of crystals (commonly called 'fir-tree crystals'), which grow perpendicularly to the cooling surfaces when steel solidifies and mechanically entangle some of the impure metal, thus preventing it from traveling inward. Professor Howe calls this type of freezing the 'land-locking type.' When the steel is violently agitated by the escape of gas its rapid movement washes off the fir-tree crys-

¹ From page 373 of No. 1, page 8.

² Pages 204 to 223 of No. 74.

³ Pages 224 to 228 of No. 74.

tals and prevents them from growing out into the liquid mass and entangling the impure metal. The quietness produced by aluminum, however, makes this growth possible.

Another important means of lessening the segregation is by making ingots narrow,¹ that is, by reducing the area of the horizontal cross-section; but this is often difficult of accomplishment. For example, if we cast fifty tons of open-hearth steel out of one ladle, it will take a very long time to cast all of this into small ingots, and therefore the first ingots cast will be too hot or else the last ingots will be too cold. There is a difference of opinion as to whether or not rapid cooling decreases or increases the degree of segregation, and it seems probable that it acts in both directions, sometimes prevailing one way and sometimes in the opposite. On first thought it would seem that slow cooling must necessarily increase segregation, because it would allow more time for the impurities to separate from one layer of metal and dissolve in the next. On the other hand, slow cooling also favors the growth of the fir-tree crystals, and therefore opposes segregation. It does not seem possible, at the present time, to tell under what conditions we should have the one influence prevailing or the other.

It seems to be pretty well established that the greater the percentage of impurities present the greater will be the extent of the segregation. Therefore high-carbon steel should be cast with due care and narrow ingots used wherever possible. Generally when the phosphorus and sulphur are low (say, not more than 0.05 per cent. each), much segregation is not liable to occur, especially in low-carbon steels.

REFERENCES ON DEFECTS IN INGOTS

70. C. A. Caspersson. Reviewed by Richard Akerman. "The Influence of the Temperature of the Bessemer Charge on the Properties of the Steel Ingots." *Stahl und Eisen*, 1883, pages 71-76.
71. Henry M. Howe. "Piping and Segregation in Steel Ingots." Transactions, American Institute of Mining Engineers, 1907. Advance proof.

¹ Some metallurgists disagree with this and believe that the large ingots do not segregate so much. Nevertheless, I am inclined to think that the greater weight of evidence is against them in this contention.

72. Henry M. Howe and Bradley Stoughton. "The Influence of the Conditions of Casting on Piping and Segregation, as Shown by Means of Wax Ingots." Transactions, American Institute of Mining Engineers, 1907. Advance proof.
73. N. Lilienberg. "Piping in Steel Ingots." Transactions, American Institute of Mining Engineers, vol. xxxvii, 1906, pages 238-247.
74. Benjamin Talbot. "Segregation in Steel Ingots." *Journal, Iron and Steel Institute*, No. 11, 1905, pages 204-247.
75. N. Lilienberg. "The Compression of Semi-liquid Steel Ingots." *Journal of the Franklin Institute*, February, 1908.
76. E. von Maltitz. "Blowholes in Steel Ingots." Transactions, American Institute of Mining Engineers, vol. xxxviii, 1907, pages 412-447.

VIII

THE MECHANICAL TREATMENT OF STEEL

METALS may be shaped either by pouring them whilst molten into a mold, as described in the following chapter, or by mechanical pressure. The choice of the casting or the mechanical method of shaping will depend on the size and form of the finished product and the purpose for which it is intended. Some shapes must be produced by casting, because they are either too intricate or too large to be shaped by pressure; others must be produced by pressure, because the service in which they are to be used demands the higher strength and ductility which mechanical work produces. Between these two classes, however, is a large number of forms, each of which is a study by itself. Financial considerations will govern in some cases, and the importance of quality in others. The advantage of quality is usually with the pressed material.

Effect of Work. — Mechanical work will multiply the strength of steel from two to five times. In order to accomplish as much as this, however, it is necessary to reduce the material to very small sizes, in order that the beneficial effect of the kneading action may extend throughout the mass, and to finish the work cold, in order that the metal may have no opportunity to recrystallize. The ductility also will be increased at first by working, but again decreases if the metal is worked cold. The increase in strength and ductility is due (1) to the closing up of blow-holes, both large and small, which are almost all welded together under pressure at high temperatures, unless they are near enough to the surface to become oxidized inside, and (2) to increasing the cohesion and adhesion of the crystals. The first effect is contributive both to strength and ductility, while the second is chiefly contributive to strength, and, if excessive, will greatly diminish ductility. Both increase the specific gravity and hardness of the metal, and are more effective in these respects, as well as in increasing strength, if hot work is followed by cold work.

Crystallization of Steel. — Metals are crystalline substances, the individual components arranging themselves in regular forms unless opposed by the rigidity of the mass in which they form. Indeed, the metallic crystals grow with astonishing rapidity when the metal crystallizes from the molten state (i.e., solidifies), or even when it is in a mobile condition (i.e., at temperatures near or above a red heat). Once crystals have formed they cannot be reduced in size except by annealing (see Chapter XIV), or by breaking them up with mechanical crushing. These facts are important, because large crystals do not adhere to each other firmly, and thus they cause a weak and brittle mass. Iron and steel follow the same laws as other metals in these respects.

Effect of Strain. — When a metal is strained, the crystals first stretch, and the amount of this stretching is directly proportional to the strain; when the metal is relieved, the crystals and the mass



STRAIGHT SLIP BANDS
IN WROUGHT IRON
MAGNIFIED 60 DIAMETERS.

Unetched.

(William Campbell.)



CURVED SLIP BANDS
IN WROUGHT IRON
MAGNIFIED 60 DIAMETERS.

Unetched.

(William Campbell.)

as a whole return to the original dimensions. If the strain is greater than the 'elastic limit,' however, the crystals yield, and the particles composing them slip along the cleavage planes, so that a permanent deformation or extension occurs in the direction of the strain. This 'elongation' is accompanied by a 'reduction in cross-sectional area,' and gives warning that the material is suffering from excessive strain. The extent to which these two

forms of distortion precede rupture is usually taken as the measure of the 'ductility' of the metal.

Rationale of the Effect of Work. — Mechanical pressure upon a metal crushes the crystals, mixes them intimately together, and breaks up the cleavage planes along which they would yield. If the work is finished above a red heat when the mass is still mobile, the crystals reform to a certain extent, decreasing the strength. The elastic limit of a structural steel rolled in this way will be a little more than one-half its ultimate strength. If the work continues while the metal is cold, there is no opportunity for the reformation of the crystals, and the strength, hardness, and brittleness are much increased.

Methods of Applying Pressure. — Aside from the differences of hot and cold working, the mechanical pressure may be exerted in one of three ways: (1) Instantaneously, by a blow, in which method the pressure is relieved before the metal has fully yielded to it; (2) more slowly, by rolling or wire-drawing, in which the pressure is relieved almost as soon as the metal has yielded to it; and (3) slowest, by presses, in which the pressure remains for a second or so after the metal has yielded.

THE FORGING OF METALS

The instantaneous application of pressure is man's first method of shaping metals and is accomplished by a blow from a falling weight, frequently aided by some other force. Examples of the first practice are found at the present time in the helve-hammer used at many small forges and steel-works. After the introduction of steam, however, this was used to raise the weight, and very soon steam-power was employed not only to raise the weight but also to force it downward for the blow, whose momentum was thus greatly increased. Hammers of this type, which is now the most prevalent, have been built capable of delivering a blow estimated as equivalent to 150 tons weight. Such large sizes are not now approved of, however, because of the inordinate expense for foundations, which must be deep and powerful in order to take up the force of the blow, while the constant jarring disturbs the foundations and alinement of machinery, even at distant parts of the plant. For very heavy forging work, such as armor-plate, etc.,

the hydraulic press is therefore preferred, and hammers are not often built in sizes above 30 or 50 tons.

Effect of Hammering. — A blow creates in a metal practically nothing but compressive strains, which act chiefly in the vertical direction, and, by transmission, in the two horizontal directions. Because the pressure is relieved almost as soon as felt, the amount

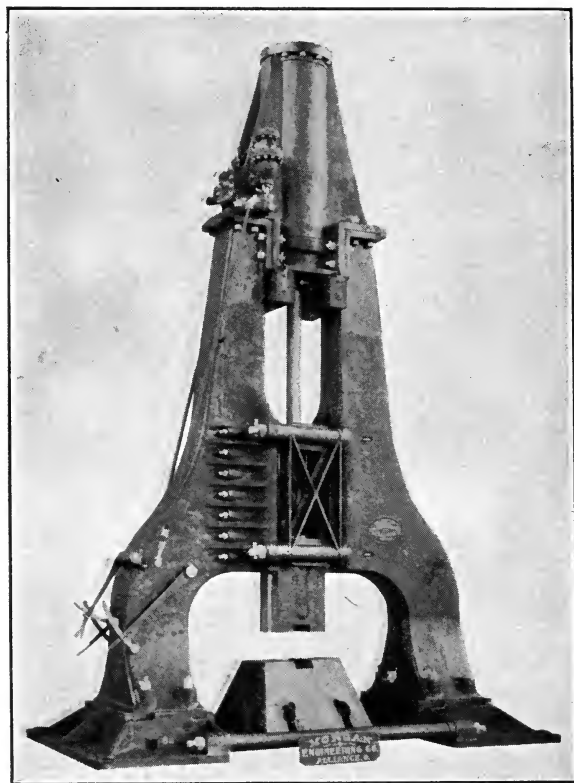

FIG. 127. — STEAM HAMMER.

of yield to it is not great in proportion to its force, and therefore it takes more pressure to accomplish a result than would be the case if the application was slower. This makes hammering a slow process of reduction, but results in a better and more uniform working of the crystals, which is one of the chief reasons for the superiority of hammered over rolled material. On the other hand,

the effect of forging extends only 1 or 2 inches beyond the upper and lower surfaces. Another and, perhaps, even more potent reason is the exact control of the operation which can be exercised by the expert forger, and more especially his control over the temperature at which the work is finished, and over the varying force of pressure applied at different stages and temperatures.

Finishing Temperatures for Forging. — Forging seldom continues after the red heat is lost, but the exact temperature will depend upon the article and the properties which it is desired to have. The colder it is finished the closer to the exact size required it can be made, because it has less shrinkage to undergo; but it will also be harder, less ductile and stronger. The relation between the finishing temperature of mechanical work and the critical points of steel will be discussed in Chapter XIV.

Drop-Forging. — There is a large variety of articles, such as parts of machinery, hammer-heads and similar tools, which are formed by the process known as 'drop-forging.' In this operation a piece of metal of the desired size is forged by repeated blows between a lower die, upon which it rests, and an upper die attached to the head of the hammer. These two dies are made in the desired form of the finished article, and the metal is squeezed into them until it has assumed the proper shape. Sometimes several pairs of dies are necessary to complete the finished shape (see Fig. 129). Drop-forgings are directly comparable with steel castings, to which they are superior in quality on account of the beneficial effect of the working. To be economically made, they must be ordered in large quantities, so that it will pay to make the costly dies of hardened steel — often an alloy. Even then, castings are usually cheaper, though sometimes forgings are still preferred on account of their quality. There are cases, however, in which drop-forgings may be made more cheaply, either because the shape is one that lends itself to rapid production in this way, or because it is one liable to cheeking, or requiring a large riser, if cast.

Forging Bars. — Crucible-steel ingots are often forged out into bars for the market, because the material will bring a price high enough to pay for the superior method of working it. The ingot, after the top third has been broken off to remove the pipe and segregate, is heated to a bright-red heat, out of contact with the flame and fuel, and then tilted down under a hammer of about 10 to 15 tons size until it is about one-half as large on the sides and four

times as long. The piece is held in a handle which fits over one end of it, and usually a second heating is necessary before both ends are down to the correct size. One end is then reheated and drawn



FIG. 128. — SOME AUTOMOBILE DROP-FORGINGS.

down to a bar of the desired size, under the same hammer, or under one of less weight, and the long bar is then used as a handle while the other end undergoes heating and reduction. The finished size is produced by light taps of the hammer just before the blue heat

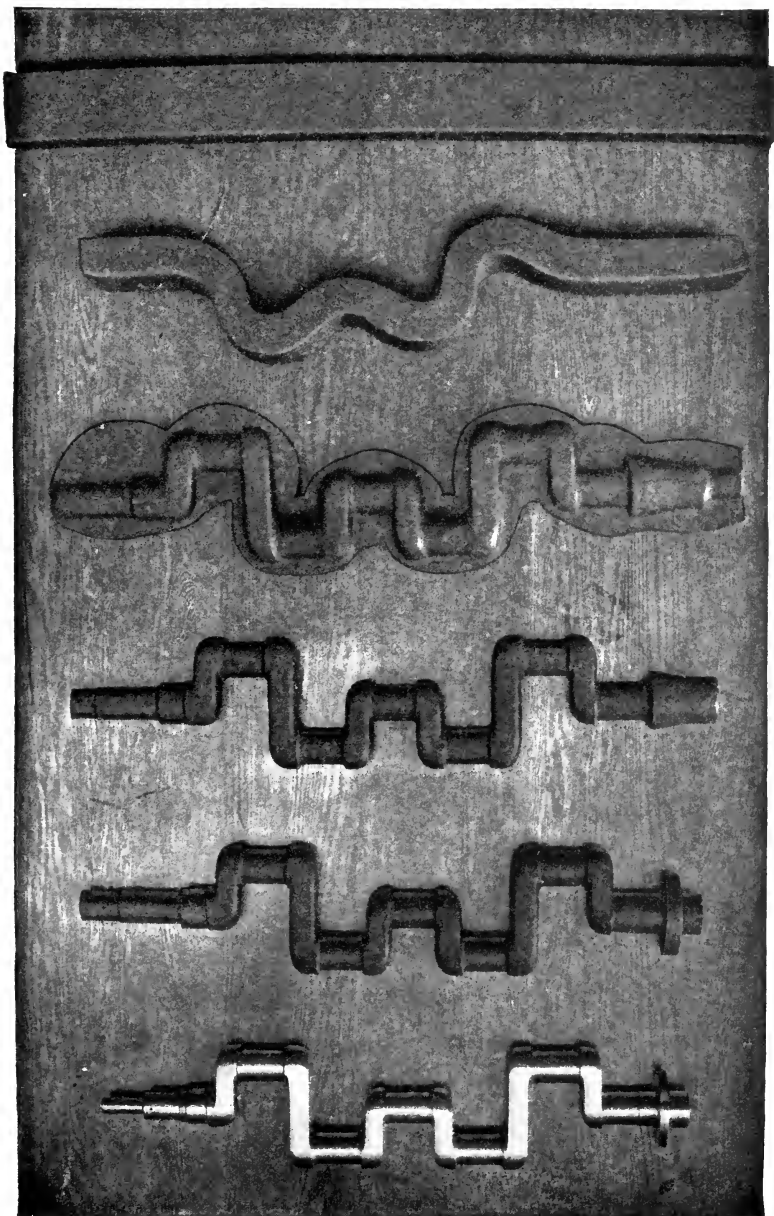

FIG. 129. — SOME STAGES IN THE MAKING OF A DROP-FORGING.

appears, and often a piece of cold steel is laid beside it on the anvil to more correctly arrest the downward blow. The finished bar will be so straight and true as to lead one to believe that it was produced by drawing through a die, or rolling in grooved rolls. Sometimes it is finished in a square shape, and sometimes as an octagon, by turning it upon the corners and drawing them down.

Forging Razors. — Flat bars for razor stock, made of cemented steel melted in crucibles without additional carbon, are produced in a manner similar to that outlined above, and then forged down by hand to the rough size of a razor. They are then stamped with the appropriate name and mark, drilled with a hole, heated to the correct temperature and hardened in water, after which the temper is drawn to the light or medium straw color (see page 387). The exact shape is then produced by grinding, care being taken not to heat the razor during this operation, lest it be tempered thereby, and the blade polished and fitted with a handle.

Forging Cannon. — Large cannon tubes are made from open-hearth steel ingots weighing perhaps 65 tons or so, more than one-half of which is discarded or 'scrapped' during the process. In France and Germany, cannon-tube ingots have been made of crucible steel by pouring many crucibles into one mold, but the expense and the liability to heterogeneity because of the many small units is believed to outweigh the advantages due to the quality of steel, which is superior on account of its process of manufacture. The heating of the ingots must be done with great care, lest a crack or hollow be formed by too rapid expansion or by the expansion of the outside away from the interior. Moreover, as reducing a flame as possible must be maintained, lest the carbon be oxidized in the outer layers of steel during the many hours required to attain the bright-red heat necessary. Ingots of the form shown in Fig. 130 are usually employed, and those cast in sand molds are preferred because they are not liable to contain surface cracks produced by tearing the steel when the iron mold is withdrawn. Only one end of the ingot projects into the



FIG. 130.

furnace, and when the desired temperature is reached, the handle or 'porter bar' is fitted over the cool end, and the crane which supports this transfers the whole over to the hammer.

By the time the heavy blows from a hammer of perhaps 75 tons force have effected a certain reduction, the ingot must go back to the furnace for another heating of about an hour or so, and this reheating is necessary at intervals. When the top end of the ingot has been drawn down to a convenient size, this is used as a handle to the other end, which is to make the completed cannon tube, and not more than the lower two-thirds of the original ingot is allowed to be present in the tube at the finish of the forging operation. The blows are delivered on all sides of the ingot in order that the center of the tube shall be the same as the center of the original ingot, for this center portion is to be drilled out in the subsequent operations, and, as we have already seen, the center of the ingot is of looser texture and contains more of the segregate.

After the inner tube is forged, an outer tube is produced in a similar manner, but of larger size, so that it may be bored out to fit over the carefully turned inner tube. After the boring the outer tube is too small to pass over the inner one, and it is therefore heated to a temperature of about 280° C. (550° F.) in a tall vertical furnace, which expands it so that it may be passed over the inner tube and 'shrunk' upon it, greatly increasing its compactness and reinforcing it against the tremendous strains it is subjected to in service. Cannons are now frequently forged under presses instead of under hammers.

THE REDUCTION OF METALS IN ROLLS

If two rolls rotating as shown in section in Fig. 131 be made to grip a piece of metal, *A*, they will drag it between them and force it out on the other side reduced in thickness. The metal between the points *OO* and *NN* is being compressed vertically, while its outer layers are suffering tension. In the case of a deep section, the unequal strain is liable to tear the steel (see Fig. 165). At the points *NN* the metal is being forced back upon itself. The mechanical pressure is therefore not as uniform as in hammering, and acts for a longer period of time. Reduction can only take place vertically, as in forging, there being always a certain amount of expansion sidewise, and a large amount of extension in length. The metal at the points *NN* being forced backward, and that at the points *OO* being forced forward, the ends of the rolled section

assume a shape somewhat like that shown in Figs. 132 and 133, when the outside of the piece is very hot. The reduction in area at each 'pass' will vary between 5 and 50 per cent. of the original, and the work is very rapid. For example, a railroad rail

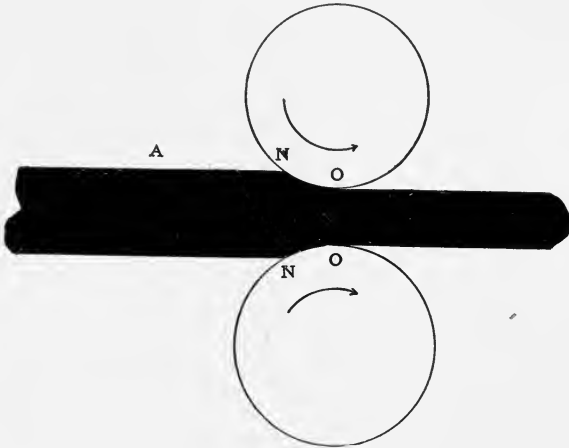

FIG. 131.

may be produced, from an ingot having a section 18 in. square, in 22 passes, varying in amount of vertical squeeze from 8 to 52 per cent., only about five minutes being required for the whole operation, the piece traveling through some of the passes at a rate of ten miles per hour, and not being reheated after the ingot comes to the



FIG. 132.—SHAPE OF ENDS OF ROLLED METAL WHEN THE INSIDE IS THE HOTTER.



FIG. 133.—SHAPE OF ENDS OF ROLLED METAL WHEN THE OUTSIDE IS THE HOTTER.

first pair of rolls. Some American rolling-mills produce about a mile of single rail per hour for 24 hours a day and 25 days per month. The temperature at which the rolled material is finished is gaged with much less accuracy than in forging operations, and is always

too high for the best quality of the steel, because economy of power urges the manufacturer to work the metal hot.

Pull-Over Mill. — In a single pair of rolls, such as shown in Fig. 131, the metal, after passing between them once, must be handed or pulled over the top of the mill, to be fed in for a second pass. This type of train is known as a 'pull-over' or 'pass-over' mill. It can be used only for shapes small in size and that can be handled readily, and the action is slower than in a continuous operation, such as in a 'three-high mill.' The pull-over mill is simple and cheap to construct and operate, and is used especially for the rolling of plates and shapes from crucible steel, whose high price renders it less important to seek rapid output. It is also used very largely for the rolling of steel to be used for tinplate. The upper roll is adjustable, so that any thickness may be produced.

Multiple-Ply Plate, etc. — Three-ply plate for plowshares, and five-ply plates or bars for burglar-proof safes and jail bars, are often made in this type of mill. We first roll independently thin plates of high-carbon, crucible, chrome steel (or an equivalent alloy steel capable of becoming very hard upon quenching in water from a red heat), and thicker plates of wrought iron. For a plowshare, a plate of wrought iron will then be sandwiched between two plates of chrome steel, tied into a bundle with wire, and raised to a welding heat. The wire burns off in the furnace, but the bundle is grasped with a pair of tongs and fed into a pair of plain rolls, where it is welded into a plate of three-ply steel which is reduced to a thickness of a little over a quarter of an inch. This plate is trimmed to about the desired size and shape and then hardened and used for a plow, the hard outer layers resisting the wear of service, and the ductile core resisting the shocks which would shatter the brittle outside. For safes and jail bars we have an inner layer of wrought iron, then two layers of chrome steel, and then two layers of wrought iron, welded together and then hardened. A burglar can neither drill through this, on account of the hardened chrome steel, nor break it with a sledge, on account of the ductile iron, which will not be hardened by the quenching.

Three-High Mills. — When a piece is passed over a two-high mill, it is often rested upon the top of the upper roll, whose travel assists somewhat in the transfer. While watching this operation at the Cambria Iron Company's mill in 1857, John Fritz con-

ceived the idea of the three-high mill, which is shown in section in Fig. 134. It will be seen that passing the piece over the top of the middle roll in this mill will result in its receiving work, and thus the output of the mill will be increased. At the present time the great bulk of the tonnage of steel and wrought iron produced, consisting of structural shapes, railroad rails, plates, wire rods,



FIG. 134.

billets and bars, is finished in this type of mill. The output is large, because the rolls can be run very fast indeed (rod mills running 600 to 1200 revolutions per minute and sometimes passing the rod through at the rate of half a mile a minute in American practice¹), and two or more pieces may be passing through at the same time. The disadvantage of the three-high mill is the power neces-

¹ The reason for this rapid rolling is not only large product, but that the thin rods may not radiate their heat during the operation and thus be finished too cold. This rapid work actually raises the heat of the metal faster than it can be radiated, and rods are hotter at the end than at the beginning of the rolling.

sary to raise large weights up to pass over the middle roll. Most Bessemer ingots are cast two tons or more in weight, and most open-hearth ingots from three tons to ten or more tons.

Reversing Mills. — Therefore ingots are often 'cogged' in two-high reversing mills to avoid this consumption of power. Moreover, the two-high mills, which have an adjustable upper roll, have the advantage of being able to work an ingot gently at first, in case it shows a tendency to be 'tender,' that is, to crack in spots

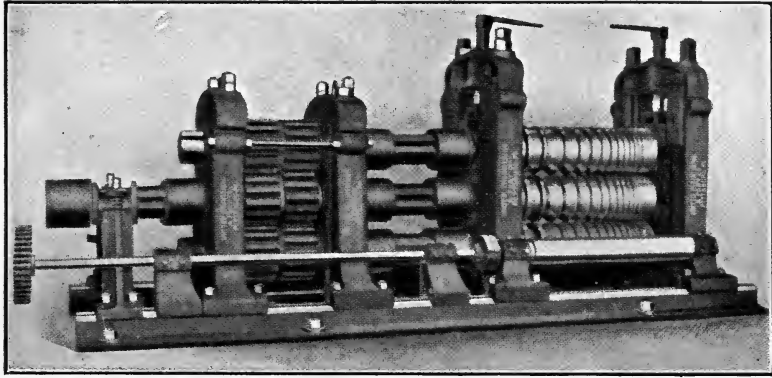

FIG. 135. — THREE-HIGH MILL.

when the pressure is applied. Three-high mills may, however, also have an adjustable middle roll, and plate mills are frequently made in this way. The disadvantages of the two-high reversing mill are its slowness and the severe strain on the engines, which are often reversed while running full speed.

Universal Mill. — During the rolling of metal there is a certain amount of expansion sidewise, which gives the piece a cross-section somewhat bulging on the sides, and makes the edges uneven, unless the rolls have collars which form a groove through which the metal passes. In 1855 R. M. Daelen, at Hoerde, Germany, devised a mill in which even edges could be produced at any width by having an auxiliary pair of vertical rolls, between which the piece passes immediately after it emerges from the horizontal rolls. These vertical rolls are adjustable to any width up to the capacity of the mill, and give only enough pressure to keep the edges even without producing any reduction. They are usually made to rotate with a surface velocity greater than that of the hori-

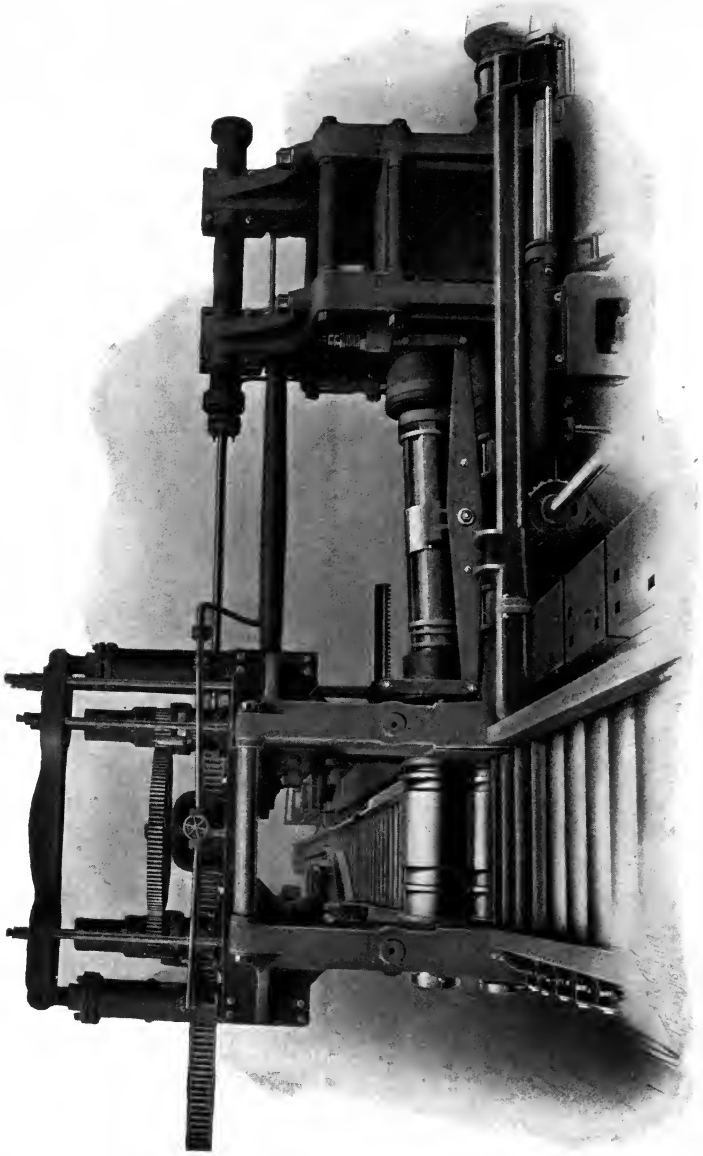

FIG. 136. — TWO-HIGH, REVERSING COGGING MILL.

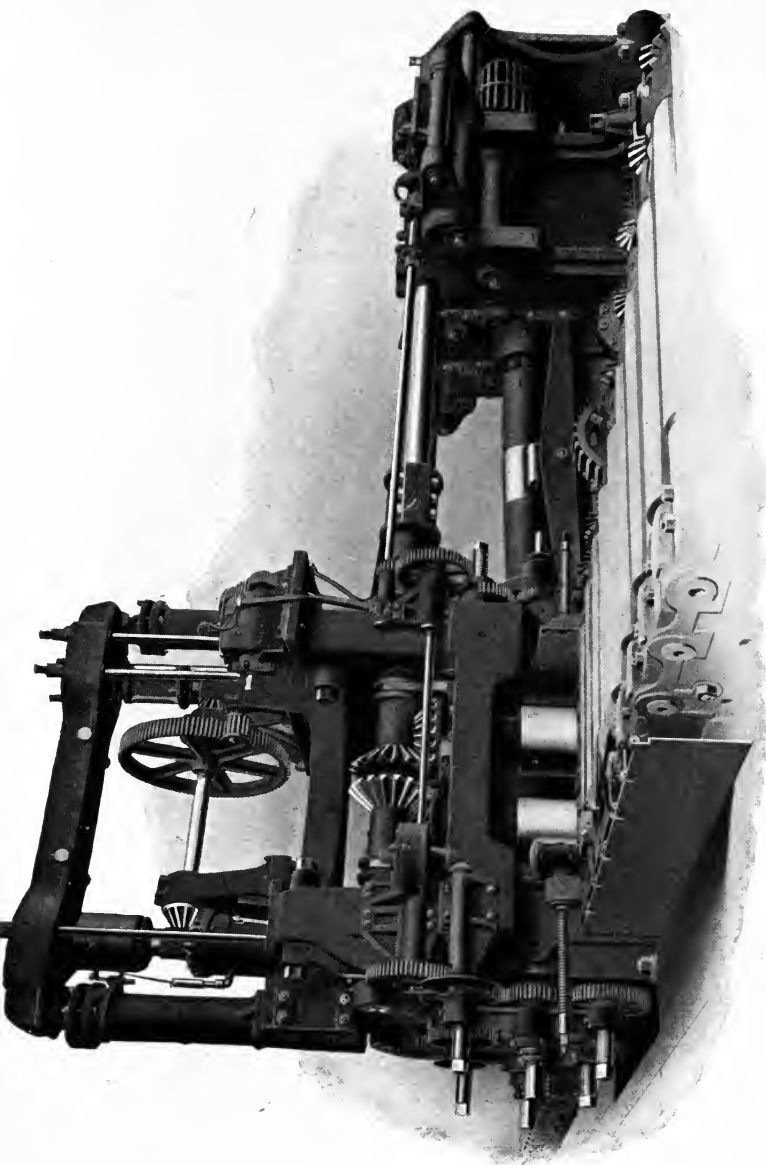

FIG. 137. — UNIVERSAL MILL.

zontal rolls, so as to prevent the serious buckling that would take place if the conditions were reversed. As this tension is not good for the edges of the metal and wears out the vertical rolls, some mills have independent control of drive for each pair of rolls, and others have friction-clutches connected with the vertical rolls, which allow them to run faster if pushed by the metal, but ordinarily run them at a slower speed. Universal mills are made two-high or three-high, and with vertical rolls on one or on both sides of the horizontal rolls. With the two-high mills (which are, of course, reversing), there is one set of vertical rolls. Slabbing-mills are usually made this way. With three-high mills, there is a pair of vertical rolls on both sides of the horizontal rolls. Plate-mills are sometimes of this kind. In England, the Universal mill is not in favor, as rolling-mill managers believe that the faster work of simple mills more than makes up for the necessity for changing grooved rolls at intervals when a new width is to be produced.

PARTS OF ROLLING MILLS

Rolls. — Rolls may be plain cylinders, by which plates and rectangular shapes are produced, or they may be cylinders with 'collars' at intervals, as shown in Fig. 138, in which large rectangles with even edges may be produced; and the collars may be on both rolls, giving an 'open pass,' or may be on only one roll and extend into grooves on the other roll, as shown in Fig. 139, giving a 'closed pass.' With open passes, the collars cannot be made to quite touch, hence the name; and the pressure may squeeze some metal between them, forming a 'fin' along the side of the piece. This results from 'overflowing the pass.' The closed pass makes the upper roll weaker, and there is also a liability of the metal becoming wedged tightly between the collars and thus drawn all the way around the roll, with the result that something will be broken. Wedge-shaped grooves may be cut in the rolls, producing the 'diamond' pass, in which small squares are made (see Fig. 139); or oval grooves make nearly round bars which are finished round in the last pass with almost no draft. Other forms of passes are shown in Figs. 139 and 165. In case rolls are weakened by deep cutting, as shown in Fig. 139, they may be strengthened by stiffeners, *D*, while long rolls for producing wide plates are sometimes

stiffened by an idle roll running on top, lest the springing of the roll make the plate thicker in the middle than at the edges.

Cast-Iron versus Steel Rolls. — Cast-iron rolls are chilled upon the outside so as to produce a surface layer of white iron (see Fig. 264), which, after turning in a lathe, makes a very smooth surface for rolling and is especially advantageous for finishing-mills. They are not so good for the mills which do preparatory work, however, because they are not so strong, and because in preparatory work we



FIG. 138. — CC = COLLARS. W = WOBBLERS.

want a rough surface to assist in gripping the metal and drawing it through. Furthermore, they cost more to turn to the desired shape, and they cannot be turned down many times (see page 203), lest we get below the 'chill.' The greater cheapness of cast iron over steel, however, counteracts these factors of higher cost. Where the rolls must be very strong and yet not too large in diameter, and for sharp corners, which would crumble if made of cast iron, steel rolls are often used. The steel employed should be high in carbon, — say 0.50 to 0.75 per cent.; but any case-hardening of steel is useless here, because the heating of the rolls

by the material passing through will soon draw their temper. This heating cannot be prevented altogether, though it is customary to have a stream of water flowing over the rolls. Sometimes nickel-steel rolls are used for strength. An analysis of roll metal of a very large American company is: 0.40 to 0.50 per cent. carbon, 0.65 per cent. manganese, 3.25 per cent. nickel, and 0.15 to 0.20 per cent. sil.con.

Diameter of Rolls. — With smaller rolls, the amount of power consumed is less because the area of metal under vertical pressure

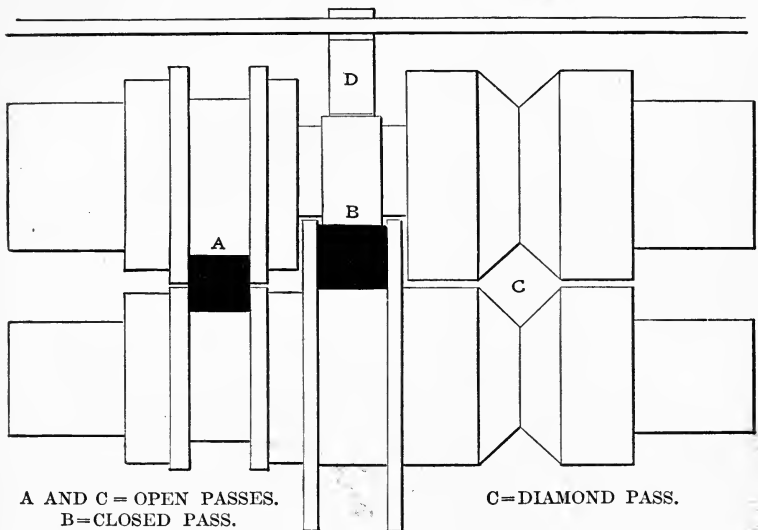

FIG. 139.

is less. There is a limit below which the diameter cannot go, however, either because the rolls will not be strong enough to give the desired pressure, or they will not grip the bar. In order to be gripped the upper and lower edge of a piece must touch the rolls at a point not more than 30° from the center line of the two rolls (see Fig. 140). Every effort is made to use smaller rolls, because the size of all the mills is regulated by them. The surfaces of all but the finishing-mill are usually 'ragged' (i.e., made rough), to make the rolls give a better grip. Those to receive the ingots are ragged the most, with deep indentations somewhat like the cogs of cog-wheels, whence the name of 'cogging rolls' for this

mill.¹ The next trains, known as the 'roughing rolls,' are also deeply marked, but even then the piece must come within the 30° line, or time is lost in trying to make them bite the piece.

Speed of Rolls. — The more work the rolls do, the slower must they revolve, because the piece entering the train gives a shock to the mechanism that is dependent upon the power exerted and the momentum of the moving parts. Thus the larger the pieces treated the colder they are, and the larger the rolls the slower must be the speed. In America, speeds are at the high limit. Reversing slab-mills may do the work at 20 or 30 r.p.m.; three-high blooming rolls may run over 50 r.p.m.; mills for finishing rails, 100 r.p.m.; and rod mills from 550 to 1200 r.p.m.

Making of Rolls. — Cast-iron or steel rolls are cast in approximately the desired shape and then turned accurately in a lathe, being fitted exactly to a templet when completed. After rolling some thousand tons of material, they become worn and produce too large a size of finished shapes. They may then be used for a larger size of the same kind of article by putting them back in the lathe and turning to another templet. For example, a roll for a 20-inch l-beam, with a certain thickness and width of flange, may be converted to one for a 20-inch l-beam with thicker web and longer flange.

The Mill. — The different parts of a rolling-mill may be seen in Fig. 142. The *wobblers* are made of the same cross-section as the spindle, some examples being shown in Fig. 143. The *coupling-*

¹ In America, the train that produces blooms (i.e., pieces of steel usually about 6 to 8½ in. square) from ingots, is sometimes, but not always, known as 'bloom rolls,' or 'blooming rolls,' instead of cogging rolls; and the train that produces 'slabs' (i.e., thick, wide, rectangular pieces that are to be rolled into plates) from ingots is known as the 'slabbing-mill.'

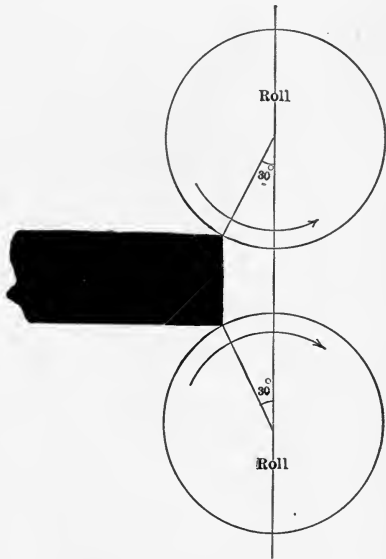

FIG. 140.

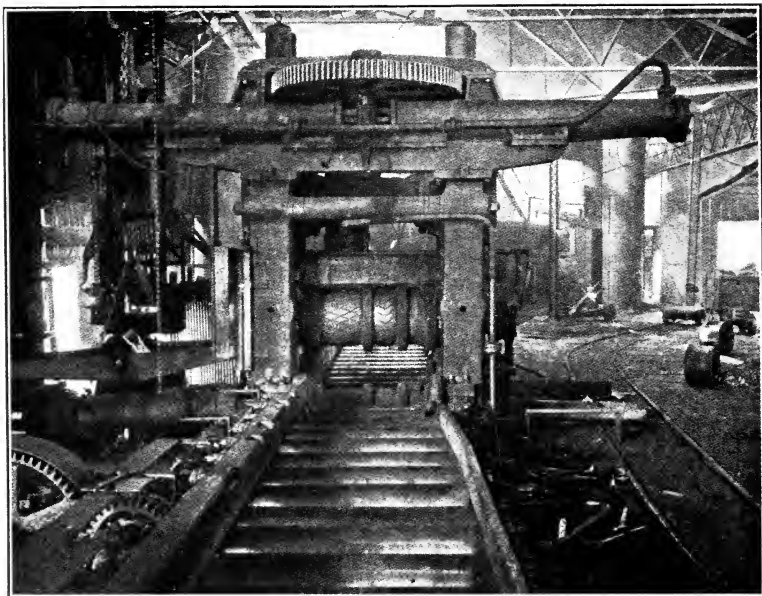

FIG. 141. — INDENTATIONS ON A COGGING MILL.

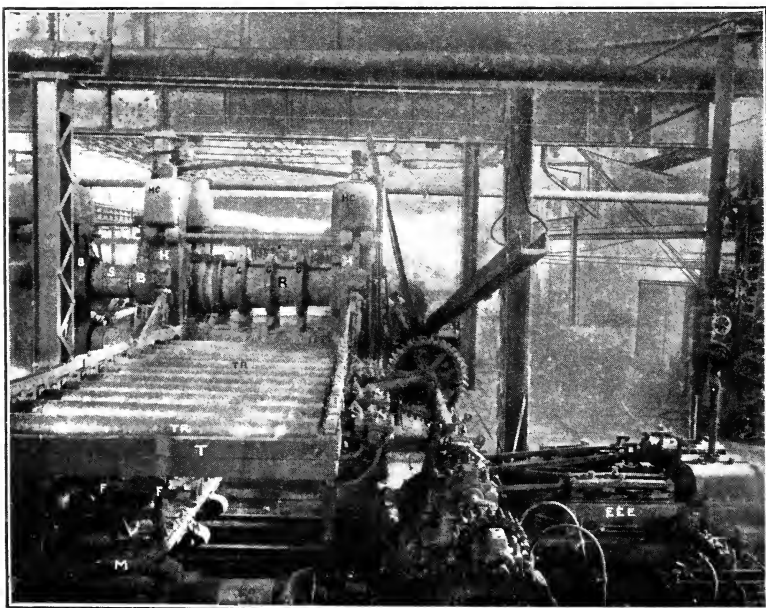

FIG. 142.

B, Coupling boxes; C, coilers; EEE, roller table engine; F, fingers, or horns on manipulator; H, housings; HC, housing cap; M, manipulator or 'Go-devil'; R, roll; S, spindle; T, roll table; TR, table rollers.

boxes fit over the spindle and wobblers, so that neither can turn without the other. In some mills the coupling-boxes are made of cast iron in order that, if any shock comes upon the driving mechanism, the boxes shall give way and relieve the strain. In other mills the boxes are made of cast steel, as it is thought that the constant delays due to broken couplings are more costly than breakages in other parts of the mill. The *spindles* are at least



FIG. 143.

B, coupling boxes; C, collars; E, roll engine; G, guides; H, housings; S, spindles; TR, table roller; HC, housing cap; W, wobblers; TM, table motor.

twice as long as the coupling-boxes, in order that they may carry both of them at once when the train is uncoupled. Both boxes slip back upon the spindle.

Pinions are now usually made of steel for the sake of strength. *Housings* are made of either steel or of cast iron, depending on the strains to which they are subjected and the opinion of the manager. In America, they are usually made so that the top can be removed and the whole train of rolls removed at once, together with the chocks, and several mills have spare sets of rolls all made up ready

and carried in a sling, so that a new set may be dropped into place with a crane with the least possible delay to the mill. Delays in rolling-mills are very costly, because of the idle labor and capital, and because other parts of the plant may be delayed thereby.

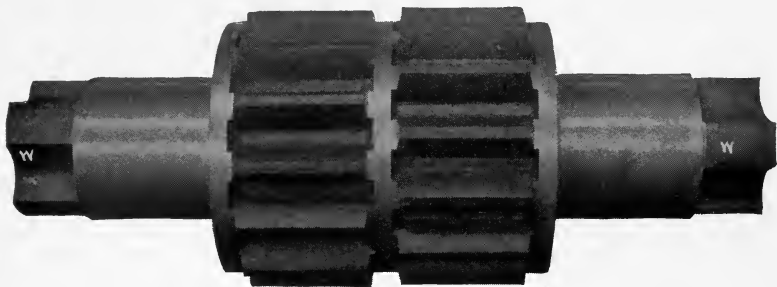

FIG. 144. — A PINION.

W = wobbler.

The *screw-down mechanism* which adjusts the distance between the rolls is operated usually by hydraulic pressure, though electric motors are coming into vogue. It is connected with a telltale gage which advises the roller exactly as to the distance separating the rolls.

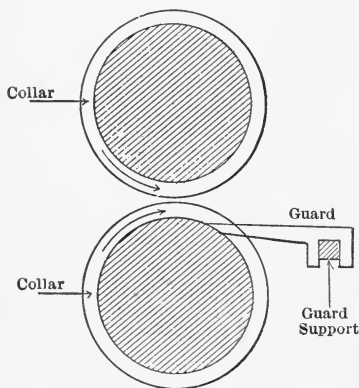

FIG. 145.

Guards are of steel and serve to peel the piece off the roll and prevent it encircling the roll (called 'collaring') in case it becomes wedged between the collars. They must be upon the lower roll, as shown in Fig. 145, or upon the upper roll, and counterbalanced to hold them in position, when they are called 'hang-

ing guards.' *Guides* are on the opposite side of the train, and assist in conducting the piece straight into the groove.

Roll Tables. — Heavy pieces are handled at the rolls by supporting them upon a series of rollers, situated in front of and behind the roll train, and known as the 'tables.' At two-high mills the tables are stationary; at three-high mills the front and back tables

are sometimes raised and lowered together by hydraulic or electric mechanism, and sometimes they are pivoted near the middle,

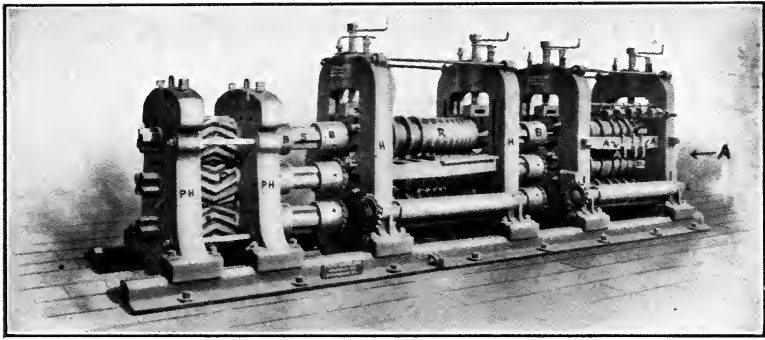

FIG. 146.

A, hanging guards; B, coupling boxes; H, housings; P, pinions; PH, pinion housing; R, rolls; S, spindles.

so that the end next the rolls can be tilted upward in order to bring the piece between the guides which direct it into the groove.

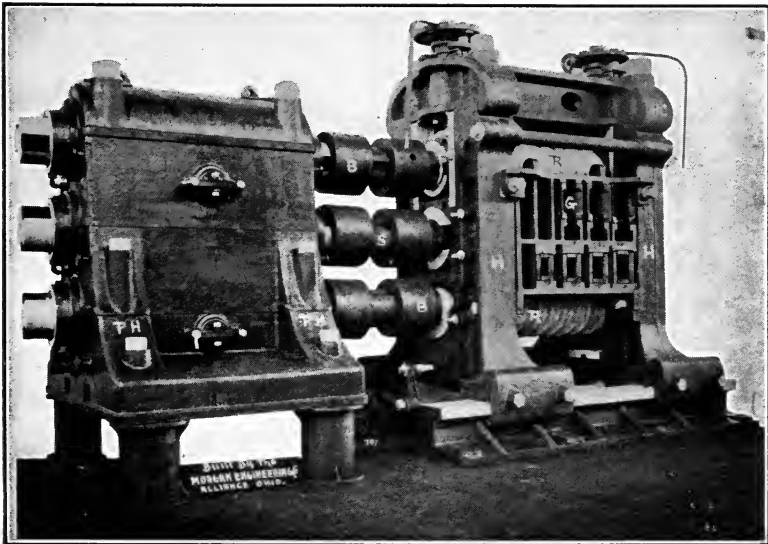

FIG. 147.

G, guides; HC, housing cap; PH, pinion housing; RR, rolls.

The rollers to handle large pieces are 'live,' that is, they are made to revolve by electric motors and thus move the piece back and

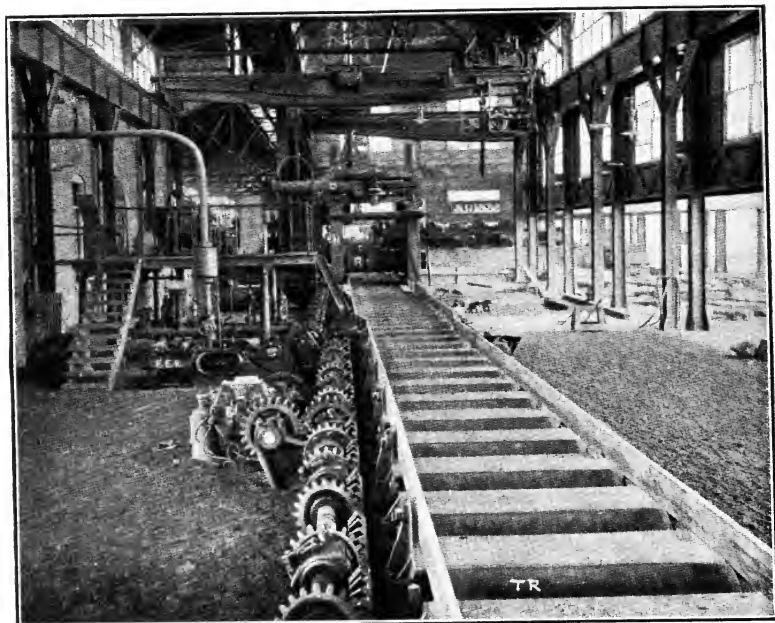

FIG. 148.

D, Screw-down mechanism; EEE, table engine; TM, table motor; TR, table roller.

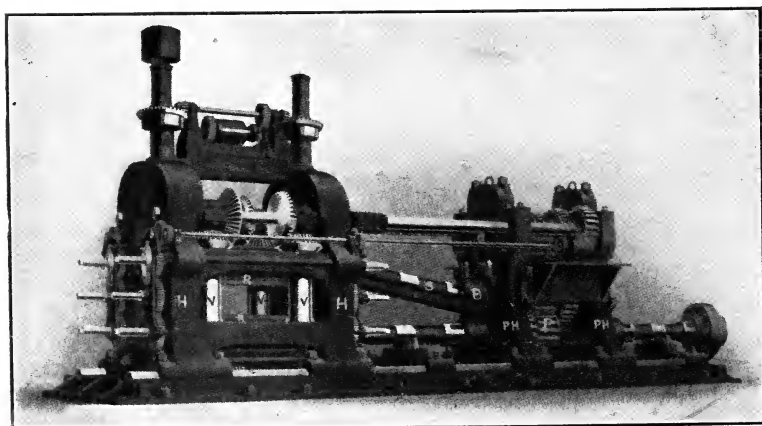

FIG. 149. — TWO-HIGH, REVERSING UNIVERSAL MILL.

VVV, Vertical rolls; RR, Horizontal rolls.

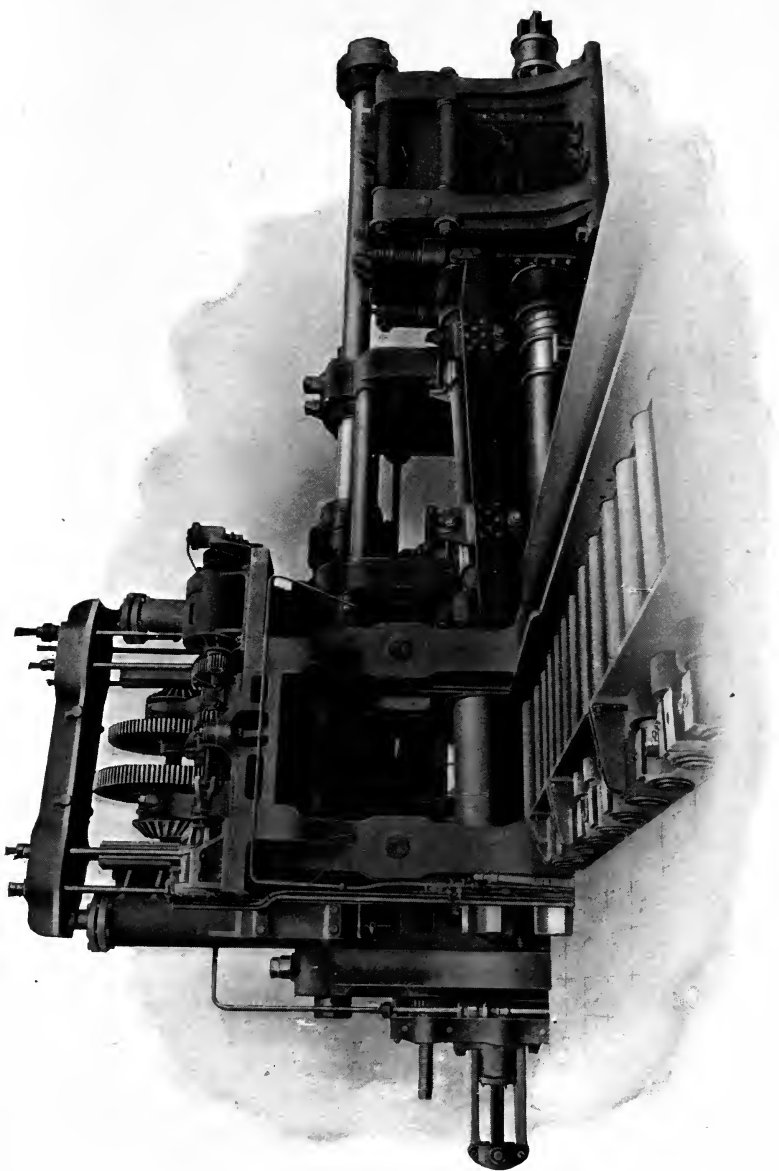

FIG. 150. — TWO-HIGH, REVERSING UNIVERSAL MILL WITH INDEPENDENT ELECTRIC DRIVE FOR VERTICAL ROLLS.

forth. 'Dead' rollers are used where pieces are to be moved by hand.

Transfer Tables. — Roller tables are sometimes made so that they may be moved bodily from one roll train to another, carrying the piece of metal with them, and so connected electrically that the rollers can be caused to revolve when the table is in any location.

Manipulators. — If two or more posts, supported on a carriage which can be moved laterally, project between the rollers of a table, their sidewise motion will transfer the piece from one pass to another. If the table is of the lifting type, the posts, or 'horns,' or 'fingers' can be brought to such a position that the lowering of the table will bring the edge of the piece upon the horns and thus

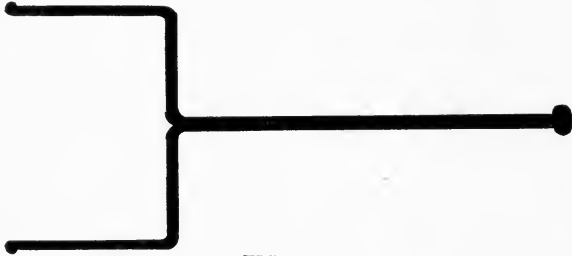

FIG. 151.

tip it on to the other side. This form of manipulator is much used at three-high blooming rolls, and is very efficient and rapid in its work. The same type is used at reversing blooming rolls, but the piece is more usually tipped over by the roller with the tool shown in Fig. 151.

Roll Engines. — The service on rolling-mill engines is very severe, because the full load comes upon it when the piece enters the rolls, and then leaves it as suddenly again. To equalize these sudden variations of power, all but the reversing engines are built with very large and heavy fly-wheels and run at a high rate of speed (from 30 to 250 r.p.m.), with governors of a quick-acting type. The Allen engine with the Porter governor serves these purposes, and the Porter-Allen type is much used. The ordinary slide-valve is used on the smaller engines. Corliss valves are commoner in America for engines doing heavy work (1000 to 3500 H.P.), while piston-valves are favored in England. The fly-wheel is placed upon the crank-shaft, to which the roll train is directly

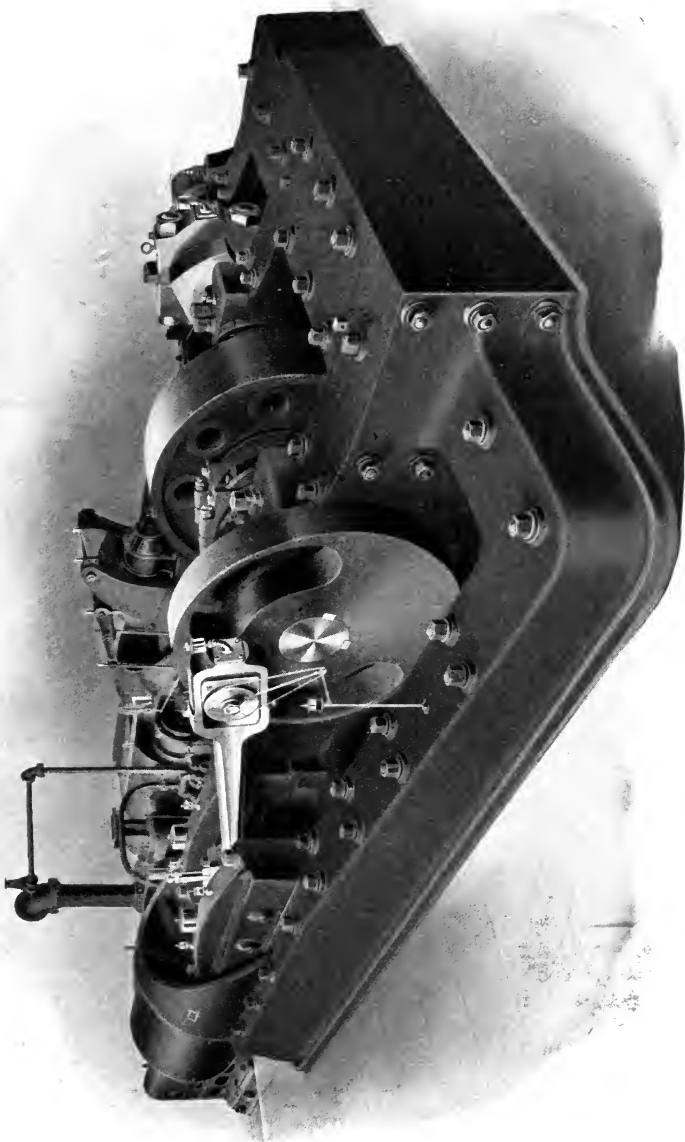

FIG. 152. — REVERSING ROLLING MILL ENGINE.

coupled. The fly-wheels very exceptionally weigh as much as 75 and 100 tons or more.

Piston-valves are used almost always for reversing engines which are compounded, so they may never come to rest at a dead

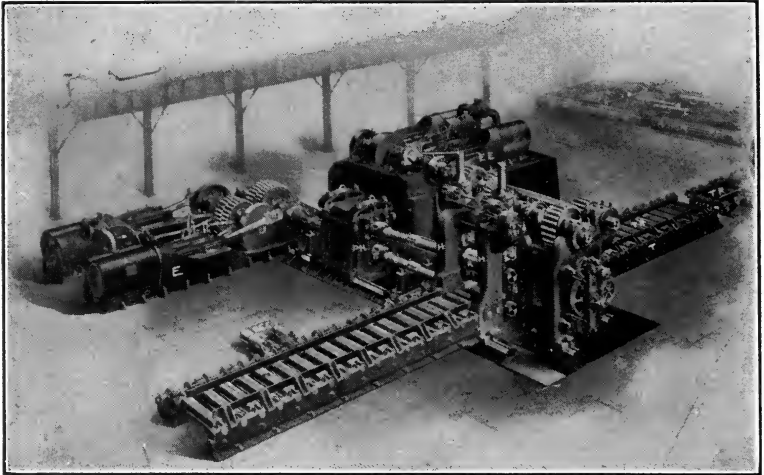

FIG. 153. — UNIVERSAL MILL.

E, Engine for horizontal rolls; EE, engine for vertical rolls; EEE, roller table engine; TT, roll tables; TR, TR, table rollers.

point. There is, of course, no fly-wheel, and the engine is directly coupled from the crank-shaft to the roll train in the large American mills, but is geared down so that the engine can develop a higher

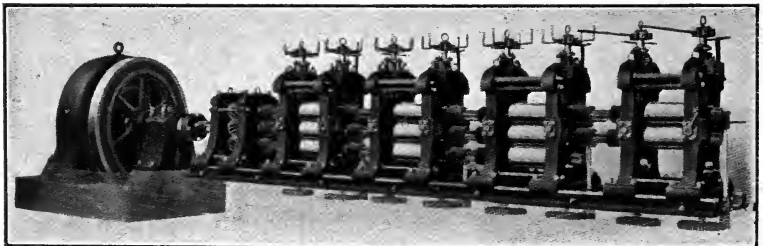

FIG. 154. — MOTOR-DRIVEN ROLLING MILL.

speed than is desired for the rolls, thus requiring less power. Reversing slabbing-mill engines have capacities up to 25,000 H.P. each.

Electric-Motor Drive. — During the year 1906, very important installations were made of electric-motor-driven roll trains. The advantages of electricity over steam are a lower operative cost, greater

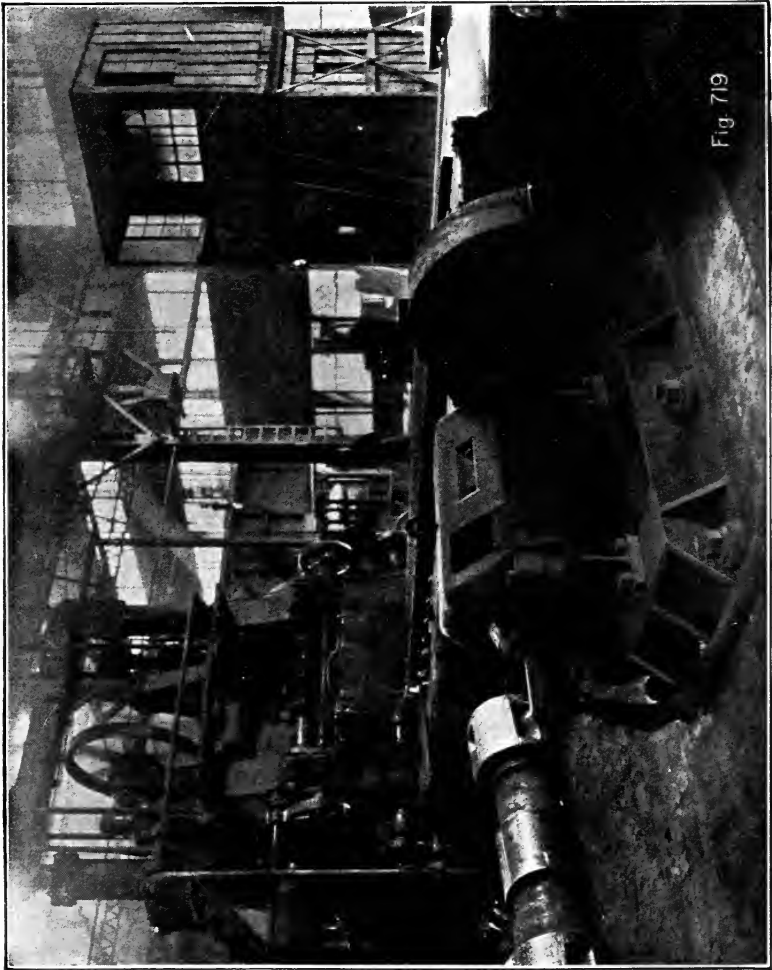

Fig. 719

FIG. 155. — ELECTRIC TABLE MOTOR.

security of operation, fewer breakdowns, and a more flexible relation between the prime mover and the load, the result of electric motors receiving a sudden shock more elastically. On the other hand, the advantage of steam is that, although it receives the load less elastically, it adjusts itself quicker and better to the ex-

treme variations in load that always occur in rolling-mills. This is especially true of reversing mills.

As already noted, the smaller the mill the less will be the load, and therefore the variation in load. Consequently, in England,

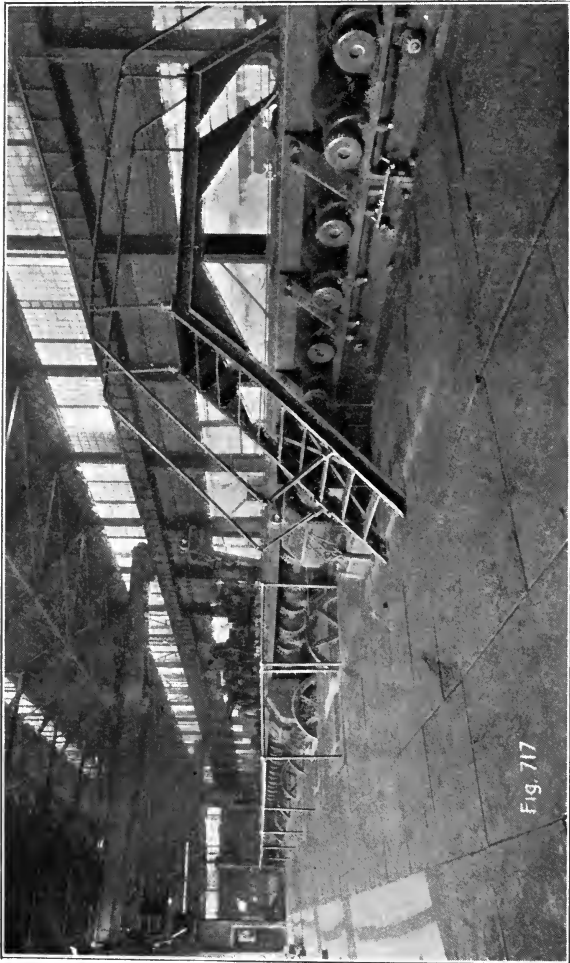

FIG. 156. — TABLE DRIVEN BY ELECTRIC MOTORS.

Sweden and Germany there are many motor-driven roll trains of the smaller size, and a few up to several hundred horse-power, including one reversing motor of 1200 H.P. In America, there are some small roll trains operated by electricity, but up to 1906 there

was only one with as high a capacity as 1500 H.P. During 1906, at some of the most important works in the country, motor-driven rail mills were begun, including two motors of 1500 H.P. each for a three-high train, and also including a rail mill operated throughout by electricity, from the bloom rolls to the finishing train, with six motors, varying in capacity from 2250 H.P. to 6000 H.P. each. The most startling innovation, however, is a reversing Universal plate-mill operated by two motors on the same shaft, which, when running at full speed (150 r.p.m.), will develop approximately 10,000 H.P. It is supposed that this mill, when built, will be capable of reversing from full speed forward to full speed backward in the space of three seconds.

Almost all American rolling-mills of most modern equipment now use electric power for driving the table rollers, the screw-down mechanism, the shears, and in fact for all purposes except driving the rolls.

ROLLING-MILL PRACTICE

Troubles in Rolling. — There are more difficulties met with in rolling-mill practice than we can discuss here, but it may be said that the seriousness of a difficulty is estimated almost altogether in proportion to the delay it causes in the operation of the mill, rather than in the loss of a small amount of material or of a part of the mill itself. For example, the breaking of a table engine, roller, or even a roll, is regretted more because of the time necessary to put in a new one than because of the loss of the part. This is one reason why electric motors to operate the tables have, in many cases, replaced small steam engines. The same conditions have also resulted in different parts of the mill being made interchangeable. In many mills it is customary to have spare table engines or motors, etc., always ready, and the least accident to one of these machines would result in its being immediately replaced by a whole new one.

The most important common troubles in rolling-mill operations, probably, are: (1) Bending and breaking of the rolls, due to their being placed under too severe a strain, either because the draft is too heavy or because the piece is cooled too much; (2) the fins caused by metal being squeezed out between the collars of the rolls, as shown in Fig. 157; these fins, besides spoiling the material, are liable to break the rolls; (3) collaring.



FIG. 157.
FIN.

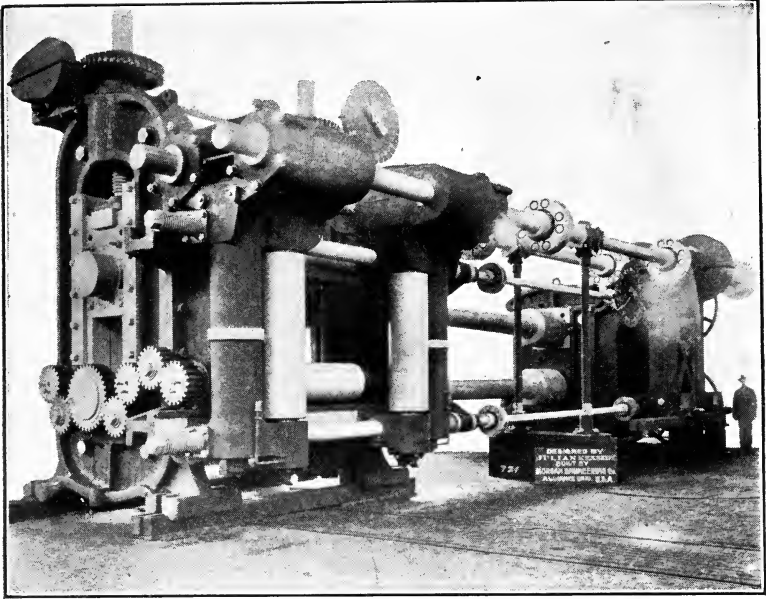

FIG. 159. — UNIVERSAL MILL.

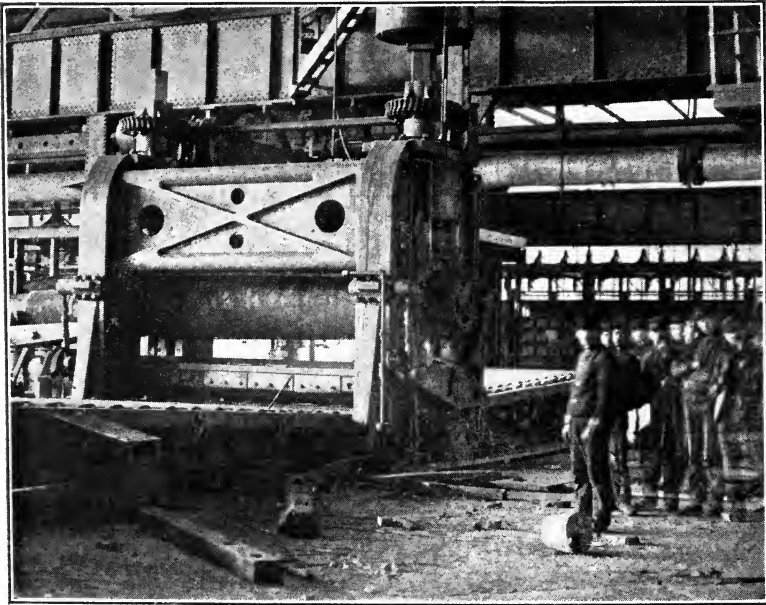

FIG. 160. — THREE-HIGH PLATE MILL.

Rolling Plates. — In the rolling of plates an ingot, usually of open-hearth steel and weighing 2 to 10 tons, is first cogged down in the slabbing-mill, producing a long, flat piece of metal. The slabbing-mills are frequently of the two-high, reversing, Universal

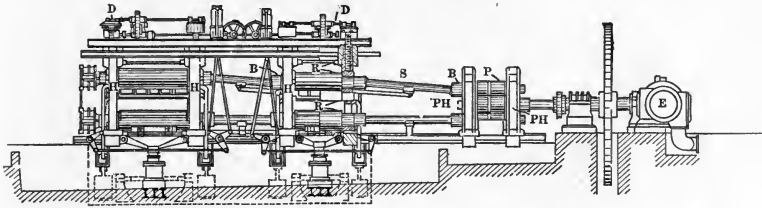

FIG. 161. — THREE-HIGH PLATE MILL, TWO STANDS OF ROLLS.

B, Coupling boxes; D, screw-down mechanism; E, roll engine; H, housings; P, pinions; PH, pinion housing; RR, rolls; S, spindles.

type. The front end of the piece is cut off in a huge hydraulic or electric shear to remove the pipe and then it is cut up into slabs of the desired size or into slabs of a size such that each one will make one plate. The slabs are then transferred to the heating furnace, heated to about 1300°C ., and rolled in a three-high or, more rarely,

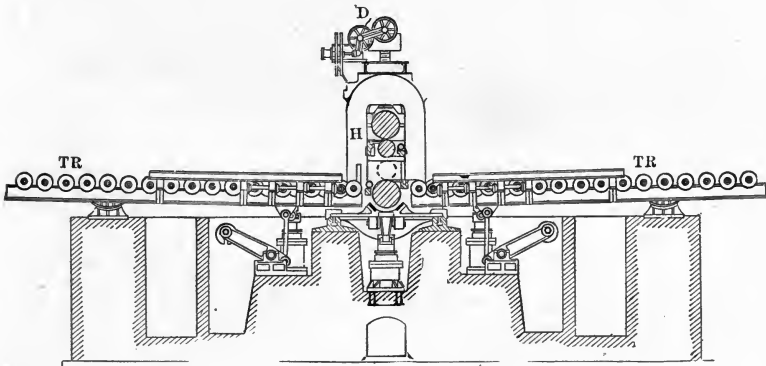

FIG. 162. — OTHER VIEW OF FIG. 161, SHOWING METHOD OF RAISING THE ENDS OF THE TABLES NEXT TO THE ROLLS.

a two-high reversing plate-mill, in some cases there being a pair of vertical rolls to keep the edges straight. During the rolling a shovelful of salt is occasionally thrown upon the surface of the plate, which carries in between the rolls some of the water which is always trickling over them to keep them cool. Sand may be

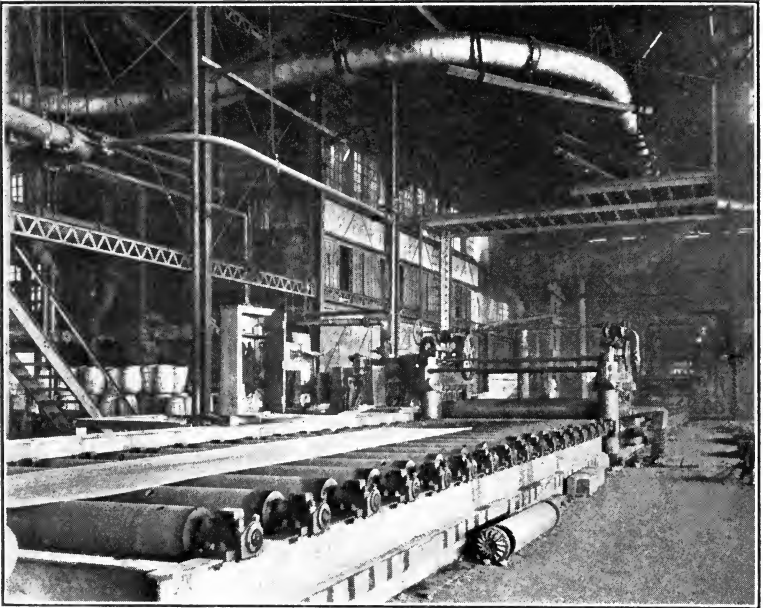

FIG. 163. — PLATE STRAIGHTENING ROLLS.

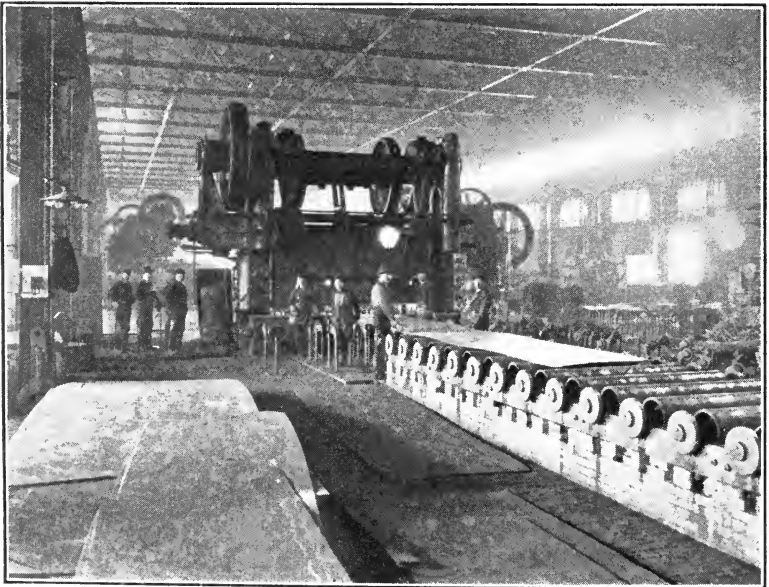

FIG. 164. — PLATE SHEARS.

used for the same purpose, and in England heather is sometimes used. As soon as this water is pressed against the hot plate it is converted into steam, causing a rapid series of explosions which blow the scale off the upper surface of the plate and give it a smoother finish. As the process continues, the operator tests the thickness of the plate with a gage, and when it is of the desired thickness, it is passed up to the straightening rolls and then to a

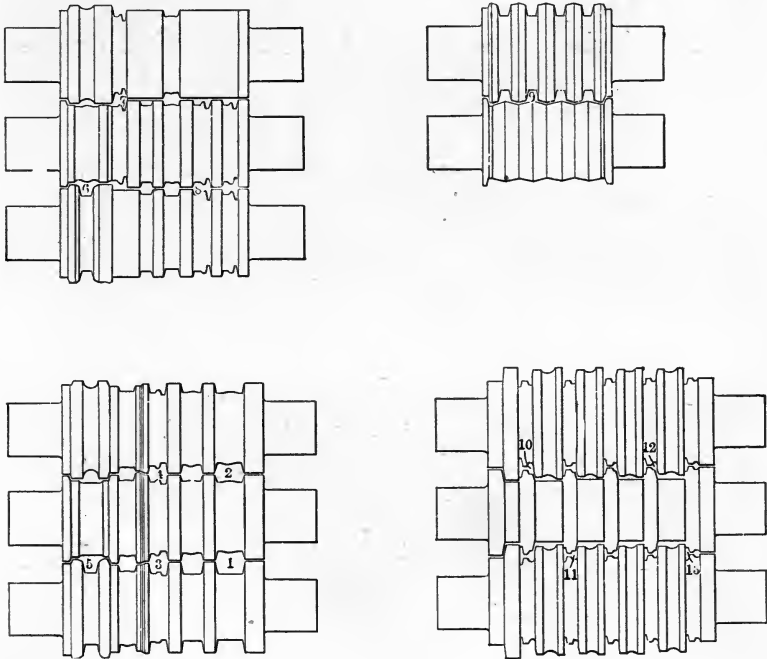

FIG. 165.

cooling table, being marked with a distinguishing mark on the way to indicate the heat of steel from which it was manufactured. When cooled it is sheared to the desired size and shape. The weight of finished plate will probably be not more than 80 per cent. of the weight of the steel sent to the rolling-mill in the form of ingots.

Rolling Rails. — An ingot of about three tons in weight is sent to the rolling-mill, where it is kept in the heating furnace for 50 minutes or more until the interior is entirely solid and it is of a uniform temperature throughout. It is then rolled into blooms, either in a three-high mill, such as shown in Fig. 142, or in a two-

high reversing mill. In the three-high mill, an ingot $18\frac{1}{2}$ in. square at the middle (tapering about $\frac{1}{8}$ to $\frac{1}{4}$ inch to a foot in order that the mold may be more easily removed) will be reduced to a bloom of about 8 in. square in nine passes, the amount of reduction in each pass being about 12 to 18 per cent. of the original area. The top end is then cut off to remove the pipe, the bottom end to remove the irregularity due to the rolling, and the piece cut in two to make two blooms. The blooms are then generally reheated in a heating furnace and passed through the series of changes shown in Fig. 165, until they have assumed the proper size and form, the greatest

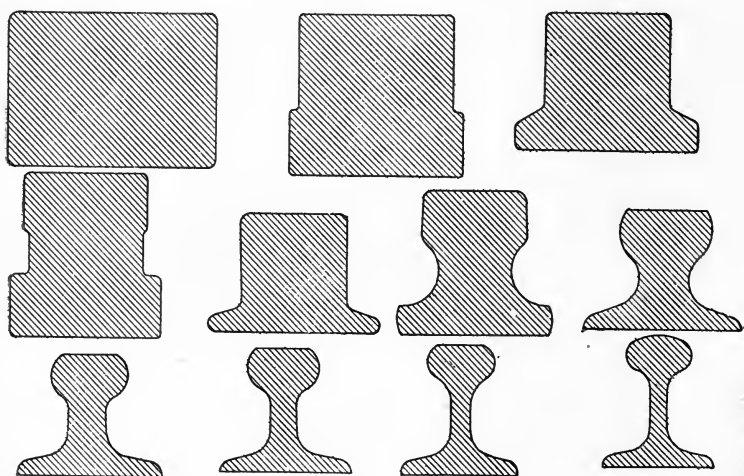

FIG. 166.

amount of draft being usually not more than 22 per cent., except upon the middle portion of the web. In some cases the blooms are not reheated, but go directly from the bloom rolls to the first roughing train. This makes the metal crack more in rolling, however, and these cracks will ultimately show as a mark on the finished product, which causes the rails to be classified by the inspector in the second or third class. Railroads will accept only 5 or 10 per cent. of their order in second-class rails, while third-class rails are not acceptable and must go into the tracks of the steel company itself or else be reheated and rolled into smaller sizes, whereby the marks will often be eliminated. If the blooms are reheated before going to the roughing train, many of the cracks

formed during blooming will be seemingly closed up, or in any event will not show. Furthermore, if this reheating is to take place, the ingots need not be heated so hot in the first instance, and therefore will not be so tender and so liable to crack.



FIG. 167. — SKELP ON A COOLING TABLE.

Making Lap-Welded Tubing. — The wrought iron or steel low in carbon is first rolled out into skelp about 20 to 25 ft. long, and of a width a little more than three times the intended diameter of the tube. The skelp is then rolled up into a rough form of a pipe,

as shown in Fig. 168, by passing it sidewise through rolls, which bend it roughly to the shape of a pipe, with edges overlapping. The same is done in the case of small 2-to-8-in. tubes, by drawing them through a die. It is then passed at a welding heat through a pair of rolls, with the seam that is to be welded

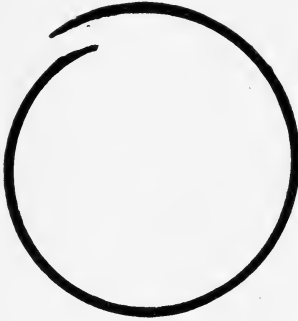

FIG. 168.

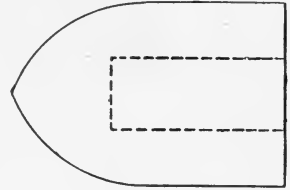

FIG. 169. — MANDRIL.

upward. Between the rolls is a mandril, on the end of a long rod and of the size of the inner diameter of the tube. The rolls press the two parts of the weld together over the mandril, and the pipe, after another rolling to give true size and after straightening and testing, is ready for service.

Making Seamless Tubes. — Seamless or weldless tubes are made either by distorting a steel plate between dies, as shown in

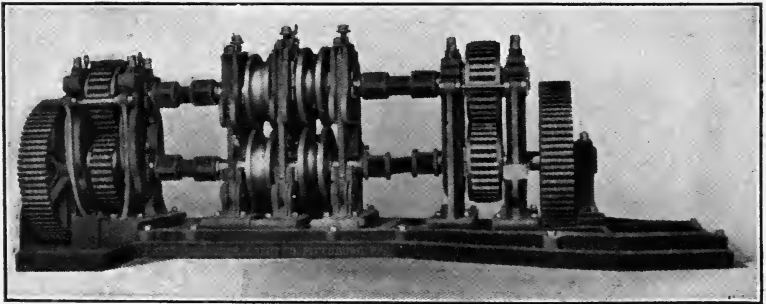

FIG. 170. — PIPE-WELDING ROLLS.

Fig. 172, or else by piercing a hole through the center of a hot steel billet and then rolling it successively between rolls over a mandril. The hole is sometimes first of small size and then expanded by pressing larger and larger expanders through it. The pierced

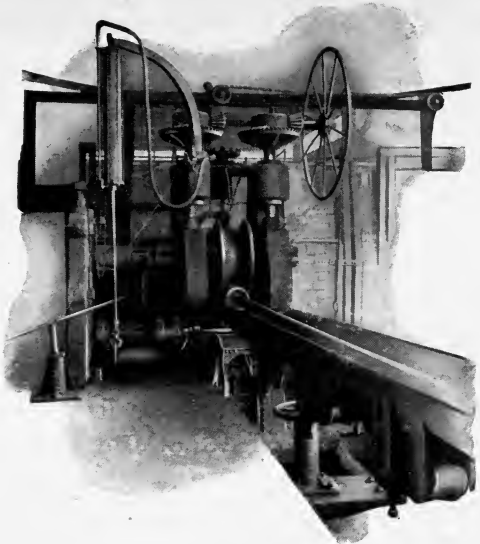

FIG. 171. — PIPE-WELDING ROLLS WITH MANDRIL IN POSITION.

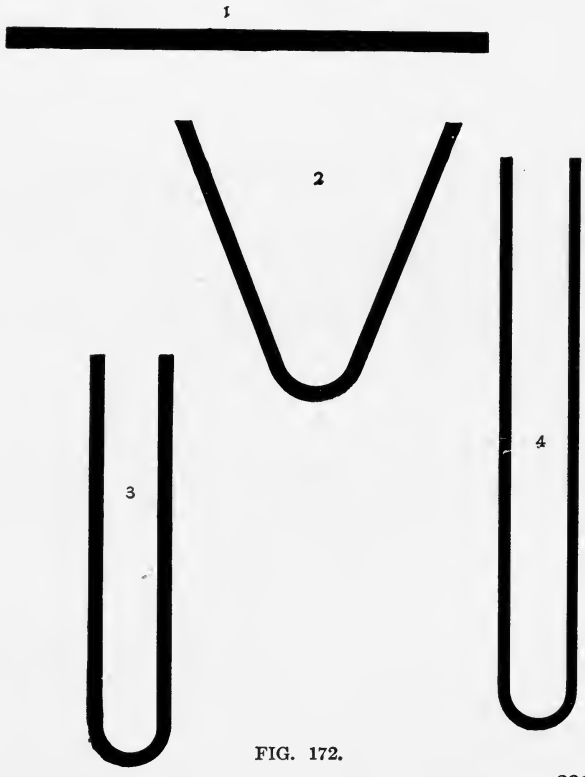

FIG. 172.

billet is then rolled over mandrils constantly decreasing in size until the inner and outer diameters are brought to the desired size.

Butt-Welded Tubes. — Butt-welded tubes are made by heating the skelp to a welding temperature and then drawing it out of the

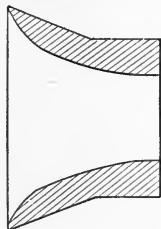

FIG. 173. — SECTION OF BELL.

furnace through a bell, as shown in Fig. 173, which curls it up and welds the edges together, without lapping. Butt-welded tubes are not so strong as lap-welded tubes, and are not usually used for boilers or high pressures, or where they will be expanded much by heat during service. They are mostly made in the small sizes.

In the United States, over a million and a half tons of pipe are made each year. It is used principally for the transmission of oil, water, steam and gas, and for conduits for electric wires. About 30 per cent. of this is made of wrought, and 70 per cent. of soft weld-steel. The steel is usually, but not always, made by the Bessemer process on account of the difficulty of making very low-carbon material in the open-hearth.

WIRE DRAWING

Wire is a product formed by being drawn cold through a die. The commonest shapes are 'rounds,' and the next, hollow tubes, but a great variety of forms may be produced at will.

Effect of Drawing. — The effect of the drawing is to produce a very exact size of material and to increase the strength, hardness, and brittleness of the metal. In the drawing of steel, the crystals of the metal are actually pulled apart and flow by each other, the outer layers of the metal being dragged back over the central core, there being at the same time a pressure exerted in all directions toward the center, which results in a certain amount of backward flowing even there. Because the crystals are so broken up during the operation, and because the metal is never heated above its critical temperature during annealing, the grain of the steel is very fine and the crystals are intimately mixed, which is probably the cause of the great strength of wire.

Annealing. — With each draft the wire becomes harder and more difficult to draw. As it is pulled through the die by a force equal to 40 to 80 per cent. of its tensile strength, it is neces-

sary to soften it at intervals by annealing, lest it break. The annealing is accomplished by enclosing the wire in some receptacle

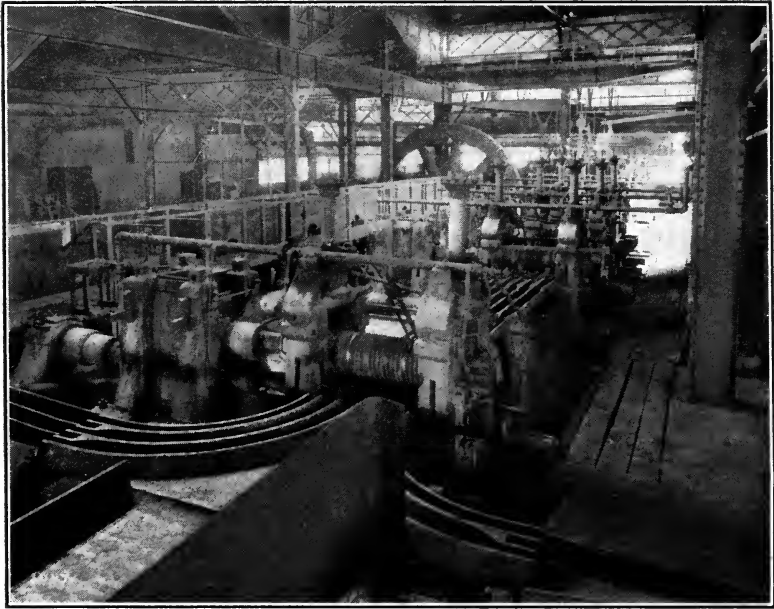

FIG. 174. — WIRE ROD ROLLING TRAIN.

These mills will roll steel down to from $\frac{7}{8}$ to $\frac{1}{2}$ inch rods, which are then drawn into wire.

that protects it from oxidation and then heating to a low-red heat. In the case of steel, it is required after every 8 to 3 passes, de-



FIG. 175. — WIRE ROD FRAME.

pending upon the amount of carbon in the metal and the amount of draft.

Dies. — Wire dies are usually made of high-carbon steel (say about 2 per cent.), through which a tapered hole is made, as shown in Fig. 176. The object of using this material is that, as it becomes worn in service, it can be reformed and used for larger sizes, which could not be done with white cast iron.

Bench. — A 'bench' on which wire is drawn consists of a reel which holds the coil of undrawn wire, a die support, and a second reel which draws the wire through the die and coils it up,

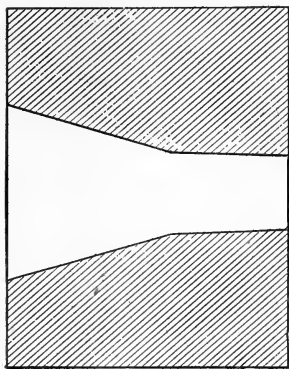

FIG. 176. — SECTION OF WIRE DIE.

and which is driven by bevel gears. The die rests against the support, and the wire, having a tapered point, is thrust through the hole and grasped by a pair of tongs, which pulls it out until it can be attached to the reel. This is then set in motion and draws the wire through. The die-holder is heaped up with lubricant of some kind, in order that the metal may pass more easily through the hole. The speed at which wire is drawn will vary from 75 to 750 feet per minute, depending upon the size and hardness of the material drawn and the amount of reduction during each draft. In many cases there is more than one die, and the wire passes successively through two, three or more, being constantly reduced in each one. Between each pair of dies is a reel, around which the wire passes two or three times, since the strength of the wire emerging from the last die would not be sufficient to draw it through all of the holes.

Draft. — The heavier the draft the greater is the hardness produced in the wire and the greater the wear of the dies. The average amount of draft will probably be from 20 to 25 per cent.

Drawing Tubes. — Hollow wire or small tubes are drawn sometimes over a mandril. This mandril may be a wire of about the size of the inner diameter of the finished tube. After several drafts, the tube is wedged so tightly on the mandril that it cannot be separated. It is then given an unbalanced squeeze between a pair of rolls, so that the tube is reduced in thickness, whereby its diameter is increased and the mandril may easily be withdrawn.

PRESSING

Steel may be pressed either hot or cold, the latter method being used chiefly for thin and soft steel, and the former for very large work, such as armor-plate, cannon, etc., for which hydraulic presses have now largely replaced the heaviest steam-hammers.



FIG. 177. — FOURTEEN-THOUSAND-TON ARMOR-PLATE PRESS.

Effect of Pressing. — The effect of pressing upon the metal is almost exactly the same as that of hammering, except that its action extends a little deeper into the material, thus giving a somewhat superior texture to this part of the body. Tests cut

from the center of large pieces forged under the press are very much superior to those cut from the same place in pieces forged under the hammer.

Hot-Pressing. — Presses vary in size usually from 600 to 14,000 tons. They may be either of the continuous or of the intermittent type. In the latter, the amount of pressure exerted increases step by step as the work progresses. The amount of work that can be done by the press in large-sized pieces is greater

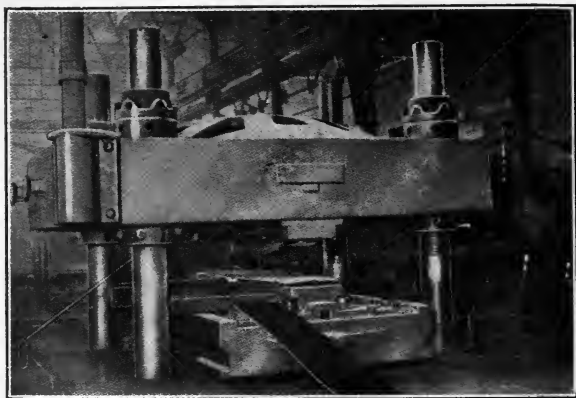

FIG. 178. — DROP-FORGING PRESS FOR PLATES.

than that done by hammers for the same amount of power used. This results in a double saving of fuel, since more work can be accomplished with one heating. By means of the 10,000-ton press at the Homestead Steel Works, a 50-ton armor-plate has been reduced 2 in. in thickness and moved forward 6 in. for each squeeze, while a 3000-ton press at the Firths Works in England has reduced a 30-ton ingot from 49 to 28 in. diameter in 30 minutes, and from 51 to 26 in. diameter in 65 minutes. Small pieces can be turned out a little faster under the hammer.

Cold-Pressing. — Thin plate for steel railroad-car construction is often formed by pressing it cold between dies under hydraulic presses of from 30- to 800-tons capacity. In this way bolsters, braces, and many other parts are formed with great economy. Sometimes two or three presses are required with different dies to complete the shaping, and occasionally it is necessary to press some of the work hot, because the distortion is so great that the steel

would otherwise be torn. Cold-pressing is also known as 'flanging.' It has one great difference from hot-pressing, in that there is no reduction in the sizes of pieces treated.

COMPARISON OF MECHANICAL METHODS

Hot-Rolling with Cold-Rolling. — Cold-rolling gives a harder material and more accurate finish as to size than any form of hot-working. Furthermore, it produces a finer grain in the metal. If the cold-rolling is followed by annealing at a temperature below the critical range of the steel (see pages 388 to 389), the material retains its fine grain, and is stronger and more ductile than metal that has been worked hot. Before cold-rolling, the metal is pickled in dilute sulphuric acid to remove the scale, and is therefore produced with a bright surface which is suitable, without machining, for use as shafting, for nickel-plating, etc. The annealing is usually effected inside closed vessels, in a reducing atmosphere of illuminating gas or some similar medium, which prevents the formation of scale. Cold-rolled steel is used for articles that are to be drawn or stamped to shape — watch and clock springs, hacksaw blades, corset steels, etc.

Hammering versus Rolling and Pressing. — Of all the mechanical methods, rolling gives by far the largest output per day, per unit of power, and usually per unit of fuel for heating. It is therefore the cheapest method, especially for labor. It does not work the metal as well as either hammering or pressing, both of which produce a much better crystalline structure, beside affording a better control of the temperature at which the operation is ended. Pressing works the metal at greater depths than hammering, and is therefore especially advantageous for producing large pieces, and the more so because small presses are very costly to install as compared to steam-hammers. Where a shape is intricate, rolling is more liable to tear the metal than hammering or pressing because, at the point where the roll is deeply cut, its surface velocity is much less than where the diameter is greater, and thus it tends to drag the metal through at different speeds.

HEATING FURNACES

Heating furnaces are usually of the reverberatory type, burning soft coal or gas. The flame produced must be as reducing as

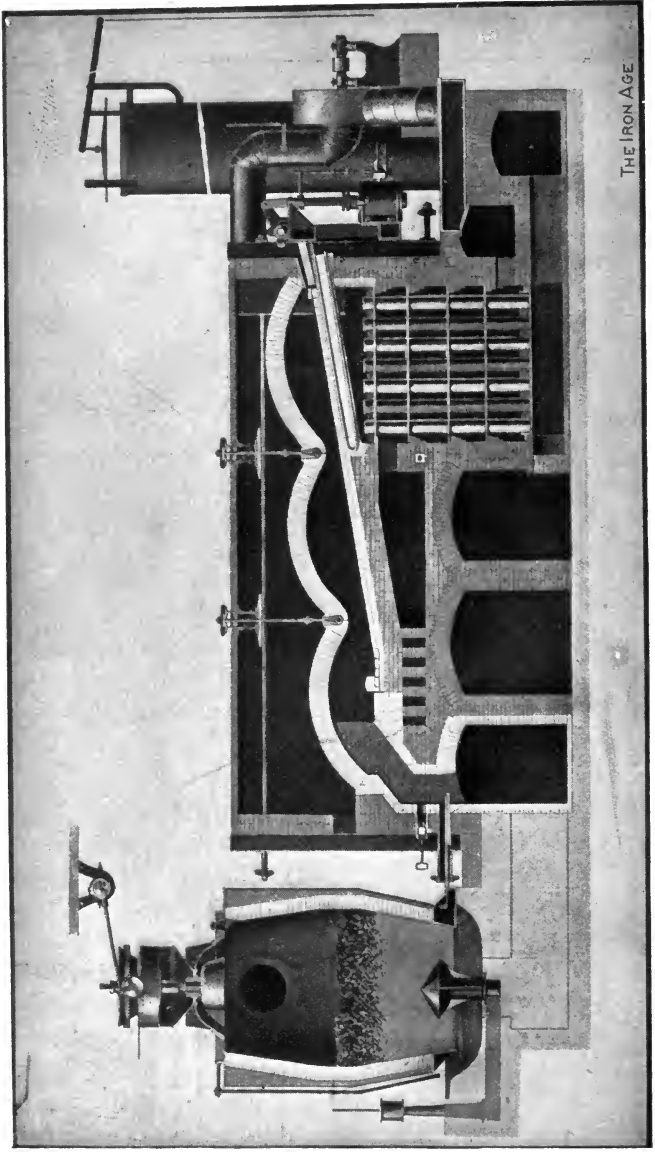

THE IRON AGE

FIG. 179. — CONTINUOUS RECUPERATIVE HEATING FURNACE.

possible in order to produce a small amount of scale. Much better control is obtained if the ash-pit is enclosed and forced draft is used to burn the fuel. In this way about half a ton of fuel will be required to heat a ton of steel from the atmospheric temperature to that necessary for mechanical work, with a loss of about 4 to 5 per cent. of the metal as scale. The gases must necessarily leave the furnace at a high temperature, and therefore it is not uncommon to have boilers situated over the heating furnace, in which steam is raised by means of the waste heat. With this economy the amount of fuel chargeable against heating the steel will be from 350 to 450 pounds per short ton of steel heated.

Regenerative Furnace. — If the heating furnaces are fired with producer gas and the regenerative method is employed, we get a far better control of the temperature and of the reducing influence of the furnace gases. By this means a short ton of steel may be heated with from 150 to 200 pounds of fuel and with a loss of metal of from 1 to 5 per cent. by oxidation.

Continuous Furnaces. — Billets and other small pieces may be heated in furnaces whose action is continuous. Such a one as this is shown in section in Fig. 180. Along the hearth stretch two lines of pipe, which are kept cool by a stream of water inside. Upon the pipes is laid a long series of billets, which are gradually moved forward toward the end at which the gas and air enter. In this way the flame is always met by colder material and finally leaves the furnace at a relatively low temperature. As the gases pass out, they go through a series of pipes, *B, B*, around which circulates the air that is afterward led to the fire and used for combustion. As soon as the billet nearest the fire end is heated to the desired temperature, a new one is pushed in at the bottom, causing the hot billet to be shoved onto the inclined plane, whence it rolls out of the furnace to the point *A*, whence it is transferred to the rolling-mill. In this type of furnace a short ton of steel may be heated with from 120 to 145 pounds of fuel, with a loss in weight of less than 1 per cent. by oxidation.

Soaking-Pits. — Ingots with molten interiors must be put in some form of furnace in which they will stand upright until they have solidified throughout and are ready to roll, in order that the pipe may form in the upper portion. The type of furnace used for this is known as a soaking-pit and is shown in Fig. 181. The original intention of soaking-pits was to have the heat in the

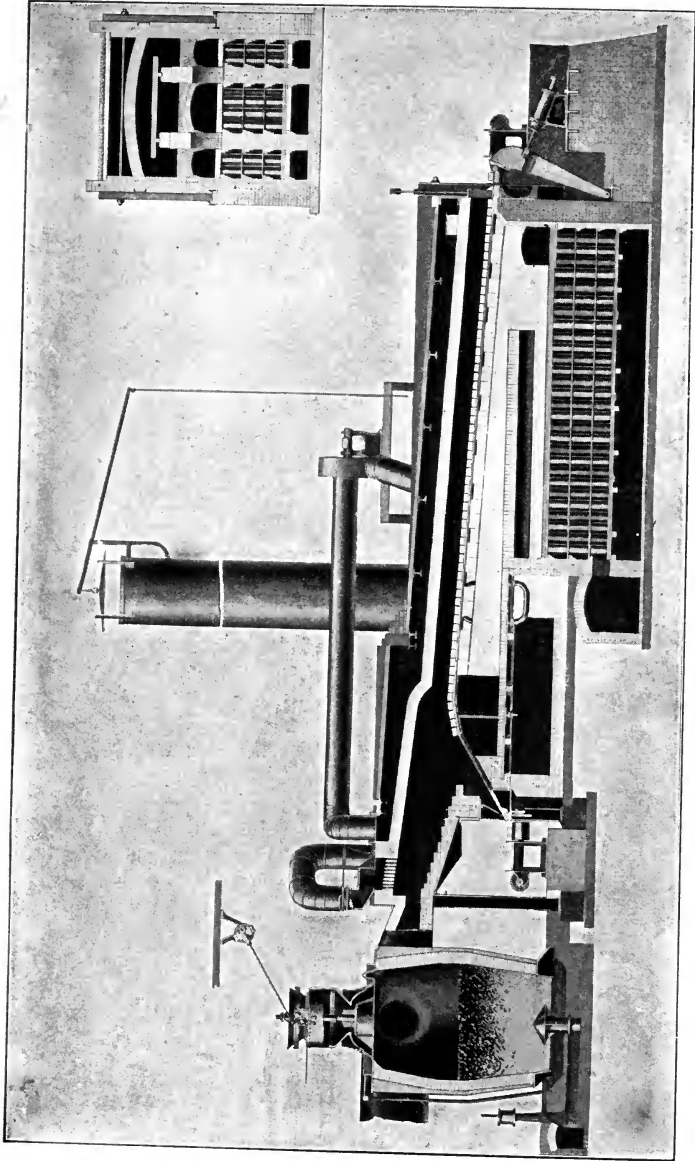

A

B B

C

FIG. 180. — CONTINUOUS RECUPERATIVE BILLET HEATING FURNACE.
B B, pipes; C, ram for pushing in cold billets.

ingot itself bring the interior of the furnace and the mass of metal to the desired temperature; but this is not found practicable in the United States, and soaking-pits are usually heated by regenerated gas and air. The ingots must be kept in these soaking-pits long enough to be entirely solid in the interior, and for this purpose at

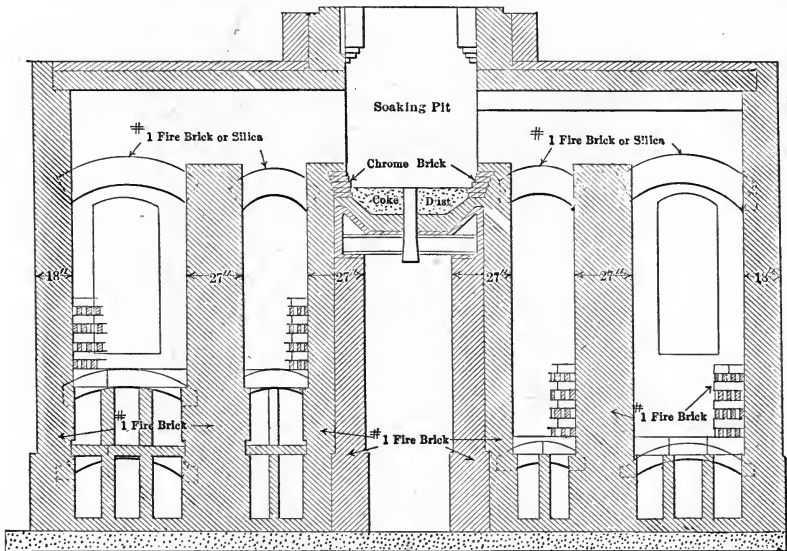

FIG. 181. — BRICKWORK OF REGENERATIVE GAS SOAKING-PIT.

least 55 minutes are required for 3-ton ingots when stripped and charged as soon as possible after teeming, and more for ones of larger size.

Furnace Bottoms. — Heating-furnace bottoms must be of some material not readily corroded by oxide of iron scale, and basic bottoms are very commonly employed with success. Heating-furnaces are also frequently supplied with a tap-hole, from which the slag, composed chiefly of oxide of iron, can be tapped at intervals. Soaking-pit bottoms are frequently covered with a layer of coke breeze to absorb the slag and prevent corrosion of the furnace bottom. This is shoveled out when an opportunity is afforded, and new breeze substituted, or is knocked out through a hole in the bottom, for which see Fig. 181.

Heating Practice. — In heating steel for rolling, the lower the temperature the better will be the quality of the product. On

the other hand, if the metal is to undergo many passes before it receives another heat, it must be correspondingly hot, in order that the finishing temperature may be high enough to avoid excessive power for reduction. There is no doubt that rolling temperatures at the present time are higher than they should be, for the metal when finished should be only just above the critical



FIG. 182. — CHARGING A SLAB INTO A HEATING FURNACE.

temperature of the steel. Until within recent years no suitable pyrometers for measuring the temperature have been available, and the temperature for drawing the material is judged by eye, so that no figures can be given. There can be no doubt that more careful attention to this point will result in less waste in rolling (on account of the production of cracked or second-class material because of too hot steel at the starting) and in the production of a higher quality of steel.

It must be remembered, however, that the steel must be hot enough to cause it to weld together wherever it has become cracked. This is especially to be observed in low-carbon steel whose welding, as well as its melting-point, is higher than that of high-carbon steel.

The casting temperature and the absence of ingotism which the author has discussed elsewhere is probably more important than any other factor in preventing cracking during rolling, as properly made steel can stand without injury a high temperature which would be very harmful otherwise. High-carbon steel is very delicate to roll especially when the silicon is also high.

REFERENCES ON MECHANICAL TREATMENT

See especially No. 31 and the current technical literature, especially Nos. 8, 9 and 12.

IX

IRON AND STEEL FOUNDING

FOUNDING is a mechanical art, and consists in pouring melted metal into a mold of any desired size and form, which the metal assumes and retains when cold. The mold is made of some kind of sand, with rare exceptions to be mentioned hereafter. The art is a very complex one, added to which it is now passing through an important transition period in which science is very rapidly taking



Sweeping up a mold.

FIG. 185. — VIEW IN AN IRON FOUNDRY.

the place of rule of thumb. It is impossible to treat the subject adequately in a single chapter, but several books are now available, to which foundrymen, metallurgists and chemists are referred, and which are also recommended to all engineers, to whom a knowledge of the art is of prime importance.

THE MAKING OF MOLDS

There are various kinds of sand molds made for foundry work, but the three principal kinds are *loam molds*, *dry-sand molds*, and *green-sand molds*.

Loam Molding. — In molding with loam, sand is usually built up into the required shape by hand, aided by machines. Fig. 185

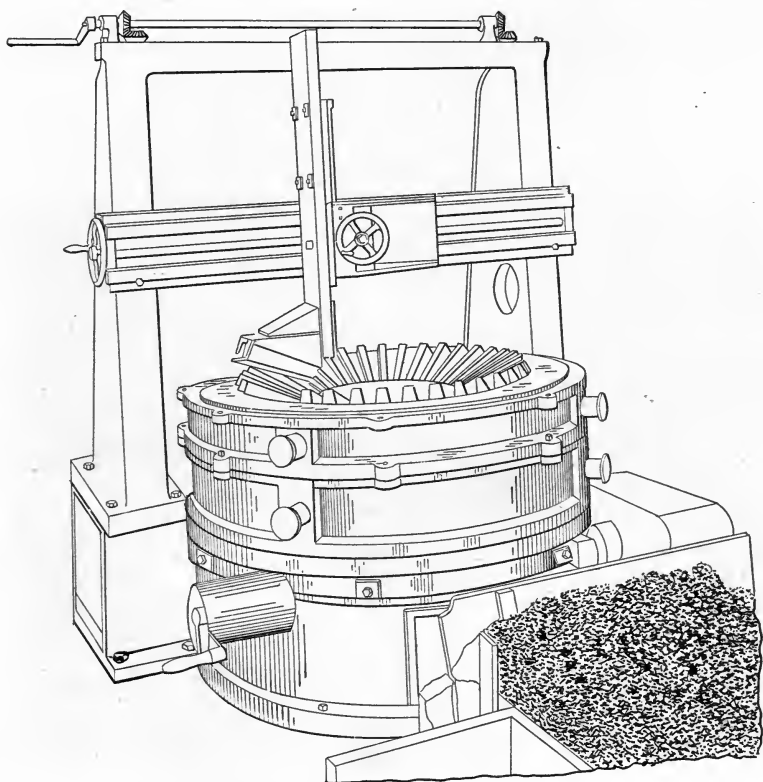

FIG. 186. — MACHINE FOR FORMING THE TEETH OF A BEVEL-GEAR.

shows the molding of a gear in which the parts are built up of brick and sand and then 'swept' into the proper shape by means of the wooden sweeps. Large wheels and gears are often swept up in this way, the teeth being formed subsequently by means of a small pattern that is moved around as the molder progresses, or

by means of a machine, as shown in Fig. 186. In the case of a gear, the arms are usually formed by placing within the swept-up mold forms of sand known as 'cores,' as shown in Fig. 187. Loam molding is common in iron foundries, but almost never used for steel castings.

Pattern-Molding. — To only a limited class of work is loam molding applicable, and the commonest manner of making a mold is to press or ram sand around a pattern, which is subsequently



FIG. 187. — PLACING CORES IN A MOLD.

removed, leaving the desired cavity. Usually the pattern is enclosed by a 'flask' much larger than itself, between which and the pattern the damp sand is rammed. The pattern (sometimes) is split into halves, one half being in the lower part, or 'drag,' of the flask, and the other half being in the upper part, or 'cope.'¹ The cope is now taken off and turned upside down, after which a lifting-screw is inserted into each half of the pattern in turn, by means of

¹The old English word 'cope,' meaning a covering for the head, which has now largely been replaced by the name 'cap.'



FIG. 188. — MAKING THE MOLD.
Pattern in the sand of lower section of flask.



FIG. 189. — MAKING THE MOLD.
Pattern removed from sand showing molded impression.

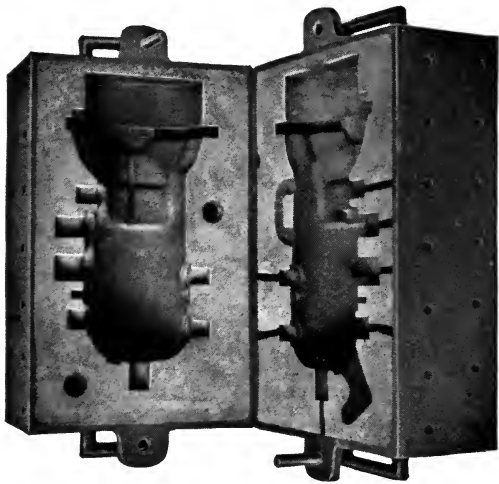

FIG. 190. — MAKING THE MOLD.
Upper and lower sections of flask molded and ready to receive cores.

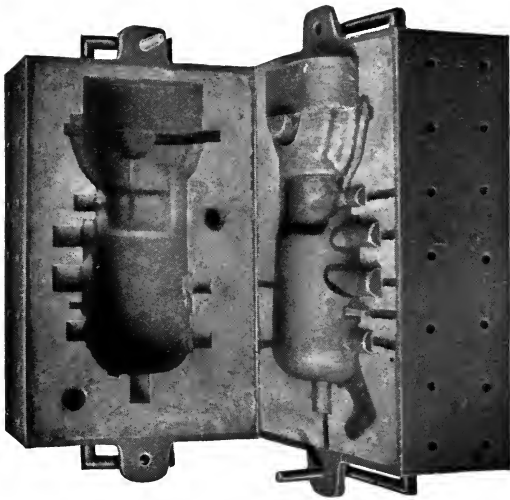

FIG. 191. — COMPLETING THE MOLD.
Cores in place.

which it is drawn from the sand; and when a 'gate' is cut through the cope, the flask is again fastened together, and a receptacle is formed of the shape of the pattern into which the metal may be poured.

The art does not consist of these simple operations alone, however, for in drawing the pattern from the sand, even though the lifting-screw be lightly tapped with a hammer in four horizontal directions to loosen the pattern, the slightest tremble of the molder's hand, or of the crane used for lifting, may cause the sand to be

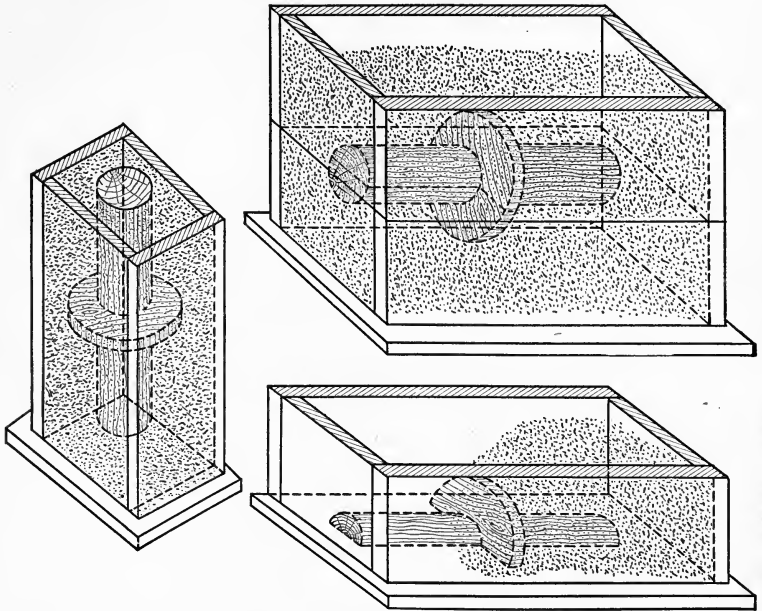

FIG. 192. — PATTERN IN SAND.

broken in places, and the chief skill of the molder as well as a large share of his time is employed in repairing the damage thus produced. Furthermore, the mold may be 'washed,' that is, painted inside; the proper cores must be put in place; parts of the sand liable to drop off must be nailed in place with thin, large-headed wire nails thrust in with the thumb; before the pattern is taken from the sand the cope must be 'vented,' that is, made porous, by jamming a wire into it many times and pulling it out again, so that the air and gases will escape when the metal is poured in; and so on.

Furthermore, it may readily be imagined that the parts of the pattern shown in Fig. 193 might be of such a shape, with flanges on the bottom, or something of that kind, that they could not be drawn without breaking the sand. In the case of such a design the pattern and flask must be split into three or more parts,¹ or else a core must be put in to make an offset. It will be evident to

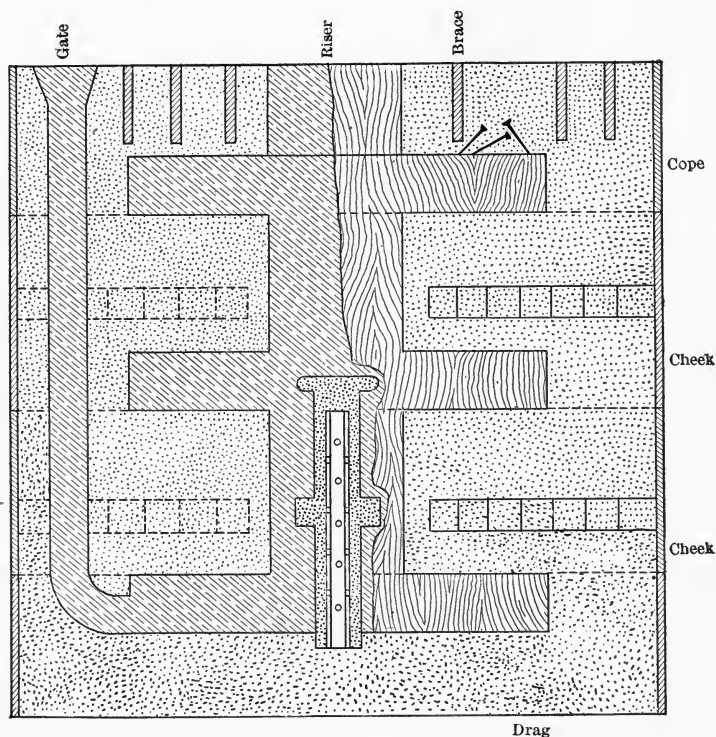

FIG. 193. — SECTION OF FLASK AND PATTERN.

every engineer that he will have to pay more for making a casting so designed.

Ramming. — In pattern molding, it is essential that the pressure of the sand around the pattern shall be nearly uniform in all places; because (1) when the metal is poured into the mold, it drives out the air already there by forcing it through the inter-

¹ The bottom and top parts being still known as the 'drag' and 'cope,' respectively, while the intermediate parts are known as 'cheeks.'



Floor and Hand Rammers



Finishing Trowel

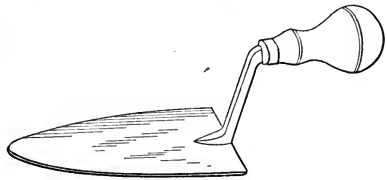

Finishing Trowel



Yankee



Lifter



Bench Lifter

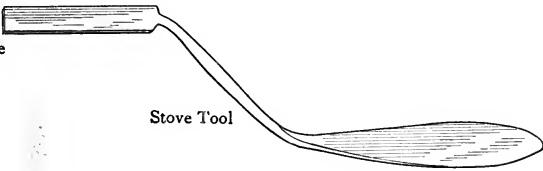

Stove Tool

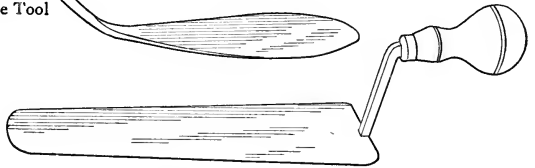

Finishing Trowel

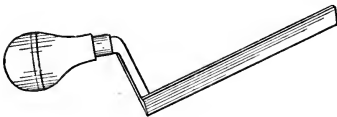

Square Trowel

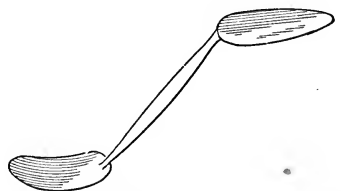

Slick and Spoon

FIG. 194.

stices between the particles of sand, and if the sand is too hard in any place, the pressure of air collected there is liable to form a depression, or 'scab,' in the casting; and because (2), if the sand is too loose in any place, the pressure of the metal upon it is liable to 'swell' it outward and thus cause an enlargement of the casting at that point. To obtain uniformity it is necessary that the sand be packed around the pattern, and not the pattern pushed into the sand. This packing is accomplished by the hands for the sand immediately adjacent to the pattern, and by rammers for the layers further distant. In the case of bench molding hand rammers are used, and for making larger molds on the floor long iron rammers are employed. The molder's skill is shown in applying the proper amount of power in ramming each different kind or part of pattern.

Dry-Sand Molds. — After ramming up the mold, drawing the pattern and applying the 'wash,' the mold may be used green (when it is called a 'green-sand mold'), or it may be put in the ovens and dried (when it is called a 'dry-sand mold'). The drying has the effect of driving off the moisture and leaving a firm, hard mass, semi-baked into a sort of brick. Sand for these molds should have slightly more clay than for green-sand molds; otherwise, instead of baking into a hard mass, they would be liable to crumble with the heat. The temperature of drying-ovens should be about 350° to 400° F. (170° to 200° C.), and they are heated by coke, coal, gas, or oil. If the temperature is too high, the mold will be burned, that is, it will crumble under the fingers after drying; if not hot enough, the mold will not be baked hard. The length of time in the oven will depend upon the size of the mold, and will vary from an hour or so to a day or so. During the drying the molds are liable to shrink somewhat, due to the action of the clay in binding together.

Green-Sand Molds. — Green sand requires less clay than dry sand, because it has a certain coherence due to its dampness. Many natural sands are found suitable for both the green-sand mold and the dry-sand mold, or they can be made up as desired by mixing a good clay with a sand rich in silica. Green-sand molds must not be rammed as hard as dry sand, so the moisture may more readily evaporate.

Washes. — For iron castings the common wash is graphite dust, which is made up into a paint with water and applied with a

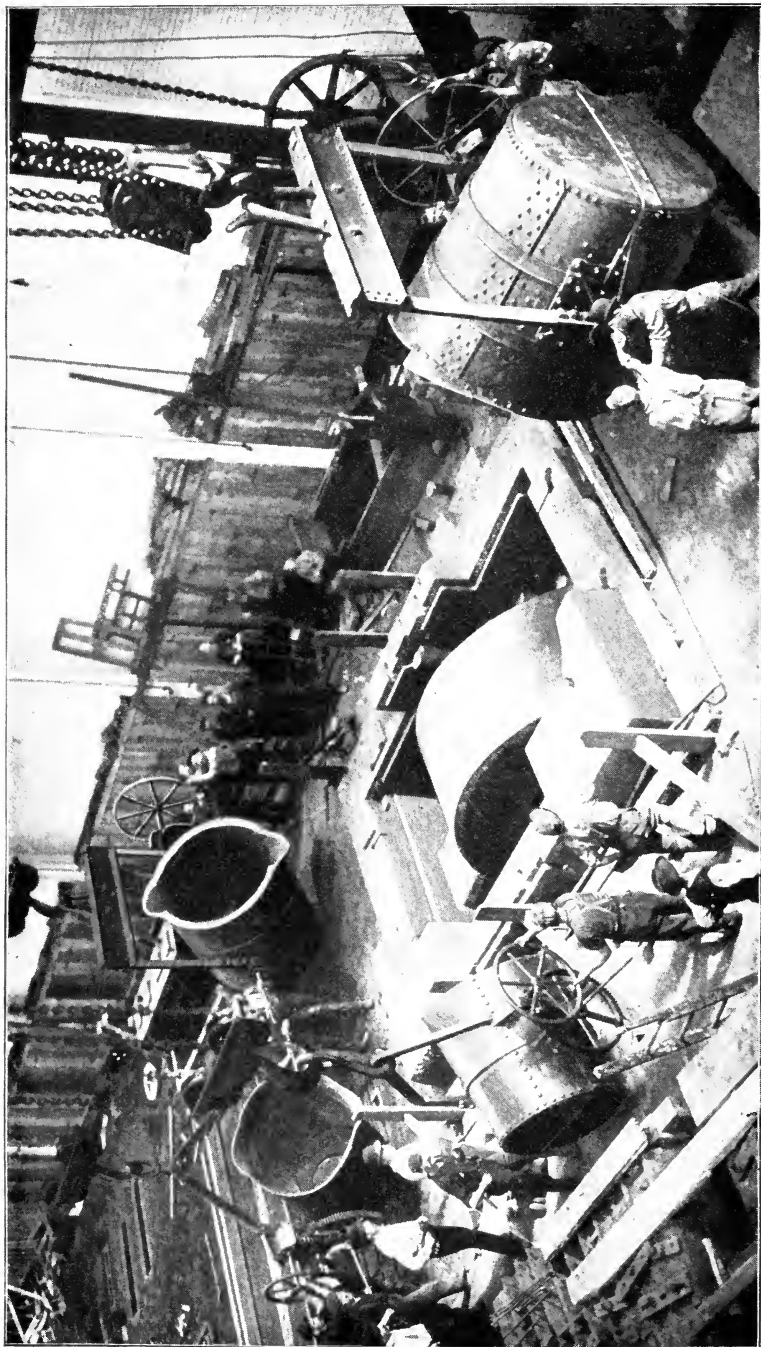

FIG. 195.

brush or dauber to the inside of a dry-sand mold before it goes to the oven. In the case of a green-sand mold, pulverized coal is dusted onto the surface through a piece of cloth, and then spread uniformly with the 'slicker.' In the case of a dry-sand steel casting, the wash is composed of pulverized silica rock, running from 98 to 99 per cent. silica, which is made up into a thick paint with water, thickened with molasses, and applied to the inside of the mold with a brush or dauber before the mold is dried. Green-sand molds for steel castings cannot ordinarily be washed. Graphite washes cannot be used for steel molds, because the hot metal attacks the graphite and becomes rough upon its surface.

The functions of washes are: (1) To make a very smooth face on the sand, so that the surface of the casting shall be smooth (this they accomplish by the very fine size of their particles); (2) to give a surface that shall resist the melting and chemical action of hot metal, and so be more easily cleaned of sand.

Skin-Dried Molds. — The inside surface of green-sand molds is occasionally dried by painting or spraying it with some inflammable liquid, such as gasolene, and then applying a match. This is more common in steel-foundry than in iron-foundry practice, and produces a little better surface to the casting. Herbert B. Atha patented a mold wash for green-sand steel castings which would enable them to be skin dried.¹ The formula for this wash was devised by me with the aid of Parker C. McIlhiney. It consists of ordinary gasolene in which is dissolved as much rosin as it will take up without warming. The rosin increases the specific gravity of the gasolene so that it forms a paint with the silica wash, which would otherwise sink to the bottom and not adhere to the brush. After the wash is applied, it is touched with a match, the burning resulting in giving a dry skin to the mold and leaving it coated with the silica. The rosin does not completely burn off, but binds the sand together and gives a tough skin, so that the sand is not so liable to drop when the cope is turned over to place it upon the drag.

Dry- versus Green-Sand Molds: For Iron Castings. — (1) Dry-sand molds are often cheaper to make and require less molding skill, because the sand does not have to be tempered so carefully, that is, brought to the proper condition of dampness, since the

¹ U. S. Letters Patent No. 686,189.

moisture is eventually to be driven off by the drying. In green-sand molds, if the sand is too wet, it is liable to 'cut' (be eroded by the stream of metal) and get dirt into the casting, and also to be impervious to the gases. (2) The sand requires less care in ramming, because, whether too hard or too soft, the expansion and contraction in drying will adjust its firmness and porosity. (3) Furthermore, the dry sand is stronger, which is an advantage, especially in large castings or when the sand is liable to be under

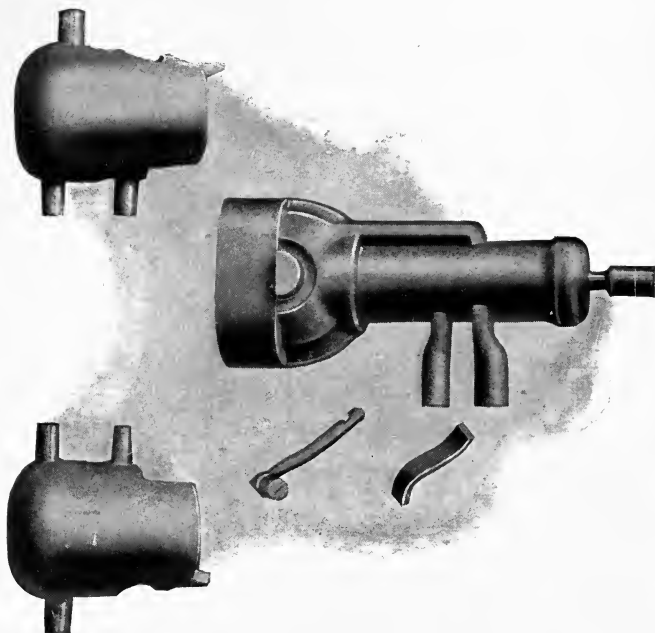

FIG. 196. — CORES FOR FORMING THE INSIDE OF A GAS-ENGINE CYLINDER CASTING.

pressure from the metal, or to have the metal fall upon it from a height. (4) Dry-sand castings are also more liable to be sound, because there is less gas in the pores of the sand.

The disadvantages of dry-sand castings are: (1) The mold is liable to shrink during drying and therefore be less true to the pattern; (2) the castings are more liable to 'check' (that is, crack in cooling), because the mold is firmer and so does not give way so easily to the crushing action when the casting contracts; (3) molds exposed to the direct action of the flame during drying, or heated

too hot, are liable to be burnt and therefore rendered useless, causing a loss; (4) in handling, the molds are liable to be damaged; and, furthermore, it is more costly to repair a dry mold than a damp one, because the adjacent sand must first be damped, the

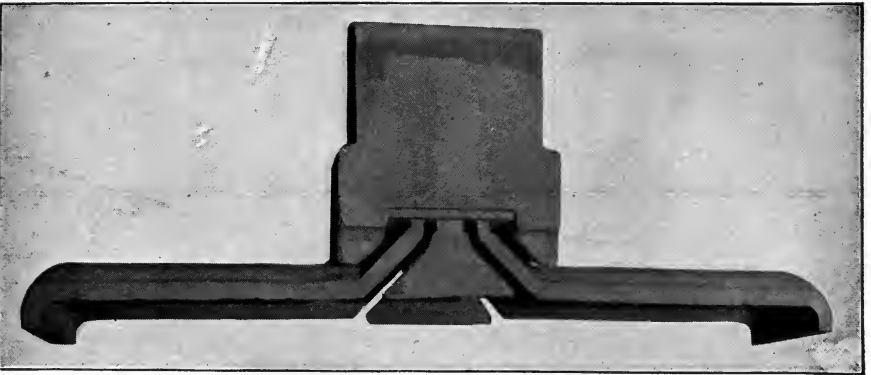

FIG. 197. — CORE.

damage repaired, and then a flame applied to dry the wound; (5) it takes longer to complete an order. The actual cost of heat is not very great, and usually is less of an item than the extra labor of handling for drying.

For Steel Castings. — Dry-sand steel castings have a surface much superior to those made in green sand.¹ They are also stronger and more liable to be sound. Soundness is much more



FIG. 198.

difficult to obtain in steel castings than in iron castings. Green-sand molds, however, have the great advantage of allowing their

¹The reason that dry-sand steel castings have a better surface is because they can be washed. In practice, however, the drying and washing is often improperly performed; therefore green-sand castings often have the better surface.

sand to crush more easily when between two parts of the casting that are being drawn together by the shrinking of the metal. This is doubly advantageous in steel work, because steel shrinks twice as much as cast iron and is therefore more liable to checking.

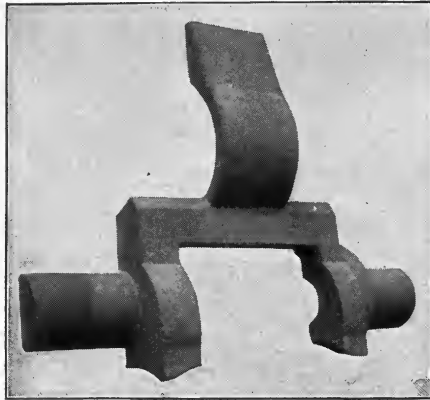

FIG. 199.

Special means may be employed for making the sand easily collapsible after the metal is poured, such as mixing with it an inflammable substance like flour, chopped hay, hay-rope, sawdust, etc., which burns away after the hot metal is poured in.

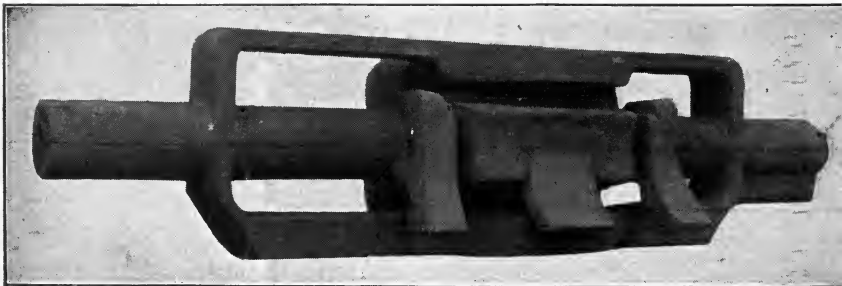

FIG. 200.

Cores. — The function of cores has already been referred to: they are set inside the mold proper to assist in forming the metal. The commonest use for them is to extend through a casting in some place to make a hole, as, for instance, the inside of a cylinder, the

bore of a pulley, etc. In this position they are subjected to great crushing strain when the metal shrinks, and therefore the bond which keeps the sand together, consisting of linseed-oil, or flour paste, a patented core compound, etc., must be of such a nature that when subjected to the heat of the liquid metal it will burn away and allow the sand to disintegrate, which both prevents it bursting the shrinking casting and permits of its being more easily cleaned out. Cores are often built up around an iron pipe



FIG. 201. — OVEN FOR DRYING SMALL CORES.

riddled with holes, so that the gases formed may readily escape through this 'vent.' In the case of large cores, the pipe is frequently wound with hay-rope, or some similar material that will burn away and make the sand more collapsible. Some cores have coke breeze or cinder in the center to make them light as well as porous.

Cores are supported sometimes by being set in the drag, sometimes by being hung in the cope (see Fig. 202); but it is more com-

mon to have a hollow adjunct to the mold, known as a 'core-print,' into which an extension of the core fits (see Fig. 190). Some-

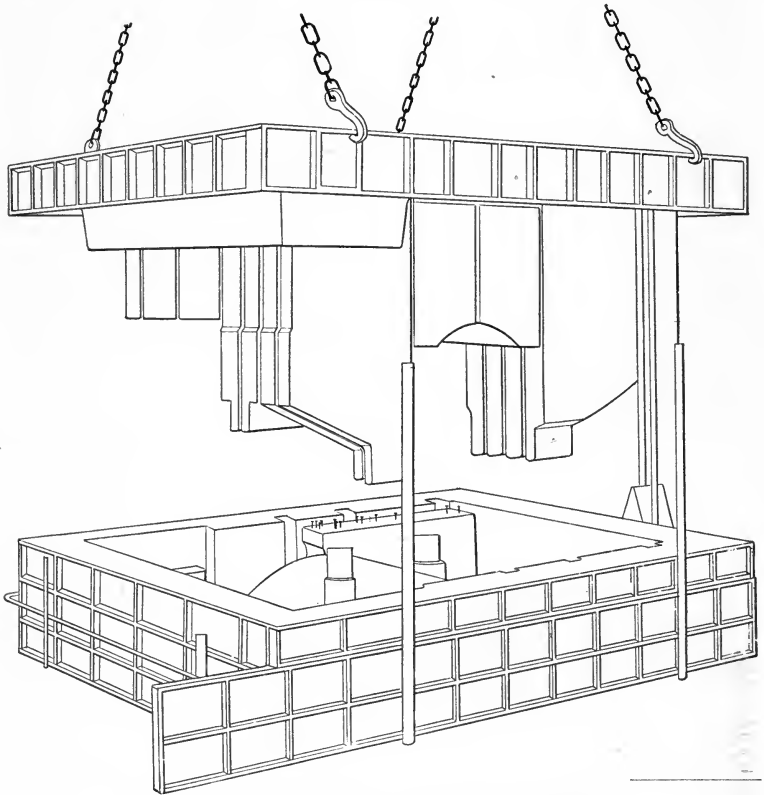

FIG. 202. — CORES HUNG FROM THE COPE.

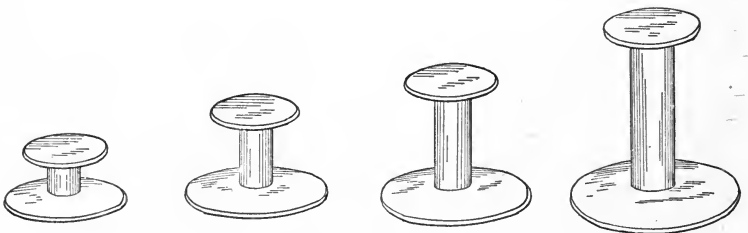

FIG. 203. — CHAPLETS.

times both ends of the core are so supported, and sometimes only one end is thus supported, while the other end rests upon a metal

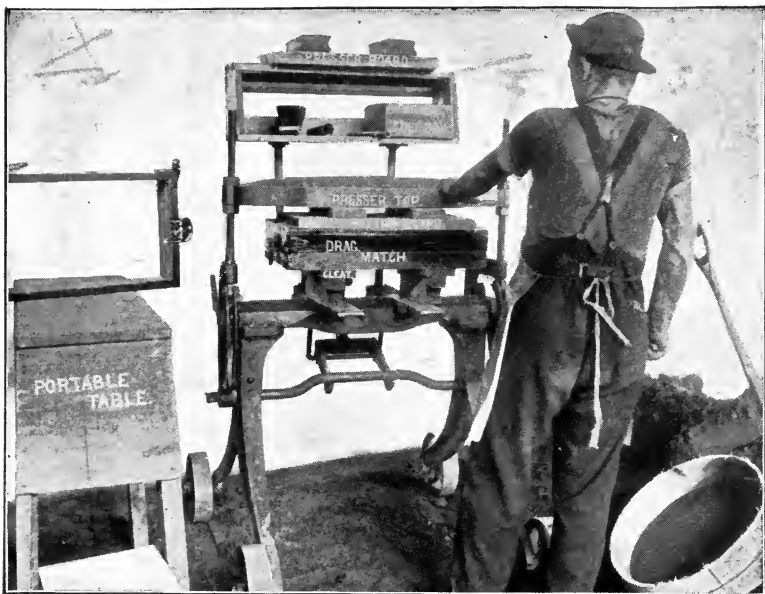

FIG. 204. — POSITION OF MACHINE WHEN PRESSING THE DRAG.



FIG. 205. — POSITION OF MACHINE WHEN PRESSING THE COPE.



FIG. 206. — CUTTING SPRUE WITH TUBULAR SPRUE CUTTER.



FIG. 207. — RAPPING THE PATTERN BEFORE SEPARATING THE MOLD.

chaplet that is absorbed in the casting when the metal is poured. Cores are often dried, lest their gases make the casting unsound or cause it to blow, that is, boil with the rapid escape of gas through the metal.

Chill Molds. — It is often desired to chill certain parts of a mold, or cool them more rapidly than the remainder, in order either to make a thick part of a casting solidify as soon, or sooner, than the thinner portions, or else to produce white cast iron at that point. The former may be desirable in the case of either an iron

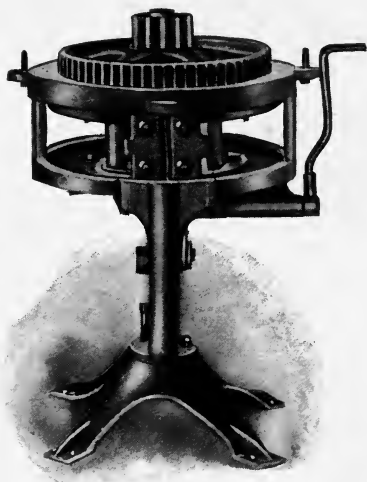

FIG. 208. — STRIPPING PLATE MOLDING MACHINE.



FIG. 209. — STRIPPING PLATE MOLDING MACHINE.

or steel casting, because the shrinkage cavity occurs in the last portion to freeze, and therefore hastening local freezing may be necessary to bring the pipe into the riser or feeder. The latter applies only in iron-casting work in which it is desired to make the outside of a casting very hard. The chilling is usually accomplished by embedding pieces of metal in the sand, against the face of which the casting is poured. This metal is oiled, blackened or 'washed,' so that it does not stick to the casting.

Permanent Molds. — A great deal of expense in foundry work is due to the fact that a sand mold must be made anew for every casting, and the subject of permanent molds has occupied the attention of foundrymen for a great many years without the prob-

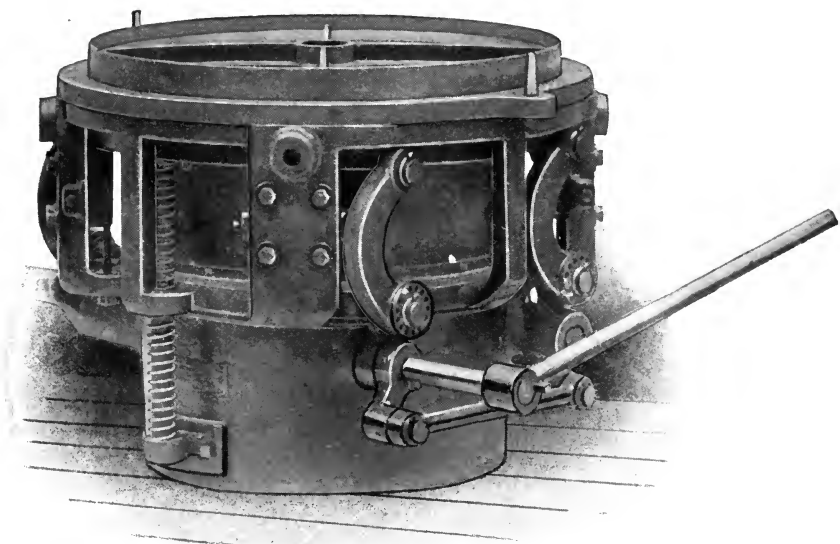

FIG. 210.

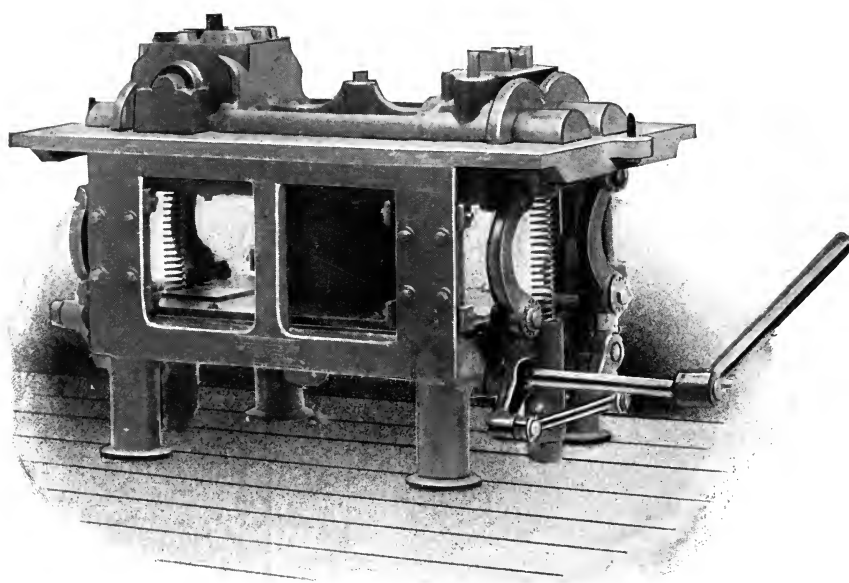

FIG. 211.

lem being solved. When a casting is knocked out of the mold, the sand is usually knocked out also and its form destroyed. In the rare case of a smooth cylinder, or something of that kind, the casting may be withdrawn without damage except to the face of the sand, and this can sometimes be repaired and swept up anew without reforming the entire mold. Again, molds for railroad car wheels, which have a metal 'chill' all the way round the tread and flange, in order that the cast iron may be white at that point to withstand the grinding action on the rails, have a certain amount

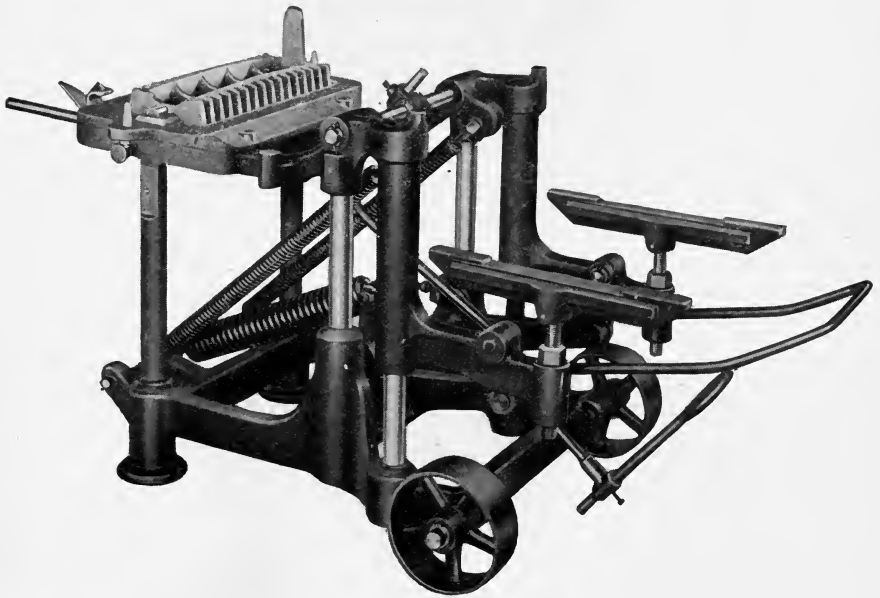
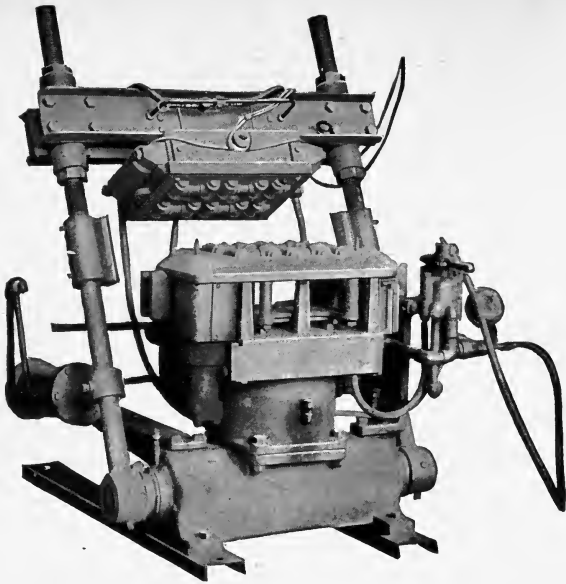

FIG. 212. — ROCK-OVER MOLDING MACHINE.

of permanency. Finally, molds carved out of carbon which has been preheated to a very high temperature are said to withstand the action of the melted metal and to last for a large number of castings.

Gated Patterns. — Where the castings are very small, a large number of them will be made into one pattern, fastened onto a common 'gate' through which they are poured, which produces very great economy in molding.

Molding Machines. — At the present time various types of



Upper head swung back to receive flask. Drag patterns on upper head.
Cope patterns on lower head. Yoke swung by power.

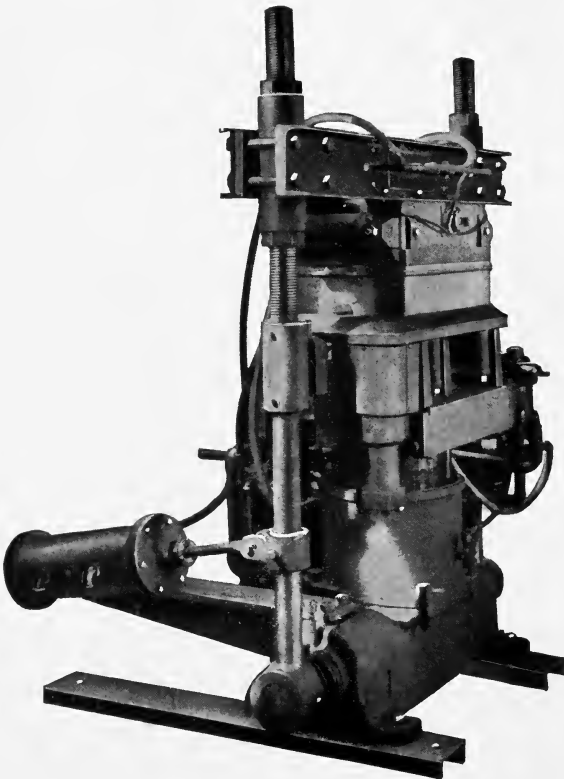

Sand frame on flask.

FIGS. 213 AND 214. — VIBRATOR MOLDING MACHINE.

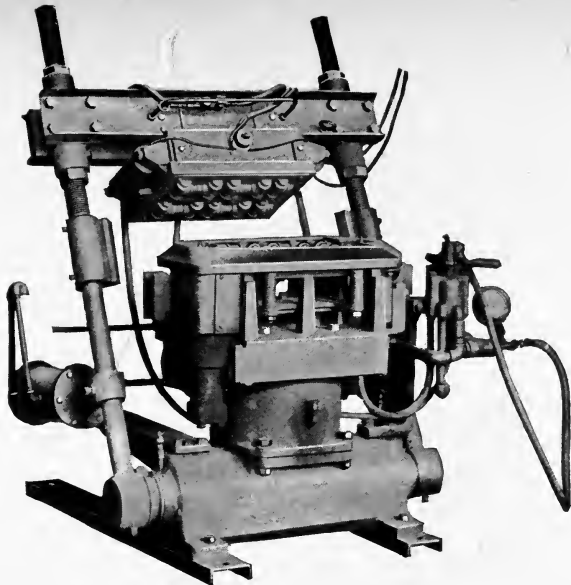

Mold removed, flask frame raised, showing method of drawing cope patterns.

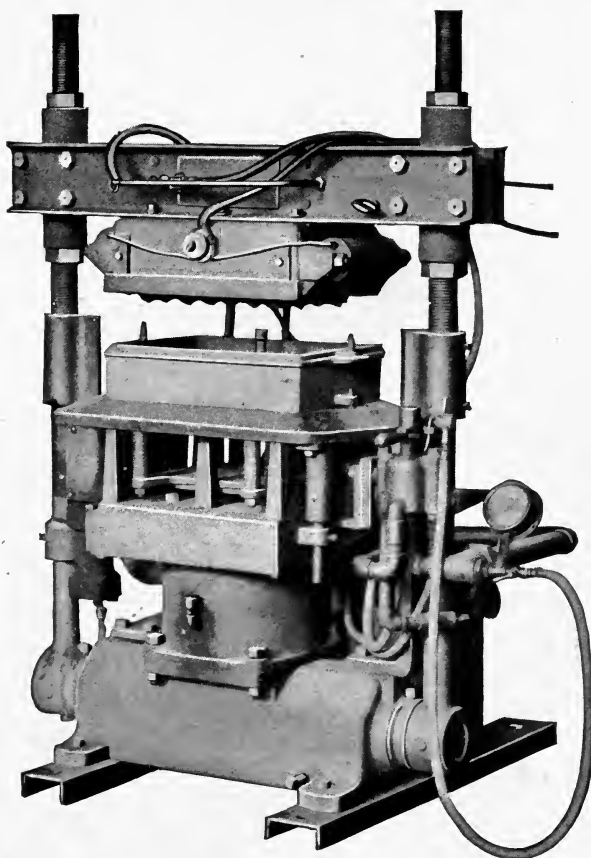

Mold lowered away, drawing drag patterns. Drag patterns may be returned with absolute accuracy.

FIGS. 215 AND 216. — VIBRATOR MOLDING MACHINE.

molding machines are being extensively introduced into foundries, in order to save some of the labor or skill required in molding, or both. The simplest form of machine is the 'squeezer,' which may be described by reference to Fig. 204. The correct amount of sand is poured into the flask and by means of a long lever the 'presser board' is forced down on top of this sand, squeezing it around the pattern and producing a half mold. In taking the flask off the pattern by hand, damage may be done the sand, and the molder's skill is still required to repair it.



FIG. 217. — VIBRATOR.

The stripping-plate machine obviates part of this difficulty, however. In this type the half pattern may be pushed up or down through a close-fitting hole in a plate known as the 'stripping-plate' (see Fig. 211). After the sand has been rammed around the pattern, a lever draws the pattern down through the stripping-plate. As this drawing is mathematically exact, no damage results to the sand and no repairs to the mold are necessary, so that unskilled laborers may be employed for the work.

A still further extension in the line of machines is the 'vibra-

tor,' whereby the pattern is vibrated an extremely small amount, some 5000 to 30,000 times per minute, during the drawing of the pattern. No stripping-plate is necessary to separate it from the sand, since the vibrator frees it perfectly and without damage.

In all these molding machines the operation may be conducted either by means of levers, or by a mechanism operated by hydraulic or pneumatic power, and several hundred patterns may be made per day by one man who is very little, if any, more skilled than a common laborer; and machines are made in which castings

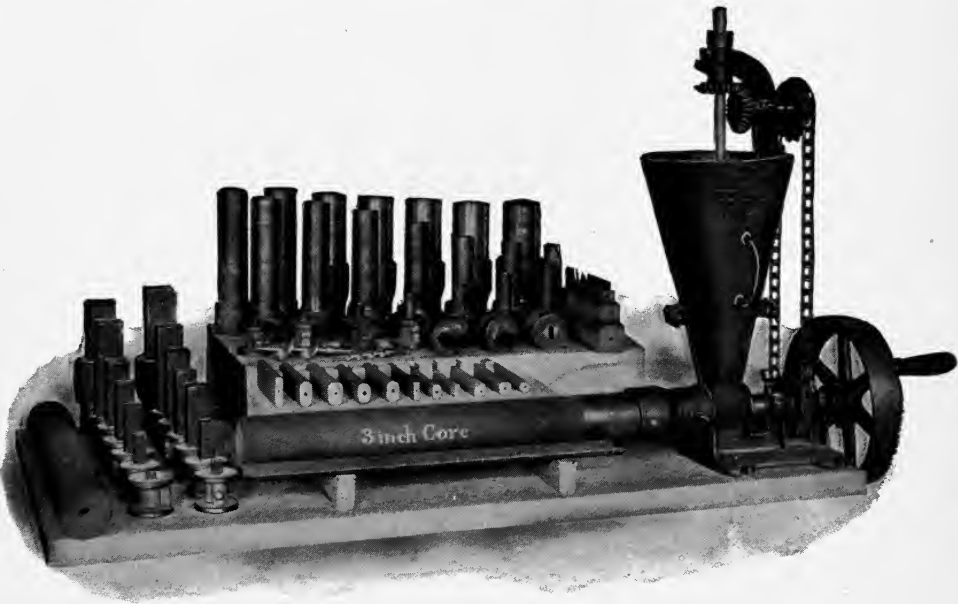

FIG. 218. — CORE MACHINE AND CORES.

weighing from a couple of ounces to several hundred pounds may be molded with great economy.

Core Machines. — There are also on the market several machines for making cores, an example of which is shown in Fig. 218.

Multiple Molds. — During the past year or two a new type of molding, known as 'multiple molding,' has come into use, in which several flasks are placed in a pile and poured through a common gate of sprue, as shown in Fig. 219. This type of molding saves mold costs, flasks, sand, floor space, and the weight of metal wasted in sprues, and many difficulties have been overcome, so

that the castings are now made accurately to size and good in all respects.

Shrinkage. — A bar of cast iron 12 in. long will contract about 0.125 in. during solidification and cooling (i.e., it will be about $11\frac{3}{4}$ in. long when cold. See page 346 for further details), while a bar

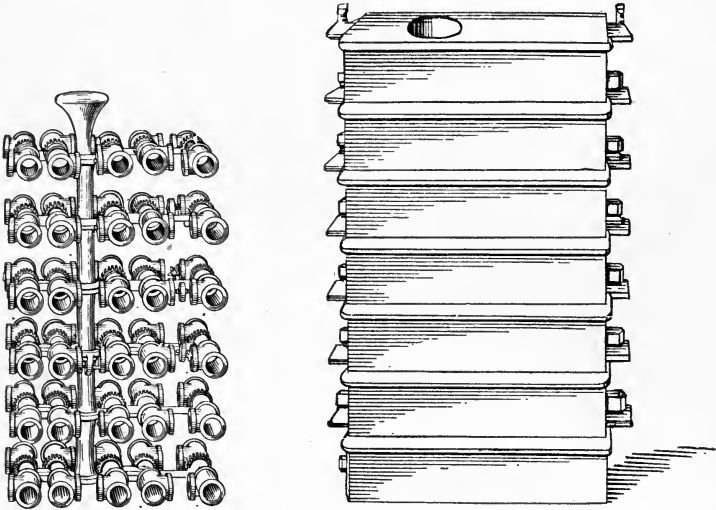

FIGS. 219 AND 220. — MULTIPLE MOLD AND CASTING.

of steel will contract about twice as much. In both cases the contraction in sectional dimensions will not be as great as in length.

DESIGN OF PATTERNS

The foregoing description will show what a great financial advantage it is to a purchaser if he designs castings that can be easily molded, and if he can order a large number of castings of exactly the same design. It is certain that a hundred castings of one design can be made with very much greater cheapness than the same number all of different designs, and of this economy the purchaser obtains his full share, because the foundry is glad to encourage such a customer and to make concessions in order to do his work. I cannot recommend too strongly to engineers the practice of making the castings in all similar machines interchangeable, both for the sake of economy and of avoiding some

delay and expense in replacement after a breakdown. The correct design of castings is furthermore one of the most important branches of engineering work, since the number of castings used is almost one-half of the total number of pieces used in engineering work, while their weight is equal to about one-sixth of the weight of all the iron and steel employed. The following general hints are therefore offered to assist in this design; but each casting is a study in itself, in order that the various desiderata referred to may be obtained.

To Avoid Checks. — The commonest error in engineering designs of castings is to make the corners too sharp, which makes them very liable to check, because of the crystalline character of iron and steel. This is the more important, because the greatest leverage comes at the corners, which therefore should be made as strong as possible. Metals are crystalline substances and the crystals grow during solidification. As solidification usually extends from the surface inward, the crystals grow in a direction perpendicular to the cooling surfaces. As shown in Fig. 221, this results in a line extending inward from all corners, marking the junction of many crystals. As the junction lines of crystals are not as strong as the crystals themselves, this makes a line of weakness on corners, which is the more marked the sharper the corner is. In case a casting is to be machined, it is much better to put a large fillet in all the corners, even if the rounded metal must be cut away later, as greater strength is obtained in this way.



FIG. 221.

The checking of castings comes from the strain produced by the shrinkage of the metal tending to crush the sand. This is the more intense the greater the distance is between the two crushing parts, because they must approach each other by an amount exactly proportional to the length of metal between them. It is therefore wise, wherever possible, to avoid long lengths of metal connecting two parts which project into the sand.

Unequal cooling strains will also cause a check. This may be illustrated by a pulley with thick arms and a thin face. The face will solidify first and therefore yield very little to the subsequent

shrinkage of the arms. Moreover, the face, being cooler, will be stronger and the tendency will be for the arms to tear themselves in two. To avoid this it is common practice to chill the arms either by setting metallic pieces in the mold, or by means of a 'water gate.' A water gate is a loose column of coke molded into the sand of the cope down which water may be poured.

To Avoid Shrinkage Cavities. — The formation of a 'pipe' or shrinkage cavity has already been explained. Such a defect in a casting would be intolerable, and is commonly avoided by having a reservoir of metal situated above the casting proper and large enough to keep it supplied with molten metal until it has completely solidified. This reservoir is known as the 'riser,' or 'header' (sometimes merely 'head'), or 'feeder.' The riser is included as a part of the mold when it is made, but is cut off the finished casting and used over again as scrap. Sometimes castings are so designed by engineers that a heavy section of metal must be molded underneath a thinner section. As the thinner section will solidify first, it cannot 'feed' this lower, heavy section; and therefore a special form of riser is required, or else the heavier section must be artificially cooled.

CUPOLA MELTING OF IRON FOR CASTINGS

Iron for castings is melted either in the cupola or the air furnace, although 'direct castings,' i.e., castings made from the metal just as it comes out of the blast furnace, are used in many cases, and especially for cast-iron ingot molds at steel-works. There are men with sufficient expertness to be able to judge by eye the character and the analysis of the liquid iron as it flows from the furnace, and this is necessary where direct castings are to be made, because the metal may vary greatly and without warning from one cast to another. In this work, however, metal mixers are sometimes used, similar to those at steel-works.

The Cupola Furnace. — The design and principle of operation of the cupola furnace bears some similarity to that of the blast furnace, the chief difference being that the coke of the cupola furnace is desired only for its melting influence, and that the only chemical reactions are minor ones and unintentional. The cupola affords the cheapest method of melting metals, because there is direct contact between the metal and fuel and therefore the maxi-

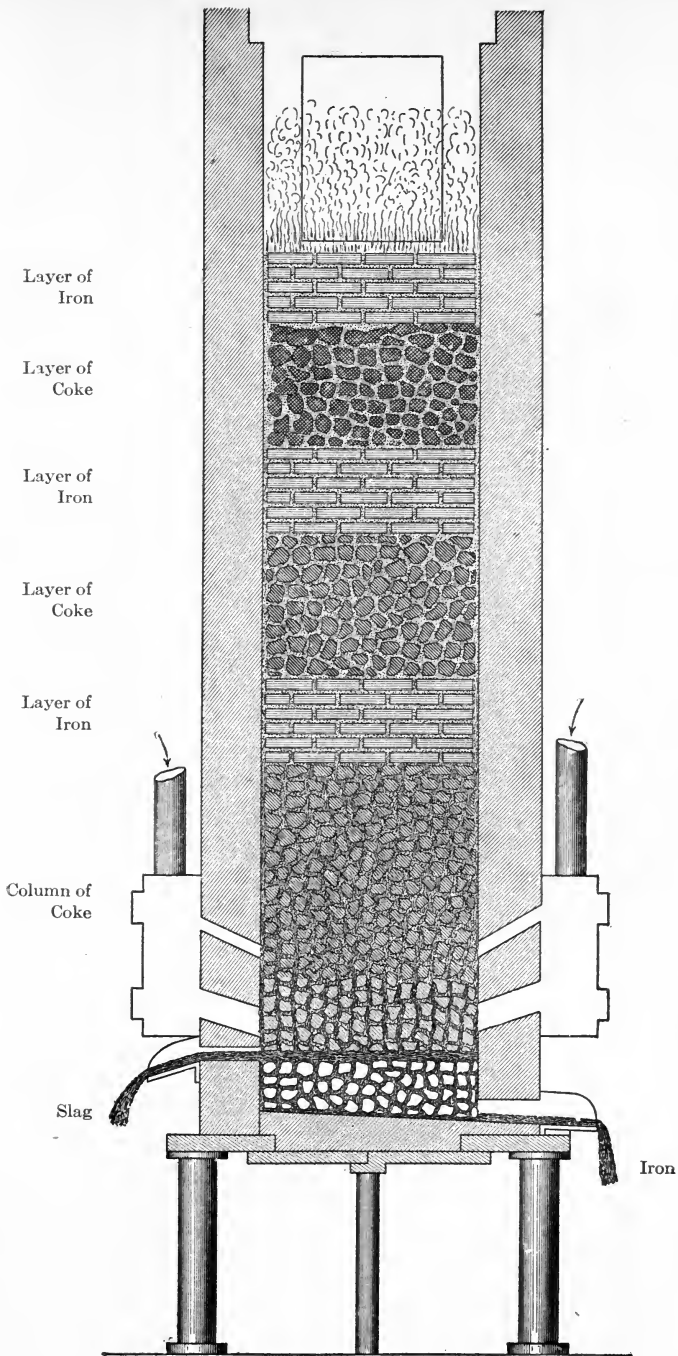

FIG. 222. — IRON CUPOLA.

mum absorption of heat. The most usual amounts of fuel burned will be from one-fourth to one-twelfth of the weight of the iron melted, the former figure prevailing where exceedingly hot metal is desired — as, for example, for very small castings for malleable cast-iron work — and the latter figure where the melting is continued for several hours and the metal is not made very hot, but is to be poured into large castings.

Cupola Zones. — The cupola should be so operated that certain well-defined zones of action are maintained, in order that rapid, hot and economical melting may be obtained and that loss by oxidation may be small. If proper conditions prevail all of these desiderata may be obtained together, while, if otherwise, wasteful methods may be accompanied by slow, irregular melting and 'dull iron,' i.e., iron not sufficiently hot. The management of the cupola is too often neglected and left in the hands of men who understand nothing of its proper operation, and whose only skill consists in knowing how to perform certain manual operations. If the iron is coming too cold (which may actually be due to too much coke having been used in the charges), their stock remedy is to put in more coke. The result is slow melting and probably still colder iron. At once an earnest complaint goes to the office of the bad quality of the coke. To get faster melting, however, the blast pressure is increased; now the iron comes faster and hotter, and the office is informed that "we have worked off that bad lot of coke." If the manager becomes doubtful and orders less coke used, every wrong thing that happens in the foundry thereafter is blamed to that order, until the manager decides that coke is cheaper than dissatisfaction and tells the cupola man to follow his own discretion.

All this is wrong. The cupola deserves the oversight of a man who is capable of understanding its operation and who will give real thought to it, and not be satisfied with blind rules of thumb.

The zones of action which, I have said, are so important in this connection are, beginning at the bottom of the cupola and going upward: (1) The crucible zone, or hearth; (2) the tuyere zone; (3) the melting zone; and (4) the stack. The cupola is filled with alternate layers of coke and iron, as shown in Fig. 222,¹ and the different zones are produced by the action of the blast and the

¹ Except, of course, during the intervals of starting up and blowing out.

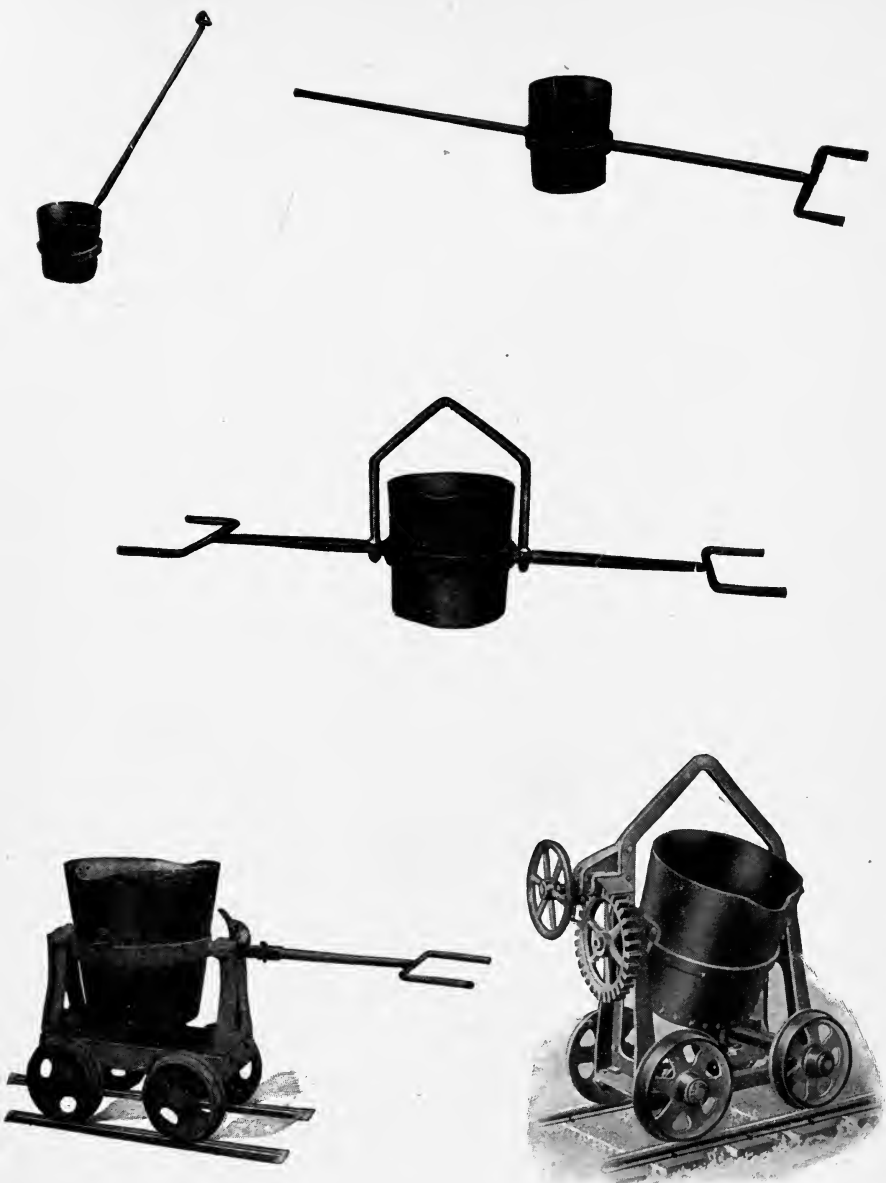

FIGS. 223 TO 227. — FOUNDRY LADLES.

heat upon these different layers. The thickness of these layers should be the same in large as in small cupolas.

Crucible Zone. — The crucible extends from the bottom of the cupola to the level of the tuyeres. The sole object of this part is to form a place in which the iron and slag may collect after they have melted and trickled down to the bottom. If the tap-hole is kept open all the time and the metal allowed to flow out of the cupola and collect in an outside ladle as fast as it melts, the crucible zone will be very shallow, and the tuyeres will be situated not more than two to five inches above the bottom. If, on the other hand, the crucible is used as a reservoir for a large amount of metal, the tuyeres are placed correspondingly high. Hotter metal may be obtained by collecting the iron in an outside ladle.

Tuyere Zone. — The tuyere zone is the place in which the blast comes in contact with, and burns, the red-hot coke. It is the zone of combustion, and all the heat of the operation should be produced in this place. It is of course situated near the tuyeres and wherever the blast may come in contact with coke. As there is always a column of coke extending from the melting zone to the very bottom of the cupola, combustion will begin immediately above the reservoir of melted metal. The upper limit of the combustion zone will depend upon the pressure of blast, because the greater the blast pressure, everything else being the same, the higher will it extend its zone of combustion. The blast pressure should be such, however, that the top of the tuyere zone, or zone of combustion, should never be more than 15 to 24 in. above the uppermost tuyeres.¹

Melting Zone. — The melting zone is the space in which all the melting of iron takes place; it is situated immediately above the tuyere zone. During the melting the iron is supported on a column of coke which extends to the bottom of the cupola, and which is the only solid material below the melting zone. When each layer or charge of iron enters the melting zone it should be about 15 to 24 in. above the uppermost tuyeres. As fast as it melts it trickles down over the column of coke to the bottom. It takes about five to ten minutes for each layer of iron to melt, however, and during this time the column of coke is burning and sinking. Therefore, the last of the iron will melt at a point about

¹ There are sometimes two rows of tuyeres in cupolas; see page 268.

7 in. lower than the first. Consequently, the melting zone overlaps the upper limit of the zone of combustion. If the layers of iron and coke are properly proportioned to the pressure of blast,

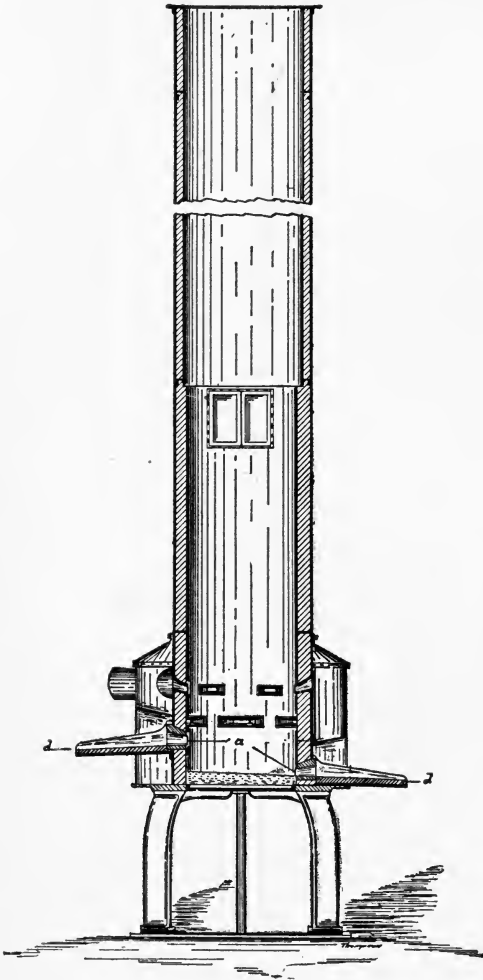

FIG. 228.

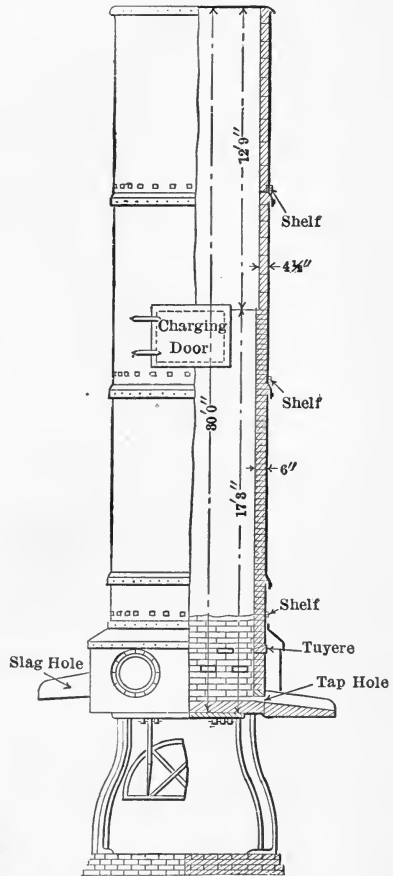

FIG. 229.

each charge of iron will enter the top of the melting zone just before the next previous charge is completely melted at the bottom, and thus a continuous stream of iron will collect in the crucible or run from the tap-hole. Also, the coke burned from the column

will be exactly replenished each time by the layer of coke coming down, and the position of the melting zone, which is the important consideration, will be maintained within constant limits.

The actual position of the melting zone may always be learned when the cupola is emptied, because the iron oxide formed there will corrode the acid lining, which will therefore be cut away somewhat at this point. Corrections may then be made, if necessary, in the next charge of the cupola.

Stack. — The stack extends above the melting zone to the level of the charging door. The function of this part of the furnace is

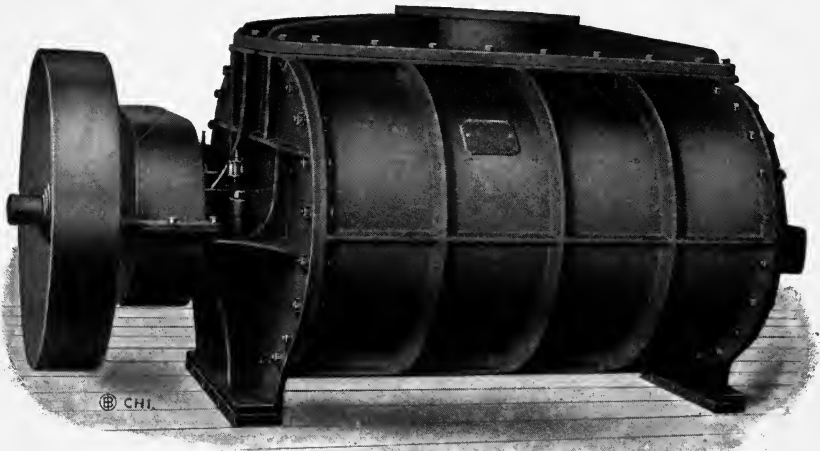

FIG. 230. — POSITIVE PRESSURE IMPELLOR BLOWER.

to contain material that will absorb heat and thus prepare itself for the actions at lower levels, and that will also keep the heat down in the melting zone as well as possible.

Tuyeres. — The blast enters the cupola through the tuyeres, of which there is usually one or two rows. The position of the upper row of tuyeres determines the position of the melting zone in the cupola. Two rows of tuyeres give faster melting in the cupola than one row, but cause greater oxidation and the consumption of more fuel on the bed, because of the melting zone being higher in the cupola.

Blast. — The blast pressure will depend somewhat upon the size of the cupola, but the present prevailing opinion is in favor

of pressures not exceeding a pound, even for the very largest cupolas, and diminishing to half a pound or so for the smaller sizes. Fan-blowers are not approved of, because if they are opposed by pressure in the cupola stack, they revolve without blowing any wind. The common type of blower used in America is of the two-impellor type, an example of which is shown in Fig. 231. It takes about 60 cu. ft. of air to burn a pound of coke, from which may be calculated the size of blower necessary for each

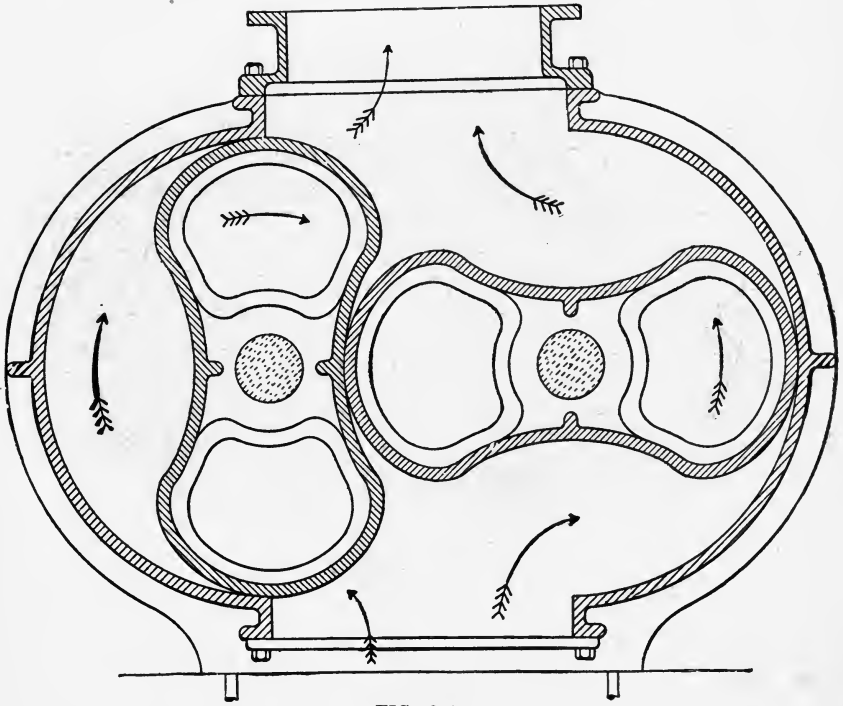

FIG. 231.

cupola, allowing about 50 to 100 per cent. excess for leaks and incomplete combustion.

Makers of cupolas and blowers give all the necessary data in their catalogues, but advocate too high blast pressures and volumes, for obvious reasons. If the blast volume is too large, or the pressure is too great, the position of the melting zone will be too high. This means that the bed of coke must be larger to reach to the upper level of the melting zone, which is wasteful. It also

means that the melted iron will have a greater height to drop through. It therefore oxidizes more, corrodes the cupola lining more, and consequently causes more waste of iron and more slag. The volume of blast is the most important consideration, but this is difficult to measure, so the pressure is the thing that is calculated upon. It must be remembered, however, that this is only a makeshift arrangement at the best.

Cupola Charge. — In the cupola is first placed shavings and wood, on top of which is placed the bed of coke, which should be large enough to reach 15 to 24 in. above the uppermost tuyeres after the kindling is burned off. On top of this is placed a layer of pig iron about 6 in. thick, then another layer of coke about 7 in. thick, another layer of iron, and so on. The actual weight of the coke for the bed and of coke and iron for each charge will therefore depend directly upon the diameter of the cupola inside the brick lining, which varies from about 32 to 120 in., or even more in some cases. The weight of the coke in each layer will be about one-sixth to one-twelfth of the weight of iron in each layer. The tuyeres and front of the cupola around the tap-hole, known as the 'breast,' are left open for an hour or so after the kindling is lighted, in order that the draft may draw air in at that point for combustion. When the kindling is thus burned off and the bottom coke well lighted; the breast is closed and the wind turned on. It is very necessary that the bed should be well lighted and level.

Cupola Melting. — The heat now generated by the combustion of coke begins to melt the iron, and in less than 15 minutes after the wind is put on the metal should begin to run from the open tap-hole. If it takes longer, then the coke bed was too high and wasteful. In another 8 to 10 minutes the first layer of iron should be all melted. Now the second layer of iron lies upon the column of coke, whose top should again be 15 to 24 in. above the uppermost tuyeres. If the layers of coke are too thick there will be a delay in the iron entering the melting zone and the extra coke burned will not have been used to the best account. If the layers of iron are too thick, the last of the layer will melt too near the tuyeres, which will oxidize it excessively and make it cold. This can be observed during the run by noting if the iron runs first hot and then cold. It is very important to watch the flame that comes off the top of the stack in the cupola. When the blast volume is

too large this flame will be 'cutting,' — i.e., oxidizing in character. Too great oxidation may also be observed if sparks of burning iron are projected from the slag-hole. If the layers of iron and coke are both too thick, there may be a correct relation between the weights of the two, but both of the irregularities mentioned above will be observed. If the layers of iron and coke are both too thin, we will have two charges of iron in the melting zone at the same time, and this may be learned by watching the iron from the tap-hole, because it will run at some times faster than at other times. This does not produce such bad results, however, as having the layers too thick. Of course, if very hot iron is required it will be necessary to have thicker layers of coke, and slower melting must be expected.

Chemical Changes. — As the iron drops down over the coke, it absorbs sulphur, the exact proportion depending chiefly upon the relative amount of coke and iron used and the per cent. of sulphur in the coke. It will vary from 0.02 to 0.035 per cent. of the iron; that is to say, if the pig iron charged contained 0.08 per cent. sulphur, there will be from 0.1 to 0.115 per cent. in the castings. The sulphur in the first iron will be higher than in that of the middle of the run, because of the extra amount of coke burned before the iron begins to come from the tap-hole. The last iron will also be somewhat higher in sulphur, because there is a larger loss of metal during the last of the run, when the oxidizing conditions are more intense, and therefore a concentration of sulphur. The best practice is to cut the blast off progressively as there is less stock in the cupola.

In many foundries it is customary to charge limestone, in the form of oyster shells, marble chippings, or crude limestone, and sometimes with it a little fluorspar (CaF_2), into the cupola. The amount of limestone varies greatly, but will average perhaps $\frac{1}{2}$ to $1\frac{1}{2}$ per cent. of the weight of the metal. This limestone fluxes the dirt on the metal and the ash of the coke and carries off some sulphur in the slag. Fluorspar makes a somewhat more liquid slag than limestone alone and the more liquid slag is believed to absorb a little more sulphur, and also to make the cupola 'drop' more easily, i.e., dump its contents when the campaign is ended, and the bottom is allowed to fall. It also cuts the lining more.

As the metal melts and falls from the melting zone down in front of the tuyeres, it suffers oxidation, which carries iron oxide

into the slag and also burns up silicon. The melted metal therefore contains from 0.25 to 0.4 per cent. less silicon than the original pig.¹ In other words, if the mixture charged contains 2.25 per cent. of silicon, the castings will contain 1.85 to 2 per cent. silicon.

Cupola Gases. — The gases coming out of the top of the cupola charge consist principally of nitrogen from the air, while the remainder is carbon dioxide— CO_2 —and carbon monoxide— CO —with sometimes a little free oxygen. The latter is evidence of a ‘cutting flame’ and shows too great oxidation in the melting zone. Such a flame may be recognized without the aid of chemical analysis after a little practice by means of the eye. It is ‘sharper’ looking than a richer flame and burns close to the top of the stock. One can identify it exactly by holding an iron rod in it for a while; after the iron becomes red hot it will oxidize much more rapidly in a cutting flame than in a reducing flame. A reducing flame will usually not burn until it becomes mixed with the air sucked in at the charging door. All the carbon monoxide that goes out of the charge represents incomplete combustion and a waste of heat. It seems to be impossible to prevent this here, however, just as in the blast furnace, whose operations cupola melting resembles in some general respects. Several analyses of cupola gases are given in Table XVIII.

¹ With good practice it should be no more than 0.30 per cent. less.

TABLE XVIII.—ANALYSIS OF CUPOLA GASES
COLLECTED ABOUT 3 OR 4 FEET BELOW THE CHARGING DOOR

Time Elapsed Since Blast was Put on	ANALYSIS BY VOLUME				
	Oxygen O	Carbon Dioxide CO ₂	Carbonic Oxide CO	Nitrogen (by Difference) N	Ratio CO ₂ is to CO as 1 is to:
10 minutes	0.0	13.8	9.9	76.3	0.717
1 hour 13 "	0.0	9.5	16.9	73.6	1.780
2 hours 17 "	0.4	9.2	16.6	73.8	1.804
3 " 13 "	0.0	6.7	21.7	71.6	3.239
4 " 15 "	0.1	7.8	22.3	69.8	2.859
38 "	1.8	7.6	15.5	75.1	2.04
1 hour 42 "	2.8	7.5	13.3	76.4	1.77
2 hours 50 "	1.9	7.1	15.8	75.2	2.225
3 " 40 "	0.1	7.2	19.0	73.7	2.64
38 "	0.0	10.2	14.6	75.2	1.431
3 " "	2.9	5.4	14.3	77.4	2.65
10 "	0.2	13.1	7.7	79.0	0.588
3 " 10 "	0.3	10.3	11.7	77.7	1.136
50 "	0.0	7.1	15.4	77.5	2.17
1 hour 40 "	0.0	8.3	13.5	78.2	1.626
2 hours 40 "	0.0	8.2	12.1	79.7	1.475
3 " 40 "	0.0	6.0	15.0	79.0	2.50
45 "	0.0	13.0	12.6	74.4	0.97
1 hour 40 "	0.0	13.0	11.2	75.8	0.862
2 hours 40 "	0.0	8.2	20.0	71.8	2.44
3 " 50 "	0.4	6.0	22.1	71.5	3.683
4 " 43 "	1.2	5.1	21.2	72.5	4.157
1 hour	0.0	9.8	15.4	74.8	1.571
1 " 53 "	0.0	9.1	16.8	74.1	1.846
2 hours 45 "	0.0	8.8	16.8	74.4	1.91
3 " 45 "	0.0	7.5	19.7	72.8	2.627
4 " 45 "	0.0	7.5	18.7	73.8	2.500
ANOTHER CUPOLA					
30 "	0.1	16.7	7.3	75.9	.437
1 hour 30 "	0.1	13.1	10.7	76.1	.817
2 hours 38 "	0.4	11.8	11.0	76.8	.932
3 " 20 "	0.0	12.8	7.7	79.5	.602

Burdening the Cupola. — It should be the duty of the foundry metallurgist or chemist to learn from his records, or other approximations, the amount and analysis of all the metal in the

yard. The following table will, for example, show a convenient form of this record.

TABLE XIX

KIND	Weight Tons	Si	S	P	Mn	Price
High Sulphur, Southern	500	0.70	0.100	1.50	0.30	\$18.00
High Silicon, Bessemer.	60	2.50	0.025	0.07	0.60	25.00
X No. 1.....	100	3.00	0.030	0.80	1.25	24.00
No. 3 Foundry.....	150	1.75	0.070	0.30	0.60	22.50
Ferrosilicon A.....	30	10.00	0.040	0.50	0.10	35.00
Ferrosilicon B.....	30	50.00	0.003	0.04	105.00
Machinery Scrap.....	100	1.70?	0.100?	1.00?	0.60?	19.00
Miscellaneous Scrap....	300	1.50?	0.20?	1.40?	0.60?	15.00
Cast-iron Borings.....	100	1.50?	0.20?	1.40?	0.60?	11.00
Steel Scrap.....	100	0.10	0.07	0.10	0.60	13.00

The price should always be in evidence. It should not be the price at which the material was purchased but the market price at the time the iron is to be used. For instance, if a large amount of high grade pig iron had been contracted for a year previously and if meanwhile the price of pig iron had been rising, the purchase price of that pig iron would not represent its present value. From the current numbers of such trade periodicals as the *Iron Age* and the *Iron Trade Review*, one can always obtain the prevailing prices for the different grades of iron.

Suppose now with these irons it is desired to burden a 72-in. cupola with a mixture for making heavy hydraulic pumps for which a satisfactory analysis might be 1.60 per cent. silicon, 0.70 per cent. phosphorus, less than 0.10 per cent. sulphur and about 0.50 per cent. manganese. The first step is to calculate the cupola charges, and the chemist knows by experience with this particular cupola that it will lose 0.25 per cent. silicon and 0.10 per cent. manganese and it will gain 0.03 per cent. sulphur. The average analysis of the mixture put into the cupola must then be 1.85 per cent. silicon, 0.70 per cent. phosphorus, less than 0.07 per cent. sulphur and about 0.60 per cent. manganese. The chemist also knows by calculation that about 5200 lbs. of iron will give a layer of the proper thickness in a 72-in. cupola. His problem now is to make such a mixture of the available pig irons that their collective weight will be 5200 lbs. and their average analysis as given above. Moreover if he is a good metallurgist

he must aim at using as large an amount as possible of the cheapest materials.

He first considers the steel scrap, but knows he cannot use very much of this because too much coke would be required for getting iron of the requisite fluidity, but he estimates that 5 per cent. (say 200 lbs.) will not increase harmfully the fuel necessary. This figure therefore comes at the top of his list (see Table XX).

Next he considers the use of machinery scrap, because he knows that his miscellaneous scrap and borings are too uncertain in analysis to be used in a mixture which must give pretty strong and non-porous castings. One thousand pounds of machinery scrap would be about 20 per cent. of his mixture, and he knows from experience that this is a fairly satisfactory proportion for scrap, so that figure goes down second in Table XX. The low price of the High Sulphur Southern Pig tempts him, but he realizes that he must offset the use of this material by some high silicon low sulphur iron. And in casting about for such a one he naturally considers first the X No. 1. He cannot use much of this either because of its high manganese and it seems reasonable to mix an equal amount of these two; the only question is, How much of this mixture will the cupola stand? To get an idea of this, he first calculates their average analysis and finds it to be 1.85 per cent. silicon, 0.065 per cent. sulphur, 1.15 per cent. phosphorus, and 0.78 per cent. manganese. Evidently the phosphorus is the only element in this mixture that gives him difficulty. Indeed, if that were not high he could make almost his whole charge up of these two irons and the scrap. The phosphorus in this mixture is 0.45 per cent. higher than that of his desired mixture. Therefore he knows that he must use a good deal of No. 3 Foundry iron to bring this element down. The phosphorus in the No. 3 Foundry iron is about as much below the desired phosphorus as that in the mixture of the High Sulphur Southern and the X No. 1 is above it. He must not forget, however, that he has already used 1000 lbs. of machinery scrap containing probably 1 per cent. of phosphorus. Therefore he must use a correspondingly larger amount of No. 3 iron to offset this also. As a first estimate he therefore considers using 800 lbs. of High Sulphur Southern, 800 lbs. of X No. 1, and 2400 lbs. of No. 3 Foundry—that is, once and a half as much No. 3 as the mixture of the other two. But a little reflection tells him that this mixture

is going to be too low in silicon, because the mixture of High Sulphur Southern and X No. 1 only gave us 1.85 per cent. silicon, while the No. 3 foundry and the machinery scrap are both below that. There are then three ways open to him. He may use a little Ferrosilicon A or he may pound up a little Ferrosilicon B and dissolve it in the ladle of iron or he may use a little High Silicon Bessemer iron. Either of these methods would do, but the writer would prefer to use the High Silicon Bessemer because this will have the effect of cutting the sulphur and phosphorus down and the expense is practically the same. (It requires such a small amount of ferrosilicon to give the desired silicon in the mixture that the expense of using it is very small, in spite of its price.) Consequently we put down the weights shown in the second column of Table XX, and we now figure out the weight of silicon, sulphur, phosphorus, and manganese in the mixture by the methods indicated there, and the average percentage of each element. The latter figures show us that the silicon is too low, and a simple calculation shows us that we need 5 lbs. more in the total weight of silicon. We can get this by increasing the amount of either High Silicon Bessemer or of X No. 1, and correspondingly decreasing the No. 3 Foundry. The High Silicon Bessemer has 0.75 per cent. more silicon than the No. 3, so it would take $(5 \text{ lbs.} \div 0.75 \text{ per cent.})$ about 650 lbs. change to make up the difference in this way. The X No. 1 has 1.25 per cent. more silicon than the No. 3, so it would take $(5 \text{ lbs.} \div 1.25 =)$ 400 lbs. change to make up the difference in this way. We naturally would prefer to use the latter, being cheaper, and if we think we can stand all that extra manganese in our castings we probably will do so; if not, we will have to use altogether 1000 lbs. of High Silicon Bessemer and only 1400 lbs. of No. 3 Foundry. We then make up a new table similar to Table XX and figure out the average analysis as before. It should now come about right.

TABLE XX

KIND	Weight Lbs.	ANALYSIS				WEIGHT OF ¹			
		Silicon %	Sulphur %	Phos- phorus %	Man- gane- se %	Silicon	Sulphur	Phos- phorus	Man- gane- se
Steel scrap.....	200	0.10	0.07	0.10	0.60	0.2	0.14	0.2	1.2
Machinery scrap.....	1000	1.70?	0.100?	1.00?	0.60?	17.0	1.00	10.0	6.0
High Sulphur Southern.....	800	0.70	0.100	1.50	0.30	5.6	0.80	12.0	2.4
X No. 1.....	800	3.00	0.030	0.80	1.25	24.0	0.24	6.4	10.0
No. 3 Foundry.....	2000	1.75	0.070	0.30	0.60	35.0	1.40	6.0	12.0
High Silicon Bessemer.....	400	2.50	0.025	0.07	0.60	10.0	0.10	0.3	2.4
Total weights.....	5200	91.8	3.68	34.9	34.0
Average percentage ²	1.77% ²	0.071 ²	0.67 ²	0.65 ²

¹ Multiply the weight of each kind of material by the percentages of the elements in it.

² Divide each total weight of element by 5200 lbs.

Loss. — The loss in melting will average about 2 to 4 per cent. It is made up of the silicon burned and the iron oxidized and carried away in the slag. There are other sources of loss in the foundry, such as a second loss of metal remelted — the sprues, risers, etc., which go back to the cupola in the form of scrap; metal spilled during pouring (which may amount to as much as 5 or 6 per cent. more), etc. In some foundries it is customary to pass the used floor sand through a magnetic concentrator, in

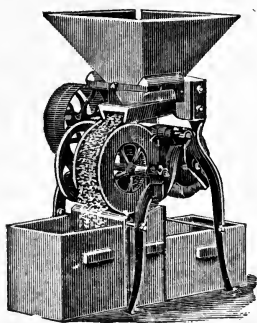

FIG. 232. — MAGNETIC CONCENTRATOR.

order to recover the pellets of iron spilled during pouring, and important economy is sometimes obtained in this way. The total loss, that is, the difference in weight between pig iron bought and castings made, will probably be about 7 to 8 per cent. of the weight of the iron bought.

Scrap Used. — Scrap pig iron is often mixed with new pig iron for the manufacture of castings, both for the sake of economy and because the scrap iron has a somewhat closer grain or texture, which increases the strength of the mixture. The amount of scrap used will depend upon the materials to be manufactured. Cast-iron pipe is usually made without scrap, this industry amounting to between 500,000 and 800,000 tons per year in the United States alone. Stove foundries, on the other hand, use a very large amount of scrap as a rule, and jobbing foundries, in general, would probably use an average of 30 to 40 per cent. of outside scrap, besides the gates, sprues, bad castings, etc., made in their own foundries. The total production of gray-iron castings in the United States will represent about 75 per cent. pig iron and 25 per cent. bought scrap.¹

Cupola Run. — The campaign of an ordinary foundry cupola is only three or four hours long. As a general thing, the kindling is started about noon and allowed to burn with a natural draft until shortly after one o'clock, when the breast is closed and the blast put on. Metal is then received until four or five o'clock in the afternoon, when the last charge is melted. The supports are then pulled out from underneath the door closing the bottom of

¹ For these estimates, I am indebted to Henry M. Lane, editor of *Castings*, in a private communication of Nov. 30, 1906.

the cupola, and the sand bottom, slag, coke, etc., left in the cupola is allowed to drop and is quenched with water. In order to allow plenty of room for the 'drop' to fall, the cupola is usually elevated above the foundry floor.

COMPARATIVE CUPOLA PRACTICE

After writing the foregoing discussion, some very valuable figures on "Comparative Cupola Practice" were presented by W. S. McQuillan to the Philadelphia Convention of the American Foundrymen's Association. The figures there given were of very great interest and value (see the *Foundry*, July, 1907, pp. 370 to 373), and confirm in a striking way the rules I have laid down above. I have copied a part of this table in my accompanying Table XXI and added several lines to it. I have also had all the calculations in the table checked up by two independent observers.

Fuel. — The first lesson we learn from the table is that a mixture of coal and coke and inferior coke give slow melting and a poor fuel ratio. Indeed, the work of the cupola using these grades of fuel is so far inferior to the others that I have separated them in Table XXI and omitted them from all my calculations. After a very careful study of the figures, I am strengthened in the opinion which I have long held and expressed that a mixture of coal and coke has nothing to recommend it except a deceptive first cost.

Tuyere Ratio. — The next most striking evidence produced by the figures is the relation between the tuyere area and the speed of melting: if we average up the iron melted per minute in the cupolas whose area is less than 6.56 times the tuyere area, we obtain a figure of 22.56 lbs.; if we get the corresponding figure for the cupolas with lesser proportionate tuyere area, we obtain 18.57 lbs. Indeed so striking is the relation that there is only one exception, namely, cupola No. 8, and we need not look far for a reason for the slow melting in this cupola. It is evidently due to the short height of stack which causes the iron to reach the melting zone before it has been sufficiently preheated. A large proportionate tuyere area evidently means that the wind will pass through the tuyeres with less resistance and a lower velocity. That is to say, we will get more wind and it will not be driven so

TABLE XXI.—COMPARATIVE CUPOLA PRACTICE

	1	2	3	4	5
Diameter of cupola, inches....	27	35	42	44	54
Height of tuyeres from sand bottom, inches.....	12	7	11	12	7.5
Height of charging door above tuyeres, inches.....	106	120	139	109	103.5
Height of charging door above tuyeres divided by diameter.	4.0	3.4	3.3	2.5	1.9
Number of tuyeres.....	6	6	6	6
Size of tuyeres, inches, vertical X horizontal.....	4x6	5x5	4x6	4½x13
Area of tuyeres, square inches.	144	170	144	336	348
Cupola area is how many times tuyere area.....	3.97	5.66 ¹	9.62	4.53	6.58
Diameter of blast pipe, inches.	8	16	14	15	17
Blast pressure, ounces, 20 minutes after start.....	9	16	8	9½	13
Class of work made.....	Job	Plate	Light Job	Boiler & Plate	Stove Plate
Lined up how often? Months.....	6	6	6	6
Weight of fuel on bed, pounds.	350	650	650	1,300	1,400
Weight of iron on bed, pounds.	700	1,300	1,400	3,000	3,000
Weight of fuel in charges subsequent to the bed, pounds..	90	125	100	175	300
Weight of iron in charges subsequent to the bed, pounds..	400	1,300	1,000	2,000	3,000
Total weight of fuel, pounds...	2,000	1,850	2,150	3,075	4,800
Total weight of iron, pounds...	8,000	14,000	16,000	27,000	33,000
Ratio of fuel on bed, above tuyeres, to iron on bed, 1 is to.....	3.2	2.8	3.5	3.2	3.7
Ratio of fuel to iron, later charges.....	4.4	10.4	10.0	11.4	10.0
One pound fuel melts how many pounds iron.....	4.0	7.5	7.6	8.8	6.9
Kind of fuel used.....	Coke	Coke	Coke	Coke	Coke
Fuel weighed or measured....	W	W	M	W	W
Height of fuel bed above tuyeres, inches.....	20	21 ¹	15	33	24
Thickness of fuel, charges after the bed, inches.....	8.4	7.0	3.8	6.1	6.9
Thickness of iron charges after the bed, inches.....	3.3	6.5	3.5	6.3	6.3
Time before iron comes after blast is on, minutes.....	7	15	5	15	10
Time to melt each iron charge after the bed, minutes.....	3.25	8.5	5.7	9	10
Total iron melted per minute, pounds.....	123	155	175	225	300
Total iron melted per minute, per square foot cupola area.	30.98	23.20	18.19	21.30	18.87

¹Two rows of tuyeres.

TABLE XXI.—COMPARATIVE CUPOLA PRACTICE.—Continued

	6	7	8	9	10	11
Diameter of cupola, inches. . . .	54	56	58	60	60	72
Height of tuyeres from sand bottom, inches.	14	25	16	2	12	24
Height of charging door above tuyeres, inches.	113	141	92	112	114	142
Height of charging door above tuyeres divided by diameter.	2.1	2.5	1.6	1.9	1.9	2.0
Number of tuyeres.	6	12	6	8	6
Size of tuyeres, inches, vertical X horizontal.	10x7	6x12	7x12	4½x7½	7x10
Area of tuyeres, square inches.	420	864	546	270	420	706
Cupola area is how many times tuyere area.	5.45	2.85	4.83 ¹	10.47	6.73	5.76
Diameter of blast pipe, inches.	18	24	20	18	18	24
Blast pressure, ounces, 20 minutes after start.	14	16	16	8	8	13½
Class of work made.	Boiler & Radiator	Rolls	Pipe Ft'g & Job	Plate	Sanitary & Plate	Electrical
Lined up how often? Months.	10	8 to 10	7	6	12	6
Weight of fuel on bed, pounds.	2,000	3,000	2,000	1,700	1,800	2,500
Weight of iron on bed, pounds.	6,000	9,000	6,000	6,000	5,000	7,000
Weight of fuel in charges subsequent to the bed, pounds.	450	450	400	200	350	600
Weight of iron in charges subsequent to the bed, pounds.	4,000	4,500	4,000	2,000	4,000	7,600
Total weight of fuel, pounds.	8,500	12,000	4,400	6,600	6,600	12,700
Total weight of iron, pounds.	64,800	100,000	30,000	49,500	50,000	127,500
Ratio of fuel on bed, above tuyeres, to iron on bed, 1 is to.	4.3	5.0	5.0	3.8	4.7	5.4
Ratio of fuel to iron, later charges.	8.8	10.0	4.1	10.0	11.4	11.7
One pound fuel melts how many pounds iron.	7.5	8.3	6.8	7.5	7.6	10.0
Kind of fuel used.	Coke	Coke	Coke	Coke	Coke	Solvay Coke
Fuel weighed or measured.	M	W	W	M	W	W
Height of fuel bed above tuyeres, inches.	32	40	14 ¹	30	22	6
Thickness of fuel, charges after the bed, inches.	10.4	9.6	8.0	3.8	6.5	7.8
Thickness of iron charges after the bed, inches.	8.4	8.8	7.3	3.4	6.8	9
Time before iron comes after blast is on, minutes.	20	5	15	1	15	15
Time to melt each iron charge after the bed, minutes.	11	12	12	5.5	11	13.5
Total iron melted per minute, pounds.	360	370	333	367	360	567
Total iron melted per minute, per square foot cupola area.	22.64	21.60	18.14	18.80	18.40	20.06

¹Two rows of tuyeres.

(For averages, see next page.)

TABLE XXI.—COMPARATIVE CUPOLA PRACTICE.—*Continued*

	A1	A2	A3	A4	Averages
Diameter of cupola, inches.	32	42	44	48
Height of tuyeres from sand bottom, inches.	11	12	9.5	14	12.6 ¹
Height of charging door above tuyeres, inches.	133	132	84.5	103	116
Height of charging door above tuyeres divided by diameter.	4.1	3.1	1.9	2.1	2.5 ²
Number of tuyeres.	6	6	8	6
Size of tuyeres, inches, vertical X horizontal.	4½x6	4x10	2½x11	4x6
Area of tuyeres, square inches.	162	240	198	144
Cupola area is how many times tuyere area.	4.96	5.77	7.68	12.56	6.56 ¹
Diameter of blast pipe, inches.	12	14	12	16
Blast pressure, ounces, 20 minutes after start.	16	12	13	8	12 ¹
Class of work made.	Gas Engine	Job	Pumps & Job	Medium Light	
Lined up how often? Months.	6	3	6
Weight of fuel on bed, pounds.	450	1,000	1,000	1,300
Weight of iron on bed, pounds.	1,000	4,500	1,000	4,000
Weight of fuel in charges subsequent to the bed, pounds.	110	250	110	200
Weight of iron in charges subsequent to the bed, pounds.	1,000	2,000	1,500	2,000
Total weight of fuel, pounds.	1,250	1,935	2,040	4,100
Total weight of iron, pounds.	8,000	12,000	14,800	32,000
Ratio of fuel on bed, above tuyeres, to iron on bed, 1 is to.	3.5	8.6	1.6	5.0	4.2
Ratio of fuel to iron, later charges.	8.7	8.0	13.6	10.0	9.5
One pound fuel melts how many pounds iron.	6.4	6.2	7.2	7.8	7.3 ¹
Kind of fuel used.	Light Coke	Coal & Coke	Coal & Coke	Coke & Coal	
Fuel weighed or measured.	M	M	W	M	
Height of fuel bed above tuyeres, inches.	21	11	25	22.5	22.5 ¹
Thickness of fuel, charges after the bed, inches.	7.3	9.5	3.9	5.8	7.0 ¹
Thickness of iron charges after the bed, inches.	6	7	4.7	5.3	6.4 ¹
Time before iron comes after blast is on, minutes.	10	15	15	7	11.3 ¹
Time to melt each iron charge after the bed, minutes.	7.7	9.5	13.8	9.46 ¹
Total iron melted per minute, pounds.	57	164	145
Total iron melted per minute, per square foot cupola area.	10.2	15.53	11.54	21.11 ²

¹ Including A1, A2, A3, A4.² Excluding A1, A2, A3, A4.

much to the center of the cupola. If the publication of these figures did no more good than to point out the advantage of the large tuyere area, they would have already contributed a very great deal to the foundry industry. It may be said to be established for the types of practice here exhibited that the collective area of the tuyeres should not be less than one-sixth, and preferably not less than one-quarter, of the horizontal area of section of the cupola.

Height of Stack. — There is also an important relation between the speed of melting and the height of the charging door above the tuyeres divided by the diameter of the cupola. The average speed of melting of the cupolas, where this ratio is greater than 2.5, is 24.12 lbs. per minute, while the average speed of melting of those whose ratio is less than 2.5 is only 19.15 lbs. per minute. There are only two exceptions to this rule: (1) Cupola No. 6 is a fast melter, but this is doubtless due to the large proportionate tuyere area. (2) Cupola No. 3 is a slow melter, but this is doubtless due to the very small proportionate tuyere area. With these exceptions the rule is universal and a comparison of different cupolas one with another only strengthens it; for example, 4 with 8, the proportionate tuyere area being nearly the same; also 2 with 6, etc. A comparison of 3 with 9 is an apparent exception which is perhaps explained by the low tuyeres in No. 9.

Blast Pressure. — The average speed of melting of the cupolas with more than 12 oz. blast pressure is only 20.75 lbs. per minute, while that with less than 12 oz. is 21.53. This relation is not so striking as to establish a rule, especially as a single cupola (No. 1) throws such a large influence into the low-blast column. Nevertheless, the evidence is sufficiently striking to discredit the theory that higher blast pressure necessarily gives faster melting. Indeed, if cupolas 3, 9, and 10 had a larger tuyere area, we should expect an average result very favorable to low blast pressure.

Height of Fuel Bed. — The original height of fuel bed is no criterion with which to figure as it in many cases is raised or lowered during the first few minutes of melting, and thereafter occupies some other position. It is the thickness of the fuel and iron charges after the bed which is the important consideration and, as already observed, these should be regulated to about 6 to 8 in. for fuel and 6 in. for iron irrespective of the diameter of

the cupola. In case hot iron is desired the layer of fuel should be at the upper limit of thickness and vice versa.

Speed of Melting. — The speed of melting is very important, because everything else being equal the faster the melting per square foot of cupola area the greater will be the efficiency of operation of the cupola, and therefore of economy under the given conditions.

OTHER MELTING FURNACES

Air-Furnace. — The air-furnace is a reverberatory furnace on the hearth of which pig iron is melted by radiation from the flame of a soft-coal fire, or, more rarely, from a gas flame. The furnace is charged by means of a large side door, or by removing the roof in sections bound together with iron, or by taking out the end, and in some cases, to effect an economy in labor, mechanical devices are employed for charging. Several designs of air-furnaces are shown in Figs. 266 to 269 inclusive.

Cupola versus Air-Furnace Melting. — The air-furnace is not as economical of fuel as the cupola, and the amount of coal used will average about one-fifth to one-third of the weight of the iron melted. The air-furnace has, however, some very important advantages which enable it to produce a higher quality of castings: (1) The metal does not absorb so much sulphur, since it is not in contact with the fuel and can only take up sulphur from the furnace gases; air-furnace iron will therefore increase only about 0.001 to 0.008 per cent. in sulphur; (2) the control of its composition in silicon and carbon is much better, as by retaining it for a longer time in the furnace after melting we may burn out any desired amount of these elements. Therefore, when making iron which must be reduced in silicon or carbon, as, for example, metal for malleable cast-iron castings, or when making iron that must be very close to a certain analysis, as, for example, cast iron that is to be chilled on the surface (for instance, railroad car wheels, rolls for reducing the size of metal bodies, etc.), the air-furnace is very commonly used; (3) air-furnace iron is stronger than cupola iron on account of lower total carbon and sulphur and better control generally.

Operation of Air-Furnace. — Forced draft is usually used for the fire, and sometimes additional air is introduced just above the

fire-bridge, in order to increase the oxidizing effect of the flame. There are also doors in the side walls for the same purpose. It takes from about $3\frac{1}{2}$ to 9 hours to melt down a charge of 5 to 35 tons, respectively, and the metal is tapped as soon thereafter as it is of the proper composition and sufficiently hot. The composition is determined by taking a test ladleful from the bath, casting it into a mold, and examining a freshly broken fracture, to determine either the amount of combined and graphitic carbon, or the depth of chill, or both. American furnaces usually vary in size from 10 to 45 tons capacity each. The loss will be about 2 to 5 per cent. of the weight of metal used.

Lining. — The lining of the bottom of the air-furnace is made of silica sand of about the same composition as the acid open-hearth furnace, i.e., containing 95 per cent. or more of silica, with just enough lime to frit the mass together at the heat of the furnace. A layer about 1 to 2 in. thick is spread all over the hearth and then set on as described in the chapter dealing with the open-hearth process. About five layers are put on in this way, and the bottom lasts on an average of 6 to 12 heats, although some foundries regularly make up a bottom after the third heat; and in other cases the bottoms last as many as 30 heats. Longer life will be obtained if the material is charged carefully so as not to break the sand, and if a strongly reducing flame is maintained during the melting period, when there is not a bath of liquid iron to protect the bottom from the corrosive iron oxide. Mixing broken fire-bricks of good quality and refractoriness with the sand seems to give more durable bottoms.

Scrap Used in Air-Furnace. — Cast-iron scrap is very liable to be high in phosphorus and sulphur and to vary greatly and unsuspectedly in all impurities. Also it is difficult to sample for chemical analysis and therefore presents some uncertainty. As the chief objects of foundrymen in undergoing the additional expense of air-furnace melting are to obtain low sulphur or a close approximation to a desired analysis or both, very little iron scrap is used. Steel or wrought iron scrap is sometimes used, however, because it reduces the total carbon and the impurities are always pretty low. I estimate the average amount as between 0 and 10 per cent.

Open-Hearth Furnaces. — Open-hearth furnaces of small size, but in other respects exactly like the open-hearth steel furnaces,

are used for melting iron for malleable castings in a few important foundries in the United States. The great drawback of this furnace is that it must be operated continuously, day and night, which means more floor space on which to set molds ready for pouring, because molding cannot well be done during the night, as the artificial light casts shadows that make the work of finishing up molds more difficult and confusing.

The advantage of the regenerative open-hearth furnace over the air-furnace is better control of the operation, and especially of the temperature, and greater fuel economy. Figures are not given out by the companies using the process, but we cannot be far wrong in estimating that the average time of melting in the open-hearth furnace will probably be somewhat less than four hours, and the amount of fuel not more than 300 to 350 pounds per ton of iron, or twice as much if melting only on the day turn. The lining will certainly last much longer on account of the better control of the character of flame. Moreover, oil can be used for melting in a regenerative furnace, because it is introduced into a very hot atmosphere, which is not practicable in the air-furnace, since the fuel condenses in the cooler atmosphere of this furnace, especially when the furnace is cold or when there is a cold charge on the hearth. Open-hearth linings are best made of dolomite, which enables a basic slag to be produced in the furnace and a reduction in phosphorus and sulphur. Cheaper pig iron and iron scrap can then be used. This basic lining is not attacked by the iron oxide and slag produced in melting and will last for hundreds of heats if not allowed to cool off too frequently. Basic linings cannot be employed in air-furnaces because dolomite contracts and expands so much on cooling and heating that the bottoms are soon cracked to pieces, for air-furnaces are not operated continuously.

MELTING STEEL FOR CASTINGS

Steel castings are made in (1) acid open-hearth furnaces, (2) basic open-hearth furnaces, (3) small Bessemer converters of special design, to produce steel at a higher temperature, and (4) crucibles. The castings are made from the metal just as it comes from the steel furnace, and the processes are mentioned above in the order of relative importance.

Open-Hearth Furnaces. — The making of steel for castings is

practically the same as making steel for ingots, except that foundry furnaces are of smaller size, varying on the average from 15 to 30 tons. In some cases furnaces smaller than this are used, but it is generally believed that no circumstances warrant this, since the expense of running the small furnaces is large in proportion. The chief difference in practice is that the temperature for steel-casting work is hotter than when ingots are made. Therefore furnace repairs are higher and the life shorter. In ordinary open-hearth foundry work the purification is continued to the point where the steel contains about 0.18 to 0.28 per cent. carbon after recarburizing, while the silicon will be usually 0.20 to 0.30 per cent.

Acid versus Basic Open-Hearth Steel. — In steel castings it is necessary to have somewhat lower phosphorus and sulphur than in ingots, because the metal is not to receive the beneficial effect of mechanical work, and therefore must be purer in order to have a good degree of strength and ductility. Consequently, if we use an acid steel-making process, we must start with very low phosphorus and low sulphur pig iron, which is costly and becomes more so each year in America. For this reason the Bessemer and the acid open-hearth steel-making processes are more expensive for casting work than the basic open-hearth. The result is a present rapid increase in the use of basic open-hearth steel in America as well as in Germany, with a probability that in a few years it will be the predominant process for this purpose. This is in spite of the fact that basic steel has very serious disadvantages, chief among which are the amount of oxygen contained in it at the end of the process and the difficulty of getting the desired amount of silicon in it with the recarburizer, both of which conditions increase the liability to blow-holes, which are especially objectionable in castings, as there is no opportunity of their being welded up and as castings may have to be discarded on account of them after a good deal of expensive machine-work has been done. On this account the acid open-hearth process has long held the predominant position in the steel-casting industry. In fact, this is the only place where the acid open-hearth process now finds important employment.

Bessemer versus Open-Hearth. — The open-hearth furnace gives a large amount of steel at long intervals, which is very inconvenient for foundry work, because the molds necessary to take all

the metal must be stored upon the foundry floor until the heat is ready to pour, and then those who are to do the teeming must interrupt their other work for half an hour or more for this purpose. Even where the foundry is large enough to have many furnaces, there is no surety that they will come out at regular and short intervals, because the operation in one may be delayed. Another disadvantage of the open-hearth process is that, in order to be economical, it must be operated continuously day and night, which also is inconvenient for foundry work. Further, it is not possible to get the metal as hot as desired without great damage to the furnace, which is subjected to a higher temperature than the metal. Lastly, since hot metal is desirable for all castings except those of very large size, it is usually necessary to tap all the metal from the furnace at once, and recarburize it at once, which prevents castings of special analysis being made, unless ordered in very large quantities. Nowadays, a great many nickel-steel castings are made in open-hearth furnaces, but this requires nice calculations, so that the castings molded shall be just equal to the capacity of the heat, and usually results in a certain amount of scrapping of high-class material.

All these objections are avoided in making castings in Bessemer converters, but they too have their great disadvantages, chief among which are the slight inferiority of the Bessemer steel and its greater cost. The latter is true only as compared with basic open-hearth steel (not acid), and is due principally to the amount of waste in the side-blown converters used for this purpose, and the greater cost of the pig iron used, which must be low in phosphorus and sulphur. Small converter plants are so very cheap — costing less than \$5000 for apparatus — that a great many iron-foundries in the United States are putting them in as an adjunct to their cupola process, in order that they may be able to make steel castings at will. The amount of capital tied up is so small, and there being no important expense in starting and stopping the converter as often as desired, they can do this economically.

Tropenas Converter. — The largest number of converters for steel-casting work are of the Tropenas type, in which the wind enters the vessel from seven tuyeres on the side, and the converter is tipped in such a manner that the streams of air are deflected onto the top of the bath. The impurities are oxidized as in the regular Bessemer process, except that the action is not quite

so rapid, and the carbon is burned to carbon dioxide instead of carbon monoxide, which generates a much larger amount of heat:

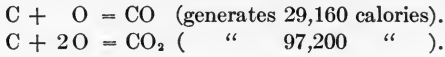

In order to assist in the superoxidation, there is a second row of tuyeres above the first, connected with a separate wind-box. The wind is not turned onto these upper tuyeres until the carbon begins to burn. The pig iron used for these converters runs frequently above 2 per cent. of silicon, and this, together with the formation of carbon dioxide, results in very hot and fluid steel, which can be poured into castings of almost any small size. The blows usually last about 15 to 20 minutes, and the loss is from 17 to 20 per cent. of the weight of pig iron charged into the cupola in which it is melted. The vessel can be started up and stopped with very little expense, and this advantage over the open-hearth, together with the small amount of capital necessary to build the converter plant and the other conditions already mentioned, has caused about 20 of these converters to be installed in America, and several in France, England and other countries.

The great disadvantages of the Tropenas converter are the waste and the cost for making repairs. Slight patching can be done through the mouth, but there is a hole in the front of the converter shell, closed by a movable steel plate, through which the operator can dig his way into the interior to perform the necessary repairs. As the lining in the neighborhood of the tuyeres is usually worn out in less than twenty blows, this costly method of lining is a serious drawback.

Long-Tuyere Converter. — Next to the Tropenas, the greater number of converters at work in America are of the Long-Tuyere, or Stoughton, type, devised by the writer. The bottom part of

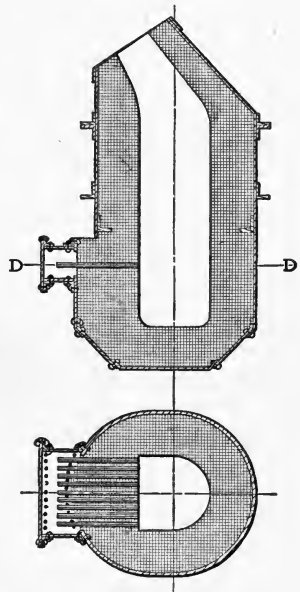

FIG. 233. — SECTIONS OF LONG-TUYERE CONVERTER.

this vessel is attached to the trunnion-ring by a method similar to that used for regular Bessemer bottoms, and may be removed with great ease, thus cheapening and facilitating repairs. Moreover, the chief repairs are in the bottom part at the mouths of the tuyeres, and therefore the lining of the upper part does not have to be relined completely for several months, although slight patching is necessary every twenty-five to thirty blows, when the bottom is changed. This converter is arranged to have but one row of tuyeres, discharging the blast immediately at the surface of the metal, and the lining on the tuyere side is thicker in order that the tuyeres may be increased in length, which decreases the loss of metal during the process. The excessive loss in the side-blown converters is due chiefly to the spitting, which is very large, especially when the tuyeres have become worn away to a short length and the streams of air are badly directed and set up interfering currents.

Another cause of the excessive loss is the large amount of slag formed, because more iron is oxidized, and this corrodes the lining very rapidly. Part of the iron is oxidized at the mouths of the tuyeres, and another part is oxidized when the violent agitation of the bath, which occurs in all of these converters, especially during the boil, throws the metal up into the stack, where it meets free oxygen. For this reason the upper row of tuyeres in the Tropenas converter results in an increase in the loss and in the corrosion of the vessel lining. After many experiments with the Tropenas vessel, I learned that the maximum amount of carbon can be oxidized to CO_2 without the use of the upper row of tuyeres, and therefore economy could be obtained by omitting them. In fact, at some Tropenas plants the valve of the upper row of tuyeres is often not opened at all during the heat, and no diminution of the temperature of the resulting steel is observed. The loss in the Long-Tuyere modification is 14 to 16 per cent., including cupola loss.

Sizes Used. — Most of the small converters have a capacity of about 2 tons, because this is economical and well proportioned to the capacity of an ordinary foundry. There are some 4- and 5-ton converters, however, and some of less than 1 ton capacity. Sizes less than 2 tons are very costly to operate in proportion to their output. The blast pressure usually employed is 3 to 5 lb., with an average of about $3\frac{3}{4}$ lb.

TABLE XXII.—ANALYSES OF SIDE-BLOWN CONVERTER-GASES

Sample No.	TIME AFTER BEGINNING OF BLOW	ANALYSES—PER CENT.				CALCULATIONS FROM ANALYSES—PER CENT.			
		CO	CO ₂	O	N and H	Total O	N ¹	O Entering	O Burning Si and Fe and Mn
1	4 min., flame starts...	0.0	8.2	1.1	90.7	7.1	88.7	23.6	16.5
2	10 " boiling.....	0.3	24.3	0.4	75.0	18.3	73.0	19.4	1.1
3	12 " shortening ² ...	0.4	8.8	0.2	90.6	6.8	88.6	23.5	16.7
4	17 " after first drop.	10.7	13.0	0.2	76.1	15.8	74.1	19.7	3.9
...	21 " end of blow...								

¹ By difference, H being estimated as 2 per cent.

² I.e., just before the first drop. There are two drops to the flame in this operation, the second marking the end.

REFERENCES ON FOUNDRY PRACTICE

90. George R. Bale. "Modern Iron Foundry Practice." Part I. Foundry Equipment, Materials Used, and Processes Followed. 1902. Part II. Machine Molding and Molding Machines, Physical Tests of Cast Iron, Methods of Cleaning Castings, Foundry Accounting, etc., etc. 1905. London. This is the most scientific book on iron foundry practice published.
91. *The Foundry*. Published monthly. Vol. xxxi, 1907. Cleveland, Ohio.
92. Thomas D. West. "American Foundry Practice." Treating of Loam, Dry-Sand and Green-Sand Molding, and containing a Practical Treatise upon the Management of Cupolas and the Melting of Iron. Published in New York. This book is tremendously popular among foundry men and editions appear at frequent intervals.
93. William J. Keep. "Cast Iron." A Record of Original Research. New York and London, 1902.
94. Thomas Turner. "Lectures on Iron-Founding." London, 1904.
95. "Penton's Foundry List." Cleveland, Ohio, 1906. A Directory of the Foundries of the United States and Canada.

For an account of small converters for steel casting work see Reference No. 52 and the files of Nos. 91 and 8.

X

THE SOLUTION THEORY OF IRON AND STEEL

SCIENTIFICALLY considered, all of the members of the iron and steel series are alloys of iron and carbon. Therefore a study of the general theory of alloys leads to important information upon iron and steel. According to the authoritative definition, "a metallic alloy is a substance possessing the general physical properties of a metal, but consisting of two or more metals, or of metals with non-metallic bodies, in intimate mixture, solution, or combination with one another, forming, when melted, a homogeneous fluid." It will be seen from this that the essential feature of an alloy is that, when melted, it shall form a homogeneous fluid. In plain language, this means that, when melted, the different components are dissolved in one another. Melted alloys, therefore, come under the general head of solutions. In fact, the great bulk of our alloys, and especially of iron and steel, are produced by first dissolving the melted components and then allowing them to freeze. The laws governing this freezing, or solidification, have only been known a few years, and if this new knowledge has made great revolutions in physical chemistry, it has led to no less important discoveries in regard to the nature of iron and steel.

Solid Solutions. — Suppose first we have two metals that are soluble in each other when liquid, and also when solid. In other words, the metals of the alloy will be just as completely dissolved in each other after solidification as before. They will then form a "solid solution," and a solid solution bears practically the same relation to a liquid solution as a solid pure metal does to the same metal when liquid. For example, gold and silver dissolve in each other when liquid, and also when solid, in any proportion. Consequently any solution of these metals will cool to the freezing-point and then solidify without there being any important change (from the metallurgical or practical standpoint) in the relations of the two metals after the freezing. The reason that these solid

solutions form in any proportion is that the two metals crystallize alike. It is, perhaps, a new thought to the reader, but it is nevertheless true, that a metal forms a crystal whenever it solidifies. Furthermore, each metal has a particular, general shape which its crystals assume, and there is almost no force powerful enough to prevent them from taking that same shape in preference to any other.

Tiny as the crystals sometimes are—often requiring the highest powers of the microscope to reveal them — their crystalline forces are very powerful. If, therefore, two metals do not form like crystals, they cannot solidify in solution, i.e., in the same crystal, but crystallization (i.e., freezing) must be accompanied by precipitation.

By European metallurgists solid solutions are often called "mixed crystals," or "isomorphous mixtures," but this terminology is objected to because the relation of two substances when dissolved is far more intimate than any mixture possibly could be. In a mixture, the microscope will always be powerful enough to distinguish the different components, but a solution always appears like a simple uniform body. Furthermore, the properties of a mixture are intermediate between the properties of its components, but a solution — either liquid or solid — has some properties which are different from any of the properties of either of its components. Again, the components of a solution are held together by chemical forces, while the components of a mixture are either not held together at all, or only because of close mechanical association. In brief, a solution has some of the peculiarities of a chemical compound, and differs from such a compound chiefly because the latter must always be composed of definite amounts of each component, and in some multiple of their atomic weights, while a solution may contain widely varying amounts of each component.

Freezing of Solid Solutions. — When metals form solid solutions, the solutions freeze more or less like pure metals. In Fig. 234 I have shown graphically the freezing of all the alloys of gold and silver, extending from no silver (i.e., 100 per cent. gold) to no gold (100 per cent. silver). This figure has been drawn from results obtained by experiment. The proportion of silver is shown by the abscissæ, or the horizontal distance away from the axis OC , and the temperature is shown by the ordinates, or the vertical

distance away from the axis OO . In other words, any point between these two axes represents by one ordinate the composition of the alloy in silver, and by the other ordinate the temperature at which the alloy is at the moment. For example, the point marked a is a certain distance from the axis OC , which shows that the alloy in question contains 50 per cent. of silver; it is also a certain distance above the axis OO , which shows that the alloy is now at a temperature of 1100°C . (1012°F).

Since there is nothing in the alloys but silver and gold, the amount of gold in each will be the complement of the amount of

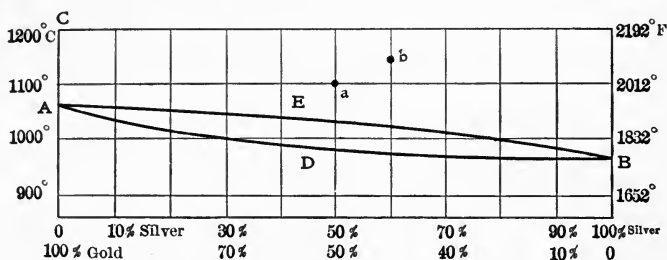

FIG. 234. — FREEZING CURVE OF THE GOLD-SILVER ALLOYS.

silver. That is to say, the percentage of silver plus the percentage of gold must always equal 100 per cent.; if there is 25 per cent. of silver there must be 75 per cent. of gold; if there is 50 per cent. of silver there must be 50 per cent. of gold, etc. The horizontal distances therefore show the percentage of gold as well as of silver, and this is given in the second line of figures under the table.

Suppose we have a solution of 50 per cent. silver and 50 per cent. gold at a temperature of 1100°C . It is represented at the point a , and is now liquid. When it cools to about 1035°C . it begins to freeze. It does not all freeze at the same time, but first some solid crystals freeze out and we have a mixture of solid crystals with liquid solution. The more the mass cools the more solid crystals there will be, each crystal being a solid solution of gold and silver. It is not until we reach a temperature of 985°C ., however, that the last liquid freezes, and then we have a solid solution of gold and silver, the two solid metals now bearing practically the same relation to each other chemically that they did when liquid.

It will be noticed that when this alloy cooled from the point a

to 1035° , it met the line AEB . This is the line that represents the beginning of freezing for all the gold-silver alloys. It has been drawn after many experiments have been made to show where it lies in the diagram. It will furthermore be noticed that when this alloy cooled to 985° , it met the line ADB . This is the line that represents the completion of freezing for all the gold-silver alloys, and its position has been learned from many experiments.

Take now the alloy containing 60 per cent. silver and 40 per cent. gold, at a temperature of 1150° C. — the point b . As this cools to a temperature of 1025° C., it meets the line AEB and freezing begins in the same way as before. Solid crystals form more and more as the alloy cools further, until we meet the line ADB at a temperature of 980° C. At this point the last liquid freezes.

THE FREEZING OF ALLOYS OF LEAD AND TIN

1. Suppose now, on the other hand, we have two metals which are soluble in each other when melted, but not when solid. Evidently there cannot be the same results as those described in the case of the gold-silver alloys. Such a series is found in the alloys of lead and tin, whose freezing is shown graphically in Fig. 235. Here again I have shown the percentage of lead and tin by the horizontal ordinates, and the temperature by the vertical ordinates. And, again, the diagram has been drawn from results obtained by experiment. The following facts are not based upon reasoning or logic, but are to be accepted because it is known that the different actions described actually took place upon trial.

2. Consider first a solution containing 83 per cent. of lead and at a temperature of 300° C. This will be represented by the point a in Fig. 235 (page 299), and will be a solution of lead in tin, still liquid, although about 26° below the melting-point of lead itself. If cooled, the solution will remain liquid until it reaches a temperature of about 275° , which brings it, we see, to the line AB . This is the lowest temperature to which it will go and retain that much lead in solution. If cooled any more, the lead will begin to precipitate and of course as much as is precipitated will immediately solidify, being already well below its melting-point. The lead comes out as crystals of solid lead, which remain mixed with the mass of the molten solution, but form no longer a part of it

chemically.¹ The solution, i.e., the part still liquid, becomes enriched in tin in proportion as the lead precipitates. Leaving this alloy here for the moment, let us next consider one with less lead.

3. Now take an alloy with 67 per cent. of lead and 33 per cent. of tin at a temperature of 250° C. This will be represented by the point *b* in Fig. 235. We have again liquid lead dissolved in liquid tin, although the alloy is 76 per cent. below the melting-point of pure lead. Suppose this alloy cools until it reaches a temperature of about 240° C., where it meets the line *AB*. It will not cool below that temperature and retain all the lead in solution. If we cool it a few degrees, lead separates out and becomes mechanically mixed with the liquid solution.

4. Consider next an alloy of 55 per cent. lead dissolved in 45 per cent. of tin at a temperature of 250° C. As this cools to a temperature slightly below 225°, it again meets the line *AB* and crystals of lead separate out and solidify. And so on: any solution, when it cools to a temperature where it meets the line *AB*, reaches its limit of solubility; it cannot cool more and retain all of the lead in solution; but if it does cool, then some of the lead must be precipitated.²

5. To sum up the preceding paragraphs, we may then say that the less lead we have in solution,³ the lower the temperature can go without any of it being precipitated. Or, in other words, the less the lead in solution the lower the temperature will go before any freezing begins. This knowledge is the result of experiment, and it has been shown that the line *AB* in Fig. 235 represents the equilibrium between the amounts of lead in the different solutions and the temperature to which each will cool before any lead is precipitated, or, in other words, the amount of lead that saturates the solution at each temperature.

¹ It is a fact that when the lead is precipitated from the solution, it carries with it a few traces of dissolved tin, but for the present we neglect this slight impurity for the sake of simplicity, and consider that pure lead separates.

² Any lead that is precipitated must of course freeze, because the temperature is already below the freezing-point of lead. Conversely, any lead that freezes must be precipitated from the alloy, because we know as a matter of experiment that frozen lead will not retain tin in solution (omitting, of course, the few traces of tin retained by the lead and which, for the sake of simplicity, we omit in the discussion).

³ Within limits to be afterward defined.

6. With this knowledge let us consider again the first solution — containing 83 per cent. of lead. We have stated that when this solution was cooled below 275° C., some lead was precipitated. Have we any evidence now as to how much lead would be precipitated with each unit drop in temperature? Evidently we have, for we know how much lead is normally in the saturated solution at each temperature; this evidence is given to us by the line *AB*. For example, assume that the solution containing 83 per cent. of lead is cooled to 240° C.; how much lead will be left in solution, and therefore how much will have been precipitated? From paragraph 3 we know that 67 per cent. of lead remained in solution down to a temperature of 240° C. and that there was an equilibrium between the amount of lead and this temperature, or, in other words, the solution is saturated with lead at this point. Therefore it would be reasonable to suppose that the solution which started with 83 per cent. of lead would retain exactly 67 per cent. of lead by the time the temperature of 240° is reached. That this reasoning is correct is proved by experimental evidence.

7. Now let us cool the same alloy to a temperature of 225° ; how much lead will this retain in solution and how much would be in a precipitated form? We have already seen (paragraph 4) that an alloy containing 55 per cent. of lead will retain all of that lead in solution until it falls to a temperature of 225° . Therefore it is reasonable to suppose that the cooling alloy we are considering will retain just 55 per cent. of lead and no more by the time its temperature has fallen to 225° , and this is in fact the case. In short, each solution will always retain enough lead to saturate itself after it once becomes saturated.

8. We have learned above that every point on the line *AB* represents the maximum amount of lead that can be retained in one of these solutions at that temperature. Therefore as soon as any solution meets the line *AB*, it follows along this line as it cools and lead precipitates in amounts proportional to the temperature, so that the solutions will always be saturated with lead.

9. It is therefore evident that if we start with any of these liquid alloys containing an amount of lead represented on the diagram to the left of the point *B*, lead will precipitate from it during cooling and the amount of lead in solution will continually decrease, so that the composition of the alloy at the different temperatures will be represented by a point traveling down the line *AB*. There-

fore, in every such case we shall reach finally a solution with 31 per cent. of lead and 69 per cent. of tin (the proportions represented by the abscissa of the point *B*) when the temperature has fallen to 180° C. (the ordinates of the point *B*). Mixed with the solution at this temperature will be the amount of lead which has separated during cooling and which will depend upon the percentage in the original solution. (If this is not clear on the first reading, a little thought will make it so, especially if the reader follows in Fig. 235 each action I have described, step by step.)

10. We have considered up to now only the solutions containing large amounts of lead and from which lead is precipitated on cooling. Let us now consider a solution containing 90 per cent. of tin at a temperature of 225° C. (point *d*, Fig. 235). It is still liquid, although below the normal melting temperature of both lead and tin. This will cool until a temperature of about 210° is reached and it meets the line *CB*. If it cools any more, tin will be precipitated and will of course freeze, because it is already below its normal freezing-point (231° C).

11. Consider next an alloy containing 85 per cent. of tin at a temperature of 225° (point *e* in Fig. 235). This will cool to about 200° C., where it meets the line *CB*, but if it cools any further, tin will be precipitated and will freeze.

12. In other words, the line *CB* represents the conditions of equilibrium between the temperature and the amount of tin that will be retained in solution, just as the line *AB* represented the equilibrium between the temperature and the amount of lead that would be retained in solution. That is to say, every point on the line *CB* represents the amount of tin that will saturate a solution at that temperature.

13. Returning then again to the alloy containing 90 per cent. of tin, how much tin will have been precipitated by the time the alloy cools to, let us say, 200° C.? Obviously 5 per cent. of tin would have been precipitated, leaving a solution containing 85 per cent. of tin, because we have already seen that 85 per cent. of tin will saturate a solution at 200° C.

14. Whatever solution we may have had to start with, provided there was always more than 69 per cent. of tin, as soon as that solution met the line *CB* it would travel down this line, precipitating tin progressively in proportionate amounts such that the tin left in the solution at the varying temperatures would corre-

spond to the ordinates of the line *CB*. In other words, this solution follows the line *CB*. Therefore, in all such alloys we shall finally arrive at a solution having 31 per cent. of lead and 69 per cent. of tin (the abscissa of the point *B*) when the temperature has fallen to 180° C., and with this solution will be mixed precipitated tin in amount depending upon the amount of tin in the original solution. This solution is known as the 'eutectic' solution.

15. We may now sum up paragraphs 9 and 14 by saying that whatever solution of lead and tin we have to start with, we will

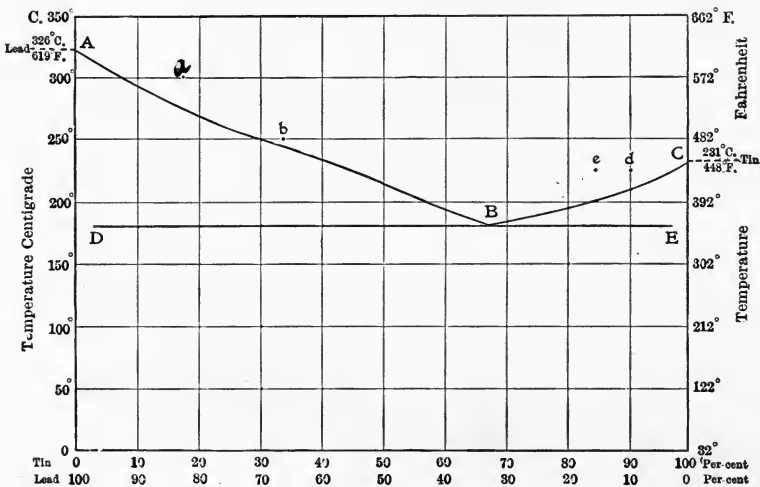

FIG. 235. — THE FREEZING OF ALLOYS OF LEAD AND TIN.

always have one containing 31 per cent. of lead and 69 per cent. of tin by the time the temperature has fallen to 180°, and with this solution will be mixed some precipitated tin or precipitated lead, as the case may be (unless, of course, we started with exactly 31 per cent. of lead and 69 per cent. of tin).

Now let us consider the further cooling of these alloys. Evidently, no change will take place in the precipitated lead or tin, as either of them would be already in the solid form. What will happen, however, to the solution containing 31 per cent. of lead and 69 per cent. of tin, which we have called the 'eutectic' solution? It is evident that when this solution cools below 180°, it must cross the point *B*, and therefore both the lines *AB* and *BC*

at once. Obviously, it cannot cross either of these lines without precipitating lead or tin. In point of fact, on crossing both of the lines at the same time, it precipitates at once all the remaining lead and all the remaining tin, and therefore completes the decomposition of the solution and the solidification.

The lead and tin separate in tiny solid crystals or flakelets, which arrange themselves in a parallel banded structure similar to that shown in Fig. 240, page 313. This structure is known as the 'eutectic' structure, after the alloy which always results when any one of the solutions of the series is cooled. The term 'eutectic alloy' means etymologically 'well-melting alloy,' because it remains melted longer than any other alloy of the same metals, and every solution the components of which are soluble in each other in the liquid state and insoluble in the solid state will form a eutectic solution in the way I have described. This applies not only to solutions of metals in each other, but to solutions of metals in liquids which are afterward frozen, and even of salts in water, etc.

Freezing-Point Curves. — The lines AB and CB are often spoken of as the "upper freezing-point curves" of the alloys, because any alloy which cools to this line will then commence to freeze. Furthermore, freezing once having commenced when either of these lines is reached, will continue progressively as the excess metal separates out. The line DE is often called the 'lower freezing-point curve,' because this line represents the temperature of freezing of the eutectic of the series, and we have already shown that every alloy in the series automatically forms a eutectic by 'selective' precipitation; therefore every alloy in the series will not be entirely solid until it reaches the temperature at which the eutectic solidifies,¹ which is always the same.

Cooling Curves. — There are certain thermal changes which accompany the chemical changes I have outlined in the preceding paragraphs. These thermal changes are of importance, because it is by means of them that we are usually able to obtain the first evidence of the precipitation of excess metal, the formation and solidification of a eutectic, etc. Consider the alloy containing 83 per cent. of lead and 17 per cent. of tin, at 300° C., and let us observe by means of a thermometer or pyrometer the rate of

¹ Some metallurgists prefer not to draw the line DE , but to represent the freezing of the eutectic merely by the point B .

cooling. At first the thermometer will fall pretty fast, but when we reach 275° , where the line AB is met, the rate of fall is suddenly retarded. It thus becomes evident to us that some event counteracts the fall in temperature. What this event is we learn from microscopic evidence, and, as has already been explained, it is the precipitation of lead. This explanation might have been expected, because the precipitation of lead at a temperature below its normal freezing-point would of course be accompanied by freezing and, during the freezing, the metal would liberate its latent heat of fusion and thus oppose the cooling of the mass as a

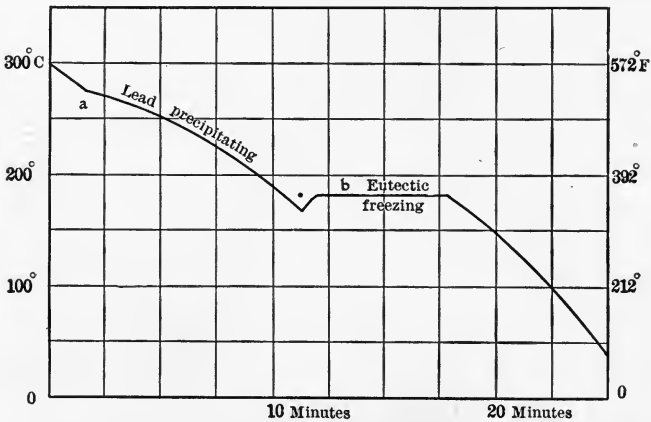

FIG. 236. — FREEZING CURVE OF AN ALLOY CONTAINING 83 PER CENT. OF LEAD AND 17 PER CENT. OF TIN.

whole. The rate of fall of temperature is, moreover, retarded all the way down to 180° , because lead is being continuously precipitated as the solution travels down the line AB . When we reach 180° , the fall of temperature is not only retarded but actually ceases; in some cases the temperature may rise slightly. This change is due to the large amount of latent heat of fusion liberated by the freezing of the eutectic. This arrest continues until the eutectic is entirely solid, after which the rate of fall becomes rapid again and proceeds without important change until the atmospheric temperature is reached, because now we have merely the cooling of a solid alloy.

These changes are represented diagrammatically in Fig. 236, in which the abscissæ show the time, in minutes, from the begin-

ning of the cooling, and the ordinates show temperatures. The change in direction at the point *a* shows the retardation due to the precipitation of the lead, while the long horizontal part at *b* shows that for several minutes the temperature was not falling at all, because the eutectic was freezing.

Next, experimenting upon the alloy with 67 per cent. of lead, we find that it cools rapidly until it meets the line *AB*, when the rate of fall is retarded continuously until we reach 180° , where again an arrest (or perhaps an actual rise) of the temperature is observed, after the completion of which the fall in temperature becomes rapid again and proceeds normally.

Similar thermal changes are observed in the alloy containing 55 per cent. of lead, but at temperatures of 225° and 180° . Now, by plotting the upper changes in the several solutions (i.e., at 275° C., at 240° C., and at 225° C.), the position of the line *AB* is determined, and by plotting the lower changes (i.e., at 180° C. in each case) the line *DE* is determined.

In studying the solutions of the series rich in tin, similar thermal changes are observed. Consider the alloy containing 90 per cent. of tin and 10 per cent. of lead; this will cool rapidly until a temperature of 210° C. is reached, when a retardation will occur and will persist until the temperature 180° is reached. By this time the excess tin will all have been precipitated and the residual solution¹ will have travelled down the line *CB* to the point *B*. Thereupon an arrest (for an actual reversal) in the rate of cooling will occur until the eutectic has solidified, after which the cooling will proceed at a rapid rate. In the case of the alloy containing 85 per cent. of tin, the first retardation will begin at 200° , and then an arrest at 180° . By plotting the points at 210° and 200° , we obtain the position of the line *CB*², and by plotting the two points at 180° we obtain further points to determine the line *DE*.

Properties of Eutectics. — As already said, not only the lead-

¹ These residual solutions are technically known as 'mother liquors' or 'mother metals,' because it is out of them that the solid metal is being 'born.'

² It should be understood that in actual experimental determination of lines corresponding to *AB*, *CB* and *DE*, in any series of alloys, not a few, but a large number of different solutions are studied, and a great many retardation points are found before the lines are drawn.

tin alloys, but every alloy of which the components are soluble when liquid, and insoluble (or nearly so) when solid, will form eutectics, and it happens that this is the case with the great majority of our metallic alloys. For this reason the properties of the eutectic are very important in all metallurgical work. It will be seen that a eutectic is not a chemical compound in atomic proportions. For example, in the case of the lead-tin alloys, the point *B* comes at 31 per cent. of lead and 69 per cent. of tin merely

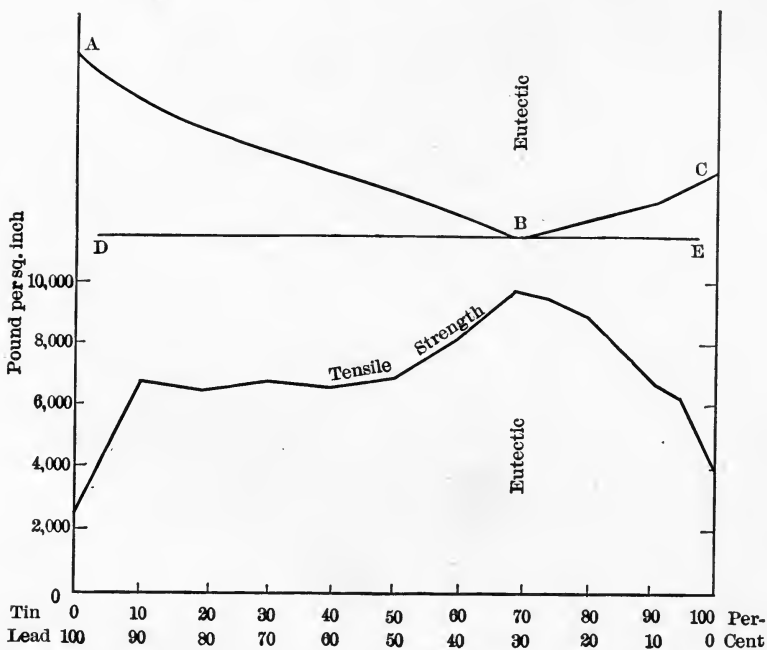

FIG. 237. — FREEZING-POINT AND STRENGTH CURVE OF THE LEAD-TIN ALLOYS.

because the line *AB* crosses the line *CB* at this ordinate, and this has no relation to atomic ratios. If the melting-point of tin happened to be higher, or if it did not precipitate from lead so fast upon cooling, the line *CB* would cut the line *AB* at a different point, and therefore the composition of the eutectic would be different.

The structure also of the eutectic is very important. The majority of eutectics have a structure similar to the banded form

shown in Fig. 240. The tiny crystals in this structure are intermingled very intimately, and this close association has a beneficial effect on the strength of the mixture. In Fig. 237 we may see how the curve showing tensile strength rises to a maximum at the point corresponding to the eutectic of the series of lead-tin alloys.

THE FREEZING OF IRON AND STEEL

1. When the iron and steel alloys are liquid, they are composed of liquid carbon dissolved in liquid iron, and their freezing-point curves are shown in Fig. 238. It will be noticed that the lines in this figure bear a close similarity to those in Fig. 235. This similarity is real, and the laws governing the freezing of this series of alloys are very similar to those governing the freezing of the lead-tin alloys. There is a eutectic of this series when the line AB crosses the line CB , and the components of this eutectic are 95.7 per cent. iron and 4.3 per cent. carbon. In the study of the iron-carbon alloys, however, we have to take into account the solid solution which forms. That is to say, we must remember that iron never separates from the liquid state without carrying 2.2 per cent. of carbon with it in solid solution.¹ It will be remembered that when lead separated from the liquid solution, it carried with it a small amount of tin as an impurity; and that when tin separated, it carried with it a small amount of lead as an impurity; but we disregard these traces of impurity for the sake of simplicity in outlining the laws of solutions. In the case of iron-carbon alloys, however, the 2.2 per cent. of carbon carried out with the iron in solid solution, substantially as an impurity, is too important in its effect upon the material to permit us to neglect it.

2. The line XY therefore divides the diagram in Fig. 238 into two parts. Everything to the left of this line freezes as a solid solution and the laws are similar to the freezing laws of the gold-silver alloys. Everything to the right of the line XY freezes selectively, according to the same laws as those given in the case of the lead-tin alloys. It is because of this difference in the freezing of the alloys that the line XY is arbitrarily considered as the

¹This solid solution may consist of carbon dissolved in the iron, or of iron carbide dissolved in the iron. We do not know definitely which, but it is not necessary to discuss this question just yet.

dividing line between steel and cast iron. That is to say, all the alloys with less than 2.2 per cent. carbon are defined as steel, and all with more than 2.2 per cent. carbon are defined as cast iron.

3. *Freezing of Steel.* — All the steels freeze as solid solutions. Let us consider a solution of 99.5 per cent. iron and 0.5 per cent. carbon at 1650° C. This will be represented by the point *b* in Fig. 238. This cools until it meets the line *AB*, and now it commences to solidify. For a few degrees of temperature it is part liquid and part solid, but by the time it has fallen to a temperature where it meets the line *Aa*, it has become entirely solid, and it is now a homogeneous solution of 0.5 per cent. of carbon in iron. Consider next a solution containing 99 per cent. of iron and 1 per cent. of carbon, at the point *c* in Fig. 238. When this cools to the temperature where it crosses the line *AB* it commences to solidify, and it is in a partly liquid and partly solid condition until it drops to a temperature where it crosses the line *Aa*, upon which solidification is complete, and it now becomes a homogeneous solution of 1 per cent. carbon in iron. The same actions take place with an alloy containing 98.5 per cent. iron and 1.5 per cent. carbon (the point *d* in Fig. 238), and also in the case of 98 per cent. iron and 2 per cent. carbon. In all these alloys we finally arrive at a solid solution of carbon in iron.¹ To this solid solution the name of 'austenite' is given, and this name applies no matter how much or how little carbon is in solid solution. In other words, all the steels are in the condition of austenite as soon as their solidification is complete.

4. *Freezing of Cast Iron.* — The freezing of cast iron is shown by the diagram to the right of the line *XY*, and if we should consider this part as a separate diagram, then it would be similar to Fig. 235, the freezing of the lead-tin alloys. There is one difference to be borne in mind, however: along the line *AB* in Fig. 235 we had a selective precipitation of lead; along the line *AB* in Fig. 238 we have a selective precipitation, not of pure iron, but of iron containing 2.2 per cent. of carbon. In other words, this entity, consisting of a solid solution of iron with 2.2 per cent. of carbon, behaves as if it were an elemental substance. Suppose we have,

¹ The formation of the solid solution from the liquid solution is discussed in detail in Professor Howe's 'Iron, Steel and Other Alloys,' but it requires too much space to be discussed here. For our purpose it is sufficient to know that when freezing is completed, we have a homogeneous solid solution of all of the carbon in all of the iron.

for example, a liquid solution of 2.5 per cent. of carbon in iron at a temperature of 1400°C . This will be represented by the point *e* in Fig. 238. The liquid solution will cool until it reaches a temperature of about 1320°C . At this point there will begin to precipitate the entity of which I have spoken, namely, iron containing 2.2 per cent. carbon in solution. This precipitation will cause the liquid solution to be impoverished in iron, and it will therefore move to the right in the diagram as the temperature falls; or, in other words, it will travel down the line *AB*. By the time the temperature of 1135°C . is reached, a large amount of the entity containing 2.2 per cent. of carbon will have precipitated, and the small amount of liquid solution left will be at the point *B*, that is, the eutectic point, where there is 4.3 per cent. carbon. With further cooling the eutectic will cross the point *B*, and therefore will complete its precipitation and its freezing. It breaks up into crystals, part of which consist of tiny flakelets of the entity before mentioned — iron containing 2.2 per cent. carbon — and the other part of crystals of graphite — i.e., carbon.

5. A similar result will be obtained in the case of a 3 per cent. liquid solution of carbon in iron. This will cool until it reaches 1280°C ., where the same entity will precipitate, decreasing the residual solution in iron so that it travels down the line *AB* and finally reaches the point *B*, after which this eutectic solution at the point *B* will precipitate as before.

6. We may sum up paragraphs 4 and 5 by saying that any solution of iron containing more than 2.2 per cent. and less than 4.3 per cent. of carbon will consist, after freezing, of a eutectic together with a certain amount of previously precipitated entity (consisting of iron with 2.2 per cent. of carbon in solid solution).

7. What will occur in case the solution contains more than 4.3 per cent. of carbon?¹ Take, for example, a liquid solution containing 4.7 per cent. of carbon at a temperature of 1200°C . This will cool until a temperature of about 1170° is reached and the line *CB* is met. As cooling proceeds to lower temperatures, carbon (i.e., graphite) precipitates out and the liquid solution remaining moves to the left in the diagram. That is to say, it travels down the line *CB*. When the temperature 1135° is reached, so much graphite is precipitated that the residual solution is now of the eutectic pro-

¹ It is very seldom that solutions contain more than 4.3 per cent. of carbon, because this much carbon does not readily dissolve in iron.

portions. With further cooling, this eutectic breaks up as before, consisting thereafter of crystals of graphite and of the entity composed of iron with 2.2 per cent. of carbon in solid solution.

8. *Summary.* — To sum up, then, all the solutions of iron and carbon containing less than 2.2 per cent. of carbon will consist,

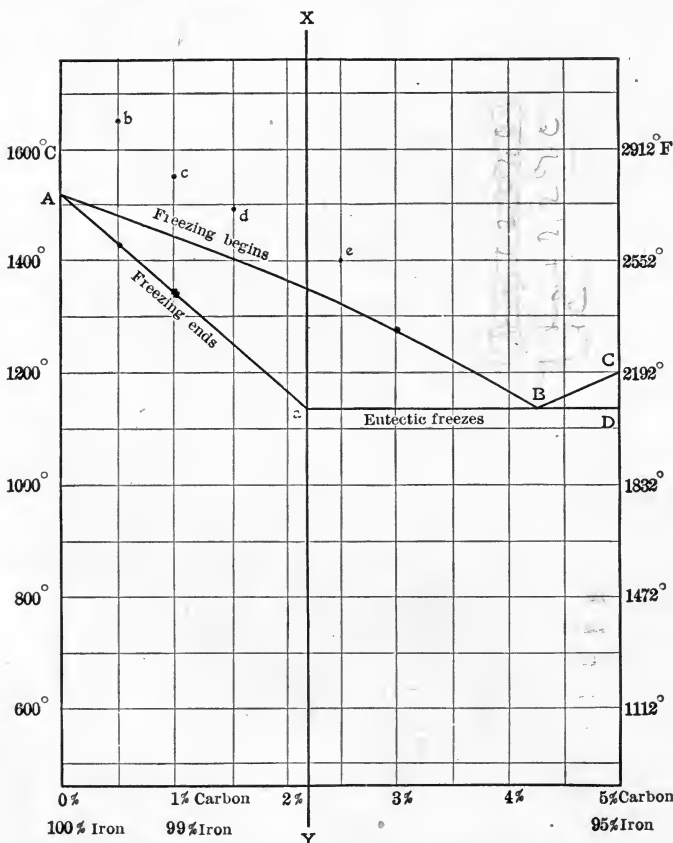

FIG. 238. — THE FREEZING OF ALLOYS OF IRON AND CARBON.

after solidification, of a solid solution of iron and carbon having the same chemical composition as the original liquid solution, and being a homogeneous solution of one in the other. There can be no eutectic formed if there is not more than 2.2 per cent. carbon. All the solutions with more than 2.2 per cent. of carbon will consist, after solidification, of a eutectic together with a certain amount of previously precipitated graphite or of the previously

precipitated entity mentioned (iron with 2.2 per cent. of carbon in solid solution).

9. *Effect of Silicon and Sulphur.* — Silicon and sulphur have an important effect upon the changes that occur in the solidification of the iron-carbon alloys. Silicon has the effect of pushing the point *B*, Fig. 238, to the left. In other words, it causes the eutectic to have less carbon than 4.3 per cent. It thus lessens the amount of total carbon that cast iron usually contains. Silicon seems to have the effect of pushing the point *a* also to the left and thus decreasing the amount of carbon that solidifies in the solid solution. In fact, we may have iron containing 2 or 3 per cent. of silicon in which the iron will solidify with only a small amount of carbon dissolved in it. Sulphur has the opposite effect and tends to push the point *B* to the right and to increase the total carbon.

10. *Rate of Cooling.* — The changes represented in Fig. 238 take place very slowly. This is of great importance, because it renders it necessary, in order that these changes may occur, that the cooling of the solutions shall be very slow. In other words, if we cool rapidly we will not get a precipitation of graphite, even when the eutectic freezes, but will obtain a solid solution containing all the carbon. This solid solution, of course, is not in a normal condition, and theoretically should never be formed to this extent, but is none the less present in many cases, because the cooling was not slow enough. As already noted, however, the presence of silicon hastens the precipitation of graphite, so that silicon in this sense takes the place of slow cooling, and in our high-silicon pig irons we often have a precipitation of almost all the carbon as graphite. In other words, we have only a very small amount of solid solution formed, which probably does not contain as much as 2.2 per cent. carbon.

THE SOLID SOLUTION OF IRON AND CARBON

We have seen that every alloy of iron and carbon contains, after solidification, a varying amount of the solid solution of iron and carbon. For example, if we started with 1 per cent. of carbon, then, immediately after solidification, we would have a solid solution of 1 per cent. carbon in iron; if we started with 1.5 per cent. of carbon, we would have a solid solution containing 1.5 per cent.; if we started with 2.2 per cent. of carbon, then we would have a solid

solution of 2.2 per cent. carbon. Even if we start with more than 2.2 per cent. carbon, then the alloy, after solidification, will consist partly of a solid solution containing 2.2 per cent. of carbon and partly of graphite.

Now, what becomes of these solid solutions which make up a part or a whole of the cast iron and steel alloys when they freeze? Does the carbon remain in solid solution down to the atmospheric temperature, or does it precipitate, or does it undergo some other change? We find by experiment that the solid solutions do not survive, but precipitate at a lower temperature, and the laws governing the decomposition of these solid solutions are similar to the laws governing the decomposition of liquid solutions — for example, of the lead-tin solutions. In short, we have again a series of curves showing the selective precipitation of the constituents of these solid solutions, and the only difference between the nature of these curves and the lead-tin curves is that these represent changes taking place in the solid state, while the lead-tin curves represent changes taking place in the liquid state.

Nature of the Solid Solution. — In the footnote on page 304 I called attention to the fact that the solid solution of iron and carbon might be a solution of pure carbon in iron, or a solution of a carbide of iron in iron, for example, of Fe_3C in iron. Several authorities hold this view,¹ while others maintain that the solution is of elemental carbon in iron. The question is of more academic than practical interest. The important thing is that, when the solution decomposes, it is a carbide of iron which precipitates. Those who believe that the solid solution is composed of elemental carbon and iron explain the precipitation of the carbide by maintaining that when the carbon separates from solution, it immediately unites with iron and forms a carbide, usually Fe_3C . With this explanation I shall hereafter, for simplicity's sake, discuss the solid solutions as if they were Fe_3C in iron.²

¹ Indeed one authority believes that there are probably several different carbides (Fe_3C , Fe_2C , FeC) dissolved in the iron.

² It may be that when the solid solution is very hot, it consists of elemental carbon dissolved in iron, but that as it falls to near the point where it begins to decompose, it consists of iron carbide dissolved in iron. This is the case with the solutions of table salt in water which, at a high temperature, consists of sodium and chlorine dissolved in water; near the freezing-point, however, the sodium and chlorine combine and the solutions consist of sodium chloride dissolved in water.

The Decomposition of the Solid Solutions. — The curves of decomposition of the solid solutions are shown in Fig. 239. The line *GOS* is the line upon which there is selective precipitation of pure iron. To this pure iron the name of 'ferrite' has been given by Professor Howe, and this name meets with universal acceptance.

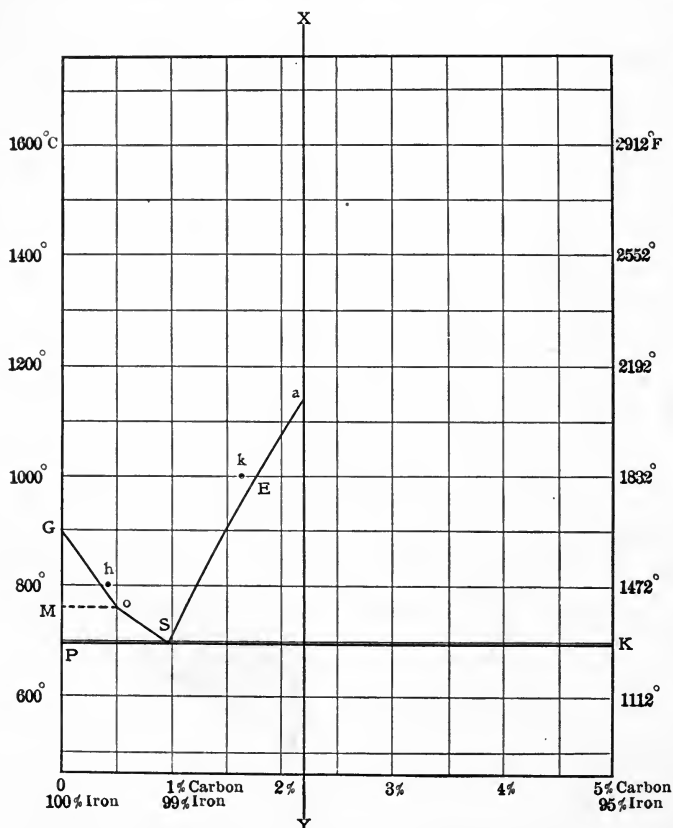

FIG. 239.—DECOMPOSITION CURVES OF THE SOLID SOLUTIONS OF IRON AND CARBON. (ALSO KNOWN AS THE CRITICAL POINTS.)

Consider first a solid solution containing 0.40 per cent. of carbon at a temperature of 800° C. This will be at the point *h* in Fig. 239. It will cool until it reaches a temperature of about 780° C. upon which ferrite will begin to precipitate. As the temperature continues to fall more and more ferrite precipitates, which impoverishes the solid solution in iron and causes it to travel down the

line OS . By the time the temperature has reached 690° , the solid solution has reached the point S , corresponding to 0.90 per cent. carbon.

Consider next an alloy containing 1.60 per cent. carbon at 1000°C .: this will be at the point k . It will cool until it reaches a temperature of about 970° , at which carbide of iron (Fe_3C) will begin to precipitate. This precipitation continues as the temperature falls, constantly decreasing the amount of carbon in the solid solution, which therefore travels down the line ES until, at 690° , it reaches the point S , where there is 0.90 per cent. carbon.

A similar precipitation will take place with all of the solid solutions of iron and carbon: if they contain less than 0.90 per cent. carbon, they will begin to precipitate out ferrite when they fall to the line $GO S$. If they contain more than 0.90 per cent. carbon, they will begin to precipitate carbide of iron when they meet the line ES . In either case the residual solid solution will travel down the line $GO S$, or else ES , until it reaches the point S when the temperature has fallen to 690°C .; we will then have some solid solution left containing 0.90 per cent. carbon, and mixed with this some previously precipitated ferrite or cementite, as the case may be.

Eutectoid. — The alloy containing 0.90 per cent. carbon is known as the ‘eutectoid alloy,’ a name invented by Professor Howe to indicate that the formation of this alloy, which results by selective precipitation of the solid solution, is similar to the formation of the well-known eutectics of liquid solutions. When this eutectoid solid solution cools below 690°C ., it is completely decomposed into its constituents, ferrite and cementite. These constituents precipitate in tiny flakelets, which arrange themselves in the banded structure already familiar to us as the structure of eutectics. A magnified view of the structure is shown in Fig. 241, while Fig. 242 shows the magnified structure of a piece of steel composed of a eutectoid together with previously precipitated ferrite; and Fig. 243 shows the structure of a steel consisting of the eutectoid with previously precipitated cementite.

It will be evident that there will be some of the eutectoid in every piece of iron or steel, for even the cast irons contain, after solidification, a certain amount of solid solution which precipitated either while the liquid alloy was traveling down the line AB ,

or during the freezing of the liquid eutectic (containing 4.3 per cent. of carbon), or both. The formation and characteristic of this eutectoid are therefore of very great importance. Its presence in iron and steel was known long before the theories that I have outlined in this chapter had begun to be understood, and the name of 'pearlite' was given to it because, under certain circumstances, it has the appearance of mother-of-pearl. The name pearlite is only used to designate the eutectoid after its complete decomposition and the separation of the ferrite and cementite into the banded structure shown in Fig. 241.

THE COMPLETE ROBERTS-AUSTEN, ROOZEBOOM DIAGRAM

We may now take the diagrams of Figs. 238 and 239 and combine them into one diagram which shall represent all the known changes in the heating and cooling of iron and steel.¹

All the lines drawn in Figs. 238 and 239 show the temperatures of the changes during cooling.

Explanation of Fig. 246. — In Fig. 246 we have an assembly of the curves showing the changes in the liquid and in the solid state. It is to be observed that the dotted line EF is somewhat doubtful. It was drawn in by Prof. H. W. Bakhuis-Roozeboom in the belief that the solid solution of iron containing 2.2 per cent. of carbon began to decompose at 1000° C. during cooling. There is no direct evidence in favor of this opinion, however, although certain theoretical considerations are in favor of it; but we are not warranted in assuming them as proven. Indeed, the changes that take place in the alloys and at the temperatures between aC and SK are yet very much in doubt, and several different theories are held. If we leave out the line EF , then the line SE would be

¹ For it is to be understood that the changes that I have spoken of as taking place during the cooling are exactly reversed during heating. It is to be observed, however, that the changes that take place during heating occur at a somewhat higher temperature than the reverse changes during cooling. This difference is probably due to a slight lag, so that the changes occur a little below the normal temperature during cooling and a little above the normal temperature during heating. This lag is especially noticeable in the changes that take place in the solid solution, and there is a difference of 20° or more Centigrade between the lines GOS , PSK , etc., if they are observed during heating.



FIG. 240. — EUTECTIC OF COPPER AND SILVER.
(William Campbell.)



FIG. 241. — PEARLITE EUTECTOID OF IRON AND CARBON.
(F. Osmond.)



FIG. 242. — PEARLITE AND FERRITE.
250 diameters.

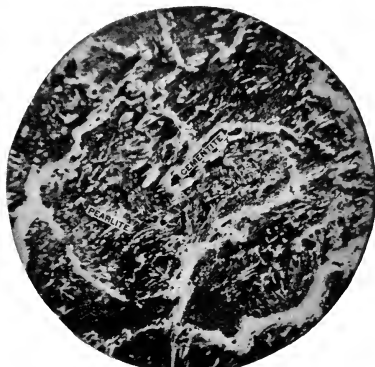

FIG. 243. — PEARLITE AND CEMENTITE.
250 diameters.

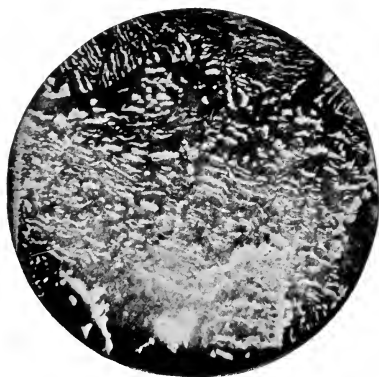

FIG. 244. — PEARLITE.
250 diameters.



FIG. 245. — PEARLITE.
1000 diameters.

Picric Acid.—Large crystallization due to long overheating. Polished in Relief.

extended to *a*, as I have shown in the diagram, and the solid solution containing 2.2 per cent. of carbon will commence to precipitate its cementite immediately after solidification is completed (1135°C.), instead of 135° lower.

Other Lines in Fig. 246. — Certain retardations in the cooling curves would indicate that there was a line extending all the way

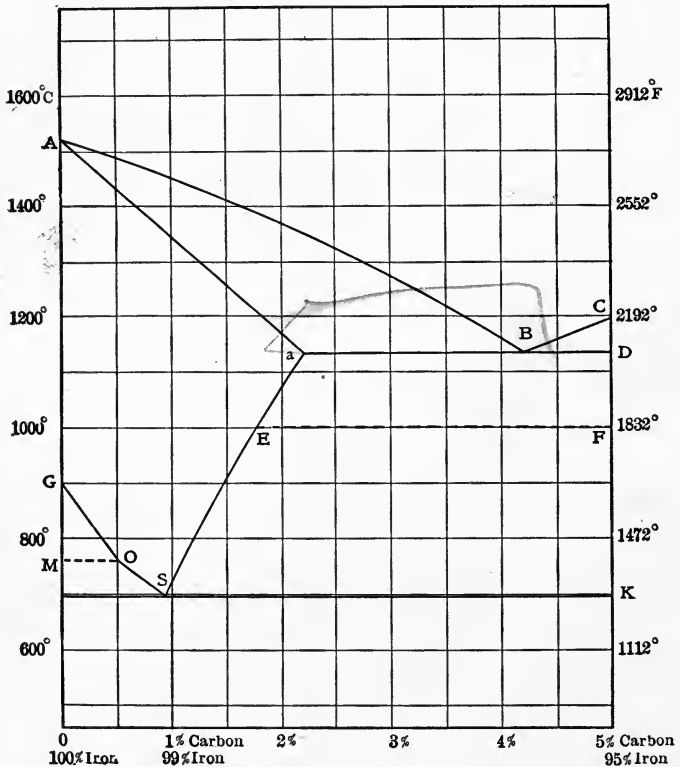

FIG. 246. — THE FREEZING AND SOLID DECOMPOSITION CURVES OF THE IRON-CARBON ALLOYS.

across this diagram at about 775°C. , and another at 600°C. The significance of these lines is as yet a matter of speculation merely, and I believe it to be well to disregard them in this brief treatise until we are able to offer some explanation.

Roberts-Austen. — The diagram of Fig. 246 is often known as the Roberts-Austen diagram, after Sir William Roberts-Austen, be-

cause the cooling curves that located the lines were first determined in his laboratory.¹

¹ See "Proceedings of the Institution of Mechanical Engineers" (England), 1897, Fourth Report of the Alloys Research Committee, Plate 2. See also 'Le Fe et l'Acier au Point de Vue de la Doctrine des Phases," H. W. Bakhuis-Roozeboom, in *Zeitschrift für physikalische Chemie*, vol. xxxiv, p. 437: French translation, "Contribution à l'Etude des Alliages," pp. 327-386, Paris, 1901.

REFERENCES

For further data on this subject see especially Nos. 1, 8, 9, 10.



XI

THE CONSTITUTION OF STEEL

THE properties of steel depend upon the chemical composition of its constituents as well as upon their size and relation to one another. Enough has been said to show that steel is not a simple homogeneous union of iron with varying proportions of carbon, silicon, manganese, etc.; but is built up of individual crystals somewhat in the same way as crystalline rocks are formed—granite, for example. But while the crystals of granite are generally visible to the naked eye, and its structure may therefore be determined by a more or less cursory examination, the structure of steel is visible only by means of the microscope and after careful polishing, sometimes followed by chemical treatment to differentiate between the various grains. Nevertheless, the structure of steel is of great importance, and in some cases, perhaps, is even more so than the chemical composition.

THE MICRO-CONSTITUENTS OF STEEL

In this chapter I shall speak only of slowly cooled steel except where I have indicated the contrary. We have already learned that slowly cooled steel must necessarily contain ferrite and cementite, resulting from the decomposition of the solid solution of iron and carbon. There are also other constituents which are found under the microscope, or separated by chemical analysis, or in both ways. These latter constituents are compounds of iron with various other impurities, such as iron sulphide, iron phosphide and iron silicide; or of two impurities with each other, such as manganese sulphide.

Ferrite. — Ferrite is theoretically pure iron, and especially iron free from carbon. It is weak as compared with several of the other constituents, having a tensile strength of about 45,000 to 50,000 lbs. per square inch; it is also very soft and ductile, re-

sembling copper in these properties, and has, furthermore, a high degree of malleability. It has a very high electrical conductivity as compared with the other constituents of iron and steel, and about one-seventh the conductivity of copper and silver, the best conductors known. (Copper and silver are of nearly the same conductivity.) Its magnetic force is the highest of any known substance, its magnetic permeability being high, and its hysteresis low. It crystallizes in the isometric system.

Ferrite is an important constituent of all steels and the predominant one in all the low-carbon steels. The industrial product approaching nearest to pure ferrite is wrought iron, if we disregard the slag, which, being mechanically mixed with the mass, does not appreciably alter its chemical and physical behavior. It is for this reason that wrought iron is so useful where a soft and ductile material is necessary, as in boilers, for instance; or where high electrical conductivity is demanded, as in telegraph wire; or a high degree of magnetism, as in the cores of electromagnets. The wrought iron made in Sweden, and known as 'Norway iron,' is greatly preferred for this latter purpose, on account of its purity.

Under the microscope ferrite may be distinguished from cementite by its softness. If steel containing these two constituents be polished on damp, rough parchment, or on chamois skin stretched over a soft background (as wood), the ferrite will wear away below the carbide and appear in intaglio. The same effect will be obtained by Osmond's 'polish attack.'¹ Ferrite is also distinguished from carbide of iron by the fact that, after being subjected to the brief action of certain reagents, such as 2 per cent. nitric acid, or ordinary commercial tincture of iodine, the ferrite is seen in darker grains and the carbide in bright thin plates, unattacked by the reagent. When the two are intimately associated in minute grains, as in pearlite, the carbide appears bright and the ferrite dark, because eaten away below the surface by the reagent.

Allotropic Modifications. — There is one peculiarity of pure iron, or ferrite, which, on account of its importance, deserves special attention, namely, its ability to assume different allotropic modifications at different temperatures. The nature of allotropism has already been explained (see page 486). To the allo-

¹ See page 453.

tropic modification of iron the names of 'alpha,' 'beta,' and 'gamma' have been assigned. The alpha modification is the one existing at atmospheric temperatures, and it is familiar to all who make or use iron. If this be heated, however, it undergoes a sudden change at about 760° C. (1390° F.). This change is evidenced by an absorption of heat and the circumstance that the iron loses almost entirely its power to attract a magnet; that is to say, it becomes about as non-magnetic as lead, copper, etc. The change in magnetism is accompanied by a change in electrical conductivity, in specific heat and in other properties. In short, the iron has changed in many of its properties without undergoing any alteration in chemical composition. This new allotropic modification of iron is known as beta iron.

If, now, beta iron be further heated to a temperature of about 890° C. (1634° F.), it again changes several of its properties and becomes what is known as gamma iron. Gamma iron differs from beta iron, especially in electrical conductivity and in crystalline form. Ferrite crystallizes always in the cubic system, and Osmond¹ and Stead² have studied the variations of form assumed by it and by its alloys with carbon. Osmond especially has studied the crystallography of the gamma, beta, and alpha modifications of the pure metal. Gamma iron does not crystallize isomorphously with either beta or alpha iron, which crystallize identically in cubes; but it assumes all the combinations of the cube and octahedron, and, in the latter form would be isomorphous with carbon in the diamond form. Therefore, in the isomorphous mixtures (i.e., solid solutions) of iron and carbon one would expect to find some carbon in the diamond form, which has indeed been accomplished by Osmond. This is used as an argument in favor of the belief that the solid solution is with carbon, not with cementite; for Osmond has shown³ that cementite does not assume any crystalline form which would be isomorphous with ferrite. Beta and alpha iron do not crystallize isomorphously with either carbon or cementite, which accords with the observed tendency of ferrite to begin to separate from the solid solution at the same temperature at which it changes from gamma to beta iron.

If ferrite is in the gamma form, say at 1000° C. (1832° F.), then it will undergo upon cooling the changes which, as I

¹ See No. 110, page 332.

² See No. 181, page 457.

³ See No. 181.

have outlined, it undergoes on heating, but reversed. That is to say, at about 890°C . (1634°F .) it will change from gamma to beta iron; at 760° (1390°F .) it will change from beta to alpha iron, in each case receiving again the properties which it had before heating. In other words, the change from one allotropic form to another is a reversible change, taking place in one direction on cooling and in the opposite direction on heating. The change on cooling takes place at a slightly lower temperature than on heating. This is not because it is other than a true reverse action, but because the change in either direction is necessarily slow and lags a little behind the temperature. The amount of this lag will vary directly with the speed of heating and cooling.

We never get pure gamma iron at any temperature unless we start with iron free from carbon, because gamma ferrite never separates from the solid solution. If, however, we have a solid solution of iron with, let us say, 0.2 per cent. of carbon, then this solid solution will begin to precipitate ferrite at a temperature of about 830°C . (1524°F .) This ferrite will be, of course, in the beta form and will be non-magnetic until the mass cools below 760° (1390°F .), when the previously precipitated ferrite will change from the beta to the alpha form. Any ferrite which separates from solid solution after that temperature is reached will separate in the first instance in the alpha form. For example, if we have a solid solution, containing, say, 0.7 per cent. carbon, this will commence to precipitate ferrite below 760°C . (about 720°), and the ferrite will be in the alpha form.¹

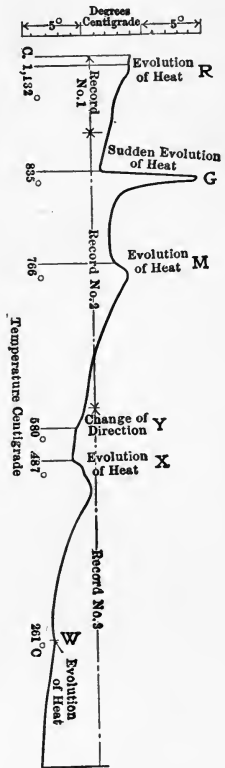

FIG. 247. — COOLING CURVE OF PURE IRON.

¹Some maintain that the ferrite always precipitates as gamma ferrite, then immediately changes to beta and next to alpha ferrite. Others maintain that when the solid solution is cooled near the line GOS , it changes from a solid solution of gamma iron into a solid solution of beta iron, and then

Cementite. — The carbide of iron, Fe_3C , is, next to ferrite, the most important constituent of steel, and practically all of the carbon is present in this form.¹ Cementite is very hard and brittle, scratching glass with ease and flying into pieces under a blow. It crystallizes usually in thin flat plates, which are large in size (sometimes up to $\frac{1}{8}$ in. in diameter) when there is much cementite present. It is attacked by reagents less than most of the other constituents and is in this way distinguished under the microscope. It is a little difficult to distinguish, by microscopic evidence alone, between steel consisting of pearlite with a slight excess of cementite and steel, consisting of pearlite with a slight excess of ferrite. The practiced eye can usually tell; but a chemical analysis readily distinguishes, since steel with less than 0.9 per cent. carbon will have excess ferrite over pearlite, and that with more than 0.9 per cent. will have excess cementite.

Cementite contains 6.6 per cent. of carbon, or, roughly, is one-fifteenth carbon. We may therefore tell the amount of cementite in any steel by multiplying the amount of carbon by fifteen.² Cementite may be separated from steel by electrolysis.³ It is magnetic at ordinary temperatures, but not above 700°C . (1292°F .).

The carbon united with iron in cementite has been given various names, such as 'cement carbon,' or 'carbon of cementation' (because of its prominent appearance in cemented steels), and 'carbon of the normal carbide,' 'annealing carbon' (because all the carbon of well-annealed steels will usually be present as cementite).

Manganiferous Cementite. — Manganese forms a carbide having the formula Mn_3C . This is isomorphous with Fe_3C , and we often find the two carbides together in one crystal. The name cementite is still applied to this crystal, although it must be recognized that

into a solid solution of alpha iron, from which alpha iron then precipitates. These questions are chiefly academic and of almost no practical importance; nor is it yet known which is the actual order, though many are inclined to agree with Professor Sauveur (see No. 111) upon the latter order.

¹ There is not wanting evidence in favor of other carbides being discovered, such as Fe_2C and FeC .

² In other words, steel containing 0.5 per cent. of carbon will contain 7.5 per cent. cementite; steel containing 1 per cent. carbon will contain 15 per cent. cementite; etc.

³ See No. 112, page 332.

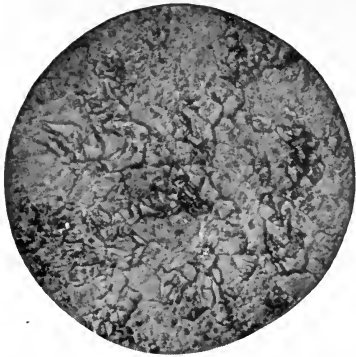

FIG. 248. — FERRITE, PURE IRON
(ELECTROLYTIC.)
1000 diameters. Etched with picric acid.



FIG. 249. — PEARLITE CRYSTALS.
Surrounded by ferrite. Magnified 250
diameters. Etched with HNO_3 .



FIG. 250. — BIG CEMENTITE CRYSTAL
IN PEARLITE.
Magnified 250 diameters. Polished in
relief.



FIG. 251. — CRYSTALS OF MANGA-
NIFEROUS CEMENTITE.
Magnified 50 diameters. Etched with
nitric acid.



FIG. 252. — ELONGATED BUBBLE OF
MANGANESE SULPHIDE.
Magnified 250 diameters. Unetched.



FIG. 253. — EUTECTIC OF Fe_3P AND
IRON.
Magnified 1000 diameters. Etched with
picric acid.

a part of the iron has been replaced by manganese, and the formula for the compound is usually written $(\text{FeMn})_3\text{C}$. The amount of manganese in these crystals is very variable, running almost all the way from nothing to 100 per cent. As manganese has an atomic weight almost the same as that of iron (Mn 55, Fe 56), one weight of manganese will replace almost exactly an equal weight of iron in the crystal. The peculiarity of the manganiferous cementite is that the crystals of free cementite are liable to be larger, especially when the proportion of manganese is large, and are seemingly harder and more difficult to machine.

Manganese Sulphide. — Manganese and sulphur unite to form manganese sulphide, having the formula MnS , and this compound is found in all steels. Indeed, all of the sulphur will be found in this combination, provided there is enough manganese in the steel to unite with it. It is necessary to have more than the theoretical amount of manganese for this purpose, however, because unless there is a surplus present, the attraction of the manganese for the sulphur does not seem to be always sufficient to catch it all. Steel should therefore always contain about four times as much manganese as sulphur, because it is advantageous to have the sulphur all in the form of manganese sulphide.

Manganese sulphide is seen under the microscope as a dove-gray substance before the polished material is etched with any reagents. It is usually collected together in round drops, which are sometimes, if large in size, seen to be elongated by the rolling or hammering of the material (see Fig. 152).

Manganese tends to make the crystals of steel smaller, which is advantageous, but makes the metal more liable to crack in heating, and still more so in cooling suddenly from a red heat.

Iron Sulphide. — The bulk of the sulphur not united with the manganese will be found in the form of iron sulphide, FeS . This iron sulphide is more brittle than manganese sulphide, and instead of coalescing in drops, it spreads out in webs or sheets. It is therefore very weakening to the steel, because the area of weakness is more extensive than the tiny spots of manganese sulphide. Steel containing iron sulphide is liable to show poor tensile test and low ductility. It is at the rolling temperature, however, that iron sulphide produces the greatest weakness, because at this point it is in a liquid form and therefore has practically no adhesion to the crystals of steel, which are liable

to break along the planes or meshes of sulphide. The same is true, to a less extent, of the effect of manganese sulphide, which is also in a liquid or pasty condition at the rolling temperature; but the extent of its damage is not so great on account of its drawing together in drops.¹ These facts explain the well-known beneficial effect of manganese in counteracting the damage due to sulphur in iron and steel.

Iron Phosphide. — Iron forms at least one phosphide, having the formula Fe_3P , and this phosphide forms with iron a series of alloys, of which the eutectic contains 64 per cent. of Fe_3P (10.2 per cent. of phosphorus). This results in a considerable lowering of the melting-point of iron for each addition of phosphorus. Even 1 per cent. of phosphorus will make the melting-point of the metal very much lower, and it is for this reason that foundry irons are often desired with a high content of phosphorus. Even where there is a smaller amount of phosphorus, there will be some of the phosphorus eutectic formed, and this remains in a molten condition for some time after the bulk of the steel has solidified. This liquid eutectic tends to migrate to the spaces between the crystals, where it remains after solidification and forms a very brittle network, which naturally makes the whole mass more or less brittle. For these reasons phosphorus is the greatest source of brittleness in steel, and especially brittleness under shock, and is thus a great enemy to the engineer and other users of the material.

Besides forming the eutectic, as I have described, phosphorus also tends to produce coarse crystallizations in steel, and this makes it both weak and brittle. It is a fact observed many times that the embrittling effect of phosphorus on steel is much less when the steel is very low in carbon, and as the carbon rises so the brittleness caused by phosphorus rises. This and other effects of phosphorus have been explained by Prof. J. E. Stead in two very able papers.² He has shown that a little phosphorus will dissolve in ferrite and that then the eutectic which produces the brittleness will not form, but as the carbon in the steel increases, it precipitates the phosphorus from the ferrite solid solution and therefore causes the eutectic to form. Hence, the more ferrite and the less cementite in steel, the less will be the brittleness produced by phosphorus.

¹ See No. 113, page 332. ² See No. 184 on page 157 and No. 115 on page 332.

Iron Silicides. — There seem to be three or more silicides of iron, but the one having the formula FeSi seems to be found most commonly in steel. It appears to increase very slightly the strength of steel, and also, to a limited extent, its hardness. The chief importance of silicon, however, as already pointed out, is in promoting soundness.

Iron Oxides. — Oxygen occurs in steel in the form of FeO and Fe_2O_3 . In either form its presence is very harmful, producing brittleness in both hot and cold steel, besides causing the liability to blow-holes already discussed. There is probably no constituent more harmful to steel than oxygen, and unfortunately the chemists are far behind in respect of not yet having found a satisfactory method of accurately determining small traces of this gas. The effect of oxygen is somewhat similar to that of sulphur and, in common parlance, makes the steel 'rotten.'

Nitrogen and Hydrogen. — Both nitrogen and hydrogen occur in steel, and one of the theories to explain the superiority of crucible steel is based upon the relative freedom of this material from these two gases. The amount of nitrogen and hydrogen present is usually very small. Hydrogen dissolves very easily in iron at a high temperature, but is evolved in part as the metal cools. In order to obtain entire freedom, however, it is necessary to heat and cool several times in vacuo.

THE STRENGTH OF STEEL

The properties of steel most commonly desired are strength and ductility. Unfortunately there is more or less incompatibility between these two. That is to say, as the strength of steel increases, the ductility usually decreases; and, conversely, as the ductility increases, the strength usually decreases. There are other properties of steel which are likewise of importance, either because they are desired, or the reverse. Among these we shall especially discuss hardness, brittleness, electric conductivity, magnetic permeability, magnetic hysteresis, permanent magnetism and weldability.

Pure iron has a tensile strength of about 45,000 lbs. per square inch and a compressive strength of about 80,000 lbs. per square inch. These are increased by means of several of the ordinary impurities found in steel, but the most important strengthener is

carbon, because this will give the maximum increase in strength with the least decrease in ductility.

Carbon. — Each increase in carbon (cementite) gives an increase in tensile strength until we reach a maximum of about 0.9 to 1 per cent. of carbon (13.5 to 15 per cent. cementite). With further increase in cementite there is a decrease in tensile strength. It is probable that the reason for this maximum of tensile strength at approximately the eutectoid ratio of the steel is due largely

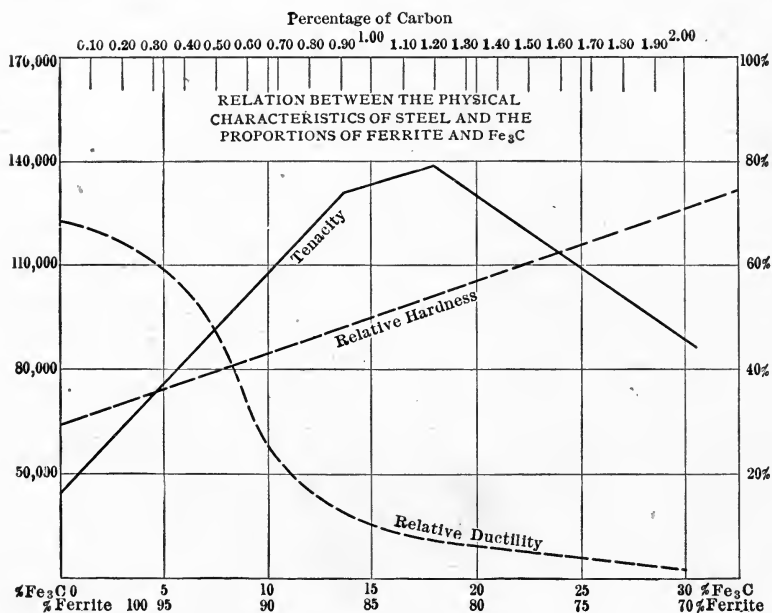

FIG. 254. From Howe, "Iron, Steel and other Alloys."

to the small crystallization and the intimate mixture of the crystalline constituents when the steel is at, or near, the eutectoid proportions.¹ With less cementite the grains of pearlite are surrounded by a network of ferrite; with more cementite the grains of pearlite are surrounded by a network of cementite, and both of these networks have a weakening effect upon the material by decreasing the adhesion of the crystals. The relation between carbon and tensile strength is shown graphically in Fig. 254.²

¹ The still greater increase in strength when the two constituents of the pearlite (ferrite and cementite) are even more intimately associated is explained on page 392. ² See page 438 of No. 1 on page 8 herein.

H. H. Campbell and W. R. Webster have studied exhaustively the effect of the different impurities upon the tensile strength of steel. The latest word on this subject has been said by Campbell who gives¹ the following rule for the effect of each 0.01 per cent. of carbon on acid and on basic open-hearth steel. Starting with 40,000 lbs. per square inch for pure steel, each 0.01 per cent. of carbon will increase the strength by 1000 lbs. per square inch in the case of acid open-hearth steel, and by 770 lbs. per square inch in the case of basic open-hearth steel. Because the color method of determining the amount of carbon does not show all the carbon present, the figures given above must be replaced by 1140 lbs. and 820 lbs. for each 0.01 per cent. of carbon, when the color test is used. We have no data to determine the strengthening effect of carbon in Bessemer and crucible steel, but it is probable that a little lower value than that given for basic open-hearth steel would be used for Bessemer, and a little higher value than that given for acid open-hearth steel would be used for crucible steel.

Silicon. — The effect of silicon on strength is probably very small in the case of rolled steel. In the case of castings, however, an important increase in tensile strength may be obtained by increasing the silicon to 0.3 or 0.4 per cent. This practice results in practically no decrease in ductility, but it is necessary to supply larger risers on account of the deep piping that will be produced. It is probable that the beneficial effect of silicon in this case is due very largely to its producing soundness.

Sulphur. — H. H. Campbell says that the effect of sulphur on the strength of acid and basic open-hearth steel is very small. It is probable, however, that this statement is only true when the sulphur is in the form of manganese sulphide, because the effect of iron sulphide would be to lower the strength and the ductility of the material. The worst effect of sulphur is undoubtedly its production of 'red-shortness' and the liability to cause checking during rolling, or, in the case of a casting, during cooling.

Phosphorus. — Campbell states that each 0.01 per cent. of phosphorus increases the strength of the steel by 1000 lbs. per square inch. It should be observed, however, that this increase of strength is measured by the resistance of the material to stresses slowly applied and that it ceases with 0.12 per cent.

¹ Page 391 of No. 2, page 8.

phosphorus and is reversed. In the case of vibratory stresses and sudden shocks, phosphorus is probably the most harmful of the elements, so that it is undesirable to increase the strength of steel by means of this element. This is the more true because of the brittleness produced by phosphorus, for an increase of strength obtained through this medium is accompanied by a much greater decrease in ductility than when the same increase in strength is obtained through the medium of carbon.

Manganese. — The beneficial effect of manganese on tensile strength begins, according to the same authority, only when the manganese is above 0.3 or 0.4 per cent. With less manganese than this, in the case of open-hearth and Bessemer steels, the presence of some other condition, probably iron oxide, masks the effect of manganese. It will be remembered that when the manganese is low, open-hearth and Bessemer steels are harmfully charged with oxygen. Furthermore, the effect of manganese is dependent upon the amount of carbon present. In acid open-hearth steel each 0.01 per cent. of manganese (beginning at 0.4 per cent.) increases the strength 80 lbs. per square inch when the carbon is 0.1 per cent., but each increase of 0.01 per cent. of carbon increases the strengthening effect of manganese by 8 lbs. So that, for example, if we have an acid open-hearth steel containing 0.4 per cent. of carbon, then each 0.01 per cent. of manganese will increase the strength by 320 lbs. per square inch. In the case of basic steel each 0.01 per cent. of manganese (beginning at 0.3 per cent.) increases the strength 130 lbs. per square inch when the carbon is 0.1 per cent., and so on to 250 lbs. per square inch when the carbon is 0.4 per cent., for each additional 0.01 per cent. of carbon increases the strengthening effect of manganese on basic steel by 4 lbs. (See Table XXVI.)

Formulae. — Campbell gives the following formulæ for the strength of acid and basic open-hearth steels:

For acid steel: $40,000 + 1000C + 1000P + xMn + R = \text{ultimate strength.}$

For basic steel: $41,500 + 770C + 1000P + yMn + R = \text{ultimate strength.}$

In these formulæ, C = 0.01 per cent. carbon (determined by combustion), P = 0.01 per cent. phosphorus, Mn = 0.01 per cent. manganese, and R = a variable, depending upon the heat treatment which the steel has received. For X and Y see Table XXVI.

Copper. — Copper, up to at least 1 per cent., does not appear

TABLE XXVI.—EFFECT OF EACH 0.01 PER CENT. MANGANESE ON OPEN-HEARTH STEEL

PERCENTAGE OF CARBON	On Acid Steel X	On Basic Steel Y
	Lbs. per sq. in.	Lbs. per sq. in.
0.05.....	...	110 ²
0.10.....	80 ¹	130
0.15.....	120	150
0.20.....	160	170
0.25.....	200	190
0.30.....	240	210
0.35.....	280	230
0.40.....	320	250
0.45.....	360	...
0.50.....	400	...
0.55.....	440	...
0.60.....	480	...

¹ Beginning only with 0.4 per cent. of manganese.

² Beginning only with 0.3 per cent. of manganese.

to have any important effect upon the strength or ductility of low- and medium-carbon steels, but increases the brittleness of steel containing 1 per cent. carbon. When the sulphur is more than 0.05 per cent. copper appears to make the steel roll less easily and above 0.5 per cent. of copper appears to make high-carbon steel draw less easily into wire.

Arsenic. — Some steels contain arsenic, which does not appear to have any effect when it is below 0.17 per cent., but any larger quantity raises the tensile strength and decreases the ductility to a very important extent.

Oxide of Iron. — All Bessemer and open-hearth steels contain more or less oxide of iron, there probably being more in basic steel than in acid, and more in Bessemer steel than in basic open-hearth steel. It is probable that this oxide of iron has not any very marked effect upon strength, as Campbell quotes some steels containing quantities larger than usual whose strength is good. No data are given as to the ductility, however, and it is probable that oxide of iron has a deleterious effect upon this quality.

HARDNESS AND BRITTLINESS OF STEEL

As a general thing the hardness and brittleness of steel increase together. The chief commercial application of this property is in such articles as railroad rails and car-wheels, bevel- and spur-

gears, axles and bearings, the wearing parts of crushing machinery, etc.¹ To produce hardness in these materials carbon is the chief agent used, because it gives the maximum hardness with the least brittleness. It is for this reason that railroad rails are now made up to 0.7 per cent. carbon, and although this material is somewhat brittle and breakages occasionally occur, the high carbon is demanded in order that the head of the rail may be durable. It is probable that even higher carbon than this would be used if it were not for the brittleness already in the ordinary railroad rails, due to the fact that, being made by the acid Bessemer process, they contain nearly 0.1 per cent. phosphorus. Phosphorus increases both the hardness and the brittleness, especially under shock. Manganese likewise increases hardness, and especially the kind of hardness which makes it more difficult and more expensive to machine the metal. With more than about 1 per cent. of manganese the steel becomes somewhat brittle. When the content rises above 2 per cent. the steel is so brittle as to be practically worthless. In this connection a curious phenomenon is observed, in that a still further increase in manganese produces a reversal of its influence, and when we have more than 7 per cent. the metal is not only extremely hard and practically impossible to machine commercially, but becomes, after heat treatment, very ductile and tough. This will be considered more fully in Chapter XV.

Silicon. — Silicon makes the steel slightly harder, but apparently without increasing its brittleness, unless we have more than 0.5 or 0.6 per cent.

ELECTRIC CONDUCTIVITY OF STEEL

The purer the material and the nearer it is to ferrite, the better will be its electric conductivity; therefore only wrought iron, or the softest and purest forms of steel, are used generally for wire for electric conduits.² The case is somewhat complicated when

¹I purposely omit here the consideration of such hardness as that produced in springs, cutting tools, etc., by heating the steel to a bright-red heat and plunging into water, as this will be discussed in Chapter XIV.

²Omitting, of course, the use of copper, which is not under consideration in this book, but which is probably the most important material used for electric conductors.

we come to third rails for electric railroads, which have now become a very important industrial product, because so pure a material will be very soft and will rapidly wear away under the abrasion of the contact-shoes. To increase the hardness of these rails with the least decrease in electric conductivity, it is best to avoid nickel and manganese, which decrease electric conductivity in greater proportion than the other elements, and to obtain the hardness as much as possible from phosphorus, and not from carbon, because phosphorus will give the greatest amount of hardness with the least decrease in the purity of the iron. As high phosphorus steels are difficult to roll, however, the section of the rail chosen should be as free as possible from sharp corners and thin flanges, in order that the tearing action in rolling may be as slight as possible.

MAGNETIC PROPERTIES OF STEEL

Alpha ferrite is the magnetic constituent of iron and steel, and therefore the greater the amount of this constituent present, the greater will be the magnetic force and magnetic permeability of the material and the less its magnetic hysteresis. On this account the cores of electromagnets, the armatures of dynamos, etc., are commonly made of Swedish wrought iron, which is the purest commercial form of iron made.¹

Ferrite has no permanent magnetism, but immediately loses its magnetic force when it is out of contact with a magnet, or, in the case of cores of electric magnets, when the electric current is cut off. Permanent magnets are therefore made of a high-carbon steel (1 per cent.), whose strength and permanency are increased if about 5 per cent. of tungsten is present. This steel is heated above the critical temperature and hardened in water, after which it is magnetized by causing an electric current to flow around it for a short time. Steel so treated will retain the magnetic force for many years. Osmond has explained the permanent magnetism of steel in the following very ingenious manner: Each molecule of alpha ferrite is believed to have a north and a south magnetic pole, which, in the ordinary unmagnetized condition of the iron,

¹ A silicon alloy of iron with a double-heat treatment discovered by R. A. Hadfield, and having a very high magnetic force and permeability, will be discussed under the head of "Alloy Steels."

will be oriented in many different directions, as shown in Fig. 255. When this piece of iron is placed in the magnetic field, however, the molecules arrange themselves in accordance with the lines of magnetic force, with their north poles all in one direction and their south poles all in the opposite direction, thus making the whole piece of iron a magnet. As soon as the magnetic force is removed, however, the molecules all return to their original orientation, and the whole piece of iron loses its magnetism. We have already learned that it is only the alpha molecules which have

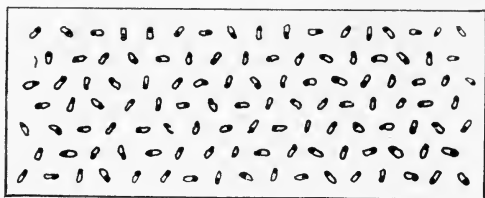

FIG. 255.

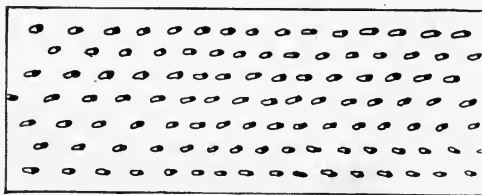

FIG. 256.

north and south magnetic poles, and if the steel consists entirely of beta or gamma molecules, it is not capable of becoming magnetic. According to Osmond's theory, when steel is cooled rapidly from above the critical temperature, the shortness of the time taken in reaching the atmospheric temperature is such that only a part of the molecules are able to change to the alpha allotropic form, and the remainder are retained in the gamma form. This retention is assisted by the 1 per cent. of carbon present, which acts as a brake to make the change slower. When, now, this hardened steel is subjected to the magnetic force, the alpha molecules orient themselves with their north poles all in one direction; but when the magnetic force is removed there is a certain number of gamma molecules present to interfere with the free movement of the alpha molecules and prevent them from

returning to the original unoriented position. This explanation implies that the magnetic force is sufficient to overcome the resistance of the gamma molecules and force the alpha molecules into a magnetic position, but that the force of the alpha molecules tending to return to their original position is not so great.

The welding of steel and the effect of different elements upon it will be discussed in Chapter XIV.

REFERENCES ON THE CONSTITUTION OF STEEL

110. F. Osmond and G. Cartaud. "The Crystallography of Iron." *Journal Iron and Steel Institute*, No. 111, 1906, pages 444-492.
111. Albert Sauveur. "The Constitution of Iron-Carbon Alloys." Same *Journal*, No. 4, 1906, pages 493-575.
112. J. O. Arnold and A. A. Read. "Chemical Relations of Carbon and Iron." *Journal of the Chemical Society*, vol. lxxv, page 788.
113. J. O. Arnold and G. B. Waterhouse. "The Influence of Sulphur and Manganese on Steel." *Journal Iron and Steel Institute*, No. 1, 1903, pages 136-160.
114. J. O. Arnold. "The Influence of Elements on Iron." Same *Journal*, No. 1, 1894, page 107.
115. J. E. Stead. Same *Journal*, No. 11, 1900, pages 60 et seq., and also Cleveland Institution of Engineers, September 6, 1906.
116. Bradley Stoughton. "Notes on the Metallography of Steel." International Engineering Congress, 1894. *Transactions, American Society of Civil Engineers*, vol. liv, Part E, pages 357-421.
117. *Proceedings of the American Society for Testing Materials*, vol. i, 1901; vol. vii, 1907. Philadelphia. This society is composed of representative men from the great purchasers and users of engineering and other kinds of materials in America, from the manufacturers and of representative scientific men. All sides of the question are usually represented in the discussions of this society.
118. *Proceedings of the International Association for Testing Materials*. Vienna, Austria.

XII

THE CONSTITUTION OF CAST IRON

PRACTICALLY all the cast iron which is not purified is used for making iron castings, so that a study of the constitution of cast iron resolves itself into a study of iron castings. The difference between cast iron and steel is that the former contains less iron and more impurities, especially carbon, silicon, phosphorus, and occasionally sulphur and manganese. The advantages of cast iron, and the reason it is used as much as it is, are its fluidity, lesser amount of shrinkage when cooling from the molten state, relative freedom from checking in cooling, and the ease with which very different properties are conferred upon it at will. Its disadvantages are its weakness and lack of ductility and malleability. The last-named deficiency renders it practically impossible to put any work upon cast iron; hence it can never be wrought to shape and must always be used in the form of castings. Its most important advantage is probably its ready fusibility, which makes it so easy to melt and cast, and its cheapness.

Graphite. — All of the characteristic qualities of cast iron are due to the presence of the large amount of impurities in it. These impurities are the same in kind as the impurities in steel, and differ only in amount, with the single exception of graphite. This constituent is almost never found in steel, or is found in such a very small number of cases, and those cases being confined to the high-carbon steels, the amount of which is very small in comparison, that we may almost disregard it. In cast iron, however, it is the largest and one of the most important constituents. It occurs in thin flakes, in sizes varying from microscopic proportions to an eighth of a square inch in area,¹ disseminated through the body of the metal and forming an intimate

¹ In rare and unusual cases the flakes of graphite may be as much as an inch and a half to two square inches in area, but practically never so large in the commercial cast irons.

mechanical mixture, a magnified section of which is shown in Fig. 259. Each flake of graphite is composed of smaller flakes, built up somewhat like the sheets of mica with which all are familiar, but with very little adhesion between the small component flakes, so that the sheet of graphite may be split apart with very little force. Graphite is very light in weight, having a specific gravity of only about 2.25 as compared with a specific gravity of 7.86 for pure iron; consequently although the percentage of graphite by weight is only 4 per cent. or less of the iron, its percentage by volume may be, in normal cases, as much as 14 per cent. This may readily be seen by noting the amount of space occupied by the graphite flakes in Fig. 263.

Combined Carbon. — We have already discussed the solidification and cooling of cast iron, and it will be remembered that all the carbon which does not precipitate as graphite forms first as austenite, which later decomposes into ferrite and cementite. In short, all the carbon in cast iron will ultimately be found partly in the form of graphite and partly in the form of cementite. The carbon of cementite in cast iron commonly goes under the name of 'combined carbon,' but it must be remembered that cementite is the constituent which gives the observed effects.

White Cast Iron. — In white cast iron the carbon, amounting often to 3 or 4 per cent., will all be in the form of cementite, which will therefore form 45 to 60 per cent. of the material; consequently white cast iron will possess largely the properties of cementite. It is very hard and brittle, being machined only with the greatest difficulty and with special kinds of cutting tools, and resisting wear by abrasion very effectively. It is so brittle as to be readily broken by the blows of a hammer, and is weak because of the presence of very large plates of cementite, which adhere but slightly to one another. Consequently white cast iron has few uses and is employed usually only as a hard surface on the outside of gray-iron castings.

Gray Cast Iron. — Gray cast iron will have about the same total amount of impurities present as white cast iron, the only difference being that the carbon is now partly or wholly precipitated as graphite. The gray color of a freshly broken fracture, from which this material receives its name, is due altogether to the graphite present, for this constituent is so weak that the iron breaks chiefly through its crystals, which are rent asunder,

leaving one part sticking to each side of the fracture. The weakness of gray cast iron as compared with steel is thus readily understood, since there is but a small proportion of metallic surface to be broken and the graphite splits so easily. An interesting experiment is to take a freshly broken surface of gray pig iron and brush one-half of it for some time with a stiff brush. In this way the adhering crystals of graphite are partially removed and we get a surface which is almost as white as the fracture of white cast iron. This shows clearly that the gray color is due altogether to the graphite and that the metallic part is as silvery white as iron itself. The prevalence of the gray color also shows how completely fracture takes place through the graphite crystals.

Gray cast-iron castings are by far the more important, and the study of their constitution is the chief object of this chapter. These castings usually contain 2 per cent. or more of graphite and less than $1\frac{1}{2}$ per cent. of combined carbon. It will be observed that this limit of combined carbon is also the range found in steel. Furthermore, it will be observed that the graphite is not a chemical component of the metallic body, but is mechanically mingled with it. In this sense, therefore, we may consider gray cast iron as a very impure steel,¹ mechanically mixed with graphite, and upon this reasoning the study of its constitution becomes much simpler,² as we may study first the properties of the metallic part, and next that of the graphite, and so be able to foretell to some extent the properties of the mixture. Indeed, the properties of the metallic part are already understood pretty well from our discussion of the constitution of steel, and there is no new constituent or new condition except the larger amounts of silicon and phosphorus, which are of minor importance, because their effect is collectively far less than the weakening and embrittling effect of the graphite. Even though we had a very pure metallic

¹The silicon in gray cast iron is usually between 0.75 per cent. and 3 per cent., or, let us say, ten times that in steel, while the phosphorus is usually from 0.5 to 1.5 per cent., or, again, about ten or more times that in steel. The sulphur varies greatly, but is not infrequently as high as 0.15 to 0.2 per cent. Manganese is an exception and is usually no higher in cast-iron castings than in steel.

²This theory of the constitution, which meets with very favorable acceptance in many quarters, was independently evolved by J. E. Johnson, Jr. (*American Machinist*, 1900), and H. M. Howe (*Trans. A. I. M. E.*, 1901, vol. xxxi, pp. 318-339).

constituent, the strength and ductility of this portion would not be sufficient to prevent the mass as a whole breaking at a small load and without exhibiting any practical ductility, because of the weakening effect of the crystals of graphite. In other words, it is the carbon which is the great factor in determining the properties of cast iron, for this may be either all graphitic, or all combined, or part in both conditions.

Effect of Temperature. — By running the blast furnace very hot, we may extend the saturation point of the iron for carbon and thus get a slightly higher total carbon. This is not a very potent influence, however, for we seldom have total carbon more than 4.5 per cent., or less than 3.25 per cent. This control, such as it is, may be exercised either during the manufacture of the pig iron or during the remelting in the cupola, because in the latter furnace the liquid iron is in contact with coke and will absorb carbon up to its saturation point at the existing temperature.

Rate of Cooling. — A far more potent influence, however, is the transfer of carbon from the graphitic into the combined form, or vice versa, by rapid or by slow cooling from the molten condition. It will be remembered that the carbon is always dissolved in the iron when the mass is in a molten condition, that is, when it is above the lines *AB* and *BC* in Fig. 246. As we cool from the molten state, graphite precipitates, but this cooling must be very slow indeed for this normal chemical change to take place completely since it is a very sluggish change and requires several seconds for its accomplishment. If, therefore, we cool with great rapidity, as, for example, by pouring the iron into a metallic mold which 'chills' it, or by some other form of artificial rapid cooling, we may prevent the precipitation of graphite by denying the time necessary for the chemical reaction, and obtain a metal in which all the carbon is in the combined form, i. e., white cast iron. It is also evident that, by a rate of cooling intermediate between this rapid rate and the slow rate which permits the precipitation of the normal amount of graphite, we may obtain an intermediate amount of carbon in the graphitic form. This variation in the speed of solidification is a very important means of producing combined carbon and is employed very largely in the 'chilling' of the surfaces of gray-iron castings, whereby we may have a relatively soft gray iron in the interior of each article and a hard surface extending to almost any desired depth. For example,

chilled-iron rolls are made in this way (see page 201), and also American railroad car wheels¹ which are cast against an iron chill (see page 337), giving nearly an inch depth of white iron around the tread and flange where the metal is to suffer abrasion in grinding over the rails, while the web and bore will be of gray cast iron, because cooled more slowly in the sand part of the mold, and thus will be less brittle and better able to withstand the shocks of service and machining.

THE EFFECT OF CARBON ON CAST IRON

The nature and constitution of gray cast iron is far more difficult to understand than that of steel, and even greater is the difficulty of predicting the effect of any change in composition or in constituents. The chief reason for this complexity is that a change in any one of the constituents of gray cast iron is liable to effect changes in several others as well. The simplest example of this is in the case of the carbon; we have total carbon, graphite, and combined carbon, and if we change any one of these three, we must change either one or both of the other two, and it makes a great deal of difference which. Indeed, we almost never change the amount of graphite without making the reverse change in the amount of combined carbon, and vice versa. Thus a very loose system of speaking of these matters has come into vogue among foundrymen. For instance, it is very common to hear a foundryman say: 'In order to soften your iron, increase the graphite'; but what he really means is: 'In order to soften your iron, decrease the combined carbon.' He knows that the one change usually follows from the other, and he speaks of it in this way, regardless of the fact that graphite can be increased (i. e., by increasing the total carbon and leaving the combined carbon the same or a little higher), and yet the iron will not be made any softer, but may even be harder.

Graphite and Shrinkage.—The most important effect of graphite on cast iron, aside from causing weakness, is in decreasing

¹In other important railroad countries it is more usual to have the car wheels made of steel, as it is believed that the iron wheels are not sufficiently strong and ductile. The manufacture of pressed-steel car wheels is increasing in America; nevertheless, the chilled cast-iron wheels seem to give very good service.

the shrinkage. The reason for this will be understood when we consider what happens when cast iron solidifies. It will be remembered that when the eutectic forms, the cast iron breaks up into alternate plates of graphite and austenite. This separation of graphite from solution is the birth of a new constituent, and this constituent occupies space, so that there is an expansion of the mass as a whole in proportion to the amount of graphite that separates. If, therefore, we pour liquid cast iron into a mold, which is, of course, entirely filled at the moment when the iron begins to solidify, the first action that takes place after the beginning of solidification is an expansion, due to the separation of graphite. The expansion continues for several moments until the chemical precipitation is completed, after which the metal begins to contract, as all metals do in cooling from a high temperature; but the preliminary expansion has been so great that the ultimate shrinkage may be only about one-half what it otherwise would have been. We can thus control this shrinkage by controlling the amount of the expansion, through varying the graphite. This point will be more readily understood by referring to Fig. 257, which is taken from a recent article by Prof. Thomas Turner of England.¹

Explanation of Fig. 257. — The point *O* marks the position occupied by the end of the bars at the moment of solidification. It will be seen that in the case of copper the metal contracts continuously from this point, as shown by the continuous drop of the curve. In the case of white cast iron, the metal contracts continuously until we reach a certain point (which is at a temperature of about 665° C.), when a momentary arrest of the shrinkage takes place, after which the metal again contracts. This arrest is common to all cast iron and steel and marks the decomposition of austenite at the point *S*, Fig. 246, page 314. Now, see what a difference there is in the case of gray cast iron, which does not shrink immediately after freezing, but expands very appreciably; as shown by the rise in the curve. This expansion is due to the graphite that is being expelled from the metal and occupies space between the particles of iron.

Again, in the case of the Northampton iron, which is high in both graphite and phosphorus, the expansion is very long-continued, and the metal cools to almost a black heat before the

¹ *Journal of the Iron and Steel Institute*, No. 1, 1906, page 57.

bar has shrunk again to the size it had when first cast. This expansion is again due to the separation of carbon, and is assisted apparently by the phosphorus keeping the iron in a semifluid condition for a long time and thus allowing the graphite more easily to separate and make place for itself. Here, too, we have an explanation why phosphoriferous irons fill every crevice of

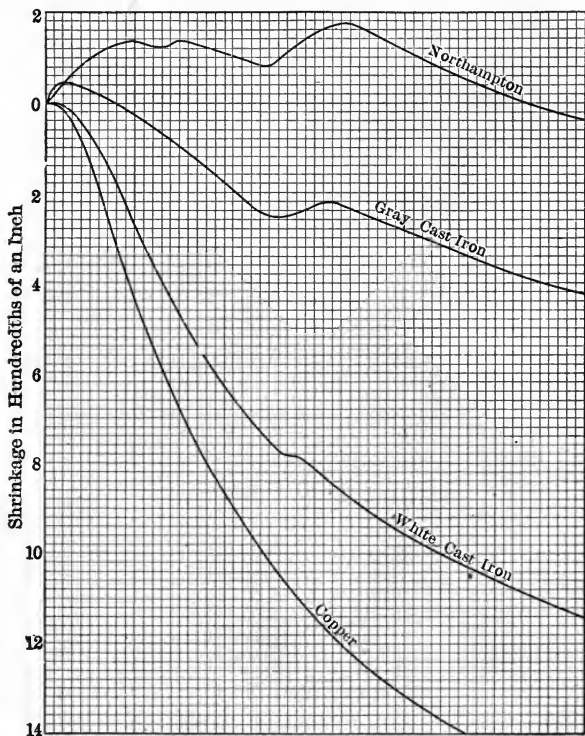

FIG. 257. — SHRINKAGE CURVES.

the molds so perfectly. Being in a pasty condition for some time, and continually expanding, the semifluid metal is forced into the tiniest crevices of the molds, filling all the corners with astonishing sharpness.

It is evident that any increase in graphite, whether caused by an increase in total carbon or by a decrease in combined carbon, will produce less shrinkage. The extent of this may be judged by noting that gray cast iron expands so much in solidifying that no contraction cavity or pipe is formed, such as occurs in the case of

steel. If the iron is only slightly gray, or if it is a very large section of metal, then a slight spongy place may be formed in the center, which is the nearest approach to a shrinkage cavity that is normally found in most iron castings.

Graphite and Porosity. — It is also evident that an increase in graphite, whether produced by an increase in total carbon or by a decrease in combined carbon, will increase the porosity of the casting, which is often disadvantageous, as in the case of hydraulic cylinders or other receptacles for holding liquids under pressure. The separation of much graphite usually is accompanied by large-sized graphite crystals, and therefore the crystals of the mass, as revealed by the fracture, appear large and the grain is said to be 'open.'

Graphite and Workability. — When we come to consider the effect of graphite upon the softness or workability of the cast iron, it is evident that we must consider it in relation to other things; for if we increase the graphite by increasing the total carbon, then we increase the workability of the metal only in so far as the graphite acts as a lubricant for the tool that is doing the cutting. Evidently the tool will have no difficulty in cutting through the soft flakes of graphite; the chief resistance to it will be given by the metallic part of the mixture. Though the lubricating effect of the graphite undoubtedly helps the tool, its presence evidently cannot increase the actual softness of the metallic body with which it is mixed. But, on the other hand, if we increase the graphite by decreasing the combined carbon, then we have not only increased the amount of lubricant, but we have, in addition, increased the softness of the metallic part of the mixture by reducing the proportion of cementite, which is the hardener, in it.

Graphite and Strength. — Everything else being equal, it is evident that the more graphite we have in cast iron, the weaker it will be, for we have already shown that gray cast iron breaks by the ready splitting apart of the flakes of graphite. Thus, if we make no change in the combined carbon, but increase the total carbon of our castings, and consequently the graphite, we should expect a corresponding decrease in strength, and this is in fact found to occur. When, however, we increase the graphite and at the same time decrease the combined carbon, we may or may not get an increase in strength, this depending altogether on how

much combined carbon there was before and after the change. For example, if we had 3 per cent. of combined carbon and 1 per cent. of graphite in a casting that casting would be weak because of too high combined carbon. To decrease this and increase the graphite would have a beneficial effect on strength. On the other hand, if we had 1 per cent. of combined carbon and 3 per cent. of graphite, to decrease the combined carbon and increase the graphite would have a detrimental effect on strength. We must therefore consider the question of strength from a much larger viewpoint than by considering any one constituent alone.

Combined Carbon and Shrinkage. — Combined carbon has very little effect on the shrinkage of cast iron except in so far as it changes the graphite. That is to say, if by increasing the combined carbon we decrease the graphite, we will get an increase in shrinkage, and vice versa.

THE EFFECT OF SILICON, SULPHUR, PHOSPHORUS, AND MANGANESE ON PIG IRON

The constitution of cast iron is, furthermore, very complicated because of the double influence of silicon, sulphur, phosphorus, and manganese. Each of these elements has a direct influence upon the properties of the material, which is in general similar to its influence upon steel. For example, silicon produces freedom from oxides and blow-holes and makes the iron more fluid; manganese counteracts the effect of sulphur and increases the difficulty of machining the material; sulphur makes the metal very tender at a red heat, and therefore liable to checking if put under strain during this period. For example, if a casting in shrinking tends to crush the sand, this strain will be more liable to break it in case the sulphur is high. Sulphur also makes solidification take place more rapidly, and causes blow-holes and dirty iron. Phosphorus makes the metal very fluid and reduces its melting-point. It also makes it more brittle under shock, especially when cold, and produces a fusible eutectic, a photomicrograph of which is shown in Fig. 253. Phosphorus and sulphur increase the tendency to segregate.

Furthermore, the various compounds of the impurities with iron and with each other, which we find in steel, are also found in

cast iron. Indeed, some of them are far more important in the latter than in the former, because the amount of the impurities is greater. This is especially true of manganese sulphide and iron sulphide, for the sulphur in cast iron is often large in amount, while the manganese is often intentionally small on account of the difficulty which this element produces in the machining of the casting. Therefore we are even more liable to find iron sulphide in cast iron than in steel.

But the direct effect of these impurities is usually far less important than their indirect effect, namely, their influence upon the carbon. After all, it is the carbon which is the chief factor in controlling the most important properties of the cast iron, and we may vary this either by increasing or decreasing the total amount, or else leaving the total amount the same, by increasing the graphite and decreasing the combined carbon, or vice versa. It is the ease with which we may vary the amount or the condition of the carbon, and therefore the properties of the iron, that is one of the most important advantages of the material. But strangely enough, although it is easy to keep this control, it can never be accomplished in a direct way. It will be remembered (see pages 35 to 38), that the blast-furnace manager can vary the amount of silicon and sulphur in his pig iron at will; that he has only a small control over the manganese and practically none over the phosphorus or carbon, but that the metal always saturates itself with this latter element; and it has also been seen (see page 306) that the limit of this saturation is small.

Silicon. — By means of his control over the silicon and sulphur, the metallurgist exercises indirectly his most important control over the condition of the carbon; for silicon acts as a precipitant of carbon, driving it out of combination and into the graphitic form, so that with about 3 per cent. of silicon, slow cooling and very low sulphur and manganese, we may obtain a cast iron in which almost none of the carbon is in the form of cementite. That is to say, the presence of this amount of silicon acts so strongly that it may partially prevent the formation of austenite during solidification, and also cause graphite to precipitate instead of cementite at 690° C. (1275° F.) when the eutectoid decomposes (point *S*, Fig. 246, page 314), so that it decomposes into ferrite and graphite instead of ferrite and cementite. The maximum pre-

precipitation of graphite seems to occur with about 2.5 to 3.5 per cent. of silicon. With each increase of silicon up to that point (the amount of sulphur, the rate of cooling and other influential conditions remaining the same), we get an increase in the amount of graphite precipitation, but when the amount of silicon exceeds about 3 per cent. it seems to reverse its effect, and each addition of silicon thereafter causes an increase in the proportion, not of graphite, but of combined carbon. At this point large amounts of various iron silicides (Fe_2Si , Fe_3Si_2 , etc.), make their appearance. Then the color of a freshly broken fracture begins to be bright like a mirror, in contradistinction to the white color of ordinary white cast iron, which has more nearly the appearance of frosted silver.

Sulphur. — The influence of sulphur upon the formation of graphite is almost the exact opposite of the influence of silicon. That is to say, each increase in the amount of sulphur present increases the amount of combined carbon in the iron. It is usually considered that each 0.01 per cent. of sulphur will neutralize fifteen times as much silicon (i.e., 0.15 per cent.) in its effect upon the condition of the carbon in the iron. It is also very important to note that when the sulphur is in the form of MnS , it is not so potent in increasing the combined carbon as when it is in the form of FeS . An interesting example of this is shown in the analysis of the two railroad car wheels given below:

	Fe	Total Carbon	Si	Mn	P	S	Graphite	C.C.
Good wheel.....	94.79	3.84	0.69	0.13	0.43	0.12	3.30	0.54
Poor wheel.....	95.00	3.52	0.65	0.12	0.52	0.19	2.35	1.17

Good wheel required 150 blows of 25-lb. sledge to break it. Poor wheel required 8 blows of 25-lb. sledge to break it.

It will be observed that the poor wheel has more than twice as much combined carbon as the good wheel, although the sulphur in the poor wheel is only about 50 per cent. more than the sulphur in the good wheel, the other impurities being nearly the same. When we come to figure out the amount of MnS and FeS in the two wheels, we find, however, the explanation of the large amount of combined carbon in the poor wheel. We also have an ex-

planation of the poor quality of this wheel in the increased amount of FeS present.

CONSTITUENT	Good Wheel Per Cent.	Bad Wheel Per Cent.
MnS.....	0.206	0.195
FeS.....	0.121	0.315
FeSi.....	2.045	1.923
Fe ₃ P.....	2.755	3.335
Pearlite.....	67.610	84.492
Ferrite.....	23.963	0.000
Cementite.....	0.000	7.390
Graphite.....	3.300	2.350
Totals.....	100.000	100.000

Manganese. — Manganese increases the total carbon in pig iron. Manganese also increases the proportion of the carbon that is in the combined form, but its influence in this respect is far less than that of the sulphur; moreover, the statement requires the following qualification: as much manganese as is combined with sulphur in the form of MnS does not increase the proportion of carbon in the combined form. Indeed, it has really the reverse effect, because it takes the sulphur out of the form of FeS, in which it is most powerful in increasing the combined carbon. In this sense therefore, the manganese actually decreases the amount of combined carbon.

The excess manganese over that necessary to form MnS (that is, the manganese in the form of $[\text{FeMn}]_3\text{C}$) increases the proportion of carbon in the combined form, and also increases the amount of total carbon even more potently than does the manganese, which is in the form of MnS. We therefore have a strange contradiction, in that when the manganese is high an increase in sulphur will, by decreasing the amount of $(\text{FeMn})_3\text{C}$, actually decrease the tendency of manganese to raise the total carbon as well as the combined carbon. To sum up, manganese and sulphur both tend to increase the total carbon and the combined carbon, and yet they neutralize each other in this respect.

Phosphorus. — The effect of phosphorus upon the carbon is somewhat self-contradictory: from a chemical standpoint it tends to increase the proportion of combined carbon, and this is especially true when the silicon is low and the phosphorus high (say above 1.25 per cent.). But phosphorus also has the effect of

lengthening the period of solidification. That is to say, it makes the iron pass through a somewhat mushy stage of solidification, and this mushy stage lasts for several minutes. This lengthening of the solidification period gives a longer time in which graphite can precipitate. Therefore, when the silicon is relatively high (at least over 1 per cent.), and there is consequently a strong tendency for graphite to precipitate during solidification, this precipitation is actually aided by the phosphorus, and the graphite occurs not only more abundantly, but in larger-sized flakes. When, however, the amount of phosphorus is very large, its chemical effect is great enough to retain the carbon in the combined form, in spite of the long period of solidification. We may sum this up by saying that if the chemical conditions are such that graphite is bound to precipitate, then the physical effect of the phosphorus makes this precipitation the more easy; but if there is enough phosphorus present to produce a strong chemical effect of its own, or if the other chemical influence is not very powerful (i.e., if the silicon is low), then phosphorus tends to keep the carbon in the combined form.

THE PROPERTIES OF CAST IRON

Let us now consider the properties of cast iron, and summarize under the head of each the influence of the various elements and conditions upon them.

Shrinkage. — The shrinkage of cast iron is of more importance than might at first appear, because the greater it is the greater will be the strains set up in the cooling of the casting, and consequently the liability to check; also, the greater will be the allowance necessary in order that the casting may be true to the size called for by the drawings. Graphite is the most important impurity in this connection, because of the expansion which its separation causes. This separation should take place at the moment of solidification, but is usually not complete then, and therefore the precipitation continues during the fall of the temperature to several degrees below the freezing-point. Furthermore, when the silicon is high, graphite instead of cementite separates at the lower critical point (i.e., the line P S K in Fig. 246, page 314). As silicon and the rate of cooling are the chief influences which control the separation of graphite, they become the governing

factors in the shrinkage of the iron. Indeed, when sulphur is practically normal and no other unusual conditions prevail, there is such a close relation between the size of the castings¹ and the percentage of silicon on the one hand, and the amount of shrinkage on the other hand, that any one of the three may be calculated when the other two are known (see Table XXVII).

TABLE XXVII.—RELATION OF SHRINKAGE TO SIZE AND PERCENTAGE OF SILICON

PER CENT. OF SILICON	½ in. square	1 in. square	2 in. X 1 in.	2 in. square	3 in. square	4 in. square	
1.00	.183	.158	.146	.130	.113	.102	Perpendicular readings show decrease due to increase in silicon.
1.50	.171	.145	.133	.117	.098	.087	
2.00	.159	.133	.121	.104	.085	.074	Horizontal readings show decrease of shrinkage due to size.
2.50	.147	.121	.108	.092	.073	.060	
3.00	.135	.108	.095	.077	.059	.045	
3.50	.123	.095	.082	.065	.046	.032	

Sulphur is important in this connection, and its effect is contrary to that of silicon, because of its tendency to retain the carbon in the combined form. Manganese and phosphorus each has a less important influence. Manganese, by increasing the total carbon, tends to increase graphite and therefore decrease shrinkage. So far as it neutralizes sulphur, moreover, its effect is in the same direction. Phosphorus decreases shrinkage, both because it contributes to the fluidity of the metal and therefore gives a better opportunity for carbon to separate, and also because of the expansion caused when the phosphorus eutectic separates from solution. A hotter casting temperature of the iron has the effect of delaying solidification by heating up the mold, so that graphite has a little more chance to separate. This effect is noticed but slightly amidst the other conditions.

A table showing the relation between the size of the casting, the amount of silicon, and the shrinkage is given above and is taken from page 155 of No. 93. Slight changes must be made in this table by each foundry for the conditions of sulphur, phosphorus, temperature, etc., obtaining there; but those given herewith will be found sufficiently accurate for all ordinary purposes where conditions are anywhere near normal.

¹ Which is the chief influential feature in the rate of cooling.

Shrinkage Tests. — At many foundries it is the custom to make a shrinkage test of the iron from each cupola at least once a day. The simplest way of making these tests is to pour into a mold 12 in. long, with a sectional area approximately proportionate to the size of the castings made, some of the iron from about the middle of the cupola run. The casting must be poured flat, and the difference between 12 in. and the length of the cold bar is the shrinkage of the metal. This method is somewhat crude and, although it gives valuable results, has been greatly improved by W. J. Keep¹ and Prof. T. Turner,² who have devised simple and inexpensive pieces of apparatus whereby the iron, after it begins its solidification, draws a curve showing first the expansion and later the contraction. It is by means of Professor Turner's apparatus that the curves shown in Fig. 257, page 339, were made. With very little care these curves can be obtained to show with sufficient accuracy for all ordinary purposes the percentage of graphite and also (other conditions being normal, or nearly so), the percentages of silicon and combined carbon, and the strength, hardness, and porosity. Indeed the curves are more useful than many single tests, because they show at a glance the net effect of several varying conditions.

Density. — The maximum density of cast iron occurs with about 1 per cent. of silicon. With less than that, the iron is liable to contain spongy spots, due to high shrinkage on account of low graphite. With more silicon the separation of graphite decreases density. Above 2 per cent. of silicon, the grain of the iron becomes so open as to be actually porous and the density falls off by 12 per cent.

TABLE OF DENSITIES

	Specific Gravity	Weight per Cubic Foot
Pure iron.....	7.86	490
White cast iron.....	7.60	474
Mottled cast iron.....	7.35	458
Light gray cast iron.....	7.20	450
Dark gray cast iron.....	6.80	425
Sample of gray cast iron when cold.....	7.17	448
Same, when liquid.....	6.65	416

¹ See Chapter XX of No. 93, page 291.² Reference on page 338.

To make a close-grained iron for hydraulic work the sulphur should be from 0.03 to 0.055 per cent. If more than this, the iron is liable to be dirty, to contain spongy spots on account of low graphite, to be difficult to machine on account of high combined carbon, and to be weak, because high sulphur, aside from its effect on carbon, reduces the strength. Especially, if the phosphorus is high must the sulphur be kept down to these limits, or the iron will be hard, brittle, and weak.

There should be from 0.4 to 0.6 per cent. of manganese. We do not want more manganese than this, or the casting will be difficult to machine. We do not want less than I have indicated, because manganese assists in counteracting the bad effects of sulphur and phosphorus.

Phosphorus has a double-acting influence on the porosity of cast iron: (1) It increases the size of the crystals, decreases shrinkage and causes a large expansion after solidification, as explained in connection with Fig. 257; but (2) it fills all the crevices between the crystals and in the interior of the iron, which, by decreasing the porosity, counteracts its first influence. When the phosphorus is high, the phosphorus and iron form a eutectic, which remains fluid for a long time and fills the tiniest crevices in the interior of the metal. For this reason iron for hydraulic work may run up to 0.7 per cent. phosphorus, but above that the iron is liable to be weak and 'cold-short,' especially under impact. In fact, where very strong iron is desired, the phosphorus should be kept down to 0.4 per cent. at least.

With the various amounts of impurities mentioned above the combined carbon will be in the neighborhood of 1 per cent. and the graphite about 2.5 per cent., the exact amounts depending upon the thickness of the castings and the rate at which they are cooled. If we desire to keep the combined carbon the same and reduce the graphite it will be necessary to reduce the total carbon. This can be accomplished by mixing in steel scrap and melting fast in the cupola, or by melting in an air-furnace instead of a cupola. This reduction in graphite results in a closing of the grain of the steel, with consequent increase in strength and density.

Segregation. — A common cause of porosity in castings is segregation, or the collection together of impurities in spots. This segregation is the greater the greater the amounts of phos-

phorus, sulphur, manganese, and silicon. Phosphorus increases the segregation by making a fluid eutectic, which does not solidify until after the remainder of the casting, but then runs into that part of the metal having the loosest texture. This part is usually in the middle of the larger sections of the casting, and when the silicon is high and there are shrinkage spots the segregation will be excessive in the neighborhood of these spots. Manganese and sulphur are also liable to collect in the same way and place. These localities, where the segregation is high, and which are known, when very bad, as 'hot spots,' are sometimes porous or surrounded by porous parts of the casting. They are sometimes so extremely hard that no tool will cut them. One way of getting rid of them is to use very large risers, or headers, which solidify last and serve as feeders for the remainder of the metal. Under these circumstances the segregation occurs in the riser, and is thus temporarily removed. This method is not advisable as a regular practice, however, because these risers ultimately find their way back into the cupola as scrap and result in increasing the impurities in a subsequent set of castings.

Headers themselves increase the density of iron castings by feeding the metal and so preventing the porous spots, and also by keeping the metal under a pressure during solidification. This latter is especially serviceable when the phosphorus is high, which tends to make the metal expand during solidification, as I have shown.

Checking. — The time when a casting usually checks is when it is just above the black heat, when the metal is in a weak and tender condition and, as shown by Fig. 257, page 339, is under strain because it is contracting upon the sand. Sulphur greatly increases weakness at this temperature, because both sulphide of manganese and sulphide of iron are now in a pasty condition, and therefore offer very little resistance to breaking. The sulphide of iron is much worse, however, because this is spread out in thin plates or membranes which offer much more extended planes of weakness than the sulphide of manganese, which is in small spots or bubbles, resembling blow-holes in its effect. Phosphorus, by decreasing shrinkage, decreases the liability of checking, but phosphorus has another influence, shown in the production of large-sized crystals, and in this respect it increases the liability of the metal to check.

Manganese, by decreasing the size of crystals, tends to counteract partially the effect of the phosphorus. The size of crystals can also be decreased to some extent by chilling the weak points and feeding them well under a head of metal. Feeding all localities liable to check has the double advantage of lessening shrinkage and segregation, both of which increase the liability to checking.

Softness, Workability, and Strength. — It is the combined carbon which is the great hardener of cast iron, the other elements producing hardness chiefly in proportion as they produce combined carbon, except manganese, which not only produces combined carbon, but also produces a compound having the formula $(\text{FeMn})_3\text{C}$, which is very hard and difficult to machine.

Silicon, by decreasing combined carbon, decreases hardness. When we get above 3 per cent. silicon, however, there begin to form new compounds with silicon which make the iron hard. Furthermore, silicon above 3 per cent. increases combined carbon, instead of decreasing it.

The maximum softness of cast iron is obtained with about 2.5 to 3 per cent. of silicon, the sulphur being not above 0.1 per cent. and the manganese not above 0.4 per cent. In large or slowly cooled castings the silicon should be near the lower limit, and in small or rapidly cooled castings near the upper limit, in order that the combined carbon may be down below 0.15 per cent. and the graphite more than 3 per cent. Such a cast iron would correspond to a soft steel, mechanically mixed with crystals of graphite. This soft steel would machine with great ease, and the graphite would act as a lubricant for the cutting tool. The mixture will have a transverse strength of about 2000 to 2200 lb., will be low in density and open in grain. To increase the strength without increasing the hardness, the best way is to cut the sulphur and phosphorus down to a low point, if possible, because sulphur, and next to it phosphorus, are the impurities which weaken iron most (aside from their influence on carbon). Another way is to decrease the total carbon, and hence the graphite, because graphite crystals, especially if large, are great weakeners of cast iron.

The strength of steel is more than double the strength of cast iron, the difference being due almost altogether to the graphite in cast iron, because silicon in itself (aside from its influence on

the carbon) is a strengthener of both iron and steel up to at least 4 per cent.

To a slight extent the total carbon may be reduced by melting steel scrap with the iron, or by decreasing the amount of manganese, provided that the manganese left be always at least twice the sulphur, otherwise the iron will be weak and brittle.

The strength of cast iron may be increased by increasing the combined carbon, but this is done at the expense of softness and workability. Cast iron containing from 1.5 to 2 per cent. of silicon (depending upon the size of the castings and rate of cooling), 0.9 per cent. of combined carbon, 0.5 per cent. of manganese and not more than 0.08 per cent. of sulphur and 0.3 per cent. of phosphorus, will work without difficulty in the machine shop and have a tensile strength of over 28,000 lb. per square inch. In many cases foundries are unwilling to go to the expense of such a low sulphur and phosphorus. In this case the strength must be obtained by raising the manganese, which is not advisable, as it decreases the softness more than any other element, causes dull iron and high total carbon.

An important point in connection with the strength of cast iron is the size of the crystals of graphite—the smaller these crystals are the greater the strength, because the smaller are the planes of easy rupture. A notable example of this is malleable cast iron, which may have a tensile strength of 45,000 lb. per square inch, even when the percentage of graphitic or temper carbon is as high as 3 per cent. The very small size of the flakes of the temper carbon does not reduce the strength as much as the same amount of the larger graphite crystals.

It is believed by many that smaller graphite crystals are obtained by mixing different brands of iron in the cupola, even though the analysis of the mixture may be the same. This, however, is denied by others, and no reliable data exist upon which we can base a definite statement. It is also believed by many that when the silicon is added to the cast iron immediately before pouring into the molds, the crystals of graphite are smaller than those formed when high-silicon irons are melted in the cupola. The practice of adding a small amount of ferrosilicon to the ladle of cast iron after it is received from the cupola is thus said to be doubly advantageous, because the silicon does not have to go through the cupola, where it suffers some oxidation, and it pro-

duces the desired softness by precipitating the graphite, but in a form which does not decrease strength so much.

To obtain high transverse strength, the silicon should be about 0.2 per cent. lower and the combined carbon about 0.2 per cent. higher than the figures given for tensile strength. Otherwise the effects are very similar.

Some estimates of the strength and workability of cast iron are given in the following table,¹ and on page 57 of No. 94.

TABLE OF CAST-IRON STRENGTH AND WORKABILITY

	Silicon Per Cent.	Sulphur Per Cent.	Phos- phorus Per Cent.	Man- ganese Per Cent.	Tensile Strength lb.	Trans- verse Strength lb.
Soft iron for pulleys, small castings, good tooling	2.20 to 2.80	Not over 0.085	Not over 0.70	0.30 to 0.70	28,000	2200
Medium iron for engine cylinders, gears, etc..	1.40 to 2.00	Not over 0.085	Not over 0.70	0.30 to 0.70	30,000	2500
Hard-iron cylinders for ammonia, air-com- pressors, etc.....	1.20 to ¹ 1.60 to ² 1.90	Not over 0.095	0.70 to 0.40	Not over 0.60	25,000	2800

¹ If annealed.

² If cooled fast.

Chill. — In the making of cast-iron rolls, railroad car wheels, anvils, etc., at least one surface of the casting is desired to have great hardness, to resist wear, and to be backed by metal which shall be stronger and not so brittle. This is accomplished by chilling the surface that is wanted in a hard condition, and so producing white cast iron to varying depths, regulated at the will of the foundrymen. The making of this kind of casting is one of the most difficult problems of cast-iron metallurgy. The metal must be very close to the given composition, and the temperature of the mold, of the chill, and of the metal when cast must be regulated with care. Therefore, air-furnaces are often employed for melting in this class of work, or else uniform

¹ Abstracted from page 197 of No. 120, page 355.



FIG. 258. — WHITE PIG IRON.
0.75 per cent. Si. 0.120 per cent. S. 50
diameters. Unetched.



FIG. 259. — GRAY PIG IRON.
0.75 per cent. Si. 0.012 per cent. S. S.
50 diameters. Unetched.



FIG. 260. — GRAY PIG IRON.
1.75 per cent. Si. 0.025 per cent. S. S.
50 diameters. Unetched.



FIG. 261. — GRAY PIG IRON.
2.5 per cent. Si. 0.012 per cent. S. S. 50
diameters. Unetched.



FIG. 262. — GRAY PIG IRON.
3.5 per cent. Si. 0.025 per cent. S. S. 50
diameters. Unetched.



FIG. 263. — NO. 2 CHARCOAL PIG IRON
VERY SLOWLY COOLED.
50 diameters. HNO_3 .

conditions of cupola melting are maintained with great care, and very little, if any, scrap, which must necessarily be of somewhat uncertain analysis, is used, except the return scrap from the foundry itself, that is, defective castings, sprues, gates, shot-iron spillings, etc., and also scrap castings of like nature, such as worn-out car wheels and broken rolls. The most important

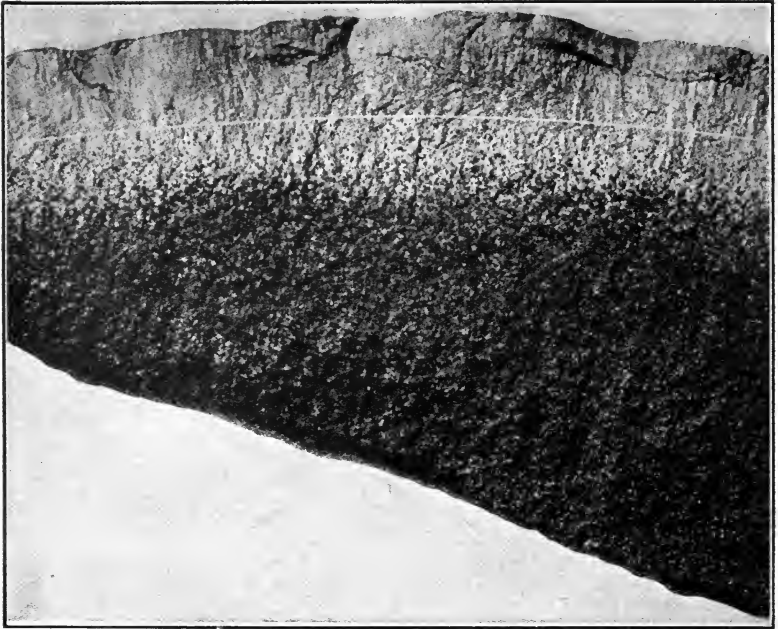

FIG. 264. — METHOD OF MEASURING THE DEPTH OF CLEAR CHILL IN A CAST-IRON ROLL.

factors in regulating the depth of the chill are the silicon and the sulphur, and in the following table is given the depth of clear chill from the surface for several different percentages of silicon and sulphur. The figures here given must only be taken as approximations, as they will vary to an important extent with different conditions in each foundry; but, starting with this as a basis, one can quickly prepare a table for himself to suit the practice in his foundry. Phosphorus has very little effect on the depth of chill, and manganese is also relatively less effective, although it increases the hardness of the chilled portion. The hotter the iron when cast the deeper the chill.

DEPTHS OF CLEAR CHILL FROM SURFACE IN INCHES

Silicon Per Cent.	Sulphur 0.2 Per Cent.	Sulphur 0.15 Per Cent.	Sulphur 0.1 Per Cent.	Sulphur 0.075 Per Cent.	Sulphur 0.05 Per Cent.
1.25.....	0.625	0.250	0.125	0.000	0.000
1.00.....	1.000	0.625	0.250	0.125	0.000
0.75.....	1.500	1.000	0.625	0.250	0.125
0.50.....	1.500	1.000	0.625	0.250
0.40.....	1.250	1.000	0.625
0.30.....	1.500	1.000

REFERENCES ON THE CONSTITUTION OF CAST IRON

- See Nos. 1, 32, 90, 91, 93, and
120. W. G. Scott. "Effect of Variations in the Constituents of Cast Iron." *Proceedings of the American Society for Testing Materials*, vol. ii, 1902, pages 181-206.
121. *Transactions of the American Foundrymen's Association*.
122. G. B. Upton. "The Iron-Carbon Equilibrium." *The Journal of Physical Chemistry*, October, 1908, vol. xii, pages 507-549. This is a very valuable study and résumé of the recent researches on the constitution of all the alloys of iron and carbon, and gives the chief known facts of scientific interest in a concise form.

XIII

MALLEABLE CAST IRON

MALLEABLE cast iron is iron which, when first made, is cast in the condition of cast iron, and is made malleable by subsequent treatment without fusion. Gray cast iron is weak and brittle, on account of the flakes of graphite which destroy its continuity and form planes of easy yielding. It will readily be understood that if the amount of graphite were less, or if its flakes occurred in a very finely pulverized form, or both, the material would be stronger and would endure a slight degree of deformation without cracking; that is, it would be malleable. These changes are indeed brought about in the manufacture of malleable cast iron. The process, which was invented by Réaumur in 1722, but has only been in practical use about 100 years and of importance less than 50, is a very ingenious operation. Malleable castings have two of the greatest advantages of cast iron; namely, fluidity and a low melting-point, combined with about three-quarters the strength and one-sixth the ductility of steel. They are very popular for railroad rolling-stock construction, especially for draw-bars, couplers and knuckles, on account of their high resiliency, resistance to shocks, and ability to be made into thin, light castings. Probably about one-half of the malleable cast-iron production of the United States goes into railroad work, although it is to be observed that at present the use of steel castings for this purpose is increasing relatively faster. The next most important use is for pipe-fittings, where malleable cast iron is equally advantageous; also for small machinery castings needing to be strong and light, household and building hardware, etc.

Process. — Pig iron of the proper kind is first melted and cast into molds of the desired size and shape. In these operations two precautions are observed: first, the proportion of silicon is low, and second, the castings are not allowed to cool too slowly. We have already learned that the precipitation of graphite is a slow

action and does not occur unless ample time is allowed or there is sufficient silicon to produce a strong chemical action. In the intentional absence of these factors malleable castings, as first made, are practically free from graphite and consist entirely of white cast iron — hard, brittle and weak.

After cooling the castings are cleaned and packed in some pulverized material, as iron ore, mill scale, lime, sand, placed in an annealing furnace and heated to a temperature of 675° to 725° C. (1250° to 1350° F.), which is, roughly, 450° C. below their melting-point, and at which temperature they are kept for many hours.

While under this heat there occurs the precipitation of graphite, which normally should have occurred during solidification, or shortly thereafter, and in the majority of cases almost all the combined carbon throughout the body of the casting is changed to graphite. But the graphite does not here form in flakes, as in ordinary gray cast iron, but in a finely comminuted condition, like a powder, to which the name of 'temper carbon' or 'temper graphite' is given (see Fig. 265). In this form it is not nearly so weakening or embrittling to the casting as flakes of graphite would be.¹



FIG. 265. — ANNEALED MALLEABLE CAST IRON.

Magnified 50 diameters. Unetched.

Properties of Malleable Cast Iron. — Malleable cast iron consists almost entirely of ferrite and temper carbon. It has a tensile strength of 40,000 to 60,000 pounds per square inch, which is about double that of gray cast iron, with an elongation of $2\frac{1}{2}$ to $5\frac{1}{2}$ per cent. in 2 in. and a reduction of area of $2\frac{1}{2}$ to 8 per cent.² A one-inch square bar on supports 12 inches apart should bear a load at

¹ We may liken this to two samples of putty, in one of which had been embedded a large number of plates of mica, and in the other the same amount of mica ground to powder.

² In the case of iron very carefully melted and annealed in iron oxide, the elongation may go as high as 8 per cent. and the reduction of area as high as 12 per cent.

the center of at least 3500 pounds, and be deflected at least half an inch before breaking. Thin sections should be capable of flattening out under a hammer and bending double without cracking.

Total Carbon in Malleable Cast Iron. — In melting the iron we take pains to produce a low total carbon, and if we anneal in iron ore or mill scale the carbon is still further reduced by a curious reaction which takes place between it and the iron oxide —



whereby it forms carbon monoxide and is eliminated. Sometimes, when the sections of metal are thin, we may eliminate almost all the carbon to the very center of the casting, which makes a more ductile material. It must be observed, however, that this reduction of carbon is not an essential feature of annealing and that the real function of this operation is to change the combined carbon to temper carbon, for the malleable cast iron owes its superiority over

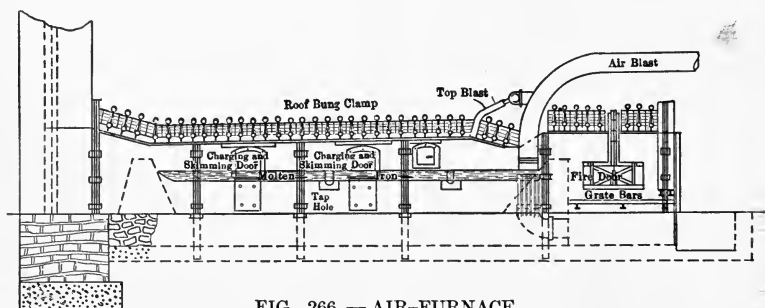

FIG. 266. — AIR-FURNACE.

gray cast iron chiefly to the finely pulverized form of its temper carbon.

Melting in the Air-Furnace. — The commonest melting-furnace for malleable cast iron is the air-furnace, because thereby we get a better control of the metal than in the cupola and the ability to produce castings with lower total carbon, lower sulphur, and any desired amount of silicon. After the metal is melted it is retained in this furnace for 15 minutes to an hour longer, and test samples are taken at intervals, from the fracture of which and the temperature of the iron we determine the correct moment for tapping. The fracture of the test ingot sample should be a clear white throughout, except when the castings are to be of very light section, in which case the metal might be tapped when the test sample

shows a few specks of graphite in the center. The practice of judging from test samples is different in each foundry, but there must be some system which insures that the metal shall be of such

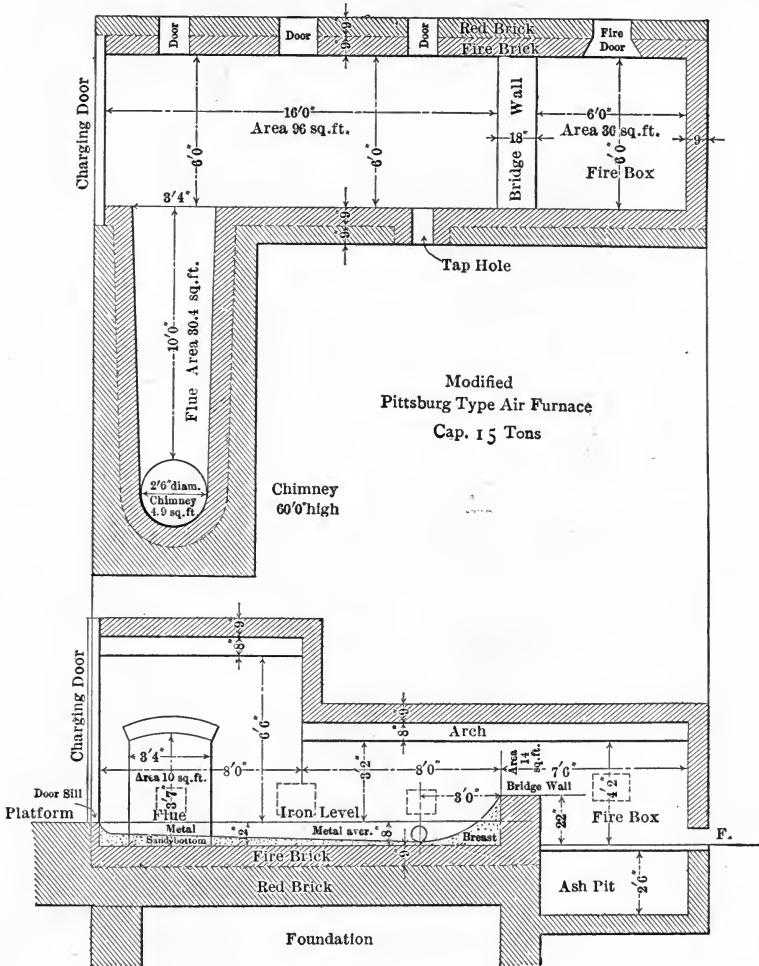

FIG. 267.

a composition when tapped that the castings will have not more than a trace of graphite if any at all (say, less than 0.15 per cent. in small castings and a little more in larger ones). It is to be remembered that any graphite is a detriment. The longer in the

furnace after melting the more silicon will be burned out, and therefore the less the liability to graphite. Consequently, the hotter we want to get the iron the higher must be the percentage of silicon in it to start with. Also, the longer the metal is in the furnace after melting the more carbon will be burned out of it. (See also pp. 284-286.) During the operation the bath is rabbled at intervals, and is skimmed so as to expose the metal directly to oxidation by the gases.

Tapping the Air-Furnace. — When the time comes to tap the furnace we may either allow a small stream to flow, which is caught

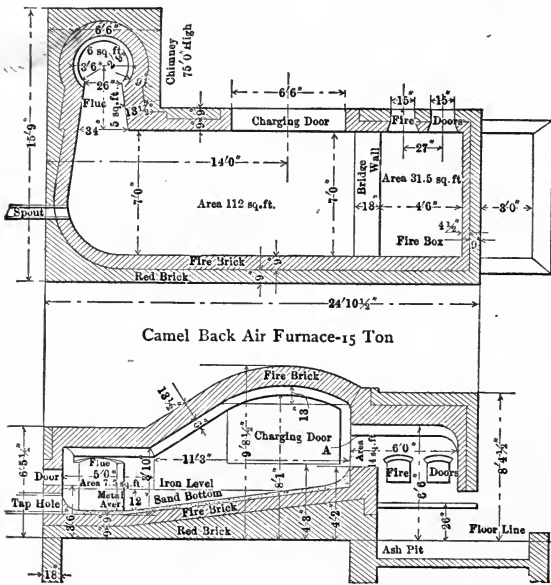

FIG. 268.

in ladles and immediately poured into the castings, whereby it takes from 20 minutes to an hour to empty a furnace of 10 to 30 tons capacity, or else we may allow the metal to run out in a big stream into a large ladle, from which it is repoured into smaller ones for casting. The first method gives a less uniform product, because the last part of the bath having been exposed longer to the oxidizing influence of the furnace, is lower in silicon and total carbon than the first part. This is not altogether a disadvantage, however, because the first metal, having come from the top of the

bath nearer the flame, is hotter, and therefore very suitable to pour into smaller castings; and these smaller castings, because they cool more rapidly, can well contain more silicon without danger of graphite precipitating. Moreover, the hotter the metal the greater the tendency for it to be white. A disadvantage of pouring the metal first into a big ladle is that it must be hotter when it comes from the furnace, and moreover the first ladle must be preheated. A middle course is possible: we may pour the top of the bath into small castings by means of ladles receiving their metal direct from the furnace tap-hole, and then enlarge the tap-hole and take all the

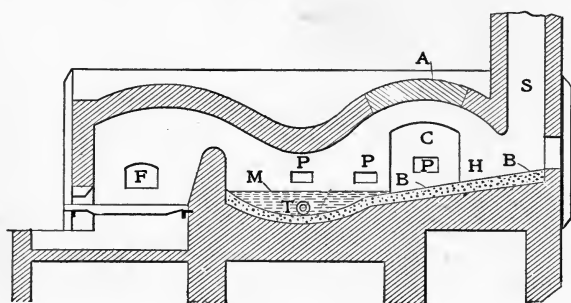

FIG. 269.

rest of the bath into a big ladle, whence it can be poured into other ladles and go to the larger-sized castings.

Cupola Melting. — In cupola melting we get metal having practically the same composition at all times of the heat,¹ and also about the same temperature. It is also cheaper in fuel, and especially so when it is desired to get very fluid iron, because obtaining hot iron in the air-furnace requires a continuation of the heating after the iron is melted, and this entails not only the use of more fuel, but also a burning out of silicon and carbon, both of which elements increase the fluidity of the metal.² Cupola metal is higher in total carbon and in sulphur, both of which decrease

¹ Except for the slightly higher sulphur at the beginning and end.

² When I say 'hot iron' here, I mean 'fluid iron,' i. e., the degree of heat above the melting-point; and in this sense hotness includes both the temperature and the state of impurity. An iron with 2 per cent. total carbon and 0.60 per cent. silicon at 1300° C. (2375° F.) will not be nearly as fluid or as far above its melting-point as one with 3 per cent. total carbon and 0.75 per cent. silicon at the same temperature.

strength and ductility. Because of the higher total carbon it is more difficult to prevent graphite separating; therefore cupola metal is used for light castings, which cool more quickly and do not usually require so much strength.

Regenerative open-hearth furnaces are also used in melting iron for malleable castings. (See also pages 285–286.)

Annealing-Boxes. — After the castings are cooled they are carefully cleaned from all adhering sand by tumbling them around in a tumbling-barrel (in which they are mixed with star-shaped



FIG. 270. — TUMBLING-BARREL.

pieces of metal something like children's jackstones), or by sand-blast, or by some other suitable method. They are then packed in the cast-iron 'saggers' or annealing pots, or boxes, together with the packing. Sometimes, though rarely, the tops of the saggers are closed by means of an iron cover, sometimes by a thick layer of the packing in the upper part, and sometimes by clay or wheel-swarf. These pots last only from 4 to 20 heats before they are largely oxidized away.

Annealing-Ovens. — The boxes are then placed in the annealing-ovens in such a way that the flame may play around them as completely as possible. The general form of ovens is shown in

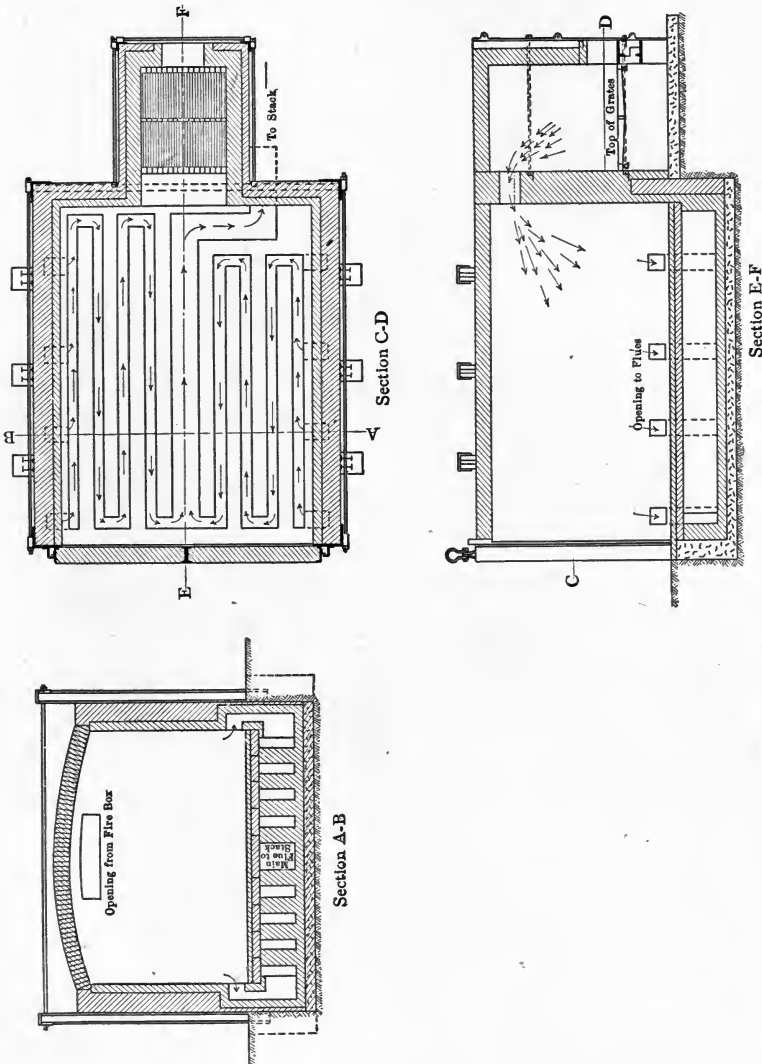

FIGS. 271 TO 273. — MALLEABLE IRON ANNEALING FURNACE.

Figs. 271 and 273. The flame usually comes in at the top and goes out at the bottom along the side, and thence through flues underneath the oven. The fuel used may be coke, coal, oil or gas, the

latter being preferable on account of the better control of the temperature, which should be increased at a very gradual and uniform rate during the heating up, and kept as constant as possible during the annealing period.

Annealing Practice. — It takes about six days for the annealing operation, including heating up and cooling down. Sometimes this can be shortened a little by decreasing the time at the full annealing heat, and by cooling rapidly or drawing the saggars out of the oven and dumping them while the contents are still at a dull-red heat. This practice is not conducive to a good quality of castings and should never be permitted in important cases. The time at the full heat should never be less than 60 hours, and preferably it should be more than that. If less, the temperature of annealing must be higher, and this decreases the strength and ductility of the castings. Annealing should not occupy too long a time, however, unless the temperature is quite low, because the temper carbon tends to draw together to larger flakes; besides which the metal may become oxidized between the grains, or 'burnt.' Air-furnace castings should be annealed at 675° to 760° C. (1250° to 1400° F.) and cupola metal at 850° to 950° C. (1560° to 1750° F.).

Packing. — As originally planned, the castings were annealed in a packing of iron oxide crushed to a size less than a quarter of an inch in diameter. The packing must surround the castings at every place, both inside and out, and no two castings must touch. Iron ore, mill scale, 'bull-dog,' and similar forms of iron oxide are used for this purpose. Usually two or three parts of old packing are used with one part of new packing, because all new packing is too energetic in its chemical action on the carbon, and all old packing will not be energetic enough in decarburizing the surface of the castings.

Annealing in iron oxide produces a white skin where the casting has been deprived of its carbon, and a black interior, due to the temper carbon; whence the name of 'black heart malleable' for this material. Tests have shown that the casting with this white skin upon it is much stronger than a similar one which has not been decarburized on the surface, and therefore the packing in iron oxide is advantageous, even though not an essential feature of the operation. When the castings are packed in some nonoxidizing material, such as sand, clay or lime, they may receive as perfect

an annealing, as far as the production of temper carbon is concerned, but will be without the white skin and of lower strength.

Composition of Iron Used. — The pig iron employed in this process is sold under the name of 'malleable coke iron' or 'malleable Bessemer.' As it is the composition of the metal poured into the molds which determines the success of the annealing and the quality of the product, we shall consider first the kind of metal needed there, and from that calculate the composition of the mixture necessary to charge into the air-furnace or cupola. In the air-furnace we do not judge the iron by its chemical analysis, but by the appearance of the test-ingot fracture when we are ready to pour, but as the second quality depends upon the first, it is the same thing in the end.

Silicon. — The proportion of silicon will depend upon the size of the casting and the amount of total carbon, because the greater each of these is the less will be the amount of silicon that will cause a precipitation. It might at first appear that the less silicon the better; but this is not altogether so, because temper carbon will not come out during annealing unless a certain amount of silicon is present; and the more there is, the more quickly, easily, and completely will the precipitation occur. For castings one inch thick the silicon may be as low as 0.35 per cent.; but this is unusual, as three-quarters of an inch thickness is rarely exceeded. For half-inch castings the silicon will be about 0.60 per cent., and for very thin and light castings with low total carbon and high sulphur (say 0.2 to 0.3 per cent.), the silicon may be up to 1 per cent. To the percentage of silicon desired in the castings we must add the amount which will be burned out in melting. In the cupola this will be about 0.2 to 0.25 per cent., and in the air-furnace from 0.15 to 0.5 per cent., or more if desired, depending on the length of time the metal is kept in the furnace after melting. The hotter we want the iron or the more total carbon we desire to burn out, the longer this time must be, and therefore the higher the silicon in the original mixture charged.

Sulphur. — Sulphur increases the tendency of castings to check, which is especially important in malleable work on account of the shrinkage of white iron being nearly double that of gray iron. Sulphur also reduces the strength and the ease of annealing. For this reason over 0.06 per cent. should not be permitted in castings requiring strength, but it actually runs up to 0.2 and 0.3 per

cent. in inferior metal, both in America and England, and especially in small castings, which do not need strength so much, and which, having less length for shrinkage, are not so liable to be checked by cooling strains.

Manganese. — Low manganese is preferred by many foundries, and one of the highest authorities in America ¹ places the limit at 0.8 per cent. It should be remembered, however, that the manganese should be at least twice the sulphur, and preferably three times, though not when the sulphur is as high as 0.3 per cent. Manganese of 0.5 per cent. tends to decrease checking. It also protects silicon from oxidation, both during melting and annealing, and on this account hastens and makes more complete the precipitation of temper carbon. It also protects the iron itself from oxidation during annealing and thus prevents the formation of 'scaled' castings. More than 0.6 per cent. manganese makes the iron hard and difficult to machine, which is disadvantageous, especially for pipe-fittings, which must be threaded with great economy in order to meet the trade competition.

Phosphorus. — Phosphorus makes the metal fluid, which is especially desirable where total carbon and silicon are low, or where sulphur and manganese are high. On the other hand, it diminishes two of the most valuable properties of the material: its resiliency and resistance to shocks. It also makes the metal hard, difficult to machine and liable to check, and amounts over 0.225 per cent. should never be permitted by engineers where the castings are subjected to strain.

Total Carbon. — Total carbon below 2.75 per cent. gives trouble in annealing and therefore makes the castings weak. It also makes the metal more sluggish. It is difficult to get as low as this in cupola melting, although mixing in large percentages of steel scrap and allowing the metal to run out of the cupola as fast as melted will reduce the proportion appreciably. In air-furnace practice the total carbon may be reduced as far as necessary. Annealing in iron oxides also removes carbon from the outer layers and even to the very center of thin castings. The lower the total carbon in the annealed castings, the better.

Scrap Used. — Not more than about 20 per cent. of bought scrap is used on the average in American practice, and a good deal of this is steel, on account of the desirability of lower total carbon,

¹ See No. 130, page 369.

and because iron scrap is too impure, too variable and too uncertain in sampling and chemical analysis for castings requiring strength, such as those for railroads and machinery. There is, however, always a large amount of 'return scrap' from the foundry, consisting of defective castings, sprues, gates, etc., which, in the case of small castings, may be greater in weight than the castings themselves. This return scrap is low in total carbon and silicon as a result of having already suffered the melting changes.

Shrinkage. — The shrinkage of malleable iron from casting is almost as great as that of steel, because almost no graphite forms. The amount of silicon and the sectional area of the castings are still the determining factors in this connection. Indeed, by means of the measurement of the section and the percentage of silicon we may estimate the shrinkage, or by means of the section and the shrinkage we may estimate the silicon very closely, other conditions and impurities being normal. The following table gives the necessary data for these estimations:

SHRINKAGE IN INCHES PER FOOT OF LENGTH

PERCENTAGE OF SILICON	$\frac{1}{4}$ Inch Square	$\frac{1}{2}$ Inch Square	$\frac{3}{4}$ Inch Square	1 Inch Square
0.35.....	0.225	0.200	0.190	0.175
0.50.....	0.220	0.195	0.183	0.170
0.75.....	0.215	0.190	0.176	0.162
1.00.....	0.211	0.183	0.137	0.102

Expansion due to Temper Carbon. — It is a very interesting fact that when the malleable cast iron is annealed and the temper carbon precipitates, the casting expands to an amount approximately equal to that which would have occurred if the graphite had separated during solidification and gray cast iron had been produced in the first instance. In other words, the temper carbon, although in a very finely powdered condition, occupies about the same amount of space as an equal weight of graphite, and causes about the same ultimate difference in size between the original pattern and the annealed casting as when gray cast iron is made. An interesting example of this expansion in annealing is shown in Fig. 274, which is a swivel snap for hitching straps. Casting No. 1 is first poured, cooled and cleaned. It is then embedded in the

sand of a mold and casting No. 2 is poured around the shank of it, as shown in No. 3 of Fig. 276. Casting No. 2 shrinks upon the shank of No. 1 so as to make a close fit, and no swiveling is possible, but the combined casting is now sent to the annealing-ovens and annealed. This causes the expansion referred to, and as casting No. 2 is larger in diameter, it expands the more, and now turns very easily around the shank of No. 1.

Miscellaneous Iron Products. — In the form of small castings malleable cast iron and similar products often masquerade under the name of steel, because under that name the producer finds a

readier market for them.

On account of their fluidity they may be cast very cheaply in small sizes, and therefore the temptation to use them as a material for 'cast-steel hammers,'¹ 'hard-steel' bevel gears, 'semi-steel castings,' and even automobile 'steel' drop-forgings, is a strong

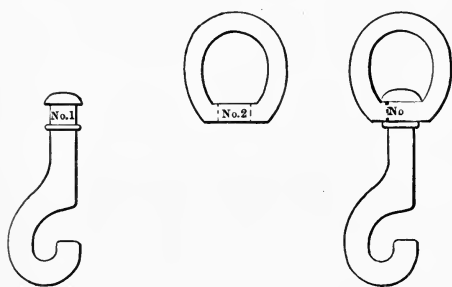

FIGS. 274 TO 276.

one. Engineers are warned to be on their guard against a deception of this kind, for legal redress has been sought many times in vain. A clever lawyer may easily confuse and outwit a judge or jury with the involved definitions and technical descriptions necessary to make the distinction clear. It is usual for the manufacturer when putting material of this kind upon the market to qualify the name 'steel' with some other letters or name, such as 'P. Q. steel,' 'Smith steel,' etc.; but they all differ from true steel in that they were not "cast into an initially malleable mass." Some are made by melting a large proportion of steel with cast iron, after which the cooled metal may or may not be annealed in iron oxide. Others are made by a long or thorough annealing of ordinary malleable castings in iron oxide, by means of which the metal is decarburized to some depth, and is then carburized again by a cementation process. This makes a very good material for some purposes, such as small bevel gears not requiring

¹The trade would ordinarily understand by this name hammers made of crucible steel, so the use of this name is really a fraud.

strength or much ductility, but it ought not to be called 'steel.' If the purpose for which it is to be used does not require any other properties than malleable cast iron possesses, then it should be used under its true name; but if it is to be used under circumstances where it is liable to strain, calling it 'steel' will not enable it to stand up under the work any better. The confusion is the more easy because genuine steel is made by the cementation of wrought iron, and wrought iron goes in England under the name of malleable iron. In America we seldom call wrought iron 'malleable iron,' but we often abbreviate malleable cast iron to 'malleable iron,' or even to 'malleable.'

REFERENCES ON MALLEABLE CAST IRON

See 90, 91, 92, and 122.

130. Richard Moldenke. "Malleable Castings," Parts I, II, and III. Instruction Papers Nos. 547A, 547B, and 547C, of the International Correspondence Schools, Scranton, Pa. This is the most thorough and valuable treatment of this subject that I know of.

XIV

THE HEAT TREATMENT OF STEEL

WE have already discussed the heat treatment of cast iron under other heads, namely: (1) the rapid cooling from the molten state, or 'chilling,' and (2) the annealing of malleable cast iron. Heat treatment is of much greater importance in connection with steel, because nearly 99 per cent. of all the steel made is heated either for the purpose of bringing it into the mobile condition in which it can be readily wrought, or for annealing. Indeed, the great majority of steel is heated several times, and some steel is subjected to two or three different kinds of heat treatment.

IMPROPER HEATING OF STEEL

Overheating. — If steel be heated to a high temperature, say 1100° C. (2010° F.), and then cooled (either slowly or rapidly) without being subjected to strain, it will be 'coarse-grained' as it is called, that is, its crystals will be relatively large in size. This can be readily seen by breaking it and examining the fracture, which will be bright and sparkling if the crystals are coarse, or dull-looking and fine-grained if they are small (see Fig. 284). The bright fracture is technically called 'crystalline' or 'fiery,' while the fine-grained one is called 'silky' or 'sappy.' The size of the crystals may also be learned with great accuracy by means of the microscope (see Figs. 277 to 282 and 286). Now, if the steel which was coarse-grained after heating to 1100° be heated instead to 1200°, the crystals will be still larger in size; if heated to 1300° they will be larger still, and so on. The size of the crystals will depend first upon which of these high temperatures it was heated to, and second upon the amount of carbon it contains. Low-carbon steel is normally larger in crystal-size than high-carbon steel.

Even the best quality of steel, if rendered coarse-grained by

'overheating,' will suffer in its valuable properties, and may become quite unfit for use. Medium- and high-carbon steel will lose both strength and ductility; low-carbon steel will lose strength even up to 50 per cent. of the original, but does not seem to be materially damaged in ductility unless the overheating is continued for a long time or at a very high temperature.

Cure for Overheating. — Let our first example be steel containing 0.9 per cent. carbon, that is, steel consisting entirely of pearlite. If this be heated from some point below the line *PSK* in Fig. 246, page 314, to some point above that line, a new crystallization will begin, and all traces of previous crystallization will disappear. It seems as if dissolving the ferrite and cementite in each other produces forces which obliterate almost all existing crystalline forms. So, if this particular steel has been made coarse-grained by overheating, we may make that grain fine again by reheating the steel from below the line *PSK* to just above it. This process is known as 'restoring,' or, by some writers, 'refining' the steel. It is an operation which should be thoroughly understood by every metallurgist and engineer. When we reheat the steel we must be careful not to go to a high temperature again, for a new crystal-size is born at the line *PSK*, and the crystals grow with every increase in temperature. The researches of Professors Howe and Sauveur¹ indicate that the size of the crystals is almost directly proportional to the temperature reached above the line *PSK*. If, therefore, we barely cross the line, we will obtain the smallest grain-size that the steel is capable of (see Fig. 281).

The cure for coarse crystallization in steel with less than 0.9 per cent. carbon is to reheat it from below the line *PSK* to above the line *GOS*, at which the last of the ferrite goes into solution. That is to say, the correct temperature for restoring the grain-size will depend upon the amount of carbon in the steel; low-carbon steel must be heated to nearly 900° C. (1650° F.); 0.4 per cent. carbon steel must be heated to nearly 800° C. (1470° F.); and so on.² We can never get as small a grain-size in steel with

¹ See page 246 of No. 1, page 8.

² It is to be remembered that the changes indicated by the lines in Fig. 246 occur at a higher temperature on heating than on cooling (see page 312); so it is well to heat the steel about 25° C. higher than the points on those lines.

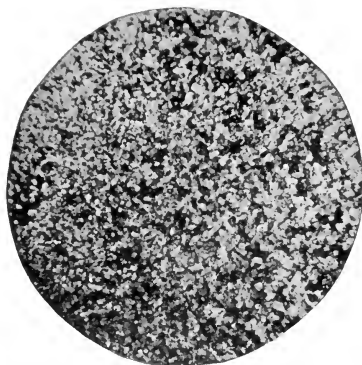

FIG. 277. — NO. 1A. STEEL OF 0.05 PER CENT. CARBON ROLLED.
Magnified 40 diameters.



FIG. 278. — NO. 1B. STEEL OF 0.50 PER CENT. CARBON ROLLED.
Magnified 60 diameters.



FIG. 279. — NO. 2A. SAME AS NO. 1A OVERHEATED TO 1420° C. (2588° F.)
Magnified 40 diameters.



FIG. 280. — NO. 2B. SAME AS NO. 1B. OVERHEATED TO 1420° C. (2588° F.)
Magnified 60 diameters.

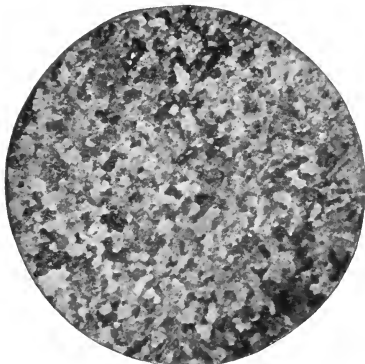

FIG. 281. — NO. 3A. SAME AS NO. 2A. REHEATED SLIGHTLY ABOVE AC_3 .
Magnified 40 diameters.

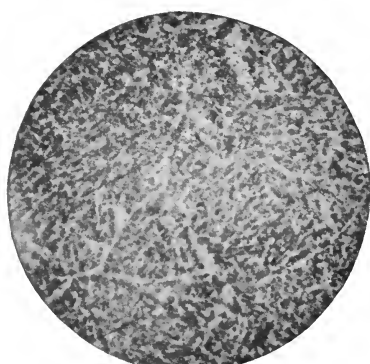

FIG. 282. — NO. 3B. SAME AS NO. 2B. REHEATED SLIGHTLY ABOVE AC_{2-3} .
Magnified 60 diameters.

Series A by F. C. Wallower in the Metallographic Laboratory of Columbia University, Department of Metallurgy.

Series B by G. Rocour in the Metallographic Laboratory of Columbia University, Department of Metallurgy.

less than 0.9 per cent. carbon as we can in that which is exactly 0.9 per cent. carbon, because a new grain-size begins to grow after we have crossed the line PSK , and yet we cannot entirely eliminate the old grain-size until we cross the line GOS . Where the lines GOS and PSK are near together (say, with 0.7 per cent. carbon), the new grain-size does not have much chance to grow before the restoration is complete, and therefore we may obtain steel with a pretty small grain; but where they are far apart (as in the low-carbon steels) the restoration can never be very thorough, because we have to go so far above PSK to obliterate the old grain-size that the new grain-size will have attained ample proportions. But the evidence seems to show that the best net result is obtained by going just above the line GOS in all cases.

In the case of steel with more than 0.9 per cent. carbon a somewhat similar condition exists: we must reheat the steel above the line Sa in order to produce complete elimination of the previous grain-size, but a new grain-size begins to grow from the crossing of the line PSK . But here we disregard the line Sa , and restore our steels in every case by reheating them over the line PSK , just as in the case of pure pearlite. The reason for this is that the lines Sa and PSK diverge so rapidly that we have to heat very far above the line PSK before we cross Sa , and therefore the new grain-size has grown greatly. Furthermore, the only object of heating above the line Sa is to take the excess cementite into solution; for the ferrite and cementite in the pearlite all went into solution as soon as we crossed the line PSK , but the amount of excess cementite is always small in proportion, and therefore in its influence on restoration. Even with steel containing 2 per cent. of carbon the excess cementite is only 16 per cent. This is different from the low-carbon steels, where the excess ferrite will be usually over 80 per cent.

Evidence of Overheating. — A piece of steel may be heated many times above the line PSK and cooled again, but obviously only the latest heating will leave its impression on the structure, because each crossing of the line on the way up removes the effect of previous heat treatment.¹ The relation between the size of

¹This is only true in a qualified sense, in that the previous overheating must not have been very close to the melting-point. We shall discuss this point under the head of "Burning." Indeed, even where burning has not

the crystals and the temperature above PSK is so constant that we may determine what this temperature was from the analysis of the steel and an examination of the grain. To do this it is usually necessary to get a piece of steel of the same analysis, heat different pieces of it to various temperatures, and compare (see page 380). The analysis must be approximately the same not only in carbon but also in phosphorus, sulphur, silicon, and manganese, as well as in any alloying elements, if present, such as nickel, chromium, tungsten, etc., because all of them have an effect upon the size of grain and also upon the change in size of grain by overheating. Generally, it is not important to know the exact temperature of overheating, but only whether or not overheating in some degree has occurred; and this is not difficult to prove, because almost all who use steel are familiar with the normal fracture of steels of different carbon and can tell at a glance if the grain is large; those who are not so familiar with its appearance may easily become so. The grain being large is proof that overheating was the cause, provided chemical analysis shows everything about normal, especially phosphorus and silicon.

Steel members of bridges or other structures sometimes break and disclose a crystalline fracture which is often attributed to the effect of vibration. The same thing occurs with points or shanks of rock drills and similar implements. It is the more general opinion among metallurgists that the crystalline fracture in all these cases is due to faulty heat treatment during manufacture, and especially to finishing the forging or rolling while the temperature is still too high. The manufacturers of steel like to maintain the opposite opinion, for obvious reasons, but I do not know of there ever having been any reliable proof offered that vibration had caused, or is capable of causing, large-sized grain in steel. It may be possible, but the more we learn about the subject the more we are inclined to believe that improper manufacture is the cause, and that the grain was large before the steel was put in service, although its nature was not disclosed until the break occurred.

Mechanical Cure for Overheating. — When steel is to be rolled

occurred, a skillful microscopist may sometimes discern the effect of overheating after the steel has been restored by reheating; because, although the crystals are all small, they are arranged in groups which show the form of the previous large crystals.

or forged it is frequently heated to a temperature of 1100° to 1350° C. (2010° to 2460° F.), and it might be thought that this treatment would seriously damage it. So it would, but for the fact that the subsequent mechanical pressure upon the metal breaks down the crystals and reduces them again to a small size. The result is that the final size of the crystals is dependent upon the temperature of the material at the finish of the mechanical operation. In other words, steel finished at 900° C. (1650° F.) has a finer structure than the same steel if finished at 1100° C. (2010° F.). We do not feel warranted in stating numerically the exact relation between the finishing temperature and the grain-size, as we have not yet sufficient evidence, but several rules affecting the final size of grain seem to be virtually established: (1) It is more advantageous to have the mechanical work applied continuously from the highest temperature employed down to the finishing temperature, rather than to have long waits during which the steel cools; and especially is this true when the amount of work put upon the metal at the lower temperatures is small. In other words, if the steel is formed roughly to shape and size at a high heat, is then allowed to cool, and a little work is done upon it at the lower temperature, the grain will not be good. (2) It is best for the metal to be worked by several passes through the rolls, or many blows of the hammer, rather than to effect the same amount of reduction by a lesser number of heavy drafts. (3) The greater the amount of reduction the better; that is, to work a large piece down to the desired article gives a better structure. (4) The best temperature at which to finish the work it probably upon, or slightly below, the lines *G-O-S* or *S-K* in Fig. 246, page 314.

Action in Rolling. — The exact crystalline action that takes place under mechanical treatment is not definitely known. In the case of rolling Professor Howe has tentatively assumed the conditions graphically shown in Fig. 283,¹ in which the line *DG* represents the size of grain at the different temperatures. At 1400° C. (2550° F.) the grain-size is represented by the distance of the line from the axis *O-O*. On the first passage through the rolls the grains are crushed to a very small size, but on emerging again they grow very rapidly. Meanwhile, however, the metal has been cooled, and this fact, as well as the inability of the grains

¹ Page 263 of No. 1, page 8.

to grow instantly, causes the new size of grain to be smaller than before. Therefore, each passage through the rolls renders the crystals smaller in size, the final size depending upon the temperature and the amount of pressure in the last pass. The only

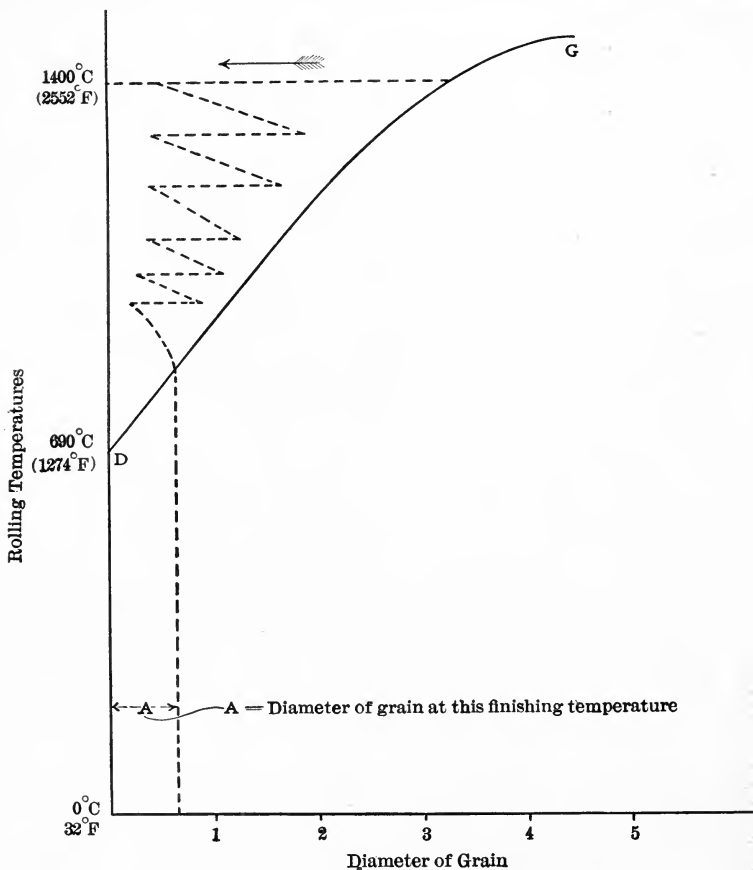

FIG. 283. From Howe, "Iron, Steel and other Alloys."

abnormal assumption in this argument is that the crystals grow rapidly after the crushing, whereas we know that when steel is heated to any of these high temperatures, the growth is relatively slow. This objection is not strong enough alone to refute the theory, but other hypotheses may be advanced for those who require further explanation. For example, it may be supposed that the steel is so mobile at the very high temperatures that it yields to

distortion, not altogether by the crushing of the crystals, but by the sliding of the crystals past one another; as the temperature becomes lower, however, the mobility of the mass becomes less, and less sliding is possible, so that more crushing of the crystals takes place.

Finishing Temperatures. — William Campbell has studied the finishing temperature of steel containing 0.5 per cent. carbon and finds that the very best qualities are produced in the steel if mechanical work is ended just at the time when ferrite begins to separate from solid solution, that is to say, just when the steel is below the line *G-O-S* in Fig. 246, page 314. Work below that temperature greatly increases the brittleness of the material, while finishing the work at a higher heat results in lower strength. Upon the evidence at hand, we may tentatively assume like conditions for steels of any carbon, and expect the best results if mechanical work is ended when the steel is at a temperature which brings it exactly upon the line *G-O-S* or *S-K*, but reserving, perhaps, the right to change this statement slightly when more data are obtained.

Welding. — This brings us to the subject of welding, or the joining of two pieces of wrought iron or steel by pressing or hammering them together while at a very high temperature. In this way a joint may be made which cannot be seen by the eye unless the steel is polished and etched with acid, which usually develops the junction line very clearly. The exact temperature of welding is not known, but probably it is very near the melting-point, when the steel is in a soft and almost pasty condition. Low-carbon steel welds most easily; moreover, all impurities, especially silicon and sulphur, reduce weldability. The procedure in welding is very simple, and consists in heating the two pieces that are to be welded to a high temperature, dissolving off the iron oxide, and then pressing the two pieces together forcibly. The dissolving off of the oxide is usually accomplished by rubbing the metal in some flux, such as borax. At the present time various patented 'welding plates' are sold. These consist of thin plates of flux which are put between the two pieces to be welded and so get rid of the oxide, the pieces being hammered together with the plate between them.

In the actual manipulation for welding the two pieces that are to be joined together are usually 'upset,' or in some way en-

larged in size, so that after the junction the part of the bar right at the weld is larger in size than the remainder. This part is then hammered continuously until the metal is at a red heat, the object being to break up the coarse crystals produced by the high temperature, and, by having a low 'finishing temperature,' to obtain a small grain-size. With proper welding this object will be attained so far as the metal immediately adjacent to the weld is concerned, but there is always a spot within six inches or so of the weld which must necessarily have been overheated without subsequently receiving mechanical treatment, i.e., 'hammer refining,' down to the proper finishing temperature. Thus it is that most welded pieces break at a point not far from the junction and under a strain much less than the original strength of the bar. Blacksmiths and experienced welders are wont to declare that if a welded bar does not break in the weld itself, then it must be as strong as the original metal. As I have shown, however, this is by no means true. In a welding test carried on with great care in this country by skilful and experienced welders who were placed upon their mettle,¹ the strength and elastic limit of the welded bar was almost never as great as the original bar, and in some cases was less than half. In ductility even worse results were obtained. In a similar test carried on at the Royal Prussian Testing Institute the average strength of welded bars of medium steel was only 58 per cent. of the original, that of softer steel only 71 per cent., and of puddled iron only 81 per cent., while the poorest results were only 23, 33, and 62 per cent. respectively. It was seen that bad crystallization adjacent to the weld was the cause of the damage.

This evidence shows positively that welded steel and iron bars should always be reheated to a temperature just above the line *G-O-S* in order to restore by heating the grain-size of all parts.

Burning. — In the vernacular of the trade, all overheated steel is termed 'burnt,' but this is not correct usage, because true burning takes place only when the overheating is most abusive, and, indeed, when the metal is heated almost to its melting-point. It is probable that steel is burnt only when it is heated above the line *A-a* in Fig. 246, page 314. Alfred Stansfield has studied this question very ably,² and distinguishes three stages of burning. The first stage is reached when the steel barely crosses the

¹ See pages 401 to 406 of No. 2, page 8.

² See No. 143, page 395.

line *A-a*, that is, when the first drops of melted metal begin to form in the interior of the mass: they segregate to the joints between the crystals and cause weakness. Stansfield thinks that steel burned only to this stage may be restored by reheating it first to a high temperature, cooling, and then heating again to a temperature just above the lines *G-O-S-K*. The second stage in burning is reached when these liquid drops segregate as far as the exterior and leave behind a cavity filled with gas.

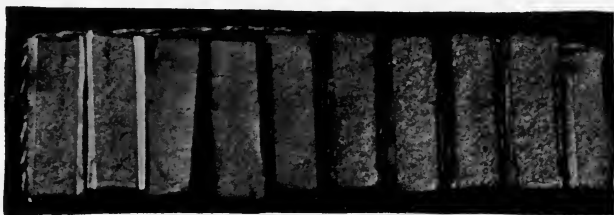
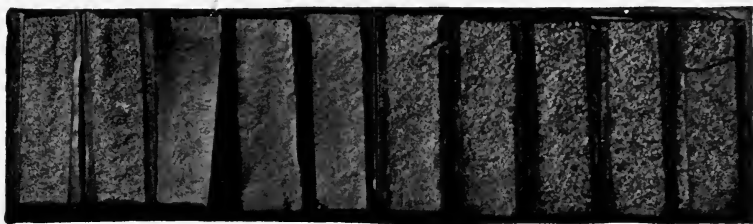

FIG. 284. — METCALF TEST. FRACTURES OF STEEL CONTAINING ONE PER CENT. OF CARBON.

Stansfield thinks that steel burned to this stage might be restored by combined reheating and forging. As a matter of safety, however, I believe it would be well to remelt all such material; in other words, send it to the scrap pile. The third and last stage of burning is reached when gas collects in the interior of the metal under sufficient pressure to break through the skin and project liquid steel, which produces the well-known scintillating effect at this temperature. Into the openings formed by these minute explosions air enters and oxidizes the interior. There can be no remedying of steel which has been burned to this extent.

Metcalf Test. — A very interesting experiment is the “Metcalf test,” originated by William Metcalf.¹ It is best performed upon a bar of high-carbon steel, because this material shows the differences in structure so readily to the eye. A bar of steel about 12 in. long is notched with a hacksaw or chisel at intervals of an inch. One end is then placed in a fire and heated to a temperature at which it scintillates, while the other end is at a black heat. Then it is removed and cooled. It is immaterial whether the cooling be rapid or slow, but time may be saved by plunging it into water. It is then broken at every notch, and an examination of the fractures will show a very large size of crystals at the end which is burnt, gradually decreasing until a fine and silky appearance is presented where the metal was exactly at the temperature of restoration, while beyond that point the fracture will be the same as that of the original bar. In case this test is made upon low-carbon steel it should not be notched before treatment, but afterwards it should be cut apart with a hacksaw at intervals of an inch, and then polished and examined under the microscope, because soft steel will not break without bending, and this bending destroys the indications of the fracture. This Metcalf test is very serviceable in case we desire to compare steel that we suspect of being overheated with overheated steel of like analysis to determine the degree of overheating.

Castings do Not Burn. — It might be thought that every steel casting would suffer the injuries due to burning because it is cooled through the space between the lines *A-B* and *A-a*, and especially so in the case of high-carbon steel, which is very easy to burn, on account of the low temperature at which this line *A-a* occurs and of the long distance between the two lines. Such injury, however, does not ordinarily take place, and this fortunate circumstance is explained partially by each of three differences between the heating and cooling of steel: (1) When steel is heated into the area where burning takes place, it is subjected longer to the burning temperature, because it generally takes longer to heat steel than to cool it. (2) When steel is being heated, the heat is traveling inward from the outside, and therefore all parts are expanding, and there is some opportunity for the crystals to draw apart and form cavities. On the other hand,

¹ See pp. 405, 406 (especially 406) of No. 116, page 332.

when it is cooling from the molten state, the outside layers are the cooler, and tend to contract upon the interior and hold the crystals more firmly together. (3) When steel is cooling from a molten state, it is constantly giving off from solution hydrogen and other deoxidizing gases which are soluble in it while liquid, and these gases prevent the oxidation of the crystal faces by the percolation of air into the interior.

Ingotism. — I have already discussed ingotism and said that the crystals in cast steel are larger than those of rolled steel, due to growth while the metal is at a high temperature, and I have stated that sometimes these crystals are very large, because the conditions of casting cause the steel to occupy a longer time in cooling from the liquid state down to a black heat. It is probable that ingots and castings do not show the effects of overheating (ingotism) to any marked extent unless they are a long time above 1100° C. (2010° F.). In case these coarse crystals do form, they may be restored to some extent by reheating the casting to a point just above the line *G-O-S*. Why ingotism is not completely remedied by the same treatment that cures the coarse crystallization due to overheating, I am unable to say, unless it be that ingotism is accompanied by burning to at least a slight extent.

Stead's Brittleness. — In addition to the damage caused by overheating, steel very low in carbon (say under 0.15 per cent.) is subject to another and peculiar danger, for if this soft steel be held for a very long time at temperatures between 500° and 750° C. (930° and 1380° F.), the crystals become enormous and the steel loses a large part of its strength and ductility. Fortunately it takes a very long time, in fact days, to produce this effect to any alarming degree, so that it is not liable to occur, even through carelessness, during manufacture or mechanical treatment. But steel is sometimes placed in positions where it may suffer this injury, for example, in the case of the tie-rods of furnaces, supports for boilers, etc., so that the danger should be borne in mind by all engineers and users of steel. I recall an instance where the breaking of a piece of chain that supported one side of a 50-ton open-hearth ladle caused a loss of life under the most horrifying conditions, due to the fact that the wrought-iron chain had been heated up many times to a temperature above 500° C. (930° F.), and had finally reached a condition of coarse

crystallization, so that it was unable to bear the strain upon it when the ladle was full of metal.

This phenomenon of coarse crystallization in low-carbon steel is known as "Stead's brittleness," after J. E. Stead, who has explained its cause. The effect seems to begin at a temperature of about 500° C., and proceeds more and more rapidly with an increase in temperature until we reach 750° C., above which no growth seems to take place. The damage may be repaired completely by heating the steel just above the line *G-O*. In other words, the remedy for coarse crystallization in this case is the same as that for coarse crystallization due to overheating, and all steel which is placed in positions where it is liable to reach these temperatures frequently, should be restored at intervals of a week or a month, or as often as may be necessary.

HARDENING OF STEEL

If steel be raised to a bright-red heat and then rapidly cooled, as, for example, by plunging it into water, it becomes very much harder and at the same time stronger and more brittle. One circumstance is absolutely necessary to produce the increase in hardness, namely, that the temperature from which rapid cooling takes place shall be above the critical temperature of the steel. Take, for example, steel containing 0.9 per cent. carbon; we may heat this ever so little below the point *S* in Fig. 246, page 314, and no increase in hardness will take place, even though we cool with extreme rapidity. On the other hand, if we cool the same steel rapidly from ever so little above the point *S*, it will be hard enough to scratch glass and brittle enough to fly into pieces under a blow of the hammer. This is the maximum practical hardness which can be obtained, for if we quench the steel at a still higher temperature, the only result of importance is to do it damage by increasing its grain-size. In case we have less than 0.9 per cent. carbon in our steel, the best temperature for hardening is just above the line *G-O-S*, because that gives the maximum hardness and also the best grain-size. The best temperature from which to harden steel with more than 0.9 per cent. carbon is just above the line *S-K*, because that gives the best grain structure, although it is true that greater hardness is obtained if we cool from above the line *S-a*.

Carbon and Hardness. — The hardness of steel increases with every increase of carbon. This applies to the hardness of steel in its natural state, and still more influentially to its hardness after the treatment I have just described. Although iron free from carbon is hardened by rapid cooling from above the point Ac_2 ($760^\circ\text{C.} = 1400^\circ\text{F.}$), and a little more so when rapidly cooled from above Ac_3 ($900^\circ\text{C.} = 1650^\circ\text{F.}$), yet this degree of hardness is so slight as to be perceptible only by means of delicate laboratory tests. With 0.25 per cent. carbon the hardness begins to be perceptible by crude tests, but it is only when we get above 0.75 per cent. carbon that ordinary steel acquires sufficient hardness for the process to be used commercially,—for example, for springs, saws, etc. Metal-cutting tools are usually made of steel containing 1 per cent. or so of carbon, while very hard implements, such as files, etc., will contain 1.5 per cent., or slightly more.

Rate of Cooling and Hardness. — The degree of hardness of steel also varies with the speed of cooling from above the critical range of temperature. When the cooling is very slow, as, for example, when it takes several days to cool, the steel will be as soft as it is possible to make it. When it is cooled by being taken out of the furnace and suspended in the air, or thrown upon a sand floor, it will still be relatively soft. When cooling is still more rapid, as, for example, when it is taken out of the furnace at a bright-red heat and plunged into a heavy oil with a low conducting power for heat, it becomes quite hard and springy, provided its carbon is in the neighborhood of 0.8 per cent. or above. Quenching in a thin oil from the same temperature makes it still harder. Quenching in water makes it harder still; and so on, the degree of hardness increasing as we quench in liquids which take the heat away from it faster and faster, such as ice-water, ice-brine, ice sodium chloride solution, and mercury near its freezing-point ($-39^\circ\text{C.} = -38^\circ\text{F.}$).

Theories of Hardening. — One essential feature of hardening is that the steel must be heated to a temperature above the line $P-S-K$, that is to say, to a point where at least some of the solid solution of iron and carbon is formed. There are several different theories to explain the hardness produced by rapid cooling from this point, the two most important being the 'carbon theory' and the 'allotropic theory.' Both of these theories depend upon the following line of reasoning: At temperatures above the critical

range the molecules of steel are in a hard condition.¹ As they cool from this point and cross the critical range of temperature, the molecules change from the hard state to a soft state, but this change is not rapid and requires time for its accomplishment; rapid cooling does not afford the necessary time, and so perpetuates the hard state of the molecules. This line of reasoning leaves only one point in doubt, namely, what causes the molecules to be hard when the steel is above the critical temperature, i.e., when iron and carbon are dissolved in each other?

The Carbon Theory. — The carbon theory assumes that the hardness of steel is due altogether to the carbon dissolved in it, and in evidence its advocates point to the extreme hardness of one form of carbon — the diamond. This theory has the advantage of simplicity, and has in its favor the fact that the hardness varies almost directly with the amount of carbon. Against the theory, it is urged that the amount of carbon is really too small to produce such a great degree of hardness in the whole mass of metal. Furthermore, although carbon is found in many metals, it does not confer hardness on any of them except iron.

The Allotropic Theory. — We have already learned that in the solid solution the iron is present in the gamma allotropic form, and there is one school of metallurgists which attributes the hardness to the allotropic form of iron alone and denies that carbon has any direct influence. It has been shown, by very delicate laboratory tests on iron practically free from carbon, that the gamma and beta allotropic modifications are harder than the alpha modification. He was not able to show how great was the increase of hardness of one form over another, because he was never able to cool the iron fast enough to prevent it changing back in part to the alpha form. In the absence of carbon the change from gamma to beta and from beta to alpha is very rapid, so that cooling has to be almost instantaneous in order to prevent it, and this, of course, is impossible. The 'allotropists' explain the

¹ It is difficult for some to understand how molecules of steel can be in a hard condition at a temperature at which we know that the mass as a whole is soft and mobile; but this can be explained by the following comparison: A ball of wet sand and clay is soft and mobile as a whole, because the particles move by each other readily and the mass changes its shape under pressure; yet the individual particles composing this mass are many of them hard enough to scratch glass with ease.

greater hardness of high-carbon steel as compared with low-carbon steel upon the basis that the presence of carbon makes the change from gamma to beta and to alpha iron slower, and therefore enables more of the iron to be retained in the gamma and beta forms by the rapid cooling.

One additional argument in favor of the allotropic theory is that when steel cools slowly through the critical range, it loses its hardness slightly before the carbon comes out of solution. This would indicate that the allotropic change took place before the carbon change, and that the allotropic change was the cause of hardness. What is true of the loss of hardness is also true of the other physical changes which take place at the same time. That is to say, the steel regains its magnetism, decreases in electric resistance, and increases in thermo-electric power in a large part before much carbon is separated from solution.

Influence of Carbon on Hardness. — I think no one to-day denies that the carbon in steel has a very important influence upon its hardness, even though it may not be the sole cause of it. This influence is twofold: (1) We have stated that the changes that take place when steel is cooled through the critical range were not rapid changes, and for this reason fast cooling was able in part to prevent their taking place. Carbon has the effect of making these changes still slower, and so increasing the effect of the rapid cooling. Howe calls this the 'brake action' of carbon. (2) The more the carbon in solid solution, the harder will that solid solution be.

The Compromise Theory. — Several theories have been advanced which are a compromise between that of 'the carbonists' and that of 'the allotropicists.' The simplest of these, and the theory now most generally accepted, is that the hardness of the molecules of steel above the critical range is due partly to the allotropic form in which the iron exists, and partly to the fact that we have a solid solution of iron and carbon.¹ In other words,

¹ Where I speak of a solution of carbon and iron, I intend to include under this also the solution of iron and a carbide of iron. That is to say, we have two substances, iron and carbon, and they are dissolved in each other. It may be that the carbon is united with part of the iron to form a carbide, and then that this carbide is dissolved in the rest of the iron; but I use the term "solid solution of iron and carbon" to cover either this condition or that of elemental carbon dissolved in iron.

the hardness is due to the fact that we have a solid solution of carbon in an allotropic form of iron.

The Internal Stress Theory. — There is an entirely independent theory of the hardness of steel which attributes it, not to the retention of a hard molecule existing above the critical range, but to stresses set up in the metal by rapid cooling through the critical range. That such stresses exist cannot be doubted, for sometimes the rapid cooling of high-carbon steel causes it to break into pieces, or to open up a cavity in the middle from end to end, but the theory itself does not seem sufficient to explain all the facts.

Tempering. — Hardened steel is too brittle to be used without some degree of tempering, except for a small variety of purposes, such as the points of armor-piercing projectiles, the face of armor plate, etc. In order to understand just what tempering does, let us consider the exact condition of hardened steel: it is in a hard and brittle condition which is not natural to it at atmospheric temperatures, but which has been brought down with it from a higher temperature by means of rapid cooling. Theoretically, when the temperature fell below 690 C°. (1272° F.), the molecules of steel should have changed over to the soft form. Their hard condition is not in equilibrium at the lower temperature, in the same sense that ice is not in equilibrium in hot weather. Why, then, does not the steel change back into the soft form? Ice, if given time enough, will all change into water when the temperature is above 0° C. (32° F.). The reason the change does not take place in the steel after we have cooled it to the atmospheric temperature is that the mass as a whole becomes too rigid and immobile at the lower temperature to permit any alteration in its molecules to take place.

However, it is only necessary to decrease this rigidity in order to permit a slight change. For example, if a piece of hardened steel be kept in boiling water for some days it will lose a part of its hardness; if it be heated a little more, it will lose more hardness and lose it much more quickly. Each loss in hardness is accompanied by a loss in brittleness as well. If it be heated to about 200° C. (392° F.), quite a little of the brittleness will be lost and a part of the hardness.¹ It is now in condition to be used for steel

¹ After the heating it is immaterial whether cooling is fast or slow, as the same result will be produced.

engraving tools, lathe tools, and other implements to cut metals. If we heat to 250° C. (480° F.), we again temper, and to a point where the steel is still less brittle and will withstand greater strains, but is at the same time sufficiently hard to be used for rock drills, penknives, stone-cutting tools, and so forth. If tempered to 275° C. (525° F.), the steel has not even yet lost so much brittleness as to be able to withstand a great deal of shock, or even bending, but is still hard enough to be suitable for dental and surgical instruments, swords, needles, hacksaws, etc. Woodsaws, the majority of springs, and other articles that must be ductile even at the expense of hardness, will be tempered to a temperature of about 300° C. (570° F.), which is the greatest degree of tempering that is ordinarily employed.

It is interesting to note that when hardened steel is tempered, the physical changes produced by the tempering — the decrease in hardness and brittleness, increase in electric conductivity, etc. — precede the separation of carbon from the solid solution. By tempering we may lose 70 per cent. of the hardness, 93 per cent. of the electric resistance, and nearly 100 per cent. of the thermo-electric power produced in the steel by the hardening operation, when only 13 per cent. of the carbon has been changed from the dissolved form.

Temper Colors. — Nature has provided a ready means of determining the temperature of steel between 200° and 300° C. (390° and 570° F.) without the aid of thermometers or other instruments; and, since this is the range of temperatures in which practically all of the tempering of hardened steel takes place, this provision is a most fortunate one. It comes about through the oxidation of the metal at those different points. At 200° C. (390° F.) a thin film of oxide forms upon the steel, but is not sufficient to entirely hide the white color underneath, so that the combination produces a light lemon color. As the temperature rises the film of oxide becomes thicker and the yellow color darker until, at about 225° C. (437° F.), it has changed to orange. At 250° C. the orange has changed to a pink which is known as 'pigeon wing.' At 275° C. the pigeon wing has turned into a light purple, which, at 300° C., becomes a blue.

Hardening, Tempering and Annealing. — Only quenching in water, or in some other medium which takes the heat away as fast or faster, goes under the name of hardening. Quenching in oil,

melted lead, etc., cools the steel less rapidly and makes it less hard and less brittle than quenching in water, so to this operation the name of 'tempering' is given. Cooling in the air, in sand, in the furnace, or by any other slow method, is called 'annealing.'

Combined Hardening and Tempering. — If steel be cooled from above the critical range by quenching in some slow conducting liquid in the first instance, as in cylinder oil, the same intermediate hardening and embrittling effect will be produced upon it as if it were first hardened in water and then tempered a certain amount. Therefore the quenching in oil and similar mediums has come to be called 'tempering.'¹ Another method of combining hardening and tempering after only one heating is used in the tempering of the cutting edges of chisels and similar tools: the end of the tool is first heated just above the critical range, and then the extreme point only is quenched in water until it is black, after which it is withdrawn and rubbed bright upon a piece of sandpaper, or upon a brick. This is done merely to give a bright surface upon which to observe the play of temper colors. The heat from the shank now begins to creep down into the point, which takes the various temper colors in order, beginning with the lemon. When the desired degree of tempering is reached — say, the pigeon-wing color — the whole tool is put into water. This is merely to 'put out the fire' and stop more heat coming down into the tempered point; it has nothing to do with the tempering operation itself.

Annealing. — If hardened steel be heated to a temperature of 600° C. (1100° F.) its pristine softness and ductility is returned to it. This process is known as 'annealing.' As a general thing we do not anneal at as low a temperature as this because we not only desire to make the steel soft, but also to give it as small a grain-size as possible, and this is done by heating just above the lines *G-O-S-K* in Fig. 246, page 314. Therefore the temper-

¹ Strictly speaking this is a misnomer, and very bad usage, but like so many incorrect terms that have become current in the iron and steel trade, it is now too firmly established to be displaced. The error in terms has gone even further than this, and the hardness of steel is known as its 'temper,' while making it softer is known as 'drawing its temper.' To temper means literally to soften, to mollify; or else to mitigate one quality with another (as justice is said to be 'tempered' with mercy). Either of these meanings is quite correct when we 'temper' hardened steel by heating it slightly, but is just the opposite when we call hardening steel in oil 'tempering,' or when we speak of 'drawing a temper.'

atures just above these lines are not only the hardening and restoring temperatures, but the annealing temperatures as well, if we cool slowly. It is only when we have a steel with a structure already fine that we use the low-temperature annealing, as, for example, with cold-rolled steel, wire, etc. To heat such steel above the line *G-O-S* would not increase its softness and would undo some of the benefit of the cold work.

Magnetism and the Lines G-O-S-K. — It will be remembered that iron is present in the solid solution in the gamma allotropic form, and therefore the solid solution is non-magnetic. Therefore all the steels to the right of the point *O* in Fig. 246, page 314, lose the last of their magnetism at the same time as they cross the lines *O-S-K*. These steels comprise all containing 0.4 per cent. of carbon and more. To harden, anneal or restore such steels we may guide our work of heating by means of an ordinary horse-shoe magnet, which makes a most accurate and simple tool. Let the magnet hang outside of the furnace and take the steel out at intervals to test it. When it no longer attracts the magnet, begin to cool it. For steels with less than 0.4 per cent. carbon we can use the magnet to tell us when the temperature corresponding to the line *M-O* is reached, for all iron loses its magnetism at that point, and then it is a comparatively simple matter to judge by eye the relatively short temperature intervals above that point which it is necessary for the steel to traverse before it crosses the line *G-O*. If this method is followed I think it will be found in many works that annealing temperatures have been much too high, and that better steel will be obtained in future. We do not get the steel any softer by annealing it hotter, but only by slower cooling.

THE CONSTITUENTS OF HARDENED AND TEMPERED STEELS

It is now pretty generally admitted by metallurgists that austenite is the solid solution of gamma iron and carbon. When this cools slowly through the critical range it decomposes into ferrite and cementite. It is also very generally admitted that the decomposition does not take place spasmodically, but progresses by stages, and many believe that the substances identified under the microscope as martensite, troostite, and sorbite are the products of these stages. That is to say, martensite is the first stage

of decomposition of austenite, troostite is the second, sorbite is the third, and pearlite is the consummation. If this is so, then austenite will be found in the steels cooled with the greatest rapidity, martensite will be found in those cooled with the next degree of rapidity, troostite will be found in the next intermediate steels, sorbite in the next, and pearlite in those slowly cooled. To this extent, indeed, the facts agree with the argument, but hardly any dare predicate further too positively from this evidence alone. Our knowledge upon this whole subject is still very new, and though a small army of workers is busy collecting evidence and interpreting it as best they can, all our present statements must necessarily be made tentatively, with the idea of presenting the facts so that they may be of some practical benefit, even though later information may oblige us to change slightly the scientific basis upon which we found them.

Austenite. — Austenite can be obtained at atmospheric temperatures in ordinary carbon steels only when three conditions are collectively present: (1) The brake action of carbon must be very strong, that is, there must be above 1.1 per cent. of carbon present; (2) the steel must be cooled with the greatest rapidity, as by quenching it in iced solutions at, or a few degrees below zero C.; and (3) it must be cooled from above 1000° C. (1830° F.). Even then austenite cannot be preserved throughout the whole mass of the steel, but at least a part of it will be decomposed to the stage represented by the martensite structure (see Fig. 288) while cementite will separate also if the carbon is very high. Under the microscope austenite may be differentiated from martensite by its white color after etching with a 10-per-cent. solution of hydrochloric acid. Better results are obtained if the etching is aided by electrolysis, the steel being made the anode, or positive pole, and a piece of platinum being made the cathode. Austenite is not a very important constituent practically, because probably it almost never occurs in commercial steels. It is immediately decomposed into later stages upon tempering.

Martensite. — Martensite is the chief constituent of ordinary hardened steels, that is, of steels quenched from above the critical range in water or in an iced solution. Its structure is shown in Fig. 288. It is even harder than austenite, for a steel needle drawn across the surface of a polished piece of steel will scratch the austenite plainly without making a mark upon the martensite. Its



FIG. 285. — NO. 1A. STEEL OF 0.34 PER CENT. CARBON OVERHEATED TO ABOUT 1300° C. (2372° F.).

Magnified 250 diameters.



FIG. 286. — NO. 2A. SAME AS NO. 1A. REHEATED SLIGHTLY ABOVE AC_3 .

Magnified 250 diameters.

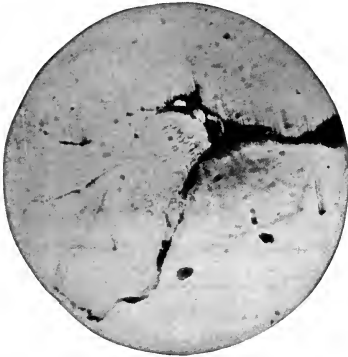

FIG. 287. — STEEL OF 1 PER CENT. CARBON BURNT.

Magnified 265 diameters.



FIG. 288. — MARTENSITE.

Magnified 250 diameters.



FIG. 289. — MARTENSITE (WHITE) AND TROOSTITE (DARK).

Magnified 500 diameters. Etched lightly with tincture of iodine. (H. C. Boynton.)

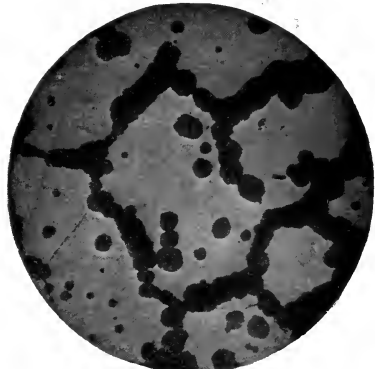

FIG. 290. — AUSTENITE (WHITE) AND TROOSTITE (DARK).

Magnified 60 diameters. Steel of 1.41 per cent. carbon. Etched with picric acid. (William Campbell.)

structure is developed by the 'polish attack' method of F. Osmond (see p. 453). Martensite is also found very largely in the tempered steels, to which they doubtless owe their quality of hardness. It was long thought to be the solid solution itself, and is still spoken of as such in several books upon the subject; but the microscope shows positively that it is not free from some decomposition.

Hardenite. — Hardenite is the name sometimes given to 'saturated martensite,' that is, martensite containing 0.9 per cent. carbon. It is often found in German and French, and occasionally in English and American books.

Troostite. — Troostite is obtained in either of three ways: (1) By quenching steel in water when it has cooled just to the line *P-S-K* in Fig. 246, page 314; (2) by quenching steel from a higher temperature in boiling water, oil, or some other of the tempering mediums; and (3) by hardening in the usual way and then tempering by reheating. In other words, troostite is a product of the usual tempering operations, and is found abundantly in tempered steels. Under the microscope it may be distinguished by the



FIG. 291. — FERRITE AND SORBITE
IN RAILED STEEL.

Magnified 250 diameters.
Etched with picric acid.

'polish attack' (page 453) or by etching with tincture of iodine. It appears as yellow, brown, blue or black colorations on the borders of the martensite, and often between the martensite and sorbite. The division between it and the martensite is very sharp, but it shades very gradually into the sorbite (Figs. 289, 290).

Sorbite. — Sorbite is very close to pearlite, and differs from it chiefly in that the crystals of ferrite and cementite are not quite perfectly developed and segregated from

one another (see Fig. 291). It might at first seem almost like splitting hairs to differentiate between the two, but this is not so, because of the importance of sorbite, due to its having greater strength than pearlite. Pearlite has a finer and more intimately

entangled structure than any other slowly cooled steel, and to this we attribute the fact that pure pearlite steel (0.9 per cent. carbon) is stronger than any other. But the structure of sorbite is even finer than that of pearlite, and sorbitic steels are correspondingly stronger than pearlitic steels.

Sorbite may be obtained by quenching the steel immediately below, or just at the end, of cooling through the critical range, or by cooling the steel pretty fast through the critical range without actually quenching, or by rapid cooling and then reheating to about 600° C. (1110° F.).

Osmondite. — Only very recently what is apparently another constituent of hardened and tempered steels has been discovered, and to this the name of 'osmondite' has been given. It would seem that osmondite is a solid solution of carbon (or of a carbide of iron) in the alpha allotropic modification of iron. It is therefore an anomaly, and can only exist in equilibrium momentarily, so to speak, because the normal solid solution contains the iron in the gamma allotropic form. It would seem, however, that when this gamma solid solution decomposes, it passes through a phase wherein the iron has changed from the gamma to the alpha form, before the precipitation of the ferrite occurs. In other words, then, osmondite is simply another stage in the decomposition of austenite into pearlite. It differs from the other stages by having a definite constitution and nature, whereas martensite, troostite and sorbite are more or less indefinite and uncertain in composition, being in fact probably a mixture of two or more constituents rather than definite and individual components.

It is evident that osmondite can never compose the whole of any piece of steel, because the earlier stages of the austenite decomposition will grade into it on the one side and the later stages on the other. That is to say, we would not expect that the entire piece of steel would change simultaneously and instantaneously from austenite into osmondite, and then likewise from osmondite to pearlite. Osmondite may be obtained by tempering hardened steel at 400° C. (750° F.), but its distinguishment under the microscope is not known at present. Our chief means of recognizing it are by the fact that it causes the steel to dissolve more rapidly in dilute sulphuric acid and to be colored more deeply by alcoholic hydrochloric acid, and by the fact that steel containing a good deal of osmondite has lost a major part of all the qualities given

to it by hardening, although almost all the carbon is still in the solid solution.

It is to be noted that the evidence proving the existence of osmondite is still open to the possibility of doubt, although the probabilities are greatly in favor of it.

Summary. — We may summarize the constituents of hardened and tempered steels in the following table, which is adapted from one designed by Howe:

STAGES OF THE TRANSFORMATION FROM AUSTENITE INTO PEARLITE

NAME	CONSTITUTION
Austenite.....	Solid solution of an iron carbide in gamma iron.
Martensite, a transition substance..	The next step. Some of the gamma iron is changed to beta and to alpha iron. It is harder than austenite.
Troostite, a transition substance...	The third step. The quantity of gamma and beta iron constantly decreasing, that of alpha iron constantly increasing.
Osmondite.....	Solid solution of iron carbide in alpha iron.
Sorbite, a transition substance....	A mixture of a constantly decreasing quantity of osmondite with a constantly increasing quantity of pearlite, too fine to be resolved by the microscope.
Pearlite.....	A conglomerate, or a mechanical mixture of free alpha iron (alpha ferrite) with the iron carbide, Fe_3C , cementite.

In a very illuminating discussion of the constitution of iron carbon alloys,¹ Albert Sauveur predicates that when steel cools slowly through the critical range and there takes place the decomposition of austenite — the solid solution of carbon and gamma iron — it first changes into a solid solution of carbon and beta iron, thence into a solid solution of carbon and alpha iron, and thence into cementite and alpha iron. In other words, Sauveur considers that, instead of the solid solution decomposing by the precipitation of its gamma ferrite, which immediately changes to beta and then to alpha ferrite, the ferrite in the solid solution is changed from gamma to beta and then to alpha, after which the precipitation occurs. By the

¹ *Journ. Iron and Steel Inst.*, No. 4, 1906, pp. 493-575.

light of recent researches this theory of Sauveur's is greatly strengthened.

REFERENCES ON THE HEAT TREATMENT OF STEEL

140. *Report of the Alloys Research Committee of the Institution of Mechanical Engineers* (England). Minutes of the Proceedings. Report No. 1, October, 1891; No. 2, April, 1893; No. 4, February, 1897; No. 5, February, 1899; No. 6, January and February, 1904; No. 7, November and December, 1905.
141. Joseph V. Woodworth. "Hardening, Tempering, Annealing, and Forging of Steel." New York, 1903. This book tells much of the practice and manipulation of these operations.
142. John Lord Bacon. "Forge Practice (Elementary)." New York, 1904. This book also deals largely with practice and manipulation.
143. Alfred Stansfield. "The Burning and Overheating of Steel." *Journal Iron and Steel Institute*, No. 11, 1903, pages 433-468.
144. Carl Benedicks. "Recherches Physiques et Physico-Chimiques sur l'Acier au Carbone." Upsala, 1904. With a good bibliography.
145. Hanns Freiherr von Jüptner. "Siderology, the Science of Iron." Translated by Charles Salter, London, 1902.
146. Hanns Freiherr von Jüptner. "Grundzuege der Siderologie." In three volumes. Vol. i, "The Constitution of Iron Alloys and Slags," Leipzig, 1900; vol. ii, "Relation Between the Thermal and Mechanical Changes, Constitution and Properties of Iron Alloys," 1902; vol. iii, "The Influence of Impurities; the Manufacture of Iron and Steel," etc.
147. J. W. Mellor. "The Crystallization of Iron and Steel." London, 1905. This is a very clear and readily intelligible discussion of the heat treatment of steel, and an introduction to metallography.
148. George W. Alling. "Points for Buyers and Users of Tool Steel." New York, 1903. Being a general review of the main sources of trouble and how to avoid them.

XV

ALLOY STEELS

WE have already described ordinary steel (which to distinguish it from the so-called alloy steels is often known as 'carbon steel') as an alloy of iron and carbon, and it is impossible to consider it otherwise with equal accuracy. But there is another class of materials to which the specific name of 'alloy steels' is applied. This comprises steels to which a controlling amount of some alloying element in addition to the carbon is added.

Definitions. — The International Committee upon the nomenclature of iron and steel defines alloy steels as "those which owe their properties chiefly to the presence of an element (or elements) other than carbon." The distinction between an element added merely to produce a slight benefit to ordinary carbon steel and the same element added to produce an alloy steel is sometimes a very delicate one. For example, manganese is added in amounts usually less than 1.50 per cent. to all Bessemer and open-hearth steels for the sake of getting rid of oxygen and neutralizing the effect of sulphur. Likewise silicon is sometimes added in amounts of 0.1 to 0.2 per cent. to get rid of blow-holes. But neither of these additions produce what is known as an alloy steel. When we make 'manganese steel' containing 10 to 20 per cent. manganese, the material has new properties quite different from the same steel without manganese and we therefore get an alloy steel. Similarly 'silicon steel' containing 2 or 3 per cent. of silicon will have an entirely new set of properties due to the silicon, and will therefore become an alloy steel.

Ternary Alloys. — A ternary alloy, or three-part alloy, is an alloy composed of iron, carbon, and one other influential element. This class includes the alloy steels which are used most abundantly by man and the most important of which are nickel steel, manganese steel, chrome steel, tungsten steel, molybdenum steel, silicon steel, vanadium steel, and titanium steel. There are sev-

eral other ternary steels which have been investigated and used to a small extent, such as boron steels, cobalt steels, etc. The field of useful ternary steels has not yet been investigated except in the most meager degree and a wide scope is left for future inventors. There are many elements whose influence on steel has not yet been studied, and even among those which are commonly used, there are some of which only limited proportions have been employed.

Quarternary Steels. — Quarternary, or four part, steels consist of iron, carbon, and two other alloying elements. The commonest and most important of these are nickel-chromium steels, tungsten-manganese and tungsten-chromium steels, nickel-manganese, manganese-silicon, tungsten-molybdenum, tungsten-nickel, nickel-vanadium steels, etc., etc. The result produced by adding an alloying element to ordinary carbon steel is astonishing and incapable of being predicated, and that obtained by a combination of two alloying elements is far more so. New products result with properties entirely different, and in some cases almost the opposite, of those of its constituents, so that almost any combination at random may lead to a surprise, even when the effect of different combinations of the same components is known. Therefore the possibilities of quarternary steels seem to be very great and the field has, as yet, hardly been touched.

Manufacture of Alloy Steels. — The manufacture of alloy steels is usually very simple and calls for no special comment here. As a general thing the alloying element is added like the recarburizer. For example, in the manufacture of manganese steel the requisite amount of ferro-manganese will be added at the end of the process; in the manufacture of nickel steel we may add ferro-nickel in the same way, but it is more common here to add shotted-nickel during the process and allow it to dissolve in the steel bath and remain there until the metal is tapped; tungsten steels and tungsten-chrome steels are often made by the crucible process and the requisite amount of ferro-chrome and ferro-tungsten, or of metallic chromium and metallic tungsten, is placed on top of the charge when the crucible is filled.

The treatment of some of the alloy steels is not so simple: Nickel steel may be heated, rolled and forged without any great precaution, but these operations are performed upon manganese, tungsten, and some of the other alloy steels only after great diffi-

culty and experience. Under the head of these different steels, I shall describe the proper method of treatment.

NICKEL STEELS

Nickel steels are the most important of all the alloy steels and are the most abundantly used. In the ordinary commercial alloys the nickel ranges from 1.50 to 4.50 per cent. and usually from 3.00 to 3.75 per cent. while the carbon is usually from 0.20 to 0.50 per cent. Not counting armor-plate, which is really a quarternary steel, containing both nickel and chromium, the most important uses of nickel steel are for structural work in bridges, railroad rails, especially on curves, steel castings, ordnance, engine forgings, shafting, especially marine shafting, frame and engine parts for automobiles, wire cables, axles, especially for automobiles and railroad cars, etc., etc. We can best learn the reasons for these particular uses by discussing the distinctive properties conferred by the nickel and their usefulness.

Tensile Properties. — The chief distinction between nickel steel and carbon steel is the higher elastic limit of the former, and especially the fact that this higher elastic limit is obtained with only a slight decrease in ductility. About 3.50 per cent. of nickel added to carbon steel will increase the elastic limit nearly 50 per cent., while reducing the ductility only about 15 to 20 per cent. It is this increase in elastic limit which is probably the chief reason for the increased resistance of nickel steel to what is known as "fatigue," that is to say, its resistance to repeated stresses and alternating stresses¹ under which all steel will ultimately break down, even though the load is far less than that it can bear indefinitely if constantly applied. It is probable that the molecular structure of nickel steel is also advantageous in this same connection. About 3.50 per cent. of nickel will give steel approximately six times the life in resistance to fatigue. The records of shipping show that the great majority of acci-

¹ Repeated stresses are stresses put upon a body at intervals and relieved meanwhile, while alternate stresses are stresses first in compression and then in tension, such, for instance, as the stresses in a wire that is bent backwards and forwards, or in a rotating shaft that is not absolutely in alignment.

dents to vessels at sea come from the breaking of the propeller shafts which is doubtless due to alternate stresses because these long shafts are put out of alignment by each passing wave, and now practically all large vessels use hollow nickel steel shafts. It is the higher elastic limit that is responsible also for the use of nickel steel in bridges, ordnance, automobile parts, and wire cables, for we may obtain equal strength with less weight or greater strength with the same weight. Besides the elastic limit the ultimate tensile strength of nickel steel is increased also by the addition of nickel. The increase is not so great in this particular, and consequently the elastic ratio, i.e., the ratio of the elastic limit to the tensile strength, is increased still more greatly. The elastic limit of ordinary rolled carbon steel should be at least one-half of the tensile strength while that of 3.50 per cent. nickel steel should be at least 60 per cent.

Crystalline Structure. — The crystalline structure of nickel steel is more minute than ordinary carbon steel, and this is probably one of the chief causes for the toughness of nickel steel, and also for the fact that cracks develop in it relatively slowly: in the yielding of steel to fatigue the damage starts by the opening of a crack of microscopic proportions through the cleavage planes of the crystals, and this crack grows and spreads from crystal to crystal until it is visible to the unaided eye, after which it proceeds with still greater rapidity. As already stated, this development is much slower in nickel steel than in carbon steel. Furthermore if an armor plate is struck by a projectile, it does not crack so easily, and the cracks do not extend so far if the plate is made of nickel steel. This fact and the greater strength of nickel steel are the chief reasons for the 3.25 per cent. of nickel in all modern armor plate.

Modulus of Elasticity. — The modulus of elasticity of nickel steel containing not more than 4 or 5 per cent. nickel is about the same as that of carbon steel, namely, about 29,500,000 pounds per square inch. With higher contents of nickel, however, and especially with more than 20 per cent. of nickel, the modulus of elasticity is lower. This results in the steel being much more resilient or springy, and this is one of the important reasons why not more than 4 per cent. of nickel is put into structural steels, for a bridge built of steel which was resilient, even though strong, would vibrate so much with the motion of a passing load as to

be unpleasant, and even unsafe on account of the repeated stresses set up. The price of nickel, of course, enters into the limitation of the amount used in structural material as well, and it is found that 3.50 per cent. can be added without great expense and with beneficial results.

Hardness. — Nickel steel is considerably harder than carbon steel, though not so much so but that it can be machined without difficulty. This is taken advantage of in the use of nickel-steel railroad rails for curves and other locations where the steel soon wears out. The additional strength of the nickel steel is also an advantage in this connection and nickel-steel rails have been tried with success upon the famous horseshoe curve of the Pennsylvania Railroad and other places. The hardness of nickel steel is also accompanied by a lower coefficient of friction, and those properties, together with the additional strength, are taken advantage of in the use of nickel steel in axles for automobiles, locomotives and railroad cars. Equal strength can be obtained in an axle of smaller size which has, of course, less bearing surface, and therefore still further reduced friction.

Soundness. — Nickel-steel castings are relatively free from blowholes and this together with the strength is a reason for the use of this material for castings. They also have a lower melting point and run more easily in the molds.

Expansibility. — The coefficient of expansion of nickel steel is one of its most astonishing and unusual characteristics, for in different samples it varies all the way from practically zero up to the ordinary figure for carbon steels.

Colby¹ gives the following figures for the average coefficient of expansion for each 1° C. temperature:

Carbon Steel.....	0.00001036	(Guillaume)
Carbon Steel (.25 per cent. C.).....	0.00001150	(Charpy)
Soft Carbon Steel.....	0.00001078	(Browne)
5.00 per cent. Nickel Steel.....	0.00001053	(Guillaume)

Invar. — But the coefficient of expansion with the ordinary atmospheric changes of temperature becomes less and less as the percentage of nickel increases until, when we reach 36 per cent. of nickel, it is less than any metal or alloy known and amounts practically to zero. This alloy is patented and sold under the

¹ Page 79 of No. 152, page 420.

name of "Invar" and is used for scientific instruments, pendulums of clocks, steel tape-measures for accurate survey work, etc. In a paper read before the American Association for the Advancement of Science in December, 1906, it was stated that tapes made of invar used experimentally for United States Government survey work showed a very great increase in accuracy over ordinary steel tapes, and also in rapidity of use. These tapes varied an infinitesimal amount during the first few months, after which they became practically constant in length. The cause of this peculiar effect of nickel upon the dilation of steel with an increase in temperature is a result of the effect of nickel upon the critical ranges of the steel, which we shall describe later.

Platinite. — As the amount of nickel increases beyond 36 per cent., there is a slight increase in the coefficient of expansion so that when we reach about 42 per cent. of nickel, the steel has the same coefficient of expansion and contraction with the atmospheric temperature as has glass. It can therefore be used for the manufacture of 'armored glass,' i.e., a plate of glass into which a network of steel wire has been rolled and which is used for fire-proofing, etc., because even though the glass should break, it is held together by the steel network. It can also be used for the electric connections passing through the glass plugs in the base of incandescent electric lights. Platinum has been used altogether for this latter purpose, in spite of its very high cost, because it was the only metal hitherto known that had the correct coefficient of expansion and contraction, and therefore the name of 'platinite' has been given to this patented nickel-steel alloy. It is much more valuable for employment in the electric light industry than for armored glass, because ordinary steel, although its coefficient of expansion is too large, still suffices for the majority of armored glass work.

Corrodibility. — Nickel steel corrodes less than carbon steel, both in the presence of the atmosphere, fresh and salt water, the ordinary acids, the smoke of locomotives, etc. Moreover, the degree of corrodibility decreases with each increase in the amount of nickel present. For this reason 30 per cent. nickel boiler tubes have been used, especially in marine boilers. The great expense of this material is, however, an obstacle to its common adoption.

Other Properties. — Ordinary nickel steel containing about 3.50 per cent. of nickel has several other properties which distinguish it

from carbon steel, among which we may mention its higher compressive strength and greater toughness under impact. This latter makes nickel steel especially resistant to shocks, for it not only takes a greater blow to bend it but it will bend through more of an angle before cracking. Nickel steel also has a greater shearing strength which makes it advantageous for rivets, because smaller rivets may be used and this means smaller holes in the structural members that are being joined, and consequently a greater area of these members left to support the strains upon them. In this connection, however, it should be remembered that nickel steel does not weld as well as carbon steel, and therefore greater care is required in upsetting the rivets during the processes of construction. Nickel segregates very little in iron and it also has the advantageous property of hindering the other elements from segregation, so that nickel steel is less liable to these irregularities than carbon steel. In steel over 0.50 per cent. carbon, nickel has a tendency to make the carbon come out as graphite.

Critical Changes. — Nickel has a very important effect upon the critical changes of iron and steel. This fact will readily be believed because it is known that many of the elements added to steel produce important changes in the critical points. G. B. Waterhouse,¹ while investigating under my direction the effect of 3.80 per cent. of nickel upon iron, showed that this amount of nickel did not make any appreciable difference in the mode of occurrence of the critical points on cooling, but it did reduce the temperature at which these critical points came by about 75° C. (167° F.).

As the amount of nickel in the alloys increases the temperatures at which the critical ranges occur become lower and lower until we reach 25 per cent. of nickel, when the critical ranges occur below the atmospheric temperature. That is to say, the steel does not ordinarily cool to the point at which the solid solution is decomposed and the beta and alpha allotropic modifications are assumed.

Irreversible Transformations. — The great peculiarity of the critical changes of the nickel-steel alloys with less than 25 per cent. of nickel is that they are irreversible. By this we mean that the change which takes place at one temperature on cooling is not reversed on heating at the same temperature, or anywhere near that temperature. In other words when we cool a nickel steel containing 20 per cent. nickel the solid solution is not decomposed and the

¹ No. 150, page 419.



FIG. 292. — 1.54 PER CENT. CARBON.
ROLLED.
Magnified 225 diameters.
Etched with picric acid.



FIG. 293. — 1.24 PER CENT. CARBON.
ROLLED.
Magnified 225 diameters.
Etched with picric acid.

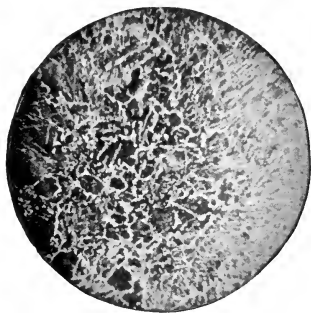

FIG. 294. — 1.24 PER CENT. CARBON.
SLOWLY COOLED STEEL.
Magnified 225 diameters.
Etched with picric acid.



FIG. 295. — 1.24 PER CENT. CARBON.
COOLED EXTREMELY SLOWLY.
Magnified 265 diameters.
Etched with picric acid.



FIG. 296. — 1.24 PER CENT. CARBON.
COOLED EXTREMELY SLOWLY.
Magnified 265 diameters.
Etched with picric acid.



FIG. 297. — 0.41 PER CENT. CARBON.
COOLED EXTREMELY SLOWLY.
Magnified 265 diameters.
Etched with picric acid.

Nickel steels containing about 3.80 per cent. nickel, 0.12 per cent. silicon, 0.05 per cent. manganese, 0.014 per cent. sulphur, 0.008 per cent. phosphorus, 0.01 per cent. aluminum.
(G. B. Waterhouse in the Author's Laboratory.)

alpha allotropic modification is not assumed until we get below 100° C. (212° F.). But having cooled the steel to that point and decomposed the solution, we can now heat it nearly to 600° C. (1112° F.) before the reverse change takes place and we again form the solid solution and the gamma allotropic modification. In other words, it is possible to have a sample of nickel steel between 100° and 600° C. which shall be in either condition we like. With 20 per cent. of nickel, nearly 1 per cent. of carbon and 1.40 per cent. of manganese, the transformation point on cooling is 188° below zero C. (306° below zero F.), while the transformation point on heating is well above the atmospheric temperature. Therefore at atmospheric temperature we may have such a piece of steel in either condition we like, and a very interesting experiment is formed by having a bar of this steel one end of which has been cooled more than 188° below zero C., while the other end has not. The end that has been cooled will be magnetic and the other end non-magnetic.

When we have more than 40 per cent. of nickel in our steels, the critical transformations are reversible like ordinary steels. That is to say, they occur at nearly the same temperature on heating as the reverse change does on cooling. It is an interesting fact that the steels in which the irreversibility of the transformation is most marked, — that is to say, the steels from 12 to 25 per cent. of nickel, — have the highest strength and elastic limit; at about 25 to 30 per cent. of nickel, where the irreversible transformation is most erratic, and beyond that point, the strength is much lower. The whole interesting question of reversible and irreversible transformation is discussed very fully in Dumas's paper No. 153, referred to at the end of this chapter.

Occurrence of Nickel. — Waterhouse tested his steel containing 3.80 per cent. of nickel and found that a part of the nickel was dissolved in the cementite which had the formula $(\text{FeNi})_3\text{C}$. The amount of nickel in the cementite was not, however, as great as that in the ferrite. That is to say, the steel, as a whole, contained 3.80 per cent. nickel, while the cementite contained only 1.86 per cent., showing that the nickel dissolves more easily in the ferrite than it does in the cementite.

Micro-structure. — In Figs. 292 to 297 I show some photomicrographs of nickel steels taken by Waterhouse, and in reference No. 1522 will be found L. Guillet's researches upon this subject.

MANGANESE STEEL

We owe the discovery of manganese steel to the untiring ingenuity of Robert A. Hadfield, of Sheffield, England, and its story will be an inspiration to every inventor, for it resulted in a material whose properties are not only the opposite of what we might reasonably have expected on logical grounds, but whose combination of great hardness and great ductility was hitherto unknown and might readily have been believed to be impossible. Constant study and perseverance must have been the qualities that led to this revolutionary invention, and it has established beyond question the principle that because a given amount of any element produces a given effect upon steels, it does not follow that a different amount will give the same effect in a different degree. Indeed a different amount may give an entirely different, and perhaps an exactly contrary, effect, as is the case of the effect of manganese upon steel.

When the manganese in steel is over 1 per cent. the metal becomes hard and somewhat brittle, and these qualities increase in intensity with every increase of manganese until, when we have 4 to 5.50 per cent. the steel can be powdered under the hammer. But as the manganese is increased from this point, these properties do not increase and when we reach 7 per cent., an entirely new set of properties begin to appear. These are well marked at 10 per cent. of manganese, and reach a maximum at 12 to 15 per cent.

Composition. — Manganese steel usually contains about 12 to 13 per cent. of manganese and 1.25 to 2 per cent. of carbon. With this amount of manganese the strength and ductility of the material reaches its maximum. This high carbon has been necessary hitherto, because ferro-manganese contains much carbon, which therefore unavoidably finds its way into the steel. In recent years, however, manganese metal, relatively free from carbon, has been made by the Goldschmidt Thermit process and otherwise, and this enables manganese steel low in carbon to be made, which is now in process of development and is giving evidence of having new and useful properties of its own and of being more easily treated and worked.

Treatment. — After manganese steel has been cast into an ingot or casting, and slowly cooled, it is almost as brittle as glass. But it is then reheated to a temperature of more than 1000° C. (1832°

F.) and rapidly cooled by plunging it into water. The temperature from which it is necessary to quench it can readily be determined, for it must be so high that when the steel is quenched little blue flames of hydrogen will appear on the surface of the water. These are due to the decomposition of water into hydrogen and oxygen by the intense heat of the steel at the moment of touching it. The steel which was very brittle before this treatment is afterwards as ductile as soft carbon steel or wrought iron, while its tensile strength is about three times as great. Thus the sudden cooling, which produces brittleness in ordinary steel, produces ductility in manganese steel. The hardness of the manganese steel is about the same in the slowly cooled and in the quenched condition, and is so great that it is not commercially practicable to machine it and there is no method known of making it softer.

Manganese steel must be heated very slowly and uniformly lest it crack. It is also very difficult to forge it, and this can only be accomplished within a narrow range of temperature above a red heat and by beginning with very light taps of the hammer. After a little working it becomes so tough that it can be rolled, although somewhat gingerly. The knowledge as to the proper method of performing these manipulations is only in a few hands, and it is only recently that any large amount of forging has been possible. Even railroad rails for curves have generally been made by casting the metal in a mold of the proper shape, including the curvature, and this has, of course, involved a great deal of expense.

Uses. — Manganese steel is used chiefly for the jaws and wearing parts of rock-crushing machinery and similar apparatus, for railroad frogs and crossings, for railroad rails on curves, mine car wheels, and burglar-proof safes. Its life in these classes of service is very many times that of all other kinds of steel, because it is not only extremely hard but is without brittleness. There is a famous curve on the Boston elevated railroad where carbon-steel rails were worn out in a very short time and the use of manganese-steel rails has proved very advantageous and economical. The use of the steel for burglar-proof safes is also very advantageous, because there is no known method of making the steel soft enough to be penetrated by a drill. The uses of manganese steel are limited chiefly because the metal must ordinarily be formed by casting, since machining and cutting to shape is practically out of the question, and forging is difficult. For structural work the advan-

tages of its high combination of strength and ductility are somewhat offset by its low elastic limit, which is only about 35 per cent. of its ultimate tensile strength. One peculiarity of manganese steel is that when it yields to tensile stresses it is elongated more uniformly over its whole length than carbon steel, which suffers its greatest elongation near the point of final rupture where a certain amount of "necking" takes place. It will be remembered that on page 65 we showed that wrought iron stretched more uniformly over its whole length than steel; manganese steel has this property in a still more marked degree even than wrought iron.

Critical Changes. — The hardness of manganese steel is due, in part, to the hardness of manganese, but still more potently to the fact that the steel is in the austenitic condition. That is to say the manganese has reduced the temperature at which the critical changes occur below that of the atmosphere, and therefore manganese steel consists entirely of austenite. It is, of course, non-magnetic. Whether or not it is capable of irreversible transformation like nickel steel is not known, for its nature and manufacture is kept as secret as possible by those who know it, for trade reasons.

CHROME STEEL

Chromium has the effect of making the critical changes of steel take place much more slowly. Therefore chromium steels are capable of greater hardness, because rapid cooling is able more completely to prevent the decomposition of austenite. They contain usually 1 to 2 per cent. of chromium and from 0.80 to 2 per cent. of carbon and are used in the hardened state. They are particularly adapted for making armor-piercing projectiles, on account of their hardness and also their very high elastic limit. They are also used for armor plate for the same reason, for parts of crushing machinery, and for very hard steel plate. This latter is not ordinarily used by itself, but is made into 3-ply and 5-ply plate for plows and burglar-proof safes, as described on page 195, for if the hardened chrome steel were used alone, its brittleness would cause it to be shattered.

Armor Plate. — Krupp armor plate contains about 3.25 per cent. of nickel, 1.50 per cent. of chromium and 0.25 per cent. of carbon. Its further manufacture is described on page 228.

Automobile Steels. — Chromium up to about 2 per cent. is also used for automobile steels where hardness is required, as for instance in gears and other parts requiring great hardness or great strength. For the latter purpose it is more common to use a nickel-chrome steel, and this is often subjected to a double heat treatment or a simple oil tempering. This treatment has the effect of greatly increasing its strength and elastic limit, so that steels of this character will have properties similar to those shown in Table XXX. There cannot be said to be any uniform composition or method of treatment for automobile steels, and my inquiries among American manufacturers seem to indicate that there is not very much of the high-priced alloy steels used in American cars, except for the frames which, as already stated, are frequently made of 3.50 per cent. nickel steel. The next most important use is probably for gears of chrome steel or nickel-chrome steel, first case-hardened by cementing with carbon to a depth of an eighth of an inch or so, and then heat-treated. The composition and treatment of alloy steels used in French automobiles is shown more fully in Guillet's article, No. 1514.

SELF-HARDENING AND HIGH-SPEED TOOL STEELS

Self-hardening Steel. — Self-hardening steel is steel which is hard without being subjected to any heat treatment or other process for making it so. It is steel which cannot be made soft, or annealed, by any process known at present. It is often called 'air-hardening steel' because when it cools in the air from a red heat or above, it is not soft like ordinary steel, but is hard and capable of cutting other metals. Manganese steel is a typical self-hardening steel and so obviously is any steel which is in the austenitic condition at atmospheric temperatures,—that is to say, whose critical temperature is below the atmospheric temperature. All the self-hardening steels are therefore non-magnetic.

Mushet Steel. — The name 'self-hardening' steel was first applied to an alloy steel invented by Robert Mushet and which owed its self-hardening properties to the simultaneous presence of both tungsten and manganese. The analyses varied greatly but were probably limited to between 4 and 12 per cent. of tungsten with 2 to 4 per cent. of manganese and 1.50 to 2.50 per cent. of carbon. A typical sample and one having excellent qualities

contained about 9 per cent. of tungsten, 2.50 per cent. of manganese, and 1.85 per cent. of carbon. This steel is incapable of being made soft by any known process and is non-magnetic. It is one of those curious phenomena met with in the metallurgy of steel, where a combination of two elements will produce a result entirely different from anything that might be predicated: Tungsten does not lower the temperature of the critical change in steel and 2.50 per cent. of manganese has but a slight effect in that direction. Nevertheless the combination of these two reduces the critical point below the atmospheric temperature.

Mushet steel has been, for many years, a famous tool steel because of its capacity for performing a large amount of heavy cutting work. It is very hard and durable and will retain its cutting edge for a long time and under very severe service. It, or its equivalent, is used very largely at the present time for very heavy, or deep, cuts and especially for cutting extra-hard metal, such as the roughing cuts on armor plate and other hard alloys. The cutting speed of which it is capable is not much, if any, greater than ordinary carbon tool steel, but the economy of its use is due to the fact that it will take such deep cuts and last so long without regrinding.

Other Self-hardening Tool Steels. — The 2.50 per cent. of manganese in Mushet steel can be replaced by 1 or 2 per cent. of chromium and again produce a self-hardening tool steel which has the advantageous properties of Mushet steel. This result is even more astonishing than the self-hardening properties of Mushet steel, because chromium has a tendency to raise the temperature at which the critical change comes, and yet the addition of 1 or 2 per cent. of chromium to a tungsten steel, which was not previously self-hardening and whose critical temperature was about 600° C. (1112° F.), reduces the critical temperature to below the atmosphere. We may also replace the 9 per cent. of tungsten in Mushet steel with 4 to 6 per cent. of molybdenum, and it is stated that this latter change produces a self-hardening tool steel which is a little tougher than Mushet steel.

Taylor and White. — Frederick W. Taylor and Maunsel White of the Bethlehem Steel Works experimented for a long period of time with the self-hardening steels existing in 1899 and previously, for the purpose of improving them by heat treatment. The full record of these and other researches were presented by Taylor in his presidential address to the American Society of Mechanical

Engineers in 1906, and form one of the most interesting records of the kind ever presented to the world. The result of these experiments was to produce a wholly new kind of steel which has fairly revolutionized the machine shop industry of the world. Taylor and White found that by applying a new method of heat treatment to the self-hardening tool steels, they gave them much greater toughness at a red heat, so that they could do their cutting work at a speed so fast that the point of the tool would become red hot with the heat of friction and the great chips of steel, which were thick and heavy on account of the depth of cut which could be made, were raised to a temperature of nearly 300°C . (572°F). In other words, the steel tool never lost its temper nor its toughness at a red heat. The heat treatment which Taylor and White employed consisted in raising the steel almost to the melting point and then plunging it in a bath of molten lead at a temperature between 700° and 850°C . (1300° and 1550°F), where it was kept until it was of the same temperature as the bath, and then removed and cooled by plunging into oil. They usually followed this cooling by reheating the steel to a temperature between 370° and 670°C . (700° and 1240°F).

The first public exhibition of the Taylor and White steel was made at the Paris Exposition in 1900 and created first incredulity and then astonishment. The amount of work performed by a tool was unheard of, as also was the speed at which the tool was made to travel through the metal it was cutting, and the length of time that elapsed before it was necessary to regrind it. It was realized that a new epoch in the tool-steel industry had been inaugurated. The fact that the method of heat treatment used by Taylor and White was subsequently shown to be unnecessary and that therefore the manufacture of high-speed steel tools, having qualities like theirs, was begun by everybody, in no way lessens the credit due them for teaching the world how to produce a new kind of metal and effecting a tremendous decrease in the price of machine work.

High-speed Steels. — The name 'high-speed steels' was not given by Taylor and White to their product, but has subsequently been adopted for all steels capable of these rapid-cutting speeds which theirs had. Soon after they had shown the world what could be done, it was found that the only heat treatment necessary to give the steel its peculiar hardness and toughness at a low red heat

was to raise it to a temperature very near its melting point and then cool it with moderate rapidity, as for example by holding it in a blast of cold air until it was below a red heat. The essential feature seems to be that the steel shall attain a high temperature which, in many cases, is so great that melted oxide drops from it, and it is almost ready to scintillate, — that is to say, it has almost crossed the line Aa in Fig. 246, page 314. After this heating it sometimes suffices to merely allow the steel to cool in air, but in this case its hardness is not as great, and cooling in a stream of air is more usual.

Composition. — It was also soon found that the composition of the self-hardening steels was not the best one for high-speed steels. Tungsten was the element which gave the steel the properties of hardness and toughness at a red heat. After the peculiar heat treatment had been learned and the presence of manganese or chromium in addition to the tungsten was shown to be unnecessary, it was found that more durable qualities could be obtained by increasing the percentage of tungsten, and steels have been put upon the market with even as high as 24 per cent. of this element. At the same time the carbon was greatly reduced and at the present usually varies from 0.40 to 0.80 per cent. in the best high-speed steels.¹

It was also found that molybdenum could replace tungsten as far as producing high-speed qualities was concerned, and many believe that the molybdenum steels are more tough and durable than the tungsten steels. Some difficulty was met with at first in working the molybdenum steels as they proved to be seamy and liable to cracks, but this was overcome with experience. The molybdenum steels do not require so high a temperature for heating previous to cooling down in the air blast as the tungsten steels.

¹ It is commonly stated in the trade that tungsten will take the place of carbon in producing hardness, but this is not true. It is far more correct to say that tungsten will assist carbon in producing hardness and therefore with high tungsten steels we may have lower carbon. This distinction may appear merely academic, but it is well worth recognition by those who expect to make a study of these steels. No amount of tungsten or any other element will make steel hard in the absence of carbon, or even when the carbon is low. The tungsten produces hardness by its effect upon the condition of the carbon, — that is by helping to retain the carbon in its solid solution, — and not by any effect of its own. It is for this reason that a lesser amount of carbon will produce hardness in the presence of tungsten or some similar agent.

According to the researches of Carpenter,¹ the molybdenum steels should be heated between 1000° and 1100° C. (1832° and 2012° F.), while the tungsten steels must be heated in the neighborhood of 1200° C. (2192° F.). Furthermore it only takes about one-half as much molybdenum as tungsten to produce the desired result, which means that there is more iron in the molybdenum steels than in the tungsten steels. In other respects the analysis of the molybdenum and the tungsten steels is about the same, containing usually 0.60 to 0.80 per cent. of carbon and anywhere from zero chromium up to sometimes as much as 4 per cent. Indeed chromium is sometimes recommended as high as 6 per cent. and over, because it gives hardness, but it also reduces toughness. The more durable qualities of the molybdenum steels than the tungsten steels are believed to be due to the larger amount of iron in them and the lower temperature necessary for tempering them.

In some cases molybdenum and tungsten have been used together in high-speed steels. In fact there are at the present time scores of brands and analyses of high-speed steels on the market, made both in America, England, and Europe and the art of manufacturing them is constantly advancing so that no very general results can be quoted. In America the most advantageous percentages of molybdenum, 6 to 15 per cent., are patented and although at one time a great many tons of this kind of high-speed steel were manufactured and gave very good results (containing usually about 10 per cent. of molybdenum) it can now be made only by one company, so that tungsten steels are more common.

Forging. — High-speed steels can only be forged at temperatures above a bright red heat, that is to say from 1050° to 1150° C. (1922° to 2100° F.) and higher.

Annealing. — The heating and annealing of high-speed steels requires a great deal of care. They must be heated up to the annealing temperature (say about 800° C.=1472° F.) with extreme slowness, and cooled down in lime or ashes or in the furnace. They are then soft enough to be machined easily, but not as soft as carbon steel.

Tempering. — The reason tungsten and molybdenum produce in steel the high-speed quality of not losing its temper at a red heat is because of their effect upon the critical temperatures. Their

¹ See page 460 of No. 1517, page 421.

effect seems to be to prolong the critical range of temperatures of the steel on slow cooling; that is to say, instead of the critical range coming in the neighborhood of 690° C. (1285° F.), as with the carbon steels, it begins, when the cooling is slow, at about 700° C. and spreads out all the way down to 300° or 400° C. (572° or 752° F.), or even lower. Molybdenum is more active than tungsten in causing this prolongation of the critical range. But if the steels are first heated to a very high temperature (1000° to 1100° C. for molybdenum steel and 1200° C. for tungsten = 1832° to 2012° and 2192° F. respectively) and then cooled moderately fast, this treatment suffices to prevent the critical changes altogether and preserves the steel in the austenitic condition. We know that this austenitic condition is one of hardness and toughness and its peculiarity under these circumstances is that it is not transformed into the pearlitic condition until the steels are heated to 650° C. (1202° F.) or thereabouts.

Magnetic Steels. — Strictly speaking, the steels used for permanent magnets are not high-speed steels, because, of course, they are never used for cutting work, but as their composition is so similar it seems well to introduce them here. A permanent magnet is made by putting a piece of hardened steel in a magnetic field for a few moments, as, for instance, by winding an insulated wire around it and passing an electric current through. The magnetic force which it obtains in this way will remain in it for a very long period of time. It is found that a steel containing about 4 to 5 per cent. of tungsten and 0.50 to 0.70 per cent. of carbon, if heated to a red heat (say 800° C. = 1472° F.) and quenched in water, will retain its magnetism better than ordinary hardened carbon steel. Sometimes about 0.50 per cent. of chromium is added to the alloy also.

SILICON STEELS

The genius of Hadfield has also given us a silicon steel alloy of importance and usefulness. In 1888¹ Hadfield investigated many alloys of iron and silicon and although these showed some remarkable properties, especially in the matter of tempering and cutting qualities, they did not lead to any alloy steels that were produced in abundance. At a later period, however,² Hadfield

¹ See No. 157, page 420.

² U. S. Patent 12,691. September 3, 1907.

developed a silicon steel which, after a double-heat treatment, showed some truly remarkable magnetic qualities. It had always been believed that pure iron had the highest magnetic force and permeability of any known substance or of any combination that could be produced, but Hadfield's new silicon steel, whose composition and treatment is shown below, had not only a greater magnetic permeability than the purest iron but also, characteristic of silicon steels, it had a high electrical resistance. Its hysteresis is, of course, low, this property always accompanying a high permeability. It is therefore a very valuable material for use in electromagnets, and in electrical generating machinery is the most efficient material known. Its high magnetic permeability gives high motor efficiency, and in addition its high electrical resistance reduces the "eddy currents" which are a source of waste.

Composition and Treatment. — Hadfield's patent covers silicon from 1 to 5 per cent., but the alloy which he recommends contains 2.75 per cent. of silicon and the smallest possible amounts of carbon, manganese, and other impurities. Before the steel is ready for use, it is subjected to a double-heat treatment by first heating it to between 900° and 1100° C. (1652° and 2012° F.) and cooling quickly, and then reheating to between 700° and 850° C. (1292° and 1562° F.) and allowing to cool very slowly. In some cases his second cooling has been extended over several days. He finds the best results by heating first to 1070° C. (1958° F.) and cooling quickly to atmospheric temperature and then heating to 750° C. (1382° F.) and cooling slowly, after which he sometimes again reheats to 800° C. (1472° F.) and then cools slowly.

VANADIUM STEELS

Vanadium steels are still in their infancy, for although the element has been used in steel metallurgy for many years, it is only recently that any important development work has been carried on. The results, however, are so very encouraging that we may expect great extension of their employment and important progress in their metallurgy. With the single exception of carbon no element has such a powerful effect upon steel as vanadium, for it is only necessary to use from 0.10 to 0.15 per cent. in order to ob-

tain very powerful results, while 0.30 per cent. should probably not be exceeded so far as present knowledge indicates. In addition to acting as a very great strengthener of steel, especially against dynamic strains, vanadium also serves as a scavenger in getting rid of oxygen and possibly nitrogen. It is also said to decrease segregation, which we may readily believe, as most of the elements which quiet the steel have this effect. Vanadium steel also has the advantage of welding readily.

The effect of vanadium is shown very well by Tables XXX and XXXII,¹ and it will be seen how efficiently this material resists alternating stresses and the other forces producing fatigue. It is to be observed that vanadium is especially advantageous when added to nickel and to chromium steels, greatly increasing their strength, toughness, and temper. In this connection it is important to note that the nickel-vanadium steels have better quality when the carbon is low, especially if they are to be subjected to heat treatment.

It would seem that vanadium should have especial advantage in high-speed tool steels, but, strange to say, the results have not always been favorable. Nevertheless experiments in this direction continue.

Manufacture. — Pure vanadium has a very high melting point and the element is therefore added to steel in the form of ferrovanadium. This alloy should be added to the bath about two or three minutes after the manganese used for recarburizing, because if the vanadium is added before the manganese, it is wasted by oxidation. It therefore should be added always under reducing conditions. Beyond this there is no special difficulty in manufacture, as the amount of alloy used is so small and as it distributes itself readily through the metal and does not segregate.

Treatment. — Vanadium steels must be heated gradually but are forged without difficulty although they must be worked a little tenderly at first. Like all steels, they must not be forged at too high a temperature, and like all alloy steels, they become even more brittle when forged below a black heat than carbon steel does.

Uses. — It is advantageous to use vanadium steel for practically every purpose that will stand the additional price, which is about the same as that of 3.50 per cent. nickel steel. It is, of course, especially useful for all purposes where strength and lightness are

¹ For which I am indebted to the American Vanadium Co.

TABLE XXX.—COMPARATIVE FIGURES—CARBON, NICKEL AND VANADIUM STEELS—PHYSICAL TESTS

A DESCRIPTION OF MATERIAL	CHEMICAL COMPOSITION					PHYSICAL TESTS											
	Carbon	Mangan- um	Chromi- um	Vanadi- um	Nickel	Elastic limit, lbs. per sq. in.	Tensile strength, lbs. per sq. in.	Ratio, per ct.	Elonga- tion in 2", per ct.	Contra- ction of area, per ct.	Pendulum impact, ft. pounds	Impact blows	Alterna- tion of stress	Right an- gle bends	Torsion twists ⁸	Rotary test	
																Stead	South- er
<i>Carbon steels.</i> ¹																	
Swedish quality—Mild ²12	.30	31,350	50,400	62	50	60	15	...	100	18 3.5	6,500	20,000	
Forging quality ³30	.50	38,080	69,440	54.9	32	47	8	25	120	12 2.8			
Nickel steels.—Forging quality ⁴25-.30	.50	3.2	49,270	87,360	56.4	34	58	14	35	100	12 3.1			
Vanadium steels.—Type "A".....	.25-.30	.50	1.0	.17	57,300	77,800	73.6	31.5	62
Annealed 800° C.....	63,570	96,080	66.2	33	61	67,500
.....	64,400	87,640	73.5	29	59	16.5	215
.....	71,110	92,230	77.1	22	65
.....	103,000	125,000	82.4	21	56	12	76	160	10
.....	110,100	127,800	86.9	20	58
.....	124,000	130,500	95	17	62
.....	127,500	138,000	92	18	65
.....	140,750	147,000	95	17	57
.....	200,000	212,000	94	12	51
.....	224,000	232,750	96	11	39
Type "C," Annealed 800° C ⁶20	.35	.80	.15	47,030	87,360	53.8	34	53	16	69	190	18 4.56
Type "D," spring steel, ⁷ normal	.45	.90	1.25	.18	101,900	162,400	62.7	13	44	4
Annealed 800° C.....	82,060	114,800	71.5	30	63
Oil tempered.....	221,000	235,000	93.8	10	39
Type "E," case-hardening steel ⁸	.15	.25	.30	.12	44,790	55,990	80.0	45	69	17	240
Soft core of same after case- hardening and stripping case.....	78,390	100,800	77.8	22	60	10

¹Fulfills the most severe crushing, bending, bulging, and expanding tests. ²Equal to best Swedish mild steel. ³Easily stands plate bend, D = 2T. ⁴Bends, etc., as forging steel. ⁵.75" round bends double cold D = 2T. ⁶.5" sq. and 1" round bars bend close double. ⁷Twists in flat tight up; ⁸1/16" rod bends double. After tempering a spring of safe working load = 40,000 with excellent carbon steel the coefficient of safe working load = 20,000. ⁹Bends close double cold. ¹⁰Nash torsion test; length 6", diameter .75".

TABLE XXXI.—TYPES OF VANADIUM STEEL
COMPOSITION

Type A, No. 1	Type A, No. 2	Type A, No. 3	Type B	Type C	Type D, No. 1	Type D, No. 2	Type E
Per cent. Carbon25-.30 Manganese .40-.50 Chromium 1.0 Vanadium .16-.18	Per cent. Carbon25-.30 Manganese .40-.50 Chromium 1.0 Vanadium .16-.18	Per cent. Carbon25-.30 Manganese .40-.50 Chromium 1.0 Vanadium .16-.18	Per cent. Carbon20 Manganese .30-.40 Chromium .50 Vanadium .12	Per cent. Carbon20 Manganese .40 Chromium .80 Vanadium .16	Per cent. Carbon45-.55 Manganese .80-1.0 Chromium 1.25 Vanadium .18	Per cent. Carbon45-.55 Manganese .80-1.0 Chromium 1.25 Vanadium .18	Per cent. Carbon12-.15 Manganese .20 Chromium .30 Vanadium .12

APPLICATIONS

“Light” axles. Connecting rods. Side and main rods. Driving axles. Piston rods.	Crank shafts. Transmission parts. Crank pins.	Gears in constant. Mesh. Not unduly pressed.	Axle work. Hammer rods and where torsion is of great moment. Bolt steel.	Intermediate steel very useful for car axles, hold- ing bolts, etc.	Solid wheels for railway use, gun barrels, crank pins.	Springs for automo- bile, carriage, and locomotive work.	Case-hardening steel for all en- gine and machine parts.
---	---	--	--	--	---	--	---

HEAT TREATMENTS

Anneal at 800° C. for one or two hours. Cool in air or ashes ac- cording to nature of piece.	Quench from 900° C. in lard or fish oil and anneal at 550° C. for $\frac{1}{2}$ to 2 hours, according to size in air.	Quench from 950° C. in lard oil and let down at 360° C. for $\frac{1}{4}$ to $\frac{1}{2}$ hour preferably in lead bath, cool in air.	Normal.	Normal.	Anneal at 800° C. for one hour. Cool slowly, taking great care not to chill or to pass from 800° C. to 600° C. too quick.	Quench in oil from 900° C. and draw back at 400° C. to 450° C. in lead bath preferred. Cool in air.	Regular case-hard- ening process.
---	--	---	---------	---------	---	--	--------------------------------------

REMARKS

All steels to be as pure as possible from sulphur and phosphorus. Sulphur may go to .035% without detriment. With phosphorus at .02% the silicon may be .15% in “D” and .10% in “A,” “B,” and “C.” With phosphorus at .03% the silicon should not exceed .05% in “A,” “B,” and “C,” or .10% in “D.”

TABLE XXXII.—RESULTS OF MECHANICAL TESTS OF TYPICAL VANADIUM AND OTHER STEELS

Automobile purposes are taken, owing to requirements of same being of the most exigent nature.

TEST	No. 1. Carbon "Axle" steel	No. 2. Nickel "axle" steel	No. 3. Vanadium "axle" steel, Type A, No. 1	No. 4. Vanadium crankshaft, steel, Type A, No. 2	No. 5. Vanadium gear steel, continual mesh, Type A, No. 3	Nature
Yield point, lbs. per sq. in.	41,330	49,270	63,570	110,100	224,000	Static
Ultimate stress, tensile strength in lbs. per sq. in.	65,840	87,360	96,080	127,800	232,750	
Ratio	62%	56%	66%	87%	96%	
Elongation on 2 in.	42%	34%	33%	20%	11%	
Contraction of area.	61%	58%	61%	58%	39%	
Torsional twists.	2.6	3.2	4.2	2.5	1.8	
Alternating bends.	10	12	18	10	6	Intermediate
Pendulum impact, foot pounds.	12.3	14	16.5	12	6	Dynamic
Alternating impact, number of stresses.	960	800	2,700	1,850	800	
Falling weight on notched bar, number of blows.	25	35	69	76	
Rotary vibrations, number of revolu- tions.	6,200	10,000	67,500	

All figures obtained under comparative conditions.

desired, such as springs, axles, frames and other parts of railroad rolling stock and automobiles. It would also seem to have special advantages for shafts and other rotating parts. It also does very well for case-hardened gears, on account of the good combination of hardness and toughness and has been used to some extent for steel castings where resistance to vibration has been demanded.

Vanadium has also been added to cast iron on account of its ability to remove oxygen and possibly nitrogen (if any is ever present), and because it makes the metal more fluid and tougher. It is said also to make chilled cast-iron rolls more durable and more ductile.

TITANIUM STEELS

Titanium has not been used much for making alloy steels, but it has one advantage which has caused its use to be recommended, namely, its high affinity for nitrogen. There is no element whose addition to iron or steel would be expected to have a greater effect in ridding it of nitrogen, but beyond these logical arguments the experiments so far made are not absolutely conclusive, although they are sufficient to cause a great deal of interest to be taken in this subject.

Titanium has often been found in pig iron in very small quantities, but its presence in the blast furnace is usually objected to, because it causes the slags to be so infusible and sticky. Ferrotitanium is now being made in electric furnaces where the temperature available overcomes the difficulty of infusible slags. This alloy is added to iron castings in amounts such that the proportion of titanium in the metal will not exceed 0.10 to 0.15 per cent. This results in an increase in strength of the iron of nearly 20 to 40 per cent. and also of greater hardness and durability against wear.

REFERENCES ON ALLOY STEELS

150. G. B. Waterhouse. "The Influence of Nickel and Carbon on Iron." *Journal of the Iron and Steel Institute*, vol. ii, 1905, pages 376-407. This includes a bibliography of a part of the subject.
151. G. B. Waterhouse. "The Burning, Overheating, and Restoring of Nickel Steel." *Proceedings of the American*

Society for Testing Materials, vol. vi, 1906, pages 247-258.

152. A. L. Colby. "A Comparison of Certain Physical Properties of Nickel Steel and Carbon Steel." Published by the Bethlehem Steel Company, 1903. A very complete compilation.
153. L. Dumas. "The Reversible and Irreversible Transformations of Nickel Steel." *Journal of the Iron and Steel Institute*, No. 11, 1905, pages 255-300.
154. D. H. Browne. "Nickel Steel; A Synopsis of Experiment and Opinion." *Transactions of the American Institute of Mining Engineers*, vol. xxix, 1899, pages 569-648. Very complete, with a good bibliography.
155. R. A. Hadfield. "Alloys of Iron and Manganese." *Proceedings of the Institution of Civil Engineers* (England), 1888.
156. R. A. Hadfield. "Manganese Steel." *Journal of the Iron and Steel Institute*, 1888.
157. R. A. Hadfield. "Alloys of Iron and Silicon." *Ibid.*, 1889.
158. R. A. Hadfield. "Alloys of Iron and Aluminum." *Ibid.*, 1890.
159. R. A. Hadfield. "Alloys of Iron and Chromium." *Ibid.*, 1892.
1510. R. A. Hadfield. "Alloys of Iron and Nickel." *Proceedings of the Institution of Civil Engineers* (England), 1899.
1511. R. A. Hadfield. "Alloys of Iron and Tungsten." *Journal of the Iron and Steel Institute*, No. 11, 1903.
1512. Henry M. Howe. "Manganese Steel." *Proceedings of the American Society of Mechanical Engineers*, 1891.
1513. C. E. Guillaume. His articles will be found listed in some of the cross-references cited.
1514. L. Guillet. "Steel Used for Motor Car Construction in France." *Journal of the Iron and Steel Institute*, No. 11, 1905, pages 166-203.
1515. L. Guillet. "The Use of Vanadium in Metallurgy." Same journal, pages 118-165.

For Guillet's other memoirs on alloy steels consult the *Revue de Métallurgie*, and the index of the *Journal of the Iron and Steel Institute* from 1904 to date.

1516. J. M. Gledhill. "The Development and Use of High-speed Tool Steel." *Journal of the Iron and Steel Institute*, No. 11, 1904, pages 127-182.
1517. H. C. H. Carpenter. "High-speed Tool Steels." Same journal, No. 1, 1905, pages 433-473, and No. 111, 1906, pages 377-396.
1518. J. T. Nicolson. "Experiments with Rapid-cutting Steel Tools." Manchester Municipal School of Technology, Manchester, England, 1903.
1519. J. Kent Smith. On vanadium steels; see *Transactions of the American Institute of Mining Engineers*, vol. xxxvii, 1907, pages 727-732. Also *The Iron Trade Review*, November 7, 1907, page 729. Vol. xli.
1520. (For Vanadium steels see also the index of the *Journal of the Iron and Steel Institute*, especially 1905 to date.
1521. L. Guillet. "Quaternary Steels." *Journal of the Iron and Steel Institute*, No. 11, 1906, pages 1-141.
1522. For all the alloy steels one should look in the four volumes of *Revue de Métallurgie*, for which see No. 10, at end of Chapter I.
1523. De Mozay. "Étude de la Dureté dans les Aciers à Outil de Tour." *Revue de Métallurgie*, vol. iv, 1907, pages 885-900.
1524. Léon Guillet. "Nouvelles Recherches sur les Aciers au Vanadium Ternaires et Quarternaires." *Revue de Métallurgie*, vol. iv, 1907, pages 775-783.
1525. P. Nicolardot. "Le Vanadium." Paris. About 1906.
1526. A. J. Rossi. "The Metallurgy of Titanium." *Transactions of the American Institute of Mining Engineers*, vol. xxxiii, 1903, pages 179-197, with cross-references.
1527. A. J. Rossi. "Titaniferous Iron Ores." *Engineering and Mining Journal*, vol. lxxviii, 1904, pages 501 and 502.
1528. J. Hoerhager. "Ueber titanhaltiges Holzkohlen-Roheisen von Turrach in Obersteiermark." *Oesterreichische Zeitschrift für Berg- und Huettenwesen*, vol. lii, 1904, pages 571-577.

XVI

THE CORROSION OF IRON AND STEEL

IRON offers so little resistance to rusting or corrosion that there are almost no circumstances of service in which it can safely be placed without some means of protection from the elements. Certain parts of machinery, in situations where rusting is not very rapid and where the metal will receive constant cleaning and oversight, are used without any protective coating, but structural work, in and outside of buildings, tin roofs,¹ wire fences, pipes, and other metallic structures, all require to be protected by some coating, such as paint, galvanizing,² tinning, nickel plating, oxidizing, etc. Boiler tubes and the inside of boilers, tanks, and pipes it is usually impossible to protect by paint, galvanizing, etc., and there is an annual loss of doubtless many thousands of tons of iron and steel from the decay of these classes of articles alone.

THE CAUSE AND OPERATION OF CORROSION

The brown powder with which we are all far too familiar under the name of rust is a hydroxide of iron — ferric hydroxide, FeO_3H_3 . It is formed wherever iron is exposed to the action of water and air. Neither dry air nor water free from oxygen has any effect upon it alone, but as air is always moist and ordinary water contains some oxygen in solution, the conditions for corrosion practically always prevail against the iron in service. The alternate attack of oxygen and water within a brief period is far more destructive than the attack of either one. For example, heavy rains, the splashing of water intermittently upon piers and columns, the rise and fall of the tide, etc., corrode the metal much faster than exposure all the

¹ Tinplate consists of a thin sheet of steel or wrought iron covered with metallic tin.

² *I.e.*, coating with metallic zinc.

time to either damp air or oxygenated water alone. Acids, while not essential to corrosion, greatly hasten its action, so that the presence of carbonic acid in the air, sulphurous, sulphuric, and hydrochloric acids in the smoke from locomotives and other fires, all greatly increase the speed of rusting. It seems evident also that at least some weak electrolysis is essential for any corrosion to occur. I shall show later that this electrolytic action will always take place where iron and water are in contact with each other, but it is very small in amount under these conditions. Where a greater electric force exists, as for example where pipe lines run close to trolley tracks and receive a leak of electricity so as to carry a part of the current, the electrolytic action is increased and corrosion much hastened. As the use of electricity to-day is far more general than ever before and the amount of coal burned and consequently the amount of corrosive gases in our atmosphere is much larger, it follows that the question of corrosion is of constantly increasing importance. Affairs have indeed reached such a state that the subject is now occupying a great deal of attention from metallurgists and engineers in the hope of getting better means of protection. Pipe lines embedded in the earth, which are alternately wet and dry, supports in tunnels, subways, and other damp places, wire fences and tin roofs are all suffering severely from decay.

Theories of Corrosion. — In an able research,¹ Allerton S. Cushman has studied the current theories that have been advanced to account for the corrosion of steel. He shows that the theory that carbonic acid, or some other acid, is necessary is wrong, and that corrosion will take place even in weak alkaline solutions. He also shows that hydrogen peroxide is not the agency producing the rust. By means of a series of extremely careful and accurate experiments he demonstrated the probability, if not, indeed, the certainty, that the two factors without which the corrosion of iron is impossible are electrolysis and the presence of hydrogen in the electrolyzed or 'ionic' condition. In brief, it is the ions of hydrogen which first cause the metal to pass in solution:

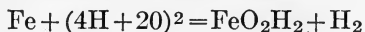

Ions of hydrogen are electropositive to iron, and when the reaction takes place, they transfer their electric charge to the metal. This

¹ See No. 160, page 436. ² $4\text{H} + 2\text{O} = 2\text{H}_2\text{O}$ in the electrolyzed condition.

is, of course, an electrolytic action and the hydrogen which takes part in it is converted from the electrolyzed (or ionic) condition to the atomic (or gaseous) condition. Therefore it is evident that the action must take place in the presence of oxygen, or some other oxidizing agent that will complete the electrolysis, else the formation of ferrous hydroxide will soon cease. This explains why the presence of oxygen so greatly increases the corrosion of iron, although it is not the oxygen itself which, after all, is the cause of the primary attack.

Rust. — Ferrous hydroxide, FeO_2H_2 , is soluble in water and its formation and solution is the first step in the production of rust. Because of its solubility, however, it does not ordinarily make its presence known until a further reaction occurs:—

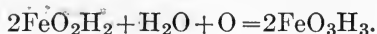

The rust, FeO_3H_3 , so formed precipitates from solution.

Unfortunately traces of ionic hydrogen are always present even in the purest water, and larger amounts in ordinary water. Substances which increased the hydrogen ions, such as oxides, promote the rusting, and the same may be said of anything which increases the electrolytic action, while substances which restrain the formation of hydrogen ions will decrease corrosion. Indeed, dipping a piece of bright iron into a solution of potassium bichromate and then wiping it off will put it into an apparently oxidized condition in which it will resist corrosion for days or even weeks. Cushman, therefore, suggests dissolving a small amount of chromic acid or potassium bichromate in boiler waters in order to restrain corrosion of the metal.

Segregation. — Evidently anything that increases the electrolytic activity will increase the attack by hydrogen and therefore the formation of rust. Unfortunately even the purest piece of iron will show differences of electric potential at different parts and therefore produce an electrolytic effect. When the metal is impure or is badly segregated, these differences in potential will be quite large, and when several pieces of steel are joined together, as in a bridge or other structure, the difference in potential between the different parts may be great. It is probable that each of the different microscopic constituents of iron and steel has a different electric potential and therefore either assists or retards the progress of rusting. Also scale, the slag in wrought iron, etc.

Self-protection from Corrosion. — It is generally believed that certain constituents in iron and steel assist in protecting underlying layers of the metal from attack. For example, the graphite which forms such a large proportion (say 10% or more) of the volume of cast iron, slag which forms nearly 4% of the volume of wrought iron, and cementite in steel, all corrode less rapidly than the pure metal, and it is probable that they are beneficial in protecting it. It must not be forgotten, however, that they likewise cause a difference in potential and to that extent probably tend to hasten corrosion. Their net effect can be learned only by experiment. Scale or foreign substances on the surface of the metal would also produce large differences in potential.

Relative Corrosion of Iron and Steel. — It is generally believed that cast iron corrodes less rapidly than either wrought iron or steel and, for this reason, cast-iron pipe is greatly preferred for city water mains and like uses where great strength is not required. The belief is a

reasonable one, since it might well be expected that the presence of graphite would be a protection, but it is only right to remark that the theory rests upon no experimental evidence and that there are other circumstances connected with cast-iron pipe which may not have given rise to the belief but which are not inherent in the material itself. These conditions are (1) the common practice of dipping cast-iron pipe in asphaltum, paint, or some similar protecting material, before it is sold and thus putting it in a



FIG. 298. — CORRODED STEEL PLATE.

condition to be in service for a long time before the metal itself is subjected to the corrosive influences. (2) When the iron is cast in the sand there seems to take place some union between the metal and the inside surface of the mold, whereby a very resisting siliceous coating or 'skin' is formed on the casting. Some believe that after this skin is worn away, cast iron corrodes as rapidly as wrought iron or steel. (3) Cast-iron pipe is thicker than the same diameter of wrought iron and steel pipe, because of the difficulty of making castings with thin sections of metal; therefore such pipe would remain in service much longer than steel or wrought iron, even though the rate of corrosion were the same. I have cited the above facts not to argue against the belief in the slow corrosion of cast iron, but merely to explain the situation as it exists, for we have as yet no scientific data upon which to form an opinion either way.

Wrought Iron vs. Steel. — There is also a very prevalent and widespread conviction that steel corrodes much more rapidly than wrought iron. This opinion too rests upon no very exact experimental evidence, although there are not incidents lacking which make in favor of it, while others make in the opposite direction, but it seems to be based principally upon the fact that corrosion is very much more rapid to-day, when steel is the world's great metal, than it was some years ago when wrought iron was chiefly used! But I have already shown that conditions to-day are more conducive to rapid corrosion than they were at any previous time.¹

Opposed to this popular belief is the result of a great many scientific tests which have shown, in almost every case, that the difference in the speed of corrosion between wrought iron and steel is very small, although favorable to wrought iron in the case of sea water and alkaline water and to steel in the case of acids and

¹ Indeed I hardly think that this argument ought to have anything like the weight that is popularly given to it. It is not at all uncommon to hear the statement that wrought iron made 20 years ago is still in service in places and conditions alongside of steel which has been replaced several times. But I am informed by a testing engineer of much experience and reputation that he has a steel fence upon his property which has been in service many years and has outlasted several other steel fences under similar conditions, but formed of steel made recently. From this he argues that the steel made to-day is more subject to corrosion than the steel made many years ago. If this is so, we are permitted to ask: Is the wrought iron made to-day more subject to corrosion than the wrought iron made several years ago?

acidulated water. As has been pointed out, however, these scientific tests are not altogether reliable as a basis for commercial comparison, because they have not usually been carried to the point where either one material or the other becomes unfit for service, but merely allow corrosion to proceed for several months and then show the relative loss in weight. Neither have these experiments taken into account sufficiently the localized, i.e., "pitting," corrosion to which badly made material is especially subject. It is immaterial whether or not the metal has lost but little weight, provided it has pitted in any one spot sufficiently to fail, or to have become dangerously thin. This pitting is believed to be due chiefly to blowholes and possibly to segregation resulting in a local increase in electric potential.

Manganese and Corrosion. — It has been suggested that the presence of manganese in steel causes an increase

in the rate of corrosion, but this assertion is based upon no reliable evidence so far as I am aware. It was brought forward to explain the supposed rapid corrosion of steel as compared with wrought iron, but if it is a true influence in this direction, then steel should corrode in acids faster than wrought iron, which it apparently does not if the steel has been made with due care and is free from blowholes and much segregation.

Badly Made Material. — There can be no doubt that badly

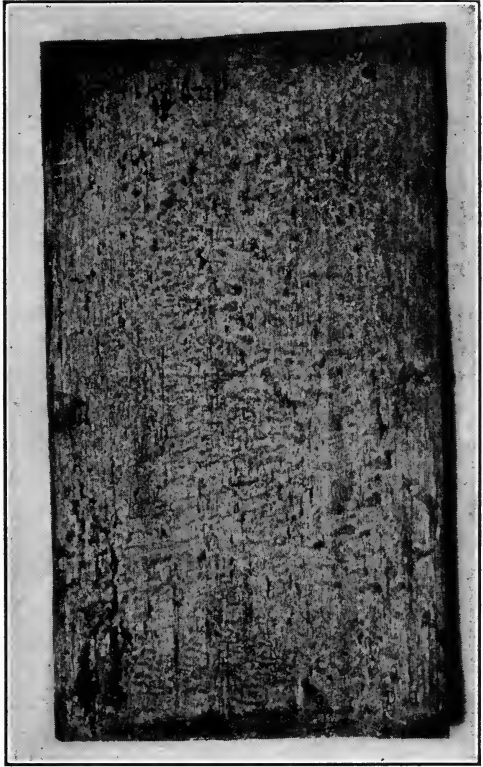

FIG. 299. — CORRODED WROUGHT-IRON PLATE.

made steel is much more liable to corrosion and to pitting than well-made steel, and it may be from this cause that the bad name which steel is popularly given comes. There can also be no doubt that badly made wrought iron is extraordinarily subject to rusting, and of this kind of material we are to-day getting a good deal. As I have noted in Chapter III, probably more than half of the wrought iron produced in America is made by 'busheling' scrap into a pile, rolling it down and marketing it as wrought iron. This material is of good quality so long as the scrap from which it is made is good, but when the scrap is collected from almost any source, and especially when it contains steel, as it sometimes does, we should expect great differences in potential and therefore rapid corrosion.

Coating. — Wrought iron has one advantage over steel in the case of articles which are to be coated, because its rough surface gives a better opportunity for the paint to adhere than the comparatively smooth and even surface of steel.

Summary. — Badly made steel and badly made wrought iron corrode faster than any other material; next in order come well-made steel and well-made wrought iron, between which two classes the difference is probably very slight, and has not been determined by any sufficiently lengthy or convincing series of tests; the next in order is probably cast iron, although as yet we cannot be quite certain that this corrodes more slowly than wrought iron and steel, except in so far as it is protected by its natural or artificial coating or both. Steel and wrought iron are both liable to pitting, which may greatly shorten their life in service even though the average rate at which they corrode is slow. Several causes may produce this pitting, such as, blowholes, segregation, bad welding in places, particles of oxide, scale or dirt, etc. When pits or holes are found with a smooth, hollow surface, it is altogether probable that they are due to blowholes and sometimes these pits may be an inch or more in diameter and extend an eighth of an inch into the plate, even before the remainder of the surface has become severely attacked. Numerous efforts are being made at the present time to improve the quality of steel and to turn out a more uniform grade of product. It is quite certain that painting is not as good to-day as it was in years past and that the quality of paint used is also worse, on the average, as shown by the fact that paint does not last as well on wooden structures. The better adherence of paint

gives an advantage to wrought iron, which however, only applies where work is so placed as to be capable of being painted.

PRESERVATIVE COATINGS FOR IRON AND STEEL

The oxidized surface which all steel retains after hot working is in itself a certain protection against corrosion, but this is only limited in effect, because the oxide is more or less porous and so allows the corrosive agencies to penetrate it and attack the surface underneath. Moreover, the scale does not adhere firmly in some places, and as its coefficient of expansion and contraction is different from that of the metal, it is liable to loosen and fall off in places and so expose the iron or steel.

Preparation of Surfaces for Coating. — It is not advisable to coat wrought iron or steel until its surface has been carefully prepared, for any rust or other product of corrosion, scale, grease, dirt, or moisture underneath the coat will either start corrosion or else, by becoming loosened, will cause the paint or galvanizing to fall off and so expose the metal underneath. The opposite is the case with cast iron, because when this metal is poured liquid into the mold a skin is formed, consisting of a chemical union of silica and oxide of iron, very firmly united to the metal and capable of being relied upon to adhere beneath the paint or other coating and serve as additional protection from corrosion. So much mill scale as adheres to wrought iron and steel with great force is permitted by some engineers to remain underneath the protective coating, but others insist upon the removal even of this upon the ground that it may become loosened later by expansion and contraction, and then spall off.

Priming Coat. — A difference of opinion exists as to the advisability of having wrought-iron and steel surfaces prepared at the mill and there given a priming coat, or else having the priming coat applied under the direction of the engineer of construction, or else of omitting the priming coat altogether and not painting the structure at all (except such parts of it as will be inaccessible after erection) until the metal has been exposed so long that the weather has loosened all the scale. This will occupy perhaps six months to a year, depending upon the corrosive conditions. During that time no great damage can be done by corrosion although the structure will, of course, look very shabby. After that period, the scale is

removed with sand blast, wire brushes, pneumatic hammers, or chisels, and after the surface is perfectly clean and dry, it is given a priming coat and at least two other good coats of paint, each one being allowed to dry thoroughly before the next is spread. For indoor work one coat of paint upon the priming coat is often considered sufficient.

Shop vs. Field Painting. — The advantage of painting the steel at the shop is that it can be done inside of some building and there is therefore less liability of hygroscopic moisture under the coating. If the shop coat is put on with care and skill it unquestionably has certain advantages, but it is too true that the shop painting and the preparation of surfaces at the shop is often carelessly done, for the manufacturer has not the interest in preserving the metal from decay that the consumer feels. Furthermore it undoubtedly saves expense to allow the structure to stand from six months to a year, provided that it is then very thoroughly cleaned and well painted when absolutely dry. If otherwise the whole work may have to be done over again at the end of a short interval.¹

Pickling. — To remove scale it is customary in many cases to pickle the steel or wrought iron, i.e., to immerse it in dilute sulphuric acid (say 10 per cent.) preferably heated to boiling so as to act more quickly. After a few minutes the scale is removed, when the metal is washed once in boiling water, once in cold water, and finally in lime water to neutralize the last traces of the acid. It should remain in the lime water until it is ready for the application of the coating, when it should first be washed free of lime, and then heated slightly above 100° C. (212° F.) to drive off all the moisture. Pickling is therefore applicable only when the metal is to be coated at the shop, either with the priming coat of paint or with zinc, tin, etc.

Comparison of Methods. — Pickling costs less than the other methods of removing scale and accomplishes the work very thoroughly. Sand blast is the next cheapest method. This latter does not get off all the scale unless it is very thorough, while, if it is too thorough, it leaves the surface in a smooth condition so that the paint does not stick so well. On the other hand, pickling must be done with great care or it may leave hydrogen upon the surface of the metal which will greatly hasten corrosion, so that pickled

¹ In which event it is customary for all interested parties to blame the paint, except the paint-maker who is in the minority.

surfaces sometimes corrode more rapidly than those which have been cleaned in any other way. Cleaning with wire brushes is more expensive than sand blasting, but if performed with great care is more effective and leaves the surface in a rougher condition which assists the adherence of the paint.

Kinds of Paint Used. — There is a great difference of opinion as to the best paint for preserving iron and steel, but some few things seem certain: (1) That no one kind of paint is suitable protection against all corrosive influences. For example, the best paint to withstand the action of the open air may fail when exposed to the elements in a damp tunnel, or when used on the parts of piers under sea water, while a good protection against this latter influence might be inefficient when exposed to the oxidizing gases in locomotive smoke, etc.; (2) that whatever paint is used must be sufficiently elastic to expand and contract with the changes in temperature of the metal without cracking; and (3) that it must contain nothing which will attack the metal and so commence corrosion. In this last connection we must especially avoid all oxidizing influences. The reader will find in the *Annual Proceedings of the American Society for Testing Materials* a very full interchange of opinions between experts in paint manufacture and engineering which will doubtless help him to form an opinion as to the best paint to use in each case.

There are two parts to every paint: (1) The vehicle which carries the pigment and undergoes a change to the solid state when the paint dries, and (2) the pigment or originally solid part of the preservative coating. These two must form a firm impervious coating upon the surface of the metal, but must not be so solid as to be inelastic or brittle.

Linseed Oil. — Linseed oil is a very good and common vehicle.¹ It is what is known as a 'drying oil.' That is to say, an oil which when exposed to the atmosphere will change from a liquid to an elastic or leathery consistency. This action takes place not by evaporation but by a process of oxidation, whereby the oil absorbs oxygen to the extent of from 10 to 18 per cent. of its weight and expands in volume, so that a coat of linseed oil spread upon glass will wrinkle up upon drying. It is because linseed is the best of all the drying oils that it is so much preferred as a paint vehicle, but when allowed to dry in the raw state it requires too long a time and the

¹ See page 336 of No. 163; page 41 of No. 164, page 436.

drying is therefore hastened by boiling it and adding some oxidizing agent, known as a 'drier,' of which the best, as far as iron and steel preservation is concerned, are the salts of lead or manganese, used without rosin. It will readily be understood how dangerous it is to indiscriminately use driers (i.e., oxidizing agents) in steel paints, because so many of them will oxidize the steel and so cause the very corrosion which it is the object of the paint to prevent.

Purity of Linseed.— This brings us to the question of the purity of linseed oil, for the usual adulterants are all harmful to steel work and cause in the end more painting and more of the expensive cleaning of structures to receive the coating, out of all proportion to their lesser first cost. Freedom from adulterants probably cannot be obtained except by constant watchfulness and frequent chemical analysis on the part of the consumer. Some impurity arises from the presence of a few per cent. of foreign seeds with the linseed, which is not always avoidable, but the greater harm comes from the fact that the oil is obtained from the linseed by pressing it while hot, in which way a larger amount of product is extracted than if cold pressure is applied, because some of the solid part of the seeds are thereby extracted together with the oil. Cold pressed linseed oil has a golden yellow color and remains clear in cold weather as distinguished from the yellowish-brown color of the hot pressed oil which also has a more acrid taste, is not so fluid, and contains more solid fats, solid organic matter, and fatty acids, all of which are harmful either because they attack the metal or else because they make a pervious paint.

Pigments.— The pigment is not as important as the vehicle and many different ones can be chosen, provided they are chemically inert to the steel. Red lead has been very much used and is very good especially for the priming coat, for it seems to form with the linseed oil a very dense, impervious coating. For the outer coats, however, it is generally well to mix the red lead with some substance that shall reduce its weight, such as graphite. Ferric oxide, Fe_2O_3 , and other oxides of iron in the form of iron ore are very cheap and withstand the action of sulphur gas better than the red-lead paints. They are very good for outer coats where locomotive smoke and similar gases are liable to be present. Sulphate of lead, white lead (a mixture of oxide and sulphate of lead with often some sulphate of zinc) and sulphate of zinc are all good white paints although expensive. Pulverized asphaltum and other

hydrocarbons are also used with success as pigments, especially where the metal is exposed in damp ground or under water.

Other Paints. — Pipe is often coated very cheaply by dipping it in melted asphaltum or pitch. The objection to this coat is that it is very hard and brittle when cold and in time it forms a network of myriads of cracks through which the atmosphere attacks the metal. For cast-iron pipe it is very useful, however, because this is protected by its natural skin. Dipping in tar would form an elastic coating, but unfortunately tar contains certain acids and oxidizing agents which attack the metal. There is a paint made by distilling off the creosote and other volatile components of tar until the solid asphaltum is left. This is then redissolved in two of the distillates, neither of which will attack iron work, and thus a paint is obtained which is said to be practically tar without any of its harmful constituents. It forms a very elastic coating which does not crack after years of exposure nor does it disintegrate under the action of the sun as the linseed oil paints sometimes do.

Galvanizing. — Galvanizing is the process of coating with metallic zinc and where this coating adheres firmly, it undoubtedly forms a very efficient means of protecting iron from corrosion. As zinc is electrically positive towards iron, whatever electrolysis exists would tend to corrode the zinc and protect the iron. Indeed this fact is taken advantage of by some engineers who hang pieces of zinc in their boilers, by means of a wire connected to the steel work, so that the electrolytic action shall corrode the zinc and protect the wrought iron or steel.

Galvanizing is usually applied to wire and wire products, thin sheets, especially corrugated sheets used for the outside of buildings, etc., tubes, hollow ware, and a great variety of articles, after the surfaces have been cleaned by pickling. There are three methods by which the galvanizing is effected, known respectively as cold galvanizing, hot galvanizing, and dry galvanizing.

Cold Galvanizing. — In the cold galvanizing process zinc is deposited electrolytically upon the surface of metallic articles which are made the cathode of an electro-plating cell. The zinc is first dissolved in sulphuric acid and water and this solution is made the electrolyte. The anode is a piece of zinc, so that as fast as the electricity deposits zinc upon the surface of the article being galvanized, it replenishes the electrolyte by dissolving zinc from the anode.

The coating is about 0.0003 to 0.0005 inch thick, equivalent to about 0.2 to 0.3 ounce of zinc per square foot of surface.

Hot Galvanizing. — In the hot galvanizing process, which is the commonest one used, the articles to be galvanized are dipped into a bath of molten zinc at a temperature of 425° to 460° C. (800° to 860° F.), i.e., slightly above the melting point (419° C. = 786° F.). The metal is exposed to the zinc bath usually about 1½ to 7½ minutes, depending upon the thickness of coating desired, which will vary between 0.0003 and 0.0010 inch or about 0.2 to 0.6 ounce of zinc per square foot of surface covered, or about 0.3 to 0.6 ounce per pound of wire. In the case of wire the iron or steel is drawn slowly through the bath of melted zinc and usually passes over a wiper as it comes out, which removes the still molten zinc and causes the zinc remaining to stick a little more firmly and have a more uniform thickness. The coating on this wiped wire is not so liable to crack and break off when the wire is bent and twisted as the coat of unwiped wire but, on the other hand, it is thinner and gives but little protection against corrosion. Sometimes articles to be galvanized are first dipped in a bath of melted lead and then in the melted zinc. This gives a cheaper coating.

Dry Galvanizing. — The process of dry galvanizing is a recent invention and consists in heating the articles to be galvanized inside a closed vessel and while they are covered with what is known as 'blue powder,' which is a zinc dust containing some oxide of zinc and relatively cheap in price because it is a by-product in the metallurgy of zinc. The temperature is about 300° C. (575° F.), and, although this is below the melting point of zinc and of iron, it is sufficiently high to produce an alloy between the two, forming, it is said, a very resisting coating which is more thoroughly attached to the surface of the metal and therefore much more durable against cracking off.

Comparison of Galvanizing Methods.—Cold galvanizing deposits a thinner coating of zinc which, if improperly performed, is liable to be porous or spongy, but it gives a better connection between iron and zinc and therefore a more durable coating. Hot galvanizing necessitates the use of a flux on the bath of melted zinc in order that the zinc may not be oxidized by air, and these fluxes probably have the effect of sometimes beginning the corrosion of the iron underneath the layer of zinc. The process of dry galvanizing is too new yet for any comparison to be drawn.

Tinning. — A large amount of metal is coated with tin in order to give protection against organic acids, such as those present in cooked foods, and also in order to give a more effective resistance to the elements. Thus cooking utensils, roofing sheets, tin cans for preserves, and many such articles are coated with tin in preference to zinc, either because zinc would not withstand so long the corrosive influence, or else would not resist it at all. In the tinning operations the metal sheets are usually drawn through a bath of liquid tin by four to six pairs of rolls which are immersed in it. Each pair of rolls presses the tin which has solidified on the surface of the iron firmly upon the metal and the result is a smooth, bright, adhering coat which protects the metal very successfully. Tin plating is more expensive than galvanizing, chiefly on account of the additional cost of the tin.

Terne Plate. — Sometimes sheet metal is coated with a mixture of two-thirds lead and one-third tin and then goes under the name of terne plate, which is used very largely for roofing and outdoor purposes. It is applied by the same method as tinning but is less expensive.

Nickel Plating. — Articles requiring a very high polish and which are to be subjected to handling, etc., are often plated with nickel. This is an electrolytic process, similar to the general operation described under the electrolytic galvanizing. Nickel plating is more expensive than galvanizing or tinning, but gives a more highly resisting surface.

Oxidized Coating. — There are one or two processes by which a black oxidized surface can be given to iron and steel which will resist rust for years and form what are known as 'black iron' objects. It is used chiefly for fancy iron work in house decorations, etc.

Enameling. — A number of articles, such as bath tubs, wash-bowls, cooking utensils, are made of cast iron or steel and then coated with a white or variously colored film known as enamel. Enameling processes are more or less secret, but usually consist in powdering the enamel upon the surface of the metallic article which has been heated to a red heat. At this temperature the mixtures forming the enamel melt and spread themselves uniformly over the surface where they chill and harden. Enamel must be insoluble in water and in chemicals with which they are liable to come in contact, and must also be sufficiently elastic to expand and contract with the metal without breaking off.

REFERENCES ON CORROSION

See especially Nos. 117, 118, and

160. Allerton S. Cushman. "The Corrosion of Iron." *Proceedings of the American Society for Testing Materials*, vol. vii, 1907, pages 211-228. Same published as *Bulletin No. 30*, Department of Agriculture, Washington, D. C. With many cross-references.
161. Henry M. Howe. "Relative Corrosion of Wrought Iron and Steel." See *Proceedings, International Association for Testing Materials*, 1900, vol. xi, Part I, pages 229-266. Paris, 1901. Abstracted in No. 162, and in *Journal Iron and Steel Institute*, No. 11, 1900, pages 567, 568.
162. Frank N. Speller. "Steel and Iron Wrought Pipe." *The Iron Age*, March 2, 1905, vol. lxxv, pages 741-745. With several cross-references on relative corrosion.
- See also the indices of No. 8 for abundant references.
163. J. Lewkowitsch. "Chemical Analysis of Oils, Fats and Waxes." London, 1898.
164. A. H. Church. "The Chemistry of Paints and Painting." London, 1901.

XVII

THE ELECTRO-METALLURGY OF IRON AND STEEL

In the electric smelting and refining of iron and steel, four modifications in practice are produced:

1. Practically any desired temperature in reason may be obtained.
2. The impurities introduced with the usual fuels are avoided.
3. The temperature is regulated with much greater accuracy.
4. The cost of the processes is increased.

For many years the first three modifications have been taken advantage of in the production of ferro-alloys — e.g., ferro-tungsten ferro-chrome, ferro-molybdenum, etc. — that is, alloys of pig iron and some other metal which is used for recarburizing in the manufacture of alloy steels. The high temperature necessary for the production of these alloys gives electric smelting especial advantages while the high price at which they can be sold enables their manufacturers to stand the additional expense with profit. But in the year 1900 a number of important electro-metallurgists in Europe and America began to use electric processes for the production of pig iron and steel on a commercial scale, and from this time the industry dates. Because the electric processes have apparently secured for themselves a permanent place in the metallurgy of iron and steel, and because of the great interest which they have evoked, I have decided to devote some space to them here, although the amount of metal produced by them is still very, very small in comparison with the older methods.

Iron and steel electro-metallurgical processes naturally divide themselves into three classes:

- (1) Ore smelting for the production of pig iron.
- (2) Refining of pig iron to produce steel, and
- (3) Electrolytic refining of steel or wrought iron to produce almost chemically pure iron.

The first two classes are electro-thermic; that is to say, they use electricity for conversion into the heat necessary for smelting;

the third class is electrolytic, that is to say, the electric current serves to produce chemical changes.

ELECTRO-THERMIC ORE SMELTING

The two most successful ore-smelting processes are those of Héroult and Keller, and in each of those the furnace is filled with

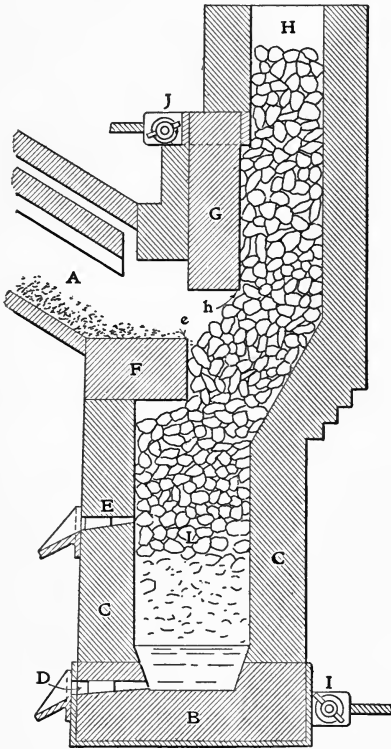

FIG. 300.—EARLY HÉROULT ORE-SMELTING FURNACE.

The ore enters the furnace through A, and meets the coke which enters through H. The electric current enters at I, to the positive electrode B, which is a block of solid carbon; it passes from B up through the charge, being conducted mainly by the coke, which is heated on account of its electrical resistance, and to the negative electrodes, F and G, which are also blocks of solid carbon. The negative electric connection is a J. The charge begins to become heated at the electrodes F and G, and constantly gains in temperature as it falls lower and lower in the furnace.

the charge, consisting of ore, flux, and coke which resembles the ordinary blast-furnace charge, except that the amount of coke is much smaller since the electricity is relied upon for the production of heat. No blast is driven into those furnaces, but a powerful current of electricity is passed through the charge, the high resistance of which, on account of its poor conductivity, produces a great deal of heat. The degree of heat can be regulated both by the intensity of the current and the character of the charge, in which the coke is the best conductor. The process will be better understood by reference to Figs. 300 and 301, and the descriptions thereunder. When a certain temperature is reached the carbon reduces the ore, and the iron thus produced absorbs from the coke carbon, silicon, sulphur and phosphorus,¹ and collects in a liquid pool at the bottom of the furnace. The gangue unites with the flux to form a

¹Some phosphorus is absorbed from the ore also.

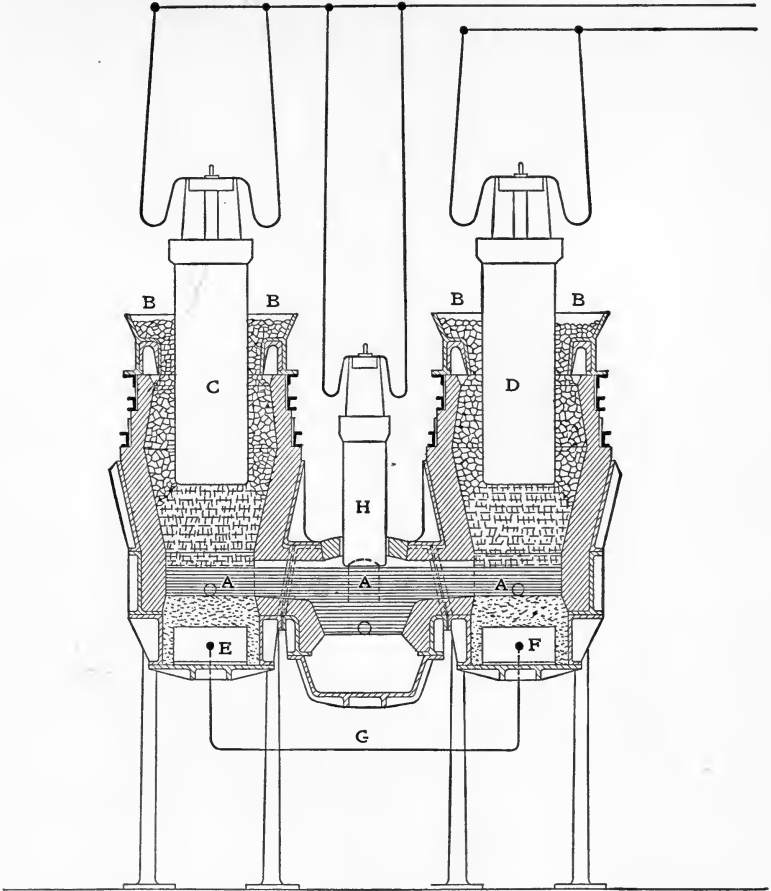

FIG. 301. — KELLER ORE-SMELTING FURNACE.

The two shafts are connected below by means of the channel AAA. The charge, consisting of ore, coke and flux, enters the shafts at BB, BB, and passes downward in the furnace as smelting progresses. C is the positive, and D the negative electrode, each consisting of a block of carbon. E and F are also blocks of carbon, electrically connected by the cable, G. The current enters at C and passes through the charge to E; thence it passes through G to F and thence through the charge in the other shaft to D. In this way the charges in both shafts are heated; liquid iron is formed and collects in the channel, AAA, while the slag floats on top of it. When the liquid pool extends all through AAA the current passes through it instead of through the cable G, and thus the melted iron is kept hot. If it should become too cold, the auxiliary electrode, H, is brought into action and the current enters at this point until the desired temperature is obtained.

slag and, on account of the very high temperature available, the slag is made intentionally very rich in lime, wherefor it has

a great solvent power for phosphorus and sulphur. On this account pig iron, very low in these two harmful elements, can be produced from relatively impure ores, and this is one of the greatest advantages of this type of ore smelting. The pig iron and slag are tapped from the bottom of the furnace through tap holes, as in other processes.

Electric vs. Coke Smelting. — The cost of electric smelting under diverse conditions has been frequently estimated and figures

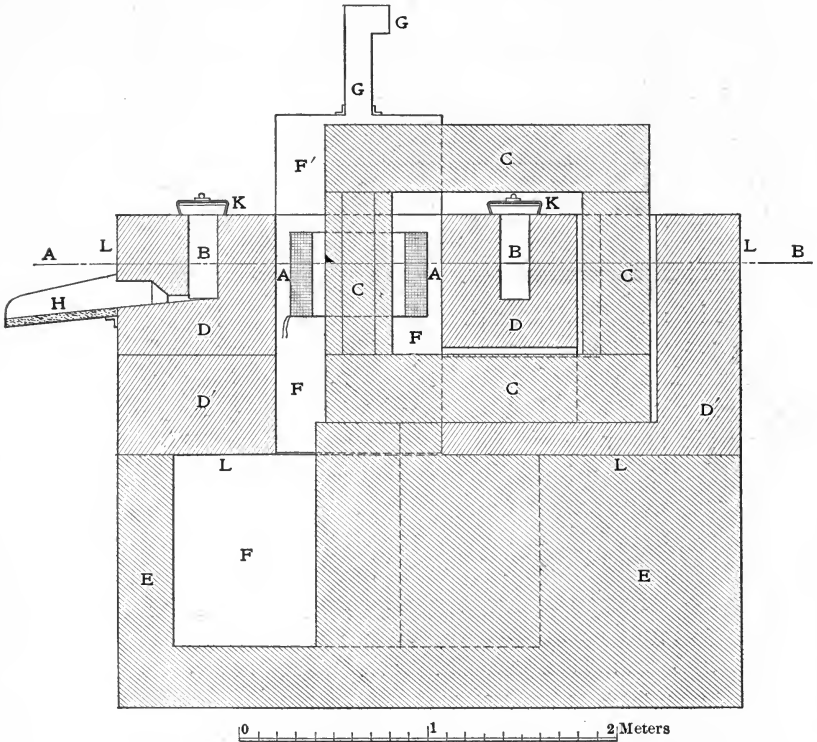

FIG. 302. — SECTION OF KJELLIN INDUCTION FURNACE.

may be found in several of the references given at the end of this chapter. It seems unwise to quote figures except where the full circumstances and conditions are described, although we may estimate that the cost of smelting may be as low as \$10 per ton of pig iron produced under the most favorable circumstances and up to \$30 per ton where ore and water power are not so cheap.

The expense depends chiefly upon the cost for the production of electricity, and this is so large that electric smelting is practically never advisable except where impure ore and water power for



FIG. 303. — VIEW OF COLBY INDUCTION FURNACE.

the production of electricity are very cheap, and where pig iron, coke and pure ore are expensive. Besides the advantages of being able to produce a very pure pig iron and to employ very impure ores, we can use electric smelting even where coke is not available by the use of charcoal as a reducing agent.

ELECTRO-THERMIC MANUFACTURE OF STEEL

There are three important types of electric furnace now in use for the refining of pig iron, known respectively as the Kjellin-Colby or induction type; the Héroult, and the Keller types.

Induction Furnace. — The induction furnace is based upon the principle of the ordinary static transformer, whereby alternating electric current is transformed to lower voltage. It was independently developed by E. A. Colby, of the United States, and F. A. Kjellin, of Sweden, whose American rights have been joined under one management. A sectional elevation of the furnace is shown in Fig. 302, in which *CCCC* is the core of an electro-magnet, around one leg of which a coil of wire, *AA*, passes. When an alternating current goes through the coil, *AA*, it sets up an alternating magnetic field in the core, *CCCC*, and this in turn sets up a secondary current in the circle, *BB*, parallel to the coil, *AA*. In other words, an alternating current passing through the coil, *AA*, induces an alternating current in the coil, *BB*, without there being any metallic connection between the two. This is a well-recognized phenomenon in electrical engineering and requires no further comment here. In the furnace operation, the circle, *BB*, is a hollow ring in the brickwork into which melted metal is poured. The resistance offered by this melted metal to the passage of the induced current generates heat which will maintain the temperature or raise it to any desired point. The slot, *BB*, is really an annular crucible into which pig iron, steel scrap, iron ore and flux may be charged as if it were an open-hearth furnace, and the operation of steel making is practically the same in principle except that electric heat is employed instead of regenerated gas and air. We may charge solid metal if desired, but, in such a case, it is well to leave a shallow circle of metal in the bottom of the slot, *BB*, after each operation is ended, to serve to carry the induced current during the beginning of the next operation, until the solid charge is melted.

There is a tap hole for slag at an upper level into the slot, and one or two tap holes for metal at a lower level; or sometimes the whole furnace is supported so as to tip forward and pour its contents out of a spout. The great advantages of the furnace are the freedom of the charge from contamination by impurities

either in fuel or in electrodes or other connections, the excellent control and wide range of temperature, and the ease and simplicity

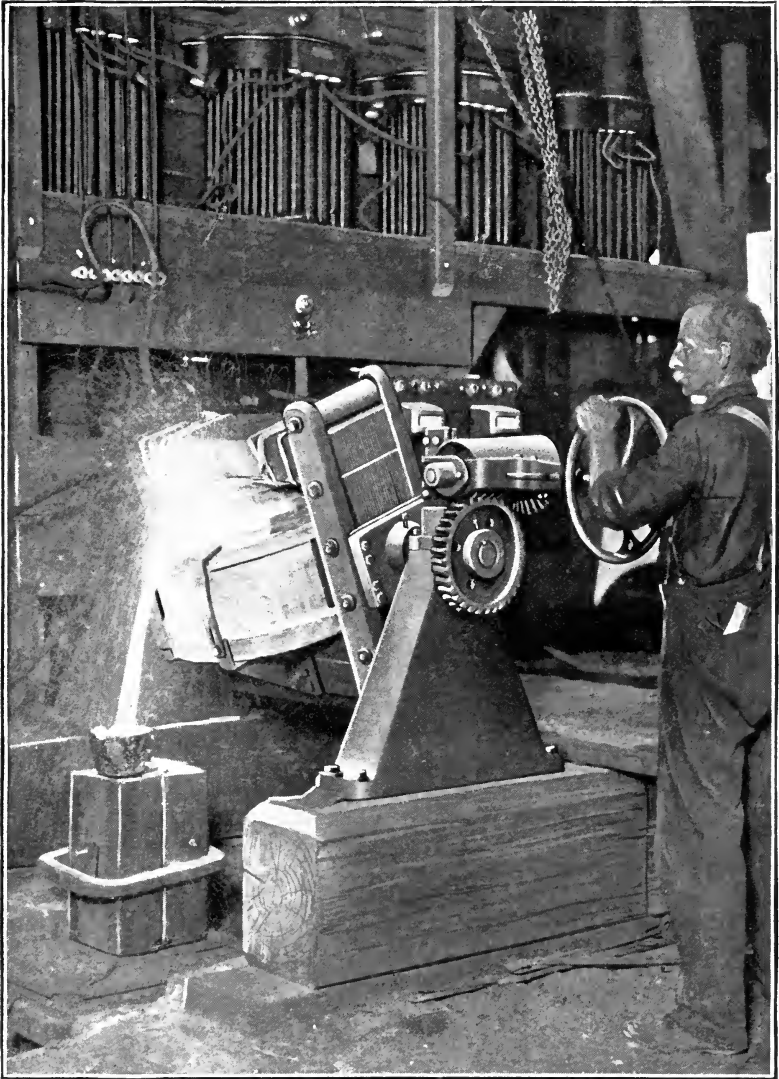
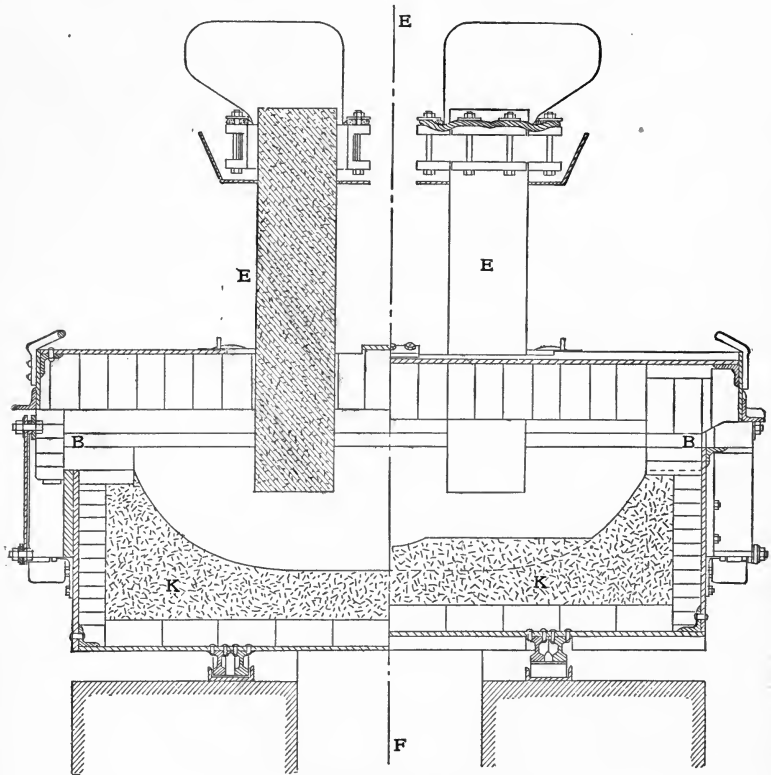

FIG. 304. — COLBY FURNACE POURING.

of operation. Its disadvantages are the high cost for electricity on account of the low efficiency of the induction process, and

the expense for replacing the annular crucible when it is badly corroded by slag and oxides. Indeed, the cost of this type of operation is so great as to practically preclude it from competition with the open-hearth process under ordinary circumstances and conditions, but it does enter into direct competition with the crucible-steel process, because of the purity obtainable when



Longitudinal Sections A B & C D

FIG. 305 — HÉROULT REFINING FURNACE.

pure charges are used, and because of the high cost of the latter process for crucibles, labor and fuel, so that altogether more than a dozen furnaces of the induction type have been installed for commercial production of steel in Europe, England and America.

Héroult Furnace. — The design and operation of the Héroult steel furnace is even more like an open-hearth than the induction

furnace, although again electric heat is substituted for regenerated gas and air. The general form of the furnace is shown in Figs. 305 to 306. There are two electrodes of carbon, one of which leads the current to the charge and the other conducts it away. The electrodes do not touch the charge, but the current arcs from one electrode to the charge, through which it passes, and thence arcs to the negative electrode. Thus combined arc and

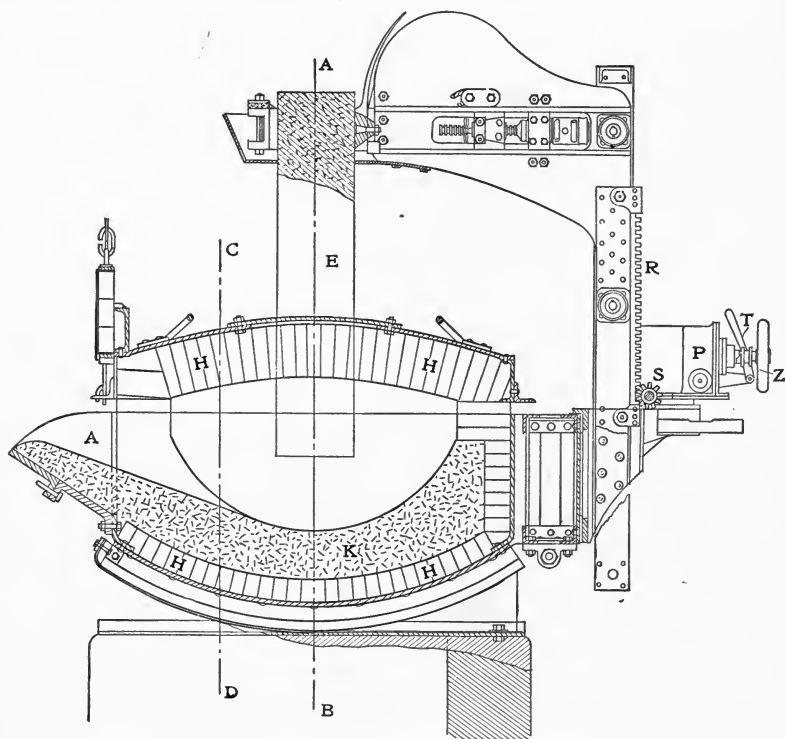

Transvers Section E F

FIG. 306. — HÉROULT REFINING FURNACE.

resistance heating is used, and the impurities of the electrode do not come in contact with the charge except in so far as the electrode burns up and deposits its ash. When desired the electrodes are lowered until they dip into the slag, but never touch the metal. The charges consist of solid or liquid pig iron, steel scrap and flux, regulated according to the principle of the basic open-hearth process, for the usual Héroult furnace is lined

with basic material. On account of the high temperature obtainable a liquid slag very high in basic components may be made, and thus steel low in phosphorus and sulphur may be produced from impure raw materials. The furnace is mounted so as to tip for discharging its contents. There are holes for the admission of air blast to the interior of the furnace and the operations of adding ore and lime and of working the charge are similar to those of the basic open-hearth process. There are four Héroult steel furnaces in Europe, and one in the United States.

ELECTROLYTIC REFINING OF IRON

The greatest amount of work on the electrolytic refining of iron has been done by C. F. Burgess, of the University of Wisconsin, who produces an iron that is almost chemically pure, the chief foreign element being hydrogen, whose presence renders the metal very hard and brittle. The hydrogen is driven off by heating the metal to a high temperature, but this is accomplished with the result of vitiating the iron with traces of carbon and sometimes other impurities, for iron has such a great affinity for carbon that it will absorb it at a red heat from coke, charcoal, and even from gases and oil vapors. Indeed, if a piece of electrolytic iron, or other iron very low in carbon, be heated in contact with steel or wrought iron higher in carbon, there will be a small amount of transfer of carbon from the low- to the high-carbon metal. The same difficulty is met with in melting the metal, and as its melting point is 1507° C. (2745° F.), there are not many kinds of crucibles that will stand the heat necessary and yet fail to yield carbon, silicon, or some other impurity to the iron. As I understand it, it is this difficulty which has been the chief obstacle in the electrolytic process, for the electrolysis itself seems to be accomplished by Burgess with success and economy. If the cost of the electrolytic product could be brought somewhere near that of Swedish iron and the other very pure forms, it is probable that it would become a commercial commodity on account of its high magnetic permeability, electric conductivity and softness.

Electrolytic Process. — In Burgess's process the electrolyte is a mixture of ferrous sulphate and ammonium sulphate and it

is kept at a temperature of 30° C. (86° F.). The anode is ordinary wrought iron or steel and the primary cathode upon which the first metal is deposited is a thin strip of sheet iron. The deposited metal sticks so slightly to this that no difficulty is met with in separating them after the operation is finished. The electric current, with a density of from 6 to 10 amperes per square of cathode surface, deposits the dissolved iron upon the cathode with an efficiency of nearly 100 per cent., and cathode plates averaging about three quarters of an inch thickness are produced in a four weeks' run.

REFERENCES ON THE ELECTRO-METALLURGY OF
IRON AND STEEL

171. Eugene Haanel, Superintendent of Mines. "Reports of the Commission Appointed to Investigate the Different Electro-Thermic Processes for the Smelting of Iron Ores and the Making of Steel." Department of the Interior, Ottawa, Canada, 1904 and 1907.
172. A number of valuable articles and references in vols. i to v, 1902 to 1907 inclusive. *The Electro-Chemical and Metallurgical Industry*.
173. C. F. Burgess and Carl Hambuechen. "Electrolytic Iron." American Electro-Chemical Society, April, 1904. Abstracted in *The Electro-Chemical and Metallurgical Industry*, vol. ii, 1904, pages 183-185.
174. Geo. P. Scholl. "The Manufacture of Ferro-Alloys in the Electric Furnace." *The Electro-Chemical and Metallurgical Industry*, vol. ii, 1904, pages 349-351, 395-396 and 449-452.
175. A number of valuable articles in W. Borchers's *Metallurgie*, vols. i to iv, 1904 to 1907 inclusive.
176. Several valuable articles and abstracts in Henry Le Chatelier's *Revue de Métallurgie*, vols. i to iv, 1904 to 1907 inclusive.
177. John B. C. Kershaw. "Electric Furnace Methods of Iron and Steel Production," vols. xxxix and xl, *The Iron Trade Review*, 1906 and 1907.
178. G. K. Burgess. "Melting Points of the Iron-Group Elements," Reprint 62. Bureau of Standards, Washington, D. C. See this Bulletin for best references on pyrometers.

XVIII

THE METALLOGRAPHY OF IRON AND STEEL

METALLOGRAPHY in its larger sense is the description or study of the structure of metals. That branch of the subject which comes under the head of microscopic metallography is, however, the most important because the structure of most metals, especially iron and steel, is discernible only when magnified. We shall see, however, that the observation of structure by eye — known as macroscopic metallography — is not without great value.

Microscopic metallography has now reached that stage of importance where it is viewed almost on a par with chemical analysis and physical testing. In the United States practically every large steel works is well equipped for the microscopic analysis of its product, and, too, important laboratories of the universities and of consulting metallurgists devote much attention to the study. Although only a little more than twenty years have elapsed since the art first received public attention, it has advanced so far as to have become by now another and a very serviceable tool in the hands of the expert. I take this opportunity, however, of offering a word of warning: reputations have more than once suffered severely, because of erroneous deduction made from microscopic evidence, and history has shown that those who "rush in where angels fear to tread" are sure to be caught sooner or later. The wise man is he who never bases an opinion upon a sample whose chemical analysis is unknown to him: who never bases an opinion upon a microphotographic negative or print, and who polishes and etches his own specimens, or has these operations performed by some one well known to him and working under his immediate direction. With these precautions the microscope is a very reliable index to an experienced mind.

PREPARATION OF SAMPLES FOR MICROSCOPIC EXAMINATION

Samples of iron and steel for microscopic analysis can be cut out of soft samples by means of a hacksaw, lathe, or other machine, and broken out of hard and brittle samples by means of a hammer. A good rule to follow is to have the surface that is to be polished about $\frac{3}{8}$ to $\frac{1}{2}$ of an inch on a side. If larger than that, it requires excessive labor for polishing. It requires about sixteen times as much labor to polish a sample an inch square as to polish one $\frac{1}{2}$ inch square, and it requires about sixty-four times the labor to polish one 2 inches square. On the other hand it is not advisable to polish too small an area, because the surface will be liable to convexity and therefore very difficult to get into focus, especially for high powers.

Rough Polishing. — After the proper size of a specimen is obtained the next step is to give its surface a bright mirrorlike polish, free from any scratches discernible even with high powers of the microscope (1,000 diameters or so), and this result is achieved with the greatest economy in labor by proceeding by gradual steps:

If the surface contains deep gouges, or marks produced by cutting or breaking it out, it should first be brought to a plane surface by rubbing across a rough file, a grindstone, or an emery wheel. For my own work I much prefer to rub the specimen across a file rather than to put it in a vice and draw a file across it, for I believe the former method produces a more even, — i.e. less rounded, — surface and therefore conduces to economy of labor in the later operations. It is best to hold the specimen lightly in the fingers and draw it back and forth across the file in a straight line, avoiding any circular motion and therefore having the polishing marks all parallel and straight across the specimen.

When a plane surface has been produced in this way the specimen should be rubbed on a very smooth file. In this operation the specimen should again be held in the fingers and rubbed in a straight line back and forth, and should be turned 90° from the first rubbing so that the marks now made will cut vertically across the first scratches. In this way it is very easy to tell when the scratches made by the first file are entirely eliminated and the operation on the second file should be continued to at least this point no matter how short and faint the old scratches may prove to be.

It only takes a minute or two to remove the last scratches on this smooth file, but it would take several minutes to remove them by means of one of the later polishing mediums, and the greatest economy is obtained by having each stage of the operation absolutely complete.

After coming off the smooth file, the specimen is again turned 90° , so that the marks now to be made run in the same direction as those made on the rough file, and rubbed across a sheet of ordinary 00 emery paper cut to about $3\frac{3}{8}$ inches wide by 9 inches long and pinned with thumb tacks upon a piece of planed, $\frac{1}{2}$ -inch board. This operation is continued until the last marks from the smooth file are removed.

Fine Polishing. — The polishing then proceeds in the same manner by steps upon French emery paper of gradually increasing fineness, each piece being cut to about $3\frac{3}{8}$ inches by 9 inches and mounted on a smooth board. Of the Hubert brand the grades are designated 0, 00, 000, and 0000.

After the 0000 French emery, the surface is very smooth and bright and is given a final burnishing by rubbing across a piece of broadcloth or baize stretched over a piece of wood, moistened with water and covered with a very thin liquid paste of water and best washed rouge. This should leave the specimen polished as bright as a mirror and free from all scratches. It may be, however, that the eye or a hand magnifying glass would discover microscopic rounded furrows in the specimen. These are due to scratches made in the early stages of polishing, which have not been eliminated, but whose corners have been rounded off by the finer grades of polishing mediums. I never permit a specimen containing these furrows to be used as the basis of any opinion.

Preparation of Rouge. — The best jeweler's rouge purchasable is not good enough for polishing, as it contains very fine particles of dirt and grit which produce scratches in the surface of the specimen during the final stages of the process. It is best washed by the metallographer himself. This is best done upon samples of not more than one teaspoonful of rouge at a time stirred in about a glassful of water in a flat pan or dish until thoroughly wetted. After allowing to settle for about five minutes the water is poured into an ordinary chemist's wash bottle where it is kept until ready for use. The last dregs of the water, containing a good deal of coarse rouge and grit, is thrown away. A little experience soon

teaches one to get the maximum amount of good rouge from a sample, without any particles that would produce scratches. The rouge in the wash bottle is protected from dust and dirt and can be poured out of the glass tube on to the broadcloth polishing board as needed. For the preparation of special powders for the very finest grades of polishing, the reader is referred to the references at the end of this chapter. I have described here the methods which I prefer and use, but there are many others which are doubtless equally as good.

Precautions as to Polishing. — Do not rub the specimen too hard on the polishing mediums. This does not produce the desired effect any more rapidly and may distort the structure of the metal so as to lead to erroneous conclusions.

Do not allow the specimen to become heated by the polishing. This is especially true of hardened steel and other heat-treated specimens which may become tempered and so altered even upon gentle heating.

Rub a piece of hard steel over each piece of polishing paper and broadcloth before using it for polishing your specimen. This is to get rid of grit.

Do not lay polishing boards down where dust will get on them, but let them stand with the full height upward inside a closed box or a small closet.

Never form an opinion upon a specimen that retains scratches or polishing marks.

Mechanical Polishing. — Instead of rubbing the specimen across different mediums by hand, we can press them against the emery papers and rouge-cloth mounted upon wooden discs about 8 inches in diameter, revolving at speeds of about 600 r.p.m. This method saves time and the necessary apparatus is very simple to make, or can be purchased complete.¹ For my own use I prefer hand-polishing except upon the rouge, because of the liability to heating the specimens with the higher surface-speed, and to damage of the specimen by having it snatched out of one's fingers.

¹ Consult references 180, 184 and 185, page 457.

DEVELOPING THE STRUCTURE FOR EXAMINATION

To develop the structure of iron and steel so as to differentiate between the constituents, four methods are available:

- (1) Polishing in bas-relief.
- (2) Etching with chemicals.
- (3) 'Polish attack,' and
- (4) Heat tinting.

Polishing in Bas-relief. — Where some of the constituents are less durable than others the method of polishing that I have described, upon a soft background, produces a bas-relief, since the softer constituents are worn to a greater depth than the harder ones. The parts thus worn down appear darker than the higher places which reflect the light better. It is by this method that graphite is best distinguished in pig iron and slag in wrought iron, because the attack by acids is liable to produce other dark spots which may not be readily differentiated. It is by the bas-relief method that F. Osmond developed so beautifully the structure of pearlite shown in Fig. 241. This method has the disadvantage, however, of rounding off the edges of the harder constituents and so causing the softer ones to appear larger than they really are.

Etching with Chemicals — Nitric Acid. — This method is probably the commonest one of developing the structure of steel. Many different strengths of acid are used by different metallographers from 0.1 per cent. up to 20 per cent., and the length of time that is necessary to expose the specimen will depend upon this factor and upon the amount of carbon present. High-carbon steel will require a longer time than soft steel and may take as much as 2½ minutes, although this is very rare. The nitric-acid solutions are usually made with alcohol instead of with water, in order to dry more quickly. Some metallographers prefer to immerse their specimens in the acid for a given length of time, and others prefer to hold the specimen in the hand with the polished surface upward, and then deposit a few drops of the etching fluid upon it with a piece of rubber tubing on the end of a glass rod. In any event it is usually better to etch a shorter time than is estimated as suitable, examine under the microscope, and then etch again if necessary. After every etching it is necessary to wash the specimen off with alcohol and dry as quickly as possible. This drying is best accomplished by absorbing all

the liquid left on the surface after the alcohol wash with a piece of soft cloth and then holding in a stream of air. Some metallographers wash the specimen after etching with alkali, and then with water and then with alcohol. Sauveur immerses his specimen in the strongest nitric acid for a few seconds and then places it in a stream of running water, washes with alcohol and dries. As the strong nitric acid puts the steel in a passive state, the length of attack by this method is only momentary, so that it is necessary to repeat it a few times. It results in a very even etching of the surface.

Iodine Etching. — Some investigators use iodine for etching, by rubbing a few drops over the surface until a film covers it, and allowing it to remain until the iodine color has disappeared, after which the iodine is washed off with alcohol and dried. A good iodine solution for this purpose is the ordinary tincture of iodine diluted with an equal volume of alcohol. It is also well to have an auxiliary solution of about $\frac{1}{4}$ this strength for lighter etching work.

Picric Acid Etching. — I have found the 5 per cent. of picric acid in alcohol, which Igevsky used for hardened and annealed steels, very useful also for wrought iron, very low carbon steels, and pearlite.

Polish Attack. — The method of 'polish attack' advised and used by Osmond, consists in rubbing the specimen upon a piece of parchment stretched over a piece of soft wood and moistened with a 2 per cent. solution of ammonium nitrate. This method gives very beautiful results in Osmond's hands and is especially valuable for developing the structure of martensite, troostite, pearlite, and sorbite.

Heat Tinting. — Heat tinting consists in warming the steel until it becomes oxidized. The different constituents are oxidized at a different rate and so may be distinguished from one another. It is most serviceable in distinguishing the phosphide of iron from the carbide, for by heating until the carbide is red, the phosphide (Fe_3P) will be yellow. The phosphorus eutectic may be distinguished from pearlite in the same way, because the former will be yellow when the latter is blue. The heat tinting must be accomplished in such a way as not to expose the metal directly to a flame. The simplest method is to put the specimen upon an iron plate heated from beneath.

MICROSCOPE AND ACCESSORIES

It is hardly desirable to describe here the different forms of microscope and accessories used for metallographic work, as the manipulations cannot well be learned, except by practice, and the catalogues of the manufacturers of scientific instruments of all iron-producing countries now give full data. A photograph of a common illuminating device, microscope and camera, is shown in Fig. 307. Those who expect to take up the subject should procure a book upon it and study it much more fully than we have space for here. The chief difference between the microscopic examination and photography of iron and steel, and of biological specimens, botanical specimens, thin rock sections, etc., arises from the non-transparency of the metal. It is necessary to illuminate them from above, since we cannot cause the light to pass through the specimen and into the instrument. This necessitates special forms of illuminators and powerful lights. For magnifications of about 500 diameters, the Welsbach mantle gives sufficient illumination. The Nernst lamp is also very useful, but for very high powers it is necessary to use the electric arc lamp. This introduces especial difficulties, because the focus which gives good definition to the eye by means of the arc light will be blurred upon the photographic plate. The use of a light-yellow screen in front of the light assists in this difficulty, but a good deal of experience is required to get good results. A mercury light avoids this difficulty.

MAGROSCOPIC METALLOGRAPHY

An experienced eye may get a very good idea of the size of crystals in iron and steel by examining a freshly broken fracture, and this is one of the branches of magroscopic metallography. For the most accurate results, however, it is not as good as microscopic examination.

It is also possible to get other information by etching a polished surface for many hours with dilute hydrochloric acid. For this purpose the polishing need only go as far as the commercial 00 emery paper, following the smoother file. In this way the center of ingots, because of their looser texture, will be eaten away much more rapidly, and this will be evident to the unaided eye. Also the interior of sections of large area will be attacked more than the

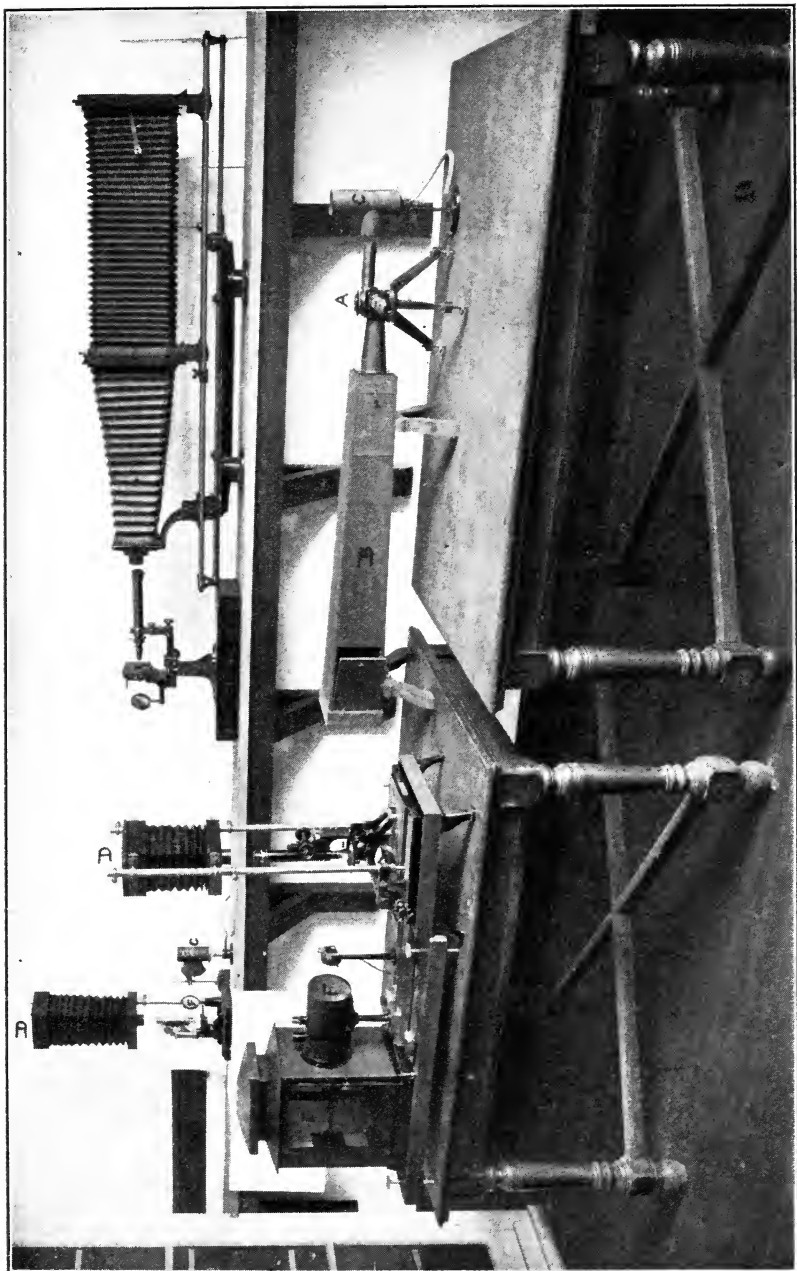
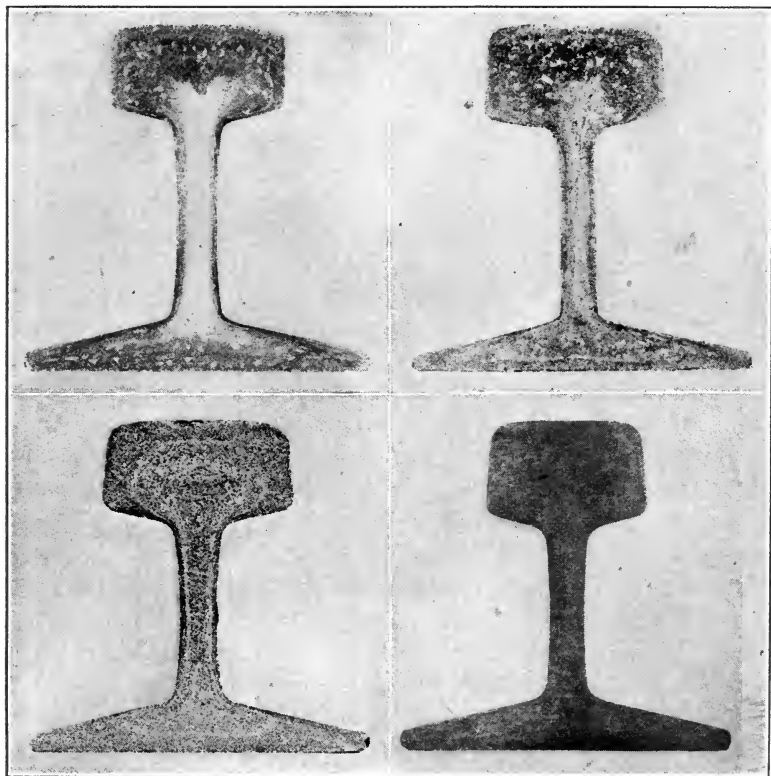

FIG. 307. — PART OF THE MICROPHOTOGRAPHIC APPARATUS IN THE METALLOGRAPHIC LABORATORY, DEPARTMENT OF METALLURGY, COLUMBIA SCHOOL OF MINES.

A, Le Chatelier camera; B, Le Chatelier camera; C, Welsbach light and stand; D, Sauveur camera; E, electric arc illumination; F, condenser for light rays.

outside, which has become harder through the work of rolling. Some blowholes, which cannot be seen by eye or have been partially welded up, may often be discovered, because the etching action is more severe in their neighborhood, and the same is true



FIGS. 308 TO 311. — RAILS ETCHED FOR SEVERAL HOURS WITH DILUTE HYDROCHLORIC ACID.

FIG. 308. — RAIL WITH SOFT INTERIOR; ROLLED FROM TOO NEAR TOP OF INGOT.

FIG. 309. — RAIL WITH BLOWHOLES AND SOFT INTERIOR.

of spots where segregation has occurred. After etching and examination, permanent records may be kept of the indications by covering the etched surface with printer's ink and then pressing it with a letter file on to a piece of cardboard or heavy paper. A few examples of records made in this way are shown in Figs. 308 to 311.

REFERENCES ON THE METALLOGRAPHY OF IRON AND STEEL

For preparation of microscopic specimens:

180. W. Campbell. "Notes on Metallography." *Columbia School of Mines Quarterly*, vol. xxv, No. 4 and vol. xxvii, No. 4.
181. F. Osmond and J. E. Stead. "Microscopic Analysis of Metals." London, 1904.
182. Henry Le Chatelier. "Sur la Métallographie Microscopique." *Bulletin de la Société d'Encouragement pour l'Industrie Nationale*, April, 1896. (In English, see) *The Metallographist*, 1901, vol. iv. Also: *Congrès International de Liège, Section de Métallurgie*, vol. i, pages 255-284.
183. E. Heyn. See especially, *Verhandlungen des Vereins zur Befoerderung des Gewerbfleisses*, 1904, pages 355-397. Also: *Stahl und Eisen*, vol. xxvi, pages 8-16 and vol. xxvi, pages 580-596.
184. J. E. Stead. *Journal of the Iron and Steel Institute*, 1894, No. 1, page 292; and the *Proceedings of the Cleveland Institution of Engineers* (England), 1900.
185. *The Metallographist*, vols. i to vi, 1898 to 1903. Edited by A. Sauveur, Boston, Mass. Succeeded by *The Iron and Steel Magazine* to 1906.
186. Paul Goerens. "Einführung in die Metallographie." Halle a. S., 1906.

For micro-photography:

187. Edward Bausch. "Manipulation of the Microscope." Third edition. Rochester, N. Y., 1897.
188. Walter Bagshaw. "Elementary Photo-Micrography." London, 1902.
189. Louis Derr. "Photography for Students of Physics and Chemistry." New York, 1906.
1800. H. Behrens. "Das Mikroskopische Gefuege der Metalle und Legierungen." Hamburg, 1894.

See also bibliography given at end of No. 116.

XIX

CHEMISTRY AND PHYSICS INTRODUCTORY TO METALLURGY

Chemical Changes. — If a piece of coal be burned, it ceases to exist as such. It disappears from sight, except for its slight residue of ash, and apparently has been wiped out of existence forever. Likewise, if a piece of steel be attacked by some acid, it disappears as such, and only a coloration of the acid gives evidence to the eye of the metal previously present. Lastly, if a piece of bright iron or steel be exposed to the weather, it is soon converted into reddish-brown rust, which bears but little resemblance to the original metal. In the first example the solid coal has been combined with oxygen of the air and converted to the form of an invisible gas; in the second case, the iron has been combined with the acid and water and converted into a liquid; in the third case the iron has been combined with oxygen and converted into a powder. In no case has there been any loss in total amounts or weights, but only a difference in composition or substance. These changes in composition are chemical changes.

Physical Changes. — Changes may occur in form or properties without any change in composition: For instance, water may be converted into ice by mere cooling, and no change in composition will take place. Or it may be converted into steam by heating and will still be composed of the same elemental constituents as when it was in the form of ice or water. Iron may be liquid or solid; it may be cold or hot; it may be magnetic or non-magnetic, and all without change in substance. These changes in properties are known as physical changes. They may consist of changes in form, strength, heat, light, magnetism, electricity — in fact, everything but composition.

Relation between Chemical and Physical Changes. — Every chemical change produces one or more physical changes. Thus, chemical changes are always accompanied by a loss or gain of heat,

and in the examples cited in paragraph 1, there were also observed changes in form, in color, etc. Conversely, we shall see too that physical changes are often the cause of starting chemical changes: heat is necessary to start the chemical action of the burning of fuel; pressure produces the explosion of dynamite; electricity breaks up many chemical compounds; light produces the chemical changes that make the photograph.

Chemical Compounds and Mechanical Mixtures. — When coal is burned it is chemically united to the oxygen of the air, and the gas formed contains properties entirely different from anything belonging to either of the substances that compose it. Likewise when steel is dissolved in an acid, or is converted to rust. This is the essential characteristic of chemical action: that the substances acting upon each other lose their individual properties and produce a new substance with different properties. Not so when the substances are merely mixed together, no matter how intimate that mixture may be. If finely ground sulphur be mixed with finely ground iron no new properties are produced, but if the mixture be heated until a chemical action takes place and the two substances unite, a new compound is formed, with new and different properties. Moreover, once the chemical union has taken place the iron and sulphur cannot be separated except by chemical means, whereas the mixture of the two could be separated by mechanical means, such as blowing the sulphur away with a slow blast of air, or picking up the particles of iron with a magnet.

Chemical Affinity. — The power that causes substances to unite, and that holds them together afterward is known as 'chemical affinity.' Like gravity, magnetism and some other great forces, its nature is not understood but its influence is very evident. Some substances have seemingly no affinity for each other (for instance, mercury and iron will not form a compound), while others have tremendous affinity — such as sodium and oxygen, which cannot be brought into each other's presence without uniting violently and generating much heat. Some substances have almost universal affinities, like oxygen which unites with every other elemental substance known except one, while others are relatively inert and form few compounds.

Conditions under which Chemical Action will Occur. — To start chemical action it is sometimes only necessary to mix the sub-

stances, as, for instance, sodium and water; in other cases we must apply heat, or pressure, or electricity, etc., even though the substances have great affinity for each other and unite vigorously after the action is once started. In other cases chemical action is very slow, no matter how started as, for instance, the rusting of iron, the dissolving of rocks in water, etc. As a general thing an increase in temperature increases all chemical affinities, but it increases some faster than others.

The Elements. — In the universe there are millions of chemical compounds, and these are mixed together to produce animal and plant forms, the earth, sea, etc. All these compounds are different combinations of only about eighty elemental substances, which are known as 'the elements.' The compounds can all be separated into their component parts by chemical means (perhaps aided by electricity), but the elements have so far resisted every attempt to break them down into simpler substances, and they are therefore considered as the simple substances and the basis of all matter. These eighty elemental substances are therefore of great importance, but some much more so than others, for only eleven of them form the great bulk of the earth as we know it, and the remainder are less abundant. The crust of the earth is made up of the following elements:

Oxygen.....	47.29 per cent.
Silicon.....	27.21 per cent.
Aluminum.....	7.81 per cent.
Iron.....	5.46 per cent.
Calcium.....	3.77 per cent.
Magnesium.....	2.68 per cent.
Sodium.....	2.36 per cent.
Potassium.....	2.40 per cent.
All others.....	1.02 per cent.

The air is 77 per cent. nitrogen and 23 per cent. oxygen. Pure water is 89 per cent. oxygen and 11 per cent. hydrogen. Plant and animal forms are composed chiefly of combinations of carbon, hydrogen, oxygen and nitrogen.

The air is the only one of the foregoing bodies in which the elements are not severally united in the form of compounds of a more or less complicated nature, and it is because the oxygen of the air is in the free, or elemental, state that it is capable of performing the chemical work of supporting life and burning fuels.

Summary. — So far we have learned that the whole universe,

so far as we know it, is built up of only about eighty different simple substances, which we call elements, and which are sometimes mixed together and sometimes chemically united, forming many millions of different combinations. We have also learned that a chemical compound has properties different from those of any of the substances composing it, and that the elements of the compound are held together by what is known as 'chemical affinity.' We have learned that chemical action does not always take place when two or more substances are mixed together, but we have often to start it by heat, electricity or some other means. Lastly we have learned that all chemical action is accompanied either by a production or consumption of heat.

Synthesis. — When two or more elements are chemically united to form a compound, or when two or more compounds are chemically united to form a further compound, the building-up process is called a 'synthesis.'

Analysis. — On the other hand, when a compound is separated into the elements which compose it, the breaking-down process is called an 'analysis'; or, another name for it is a 'decomposition.'

Definition of Metallurgy. — Metallurgy is the art of extracting metals from their ores and adapting them to their intended service. As iron occurs in the earth combined with one or more other elements, the process of extracting it consists in decomposing the compounds and obtaining the metal from them. But this is not all of the metallurgy of iron for, after it is extracted, it must be adapted to the service for which it is intended, and for this purpose various other elements are combined with it in proportions depending upon the uses to which the metal is to be put. Even one part of some of the added elements in ten thousand parts of iron will make a great difference in its properties, so that these syntheses must be performed with great care.

Qualitative and Quantitative Chemical Analysis. — Chemical analysis is important in metallurgy in another connection, because every substance put into the furnaces for smelting, and every substance produced must be carefully 'analyzed' in order that we may know exactly what is in them and guide our operations accordingly. A 'qualitative analysis' will show what elements are in any substance, while a 'quantitative analysis' will show how much of each is present.

OXYGEN

Occurrence. — Oxygen occurs free in the air; combined with hydrogen in water, and combined with silicon, with metals and with many other elements in the earth's crust. It is the most abundant element known to us.

Uses. — When breathed into our lungs oxygen performs certain chemical reactions which produce the heat that keeps us alive, and which purify the blood. The only other abundant constituent of the air is nitrogen, and this is so inactive chemically that it serves chiefly to dilute the oxygen. Oxygen also reacts chemically with coal, coke, oil, gas and other fuels to produce the heat for our fires, among which we must include prominently the fires so necessary in metallurgy.

Preparation. — Oxygen is very easily prepared in a concentrated form in a great variety of ways. If, by means of combined pressure and cold, air be converted into a liquid, its two components may be separated by centrifugal force, or else the nitrogen may be allowed to evaporate, leaving the liquid oxygen behind. No chemical processes are necessary for this separation because the elements are not combined. Where a compound exists, other means must be employed: For example, water may be decomposed into oxygen and hydrogen by an electric current, and from 100 parts by weight of water we can always obtain 89 parts of oxygen and 11 parts of hydrogen, nothing being lost in the change.

Chemical Action. — Oxygen is an odorless, colorless, tasteless gas. At the ordinary temperature it forms few chemical reactions, but, when heated, is one of the most active of the elements, vigorously attacking, for example, hydrogen and carbon, as well as their mutual compounds in the form of gases, when once a chemical reaction is started with a match, electric spark or similar means. It also attacks almost all the metals at a red heat, and some of them at lower temperatures, — iron for instance, which is coated with an 'oxide' upon being heated about twice as hot as boiling water. All the simple compounds of the elements with oxygen go under the name of 'oxides,' and their formation is accompanied with the production of heat.

Phlogiston Theory. — Centuries ago it was observed that lead, when melted and exposed to the air, became an apparently new

substance, and at the same time gained in weight. Starting with the same weight of lead and allowing the action to go on until complete, always resulted in the same gain in weight. The ancients believed that this action was the transfer from the fire to the metal of a certain indefinable substance which they called 'phlogiston.' They learned that if the lead and 'phlogiston' were later heated with charcoal, metallic lead was again produced, and they said that the 'phlogiston' was driven out of it. We now know that it was oxygen from the air that attacked the lead when melted and formed 'lead oxide,' and that when the lead oxide was heated with charcoal (carbon) the charcoal robbed the lead of its oxygen and formed 'carbonic oxide' leaving metallic lead again.

Oxidation and Reduction. — When oxygen attacks an element and forms an oxide the process is said to be an 'oxidation,' and when an oxide is deprived of its oxygen and reduced to a metal the process is said to be a 'reduction.' Iron is 'reduced' from its ores, which are usually oxides. Oxidation and reduction are therefore opposite actions in chemistry, the first adding something to a substance and the second taking something away. At first the terms were used in connection with oxygen alone, but are now applied to adding or taking away anything. In metallurgy oxidation and reduction are all-important, for everything that is reduced goes with the metals, and everything that is oxidized passes away with the impurities. In the example cited where melted lead was oxidized, the oxide separated itself from the metal just as fast as formed, floating upon the top of it, and when the reduction with charcoal was effected, the lead separated itself from the mass and dropped down into the bottom of the furnace as fast as it was reduced. This latter was then a metallurgical operation.

Combustion. — Combustion is a form of oxidation, in which a 'combustible' is chemically united with oxygen, and, as we know, this combustion, or burning, is our chief means of obtaining heat. When there is just the right amount of both oxygen and combustible to enter into combination, we have 'perfect combustion,' but if the compound is formed and there is either oxygen or combustible left over, we have 'incomplete combustion.' Incomplete combustion always means waste of heat. Thus, we know that too much air passed through a fire-bed will carry waste heat up the chimney, or if we have too little oxygen and carry a

combustible gas up the chimney, or leave unburned fuel on the grate, we again waste heat.

THERMO-CHEMISTRY

Chemical Energy. — If two or more substances combine and produce heat, they have chemical energy, and they transform this chemical energy into heat energy, which can be transformed in turn into other forms and into work. Not all chemical actions produce heat, but some are accompanied by a consumption of heat, and therefore use up energy, or rather, they transform energy into chemical work. But the heat energy so transformed into chemical work is not lost, for we can get it back again by reversing the action. For instance, if lead oxide be reduced, a consumption of heat occurs, and the same amount of heat will be produced if we burn the lead and produce the oxide again. So it is in every case: the heat produced by the formation of a compound is the same in amount as the heat consumed when the compound is broken up, and the heat produced by any chemical reaction is the same in amount as that consumed when the action is reversed. The science that treats of the heat changes accompanying chemical changes is called 'thermo-chemistry.' As a general thing syntheses and oxidations are accompanied by a production of heat, while decompositions and reductions are accompanied by an absorption of heat. Thermo-chemistry is very important in metallurgy because metallurgy is chemistry carried on at high temperatures, and the metallurgist must know how much heat is required for all his reactions, and by what reactions he may obtain it.

Maximum Affinity. — If iron is heated in air the oxide of iron is formed, and if this be mixed with powdered aluminum and the action started with a fuse, the aluminum will rob the iron of its oxygen and unite with it instead. The reason for this is that aluminum has a greater affinity for oxygen than iron has. This process of selection is a common one in chemistry and any substance will decompose a compound provided it can form a new compound with greater chemical affinities. Likewise, if we have a limited amount of a substance in the presence of two others, it will combine with the one for which it has the greatest affinity to the exclusion of the other. For example, if we have liquid iron

and aluminum in the presence of oxygen, none of the iron will be oxidized until all the aluminum has been oxidized.

Net Heat of Chemical Reactions. — When iron oxide is formed, 195,600 units of heat are evolved; when aluminum oxide is formed, 392,600 units of heat are evolved. Therefore, when aluminum decomposes iron oxide and forms aluminum oxide instead, the net heat effect of the reaction is to evolve $(392,600 - 195,600 =)$ 197,000 units of heat. But suppose a reaction occurs in which the decomposition brought about consumes more heat than the compound formed produces? For example, if iron oxide is attacked by carbon and deprived of its oxygen there will be a net loss of heat, instead of a gain, because carbonic oxide generates only 29,160 heat units in its formation, while 195,600 heat units are consumed in the decomposition of iron oxide. Such a reaction would not go on unless we constantly supplied heat to the bodies. This is important in metallurgy because it means that when we smelt iron oxide with coke (carbon) we cannot reduce the iron unless we continually heat the bodies. In the case where aluminum reduced the iron it was only necessary to start the reaction, but with carbon smelting it is not only necessary to start the action with heat, but also to continually supply the $(195,600 - 29,160 =)$ 166,440 units of heat that are absorbed.

Temperatures. — Temperature is the degree of heat. There are two scales by which it is commonly measured, known respectively as the Fahrenheit and the Centigrade scale. In both of these the freezing and boiling points of water are taken as the standards. In the Fahrenheit scale, 32° is the freezing point of water, and 212° is the boiling point. Each degree is therefore $\frac{1}{180}$ of this interval. In the Centigrade scale 0° is the freezing point and 100° is the boiling point of water. Each degree is therefore $\frac{1}{100}$ of this interval. One degree Centigrade equals $1\frac{1}{9}^{\circ}$ Fahrenheit. A table of comparison is shown in Table XXXIV, page 487.

Heat Units. — The amount of heat in a body is different from its temperature; it takes much more heat to raise a pound of water to 200° F. than it does to raise a pound of iron, and more to raise iron than copper, lead or gold. There are two standards by which amounts of heat are measured: A British Thermal Unit (known as B. T. U.) is the amount of heat required to raise one pound of water one degree Fahrenheit; a calorie is the amount

of heat required to raise one gram of water one degree Centigrade. In both cases the water must start at its maximum density, which is at 39.1° F. ($=4^{\circ}$ C.). One B. T. U. equals 252 calories.¹ In this book I shall generally use calories, as that is the ordinary system in scientific work. One Calorie = 1,000 calories.

Summary. — We have now learned that metallurgy is chemistry at high temperatures, and that when iron is reduced from its ores, we must decompose the ores, which consumes a great deal of heat. We have also learned how heat is obtained from chemical reactions, and chiefly from combustion. We have learned that oxygen forms oxides with many of the elements, and that some of the elements have a greater affinity for oxygen than others, so that they will keep, or even take, the oxygen away from them. Lastly we have learned that any reduced substances will join with the metal in our furnaces, and any oxidized ones will join with the impurities, and that the reduced substances will not ordinarily mix with the oxidized ones.

CHEMICAL EQUATIONS

Combining Weights. — When metals unite in compounds they always do so in certain definite proportions. The compound of oxygen and iron contains 16 parts of oxygen and 56 of iron; that of oxygen and calcium, 16 parts of oxygen and 40 of calcium; that of iron and sulphur, 56 parts of iron and 32 of sulphur; that of calcium and sulphur, 40 parts of calcium and 32 of sulphur. These characteristic combining weights are known as 'atomic weights' for a reason that will be evident shortly. A list of about one-half of the known elements with their atomic weights is given in the table on the next page, those which are of the least importance in metallurgy of iron and steel being omitted, and those which are of greatest importance being printed in small capitals.

The Atomic Theory. — The atomic theory supposes that all of the elements are made up of a myriad of tiny particles called atoms. The atoms are the smallest particles of matter that can exist; too small to be even conceived of by the imagination, and yet all having a definite size and weight and incapable of being divided into finer particles. All the atoms in any one element are alike in composition, size, and weight, but differ in these three properties from the atoms of all of the other elements. When two or

¹ See page 171. One pound avoirdupois = 453.59 grams; one ounce avoirdupois = 28.3495 grams.

TABLE XXXIII

ALUMINUM.....	Al	27	MAGNESIUM.....	Mg	24
Antimony.....	Sb	120	MANGANESE.....	Mn	55
Arsenic.....	As	75	Molybdenum.....	Mo	96
Barium.....	Ba	137.4	NICKEL.....	Ni	59
Bismuth.....	Bi	208	Nitrogen.....	N	14
Boron.....	B	11	OXYGEN.....	O	16
CALCIUM.....	Ca	40	PHOSPHORUS.....	P	31
CARBON.....	C	12	Potassium.....	K	39
Chlorine.....	Cl	35.5	SILICON.....	Si	28.4
CHROMIUM.....	Cr	52	Silver.....	Ag	108
Cobalt.....	Co	59	Sodium.....	Na	23
Copper.....	Cu	63.6	SULPHUR.....	S	32
Fluorine.....	F	19	Tin.....	Sn	118.5
Gold.....	Au	197	Titanium.....	Ti	48
HYDROGEN.....	H	1	TUNGSTEN.....	Wo	184
Iodine.....	I	127	VANADIUM.....	V	51
IRON.....	Fe	56	Zinc.....	Zn	65.4
Lead.....	Pb	207			

These combining weights are used in the laboratories of chemical analysis, in calculating furnace burdens and similar work. A list should be kept for convenient reference.

more elements combine chemically the atoms of one are locked with bonds of chemical affinity to the atoms of the others, and thus the weights of each element entering the compound is in proportion to the weight of its atoms.

Chemical Symbols. — In writing the elements it is customary to represent each by one or two initial letters, instead of writing the name out in full. This is a sort of shorthand of chemistry. The representative letters are taken from the Latin name of the elements, and the same symbols are employed in every civilized country of the world. The symbol for iron is Fe, because the Latin name for iron is *ferrum*. That for aluminum is Al; for calcium, Ca; for carbon, C; for hydrogen, H; for magnesium, Mg; for manganese, Mn; for oxygen, O; for phosphorus, P; for silicon, Si; and for sulphur, S. These eleven symbols should be learned, as they will be used frequently in the body of the work. Others are shown in Table XXXIII.

Multiple Proportions of Atomic Weights. — It does not require much thought to see that atoms may combine in more than one way. For instance, one atom of carbon may combine with one atom of oxygen, and again one atom of carbon may combine with two atoms of oxygen. In the first compound there will be 12 weights of carbon and 16 of oxygen; in the second, 12 weights of carbon and 32 of oxygen. Likewise, one atom of iron may com-

bine with one atom of oxygen, or two atoms of iron may combine with three atoms of oxygen. Each of these compounds will have different properties. It is possible to represent these compounds in a very simple way by using the symbols for the elements, for each symbol designates one atom of the element. To represent the first compound of carbon and oxygen we write their symbolic letters together — thus, CO. To represent the compound containing one atom of carbon and two of oxygen we write, COO, or, CO₂. To represent the first iron oxide we write — FeO. To represent the second one, Fe₂O₃. Then the formulæ for these compounds tell us not only what elements make up the compound, but also how much of each is present. For example, in the first iron oxide we have 56 parts of iron and 16 parts of oxygen; in the second we have 112 parts of iron and 48 of oxygen.

Molecules. — When two or more atoms are held together by chemical affinity the particle formed is known as a molecule. The symbol, CO, represents a molecule of carbonic oxide; Fe₂O₃ represents a molecule of iron oxide.

Chemical Equations. — Chemical shorthand may be used to represent chemical reactions, and will indicate at a glance what is taking place. A synthesis will be shown as follows:

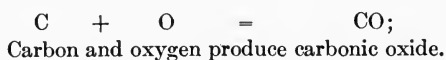

The decomposition of water would be written:

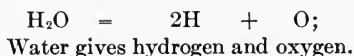

The reduction of iron oxide by carbon:

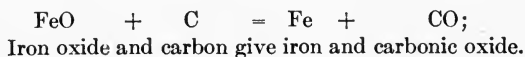

The reduction of iron oxide by aluminum:

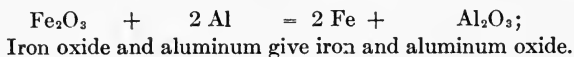

Indestructibility of Matter. — In the equations written above it will be noticed that there are always as many atoms of each element on the left-hand side of the equation mark as on the right. This is in accordance with the fundamental law of chemistry that matter can neither be destroyed nor created. If we combine car-

bon with oxygen the weight of carbonic oxide formed is exactly equal to the weight of carbon and oxygen together. Also, if we decompose water the total weight of hydrogen and oxygen will be equal to the weight of water from which it came.

HYDROGEN

Occurrence. — Hydrogen forms 11 per cent. of water, which is a compound of hydrogen and oxygen, whose molecules contain two atoms of hydrogen and one of oxygen, so that they have the formula, H_2O . Hydrogen also occurs in all living forms.

Properties. — Hydrogen is a colorless, tasteless, odorless gas, and the lightest substance known, so that it would be very useful for filling balloons except for its cost. It has a high chemical affinity for oxygen and a stream of it when ignited will burn readily in the air and produce water vapor with the evolution of 58,060 calories:

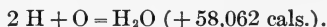

It is therefore a good combustible, and an impure form of it is indeed one of our important fuel gases, going under the name of 'water gas.' It is also a good 'reducing agent'; that is, it will reduce substances by taking their oxygen away.

Hydrocarbons. — Hydrogen has a strong affinity for carbon, and forms with it a long series of compounds known as 'hydrocarbons,' of which there are about two hundred different combinations. These form the basis of mineral oil, or petroleum, from which we get kerosene, gasoline, naphtha, benzene, lubricating oils, vaseline, paraffine, etc. The 'light hydrocarbons' are found in kerosene, gasoline, etc., while the 'heavy hydrocarbons' are found in the less volatile oils. Some of the more important compounds are as follows: Methane, whose molecule has the formula, CH_4 , is the chief constituent of natural gas; when it burns the following reaction takes place:—

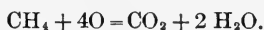

Ethylene, C_2H_4 , is a heavier hydrocarbon than methane because its molecule contains more atoms of carbon, while acetylene, C_2H_2 , is heavier still and is the most powerful illuminating gas known. Benzene, C_6H_6 , has the same relation between the atoms of hydrogen and carbon as acetylene, but a different number of

them in the molecule, so that it is an entirely different substance with different properties.

Thermo-chemistry of the Hydrocarbons. — When methane burns we get the following reaction:—

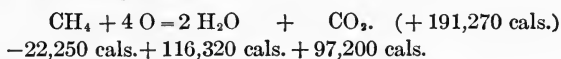

If we put the heat of combination under each of the compounds then we can readily calculate the net heat produced or consumed by the reaction, because all the compounds on the left of the equation mark are decomposed and all those on the right are formed. Therefore the sum of the heats on the left is to be compared with the sum of the heats on the right. If the right-hand sum is greater, heat is produced; if the left-hand sum is greater, heat is destroyed. In the burning of methane 191,270 calories are produced and we therefore place (+191,270 cal.) at the end of the equation.

Let us now consider for comparison the reduction of tin oxide by carbonic oxide, as follows:

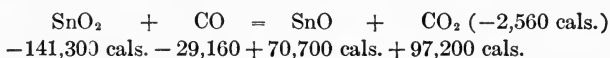

In this case we find that the sum on the left is greater, and 2,560 calories are consumed. We therefore place (-2,560 cal.) next to the equation.

Preparation of Hydrogen. — The cheapest method of obtaining hydrogen is by decomposing water. This may be done as follows:

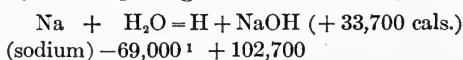

We see that this is a heat-producing reaction. Another way:

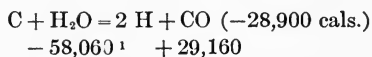

We do this by passing water vapor over red-hot carbon, but the reaction consumes heat so we must frequently heat the carbon or the reaction will not go on.

Still another way is to pass an electric current through a body of water. Hydrogen gas appears at one electric connection and oxygen gas at the other. This process is known as the 'electrolysis' of water, and it is an operation in 'electro-chemistry.' If

¹ The heat of formation of water is 69,000 cal. in liquid form and 58,060 in gaseous form. For other heats of reactions, see page 124, No. 53, page 125.

it is carried out perfectly the amount of electric energy passed into the water will be equal to the amount of heat energy required for the decomposition, — that is, 69,000¹ calories.

Summary. — Now we have learned that each element is constituted of infinitesimal particles called atoms which are all identical in weight and composition, and that when elements form compounds the atoms of one are joined to those of the other by bonds of chemical affinity. We have also learned that the atoms of elements are represented by letter symbols, and that we can express reactions between them by putting the symbols together in molecules and then showing how they break up and change places to form other molecules, and that there are no atoms and no weight lost or gained in any of these changes, but there is a gain or loss in heat energy to correspond exactly with each loss or gain of chemical energy. And we have seen how the loss or gain of heat may be determined by reckoning the total heat of compounds decomposed as heat lost, and the total heat of compounds formed as heat produced. From this point we shall go on to consider the important elements more in detail as to their chemical behavior.

ELEMENTS, COMPOUNDS, AND RADICALS

Metallic and Non-metallic Elements. — All the metals are elements, but some of the elements are not metals; for instance, we know without being told that oxygen is not a metal. The distinction between metallic and non-metallic elements is not very clear. It once was considered that all elements which looked like metals should be classified as such; they were said to have 'metallic luster.' And all others were classified as non-metals. But this classification has been shown to be deceiving, and a chemical one has taken its place: Now all the elements that form 'bases' are classified as metals, and all those that form 'acids' are classified as non-metals.

Acids and Bases. — Acids are generally sharp to the taste and have certain other characteristic chemical properties of which one of the most distinctive is their ability to turn litmus a red color. Bases have certain other characteristic properties of which one of the most distinctive is their ability to turn litmus a blue color.

¹ See footnote, page 470.

Acids will destroy the characteristic properties of bases and neutralize them, and conversely, bases will neutralize acids. Acids and bases have strong affinity for each other and either one will attack the other if opportunity offers. That is why a basic slag will attack an acid furnace lining, or an acid slag will attack a basic lining. Metallurgical acids are 'anhydrous' (water-free).

Salts. — When an acid and a base just neutralize each other they form what is known as a salt. Let us dissolve 36.5 grains of hydrochloric acid, HCl, in water, and put a piece of paper soaked in litmus in it; the paper will at once turn a brilliant red. Now let us dissolve 40 grains of caustic soda, NaOH, in another vessel. Caustic soda is a strong base; if we put one end of our piece of red litmus paper in the solution it will turn blue. Now let us pour the acid solution into the basic solution, and we will get the following reaction:—

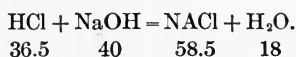

Now, 36.5 is the molecular weight of HCl (because one atom of hydrogen weighs 1, and one of chlorine weighs 35.5), and 40 is the molecular weight of NaOH (one atom of Na=23; one of O=16, and one of H=1); therefore there must be as many molecules of HCl present as of NaOH, and a complete neutralization will occur. Moreover it will be seen that the total weight of atoms at the right of the equation mark is the same as that at the left. This neutralization forms 'sodium chloride,' which is our common table salt. The salt will be dissolved in the water used in the experiment. If now we put in this salt solution the piece of litmus paper, one end of which is red and the other blue, it will not change its colors at all.

Radicals. — Let us consider the neutralization of caustic soda by sulphuric acid, H₂SO₄:

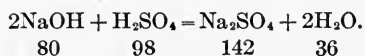

In this reaction the SO₄ has changed places with the OH. When two or more atoms are joined together and travel around in company in this way, acting as if they were inseparable, they are called 'radicals.' In this reaction, the SO₄ is called an 'acid radical,' and the OH is called the 'hydroxide radical.' For the time being these radicals act as if they were elementary substances.

Valence. — Let us consider four compounds with hydrogen, as follows:

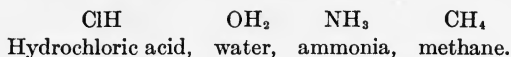

One atom of hydrogen can hold one of chlorine, but it takes two to hold one atom of oxygen, three to hold one of nitrogen, and four to hold one of carbon. Conversely, one of chlorine can hold one of hydrogen, one of oxygen can hold two of hydrogen, one of nitrogen, three, and one of carbon, four. This capacity for holding numbers of atoms is called 'valence.' In the compounds shown above, chlorine is uni-valent, oxygen is bi-valent, nitrogen, tri-valent, and carbon, quadri-valent. In each case hydrogen is uni-valent; indeed hydrogen is established as the standard of valency, with a holding power of one. We can determine the valence of other elements by learning how many atoms of hydrogen they will hold, or, if they do not form a compound with hydrogen, we can compare them with some other element that does. For example, calcium forms a very common oxide, CaO, known as lime. In lime calcium holds one atom of oxygen; but it takes two atoms of hydrogen to hold one atom of oxygen; therefore calcium is bi-valent.

Chemical Stability. — We have already seen enough compounds to know that the valence of several of the elements is not a constant quantity. For example, carbon and hydrogen atoms unite in nearly two hundred different combinations. Likewise, iron forms FeO and Fe₂O₃. In the first it has a valence of two; in the second, of three. But there is a difference in the stability of these compounds; the oxide, FeO, can only exist under strong reducing conditions, and will take on more oxygen with the least opportunity. Iron forms two sulphides, designated as FeS and FeS₂. In the second compound it has a valence of four, but this sulphide is not as strong a one as the other, and the second atom of sulphur may be driven off by heating it slightly: FeS₂ = FeS + S.

Ferrous and Ferric Compounds. — The oxide, FeO, is called 'ferrous oxide'; while FeS is called 'ferrous sulphide.' The oxide, Fe₂O₃, is called 'ferric oxide,' while FeS₂ is called 'ferric sulphide.' Manganese forms two oxides: MnO is called 'manganous oxide,' and MnO₂ is called 'manganic oxide.' So with all compounds; that having the lower valence is given the suffix -ous, and that with the higher valence, -ic.

Mono-, Bi-, Tri-, etc. — FeS is also called 'iron mono-sulphide,' from the Latin, meaning one; FeS₂ is sometimes called 'iron bi-sulphide.' MnO is called 'manganese monoxide,' and MnO₂, 'manganese bi-oxide' (di-oxide is sometimes used instead of bi-oxide). H₂O is 'hydrogen monoxide'; H₂O₂ is 'hydrogen di-oxide.' Fe₂O₃ is called 'iron sesqui-oxide,' from the Latin meaning three halves.

Sub- and Per-. — When an element has a very low valence it is given the prefix 'sub-,' and when it has an unusually high valence it has the prefix 'per-.' For example, Fe₂O (if such a compound were capable of forming) would be called 'iron sub-oxide'; while FeO₂ (if possible) would be called 'iron peroxide.' H₂O₂ is often known as 'hydrogen per-oxide.' In the same way we may have sub-sulphides (Fe₇S₈ is called 'iron sub-sulphide'), sub-carbides, etc.

Oxidizing Agents. — When additional atoms are put in the molecules of a compound it is said to be oxidized. For example, FeO will be oxidized to Fe₂O₃ (2 FeO + O = Fe₂O₃); FeS will be oxidized to FeS₂. Oxidation can only be produced by means of some 'oxidizing agent.' The commonest oxidizing agent in metallurgy is the oxygen of the air, and the next most important in iron and steel processes is Fe₂O₃, and slags very rich in Fe₂O₃:

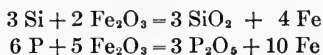

Another important one is carbon di-oxide:

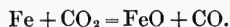

Reducing Agents. — When atoms are taken out of the molecule of a compound it is said to be reduced. Reduction can only go on in the presence of some 'reducing agent.' The commonest reducing agent in metallurgy is carbon in the form of coke, charcoal, etc.

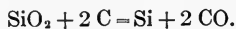

Another one is carbon monoxide, and another is hydrogen:

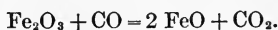

Manganese is also a reducing agent for iron:

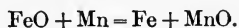

CHEMICAL REACTIONS AND COMPOUNDS

Organic and Inorganic Chemistry. — The chemistry of living organisms, such as plants, animals, etc., is a very complex subject, and quite distinct from inorganic chemistry. Because carbon enters into all organisms we may describe organic chemistry as the chemistry of the carbon compounds. Inorganic chemistry is the chemistry of the metals and of compounds in which carbon enters in relatively small proportions. Inorganic chemistry is the only one that concerns metallurgists especially.

Wet and Dry Chemistry. — In the analytical laboratories they perform their chemical reactions by dissolving everything in water and so getting them in the liquid form, because solids do not unite with each other rapidly, and gases are not easily controlled. This branch of chemistry is known as 'wet chemistry.' In iron and steel metallurgy, however, we get everything in liquid form by melting it. This is known as 'dry chemistry.' The reactions that take place in dry chemistry are the same in principle as those of wet chemistry. The chief difference is that we cause substances to react directly instead of dissolving them all in water.

Carbon. — Carbon occurs in the earth in the crystallized form as graphite and as diamonds. Of these the diamond is the purer variety, but both may be considered as pure carbon in different forms. The element may be obtained in a massive, or uncrystallized, form by burning organic matter, such as wood, when a black residue of carbon (charcoal) will be left. The most abundant occurrence of carbon is, however, in combination with other elements in the various forms of living matter, and also in inorganic compounds with metals, known as carbonates, such as the carbonate of lime, CaCO_3 , called limestone, or, when in the crystallized form, marble.

When bituminous coal is burned in a smothered sort of way, that is, in the absence of much air, a silvery-gray residue is left which is an impure form of carbon, called coke. Crystals of graphite often are present on the surface of coke. This coke is one of the most important of all metallurgical reducing agents, as well as fuels. Carbon also forms a number of hydrocarbons which are used in the form of gases as reducing agents and fuels, because both their carbon and hydrogen will unite with oxygen.

Carbon forms two oxides, — CO and CO₂. The first combination is accompanied with the production of 29,160 calories, and the second, 97,200 calories. The formation of CO is not complete combustion, because it will itself be further oxidized: CO + O = CO₂, with the evolution of 68,040 calories. The heat of formation of C + O together with that of CO + O is just equal to that of the reaction:

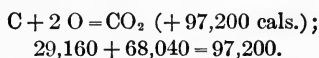

Carbon di-oxide, CO₂, is an acid radical and unites with many bases to form 'carbonates,' of which the commonest are those of calcium, CaCO₃, magnesium, MgCO₃, and sodium, Na₂CO₃. As CO₂ is very volatile, the carbonates may be decomposed by heat, which drives the CO₂ off as a gas:



Chemical Behavior of Iron. — Iron is attacked by many of the wet acids, — sulphuric, nitric, hydrochloric, acetic, etc. When heated it is attacked by oxygen, and also when cold provided the air is damp. At a red heat, iron decomposes water vapor (2 Fe + 3 H₂O = Fe₂O₃ + 6 H). It has a high affinity for oxygen, and also for small amounts of carbon, silicon, sulphur, phosphorus and hydrogen. The last-named gas will penetrate solid iron very readily at a red heat and form a compound with it. Iron practically never occurs in the earth except combined with oxygen or some other elements.

Chemical Behavior of Silicon. — Silicon has a high affinity for oxygen, with which it forms a very common oxide, SiO₂, which is known as silica. This compound is decomposed with great difficulty; the following reaction takes place only when we get to the very high temperature in the hearth of the iron blast furnace:

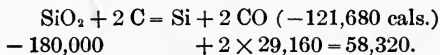

We must remember the difference between silicon and its oxide, silica. Silicon never occurs uncombined in the earth, but silica is the most abundant constituent known to us. Quartz is a crystallized form of pure silica, while flint, jasper, agate, etc., are uncrystallized forms. Opal is silica combined with water.

Silicates. — Silica is the great acid of dry chemistry, and when in the melted condition will neutralize every base with which it comes in contact, forming a series of salts known as 'silicates.' The great bulk of the earth's rocks are either pure silica or silicates of the different metals, and all metallurgical slags are silicates. The mono-silicate of iron has the formula, — Fe_2SiO_4 . But it is more commonly written, — $(\text{FeO})_2\text{SiO}_2$, which is the same as $\text{Fe}_2\text{O}_2\text{SiO}_2$. The series of commonest iron silicates are given below:

- $\text{FeO}\cdot\text{SiO}_2$ Sub-silicate.
- $(\text{FeO})_2\text{SiO}_2$ Mono-silicate.
- $(\text{FeO})_2(\text{SiO}_2)_2$ Sesqui-silicate.
- $\text{FeO}(\text{SiO}_2)_2$ Bi-silicate.
- $\text{FeO}(\text{SiO}_2)_3$ Tri-silicate.

With lime, CaO , and magnesia, MgO , a similar series is formed, but the silicates of alumina, Al_2O_3 , are more complicated in composition. The different metallic silicates have the property of dissolving in each other when melted, and of dissolving the oxides of metals, and various other oxidized substances, but not of dissolving metals or reduced substances.

Feldspar. — With potassium and aluminum silica forms a series of silicates known as the feldspars, which are common constituents of the earth's crust. The feldspars are chiefly important because when reduced to powdered form they become clay, which has the peculiar property of becoming plastic when moistened. The purer clays melt at a very high temperature and are therefore used as the bond to hold together the material for the linings of furnaces, but the clays that contain much potassium or sodium melt relatively easily, and are not so 'refractory.' Clays contain a certain amount of water of crystallization, that is, water chemically combined with the molecule of the silicates. If they are heated so hot that this water of crystallization is driven out of them, they will not again become plastic.

Chemical Behavior of Aluminum. — Aluminum has great affinity for oxygen and is therefore used, like silicon, for the purpose of de-oxidizing steel:

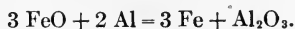

Indeed aluminum retains its oxygen more tenaciously than silicon, and even the highest temperature of our fuel furnaces does not

effect its reduction. The oxide of aluminum, Al_2O_3 , called alumina, is a common constituent of rocks, and when nearly pure is used as an ore of the metal, its reduction being effected in electric furnaces. Alumina is very refractory, that is, it will stand a high temperature without melting, and is neutral in character, that is, it is attacked neither by acid nor basic slags. It is therefore used as a neutral lining for some furnaces. Alumina is also useful in blast-furnace slags; in acid slags it acts as a base, and in basic slags as an acid, rendering the slags more fluid.

Chemical Behavior of Manganese. — Manganese has a higher affinity for both oxygen and sulphur than iron has, and is therefore used as a de-oxidizer and de-sulphurizer of iron and steel. If sufficient manganese is present, and the metal bath kept liquid a sufficient time, neither oxygen nor sulphur will be found combined with iron:

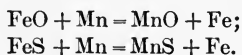

Chemical Behavior of Sulphur. — Sulphur is found in the earth native (that is, free from combination), especially in volcanic regions, and also combined with metals as sulphides. Iron bisulphide, called 'iron pyrites,' FeS_2 , is very abundant and is the chief source of sulphuric acid manufacture, while the sulphides of copper, lead, and zinc are the principal commercial ores of those metals. Iron sulphides are not used so much as ores on account of the expense of ridding the iron of sulphur, which is very harmful to it. Sulphur readily combines with oxygen at a slightly elevated temperature to form SO_2 and SO_3 , and these combine with water to form sulphurous and sulphuric acids ($\text{H}_2\text{O} + \text{SO}_2 = \text{H}_2\text{SO}_3$; and $\text{H}_2\text{O} + \text{SO}_3 = \text{H}_2\text{SO}_4$). In wet chemistry sulphuric acid attacks metals to form sulphates:

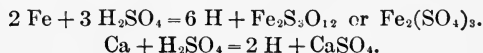

Phosphorus. — Phosphorus occurs in nature usually as metallic phosphates, and chiefly as phosphate of lime, $\text{Ca}_2(\text{PO}_4)_2$, a natural mineral to which the name of apatite is given. It is in this form that it ordinarily gets into the blast furnace with the iron ores which it accompanies in the earth. Phosphate is necessary to animal and vegetable life and a good part of bones and living

organisms are composed of it. The phosphates that will dissolve easily are therefore valuable fertilizers. Consequently certain slags which are used to remove the phosphorus from steel can be sold for fertilizing purposes.

Phosphorus acts the part of an acid-forming element, and the phosphate radical will form salts with many metallic oxides, but especially with iron oxides, magnesium oxide and lime, for the latter of which it has great affinity. But it is a weaker acid than silica, and silica will drive the phosphate radical away from all the basic radicals until the silica has completely satisfied itself. For this reason phosphorus cannot be combined in slags unless there is a superfluity of bases present over the amount necessary to practically surfeit the silica. In our iron slags this means usually at least 40 per cent. of lime plus magnesia plus iron oxide.

Calcium and Magnesium. — Calcium forms a very common oxide, CaO , known as lime, and magnesia forms a similar one, MgO , called magnesia. These occur in nature chiefly combined with carbonic acid to form carbonates; CaCO_3 is called limestone, and MgCO_3 , magnesite. The two carbonates often occur combined together in a compound having the formula, — $(\text{Ca.Mg})\text{CO}_3$. This type of formula is used to indicate that the calcium and magnesium replace each other in the carbonate in almost any relative proportion. The natural rock, $(\text{Ca.Mg})\text{CO}_3$ has the mineralogical name of 'dolomite.'

Limestone is used as a material to add to the charge of the iron blast furnace because the carbonic acid is driven off in the upper levels of the furnace as soon as it begins to become hot ($\text{CaCO}_3 + \text{heat} = \text{CaO} + \text{CO}_2$) and the lime so produced serves as a base in the blast-furnace slag. Burnt limestone, that is, limestone from which the carbonic acid has been driven off by heat, is also added to the slags made in some of the steel furnaces, in order to increase their basicity. Lime has the peculiarity of absorbing moisture from the air and forming a hydrate [$\text{CaO} + \text{H}_2\text{O} = \text{Ca}(\text{OH})_2$]. This is known as 'slacking,' and it causes the lime to lose its coherence. For this reason furnace linings cannot be made of it.

Magnesia is made by burning magnesite ($\text{MgCO}_3 + \text{heat} = \text{MgO} + \text{CO}_2$), and this is much used for making the basic linings of furnaces. Burnt dolomite is used for patching basic furnace linings, but it is not as durable as magnesia for the original lining.

CHEMICAL SOLUTIONS

Chemical Compounds, Mechanical Mixtures, and Chemical Solutions. — We have learned that the differences between mechanical mixtures and chemical compounds are: (1) The properties of compounds are different from those of its components; (2) the formation of a compound is attended with the production of heat; (3) the components of a compound are held together with bonds of chemical affinity, and (4) the components always form the compound in the same definite proportions. There is another class of combinations different from both compounds and mixtures, and known as solutions. These have some of the characteristics of compounds and also of mixtures. (1) The properties of a solution are different from those of its components, but not to as marked a degree as is the case with compounds; (2) its formation is attended with the production or consumption of heat; (3) the components of the solution are held together by bonds of chemical affinity, and can only be separated by chemical means, or by electricity, but (4) unlike compounds, and to a limited degree like mixtures, the components of a solution may vary widely in proportions. In some cases the variation is infinite, as with melted gold and silver, which will dissolve in each other in any proportion; likewise, with melted copper and silver. In other cases the limit of solubility is very narrow, as in the case of melted iron, which will dissolve only about 5 per cent. of carbon, while carbon will dissolve apparently only 1 per cent. or so of iron.

Just as some substances resist all our efforts to make them combine chemically, so others refuse to dissolve. For instance, several salts and liquids will not dissolve in water, the best solvent known, or rather, dissolve to such a slight degree that, for practical purposes, it may be neglected. The same is true of iron and mercury, melted lead, and zinc, etc.

Essence of Solubility. — Just what the nature of the state of solution is cannot be told at present, but the atoms, or molecules, of the dissolved substance, known as the 'solute,' seem to be held by the molecules of the solvent. One striking difference existing between a solution and a mixture is that the solute seems to occupy no space. If we mix with hot water one-quarter of its

weight of table salt, the level of the water will rise in the containing vessel an amount equivalent to the bulk of the salt, but, as soon as the water dissolves the salt, it will fall back to its original volume. In short, we now have a quarter more weight of material in the same bulk, so that the specific weight of the mass increases 25 per cent. In several ways which we have not space here to discuss we can know of the presence of a greater number of molecules than ordinary in the same space when two or more substances are dissolved in each other; for instance, 'osmotic pressure,' surface tension. Metals dissolved in each other are heavier than the same bulk of any of the metals alone.

Precipitation. — If we dissolve 27 per cent. of table salt in hot water and then allow the water to cool, some of the salt will fall out of solution again and crystallize. This action is called 'precipitation.' It is one of the most important actions in chemistry. We may cause a precipitation by another means: If we have as much of any salt dissolved in water as it will take, and then add to the solution a more soluble one, the water will dissolve the new salt and precipitate the old one in corresponding amount. The same applies in metallic solutions: If we have 5 per cent. of carbon dissolved in iron and then add some metallic silicon, the iron will precipitate graphite in flakes of 'kish,' and dissolve silicon. The commonest method of precipitating elements in wet chemistry is by producing chemical change: Suppose we have some table salt (NaCl) dissolved in water and add just enough silver nitrate (AgNO₃) to react with it; we form silver chloride which is insoluble, and which precipitates almost instantaneously:



This is only a partial precipitation, because sodium nitrate is still left in solution, but is often of great service.

Solubility and Temperature. — As a general thing the higher the temperature the greater amount of solute can be dissolved in any given solvent. This rule is not universal, but usually applies in practical metallurgical chemistry. Five per cent., or even more, carbon will dissolve in iron at a high temperature, but some of this precipitates as the metal cools near its solidification temperature.

Alloys. — Metallic alloys are dependent upon solution for their formation. Two metals which will not dissolve cannot be made

to form alloys, and, in practice, all alloys are made by dissolving melted metals in each other. The only exception is certain alloys made by dissolving solid metals in each other under great pressure.

Nature of Slags. — Slags are molten solutions, and as a general rule, they will dissolve all the oxidized substances with which they come in contact in the furnace (except of course the furnace lining itself), and will precipitate all the reduced substances. For example, metals will be precipitated as fast as reduced from their combinations in the ores: phosphorus, if oxidized by being combined with some base as a phosphate, will be dissolved, but, if silica takes the base away from it, the reduced phosphorus will be precipitated again.

SOME PRINCIPLES OF PHYSICS

Dalton and Gay Lussac Law. — When elements or compounds are in the gaseous form they all expand and contract at the same rate. In brief, every gas expands $\frac{1}{273}$ of its volume for every degree Centigrade that the temperature is increased, and $\frac{1}{491.4}$ for every degree Fahrenheit. Air or steam at 273° C. (491° F.) has twice the volume of the same weight of air or steam at 0° C. (32° F.). The amount of increase or decrease in volume can be calculated by multiplying its volume at 0° C. by the number of degrees increase or decrease in temperature and then dividing the product so obtained by 273, if Centigrade units are used, or by 491.4 if Fahrenheit.

Boyle's Law. — The volume of gases also increases or decreases in proportion to lessening or increasing the pressure. Ordinarily gases are under the atmospheric pressure, which is 15 pounds per square inch. If we increase the pressure upon them to 30 pounds, their volume becomes one-half; if we increase it to 45 pounds, it becomes one-third, etc.

Specific Gravity. — The specific gravity of bodies is the relative weights of a unit volume. For example, a cubic inch of iron weighs nearly 8 times as much as a cubic inch of ice, and a cubic inch of lead or platinum weighs more still. The specific gravity of solids and liquids are usually compared with water as a standard, and water at its temperature of maximum density — 4° C. (39.2° F.) — is given an arbitrary value of 1. Gases are usually com-

pared with air as a standard, and air at 0° C. (32° F.) and under a pressure of 760 millimeters of mercury (=practically 15 pounds per square inch) is given an arbitrary value of 1. (See page 27.)

Avogadro's Hypothesis. — Equal volumes of all gases contain the same number of molecules.¹ This is an important observation and leads us to another: that the specific gravities of gases bear the same relation to each other as their molecular weights. In other words, nitrogen is 14 times as heavy as hydrogen, and carbon monoxide, (CO) 14 times.

Heat. — The atoms and molecules of all bodies are never in a state of rest, even though the body itself appears to be quiet. It is this constant and violent motion of the molecules which we know under the name of heat. To raise the temperature of a substance increases the motion and *vice versa*. In the case of solids the vibration of each molecule is of course confined to a very small space indeed, but in the case of gases, the molecules travel until they strike against some other body with force enough to resist them, as, for instance, some other molecule, or the walls of the vessel in which they are contained, when they move with equal velocity in another direction. It is, in fact, the constant impact of molecules upon the walls of the containing vessel that causes gases to exert pressure. This explains why it takes twice as much pressure to confine the same weight of a gas into one-half the volume, because now the molecules have only one-half as far to travel between containing walls and therefore they strike them twice as often. It also explains why gases expand when their temperature is raised, provided the pressure under which they are confined remains constant, because if their motion is more rapid they exert greater pressure against the containing walls.

Conservation of Energy. — The law of conservation of energy tells us that energy can be neither created nor destroyed. We can convert chemical energy into heat, or heat into motion, but we cannot get energy out of anything into which we do not put an equivalent amount in some form or another. We may waste energy, such as energy lost in heat from friction which is useless to us, but it does not cease to exist.

¹ It being understood of course that the conditions of pressure and temperature are identical.

PHYSICAL PROPERTIES OF METALS

Tensile Strength. — The tensile strength of a body is its resistance to being pulled asunder. It is usually measured in pounds per square inch; that is to say, a bar of wrought iron for example, with one square inch cross-sectional area¹ will support about 50,000 pounds weight.

Stress and Strain. — A stress is a force put upon a body, and a strain is the deformation of the body produced by a stress. For instance, if a bar of wrought iron one square inch in cross-sectional area and 2 inches long be made to support a weight of 10,000 pounds, it will stretch about 0.0007 inch; the 10,000 weight is the stress, and the 0.0007 inch is the corresponding strain.

Elastic Limit. — In the case just mentioned, if the 10,000 weight be removed the strain will be removed. That is, the bar will return to its original length of 2 inches. Now if the same bar be loaded with 20,000 pounds it will stretch 0.0014 inch, and again this elongation will be lost when the weight is removed. If, however, we load the bar with 30,000, it will stretch a little more than 0.0021 inch, and now it will not return to its original 2-inch length when the weight is removed, but will be permanently elongated. It has taken a 'permanent set,' as it is called. The 'elastic limit' of a body is the force necessary to produce the first permanent set. It is usually measured in pounds per square inch. Another way of expressing the elastic limit is to say it is the force beyond which the strain is not proportional to the stress.

Modulus of Elasticity. — The modulus of elasticity tells of the resilience, or springiness, of a body, that is to say, how much it will yield under any stress up to the elastic limit. The modulus of elasticity is obtained by dividing any stress up to the elastic limit by the strain produced per inch of length. For example, the wrought iron mentioned in the last paragraph stretched 0.0014 inch in a length of 2 inches, = 0.0007 per inch of length, with a stress of 20,000 pounds per square inch; its modulus of elasticity will then be:

$$\frac{20,000}{0.0007} = 28,500,000.$$

¹ Say a round bar about 1½-inch diameter, or a square bar one inch on a side.

Percentage Elongation. — After a bar under tensile stress has passed its elastic limit it begins to be permanently elongated in the direction of the pull. A soft metal, like copper or mild steel, will stretch out somewhat like molasses candy before finally breaking, and may be almost twice as long as it was originally. The increase in length, divided by the original length, is the percentage elongation. It is usually measured on a length of two inches, or of eight inches.

Reduction of Area. — When a bar is elongated it of course shrinks in cross-section; finally, just before the bar breaks, it usually ‘necks down’ directly at the point on either side of the fracture. This type of fracture occurs with soft metals. The original area, minus the area of smallest cross-section after fracture is called the ‘reduction of area,’ and this divided by the original area is the ‘percentage reduction of area.’

Ductility. — The percentage elongation and the percentage reduction of area are usually taken together as the measure of the ductility of a metal.

Compressive Strength. — The compressive strength of a body is its resistance to crushing. It also is usually measured in pounds per square inch.¹ The terms ‘stress and strain,’ ‘elastic limit,’ and ‘modulus of elasticity’ all have the same meaning when referred to compressive as to tensile stresses.

Transverse Strength. — If a bar one inch square be supported on thin edges placed twelve inches apart its resistance to a force applied half way between the supports is called its ‘transverse strength.’ Here again we have the same terms, ‘stress and strain,’ etc.

Impact. — If a bar be supported on thin edges placed a certain distance apart and then a falling weight be allowed to strike upon it at a point midway between the supports, its resistance to this force will give an indication of its strength under impact, while the amount that it will bend before breaking will indicate its ductility under impact, or under ‘shock.’

Shearing Strength. — The resistance of a body to being cut in two by a pair of knife edges, is called its shearing strength. Rivets are sometimes tested in this way, because they are subjected to this kind of stress in service.

¹ In Great Britain they often use long tons (2,240 lbs.) per square inch, instead of pounds, both for tensile and compressive stresses.

Torsion. — The resistance of a bar to being twisted like a corkscrew is called its torsional strength. The number of twists it will endure before breaking gives an indication of its ductility under this stress.

Repeated Stress. — If a certain kind of stress be applied to a body, then relieved, applied again, and so on alternately, this class of test is called 'repeated stress.' A metal will break under many applications of a repeated stress much less in amount than that required to break it if constantly applied. It is to be understood, however, that the interval between the applications of the stress must be very short so the metal will have no opportunity to rest between applications.

Alternate Stresses. — If we place a body first under tension, then under compression, and so on alternately, it produces what is known as 'alternate stresses.' It is like in nature to bending a wire back and forth, and metals will break under alternate stress even less than their elastic limits under either tension or compression alone.

Toughness. — The toughness of a metal is its resistance to breaking after its elastic limit is passed. It is the direct opposite of brittleness.

Brittleness. — The brittleness of a metal is the ease with which it breaks after its elastic limit is exceeded. A very brittle steel will have an elastic limit exactly equal to its ultimate tensile or compressive strength; that is to say, it will take no permanent elongation or reduction of area; its ductility will be zero. Some metals are more brittle under shock than under constantly applied stress, and *vice versa*.

Malleability. — Malleability is the quality of being deformed under a hammer. Gold is the most malleable of metals and can be hammered into sheets of extreme thinness without cracking.

Resilience. — We have already described resilience under the head of modulus of elasticity. A very resilient metal, that is, one with a small modulus, would be unsuitable for a bridge even though strong, because its vibration under a moving load would be so great.

Hardness. — The hardness of a metal is its resistance to being scratched, or to wearing away under friction. In steel metallurgy hardness is often used to mean brittleness, but this is no longer

advisable, because we are now making hard steels that are also tough.

Allotropy. — Allotropy is the capacity that certain elements have of changing their properties without changing their composition or purity. For example, we may have pure carbon in the form of diamond, graphite or charcoal; we may have iron in a magnetic or non-magnetic condition; we may have sulphur in a brittle or in a pasty state, etc. What the nature of allotropy is we cannot at present tell. It may perhaps have to do with the relations of the different atoms in the molecules of the element. When elements form compounds the atoms of one are joined to the atoms of the others, and even when elements are in the pure state their atoms are often joined together to form molecules. Allotropy may be a difference in the number of atoms that are in each molecule, or perhaps in the form in which they are joined together. An allotropic change is always accompanied by a loss or gain of heat.

Crystallization. — The tendency of most elements and compounds to arrange themselves into regular forms called crystals is really a powerful force of Nature, and one of the most wonderful and charming studies imaginable. The crystalline forms of each particular substance are usually the same, or very similar, but different from almost all other substances. Each crystal is built up of smaller crystals, and these in turn of still smaller ones. The tendency to produce a regular form is well illustrated in the case of alum: If a piece of an alum crystal be broken off and the main part be immersed in a saturated alum solution, the crystal will slowly repair itself and renew the lost part until it is again perfect. Moreover, if the alum solution is impure, the crystal will take to itself only the pure salt, and leave the impurity.

TABLE XXXIV.—COMPARISON OF DEGREES CENTIGRADE AND FAHRENHEIT

Below zero		Above zero		Above zero		Equivalents	
C.	F.	C.	F.	C.	F.	C.	F.
-200°	= -328°	+ 525°	= + 977°	+ 1,250°	= 2,282°	1°	= 1.8
150	= 238	550	= 1,022	1,275	= 2,327	2	= 3.6
100	= 148	575	= 1,067	1,300	= 2,372	3	= 5.4
50	= 58	600	= 1,112	1,325	= 2,417	4	= 7.2
		625	= 1,157	1,350	= 2,462	5	= 9.0
		650	= 1,202	1,375	= 2,507	6	= 10.8
		675	= 1,247	1,400	= 2,552	7	= 12.6
		700	= 1,292	1,425	= 2,597	8	= 14.4
		725	= 1,337	1,450	= 2,642	9	= 16.2
		750	= 1,382	1,475	= 2,687	10	= 18.0
		775	= 1,427	1,500	= 2,732	11	= 19.8
		800	= 1,472	1,525	= 2,777	12	= 21.6
		825	= 1,517	1,550	= 2,822	13	= 23.4
		850	= 1,562	1,575	= 2,867	14	= 25.2
		875	= 1,627	1,600	= 2,912	15	= 27.0
		900	= 1,652	1,625	= 2,957	16	= 28.8
		925	= 1,697	1,650	= 3,002	17	= 30.6
		950	= 1,742	1,675	= 3,047	18	= 32.4
		1,000	= 1,832	1,700	= 3,092	19	= 34.2
		1,025	= 1,877	1,725	= 3,137	20	= 36.0
		1,050	= 1,922	1,750	= 3,182	21	= 37.8
		1,075	= 1,967	1,775	= 3,227	22	= 39.6
		1,100	= 2,012	1,800	= 3,272	23	= 41.4
		1,125	= 2,057	1,825	= 3,317	24	= 43.2
		1,150	= 2,102	1,850	= 3,362	25	= 45.0
		1,175	= 2,147	1,875	= 3,407		
		1,200	= 2,192	1,900	= 3,452		
		1,225	= 2,237	2,000	= 3,632		

INDEX TO AUTHORITIES CITED

- ALLING, GEORGE W., 395.
 AKERMAN, RICHARD, 125, 183.
 ATHA, HERBERT B., 245.
 AUSTEN. See ROBERTS-AUSTEN.
 ARNOLD, J. O., 9, 332.
- BACON, JOHN LORD, 395.
 BAGSHAW, WALTER, 457.
 BALE, GEO. R., 291.
 BAKHUIS-ROOZEBOOM, H. W., 312, 315.
 BAUERMAN, H., 93.
 BAUSCH, EDWARD, 457.
 BEHRENS, H., 457.
 BELL, SIR I. LOWTHIAN, 67, 73.
 BENEDICKS, CARL, 395.
 BLAIR, A. A., 8, 144.
 BORCHERS W., 447.
 BRINELL, J. A., 174.
 BROWNE, D. H., 420.
 BURGESS, C. F., 446, 447.
- CAMPBELL, H. H., 8, 117, 152, 155, 169, 326, 327.
 CAMPBELL, WILLIAM, 377, 457.
 CARPENTER, H. C. H., 412, 421.
 CARTAUD, C., 332.
 CASPERSSON, C. A., 183.
 CHARPY, G., 400.
 CHURCH, A. H., 436.
 COLBY, ALBERT LADD, 400, 420.
 COLBY, E. A., 442.
 CORT, HENRY, 57.
 CUSHMAN, ALLERTON S., 423, 436.
- DAELEN, R. M., 197.
 DEER, LOUIS, 457.
 DE MOZAY, 421.
- DORMAN, W. H., 94.
 DUMAS, L., 404, 420.
- FRITZ, JOHN, 195.
- GAGES, LEON, 73.
 GLEDHILL, J. M., 421.
 GOERENS, PAUL, 457.
 GUILLAUME, C. E., 400, 420.
 GUILLET, L., 404, 408, 420, 421.
- HAANEL, EUGENE, 447.
 HADFIELD, R. A., 330, 405, 413, 420.
 HAMBUECHEN, CARL, 447.
 HARBORD, F. W., 72.
 HEYN, E., 457.
 HOERHAGER, J., 421.
 HOWE, HENRY M., 8, 72, 86, 91, 125, 177, 178, 182, 183, 184, 310, 311, 335, 371, 375, 384, 385, 394, 420, 427, 436.
- JOHNSON, JR., J. E., 39, 174, 335.
 JÜPTNER, HANNS FREIHERR VON, 395.
- KEEP, WILLIAM J., 291, 347.
 KERSHAW, JOHN B. C., 447.
 KJELLIN, F. A., 442.
- LE CHATELIER, H., 447, 455, 457.
 LEDEBUR, A., 72.
 LEWKOWITSCH, 436.
 LILIENBERG, N., 184.
- McILHINEY, PARKER C., 245.
 McQUILLAN, W. S., 279.
 MELLOR, J. W., 395.
 METCALE, WILLIAM, 379, 380.

- MOLDENKE, RICHARD, 369.
MONELL, AMBROSE, 158.
MUELLER, FRIEDRICH C. G., 125.
MUSHET, ROBERT, 408.
- NICOLARDOT, P., 421.
NICOLSON, J. T., 421.
NOBLE, H., 73.
- OSMOND, F., 317, 330-2, 392, 453,
457.
- OVERMAN, FREDERICK, 94.
- PAVLOV, M. A., 93.
PERCY, JOHN, 73.
PHILLIPS, J. ARTHUR, 94.
PHILLIPS, W. B., 126.
PROCHASKA, ERNEST, 126.
- READ, A. A., 332.
RICHARDS, J. W., 122, 125, 136.
ROBERTS-AUSTEN, SIR WILLIAM, 312,
314-15.
ROE, JAMES P., 77.
ROOZEBOOM. See BAKHUIS-ROOZE-
BOOM.
ROSSI, A. J., 421.
RYLAND'S DIRECTORY, 8.
- SANITER, E. H., 149.
SAUVEUR, ALBERT, 320, 332, 371, 394,
395, 453, 455, 457.
SCHOLL, GEO. P., 447.
SCOTT, W. G., 355.
SMITH, J. KENT, 421.
SPELLER, F. N., 436.
STANSFIELD, ALFRED, 378, 379, 395.
STEAD, J. E., 182, 323, 332, 382,
457.
SWANK, JAMES M., 8, 10.
- TALBOT, BENJAMIN, 182, 184.
TAYLOR, FREDERICK W., 409.
TRURAN, W., 94.
TURNER, THOMAS, 93, 291, 338,
347.
- VATHAIRE, A. DE, 93.
- WATERHOUSE, G. B., 332, 402, 403,
404, 419.
WEBSTER, W. R., 326.
WEDDING, HERMANN, 72, 126.
WEST, THOMAS D., 291.
WHITE, MAUNSEL, 409.
WOODWORTH, JOSEPH V., 395.

INDEX

- Acetylene, 469.
- Acid, compared with basic Bessemer, 125.
 compared with basic steel, 59.
 distinguished from basic steel, 67.
 furnaces for steel castings, 286-92.
- Acids, definition of, 471-72.
 effect on corrosion, 423.
- Acid steel, oxygen in, 328.
 vs. basic furnaces for castings, 287.
- Adulterants in linseed oil, 432.
- After-blow in basic Bessemer, 123.
- Agate, 476.
- Air, amount of moisture in, 38.
 and moisture producing rust, 422.
 composition of, 460.
- Air-furnace, 284-85, 286, 348, 352, 358-62.
 compared with cupola, 361-62.
- Air-hardening steel, 408.
 liquid, 462.
 necessary to burn coke, 269.
- Alloys, 292, 481.
- Alloy steels, 396-421.
 definition of, 396.
- Allotropic modifications of iron, 317-19, 383, 384-86.
- Allotropy, 486.
- Alpha iron, 318, 384-85, 393, 394.
- Alternate stresses, 398, 415, 416, 418, 485-86.
- Aluminum, chemistry of, 477-78.
- Aluminum in steel, 174.
- American iron and steel manufacture, scheme of, 51-53.
 Lancashire process, 71.
- Analysis, 461.
- Anhydrous acids, 472.
- Animal forms, composition of, 460.
- Annealing boxes for malleable castings, 362.
 carbon, 320.
 malleable castings, 52, 357, 358, 364, 365, 366, 367, 370.
 ovens, 363.
 pots for malleable castings, 362.
 steel, 224-25, 229, 370, 378, 382, 383, 387-89, 412.
- Anthracite, 12.
- Anvils, chilling of, 352.
- Apatite, 478.
- Armor plate, 227, 386, 398, 407.
- Arsenic, effect on steel, 328.
- Atmospheric pressure, 482.
- Atomic weights, 466, 467.
- Atoms, 466, 471.
- Austenite, 305, 334, 338, 342, 389-95, 407, 408, 413.
- Automobile steels, 190-91, 408, 417, 418, 419.
- Avagadro's hypothesis, 482.
- Axles, properties of, 329.
- Baby Bessemer converters, 286-92.
- Badly made material and corrosion, 427-29.
- Balling in puddling process, 81.
- Bands, 65.
- Bar iron, 70.
- Bars, forging of, 189.
 rolling of, 196.
- Bases, definition of, 471-72.
- Basic Bessemer compared with acid, 125.

- Basic Bessemer compared with acid steel, 59-60.
 distinguished from acid steel, 66-7.
 furnace lining, 472.
 pig iron, 42, 104, 146.
 process, 51, 122-25.
 slag, 471-72.
 steel for railroad rails, 62-63.
 steel in U. S., 53.
 steel, oxygen in, 328.
 steel, strength of, 327.
vs. acid furnaces for steel castings, 287.
- Bas-relief polishing, 452.
- Bath in Bessemer converter, depth of, 102.
- Bearings, properties of, 329.
- Bed of cupola, 266, 269, 270, 274, 280-84.
- Beehive coke oven, 12, 14, 16.
- Bell, 224.
- Bell-Krupp process, 67-68.
- Bell of blast furnace, 23.
- Bench, 226.
 molding, 243.
- Bertrand-Thiel process, 159.
- Bessemer blow, 96, 105.
- Bessemer boil, 118.
 compared with open-hearth steel, 60-63, 287-88.
 converter, 98-102, 286-92.
 distinguished from open-hearth steel, 67.
 flames, 96, 105, 118, 119.
 fume, 118.
 gases, 116-17.
 ingots, weight of, 197.
 iron, analyses of, 95, 104.
 ores defined, 61.
 pig iron, 95.
 process, 53, 61, 95-126.
 recarburizing in, 54, 60, 103-5, 120.
 removal of impurities in, 112-13, 114-15, 116, 122.
 slags, 95, 100, 110, 113, 114, 117-18.
- Bessemer steel in U. S., 53.
 steel, strength of, 326.
 steel, uses of, 61-63, 224.
- Beta iron, 318, 384-85, 394.
- Billets, 65, 196.
- Bi-prefix, 473.
- Bisilicate, 477.
- Biting of piece by rolls, 203.
- Bi-valent, 473.
- Black heart malleable castings, 364.
- Black iron, 435.
- Blast furnace, 2, 11-50.
 chemistry of, 30-91, 465.
 cinder. *See* Slags.
 dimensions and parts, 23, 24-28.
 fuels and fluxes, 11.
 limestone used in, 13.
 lining of, 24, 25-26.
 ore used in, amount of, 13.
 slags, 37, 39-40.
 smelting practice, 30.
 stoves. *See* Stoves.
vs. electric furnace, 440-41.
- Blast furnaces in United States, 16.
- Blast, in Bessemer process, 110.
 pressures in cupola, 264, 266, 268, 269, 270, 271, 272, 273, 280-3, 284.
 volumes in cupola. *See* Blast pressure.
- Blister steel, 87.
- Blooming rolls, 203, 220.
- Blooms, 65, 219.
- Blower for cupola, 268, 269.
- Blow-holes, 54, 59, 173, 174, 175, 185, 287, 324, 341, 427, 428, 456.
- Blowing engines for blast furnace, 26, 27.
- Blowpipe, 44, 168.
- Blue powder, 434.
- 'Body' in bar iron, 70-71.
- Boil in puddling process, 79.
- Boiler, supports, 381.
 tubes, 224.
- Boilers over heating furnaces, 231.
- Boiling linseed oil, 432.
- Boilings, 85.
- Boron steels, 397.

- Bosh of blast furnace, 24, 25-26.
 Bottom casting, 178.
 Bottoms for heating furnaces, 233.
 Boyle's law, 482.
 Brake action of carbon, 385, 390.
 Breast of, blast furnace, 25.
 cupola, 270.
 Breeze, defined, 19.
 British thermal unit, 162, 171, 465.
 Brittleness, defined, 486.
 of Stead, 381-82.
 of steel, 224, 327, 328-29, 386-87.
 See also Ductility.
 Bulldog, 75.
 Burdening the cupola, 273-77.
 Burglar-proof safes, 195, 406.
 Burning of, molds in drying, 247.
 steel, 373-74, 378-80, 380-81.
 Busheling, 428.
 Butterfly reversing valve, 165.
 Butt-welded tubes, 224.
 By-product coke oven. See Retort
 coke oven.
- Calcining siderite, 16.
 Calcium, chemistry of, 479.
 Calcium chloride used in open hearth,
 149.
 Calcium fluoride used in open hearth,
 149.
 Calculating a blast-furnace charge,
 46-50.
 Calorie defined, 465.
 Calorific equation, in Bessemer pro-
 cess, 120-22.
 of basic Bessemer, 124.
 Campbell open-hearth process, 159-
 60.
 Camera for micro-photography, 454-
 55.
 Cannon, 192, 193, 227.
 Carbide of iron. See Cementite.
 Carbon, 5.
 Carbon. See also Graphite and Com-
 bined carbon.
 as a reducing agent, 474.
 chemical affinity for iron, 6.
 chemistry of, 475-76.
- Carbon, control of in pig iron, 342.
 in air furnace, 284.
 in iron and steel, 3, 51, 54, 63, 92,
 159, 180-83, 325-26, 327,
 329, 330, 336, 337-41, 370-
 74, 383, 385, 398, 405, 407,
 414, 446, 481, 423, 480.
 in the blast furnace, 33.
 Carbonates, 475, 476, 479.
 Carbonic oxide, 463.
 Carbonists, 385.
 Carbon monoxide as a reducing agent,
 474.
 Carbon, oxides of, 475-76.
 of cementation, 320.
 of the normal carbide, 320.
 steel, 396.
 theory of hardness, 383, 384.
 Carburization of wrought iron, the,
 85-94.
 Car-casting process, 107-8.
 Car wheels, 328-29, 337, 343-44, 352.
 Case-hardening, 201, 408.
 Casting bed of blast furnace, 42.
 Casting house of blast furnace, 43.
 Castings, 65, 261, 380-81.
 compared with drop-forgings,
 189.
 Casting temperature of steel ingots,
 60-61, 176, 183.
 Casting with large end up, 178.
 Cast iron. See also Blast furnace,
 Pig iron.
 checking of, 355, 349-50.
 chilling of, 253, 352-55, 336, 370.
 constitution of, 333-55.
 corrosion of, 425-26, 428-29.
 definition of, 6, 11.
 description of, 3.
 density of, 347.
 fluidity of, 341, 361.
 gray, as impure steel, 335.
 color due to, 334.
 cooling curve of, 339.
 definition of, 7.
 density of, 347.
 photomicrograph of, 353.
 properties of, 334-55.

- Cast iron pipe, 278, 425-26, 433.
 properties of, 333-55.
 rate of cooling of, 326.
 rolls, 201.
 shrinkage of, 260, 261-62, 337-40, 341, 345-46, 347, 350, 365, 367, 482.
 skin of, 426, 429.
 softness of, 350-52.
 solidification of, 338, 339, 341.
 spongy spots in, 340, 347, 348.
 steel scrap in, 348, 351, 366-67.
 strength of, 341, 347, 350-52, 364.
 vanadium in, 419.
vs. steel, 333.
 workability of, 340, 350-52.
 white, definition of, 7.
 properties of, etc., 220, 253, 334, 336, 339, 347, 352-55, 357.
- Cast steel, 66, 87, 368, 381.
- Cement manufacture from slag, 39.
 carbon, 320.
- Cementation of iron, 34, 85, 86, 87.
- Cementite, 86, 304, 309, 311, 313, 314, 316, 320-21, 323, 325-28, 334, 342, 345, 373, 389, 390, 392, 394, 404, 425.
- Centigrade, 465, 487.
 converted to Fahrenheit degrees, 487.
- Chain rods, 65.
- Chaplets, 250.
- Characteristics of acid open hearth, 55-56.
 of basic open-hearth process, 57.
 of Bessemer process, 54.
- Charcoal, 12, 90, 441, 474, 475.
 fineries, 69.
 hearth, Walloon, 70.
 iron, 12, 353.
- Checking, 173, 241, 246, 248, 261.
- Chemical affinity, 459, 461, 464.
 changes, 458-82.
 compounds, 293, 303, 471, 474-81.
 energy, 464, 471.
 equations, 466-69.
- Chemical reactions, 474-79.
 stability, 473.
 symbols, 467, 471.
- Chemistry and physics introductory to metallurgy, 458-87.
 of Bessemer process, 53.
 of crucible process, 93.
 of puddling, 57.
- Chicago as an iron center, 12.
- Chilling castings, 201, 262, 336, 350.
- Chill molds, 253, 255.
- Chisels, 388, 430.
- Chocks, 205.
- Chrome steel, 195, 396, 397, 407-8, 409, 413, 415, 416, 417.
- Chromic acid and corrosion, 424.
- Chromium, effect on crystallization, 374.
- Cinder, blast furnace, 13.
 in puddling process, 85.
 notch of blast furnace, 25.
- Clay, 477.
 iron stone, 15.
- Cleaning blast furnace gas, 30.
- Clearing stage in puddling, 78, 82.
- Cleveland, England district, iron ores, 15.
- Closed pass, 200.
- Coarse-grained steel, 370.
- Coating of wrought iron, 428.
- Cobalt steels, 397.
- Coefficient of friction, 400.
- Cogging mill, 198, 202.
- Coke, 12, 13, 17, 91, 440-41, 474, 475.
- Colby induction furnace, 441-44.
- Cold short, 348.
- Cold shut, 178.
 work compared with hot work, 229, 328.
- Collars on rolls, 197.
- Collaring, 206, 215.
- Colors, temper, 387.
- Combined carbon in iron, 334-51.
- Combustion, 463, 466.
- Coming to nature in puddling, 58, 179.
- Comparative cupola practice, 279-84.

- Comparison of purification processes, 59-65.
- Compressive strength of steel, 324, 485.
- Compromise theory of hardness of steel, 385.
- Concentrator, magnetic, 278.
- Connellsville coke, 13.
- Conservation of energy, 483.
- Constitution of steel, the, 316-32.
- Constituents of hardened and tempered steels, 389-95.
- Continuous heating furnaces, 230, 231, 232.
- Contraction. See Shrinkage.
- Converting pots, 86.
- Cooling curve of pure iron, 319.
curves, 300, 339.
of blast furnace, 24.
rate of. See Rate of cooling.
steel, 380-81.
strains, 261-62.
table, 221.
- Cope, 238, 250.
- Copper, cooling curve of, 339.
effect on steel, 327-28.
- Cores, 238-39, 241, 249, 250, 246-53, 259.
- Corrosion of iron and steel, the, 64, 401, 422-36.
- Country heat, 87.
- Critical range of steel, 310, 314, 330, 370-75, 382-95, 386, 388, 401, 402, 407, 413.
- Critical temperature in Bessemer process, 110-11.
- Crucible furnaces, 87-91, 286.
process, 85-87, 90, 92, 397, 444.
steel, 52, 53, 63, 66-67, 74-94, 195, 326.
- Crystalline forces, 293.
- Crystallization of iron and steel, 179, 186, 224, 261, 293, 318, 323, 325, 370-82, 392-93, 398-99, 481, 487.
- Crystals of steel, growth of, 376.
- Cuban ore used in U. S., 17.
- Cupola, 262-85, 348, 354, 358.
- Cupola charge, 270, 271, 273-79, 280-82.
chemistry of, 271-73, 274, 278, 284, 365.
coal in, 279.
coke in iron, 264.
compared with air furnace, 361-62.
crucible zone of, 264, 266.
dimensions, 267, 280-82.
limestone in, 271.
lining of, 267, 268, 270, 271, 272, 280-82.
melting in, 270-71, 278-79, 280-82, 284.
run, or campaign, 278-79.
time of melting in, 266, 267, 270, 278-79, 280-83, 284.
used for Bessemer process, 97.
- Cutting of molds, 246.
- Dalton and Gay Lussac law, 482.
- Dannemora iron ore, 70.
- Dead rollers, 210.
- Decomposition, 461, 464.
of iron solid solution, 309, 310-15.
- Defects in ingots, 173-84.
- Definitions of iron and steel, 66.
- Delays in rolling mills, 206, 215.
- Dellwik-Fleischer gas, 171-72.
- Density, 482.
of cast iron, 347, 349.
- Dental instruments, tempering of, 387.
- Deoxidising steel, 477.
- Depth of chill in cast iron, 354-55.
See also Chilling.
- Descent of charge in blast furnace, 30.
- Developing structure for metallography, 452.
- Diamond, 384, 475.
form of carbon in steel, 318.
pass, 200.
- Dies. See Wire.
- Direct castings, 262.
- Dirt and corrosion, 428, 429.
- Dirty cast iron and sulphur, 341.

- Distinguishing between different products, 66.
- Dolomite, 479.
- Double heat treatment, 414.
shear heat, 87.
steel, 87.
- Doubling in tin-plate rolling, 61.
- Down-comer of blast furnace, 30.
- Draft, 215.
in rolling, 220.
in wire drawing, 224-25, 226.
- Drag, 238.
- Drawing, of wire. See Wire.
temper, 388.
- Dried air in blast furnace, 38.
- Driers in paint oils, 432.
- Drop-forging, 189, 190-91, 368.
- Drop of cupola, 271, 279.
- Dry chemistry, 475.
- Drying oil, 431.
- Drying ovens, 243, 249.
- Dry-sand molds, 237, 243, 245-48.
- Ductility, defined, 485.
of metals, measure of, 187.
of steel, 67, 324, 325, 326, 328, 329, 371, 387, 486.
as affected by forging temperatures, 189.
as affected by mechanical work, 185.
as affected by oxygen, 328.
as affected by welding, 378.
- Dull iron, 264.
- Duplex process, 157, 158-59.
- Duplicating patterns, 260.
- Dust-catcher of blast furnace, 30.
- Earth's crust, composition of, 460.
- Eccentric converter, 99, 100.
- Effect of work on steel, rationale of, 187.
- Elastic limit, defined, 484.
of carbon and nickel steels, 399.
of steel, compared with ultimate strength, 187.
of welded pieces, 378.
when exceeded, 186.
- Elastic limit, ratio, 399.
- Electric, conductivity of steel, 329-30, 414.
furnaces, 419.
motors in rolling mills, 206, 208, 209, 212, 213-15.
resistance, decrease on cooling, 385, 394.
resistance, loss of in tempering, 387, 394.
- Electro-chemistry, 470.
- Electrolysis, defined, 470.
and corrosion, 423, 423-29.
- Electrolytic, iron, 321.
refining, 437, 446-47.
- Electrometallurgy of iron and steel, the, 437-47.
- Electroplating, 433-35.
- Electro-thermic processes, 437, 447.
- Elements, 460, 461, 466, 467, 471.
- Elongation, of steel under strain, 186.
percentage of, defined, 484.
- Enameling, 435.
- Engraving tools, tempering of, 387.
- Etching for metallography, 448, 452-53.
- Ethylene, 469.
- Eutectic alloy. See Eutectics.
- Eutectic not a chemical compound, 303.
- Eutectics, 299-305, 306-8, 311, 312-15, 338.
- Eutectoid, 311-15, 325.
- Expansibility of steels, 400.
- Expense in puddling process, 83.
- Explosion doors of blast furnace, 44.
- Explosions in blast furnace, 44.
- Fahrenheit, 465, 487.
converted to centigrade degrees, 487.
- Fatigue of steel, 398, 415.
- Feeders on castings, 177. See also Risers.
- Feldspar, 477.
- Ferric compounds, 473.
oxide as a pigment, 432.

- Ferrite, 310, 311, 313, 316-19, 321, 323, 325, 329, 330-32, 334, 357, 371-73, 389, 392.
- Ferro-alloys, 437.
- Ferro-chrome, 437.
- Ferromanganese, 90, 104, 397, 405.
- Ferro-molybdenum, 437.
- Ferro-nickel, 397.
- Ferrophosphorus added to basic steel, 61.
- Ferrosilicon, 104, 274, 351.
- Ferro-tungsten, 437.
- Ferrous compounds, 473.
hydroxide in corrosion, 423-24.
- Ferrum, 467.
- Fertilizers, 478.
- Fettling of puddling furnaces, 74-75.
- Fibers in wrought iron, 58.
- Field *vs.* shop painting, 430.
- Fillets in patterns, 261.
- Fin, 200, 215.
- Finery fire, 68.
- Fingers on manipulator, 204.
- Finishing temperatures for rolling, 194-95, 229. See also Temperatures.
- Fireclay crucibles, 90.
- Fir-tree crystals, 182, 183.
- Five-ply plate, 195.
- Flanging, 229.
- Flask, 238.
- Flint, 476.
- Floor-rammers, 242-43.
- Fluorspar, 149, 271.
- Flushing a blast furnace, 39, 40.
- Fluxes, blast furnace, 11, 13.
- Fly-wheels on rolling engines, 210, 212.
- Forge iron, 74, 104.
- Forging. See also Hammering, and Pressing.
compared with rolling, 229.
drop-, 189.
finishing temperatures for, 189.
of metals, the, 187-93, 227-29.
- Foundry irons, analyses of, 104, 274.
ladles, 265.
- Foundry practice, 236-92.
- Fracture of steel, 370, 454. See also Crystallization.
- Freezing, 44-45, 179, 186, 293. See also Solidification.
of alloys of lead and tin, 295-304.
of iron and steel, 304-15.
- Freezing-point curves, 294, 300-15.
- Fuels, 11, 83, 93, 160-72, 229-35, 264, 286, 363-64.
- Furnace linings, 477, 479, 481.
- Galvanizing, 422, 429, 433-34.
- Gamma iron, 318, 384, 385, 389, 393, 394.
- Ganister for converter lining, 99.
- Gas engines utilizing blast furnace gas, 31.
- Gaseous fuels, 475.
- Gases from baby Bessemer, 290-91.
from cupola, 272-73.
- Gas mains, 165.
producer grate area, 162.
producers, 129, 160-64, 171.
- Gayley's air-drying process, 38-39.
- Gay Lussac and Dalton law, 482.
- Gate, 240, 241.
- Gated patterns, 255.
- Gears, properties of, 328-29, 408, 419.
- Gold, 486.
- Goldschmidt Thermit process, 405.
- Gold-silver alloys, 293-95, 304, 480.
- Grading cast steel by eye, 92-93.
- Grain of steel. See also Crystallization of steel.
- Graphite, 475.
and corrosion, 425.
and expansions. See Graphite and Shrinkage.
and manganese, 344.
and phosphorus, 344-45.
and porosity, 340.
and shrinkage, 337-40, 345, 347.
and silicon, 343.
and strength, 337, 340-41, 351, 356.
and sulphur, 343.

- Graphite and workability, 340.
 as a pigment, 432.
 distinction under the microscope, 452.
 crucibles, 90.
 for washes, 243-45.
 in cast iron, 333-55, 481.
 in steel, 333.
 precipitation in malleable castings, 357.
 properties and structure of, 334.
- Grease producing corrosion, 429.
- Green-sand molds, 237, 243, 245-48.
- Grooved rolls, 198, 200, 201, 202, 204, 207, 208.
- Guards, 206.
- Guides, 205, 207.
- Hacksaws, tempering of, 387.
- Hammering. See also Forging.
 compared with rolling, 193.
 control of temperatures in, 189.
 effect of, 188-89, 375-78.
- Hammer refining, 378. See also Restoring.
- Hand rammers, 242-43.
- Hanging guards, 206.
 of blast furnace charge, 44.
- Hardened steel, constituents of, 389-95.
 uses of, 386.
- Hardening of steel, 382-95.
 and magnetism, 330.
 theories of, 383-86.
- Hardenite, 392.
- Hardness. See also Workability (for cast iron).
 defined, 486.
 of cast iron, 347.
 of cast iron and manganese, 341.
 of nickel steel, 400.
 of steel, 325, 328-29.
 as affected by cold work, 224.
 as affected by forging temperatures, 189.
 due to carbon alone, 411.
 loss of in tempering, 387.
 loss of on annealing, 385, 394.
- Hardness produced by quenching, 195, 382-95.
- Harnet's liquid compression, 179.
- Head, or header. See Riser.
- Hearth of blast furnace, 24.
 of cupola. See Crucible zone.
- Heat, definition of, 483.
 effects of chemical reactions, 11.
 energy, 471.
 from chemical change, 459, 470.
 See Thermo-chemistry.
 in rolling, 219.
 in Bessemer process, 60.
 tinting, 452-53.
 to start chemical change, 459, 460, 461, 462, 463, 464-66, 470-71, 475-76, 479.
 treatment of cast iron, 370.
 treatment of steel, the, 370-95.
 units, 465.
- Heating for rolling, etc., 193, 217, 219, 220, 380.
 furnaces, 229-35.
 of steel, improper, 370-82.
- Helve hammers, 187.
- Hematite, 14.
- Héroult process, 438-41, 444-46.
 steel process, 444-46.
- Heyl and Patterson pig-casting machine, 41.
- High-carbon steel, rolling of, 235.
- High-speed steels, 408-13, 415.
- Hollow wire. See Tubes.
- Hoops, 65.
- Hopper of blast furnace, 23, 24.
- Horns on manipulator, 204.
- Horse-shoe bars, 65.
- Hot-blast for blast furnace, 24, 27.
- Hot iron, 361.
- Hot spots in cast iron, 349.
- Hot work compared with cold work, 229.
- Housing cap, 205, 207.
- Housings, 204-12.
- Hughes mechanically poked gas-producer, 164.
- Hydraulic presses compared with hammers, 188, 193, 227-28, 229.

- Hydro-carbons, 433, 469-71.
 Hydrochloric acid for etching, 454.
 Hydrogen and corrosion, 423, 430.
 Hydrogen, chemistry of, 469-71.
 in Bessemer steel, 60.
 in crucible steel, 63.
 in iron, 446, 476.
 in steel, 173, 324, 381.
- Illuminating gas, 469.
 Impact, 485.
 Impurities in cast iron, effect of, 342.
 Incomplete combustion, 463.
 Indestructibility of matter, 468.
 Induction furnaces, 440, 441, 442-44.
 Ingotism, 173, 179-80, 197, 235, 381.
 Ingot molds, 92, 107-8, 111.
 Ingots of large size, form of, 192.
 heating of, 192.
 solidification of, 177.
 taper of, 220.
 texture of center of, 193, 349, 454.
- Inorganic chemistry, 474-75.
 Iodine etching, 453.
 Internal stress theory of hardness, 386.
- Invar, 400-1.
 Invention of puddling, 57.
 Ionic hydrogen and corrosion, 423.
- Iron. See also Cast iron, Pig iron, Wrought iron, Malleable cast iron, Malleable iron.
 abundance of, 4.
 and carbon, 6.
 castings, 333.
 chemistry of, 476.
 cupola. See Cupola.
 density of, 347.
 foundries, use of Bessemer in, 288.
 hardness of, 383.
 melting point of, 446.
 occurrence of in earth, 4, 461.
 ore as pigments, 432.
 ores described, 14.
 oxide. See also Oxygen.
 specific gravity of, 334.
- Iron, strength of, 324.
 Irregularities in blast-furnace working, 42-45.
 Irreversible transformations, 402, 404.
 Isomorphous mixtures, 293, 318.
- Jail bars, 195.
 Jasper, 476.
 Jobbing foundries, use of scrap in, 278.
- Keller process, 438-41.
 Killing in crucible process, 91.
 Kish, 481.
 Kjellin electric furnace, 440.
 Knobbed charcoal iron, 68.
 iron, 70.
 Knobbling fire, 68, 69, 70.
 Krupp purification process, 67-68.
- Ladles, foundry, 265.
 Lag in heating and cooling, 312.
 Lake Superior iron ores, 14, 16, 17.
 Lancashire process, 70-72.
 Lap-welded tubing, making of, 221-22.
- Latent heat of fusion, 301.
 Lathe tools, tempering of, 387.
 Law of smelting, 466.
 Layers of iron and coke in cupola, 266, 267, 269, 274, 280-84.
- Le Chatelier microscope, 455.
 Lead, 462-63. See also Paints.
 and zinc, 480.
 coatings, 434.
 in terne plate, 435.
- Lead-tin alloys, 295-304.
 Lifters, 242.
 Lifting screw, 238.
- Lillienberg's liquid compression, 179.
 Lime, 473, 479. See also Blast furnace, Open hearth, Cupola.
 Limestone, 33, 475, 479. See also Blast furnace, Open hearth, Cupola.
- Limonite, 15.
 Linseed oil, 431-32.
 Liquid air, 462.
 Liquid cast iron, density of, 347.

- Liquid compression of ingots, 179.
 Live rollers, 207.
 Loading a blast furnace, 22.
 an ore boat, 19.
 Loam molding, 236-38, 255.
 Long-tuyere converters, 289-90.
 Loose texture in center of castings,
 349. See also Ingots.
 Loss, in air furnace, 285.
 in baby Bessemer converters, 288,
 289, 290.
 in Bessemer process, 118-19.
 in crucible process, 93.
 in cupola, 264, 278.
 in puddling process, 83-84.
 in rolling plates, 219.
 Lorraine iron ore, 15.
 Lothringen iron ore, 15.
 Low-carbon steel in open hearth,
 making of, 149.
 steels, ferrite in, 317.
 Luminosity of flames, 164, 165.
 Luxemburg iron ore, 15.
- Magnesia, 46-47, 477, 479.
 Magnesite, 479.
 Magnesium, chemistry of, 479.
 Magnetism of iron and steel, 4, 330-32,
 385, 389, 394.
 Magnetite, 15.
 Magnet steels, 413, 414.
 Macroscopic metallography, 448, 454-
 57.
 Malleable, Bessemer iron, 365.
 cast iron, 53, 284-86, 351, 356-
 69.
 annealing of, 370.
 as steel castings, 66, 368-69.
 definition of, 7.
 description of, 4.
 melting of, in cupola, 264.
 properties of, 356, 357-58.
 strength of, 351, 364.
 uses of, 356.
 coke iron, 365.
 iron, 369.
 Malleability, 486.
 Mandril, 222, 226.
- Manganese, chemistry of, 478.
 as a reducing agent, 474.
 and sulphur, 341, 343-44.
 in acid open hearth, 152, 155.
 in basic process, 146, 396.
 in Bessemer process, 95, 102, 113,
 396.
 in blast furnace, 38.
 in cast iron, 329, 335, 341, 342,
 343-44, 346, 348, 349, 350,
 351, 352, 354, 366, 374. See
 also in steel.
 in cupola, 274.
 in steel, 54, 64, 66, 67, 174, 182,
 322-23, 327, 328, 330, 396,
 405-7, 427.
 in wrought iron, 66.
 oxides, 473.
 salts as paint driers, 432.
 steel, 329, 396, 397, 405-7, 408.
 sulphide, 98, 316, 321, 322, 343,
 349.
 Manganiferous cementite, 320-22.
 Manipulators, 210, 204.
 Manufacture. See Pig iron, Wrought
 iron, Steel, etc.
 Marble, 475.
 Martensite, 389-95.
 Match for molding, 251.
 Maximum affinity, 464.
 Mechanical gas producers, 112, 161.
 mixtures, 459, 479.
 puddling furnace, 68, 76.
 treatment, effect on crystalliza-
 tion, 375-78.
 treatment of steel, the, 185-
 235.
 work, its effect on strength, etc.,
 185.
- Melting, fineries, 69.
 heat, 87.
 holes, 87-88.
 iron. See also Cupola, Air fur-
 nace, Open-hearth furnace
 for iron.
 -point of cast iron. See Fluidity
 of cast iron.
 steel for castings, 286-92.

- Melting zone of cupola, 264, 266, 267, 268, 272, 279-84.
- Merchant bar, 58, 65.
- Mercury and iron, 459, 480.
- Mesabi iron ore, 19, 44.
- Metal-cutting tools, tempering of, 387.
- Metallic and non-metallic elements, 471.
lustre, 471.
- Metallography of iron and steel, the, 448-57.
- Metallurgy, definition of, 461.
- Metcalf test, 379-80.
- Methane, 469.
- Mica schist for converter lining, 99-100.
- Micro-constituents of steel, the, 316-32.
- Micro-photographic apparatus, 454-55.
- Microscope, 316-24, 353, 370, 380, 390-95, 392, 404, 448-57.
- Mill iron, 74.
- Mill scale. See also Scale.
- Mineral oil. See Petroleum and Oil for Fuel.
- Minette iron ore, 15.
- Mining ore at Lake Superior, 19.
- Miscellaneous purification processes, 67-72.
- Mixed crystals, 293.
- Mixer, 95-97, 102, 262.
- Mixtures, 293. See Mechanical mixtures.
- Modulus of elasticity, 399-400, 484.
- Moisture producing corrosion, 422, 429, 430.
- Mold cars for car-casting process, 107-8.
- Molders' tools, 242.
- Molding machines, 237, 251-60.
sand, 243.
- Molds, making of, 237-62.
- Molecules, 468, 482.
- Molybdenum steel, 396, 409-13.
- Mond gas, 172.
- Monell process, 157, 158.
- Monkey of blast furnace, 25.
- Mono-, prefix, 473.
- Monosilicate, 476.
- Morgan, water sealed gas producer, 163.
- Mother metals, 302.
liquors, 302.
- Mottled, cast iron, 7, 347.
pig iron, definition of, 7.
- Muck bar, 58.
- Multiple, molds, 259.
proportions of atomic weights, 467.
- Multiple-ply plate, 195.
- Mushet steel, 408-11.
- Mushroom reversing valves, 166, 167.
- Nailing molds, 240, 247.
- Nail plate, 65.
- Natural gas, 166-68, 469.
- Necking of steel, 407, 484.
- Needles, tempering of, 387.
- Net heat of chemical reactions, 465.
- Neutral furnace linings, 477.
- Nickel, effect on crystallization, 374.
effect on electric conductivity, 330.
- Nickel-plating, 229, 435.
steel, 202, 288, 396, 397, 398-404, 407, 408, 415, 416-19.
uses of, 398, 400-1.
- Nitric acid etching for metallography, 452-53.
- Nitrogen in the blast furnace, 32.
in steel, 60, 63, 173, 324, 381, 415, 419.
- Non-magnetic iron or steel, 318, 404, 407, 408, 409.
- Northampton cast iron, cooling curve of, 339.
- Norway iron, 317.
iron for magnets, 330.
- Nozzles of steel ladles, 106.
- Number of Bessemer converters in America, 51, 52.
blast furnaces in America, 51, 52.
open-hearth furnaces in America, 51, 58.

- Number of puddling furnaces in America, 51, 53.
- Oil for fuel, 169-70.
- Oölitic hematite, 15.
- Opal, 476.
- Open grain in cast iron, 180, 340, 347-48.
- Open-hearth casting pit, 131, 142, 143, 151.
- bath, 138.
- boil, 148.
- bottom, 138-39.
- Campbell type, 142-44, 159-60.
- charging, 155-56.
- charging boxes, 128, 130, 131, 140.
- charging machines, 127, 128, 129, 130-31.
- chimney, 136-37.
- construction, 138-39.
- cycles, 127.
- dirt pockets, 132, 134, 135.
- draught, 136-37.
- for melting iron, 285-86, 362.
- fuels, 144, 155, 160-72.
- fuels, amount used, 144, 155, 167, 169.
- furnace, 56, 442, 444.
- hearth, 138-39.
- house, 128, 131, 140, 142, 151.
- ingot molds, 128, 154.
- ingots, weight of, 197.
- life, 137-38.
- lime in, 56-57, 146, 148.
- lining, 57, 138-39, 140-41, 142-43, 146, 160.
- melting platform, 127-28.
- molten pig in, 127, 155-56.
- natural gas in, 167-68.
- oil in, 169.
- operation of, 56.
- plant, 127-31.
- ports, 135-36, 137.
- regenerators, 129, 132-35, 136, 137, 138, 169.
- repairs, 139-40, 141, 142-43.
- reversals, 144.
- Open-hearth reversing valves, 129, 144, 165, 166, 167.
- roof, 136, 137.
- scrap used in, 55, 145.
- size of, 144-45.
- slag pockets, 132, 134, 135.
- stationary, 56, 132, 134, 138, 139-41.
- tap-hole, 139-40.
- temperature, 134-35, 144.
- tilting, 128, 131, 132, 140-41, 142-44, 157, 160.
- valves, 165, 166, 167.
- Wellman type, 142-44.
- working platform, 127-28.
- Open-hearth process, the, 56, 127-72.
- acid, chemistry of, 152-55.
- loss, 152-54.
- practice, 152-55, 159-60.
- recarburizing, 59, 124-55, 129.
- See also Acid steel.
- basic, chemistry of, 147-52.
- fluxes, 146.
- loss, 150.
- practice, 145-52, 155-60.
- recarburizing, 129, 150-52.
- removal of impurities, 147.
- See also Basic steel.
- boil in, 156.
- charging, 145-6.
- compared with Bessemer, 60-63.
- compared with electric, 444.
- Monell process, 158-59.
- ore used in, 144, 145, 146, 148, 149, 150, 154, 156-60.
- oxidation in, 156.
- pig-and-ore process, 145, 156.
- pig-and-scrap process, 145.
- recarburizing, 59, 129.
- rephosphorization, 150.
- special processes, 155-60.
- Talbot process, 157-58.
- teeming, 131, 142, 145, 151, 154.
- slag, 138, 140, 141, 146, 147, 148-50, 152, 154, 155, 157, 158, 159, 160.
- steel distinguished from Bessemer, 67, 287-88.

- Open-hearth steel for railroad rails,
 61-63.
 in U. S., 53.
 not often very low carbon, 149.
 strength of, 326, 327.
 stock, 129-30, 150, 155-56.
 teeming ladle, 128, 151, 131, 381.
- Open pass, 200.
- Operation of regenerative furnace, 56.
- Ore boats, 20. See also Blast Furnace for ores.
 handling mechanism at blast furnace, 22.
 used in open hearth, 55, 148.
- Organic acids and corrosion, 435.
 chemistry, 474-75.
- Osmondite, 393.
- Osmond's polish attack, 453.
 theory of permanent magnetism, 330-32.
- Osmotic pressure, 480.
- Otto Hoffmann coke oven. See Retort coke oven.
- Overheating of steel, 221, 234, 370-82, 391.
- Overfilling the pass, 200.
- Oxidation by and in paints, 431-33.
 definition of, 463, 464.
 of steel in tempering, 387.
 in cupola, 264. See Loss in cupola.
 in puddling, 57-58.
- Oxide of iron. See Oxygen.
- Oxidized coatings, 435. See Scale.
- Oxidizing agents, 423, 432, 474.
- Oxidizing effect of slags, 59.
- Oxygen, chemistry of, 459, 462-64.
 in blast furnace, 32.
 in cast iron, 174, 341.
 in steel, 54, 59, 60, 63, 173, 174, 287, 324, 327, 328, 415, 424, 428, 429.
- Packing for malleable castings, 357, 362, 364.
- Paint, 422, 429-33.
- Painting, quality of, 428-29.
 wrought iron, 64, 428.
- Paints, kinds of, 431-33.
- Pass in rolling, 194.
- Pass-over mill, 195.
- Pasty condition in freezing, 339.
- Pasty stage of solidification and phosphorus, 339, 345.
- Pattern molding, 238-62.
- Patterns, designs of, 260-62.
- Pearlite, 312, 313, 317, 321, 371, 390, 392-93, 394, 452-53.
- Pellets in Bessemer slags, 117, 118, 120.
 of iron in foundry practice, 278.
- Penknives, tempering of, 387.
- Per-, prefix, 474.
- Perfect combustion, 463.
- Permanent molds, 253.
 set defined, 484.
- Petroleum. See Oil.
- Phlogiston theory, 462.
- Phosphide of iron, 316, 323, 453.
- Phosphorus, chemistry of, 478-79.
 eutectic, 321, 341, 453.
 in basic open-hearth process, 56-57, 146, 147-52, 159, 481-82.
 in blast furnace, 38.
 in electric smelting, 439-40, 446,
 in iron and steel, 61, 62, 66, 67,
 74, 146, 180-83, 323, 326-27,
 329, 330, 335, 338-39, 341,
 342, 344-45, 346, 348, 349,
 350, 352, 354, 366, 374.
 in ores, 15, 61.
 in puddling, 57, 78.
- Photo-micrographic apparatus, 454-55.
- Physical changes, 458-59.
 properties of metals, 483-87.
- Physics, introductory to metallurgy, 458-87.
 principles of, 482-87.
 used in crucible process, 90.
- Pickling, 229, 430-31, 433.
- Picric acid etching, 453.
- Pig beds of blast furnace, 42, 43.
- Pigging up in basic open hearth, 148.

- Pig iron, 4, 5, 7, 11, 12, 16, 42, 43, 289.
 See also Cast iron.
 ladles, 40.
 Pigment in a paint, 431-33.
 Pig-molding machines, 41-42.
 Pigs, 42.
 "Pig-washing" process, or Bell-Krupp, 67-68.
 Piling, muck bar, 58.
 wrought-iron scrap, 428.
 Pinion housing, 207.
 Pinions, 204, 206, 207.
 Pipe, 61, 65, 220, 224.
 fittings, manufacture of, 366.
 Pipes in iron and steel, 173, 176-79,
 253, 262, 278, 339-40.
 Pipe-welding rolls, 222, 223.
 Pitch as a pigment, 433.
 Pitting, 427, 428.
 Pittsburg, as an iron center, 12.
 Plant forms, composition of, 460.
 Plates, 65, 196, 201.
 Platinite, 401.
 Pneumatic hammers, 430.
 Polish attack, 317, 392, 452-53.
 Polishing for metallography, 448,
 449-51.
 Porosity of cast iron, 340, 347.
 Porter-Allen engine, 210.
 Porter bar for ingots in forging,
 192.
 Porter governor, 210.
 Potassium bichromate and corrosion,
 424.
 Pouring, in crucible process, 92.
 metal into Bessemer converter,
 104.
 Power, from blast-furnace gas, 30.
 consumed in rolling, 202, 203.
 Precipitation, 481.
 Preparation, of samples for metallography, 449-51, 452-59.
 of surfaces for coating, 249, 430.
 Preservative coatings. See Paint,
 Galvanizing, etc.
 Presser board, 258.
 Pressing, 227-29.
 Pressing linseed, 432.
 Pressure on steel, methods of applying, 187.
 and volume of gases, 482.
 Price of Bessemer pig iron, 61.
 Priming coat, 429, 232.
 Process. See Index to authorities cited.
 Producer-gas, 160-72.
 Production of steel in U. S., 65.
 Projectiles, 386.
 Properties of cast iron, the, 345-55.
 Puddle balls, 58.
 Puddled bar, 58, 83.
 Puddle rolls, 58, 82.
 Puddling furnace, 57, 74-94.
 process, 57-58, 74-94.
 slag or cinder, 57.
 Pulling in crucible process, 91-92.
 Pull-over mill, 195.
 Purification of pig iron, 51-72.
 Qualitative chemistry, 461.
 Quantitative chemistry, 461.
 Quarternary steels, 397, 407-13, 415-16, 418.
 Quartz, 476.
 Quenching steel. See Hardening steel.
 Rabbling in air furnace, 360.
 of puddling process, 78, 79.
 Radicals, 471-74.
 Ragging. See Roughing.
 Railroad car wheels. See Car wheels.
 Railroad rails, 61-63, 65, 194, 196,
 215, 219-21, 328-29, 330,
 400, 406, 456.
 Rammers, molders', 242.
 Ramming molds, 241-43, 246.
 Rapping patterns, 240, 252, 258-59.
 Rate of cooling, effect on iron, 308,
 336, 345, 356.
 cooling of steel, 382-95.
 Razors, forging of, 192.
 Recarburizing, 397, 415, 437. See also Bessemer Process; Open-hearth process.
 Recuperative heating furnaces, 230,
 231, 232.

- Red lead, 432.
- Red-shortness of cast iron and sulphur, 341.
of steel, 326.
- Reducing agents, 474, 475, 496.
- Reduction, definition of, 463, 464.
of area defined, 484-85.
of steel under strain, 186.
of metals in rolls, 194, 193-235, 220.
- Reel, 226.
- Refinery hearth, 68.
- Refining steel, 371. See also Crystallization.
- Refractory clays, 477.
- Regenerative furnace. See also Crucible process; Open-hearth furnace.
heating furnaces, 231.
- Repairs for steel-casting furnaces, 287.
- Repeated stresses, 398, 416, 485.
- Rephosphorization of steel, 59-60.
See Open hearth.
- Rerolling rails, 220.
- Residual silicon in Bessemer process, 112.
- Resilience, 399, 484, 486.
of malleable cast iron, 356, 366.
- Restoring steel, 371, 380, 388-89. See also Crystallization.
- Retort coke oven, 13, 14, 15.
- Return scrap, 367.
- Reverberatory furnaces, for heating, 229-31.
- Reversing mills, 197, 198, 199, 204, 208, 209, 210, 211, 212, 219-20.
- Risers on castings, 177, 182, 189, 241, 253, 262, 349.
- Rivets, 402, 485.
- Roberts-Austen, Roozeboom diagram, 312, 314-15.
- Rock drills, tempering of, 387.
- Rock-over molding machine, 255.
- Rod mill, 203.
- Rods, wire. See Wire rods.
- Roe puddling furnace, 76-77, 83-84.
- Rolled steel, crystallization of, 381.
- Roll engines, 205, 211, 212, 217, 210-12.
- Roller table engine, 204, 208, 212.
- Rolling, 193-235.
compared with hammering, 193.
effect of, 193-95, 375-78, 381.
mills, 203-15.
delays in, 206.
parts of, 200-25.
speed of, 194, 196.
- Roll scale used for fettling, 75.
chilled, 337, 352, 419.
- Rolls, 200-3.
- Roll tables, 206, 208, 209, 212, 213, 214, 217, 218, 221.
- Roozeboom diagram, 312, 314-15.
- Rosin in paint vehicles, 432.
- Rotary squeezer, 76.
- Rouge for polishing, preparation of, 450.
- Roughing of rolls, 201, 202, 203.
- Rule of smelting and oxidation, 52.
- Running-out fire, 68.
- Rust, 422-24, 458, 459, 460.
- Rusting of iron and steel. See also Corrosion.
- Saggers, 362.
- Salt used in rolling, 217.
- Salts, 472.
- Sand blast, 362, 430.
in rolling, 217.
for molding, 243.
- Sand-casting of pig iron, 42.
- Sappy. See Silky.
- Saturated martensite, 392.
- Sault Ste. Marie, 20, 21.
- Sauveur method of etching, 453.
- Saws. See Wood saws; Hacksaws.
- Scabs on castings, 243.
- Scaffolding of blast furnace, 44.
- Scale, 219, 231-35, 425, 428, 429.
Scaled castings, 366.
- Science in the iron foundry, 236.
- Scintillating of steel, 379.
- Scrap, analysis of, 274, 275, 278, 285.
- Scrap iron, grain of, 278.

- Scrap produced in forging cannon, 192-93.
 used in iron castings, 53, 275, 278, 285, 354, 366-67.
 used in steel manufacture, 53, 90, 105.
- Screw-down mechanism, 206, 208, 209, 217.
- Sea water and corrosion, 426-27, 431.
- Seamless tubes, making of, 222-24.
- Second-class rails, 220.
- Segregate, 180-83, 193.
- Segregation, 173, 180-83, 341, 348-49, 350, 402, 415, 424, 427-28, 456.
- Selective freezing, 304.
 precipitation, 300, 309, 311.
- Self-fluxing in blast furnace, 47.
- Self-hardening steels, 408-11.
- Semi-steel castings, 368.
- Sesqui-oxide of iron, 474.
- Sesquisilicate, 477.
- Shape produced by rolling, 194, 197.
- Shearing strength, 485.
- Shear steel, 87.
- Shears, 218.
- Sheets, 65.
- Sheffield, England, 15, 70, 86, 87, 88.
- Shingling, 77.
- Shock, 485.
- Shop vs. field painting, 430.
- Shovel loading soft ore, 18.
- Shrinkage, 482.
 cavity. See Pipe.
 of cast iron. See Cast iron.
- Shrinking of molds in drying, 246.
 outer cannon tubes, 193.
- Siderite, 15.
- Silica, 476, 478-79, 482.
- Silica wash, 245.
- Silicates, 476-77.
- Silicide of iron, 316, 324.
- Silicon, chemistry of, 476.
 control of in pig iron, 35-38, 45, 342.
 in air furnace, 284.
 in basic open-hearth process, 57, 146, 287.
- Silicon, in Bessemer process, 60, 95, 110-12, 114-15.
 in cast iron, 308, 329, 335, 341-43, 345, 346, 347, 349, 350, 351, 352, 354-55, 481.
 in crucible process, 91.
 in malleable cast iron, 356, 360, 365, 367.
 steel, 54, 66-67, 174, 182, 274, 326, 330, 396. See also Silicon in cast iron.
 steel, 330, 396, 413-14.
- Silico-Spiegel, analysis of, 104.
- Silky fracture, 370, 380.
- Silver-gold. See Gold-silver.
- Single-shear heat, 87.
 steel, 87.
- Size of castings and shrinkage, 346.
 of crystals. See Crystallization.
- Skelp, 65, 221.
- Skimmer of blast furnace, 40.
- Skimming the air furnace, 360.
- Skin-dried molds, 245.
- Slabbing mill, 200, 203, 212, 217.
- Slabs, 217, 234.
- Slacking of lime, 479.
- Slag. See also Cinder.
- Slag and corrosion, 425, 425-28.
 distinction under microscope, 452.
 in steel, 66.
 in wrought iron, 4, 58, 64, 66, 77, 81, 83, 85, 317.
 made in heating furnaces, 233.
- Slags, 419, 439-40, 463, 474, 476, 477, 478, 479, 481.
- Slick for molding, 242, 245.
- Slip bands, 186, 399.
- Slips in blast furnace, 44.
- Smelting in U. S., distribution of, 16.
 Law of. See Law of smelting.
 zone of blast furnace, 30.
- Smoke, producing rust, 43, 431, 432.
- Soaking pits, 111, 231-33.
- Solidification, 177, 338, 339, 341. See also Freezing.
- Solid solutions, 292-95, 304-15, 345, 385, 389-95, 402, 411.

- Solubility, 480.
 Solute, 480.
 Solutions, 292, 293, 292-315, 479-82.
 Soo canal. See Sault Ste. Marie.
 Sorbite, 325, 389-95.
 Soundness, 246, 326, 400.
 Sows, 42.
 Spanish ore used in U. S., 17.
 Spathic iron ore, 15.
 Specific gravity, 482.
 Spectroscope in Bessemer process, 105.
 Speed of cooling. See Rate of cooling.
 Spiegeleisen, 103, 104, 105.
 Spike rods, 65.
 Spindles, 204-12.
 Spitting in Bessemer process, 95, 290.
 Splice bars, 65.
 Spongy spots in cast iron. See Cast iron.
 Spring heat, 87.
 Springiness. See Resilience.
 Springs, tempering of, 387.
 Sprues, 252, 259.
 Squeezers, 76, 258.
 Stack of blast furnace, 24.
 of cupola, 264, 268, 272, 273, 279-84.
 Stead's brittleness, 381-82.
 Steam hammers, 187-93, 227-28, 229, compared with electric motor drives for rolls, 213.
 Steel castings, 247, 356.
 compared with white cast iron, 226.
 Steel-conversion process, 85-87.
 Steel-converting furnace, 86.
 definition of, 7.
 description of, 4.
 in wrought-iron piles, 428.
 ladles, 106.
 pipe made, 224.
 production of different countries, 63.
 rolls, 201.
 Steel, strength of, 67, 185, 189, 224, 324-29, 350, 371, 392.
 through heat, 87.
 uses of, 65.
 vs. cast iron, 333.
 Stiffeners on rolls, 200.
 Stone-cutting tools, tempering of, 387.
 Stools for ingot molds, 107-8.
 Stoppers of steel ladles, 106.
 Stoughton converters, 289-90.
 Stove foundries, use of scrap in, 278.
 Stoves, blast furnace, 2, 27, 28.
 Straightening rolls, 218.
 Strain defined, 483.
 Strain, effect of, on steel, 186.
 Strength of welded pieces, 378.
 Stress defined, 483.
 Stripping ingots, 108-9.
 Stripping-plate molding machines, 253-258.
 Strips, 65.
 Structural shapes, rolling of, 196.
 Structure of eutectics. See Eutectics.
 Sub-, prefix, 474.
 Subsulfate, 477.
 Sulfate of lead or zinc as pigments, 432.
 Sulfide of iron, 316, 322-23, 343, 349, 473.
 of manganese. See Manganese sulfide.
 Sulfur, chemistry of, 478.
 Sulfur elimination in mixer, 98.
 Sulfuric acid, 430, 433, 478.
 Sulphur in air furnace, 284.
 in blast furnace, 34, 36.
 in cast iron, 180-83, 308, 323-23, 335, 341, 342, 343-44, 346, 348, 349, 350, 352, 354-55, 365-66, 374.
 in electric smelting, 439-40, 446.
 in puddling process, 78.
 in steel, 67, 308, 322-23, 326, 374.
 See also Sulphur in cast iron.
 Sulphurous acid, 478.
 Surface tension, 480.

- Surgical instruments, tempering of, 387.
- Sweden, recarburizing Bessemer in, 120.
- Swedish iron, 317, 330, 446. See Norway iron.
- Swedish Lancashire process, 70-72.
- Sweeping a mold, 236-37, 255.
- Swelling of a casting, 243.
- Swords, tempering of, 387.
- Synthesis, 461, 464.
- Table, engines, 215.
roller, 205, 208, 209, 212.
- Talbot process, 157-58.
- Tap cinder, 85.
- Tap-hole of cupola, 266, 267, 280-82.
- Tappings, 85.
- Tar as a paint, 433.
- Taylor revolving bottom gas-producer, 161.
- Teeming steel into molds, 106-7.
- Temper, carbon, 357, 358, 365, 367.
colors, 387.
- Temperature, and affinity, 460.
and volume of gases, 482.
annealing malleable castings, 357, 364.
blast furnace, 336.
casting, 60-61, 287, 346, 354.
defined, 465.
drying ovens, 243.
effect on solubility, 481.
expanding cannon tubes, 193.
hardening steel, 382.
welding, 377.
- Temperatures, annealing, 388-89.
Bessemer process, 53, 105, 106-7, 116-17.
electric smelting, 437.
finishing in rolling and hammering, 190, 229, 375-78.
finishing in welding, 378.
open-hearth furnace, 134-35, 144.
to produce ingotism, 381.
to produce Stead's brittleness, 381, 382.
puddling, 83.
- Temperatures, restoring steel. See Crystallization; Restoring.
rolling, 196, 203, 217, 234, 374, 375.
tempering, 386-87.
- Tempered steel, constituents of, 389-95.
- Tempering, 412-13.
fire clay crucibles, 90.
of steel, 386-95.
- Tenderness produced by ingotism, 197.
- Tensile strength, defined, 483.
- Ternary alloys, 396-97.
- Terne plate, 435.
- Texture of center of ingots, 193, 228.
See also Ingots.
- Thermo-chemistry, 464-66.
- Thermo-electric power, 385, 387, 394.
- Third-class rails, 220.
- Third rails, 330.
- Three-high mill, 195, 195-97, 200, 206-7, 219.
- Throat of blast furnace, 24.
- Three-ply plate, 195.
- Tie-rods for furnaces, 381.
- Tilting, 189.
- Time, in air-furnace operation, 285.
in open hearth, 55.
of drying molds, 243.
- Tin, 430.
lead. See Lead-tin.
plate, 61, 195, 422, 435.
- Titanium, 15, 419, 396.
- Tool steels, 408-13.
- Torsion, 485.
- Total carbon in cast iron, 336, 344, 348, 350, 358, 366-67.
- Toughness, defined, 486.
- Transfer tables, 210.
- Transportation of iron ore in United States, 16, 17, 20.
- Transverse strength, 350, 352, 485.
- Tri-, prefix, 473.
- Trisilicate, 477.
- Tri-valent, 473.
- Troostite, 389-95.

- Tropenas converters, 288-89, 290.
Troubles in rolling, 215.
Trowels for molding, 242.
Tubes, drawing of, 226.
Tubing, lap-welded, 221-22.
Tumbling barrel, 362.
Tungsten, effect on crystallization, 374.
Tungsten steel, 397, 396, 408-13.
Tuyere notches, 24.
Tuyeres, of Bessemer converter, 98-99, 100-2.
 of blast furnace, 24, 25.
Two-high mill, 200, 206, 219-20.
- Uehling pig-casting machine, 41.
United States iron ores, 16, 17.
Uni-valent, 473.
Universal mill, 197, 199, 208, 209, 212, 216.
Unloading ore boats, 20, 21.
Uses of pig iron, 51.
- Valence, 472-73.
Vanadium steel, 396, 414-19.
Vehicle of paints, 431-33.
Venting molds, 240, 249.
Vertical rolls. See Universal mill.
Vibration and crystallization of steel, 374.
Vibrator molding machines, 256-59.
Vibratory stresses in steel, 327.
Volume of gases, 482.
- Walloon charcoal hearth, 70-72.
"Washed metal," produced by Bell-Krupp, 68.
Washes for molds, 240, 243, 243-46.
Waste. See also Loss.
 gas from blast furnace, 27.
Water, composition of, 460.
 cracks in steel, 386.
 gas, 170-72, 469.
 gas-producer, 171.
 gates, 262.
 on rolls, 217.
 -sealed gas-producers, 162-63.
 -sealed reversing valve, 166, 167.
- Weather loosening scale, 429-30.
Weight, and volume of air compared, 27.
Welded pipe, 61.
Welding, 64, 195, 377-78, 415, 428.
Weldless tubes, 222-23.
Wet chemistry, 475.
White lead as pigment, 432.
Whitworth's liquid compression, 179.
Wind in cupola. See Blast pressure.
Wire, 61, 224-26, 328.
 brushes for cleaning steel, 430.
 rod frame, 225.
 rod rolling train, 225.
 rods, 65, 196.
- Wobblers, 203, 205, 206.
Wood saws, tempering of, 387.
Wrought iron, as malleable iron, 369.
 compared with knobbled iron, 70.
 compared with low-carbon steel, 64.
 corrosion of, *vs.* steel, 425-29.
 crystallization of, 381.
 definition of, 7.
 description of, 4.
 distinguish from steel, 66.
 electric conductivity of, 329.
 ferrite in, 317.
 from scrap, 428.
 heat treatment of, 381.
 in United States, 53.
 manufacture of, 74-94.
 modulus of elasticity of, 484.
 not hardened by quenching, 195.
 pipe made, 224.
 properties of, 64.
 scrap used in United States, 53.
 slip bands in, 186.
 strain test of, 65.
 tensile strength of, 65, 483.
 uses of, 51-52, 65, 64, 90, 317, 330.
- Zinc, 430. See also Galvanizing.
 melting point of, 434.
 salts as pigments, 432.
- Zone of combustion in cupola. See Tuyere zone.
Zones of cupola, 264-85.





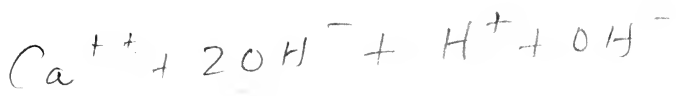
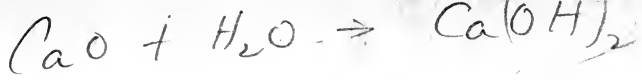

CaO

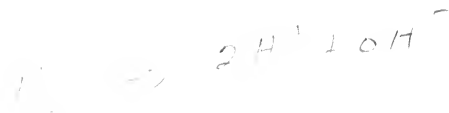



UNIVERSITY OF CALIFORNIA LIBRARY
BERKELEY

Return to desk from which borrowed.
This book is DUE on the last date stamped below.

MAR 17 1948

MAR 21 1948

APR 8 1948

APR 20 1948

MAY 12 1948

4 Apr 49

25 Apr 49

YC 68519

UNIVERSITY OF CALIFORNIA LIBRARY

