

Cornell University

Ithaca, New York

COLLEGE OF ARCHITECTURE

LIBRARY

Cornell University Library
TA 670.B16 1909

A treatise on masonry construction /



3 1924 015 384 427

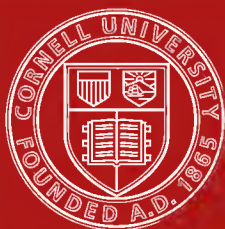

Cornell University
Library

The original of this book is in
the Cornell University Library.

There are no known copyright restrictions in
the United States on the use of the text.

<http://www.archive.org/details/cu31924015384427>

A TREATISE
ON
MASONRY CONSTRUCTION

WORKS OF THE LATE

PROF. IRA O. BAKER

PUBLISHED BY

JOHN WILEY & SONS, Inc.

A Treatise on Masonry Construction.

Materials and Methods of Testing Strength, etc.; Combinations of Materials—Composition, etc.; Foundations—Bearing Power of Soils, etc.; Masonry Structure—Dams, Retaining Walls, Abutments, Piers, Culverts, Voussoir Arches, Elastic Arches. Tenth Edition, Re-written and Enlarged. 745 pages, 6 by 9, 244 figures, cloth, \$5.00 net.

A Treatise on Roads and Pavements.

Third Edition, Re-written and Enlarged. 666 pages, 6 by 9, 235 figures, 83 tables, cloth, \$4.50 net.

A TREATISE
ON
MASONRY CONSTRUCTION

BY
IRA OSBORN BAKER
LATE PROFESSOR OF CIVIL ENGINEERING, UNIVERSITY OF ILLINOIS

TENTH EDITION, RE-WRITTEN AND ENLARGED
NINTH IMPRESSION

NEW YORK
JOHN WILEY & SONS, INC.
LONDON: CHAPMAN & HALL, LIMITED

Ar. 2487
Copyright, 1889, 1899, 1909,
BY
IRA O. BAKER

Printed in U. S. A.

PRESS OF
BRAUNWORTH & CO., INC.
BOOK MANUFACTURERS
BROOKLYN, NEW YORK

PREFACE FOR TENTH EDITION

THE first edition of this volume appeared in 1889, but developments in the manufacture and testing of portland cement and the increasing use of concrete made a revision necessary in 1899; and now the extensive use of plain concrete and the introduction of reinforced concrete make a further revision necessary. Therefore it has been decided to re-write the entire book to the end that it may be brought up to date in various matters and that numerous modifications may be made in the text. The size of the volume has been increased by adding to the size and the number of the pages. Numerous changes and additions have been made throughout the book, but the most of the entirely new matter will be found in the chapter on Plain Concrete and in the three new chapters on Reinforced Concrete, Concrete Building-Blocks, and Elastic Arch, and also in connection with the new structures illustrated. The number of structures described has been materially increased, and it is believed that those presented represent the latest practice of leading engineers. The author is under obligations to many engineers for the use of drawings in preparing illustrations, and has tried to acknowledge each in its proper place. This edition contains all of the elements which made former editions convenient for practical use and ready reference.

CHAMPAIGN, ILL., August 15, 1909.

PREFACE FOR FIRST EDITION

THE present volume is an outgrowth of the needs of the author's own class-room. The matter is essentially that presented to his classes for a number of years past, a considerable part having been used in the form of a blue-print manuscript text-book. It is now published for the greater convenience of his own students, and with the hope that it may be useful to others. The author knows of no work which treats of any considerable part of the field covered by this volume. Nearly all of the matter is believed to be entirely new.

The object has been to develop principles and methods and to give such examples as illustrate them, rather than to accumulate details or to describe individual structures. The underlying principles of ordinary practice are explained; and, where needed, ways are pointed out whereby it may be improved. The common theories are compared with the results of actual practice; and only those are recommended which have been verified by experiments or experience, since true theory and good practice are always in accord. The author has had the benefit of suggestions and advice from practical masons and engineers, and believes that the information here presented is reliable, and that the examples cited represent good practice. The structures illustrated are actual ones. The accredited illustrations are from well-authenticated copies of working drawings, and are presented without any modification whatever; while those not accredited are representative of practice so common that a single name could not properly be attached.

In the preparation of the book the endeavor has been to observe a logical order and a due proportion between different parts. Great care has been taken in classifying and arranging the matter. It will be helpful to the reader to notice that the volume is divided successively into parts, chapters, articles, sections having small-capital black-face side-heads, sections having lower-case black-face side-heads, sections having lower-case italic side-heads, and sections having simply the serial number. In some cases the major subdivisions of the sections are indicated by small numerals. The constant aim has been to present the subject clearly and concisely.

Every precaution has been taken to present the work in a form for convenient practical use and ready reference. Numerous cross references are given by section number; and whenever a figure or a table is mentioned, the citation is accompanied by the number of the page on which it may be found. The table of contents shows the general scope of the book; the running title assists in finding the different parts; and a very full index makes everything in the book easy of access. There are also a number of helps for the student, which the experienced teacher will not fail to recognize and appreciate.

Although the book has been specially arranged for engineering and architectural students, it is hoped that the information concerning the strengths of the materials, the data for facilitating the making of estimates, the plans, and the costs of actual structures, will prove useful to the man of experience. Considering the large amount of practical details presented and the great difference in the methods employed by various constructors, it is probable that practical men will find much to criticise. The views here expressed are, however, the results of observation throughout the entire country, and of consultation and correspondence with many prominent and practical men, and represent average good practice. The experienced engineer may possibly also feel that some subjects should have been treated more fully; but it is neither wise nor possible to give in a single volume minute details. These belong to technical journals, proceedings of societies, and special reports of particular work.

No pains have been spared in verifying data and checking results. Should any error, either of printer or author, be discovered—as is very possible in a work of so much detail, despite the great care used,—the writer will be greatly obliged by prompt notification of the same.

The author gratefully acknowledges his indebtedness to many engineers for advice and data, and to his former pupil and present co-laborer, Prof. A. N. Talbot, for many valuable suggestions.

CHAMPAIGN, ILL., July 9, 1889.

CONTENTS

PART I. THE MATERIALS

CHAPTER I. NATURAL STONE

	PAGE
INTRODUCTION.	1
ART. 1. REQUISITES FOR GOOD BUILDING STONE.	3
ART. 2. TESTS OF BUILDING STONE.	5
<i>Weight.</i>	6
<i>Hardness and Toughness.</i>	7
<i>Strength.</i> Crushing Strength. Transverse Strength. Shearing Strength. Elasticity.	7
<i>Durability.</i> Destructive Agents: mechanical, chemical. Resisting Agents: chemical composition, physical structure, seasoning. Methods of Testing Durability: natural, artificial. Methods of Preserving.	15
ART. 3. CLASSIFICATION AND DESCRIPTION OF BUILDING STONES.	27
Classification. Description of Trap, Granite, Marble, Limestone, and Sandstone. Location of Quarries.	

CHAPTER II. BUILDING BRICK

ART. 1. CLAY BRICK.	34
Classification. Tests. Strength. Cost.	
ART. 2. SAND-LIME BRICK.	45
Materials. Characteristics. Cost.	

CHAPTER III. COMMON AND HYDRAULIC LIME

CLASSIFICATION OF LIME AND CEMENT.	49
ART. 1. COMMON LIME.	50
Kinds. Testing. Storing. Cost.	
ART. 2. HYDRAULIC LIME.	53

CHAPTER IV. HYDRAULIC CEMENT

CLASSIFICATION OF CEMENTS.	54
ART. I. PORTLAND, NATURAL, AND POZZOLAN CEMENT	55
Description. Manufacture. Weight. Cost	

	PAGE
ART. 2. TESTING CEMENT.	58
Color, Thoroughness of Burning, Activity, Soundness, Fineness, Strength.	
CHAPTER V. SAND, GRAVEL, AND BROKEN STONE	
ART. 1. SAND.	85
Requisites for Good Sand: Durability, Sharpness, Cleanness, Fine- ness, Voids. Stone Screenings. Selecting a Sand. Cost. Weight.	
ART. 2. GRAVEL.	97
Requisites for Good Gravel: Minerals, Cleanness, Voids.	
ART. 3. BROKEN STONE.	100
Sizes. Voids. Weight. Cost.	

PART II. PREPARING AND USING THE MATERIALS

CHAPTER VI. LIME AND CEMENT MORTAR

ART. 1. LIME MORTAR.	104
Slaking the Lime. Proportioning. Mixing. Strength. Effect of Freezing. Data for Estimates.	
ART. 2. CEMENT MORTAR.	108
Density of Mortar. Theory of Proportions. Units used in Propor- tioning. Mixing. Data for Estimates. Strength. Cost. Effect of Re-tempering. Waterproof Mortar. Effect of Freezing.	

CHAPTER VII. PLAIN CONCRETE

DEFINITION. USES. PLAN OF PROPOSED DISCUSSION.	132
ART. 1. THE MATERIALS.	133
Cement. Sand. Broken Stone. Gravel. Cinders.	
ART. 2. LAWS OF PROPORTIONS.	137
Density. Theory of Proportions: Relation between Strength and Amount of Cement; Relation between Strength and Density. Methods of Proportioning: By Arbitrary Assignment; By Voids; By Trial; By Sieve Analysis. Units Used in Proportioning. Ingredients required for a Yard.	
ART. 3. FORMS FOR CONCRETE.	159
Ordinary Construction. Improved Construction. Cleaning the Forms. Time to Remove. Cost.	
ART. 4. MAKING AND PLACING CONCRETE.	166
Consistency. Mixing. Placing. Depositing under Water. Laying in Freezing Weather. Finish of Surface. Waterproofing Concrete. Contraction Joints. Efflorescence. Effect of Sea-Water. Effect of Alkali. Effect of Oil.	

	PAGE
ART. 5. STRENGTH, WEIGHT, AND COST.	194
Compressive Strength. Tensile Strength. Transverse Strength. Shearing Strength. Modulus of Elasticity. Weight. Cost.	

CHAPTER VIII. REINFORCED CONCRETE

DEFINITION. HISTORY. ADVANTAGES AND DISADVANTAGES.	218
ART. 1. REINFORCED CONCRETE BEAMS.	221
Theory of Flexure. Formulas for Bending. Bond. Diagonal Tension. The Reinforcement. Working Stresses. Fireproofing. Economic Design.	
ART. 2. REINFORCED CONCRETE COLUMNS.	243
Long <i>vs.</i> Short Columns. Eccentric Loads. Strength of Plain Concrete Columns. Column Reinforcement. Formulas for Longitudinal Reinforcement. Formulas for Circumferential Reinforcement. Working Stresses.	
ART. 3. DETAILS OF CONSTRUCTION.	250
The Forms. Placing the Reinforcement. Placing the Concrete. Removing the Forms. Expansion and Contraction. Separately Moulded Members. Cost of Reinforced Concrete Buildings. Bibliography.	

CHAPTER IX. CONCRETE BUILDING-BLOCKS AND ARTIFICIAL STONE

ART. 1. CONCRETE BUILDING-BLOCKS.	262
Sizes. Forms. Materials. Manufacture. Laying.	
ART. 2. ARTIFICIAL STONE.	267

CHAPTER X. STONE CUTTING

ART. 1. TOOLS.	269
Eighteen hand tools illustrated and described. Machine tools described.	
ART. 2. METHODS OF FORMING THE SURFACES.	273
Four methods illustrated and described.	
ART. 3. METHODS OF FINISHING THE SURFACES.	275
Eight methods illustrated and described.	

CHAPTER XI. STONE MASONRY

ART. 1. DEFINITIONS AND DESCRIPTIONS.	279
Definitions. Classifications. General Rules for Laying. Ashlar Masonry. Squared-stone Masonry. Rubble Masonry. Concrete Rubble.	

	PAGE
ART. 2. STRENGTH AND COST.	293
Crushing Strength. Pressure allowed. Measurement of Stone Masonry. Cost. Bibliography.	

CHAPTER XII. BRICK MASONRY.

MORTAR. BOND. LAYING. IMPROVEMENTS IN METHODS OF LAYING. CRUSHING STRENGTH. PRESSURE ALLOWED. TRANSVERSE STRENGTH. MEASUREMENT. DATA FOR ESTIMATES. COST. SPECI- FICATIONS. WATERPROOF BRICK MASONRY.	306
--	-----

PART III. FOUNDATIONS.

CHAPTER XIII. INTRODUCTORY.

DEFINITIONS, AND PLAN OF PROPOSED DISCUSSION.	330
---	-----

CHAPTER XIV. ORDINARY FOUNDATIONS.

ART. 1. THE BED OF THE FOUNDATION.	333
Examination of the Site. Bearing Power of Soils. Methods of Im- proving Bearing Power.	
ART. 2. DESIGNING THE FOUNDATION.	347
Load to be Supported. Area Required. Center of Pressure and Center of Base. Independent Piers. Effect of Wind. Spread Foot- ings. Deep Foundations: Concrete Piers; Hydraulic Caissons.	
ART. 3. PREPARING THE BED.	364
On Rock. On Firm Earth. In Wet Ground.	

CHAPTER XV. PILE FOUNDATIONS.

ART. 1. DESCRIPTION OF PILES.	367
Bearing Piles. Screw Piles. Disk Piles. Sheet Piles.	
ART. 2. PILE DRIVING.	377
Pile-driving Machines: drop-hammer, steam-hammer, water-jet. Cost of Driving Piles.	
ART. 3. BEARING POWER OF PILES.	387
Column Piles. Friction Piles. Formulas for Bearing Power. Bear- ing Power Determined by Experiment.	
ART. 4. ARRANGEMENT OF THE FOUNDATION.	399
Distance between Piles. Lateral Yielding. Sawing off Piles. Finishing the Foundation.	

CHAPTER XVI. FOUNDATIONS UNDER WATER

	PAGE
PLAN OF PROPOSED DISCUSSION.	405
ART. 1. COFFER-DAM PROCESS.	406
Construction of Dam. Leakage. Pumps. Preparing the Founda- tion. Cost. Conclusion.	
ART. 2. CRIB AND OPEN-CAISSON PROCESS.	417
Principle. Construction of Crib. Construction of Caisson. Ex- cavating the Site.	
ART. 3. DREDGING THROUGH WELLS.	422
Principle. Excavators. Noted Examples. Frictional Resistance. Cost. Conclusion.	
ART. 4. PNEUMATIC PROCESS.	428
Principle. History. Vacuum Process. Pneumatic Piles. Pneu- matic Caissons. Position of Air Lock. Excavation. Rate of Sinking. Maximum Depth Reached. Guiding the Caisson. Frictional Resistance. Filling the Air-Chamber. Noted Examples. Pneumatic Foundations for Buildings. Physiological. Effect of Compressed Air. Cost of Pneumatic Foundations. Conclusion.	
ART. 5. FREEZING PROCESS.	455
Principle. History. Advantages and Disadvantages.	
ART. 6. COMPARISON OF METHODS.	456

PART IV. MASONRY STRUCTURES

CHAPTER XVII. MASONRY DAMS

CLASSIFICATIONS OF DAMS.	458
ART. 1. STABILITY OF GRAVITY DAMS.	459
Methods of Failure. Stability against Sliding. Stability against Overturning. Stability against Crushing. Further Refinement.	
ART. 2. OUTLINES OF THE DESIGN.	478
Width on Top. The Profile. Noted Examples: Gravity Dams; Arch Dams. The Plan. Overfall Dams. Solid <i>vs.</i> Hollow Dams. Quality of the Masonry.	

CHAPTER XVIII. RETAINING WALLS

ART. 1. THEORY OF STABILITY.	489
Method of Failure. Difficulties of the Problem. Theories of Earth Pressure. Coefficient of Cohesion. Reliability of Theoretical Formulas for Earth Pressure. Empirical Rules for Thickness of Wall.	

	PAGE
ART. 2. DETAILS OF CONSTRUCTION.	511
Foundation. Drainage. Contraction Joints. Placing the Back-Filling. Land Ties. Relieving Arches. Economical Vertical Cross Section. Design of Reinforced-Concrete Retaining Walls. Examples.	
CHAPTER XIX. BRIDGE ABUTMENTS	
Definitious. Comparison of forms. Theory of Stability. Foundation. Examples: Wing Abutments; Straight Abutments; U Abutments; T Abutments; Pier Abutment.	535
CHAPTER XX. BRIDGE PIERS	
Functions of a Bridge Pier. Theory of Stability. Form of Cross Section. Pivot Piers. Examples: Plain Concrete; Reinforced Concrete.	551
CHAPTER XXI. CULVERTS	
ART. 1. WATERWAY REQUIRED.	564
The Factors. Methods of Determining Waterway. Formulas.	
ART. 2. PIPE CULVERTS.	569
General Design of Culverts. Vitrified Pipe Culvert. Examples. Concrete Pipe Culvert. Examples.	
ART. 3. BOX CULVERT.	579
Materials. Reinforced Concrete Box-Culvert. Examples. Cost.	
ART. 4. ARCH CULVERT.	593
Splay of Wings. Junction of Wings to Body. Examples. Cost.	
CHAPTER XXII. VOUSSOIR ARCHES	
CLASSIFICATION AND DEFINITIONS.	606
ART. 1. THEORY OF STABILITY.	608
Line of Resistance Defined. Methods of Failure. External Forces. Hypotheses for the Crown Thrust. To Find the Crown Thrust. Rational Theory of the Arch. Scheffler's Theory. Rankine's Theory. Stability of Abutment.	
ART. 2. EMPIRICAL RULES FOR STABILITY.	641
Formulas for Proportions. Dimensions of Actual Arches. Dimensions of Actual Abutments.	
ART. 3. ARCH CENTERS.	650
Definitions. The Problem of Center Construction. The Load to be Supported. Outline Forms of Centers. Camber. Striking the Center.	
ART. 4. DETAILS OF CONSTRUCTION.	659
Backing. Hollow Spandrels. Examples of Large Voussoir Arches.	
ART. 5. BRICK ARCHES.	667
Bond. Examples. Uses.	

CHAPTER XXIII. ELASTIC ARCHES

	PAGE
ART. 1. PLAIN-CONCRETE ARCH HAVING FIXED ENDS.	670
Equations of Condition. To Find the True Equilibrium Polygon. Live and Dead Load Stresses. Temperature Stresses. Stresses due to Shortening. Combined Stresses. Approximate Solutions. Reliability of Elastic Theory. Placing the Concrete. Noted Examples of Plain- Concrete Hingeless Arches.	
ART. 2. REINFORCED-CONCRETE HINGELESS ARCH.	708
Equation of Condition. Advantages of Reinforced Arch. Analysis of Reinforced Arch. Systems of Reinforcing. Examples of Reinforced- Concrete Hingeless Arches.	
ART. 3. HINGED ARCH.	720
Analysis of Hinged Arch. Hinged <i>vs.</i> Hingeless Arches. Dimensions of Hinged Arches.	

APPENDIXES. SPECIFICATIONS

I. SPECIFICATIONS FOR CEMENT.	723
II. SPECIFICATIONS FOR CONCRETE.	726
III. SPECIFICATIONS FOR MASONRY.	729

MASONRY CONSTRUCTION

INTRODUCTION

MASONRY may be defined as any construction formed of inorganic non-metallic material in which the parts are so fitted together as to form a single united whole. In this broad sense it includes all kinds of stone masonry, every variety of brick work, and all of the monolithic work commonly called concrete. "Masonry, the most permanent form of construction which man can make, the only material suitable for those works which assume a monumental character and, enduring from one epoch to another, transmit to future ages the actual work of today—masonry respected for its antiquity, admired for its enduring futurity," is the subject of this volume.

Under the general head of Masonry Construction will be discussed the subjects relating to the use of stone and brick as employed by the engineer or architect in the construction of buildings, retaining walls, bridge piers, culverts, arches, etc., including the foundations for the same. For convenience, the subject will be divided as follows:

Part I. Description and Characteristics of the Materials.

Part II. Methods of Preparing and Using the Materials.

Part III. Foundations.

Part IV. Masonry Structures.

“The first cost of masonry should be its only cost. Though superstructures decay and drift away, though embankments should crumble and wash out, masonry should stand as one great mass of solid rock, firm and enduring.”

—*Anonymous.*

PART I

THE MATERIALS

CHAPTER I

NATURAL STONE

1. The selection of a stone for structural purposes is always a matter of moment, and is sometimes a question of great importance. Usually a structure is made of stone to secure either durability or strength, or both; but natural stones differ in strength and durability as much as any building material, and stone from different parts of the same quarry may vary considerably. It is not expected that the engineer or architect should be an expert geologist, mineralogist, or chemist; but it is reasonable to expect that he should be fairly well informed as to the qualities of the different classes of building stones and also as to the precautions to be taken in selecting a stone for any particular purpose.

ART. 1. REQUISITES FOR GOOD BUILDING STONE.

2. The qualities which are most important in stone used for construction are cheapness, durability, strength, and beauty. The relative importance of these different qualities varies greatly with the nature of the structure and with the personal opinion of the engineer or architect.

3. **CHEAPNESS.** The factor which usually determines the value of a stone for structural purposes is its cheapness. The items which contribute to the cheapness of a stone are abundance, proximity of quarries to place of use, facility of transportation, and the ease with which the stone is quarried and worked.

The wide distribution and the great variety of good building stone in this country are such that suitable stone should everywhere be cheap. That such is not the case is probably due either to a lack of the development of home resources or to a lack of confidence in home products. The several State and Government geological surveys have recently done much to increase our knowledge of the building stones of this country.

“The lack of confidence in home resources has very frequently caused stones of demonstrated good quality to be carried far and wide, and frequently to be laid down upon the outcropping ledges of material in every way their equal. The first stone house erected in San Francisco, for example, was built of stone brought from China; and even in 1880 the granites mostly employed there were brought from New England or from Scotland. Yet there are no stones in our country more to be recommended than the California granites. Some of the prominent public and private buildings in Cincinnati are constructed of stone that was carried by water and railway a distance of about 1500 miles. Within 150 miles of Cincinnati, in the sub-carboniferous limestone district of Kentucky, there are very extensive deposits of dolomitic limestone that afford a beautiful building stone, which can be quarried at no more expense than that of the granite of Maine. Moreover, this dolomite is easily carved, and requires not more than one third the labor to give it a surface that is needed by granite. Experience has shown that the endurance of this stone under the influence of weather is very great; yet because it has lacked authoritative indorsement there has been little market for it, and lack of confidence in it has led to the transportation half-way across the continent of a stone little, if any, superior to it.”

Development of local resources follows in the wake of good information concerning them, for the lack of confidence in home products can not be attributed to prejudice.

The facility with which a stone may be quarried and worked is an element affecting cheapness. To be cheaply worked, a stone must not only be as soft as durability will allow, but it should have no flaws, knots, or hard crystals.

4. DURABILITY. Next in importance after cheapness is durability. Rock is supposed to be the type of all that is unchangeable and lasting; but the truth is that, unless a stone is suited to the conditions in which it is placed, there are few substances more liable to decay and utter failure. The durability of stone is a subject upon which there is very little reliable knowledge. The question of endurance under the action of weather and other forces can not be readily determined. The external aspect of the stone may fail to give any clue to it; nor can all the tests we yet know determine to a certainty, in the laboratory, just how a given rock will withstand the effect of our variable climate and the gases of our cities. If our land were what is known as a rainless country, and if the temperature were uniform throughout the year, the selection of a durable building stone would be much simplified. The cities of northern Europe are full of failures in the stones of important structures. The most

costly building erected in modern times, perhaps the most costly edifice reared since the Great Pyramid,—the Parliament House in London,—was built of a stone taken on the recommendation of a committee representing the best scientific and technical skill of Great Britain. The stone selected was submitted to various tests, but the corroding influence of the London atmosphere was overlooked. The great structure was built, and now it seems questionable whether it can be made to endure as long as a timber building would stand, so great is the effect of the gases of the atmosphere upon the stone. This is only one of the numerous instances that might be cited in which a neglect to consider the climatic conditions of a particular locality in selecting a building material has proved disastrous.

“The great difference which may exist in the durability of stones of the same kind, presenting little difference in appearance, is strikingly exemplified at Oxford, England, where Christ Church Cathedral, built in the twelfth or thirteenth century of oölite from a quarry about fifteen miles away, is in good preservation, while many colleges only two or three centuries old, built also of oölite from a quarry in the neighborhood of Oxford, are rapidly crumbling to pieces.”*

5. STRENGTH. The strength of stone is in some instances a cardinal quality, as when it is to form piers or columns to support great weights, or lintels that span considerable intervals. It is also an indispensable attribute of stone that is to be exposed to mechanical violence or unusual wear, as in steps, sills, jambs, etc.

6. BEAUTY. This element is of more importance to the architect than to the engineer; and yet the latter can not afford to neglect entirely the element of beauty in the design of his most utilitarian structures. The stone should have a durable and pleasing color.

ART. 2. TESTS OF BUILDING STONE.

7. As a general rule, the densest, hardest, and most uniform stone will most nearly meet the preceding requisites for a good building stone. The fitness of stone for structural purposes can be determined approximately by examining a fresh fracture. It should be bright, clean, and sharp, without loose grains, and free from any dull, earthy appearance. The stone should contain no “drys,” i.e., seams containing material not thoroughly cemented together, nor “crow-foots,” i.e., veins containing dark-colored, uncemented material.

The more formal tests employed to determine the qualities of a building stone are: (1) weight or density, (2) hardness and toughness, (3) strength, (4) durability.

* Rankine's Civil Engineering, p. 362.

1. WEIGHT OF STONE.

8. Weight or density is an important property, since upon it depends to a large extent the strength and durability of the stone.

If it is desired to find the exact weight per cubic foot of a given stone, it is generally easier to find its specific gravity first, and then multiply by 62.4—the weight, in pounds, of a cubic foot of water. This method obviates, on the one hand, the expense of dressing a sample to regular dimensions, or, on the other hand, the inaccuracy of determining the volume of a rough, irregular piece. Notice, however, that this method determines the weight of a cubic foot of the solid material, which will be a little more than the weight of a cubic foot of the stone as used for structural purposes. In finding the specific gravity there is some difficulty in getting the correct displacement of porous stones,—and all stones are more or less porous. There are various methods of overcoming this difficulty, which give slightly different results. The following method, recommended by General Gillmore, is most frequently used:

All loose grains and sharp corners having been removed from the sample and its weight taken, it is immersed in water and weighed there after all bubbling has ceased. It is then taken out of the water, and, after being compressed lightly in bibulous paper to absorb the water on its surface, is weighed again. The specific gravity is found by dividing the weight of the dry stone by the difference between the weight of the saturated stone in air and in water. Or expressing this in a formula,

$$\text{Specific Gravity} = \frac{W_a}{W_s - W_t},$$

in which W_a represents the weight of dry stone in air, W_s the weight of saturated stone in air, W_t the weight of stone immersed in water.

The following table contains the weight of the stones most frequently met with.

TABLE 1.
WEIGHT OF BUILDING STONES.

KIND OF STONE.	Mean Specific Gravity.	POUNDS PER CUBIC FOOT.		
		Min.	Max.	Mean.
Granites.....	2.67	161	178	167
Limestones.....	2.53	146	174	158
Marbles.....	2.72	157	180	170
Sandstones.....	2.22	127	151	139
Slates.....	2.78	160	175	174

2. HARDNESS AND TOUGHNESS.

9. The apparent hardness of a stone depends upon (1) the hardness of its component minerals and (2) their state of aggregation. The hardness of the component minerals is determined by the resistance they offer to being scratched; and varies from that of talc which can easily be scratched with the thumb-nail, to that of quartz which scratches glass. Many rocks composed of hard materials work readily, because their grains are loosely coherent; while others composed of softer materials are quite tough and difficult to work, owing to the tenacity with which the particles adhere to each other. Obviously a stone in which the grains adhere closely and strongly one to another will be stronger and more durable than one which is loose textured and friable.

The toughness of a stone depends upon the force with which the particles of the component minerals are held together.

Both hardness and toughness should exist in a stone used for stoops, pavements, road-metal, the facing of piers, etc. No experiments have been made in this country to test the resisting power of stone when exposed to the different kinds of service. A table of the resistance of stones to abrasion is often quoted, but as it contains only foreign stones, which are described by local names, it is not of much value.

3. STRENGTH.

Under this head will be included (1) crushing or compressive strength, (2) transverse strength, (3) shearing strength, (4) elasticity. Usually, when simply the strength is referred to, the crushing strength is intended.

10. **CRUSHING STRENGTH.** The crushing strength of a stone is determined by applying measured force to prisms until they are crushed. The results for the crushing strength vary greatly with the details of the experiments. Several points, which should not be neglected either in planning a series of experiments or in using the results obtained by experiment, will be taken up separately, although they are not entirely independent.

11. **Form of Test Specimen.** Experiments show that all brittle materials when subjected to a compressive load fail by shearing on certain definite angles. For brick or stone, the plane of rupture makes an angle of about 30° with the direction of the compressing force. For this reason, the theoretically best form of test specimen would be a prism having a height of about one and a half times the least lateral dimension. The result is not materially different if

the height is three or four times the least lateral dimension. But if the test specimen is broader than high, the material is not free to fail along the above plane of rupture; and consequently the strength per unit of bed area is greater than when the height is greater than the breadth.

However, notwithstanding the fact that theoretically the test specimen should be higher than broad, it is quite the universal custom to determine the crushing strength of stone by testing cubes; and this practice is likely to continue so that the results may be comparable with those hitherto obtained and published. Theoretically the strength of a cube of stone is about 9 per cent greater than that of a prism one and a half times as high as broad.

12. Size of the Cube. Although the cube is the form of test specimen generally adopted, there is not equal unanimity as to the size of the cube; but it has been conclusively proved that the strength per square inch of bed area is independent of the size of the cube, and therefore the size of the test specimen is immaterial. A two-inch cube is most frequently used in compression tests.

General Gillmore, in 1875, made two sets of experiments which he claimed proved that the relation between the crushing strength and the size of the cube can be expressed by the formula

$$y = a \sqrt[3]{x},$$

in which y is the total crushing pressure in pounds per square inch of bed area, a is the crushing pressure of a 1-inch cube of the same material, and x is the length in inches of an edge of the cube under trial. For two samples of Berea (Ohio) sandstone, a was 7000 and 9500 lb., respectively.* But the testing machine was too crude, the experiments were insufficient in number, and the cubes were too small and too nearly the same size to establish any such law. Results by other observers with better machines, particularly by General Gillmore himself † with the large and accurate testing machine at the Watertown (Mass.) Arsenal, ‡ uniformly show this supposed law to be without any foundation. Unfortunately the above relation between strength and bed area is frequently quoted, and has found a wide acceptance among engineers and architects, notwithstanding the fact that it is not true.

* Report on Strength of Building Stone, Appendix, Report of Chief of Engineers of U. S. A. for 1875.

† Notes on the Compressive Resistance of Freestone, Brick Piers, Hydraulic Cements, Mortars, and Concrete, Q. A. Gillmore. John Wiley & Sons, New York, 1888.

‡ Report on the "Tests of Metals," etc., for the year ending June 30, 1884, p. 126, 166, 167, 197, 212, 213, 215; the same being Sen. Ex. Doc. No. 35, 49th Cong., 1st Session. For a discussion of these data by the author, see *Engineering News*, vol. xix, p. 511-512.

13. Dressing the Cube. It is well known that even large stones can be broken by striking a number of comparatively light blows along any particular line, in which case the force of the blows gradually weakens the cohesion of the particles. This principle finds application in the preparation of test specimens of stone.

The position of the test specimen with reference to the bedding planes of the rock in its native position has a very important relation to the strength of the stone. The direction in which a stone splits most easily is called the rift, and the next easiest the grain, while the direction in which the resistance to splitting is the greatest is called the head. The test specimen will be the strongest, if the pressure is applied perpendicular to the rift. In most cases the rift is horizontal, i.e., is parallel to the natural bed; but in some cases the rift makes an angle with the natural bed. Horizontally bedded stones are quarried by blasting or wedging along the natural lines of cleavage, or by channeling and wedging along the laminations; but if the rift is not horizontal, it is common practice to cut out blocks without reference to the natural seams, since the quarrying machines run most easily upon horizontal tracks, and since it is desirable to maintain a level quarry floor. In the last case, then, there is a difference between the rift and the "natural bed"; and in preparing test specimens care should be taken to have two sides of the cubes parallel to the rift, which should be marked so that the pressure may be applied on these faces. It is not sufficient to have the faces of the cubes parallel and perpendicular to the broadest face of the original block, for the latter may not have been cut out with reference to the rift. The rift can be determined by a careful examination of the block. The failure to apply the pressure perpendicular to the rift doubtless accounts for part of the large difference in strength of different specimens found by most experimenters.

If the specimen is dressed by hand, the concussion of the tool greatly affects its internal conditions, particularly with test specimens of small dimensions. With 2-inch cubes, the tool-dressed specimen usually shows only about 60 per cent of the strength of the sawed sample. The sawed sample most nearly represents the conditions of actual practice. Unfortunately, experimenters seldom state whether the specimens were tool-dressed or sawed. The disintegrating effect of the tool in dressing is greater with small than with large specimens. This may account for some of the difference in strength of different sizes of test specimen as seems to be shown by some experiments.

14. Cushions. Homogeneous stones in small cubes appear in all cases to break as shown in Fig. 1. The forms of the fragments *a* and *b* are, approximately, either conical or pyramidal. The more

or less disk-shaped pieces *c* and *d* are detached from the four sides of the cube with a slight explosion. In the angles *e* and *f*, the stone is generally found crushed and ground into powder. This general form of breakage occurs also in non-homogeneous stones when

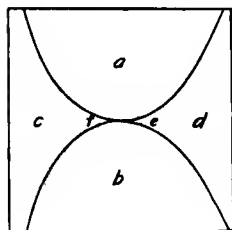

FIG. 1.

crushed on their beds, but in this case the modification which the grain of the stone produces must be taken into account.

The nature of the material in contact with the stone while under pressure is a matter of great moment. If the materials which press upon the top and bottom of the specimen are soft and yielding and press out sidewise, they introduce horizontal forces which materially diminish the apparent crushing strength of the stone. If the pressing

surfaces are hard and unyielding, the resistance of these surfaces adds considerably to the apparent strength.

Formerly steel, wood, lead, and leather were much used as pressing surfaces. Under certain limitations, the relative crushing strengths of stones with these different pressing surfaces are 100, 89, 65, and 62 respectively.*

Tests of the strength of blocks of stone are useful only in comparing different stones, and give no idea of the strength of structures built of such stone (see § 622) or of the crushing strength of stone in large masses in its native bed (see § 657). Then, since it is not possible to have the stone under the same conditions while being tested that it is in the actual structure, it is best to test the stone under conditions that can be accurately described and readily duplicated. Therefore it is rapidly coming to be the custom to test the stone between metal pressing surfaces. Under these conditions the strength of the specimen will vary greatly with the degree of smoothness of its bed surfaces. Hence, to obtain definite and precise results, these surfaces should be rubbed or ground perfectly smooth; but as this is tedious and expensive, it is quite common to reduce the bed-surfaces to planes by plastering them with a thin coat of plaster of paris, and inverting the cube on a sheet of plate glass or allowing the plaster to set under a small pressure between the metal pressing surfaces of the testing machine. With the stronger stones, specimens with plastered beds will show less strength than those having rubbed beds, and this difference will vary also with the length of time the plaster is allowed to harden. With a stone having a strength of 5,000 to 6,000 pounds per square inch, allowing the plaster to attain its

* Report on Building Stones, in Report of Chief of Engineers, U. S. A., 1875, App. II; also bound separately, page 29.

maximum strength, this difference varied from 5 to 20 per cent, the mean for ten trials being almost 10 per cent of the strength of the specimen with rubbed beds.

The testing machine should be provided with a plate having a ball-and-socket bearing, to secure a uniform distribution of the pressure; and care must be taken to place the test piece accurately in the axis of the testing machine. If the specimen spalls off on only one side, it is almost certain that it was not well bedded or that it was not placed centrally in the machine. If the cube is well bedded and properly placed in the machine, it will fail suddenly with a considerable report and the pieces will fly in all directions.

15. Effect of Water. The specimen should be reasonably dry, since a wet stone is not as strong as a dry one (see § 79).

16. Data on Crushing Strength. Table 2 shows the results of all the stones tested with the U. S. testing machine at the Watertown Arsenal from 1883 to 1905, except two stones noted below. The quantities in the columns headed "Min." represent the strength of the weakest stone of each particular kind, and are the mean of three or more tests; and similarly for the quantities in the columns headed "Max."

Two samples of granite were tested which are not included in Table 2. The results in the table are for test specimens prepared

TABLE 2.
COMPRESSIVE STRENGTH OF STONES.
Cubes set in plaster of paris.

KIND OF STONE.	No. of Quarries.	No. of Tests.	ULTIMATE CRUSHING STRENGTH.					
			Pounds per Square Inch.			Tons per Square Foot.		
			Min.	Max.	Mean.	Min.	Max.	Mean.
Granite	10	37	2 045	27 738	19 379	147	1 990	1 400
Limestone ..	15	35	3 634	24 121	9 438	261	1 740	680
Marble	10	21	6 872	17 780	12 709	495	1 280	910
Sandstone . . .	19	84	4 353	15 163	9 333	313	1 090	670

in the usual way; but the two cubes referred to were dressed out to 2½ inches on a side and then reduced on a rubbing bed to 2 inches. The average for six tests of this stone, granite from Salisbury, N. C., was 49,457 pounds per square inch, the maximum for a single cube being 51,990.* The results for this stone are the highest known to

* Tests of Metals, etc., 1905, p. 421.

have been obtained for the crushing strength of any stone or brick, and are probably largely due to the manner of dressing the specimens and also to unusual care in selecting the sample (§ 13), in bedding the cubes, and in placing them in the testing machine; and hence are not to be taken as representative.

For somewhat similar reasons the argillaceous limestone from which the Rosendale natural cement is made, gave a crushing strength of 40,875 pounds per square inch.

17. Crushing Strength of Slabs. Only a few experiments have been made to determine the crushing strength of slabs of stone, that is, of specimens less in height than in width; and in the experiments most of the specimens had a thickness proportionally much greater than the blocks of stones employed in ordinary masonry. All of the experiments show that the strength per square inch of bed area is considerably greater for slabs than for cubes.

Prof. J. B. Johnson from experiments by Bauschinger deduces the formula*

$$\frac{\text{strength of prism}}{\text{strength of cube}} = 0.778 + 0.222 \frac{b}{h}.$$

in which b = the least lateral dimension of the prism and h = its height. Eight experiments with the U. S. testing machine at Watertown † agree reasonably well with this formula.

18. TRANSVERSE STRENGTH. When stones are used for lintels, etc., their transverse strength becomes important. The ability of a stone to resist as a beam depends upon its tensile strength, since that is always much less than its compressive strength. A knowledge of the relative tensile and compressive strengths of stones is valuable in interpreting the effect of different pressing surfaces in compressive tests, and also in determining the thickness required for lintels, sidewalks, cover stones for box culverts, thickness of footing courses, etc.

Owing to the small cross section of the specimen employed in determining the transverse strength of stones,—usually a bar 1 inch square,—the manner of dressing the sample affects the apparent transverse strength to a greater degree than the compressive strength (see § 13).

The following formulas are useful in computing the breaking load of a slab of stone. Let W represent the concentrated center load *plus* half of the weight of the beam itself, in pounds; and let

* Johnson's Materials of Construction, p. 31.

† See Report on "Tests of Metals, etc.," for 1884.—Sen. Ex. Doc. No. 35, 49th Cong., 1st Session,—p. 126 and 212; or Notes on the Compressive Resistance of Free-stone, Brick Piers and Hydraulic Cements, Mortars and Concretes, Q. A. Gillmore, p. 34, 37, 69.

b , d , and l represent the breadth, depth, and length, in inches, respectively. Let R = the modulus of rupture, in lb. per sq. in.; let C = the weight, in pounds, required to break a bar 1 inch square and 1 foot long between bearings; and let L = the length of the beam in feet. Then

$$W = \frac{2 b d^2}{3 l} R = \frac{b d^2}{L} C.$$

The equivalent uniformly distributed weight is equal to twice the concentrated center load.

19. According to tests made with the U. S. testing machine at Watertown, the transverse strength of each of the several classes of building stones in terms of its crushing strength is as follows:*

Granite	8.7 per cent
Marble	15.2 " "
Limestone	17.4 " "
Sandstone	14.2 " "

Each result is the mean of four to six tests. The relatively small transverse strength of granite is evidence of the "grain" of that stone, the property which makes it easy to quarry prismatic blocks of that material.

Table 3 gives the modulus of rupture of several kinds of stone as determined with the testing machine at the U. S. Arsenal at Watertown, Mass., from 1883 to 1905. Each result is the mean of from one to four tests.

TABLE 3.
TRANSVERSE STRENGTH OF STONE.

REF. No.	KIND OF STONE.	MODULUS OF RUPTURE. Pounds per Square Inch.		
		Min.	Max.	Mean.
1	Bluestone, North River	4 433	5 618	5 026
2	Granite	1 216	2 610	1 849
3	Limestone	253	2 864	1 377
4	Marble	382	2 293	1 390
5	Sandstone	495	3 009	1 378
6	Slate—one test	7 671

The question of what margin should be allowed for safety is one that can not be determined in the abstract; it depends upon the accuracy with which the maximum load is estimated, upon whether

*Tests of Metals, etc., 1895, p. 319.

the live load is applied with or without shock, upon the care with which the stone was selected, etc. This subject will be discussed further in connection with the use of the data of the above table in subsequent parts of this volume.

20. SHEARING STRENGTH. Only occasionally is a stone used in such a position that its shearing strength is of any moment; but sometimes the shearing strength is important, for example, in a lintel or in a corbel. Not many experiments have been made on the shearing strength of stone, partly because of the relative unimportance of the matter and partly because of the difficulty in making the experiments to obtain a failure by shear independent of cross breaking.

The average of seventeen experiments on the U. S. testing machine at Watertown * seems to show that the shearing strength of stone is 11.4 per cent of its crushing strength, the range being from 7.9 to 22.1; while the average of eighteen experiments by Bauschinger † is 6.6 per cent, the range being from 5.7 to 19.1. The difference between the two sets of experiments is considerable; and is probably partly due to the use of different stones, but probably largely to differences in the method of making the experiments. In this connection see § 408.

Four to six tests upon each kind of stone, each test specimen coming from a different quarry, with the U. S. testing machine ‡ gave the shearing strength in terms of the compressive strength as follows:

Granite	11.8 per cent
Limestone	12.5 " "
Marble.....	9.6 " "
Sandstone.....	12.9 " "

21. ELASTICITY. The modulus of elasticity of a stone is of value in computing the distortion under load of a monolith; and may throw a little light upon the distortion of stone masonry under load, although the yielding due to the mortar may be proportionally very large. The modulus of elasticity of all stones varies with the load, unlike that for steel, which is constant for all loads below the elastic limit. The granites, limestones, and marbles are nearly perfectly elastic for all working loads, but the sandstones take a permanent set for the smallest loads. Masonry is not usually subjected to loads of more than 100 to 1,000 pounds per square inch; and hence the values of the modulus of elasticity between these limits are given in Table 4.

* Tests of Metals, etc., 1894, p. 430-431.

† Johnson's Materials of Construction, p. 643.

‡ Tests of Metals, etc., 1895, p. 319-20.

TABLE 4.
 MODULUS OF ELASTICITY OF STONE.*
 Between limits of 100 to 1,000 lb. per sq. in.

REF. No.	KIND OF STONE.	POUNDS PER SQUARE INCH.		
		Min.	Max.	Mean.
1	Granite.....	1 205 000	9 800 000	4 639 000
2	Limestone.....	2 439 000	10 989 000	4 675 000
3	Marble.....	3 640 000	12 000 000	6 949 000
4	Sandstone.....	1 020 000	5 714 000	2 212 800

4. DURABILITY.

22. "Although the art of building has been practiced from the earliest times, and constant demands have been made in every age for the means of determining the best materials, yet the process of ascertaining the durability of stone appears to have received but little definite scientific attention, and the processes usually employed for solving this question are still in a very unsatisfactory state. Hardly any department of technical science is so much neglected as that which embraces the study of the nature of stone, and all the varied resources of lithology in chemical, microscopical, and physical methods of investigation, wonderfully developed within the last quarter century, have never yet been properly applied to the selection and protection of stone used for building purposes." †

Examples of the rapid decay of building stones have already been referred to, and numerous others could be cited, in which a stone which it was supposed would last forever has already begun to decay. In every way, the question of durability is of more interest to the architect than to the engineer; although it is of enough importance to the latter to warrant a brief discussion here.

23. **DESTRUCTIVE AGENTS.** The destructive agents may be classified as mechanical, chemical, and organic. The last are unimportant, and will not be considered here.

24. **Mechanical Agents.** For our climate the mechanical agents are the most detrimental. These are frost, wind, rain, fire, pressure, and friction.

The action of frost is usually one of the main causes of rapid decay. Two elements are involved,—the friability of the material

* Tests of Metals, etc., 1894, p. 393-420; *ibid.*, 1895, p. 341-372.

† Tenth (1880) Census of the U. S., vol. x, Report on the Quarry Industry, p. 364.

and its power of absorbing moisture. In addition to the alternate freezing and thawing, the constant variations of temperature from day to day, and even from hour to hour, give rise to molecular motions which affect the durability of stone as a building material. This effect is greatest in isolated masses,—as monuments, bridge piers, etc.

The effect of rain depends upon the solvent action of the gases which it contains, and upon its mechanical effect in the wear of pattering drops and streams trickling down the face of the stone.

A gentle breeze dries out the moisture of a building stone and tends to preserve it; but a violent wind wears it away by dashing sand grains, street dust, ice particles, etc., against its face. The extreme of such action is illustrated by the vast erosion of the sandstone in the plateaus of Colorado, Arizona, etc., into tabular *mésas*, isolated pillars, and grotesquely shaped hills, by the erosive force of sand grains borne by the winds. The effect is similar to that of the sand blast as used in various processes of manufacture. A violent wind also forces the rain-water, with all the corrosive acids it contains, into the pores of stones, and carries off the loosened grains, thus keeping a fresh surface of the stone exposed. Again, the swaying of tall edifices by the wind causes a continual motion, not only in the joints between the blocks, but among the grains of the stones themselves. Many stones have a certain degree of flexibility, it is true; and yet the play of the grains must gradually increase, and a tendency to disintegration results.

Experience in great fires in the cities shows that there is no stone which can withstand the fierce heat of a mass of burning buildings. Sandstone seems to be the least affected by great heat, and granite most.

Friction affects sidewalks, pavements, etc., and may also affect bridge piers, sea walls, docks, etc.

The effect of pressure in destroying stone is of little importance, provided the load to be borne does not too nearly equal the crushing strength. The pressure to which stone is subjected does not generally exceed one tenth of the ultimate strength as determined by methods already described.

25. Chemical Agents. The principal chemical agents of destruction are acids. Every constituent of stone, except quartz, is subject to attack by acids; and the carbonates, which enter as chief constituents or as cementing materials, yield very readily to such action. Oxygen and ammonia by their chemical action tend to destroy stones. The sulphur acids and carbonic acid, which result from the combustion of gas, coal, etc., and sometimes from certain kinds of manufactories, have a very marked effect upon the durability

of stone. The nitric acid in the rain and the atmosphere exerts a perceptible influence in destroying building stone.

26. RESISTING AGENTS. The durability of a building stone depends upon three conditions, viz.: the chemical and mineralogical nature of its constituents, its physical structure, and the character and position of its exposed surfaces.

27. Chemical Composition. The chemical composition of the principal constituent mineral and of the cementing material has an important effect upon the durability of a stone.

A siliceous stone, other things being equal, is more durable than a limestone; but the durability of the former plainly depends upon the state of aggregation of the individual grains and their cementing bond, as well as on the chemical relation of the silica to the other chemical ingredients. A dolomitic limestone is more durable than a pure limestone.

A stone that absorbs moisture abundantly and rapidly is likely to be injured by alternate freezing and thawing; hence clayey constituents are injurious. An argillaceous stone is generally compact, and often has no pores visible to the eye; yet such will disintegrate rapidly either by freezing and thawing, or by corrosive vapors.

The presence of calcium carbonate, as in some forms of marble and in earthy limestones, renders a building material liable to rapid attack by acid vapors. In some sandstones the cementing material is the hydrated form of ferric oxide, which is soluble and easily removed. Sandstones in which the cementing material is siliceous are likely to be the most durable, although they are not so easily worked as the former. A stone that has a high percentage of alumina (if it be also non-crystalline), or of organic matter, or of protoxide of iron, will usually disintegrate rapidly. Such stones are generally of a bluish color.

28. Seasoning. All stones, and especially limestones and sandstones, when first quarried contain considerable quarry sap. When full of sap the stone works considerably easier under the tool than when well seasoned. This hardening by seasoning adds very much to the durability of the stone. If a stone freezes while full of quarry sap, it is nearly certain to crack; but if it is first allowed to season, it is not likely to be appreciably damaged by a single freezing. The cause of the hardening by seasoning has not been experimentally determined; but it is supposed to be due to the fact that the quarry sap holds in solution a small amount of calcareous or siliceous matter, and that in seasoning this material is drawn to the surface and is deposited in the pores of the stone by the evaporation of the sap. The matter in solution in the sap thus becomes an additional cementing material and binds the grains more firmly together.

No determination has been made of either the quantity or the composition of the quarry sap; and the surprising thing is that an otherwise inappreciable amount of liquid can produce such a marked effect.

29. Physical Structure. The physical properties which contribute to durability are hardness, toughness, homogeneity, contiguity of the grains, and the structure—whether crystalline or amorphous.

Although hardness (resistance to crushing) is often regarded as the most important element, yet resistance to weathering does not necessarily depend upon hardness alone, but upon hardness and the non-absorbent properties of the stone. A hard material of close and firm texture is, however, in those qualities at least, especially fitted to resist friction, and is therefore suitable for use in stoops, pavements, and road metal, and to resist the wear of rain drops, dripping rain-water, the blows of the waves, etc.

Porosity is an objectionable element. An excessive porosity increases the layer of decomposition which is caused by the acids of the atmosphere and of the rain, and also deepens the penetration of frost and promotes its work of disintegration.

If the constituents of a rock differ greatly in hardness, texture, solubility, porosity, etc., the weathering is unequal, the surface is roughened, and the sensibility of the stone to the action of frost is increased.

The principle which obtains in applying an artificial cement, such as glue, in the thinnest film in order to secure the greatest binding force, finds its analogy in the building stones. The thinner the films of the natural cement and the closer the grains of the predominant minerals, the stronger and more durable the stone. One source of weakness in the once famous brown-stone of New York City lies in the separation of the rounded grains of quartz and feldspar by a superabundance of ocherous cement. Of course the further separation produced by fissure, looseness of lamination, empty cavities and geodes, and excess of mica tends to deteriorate still further a weak building stone.

Experience has generally shown that a crystalline structure resists atmospheric attack better than an amorphous one, as has been abundantly illustrated in the buildings of New York City. The same fact is generally true also with the sedimentary rocks, a crystalline limestone or good marble resisting erosion better than earthy limestones. A stone that is compactly and finely granular will exfoliate more easily by freezing and thawing than one that is coarse-grained. A stone that is laminar in structure absorbs moisture unequally and will be seriously affected by unequal expansion and contraction,—especially by freezing and thawing. Such a stone

will gradually separate into sheets. A stone that has a granular texture, as contrasted with one that is crystalline or fibrous, will crumble sooner by frost and by chemical agents, because of the easy dislodgment of the individual grains.

The condition of the surface, whether rough or polished, influences the durability,—the smoother surface being the better. The stone is more durable if the exposed surface is vertical than if inclined. The lamination of the stone should be horizontal.

30. METHODS OF TESTING DURABILITY. It has long been recognized that there are two ways in which a judgment can be formed of the durability of a building stone, and these may be distinguished as natural and artificial.

31. Natural Methods. The natural methods must always take the precedence whenever they can be used, because they involve (1) the exact agencies concerned in the atmospheric attack upon stone, and (2) long periods of time far beyond the reach of artificial experiment.

A study of the surfaces of old buildings, bridge piers, monuments, tombstones, etc., which have been exposed to atmospheric influences for years, is one of the best sources of reliable information concerning the durability of stone. A durable stone will retain the tool marks made in working it, and preserve its edges and corners sharp and true.

Another method is to visit the quarry and observe whether the ledges that have been exposed to the weather are deeply corroded, or whether these old surfaces are still fresh. In applying this test, consideration must be given to the modifying effect of geological phenomena. It has been pointed out that "the length of time the ledges have been exposed, and the changes of actions to which they may have been subjected during long geological periods, are unknown; and since different quarries may not have been exposed to the same action, they do not always afford definite data for reliable comparative estimates of durability, except where different specimens occur in the same quarry." North of the glacial limit, all the products of decomposition have been planed away and deposited as drift-formation over the length and breadth of the land. The rocks are therefore, in general, quite fresh in appearance, and possess only a slight depth of cap or worthless rock. The same classes of rock, however, in the South are covered with rotten products from long ages of atmospheric action.

32. Artificial Methods of Testing Durability. The older artificial methods of determining durability were based upon the assumption that the relative durability of stones is proportional to their crushing strength, their absorptive power, their resistance to freezing, and their solubility in acids; but it is now known that stones differ

widely in durability which do not differ much if any in one or more of the above respects, and consequently the determination of the above elements for several building stones is only an approximate method of determining their durability. In making the experiments each element acts by itself, while in the structure the stone is exposed to the combined action of all the methods of attack; and their action may be very different separately than simultaneously.

In recent years it has been claimed that the best artificial method of determining the probable durability of a stone was to study its surface or a thin, transparent slice under the microscope. Undoubtedly this method gives valuable information, but it still remains true that in the present state of our knowledge the methods of determining the durability of building stones by laboratory tests are unsatisfactory and the results are unreliable. The object sought is important, and therefore the difficulties should stimulate greater care in making the experiments and in interpreting the results.

33. In a general way the weight and crushing strength throw some light upon the durability of a stone.

The heavier a stone the more dense it is, and, other things being the same, the more durable it is; but to this there are some exceptions. The more dense it is, the less water it will absorb, and hence it is less likely to be affected by frost and the acids of the atmosphere. The weights of the several classes of stones are given in Table 1, page 6.

As a rule the stronger stones are the more durable, but there are numerous and sometimes marked exceptions to this rule. The crushing strength of building stones is given in Table 2, page 11.

The following may be regarded as the distinctive tests of durability: (1) absorptive power; (2) freezing test; (3) Brard's test; (4) acid test; (5) quenching test; (6) resistance to fire; (7) chemical analysis; and (8) microscopical examination.

34. Absorptive Power. Other things being equal, the less the absorption the more durable the stone. To determine the absorptive power, dry the specimen and weigh it carefully; then soak it in water for 24 hours, and weigh again. The increase in weight will be the amount of absorption. Table 5, page 21, shows the weight of water absorbed by the stone as compared with the weight of the dry stone—that is, if 300 units of dry stone weigh 301 units after immersion, the absorption is 1 in 300, and is recorded as 1-300.

Dr. Hiram A. Cutting, State Geologist of Vermont, determined the absorptive power * by placing the specimens in water under the receiver of an air-pump, and found the ratio of absorption a little larger than is given in Table 5. It is believed, however, that the

*Van Nostrand's Engin'g Mag., vol. xxiv, p. 491-95.

results given in Table 5* more nearly represent the conditions of actual practice. The values in the "Max." column are the means of two or three of the largest results, and those in the "Min." column of two or three of the smallest. The value in the last column is the mean for 20 or more specimens.

TABLE 5.
ABSORPTIVE POWER OF STONE, BRICK, AND MORTAR.

KIND OF MATERIAL.	RATIO OF ABSORPTION.		
	Max.	Min.	Average.
Granites	1-150	0	1-750
Marbles	1-150	0	1-300
Limestones	1-20	1-500	1-38
Sandstones	1-15	1-240	1-24
Bricks	1-4	1-50	1-10
Mortars	1-2	1-10	1-4

35. Freezing Test. The probable effect of frost upon a stone may be determined by freezing and thawing a specimen several times while saturated with water, and then either measuring the amount disintegrated or finding the loss in strength. The loss in weight of even a poor building stone after any reasonable number of alternate freezings and thawings, say twenty-five, is too small to furnish any reliable estimate of the weathering quality of the stone. The determination of the loss of strength by freezing is unsatisfactory, since the difference before and after freezing is quite small, and since the comparison must be made between different specimens; and hence a reliable result would require a large number of tests, and even then the results would be only relative.

The test should be made with cubes of the same size, or at least with specimens having the same superficial area per unit of weight, as the disintegration is wholly on the surface. The cubes should first be brushed to remove any loose grains, and then weighed; they should next be immersed in water for 24 hours, and afterwards exposed to alternate freezing and thawing for, say, twenty-five times; finally they should be thoroughly dried, brushed, and again weighed. The loss in weight is supposed to measure the relative durability.

The first part of Table 6, page 23, shows the results of freezing and thawing each sample eight times.† The results are tabulated in the order of the losses in the freezing tests. The samples were tool-

* Appen. II, Report of Chief of Engineers, U.S.A., 1875.

† Trans. Amer. Soc. of Civil Engineers, vol. xxxiii, p. 243.

dressed to rectangular faces; but were not of the same size, and hence the results are only approximate.

36. Brard's Test. Brard's method of determining the effect of frost is much used; and although it does not exactly conform to the conditions met with in nature, it seems to be the best artificial means yet devised for determining the probable resistance of a stone to weathering. The test consists in weighing carefully some small pieces of the stone, which are then boiled in a solution of sulphate of soda, and afterwards hung up for a few hours in the open air. It is important that the solution be saturated only at or below 80° Fahr., as otherwise undue chemical action will be set up. The salt crystallizes in the pores of the stone, expands, and produces an effect somewhat similar to frost, as it causes small pieces to separate in the form of dust. The specimens are again weighed, and those which suffer the smallest loss of weight are the best. The test is often repeated several times. It will be seen that this method depends upon the assumption that the action of the salt in crystallizing is similar to that of water in freezing. This is not entirely correct, since it substitutes chemical and mechanical action for merely mechanical, to disintegrate the stone, thus giving the specimen a worse character than it really deserves. The following results were obtained by this method: *

	Relative Ratio of Loss.
Hard brick	1
Light dove-colored sandstone from Seneca, Ohio	2
Coarse-grained sandstone from Nova Scotia	2
Coarse-grained sandstone from Little Falls, N. J.	5
Coarse dolomitic marble from Pleasantville, N. Y.	7
Coarse-grained sandstone from Connecticut	13
Soft brick	16
Fine-grained sandstone from Connecticut	19

Table 6 shows the results of a series of tests to compare the losses by the artificial freezing test with those by the sulphate of soda (Brard's) test. The specimens were tool-dressed and had only approximately rectangular faces, but the pieces in the two tests were of nearly the same weight. The results of the two series do not agree very closely; but it is clear that the action of the sulphate of soda is much more powerful than that of freezing water.

37. Acid Test. To determine the effect of the atmosphere of a large city, where coal is used for fuel, soak clean small pieces of the stone for several days in water which contains one per cent each of sulphuric and hydrochloric acids, and agitate frequently. If the

*Tenth Census, vol. x, Report on the Quarry Industry, p. 385.

stone contains any earthy matter likely to be dissolved by the gases of the atmosphere, the water will be more or less cloudy or muddy. The following results were obtained by this method.*

	Relative Ratio of Loss.
White brick	1
Red brick	5
Nova Scotia sandstone.....	9
Connecticut brown-stone	30

TABLE 6.

RESULTS OF THE FREEZING TEST AND OF BRARD'S TEST.

REF. No.	KIND OF STONE.	FREEZING TEST.		BRARD'S TEST.	
		Original Weight, Grams.	Loss, parts in 10 000.	Original Weight, Grams.	Loss, parts in 10 000.
1	Granite, coarse grained	52	1.38	72	15.51
2	" medium grained red	63	1.76	56	6.55
3	" fine grained gray	59	*	44	5.16
4	" Au Sable, Norite	44	*	35	3.84
5	Gneiss, rather fine grained	53	*	62	6.33
6	Limestone, fine grained	55	2.07	67	25.99
7	Marble, medium crystalline dolomitic	94	2.30	94	17.01
8	" coarse crystalline dolomitic .	64	3.10	72	10.78
9	Brick, pressed	37	6.86	37	24.86
10	Sandstone	20	8.89	24	57.78
11	" very fine grained	40	10.63	38	47.65
12	"	22	14.21	28	145.18
13	" decomposed	24	25.31	23	1 621.31
14	" decomposed	38	68.74	39	482.12

*Very slight, about same as No. 2.

38. Quenching Test. Some experimenters heat the specimens to 500° to 600° F., and plunge them while hot into cold water. The results are supposed to show the relative resistance to frost action, and also to indicate something as to the fire resisting qualities of the stone. The following comparative results were obtained by this method:†

	Relative Ratio of Loss.
White brick.....	1
Red brick	2
Brown-stone (sandstone from Connecticut)	5
Nova Scotia sandstone	14

*Tenth Census of the U. S., vol. x, Report on the Quarry Industry, p. 385.

†Tenth Census of the U. S., vol. x, Report on the Quarry Industry, p. 384. For a table showing essentially the same results, see Van Nostrand's Engin'g Mag., vol. xiv, p. 537.

39. Resistance to Fire. Stones differ greatly in their ability to resist the heat of a burning building. Of course, the injurious effect of a conflagration is greater in proportion as the temperature is higher; but there are no reliable data for estimating accurately the effect of different temperatures.

Experiences with great conflagrations have established the fact that granite is less fireproof than either limestone or sandstone. The susceptibility of granite to the effect of heat is doubtless partly due to the fact that it has a compact and complex structure, and that each of its constituent minerals has different degrees of expansibility; and possibly partly also to the water in minute cavities which upon becoming highly heated is converted into steam and causes an explosion.

Up to the point at which limestones and marbles are converted into quicklime, i.e., between about 900° and 1,000° Fahr., they are not much injured by heat. Limestones and marbles seldom crack from heat alone; but crumble when water is thrown on them. It should be remembered that the sudden cooling of the surface of a heated stone due to repeated dashes of cold water, often has more to do with its disintegration than heat alone.

Sandstones are not usually injured by a conflagration, except for the discoloration caused by the smoke. The great durability of sandstone under fire, and incidentally the relative resistance of sandstone and granite, was shown at the burning of St. Peter's Church at Lamerton, England. "The church itself, which was built in great part of granite, was completely ruined; while the tower, built of local sandstone, around which the heat of the fire was so great as to melt six of the bells as they hung in the belfry, was left intact, although the granite window jams and sills were destroyed."*

40. Chemical Analysis. A chemical analysis of a stone is of very little value in itself, since the analysis alone does not show whether any particular constituent is contained in the grains where it is not easily attacked, or in the cement that holds the grains together where it is easily attacked by the acid gases of the atmosphere. But sometimes a chemical analysis is important in connection with a microscopical examination.

41. Microscopical Examination. It is now held that the best method of determining the probable durability of a building stone is to study its surface, or thin transparent slices, under a microscope. This method of study in recent years has been most fruitful in developing interesting and valuable knowledge of a scientific and truly practical character. An examination of a section by means of the microscope will show, not merely the various substances which compose it, but also the method according to which they are arranged

*American Architect, vol. iv, p. 80

and by which they are attached to one another. For example, "pyrites is considered to be the enemy of the quarryman and constructor, since it decomposes with ease, and stains and discolors the rock. Pyrites in sharp, well defined crystals sometimes decomposes with great difficulty. If a crystal or grain of pyrites is embedded in soft, porous, light colored sandstones, like those which come from Ohio, its presence will with certainty soon demonstrate itself by the black spot which will form about it in the porous stone, and which will permanently disfigure and mar its beauty. If the same grain of pyrites is situated in a very hard, compact, non-absorbent stone, the constituent minerals of which are not rifted or cracked, this grain of pyrites may decompose and the products be washed away, leaving the stone untarnished."

42. METHODS OF PRESERVING. Vitruvius, the Roman architect, two thousand years ago recommended that stone should be quarried in summer when driest, and that it should be seasoned by being allowed to lie two years before being used, so as to allow the quarry sap to evaporate. It is a notable fact that in the erection of St. Paul's Cathedral in London, England, Sir Christopher Wren required that the stone, after being quarried, should be exposed for three years on the sea-beach before its introduction into the building.

The methods of dressing a stone have an important bearing upon its durability. If the surface is finished with a tool similar to the bush hammer (Fig. 44, page 270) or the patent hammer (Fig. 46, page 271), the heavy blows deaden the face of the stone, i.e., break the grains and produce minute fissures, and render it much more susceptible to the action of frost. Granite and other compact crystalline rocks are most durable with a rock-face finish, i.e., a surface untouched by chisel or hammer; while the softer and more absorbent stones are usually most durable when finished with a sawed or rubbed surface.

It has already been stated that, in order to resist the effects of both pressure and weathering, a stone should be placed on its natural bed. This simple precaution adds considerably to the durability of any laminated stone.

43. Many methods have been devised for preventing or checking the action of the weather upon building stones; but none of them are satisfactory or very efficient. These preservatives consist of some liquid into which the stone may be dipped or which may be applied with a brush to its outer surface, to fill the pores and prevent the access of moisture. Paint, coal tar, linseed oil, paraffine, and numerous chemical preparations have been used.*

*For an elaborate and valuable article by Prof. Eggleston on the causes of decay and the methods of preserving building stones, see *Trans. Am. Soc. of C. E.*, vol. xv. p. 647-704; and for a discussion on the same, see same volume, p. 705-16.

As an example of a simple and comparatively efficient preparation used for this purpose, see § 379 and 642.

Another method of treatment consists in bathing the stone in successive solutions, the chemical actions bringing about the formation of insoluble silicates in the pores of the stone. For example, if a stone front is first washed with an alkaline fluid to remove dirt, and this followed by a succession of baths of silicate of soda or potash, and the surface is then bathed in a solution of chloride of lime, an insoluble lime silicate is formed. The soluble salt is then washed away, and the insoluble silicate forms a durable cement and checks disintegration. If lime-water is substituted for chloride of lime, there is no soluble chloride to wash away.

44. BIBLIOGRAPHICAL. A large number of tests have been applied to the building stones of the United States. For the results and details of some of the more important of these tests see: Report on Strength of Building Stone, Gen. Q. A. Gillmore, Appen. II, Report of Chief of Engineers, U. S. A., for 1875; Tenth Census of the U. S., Vol. X, Report on the Quarry Industry, p. 330-35; the several annual reports of tests made with the U. S. Government testing machine at the Watertown (Mass.) Arsenal, published by the U. S. War Department under the title Report on Tests of Metals and Other Materials; Transactions of the American Society of Civil Engineers, Vol. II, p. 145-51 and p. 187-92; *ibid.*, Vol. XXXIII, p. 233-56; Journal of the Association of Engineering Societies, Vol. V, p. 176-79, Vol. IX, p. 33-43; *Engineering News*, Vol. XXXI, p. 135 (Feb. 15, 1884); The Materials of Construction, J. B. Johnson, John Wiley & Sons, New York, 1897, p. 630-51; Notes on the Compressive Resistance of Freestones, Brick Piers, and Hydraulic Cement Mortars and Concretes, Gen. Q. A. Gillmore, John Wiley & Sons, New York, 1888; and the reports of the various State Geological Surveys, and the commissioners of the various State capitols and of other public buildings.

By way of comparison the following reports of tests of building stones of Great Britain may be interesting: Proceedings of the Institute of Civil Engineers, Vol. CVII (1891-92), p. 341-69; abstract of the above, *Engineering News*, Vol. XXVIII, p. 279-82 (Sept. 22, 1892).

In consulting the above references or in using the results, the details of the manner of making the experiments should be kept clearly in mind.

ART. 3. CLASSIFICATION AND DESCRIPTION OF BUILDING STONES.

45. CLASSIFICATION. Building stones are variously classified according to geological position, physical structure, and chemical composition.

46. Geological Classification. The geological position of rocks has but little connection with their properties as building materials. As a general rule, the more ancient rocks are the stronger and the more durable; but to this there are many exceptions. According to the usual geological classification, rocks are divided into igneous, metamorphic, and sedimentary. Greenstone, basalt, and lava are examples of igneous rocks; granite, marble, and slate, of metamorphic; and sandstone, limestone, and clay, of sedimentary. Although clay can hardly be classed with building stones, it is not entirely out of place in this connection, since it is employed in making bricks and cement, which are important elements of masonry.

47. Physical Classification. With respect to the structural character of large masses, rocks are divided into stratified and unstratified.

In their more minute structure the *unstratified* rocks present, for the most part, an aggregate of crystalline grains, firmly adhering together. Granite, trap, basalt, and lava are examples of this class.

In the more minute structure of *stratified* rocks, the following varieties are distinguished: 1. *Compact crystalline* structure; accompanied by great strength and durability, as in quartz-rock and marble. 2. *Slaty* structure, easily split into thin layers; accompanied by both extremes of strength and durability, clay-slate and hornblende-slate being the strongest and most durable. 3. The *granular crystalline* structure, in which crystalline grains either adhere firmly together, as in gneiss, or are cemented into one mass by some other material, as in sandstone; accompanied by all degrees of compactness, porosity, strength, and durability, the lowest extreme being sand. 4. The *compact granular* structure, in which the grains are too small to be visible to the unaided eye, as in blue limestone; accompanied by considerable strength and durability. 5. *Porous granular* structure, in which the grains are not crystalline, and are often, if not always, minute shells cemented together; accompanied by a low degree of strength and durability. 6. The *conglomerate* structure, where fragments of one material are embedded in a mass of another, as graywacke; accompanied by all degrees of strength and durability.

A study of the fractured surface of a stone is a good means of

determining its structural character. The even fracture, when the surfaces of division are planes in definite positions, is characteristic of a crystalline structure. The uneven fracture, when the broken surface presents sharp projections, is characteristic of a granular structure. The slaty fracture gives an even surface for planes of division parallel to the lamination, and uneven for other directions of division. The conchoidal fracture presents smooth concave and convex surfaces, and is characteristic of a hard and compact structure. The earthy fracture leaves a rough, dull surface, and indicates softness and brittleness.

48. Chemical Classification. Stones are divided into three classes with respect to their chemical composition, each distinguished by the earth which forms its chief constituent, viz.: siliceous stones, argillaceous stones, and calcareous stones.

Siliceous Stones are those in which silica is the characteristic earthy constituent. With a few exceptions their structure is crystalline granular, and the crystalline grains contained in them are hard and durable; hence weakness and decay in them generally arise from the decomposition or disintegration of some softer and more perishable material, by which the grains are cemented together, or, when they are porous, by the freezing of water in their pores. The principal siliceous stones are granite, syenite, gneiss, mica-slate, greenstone, basalt, trap, porphyry, quartz-rock, hornblende-slate, and sandstone.

Argillaceous or Clayey Stones are those in which alumina, although it may not always be the most abundant constituent, exists in sufficient quantity to give the stone its characteristic properties. The principal kinds are slate and graywacke-slate.

Calcareous Stones are those in which carbonate of lime predominates. They effervesce with the dilute mineral acids, which combine with the lime and set free carbonic acid gas. Sulphuric acid forms an insoluble compound with the lime. Nitric and muriatic acids form compounds with it, which are soluble in water. By the action of intense heat the carbonic acid is expelled in gaseous form, and the lime is left in its caustic or alkaline state, when it is called quicklime. Some calcareous stones consist of pure carbonate of lime; in others it is mixed with sand, clay, and oxide of iron, or combined with carbonate of magnesia. The durability of calcareous stones depends upon their compactness, those which are porous being disintegrated by the freezing of water, and by the chemical action of an acid atmosphere. Such stones are, for the most part, easily wrought. The principal calcareous stones are marble, compact limestone, granular limestone (the calcareous stone of the geological classification), and magnesian limestone or dolomite.

49. DESCRIPTION OF BUILDING STONES. A few of the more prominent classes of building stones will now be briefly described.

50. Trap. Although trap is the strongest of building materials, and exceedingly durable, it is little used, owing to the great difficulty with which it is quarried and wrought. It is an exceedingly tough rock, and, being generally without cleavage or bedding, is especially intractable under the hammer or chisel. It is, however, sometimes used with excellent effect in cyclopean architecture, the blocks of various shapes and sizes being fitted together with no effort to form regular courses. The "Palisades" (the bluff skirting the western shore of the Hudson River, opposite and above New York) are composed of trap-rock. It is much used for road-metal, paving blocks, and railroad ballast.

51. Granite. Granite is the strongest and most durable of all the stones in common use. It generally breaks with regularity, and may be quarried in simple shapes with facility; but it is extremely hard and tough, and therefore can be wrought into elaborate forms only with a great expenditure of labor. For this reason the use of granite is somewhat limited. Its strength and durability commend it, however, for foundations, docks, piers, etc., and for massive buildings; and for these purposes it is in use the world over.

The larger portion of our granites are some shade of gray in color, though pink and red varieties are not uncommon, and black varieties occasionally occur. They vary in texture from very fine and homogeneous to coarsely porphyritic rocks, in which the individual grains are an inch or more in length. Excellent granites are found in New England, throughout the Alleghany belt, in the Rocky Mountains, and in the Sierra Nevada Mountains. Very large granite quarries exist at Vinalhaven, Maine; at Gloucester and Quincy, Massachusetts; and at Concord, New Hampshire. These quarries furnish nearly all the granite used in this country. An excellent granite, which is largely used at Chicago and in the Northwest, is found at St. Cloud, Minnesota.

At the Vinalhaven quarry a single block 300 feet long, 20 feet wide, and 6 to 10 feet thick was blasted out, being afterwards broken up. Until recently the largest single block ever quarried and dressed in this country was that used for the General Wool Monument, now in Troy, New York, which measured, when completed, 60 feet in height by $5\frac{1}{2}$ feet square at the base, being only 9 feet shorter than the Egyptian Obelisk now in Central Park, New York. In 1887 the Bodwell Granite Company took out from its quarries in Maine a granite shaft 115 feet long, 10 feet square at the base, and weighing 850 tons. It is claimed that this is the largest quarried stone on record.

52. Marbles. In common language, any limestone which will take a good polish is called a marble; but the name is properly applied only to limestones which have been exposed to metamorphic action, and have thereby been rendered more crystalline in texture, and have had their color more or less modified or totally removed. Marbles exhibit great diversity of color and texture. They are pure white, mottled white, gray, blue, black, red, yellow, or mottled with various mixtures of these colors. Marble is confessedly the most beautiful of all building materials, but is chiefly employed for interior decorations.

53. Limestones. Limestones are composed chiefly or largely of carbonate of lime. There are many varieties of limestone, which differ in color, composition, and value for engineering and building purposes, owing to the differences in the character of the deposits and chemical combinations entering into them. "If the rock is compact, fine grained, and has been deposited by chemical agencies, we have a variety of limestone known as travertine. If it contains much sand, and has a more or less conchoidal fracture, we have a siliceous limestone. If the silica is very fine grained, it is hornstone. If the silica is distributed in nodules or flakes, either in seams or throughout the mass, it is cherty limestone; if it contains silica and clay in about equal proportions, hydraulic limestone; if clay alone is the principal impurity, argillaceous limestone; if iron is the principal impurity, ferruginous limestone; if iron and clay exceed the lime, ironstone. If the ironstone is decomposed and the iron hydrated, it is rottenstone; if carbonate of magnesia forms one third or less, magnesian limestone; if carbonate of magnesia forms more than one third, dolomitic limestone."

The light colored and fine grained limestones are deservedly esteemed as among our best building materials. They are, however, less easily and accurately worked under the chisel than sandstones, and for this reason and their greater rarity are far less generally used. The gray limestones, like that of Lockport, New York, when hammer dressed, have the appearance of light granite, and, since they are easily wrought, they are advantageously used for trimmings in buildings of brick.

Some of the softer limestones possess qualities which specially commend them for building materials. For example, the cream-colored limestone of the Paris basin (*calcaire grossier*) which is so soft when first quarried that it may be dressed with great facility, hardens on exposure, and is a durable stone. Walls laid up of this material are frequently planed down to a common surface, and elaborately ornamented at small expense. The Topeka stone, found and now largely used in Kansas, has the same qualities. It may be

sawed out in blocks almost as easily as wood, and yet is handsome and durable when placed in position. The Bermuda stone and *coquina* are treated in the same way.

Large quantities of limestones and dolomites are quarried in nearly all of the Western States. These are mostly of a dull grayish color, and their uses are chiefly local. The light colored oölitic limestone of Bedford, Indiana, is, however, an exception to this rule. Not only are the lasting qualities fair and the color pleasing, but its fine even grain and softness render it admirably adapted for carved work. It has been very widely used within the last few years. This stone is often found in layers 20 and 30 feet thick, and is much used for bridge piers and other massive work.

54. Sandstones. "Sandstones vary much in color and fitness for architectural purposes, but they include some of the most beautiful, durable, and highly valued materials used in construction. Whatever their differences, they have this in common, that they are chiefly composed of sand—that is, grains of quartz—to a greater or less degree cemented and consolidated. They also frequently contain other ingredients, as lime, iron, alumina, manganese, etc., by which the color and texture are modified. Where a sandstone is composed exclusively of grains of quartz without foreign matter, it may be snow-white in color. Examples of this variety are known in many localities. They are rarely used for building, though they may be employed for that purpose with excellent effect. They have been more generally valued as furnishing material for the manufacture of glass. The color of sandstones is frequently bright and handsome, and constitutes one of the many qualities which have rendered them so popular. It is usually caused by iron; when gray, blue, or green, by the protoxide, as carbonate or silicate; when brown, by the hydrated oxide; when red, by the anhydrous oxide. The purple sandstones usually derive this shade of color from a small quantity of manganese.

"The texture of sandstones varies with the coarseness of the sand of which they are composed, and the degree to which it is consolidated. Usually the material which unites the grains of sand is silica; and this is the best of all cements. This silica has been deposited from solution, and sometimes fills all the interstices between the grains. If the process of consolidation has been carried far enough, or the quartz grains have been cemented by fusion, the sandstone is converted into quartzite,—one of the strongest and most durable of rocks, but, in the ratio of its compactness, difficult to work. Lime and iron often act as cements in sandstones, but both are more soluble and less strong than silica. Hence the finest and most indestructible sandstones are such as consist exclusively of

grains of quartz united by siliceous cement. In some sandstones part of the grains are fragments of feldspar, and these, being liable to decomposition, are elements of weakness in the stone. The very fine grained sandstones often contain a large amount of clay, and thus, though very handsome, are generally less strong than those which are more purely siliceous.

“The durability of sandstones varies with both their physical and chemical composition. Sandstones composed of nearly pure silica which is well cemented are as resistant to weather as granite, and are very much less affected by the action of fire. Taken as a whole, they may be regarded as among the most durable of building materials. When first taken from the quarry and saturated with quarry water, they are frequently very soft, but on exposure become much harder by the precipitation of the soluble silica contained in them.

“Since they form an important part of all the groups of sedimentary rocks, sandstones are abundant in nearly all countries; and as they are quarried with great ease, and are wrought with the hammer and chisel with much greater facility than limestones, granites, and most other kinds of rocks, these qualities, joined to their various and pleasing colors and their durability, have made them the most popular and useful of building stones.”

55. The United States is abundantly supplied with sandstones suitable for building purposes. The following are some of the most noted:

1. *The Brownstones* of Connecticut and New Jersey were formerly much used in buildings, particularly of the Atlantic cities; but experience has shown that they are seriously lacking in durability, since their cementing material is readily decomposed by the acids in the atmosphere of cities.

2. *The Berea sandstone* is derived from the Berea grit, a member of the Lower Carboniferous series in Northern Ohio. It is frequently called the Cleveland sandstone, from the name of the firm controlling a number of the quarries. The principal quarries are located at Amherst and Berea. The stone from Amherst is generally light drab in color, very homogeneous in texture, and composed of nearly pure silica. It is very resistant to fire and weathering, and is, on the whole, one of the best and handsomest building stones known. The Berea stone is lighter in color than the Amherst, but sometimes contains sulphide of iron, and is then liable to stain and decompose.

3. *The Waverly sandstone*, also derived from the Lower Carboniferous series, comes from Southern Ohio. This is a fine grained homogeneous stone of a light drab or dove color, which works with facility, and which is very handsome and durable. It forms the

material of which many of the finest buildings of Cincinnati are constructed, and is, justly, highly esteemed there and elsewhere.

4. *The Lake Superior sandstone* is a dark, purplish-brown stone of the Potsdam age, quarried at Bass Island, Marquette, Mich. This is rather a coarse stone, of medium strength, but homogeneous and durable, and one much used in the Lake cities.

5. *The St. Genevieve sandstone* is a fine grained sandstone of a delicate drab or straw color, very homogeneous in tone and texture. It is quarried at St. Genevieve, Missouri, and is one of the handsomest of all our sandstones.

6. *The Medina sandstone*, which forms the base of the Upper Silurian series in Western New York, furnishes a remarkably strong and durable stone, much used for pavements and curbing in the Lake cities.

56. Other Names. There is a great variety of names of more or less local application, derived from the appearance of the stone, the use to which it is put, etc., which it would be impossible to classify. The same stone often passes under entirely different names in different localities; and stones entirely different in their essential characteristics often pass under the same name.

57. LOCATION OF QUARRIES. For information concerning the location of quarries, character of product, etc., see: Tenth Census of the U. S., Vol. X, Report on Quarry Industry, p. 107-363; Report of Smithsonian Institution, 1885-86, Part II, p. 357-488; Merrill's Stones for Building and Decoration, p. 45-312—substantially the same as the preceding;—and the reports of the various State geological surveys.

58. COST. See § 587.

CHAPTER II

BUILDING BRICK

61. Until about 1901 the word brick always meant, in this country at least, a prism of burned clay; but at about the above date a brick composed of sand and lime was put upon the market, and the importance of the latter kind of brick is sufficient to require consideration here. Adobe bricks are sun-dried blocks of loam or clay, and are an important building material in many arid or semi-arid regions; but the primitive character of the structures built with such brick does not justify any consideration of that material here. Recently a cement brick, i. e., a block of about the size of an ordinary brick made of cement mortar, has been put upon the market; but it is not in common use, and can be considered better after cement has been studied, and hence a discussion of this form of brick will be deferred to Chapter XI.

This chapter, then, will be divided into two parts, viz.: Art. 1, Common or Clay Brick; and Art. 2, Sand-Lime Brick.

ART. 1. CLAY BRICK.

62. Brick is a most valuable building material. Its comparative cheapness, the ease with which it is transported and handled, and the facility with which it is worked into structures of any desired form, are its valuable characteristics. It is, when properly made, nearly as strong as the best building stone. It is but slightly affected by changes of temperature or of humidity; and is also lighter than stone.

Bricks are much used in architectural construction, but proportionally much less in engineering structures, notwithstanding their good qualities which recommend them as substitutes for stone. In former editions of this volume arguments were given why brick under certain conditions should be substituted for stone in engineering structures, particularly as recent improvements in the process of manufacture had decreased the cost while they had increased the quality and the uniformity of the product; but at about the time of

the improvements in the quality of brick, the developments in the portland cement industry led to the greatly increased use of concrete in both architectural and engineering construction, and consequently brick is now a relatively less important building material than formerly. Nevertheless brick is still an important constructive material; and the increasing cost of lumber is likely to increase the importance of brick as a material of architectural construction; but concrete owing to its cheapness and strength is likely to be used more and more in engineering structures where brick formerly was employed.

63. There are two kinds of clay brick,—fire brick and common brick. Both are made by submitting clay which has been prepared properly and moulded into shape, to a temperature which converts it into a semi-vitrified mass.

64. FIRE BRICK. Fire bricks are used whenever very high temperatures are to be resisted. They are made either of a very nearly pure clay, or of a mixture of pure clay and clean sand, or, in rare cases, of nearly pure silica cemented with a small proportion of clay. The presence of oxide of iron is very injurious, and, as a rule, the presence of 6 per cent justifies the rejection of the brick. In specifications it should generally be stipulated that fire brick should contain less than 6 per cent of oxide of iron, and less than an aggregate of 3 per cent of combined lime, soda, potash, and magnesia. The sulphide of iron—pyrites—is even worse in its effect on fire brick than the substances first named.

When intended to resist only extremely high heat, silica should be in excess; and if to be exposed to the action of metallic oxides, which would tend to unite with silica, alumina should be in excess.

Good fire brick should be uniform in size, regular in shape, homogeneous in texture and composition, easily cut, strong, and infusible.

65. BUILDING BRICK. The Clay. The quality of the brick depends primarily upon the kind of clay used. Common clays, of which the common brick is made, consist principally of silicate of alumina; but they also usually contain lime, magnesia, and oxide of iron. The latter ingredient is useful, improving the product by giving it hardness and strength; hence the red brick of the Eastern States is often of better quality than the white and yellow brick made in the West. Silicate of lime renders the clay too fusible, and causes the bricks to soften and to become distorted in the process of burning. Carbonate of lime is certain to decompose in burning, and the caustic lime left behind absorbs moisture, prevents the adherence of the mortar, and promotes disintegration.

Uncombined silica, if not in excess, is beneficial, as it preserves the form of the brick at high temperatures. In excess it destroys the

cohesion, and renders the bricks brittle and weak. Twenty-five per cent of silica is a good proportion.

66. Moulding. In the old process the clay is tempered with water and mixed to a plastic state in a pit with a tempering wheel, or in a primitive pug-mill; and then the soft, plastic clay is pressed into the moulds by hand. This method is so slow and laborious that it has been almost entirely displaced by more economical and expeditious ones in which the work is done wholly by machinery. There is a great variety of machines for preparing and moulding the clay, which, however, may be grouped into three classes, according to the condition of the clay when moulded: (1) soft-mud machines, for which the clay is reduced to a soft mud by adding about one quarter of its volume of water; (2) stiff-mud machines, for which the clay is reduced to a stiff mud; and (3) dry-clay machines, with which the dry or nearly dry clay is forced into the moulds by a heavy pressure without having been reduced to a plastic mass. These machines may also be divided into two classes, according to the method of filling the moulds: (1) Those in which a continuous stream of clay is forced from the pug-mill through a die and is afterwards cut up into bricks; and (2) those in which the clay is forced into moulds moving under the nozzle of the pug-mill.

67. Burning. The time of burning varies with the character of the clay, the form and size of kiln, and the kind of fuel. With the older processes of burning, the brick, when dry enough, is built up in sections—by brick-makers, called “arches,”—which are usually about 5 bricks ($3\frac{1}{2}$ feet) wide, 30 to 40 bricks (20 to 30 feet) long, and from 35 to 50 courses high. Each section or “arch” has an opening—called an “eye”—at the bottom in the center of its width, which runs entirely through the kiln, and in which the fuel used in burning is placed. After the bricks are thus stacked up, the entire pile is enclosed with a wall of green brick, and the joints between the casing bricks are carefully stopped with mud. Burning, including drying, occupies from 6 to 15 days. The brick is first subjected to a moderate heat, and when all moisture has been expelled, the heat is increased slowly until the “arch-brick,” i.e., those next to the “eye,” attain a white heat. This temperature is kept up until the burning is complete. Finally, all openings are closed, and the mass slowly cools.

With the more modern processes of burning, the principal yards have permanent kilns. These are usually either a rectangular space surrounded, except for very wide doors at the ends, by permanent brick walls having fire-boxes on the outside; or the kiln may be entirely enclosed—above as well as on the sides—with brick masonry. The latter are usually circular, and are sometimes made in com-

partments, each of which has a separate entrance and independent connection with the chimney. The latter may be built within the kiln or entirely outside, but a downward draught is invariably secured. The fuel, usually fine coal, is placed near the top of the kiln, and the down draught causes a free circulation of the flame and heated gases about the material being burned. While some compartments are being fired others are being filled, and still others are being emptied.

68. CLASSIFICATION OF BUILDING BRICK. Bricks are classified according to (1) the way in which they are moulded; (2) their position in the kiln while being burned; and (3) their form or use.

69. Classification according to Method of Moulding. The method of moulding gives rise to the following terms:

Soft-mud Brick. A brick moulded by placing soft clay in a mould. It may be moulded either by hand or with machinery.

Stiff-mud Brick. One moulded by forcing a prism of stiff clay through a die and afterwards cutting it up into bricks.

Pressed Brick. One moulded by pressing dry or semi-dry clay into a mould.

Re-pressed Brick. Usually a stiff-mud brick which has been subjected to an enormous pressure to render the form more regular and to increase its strength and density. It is doubtful whether the re-pressing increases either the strength or the density. Occasionally in the East, and more formerly than at present, a soft-mud brick, after being partially dried, is re-pressed, which process greatly improves the form and also the strength and the density. A re-pressed brick is sometimes, but inappropriately, called a pressed brick.

Slop Brick. In moulding brick by hand, the moulds are sometimes dipped into water just before being filled with clay, to prevent the mud from sticking to them. Brick moulded by this process is known as slop brick. It is deficient in color, and has a comparatively smooth surface, with rounded edges and corners. This kind of brick is now seldom made.

Sanded Brick. Ordinarily, in making soft-mud brick, sand is sprinkled into the moulds to prevent the clay from sticking; the brick is then called sanded brick. The sand *on the surface* is of no serious advantage or disadvantage. In hand-moulding, when sand is used for this purpose, it is certain to become mixed with the clay and occurs in streaks in the finished brick, which is very undesirable; and owing to details of the process, which it is here unnecessary to explain, every third brick is especially bad.

Machine-made Brick. Brick is frequently described as "machine-made"; but this is very indefinite, since all grades and kinds are made by machinery.

70. Classification according to Position in Kiln. When brick was generally burned in the old-style up-draught kiln, the classification according to position was important; but with the new styles of kilns and improved methods of burning, the quality is so nearly uniform throughout the kiln, that the classification is less important. Three grades of brick are taken from the old-style kiln: arch brick, body brick, and salmon brick.

Arch or Clinker Bricks. Those which form the tops and sides of the arches in which the fire is built. Being over-burned and partially vitrified, they are hard, brittle, and weak.

Body, Cherry, or Hard Bricks. Those taken from the interior of the pile. The best bricks in the kiln.

Salmon, Pale, or Soft Bricks. Those which form the exterior of the mass. Being underburned, they are too soft for ordinary work, unless it be for filling. The terms *salmon* and *pale* refer to the color of the brick, and hence are not applicable to a brick made of a clay that does not burn red. Although nearly all brick clays burn red, yet the localities where the contrary is true are sufficiently numerous to make it desirable to use a different term in designating the *quality*. There is, necessarily, no relation between color, and strength and density. Brick-makers naturally have a prejudice against the term *soft brick*, which doubtless explains the nearly universal prevalence of the less appropriate term—salmon.

71. Classification according to Use. The form or use of bricks gives rise to the following terms.

Compass Brick. One having one edge shorter than the other. Used in lining circular shafts, etc.

Feather-edge Brick. One having one edge thinner than the other. Used in arches; and more properly, but less frequently, called *vousoir brick*.

Face Brick. Those which, owing to uniformity of size and color, are suitable for the face of the wall of buildings. Sometimes face bricks are simply the best ordinary brick; but generally the term is applied only to re-pressed or pressed brick made specially for this purpose.

Sewer Brick. Ordinary hard brick, smooth, and regular in form.

Paving Brick. Very hard, ordinary brick. A vitrified clay block, very much larger than ordinary brick (see § 83), is sometimes used for paving, and is called a paving brick, but more often, and more properly, a *brick paving-block*.

Vitrified Brick. The introduction of brick for street pavements about 1890 led to a new grade of building brick, viz., vitrified brick, one burned to the point of vitrification and then annealed or toughened by slowly cooling. Vitrified brick and paving blocks, though origi-

nally made for paving purposes, are now much used in building and engineering structures.

72. TESTS FOR BRICK. The tests usually applied to determine the quality of brick are those for: (1) form, (2) texture, (3) absorptive power, (4) crushing strength, (5) transverse strength. Brick are so common, and the requisites for good building brick are so obvious, and it is so easy to determine whether any particular lot of brick has the desirable qualities, that there is not much need of laboratory tests of building brick. However, the several tests enumerated above will be briefly considered.

73. Form. A good brick should have plane faces, parallel sides, and sharp edges and angles. In regularity of form re-pressed brick ranks first, dry-clay brick next, then stiff-mud brick, and soft-mud brick last. Regularity of form depends largely upon the quality of the clay and the method of burning. A good brick should not have depressions or kiln marks on its edges caused by the pressure of the brick above it in the kiln.

74. Texture. A good brick should have a fine, compact, uniform texture; and should contain no fissures, air bubbles, pebbles, or lumps of lime. It should give a clear ringing sound when struck a sharp blow with a hammer or another brick. A brick which gives a clear ringing sound is strong and durable enough for any ordinary work.

The compactness and uniformity of texture, which greatly influence the durability of brick, depend mainly upon the method of moulding. As a general rule, hand-moulded bricks are best in this respect, since the clay in them is more uniformly tempered before being moulded; but this advantage is partially neutralized by the presence of sand seams (§ 69). Machine-moulded soft-mud bricks rank next in compactness and uniformity of texture. Then come machine-moulded stiff-mud bricks, which vary greatly in durability with the kind of machine used in their manufacture. By some of the machines, the brick is moulded in layers (parallel to any face, according to the kind of machine), which are not thoroughly cemented, and which separate under the action of the frost. In compactness, the dry-clay brick comes last. However, the relative value of the products made by the different processes varies with the nature of the clay used.

75. Absorptive Power. Formerly, it was believed that the absorptive power of a building brick had an important effect upon its ability to resist destruction by frost; but experiments and a more careful study of experience have shown that the absorptive power of a brick has little or nothing to do with its durability. Apparently there are two reasons for this: (1) the pores of the brick are not entirely filled with water, and consequently the expansion of the water in freezing is cushioned by the air in the pores; and (2) with the more

porous bricks, the water freezes in the pores without any destructive effect much as water freezes in a large-necked bottle, and with the more dense bricks the strength of the burned clay is greater than the expansive force of the water. The absorptive power varies with the chemical composition of the clay, and there seems to be no close relation between the absorptive power and the strength of a brick or the loss of strength by freezing.*

76. There are different methods in use for determining the amount of water taken up by a brick, and these lead to slightly different results. Some experimenters dry the bricks in a hot-air chamber, while some dry them simply by exposing them in a dry room; some experimenters immerse the bricks in water in the open air, while others immerse them under the receiver of an air-pump; some immerse whole brick, and some use small pieces; and, again, some dry the surface with bibulous paper, while others allow the surface to dry by evaporation. Air-drying represents the conditions of actual exposure in masonry structures, since water not expelled in that way is so diffused as to do no harm in freezing. Immersion in the open air more nearly represents actual practice than immersion in a vacuum. The conditions of actual practice are best represented by testing whole brick, since some kinds have a more or less impervious skin. Drying the surface by evaporation is more accurate than drying it with paper; however, neither process is capable of giving mathematical accuracy.

77. Soft under-burned brick, such as are frequently used in filling in the interior of walls, will absorb from 30 to 35 per cent of their weight of water; some good dry-clay or pressed brick have an absorption of 15 to 20 per cent, while others run from 5 to 10 per cent; and some vitrified brick absorb only 1 to 2 per cent.†

78. **Crushing Strength.** The crushing strength of brick is valuable only in comparing different brands; and gives no idea of the strength of walls built of such bricks (see § 622). The crushing strength of brick is of relatively less importance than that of stone, since owing to the relatively smaller size of the brick and consequently the relatively larger proportion of mortar, the strength of brick masonry is more dependent upon the strength of the mortar than is stone masonry. The strength of the brick is of relatively small importance unless the mortar is nearly as strong as the brick (see § 623); and as this is never the case unless a rich portland-cement mortar is used, it follows that in ordinary brick masonry the crushing strength of the brick is of small importance provided a reasonably good quality is employed.

* Report German Royal Experiment Station, Thonindustrie, Zeitung, No. 74, 1905.

† Tests of Metals, etc., 1894, p. 448; *ibid.*, 1895, p. 435-36; *ibid.*, 1896, p. 347.

It has already been explained (§ 10-15) that the results for the crushing strength of stone vary greatly with the details of the experiments; but this difference is even greater in the case of brick than that of stone. In testing stone the uniform practice is to test cubes (§ 11) whose faces are carefully dressed to parallel planes. In testing brick there is no established custom. (1) Some few experimenters test cubes; but nearly all of the tests that have been published have been made with some form of specimen other than the cube. With stone it is necessary to specially prepare a test specimen, and the cube is as easy to prepare as any form; but with brick it is not equally necessary to specially prepare a test specimen, and hence it has become the custom to use a half or a whole brick in making the compression test. (2) Some experimenters grind the dressed surfaces to exact planes, and some level up the surfaces by putting on a thin coat of plaster of paris, while others do nothing to prepare the bedding surfaces—particularly with pressed brick. (3) Sometimes brick are tested on end, sometimes on edge, and sometimes flatwise, the last being the more common practice with the testing machine at the U. S. Watertown Arsenal.

79. Soaking a brick in water decreases its compressive strength, apparently because the water acts as a lubricant on the plane of rupture. In a series of experiments with the U. S. testing machine at Watertown, of thirty tests upon ordinary building brick from ten localities, all but two showed a loss of strength due to immersion in water for one week; and the wet half of a brick gave an average strength of only 85 per cent of the strength of the dry half.

80. Some experiments with the testing machine at the U. S. Arsenal at Watertown, to determine the relative strength of hard-burned face brick tested flatwise, edgewise, and endwise, gave averages for four tests each as follows:*

Flatwise	11 174 lb. per sq. in. = 100 per cent.
Edgewise.....	8 978 " " " = 80 "
Endwise.....	6 972 " " " = 62 "

The pressed surfaces were set in plaster of paris. Other tests with common brick gave approximately the same results.†

According to the formula of § 17, a brick tested flatwise would be 2 per cent stronger than when tested as a cube.

Bricks sent to the World's Columbian Exposition at Chicago in 1893 from several States, and afterwards tested at the Watertown Arsenal flatwise with the pressed surfaces set in plaster of paris, gave the results in Table 7, page 42.

*Tests of Metals, etc., 1894, p. 439.

† *Ibid.*, 1885, p. 1158-59.

TABLE 7.
COMPRESSIVE STRENGTH OF BRICK SENT TO THE WORLD'S
COLUMBIAN EXPOSITION.*

REF. No.	STATE.	COMPRESSIVE STRENGTH, Pounds per Square Inch.	
		Lowest.	Highest.
1	Arkansas	3 465	9 469
2	Florida	2 477	5 077
3	Idaho	7 393	22 561
4	Illinois	3 966	12 280
5	Iowa	5 828	12 269
6	Minnesota	1 311	7 402
7	S. Dakota	3 648	8 936
8	Utah	3 202	4 362
9	Washington	2 405	13 137
10	Wyoming	11 060	13 077
11	Japan	4 782	5 529
12	Sweden	5 000	22 955

For bricks sent to the Louisiana Purchase Exposition at St. Louis in 1904, and afterwards tested at Watertown flatwise, the surfaces being set in neat portland-cement mortar, the average of five tests is as shown in Table 8.†

TABLE 8.
COMPRESSIVE STRENGTH OF BRICK MANUFACTURED BY DIFFERENT
PROCESSES AT DIFFERENT PLACES.

REF. No.	KIND OF BRICK.	COMPRESSIVE STRENGTH, Pounds per Square Inch.		
		Min.	Max.	Mean.
FACE BRICK:				
1	Stiff-mud	8 930	15 330	12 766
2	Dry-pressed	8 930	17 990	11 190
3	Re-pressed soft-mud	5 770	7 560	6 780
COMMON BRICK:				
4	Hard-burned, soft-mud, Cambridge	9 140	14 750	11 340
5	“ “ “ “ Brookfield	4 340	4 580	4 475
6	“ “ “ “ Mechanicsville	5 110	6 730	5 808
7	Medium-burned, soft-mud, Cambridge	4 610	8 590	6 590
8	“ “ “ “ Brookfield	4 200	6 850	5 248

* Tests of Metals, etc., 1894, p. 456-68.

† *Ibid.*, 1904, p. 453-54.

Five samples each of fourteen lots of Hudson River brick gave an average crushing strength of 3,943 lb. per sq. in. for half bricks tested flatwise, the range for the averages of the several lots being from 2,701 to 5,416, and the range for the individual brick being from 1,607 to 8,944.*

The highest known crushing strength of any brick is 38,446 lb. per sq. in.,† and as the brick was tested on end the result is exceedingly remarkable.

81. Transverse Strength. A brick is not often used where it is subjected to a direct bending stress, but the method of failure of brick piers (§ 618) shows that the transverse strength of the brick indirectly affects the compressive resistance of brick masonry. The experiments necessary to determine the transverse strength of brick are easily made (§ 18), and give definite results, as well as furnish important information concerning the practical value of the brick; and hence the determination of the transverse strength is one of the best means of judging the quality of a brick.

According to experiments made with the U. S. testing machine at Watertown upon sixteen different grades of brick from six factories, the transverse strength is 13.5 per cent of the compressive strength of half brick tested flatwise.‡ From 1883 to 1905 there were made with the U. S. testing machine thirty-seven determinations of the transverse strength of brick from eleven factories, the lowest being 308 lb. per sq. in., the highest being 2,589, and the mean, 1,002.

The transverse strength of shale paving or building brick is considerably larger than any of the above, being from 2,500 to 4,000 lb. per sq. in.

82. Shearing Strength. The shearing strength of nine specimens of brick from five factories tested on the U. S. testing machine in 1894 gave a shearing strength equal to 10.1 per cent of the crushing strength flatwise; and sixteen samples from six factories, tested in 1895, gave 4.7 per cent. In the first lot the range was from 7 to 17 per cent; and in the second from 8 to 30 per cent. Apparently a higher compressive strength is accompanied by a proportionally lower shearing strength; but the tendency is not very marked.

83. SIZE. The size of common brick varies widely with the locality and also with the maker, and with the same maker the brick are likely to be larger as the working season advances, owing to the wear of the moulds or the die. Hard-burned bricks are smaller than soft-burned ones, owing to the greater shrinkage in burning; and this difference varies with the different kinds of clays.

* *Engineering News*, vol. liii, p. 384.

† *Tests of Metals, etc.*, 1907, p. 286.

‡ *Ibid.*, 1895, p. 323.

In England the legal standard size for brick is $8\frac{3}{4} \times 4\frac{3}{8} \times 2\frac{3}{4}$ inches. In Scotland the average size is about $9\frac{1}{2} \times 4\frac{1}{2} \times 3\frac{1}{2}$ inches; in Germany, $9\frac{7}{8} \times 4\frac{1}{4} \times 2\frac{5}{8}$ inches; in Austria, $11\frac{1}{2} \times 5\frac{1}{2} \times 2\frac{5}{8}$ inches; in Cuba, $11 \times 5\frac{1}{2} \times 2\frac{5}{8}$ inches; and in South America, $12\frac{3}{4} \times 6\frac{1}{4} \times 2\frac{1}{2}$ inches.

In the United States there is no legal standard, and the dimensions vary greatly. In 1887 the National Brick Makers' Association adopted standard sizes for brick, but in 1893 modified them slightly and in 1899 re-affirmed the latter dimensions, which are:

Common Brick	$8\frac{1}{2} \times 4 \times 2\frac{1}{4}$ inches.
Paving Brick.....	$8\frac{1}{2} \times 4 \times 2\frac{1}{2}$ inches.
Pressed Brick	$8\frac{3}{8} \times 4 \times 2\frac{3}{8}$ inches.
Roman Brick.....	$12 \times 4 \times 1\frac{1}{2}$ inches.
Norman Brick.....	$12 \times 4 \times 2\frac{3}{8}$ inches.

Paving blocks are occasionally used as building bricks. The blocks range in size from $9 \times 4 \times 3$ to $9 \times 5 \times 4$ inches, the former being much the more common.

84. Large brick are worth more per thousand than small ones, a seemingly small difference in the size of the individual brick making a greater difference in the volume of a thousand bricks than is usually supposed. If, reckoned according to the cubic contents, brick $8 \times 4 \times 2$ inches is worth \$10 per thousand, brick $8\frac{1}{2} \times 4\frac{1}{4} \times 2\frac{1}{4}$ is worth \$12.33 per thousand, and $8\frac{1}{2} \times 4\frac{1}{2} \times 2\frac{1}{2}$ is worth \$15 per thousand. In the first case a difference of $\frac{1}{8}$ inch on each dimension is worth \$1.16 per thousand, and in the second case, \$1.25.

Further, where bricks are laid by the thousand, small bricks are doubly expensive.

85. **Cost.** In 1905 the average selling price of brick in the several States was as in Table 9.* Prices have been gradually rising for eight years.

TABLE 9.
AVERAGE SELLING PRICE OF CLAY BRICK IN THE
SEVERAL STATES.

REF. No.	KIND.	AVERAGE SELLING PRICE PER 1 000.		
		Least.	Highest.	Mean.
1	Common	\$4.28	\$9.48	\$6.25
2	Paving	7.58	19.23	10.07
3	Pressed (Face)	8.58	26.15	13.12

* Mineral Resources of the U. S., 1905, p. 957.

ART. 2. SAND-LIME BRICK.

86. Sand-lime brick consist of a mass of sand cemented together with lime. There are two classes of sand-lime brick: one in which the binding material is carbonate of lime, and the other in which the binding material is silicate of lime.

The first is virtually a brick made of ordinary lime mortar, moulded as are soft-mud clay brick, and hardened in the open air in an atmosphere rich in carbon dioxide (CO_2), either with or without pressure. This form may properly be called a lime-mortar brick. It is the older form of sand-lime brick, and was formerly made in a small way where sand and lime were cheap and clay and fuel were expensive; but the brick is so weak and friable that it has not given satisfaction, and needs no further consideration here.

The second kind of sand-lime brick is made from a mixture of sand and lime which is moulded in a press and hardened by being subjected to steam under pressure. In this case the binding material consists chiefly of hydrosilicate of lime. Probably part of the lime is converted into carbonate by absorbing carbon dioxide; but the rest of the lime combines with the silica of the sand and forms hydrosilicate of lime, a stable and comparatively strong cementing material. This form is the only one to which the term sand-lime brick is now applied; but in consulting the past literature on the subject, a careful distinction should be made between the two forms so-called sand-lime brick. This form of sand-lime brick was first manufactured in Germany about 1880, and has been used there to considerable extent. It was introduced into this country about 1901. Although the number of sand-lime brick manufactured here is quite small in comparison with the number of clay brick made, the number is so large and is increasing so rapidly as to require a discussion here of this form of brick.

87. THE MATERIALS. The Sand. Any sand can be used, but the best results are obtained with a pure silica sand, not containing too many coarse grains, properly graded so as to leave the smallest possible interstitial spaces. If the grains are coarse, the surface of the brick will not be as smooth as though the grains were finer; and unless there are a good many fine grains, there will not be sufficient surface to allow the most complete combination of the lime and the silica. If the size of the sand grains is not properly graded, too much lime will be required to fill the voids or interstitial spaces, which will needlessly add to the cost without any compensating advantage.

88. The Lime. The quantity of lime used varies from 4 to 10 per cent according to the per cent of voids in the sand, and according

to the preference of the manufacturer. Either a high-calcium lime or a magnesian lime (see § 105) may be used, although the former appears to make the stronger brick.

The lime must be reduced to a paste or powder before being mixed with the sand, and there are four ways of doing this: (1) wet slaking, (2) dry slaking, (3) acid slaking, and (4) grinding. In the first process the lime is slaked to a paste in the usual way by drenching with water and by agitation (§ 222); in the second the lime is slaked to a dry powder by adding only enough water that the heat of the chemical reaction will just dry the hydrate; in the third method, after the slaking has begun, a small amount of hydrochloric acid is added to accelerate the slaking process; in the fourth method the quicklime is ground to a powder, and in mixing with the sand only enough water is added to make it possible to work the mixture in the press.

89. Moulding. The mixture of sand and lime is thoroughly mixed, and is then forced into moulds under very high pressure, very much as dry-clay brick are moulded. The higher the pressure the stronger and more dense the brick.

90. Hardening. The bricks are hardened by being exposed in a closed cylinder to a steam pressure of 100 to 150 lb. per sq. in. for from 12 to 4 hours, respectively. As a rule the bricks are moulded during the day, and are left in the hardening cylinder over night. As soon as the bricks come from the hardening cylinder they can be used; but it is better to allow them to stand a day or two, as when they dry out they become harder.

91. CHARACTERISTICS OF SAND-LIME BRICK. The makers of sand-lime brick usually claim that their product is equal in appearance and quality to any dry-clay (pressed) face brick; and that sand-lime brick will gain in hardness under the action of either air or water.

92. Form and Color. Sand-lime brick have plane faces, free from kiln marks. The corners are square and sharp as they come from the press, but are likely to crumble off in being placed in the hardening cylinder. The color is usually white, sometimes pure and uniform, and sometimes tinted according to the color of the sand; and it is easy to give the brick almost any color by mixing coloring matter with the sand and the lime before moulding.

93. Crushing Strength. Three whole bricks from one maker in Arizona, when crushed flatwise with pressed surfaces set in plaster of paris, gave an average crushing strength of 3,000 lb. per sq. in., the variation from the mean being about 7 per cent each way; and four other bricks from West Point, N. Y., gave an average crushing strength of 3,717 lb. per sq. in., the range being from 2,940 to 4,260.*

* Tests of Metals, etc., 1905, p. 459-60.

Forty-five half brick from five makers, tested under the author's direction, flatwise with plastered surfaces, gave an average crushing strength of 3,693 lb. per sq. in., the range for the different makes being from 2,412 to 6,123.*

Five tests of German sand-lime brick hardened under high pressure gave an average crushing strength of 2,710 lb. per sq. in., the range being from 1,704 to 4,189; and three samples hardened under low pressure gave an average strength of 1,199 lb. per sq. in., the range being from 850 to 1,353.† No details are known as to the method of making the above experiments.

94. Most of the clay brick used in New York City have an average crushing strength of about 4,000 lb. per sq. in. for half brick tested flatwise (see § 80); and brick masonry is seldom subjected to a compressive stress of more than 200 lb. per sq. in. (see § 628-29). Therefore the above results show that sand-lime brick can be made strong enough for use in any ordinary brick work.

95. **Transverse Strength.** The average of fifty-five brick from five makers, tested under the author's direction, gave an average transverse strength of 571 lb. per sq. in., with a range for the different brands from 420 to 766.*

96. **Absorption.** Sixty-six samples from six makers, tested under the author's direction, gave an average absorption of 10.6 per cent by weight, the range of the brands being from 8.5 to 13.5 per cent.* The absorptive power of sand-lime brick seems to be less than that of equally strong clay brick.

97. **Resistance to Freezing.** One-inch cubes of sand-lime brick were practically disintegrated after being frozen and thawed daily for twenty-nine days.‡ Three cubes each of three brands when frozen and thawed eighteen times gave losses by weight as follows: 100 per cent, 13.2 per cent, 2.7 per cent.¶ Soft pressed clay brick in the same tests lost nothing. Two half brick after freezing and thawing twenty times lost 14.3 and 5.3 per cent by weight respectively; and a soft clay brick in the same series lost nothing.*

Apparently, ordinary sand-lime brick do not stand frost as well as equally strong clay brick.

98. **Effect of Weather.** Two each of three brands of sand-lime brick were placed in the open air where they were exposed to the sun, wind, and rain from August to March inclusive. One each of each brand was kept in a closed box in a dry place. The exposed brick were thoroughly dried and tested. The average modulus of rupture of the unexposed brick was 791 lb. per sq. in., and of the exposed

* Bachelor's Thesis of L. E. Curfman, '05, University of Illinois Library.

† Trans. Amer. Ceramic Society, 1902, p. 171.

‡ *Engineering News*, vol. li, p. 388.

¶ *Clay Record*, Jan. 16, 1905, p. 35.

640—a loss of 19 per cent;—and the average crushing strength of the unexposed sample was 3,423 lb. per sq. in., and of the exposed 3,115—a loss of 9 per cent.*

99. Effect of Fire. In three tests, made under the direction of the author, which can not be briefly described, no one of the six brands of sand-lime bricks seemed to stand the effect of fire as well as dry-clay bricks having about the same compressive strength. It is said that many of the fire inspectors of Germany have pronounced the fire-resisting qualities of sand-lime brick satisfactory. American manufacturers of sand-lime bricks claim that they can be used as fire brick.

100. Cost. It is claimed and also denied that under equally favorable conditions sand-lime brick of the grade of dry-pressed clay brick can be made as cheaply as common clay brick; but the probabilities are that the sand-lime brick industry is too new to have settled the controversy definitely either way. In localities in which clay or fuel is scarce and in which lime and sand are plentiful, sand-lime brick can probably be made cheaper than clay brick.

The average selling price of common sand-lime brick in the United States in 1905 was \$6.44 per thousand, and of front brick \$9.42.† Compare these prices with those for clay brick in Table 9, page 44.

* Bachelor's Thesis of L. E. Curfman, '05, University of Illinois Library.

† Mineral Resources of the U. S., 1905, p. 1006.

CHAPTER III

COMMON AND HYDRAULIC LIME

102. CLASSIFICATION OF LIME AND CEMENT. Considered as materials for use in the builders' art, the products of calcination of limestone are classified as common lime, hydraulic lime, and hydraulic cement. If the limestone is nearly pure carbonate of lime, the product is common lime, which will slake upon the addition of water, and mortar made of it will harden by absorbing carbonic acid from the air; but will not harden under water. If the limestone contains from 5 to 20 per cent of clay (silica and alumina) the product is hydraulic lime, which will slake upon the addition of water, and mortar made of it will harden either in air or under water by the chemical action between the hydraulic lime and the water used in making the mortar. If the limestone contains from 20 to 23 per cent of clay, the product is hydraulic cement, which will not slake upon the addition of water but must be reduced to a paste by grinding, and which will set either in air or under water by the chemical action between the cement and the water used in making the mortar.

Common lime is sometimes called air-lime, because a paste or mortar made from it requires exposure to the air to enable it to "set," or harden. The hydraulic limes and cements are called water-limes and water-cements, from their property of hardening under water. Notice that common lime differs from hydraulic lime and hydraulic cement in that common lime will not set or harden under water, while both hydraulic lime and hydraulic cement will set under water. Common lime and hydraulic lime differ from hydraulic cement in that the two former as they come from the kiln will absorb water and crumble to a powder, and if more water is added will break or reduce to a paste; while cement after being burned is practically unaffected by water until it is first reduced to a fine powder by grinding.

Lime and cement are important materials of engineering construction since they are the only substances that are used to bind together bricks and blocks of stone to form masonry structures.

ART. 1. COMMON LIME.

103. DESCRIPTION. Lime is produced by heating a pure or nearly pure limestone in a kiln to such a temperature as will drive off the carbon dioxide and leave calcium oxide. When fresh lime is brought into contact with water it will rapidly absorb nearly a quarter of its weight of that substance. This absorption is accompanied by a great rise of temperature, by the evolution of a hot and slightly caustic vapor, by the bursting of the lime into pieces; and finally the lime is reduced to a powder, the volume of which is from two and a half to three and a half times the volume of the original lime—the increase of bulk being proportional to the purity of the limestone. In this condition the lime is said to be slaked, and is ready for use in making mortar.

On exposure to the air a paste of lime absorbs carbon dioxide, the oxide of calcium slowly changes back to carbonate, and the mortar sets or hardens.

In making mortar, sand is mixed with lime paste for three reasons: (1) to prevent shrinkage of the paste through the drying out of the water; (2) to cheapen the resultant product; and (3) to subdivide the lime paste into thin films so that the carbon dioxide in the air may have better access to the calcium oxide. Lime mortar hardens very slowly, owing to the small amount of carbon dioxide that the calcium oxide can absorb from the air; and what is more important from a builder's point of view, the mortar in the interior of the wall never fully hardens, as only the exposed portions have an opportunity to absorb carbon dioxide. (Lime does not harden at all under water.) It is probable that a certain amount of chemical action takes place between the lime and the sand, as the strength of sand-lime brick (see § 86) is chiefly due to such action; but at atmospheric pressure and temperature, this action is inappreciable and is of no practical importance in construction.

104. Fat vs. Lean Lime. If the limestone is nearly pure, the resulting lime will be nearly white, and will slake to an unctuous paste that is impalpable to both sight and touch; and hence such lime is called a fat or rich lime. If the limestone contains considerable impurities, as silica, alumina, iron oxide, etc., the resulting lime will not be white, but will vary from a yellowish white to a gray or a brown, according to the amount and kind of the impurities present. Such a lime is known as a lean or meager lime, and exhibits a more moderate rise of temperature, evolves less vapor, slakes more slowly, seldom reduces to an impalpable powder, yields a thin paste, and expands less than a fat lime.

105. High-Calcium vs. Magnesian Lime. If the limestone is nearly a pure calcium carbonate, it will yield nearly pure calcium oxide, and the product will be known commercially as a high-calcium lime; but if the limestone should contain any considerable quantity of magnesium carbonate, the resulting lime will be a mixture of the oxides of calcium and magnesium, and will be known commercially as magnesian or dolomitic lime. Magnesian limes usually slake more slowly, evolve less heat, expand less, set more slowly, and make a stronger mortar than the high-calcium limes. The differences between these two classes of limes vary with the amount and nature of the constituents and with the temperature at which each is burned. The two classes of lime shade gradually one into the other; but commercially any lime containing less than 10 per cent of magnesium oxide is known as pure or high-calcium lime, and a lime containing more than 10 per cent of magnesium oxide is known as magnesian or dolomitic lime. The high-calcium limes are known as "hot" or "quick" limes; and the magnesian limes, as "cool" or "slow" limes.

106. Table 10 shows the relative strength of the two kinds of lime. Notice that the magnesian lime sets more slowly, but finally gains greater strength than the high-calcium lime.

TABLE 10.
TENSILE STRENGTH OF LIME MORTAR BRIQUETTES.*

REF. No.	AGE WHEN TESTED.	TENSILE STRENGTH. Pounds per Square Inch	
		High Calcium Lime.	Magnesian Lime.
1	Four weeks	31
2	Eight weeks	36	29
3	Three months	39	37
4	Four months	39	51
5	Six months	51	83
6	One year	45	93

The results in Table 10 are for briquettes (§ 167) 1 inch square, with all sides exposed to the air; and consequently in actual practice lime mortar does not gain its strength as rapidly as shown in Table 10. Further, the briquettes were composed of 1 volume of slaked lime to 2 volumes of sand, and were probably comparatively porous; and therefore, for this reason also, the briquettes gained strength faster than lime mortar is likely to do in practice.

* *Municipal Engineering*, vol. xxviii, p. 6.

107. Hydrated Lime. There has recently been put upon the market lime which has been slaked to a dry powder in a closed cylinder and which is called hydrated lime. Its chief merits are: (1) it is perfectly slaked, and therefore will make a maximum of paste; and (2) it is ready for immediate use, and hence no time and labor is lost in slaking it. It usually contains two or three per cent of uncombined water. Hydrated lime, unlike unslaked lime, can be kept indefinitely without deteriorating by the absorption of water from the air.

108. TESTING. Good lime may be known by the following tests which can readily be applied to any sample:

1. The lime should be free from cinders and clinkers, with not more than 10 per cent of other impurities,—as silica, alumina, etc.

2. It is generally stated that good unslaked lime should be in hard lumps with but little dust. Ordinarily lime is made from a limestone, in which case the lime should be in lumps when freshly burned, and the presence of any considerable amount of powder or dust indicates that it has been exposed to the air so much since burning that air-slaking has begun; but partially air-slaked lime does not absorb enough water to fully slake it, as the small particles are covered with a fine dust which prevents them from slaking perfectly when water is added later (see § 222–24). However, lime made from shells, crystalline marbles, soft chalk or shelly limestones, is frequently in small fragments when fresh from the kiln, in which case dust is no evidence of air-slaking.

3. The lime should slake readily in water, forming a very fine smooth paste, without any residue.

4. The lime should dissolve in soft water, when this is added in sufficient quantities.

109. STORING. As lime abstracts water from the atmosphere and is thereby partially slaked, which is a detriment to its perfect slaking later, it should be kept as much as possible from the air, or at least from draughts of damp air. If the lime is in bulk, it is impossible to prevent it from air-slaking for any considerable time. If it is in barrels, it may be preserved for a considerable time by storing it in a dry place; but if stored for a great while, or in a damp place, the lime will absorb moisture from the air and the consequent swelling will burst the barrels.

If lime is exposed to the air in a thin layer on a dry floor and is frequently stirred, it will finally slake perfectly and become practically a dry powder.

110. Lime, when mixed to a paste with water, may be kept for an indefinite time in that condition without deterioration, if protected from contact with the air so that the water will not dry out.

is customary to keep the lime paste in casks, or in the wide, shallow boxes in which it was slaked, or heaped up on the ground, covered over with the sand to be subsequently incorporated with it in making mortar.

111. COST. Unslaked lime is sold by the barrel (usually about 75 pounds net) or by the bushel (75 pounds). The price of unslaked lime in bulk in car-load lots is usually 50 to 60 cents per barrel, including freight for 100 to 200 miles; and in barrels the cost is from 20 to 25 cents per barrel more to cover the cost of cooperage.

ART. 2. HYDRAULIC LIME.

112. DESCRIPTION. Hydraulic lime is like common lime in that it will slake, and differs from it in that it will harden under water. Hydraulic lime may be either argillaceous or siliceous. The former is derived from limestones containing from 10 to 20 per cent of clay, and is nogeneously mixed with carbonate of lime as the principal ingredient; the latter from siliceous limestones containing from 12 to 18 per cent of silica. Small percentages of oxides of iron, carbonate of magnesia, etc., are generally present.

During the burning, the carbonic acid is expelled, and the silica and alumina entering into combination with a portion of the lime form both the silicate and the aluminate of lime, leaving in the unslaked product an excess of quick or caustic lime, which induces swelling, and becomes hydrate of lime when brought into contact with water.

Hydraulic lime is slaked by sprinkling with just sufficient water to slake the free lime. The free lime has a greater avidity for the water than the hydraulic elements, and consequently the former absorbs the water, expands, and disintegrates the whole mass while the hydraulic ingredients are not affected. Hydraulic lime is usually screened, and packed in sacks or barrels before being sent to market. It may be kept without injury in this form as long as it is protected from moisture and air.

No hydraulic lime was ever manufactured in the United States, and none is now used here. It is manufactured in several localities in Europe, notably at Teil and Scilly, in France, from which places large quantities were formerly brought to this country.

CHAPTER IV

HYDRAULIC CEMENT

113. CLASSIFICATION. The most important cements are the products of the calcination of an argillaceous limestone, i.e., are a combination of lime, silica, and alumina (see § 102). Such cements may be divided, according to the method of manufacture, into three classes, viz.: portland cement, natural cement, and pozzolan. The first two differ from the third in that the ingredients of which the first two are composed must be roasted and then pulverized before they acquire the property of hardening under water, while the ingredients of the third need only to be pulverized and mixed with water to a paste.

Whenever cement is referred to as a material of construction, one or the other of the above kinds is nearly always intended; but there are two other forms of hydraulic cement that are of enough interest to warrant a brief mention here.

114. Iron-Ore Cement. A cement has recently been made by using limestone and iron ore instead of limestone and clay. It is known as iron-ore cement. Such cement if ground to the fineness of commercial portland is more slow-setting, but ultimately attains greater strength than portland cement or any of the limestone-clay cements mentioned in the preceding section. If iron-ore cement is ground very much finer than ordinary portland cement, it becomes as quick-setting as the latter, and, besides, contains 70 to 80 per cent of active material as against the 30 to 40 per cent in ordinary portland cement (§ 139). In this respect iron-ore cement is much superior to portland, since if portland cement were ground extremely fine it would become too quick-setting for practical use. It is not yet proved that with present grinding machinery it is economical to grind iron-ore cement fine enough to make it as quick-setting as portland cement. If the finer-ground iron-ore cement can be made commercially, it will make possible the use of either a stronger mortar or a leaner mortar than at present. Iron-ore cement is superior to portland also in that it is not injured by immersion in sea water.

Iron-ore cement has been manufactured on a commercial scale

for a few years past in Hamburg, Germany; and the claim is that it will soon be made in the United States.

115. Magnesia Cement. A mixture of magnesium oxide and magnesium chloride makes the strongest hydraulic cement known. This discovery was made in about 1853 by Sorel, a French chemist; and the cement is known as Sorel or magnesia cement. The magnesium oxide, or magnesia, is prepared either by calcining magnesite, a comparatively rare material, or from sea-salt. The cement is made by wetting the pulverized magnesium oxide with bittern water, the refuse of sea-side salt works, which contains magnesium chloride.

Magnesia cement was used about 1870 to a considerable extent in making emery wheels and in a small way in making artificial stone, Sorel stone (§529); but at present it seems not to be in use owing to its great cost, quick setting, and lack of durability.

ART. 1. PORTLAND, NATURAL, AND POZZOLAN CEMENT.

116. PORTLAND CEMENT. Portland cement is produced by calcining a mixture containing from 75 to 80 per cent of carbonate of lime and 20 to 23 per cent of clay, at such a high temperature that the silica and alumina of the clay combines with the lime of the limestone. To secure a complete chemical combination of the clay and the lime, it is necessary that the raw materials shall be reduced to a powder and be thoroughly mixed before burning, and it is also necessary that the calcination shall take place at a high temperature.

In a general way portland cement differs from natural cement by being heavier, stronger, and usually slower-setting.

117. Portland cement derives its name from the resemblance which hardened mortar made of it bears to a stone found in the isle of Portland, off the south coast of England. Portland cement was made first in England about 1827, and in America about 1874.

Until about 1897 more portland cement was imported into this country than was made here; but since that date the imports have gradually fallen off and the domestic manufacture has increased very rapidly, so that in 1907 the imports of portland cement were less than 2 per cent of the domestic manufacture. The production of domestic portland cement increased more than twenty-fold from 1897 to 1907. The domestic consumption per capita of portland cement increased one hundred-fold from 1880 to 1905, and the consumption per capita of all kinds of cement increased ten-fold in the same time. In 1887 only about one fifth of the cement used in this country was portland, in 1897, one third, and in 1907 over nine tenths was portland. The best American portland cement is better than the best imported, and is sold equally cheap or cheaper.

In 1905 portland cement was made at eighty-nine works in twenty-one States; but nearly one half of the production comes from the Lehigh Valley in northeastern Pennsylvania and northwestern New Jersey.

118. Silica Cement. Formerly, when portland cement was more expensive and was not ground as fine as now, some manufacturers mixed silica sand and portland cement and ground the mixture. Owing to the effect of the re-grinding of the cement, the mixture of sand and cement gave nearly as great a strength as the original cement neat, and hence the ground mixture could be used as cement. This form of cement is not now made.

119. NATURAL CEMENT. Natural cement is produced by calcining at a comparatively low temperature either a natural argillaceous limestone or a natural magnesian limestone without pulverization or the admixture of other materials. The stone is quarried, broken into pieces, and burned in a kiln. The burnt cement is then crushed into small fragments, ground, packed, and sent to market.

In the process of manufacture natural cement is distinguished from portland, in using a natural instead of an artificial mixture and in calcining at a lower temperature. As a product, natural cement is distinguished from portland in weighing less, being less strong, and as a rule setting more quickly.

In Europe in making this class of cement argillaceous limestone is generally used, and the product is called Roman cement. In the United States magnesian limestone is usually employed in making natural cement.

120. Natural cement was first made in this country in 1818 in connection with the construction of the Erie Canal. In 1905 natural cement was made in fifty-eight works in sixteen States; but nearly half of the product came from the Rosendale district, Ulster County, N. Y. The domestic production of natural cement is gradually falling off, owing to the greatly increased production of portland cement.

121. Improved Natural Cement. Some manufacturers, particularly in the Lehigh Valley portland cement district, mix inferior portland cement with natural cement, and sell it as improved natural cement, or sell the inferior portland as natural cement.

122. POZZOLAN. Pozzolan is a term applied to a combination of silica and alumina which, when mixed with common lime and made into mortar, has the property of hardening under water. There are several classes of materials possessing this property.

Pozzolan proper is a material of volcanic origin, and is the first substance known to possess the peculiar property of hydraulicity. The discovery was made at Pozzuoli, Italy, near the base of Mount

suivus,—hence the name. Vitruvius and Pliny both mention that pozzolan was extensively used by the Romans before their day; but Vitruvius gives a formula for its use in monolithic masonry, which with slight variations has been followed in Italy ever since. It is as follows: “12 parts pozzolan, well pulverized; 6 parts quartz-sand, well washed; and 9 parts rich lime, well slaked.”

Trass is a volcanic earth closely resembling pozzolan, and is employed in substantially the same way. Arènes is a species of porous clayey sand that makes a fair air-lime mortar by adding water, and by adding also fat lime it makes a fair hydraulic cement.

123. Slag Cement. Slag cement is by far the most important of the pozzolan cements. It is sometimes, but inappropriately, called pozzolan cement. It is the product obtained by grinding together pulverized slaked lime and granulated blast-furnace slag, without previous calcination. This cement is likely to contain so much sulphur in the form of sulphides as to make it unfit for use in the air, because on exposure the sulphides change to sulphates and, in so doing, expand; and hence such cements are liable to destroy the structure. But slag cement can safely be used under water and generally in positions where constantly exposed to moisture, as in foundations, sewers, etc., and in the interior of heavy masses of masonry or concrete. It is claimed that slag cement will not stain the stone laid with it. Slag cement was formerly made at nine works in seven States, but in recent years most of the mills have been idle, partly because of the increased manufacture of portland cement from limestone and clay, and partly because of the use of the blast-furnace slag in the manufacture of a true portland cement.

124. A careful distinction should be made between slag cement as defined above and a portland cement made by calcining a mixture of slag and lime. Notice that the slag cement is made simply by grinding and grinding blast-furnace slag and hydrated lime, while portland cement is made by mixing, calcining, and grinding the slag and the lime. Cement made in the last way differs in no material respect from portland cements made of limestone and clay.

Slag cement may be known in its powdered form by a light lilac color, by the absence of grit (due to fine grinding and the slaked lime), and by its low specific gravity (see § 136); and in the form of hardened mortar it may be known by the intense bluish-green color of the fresh fracture after long submersion in water, due to the presence of sulphides, which color fades if exposed to dry air.

125. WEIGHT. Cement is generally sold by the barrel, although not necessarily in a barrel. Imported cement is always sold in barrels, but domestic cement is usually sold in bags, sometimes in barrels, less frequently in bulk.

Portland cement usually weighs 400 pounds per barrel gross, and 376 pounds net. A bag of portland usually weighs 94 pounds, of which four are counted a barrel.

Natural cement made in or near Rosendale, N. Y., formerly weighed 318 pounds per barrel gross, and 300 net. Cement made in Akron, N. Y., Milwaukee, Wis., Utica, Ill., Louisville, Ky., formerly weighed 285 pounds per barrel gross, and 265 net. Cloth bags usually contain one third, and paper bags one fourth of a barrel.

Slag cement formerly weighed from 325 to 350 pounds net per barrel.

126. In 1904 most of the national engineering societies adopted specifications for the reception of cement, which require that a bag of cement shall weigh 94 pounds net, and that four such bags shall constitute a barrel of portland and three a barrel of natural.

127. Cost. Portland Cement. In 1905 the average selling price of portland at the mills was 94 cents per barrel in cloth bags, and the average price in the Lehigh Valley district was 81 cents, not including the cost of the bag which may be returned. The price in paper bags is usually about 5 cents per barrel more than in cloth; and the price in wood is about 15 cents per barrel more than in cloth.

Of course the cost to the consumer includes freight, but during the above year portland cement could be had in car-load lots at almost any place in the upper Mississippi Valley for \$1.50 to \$1.75 per barrel in cloth.

128. Natural Cement. In 1905 the average price of natural cement at the mill was 54 cents in cloth, not including the cost of the bags, the lowest average for a State being 40 cents and the highest 69 cents.* In localities where there was sharp competition between different natural-cement manufacturers, or between natural and portland cement, natural cement has been sold at the remarkably low price of 60 cents per barrel in paper bags, including freight for 100 to 200 miles.

129. Slag Cement. In 1905 slag cement sold at the mill at from 71 to 76 cents per barrel.

ART. 2. TESTING CEMENT.

130. IMPORTANCE OF TESTS. Of all the materials of construction, cement is the one most difficult to test, and also the one subject to the greatest variations and therefore the one most in need of testing. The value of a cement varies greatly with its chemical composition, the temperature of calcination, the fineness of grinding, etc.; and from the moment the clinker is reduced to a powder, its physical

* Mineral Resources of the U. S., 1905, p. 934.

l chemical properties are constantly undergoing changes which affect its quality and value as a building material, and even after cement has been made into a mortar and become a part of the structure, these changes may continue. Not only is there greater variation in cement than in any other building material; but unfortunately the results of the tests of cement depend, to a greater extent than with any other material, upon the personal equation of the one making the tests and the conditions under which they are made. With all other building materials the tests are made upon the finished product, while with cement the test is made upon an intermediate state of the material; and further, with cement the most important tests are made upon samples fabricated by the one who makes the tests, and the results are dependent almost wholly upon the manner of preparing, storing, and testing the samples. Therefore the testing of cement to determine its fitness for the use proposed is a matter of very great importance.

The properties of cement which are examined to determine its constructive value are: (1) color, (2) thoroughness of burning, (3) fineness, (4) soundness, (5) chemical composition, (6) activity, (7) strength.

131. COLOR. The color of the cement powder indicates but little to its quality, since it is chiefly due to oxides of iron and manganese, which in no way affect the cementitious value; but for any given brand, variations in shade may indicate differences in the character of the rock or in the degree of burning.

With portland cement, gray or greenish gray is generally considered best; bluish gray indicates a probable excess of lime, and brown an excess of clay. An undue proportion of under-burned material is generally indicated by a yellowish shade, with a marked difference between the color of the hard-burned, unground particles retained by a fine sieve and the finer cement which passes through the sieve. However, there has recently been put upon the market a white portland cement. It is sold in three grades according to the whiteness, the best being nearly snow white. All grades of the white portland cement are too expensive for ordinary masonry work, but there are various other purposes for which it is valuable. Mortar made of it is said not to stain the stone.

Natural cements are usually brown, but vary from very light to very dark.

Slag cement has a mauve tint—a delicate lilac.

132. THOROUGHNESS OF BURNING. The higher the temperature of burning the greater the weight of the clinker (the unground cement). Two methods have been employed in utilizing this principle as a test of the thoroughness of burning, viz.: (1) determine the weight of a

unit of volume of the ground cement, or (2) determine the specific gravity of the cement.

133. Weight. For any particular cement the weight varies with the temperature of burning, the degree of fineness in grinding, and the density of packing. Other things being the same, the harder-burned varieties are the heavier. The finer a cement is ground the more bulky it becomes, and consequently the less it weighs. Hence light weight may be caused by laudable fine grinding or by objectionable under-burning. Further, since cement absorbs water and carbonic acid from the air, the weight decreases with the exposure of the cement.

The weight per unit of volume is usually determined by sifting the cement into a measure, and striking the top level with a straight-edge. In careful work the height of fall and the size of the measuring vessel are specified. The weight per cubic foot is neither exactly constant, nor can it be determined precisely; and is of very little service in determining the value of a cement. However, it is often specified as one of the requirements to be fulfilled. The determination of the weight of a cement was the first test ever made of a hydraulic cement.

The following values, determined by sifting the cement with a fall of three feet into a box having a capacity of one tenth of a cubic foot, may be taken as fair averages for ordinary cements. The difference in weight for any particular kind is mainly due to a difference in fineness:

Portland 75 to 90 lb. per cubic foot, or 94 to 112 lb. per bushel.

Natural 50 to 56 lb. per cubic foot, or 62 to 70 lb. per bushel.

The weight of a cement is not now used as a test of quality; but the weight is of considerable value in reducing proportions given by weight to equivalent volumetric proportions, and vice versa. Specifications for the reception of cement frequently specify the net weight per barrel; but this is a specification for quantity and not quality, while only the latter is now under consideration.

134. Specific Gravity. The determination of the specific gravity of a cement was once believed to be a good test of proper calcination; but the test is not of much value for that purpose, as it has recently been proved that after ignition to expel the water and carbon dioxide absorbed from the air, all cements, both under-burned and over-burned, are so nearly identical as to render the test of little or no value as an indication of quality.* Further, the specific gravity of a cement depends upon its chemical composition, and varies with

*Proc. Inst. of C. E., vol. cvi, p. 342-45; summary of same in *Engineering Record*, vol. lv, p. 176. Also Proc. Amer. Soc. Testing Materials, vol. vii, p. 363-68.

fineness and its age. Ordinarily a low specific gravity is due to seasoning of the cement or the clinker, either of which is beneficial. It is sometimes claimed that the specific gravity test is valuable detecting adulteration; but the test is not of much value for this purpose, unless the amount of adulterant is very large or it has a specific gravity differing greatly from that of the cement. The specific gravity is of some value in determining the density of cement mortars and concretes (see § 233 and 290).

135. The specific gravity is determined by immersing a known weight of the cement in a liquid which will not act upon it (usually kerosene or benzene), and obtaining the volume of the liquid displaced. The latter is obtained by means of a glass bulb having a graduated stem above, the rise of the liquid in the tube indicating the volume of the cement introduced. The specific gravity is equal to the weight of the cement in grams divided by the displaced volume in cubic centimeters.

136. To be of any value for any purpose the test must be very carefully made. As cement absorbs moisture from the air, it should be heated to 212° Fahr. to drive off the water; and the cement should be cooled to the temperature of the air before proceeding with the test. The cement should be passed through a sieve to eliminate lumps; and it should fall through the liquid in a finely divided state so as to allow the air to escape. The liquid should be at about 60° Fahr., to prevent undue evaporation; and the bulb should be immersed in water to prevent a change of temperature between observations. The specific gravity of portland cement varies from 3.00 to 3.25, usually between 3.05 and 3.17. Natural cement varies from 2.75 to 3.05, and is usually between 2.80 and 3.00. The specifications proposed by the American Society of Testing Materials and adopted by various other national engineering societies,* which may properly be called the Standard American Cement Specifications, require that the specific gravity of portland cement, when thoroughly dried at 100° C., shall not be less than 3.10, and of natural not less than 2.80 (see Appendix I). Slag cement has a specific gravity of 2.72 to 2.76. The specific gravity of cement decreases with age owing to the absorption of water and carbonic acid from the air.

137. FINENESS. The question of fineness is wholly a matter of economy. Cement until ground is a mass of partially vitrified clinker, which is not affected by water, and which has no setting power. It is only after it is ground that the addition of water induces hydration. Consequently the coarse particles in a cement have no setting power whatever, and may for practical purposes be considered as so much sand and essentially an adulterant.

*Proc. Amer. Soc. for Testing Materials, vol. v, p. 75-78.

There is another reason why cement should be well ground. A mortar or concrete being composed of a certain quantity of inert material bound together by cement, it is evident that to secure a strong mortar or concrete it is essential that each piece of aggregate shall be entirely surrounded by the cementing material, so that no two pieces are in actual contact. Obviously, then, the finer a cement the greater surface will a given weight cover, and the more economy will there be in its use.

138. Measuring Fineness. The degree of fineness is measured by determining the proportion which will not pass through sieves of a specified number of meshes per square inch. Formerly, three sieves were used for this purpose, viz., sieves having 50, 75, and 100 meshes per linear inch, or 2,500, 5,625, and 10,000 meshes per square inch respectively; but at present only two sieves are used, the No. 100 and the No. 200. The change was made because the per cent left on the coarser sieves had no special significance. The wire cloth of the No. 100 sieve should be made of wire 0.0045 inch in diameter; and the No. 200 of wire having a diameter of 0.0024 inch. As it is nearly impossible to procure cloth absolutely true, it has been agreed that the No. 100 sieve may have from 96 to 100 meshes per linear inch and the No. 200 sieve from 180 to 200, and still be considered standard.

Preparatory to beginning the test, the cement should be put through a coarser sieve, say a No. 50, to remove any lumps or foreign matter. It is difficult to get the cement through the sieve, but a teaspoonful of moderately fine shot placed upon the sieve with the cement will materially facilitate the sifting. The shot should be weighed before being used, as otherwise it will be difficult to separate the cement and the shot preparatory to weighing the former. Unfortunately the shot seriously injures the sieve.

139. Specifications for Fineness. The specifications of the American Society for Testing Materials (the standard American specifications) require that portland cement shall not leave more than 8 per cent on the No. 100 sieve and not more than 25 per cent on the No. 200 sieve; and that natural cement shall not leave more than 10 per cent on the No. 100 sieve nor more than 30 per cent on the No. 200 sieve (see Appendix I).

The only active element in the cement is the impalpable flour. Apparently about half of the cement passing the No. 200 sieve is inert and acts only as so much sand,* although the exact proportion of flour present depends upon the chemical composition of the cement and the method of grinding. In other words then, only about 40

* Spackman and Lesley in a paper before the 1907 Convention of the Assoc. of Amer. Portland Cement Manufacturers; see *Engineering Record*, vol. lvi, p. 691-92.

ment of standard portland cement is active. If it were ground enough for all to be active, it would be too quick-setting for tical use.

40. SOUNDNESS. Soundness refers to the ability of a cement to n its strength and form unimpaired for an indefinite period. test to determine soundness is frequently called a test for con- cy of volume.

oundness is a most important element; since if a cement ulti- ly loses its strength it is worthless, and if it finally expands it mes a destructive agent. A cement may be unsound because e presence in it of some active element which causes the mortar p- and or contract in setting, or the unsoundness may be due to rior agencies which act upon the ingredients of the cement. ound cements fail by swelling and cracking under the action pansives; but sometimes the mortar fails by a gradual softening e mass without material change of form. The expansive action ually due to free lime or free magnesia in the cement, but may be ed by sulphur compounds. The principal exterior agencies g upon a cement are air, sea-water, and extremes of heat and

The presence of small quantities of free lime in the cement is a ent cause of unsoundness. The lime slakes, and causes the ar to swell and crack—and perhaps finally disintegrate. The ee of heat employed in the burning, and the fineness, modify effect of the free lime. Lime burned at a high heat slakes more ly than when burned at a low temperature, and is therefore more y to be injurious. Finely ground lime slakes more quickly than sely ground, and hence with fine cement the lime may slake e the cement has set, and therefore do no harm. The lime in y ground cements will air-slake sooner than that in coarsely nd.

Free magnesia in cement acts very much like free lime. The n of the magnesia is much slower than that of lime, and hence esence is a more serious defect, since it is less likely to be detected e the cement is used. The effect of magnesian cement is not oughly understood, but seems to vary with the composition of the ent, the degree of burning, and the amount of water used in ng. It was formerly held that $1\frac{1}{2}$ or 2 per cent of magnesia in and cement was dangerous; but it is now known that 5 per cent t injurious, while 8 per cent may produce expansion. Since y of the natural cements are made of magnesium limestone, they ain much more magnesia than portland cements; but chemists ot agreed as to the manner in which the different constituents ombined, and consequently are not agreed either as to the amount

or effect of free magnesia in a natural cement. Fortunately, it is not necessary to resort to a chemical analysis to determine the amount of lime or magnesia present, for a cement which successfully stands the ordinary test for soundness (§ 143) for 7, or at most 28 days, may be used with reasonable confidence.

Seasoning or aging improves cement in that the lime and the magnesia are slaked by the absorption of moisture from the air. The effect of lime and magnesia seems to be more serious in water than in air, and greater in sea-water than in fresh water.

141. The action of sulphur in a cement is extremely variable, depending upon the state in which it may exist and upon the nature of the cement. Sulphur may occur naturally in the cement or may be added in the form of sulphate of lime (plaster of paris) to retard the time of set (§ 154). Under certain conditions the sulphur may form sulphides, which on exposure to the air oxidize and form sulphates and cause the mortar to decrease in strength. Many, if not all, of the slag cements contain an excess of sulphides, and are therefore unfit for use in the air, particularly a very dry atmosphere, although under water they may give satisfactory results and compare favorably with portland cement.

142. Tests of Soundness. Several methods of testing soundness have been proposed. They may be classified as: (1) Pat Test; (2) Accelerated Tests; and (3) Expansion Test.

143. Pat Test. The ordinary or "normal" method of testing soundness is to make small cakes or pats of neat mortar 3 or 4 inches in diameter, about half an inch thick and having thin edges, upon a clean sheet of glass; and expose one in the air at ordinary temperature and immerse the other in water at about the temperature of the air, and examine both from day to day for 28 days if possible, to see if they show any cracks or signs of distortion. The German standard specifications require the cake to be kept 24 hours in a closed box or under a damp cloth, and then stored in water. The French, to make sure that the pats do not get dry before immersion, recommend that the cakes be immersed immediately after mixing without waiting for the mortar to set. Some really sound natural cements will disintegrate if immersed before setting has begun.

The amount of water used in mixing the mortar, within a reasonable limit, seems to have no material effect on the results. However, as it costs but little more time and trouble, it is wise to use mortar of standard consistency (see § 161).

144. To examine the pat, note the following:

1. Is it loose from the glass? For the very best results the pat should remain attached to the glass; but being loose, in either the air or the water, is not considered indicative of serious unsoundness.

2. Is the side next to the glass flat or curved? The pats are more likely to curl in air than in water, and a moderate curvature in air is not regarded as very serious.

3. Is the glass cracked? Really good cements frequently crack the glass of the water pats.

4. Are there any radial cracks? Neither pats should show any radial cracks, wide at the thin edge of the pat and narrowing as they go toward the center. These cracks should not be confused with irregular hair-like shrinkage cracks, which appear over the entire surface when the pats are made too wet or dry out too much while setting.

5. Are there any blotches on the surface? There should be no blotches, as they usually indicate an unsafe amount of sulphides. The presence of sulphides will also be revealed by a greenish color of the interior of the pat exposed under water.

145. If there are any considerable indications of sulphides, before accepting the cement a chemical analysis should be made to determine the amount of sulphur and the probable ultimate action of the cement (see § 148).

Another excellent method of examining for the presence of sulphides is, in making the test for tensile strength (§ 157-79), to store part of the briquettes in air and part in water. Any material difference in strength between the two lots is sufficient ground for rejecting the cement for use in a dry place. Of course due consideration should be given to the possible effect of evaporation of water from the briquettes stored in air.

146. *Accelerated Tests.* The normal or cold-pat test, extending over a reasonable period, sometimes fails to detect unsoundness; and many efforts have been made to utilize heat to accelerate the action, with a view of determining from the effect of heat during a short time what would be the action in a longer period under normal conditions. Some of these tests have been fairly successful, but none have been extensively employed. It is difficult to interpret the tests, as the results vary with the per cent of lime, magnesia, sulphides, etc., present, and with their proportions relative to each other and to the whole. There is a great diversity as to the value of accelerated tests. Many natural cements which go all to pieces in the accelerated tests, particularly the boiling test, still stand well in actual service. This is a strong argument against drawing adverse conclusions from accelerated tests when applied to portland cement.

The *warm-water test*, proposed by Mr. Faija,* a British authority, is made with a covered vessel partly full of water maintained at a temperature of 100° to 115° F., in the upper part of which the pat

* Trans. Am. Soc. of C. E., vol. xvii, p. 223; vol. xxx, p. 57.

is placed until set. When the pat is set, it is placed in the water for 24 hours. If the cement remains firmly attached to the glass and shows no cracks, it is very probably sound.

The *hot-water test*, proposed by Mr. Maclay,* an American authority, is substantially like Faija's test above, except that Maclay recommends 195° to 200° F.

The *boiling test*, suggested by Professor Tetmajer, the Swiss authority, consists in placing the mortar in cold water immediately after mixing, then gradually raising the temperature to boiling after about an hour, and boiling for three hours. The test specimen consists of a small ball of such a consistency that when flattened to half its diameter it neither cracks nor runs at the edges.

The *flame test* is made by placing a ball of the cement paste, about 2 inches in diameter, on a wire gauze and applying the flame of a Bunsen burner gradually until at the end of an hour the temperature is about 90° C. (194° F.). The heat is then increased until the lower part of the ball becomes red-hot. The appearance of cracks probably indicates the presence of an expansive element.

The *kiln test* consists of exposing a small cake of cement mortar, after it has set, to a temperature of 110° to 120° C. (166° to 248° F.) in a drying oven until all the water is driven off. If no edge cracks appear, the cement is considered of constant volume.

The *chloride-of-lime test* is to mix the paste for the cakes with a solution of 40 grams of calcium chloride per liter of water, allow to set, immerse in the same solution for 24 hours, and then examine for checking and softening. The chloride of lime accelerates the hydration of the free lime. The chloride in the solution used in mixing causes the slaking before setting of only so much of the free lime as is not objectionable in the cement. The chloride of calcium has no effect upon free magnesia.

147. Expansion Test. Various experimenters test the soundness of cement by measuring the expansion of a bar of cement mortar. The French Commission recommend the measurement of the expansion of a bar 32 inches long by $\frac{1}{2}$ inch square, or the measurement of the increase of circumference of a cylinder. The German standard test requires the measurement of the increase in length of a prism 4 inches long by 2 inches square. The apparatus for making these tests can be had in the market. The tests require very delicate manipulation to secure reliable results.

148. CHEMICAL ANALYSIS. Chemical analysis may render valuable service in the detection of adulteration of cement with considerable amounts of inert material, such as slag or ground limestone. It is of use, also, in determining whether certain constituents, believed to

* Trans. Am. Soc. of C. E., vol. xxvii, p. 412.

armful when in excess of a certain percentage, as magnesia and sulfuric anhydride, are present in inadmissible proportions.

The determination of the principal constituents of cement—silica, alumina, iron oxide and lime—is not conclusive as an indication of quality. Faulty character of cement results more frequently from imperfect preparation of the raw material or defective burning than from incorrect proportions of the constituents. Cement made from very finely-ground material, and thoroughly burned, may contain much more lime than the amount usually present and still be perfectly sound. On the other hand, cements low in lime may, on account of careless preparation of the raw material, be of dangerous character. Further, the ash of the fuel used in burning may greatly modify the composition of the product as largely to destroy the significance of the results of analysis.

As a method to be followed for the analysis of cement, that proposed by the Committee on Uniformity in the Analysis of Material for the Portland Cement Industry, of the New York Section of the American Society for Chemical Industry, and published in the *Journal of the American Society* for January 15, 1902, is recommended.*

49. The following simple chemical tests may at times be valuable in testing the purity of a portland cement.†

To test for the presence of limestone or sand, "put into a test tube as much cement as can be taken on a nickel five-cent piece, moisten it with half a teaspoonful of water, and cover with clear phosphoric acid poured slowly upon the cement while stirring it with a glass rod. Pure portland cement will effervesce slightly and give off some pungent gas, and will gradually form a bright yellow

jelly without any sediment. Powdered limestone or powdered sand-rock mixed with the cement will cause a violent effervescence, the acid boiling and giving off strong fumes until all of the carbonate of lime has been consumed, when the bright yellow jelly will form. Powdered sand or quartz or silica mixed with the cement will produce no other effect than to remain undissolved as a sediment at the bottom of the yellow jelly. Reject cement which has either of these characteristics."

To test for the presence of slag, "add benzine to methylene iodide (C_2I_2), which has a specific gravity of 3.29, until the specific gravity of the mixture is 2.95. Put a half inch of the dry cement into a test tube, and pour in a little of the mixture, stirring to a thin grout. Stopper the tube and let it stand. If slag is present, it will remain at the top while the cement will settle to the bottom. The separation can not be seen if coloring matter is present."

* Proc. Amer. Soc. of Civil Engineers, vol. xxix, p. 3.

† Judson's City Roads and Pavements, p. 45-46.

“Coloring matter in any cement will show itself in the acid test by giving a black or gray color to the resultant jelly which would otherwise be yellow. The coloring matter may, or may not, be injurious in itself; but its presence shows that the manufacturer wished to disguise the cement, which should be rejected, because there are plenty of good cements which need no disguise.”

150. ACTIVITY. When cement powder is mixed with water to a plastic condition and allowed to stand, the cement chemically combines with the water and the entire mass gradually becomes firm and hard. This process of solidifying is called setting. Cements differ very widely in their rate and manner of setting. Some occupy but a few minutes in the operation, while others require several hours. Some begin to set comparatively early and take considerable time to complete the process; while others stand considerable time without apparent change, and then set very quickly.

A knowledge of the activity of a cement is of importance both in testing and in using a cement, since its strength is seriously impaired if the mortar is disturbed after it has begun to set. Ordinarily the moderately slow-setting cements are preferable, since they need not be handled so rapidly and may be mixed in larger quantities; but in some cases it is necessary to use a rapid-setting cement, as for example when an inflow of water is to be prevented.

To determine the rate of setting, points have been arbitrarily fixed at which the set is said to begin and to end. It is very difficult to determine these points with exactness, particularly the latter; but an exact determination is not necessary to judge of the fitness of a cement for a particular use. For this purpose it is ordinarily sufficient to say that a mortar has begun to set when it has lost its plasticity, i.e., when its form can not be altered without producing a fracture; and that it has set hard when it will resist a slight pressure of the thumb-nail. Cements will increase in hardness long after they can not be indented with the thumb-nail.

To obtain uniform results the mortar should have a definite plasticity, and to obtain results comparable with those found by others, mortar of a standard plasticity should be employed. For the method of making a mortar of standard plasticity, see § 161-65.

151. There are two methods or forms of instruments used in making this test, viz.: Gillmore's and Vicat's. The former is more frequently used, apparently because of the cheaper and simpler apparatus required; but the latter is used in the better equipped laboratories. Both forms of apparatus are made by all manufacturers of cement-testing appliances.

152. Gillmore's Test. Mix the cement with water to a plastic mortar (see § 161-65), and make a cake or pat 2 or 3 inches in diameter

and about $\frac{1}{2}$ inch thick. The mortar is said to have begun to set when it will just support a wire $\frac{1}{16}$ -inch in diameter weighing $\frac{1}{4}$ pound and to have "set hard" when it will bear a $\frac{1}{24}$ -inch wire weighing 1 pound. The interval between the time of adding the water and the time when the light wire is just supported is the time of beginning to set, and the interval between the time the light wire is supported and the time when the heavy one is just supported is the time of setting.

153. Vicat's Test. The apparatus consists of two parts: 1. A stand supporting an arm through which a rod weighing 300 grams (10.58 oz.) slides freely and carries in its lower end a penetrating needle having a cross section of a square millimeter (0.0006 sq. in.). The rod carries an index which moves over a graduated scale and by which the depth of penetration is read. 2. A vulcanite ring having a height of 4 centimeters (1.57 inches), and a diameter at one end of 7 centimeters and at the other of 6 centimeters.

In making the test, not less than 500 grams of cement are mixed to a paste of the normal consistency (see § 161-65) and formed into a ball; and then the mixing should be completed by tossing the ball six times from one hand to the other, a distance of 6 inches. The ball is next pressed into the vulcanite ring, through the larger opening, and smoothed off; then the ring is placed, small end up, on a glass plate and the top is smoothed off with a trowel. The paste, confined in the ring and resting on the glass plate, is now placed on the base of the instrument under the arm carrying the sliding rod, and the penetrating needle is brought into contact with the surface of the paste and quickly released. At first the needle will penetrate to the glass, in which case the index should read zero, provided glass of the proper thickness has been used; but as a precaution the index should be read and recorded when the needle rests upon the glass. The set is said to have commenced when the needle comes to rest 5 millimeters above the glass; and the cement is said to have "set hard" when the needle no longer sinks visibly into the mass. Care should be taken to keep the needle clean, as the collection of cement on its sides decreases the penetration, while cement on the point reduces the area and tends to increase the penetration.

As a rule the values by the Vicat needle are only about two thirds as great as those by the Gillmore needles. Usually specifications do not say which method is to be employed. However, the exact time of set is of no great importance, and a determination by either method is subject to a considerable error; besides, in practice mortars are mixed wetter than in laboratory practice and are also mixed with sand, and for these two reasons the mortar used in ordinary construction will require six to eight times as long to set as that employed in laboratory tests.

154. Elements Affecting Activity. The determination of the time of set is only approximate, since it is affected by the temperature of the mixing water, the temperature and humidity of the air during the test, the percentage of water used, and the amount of moulding the paste receives. It is usually specified that the water and air shall be from 60° to 65° F. The higher the temperature, the more rapid the set. The test pieces should be stored in moist air during the test, either by being placed on a rack over water contained in a pan and covered with a damp cloth, the cloth being kept away from the test pieces by a wire screen, or better by being stored in a moist box or closet.

The character of the cement materially affects the time of set. Other things being the same, the finer the cement is ground the quicker it sets.

Sulphate of lime (plaster of paris) is usually added to portland cement by the manufacturer to retard the time of set. The addition of 1 or 2 per cent is sufficient to change the time of setting from a few minutes to several hours. Cement which has been made slow-setting by the addition of sulphate of lime, usually becomes quick-setting again after exposure to the air; and cement which has not had its time of setting changed by the addition of sulphate of lime, usually becomes slower-setting with age. Cement which has become slow-setting by the addition of sulphate of lime will become quick-setting if mixed with a solution of carbonate of soda.

Calcium chloride (chloride of lime) in the water used in mixing will affect the time of set, a weak solution accelerating the set and a strong solution retarding it. A 10-per-cent solution will cause ordinary portland cement to set in about one third of the normal time. Ordinary carpenter's glue dissolved in the water will retard the set. Glue equal to 1 per cent of the dry cement about doubles the time of set—both initial and final,—but weakens the mortar about 20 per cent.

155. The standard tests for activity are usually made on neat cement on account of the interference of the sand grains with the descent of the needle. The rate of setting of neat mortar gives but little indication of what the action may be with sand. Sand increases the time of setting, but very differently for different cements. With some cements a mortar composed of one part cement to three parts sand will require twice as long to set as a neat mortar, while with other cements the time will be eight or ten times as long.

156. Time of Set. A few of the quickest *natural* cements when tested neat with the minimum of water will begin to set in 5 to 10 minutes, and set hard in 15 to 20 minutes; while the majority when

tested with the standard quantity of water will begin to set in 20 to 30 minutes and will set hard in 60 to 100 minutes; and a few of the slowest will not begin to set under 60 minutes.

The quickest of the *portlands* will begin to set in 20 to 40 minutes; but the majority will not begin to set under 60 to 90 minutes, and will not set hard under 5 or 6 hours. The 1887 standard German specifications reject a portland cement which begins to set in less than 30 minutes or which sets hard in less than 3 hours.

157. TENSILE STRENGTH. This is the most important of the tests for cement, and in a degree it includes most of the other tests. The strength of cement mortar is usually determined by submitting a specimen having a cross section of 1 square inch to a tensile stress. The reason for adopting tensile tests instead of compressive is the greater ease of making the former and the less variation in the results. Mortar is eight to ten times as strong in compression as in tension.

The accurate determination of the tensile strength of cement is much more difficult than at first appears. Many things, apparently of minor importance, exert such a marked influence upon the results that it is only by the greatest care that trustworthy tests can be made. The variations in the results of different experienced operators working by the same method and upon the same material are frequently very large; and therefore careful attention should be given to the standard method of making the tests, so the results will be comparable with those obtained by others.

158. Neat vs. Sand Tests. Although in practice it is the almost universal custom to mix cement with sand, tests are usually made of both neat cement and sand mixtures. There are two serious objections to testing cement neat. 1. Most neat portland cements decrease in tensile strength after a time. The strength of a cement is due to the aluminates of lime and the silicates of lime, the former being responsible for the setting and the early strength and the latter for the final strength. The strength due to the aluminates is not permanent, but decreases after about 28 days; while the strength due to the silicates increases slowly and does not overcome the loss due to the aluminates until about a year—see Fig. 7, page 122. This decrease is most marked with high-grade portlands which attain their strength rapidly. There is no loss of strength in natural cements, probably because the combination of the lime with the silica and alumina are different from those in portland cement. 2. A second objection to neat tests is that coarsely ground cements show greater strength than finely ground cements, although the latter mixed with the usual proportion of sand will give the greater strength.

On the other hand, more skill is required to secure uniform results with sand than with neat cement.

159. The Sand. The quality of the sand employed in the tests is of great importance, for sands looking alike and sifted through the same sieve give results varying 30 to 40 per cent. To secure uniformity in the results, it is necessary to adopt some particular sand as a standard.

The Committee of the American Society for Testing Materials, in co-operation with similar committees from various other national engineering societies, "recommends the natural sand from Ottawa, Ill., screened to pass a sieve having 20 meshes per linear inch and retained on a sieve having 30 meshes per linear inch. The wires of the sieves are to have diameters of 0.0165 and 0.0112 inches respectively, i.e., half the width of the opening in each case. Sand having passed the No. 20 sieve shall be considered standard when not more than one per cent passes a No. 30 sieve after one minute of continuous sifting of a 500-gram sample. The Sandusky Portland Cement Co., of Sandusky, Ohio, has agreed to undertake the preparation of this sand, and to furnish it at a price only sufficient to cover actual cost."

160. Formerly American engineers used crushed quartz, such as is employed in the manufacture of sand paper; but it did not prove satisfactory.

The standard sand employed in the official German tests is a natural quartz sand obtained at Freienwalde on the Oder, passing a sieve of 60 meshes per square centimeter (20 per linear inch) and caught upon a sieve of 120 meshes per square centimeter (28 per linear inch).

The sand used in ordinary building operations will usually give a greater strength than the so-called standard sand, since usually the former consists of grains having a greater variety of sizes, and consequently there are fewer voids to be filled by the cement (see Table 19, page 93).

161. Normal Consistency. The amount of water necessary to make the strongest mortar varies with each cement. It is commonly expressed in per cents by weight, although in part at least it depends upon volume. The variation in the amount of water required depends upon the degree of fineness, the specific gravity, and the chemical composition. If the cement is coarsely ground, the voids are less, and consequently the volume of water required is less. If the specific gravity of one cement is greater than that of another, equal volumes of cement will require different volumes of water. The chemical composition has the greatest influence upon the amount of water necessary. Part of the water is required to combine chem-

ically with the cement, and part acts physically in reducing the cement to a plastic mass; and the portion required for each of these effects differs with different cements. The dryness and porosity of the sand may also appreciably affect the quantity of water required. The finer the sand, the greater the amount of water required. Again, the same consistency may be arrived at in two ways—by using a small quantity of water and working thoroughly, or by using a larger quantity and working less.

Various methods have been used for identifying a particular plasticity, and different standards of consistency have been proposed; * but none are without objection. The attempt is to adopt a consistency which shall be a compromise between that which will give the greatest strength and that which will give the most uniform results. Two methods of obtaining the same degree of plasticity will be described, viz.: 1, the one proposed by the Committee of the American Society for Testing Materials, which has been generally adopted in this country, and which for convenience will here be called the penetration method; and 2, a method somewhat like one frequently employed in France, and which will here be called the ball method.

162. Penetration Method. A paste of neat cement has the proper plasticity when a rod or "piston" of a certain diameter and weight will penetrate the mass to a certain depth. The apparatus required is known as a Vicat penetration apparatus, and consists of a base supporting an arm through which a bar weighing 300 grams (10.57 oz.) slides freely. The lower end of the bar is a cylinder 1 centimeter (0.39 in.) in diameter. To the bar is attached an index which moves over a graduated scale. The paste is placed in a conical hard-rubber ring 7 centimeters (2.76 in.) in diameter at the base and 4 centimeters (1.57 in.) deep. This is the same apparatus as used in making the activity test (§ 153), except that the needle is replaced by the rod, and a weight on the top of the sliding bar has been changed to compensate for the difference in weight between the rod and the needle.

The paste must be mixed as follows: "The material is weighed and placed on the mixing table and a crater formed in the center, into which the proper percentage of clean water is poured; the material on the outer edge is turned into the crater by the aid of a trowel. As soon as the water has been absorbed, which should not require more than one minute, the operation is completed by vigorously kneading with the hands for an additional one and a half minutes, the process being similar to that used in kneading dough.

* For a description of several see the 9th edition of this volume, p. 69-71, or Taylor's Practical Cement Testing, p. 93.

The paste should then be quickly formed into a ball with the hands, completing the operation by tossing it six times from one hand to the other, maintained 6 inches apart; the ball is then pressed into the hard-rubber ring, through the larger opening, and smoothed off. The ring is then placed on its large end on a glass plate, and the smaller end is smoothed off with a trowel. The paste, confined in the ring resting on the plate, is placed under the rod bearing the cylinder, which is brought into contact with the surface and quickly released."*

The paste is of normal consistency, i.e., of proper plasticity, if the rod penetrates to a depth of 10 millimeters. If the penetration is not the correct amount, a new portion of cement should be weighed out and mixed with more or less water as the case may require, and a new trial made. For any particular cement the exact amount of water required to produce the standard degree of plasticity can be determined only by experiment; but portland cements require from 18 to 24 per cent, usually 19 to 21, and natural cements from 30 to 40 per cent, usually from 34 to 37 per cent.

The consistency recommended above is wetter than has frequently been employed in the past; but is believed to give more uniform results than a dryer mixture. Some specifications, particularly those of the U. S. Army Engineers, require that all cements be mixed with the same quantity of water; but this is not generally considered good practice, since the action of different cements is more nearly the same when mixed to a uniform consistency than when mixed with a uniform quantity of water.

With the usual portland cement only about 12 to 14 per cent of water is required for chemical combination, and consequently the water required to produce normal plasticity is considerably more than is required for the hydration.

163. Ball Method. If a Vicat apparatus is not at hand, substantially the same result may be obtained as follows: Mix the paste to such a consistency that if a ball of mortar about 2 inches in diameter be dropped upon a stone slab or glass plate from a height of 20 inches, it will not crack nor flatten to less than half of its original diameter. This is a simple, rapid, and reasonably accurate method of identifying a certain degree of plasticity, and gives a consistency formerly much employed; but to secure the normal consistency required by the standard American specification, first determine the plasticity by the ball method, and then in making pastes for the standard tests use the amount of water required by the ball method plus 1 per cent of the weight of the dry cement.

* Standard American Specifications for Testing Cement—see Appendix I.

164. **Amount of Water for Sand Mortars.** Neither of the above methods of determining plasticity is applicable to mixtures of sand and cement,—the first because the sand grains interfere with the penetration of the rod, and the second because the mortar is so deficient in cohesion that the ball will not hold its shape when dropped on the stone slab. The only method of determining the normal consistency of mortar is to compare it by the eye and under the trowel with neat cement paste of normal consistency determined as above. This has been done by a number of experts under the direction of the Committee on Uniform Tests of Cement of the American Society of Civil Engineers with the results shown in Table 11, when the percentage for neat cement has been determined as described in § 162.

TABLE 11.

STANDARD PERCENTAGES OF WATER FOR A 1 : 3 PORTLAND CEMENT MORTAR OF NORMAL CONSISTENCY.

Per Cent for Neat Cement.	One Part Portland Cement to Three Parts Standard Ottawa Sand, by Weight.	Per Cent for Neat Cement.	One Part Portland Cement to Three Parts Standard Ottawa Sand, by Weight.	Per Cent for Neat Cement.	One Part Portland Cement to Three Parts Standard Ottawa Sand, by Weight.
15	8.0	23	9.3	31	10.7
16	8.2	24	9.5	32	10.8
17	8.3	25	9.7	33	11.0
18	8.5	26	9.8	34	11.2
19	8.7	27	10.0	35	11.4
20	8.8	28	10.2	36	11.5
21	9.0	29	10.3	37	11.7
22	9.2	30	10.5	38	11.8

165. Table 11, which may properly be called the American standard, applies only to a 1 : 3* mortar; but it sometimes happens in experimental work that other proportions of cement and sand are used, and then it is desirable to know the per cent of water required to produce normal consistency. In this case Table 12 may be used. This table is based upon a formula prepared by Feret†, and was recommended for temporary use by the Committee of the American Society for Testing Materials awaiting the results of further investigations by that society. Notice that Table 11 gives slightly smaller results for a 1 : 3 mortar than Table 12, page 76.

* A common method of stating the composition of a mortar. 1 : 3 signifies 1 part cement to 3 parts sand. The quantity of cement is the unit and is always given first.

† Commission des Méthodes d'Essai des Matériaux, 1895, vol. iv, p. 103.

TABLE 12.

FERET'S PERCENTAGES OF WATER FOR PORTLAND CEMENT MORTAR OF STANDARD CONSISTENCY.

PER CENT FOR NEAT CEMENT.	PER CENT OF WATER IN TERMS OF THE CEMENT AND SAND.					PER CENT FOR NEAT CEMENT.	PER CENT OF WATER IN TERMS OF THE CEMENT AND SAND.				
	1:1	1:2	1:3	1:4	1:5		1:1	1:2	1:3	1:4	1:5
18	12.0	10.0	9.0	8.4	8.0	33	17.0	13.3	11.5	10.4	9.6
19	12.3	10.2	9.2	8.5	8.1	34	17.3	13.6	11.7	10.5	9.7
20	12.7	10.4	9.3	8.7	8.2	35	17.7	13.8	11.8	10.7	9.9
21	13.0	10.7	9.5	8.8	8.3	36	18.0	14.0	12.0	10.8	10.0
22	13.3	10.9	9.7	8.9	8.4	37	18.3	14.2	12.2	10.9	10.1
23	13.7	11.1	9.8	9.1	8.5	38	18.7	14.4	12.3	11.1	10.2
24	14.0	11.3	10.0	9.2	8.6	39	19.0	14.7	12.5	11.2	10.3
25	14.3	11.6	10.2	9.3	8.8	40	19.3	14.9	12.7	11.3	10.4
26	14.7	11.8	10.3	9.5	8.9	41	19.7	15.1	12.8	11.5	10.5
27	15.0	12.0	10.5	9.6	9.0	42	20.0	15.3	13.0	11.6	10.6
28	15.3	12.2	10.7	9.7	9.1	43	20.3	15.6	13.2	11.7	10.7
29	15.7	12.5	10.8	9.9	9.2	44	20.7	15.8	13.3	11.9	10.8
30	16.0	12.7	11.0	10.0	9.3	45	21.0	16.0	13.5	12.0	11.0
31	16.3	12.9	11.2	10.1	9.4	46	21.3	16.1	13.7	12.1	11.1
32	16.7	13.1	11.3	10.3	9.5						

166. Mixing the Mortar. The sand and the cement should be thoroughly mixed dry, and the water required to reduce the mass to the proper consistency should be added all at once. The mixing should be prompt and thorough. The mass should not be simply turned, but the mortar should be rubbed against the top of the slate or glass mixing-table with the ball of the hand or a trowel. Insufficient working greatly decreases the strength of the mortar—frequently one half. With a slow-setting cement a kilogram of the dry materials should be strongly and rapidly rubbed for not less than 5 minutes, when the consistency should be such that it will not be changed by an additional mixing for 3 minutes.

A variety of machines for mixing mortar for experimental purposes have been devised,* but none has proved even fairly successful.

167. Form of Briquette. In 1885 a Committee of the American Society of Civil Engineers recommended a form of briquette which has been the standard in this country until recently. The present standard, Fig. 2, is the same as the former one except that the corners of the briquette are rounded off to facilitate its removal from the moulds. Practically the same form is used in England; and the form employed in continental Europe is somewhat similar to the

* For illustrations of several, see Taylor's Practical Cement Testing, p. 126-27; or Meade's Portland Cement, p. 340-41.

above, except that the section is 5 square centimeters (0.8 square inch) and the reduction to produce the minimum section is by very much more abrupt curves. The continental form gives only 70 to 80 per cent as much strength as the American form.

168. The Moulds. The moulds should be of brass or some non-corrodible material, and should have sufficient metal on the sides to prevent spreading during the filling of the moulds. They may be single or multiple, the latter being preferable where a great number of briquettes are required, since the greater quantity of mortar that can be mixed at once tends to produce greater uniformity in the results. The moulds are in two parts, to facilitate removal of the briquette without breaking it. The moulds should be cleaned and wiped with an oily rag before being used.

169. Moulding the Briquette. Immediately after having worked the paste or mortar to the proper consistency, it should be placed in the briquette moulds by hand. "The moulds should be filled at once, the material being pressed in firmly with the fingers and smoothed off with a trowel without ramming. The material should be heaped up on the upper surface of the mould; and, in smoothing off, the trowel should be drawn over the mould in such a manner as to exert a moderate pressure on the excess material. The mould should then be turned over and the operation repeated."*

"A check upon the uniformity of the mixing and moulding is afforded by weighing the briquettes just prior to immersion, or upon removal from the moist closet. Briquettes which vary in weight more than 3 per cent from the average should not be tested."*

170. Several machines have been made for moulding the briquettes;† but all are very slow, and none permit of moulding more than one briquette at a time, and none are practicable with pastes or mortars of the consistency recommended for American practice.

171. Number of Briquettes. The greater the number tested, the more reliable will be the mean of the results; but the greater the number, the more time required to make the test. The greater

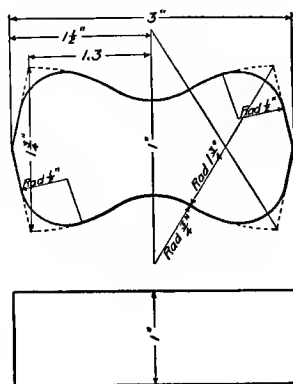

FIG. 2.

* Report of Committee of the American Society of Civil Engineers, on Uniform Tests of Cement, 1904.

† For illustrations of several, see Taylor's Practical Cement Testing, p. 127-29; or Meade's Portland Cement, p. 342-44.

the skill of the operator, the more uniform the results, and hence the fewer briquettes required to obtain any particular degree of accuracy. The accuracy of a series of tests is expressed numerically by the probable error.* "A skilled operator should be able to obtain results having a probable error for a single determination of not more than 4 per cent of the mean."† "An expert working under good conditions may expect to obtain an extreme variation between the results in a set of ten briquettes not exceeding 20 per cent of the mean, and a maximum variation from the mean not exceeding 12 per cent."‡

The inexperienced person should make preliminary tests to determine his degree of uniformity, and one should not attempt to make tests upon which to accept or reject cement until he can at least approximately approach the above limits. Some expert operators always make ten briquettes for each test, while others make only three to five. If the total number of briquettes made of any one sample of cement requires a larger batch of mortar than can be conveniently mixed at one time, the briquettes for each period should be taken equally from the different batches.

172. Storing the Briquettes. During the first 24 hours the test specimens should be kept in a moist chamber or under a damp cloth to prevent them from drying out. The moist chamber is usually either a soapstone or slate box having a shallow receptacle at the bottom for holding water, or a wooden box with metal lining and inside of that a lining of felt which is kept wet. When cloth is used, it should be kept from coming into direct contact with the briquettes by means of a wire screen or some similar device; and care should be taken to keep the cloth uniformly moist, either by immersing its ends in water or inverting a pan over the cloth and the briquette moulds.

The damp cloth is in more common use than the moist chamber, but the latter is much the better, since it is nearly impossible to prevent the cloth from drying out unequally.

* The probable error is an error of such a value that the probability of the real error being greater than it, is equal to the probability of the real error being less than it.

The probable error of a single observation is $E_s = 0.6745 \sqrt{\frac{\Sigma d^2}{n-1}}$ in which d is the difference between any one determination and the mean of the series, Σ a sign indicating the sum of all the d^2 quantities, and n is the number of determinations. The probable error of the arithmetical mean is $E_m = \frac{E_s}{\sqrt{n}}$. Approximately, $E_m = 0.84f$, in which f is the mean of the errors.

† Taylor's Practical Cement Testing, p. 150.

‡ Sabin's Cement and Concrete, p. 137.

73. After 24 hours in moist air, the briquettes to be broken at lay should be taken from the chamber and immediately tested; those to be broken later should be immersed in water at about Fahr. The volume of the water should be at least four or five times the volume of the immersed briquettes; and the water should be renewed about every seven days or there should be a gentle current through the storage tank all the time. In no case should water be allowed to become "stale" or alkaline by the absorption of lime and salts from the briquettes, as "stale" water may reduce the strength of the briquettes nearly one half.

The briquettes should be labelled or numbered to preserve their identity. The briquettes may be marked with a soft lead pencil or stamped with steel dies. Neat-cement briquettes may be stamped with steel dies, as may also sand briquettes provided a thin layer of cement is spread over one end in which to stamp the number.

74. Age when Tested. Since in many cases it is impracticable to extend the tests over a longer time, it has become customary to test the briquettes at one and seven days. This practice, together with a demand for high tensile strength, has led manufacturers to increase the proportion of lime in their cements to the highest possible limit, which brings them near the danger-line of unsoundness. High strength at 1 or 7 days is usually followed by a decrease in strength at 28 days. Steadily increasing strength at long periods is better proof of good quality than high results during the first few days.

The German standard test recognizes only breaks at 28 days. In all cases the time is counted from the instant of adding the water to mixing the briquette. The briquettes should be tested as soon as taken from the water, as drying out materially lowers their strength.

75. The Testing Machine. There are three types in common.

In one the weight is applied by a stream of shot, which runs from a reservoir into a pail suspended at the end of the steelyard arm when the briquette breaks the arm falls, automatically cutting off the flow of shot. In the second type, a heavy weight is slowly lowered along a graduated beam by a cord wound on a wheel turned by the operator. The third type is simply a spring balance. The first form is the most compact, the most rapid, and the most common; the second is the most accurate; and the third is the cheapest and most portable. Each type is made by each manufacturer of cement-testing appliances.

76. The Clips. The most important part of the testing machine is the clips, by means of which the stress is applied to the briquette. There are four important conditions to be fulfilled. 1. The form should be such as to grasp the briquette on four symmetrical

surfaces. 2. The surface of contact must be large enough to prevent the briquette from being crushed between the points of contact. 3. The clip must turn without appreciable friction when under stress. 4. The clip must not spread appreciably while subjected to the maximum load.

Fig. 3 shows three types of clips in common use. Type 1 is the form recommended by a Committee of the American Society of Civil Engineers in 1904. The surface of contact between the clip and the briquette is $\frac{1}{4}$ inch wide, and the distance between the centers of the surfaces of contact of a clip is $1\frac{1}{4}$ inch. The points of contact should accurately fit the briquette, for if the pressure is not uniformly distributed over this surface the concentrated pressure creates a tendency to break in the clip. At best a considerable pro-

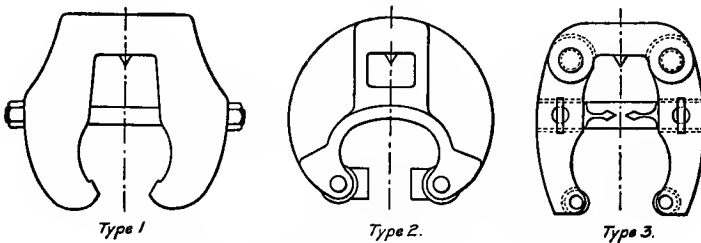

FIG. 3.—CLIPS FOR HOLDING BRIQUETTES.

portion of the briquettes do break in the clips; and several devices have been introduced to prevent it, but none is reasonably successful. Type 2 is a roller-bearing clip, which permits a rolling contact with the briquette, and has a rear projection, or sometimes a solid back, on the clip to aid in inserting the briquette centrally. Type 3 is a self-adjusting roller-bearing clip so arranged that the briquette may receive the same pressure on both sides as it adjusts itself to the pull.

Great care should be taken to center the briquette properly in the clips, as cross strains lower the observed breaking strength. An eccentricity of $\frac{1}{16}$ inch may reduce the strength 20 per cent.

177. The Speed. The more rapidly the load is applied the greater will be the results obtained. For a number of years the standard rate in this country was 400 pounds per minute, but the recently adopted standard specifications (see Appendix I) require a rate of 600 pounds per minute.

The French and German standard specifications require 660 pounds per minute.

78. Data on Tensile Strength. The specifications adopted by American Society for Testing Materials in 1904, and adopted also various other national engineering societies, require that "the minimum tensile strength of briquettes 1 inch square in cross section be within the limits shown in Table 13, and there shall be no regression in strength within the periods specified. For example, minimum requirement for the twenty-four hour neat-cement should be some specified value within the limits of 150 and 200 lbs; and so on for each period stated."

Specifications for strength should be fixed, within the limits in Table 13, to suit the conditions under which the cement is to be used, also in accordance with the personal equation of the one who is to make the tests. If the one who is to test the cement is not already an expert, he should get a number of standard brands and test them to determine his personal equation in comparison with the data in Table 13, and then write the specifications accordingly.

TABLE 13.

MINIMUM REQUIREMENTS FOR THE TENSILE STRENGTH OF CEMENT.

AGE OF MORTAR WHEN TESTED.	AVERAGE TENSILE STRENGTH IN POUNDS PER SQUARE INCH.	
	Portland.	Natural.
CLEAR CEMENT.		
—24 hours in moist air	150-200	50-100
3s—1 day in moist air, 6 days in water	450-550	100-200
7s—1 day in moist air, 27 days in water	550-650	200-300
PART CEMENT, 3 PARTS STANDARD SAND.		
3s—1 day in moist air, 6 days in water	150-200	25- 75
7s—1 day in moist air, 27 days in water	200-300	75-150

79. Table 14, page 82, shows the results of tests of 7,000 briquettes of 783 samples of 16 brands of portland cement tested at a laboratory in 1905, and of many thousand tests of twelve brands of natural cements made at two laboratories in 1905. Compare these results with those in Table 13 to see the relation between standard requirements and the ability of the manufacturers to meet them.

For additional data on the strength of mortars composed of different proportions of cement and sand see Fig. 4 (page 112), Fig. 7 (page 122), and Fig. 8 (page 123).

TABLE 14.
RESULTS OF TENSILE TESTS OF CEMENT.
Pounds per square inch.

AGE WHEN TESTED.	PORTLAND.			NATURAL.		
	Min.	Max.	Mean.	Min.	Max.	Mean.
CLEAR CEMENT.						
1 day.....	199	652	382	125	182	147
7 days.....	502	817	689	128	283	203
28 days.....	598	855	750	187	409	283
1 CEMENT TO 3 STANDARD SAND.						
7 days.....	124	290	240
28 days.....	165	368	328
1 CEMENT TO 1 STANDARD SAND.						
7 days.....	96	156	102
28 days.....	168	206	181
1 CEMENT TO 2 STANDARD SAND.						
7 days.....	165	195	179
28 days.....	265	310	289

180. Equating the Results. It not infrequently occurs that several samples of cement are submitted, and it is required to determine which is the most economical. One may be high-priced and have great strength; another may show great strength neat and be coarsely ground. If the cement is tested neat, then strength, fineness, and cost should be considered; but if the cement is tested with the proportion of sand usually employed in practice, then only strength and cost need to be considered.

TABLE 15.
RELATIVE ECONOMY OF CEMENTS TESTED NEAT AT 7 DAYS.

CEMENTS.	FINENESS.		TENSILE STRENGTH.		CHEAPNESS.		RELATIVE ECONOMY.	
	Per cent Passing No. 100 Sieve.	Relative.	Pounds per Square Inch.	Relative.	Cost per Barrel.	Relative.	Product of Relative Fineness, Relative Strength, and Relative Cost.	Rank.
A	90.0	98.1	628	81.5	\$2.30	100.0	79.95	2
B	88.0	95.9	771	100.0	2.34	98.3	94.26	1
C	88.7	96.6	477	61.9	2.40	95.8	57.28	4
D	91.8	100.0	391	50.7	2.45	93.8	47.55	5
E	81.5	88.8	660	85.6	2.47	93.1	70.79	3

Table 15 shows the method of deducing the relative economy when the cement is tested neat; and Table 16 shows the method when the cement is tested with sand. The data are from actual practice in 1892, and the cements are the same in both tables. Results similar to the above could be deduced for any other age; the circumstances under which the cement is to be used should determine the age for which the comparison should be made.

TABLE 16.

RELATIVE ECONOMY OF CEMENTS TESTED WITH SAND AT 7 DAYS.

CEMENTS.	TENSILE STRENGTH 1 c. to 3 s.		CHEAPNESS.		RELATIVE ECONOMY.	
	Pounds per Square Inch.	Relative.	Cost per Barrel.	Relative.	Product of Rela- tive Strength and Relative Cost.	Rank.
A	168	95.4	\$2.30	100.0	95.40	2
B	176	100.0	2.34	98.3	98.30	1
C	166	94.3	2.40	95.8	90.33	3
D	135	76.7	2.45	93.8	71.94	4
E	135	76.7	2.47	93.1	71.40	5

The above method of equating the results gives the advantage to a cement which gains its strength rapidly and which is liable to be unsound; and therefore this method should be used with discretion, particularly with short-time tests.

181. Specifications. Cement is so variable in quality and intrinsic value that no considerable quantity should be accepted without testing it to see that it conforms to a specified standard. A careful study of Art. 2 preceding, will enable any one to prepare such specifications as will suit the special requirements, and also to give the instructions necessary for applying the tests.

For specifications that may properly be called the American standard specifications for cement, see Appendix I.

182. BIBLIOGRAPHY OF CEMENT. For additional data on matters relating to the manufacture, the chemical composition, and the method of testing lime and cement, see the following:

1. BUTLER, D. B., PORTLAND CEMENT, ITS MANUFACTURE, TESTING, AND USE; E. & F. N. Spon, London, 1899; p. 360, $5\frac{1}{2}$ " \times $8\frac{1}{2}$ ". A British book describing English methods of manufacture, and treating quite fully the methods of testing.

2. ECKEL, EDWIN C., CEMENTS, LIMES, AND PLASTERS, THEIR MATERIALS, MANUFACTURE, AND PROPERTIES; John Wiley & Sons,

New York, 1905; p. 712, 6"×9". A quite full account of the materials and methods of manufacture of limes, portland cements, natural cements, and of some of the less common hydraulic cements.

3. FALK, MYRON S., CEMENTS, MORTARS, AND CONCRETES; M. C. Clark, New York, 1904; p. 174, 6"×9".

4. MEADE, RICHARD K., PORTLAND CEMENT, ITS COMPOSITION, RAW MATERIAL, MANUFACTURE, TESTING, AND ANALYSIS; The Chemical Publishing Co., Easton, Pa., 1906; p. 385, 6"×9". A study of portland cement chiefly from the viewpoint of the manufacturer and the chemist.

5. SABIN, LOUIS CARLTON, CEMENT AND CONCRETE; McGraw Publishing Co., New York City, 1905; p. 507, 6"×9". Part I (27 p.) relates to methods of manufacture. Part II (126 p.) gives the results of numerous comparative tests of portland and natural cements. Part III (186 p.) is devoted to the preparation and properties of mortar and concrete. Part IV (142 p.) describes the uses of mortar and concrete.

6. TAYLOR, W. PURVES, PRACTICAL CEMENT TESTING; M. C. Clark Publishing Co., New York City, 1906; p. 320, 6"×9". Thirty-three pages are devoted to statistics, composition, and manufacture; and the remainder of the book to detailed descriptions of the methods of testing. The book is fully illustrated, and is practically a laboratory guide to testing the hydraulic cements.

7. WATERBURY, LESLIE A., CEMENT LABORATORY MANUAL; John Wiley & Sons, New York, 1908; p. 122, 5"×7". A detailed description of the various steps in testing hydraulic cements, with illustrations of the apparatus employed.

CHAPTER V

SAND, GRAVEL, AND BROKEN STONE

183. Sand is used in making mortar; and gravel, or sand and broken stone, in making concrete. The qualities of the sand and broken stone have an important effect upon the strength and the cost of the mortar and the concrete. The effect of the variation in these materials is frequently overlooked, even though the cement is subject to rigid specifications.

ART. 1. SAND.

184. Sand is mixed with lime or cement to reduce the cost of the mortar; and is added to lime also to prevent the cracking which would occur if lime were used alone. Any material may be used to dilute the mortar, provided it has no effect upon the durability of the cementing material and is not itself liable to decay. Pulverized stone, powdered brick, slag, or coal cinders may be used; but natural sand is by far the most common, although fine crushed stone, or "stone screenings," is sometimes employed and is in some respects better than natural sand.

In testing cement a standard natural sand or crushed quartz is employed; but in the execution of actual work local natural sand must be employed for economic reasons. Before commencing any considerable work, all available natural sands and possible substitutes should be examined to determine their values for use in mortar.

185. REQUISITES FOR GOOD SAND. To be suitable for use in mortar, the sand should be sharp, clean, and coarse; and the grains should be composed of durable minerals, and the gradation of the sizes of the grains should be such as to give a minimum of voids, i.e., interstices between the grains.

The usual specifications are simply: "The sand shall be sharp clean, and coarse."

186. Durability. As a rule ocean and lake sands are more durable than glacial sands. The latter are rock-meal ground in the geological mill, and usually consist of silica with a considerable admixture of mica, hornblende, feldspar, carbonate of lime, etc.

The silica is hard and durable; but the mica, hornblende, feldspar, and carbonate of lime are soft and friable, and are easily decomposed by the gases of the atmosphere and the acids of rain-water. The lake and ocean sands are older geologically; and therefore are as a rule nearly pure quartz, since the action of the elements has eliminated the softer and more easily decomposed constituents. Some ocean sands are nearly pure carbonate of lime, which is soft and friable, and are therefore entirely unfit for use in mortar. These are known as calcareous sands.

The glacial sands frequently contain so large a proportion of soft and easily decomposed constituents as to render them unfit for use in exposed work, as for example in cement sidewalks. Instead of constructing exposed work with poor drift sand, it is better either to ship natural silica sand a considerable distance or to secure crushed quartz. Crushed granite is frequently used instead of sand in cement sidewalk construction; but granite frequently contains mica, hornblende, and feldspar which render it unsuitable for this kind of work.

However, as a rule the physical condition of the sand is of more importance than its chemical composition.

187. Sharpness. Sharp sand, i.e., sand with angular grains, is preferable to that with rounded grains because (1) the angular grains are rougher and therefore the cement will adhere better; and (2) the angular grains offer greater resistance to moving one on the other when under compression. On the other hand, the sharper the sand the greater the proportion of the interstices between the grains (compare line 4 of Table 19, page 93, with the preceding lines of the table), and consequently the greater the amount of cement required to produce a given strength or density. For crushing strength a high degree of sharpness is more important than a small per cent of voids; but for tensile strength, economy, and water-tightness a small per cent of voids is more important.

The sharpness of sand can be determined approximately by rubbing a few grains in the hand and noting whether there is any cutting action, or by crushing it near the ear and noting if a grating sound is produced; but an examination through a small lens is a better means. Strictly speaking, the grains of all natural sand are rounded rather than angular. Sharp sand is often difficult to obtain, and the requirement that "the sand shall be sharp" is practically a dead letter in most specifications. For the reasons given in the preceding paragraph, sharpness should not be specified.

188. Cleanness. Clean sand is necessary for the strongest mortar, since an envelop of loam or organic matter about the sand grains will prevent the adherence of the cement. The cleanness of sand

may be judged by pressing it together in the hand while it is damp; if the sand sticks together when the pressure is removed, it is entirely too dirty for use in mortar. The cleanness may also be tested by rubbing a little of the dry sand in the palm of the hand; if the hand is nearly or quite clean after throwing the sand out, the sand is probably clean enough for mortar. The cleanness of the sand may be tested quantitatively by agitating a quantity of sand with water in a graduated glass flask; after allowing the mixture to settle, the amount of precipitate and of sand may be read from the graduation. Care should be taken that the precipitate has fully settled, since it will condense considerably after its upper surface is clearly marked.

In engineering literature but few definite specifications for the cleanness of sand can be found, a diligent search revealing only the following: For bridge work on the New York Central and Hudson River R. R., the specifications require that the sand shall be so clean as not to soil white paper when rubbed on it. For the retaining walls on the Chicago Sanitary Canal, the suspended matter when shaken with water was limited to 0.5 per cent. For the dam on the Monongahela River, built under the direction of the U. S. A. engineers, the suspended matter was limited to 1 per cent. For the dam at Portage, N. Y., built by the State Engineer, the "aggregate of the impurities" was limited to 5 to 8 per cent. The contamination permissible in any particular case depends upon the cleanness of the sand available and upon the difficulty of obtaining perfectly clean sand. Sand employed in masonry construction frequently contains 5, and sometimes 10, per cent of suspended matter.

Under no consideration should the sand contain any leaves, straw, paper, shavings, chips, etc.

189. Effect of Clay. The effect of clay in the sand varies with the richness of the mortar, i. e., with the proportion of cement. The strength and density of neat cements and of mortars containing 1 or 2 parts of sand, are decreased by even slight additions of clay; but the strength, and also the density, of mortars containing three or four parts of sand are usually increased by the addition of 10 to 20 per cent of finely pulverized clay, and still leaner mortars are improved by even larger percentages of clay. The clay, if finely pulverized, helps to fill the voids of the sand and causes the cementing material to coat the grains better and bind them together more strongly. The exact effect of the clay depends chiefly upon the fineness of the sand grains and upon the percentages of the voids (§ 193) in the clean sand; but depends also upon the thoroughness of mixing and the amount of water used, for if the clay forms a coating on the sand grains and is not removed in the mixing, a small amount of clay is very deleterious.

Lean mortars containing clay to a considerable per cent of the cement are more plastic and work better under the trowel than similar mortars made of clean sand; and clay is sometimes added to produce this effect. The presence of the clay retards the setting of the cement—natural usually more than portland—and makes the mortar more susceptible to the action of frost.

190. Washing Sand. Sand is sometimes washed. This may be done by placing it on a wire screen and playing upon it with a hose, or by placing it in an inclined revolving cylindrical screen and drenching it with water. When only comparatively small quantities of clean sand are required, it can be washed by shoveling it into the upper end of an inclined V-shaped trough and playing upon it with a hose, the clay and lighter organic matter floating away and leaving the clean sand in the lower portion of the trough, from which it can be drawn off by removing plugs in the sides of the trough. Sand can be washed fairly clean by this method at an expense of about 10 cents per cubic yard exclusive of the cost of the water. For a sketch and description of an elaborate machine for washing sand by paddles revolving in a box, see *Engineering News*, Vol. xli, page 111 (Feb. 16, 1899). By this method the cost of thoroughly washing dirty sand is about 15 cents per cubic yard.

Washing may or may not improve the mortar-making qualities of a sand. The washing may carry away only the finer particles of the impurities, and thereby increase the strength of the mortar; or the washing may remove all the impurities and also the finer sand grains, and thereby increase the per cent of voids and hence weaken the mortar. Before deciding to wash any particular sand, a test should be made of the effect upon the strength of the mortar of any particular method of washing.

191. Fineness. Coarse sand is preferable to fine, since (1) the former has less surface to be covered and hence requires less cement; and (2) the coarse sand requires less labor to fill the interstices with the cement. The sand should be screened to remove the pebbles, the fineness of the screen depending upon the kind of work in which the mortar is to be used. The coarser the sand the better, even if it may properly be designated fine gravel, provided the diameter of the largest pebble is not too nearly equal to the thickness of the mortar joint.

Table 17 gives the results of a series of experiments to determine the effect of the size of grains of sand upon the tensile strength of cement mortar. The briquettes were all made at the same time by the same person from the same cement and sand, the only difference being in the fineness of the sand. The table clearly shows that coarse sand is better than fine. Notice that the results in line 4 of

TABLE 17.

EFFECT OF FINENESS OF SAND UPON THE TENSILE STRENGTH OF 1 : 2 CEMENT MORTAR.

REF. No.	SAND CAUGHT BETWEEN THE TWO SIEVES STATED BELOW.	TENSILE STRENGTH, IN POUNDS PER SQUARE INCH, AFTER				
		7 Days.	1 Mo.	3 Mos.	6 Mos.	12 Mos.
1	No. 4 and No. 8	243	442	539	470	665
2	" 8 " " 16	269	345	473	512	572
3	" 16 " " 20	186	250	313	397	396
4	" 20 " " 30	211	281	322	402	440
5	" 30 " " 50	149	205	238	275	318
6	" 50 " " 75	122	214	260	275	308
7	" 75 " " 100	98	153	211	208	253
8	Passing No. 100	98	155	161	229	271

the table are larger than those in line 3. This is probably due to the fact that the sand for line 4 has a greater range of sizes and consequently fewer voids. If this explanation is true, the coarse sand is relatively better than appears from Table 17, since the sand in each line of the lower half of the table has greater variety of sizes than those in the upper half.

Table 18 shows the fineness of natural sands employed in actual construction; and as the sands were to all appearances of the same

TABLE 18.

TENSILE STRENGTH OF 1 : 3 PORTLAND CEMENT MORTARS WITH NATURAL SANDS DIFFERING CHIEFLY IN FINENESS.

REF. No.	FINENESS.								PER CENT PASSING No. 100.	TENSILE STRENGTH, LB. PER SQ. IN.
	Per Cent, by weight, caught on Sieve No.									
	4	8	16	20	30	50	75	100		
1	0	26	21	16	11	9	8	7	2	700
2	0	29	29	13	10	12	5	1	1	447
3	0	22	21	11	17	20	8	1	1	370
4	0	13	15	10	19	33	6	1	1	341
5	0	9	10	6	11	45	15	2	1	332
6	0	13	15	7	8	38	15	4	1	309
7	0	0	0	0	1	6	69	23	2	246
8	0	0	0	0	0	0	0	6	94	200
9	0	0	0	2	3	15	45	30	5	189

character, this table also shows at least approximately the effect of fineness upon tensile strength. This table agrees with the preceding in showing that the coarser sand makes the stronger mortar. This conclusion is perfectly general.

If the voids are filled with cement, uniform coarse grains give greater strength than coarse and fine mixed; or, in other words, for rich mortar coarse grains are more important than small voids. But if the voids are not filled, then coarse and fine sand mixed give greater strength than uniform coarse grains; or, in other words, for lean mortar a small proportion of voids is more important than coarse grains.*

192. Specifications seldom contain any numerical requirement for the fineness of the sand. The two following are all that can be found. For the retaining-wall masonry on the Chicago Sanitary Canal the requirements were that not more than 50 per cent should pass a No. 50 sieve, and not more than 12 per cent should pass a No. 80 sieve. For the Portage Dam on the Genesee River, built by the New York State Engineer, the specifications were that at least 75 per cent should pass a No. 20 sieve and be caught on a No. 40.

The fineness of the sand employed in several noted works is as follows, the larger figures being the number of the sieve, and the smaller figures preceding the number of the sieve being the per cent retained by that sieve, and the small number after the last sieve number being the per cent passing that sieve: Poe Lock, St. Mary's Fall Canal, ⁵ 20 ¹⁵ 30 ³⁵ 40 ⁴⁵; concrete for pavement foundations in the City of Washington, D. C., ⁰ 3 ⁷ 6 ⁸ 8 ¹³ 10 ³⁰ 20 ³² 40 ⁷ 60 ² 80 ¹; Genesee (N. Y.) Storage Dam, ⁰ 20 ⁸ 30 ⁵⁴ 50 ³⁴ 100 ⁴; Rough River (Ky.) Improvement, ¹¹ 20 ¹⁴ 30 ⁵³ 50 ²²; St. Regis sand, Soulanges Canal, Canada, ¹² 20 ²⁸ 30 ⁵¹ 50 ¹¹; Grand Coteau sand,† Soulanges Canal, Canada, ¹⁴ 20 ³⁰ 30 ²⁷ 50 ³⁰. Tables 18 (page 89) and 19 (page 93) show the fineness of a number of natural sands employed in actual work.

The specifications proposed by the German Concrete Society‡ for concrete structures designate as sand any grain of natural sand or crushed stone less than 0.28 inch in diameter, material having pieces larger than this being called pebbles or broken stone. Many American engineers draw the line between sand and pebbles or broken stone at pieces 0.20 inch in diameter. A noted American authority says a good sand should have all of its grains less than

* Report of Chief of Engineers, U. S. A., 1896, p. 2862, or Jour. West. Soc. of Engrs. vol. ii, p. 519; and Report of Operations of the Engineering Department of the District of Columbia, 1896, p. 195.

† A 1 : 2 mortar with this sand was only 79 per cent as strong as that immediately preceding; and with a 1 : 3 mortar only 71 per cent.—Trans. Can. Soc. of C. E., vol. ix, p. 297.

‡ *Engineering News*, vol. liv, p. 478-81.

0.20 inch in diameter and should have not less than 30 per cent that will pass a No. 40 sieve.*

193. Voids. The smaller the proportion of voids, i.e., the interstices between the grains of the sand, the less the amount of cement required, and consequently the more economical the sand.

The per cent of voids in sand may be determined by either of two methods, which for brevity will here be designated as (1) determining voids by the specific gravity method, and (2) determining voids by direct measurement.

194. Determining Voids by Specific Gravity Method. This method consists in determining (1) the specific gravity of the sand and from that computing the weight of a cubic unit of the solid material, and (2) the weight of a cubic unit of the sand. The difference between the first weight and the second weight, divided by the first weight, gives the proportion of voids, or expressed in percentages, gives the per cent of voids.

The specific gravity of siliceous sands is quite uniformly 2.65; but glacial sand containing fragments of limestone, sandstone, shale, and slate may have a specific gravity of 2.60 or even a little less. However, it is sufficient to assume the specific gravity of good siliceous sand at 2.65. The sand should be dried at a temperature not less than 212° Fahr. until there is no further loss of weight. The weight of a unit of sand may be determined for the sand loose, shaken, or rammed, and the per cent of voids will be for the corresponding condition. It is probably better to determine the voids for the sand when rammed, since the mortar is either compressed or rammed when used.

195. Determining Voids by Direct Measurement. The proportion of voids may be determined by filling a vessel with sand and then determining the amount of water that can be poured into the vessel with the sand. The quantity of water poured into the sand divided by the amount of water alone which the vessel will contain is the proportion of voids in the sand. The quantities of water as above may be determined either by volume or by weight. The proportion of voids may be determined for the sand loose, shaken, or rammed, the latter condition being the more appropriate, since the mortar is either compressed or rammed when used. For accurate work the sand should be dried to expel all moisture, as moisture affects both the weight and the volume of the sand, particularly if the sand is fine (see § 196). Further, even though the sand is so coarse that its volume is not appreciably affected by the moisture present, the sand should be dried since it is the total per cent of voids in the sand, and not of the air-filled voids alone, that is desired.

*S. E. Thompson, in *Engineering News*, vol. lix, p. 28.

The above method is subject to considerable error, since it is difficult to eliminate the air bubbles,—particularly if the sand is fine or has been rammed. Further, if the sand is dirty and the water is poured upon it, there is liability of the clay's being washed down and puddling a stratum which will prevent the water's penetrating to the bottom. If the bubbles are not excluded, or if the water does not penetrate to the bottom, the result obtained is less than the true proportion of voids.

Hence, to determine the voids more accurately, put part of the water into the vessel and sprinkle the sand slowly into the water, so as to give opportunity for the air bubbles to escape. The sand should not drop through any considerable depth of water, as there is a liability that the sand may become separated into strata having a single size of grains in each, in which case the voids will be greater than if the several sizes were thoroughly mixed. Add water from time to time, and continue to drop in the sand until the vessel is full of water and the sand is at the top of the water. Finally, as before, the quantity of water in the vessel with the sand, divided by the amount of water alone which the vessel will contain, is the proportion of voids in the sand.

196. Effect of Moisture on Voids. A small per cent of moisture has a surprising effect upon the volume and consequently upon the per cent of voids. For example, fine sand containing 2 per cent of moisture uniformly distributed has nearly 20 per cent greater volume than the same sand when perfectly dry.* This effect of moisture increases with the fineness of the sand, and decreases with the amount of water present, and with the amount of tamping. When saturated, sand will have a bulk less than the original dry volume.

A knowledge of the amount and of the effect of moisture present in the sand is important in proportioning mortar. For example, with ordinary sand 3 or 4 per cent of water will increase the volume so that a mortar consisting of 1 volume of cement to 4 volumes of damp sand is equivalent to a 1 to 3 mortar of dry sand.

197. Data on Voids. Table 19, page 93, shows the voids of a number of both artificial and natural sands. An examination of the table shows that the voids of natural sand when rammed vary from 30 to 37 per cent. Sands No. 10, 11, and 12 are fairly good, although they are finer than the first four in Table 18, page 89; but sands No. 13 and 14 are too fine to give a strong mortar, although they have a fairly low per cent of voids. All five of these sands are frequently employed in making mortar and concrete for important work.

* Feret, Chief of Laboratory Ponts et Chaussées, in *Engineering News*, vol. xxvii, p. 310. For similar data see Report of Chief of Engineers, U. S. A., 1895, p. 2935.

TABLE 19.
FINENESS, VOIDS, AND WEIGHT OF SANDS FOR MORTAR.
Arranged in order of per cent of voids.

REF. No.	DESCRIPTION.	FINENESS.					Per Cent passing No. 75.	VOIDS, PER CENT OF THE VOLUME.		WEIGHT, LB. PER CU. FT.	
		Per Cent, by weight, caught on Sieve No.						Dry and Loose.	Saturated and Rammed.	Dry and Loose.	Dry and Well shaken.
		5	20	30	50	75					
1	Crushed quartz	0	0	99	1	0	0	55	43	81	86
2	Crushed granite	0	0	100	0	0	0	54	41	80	87
3	Crushed limestone (flinty)	0	0	100	0	0	0	53	41	83	91
4	German standard sand	0	0	99	1	0	0	41	38	94	104
5	Bibbus's sand, Urbana, Ill., sifted	0	100	0	0	0	0	46	37.8	91	99
6	" " " " " "	0	0	100	0	0	0	45	36.3	88	97
7	" " " " " "	0	0	0	100	0	0	44	36.0	85	96
8	" " " " " "	0	0	0	0	100	0	45	35.7	86	97
9	" " " " " "	0	0	0	0	0	100	47	33.3	83	95
10	" " " " unsifted	0	27	21	23	9	20	41	30.0	91	100
11	Sand from cement walk, Champaign, Ill.	0	13	17	24	39	5	44	36	83	97
12	"Torpedo sand," Chicago	0	41	19	18	18	3	45	37.	101	113
13	Sand from municipal work, Illinois	0	4	1	2	12	81	37*		90
14	Sand much used in Chicago	0	3	1	3	24	67	37*		98
15	Sand from municipal work, Chicago	0	27	19	32	14	8	28*		106
16	Limestone screenings (flinty), crusher run	0	60	13	7	5	15	28*		110
17	Granite screenings, crusher run	0	56	12	11	8	13	26*		113
18	Sand artificially mixed	0	38†	12‡	12‡	12‡	25†	22*		123

† 12½% passing No. 100.

† 12½% on No. 10; 12½% on No. 15; 12½% on No. 20.

*Dry and well shaken.

198. The following observations may be useful in investigating the relative merits of different sands:

The proportion of voids is independent of the size of the grains, but depends upon the gradation of the sizes, and varies with the form of the grains and the roughness of the surface. A mass of perfectly smooth spheres of any uniform size packed as closely as possible would have 26 per cent of voids; but if the spheres are packed as loosely as possible the voids would be 48 per cent. A promiscuous mass of bird-shot of nominally one size has about 36 per cent of voids. The difference between this and the theoretical minimum per cent for perfectly smooth spheres is due to the variation in size, to the roughness of the surface, and to not securing in all parts of the mass the arrangement of the shot necessary for minimum voids.

If the mass of sand consists of a mixture of two sizes of grains such that the smaller grains can occupy the voids between the larger, then the proportion of voids may be very much smaller than with a single size of grains. The proportion of any particular size should be only sufficient to fill the voids between the grains of the next larger size.

The finer the sand the more nearly uniform the size of the grains, and consequently the greater the proportion of voids. The advantage of coarse sand over fine increases as the proportion of cement decreases, since with the smaller proportions of cement the voids are not filled.

199. STONE SCREENINGS. The finer particles screened out of crushed stone are sometimes used instead of sand. For the physical characteristics of stone screenings see No. 16 and 17, page 93.

Experiments show that sandstone screenings give a slightly stronger mortar than natural sand, probably because of the greater sharpness of the grains. Crushed limestone usually makes a considerably stronger mortar, in both tension and compression, than natural sand, and this difference seems to increase with the age of the mortar.* In some cases limestone screenings give 50 to 100 per cent more strength than the best available sand. Part of the greater strength is unquestionably due to the greater sharpness of the limestone screenings, and the part that increases with the age of the mortar seems to be due to some chemical action between the limestone and the cement.

A portion of the advantage of screenings over sand is due to the smaller per cent of voids in the screenings; in other words, stone screenings, particularly limestone screenings, have more very fine

*Annual Report of Chief of Engineers, U. S. A., 1893, Part 3, p. 3015; *ibid.*, 1894, Part 4, p. 2321; *ibid.*, 1895, Part 4, p. 2953; Jour. West. Soc. of Engrs., vol. ii, p. 394 and 400; *Engineering News*, vol. xlix, p. 306, 343.

particles and hence a smaller per cent of voids, and consequently give greater strength, particularly with the leaner mortars.

Screenings are liable to contain an undue amount of dust; and hence it is very important that a sieve analysis of the material be made to determine the amount and the fineness of the dust present. If there is an undue amount of fine material, the mass should be screened before being used in mixing mortar.

200. SELECTING A SAND. Natural sands differ greatly in fineness, in the per cent of voids, in cleanness, and consequently in their effect upon the strength and quality of the mortar in which they are used. Therefore, before commencing any considerable work all available natural sands and all possible substitutes should be examined to determine their value for use in mortar.

Before beginning the comparison of the different sands a sieve analysis of each should be made to determine whether or not the sand has a proper proportion of different sized grains. In the present condition of our knowledge we do not know the exact gradation of sizes which will give the best results; but sometimes a sieve analysis will show that a sand is unfit for mortar, and sometimes that the sand can be materially improved by screening out some portion of it or by adding either fine or coarse sand. As a check upon the conclusions drawn from the results of the fineness test, a determination should be made of the per cent of voids in each sand (§ 194-95). Further, an investigation should be made to see whether or not any particular sand would be improved by washing (§ 190).

After a preliminary examination of each sand as above, briquettes having the proportions of sand and cement to be used in the work should be made of each, and should be tested at different ages,—if time permits, at least at 1 week and 1 month. The test should be made with the particular cement to be used in the work, since the fineness of the cement affects the result differently with different sands. The mortar for the briquettes should preferably have the plasticity to be used in the work rather than the normal consistency prescribed for laboratory tests of cement (§ 161), since the fineness and cleanness of different sands affect the plasticity of the mortar.

201. Owing to lack of time it is sometimes impossible to wait for a complete test as above, in which case sands may be compared by determining which produces the smallest volume of mortar for the same quantities of dry materials. The cement and the dry sand should be weighed out in the proportions to be used in practice, and should be mixed to the consistency to be used in practice; then the mortar should be introduced into a cylinder, and the volume of the compacted mortar noted. Dry mortar will have the same volume after setting as when it was green, but wet mortar will contract in

setting, owing to the expulsion of the surplus water; and therefore after the mortar has nearly set (but not too hard to be removed from the cylinder), the surplus water should be poured off and the volume of the mortar be again noted. If equal dry weights of two sands are mixed with the same proportion of a cement, that sand is best which gives the least volume of mortar determined as above. The proportion of cement and also the degree of plasticity used in making this test should be that to be employed in actual practice, since differences in the amount of cement or water will change the relative volume of mortar produced.

This method of comparing sands is more accurate than by measuring the voids, for three reasons: 1. The cement paste coats the grains of the sand and increases the volume of the mortar, and this increase varies considerably with the fineness of the sand; and hence it is more accurate to compare sands by making mortars of them and comparing their densities than to compare sands by their voids. 2. The per cent of voids in a mass of sand varies with its compactness, and hence there may be considerable error in comparing different sands by measuring their voids. 3. A small amount of moisture in a mass of sand affects its weight much less than its volume; and hence it is more accurate to compare the sands by mixing the mortars by weight and comparing their densities than to compare the sands by measuring the voids directly. Of course the sands could be dried before determining the voids; but that requires more labor, and does not remove the preceding objections to the method of comparing sands by measuring the voids directly. The method of comparing sands by the direct determination of the voids may be useful in reducing the number of sands to be tested by determining the relative density of the mortars.

202. By one of the preceding methods compare all available sands and screenings, and after determining the one giving the mortar of the greatest strength or of the greatest density, inquire into the relative cost of each. It may be economy to pay considerable for transportation of a better sand than to use an inferior local sand; or it may be more economical to use a local sand with an increased proportion of cement than to bring in a better sand from a distance.* In this connection the possibility of using stone screenings (§ 199) should not be overlooked.

203. COST AND WEIGHT OF SAND. The price of reasonably good sand varies from 40 cents to \$1.60 per cubic yard, according to the locality, but usually from 60 cents to \$1.00.

* For the results of two investigations as to the relative qualities of several sands for mortar, see *Engineering News*, vol. liii, p. 127-29, or *Engineering Record*, vol. 1, p. 103-05; and *Engineering News*, vol. liv, p. 301.

Sand is sometimes sold by the ton. It weighs when dry from 80 to 100 pounds per cubic foot (usually from 85 to 95), or about $1\frac{1}{3}$ to $1\frac{1}{2}$ tons per cubic yard.

ART. 2. GRAVEL.

204. The term gravel is sometimes used as meaning a mixture of coarse pebbles and sand, and sometimes as meaning pebbles without sand. The first definition is the more logical and also the more common, and will be used in this volume.

Gravel or broken stone are mixed with cement mortar to make an artificial stone called concrete (Chap. VII). The quality of the concrete varies greatly with the condition of the gravel or broken stone, but unfortunately too little attention is given to the character of this component.

205. REQUISITES OF GOOD GRAVEL. To be suitable for use in making concrete, gravel should have the following characteristics: (1) it should be composed of durable minerals; (2) it should be at least reasonably clean; and (3) it should have such a variety of sizes as to give a small per cent of voids.

206. The Minerals. Practically all that was said about the durability of sand (see § 186) applies with equal force to gravel. Most gravels are sufficiently durable for use in concrete. In some localities, particularly in the foot-hills of the Appalachian and the Ozark Mountains, a material, locally called gravel, composed of angular fragments of chert, is found in the stream-beds; but such material is unsuitable for concrete, since it is checked and is easily broken, and because its flat glassy faces are too smooth for good adhesion of the cement.

207. Cleanness. All that was said under this head concerning sand (see § 188-90) applies also to gravel. A quantity of finely divided clay equal to 10 or 20 per cent of the gravel does no harm, and may add to the strength of the concrete,—particularly if the cement paste does not entirely fill the voids. The greater the proportion of clay, the more thorough should be the mixing.

208. Maximum Size. The larger the maximum size of pebbles the denser and stronger will be the concrete; but experience has shown that for plain concrete it is impracticable to use fragments larger than about 3 inches in diameter, and that for reinforced concrete the maximum size should not be more than about 1 inch.

209. Voids. For two methods of determining the per cent of voids, see § 194-95. The specific gravity of gravel is practically constant and equal to 2.65. All that was said about voids of sand (§ 196-98) applies with equal force to gravel.

Since the fragments are larger in gravel than in sand, the former may have, and usually does have, a smaller per cent of voids. The voids of a well-proportioned gravel passing a 2-inch screen usually range from 20 to 30 per cent, and occasionally are as low as 15 per cent. Gravel is sometimes washed to remove an excess of loam and clay, and not infrequently the washing removes also some fine sand, which needlessly increases the per cent of voids. The washing should be done in such a manner as to remove no sand, and as a rule only part of the clay.

Coarse gravel is sometimes run through a crusher to reduce the size of the larger pebbles, after which the material has a larger per cent of voids because the sharp angles of the crushed gravel prevent it from packing so closely. On the other hand, the new faces of the broken pebbles usually offer a better surface for the adhesion of the cement than the original water-worn surfaces.

Before adopting a gravel for any important work, the per cent of voids should be determined; and if the result is not entirely satisfactory, the gravel should be separated into several sizes by screening, and the various sizes should be combined in different proportions to see if the per cent of voids can be reduced. For an example of the large saving that may be made by screening the gravel, see the last paragraph in the following section. An advantageous combination can sometimes be discovered by inspection, and may always be found by trial. An easy way of making this trial is as follows:

Procure a piece of 10- or 12-inch vitrified pipe with a cement bottom, or a strong wooden box, preferably metal-lined, and fill it with the coarsest gravel to a depth of a foot or more, tamping the material as it is put in. Make a line around the pipe on the inside to indicate the depth of the stone. Weigh the vessel with the pebbles, empty out the latter and weigh the vessel alone, and determine the weight of the pebbles alone. Next take a new portion of the coarse material and add, say, one tenth of its weight of the next finer material, and repeat the above trial with this mixture. If the amount of this mixture compacted into the pipe or box weighs more than that of the corresponding coarse material, then this mixture is the better for making concrete; and vice versa, if the weight of this mixture is less, then this mixture is not as good for concrete as the corresponding coarse material. By successive trials find the most advantageous combination of sizes to produce a minimum per cent of voids, and this is the most economical combination.

For a direct but elaborate scientific method of determining the proportions of the various sizes to be used to secure the minimum per cent of voids, see § 302-09.

TABLE 20.
VOIDS AND WEIGHT OF GRAVEL AND BROKEN STONE FOR CONCRETE.
Arranged in the order of the voids.

REF. No.	MATERIAL.	FINENESS.										VOIDS, PER CENT OF VOLUME.		WEIGHTS, LB. PER CU. FT.		
		Per cent by weight not passing ring having diameter of			Per cent by weight on Sieve No.*							Per cent passing Sieve No. 75.	Loose.	Rammed.	Loose.	Rammed.
		2"	1"	3/4"	5	20	30	50	75							
1	Flint (screened)	0	100	0	53	49	77	79
2	"	33	33	33	0	48	43	86	89
3	"	0	25	75	0	49	39	85	101
4	Granite (screened)	...	0	100	0	48	44	83	86
5	"	0	100	0	48	44	84	87
6	"	0	84	16	0	44	39	92	94
7	" (crusher run)	0	27	32	21	9	4	3	2	2	2	2	35	30	104	112
8	Limestone (screened)	0	100	51	45	84	95
9	"	0	100	0	45	38	93	105
10	"	0	30	...	51	19	0	33	28	110	118
11	" (crusher run)	4	23	24	17	19	4	2	1	1	1	5	32	27	112	121
12	Pebbles (screened)	0	100	0	45	42	82	90
13	"	...	0	20	80	0	44	39	84	92
14	"	0	100	0	44	40	90	97
15	"	0	26	14	60	0	41	37	100	117
16	Gravel (screened)	0	16	9	36	39	0	37	32	115	124
17	" (unscreened)	0	10	7	24	34	10	5	7	7	7	1	34	27	120	131
18	"	0	11	6	18	33	7	9	15	15	15	1	30	20	125	145

* The diameter of the meshes is as follows: No. 5, 0.18"; No. 20, 0.032"; No. 30, 0.022"; No. 50, 0.012"; No. 75, 0.007".

210. DATA ON PHYSICAL CHARACTERISTICS. The physical characteristics of screened and unscreened gravel are given near the foot of Table 20, page 99. Judging from the little data that can be found in engineering literature and from all the information gathered by an extensive correspondence, gravels No. 16 and No. 17 of the table are representative of the gravels employed in actual work.

Concerning No. 18 notice that 65 per cent passed a No. 5 screen; and therefore this mixture could more properly be called gravelly sand. If one fifth of the material passing the No. 5 sieve be omitted, the voids in the remainder when rammed will be only 15 per cent instead of 20; and therefore if one tenth of this gravel were passed through a No. 5 sieve and that portion retained on the sieve were mixed with the remainder of the original, the voids would be reduced to 15 per cent, which would materially improve the quality of the gravel for making concrete. This is a valuable hint as to the possible advantage of sifting even a portion of the gravel. For an example of the saving secured by grading the materials, see the last paragraph of § 306.

ART. 3. BROKEN STONE.

211. In masonry construction broken stone is used as one of the ingredients of concrete. Any hard and durable stone is suitable for use in making concrete. Trap, granite (not only true granite, but also syenite, diorite, gneiss, etc., which are frequently called granites), limestones, and the more compact sandstones make good broken stone for concrete; while the looser-textured sandstones, shales, and slates are poor for this purpose. The suitability of any particular stone for making concrete may be tested by using it in making a cube of concrete and crushing it at any age desired; if the fragments of the stone pull out of the mortar, the adhesion of the cement limits the strength of the concrete, but if the fragments of stone are broken across, then the strength of the concrete is limited by the shearing strength of the stone. A stone which breaks in approximately cubical pieces rather than in long, thin, splintery fragments should be preferred, since the latter is liable to break under pressure or while being rammed into place, and thus leave two uncemented surfaces.

212. SIZES. The stone should be broken small enough to be conveniently handled and easily incorporated with the mortar; but, other things being the same, the larger the stone, the stronger and the denser the concrete. For plain concrete the stone is usually broken to pass any way through a 2- or 2½-inch ring; but for reinforced concrete (Chap. VIII), the stone is broken to pass a ¾- or

1-inch ring, the smaller stone being used so the concrete may fit itself more closely around the reinforcing metal. The finer the stone is broken the greater the cost; and the finer the stone the greater the surface to be coated, and consequently the greater the amount of cement required.

Stone is sometimes screened to approximately one size. This is only a waste of labor and material, for the screened stone requires more cement and makes a weaker concrete.

213. VOIDS. The per cent of voids in a mass of broken stone may be determined by either of the two methods employed in finding the voids in sand (see § 194-95).

214. Determining Voids by Specific Gravity Method. This method is fully described in § 194. The specific gravity of stones is stated in Table 21.

TABLE 21.

SPECIFIC GRAVITY OF VARIOUS AGGREGATES FOR CONCRETE.

REF. No.	KIND OF MATERIAL.	SPECIFIC GRAVITY.		
		Min.	Max.	Mean
1	Granite	2.58	2.85	2.68
2	Limestone	2.34	2.79	2.53
3	Marble	2.51	2.88	2.72
4	Sandstone	2.03	2.42	2.22
5	Slate	2.56	2.81	2.78
6	Trap	2.78	3.03	2.92

215. Determining Voids by Direct Measurement. For a description of this method as applied to sand, see § 195. The method by pouring water into the mass is reasonably accurate for stone having but little fine material in it; but for ordinary crusher-run broken stone, the material should be dropped into the water and not the water poured into the stone.

If the stone is porous, it is best to wet it, so as to determine the voids between the fragments; for the water absorbed by the material should not be included in the voids, since when the concrete is mixed the aggregate is usually dampened,—particularly if it is porous. Of course, in wetting the aggregate before determining the voids, no loose water should remain in the pile. The voids may be determined for the material either loose or compacted. The proportion of the voids is found to determine the amount of mortar that will be required to fill the voids of the concrete in place; and therefore it is better to determine the voids in the compacted mass, since the

concrete is usually rammed when laid. The compacting may be done by shaking or by ramming, the latter being the better method, since it more nearly agrees with the conditions under which the concrete is used, and, further, since in compacting by shaking the smaller pieces work to the bottom and the larger to the top, which separation increases the percentage of voids.

The method of determining voids by direct measurement usually gives results slightly too small, owing to the difficulty of excluding all the air-bubbles. However, a high degree of accuracy can not be expected, since the material is neither uniform in composition nor uniformly mixed.

216. Data on Voids. Table 20, page 99, shows the per cent of voids in various grades of broken stones used in making concrete.

The per cent of voids in broken stone varies with the hardness of the stone, the form of the fragments, and the relative proportions of the several sizes present. The last element is the most important. If broken stone passing a 3½-inch ring and not a ½-inch screen be separated into three sizes, any one size will give from 52 to 54 per cent of voids loose, while equal parts of any two of the three sizes will give 48 to 50 per cent, and a mixture in which the volume of the smallest size is equal to the sum of the other two gives a trifle less than 48 per cent. Notice, however, that unscreened crushed stone has only 32 to 35 per cent voids—see lines 7 and 11 of Table 20. This is a very excellent reason for not screening the broken stone to be used in making concrete.

A mass of pebbles retained between the same screens as a corresponding mass of broken stone has only about three fourths as many voids as the stone.

217. WEIGHT. The weight of crushed stone varies with the amount of compacting it has received, whether by being dropped into the bin or car, or by being shaken during transportation. There are not much definite data on this subject. In one test a mass of crushed *trap* dropped about 8 feet into a bin had weights as follows: *

½-inch trap and under	2 648 lb. per cu. yd.
½-inch to 1½-inch trap	2 432 " " "
1½-inch to 3-inch trap	2 526 " " "

Some tests on crushed *limestone* after a drop of 15 feet, made under the author's direction, had weights as follows: *

½-inch crusher-run limestone screenings	2 544 lb. per cu. yd.
½-inch to 2-inch limestone	2 420 " " "
2-inch to 3-inch "	2 510 " " "

* Bulletin No. 23 of University of Illinois Engineering Experiment Station—Voids, Settlement and Weight of Crushed Stone, by Ira O. Baker.

218. Cost. Crushed limestone is occasionally sold f.o.b. at the quarry as low as 35 to 40 cents per ton (about 42 to 48 cents per cu. yd.), and frequently as low as 45 to 50 cents per ton (54 to 60 cents per cu. yd.). The cost of crushed trap f.o.b. at the quarries in New Jersey for several years previous to 1900, was 40 to 50 cents per ton (about 50 to 62 cents per cu. yd.); but in that year it was increased nearly 50 per cent. In Massachusetts, the cost of broken trap on cars at the end of the railroad transportation, varies from \$1.10 to \$1.60 per ton (about \$1.32 to \$1.93 per cu. yd.). In Boston, the cost of crushed granite delivered on the streets is \$1.65 to \$1.90 per ton. In Montreal, syenite delivered on the street costs an average of \$1.15 to \$1.20 per ton.

PART II

METHODS OF PREPARING AND USING THE MATERIALS

CHAPTER VI

LIME AND CEMENT MORTAR

ART. 1. LIME MORTAR.

220. Mortar made of a paste of common or fat lime is extensively used in brick masonry, on account of (1) its intrinsic cheapness, (2) its great economic advantage owing to its great increase of volume in slaking, and (3) the simplicity attending the preparation of the mortar.

221. SLAKING THE LIME. Many persons seem to believe that the slaking of lime is such a simple process that any one can do it; but a little care and attention to the principles involved may materially increase the amount of paste obtained, and hence decrease the amount of lime required. Further, if the lime is not completely slaked before being used, the swelling due to the subsequent hydration of the unslaked portion may damage and possibly destroy the structure in which the unslaked lime is used.

Hydrated lime (§ 107) is lime that has been slaked by the manufacturer. It is sold in the form of a dry powder, and is ready for mixing with the sand and water required to make the mortar.

There are three methods of slaking lime on the work, viz.: (1) drowning, (2) sprinkling, and (3) air slaking.

222. Slaking by Drowning. The ordinary method consists in placing the lumps in a layer 6 or 8 inches deep in either a water-tight box or a basin formed in the sand to be used in mixing the mortar, and pouring upon the lumps a quantity of water $2\frac{1}{2}$ to 3 times the volume of the lime. If the quantity of water added is just right, the lime will be reduced to a thick paste; but if too much water is used, the lime will be reduced to a semi-liquid condition and a considerable part of its binding quality will be destroyed. This method takes

its name from the tendency to use an excessive amount of water, i.e., of drowning or killing the lime.

223. With a high-calcium or quick-slaking lime (§ 105) the best results are obtained when all the water is added at once; but with a magnesian or slow-slaking lime (§ 105) only a little water should be added at first, and then after the lime and water are hot, more water may be added gradually so as not to chill the mixture and retard the slaking. The slaking proceeds more rapidly and is more complete if the mass is hot. The lime absorbs the water, and the chemical action generates heat enough to change part of the absorbed water into steam which bursts the lumps of lime apart and thus exposes new surfaces to the action of the water; but if cold water is added after the slaking has begun, it chills the mass, prevents the formation of steam and the consequent bursting of the lumps, and hence the slaking is not complete, and the amount of paste formed is less than it should be. Further, when the slaking has been thus retarded, a thin paste forms on the outside of the fragments of the unslaked lime, which excludes the water from the interior or unslaked portion of the lump; and hence it is difficult, if not impossible, to thoroughly slake lime that has been chilled in the slaking. Partial air slaking is harmful in much the same way, since the slaked lime on the outside of a lump prevents the free access of the water to its interior.

Stirring the lime while slaking chills the mass and thereby retards the slaking; but, on the other hand, stirring breaks up the friable lumps and thereby aids the slaking. Therefore if the mass is stirred at all, the stirring should be done in such a manner as to cool the mass as little as possible. The swelling of the lime in the lower portion of the mass frequently lifts some of the lumps out of the water, the heat in the lump causes a column of steam to rise from it, and the lump is said to "burn." This "burning" is detrimental, since a film of slaked lime is formed on the surface of the unslaked portion which tends to prevent complete slaking. Therefore it is important that lumps which are "burning" should be pushed back into contact with the water. "Burning" can be prevented by covering the box with boards or a tarpaulin to retain the heat and the moisture.

There are two reasons why care should be taken to secure complete hydration of the lime. 1. Imperfect slaking is uneconomical. With reasonable care the high-calcium limes will give a volume of paste equal to three or more times the volume of the unslaked lime; while unskilful slaking may reduce the paste to less than two volumes. 2. The unslaked particles may do no harm if the lime is used in mortar for masonry; but if used for plastering, particularly for

the white coat, they may slake after the mortar is on the wall and cause a portion of the surface to flake out.

224. Slaking by Sprinkling. This method consists in forming the unslaked lime into a heap of convenient size, sprinkling it with water equal to one quarter to one third of its volume, covering with the sand to be used in the mortar, and allowing it to stand for at least a day or two. When the slaking is completed, the lime is in the form of a powder. This method was formerly very common in this country, but was abandoned because of the extra care and labor required. It is said to be in common use now in Europe.

225. Air Slaking. Lime slakes spontaneously when exposed to the air by absorbing moisture from the atmosphere; but this is not a practicable method owing to the immense storage area, the long time, and the frequent stirring required. Lime that is thoroughly air-slaked is as good, or even better, than that slaked in the usual way—a popular prejudice to the contrary notwithstanding. However, lime that is only partially air-slaked is undesirable, since it is more difficult to slake by the ordinary process than lime that is not partially air-slaked (see § 223).

226. PROPORTIONING THE MORTAR. Lime mortar consists of a mixture of lime paste and sand. The requisites for good sand for mortar making have been considered in Art. 1, Chapter V.

There are four reasons for adding sand to the lime paste: (1) to divide the paste into thin films and make the mortar more porous, thus allowing the penetration of the air and facilitating the absorption of the carbonic acid which causes the setting of the mortar; (2) to prevent excessive cracking of the mortar owing to shrinkage due to the evaporation of the water in the lime paste; (3) to give greater strength to the mortar against crushing (practically the only stress that comes upon mortar), since sand has a greater resistance to compression than lime paste either before or after it has set; and (4) to reduce the amount of lime necessary to make a given bulk of mortar, thus decreasing the cost.

Since the paste sets or hardens very slowly, even in the open air, unless it be subdivided into small particles or thin films, it is important that the volume of the paste should be but slightly in excess of what is sufficient to coat all the grains of the sand and to fill the voids between them. If either more or less sand than this is used, the mortar will be injured. An excess of lime paste will prevent the mortar from setting properly, and will cause it to shrink unduly; while a deficiency will make the mortar porous and weak. An excess of lime paste also decreases the compressive resistance of the mortar. With most sands the proper proportion will be from 2.5 to 3 volumes of sand to 1 volume of lime paste.

In proportioning cement mortar it is necessary to measure the sand and the cement to get the proper relation; but with lime mortar the proper proportion of sand and paste can be determined from the way the mortar behaves during the mixing, as will be explained in the next section.

227. MIXING THE MORTAR. After the lime is slaked, the sand is spread evenly over the paste, and the ingredients are mixed with a shovel or hoe, a little water being added occasionally if the mortar is too stiff. The mixing should be thorough, i.e., should be continued until the mortar is of a uniform color.

To determine whether the proportion of sand is right, hold the hoe-handle nearly horizontal and lift up a hoeful of mortar. If the mortar will not of itself slide from the hoe, it does not contain enough sand; and if a hoeful of mortar can not be thus lifted up, it contains too much sand. The brick-mason on the wall by a somewhat similar process checks the proportions of the mortar by the way in which it slips from the trowel. If there is an excess of sand, the mortar will be "brash" or "short," and will drop from the trowel so abruptly as to make it impossible to "string out the mortar," i.e., to spread the mortar over several bricks by simply allowing it to flow from the trowel as the latter is drawn along. On the other hand, if there is an excess of paste, the mortar will not flow from the trowel, at least in sufficient quantity to make the joint. This method of proportioning gives a mortar that works well under the trowel, and with reasonably clean sand also a mortar of practically maximum strength.

If the sand is very fine and contains a good deal of finely pulverized clay, the above test may be satisfied when the mortar contains too little lime; but lime paste is so cheap, and lime mortar is so weak, that a sand with any considerable amount of clay should not be used in lime mortar, since the clay is a source of weakness.

228. USES OF LIME MORTAR. Mortar composed of common lime and sand is not fit for thick walls, because it depends upon the slow action of the atmosphere for hardening it; and, being excluded from the air by the surrounding masonry, the mortar in the interior of the mass hardens only after the lapse of years, or perhaps never.* The mortar of cement, if of good quality, sets immediately; and continues to harden without contact with the air. Owing to its not setting when excluded from the air, common lime mortar should never be used for masonry construction under water, or in soil that

* Lime mortar taken from the walls of ancient buildings has been found to be only 50 to 80 per cent saturated with carbonic acid after nearly 2,000 years of exposure. Lime paste 2,000 years old has been found in subterranean vaults in exactly the condition, except for a thin crust on top, as when freshly mixed.

is constantly wet; and, owing to its weakness, it is unsuitable for structures requiring great strength, or that are subject to shock.

229. STRENGTH. For data on the strength of lime mortar see Table 10, page 51, and Fig. 7, page 122.

230. EFFECT OF FREEZING. The freezing of lime mortar retards the evaporation of the water, and consequently delays the combination of the lime with the carbonic gas of the atmosphere. The expansive action of the freezing water is not very serious upon lime mortar, since it hardens so slowly. Consequently lime mortar is not seriously injured by freezing, provided it remains frozen until it has set. Alternate freezing and thawing somewhat damages its adhesive and cohesive strength. However, even if the strength of the mortar were not materially affected by freezing and thawing, it is not always permissible to lay masonry during freezing weather; for example, if the mortar in a thin wall freezes before setting and afterwards thaws on one side only, the wall may settle injuriously.

When masonry is to be laid in lime mortar during freezing weather, frequently the mortar is mixed with a minimum of water and then thinned to the proper consistency by adding hot water just before using. This is undesirable practice (see § 223). When the very best results are sought, the brick or stone should be warmed—enough to thaw off any ice upon the surface is sufficient—before being laid. They may be warmed either by laying them on a furnace, or by suspending them over a slow fire, or by wetting with hot water, or by blowing steam through a hose against them.

231. DATA FOR ESTIMATES. The following data are useful in making estimates:

Lime weighs about 200 pounds per barrel. One barrel of lime will make about $2\frac{1}{2}$ barrels (0.3 cu. yd.) of stiff lime paste. One barrel of lime paste and three barrels of sand will make about three barrels (0.4 cu. yd.) of good lime mortar. One barrel of unslaked lime will make about 6.75 barrels (0.95 cu. yd.) of 1 : 3 mortar.

ART. 2. CEMENT MORTAR.

232. Cement mortar may consist of either neat cement or a mixture of cement and sand, usually the latter. Cement mortar is not much used for brick masonry, owing to the difficulty of handling it with a trowel; but it is usually employed in laying stone masonry, where the comparatively large quantities required can be handled in a bucket.

233. DENSITY OF MORTAR. The density of a mortar is represented by the ratio of the volume of the solid particles to the total volume

of the mortar.* The density is the complement of the voids, i.e., $1-d=v$ in which d is the density and v the ratio of the volume of the voids to the volume of the mortar. The density of a mortar is an important factor in its strength, permeability and cost; and a knowledge of the density is essential to any thorough understanding of the best method of proportioning a cement mortar and also of the laws governing its strength.

234. To determine the density of a mortar, weigh the amount of cement, sand, and water employed in making a given quantity of mortar, and then measure the volume of the mortar produced. If the weights are determined by the metric system, the space occupied by the solid particles of the cement or of the sand is found by dividing the weight of the material used by its specific gravity,—if the weight is taken in grams the volume will be in cubic centimeters, and if the weight is in kilograms the volume is in cubic decimeters, etc. If the weights are determined in pounds, the weight of the material used divided by its specific gravity gives the weight in pounds of a volume of water equal to the volume of the solid particles; and this result divided by the weight of a cubic inch or of a cubic foot of water will give the volume in cubic inches or in cubic feet, respectively.† The percentage of each of the ingredients is found by dividing the absolute volume of each by the volume of the mortar.

The following example will make the above statements more clear. What is the density of a 1 : 3 mortar by weight, the specific gravity of the cement being 3.17 and that of the sand 2.64? 500 grams of cement and 1500 grams of sand were mixed with water to a normal consistency, which required 193 grams of water; and the volume of the freshly mixed mortar was 962 cubic centimeters. The volume occupied by each of the ingredients is computed as follows:

$$\begin{array}{r}
 \text{Absolute volume of cement} = \frac{500}{3.17} = 158 \text{ c.c.} \\
 \text{“ “ “ sand} = \frac{1500}{2.64} = 568 \text{ c.c.} \\
 \text{“ “ “ water} = \frac{193}{1} = 193 \text{ c.c.} \\
 \hline
 \text{Total volume of cement, sand, and water} = 919 \text{ c.c.} \\
 \text{Measured volume of fresh mortar} = 962 \text{ c.c.} \\
 \hline
 \text{Volume of entrained air} = \text{difference} = 43 \text{ c.c.}
 \end{array}$$

* Notice that the word density is used here in a different sense from that usual in the physical sciences. The term solidity would have been a better term, but the term density has been used so much in this sense in this connection that it is now unwise to attempt to change.

† For an example of the method of computing density, using pounds and cubic inches, see § 290.

Ratio of volume of cement to volume of mortar	$= \frac{158}{962} = 0.164$
Ratio of volume of sand to volume of mortar	$= \frac{568}{962} = 0.590$
Ratio of volume of water to volume of mortar	$= \frac{193}{962} = 0.201$
Ratio of volume of air to volume of mortar	$= \frac{43}{962} = 0.045$
Total volume of mortar	$= 1.000$
Density of mortar	$= 0.164 + 0.590 = 0.754$
Voids in mortar	$= 1.000 - 0.754 = 0.246$

235. The sand used in the above example has the same granulometric composition as the "coarse" sand in § 237. With the medium sand a 1:3 mortar of the same consistency has a density of 0.702 and contains 8 per cent of air; and with the fine sand of § 237 the mortar has a density of 0.603 and contains 11 per cent of air. If the tamping is not very thorough, the per cent of entrained air may be twice that stated above. If the mortar is mixed wetter than the standard consistency employed in testing cement, there will be less air entrained. If the mortar is mixed to standard consistency, the volume of the freshly mixed mortar will be the same as that of the mortar after it has set; but if the mortar be mixed quite wet, the volume after setting will be considerably less than that of the freshly mixed mortar, as the sand and cement settle and cause free water to rise to the surface. The density of the set mortar, or at least of the settled or compacted mortar, is the more important, since the only object in determining the density of the freshly mixed mortar is to find the amount of air entrained in the mixing.

The density of neat cement mortar varies with the cement and with the plasticity, and ranges between 0.49 and 0.59, usually between 0.51 and 0.55. The density of a sand mortar varies with the fineness of the sand, being less as the sand is finer, and also with the richness of the mortar, being slightly less for lean mixtures; and usually ranges from 0.60 for a fine sand to 0.75 for a coarse sand. Or, to state the preceding facts in another form, the voids in neat cement mortar vary from 40 to 50 per cent, and in sand mortar from 25 to 50 per cent, being greater the finer the sand.

236. THEORY OF PROPORTIONS. The whole theory of the proportioning of cement mortar is comprised in two laws, viz.:

1. For the same cement and the same sand, the strength increases with the amount of cement in a unit of volume of the mortar.

2. For the same proportion of cement in a given volume of

mortar, the strongest mortar is that which has the greatest density, i. e., contains the largest proportion of solid matter.

The first law has long been understood and acted upon by all users of cement; and is useful in determining the proportion or amount of cement to be used in any particular case. The second law does not seem to be generally appreciated, although it is very useful in comparing different sands. It was discovered by Mr. René Feret, Chief of the Laboratory of Bridges and Roads at Boulogne-sur-Mer, France.*

237. Relation between Strength and Amount of Cement. The effect of varying the amount of cement in a unit of volume of the mortar differs according to the fineness of the cement and its capacity for taking up water, the plasticity of the mortar, and the fineness of the sand. Fig. 4, page 112, is from Mr. Feret's experiments † and shows the strength of plastic cement mortar with various proportions of cement for three different grades of sand. The granulometric composition of the three sands is as follows:

Coarse sand	= 73% C + 25% M + 2% F,
Medium sand	= 17% C + 70% M + 13% F,
Fine sand	= 0% C + 1% M + 99% F,

in which *C*, *M*, and *F* represent grains of sand having sizes as follows:

<i>C</i> , coarse grains, passing circular holes	5 mm. (0.20 in.) in diameter.
retained by circular holes	2 mm. (0.079 in.) " "
<i>M</i> , medium grains passing circular holes	2 mm. (0.079 in.) " "
retained by circular holes	0.5 mm. (0.020 in.) " "
<i>F</i> , fine grains passing circular holes	0.5 mm. (0.020 in.) " "

The coarse sand had 37 per cent voids, the medium 43, and the fine 44. The value for each proportion is the mean of twenty-five briquettes, broken when 5 months old.

Notice that the 1 : 0.3 fine-sand mortar is stronger than the neat cement, which is contrary to the first law mentioned in § 236. This exception is due to the abnormally fine sand and to the very rich mortar.

Fig. 4 is useful in fixing the proportions of cement to be used in practice, since it shows the relative strength of different mixtures. The amount or proportion of cement to be used in any particular case is entirely a matter of judgment.

* "Sur la Compacité des Mortiers Hydrauliques," *Annales des Ponts et Chaussées*, July, 1892, ii, p. 5-164,—the most elaborate and valuable study yet made of the relation of strength and density of cement mortar.

† Bulletin de la Société d'Encouragement pour l'Industrie Nationale, 1897, vol. ii, p. 1593.

238. Relation between Strength and Density. Having decided upon the proportion of the cement to the sand, the next step is to select the sand that will give a mortar of maximum strength and greatest density. Selecting the sand is a very important step, since sands differ greatly in their mortar-making qualities (see Table 18, page 89). The second law of § 236 affords an easy means of comparing two sands. This law is substantially only another way

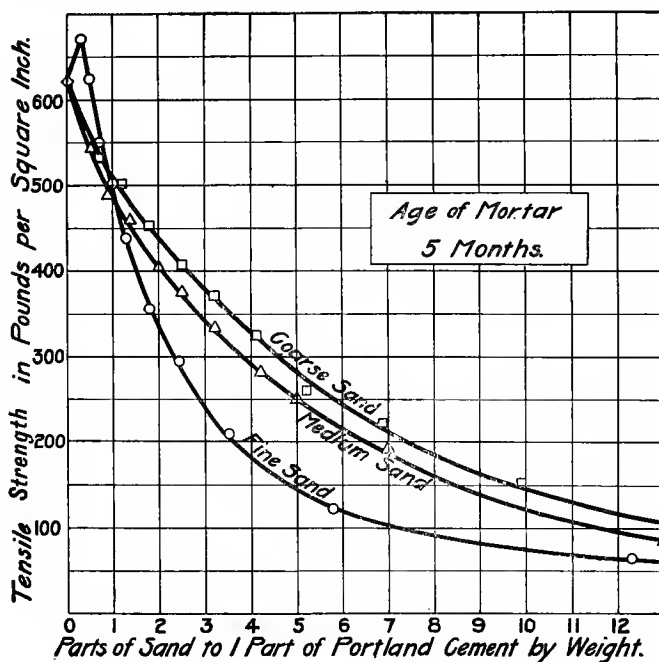

FIG. 4.—STRENGTH OF CEMENT MORTARS WITH DIFFERENT PROPORTIONS OF DIFFERENT NATURAL SANDS.

of stating that the sand having the smallest per cent of voids will make the best mortar.

There are two methods of determining the relative mortar-making qualities of different sands: 1. By the method of § 201, determine the volume of mortar produced with the same weight of the different sands mixed with the same proportion of cement, and the sand giving the least volume of mortar is the best. 2. By the method of § 234, determine the density of the mortar made with each of the sands, using a constant proportion of cement, and then

the sand giving the greatest density will make the strongest and cheapest mortar.

Fig. 5 shows the density of mortars made with different proportions of three sands differing only in fineness.* Three sizes of grains were used, *C*, *M*, and *F*, the numerical values of which are stated in the preceding section.

The diagram is obtained by mixing the three sizes of sand in various proportions, and using each of these mixtures in making a 1 : 3 mortar, and then determining the density of each mortar as explained in § 234.

The density of each mortar is recorded at the point of the diagram corresponding to the granulometric composition of the sand. The proportion of each of the three sizes in the sand is represented by the perpendicular distance from the side opposite each vertex.

For example, a point at *C* represents sand composed wholly of coarse grains; a point half-way between *C* and *F* represents a sand composed of equal parts of coarse and fine grains; and a point half-way from *M* to the base of the diagram represents a sand composed of 50 per cent of *M* grains, 25 per cent of *C* grains, and 25 per cent of *F* grains. The contour lines are drawn through points representing the same density.

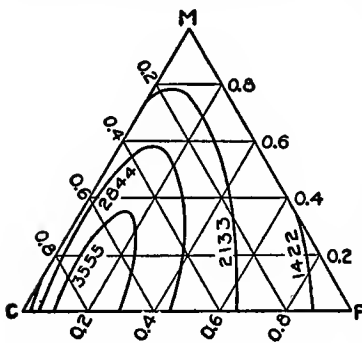

FIG. 6.—COMPRESSIVE STRENGTH OF A 1 : 3 MORTAR MADE OF THE SAME SANDS AS IN FIG. 5.

A comparison of Fig. 5 and 6 shows that the granulometric composition of the sand which gives maximum density also gives maximum compressive strength. The agreement is not exact,

* Feret in *Annales des Ponts et Chaussées*, 1892, ii, p. 164, Plate IV, Fig. 32.

due to errors of observation; but the similarity in the general form of the contour lines in Fig. 5 and 6 indicates that the density varies as the strength.

240. UNITS USED IN PROPORTIONING. In laboratory work the proportions of the cement and sand are uniformly determined by weighing; but there is no uniform practice of measuring the proportions on the work. One of the three following methods is generally employed, viz.: (1) by weight; (2) by volumes of packed cement and loose sand; (3) by volumes of loose cement and loose sand.

1. *By Weight.* The most accurate, but least common, method is to weigh the ingredients for each batch. This method could be used more easily now than formerly, since at the present time cement is usually shipped in bags holding 94 pounds, while formerly it was shipped in barrels holding 380 pounds; and hence if a batch containing one or more bags of cement is desired, it is necessary to weigh only the sand. Weighing the sand would add some complication and cost, but would give better control of the mixture. This method is said to be common in Germany, and has been used on a few jobs in this country.

Occasionally the weight of a unit of volume of the sand and the cement is determined, and the proportions of the mortar are nominally adjusted according to weight, although the actual proportioning is done by volumes. This is practically no better than one of the two following methods.

2. *By Volumes of Packed Cement and Loose Sand.* This method consists in mixing one barrel of packed cement as received from the manufacturer with one or more barrels of loose sand. The measuring is done by emptying a barrel of cement upon the mortar board and then filling the barrel full of sand one or more times. This method is inaccurate, since the volume of a barrel of cement is not the same as packed by different makers. Further, the presence of moisture affects the volume of sand considerably more than its weight (see § 196), and the volume of the sand varies with the method of handling it in the measuring; and hence, for these reasons also, this method is not very accurate.

Not infrequently in the use of this method both heads of the barrel were knocked out, the barrel was set upon the mortar board and filled with sand, and then the barrel was lifted up and the sand spilled out. Notice that this procedure uses more sand than that described above.

The method of proportioning by volumes of packed cement and loose sand was more convenient formerly when cement was usually shipped in barrels than now when cement is generally shipped in bags, for then the barrel was always at hand for use in measuring the

sand. When the cement is shipped in bags, about the only practicable way of applying this method is to assume the weight of a cubic foot of packed cement, or what is the same thing, assume the number of cubic feet in a barrel, and then measure the sand in cubic feet. A cubic foot of portland cement as packed in a barrel usually weighs a little over 100 pounds, but recently it has become common to assume for convenience that a cubic foot of packed portland cement weighs 100 pounds, and a cubic foot of natural cement 75. The proportioning is then done by mixing a bag or barrel of cement with a certain number of cubic feet of sand, which is virtually weighing the cement and measuring the sand by volumes.

American portland cement as packed in the barrel weighs about 100 pounds per cubic foot, and dry loose sand about 90 pounds, and therefore equal parts of cement and sand by weight, say 100 pounds of cement to 100 pounds of dry sand, would be equivalent to 1 cubic foot of packed cement to 1.11 cubic foot of loose sand, or 1 volume of packed cement to 1.11 volumes of loose sand. Natural cement weighs about 75 pounds per cubic foot as packed in a barrel, and hence a 1 : 1 natural cement mortar by weight is equivalent to 1:0.8 by volumes of packed cement and loose sand.

3. *By Volumes of Loose Cement and Loose Sand.* A volume of loose cement is mixed with one or more volumes of loose sand. This method was much more common formerly when cement was usually shipped in barrels than now when it is nearly always shipped in bags. Then it was common to fill a wheelbarrow with loose cement and fill one or more wheelbarrows equally full of sand. As far as the sand is concerned, this method is as inaccurate as the second; and in addition, it is subject to great variations owing to differences in the fineness and compactness of the cement. This is the most inaccurate of the three methods.

At present a modification of this method is in common use. A trial bag of cement is emptied into a wheelbarrow to show how full the wheelbarrows should be filled with sand, the actual measuring being done by emptying a bag of cement on the mortar board and adding one or more equal volumes of sand. By this method there is no uncertainty in measuring the cement; and there is no serious objection to this procedure provided it was distinctly understood that the cement was to be measured loose and not compacted.

When cement was shipped in barrels the proportioning was occasionally done by throwing into the mortar box one shovelful of cement to one or more shovelfuls of sand. This is very crude, and should never be permitted.

Since American portland cement weighs about 90 pounds per cubic foot when shoveled loosely into a box, and since sand weighs

the same, a 1:1 portland cement mortar by weight is equivalent to a 1:1 mortar by volumes of loose cement and loose sand. Since natural cement weighs about 56 pounds per cubic foot when shoveled into a box, a 1:1 natural cement mortar by weight is equivalent to a 1:0.6 by volumes of loose cement and loose sand.

241. Not infrequently the proportions are stated as 1 part of cement to a certain number of parts of sand, without stating whether the parts are to be determined by weight or by volume, or whether the cement is to be measured packed or loose. The examples in the above discussion show the differences possible when the method of proportioning is not stated; and Table 22, page 120, shows incidentally the relative amounts of cement required by the three methods of proportioning. Indefiniteness in stating the proportions is likely to cause misunderstandings between the engineer and the contractor.

The only definite and accurate method of proportion is by weight, for the amount of cement in a given volume of either packed or loose cement is liable to considerable variation, and the volume of sand is materially affected by the presence of even a small amount of moisture—particularly if the sand is fine. Weighing each unit of sand adds some complications and expense; but it secures definiteness of results and in a work of any magnitude may save enough cement to pay for the extra trouble. If the sand for each batch is not weighed, the weighing of an occasional batch will serve as a valuable check upon the method of proportioning actually employed.

242. PROPORTIONS USED IN PRACTICE. The proportions commonly employed in practice are: for portland cement 1 : 2 or 1 : 3; and for natural cement 1 : 1 or 1 : 2. The specifications do not usually define which method is to be employed in the proportioning; and hence the same mortar may be designated by very different proportions by different persons. Further, the proportions are usually fixed without regard to the quality of the sand to be used, although the difference between two sands may make more than a unit difference in the proportions. For example, a 1 : 3 mortar with one sand may be better than a 1 : 2 mortar with another sand (see Table 18, page 89).

243. MIXING THE MORTAR. When the mortar is required in small quantities, as for use in ordinary masonry, it is mixed as follows: About half the sand to be used in a batch of mortar is spread evenly over the bed of the mortar box, then the dry cement is spread evenly over the sand, and finally the remainder of the sand is spread on top. The sand and cement are then mixed with a hoe or by turning and re-turning with a shovel. The mixing can be done more economically with a shovel than with a hoe; but the effectiveness of the shovel

.....

varies greatly with the manner of using it. It is not sufficient to simply turn the mass; but the sand and cement should be allowed to run off from the shovel in such a manner as to thoroughly mix them. Owing to the difficulty of getting laborers to do this, the hoe is sometimes prescribed. If skilfully done, twice turning with a shovel will thoroughly mix the dry ingredients, although four turnings are sometimes specified, and occasionally as high as six. It is very important that the sand and cement be thoroughly mixed. When thoroughly mixed the mass will have a uniform color.

The dampness of the sand is a matter of some importance. If the sand is very damp when it is mixed with the cement, sufficient moisture may be given off to cause the cement to set partially, which may materially decrease its strength. This is particularly noticeable with quick-setting cements.

The dry mixture is next shoveled to one end of the box, and water is poured into the other. The sand and cement are then drawn down with a hoe, small quantities at a time, and mixed with water until enough has been added to make a stiff paste. The mortar should be vigorously worked to insure a uniform product. When the mortar is of the proper plasticity the hoe should be clean when drawn out of it, or at most but very little mortar should stick to it.

Cements vary greatly in their capacity for water (see § 161), the naturals requiring more than the portlands and the fresh-ground more than the stale. An excess of water is better than a deficiency, particularly with a quick-setting cement, as its capacity for combining with water is very great; and further an excess is better than a deficiency, owing to the possibility of the water evaporating before it has combined with the cement. On the other hand, an excess of water decreases the strength of the mortar. If the mortar is stiff, the brick or stone should be dampened before laying; else the brick will absorb the water from the mortar before it can set, and thus destroy the adherence of the mortar.

It is customary to mix mortar for use upon the work considerably wetter than for experiments in the laboratory. A wet mortar is more easily mixed, is less likely to deteriorate from the loss of water by vaporization, and is less likely to be damaged by the absorption of water by the stone. Of course, a great excess of water makes the mortar weak and porous, and difficult to keep in the joints. In hot dry weather, the mortar in the box and also in the wall should be shielded from the direct rays of the sun.

244. Where large quantities of mortar are required, as in the construction of a large masonry dam, an automatic-measuring and

mortar-mixing machine is sometimes used.* Mortar mixers are somewhat similar to concrete mixers (see § 340-41), but are only occasionally required, and are likely to be used less frequently in the future than in the past owing to the substitution of concrete instead of masonry; and hence nothing more will be said here concerning mortar-mixing machines.

245. GROUT. This is a thin or liquid mortar of lime or cement. The interior of a wall is sometimes laid up dry; and grout is poured on top of the wall and is expected to find its way downwards and fill all voids, thus making a solid mass of the wall. Grout should never be used when it can be avoided. If made thin, it is porous and weak; and if made thick, it fills only the upper portions of the wall. To get the greatest strength, the mortar should have only enough water to make a stiff paste.

246. DATA FOR ESTIMATES. The following will be found useful in estimating the amounts of the different ingredients necessary to produce any required quantity of mortar:

247. Portland Cement. In this country portland cement now weighs 376 pounds net per barrel, and is usually shipped in bags weighing 94 pounds net, of which four make a barrel. The capacity of an American cement barrel, which is generally a little greater than that of a foreign one, varies from 3.50 to 3.70, the average being 3.61 cu. ft. A barrel of portland cement will make from 1.2 to 1.4 barrels measured loose.

The quantity of paste produced from a given quantity of cement depends upon the amount of water used, and also upon the thoroughness of mixing and the degree of tamping. In a general way the dryer the mortar the greater the volume; and the less thorough the mixing or the less the tamping, the greater the volume. From 100 to 105 pounds of cement and from 29 to 31 pounds of water will make a cubic foot of paste having about the plasticity used by masons, which is considerably wetter than the standard consistency employed in laboratory tests of cements. Occasionally a cement is found of which only 95 pounds are required to make a cubic foot of paste.

248. Natural Cement. Formerly Rosendale natural cement weighed 300 pounds net per barrel, and the product of western mills 265 pounds net; but recently most of the manufacturers of natural cement have agreed upon a uniform weight of 282 pounds net per barrel, and also agreed upon three bags of 94 pounds each to the barrel. A barrel of natural cement will make from 1.33 to 1.50 barrels if measured loose.

Volume for volume, natural cement will make about the same amount of paste as portland; that is, 75 to 80 pounds of natural

* *Engineering Record*, vol. xxxii, p. 166.

cement and about 0.45 cu. ft. of water will make a cubic foot of plastic paste.

249. QUANTITIES FOR A YARD OF MORTAR. Table 22, page 120, shows the approximate quantities of cement and sand required for a cubic yard of mortar by the three methods of proportioning described in § 240. The table is based upon actual tests made by carefully mixing one half cubic foot of the several mortars; but at best such data are only approximately applicable to any particular case, since so much depends upon the specific gravity, fineness, compactness, etc., of the cement; upon the fineness, humidity, sharpness, compactness, etc., of the sand; and particularly upon the amount of water used in mixing. The consistency of the mortar in Table 22 is about that usually employed in laying brick or stone masonry. In the preceding edition of this book was given a similar table showing the quantities required for dry mortar, that is, for mortar of such consistency that moisture flushed to the surface when the mortar was struck with the back of the shovel used in mixing. Dry mortar is less dense and requires less cement than plastic, since more air is entrained in the mixing. If the mortar is mixed wetter than that in Table 22, as wet, for example, as is usually employed in making concrete, it will be more dense and hence will require more cement and more sand.

The volume of the resulting mortar is always less than the sum of the volumes of the cement and sand, or of the paste and sand, because part of the paste enters the voids of the sand; but the volume of the mortar is always greater than the sum of the volumes of the paste and the solids in the sand, because of imperfect mixing and also because the paste coats the grains of sand and thereby increases their size and consequently the volume of the interstices between them. This increase in volume varies with the dampness and compactness of the mortar. For example, the volume of a rather dry mortar with cement paste equal to the voids, when compacted enough to exclude great voids, was 126 per cent of the sum of the volumes of the paste and solids of the sand; and the same mortar when rammed had a volume of 102 to 104 per cent. If the paste is more than equal to the voids, the per cent of increase is less; and if the paste is not equal to the voids, the per cent of increase is more. The excess of the volume of the mortar over that of the sand increases with the fineness of the sand and with the amount of water used in mixing.

The attempt is frequently made to compute the amount of mortar produced by mixing certain quantities of cement and sand, knowing only the per cent of voids in the sand; but the data in the preceding paragraph show that such computations at best are very crude.

TABLE 22.
 CEMENT AND SAND REQUIRED FOR 1 CUBIC YARD OF COMPACT PLASTIC MORTAR.
 Portland cement = 376 lb. per bbl. Natural cement = 282 lb. per bbl.
 Dry sand = 93 lb. per cu. ft. Voids in sand = 37%.

PROPORTIONS.	MORTAR PROPORTIONED BY WEIGHT.				MORTAR PROPORTIONED BY VOLUMES OF PACKED CEMENT AND LOOSE SAND.				MORTAR PROPORTIONED BY VOLUMES OF LOOSE CEMENT AND LOOSE SAND.			
	Portland.		Natural.		Portland.		Natural.		Portland.		Natural.	
	Cement bbl.	Sand cu. yd.	Cement bbl.	Sand cu. yd.	Cement bbl.	Sand cu. yd.	Cement bbl.	Sand cu. yd.	Cement bbl.	Sand cu. yd.	Cement bbl.	Sand cu. yd.
1:0	7.59	0.00	8.05	0.00	7.59	0.00	8.05	0.00	7.59	0.00	8.05	0.00
1:1	4.24	0.63	4.99	0.56	4.43	0.60	4.72	0.61	4.00	0.68	4.11	0.70
1:2	2.89	0.87	3.54	0.79	3.10	0.83	3.19	0.84	2.62	0.91	2.59	0.91
1:3	2.17	0.97	2.70	0.91	2.36	0.95	2.32	0.94	1.93	1.00	1.79	0.97
1:4	1.69	1.01	2.12	0.95	1.85	1.00	1.79	0.97	1.49	1.02	1.47	1.00
1:5	1.38	1.02	1.74	0.98	1.52	1.02	1.49	1.00	1.20	1.03
1:6	1.11	1.04	1.49	1.00	1.28	1.03	1.01	1.04

cent of voids. On the other hand, in actual practice the mortar is not likely to be as thoroughly mixed nor seasoned under as favorable conditions as in the laboratory, and hence it is not likely that the mortar used in ordinary practice will have as great strength as shown by laboratory tests. Further, mortar which sets under even a moderate pressure may be something like one third stronger than that which sets without pressure; and in practice mortar nearly always sets under more or less pressure.

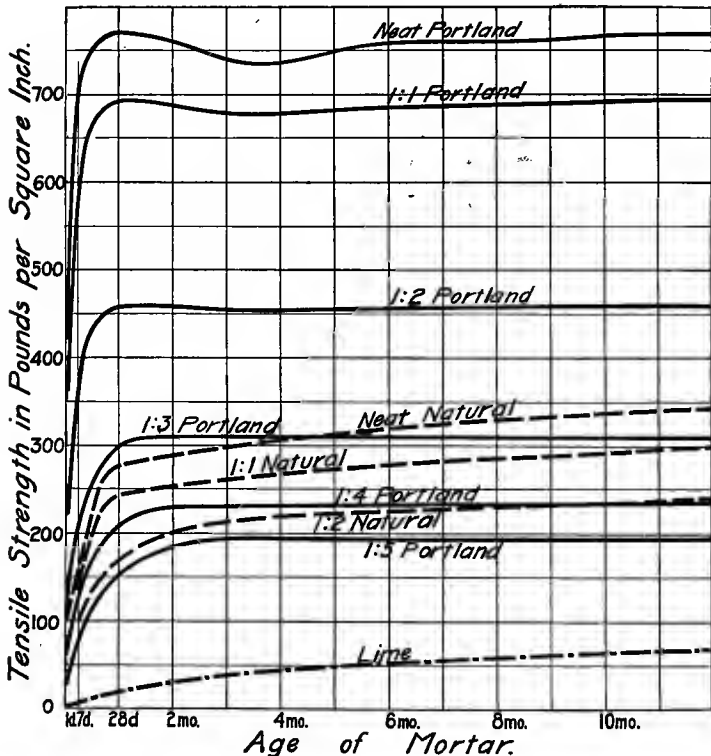

FIG. 7.—EFFECT OF TIME UPON THE STRENGTH OF MORTARS.

253. Effect of Time. Fig. 7 shows the effect of time on the strength of mortars.* The curves for neat and the 1:3 portland cement represent the average of over 150,000 briquettes; while the lines for the other portland-cement mortars are based upon 300 to 500 tests each. The curves for natural cement represent

* Taylor and Thompson's Concrete Plain and Reinforced, p. 99 and 100.

seven different sections of the United States. The line representing lime is based upon only a few experiments by the writer, and represents the value obtained by exposing standard briquettes of mortar freely to the air; but this line is not well determined.

Note that the portland cement both neat and with sand gains its strength proportionally more rapidly than natural cement, notwithstanding the fact that the latter will usually attain "hard set" earlier than the former.

Notice the sag in the curves for the neat and the 1 : 1 portland-cement mortars. This is due to the hardening action of some of the constituents of the cement not being permanent—see § 158.

Notice that portland cement both neat and with sand does not gain much strength after 28 days, while natural cement both neat and with sand continues to gain strength for at least a year. Tests extending over a longer time usually show a falling off in the strength of the neat and rich portland mortars, while natural cement, either neat or with sand, gains strength continuously for at least four or five years. Some natural cements after four or five years are nearly as strong as some portlands.* The chief advantage of portland cements over naturals is that they are more uniform in quality and gain their strength earlier; and the fact that they lose a small part of their strength is not serious.

254. Effect of Sand. Fig. 8 shows the strength at six months of a portland and a natural cement mixed with various proportions of natural sand. Such relations vary with the fineness of the cement and of the sand, but the above is believed to be fairly representative except that the cement is a little coarser than required by the present standard specifications. A diagram like Fig. 8, is useful in discussing the question of relative economy of natural and portland cement (§ 259), in which case it should be made for the particular brands of cement to be considered and with the sand to be used in practice.

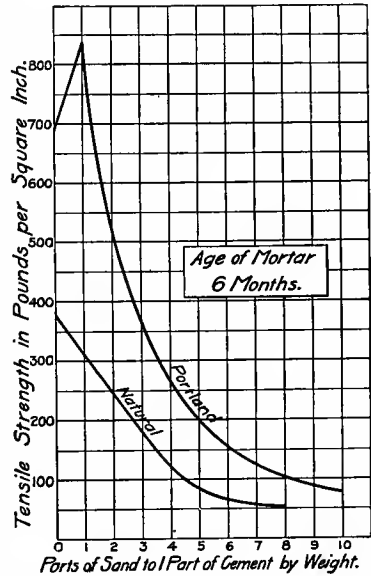

FIG. 8. — EFFECT OF SAND ON THE STRENGTH OF CEMENT MORTARS.

* For example, see Proc. Amer. Soc. for Testing Materials, vol. v (1905), p. 323-26.

255. Compressive Strength. Not nearly as many experiments have been made upon the compressive strength of mortar as upon the tensile strength, partly because of the greater difficulty of moulding the test specimen, and partly because of the uncertainty introduced by the smoothness of the pressed surface, and partly because of the larger and more expensive testing machine required. Experiments seem to show that the crushing strength of cubes is about 8 to 10 times the tensile strength of the same mortar at the same age determined in the usual manner. This ratio increases with the age of the mortar and with the proportion of sand, and decreases with the wetness of the mortars; and varies for different cements and different sands. Several formulas have been proposed to express the relation between the crushing and the tensile strength of cement mortar, but none are reasonably general. The standard German specifications require that the compressive strength of cement mortar shall be at least 10 times its tensile strength.

Data determined by submitting cubes of mortar to a compressive stress are of little or no value as showing the strength of mortar when employed in thin layers, as in the joints of masonry. The strength per unit of bed area increases rapidly as the thickness of the test specimen decreases, but no experiments have ever been made to determine the law of this increase for mortar.

256. Adhesive Strength. Although the adhesion of cement mortar is as important for purposes of construction as its cohesive strength, very few experiments have been made to determine the power with which mortars stick to brick, stone, etc.; and, unfortunately, the results of the few experiments that have been made differ very greatly. All tests for adhesive power are subject to the same causes of variation as cohesive tests, and in addition are subject to variations because of differences of the test specimens in absorptive power, in porosity, in smoothness of the surface, to variations in the pressure upon the specimens, etc., and apparently differences in fineness of the cement and in the character and fineness of the sand make more difference in the tests of adhesion than in the tensile tests. Further, in some of the methods that have been employed to determine adhesion, errors due to eccentricity of stress are proportionally much greater than in ordinary tensile tests.

257. Two methods have been employed in making tests of the adhesive power of mortars; viz.: (1) cementing two bricks or pieces of stone together, and then pulling them apart; and (2) moulding a piece of the material to be tested in the middle of a briquette, and then testing the briquette in the usual way.

1. When two bricks are cemented together crosswise, the results are so variable as to be of little value—partly for the reasons men-

tioned in § 256, but chiefly because with so large a surface of contact there are nearly certain to be large eccentric stresses which greatly reduce the results. In one set of twenty-five experiments using both natural and portland cement the ratio of the tensile strength to the adhesion to soft brick varied from 3.9 to 26; and *decreased* somewhat uniformly from 28 days to 6 months, and *increased* from neat cement to 1 : 3 mortar.* The wide range of these results, and the surprising way in which they varied with age and the richness of the mortar, is characteristic of this method of making tests of adhesion.

A set of 1200 experiments † made in 1882 by cementing two pieces of stone $1\frac{1}{2}$ inches long by 1 inch wide showed not much difference between the adhesion of hydraulic cement to polished plate glass and to chiseled granite or sawed limestone. The results for the adhesion to sawed limestone of a neat portland mortar having a tensile strength of 425 lb. per sq. in. at 7 days, are: at 7 days, 61 lb. per sq. in.; at 28 days, 84 lb. per sq. in. The finer the cement the greater the adhesion. There seems to be no constant relation between the cohesive and the adhesive strength of a cement.

2. The French have a standard method of testing the relative adhesion of different cements and also of testing the adhesion of a cement to different surfaces. To determine relative adhesion of different cements, a half briquette is moulded of standard mortar, and after it has hardened the other half briquette is moulded against the first half, and then the briquette is tested in the ordinary cement-testing machine. Results by this method show great differences for different cements, and no apparent relation between mortars of different proportions.‡

To determine the adhesion of a cement to different surfaces, a plate of the material to be tested is moulded into the middle of the briquette. Results by this method show an adhesion of a 1 : 2 portland-cement mortar at 28 days to sandstone of from 78 to 125 lb. per sq. in.¶

Mr. L. C. Sabin made some tests of adhesion by inserting thin plates of soft dolomitic limestone in the middle of the ordinary briquette mould and then filling the mould with mortar in the ordinary way.** The results show a ratio of cohesive to adhesive strength of portland mortar from 2.03 to 3.05. In both cases there is no practical difference in the ratio for 28 days and 6 months, nor between neat cement and a 1 : 2 mortar. The greatest adhesion is

* Sabin's Cement and Concrete, p. 279.

† I. J. Mann, Proc. Inst. Civil Eng'rs., vol. lxxi, p. 256-69.

‡ Taylor and Thompson's Concrete Plain and Reinforced, p. 124.

¶ Commission des Methodes d'Essai des Materiaux de Construction, 1895. vol. iv.

p. 285.

** Sabin's Cement and Concrete, p. 275,

given by a mortar considerably wetter than that which gives the highest tensile strength.

258. COST OF MORTAR. Knowing the price of the materials, it is very easy, by the use of Table 22, page 120, to compute the cost of the ingredients required for a cubic yard of mortar. The expense for labor is quite variable, depending upon the distance the materials must be moved, the quantity mixed at a time, etc. As a rough approximation, it may be assumed that the cost of mixing mortar is \$1.00 per cubic yard. The following example illustrates the method of computing the cost. The cost of a cubic yard of mortar composed of 1 part portland cement and 2 parts sand, both by weight, is about as follows:

Cement.....	2.89 bbl. (see page 120) @ \$1.80 =	\$5.20
Sand.....	0.87 cu. yd. (see page 120) @ .75 =	.65
Labor, handling materials and mixing $\frac{1}{2}$ day @ 2.00 =	1.00
Total cost of 1 cubic yard of mortar.....		= \$6.85

259. Natural vs. Portland Cement Mortar. It is sometimes a question whether portland or natural cement should be used. If

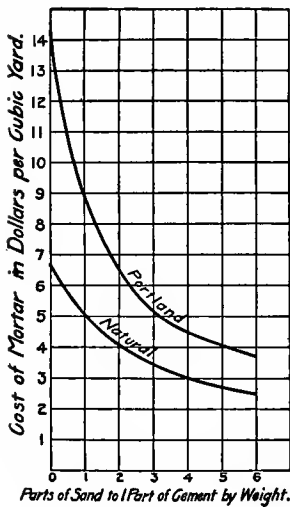

FIG. 9.—COST OF CEMENT MORTARS.

a quick-setting cement is required, then natural cement is to be preferred, since as a rule the natural cements are quicker-setting, although there are many and marked exceptions to this rule. Other things being the same, a slow-setting cement is preferable, since it is not so likely to set before reaching its place in the wall. This is an important item, since with a quick-setting cement any slight delay may necessitate the throwing away of a boxful of mortar or the removal of a stone to scrape out the partially-set mortar.

Generally, however, this question should be decided upon economical grounds, which makes it a question of relative strength and relative prices. The tensile strength of natural and portland cement mortars is shown in Fig. 8, page 123. The cost of mortar of various

proportions of sand may be computed as in the preceding section. Assuming portland cement to cost \$1.80 per barrel, natural 75 cents per barrel, and sand 75 cents per cubic yard, and using

Table 22, page 120, the cost of the materials in a cubic yard of mortar is as in Fig. 9.

By plotting the strength of portland and natural cement mortar 6 months old and the cost of a yard of mortar as given in Fig. 9, Fig. 10 is obtained, which shows the relation between the strength at 6 months and the cost of the mortar made of the two kinds of cement. The curves lie so close together that the diagram is not very significant, but it will serve to illustrate an interesting, if not valuable, method of investigating the relative economy of natural and portland cement. Notice that for any tensile strength under about 300 lb. per sq. in. (the strength of neat natural cement) either natural or portland cement may be used, but that the former is a little cheaper. In other words, Fig. 10 shows that if a strength of about 300 lb. per sq. in. at 6 months is sufficient, natural cement is the cheaper. A considerable change in prices does not materially alter the result, and hence the conclusion may be drawn that if a strength of 250 to 350 lb. per sq. in. at 6 months is sufficient, natural cement is more economical than portland.

For other ages it should be remembered that as the age increases natural cement is relatively stronger than portland (§ 253).

However, in this connection it should not be forgotten that other considerations than strength and cost may govern the choice of a cement; for example, uniformity of product, rapidity of set, and soundness are of equal or greater importance than strength and cost. Portland cement is more uniform in quality than natural cement, and for this reason is usually selected in preference to natural cement. The rapid development of the portland cement industry in recent years in this country has greatly increased the use of portland cement relative to that of natural cement.

260. Mortar made of two brands of portland or natural cement will differ considerably in economic value, and hence to be of the highest value the above comparison should be made between the

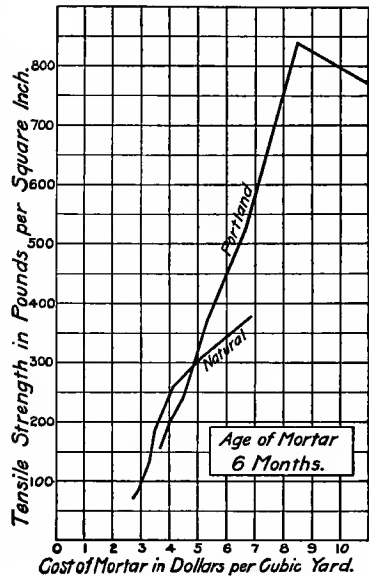

FIG. 10. — RELATIVE ECONOMY OF NATURAL AND PORTLAND CEMENT MORTAR.

most economical portland and the most economical natural cement as determined by the method described in § 180. Prices vary with locality, and hence there may be places in which the above investigation as to the relative economy of natural and portland cement will lead to a considerable saving in construction work requiring a large amount of cement. Such an investigation is less important now than formerly, owing to the decrease in price and increase in strength of portland cement.

261. EFFECT OF RE-TEMPERING. Frequently, in practice, cement mortar which has taken an initial set, is re-mixed and used. Masons generally claim that re-tempering, i.e., adding water and re-mixing, is beneficial; while engineers and architects usually specify that mortar which has taken an initial set shall not be used.

Re-tempering makes the mortar slightly less "short" or "brash," that is, a little more plastic and easy to handle. Re-tempering also increases the time of set, the increase being very different for different cements. But on the other hand, re-tempering usually weakens a cement mortar. A quick-setting natural cement sometimes loses 30 or 40 per cent of its strength by being re-tempered after standing 20 minutes, and 70 or 80 per cent by being re-tempered after standing 1 hour. With slow-setting cements, particularly portlands, the loss by re-tempering immediately after initial set is not material. A mortar which has been insufficiently worked is sometimes made appreciably stronger by re-tempering, the additional labor in re-mixing more than compensating for the loss caused by breaking the set.

The loss of strength by re-tempering is greater for quick-setting than for slow-setting cement, and greater for neat than for sand mortar, and greater with fine sand than with coarse. The loss increases with the amount of set. If mortar is to stand a considerable time, the injury will be less if it is re-tempered several times during the interval than if it is allowed to stand undisturbed to the end of the time and is then re-mixed. Re-tempered mortar shrinks less in setting than fresh mortar, which is an advantage in joining new concrete to old (see § 345).

The only safe rule for practical work is to require the mortar to be thoroughly mixed, and then not permit any to be used which has taken an initial set. This rule should be more strenuously insisted upon with natural than with portland cements, and more with quick-setting than with slow-setting varieties.

262. LIME WITH CEMENT. Cement mortar before it begins to set has no cohesive or adhesive properties, and is what the mason calls "poor," "short," "brash"; and consequently is difficult to use, since it will not stick to the edge of the brick already laid suffi-

ciently to give mortar with which to strike the joint. The addition of a small per cent of lime makes the mortar "fat" or "rich," and causes it to work better under the trowel.

The lime should be slaked before being mixed with the cement. Formerly it was necessary to use lime paste for this purpose; but now either lime paste or dry hydrated lime may be used. Dry hydrated lime made from pure limestone contains 32 per cent of water, but lime made from either an impure or a magnesian limestone will contain less, depending upon the amount of impurities or of magnesium present. Lime paste usually weighs about $2\frac{1}{2}$ times as much as the unslaked lime.

The effect of the lime upon the strength of the mortar will vary with the character of the cement, the fineness of the sand, and the proportions of cement to sand. The addition of unslaked lime equal to 5 to 10 per cent of the cement does not materially decrease the strength of a 1 : 3 or a 1 : 4 mortar, and frequently slightly increases it. In all cases the addition of 5 to 10 per cent of lime decreases the cost more rapidly than the strength and hence is economical; but the substitution of more than about 10 per cent decreases the strength more rapidly than the cost, and hence is not economical. The economy of using lime with cement is, of course, greater with portland than with natural cement owing to the greater cost of the former. One large manufacturer of natural cement grinds 15 per cent of hydrated lime with the cement and sells the mixture as "bricklayer's cement."

The addition of lime as above to a 1 : 3 or a 1 : 4 cement mortar makes it more dense, and hence more nearly waterproof; and also increases its adhesive strength more than its cohesive strength.*

The addition of lime to cement mortar does not materially affect the time of set, and usually slightly increases it.

263. The discussion in the preceding section refers to the addition of a comparatively small portion of lime to a cement mortar; but it is also common to add a small per cent of cement to a lime mortar when a mortar of greater strength or greater activity is desired than can be obtained with lime alone. The cement adds to the strength of the mortar, but not proportionally to the increase in cost. When a stronger or quicker-setting mortar is desired than can be obtained with lime alone, it would be cheaper to use a lean cement mortar, if such a mortar were not so difficult to handle with a trowel.

264. WATERPROOF MORTAR. A non-absorbent and impermeable mortar is important in all forms of masonry construction, and in some cases such a mortar is vitally essential. If the mortar is porous, it will absorb water, which may freeze and cause disintegration;

* Sabin's Cement and Concrete, p. 280-84.

and if the mortar is permeable, it may permit water to percolate or flow through it, which will make it useless for some purposes.

To make a non-absorbent and impermeable mortar, use sand containing a small per cent of voids, that is, sand containing a proper proportion of grains of various sizes, and enough fine-ground cement to completely fill the voids in the sand; and mix the mortar very thoroughly, making it neither very wet nor very dry. There are a number of foreign ingredients that are sometimes mixed with mortar to make it impervious, but usually it is both better and cheaper to use a richer mortar than to add the foreign substances. The method of making mortar impervious by filling the voids with some foreign ingredient is substantially the same as for concrete (§ 369-76)

265. FREEZING OF MORTAR. The freezing of mortar before it has set has two effects: (1) the low temperature retards the setting and hardening action; and (2) the expansive force of the freezing water tends to destroy the cohesive strength of the cement.

Owing to the retardation of the low temperature, the setting and hardening may be so delayed that the water may be dried out of the mortar and not leave enough for the chemical action of hardening; and consequently the mortar will be weak and crumbly. This would be substantially the same as using mortar with a dry porous brick. In ordinary practice cement mortar is always mixed with considerably more water than is required for the chemical combination; but when mortar is likely to be exposed to frost, it should be mixed dryer than usual to hasten the set, and hence the drying out may seriously injure the strength of the mortar. Whether the water evaporates to an injurious extent or not depends upon the humidity of the air, the temperature of the mortar, the activity of the cement, and the extent of the exposed surface of the mortar. The mortar in the interior of the wall is not likely to be injured by the loss of water while frozen; but the edges of the joints are often thus seriously injured. In the latter case the damage may be fully repaired by pointing the masonry (§ 565) after the mortar has fully set.

On the other hand, when the cement has partially set, if the expansive force of the freezing water is greater than the cohesive strength of the mortar, then the bond of the mortar is broken, and on thawing out the mortar will crumble. Whether this action will take place or not will depend chiefly upon the strength and activity of the cement, upon its hardness at the time of freezing, and upon the amount of free water present. Further, cement in setting generates some heat (§ 348) which tends to prevent freezing.

The relative effects of these several elements are not known certainly; but it has been proven conclusively that for the best results the following precautions should be observed: 1. Use a

quick-setting cement. 2. Make the mortar richer than for ordinary temperatures. 3. Use the minimum quantity of water in mixing the mortar. 4. Prevent freezing as long as possible.

266. There are various ways of preventing freezing: 1. Cover the masonry with tarpaulin, straw, manure, etc. 2. Warm the stone and the ingredients of the mortar. Heating the ingredients is not of much advantage, particularly with portland cement. 3. Instead of trying to maintain a temperature above the freezing point of fresh water, add salt to the water to prevent its freezing. To prevent water from freezing down to 0° F., add salt equal to 1 per cent of the weight of the water for each 1° F. below freezing. A common rule which has been much used to keep mortar from freezing is: "Dissolve 1 pound of salt in 18 gallons of water [practically 150 pounds] when the temperature is at 30° F., and add 1 ounce of salt for each 1° of lower temperature." This rule does not give as much salt as the first one—at 31° only about two thirds as much and at 20° only about one tenth as much,—and it gives either too much salt for temperatures only a little below freezing or too little for temperatures near zero. The fact that the second rule has been successfully used to prevent damage to mortar at atmospheric temperatures 10° or 15° F. below freezing, seems to show that with mortar it is not necessary to use the full amount of salt required to keep the water from freezing. Apparently then a safe rule would be: "Use salt equal to $\frac{1}{3}$ of 1 per cent of the weight of the water used in making the mortar for each 1° F. below freezing." This rule is better than the second one above because it gives the correct relative proportions of salt at all temperatures; and below 28° the last rule gives more salt than the second rule, and therefore is more safe at low temperatures where most needed.

Alternate freezing and thawing are more damaging than continuous freezing, since with the former the bond may be repeatedly broken; and the damage due to successive disturbance increases with the number.

267. Practice has shown that portland-cement mortar of the usual proportions laid in the ordinary way is not materially injured by alternate freezing and thawing, or by a temperature of 10° to 15° F. below freezing, except perhaps at the exposed edges of the joints. Under the same conditions natural-cement mortar is likely to be materially damaged.

By the use of salt, even in less proportions than specified above, or by warming the materials, masonry may be safely laid with portland-cement mortar at a temperature of 0° F.; and the same may usually be done with natural cement, although it will ordinarily be necessary to re-point the masonry in the spring. Warming the materials is not as effective as using salt.

CHAPTER VII

PLAIN CONCRETE

275. Concrete consists of mortar in which are embedded pebbles or pieces of stone, broken brick, etc. At present the mortar used in making concrete is invariably cement, although in ancient times lime was so used. Of course, common lime is wholly unfit for use in large masses of concrete, since it does not set when excluded from the air. The lime used by the ancients usually had some hydraulic properties.

Concrete has been in use from remote antiquity, but it is only comparatively recently that it has been used to any considerable extent. The development of the American portland cement industry has greatly stimulated the use of concrete in this country in recent years; and at present concrete occupies a peculiar and preeminent position in structural work.

“Concrete is admirably adapted to a variety of most important uses. For foundations in damp and yielding soils and for subterranean and submarine masonry, under almost every combination of circumstances likely to be met in practice, it is superior to brick masonry in strength, hardness, and durability; is more economical, and in some cases is a safe substitute for the best natural stone, while it is almost always preferable to the poorer varieties. For submarine masonry, concrete possesses the advantage that it can be laid, under certain precautions, without exhausting the water and without the use of a diving-bell or submarine armor. On account of its continuity and its impermeability to water, it is an excellent material to form a substratum in soils infested with springs; for sewers and conduits; for basement and retaining walls; for piers and abutments; for the hearting and backing of walls faced with bricks, rubble, or ashlar work; for pavements in areas, basements, sidewalks, and cellars; for the walls and floors of cisterns, vaults, etc. Groined and vaulted arches, and even entire bridges, dwelling-houses, and factories, in single monolithic masses, with suitable ornamentation, have been constructed of this material alone.”

The use of concrete enables the engineer to build his superstructure on a monolith as long, as wide, and as deep as he may think best, which can not fail in parts, but, if rightly proportioned, must go all together—if it fails at all.

276. This chapter will treat of plain concrete, i.e., of concrete without steel reinforcement; and the next chapter will consider reinforced concrete, i.e., a combination of concrete and steel.

This chapter is divided into five articles which treat respectively of: (1) the materials; (2) the laws of proportions; (3) the forms; (4) mixing and placing, and matters related thereto; and (5) strength and cost.

ART. 1. THE MATERIALS.

277. CEMENT. The cement has been fully described in Chapter IV.

278. SAND. The sand is considered in Art. 1 of Chapter V.

279. AGGREGATE. When concrete is considered as mortar with pieces of hard material embedded in it, the mortar is called the matrix and the coarse material the aggregate; but sometimes concrete is considered as a mixture of cement, sand, and coarser material, in which case the cement paste is called the matrix, the sand the fine aggregate, and the stone or pebbles the coarse aggregate.

The coarse aggregate may consist of small pieces of any hard material, as pebbles, broken stone, broken brick, shells, slag, cinders, coke, etc. It is added to the mortar to reduce the cost; and within limits the addition of a reasonably strong aggregate also adds to the strength of the concrete. Ordinarily either broken stone or gravel is used. Coke or cinders are used when a light and not strong concrete is desired, as for the foundation of a pavement on a bridge or for the floors of a tall building.

280. Gravel. Gravel as an ingredient of concrete has been discussed in Art. 2 of Chapter V.

281. Broken Stone. The qualities of broken stone which render it suitable for use in concrete have been considered in Art. 3 of Chapter V.

282. Screened vs. Unscreened Broken Stone. It is sometimes specified that the broken stone to be used in making concrete shall be screened to practically a uniform size; but this is unwise for three reasons, viz.: 1. With graded sizes the smaller pieces fit into the spaces between the larger, and consequently less mortar is required to fill the spaces between the fragments of the stone. Therefore the unscreened broken stone is more economical than screened broken stone. 2. A concrete containing the smaller fragments of broken stone is stronger than though they were replaced with cement and sand. Experiments show that sandstone screenings give a considerably stronger mortar than natural sand of equal fineness, and that limestone screenings make stronger mortar than sandstone screenings, the latter making a mortar from 10 to 50 per cent stronger

than natural sand.* Hence, reasoning by analogy, we may conclude that including the finer particles of broken stone will make a stronger concrete than replacing them with mortar made of natural sand. Further, experiments show that a concrete containing a considerable proportion of broken stone is stronger than the mortar alone (see the second and third paragraphs of § 294). Since the mortar alone is weaker than the concrete, the less the proportion of mortar the stronger the concrete, provided the voids of the aggregate are filled; and therefore concrete made of broken stone of graded sizes is stronger than that made of practically one size of broken stone.

3. A single size of broken stone has a greater tendency to form arches while being rammed into place, than stone of graded sizes; and consequently does not make as strong or as dense concrete.

Therefore concrete made with screened stone is more expensive; less dense, and weaker than concrete made with unscreened stone. In short, screening the stone to nearly one size is not only a needless expense, but is also a positive detriment.

The dust should be removed, since it has no strength of itself and adds greatly to the surface to be coated, and also prevents the contact of the cement and the body of the broken stone. Particles of the size of sand grains may be allowed to remain if not too fine or in excess. The small particles of broken stone should be removed, if to do so will reduce the proportion of voids (§ 213-16).

283. Gravel vs. Broken Stone. Often there is debate as to the relative merits of gravel and broken stone as the aggregate for concrete. The elements to be considered are strength, density, and cost.

284. Relative Strength. In Chapter VI it was shown that finely crushed stone gave mortars of greater tensile and compressive strengths than equal proportions of sand; and hence, reasoning by analogy, the conclusion is that concrete composed of broken stone is stronger than that containing an equal proportion of gravel. This element of strength is due to the fact that the cement adheres more closely to the rough surfaces of the angular fragments of broken stone than to the smooth surface of the rounded pebbles.

Again, part of the resistance of concrete to crushing is due to the frictional resistance of one piece of aggregate to moving on another; and consequently for this reason broken stone is better than gravel. It is well known that broken stone makes better macadam than gravel, since the rounded pebbles are more easily displaced than the angular fragments of broken stone. Concrete differs from macadam only in the use of a better binding material;

* Annual Report of Chief of Engineers, U. S. A., 1893, Part 3, p. 3015; *ibid.*, 1894, Part 4, p. 2321; *ibid.*, 1895, Part 4, p. 2953; Jour. West. Soc. of Eng'rs, vol. ii, p. 394 and 400.

and the greater the frictional resistance between the particles the stronger the mass or the less the cement required.

A series of experiments made by the City of Washington, D. C.,* to determine the relative value of broken stone and gravel for concrete, which are summarized in § 396, gives the following results:

CRUSHING STRENGTH OF GRAVEL CONCRETE IN TERMS OF THAT OF
BROKEN-STONE CONCRETE.

AGE OF CONCRETE WHEN TESTED.	CONCRETE MADE WITH	
	NATURAL CEMENT.	PORTLAND CEMENT.
10 days.	38 per cent.	76 per cent.
45 "	78 " "	91 " "
3 months.	96 " "	119 " "
6 "	43 " "	73 " "
1 year.	83 " "	108 " "
<i>Mean</i>	68 " "	93 " "

Each result is the mean for two 1-foot cubes, except that the values for a year are the means for five cubes.

A series of forty-eight experiments† using four different proportions of concrete, each having mortar equal to 40, 50 and 67 per cent of the volume of the stone or gravel, and the stone and the gravel being the same in all the experiments, gave average results as follows:

CRUSHING STRENGTH OF GRAVEL CONCRETE IN TERMS OF THAT OF
BROKEN-STONE CONCRETE.

7 days.	77 per cent.
28 "	79 " "
6 months.	85 " "
12 "	89 " "
<i>Mean</i>	82 " "

The gravel had 40 per cent of voids, while the broken stone had 47, which favored the gravel. The strength of the gravel concrete approaches that of the broken stone as the age increases, which is probably due to the internal friction of the broken stone having a greater relative effect at the earlier ages, i.e., on the weaker concrete.

All of the above results seem to show that broken stone makes a stronger concrete than gravel.

285. Relative Density. Experience in practice shows that gravel concrete is more easily compacted and has fewer cavities in it

* Report of Engineer Commissioner of the District of Columbia for 1897, p. 165.

† Ciments et Chaux Hydrauliques, E. Candlot, Paris, 1898, p. 446-47.

than broken-stone concrete; and hence, other things being the same, gravel concrete is denser and more waterproof. The specific gravity of gravel is generally greater than that of broken stone; and hence the gravel concrete is generally the heavier—usually a desirable quality. In general, any rounded material like sand or gravel gives under similar conditions a denser concrete than an angular material, like screenings or broken stone.

286. However, since gravel is liable to contain so much clay or loam as to materially reduce the strength of the concrete, some engineers prefer broken stone to gravel for this reason alone. Even though only portions of the gravel are naturally dirty, or even though only portions of it are likely to contain an undue amount of the stripping, some engineers prefer broken stone to gravel owing to the greater care required in inspection and to the uncertainty of eliminating all dirty gravel.

287. *Relative Cost.* As a rule, the first cost of the gravel is less than that of broken stone, and the former is also considerably easier to handle.

Since gravel is frequently cheaper than broken stone, a mixture of broken stone and gravel may make a more efficient concrete than either alone, i. e., may give greater strength for the same cost, or give less cost for the same strength.

288. CINDERS. Cinders are lighter, more porous, and more friable than gravel or broken stone; but cinders are valuable as an aggregate for concrete where lightness is more important than strength, as in the successive floors of tall buildings, or where a poor conductor of sound or heat is required. Cinder concrete may be easily cut or chipped, and nails may be readily driven into it—both of which qualities are additional reasons for using it for floors, particularly for the filling between the steel beams used in the construction of fire-proof floors. Cinders for use in concrete should not contain many, if any, fine ashes, since they present too much surface to be covered by the cement. Cinders made by power plants, sometimes called steam cinders, are better for this purpose than ashes from household furnaces, because the fires in the former are hotter and fuse most of the ashes into cinders, leaving little or no fine material. Steam cinders that have been drenched with water as soon as drawn from the furnace, usually called black cinders, are better than those that have been allowed to burn in the pile, since they contain fewer fine ashes. Wood ashes are very objectionable, as they contain a great deal of fine material, and also since a considerable part of them is soluble.

Cinder concrete should be mixed quite wet, and should not be rammed, since ramming is likely to crush the cinders and thereby leave uncemented surfaces.

ART. 2. LAWS OF PROPORTIONS OF CONCRETE.

289. The proper proportioning of the ingredients of a concrete is an important matter. The ideal proportion would be that which secures the least cost, the greatest strength, and the maximum density. The cost varies chiefly with the proportion of cement used; and for the same amount of cement in a unit of volume of concrete, the strength and the density vary with the relative proportions of sand and stone, and with the gradation of the sizes of each. Improper proportions may greatly increase the cost, or decrease the strength, or both. The first step toward an understanding of the correct theory of proportioning is to study the law governing the density of a concrete.

290. DENSITY.* The density of concrete is an important factor in its strength and cost, and is the most important element affecting its permeability. For a method of determining the density of concrete when the metric system of weights and volumes is used, see § 234. The following example will illustrate the method when pounds and cubic feet are used.

What is the density of a 1 : 3 : 6 concrete which required 25 pounds of portland cement, 75 pounds of sand, 150 pounds of broken limestone, and 13 pounds and 14 ounces (13.88 pounds) of water to make 2,821.8 cubic inches of rammed concrete? The specific gravity of the cement was 3.09, of the sand 2.64, and of the stone 2.99. The weight in pounds of the cement, for example, divided by its specific gravity gives the weight in pounds of a volume of water equal to the volume of the solid particles of the cement; and this divided by the weight in pounds of a cubic inch of water will give the volume in cubic inches occupied by the solid particles of the cement. The weight in pounds of a cubic inch of water is equal to the weight of a cubic foot divided by the number of cubic inches in a cubic foot; or $62.3 \div 1728 = 0.0360$ lb.

Absolute volume of cement	$= \frac{25}{3.09 \times 0.0360}$	= 225	cu. in.
" " " sand	$= \frac{75}{2.64 \times 0.0360}$	= 798	" "
" " " stone	$= \frac{150}{2.99 \times 0.0360}$	= 1 390	" "
" " " water	$= \frac{13.88}{1 \times 0.0360}$	= 386	" "
Total volume cement, sand, stone, and water		= 2 799	cu. in.
Measured volume of concrete		= 2 821.8	" "
Volume of entrained air = difference		= 22.8	cu. in.

* For a definition of density, see § 233.

Ratio of volume of cement	to volume of concrete	$= \frac{225}{2821.8}$	$= 0.079$	
“ “ “ “ sand	“ “ “ “	$= \frac{798}{2821.8}$	$= 0.283$	
“ “ “ “ stone	“ “ “ “	$= \frac{1390}{2821.8}$	$= 0.493$	
“ “ “ “ water	“ “ “ “	$= \frac{386}{2821.8}$	$= 0.137$	
“ “ “ “ entrained air	“ “ “ “	$= \frac{22.8}{2821.8}$	$= 0.008$	
Total volume of mortar			$= 1.000$	
Density of concrete		$= 0.079 + 0.283 + 0.493$	$= 0.855$	
Total voids		$= 0.137 + 0.008$	$= 0.145$	

The density of concrete is chiefly dependent upon the gradation of the sizes of the sand and the stone. The density increases with (1) the proportion of sand, (2) the proportion of stone, (3) the size of the stone, and (4) with the increase in the specific gravity of the stone. Any reasonably well-proportioned concrete will have a density between 0.80 and 0.84, and a carefully proportioned concrete may have a density of 0.84 to 0.88.*

291. THEORY OF PROPORTIONS. The whole theory of the proper proportions of concrete is comprised in two well-established laws which are similar to those governing the proportioning of cement mortar (§ 236), viz.:

1. For the same sand and the same coarse material, the strongest concrete is that containing the greatest per cent of cement in a unit of volume of concrete.

2. For the same per cent of cement and the same aggregate, the strongest concrete is made with that combination of the sand and the coarse material which gives a concrete of the greatest density.

The second law is equivalent to saying that the cement should fill the voids of the sand and the resulting mortar should fill the voids of the coarser aggregate. If the cement does not fill the voids of the sand, or if the mortar does not fill the voids of the aggregate, the concrete will obviously be less dense and also weaker than when the voids are filled. If the cement more than fills the voids of the sand, or if the mortar more than fills the voids of the aggregate, the concrete will be less dense than though the voids were just filled, since both the paste and the cement mortar have a less density than ordinary concrete; and hence the strength due to the increased amount of cement may be neutralized by the decrease in density, but the possibilities of this depend upon the plasticity of the mortar,

* Taylor and Thompson's *Concrete Plain and Reinforced*, ed. 1905, p 258-59; *Trans. Amer. Soc. of C. E.*, vol. lix, p. 112, Table 8.

the amount of tamping, the character of the sand and the stone, and the gradation of the sizes.

292. Relation between Strength and Amount of Cement. According to the first law, the strength of concrete varies with the amount of cement in a unit of volume of the concrete. Table 24 shows the strength of concrete in terms of the cement employed. The data from which this table was made are the same as those summarized in Table 30, page 196. The actual crushing strengths were plotted, and it was found that they could be reasonably well represented by a right line passing through the origin of co-ordinates. The values for this average line are shown in the next to last column of Table 24.

TABLE 24.

RELATION BETWEEN THE CRUSHING STRENGTH OF CONCRETE AND THE PROPORTION OF CEMENT.

Mortar equal to the voids in the aggregate.

REF. No.	COMPOSITION OF MORTAR. Volumes Loose.		PROPORTION OF CEMENT.		CRUSHING STRENGTH OF THE CONCRETE. Pounds per Square Inch.		
	Cement.	Sand.	Actual.	Relative.	Actual.	Theoretical.	Relative.
1	1	1	0.50	1.00	4 467	5 000	1.00
2	1	2	0.33	0.67	3 731	3 300	0.66
3	1	3	0.25	0.50	2 553	2 500	0.50
4	1	4	0.20	0.40	2 015	2 000	0.40
5	1	5	0.17	0.33	1 796	1 600	0.32
6	1	6	0.14	0.28	1 365	1 400	0.28

These experiments seem to prove that the strength of concrete varies as the quantity of cement, provided the voids of the coarse material are filled with mortar.

The same conclusion is proved by the data summarized in Fig. 11, page 140. The diagram presents the results of forty-eight experiments on 4-inch cubes.* Each point represents two experiments, the age of the mortar in one being 7 days and in the other 28 days. The points with one circle around them represent the strength of broken-stone concrete, and the points with two circles gravel concrete. Both the sand and the gravel employed in these experiments were very coarse, and consequently the amount of cement per cubic yard is unusually great.

293. Relation between Strength and Density. Table 25, page 141, shows that with the same aggregate and the same proportion of

* Candlot's Ciments et Chaux Hydrauliques, p. 340-41.

cement, the densest mortar is the strongest. Notice that the strength decreases more rapidly than the density and that the strength of the weakest concrete is only one eighth of that of the strongest. In the first line of Table 25, the mortar is just enough to fill the voids; but in subsequent lines the proportion of mortar is too great to fill the voids, and consequently both the density and the strength are less

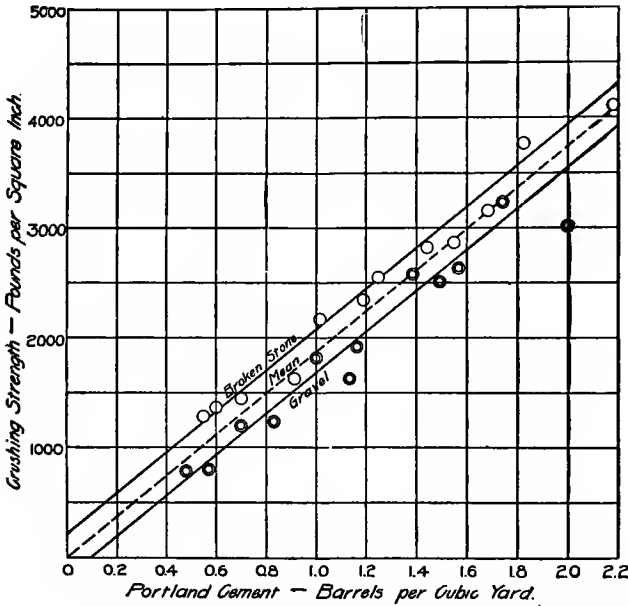

FIG. 11.—RELATION BETWEEN THE STRENGTH OF CONCRETE AND THE AMOUNT OF CEMENT.

than in the line above. The decrease in strength by substituting one part of sand for an equal weight of stone is due to the fact that the sand and the stone have approximately the same per cent of voids, while the sand has the greater and also the smoother surface; and the decrease in density is due to the fact that the sand has a less density than the stone which it displaced.

Table 25 is a striking illustration of the advantage of properly proportioning the ingredients of concrete. The fact that the densest concrete is the strongest affords a convenient means of comparing different sands and stone and also of determining the best proportions for any particular sand and stone, as will be explained later (see § 301).

TABLE 25.
RELATION BETWEEN STRENGTH AND DENSITY OF CONCRETE.*

REF. No.	PROPORTIONS BY WEIGHT.				Density.	Modulus of Rupture, lb. per sq. in.
	Cement to Aggregate.	Cement.	Sand.	Broken Stone.		
1	1 : 8	1	2	6	0.865	319
2	1 : 8	1	3	5	0.833	285
3	1 : 8	1	4	4	0.801	209
4	1 : 8	1	5	3	0.799	151
5	1 : 8	1	6	2	0.760	102
6	1 : 8	1	8	0	0.754	41

294. The following data illustrate the fact that an improper proportion or gradation of the ingredients of concrete may neutralize the effect of an increased amount of cement.

Table 26 shows that a concrete containing a considerable proportion of pebbles may be stronger than the mortar alone, although the mortar contains $1\frac{1}{2}$ to 2 times as much cement as the richer concrete and 2 to $2\frac{1}{4}$ times as much as the leaner. These anomalous results are probably due to two causes: (1) the larger aggregate

TABLE 26.
RELATIVE STRENGTH OF MORTAR AND GRAVEL CONCRETE.†

REF. No.	PROPORTIONS.			Crushing Strength when 28 days old, lb. per sq. in.	Strength of the Concrete in terms of that of the Mortar.
	Portland Cement.	Sand.	Pebbles.		
1	1	2	0	2 158	100 per cent
2			3	2 783	129 " "
3			5	2 414	112 " "
4	1	3	0	1 406	100 per cent
5			5	1 661	118 " "
6			6.5	1 534	109 " "
7	1	4	0	1 068	100 per cent
8			5	1 291	121 " "
9			8.5	1 221	114 " "

* Experiments by W. B. Fuller, in Taylor and Thompson's Concrete Plain and Reinforced, ed. 1905, p. 258-59. The pages referred to also contain data for numerous other proportions, all of which agree substantially with the above.

† Dr. R. Dyckerhoff, as quoted in "Der Portland Cement und seine Anwendungen im Bauwesen," p. 90.

gives the greater strength; and (2) the mortar probably had abnormally small density owing to the coarseness of the sand and the dryness of the mixture, while the concrete probably had an abnormally great density.

The average crushing strength of twenty cubes of concrete ranging from 4 to 16 inches on a side composed of 1 volume of cement, 3 volumes of sand, and 6 volumes of stone, was 20 per cent more than that of an equal number of similar cubes made of the mortar alone.* Two other sets of the same experiments gave somewhat similar results.†

Substantially the same general results are shown by the following data:‡ Each value is the mean of three to five 12-inch cubes tested when three months old. The stone was 1½-inch trap.

PROPORTIONS OF THE CONCRETE.	CRUSHING STRENGTH, lb. per sq. in.
1 : 2 : 2	1 768
1 : 2 : 3	1 911
1 : 2 : 4	2 155
1 : 2 : 5	2 452
1 : 2 : 6	2 124
1 : 2 : 7	1 650
1 : 2 : 8	1 332

The preceding results differ among themselves owing to the differences in the materials, the methods of proportioning, etc.; but all show the advantage possible by properly proportioning the ingredients of concrete.

295. METHODS OF PROPORTIONING. There are four methods in more or less general use in determining the proportions to be employed, which may be briefly designated as follows: (1) by arbitrary assignment; (2) by the voids; (3) by trial; and (4) by sieve-analysis curves. These methods will be considered separately in the order.

296. Proportioning by Arbitrary Assignment. The most common and least scientific method of proportioning concrete is to assume the relations as a matter of judgment, without much, if any, consideration of the character of the aggregate; that is, the proportions are assigned without any reference to the fineness or coarseness of the sand and the stone, or to the gradation of the sizes of each. This method is frequently employed regardless of whether the broken

* Notes on the Compressive Resistance of Freestones, Brick Piers, Hydraulic Cement, Mortar, and Concretes, Q. A. Gilmore. John Wiley & Sons, New York, 1888, p. 143-46.

† *Ibid.*, p. 137-40, 141-42.

‡ Tests of Metals, etc., Watertown Arsenal, 1899, p. 798.

stone to be used is crusher-run having sizes varying from $\frac{1}{4}$ to $2\frac{1}{2}$ inches and having 20 per cent voids, or whether it is screened to practically one size and has 50 per cent of voids. Again, if a strong concrete is desired, a proportion of 1 : 2 : 4 may be adopted without any consideration whether some other proportion of the same ingredients might not give a cheaper and also a stronger concrete. Often concrete proportioned by this process can be greatly improved by substituting coarse aggregate for a portion of the sand. For example, in Table 25, page 141, each concrete is stronger than the one in the line below it, simply because in the latter a portion of the stone has been replaced by sand.

Unless the character of the materials to be used is known, and unless the qualities of the concrete made with certain proportions of the ingredients are known, this method should not be employed.

297. Proportioning by Voids. Since it has been proved by experiment that the densest concrete is the strongest, and since it has been proved that cement paste is less dense than cement mortar and that cement mortar is less dense than a well-proportioned concrete, it follows that the densest and the strongest concrete that can be made with any proportion of cement and any combination of a particular sand and aggregate is that in which the cement paste fills the voids of the sand and the resulting mortar fills the voids in the coarse aggregate. Therefore, to determine the best proportions for any sand and aggregate, find the per cent of voids in the sand and in the stone, and use enough cement paste to fill the voids in the sand and enough mortar to fill the voids in the coarse aggregate.

The voids in the sand may be determined by either of the two methods discussed in § 194-95; and those in the stone by either method described in § 214-15.

298. However, in using this method it should not be overlooked that the use of cement paste equal to the voids in the sand does not insure that the voids of the sand are filled, and that the use of mortar equal to the voids in the stone does not insure that the voids of the stone are filled. The cement paste surrounds the sand grains and virtually increases the size of all the grains and thereby increases the voids, since there are then no small grains to occupy the interstices between the larger ones; and further, the water in the paste by its superficial tension keeps the sand grains apart and thus increases the per cent of voids. A similar effect occurs when mortar is mixed with the aggregate.

The increase in volume due to mixing cement paste with the sand is small in comparison with that due to mixing mortar with the aggregate, and hence will be neglected here. Besides, the determination of the best proportion of cement, i.e., of the strength of

the mortar, to be used in any case is wholly a matter of judgment, and hence great refinement is inadmissible; and further, if a concrete of the best possible proportions is desired, either the third or fourth method of proportioning (§ 301 or 302-309) must be employed. However, whatever grade of mortar is employed, it is always wise to use enough of it to fill the voids in the broken stone.

Table 27 gives the result of fifteen experiments to determine the amount of mortar required to fill the voids in broken stone. The mortar was moderately dry, and the concrete was quite dry, moisture flushing to the surface only after vigorous tamping. The broken stone was No. 10 of Table 20, page 99, and contained 28 per cent of voids when rammed.

TABLE 27.
AMOUNT OF MORTAR REQUIRED TO FILL THE VOIDS OF
BROKEN STONE.

REF. No.	Volume of Mortar in terms of the Voids in the Rammed Stone.	Volume of Rammed Concrete in terms of the Volume of Rammed Stone.	Air-filled Voids in the Rammed Concrete (while wet).
1	70 per cent	105.0 per cent	15.3 per cent
2	80 " "	105.5 " "	12.2 " "
3	90 " "	106.5 " "	9.5 " "
4	100 " "	107.5 " "	7.0 " "
5	110 " "	109.0 " "	4.9 " "
6	120 " "	110.5 " "	2.8 " "
7	130 " "	112.5 " "	1.2 " "
8	140 " "	114.0 " "	0.0 " "

Line 4 of Table 27 shows that if the mortar is equal to the voids, the volume of the rammed concrete is $7\frac{1}{2}$ per cent more than the volume of the rammed broken stone alone. Possibly part of the increase of volume was due to imperfect mixing, although it was believed that the mass was perfectly mixed. The table also shows that the voids in this concrete are equal to 7 per cent of its volume; in other words, even though the volume of the mortar is equal to the volume of the voids, the voids are not filled. Apparently the voids can be entirely filled with this grade of mortar only when the mortar is about 40 per cent in excess of the voids.

The increase in volume in Table 27 may be regarded as the maximum, since the mortar was quite dry and the stone unscreened. With moderately wet mortar and the same stone, the increase in volume was only about half that in the table; and with moist mortar and stone ranging between 2 inches and 1 inch, there was no appreciable

increase of volume. With pebbles the increase is only about two thirds that with broken stone of the same size. With fine gravel (No. 18, page 99) the per cent of increase was considerably greater than in Table 27; with mortar equal to 150 per cent of the voids, it was possible to fill only about 5 to 7 per cent of the voids. The mortar used in Table 27 was 1 volume of cement to 2 volumes of sand, both measured loose; but with richer mortars the increase in volume was a little less, and with leaner mortars a little more.

The voids in Table 27 are for the wet concrete. As the concrete dries out the air-filled voids will increase, since all the water employed in making the concrete does not enter into chemical combination with the cement (§ 365); and consequently when the concrete has dried out the space occupied by the free water will be filled with air.

299. The details of the method of determining the relative quantities of the several ingredients will be illustrated by the following example. Assume the aggregate to be broken stone, unscreened except to remove the dust, containing 33 per cent of voids when loose and 28 when rammed (see No. 10, Table 20, page 99). Also assume that the sand has 45 per cent of voids when measured loose and 37 when rammed. Further assume that a concrete of maximum density is desired; and that therefore the mortar should be equal to about 140 per cent of the voids (see Table 27).

To determine the reduction in volume by ramming the broken stone, use the relation: the solid material in 1 cu. yd. of rammed stone *is to* the volume of 1 cu. yd. of rammed stone *as* the solid material in 1 cu. yd. of loose stone *is to* the equivalent volume of rammed stone; or 0.72 *is to* 1.00 *as* 0.67 *is to* 0.93, the volume of a cubic yard of loose stone after ramming. The aggregate compacts 7 per cent in ramming, and a yard of loose material will equal 0.93 of a yard rammed. Adding mortar equal to 140 per cent of the voids increases the volume to about 114 per cent (Table 27); and therefore adding the mortar will increase the volume of the rammed aggregate to $0.93 \times 1.14 = 1.06$ cu. yd., which is the volume of concrete produced by a yard of loose aggregate. To produce a yard of concrete will therefore require $1 \div 1.06 = 0.94$ cu. yd. of loose broken stone.

Since the mortar is to be equal to 140 per cent of the voids in the rammed stone, a yard of concrete will require $0.94 \times 0.93 \times 0.28 \times 1.40 = 0.34$ cu. yd. of mortar. To determine the relative amounts of sand and cement in the mortar proceed as follows: The solid material in a cubic yard of loose sand *is to* the volume of 1 cu. yd. of loose sand *as* the solid material in 1 cu. yd. of rammed sand *is to* the equivalent volume of loose sand; or 0.55 *is to* 1 *as* 0.63 *is to* 1.14, the volume of loose sand required to make a cubic yard of rammed sand. Since the mortar is to have cement paste equal to the voids in the

rammed sand, the composition of the mortar is as follows: 0.37 *is to* 1.14 as 1 *is to* 3 nearly; or the mortar is 1 part cement paste to practically 3 parts of loose sand. The 1 part cement paste will require an equal volume of packed cement. Hence, from Table 22, page 120, a cubic yard of this mortar will require 2.36 bbl. of packed portland cement and 0.95 cu. yd. of loose sand; and consequently 0.34 cu. yd. of mortar will require 0.80 bbl. of packed cement and 0.32 cu. yd. of loose sand.

The composition of the concrete then is: 0.80 bbl. of cement, 0.32 cu. yd. of sand, and 0.94 cu. yd. of stone. Since it is assumed that 1 bbl. of cement is 0.13 cu. yd., the composition is 0.10 cu. yd. of cement, 0.35 cu. yd. of sand, and 0.94 cu. yd. of stone; or 1 volume of packed portland cement, 3 volumes of loose sand, and $8\frac{1}{2}$ volumes of loose broken stone.

300. The method of proportioning a concrete with reference to the voids is objectionable, since the per cent of voids in the sand may be greatly affected by a small per cent of moisture (§ 196), and also owing to possible errors in determining the voids by a direct measurement by the use of water (§ 195). However, this method is more scientific than the first method mentioned in § 295, and is more simple but less scientific than either the third or fourth method.

301. Proportioning by Trial. The principle that for the same proportion of cement the strongest and cheapest concrete is also the densest, leads to a simple method of finding the best relation of the sand and the stone. That combination of sizes of sand and stone which with a constant quantity of cement gives the least volume of concrete is the best.

To apply this method procure a vessel of uniform cross section, say a cylinder, 10 or 12 inches in diameter and 12 or 14 inches deep, its strength being such that its volume will not be changed in tamping it full of concrete. Weigh out a unit of cement, and any number of units of sand, say two, and also weigh out any number of units of broken stone, say five, taking care that the quantities are such that when the ingredients are thoroughly mixed and placed in the cylinder, the mixture will fill it only partly full, say three quarters full. Make a concrete of any desired consistency by mixing the cement, sand and stone with water on a sheet of steel; and tamp the concrete into the cylinder leaving the upper surface smooth and horizontal, and then measure the depth of the concrete from the upper end of the cylinder. Next empty the concrete from the cylinder, clean it and the tools; and make another batch with different proportions of sand and stone, but keeping the quantity of cement and the plasticity of the concrete the same as before. If this batch, when tamped into the cylinder, gives a less volume of concrete, this proportion is better

than the first. Continue the trials until the proportions have been found which will give the least depth in the pipe. The proportions can be varied almost infinitely by screening the sand and the stone, and trying different combinations of the several portions.*

The following principles will serve as a guide in selecting the proportions to be tried. 1. The larger the maximum size of the aggregate, the denser and stronger the concrete; but it is not practicable to use larger fragments than $2\frac{1}{2}$ or 3 inches in diameter in plain concrete or $\frac{3}{4}$ to 1 inch in reinforced concrete. 2. The greatest density will be obtained with an aggregate graded nearly uniformly from fine to coarse. 3. An excess of fine or medium sized particles decreases the density. 4. The coarser the stone the coarser the sand must be; and vice versa, the finer the stone the finer should be the sand.

This method is very valuable as an easy and practicable means of determining the best proportions in which to combine natural mixtures of a sand and an aggregate; but it is impracticable for an exhaustive study to find the very best proportions attainable by screening the sand and the stone and making artificial combinations of the several portions. The only practical method of determining the best possible artificial mixtures of sand and stone is by the use of sieve-analysis curves (§ 302-307).

302. Proportioning by Sieve-Analysis Curves.† “Sieve analysis consists in separating the particles or grains of a sample of any material—such as broken stone, gravel, sand or cement—into the various sizes of which it is composed, so that the material may be represented by a curve each of whose ordinates is the percentage of the weight of the total sample which passes a sieve having holes of a diameter represented by the distance of this ordinate from the origin in the diagram.”‡ The line *DBKLA*, Fig. 12, page 148, is a typical sieve-analysis curve for crusher-run micaceous-quartz stone; and the line *OF* represents a fine sand.

“The objects of sieve-analysis curves as applied to concrete aggregates are: (1) to show graphically the sizes and relative sizes of the particles; (2) to indicate what sized particles are needed to make the aggregate more nearly perfect, and so to enable the engineer to improve it by the addition or substitution of another material;

* For the results of a series of trials to determine the density of various combinations of broken stone screened to several sizes, see *Engineering News*, vol. liv, p. 598-601.

† This method of proportioning the sizes of the sand and stone in concrete was devised by Wm. B. Fuller, and is described by him in detail on pages 183-215 of Taylor and Thompson's *Concrete Plain and Reinforced* (1905 edition), from which these extracts are taken by permission of the authors.

‡ *Ibid.*, p.187.

and (3) to afford means for determining the best proportions of different aggregates."*

"The experience which the writer [Fuller] has had and the various experiments which he has made indicate that concrete which works the smoothest in placing and gives the highest breaking strength for a given percentage of cement, is made from an aggregate whose sieve analysis, taken after mixing the sand and the stone, forms a curve approaching a parabola having its beginning at the zero of coordinates and passing through the intersection of the curve of the coarsest stone with the 100 per cent line, that is, passing through the upper end of the coarsest stone curve."† In Fig. 12, the parabola *OCPA* represents a theoretically perfect combination of sizes of that particular sand and crusher-run stone. This curve shows, for

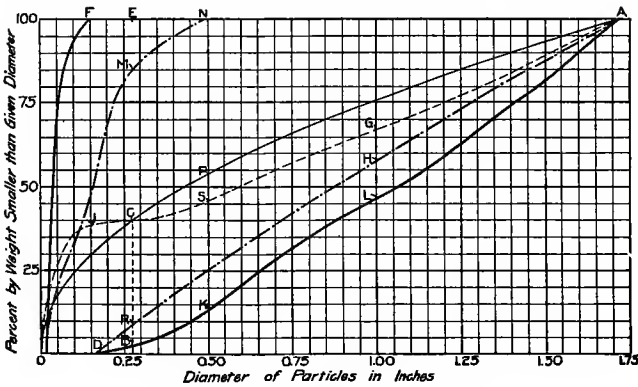

FIG. 12.—SIEVE-ANALYSIS CURVES.

example, that for the best combination of the above materials 93 per cent of the mixture should pass the $1\frac{1}{2}$ -inch sieve, 76 per cent should pass the 1-inch sieve, 54 per cent the $\frac{1}{2}$ -inch, and so on.

"Where, as in Fig. 12, the materials to be mixed are represented by only two curves no combination of which will make a curve as close to a parabola as is desirable, there is another limiting condition which was brought out by the experiments, viz., that for the best results the combined curve shall intersect the parabola on the 40 per cent line, at *C*, and that the finer material shall be assumed to include the cement."‡

* Taylor and Thompson's Concrete Plain and Reinforced (1905 edition), p. 187.

† *Ibid.*, p. 195.

‡ *Ibid.*, p. 205-6.

303. The curve *DBKLA*, Fig. 12, may be transformed so that it will pass through *C*, by changing the distances from the top of the diagram to the line *DBKLA* in the proportion $\frac{EC}{EB} = \frac{60}{98} = 61$ per cent, which shows that 61 per cent of the dry materials should be broken stone. In a similar manner the line *OF* is replotted in the position *OJ*. The line *OJCGA* is assumed to represent the best possible combination of sizes of this sand and stone. For example, with the best possible combination of sizes of this stone and sand, 89 per cent would pass the 1.50-inch sieve, 67 per cent would pass the 1-inch sieve, 46 per cent the $\frac{1}{2}$ -inch sieve, and so on.

The proportion of cement to be used to give the required strength of concrete must always be assumed; and in this example it will be assumed that the cement is to constitute one eighth of the dry materials (measured before the sand and stone are mixed together), which will make the cement one ninth or 11 per cent of the total dry materials. Since the diagram shows that the sand and cement are to constitute 39 per cent of the dry materials, the sand must then be $39 - 11 = 28$ per cent.

The proportions of concrete for 1 part cement to 8 parts of sand and stone, measured separately, then are: 11 per cent cement, 28 per cent sand, and 61 per cent broken stone, or 1 : 2.5 : 5.5 by weight. If the proportions are required by volume and the relative weights of the sand and the stone differ from their relative volumes, the proportions should be corrected accordingly.

304. An important feature of the sieve-analysis curves is that they show how the materials may be improved by adding or subtracting some particular size. For example, if the stone represented by the curve *DBKLA* in Fig. 12 had contained more pieces 0.5 and 1.0 inch in diameter, its curve would have more nearly approached the parabola in the region *SG*. If a stone giving the line *DRHA* were used, the ratio for transforming the line to make it pass through *C* would be $\frac{EC}{ER} = \frac{60}{91} = 66$ per cent, which shows that with the assortment of sizes of broken stone represented by this line the best concrete is made by using 66 per cent of broken stone. For a 1 : 8 mixture as before, the proportions would be 11 : 23 : 66, or 1 : 2 : 6, —a cheaper, stronger, and denser concrete than that made with the stone represented by the line *DBKLA*.

A still better concrete would have resulted with the use of a coarse sand having a curve similar to the line *OMN*, since then to make the combination of lines *OMN* and *DBKLA* pass through *C*, the ratio would be $\frac{MC}{MB} = \frac{45}{85} = 54$ per cent. This shows that with

coarse sand less broken stone should be used than with finesand, which is as should have been expected.

305. When the sieve-analysis curves for two materials overlap or extend past each other in the diagram corresponding to Fig. 12, or when more than two materials are to be used, the problem is more difficult; and the reader is referred to pages 197–205 of Taylor and Thompson's Concrete Plain and Reinforced (1905 edition) for detailed explanations. However, the following example, taken from pages 207 and 208 of that book, will give a fair idea of the method of solution, and will also show the value of sieve-analysis curves in proportioning concrete.

"Given a medium sand and three sizes of crushed stone, as shown in Fig. 13, to find what percentage of each will best combine to make

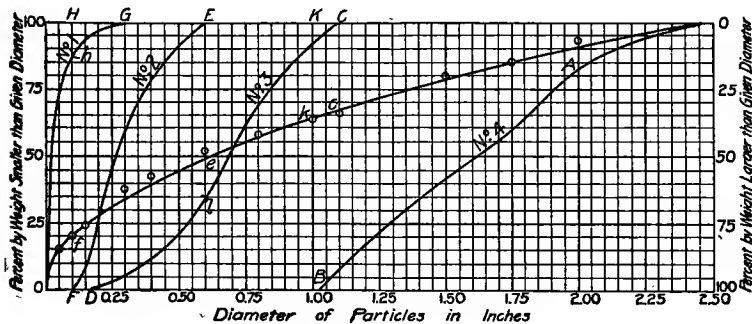

FIG. 13.—SIEVE-ANALYSIS CURVES FOR ONE SAND AND THREE SIZES OF STONE.

the strongest and most impermeable concrete." The parabola passing through the zero point and the point at which curve No. 4 reaches 100 per cent is shown in Fig. 13.

"We see at once that the percentage of No. 4 stone required is $\frac{Kk}{KB} = \frac{36}{100} = 36$ per cent. (To be sure, about 8 per cent of No. 4 is overlapped by No. 3, but this is so slight it need not here be considered.)

"Let us determine sand curve No. 1 at 0.10 diameter ordinate, since it can be seen by inspection that the portion Oh of curve No. 1 very nearly fits the parabola, and that grains smaller than 0.10 diameter must be supplied wholly from this curve, while the larger grains represented by portion hG are found also in No. 2 curve. Accordingly, we have the percentage $\frac{Ff}{Fh} = \frac{20}{88} = 23$ per cent.

"A part of No. 3 curve, that portion extending from D to l is overlapped by nearly the whole of No. 2 curve. We can see,

however, that No. 3 curve alone must supply 14 per cent of the material in the parabola (that portion extending from *e* to *k*). This leaves $100 - (36 + 23 + 14) = 27$ per cent of the mixture to be furnished by the overlapping portions of No. 3 and No. 2 in such ratio as best fits the parabola.

"From a study of the two curves, we find by inspection and trial plottings that most of the material required would be better supplied by No. 2 curve, since it contains stone corresponding very well to the needs of that part of the parabola extending from *f* to *e*. Let us consider 23 per cent as the proper amount of the final mixture to be furnished by No. 2 curve, which would leave $14 + 4 = 18$ per cent as the total portion which must be supplied by No. 3 curve.

"Now, on any of the ordinates, we can locate points through which a curve may be drawn which represents a mixture of the given sand and stone in the proportions just found, for example:

ORDINATES.	PER CENT. RETAINED.
1.75	$40 \times 36\% \dots\dots\dots = 14$
1.50	$57 \times 36\% \dots\dots\dots = 20$
1.10	$92 \times 36\% \dots\dots\dots = 33$
1.00	$(100 \times 36\%) + (8 \times 18\%) = 36 + 1 \dots\dots\dots = 37$
0.80	$36 + (31 \times 18\%) = 36 + 6 \dots\dots\dots = 42$
0.60	$36 + (66 \times 18\%) = 36 + 12 \dots\dots\dots = 48$
0.40	$36 + (88 \times 18\%) + (21 \times 23\%) = 36 + 16 + 5 \dots\dots\dots = 57$
0.30	$36 + (93 \times 18\%) + (40 \times 23\%) = 36 + 17 + 9 \dots\dots\dots = 62$
0.15	$36 + 18 + (92 \times 23\%) + (6 \times 23\%) = 36 + 18 + 21 + 1 \dots\dots\dots = 76$
0.05	$36 + 18 + 23 + (30 \times 23\%) = 36 + 18 + 23 + 7 \dots\dots\dots = 84$

"These percentages are plotted on the diagram as small circles. The same points would have been obtained if we had begun at the left of the diagram and calculated the percentages passing the sieve."

These points lie quite close to the theoretical curve, and hence we may assume that about the best concrete that can be made of the given materials will consist of 23 per cent of the sand, 23 per cent of the finest stone (No. 2), 18 per cent of medium stone (No. 3), and 36 per cent of the coarsest stone (No. 4).

306. This method affords a means of determining the best proportions in which to mix the fine and the coarse aggregate, and also shows how the aggregate may be improved by adding or subtracting some particular size. Sieve analyses can be made from time to time as the work progresses to see whether or not the sizes of the aggregate have changed; and if sizes have changed, the proportions can be varied to secure the most economical and the densest concrete. In a work of any magnitude the greater labor required

in determining the proportions by sieve-analysis curves is likely to be justified by the better quality, or the less cost, of the concrete; and the extra labor required to make sieve analyses during the progress of the work will be worth all its costs because of the better control of the proportions of the concrete.

To secure the maximum benefit of this method of proportioning, it is necessary to screen the aggregate to several sizes and then combine them in the proportions indicated by the sieve-analysis curves. As to whether or not the increased cost of screening and proportioning would be justified by the saving of cement, depends upon the magnitude of the work and other conditions. The following example illustrates the possibilities:

"The ordinary mixture for water-tight concrete is about 1 : 2½ : 4½, which requires 1.37 barrels of cement per cubic yard of concrete. By carefully grading the materials by methods of sieve analysis the writer [Fuller] has obtained water-tight work with a mixture of about 1 : 3 : 7, which requires only 1.01 barrels of cement per cubic yard of concrete. This saving of 0.36 barrel is equivalent, with portland cement at \$1.60 per barrel, to \$0.58 per cubic yard of concrete. The added cost of labor for proportioning and mixing the concrete because of the use of five grades of aggregate instead of two, was about \$0.15 per cubic yard, thus effecting a net saving of \$0.43 per cubic yard."*

307. *Modification of the Parabolic Curve.* The principle that the best combination of sizes is that corresponding to the ordinates of a parabola, was deduced from a series of experiments made by Mr. Fuller at Little Falls, N. J., in 1901; but experiments made by Mr. Fuller at Jerome Park Reservoir, New York City, in 1904-05 † seem to show that the parabola does not give quite enough coarse sand and fine stone, and that the ideal sieve-analysis curve for this material consists of an ellipse for the sand and a tangent thereto for the stone. The exact curve starts upon and is tangent to the vertical zero axis of percentages at 7 per cent—that is, at least 7 per cent of the aggregate *plus* cement is finer than the No. 200 sieve—and runs as an ellipse to a point on a vertical ordinate whose value represents a size about one tenth of the diameter of the maximum fragment of the aggregate, and thence by a tangent to the 100 per cent point on the ordinate of the maximum diameter. For the exact data for the curves for the materials experimented on at the Jerome Park Reservoir, see Transactions American Society of Civil Engineers, Vol. lix, page 90. The form of the best curve for any material is nearly the

* W. B. Fuller in Taylor and Thompson's Concrete Plain and Reinforced, ed. 1905, p. 183.

† Trans. Amer. Soc. of Civil Eng'rs., vol. lix, p. 90.

same for all sizes of stone; that is, the curves for a $\frac{1}{2}$ -inch, a 1-inch, or a $2\frac{1}{4}$ -inch maximum stone are nearly the same except the horizontal scale.

308. *Examples of Application of Sieve-Analysis Curves.* Fig. 14, shows (1) the sieve-analysis curves of the bank run of natural gravel, (2) the same material after being screened to two sizes—one greater than 0.20 inch and the other less than 0.20 inch, (3) an artificial combination of these two sizes, and (4) the ideal curve.*

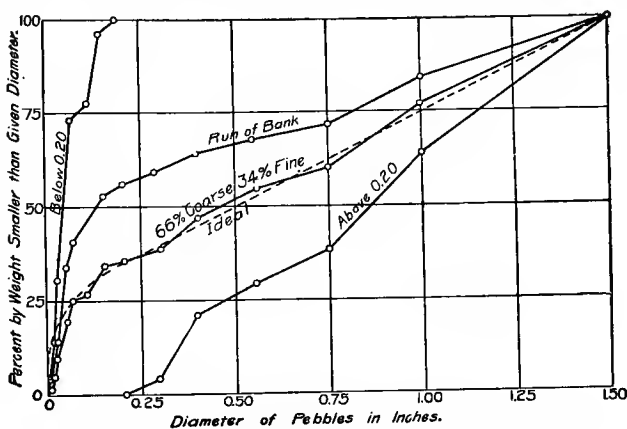

FIG. 14.—SIEVE-ANALYSIS CURVES OF BANK-RUN GRAVEL.

The latter was drawn by the methods referred to in the preceding section, and shows by the length of the ordinate for a diameter 0.20 inch that 66 per cent of the ideal mixture should be coarser than 0.20 inch in diameter and 34 per cent finer. The combined curve gives the result of taking these percentages of the two sizes, and shows that this is almost an ideal mixture, except that there is a deficiency of fine sand,—but this will be made up in part by the cement.

Fig. 15, page 154, shows the sieve-analysis curves for one of the best gravels near Cortland, N. Y.† The ideal curve shows that 34 per cent of the perfect mixture should be smaller than 0.20 inch in diameter, and hence 66 per cent is larger. The curve for this combination is shown. This curve gives almost ideal results for the sand portion, but has too much medium-coarse material. The next lower curve shows the effect of trying to remedy the defect of the preceding curve by using more coarse material. This combination improves the stone portion of the mixture; but the sand portion is not nearly

* Trans. Am. Soc. of Civil Engrs., vol. lix, p. 145.

† *Ibid.*, p. 147.

as satisfactory as in the preceding curve, which shows that the material screened to these two sizes can not be combined so as to make an approximately ideal mixture. An inspection of the curve for the material above 0.20 inch in diameter shows that this portion of the material conforms closely to the ideal curve down to 0.1 inch in diameter, which suggests screening the material into three sizes—one finer than 0.20, one between 0.20 and 0.40, and one coarser than 0.40. Fig. 16 shows the sieve-analysis curves for each of these three sizes of this gravel, and also the curve for a near ideal combination of the three sizes.* The concrete made of the

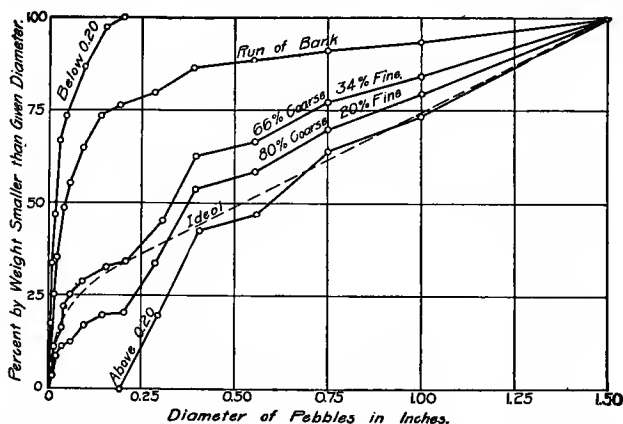

FIG. 15.—SIEVE-ANALYSIS CURVES FOR TWO SIZES OF BANK-RUN GRAVEL.

combination of these sizes will be dense and strong, but whether it is economical or not depends upon the relative cost of screening the gravel and the cost of the cement saved. For one such comparison see § 306.

309. In practice it may not always be wise to separate the aggregate into different sizes and re-combine them according to an ideal sieve-analysis curve; but on a job of any considerable magnitude it is probably always wise to make a sieve analysis of the material to be used, since the curve will indicate the direction in which improvements can be made, and often improvement is possible without additional cost.

310. UNITS USED IN PROPORTIONING. Concrete may be proportioned in any one of three ways: (1) by weight; (2) by volumes of packed cement, loose sand, and loose stone; or (3) by volumes of loose cement, loose sand, and loose stone.

*Trans. Amer. Soc. of C. E., vol. lix, p. 148.

311. Proportions by Weight. Only occasionally is the proportioning done by weighing, on account of the increased expense. This is the most accurate method, but ordinarily it is cheaper to use more cement than to incur the increased expense of weighing the ingredients.

Automatic weighing machines are occasionally employed. These consist of a series of automatic tipping buckets placed under spouts leading from the storage bins. When the proper weight of material is in the bucket it automatically tips, shuts a valve in the spout, and empties into the hopper leading to the mixing machine. When all

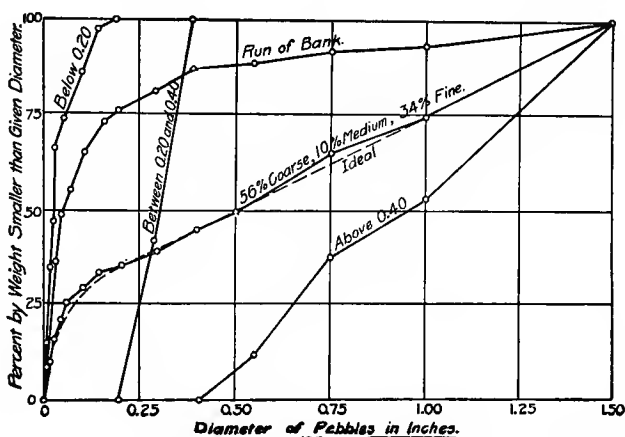

FIG. 16.—IDEAL COMBINATION OF THREE SIZES OF BANK-RUN GRAVEL.

three ingredients have been emptied into the hopper, a valve opens and they are emptied into the mixing machine. When different sizes of stone are used to secure a well-graded aggregate, bins and automatic tipping buckets are supplied for each size.

312. Proportions by Volumes of Packed Cement and Loose Sand and Stone. This is the most common method of proportioning. A barrel of packed portland cement is assumed to be 3.8 cu. ft., or a cubic foot of packed portland cement is assumed to weigh 100 lb.; and in the proportioning a barrel or a bag of cement is mixed with the required number of cubic feet of loose sand and loose stone. For example, a 1 : 2 : 4 mixture then means 1 cu. ft. of packed cement, 2 cu. ft. of sand, and 4 cu. ft. of stone; or 1 bbl. of cement, 2 bbl. (7.6 cu. ft.) of sand, 4 bbl. (15.2 cu. ft.) of stone; or 1 bag of cement, 1.9 cu. ft. of sand, and 3.8 cu. ft. of stone. This system is virtually measuring the cement by weight and the sand and stone by volumes.

313. Proportions by Volume of Loose Cement and Loose Sand and Stone. When cement was usually shipped in a barrel, and a fractional part of a barrel was used for a batch of concrete, the cement was measured loose; but at present this method is not employed, because it is simpler to consider the bag of cement as the unit.

The preceding paragraph assumes that the measuring is done by hand, but there are two automatic measuring machines on the market which measure the ingredients by volumes loose. One of these machines, the Trump mixer, consists of several bottomless storage cylinders from the bottom of which each of the ingredients flows into a revolving platform from which it is scraped off by stationary arms resting upon the top of the platform and projecting into the material a sufficient distance to scrape off the proper amount of each. The other of these machines, the Gilbreth measurer, consists of several drums, one for each material, placed directly under the storage bins and rotating upon the same horizontal shaft, the quantity of the materials being regulated by means of gates in the bins.

314. PROPORTIONS USED IN PRACTICE. While a statement of the proportions used in practice may be of interest, it can not be of any great value, since it is impracticable, if not impossible, to describe fully the circumstances and limitations under which the work was done. Further, the specifications and records from which such data must be drawn are frequently very indefinite. It is believed that the following examples are as accurate as it is possible or practicable to make them, and also that they are representative of the best American practice.

For foundations for pavements: 1 volume of *natural* cement, 2 volumes of sand, and 4 or 5, and occasionally 6, volumes of broken stone; or 1 volume of *portland* cement, 3 volumes of sand, and 6 or 7 volumes of broken stone. Occasionally gravel is specified, and more rarely gravel and broken stone mixed.

For foundations and minor railroad structures: 1 volume of *natural* cement, 2 volumes of sand, and 3 to 5 parts of broken stone; or 1 part *portland* cement, 3 parts sand, and 4 or 5 parts broken stone.

For important bridge and tunnel work: 1 part of *portland* cement, 3 parts of sand, and 4 or 5 parts of broken stone.

For steel-grillage foundations: 1 part *portland* cement, 1 part sand, and 2 parts broken stone.

For reinforced concrete structures: 1 volume of *portland* cement, 2 or 2½ volumes of sand, 4 or 5 volumes of broken stone.

In harbor improvements the proportions of concrete range from the richest (used to resist the violent action of waves and ice) to the very leanest (used for filling in cribwork). At Buffalo, N. Y., an

extensive breakwater built in 1890 by the U. S. A. engineers, consisted of concrete blocks on the faces and a backing of concrete deposited in place. Portland was used for the blocks and natural for the backing, the proportions being: 1 volume cement, 3 sand, and $8\frac{1}{2}$ of broken stone and pebbles mixed in equal parts.

315. For the retaining walls on the Chicago Sanitary Canal, built in 1895-97: 1 part natural cement, $1\frac{1}{2}$ parts sand, and 4 parts un-screened limestone.

For the dams, locks, etc., on the Illinois and Mississippi Canal, 1893-98: 1 volume of loose portland cement, 8 volumes of gravel and broken stone; or 1 volume of loose natural cement and 5 volumes of gravel and broken stone.

For the Poe Lock of the St. Mary's Fall Canal, constructed in 1890-95: 1 part natural cement, $1\frac{1}{2}$ parts of sand, and 4 parts of sandstone broken to pass a $2\frac{1}{2}$ -inch ring and not a $\frac{3}{8}$ -inch screen. The broken stone had 46 per cent voids loose and 38 when rammed.

For the concrete blocks used in constructing the Mississippi Jetties, built in 1875-80, the proportions were: 1 part portland cement, 1 part sand, 1 part gravel, and 5 parts broken stone.

For incidental information concerning proportions used in practice, see Cost of Concrete, § 421-23, § 1085, and § 1110.

316. For an interesting account of a method of determining the proportions of a concrete after it has set in place, see *Engineering News*, Vol. lix, p. 46,—January 9, 1908.

317. INGREDIENTS FOR A YARD. Table 28, page 158, gives the quantities of cement, sand, and stone required for a cubic yard of concrete of different proportions, using three grades of broken stone or gravel. The concrete was mixed wet and also mixed very thoroughly. If it had been mixed drier or less thoroughly, it would have been less dense, and consequently less quantities of materials would have been required to make a yard.

Data like that in Table 28 are affected by the fineness of the cement, the fineness and the dampness of the sand, the kind and the coarseness of the stone, the proportions of the several sizes of sand grains and stone fragments, the thoroughness of the mixing, the amount of tamping, etc.; and different experimenters have obtained widely different results. Most experimenters obtain a less quantity of ingredients per cubic yard than in Table 28, probably chiefly because the concrete is mixed drier and entrains more air, and hence is less dense. For data somewhat similar to that in Table 28, see: Transactions American Society of Civil Engineers, Vol. xlii (1899), p. 109-11, and 137; Johnson's Materials of Construction, p. 610a; Tests of Metals, Watertown Arsenal, 1899, p. 786-87; Report of Chief of Engineers, U. S. A., 1895, p. 2922-31.

TABLE 28.

INGREDIENTS REQUIRED FOR A CUBIC YARD OF WET CONCRETE.*

1 cu. ft. of packed cement assumed to weigh 100 lb.

PROPORTIONS BY VOLUMES.			SCIENTIFICALLY GRADED STONE.			UNSCREENED STONE.			SCREENED STONE.		
Packed Cement.	Loose Sand.	Loose Stone.	Size 2" to 0.20" Voids 20%.			Size 2" to 0.20" Voids 30 %.			Size 2" to 1" Voids 50 %.		
			Cement bbl.	Sand cu. yd.	Stone cu. yd.	Cement bbl.	Sand cu. yd.	Stone cu. yd.	Cement bbl.	Sand cu. yd.	Stone cu. yd.
1	2	3	1.50	0.42	0.63	1.61	0.45	0.68	1.89	0.53	0.80
		4	1.27	0.36	0.72	1.38	0.39	0.78	1.65	0.46	0.93
		5	1.10	0.31	0.77	1.20	0.34	0.84	1.47	0.41	1.03
		6	0.97	0.27	0.82	1.06	0.30	0.89	1.32	0.37	1.11
1	3	4	1.12	0.47	0.63	1.21	0.51	0.68	1.42	0.60	0.80
		5	0.99	0.42	0.70	1.07	0.45	0.75	1.28	0.54	0.90
		6	0.88	0.37	0.74	0.96	0.41	0.81	1.16	0.49	0.98
		7	0.80	0.34	0.79	0.87	0.37	0.86	1.07	0.45	1.05
		8	0.73	0.31	0.82	0.80	0.34	0.90	0.99	0.42	1.11
1	4	5	0.90	0.51	0.63	0.96	0.54	0.68	1.13	0.64	0.68
		6	0.81	0.46	0.68	0.87	0.49	0.73	1.04	0.59	0.88
		7	0.74	0.42	0.73	0.80	0.45	0.79	0.96	0.54	0.95
		8	0.68	0.38	0.77	0.74	0.42	0.83	0.90	0.51	1.01
		9	0.63	0.35	0.80	0.68	0.38	0.86	0.84	0.47	1.06

318. Fuller's Rule. The following rule, devised by Wm. B. Fuller, † gives the quantities of cement, sand, and stone required to make a cubic yard of concrete; and is fairly representative of all classes of materials. This rule is valuable because it is so simple that it can be carried in the memory.

c = number of parts of cement.

s = number of parts of sand.

g = number of parts of gravel or broken stone.

C = number of barrels of packed portland cement required for 1 cu. yd. of concrete.

S = number of cubic yards of loose sand required for 1 cu. yd. of concrete.

G = number of cubic yards of loose gravel or broken stone required for 1 cu. yd. of concrete.

* From Taylor and Thompson's Concrete Plain and Reinforced, p. 229-35, where a much more extended table may be found.

† Taylor and Thompson's Concrete Plain and Reinforced, p. 16.

$$C = \frac{11}{c+s+g}$$

$$S = C \times s \times \frac{3.8}{27}$$

$$G = C \times g \times \frac{3.8}{27}$$

“If the coarse material is broken stone screened to uniform size, it will contain less solid matter in a given volume than average stone, and hence about 5 per cent should be added to quantities of all three ingredients as computed by the above rule. On the other hand, if the coarse material is well graded in size, about 5 per cent may be deducted from all of the quantities.”

The above formulas are sometimes modified by changing the constants 11 and 3.8. For example, one engineer substitutes 9.5 for the 11, and 4 for the 3.8.

ART. 3. FORMS FOR CONCRETE.

319. Freshly mixed concrete is plastic until the process of setting begins, and hence must be confined within the limits set for the finished structure until the mass hardens. This is usually accomplished by the use of wooden moulds or forms which are built so that their inside dimensions are exactly the shape of the finished structure. In this article it is proposed to describe the more important principles involved in designing and constructing forms for the most simple concrete structure; but the more complicated problems encountered in the construction of forms for the more elaborate concrete structures will be considered in connection with the discussion of the structures themselves—particularly reinforced-concrete buildings, see Art. 3, Chapter VIII.

The forms should be designed at the same time that the outlines of the structure are fixed, and instructions and sketches should be prepared for the guidance of the carpenter who is to build the forms, in order that they may be sufficiently strong and not needlessly extravagant, and also that the carpenter may not waste time in the field in studying the masonry plan. The forms should be designed with a view to saving time and material in taking down as well as to economy of material and time in the construction and the erection.

320. ORDINARY CONSTRUCTION. The forms are usually made by setting up studdings and nailing horizontal planks to them. The forms must be built strong enough to hold the plastic mass in place during tamping and hardening; and should be tight enough to prevent serious leakage of the more fluid portion of the concrete. The forms

should have a smooth even inside surface so as to give a smooth finish to the completed structure. If the forms spring out of place, the concrete may flow out and be wasted; and at best any springing of the forms will injure the appearance of the surface of the finished structure.

In concrete buildings, where the cost of the forms is a large part of the entire cost of the structure, and where a failure of the forms may cause serious loss of property and possible loss of life, it is of the utmost importance to carefully study every detail of the design and construction of the forms to secure safety and prevent extravagance; but in the simpler concrete structures where the concrete is usually deposited in layers, it is not possible to secure great accuracy in the design of the forms. Either 1-inch or 2-inch plank may be used, and the studding may vary from 2- by 4-inch to 4- by 6-inch, depending upon their distance apart, the height of the forms, and the amount of bracing. Experience seems to prove that with 1-inch plank the studding may be 2 feet apart, with 1½-inch plank 3½ or 4 feet, and with 2-inch plank 5 feet.

321. Bracing the Forms. There are two methods employed for bracing the vertical studding,—either inclined exterior wood braces are used, or interior horizontal ties of wire or rods connect the studs on the opposite sides of the forms. Occasionally large posts are used which are tied across at the top and the bottom, and trussed on the outside.

322. Inclined Braces. The studding may be braced by inclined braces whose lower ends are nailed to or abut against a stake and whose upper ends are nailed to the studding or abut against a block nailed to the studding—see Fig. 17. It is important that the stake, or better the post, be substantial enough to give the required resistance; and for that reason, unless the ground is quite firm, it is wise to drive a second stake behind the first one and brace the top of the inside stake from the bottom of the outside one, somewhat as shown in Fig. 17. For convenience in setting the braces, it is wise to place, say, a 2- by 6-inch scantling against a row of stakes for the braces to abut against and insert a folding wedge between the foot of the brace and the scantling, as at *E* in Fig. 17. The upper end of the brace is sometimes simply nailed against the side of the vertical posts as shown at *C* and *D*, Fig. 17; but this is wise only when the brace is a 1- by 6-inch plank. When the brace is a 2- by 4-inch scantling, the upper end is sometimes beveled and toe-nailed against the outside of the vertical post, as shown at *B*; but the most substantial construction is to nail a block on the post and cut the brace to a bevel so it will fit against the post and also against the block, as shown in *A*.

The sizes of the inclined braces depend upon their length, their inclination, and their number. An approximate rule for the size of the braces, derived from experience, is that the number of square inches in the cross section of a brace should equal its length in feet. If thin plank of any considerable length are used for braces, they should be in pairs and be stiffened by cross pieces nailed to the two planks.

The advantage of outside braces is that the interior of the forms is left entirely unobstructed; but on high walls the amount of timber required for exterior braces is very great, and not infrequently the

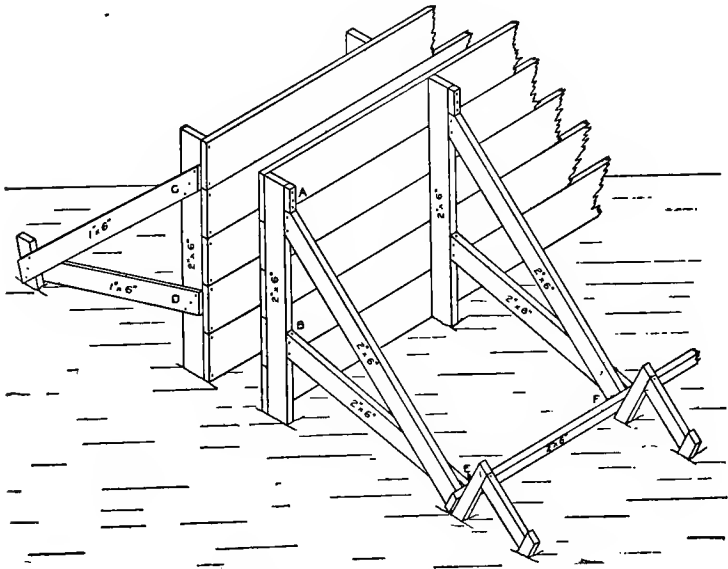

FIG. 17.—EXTERNALLY BRACED FORMS.

exterior braces seriously interfere with the handling of the materials for the concrete and also of the concrete itself. Further, exterior braces are usually less secure and more expensive, both in material and in time, to erect than interior rods or wire.

323. Horizontal Ties. The posts on opposite sides of the forms may be tied together by rods or wires running from side to side across the form. The wire is passed around the stud on each side of the form through the crack between two planks, and tightened by being twisted with a stick. After the concrete is in position and the form is taken down, the wire is cut off a little under the surface of the concrete, and the hole is plastered up with mortar. To keep the

sides of the forms the proper distance apart, a piece of wood of the right length should be placed beside the wire, and should be left there until the concrete reaches that height, when the strut is to be removed. The trouble of keeping these pieces of wood in place and the difficulty of getting them removed at the proper time, are a serious objection to tying the forms together with wire; and, besides, the first cost of the wire is considerable, and a surprisingly large amount of time is required to put it into place.

When the sides of the forms are tied together with rods, it is customary to pass them through a pipe, so that the rod may be drawn out when the forms are taken down. For an example, see Fig. 120, page 530. The pipe should be cut a little shorter than the distance between the sides of the form, and should be held in position by placing at each end a 2-inch block with a hole through it. When the rod is withdrawn the block is removed and the hole is plastered up with mortar. The rod is better than the wire since the latter is nearly sure to stretch and allow the forms to get out of line, and sometimes the wire breaks and causes serious trouble. The rods and pipes cost a little more than the wire, but cost less to put into place and are much more substantial. Sometimes the pipes are dispensed with, and pieces of wood or small beams of concrete are used to keep the sides of the forms the proper distance apart, in which case the rods are either greased or wrapped in greased paper to facilitate their removal after the concrete has set. However, it is nearly impossible to secure a water-tight wall when rods without pipes are used for ties. Sometimes rods are used having sleeve nuts near each end, see Fig. 119, page 529; and after the forms are removed the end of the rod is unscrewed. Whatever the form of the tie, the metal left in the concrete should not come nearer to the surface than 2 inches, as otherwise rust stains are likely to appear.

324. The Plank. The plank used in the forms should be reasonably free from knots. Green lumber is preferable to that which is thoroughly seasoned, because it is less affected by the water in the concrete. If a good surface is required on the finished concrete, the plank should be surfaced on one side; and some contractors prefer to use surfaced lumber in all cases, as less concrete adheres to the lumber and hence it requires less labor to clean the plank for use again. If the concrete is wet when it is placed in the forms, the plank should be tongued and grooved to insure tight forms. Sometimes the edges of the plank are beveled, so the thin edge will crush as the plank absorbs water from the concrete and swells, thus preventing the plank from buckling and marring the surface of the completed structure.

The forms should be built reasonably tight; but any joints or

holes may be closed with plaster of paris or putty, or may be covered with building paper or a thin sheet of steel. If the forms are to be removed before the concrete becomes hard, the plank should be coated with heavy oil, soft soap, or some greasy substance to prevent the concrete from adhering to the plank. Soap is better than oil or grease, since it is soluble in cold water and hence is comparatively easily removed from the concrete surface. Soft soap thinned with water and spread with a whitewash brush or a broom is efficient and is usually quite cheap. If the forms are not to be removed until the concrete has become hard, the concrete will not adhere seriously if the forms are simply wet thoroughly with water just before the concrete comes against them.

325 Edges and Corners. In designing concrete structures, sharp edges and corners should be avoided as far as possible, since with a brittle substance like concrete these are likely to be broken off in removing the forms or in service. The corners of the concrete may be rounded off by nailing beveled fillets or strips of concave quarter-round in the corners of the forms before beginning to deposit concrete. For an example, see Fig. 182 and 183, page 603.

It is very important that the forms for copings, water tables, etc., be so designed that they can be removed without damaging the corners or edges of the concrete. Sometimes a panel of planks or a rectangle of half-round strips is nailed against the inside of the form to give a little ornamentation to the finished surface of the concrete. For an example of the former, see Fig. 118, page 528. The latter method was used in the abutment represented in Fig. 133, page 543, but is not shown in the figure. Occasionally beveled strips are nailed on the inside of the form to give the concrete the appearance of cut stone masonry having chamfered joints, but this is indefensible from the artistic standpoint. For an example of this construction, see the arch ring in Fig. 181, page 602.

326. IMPROVED CONSTRUCTION. The cost of labor and material required for forms is an important part of the cost of any concrete work, and particularly of thin walls or parts of buildings; and consequently there have been many attempts to reduce the cost of forms. However, none of the improvements has made any great reduction in the cost of forms, nor are any of the improvements without accompanying objections; and therefore there is still room for improvements in reducing the cost of the materials and the labor for forms.

Only a few of the many attempts to improve the forms for mass concrete work will be referred to here.

327. Sectional Forms. For structures having large areas of flat surfaces, such as a retaining wall, the forms are sometimes made in

sections, which, after the concrete has set, may be taken down in one piece and be set up again, thus facilitating the placing and the removal of the forms. The sections are made of planks fastened together with battens, and are placed one above the other or end to end as may be required, and are held in place by being lightly nailed to the upright posts.

Sectional forms are also made to be used without continuous upright posts, the two opposite sides being held in position by bolts and separators, and successive sections being held together by pro-

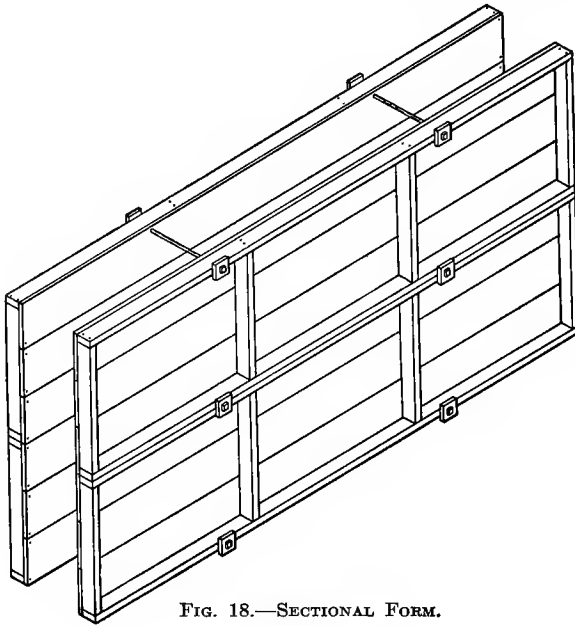

FIG. 18.—SECTIONAL FORM.

jecting metal lugs on the outside. Fig. 18 shows one of the several varieties of sectional or panel forms for wall construction. The rods run through pipes which act as spacers and also facilitate the removal of the rods. The bottoms of the panels overlap the part of the wall already in place, the forms being supported by the pipe and rod.

Fig. 19 shows another method of making sectional forms.* In using the frame, a section of wall is built up one foot high and allowed to set; and then the frame is removed by unbolting, and is raised one foot higher, the rear face of the form being moved inward sufficiently to allow for the corresponding batter of the wall. Fig. 20 shows a

* *Engineering News*, vol. xlvi, p. 424.

somewhat similar arrangement of the forms for a coping.* The frame may be taken down by removing the bolts *B* and *C*. Notice the beveled strips *m*, *m*, *m*.

328. Slotted-Frame Form. Sometimes instead of using posts continuous from top to bottom of the wall, slotted frames 5 or 6 feet long are so arranged that the short posts may be raised as the work progresses without removing the bolts which hold the sides of the form together, thus permitting the removal of the lower plank for use again. Fig. 21, page 166, shows this form of construction, the slotted frames being ready to be moved up.

329. Plank Holders. Upon the market are several patented metal plank-holders that permit the addition of one plank at a time and do not require either nails or uprights; but their value has not yet been established by experience.

330. Metal Forms. Metal forms have been tried; but, up to date, wood has proved to be the most economical material for forms for concrete work, except possibly for small sewers and conduits. If sheet metal is placed on a wood back or on a metal stiffening frame, there is danger of its becoming dented, bent, or otherwise defaced so as to give an imperfect surface to the concrete; and if the metal covering is sufficiently thick to resist damage, it is too heavy and too expensive.

331. CLEANING THE FORMS. Before beginning to deposit concrete, all debris, such as sawdust, shavings, blocks of wood, etc., should be removed from the inside of the forms. This precaution is particularly important with forms for columns, girders, beams, and floors.

All dry mortar left on the forms during the previous day's work should be removed before beginning to deposit concrete, as otherwise an imperfect face will be obtained.

* *Engineering News*, vol. 1, p. 37.

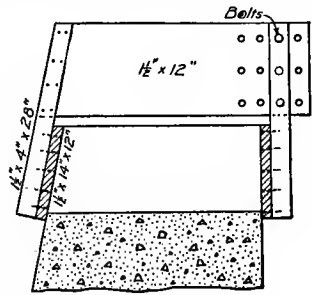

FIG. 19.—SECTIONAL FORM FOR WALL.

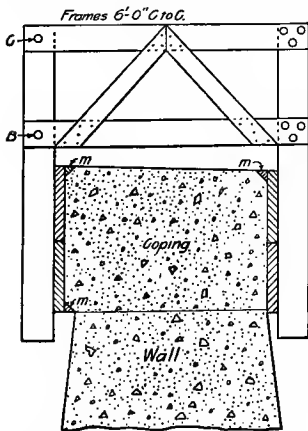

FIG. 20.—SECTIONAL FORM FOR COPING OF WALL.

332. TIME TO REMOVE FORMS. As a rule the forms should not be removed within 48 hours after the concrete is deposited; and in cold weather they should be allowed to remain longer than in warm weather to give ample time for the cement to set. The forms can be removed from the back of a wall sooner than from the face. With mass concrete it is usually safe to remove the forms from the face when the concrete has set so it can not be indented with the thumb nail; but with arches, columns, and girders, more time should be allowed. In concrete building-work it is usually desirable to remove

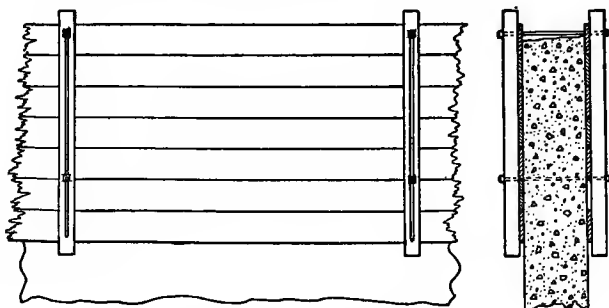

FIG. 21.—SLOTTED-FRAME FORM.

the forms as soon as possible in order to use them elsewhere, but removing forms too soon has frequently been the cause of serious accidents; and hence it is wise when placing the concrete for columns, girders, and floors, to mould some cubes or beams which are later broken in a testing machine to determine whether or not it is then safe to remove the forms.

In this connection it should not be forgotten that concrete sets faster during a hot dry day than during a damp muggy one, and also that occasional batches will set abnormally slow either because of slower-setting cement or of impurities in the sand.

333. COST OF FORMS. For data on the cost of forms, see § 417 and Table 46, page 258, and also "Forms, Cost of," in index.

ART. 4. MAKING AND PLACING CONCRETE.

334. CONSISTENCY OF CONCRETE. There is considerable diversity of opinion among engineers as to the amount of water to be used in making concrete; but in recent years there has been a decided tendency toward the use of more water than formerly. Until recently one extreme advocated the use of dry concrete, i.e., of a

concrete mixed so dry that moisture would just flush to the surface under vigorous tamping; while the other extreme advocated the use of wet concrete, i.e., a concrete that would quake like liver or jelly when tamped. At present only comparatively few advocate the use of dry concrete, and most engineers prefer a plastic or quaking mixture; but a considerable number use a very wet or mushy concrete, i.e., a mixture which can not be tamped and into which a man sinks to his ankles or above in walking over it.

335. Dry vs. Wet Concrete. The following is the conclusion of the most elaborate series of tests made to determine the relative strength of wet and dry concrete.* The mean crushing strength of 156 1-foot cubes of concrete made with mortar as "dry as damp earth" was 13 per cent more than the average of 148 cubes that "quaked like liver under moderate ramming," and 11 per cent more than the average of 144 cubes made with mortar of the "ordinary consistency used by the average mason." The cubes were made of five brands of portland cement and five proportions of sand varying from 1 : 1 to 1 : 5; half the cubes had a little more mortar than enough to fill the voids of the broken stone, while the other half had only about 80 per cent as much mortar as voids. One quarter of the cubes were stored in water, one quarter in a cellar, one quarter under a wet cloth, and one quarter in the open air. All were broken when approximately 2 years old. The difference in the amount of mortar made no appreciable difference in the strength.

Experiments frequently show a greater difference than the above. For example, the mean of twelve cubes of dry concrete was 51 per cent stronger than corresponding cubes of quaking concrete.† But all experiments show that the difference between the strength of wet and dry concrete is greater at earlier ages than later, and that after 3 to 6 months there is but little difference.

It is unquestionably true that with sufficient ramming, dry mixtures of neat cement, and also of cement and sand, are stronger than wet mixtures; and hence if the absolute maximum strength of concrete is desired a dry mixture should be used. But the amount of water to be used in making concrete is usually a question of expediency and cost, rather than a question of the greatest attainable strength regardless of expense.

336. A consideration of the following principles will be useful in determining whether to use a wet or a dry concrete. 1. Dry mixtures set more quickly and gain strength more rapidly than wet

* Geo. W. Rafter in Report of the New York State Engineer for 1897, p. 375-460; in Report of Tests of Metals, etc., Watertown Arsenal, 1898, p. 421-639; and also in Trans. Amer. Soc. of C. E., vol. xlii, p. 104-116.

† M. Feret, a French authority, *Engineering News*, vol. xxvii, p. 311.

ones; and therefore if quick set and early strength are desired, dry concrete should be preferred. 2. Wet concrete contains a great number of invisible pores, while dry concrete is likely to contain a considerable number of visible voids; and for this reason there is likelihood that wet concrete will be pronounced the more dense, even though both have the same density. 3. Wet concrete is more easily mixed; and therefore if the concrete is mixed by hand and the supervision is insufficient or the labor is careless, or if the machine by which it is mixed is inefficient, wet mixtures are to be preferred. 4. Wet mixtures can be compacted into place with less effort than dry; but on the other hand the excess of water makes the mass more porous than though the concrete had been mixed dry and thoroughly compacted by ramming. Dry concrete must be compacted by ramming, or it will be weak and porous; therefore if the concrete can not be rammed, it should be mixed wet and then the stones by their own weight will bury themselves in the mortar, and the mortar will flow into the voids. 5. A rich concrete can be compacted much easier than a lean one, owing to the lubricating effect of the mortar; and hence rich concretes can be mixed drier than lean ones. The quaking of concrete is due more to the excess of mortar than to the excess of water. 6. Lean concretes should be mixed rather dry, since if quite wet the cement will find its way to the bottom of the layer and destroy the uniformity of the mixture. 7. Machine-made concrete may be mixed drier than hand-made, owing to the more thorough incorporation of the ingredients. 8. Gravel concrete can be more easily compacted than broken-stone, and hence may be mixed drier. 9. In mixing dry by hand there is a tendency for the cement to ball up, or form nodules of neat cement; while in mixing wet this does not occur. 10. If wet concrete is deposited in a wood form, there is liability of the water exuding between the planking and carrying away part of the cement and thus weakening the face—which should be the strongest part of the mass. 11. With reinforced concrete a wet mixture is necessary so that the mortar will certainly flow around the reinforcing steel and come into contact with its surface. 12. A great excess of water not only makes the concrete porous and therefore weak, but also tends to destroy the cement by the washing out of the finest particles. 13. If the concrete is mixed with a great excess of water, when it is deposited in place, the excess water will rise to the surface and carry with it the finest or active particles of cement, which will decrease the strength of the concrete and also deposit upon the surface of the mass a light colored powdery substance which will prevent the adherence of the next layer of concrete.

The conclusion is that dry concrete if thoroughly tamped is the

strongest, but also the most expensive to mix and lay; that quaking concrete is nearly as strong as dry, and is more easily mixed, and does not require as much tamping; and that mushy or fluid concrete is considerably weaker, and requires tighter forms, but does not require any tamping. Dry concrete must be employed where great strength is required at an early date; but it must be thoroughly tamped,—a thing difficult to secure with ordinary laborers. Plastic or quaking concrete is suitable for plain concrete in large masses, but care is required to secure a solid surface (see § 353). A wet or mushy mixture must be used for reinforced concrete, and will usually give a solid surface next to the form without any special care.

337. Amount of Water Required. The amount of water required to produce any particular plasticity varies so greatly with the proportions of the ingredients, the kind and fineness of the cement, the dampness of the sand, the kind of aggregate, the amount of mixing, etc., that it is scarcely possible to give any valuable general data. For example, in the experiments referred to in the first paragraph of § 335, the average quantity of water for the different grades of dry mortar was 19.8 lb. per cu. ft., and for the plastic 21.4, and for the wet 22.5, the sand being reasonably dry; while other experimenters obtain nominally the same degree of plasticity with less than half as much water.

As a rule, with well-graded ingredients in the usual proportions, plastic or quaking concrete will require about 8 to 10 pounds, or about 1 to 1½ gallons, of water per cubic foot. The amount of water required increases slightly as the proportions of sand and stone increase. The water required to produce a plastic or quaking consistency, in terms of the weight of the *cement*, is about as follows: for neat cement 20 per cent; for rich mortar 25 to 30 per cent; for rich concrete 30 to 33 per cent; for lean concrete 33 to 50 per cent; and for very lean concrete 50 to 100 per cent. The weight of water in a wet mixture in terms of the weight of the *total dry materials* is about as follows: for mortar, 10 per cent; and for concrete, 7 or 8 per cent.

If the aggregate is porous, it should be drenched before beginning to mix the concrete, as otherwise the aggregate by absorbing the water employed in mixing may rob the cement of the water required in setting and thus ruin the concrete. Obviously this precaution is most important with dry mixtures.

338. MIXING CONCRETE. The value of the concrete depends greatly upon the thoroughness of the mixing. Every grain of sand and every fragment of aggregate should have cement adhering to every point of its surface. Thorough mixing not only causes the cement to adhere to all the surfaces, but forces it into intimate contact

with the other ingredients at every point. The longer and more thorough the mixing the better, provided the time does not trench upon the time of set or the working does not break and pulverize the angles of the stone. Uniformity of the mixture is as important as intimacy of contact between the ingredients. The mixing has been thorough if the mass has a uniform color, if no uncoated particles of sand or stone are visible, if the mortar is distributed uniformly throughout the mass, or if the consistency of the concrete is uniform throughout. Lean mixtures require more mixing than rich ones, and dry mixtures require more than wet ones.

Concrete may be mixed by hand or by machine. The latter is the better; since the work is more quickly and more thoroughly done, and since ordinarily the ingredients are brought into more intimate contact. If any considerable quantity is required, machine mixing is the cheaper; but on small jobs hand mixing is the cheaper. More careful inspection is required to secure thorough mixing by hand than by machinery; and for this reason machine mixing is preferred for thin walls and for reinforced work, since in these cases a single batch of poorly mixed concrete may materially affect the strength or water-tightness of the structure.

However, in discussing the relative merits of hand-mixed and machine-mixed concrete it is important to state the kind of machine with which the comparison is made, since there is as much difference between the products of different machines as between good and poor hand mixing.

339. Hand Mixing. There is great variety in the details of hand mixing; but in any case a water-tight platform or shallow box should be used. The sand and the aggregate are usually measured in a wheelbarrow, the quantity being adjusted to one or more bags of cement; but if this method is used, the barrow should be so constructed that the top of the load can be stricken off with a straight edge. If the sand and stone can be stored near the mixing board, it is more accurate to measure the quantities by shoveling them into bottomless boxes set upon the mixing board. These boxes may be 6 or 8 inches deep and have other dimensions to give the required proportions of concrete.

For the best results the sand should be evenly spread upon the mixing board, and the requisite amount of cement should be uniformly spread over the sand. These should be turned with the shovel until thoroughly mixed. It is not sufficient to simply turn the mass with the shovel, but the sand and cement should be allowed to run off from the shovel in such a way as to thoroughly mix them. If skilfully done, two turnings will usually give a uniform mixture.

Some engineers add water to the cement and sand, thus forming

a mortar before adding the stone; while others mix the dry cement and the sand with the stone before adding the water. It is claimed that the latter requires a little less labor and gives equally good concrete. Some engineers add the water with a spray to secure greater uniformity and to prevent the washing away of the cement, and depend upon the appearance of the concrete to secure the right consistency; while others measure the water in buckets and pour nearly all of it on the dry materials before beginning to turn the wet mixture, reserving a little water to wet the dry spots as the turning proceeds. In either case the stone should be dampened before being mixed.

The mixed cement and sand, either before or after wetting, may be shoveled upon the broken stone previously spread evenly on the mixing board; or the cement and sand, either before or after wetting, may be spread evenly on the board and the broken stone dumped on it. In any case the mass should be turned and re-turned until every fragment is covered with mortar.

Specifications usually require concrete to be turned at least four times, and frequently six.

340. Machine Mixers. There are at least twenty-five concrete-mixing machines upon the market. According to the method of charging and discharging, concrete mixers may be divided into two classes: (1) continuous mixers, those into which the materials are fed continuously, usually with shovels, and from which the concrete is discharged in a steady stream; and (2) intermittent or batch mixers, those which receive one or more bags of cement with the proper proportion of sand and stone, and after mixing the charge is discharged in one mass.

There are two forms of continuous mixers,—the power mixer and the gravity mixer. In the latter the ingredients are mixed in falling through a vertical or inclined chute by striking against rods or in falling from inclined shelves. Of the continuous power mixers there are two types: one in which the concrete is forced along a horizontal trough by an endless screw or by revolving paddles; and another in which the concrete is mixed in its passage through either a long horizontal box, square in cross section, or a cylinder which revolves about a horizontal axis.

The batch mixers have a mixing chamber in the form of a cube, or a cylinder, or a double cone, which revolves about a horizontal axis. In some of the machines of this type the contents are discharged by changing the position of inside deflectors, without stopping the machine; and in others the mixing chamber is tilted on a horizontal axis to discharge a batch.

Each machine has some advantages to recommend it. Batch mixers are usually preferred unless the materials are measured and

fed mechanically, owing to the difficulty of uniformly feeding the continuous mixer.* Some of the mixers are equipped with automatic measuring devices.

341. A machine mixer should be used in preference to hand mixing when the cost of setting up, taking down, and transporting the mixer is less than the difference in the cost of mixing the required amount of concrete by hand and by machine. Under ordinary conditions, if more than 150 or 200 cu. yd. of concrete are required, it is cheaper to mix by machine than by hand.

342. PLACING THE CONCRETE. After mixing, the concrete is conveyed in wheelbarrows or in buckets swung from a crane or in cars running on a track, and deposited in the structure in layers 6 to 8 inches thick if the concrete is mixed dry, and from 12 to 16 inches thick if it is mixed wet. If the concrete is wet, it can be dumped from almost any height; but if mixed dry, it should not be allowed to fall from any considerable height, as doing so separates the ingredients. If in handling dry concrete the larger fragments become separated, they should be re-turned and be worked into the mass with the edge of a shovel.

If the concrete was mixed either dry or plastic, it should be compacted by ramming; and if the concrete is wet, it should be stirred to allow the entrained air and surplus water to rise to the surface. The stirring or "puddling" may be done either by plunging a rod up and down in it, or by men wearing rubber boots walking around in it.

343. The rammer ordinarily used for dry or plastic concrete consists of a block of iron having a face 6 to 8 inches square and weighing anything up to 20 or even 30 pounds. A rammer having a 2- by 4-inch face is convenient for use close to the forms. The face of the rammer is sometimes corrugated, to keep the surface of the layer rough and thus give a better bond with the next, and also to transfer the compacting effect of the blow deeper. The tamping should be vigorous enough to thoroughly compact the mass; but too severe or too long-continued pounding injures the strength of the concrete by forcing the broken stone to the bottom of the layer, or by disturbing the incipient set of the cement.

With wet concrete the so-called rammer may be either a round wooden rod 2 inches in diameter or a piece of scantling having a 2- by 4-inch face at the lower end and rounded at the upper end for a handle.

344. After the concrete is in place it should be protected from the sun, and should not be disturbed by walking upon it until fully set.

* For a consideration of the relative merits of the different type forms of concrete mixers, see *Engineering News*, vol. 1, p. 186-89, and p. 223.

This limit should be at least 12 hours, and is frequently specified as 4 or 5 days.

345. Bonding New to Old Concrete. When one layer of concrete is to be deposited upon another partially set, precautions must be taken to secure a good union between the two,—particularly if the joint is likely to be subjected to tensile or shearing stress, or if the concrete is required to be water-tight. If the first layer is only partially set, it is sufficient to simply wet the old concrete, taking care that no puddles of water are left upon its surface. In case the first layer is fully set, it is wise to sweep the surface with a 1 : 1 or 1 : 2 cement mortar to make sure that the two layers adhere firmly. If the sand or gravel contains any appreciable clay and the concrete is mixed wet, clay is liable to be flushed to the surface and prevent the adherence of the next layer; therefore under these conditions the surface should be swept or washed perfectly clean, and then the surface should be thoroughly swept with a rich cement mortar. An almost invisible film of oil or grease, which often gets on the concrete from the forms, is very effective in preventing a bond, and is very difficult to remove. For this reason it is better to use soap than oil on the inside of the forms, since soap is soluble in cold water and hence is easily washed off. If the joint is likely to be subjected to a considerable shearing stress, it is wise to roughen the surface before it sets or to embed a timber, say 4 or 6 inches square, in such a way that when it is removed a groove will be left which will be filled with the new concrete. Sometimes large stones are partially embedded in the upper surface for doweling the old to the new work.

In attempting to bond new concrete to that which has been set a long time, it is of appreciable advantage to allow the new concrete to take an initial set and then add water and re-mix it before using it. The advantage is due to two things: First, since concrete shrinks in hardening in air, allowing the concrete to take an initial set and then re-mixing it eliminates part of the ordinary shrinkage. Second, all concrete shrinks through cooling after the elevation of temperature due to the chemical action of setting, and the addition of water the second time cools the concrete and prevents at least part of the shrinkage due to this cause.

In building tanks or other structures which must be water-tight, the surest way is to build the work as a monolith, i.e., without stopping the work; but with reasonable care a water-tight joint may be made by observing the above precautions. In this connection see § 382.

346. Laying Rubble Concrete. Rubble concrete is concrete in which large stones are bedded. The embedded stones decrease the cost of construction, since the cost of crushing the embedded stones

is saved, and also since no cement is required to combine these stones into a solid mass. Of course, rubble concrete can be used only in massive work. The important things to be observed in laying rubble concrete are: 1. The large stones should be clean, and should be laid far enough apart to be fully encased in the concrete. 2. The concrete should be wet enough to flow easily around the stones, and should be deposited in layers whose thickness varies with the size of the stone to be embedded. 3. If the large stones do not sink into the concrete by their own weight, they should be driven in with a rammer.

347. DEPOSITING CONCRETE UNDER WATER. In laying concrete under water, an essential requisite is that it shall not fall from any height, but be deposited in the allotted place in a compact mass, as otherwise the cement will be separated from the other ingredients and the strength of the work will be seriously impaired. If the concrete is allowed to fall through the water, the finer or active portions of the cement are likely to be washed out and thus weaken the concrete; and, besides, the ingredients will be deposited in a series, the heaviest—the stone—at the bottom and the lightest—the cement—at the top, a fall of even a few feet causing an appreciable separation. Of course, concrete should not be used in running water, as the cement would be washed away.

There are three methods in common use in depositing concrete under water: (1) placing it in bags and forming a pile of bags under the water; (2) passing it through a tube in a continuous flow; and (3) lowering it in a self-dumping bucket with a crane.

1. Concrete is sometimes deposited under water by enclosing it in open-cloth bags, the cement oozing through the meshes sufficiently to unite the whole into a single mass. Concrete has also been successfully deposited under water by enclosing it in paper bags, and lowering or sliding them down a chute into place. The bags get wet and the pressure of the concrete soon bursts them, thus allowing the concrete to unite into a single mass.

2. The tube used for depositing concrete under water is called a *trémie*. It consists of a wooden or steel tube 12 or 14 inches in diameter, open at the top and the bottom, and is suspended from a crane or movable frame running on a track, by which it is moved about as the work progresses. The upper end is hopper-shaped, and is kept above the water; the lower end rests against the bottom. The concrete should be mixed plastic, but neither dry nor wet—the former is liable to clog in the chute, and the latter flows out at the lower end too easily. When the concrete is to be deposited in large masses, the *trémie* is filled by placing the lower end on the bottom and filling the tube by dropping concrete through the water; or

the trémie may be filled by placing its lower end in a box having a movable bottom, filling the tube, lowering all to the bottom, and then detaching the bottom of the box. After the tube is full it is raised a little from the bottom, and as the concrete flows out below, more is thrown in at the top.

3. There are a number of bottom-dumping buckets upon the market, designed for depositing concrete under water; but it is possible to make a home-made bucket that will serve the purpose. A wooden box having a V-shaped bottom is so constructed that on reaching the bottom a pin may be drawn out by a string reaching to the surface, thus permitting one or both of the sloping sides to swing open and allowing the concrete to fall out. The box is then raised to be refilled. The box should preferably have a lid.

348. LAYING CONCRETE IN FREEZING WEATHER. The effect of cold is to retard the setting of cement; and if a mass of concrete is repeatedly frozen and thawed before it has dried out or has set hard enough to resist the expansive action of the frost, the bond between the cement and the coarser materials may be destroyed. However, with large masses of concrete there is usually little probability of the mass's freezing much, if any, before the cement has set sufficiently to resist the expansive action of the frost, since the temperature of the concrete when freshly mixed is considerably above freezing, and since it is protected by the forms. Further, the chemical action of setting causes a considerable rise of temperature. The temperature at the center of a 1-foot cube of neat portland-cement mortar may be 200° F., and that of natural cement 100° F.* The rise of temperature of concrete is less than that of neat mortar, but the effect of this increase of temperature in concrete must considerably retard its freezing. Most natural cements are seriously injured by freezing, but portland cement will stand a moderate amount of freezing without material damage.

Foundations or heavy walls whose face appearance is unimportant, may be laid with portland-cement concrete in freezing weather without any further precaution than to keep the upper surface of the concrete free from ice and frozen dirt and to cover the work with cement bags or straw or manure or some such material when stopping work at noon or night. If it is not permissible to allow the concrete to freeze, it may safely be laid in freezing weather by taking one or more of the four following precautions:

1. Use dry concrete, as it will set quicker than a wet mixture; but care must be taken to tamp it well.

2. Lower the freezing point of the water used in making the

*Tests of Metals, U. S. A., 1901, p. 493. For similar but less striking results, see Johnson's Materials of Construction, p. 414.

concrete, by adding common salt. To prevent water from freezing absolutely until the temperature reaches 0° Fahr., add salt equal to 1 per cent of the weight of the water for each degree below freezing. But for the two reasons stated in the first paragraph of this section, it is not necessary to use in concrete the full amount of salt required by the above rule. A common rule, which has long been in use with success for temperatures of 10° to 15° F. below freezing, is: "Dissolve 1 pound of salt in 18 gallons of water when the temperature is 32° F., and add 3 ounces of salt for each 3° of lower temperature." This rule gives proportionally an excess of salt at temperatures near zero. A more scientific rule, and one more easily remembered, is: "Add $\frac{1}{2}$ of 1 per-cent of salt for each 1° F. below freezing." Except between 32° and 28° , this rule gives more salt than the common rule above. Salt up to 10 per cent does not weaken the concrete.*

Several other substances could be used to lower the freezing point of the water, but salt is much the cheapest. The only objection to salt is that it is liable to cause a white, powdery deposit on the surface, which, however, is likely soon to be washed off or blown away. Dissolving the salt in the water rather than mixing it with the cement lessens the probability of efflorescence. Concrete to which salt has been added dries out more slowly, and hence retains its dark color longer, than that containing no salt; but both are likely finally to have the same color.

3. Warm the ingredients, which accelerates the setting of the cement and also lengthens the time before the mixture becomes cold enough to freeze. The water may be heated with a jet of steam, and in extreme cases the sand and the stone may be heated on a steel plate placed upon two brick walls with a fire between.† With proper care it is possible to get the concrete into place at 60° F.

4. Protect the concrete by surrounding the work with a canvas or wood covering, and heating the interior with steam pipes, stoves, or open charcoal fires.‡ In temperatures only a few degrees below freezing, it is sufficient to nail building paper on the outside of the forms. A single thickness of tarred paper, well tacked and so put on as to prevent a free circulation of air, has raised the temperature of the air under it 20° F.

349. From the above it is seen that concrete can be safely laid in freezing weather with reasonable precautions; but nevertheless

* Proc. Amer. Soc. for Testing Materials, vol. iii, p. 393.

† For an illustration of a combined water, sand, and stone heater used by the New York Central Railroad, see *Engineering News*, vol. xlix, p. 246; or *Engineering-Contracting*, vol. xxvi, p. 201-02.

‡ For an illustrated account of the method of heating the ingredients of the concrete and also of inclosing a large reinforced-concrete building while in process of construction, see *Engineering News*, vol. liv, p. 240-42; or *Engineering Record*, vol. li, p. 249-50.

it should not be done unless really necessary, since there is then more danger through carelessness, and also since the concrete freezes to the tools and forms, which adds considerably to the expense. Concrete has been laid comparatively frequently when the atmosphere was 10° or 15° F. below zero,—sometimes by simply heating the water, but usually by heating all the materials for the concrete.

350. FINISH OF THE SURFACE OF CONCRETE. The character of the surface is an important factor in the appearance of a concrete structure. It is not wise to neglect entirely the looks of any concrete work; and in some structures the appearance is the most important part of its design and construction. It is really difficult to secure a smooth surface of even grain and uniform color on a concrete structure. The imperfections of the surface are usually due to one or more of four causes, viz.: (1) imperfectly made forms; (2) badly mixed or carelessly placed concrete; (3) efflorescence and discoloration of the surface; or (4) unsightly construction joints.

1. If the joints of the forms are not close, the concrete will run between the planks and leave an ugly fin. If a plank springs out of place, a swell is produced on the face of the concrete. If a very smooth surface is sought, the grain of the wood forms is reproduced in the concrete, and even closely made joints leave a conspicuous line in the finished concrete.

2. If the concrete is not uniformly mixed or is unmixed in the handling, the surface will be irregularly colored and will contain pitted and honeycombed spots.

3. If the concrete is not water-tight, and particularly if there is water or earth against the back of the concrete, efflorescence and discoloration are likely to appear. The efflorescence is due to water percolating through the concrete and dissolving the soluble salts, which are left as a white, powdery substance on the surface when the water evaporates (see § 388).

4. If the placing of the concrete does not proceed continuously day and night, an unsightly line on the surface is likely to show where the two days' work joined. This defect may be almost entirely eliminated by nailing a triangular strip against the form and finishing the day's work to the inner edge of this strip, thus producing on the face of the concrete a regular groove instead of the usual ragged division line.

There are various ways of correcting the above defects or of securing a surface of better appearance than any left by the most perfect forms. These will next be briefly considered, attention being given first to the methods of finishing a plain smooth surface and then to the methods of finishing that secure a more ornamental surface.

351. Mortar Face. When it was the custom to use a dry or semi-plastic concrete, it was also the custom to make the surface of a richer mixture than the body of the concrete. A 1 : 2 or 1 : 3 mortar was frequently used for this purpose. This facing mortar was sometimes simply banked up against the form a little ahead of the concrete, the tamping of the concrete uniting the two together firmly. A neater and more economical method was to place next to the form a frame into which the face mortar was packed and which was afterwards withdrawn. This frame or form consisted of a $\frac{3}{16}$ -inch steel plate about 8 inches high and 5 feet long, having three 1-inch steel angles riveted transversely to it. This plate was set vertically with the projecting angles against the face form, and the rich mortar was packed between the plate and the wooden form. The plate sometimes had a flare at the top to facilitate the introduction of the mortar, and sometimes handles were attached to aid in withdrawing it. After the plate was withdrawn the concrete and facing mortar were thoroughly tamped to secure a good union between the two.

This form of face has been abandoned because of its expense and also because of the substitution of a wet for a dry concrete which permits a different procedure.

352. Although a mortar face is now not much used for a vertical surface, it is customary to finish an exposed horizontal or nearly horizontal surface with a coating of rich mortar. The mortar should be mixed to a plastic consistency and should be put on immediately after the concrete is deposited, care being taken that the surface of the concrete is clean. The facing mortar should be 1 or 1½ inches thick, and should be troweled down hard and smooth; but excessive troweling is likely to cause innumerable hair cracks in the finished surface.

Hair cracks on the surface are due to shrinkage, and are worse the richer the face mortar, and are worse with wet than with dry concrete. These cracks are only the width and depth of a coarse hair, and do not materially weaken the concrete; but they do seriously disfigure a smooth concrete surface. Often they do not appear for several weeks after the concrete has set. Excessive troweling brings to the surface water which carries with it the most finely ground portions of the cement, and makes the surface mortar richer, and consequently increases the liability of surface cracks. These hair cracks or "map lines" or "crazing of the surface" may usually be prevented by keeping the surface wet for a considerable time.

353. Spade Finish. One of the advantages of a wet over a dry concrete is that the former will flow against the form and give a more solid surface. With plastic or wet concrete a solid surface is insured

by forcing a flat-blade spade vertically down between the concrete and the form, and then pulling the top of the spade away from the form. This forces the coarse fragments back from the face and allows the mortar to flow against the form. A perforated or a fork-like spade is sometimes used in this work.

354. Whitewash Finish. Sometimes it is desired simply to whitewash a surface to secure a uniform color, in which case the following formula may be useful. It has long been used for both inside and outside work, and gives a coating that resists wear well and that retains its brilliancy for years.

Slack with warm water half a bushel of lime, covering it during the process to keep in the steam; and strain the liquid through a fine sieve or strainer. To the slaked lime add the following: 1 peck of salt previously well dissolved in warm water, 3 pounds of ground rice boiled to a thin paste and stirred in boiling hot water, $\frac{1}{2}$ pound of powdered Spanish whiting, 1 pound of glue which has been previously dissolved over a slow fire, and 5 gallons of hot water. Stir well and let the mixture stand for a few days, covered from dirt. Strain carefully and apply hot with a brush or a spray pump. Coloring matter may be put in to make almost any shade.

355. Grout Finish. Discolorations and small honeycomb spots and the marks of the grain of the wood forms can be obliterated by applying to the surface a wash of neat portland-cement grout. The grout should be mixed to about the consistency of thick cream, and should be applied with a whitewash brush or an old broom, worked perpendicularly to the horizontal joints of the forms. The color of the finished surface will be considerably lighter if plaster of paris be substituted for about one quarter of the cement.

Of course any considerable holes in the surface should be plastered up with a 1 : 2 or 1 : 3 mortar before applying the wash.

356. Plaster Finish. When, after removing the forms, the surface of the concrete is spotted, honeycombed, and has holes in it because of the adhesion of the concrete to the forms, the attempt is sometimes made to plaster the surface with a coat of cement mortar; but it is nearly impossible to make the plaster coat adhere firmly to the set concrete. Owing to the difficulty of getting the coat to adhere, it is unwise to attempt to plaster a surface simply to improve its appearance, although a plaster coat is sometimes applied to make a wall waterproof (see § 363).

To insure a good plaster face upon the concrete stadium at Syracuse, N. Y., wire nails were driven at frequent intervals into the forms so as to project from the concrete when the forms were removed; and then after the concrete had set and the forms had been removed a washer was placed upon each projecting nail and sheets of wire

lathing were placed against the face of the concrete and fastened in position by bending down the projecting end of the nail, the washer keeping the lathing a little distance from the concrete. The plastering was then applied to the wire lathing.

357. Rubbed Surface. The following method is effective in removing the marks of the forms and is not expensive, provided it is applied while the concrete is still green, say, 24 to 48 hours old. As soon as the forms are taken down, the concrete is rubbed with a soft brick or a block of wood, taking care to use plenty of water either by dipping the brick or block into a pail of water or by throwing the water on the wall with a whitewash brush or small broom.

358. Honeycombed Surface. The purpose of the preceding methods is to secure a uniform and smooth surface; but an artistic effect can be produced by proceeding in the opposite direction. A facing 2 or 3 inches thick of dry concrete composed of 1 part cement, 3 parts of sand or screening, and 3 parts of $\frac{1}{4}$ - or $\frac{3}{8}$ -inch pebbles or broken stone may be applied by either process described in § 351. The facing should not be spaded, as it should be mixed too dry to permit any flushing of the mortar. The surface should be evenly grained and finely honeycombed, the imprint of the joints between the planks of the form should scarcely be noticed, and the grain of the wood should not show at all. There is no efflorescence on such a surface. This surface is much used in the buildings of the South Side Parks in Chicago with entire satisfaction.

359. Scrubbed Surface. A very handsome surface can be obtained by removing the forms while the concrete is still friable and scrubbing the surface with water and a brush, and then rinsing with clean water. If the scrubbing is done at the right time, the mortar may be removed to a considerable depth between the stones, giving a decided relief and producing a rough-coarse texture that is very pleasing. The appearance of the finished surface depends, of course, upon the character of the aggregate and upon the uniformity of its distribution. To secure the most artistic effect, the concrete should have a facing an inch or two thick, made with pebbles or crushed stone not exceeding $\frac{3}{8}$ or $\frac{1}{2}$ inch in greatest dimensions, the proportions being 1 : 2 : 2. The facing mixture for different portions of the structure may be made with different-colored or different-graded aggregates. The facing of fine concrete may be applied in either of the ways mentioned in § 351.

The time to be allowed for setting before scrubbing depends upon the nature of the cement and the atmospheric conditions; but with portland cement in warm weather the scrubbing can ordinarily be done easily and successfully after the concrete has set for a day, and in cold weather after it has set for a week. The cost is not great,

since if done after the concrete has set 10 or 12 hours a man can scrub 100 sq. ft. per hour with a free flow of water from a hose or a sponge; and if the concrete has set one day in warm weather, a man can finish 20 to 30 sq. ft. per hour.

If the wall to be treated is too high to be completed in one day, the face forms must be constructed so as to permit the removal of the planking at the bottom without disturbing the planking or the studding at the top. This can be done by setting the studding 8 or 10 inches away from the face and supporting the planking by small cleats nailed to the studding and to the planking—see Fig. 117, page 527, Fig. 119, page 529, Fig. 120, page 530.

360. Acid Treatment. If the concrete has set too hard to permit the application of the method described in the preceding section, the same result can be accomplished by first washing the surface of the concrete with a dilute acid, and then with an alkaline solution, and finally rinsing with clean water. This method can be applied at any time after the removal of the forms. Hydrochloric acid is preferable, and a solution of 1 part acid and 5 parts of water has been used with success.

The cost of this method of treatment is 2 to 3 cents per sq. ft., exclusive of the extra for the richer face mortar required.

361. Tooled Surface. By cutting into the body of the concrete with a pick or pointed tool, a surface roughening is produced which breaks up the light and gives a pleasing variation of shade and color. This method of finishing the surface can not ordinarily be applied to gravel concrete, as the pebbles will be dislodged before being chipped. This surface is much used by landscape architects; and is produced at comparatively small expense, since a man will dress 40 to 50 square feet of mass concrete per day.

A similar, but less pleasing, finish may be produced at a little less expense by the use of a bush-hammer. If the surface is to be picked or bush-hammered, less care need be taken with the forms, thus compensating in part for the cost of dressing the concrete.

362. Colored Facing. A colored face may be obtained by using a suitably colored aggregate or by mixing mineral pigment in the concrete. The first is the better, since it gives a durable color and does not injure either the strength or the durability of the concrete. Mineral pigments may be secured in almost any shade from any one of several well-known firms; but many of these coloring materials injure the strength of the concrete, and most of them fade in time. Directions for using the pigments may be had of the makers.

363. WATERPROOF CONCRETE. For some purposes water-tight concrete is very important, as, for example, to keep dry an inclosed space below the water level, or for tanks, aqueducts, or sewers. In

aqueducts and sewers it is required only that the leakage shall be small in comparison with the liquid conveyed; while in basements and subways it is essential not only that no water penetrate but that dampness should be prevented. In reinforced-concrete construction it is vitally important that water shall not come in contact with the steel, since it means not only the weakening of the structure by the rusting of the steel but possibly the disruption of the concrete itself, which is a still more serious matter.

The waterproof qualities of a concrete are tested either by determining the amount of water absorbed in a given time or by observing the amount of water per unit of area that flows through a given thickness in a known time under a definite head. The latter method is the better, and is the more frequently employed. For illustrated descriptions of the details of four methods of making permeability tests see: (1) Transactions American Society of Civil Engineers, Vol. lix, page 127-37; (2) Transactions American Society for Testing Materials, Vol. vi, page 334-41; (3) Bulletin No. 329, U. S. Geological Survey—Organization, Equipment, and Operation of the Structural-Materials Testing Laboratories at St. Louis, Mo.,—page 76-79; (4) *Engineering News*, Vol. xlvii, page 517-18.

364. In discussing waterproof concrete, a distinction should be made between seepage through pores and leakage through cracks due to settlement or to changes in temperature. Only the former will be discussed here, the latter being considered in § 384.

In many cases the difficulty in waterproofing is increased by the failure to provide drainage; but this phase of the subject will be considered in subsequent chapters in connection with the discussion of the different structures.

365. Porosity vs. Permeability. In this connection the difference between porosity and permeability should not be overlooked. Porosity is measured by the percentage of voids in the material, while permeability is measured by the amount of water that will pass through the material in a given time under specified conditions of thickness, area, and pressure. Porosity depends upon the amount of voids, while permeability depends upon the size of the voids and their inter-communication. The densest neat portland-cement mortar has from 40 to 43 per cent voids, but is absolutely impervious; while a 1 : 2 : 4 concrete made of well-assorted ingredients has only about 12 or 14 per cent of voids, and may be slightly permeable. In the first case, the voids are so small and so uniformly distributed that it is impossible after the mortar has set to displace the air in them by forcing in water; while in the second case, owing to the impossibility of getting a perfect mixture, the voids are larger and are inter-connected so as to permit the percolation of water.

The voids in concrete are due partly to entrained air and partly to the space occupied by the water. In dry concrete the air-filled voids are the larger, but in a wet concrete the water-filled spaces are the greater. Considerably more water is used in making concrete than is required for the chemical action in the setting of the cement, and consequently the evaporation of the water leaves the concrete porous. Portland cement requires for complete hydration from 12 to 14 per cent of its weight of water. The rate of hydration varies with the composition of the cement, its fineness, etc.; but from experiments with five brands, the author concludes that usually only about 8 to 10 per cent of water enters into combination with the cement at the end of a week. The densest 1 : 2 : 4 concrete requires water equal to about 32 per cent of the weight of the cement; and this water occupies about 12 per cent of the volume of the concrete. But as only about 8 per cent of water combines with the cement within 7 days, there remains water equal to about three fourths of 12 per cent, or 9 per cent, of the volume of the concrete to be evaporated; and consequently the water-filled pores constitute about 9 per cent of the volume of the concrete. With well-mixed wet concrete the air-filled voids do not constitute more than 1 or 2 per cent of the volume; and consequently the voids in a rich, well-graded, and thoroughly mixed concrete should not exceed more than 10 or 11 per cent.

366. METHODS OF WATERPROOFING CONCRETE. In recent years a great deal of attention has been given to methods of rendering concrete waterproof, but there is no uniformity as to the best practice. The various methods employed may be divided into four classes as follows: (1) grading the aggregate and proportioning the cement so as to secure a concrete so dense as to be waterproof; (2) mixing some substance with the concrete to make it impermeable; (3) applying a waterproof coating to the concrete after it is in place; and (4) surrounding the structure with a bituminous shield to keep the water away from the concrete. For brevity these will be designated: (1) Dense Concrete; (2) Waterproofing Ingredients; (3) Waterproof Coating; and (4) Bituminous Shield.

367. Dense Concrete. By grading the ingredients according to the ideal sieve-analysis curve (§ 302) it is possible to make concrete that is practically water-tight. The chief points to be considered in making impermeable concrete are: 1. The greater the proportion of cement the less the permeability, but in a much larger inverse ratio. If the aggregates are well graded, cement equal to from 12 to 15 per cent of the weight of the dry materials will usually give a water-tight concrete under high pressure.* 2. Gravel produces a

* Trans Amer. Soc. of Civil Engrs., vol. lix, p. 127-37.

more water-tight concrete than broken stone. 3. The larger the maximum size of the aggregate the less the permeability, although it is not so easy to get a uniform mixture with large stone as with small. 4. The finer sand grains should be slightly in excess of the proportion required by the ideal sieve-analysis curve for maximum density and strength. 5. The concrete should be mixed wet or at least so as to quake freely when tamped and so as to leave no empty pockets. 6. The concrete should be mixed very thoroughly. 7. For the best results the entire structure should be laid in one continuous operation; but if this is impracticable, particular care should be taken in joining the fresh concrete to that already set (see § 345). 8. The permeability will decrease with the time of flow, owing to the silting up of the mass by the soluble portions of the cement carried by the percolating water. 9. The permeability decreases with the age of the specimen, owing to a slight swelling of the particles of cement in hardening.

The proportions employed to prevent percolation usually are: with ordinary materials 1 : 2 : 4; and with carefully graded materials 1 : 2 : 6 or 1 : 3 : 5.

368. Troweled Finish. A particular case of the making of a concrete dense enough to resist the penetration of water, is the method of finishing the floors of basements, reservoirs, and tanks. A layer of ordinary concrete is placed, and upon it is immediately laid a coating of 1 : 1 or 1 : 2 plastic cement mortar which is then troweled. The troweling forms a rich dense film on the surface, which is nearly, if not absolutely, water-tight. This surface is frequently, but improperly, called a granolithic finish.

Obviously this method is not applicable to a vertical surface, since the forms can not be removed until the surface of the concrete is too hard to trowel. A mortar face, constructed as described in § 351, would add to the impermeability of the concrete; but there are better methods of securing the same result.

369. Waterproofing Ingredients. The principle of this method is to mix in the concrete some finely divided material which will at least partly fill the voids and thereby reduce the permeability of the concrete. There are two methods of accomplishing this result: (1) adding a single inert void-filling substance, and (2) adding one or more substances which by action upon the cement or between themselves may produce a void-filling material.

There are two distinct classes of void-filling materials: (1) those that have a capillary attraction for water, and (2) those that have a capillary repulsion for water. The first reduces permeability by obstructing the voids, while the second acts by decreasing the volume of the voids and also by its repellent action for water. Examples

of the first class of materials are lime, clay, and pozzolan cement; and of the second, wax, resin, alum and soap, and a number of proprietary articles. The difference in action between capillary attractive and capillary repellent void-filling materials seems not to have been investigated, except possibly by the originators of certain waterproofing compounds, and except as stated in § 373.

Several of the more common ingredients added to concrete to render it impermeable will be considered. Whatever the ingredient added, it should be uniformly incorporated; and the concrete should be of a plastic consistency, and should be thoroughly mixed, carefully placed, and well tamped. Waterproofing concrete, by adding void-filling materials, is proportionally more effective with lean than with rich concrete, since with the latter the cement furnishes enough fine material to fill at least the larger voids.

370. Lime. Hydrated lime (§ 107) is cheap, is easily obtained, is in fine particles, and is easy to mix with the concrete; and therefore it is an excellent material for reducing the permeability of concrete. Experiments* show that hydrated lime in the following percentages renders concrete made with the usual materials practically water-tight under a pressure of 60 pounds per square inch: for a 1 : 2 : 4 concrete add dry hydrated lime equal to 8 per cent of the weight of the dry cement, for a 1 : 2½ : 4½ concrete add 12 per cent, and for a 1 : 3 : 5 concrete add 16 per cent. Smaller per cents give satisfactory results under smaller pressures. Lime is more effective to resist low pressures than high. This use of lime is most advantageous with lean concrete, and in localities where cement is unusually high-priced. Lime has a capillary attraction for water.

Slaked lime is equally as good as hydrated except for the difficulty of getting it evenly distributed throughout the concrete.

371. Pozzolan Cement. Pozzolan cement (§ 122-24) being largely composed of lime acts substantially the same as lime in making concrete water-tight, except that lime adds practically nothing to the strength of the concrete while pozzolanic material adds considerable strength. Since pozzolan cement is not plentiful (§ 123), this method of making concrete waterproof is not of much practical importance. However, pozzolanic material is specially valuable for waterproofing concrete to be exposed to sea water, since it is not acted upon by the sulphates in the sea water (§ 391).

372. Clay. It has long been known that the addition of clay in a finely divided state materially increases the water-tightness of concrete. Clay is ineffective with rich well-proportioned concrete, since the cement furnishes sufficient fine material to fill the voids; but with lean concretes 10 to 15 per cent of finely divided clay,

* By S. E. Thompson, *Engineering-Contracting*, vol. xxx, p. 42-43.

either added directly or by the substitution of a dirty for a clean sand, increases the water-tightness without materially decreasing the strength. In this connection see § 189. It would not be easy to add clay directly; but the clay naturally in a gravel may materially affect the waterproof quality of the concrete.*

Clay has a capillary attraction for water, which is an undesirable quality for a waterproofing material.

373. Alum and Soap. These materials have been used for more than sixty years as washes for rendering masonry impervious to water (see § 642); and in recent years they have frequently been used as ingredients of concrete to make the entire mass impervious. The alum in the form of a fine powder may be mixed with the cement, and the soap may be dissolved in the water used in mixing the concrete; or both the alum and the soap may be dissolved in the water. In the latter case the water must be frequently stirred to prevent the compound from accumulating in large masses on the surface of the water which it is not easy to break up. Since the alum is the more soluble, it may be dissolved in, say, one fifth of the water and the soap in the remaining four fifths, and then the two portions may be mixed, being careful to stir the water as the mixing progresses. The alum and the soap combine and form a flocculent, insoluble, water-repelling compound. This capillary repellent compound not only partially fills the voids and thereby decreases the permeability of the concrete, but also by its water-repelling property still further decreases the permeability.

The best proportions are: alum 1 part and hard soap 2.2 parts, both by weight. Soap varies in its chemical composition and particularly in the water it contains; but the above proportions are the chemical combining weights for alum and the best hard soap, and are sufficiently exact for any good well-seasoned hard soap. Any reasonably pure soap will do, but if soft soap is used, a greater amount should be employed according to the amount of water in it. Soft soap contains from 50 to 90, or even 95, per cent of water. An excess of alum does no harm, since alum is itself a fair waterproofing material; but an excess of soap is better than an excess of alum, since the excess soap will unite with the free lime of the cement and form calcium soap—a finely divided, water-repelling compound (§ 375). The above is the reason why widely divergent proportions of alum and soap have given fairly successful results in practice.

The amount of alum and soap to be used is limited practically to alum equal to $1\frac{1}{2}$ per cent of the water and soap equal to 3 per cent,

* For a new and interesting explanation of possibly a heretofore unrecognized action of clay with cement, see an article by R. H. Gaines, *Trans. Amer. Soc. of Civil Engr's.*, vol. lix, (1907), p. 159-69; or *Engineering News*, vol. lviii, p. 344-46.

because it is impossible to dissolve more than about 3 per cent of hard soap in cold water. Of course, if it is desired to use greater amounts, the soap may first be dissolved in hot water which may afterwards be mixed with a larger portion of cold water. The above amounts of alum and soap will produce 3 per cent of dry water-repelling compound; and this is enough to render any reasonably dense concrete practically, if not absolutely, water-tight. In a series of tests by the author,* 1.3 per cent of the alum and soap compound incorporated in a cement mortar having 23.8 per cent of voids reduced the percolation to one third of that of similar, untreated mortar; in other words, alum and soap compound equal to about one twentieth of the voids in a lean and porous mortar stopped two thirds of the percolation. This seems to show that the alum and soap compound in mortar or concrete acts like oil on the wires of a moderately fine sieve, i.e., prevents percolation chiefly by its water-repelling properties, rather than as a mere void-filling material.

The addition of the alum and soap weaken the mortar, 2 per cent of the compound decreasing the strength about 20 per cent, varying a little with the method of storage.

374. Instead of using alum and soap as above, it is better to use aluminium sulphate (sometimes, but improperly, called alum) and soap. The aluminium sulphate is cheaper than alum, and only two thirds as much of it is required to produce substantially the same amount of void-filling material as the alum and soap. The best proportions are 1 part aluminium sulphate to 3 parts of hard soap. As in the preceding case an excess of either ingredient does no harm, although an excess of soap is better than a deficiency.

375. *Lime and Soap.* Lime and soap combine to form calcium soap, a finely divided water-repelling compound; and hence another method of rendering mortar or concrete waterproof is to incorporate lime and soap in it. The proper proportion is unslaked lime 1 part and hard soap 12 parts; and, since it is impossible to dissolve more than about 3 per cent of hard soap in cold water, the amounts to be used in practice are unslaked lime 0.25 per cent and hard soap 3 per cent of the weight of the water, and these amounts will give 2.7 per cent of void-filling compound. These quantities will make any reasonably good concrete absolutely water-tight. Before the water containing the soap and lime is used, it should be stirred to mix the ingredients and to keep the precipitate in suspension. Calcium soap is a product in the manufacture of candles; and hence if a considerable amount of concrete is to be waterproofed, as in the construction of a long aqueduct, it might be wise to buy the calcium soap and add it directly to the cement.

* The Technograph, University of Illinois, No. 23 (1909), p. 49-54.

Calcium soap is formed, if an excess of soap is added in the alum and soap compound, provided the cement contains any free lime—as it usually does. Apparently calcium soap is the essential element of several proprietary waterproofing compounds.

376. Proprietary Compounds. There are upon the market several proprietary compounds to be mixed with the concrete to make it impervious. Some are liquid to be added to the water used in mixing the concrete; some are powders to be mixed with the dry cement; some are sold mixed with the cement ready for use; and some are not sold but are applied by the proprietors. Only a comparatively small proportion of each is required to make ordinary mortar or concrete waterproof. It is not proved that they are any more effective than some of the means previously described.

377. Other Ingredients. There are several other materials that may be used to make concrete impervious; but none of them is as cheap or as effective as those previously mentioned. Among these are: alum alone, aluminium sulphate alone, wax, resin, paraffine, stearic acid, and oil emulsion.

Alum and lye are sometimes recommended; but cement is sometimes destroyed by contact with alkaline water, and therefore the lye may injure the cement.

378. Waterproof Coatings. Under this head will be discussed all coatings applied to the surface of the concrete after it has set. Such coatings range from a wash to a plaster.

379. Alum and Soap Washes. The oldest, the best known, and probably the most effective method of rendering set concrete waterproof is to apply alternate washes of soap and alum solutions. This is the well-known Sylvester method of making masonry impervious. The alum and soap combine, and form an insoluble compound in the pores of the concrete. The alum solution is made by dissolving 1 pound of alum per gallon of water, and the soap solution by dissolving 2.2 pounds of hard soap per gallon of water. For information concerning the necessary accuracy of proportions, see § 373. The concrete should be clean and dry, and not colder than about 50° F. The soap wash should be applied boiling hot, but the alum solution may be 60° to 70° F. when applied. One wash should be put on and allowed to dry—usually for 24 hours,—when the other is applied. The solutions should be well rubbed in, but care should be taken not to form a froth. Two pairs of coats of the above solutions will usually make any fairly good concrete practically impervious under moderate pressures; and eight pairs of coats have made leaky concrete impervious under a head of 100 feet.

Instead of using alum and soap as above, it is both cheaper and

more effective to substitute aluminium sulphate for the alum (see § 374).

380. Grout Wash. A cream of neat cement spread on with a whitewash brush is quite effective, if well rubbed in. One or two coats will make ordinary concrete practically impermeable under a 10-foot head of water. The grout wash is most effective if it is put upon the water side of the concrete.

381. Other Washes. Any of the materials mentioned in § 377 may be used as a wash; but they are more expensive and not as effective as the alum and soap or as the grout wash. The surface of the concrete is sometimes painted with linseed oil. Most, if not all, of the proprietary compounds (§ 376) may be used as a wash as well as an ingredient to be mixed in the concrete. Sodium silicate ("soluble glass") and also paraffine dissolved in naphtha are sometimes used, but both are more expensive and no more effective than the alum and soap or the grout washes.

382. Waterproof Plaster. Very frequently the attempt is made to waterproof a concrete or masonry wall by applying an impervious plaster. The plaster is made waterproof by the use of the alum and soap mixture or some of the proprietary compounds. The proportions of the plaster coat are usually 1 part cement to 2 or 3 parts of sand. It is usual to apply a 1-inch coat to floors and a $\frac{3}{4}$ -inch coat to vertical surfaces.

The difficulty is to make the plaster stick (see § 356). The wall should be thoroughly cleaned before the coating is applied, and the plaster should be troweled with considerable pressure; and if the wall is under water, the pressure should be relieved by drainage or by pumping until the plaster has set.

Most failures with this method of waterproofing occur because the wall was not absolutely clean. The plaster can usually be made to adhere if the concrete wall is thoroughly and repeatedly washed with water; but if the wall has a dense hard surface of nearly neat cement, it may be necessary to wash it with dilute hydrochloric acid to dissolve out the cement and roughen the surface. Of course the acid must be thoroughly washed off. A coat of ordinary whitewash, or a layer of laitance, or an almost invisible film of the oil or grease used to keep the concrete from sticking to the forms, will keep the plastering from adhering unless they are scrupulously removed.

Sometimes the surface is cleaned and then covered with a coat of tar; and while the tar is still tacky, the impervious plaster is troweled on. The tar should be made thick by boiling and should be applied very hot, when it will adhere to the smoothest surface. The tar could be used alone, if it were not for its color and if it did not become brittle by oxidation.

383. Asphalt Coating. Where its color is not objectionable, asphalt is sometimes used to make concrete or masonry water-tight. The asphalt should not flow at 180° to 200° F., and should not be brittle at 0° F. The surface of the concrete should be dry and warm, or should first be coated with paint made by dissolving asphalt in naphtha. The asphalt should be heated to about 450° F. but not more, and should be applied without unnecessary cooling.

384. Bituminous Shield. This method of making concrete waterproof consists in surrounding the structure with an impervious shield which keeps the water away from the concrete; and hence, strictly speaking, is not a method of rendering concrete impervious. The waterproof diaphragm consists of several, usually four or more, thicknesses of tarred paper or felt (usually the former) cemented together and covered with tar. Of course, the several sheets should break joints, and every precaution should be taken to make the shield continuous and to prevent its being punctured during subsequent building operations.

Sometimes the shield is put outside of the wall, in which case it is usual to protect it by building a brick wall against it. With this construction, if, after the building is completed, the diaphragm is not water-tight, as is frequently the case owing to imperfect workmanship or to its having been punctured, it is sometimes necessary to tear out a considerable portion of the original wall to discover and stop the leak; and hence the water-tight shield is sometimes placed on the inside of the main wall and a brick protecting wall is built inside of the waterproof diaphragm, so that if repairs of the waterproofing are required it is necessary to tear down only the lighter protecting wall. However, other things being the same, such a shield is most effective on the outside.

The objection to this method is its relatively great cost and the amount of space it occupies; and the advantage claimed for it is that the water-tightness of the diaphragm is not affected by the cracks in the wall due to settlement or to expansion and contraction.

385. CONTRACTION JOINTS. Concrete is usually laid in warm weather, and consequently in cold weather contraction cracks are likely to appear in thin walls of any considerable length, since the resulting stress is greater than the tensile resistance of the concrete; and unless care is taken to confine these cracks to straight lines by proper contraction joints, they may seriously disfigure the face of the work. Concrete laid in cold weather is likely to expand during warm weather; but this usually does no harm, since concrete is better able to resist compression than tension. Again, concrete which sets in air shrinks 0.0003 to 0.0005 per unit of length, and that which sets in water swells 0.0002 to 0.0005, the change being greater the richer the

concrete. Air-hardened concrete swells when immersed in water, and water-hardened concrete shrinks when exposed to the air. Further, the cracking of large masses of concrete is sometimes due, at least in part, to the cooling of the cement after the rise of temperature caused by the chemical action of setting (see § 348).

Therefore, for these three reasons, it is customary to provide contraction joints at intervals in concrete structures, or to reinforce the concrete with sufficient steel to enable the structure to withstand the tensile stress produced by the contraction. The method of preventing contraction cracks by reinforcing the concrete will be considered in the next chapter.

Another advantage of dividing a continuous wall into sections by vertical joints is that each section can be built by itself with a minimum liability of unsightly horizontal seams between different days' work.

386. Distance Apart. Contraction joints in floors exposed to the weather, sidewalks, curbs, etc., are usually not more than 5 or 6 feet apart; but for thicker construction they can be much farther apart, since the temperature of the interior of a large mass of concrete is not much affected by external temperature changes. It is customary to build retaining walls and bridge abutments with vertical contraction joints 25 to 50 feet apart, the distance varying according to the thickness of the wall; and sewers and culverts, which are less exposed to changes of temperature, with joints 60 to 75 feet apart.

387. How Made. Vertical contraction joints are made in three ways, viz.: (1) planes of weakness, (2) tongue-and-groove joints, and (3) dowel joints.

1. Planes of weakness are made by building a temporary partition in the form, and casting the section thus enclosed as a single mass. When the concrete is set, the partition is removed and the new concrete is deposited against the old without any attempt to secure a bond between the new and the old, thus leaving a vertical plane of cleavage between the adjacent sections. To mask the ragged appearance of the joint, sometimes a triangular strip is nailed to the form where the partition joins the face of the form in such a manner as to leave a vertical triangular groove in the face of the wall with the plane of the contraction joint passing through its apex. Sometimes a sheet of tarred paper is placed in the joint between the sections to prevent a possible adhesion of the new to the old concrete.

2. A tongue-and-groove contraction joint is made by placing vertically against the face of the temporary partition or bulkhead a triangular or rectangular or U-shaped timber which forms a vertical groove in the end of the first section of the concrete into which the concrete of the second section is built, thus forming a concrete

tongue. The advantage of the tongue-and-groove joint over the plane of weakness is to strengthen the wall against a lateral thrust applied near the joint.

3. A dowel contraction joint is frequently employed by railroads, and is made by inserting a short piece of railroad rail in the end of a section of a retaining wall and allowing the rail to project a short distance; and then when the second section is to be built against the first, the projecting ends of the rails are wrapped with paper or coated with soap or axle-grease to prevent the adhesion of the concrete. The projecting rails bind the two sections together laterally, but the concrete in the last-laid section is free to slip on the rails with temperature changes.

388. EFFLORESCENCE. This is a white powder on the face of masonry, due to the soluble salts in the mortar or concrete being dissolved by the percolating water and being deposited upon the surface when the water evaporates, which frequently disfigures the face of concrete walls. Efflorescence is most likely to occur below the horizontal joints and is particularly noticeable just below the horizontal seam between two successive days' work. The reason for this is as follows: The concrete is placed in layers, and if it is laid dry and tamped, the top surface will be richer and denser, and consequently will stop any percolating water and divert it to the surface of the wall; and this impervious film is more marked between the concrete laid on succeeding days, because the top surface of the set concrete is usually treated with a rich mortar to insure a good bond (§ 345). Efflorescence appears upon concrete which has been built without stopping work at night and which has been puddled in and not tamped in layers. It appears particularly after a period of wet weather, owing to the saturation of the face of the concrete with water which dissolves the soluble salts and later deposits them upon the face of the wall. Efflorescence usually occurs in irregular patches, since in even the best work different portions of the concrete have different densities owing to their being richer, or containing more or less water, or being tamped more or less severely. Different cements contain different proportions of soluble salts, and hence give different amounts of efflorescence.

389. There are three methods of preventing or at least of decreasing efflorescence, as follows:

1. Use a cement that has little or no soluble salts in it. There are cements upon the market which are almost entirely free from soluble salts (sulphates and chlorides), and which cause little or no efflorescence.

2. Incline the top surface of all layers, particularly the last one laid each day, toward the back of the wall so the soluble salts will be

carried toward the back instead of toward the face of the wall; but this remedy is not applicable with wet or at least with sloppy concrete, unless the last concrete laid at night is mixed drier to permit of thus sloping the surface. If the back of the wall is stepped, as is common in bridge abutments and retaining walls, the top of the step should be given a flat downward slope away from the body of the wall, to prevent pools of water from standing on the top of the step and soaking into the body of the concrete.

3. Make the concrete waterproof, since if the water is kept out it will not dissolve the salts, and consequently efflorescence will be prevented. For a discussion of the several ways of making concrete impervious, see § 363-83; and for a method of rendering the efflorescence almost invisible, see § 643.

390. Efflorescence is partially removed by the wind and the rain, and can be entirely removed by scrubbing the surface with dilute hydrochloric acid; but it may return. This scrubbing process is expensive in brushes, acid, and time.

391. CONCRETE IN SEA WATER. The action of sea water upon cement and concrete is not well understood. However, it has been established that under certain conditions concrete is nearly sure to fail, while under other conditions it will probably withstand the action of sea water at least for a considerable time. It is certain that cement which contains a comparatively high per cent of lime, alumina, or gypsum, is dangerous for use in sea water, since the salts in the sea water combine with these elements and form compounds which swell and ultimately destroy the mortar or concrete. Apparently the indirect action of the sulphates in sea water upon the free lime in the cement is the most active cause of disintegration. It is certain that a dense concrete withstands the action of sea water better than a porous mixture, and that, other things being the same, concrete made with fine sand is more durable than that made with coarse sand. Sea water carrying silt is not as destructive as clear sea water, apparently because the silt closes the pores of the concrete and makes it less permeable. Waterproofing the concrete would doubtless increase its resistance to the disintegration by sea water; but neither clay (§ 372) nor alum (§ 377) should be used for this purpose, since alumina increases the destructive action of sea water. It is claimed that iron-ore cement (§ 114) is not affected by sea water.

392. EFFECT OF ALKALI ON CONCRETE. Recently attention has been called to the fact that the natural alkali waters of the western part of this country seem to have a disintegrating effect upon concrete.* Neither the cause of this action nor the remedy is yet clearly

* Bulletin No. 69, Montana Agricultural College Experiment Station; and *Trans. Amer. Soc. for Testing Materials*, vol. viii (1908), p. 484-93.

established; but apparently the action of alkali water is due to the indirect effect of the soluble sulphates upon the free lime in the cement, and apparently the damage is most serious on surfaces situated between high and low water. The remedy seems to be to use sand free from soluble salts, and either to make a concrete so dense that it will be practically waterproof or to protect the concrete by waterproofing it (§ 366). It is probable that iron-ore cement (§ 114) will resist the action of alkali water.

393. EFFECT OF OIL ON CONCRETE. Until recently it has generally been believed that oil had no harmful effect upon cement and concrete; but it has recently been discovered that at least some animal and vegetable oils contain acids which combine with the lime of the cement and form compounds which by their expansive action disintegrate cement mortar and concrete.* Mineral oils produce no harmful effect.

This effect of oil is not very serious, since ordinarily concrete is seldom subjected to large doses of any kind of oil, much less animal or vegetable oils containing harmful acids. The damage is less the denser the concrete, and the longer it has set. Neither the alum and soap washes nor a coat of paraffine or linseed oil or sodium silicate protects the concrete against the disintegrating effect of oil

ART. 5. STRENGTH, WEIGHT, AND COST OF CONCRETE.

394. STRENGTH. The strength of concrete depends upon the kind and amount of the cement, the kind and size of the aggregate, the proportions, the grading of the aggregate, the amount of water, the thoroughness of the mixing, the amount of tamping, the age of the concrete, and the conditions under which the concrete seasons. The strength of the concrete varies greatly with its density, which depends chiefly upon the grading of the aggregate, the wetness of the concrete and the amount of tamping—elements, the importance of which have only recently been recognized, and consequently the reports of many experiments contain no information on these important factors. This incompleteness of the reports of most experiments is because tests are usually made to determine only the effect of a variation in some one factor in the manufacture of concrete; and as the other factors are the same in all the experiments of the series, little or no information is given concerning them, and consequently the results are usually valuable only for the one purpose for which the experiments were made. This probably explains the wide variation sometimes found between results of apparently similar experiments.

Formerly, when only massive plain concrete was used, the compressive strength alone was regarded as important; but since the

* *Engineering News*, vol. liii, p. 279-82

introduction of reinforced concrete, the transverse and the shearing strength have become of interest. A few data will be given concerning the compressive, transverse, and shearing strengths of plain concrete.

395. COMPRESSIVE STRENGTH OF STONE CONCRETE. The results of experiments to determine the crushing strength vary materially with the form of the test specimen and also with the condition of the pressed surface. Usually the test specimen is a cube, but occasionally prisms much taller than broad have been used. The latter give much smaller results than the former. The smoothness of the pressed surface materially affects the results for compressive strength, and unfortunately there is no agreement as to the method of preparing the surface. Probably the best method is to give the surface a coat of neat cement paste or of plaster of paris, and turn it upside down upon a sheet of plate glass. If there is plenty of time for the cement to set, it is more scientific to use the cement; but the plaster of paris is more commonly used, because of its more rapid set.

396. Dow's Experiments. Table 29 shows the results of a series of experiments made by A. W. Dow, Inspector of Asphalt and

TABLE 29.

CRUSHING STRENGTH OF NATURAL- AND PORTLAND-CEMENT
CONCRETE, IN POUNDS PER SQUARE INCH

REF. No.	COMPOSITION OF CONCRETE BY VOLUMES LOOSE.				VOIDS IN AGGREGATE.		AGE OF CUBES WHEN BROKEN.				
	Mortar.		Aggregate. Sizes from $2\frac{1}{2}$ " to $\frac{1}{8}$ ".		Per Cent of Volume.	Per Cent of Voids filled with Mortar.	Ten Days.	Forty- five Days.	Three Mos.	Six Mos.	One Year.
	Ce- ment.	Sand.	Broken Stone.*	Gravel.							
Natural Cement.											
1	1	2	6	45.3	83.9	228	539	375	795	915
2	1	2	6†	45.7	83.9	596	829
3	1	2	6‡	39.5	96.2	800
4	1	2	6	29.3	129.1	87	421	361	344	763
5	1	2	3	3	35.5	107.0	108	364	593	632	841
6	1	2	4	2	37.8	100.6	915
Portland Cement.											
7	1	2	6	45.3	83.9	908	1 790	2 260	2 510	3 060
8	1	2	6†	45.7	83.9	1 630	1 530	1 850
9	1	2	6‡	39.5	96.2	2 700
10	1	2	...	6	29.3	129.1	694	1 630	2 680	1 840	2 820
11	1	2	3	3	35.5	107.0	950	1 850	2 070	2 750
12	1	2	4	2	37.8	100.6	2 840

* Gneiss. † Coarse. ‡ Three fourths ordinary stone, one fourth granolithic.

Cement, Washington, D. C.* Each result is the mean of two 1-foot cubes, except those for one year, which are the mean of five. Owing to the friction of the hydrostatic press with which the tests were made, the results are 3 to 8 per cent too high. With the natural cement the water used was 0.317 cu. ft. (20 lb.) per cu. ft. of rammed concrete, and with portland cement 0.24 cu. ft. (12 lb.)—in both cases including the moisture in the sand. The sand contained 4.4 per cent of water, which increased the volume of the sand and made the mortar slightly richer than as stated.

397. Rafter's Experiments. Mr. George W. Rafter, under the direction of the State Engineer of New York, tested 542 1-foot cubes of concrete in which five brands of portland cement and one of natural were used.† The sand was pure, clean, sharp silica, containing 32 per cent of voids. The aggregate was sandstone broken to pass a 2-inch ring, and had 37 per cent voids when tamped. In half the blocks the mortar was a little more than enough to fill the voids; and in the other half the mortar was equal to about 80 per cent of the voids.

In making the cubes whose strength is summarized in Table 30, three brands of portland cement were used which meet the specifications of Table 13, page 81. The mortar for these cubes was mixed as "dry as damp earth," and the test specimens were stored under water for four months and then buried in sand. The age when tested ranged from 550 to 650 days, the average being about 600.

TABLE 30.
CRUSHING STRENGTH OF PORTLAND-CEMENT AND BROKEN-STONE
CONCRETE.

Voids of broken stone nearly filled with mortar—see § 397.
Age when tested 600 days.

REF. No.	COMPOSITION OF THE MORTAR.		NO. OF CUBES TESTED.	MEAN CRUSHING STRENGTH.	
	Cement.	Sand.		Lb. per Sq. In.	Tons per Sq. Ft.
1	1	1	3	4 467	322
2	1	2	6	3 731	268
3	1	3	6	2 553	184
4	1	4	6	2 015	145
5	1	5	2	1 796	129
6	1	6	1	1 365	98

* Report of the Operations of the Engineering Department of the District of Columbia for the year ending June 30, 1897, p. 160-66.

† Tests of Metals, etc., Watertown Arsenal, 1898, p. 415-560; or Report of the New York State Engineer, 1897, p. 375-460; or Trans. Amer. Soc. of C. E., vol. xlii, p. 104-54.

The cubes were crushed on the U. S. Watertown Arsenal testing machine. The individual results agreed well among themselves.

The cubes summarized in Table 30 were stored under water. An equal number of companion blocks stored in a cool cellar gave 82 per cent as much strength; those fully exposed to the weather, 81 per cent; and those covered with burlap and wetted several times a day for about three months and afterwards exposed to the weather, 80 per cent.

The cubes of Table 30 were mixed as "dry as damp earth." Companion blocks, of which the mortar was mixed to the "ordinary consistency used by the average mason," gave 90 per cent as much strength; and those mixed to "quake like liver under moderate ramming," 88 per cent.

The cubes containing mortar practically equal to the voids in the broken stone were 3 per cent stronger than those containing mortar equal to about 80 per cent of the voids.

398. Kimball's Experiments. Mr. George A. Kimball, Chief Engineer of the Boston Elevated Railway Co., made 372 1-foot concrete cubes which were tested at the U. S. Arsenal at Watertown, Mass.* The results are summarized in Table 31. The mixing of

TABLE 31.

CRUSHING STRENGTH OF PORTLAND-CEMENT AND BROKEN-STONE CONCRETE.

Results are in pounds per square inch.

REF. No.	PROPORTIONS.			AGE WHEN TESTED.			
	Cement.	Sand.	Stone.	One Week.	One Month.	Three Months.	Six Months.
1	1	0	2	3 068	3 534	4 178	5 231
2	1	2	4	1 543	2 416	2 896	3 827
3	1	3	6	1 379	2 158	2 588	3 110
4	1	6	12	591	993	1 112	1 366

the concrete for the test specimen was done as nearly as possible like that of the concrete which went into actual construction. The consistency was such that with the richer mixtures water barely flushed to the surface under severe ramming, while with the leaner mixtures the surface merely appeared moist. The cubes were stored

* Tests of Metals, etc., Watertown Arsenal, 1899, p. 719-834.

in a room the temperature of which was usually about 40° F., although it ordinarily varied from 28° to 50° and twice fell to 20°. When the temperature of the room was below 32° the cubes were covered with burlaps. Five different brands of portland cement were used. In the first line of the table, each result is the mean of fourteen tests, and in the remainder of the table each result is the mean of twenty-six.

399. Other Results. For additional data on the crushing strength of gravel concrete, see Table 26, page 141; and for data on the strength of gravel and broken-stone concrete, see Fig. 11, page 140.

400. Compressive Strength for Different Proportions. M. Feret, the noted French authority, as a result of an elaborate study of the

TABLE 32.

COMPRESSIVE STRENGTH OF PORTLAND-CEMENT CONCRETE OF VARIOUS PROPORTIONS.

Results are in pounds per square inch.

PROPORTIONS.			AGE 1 MONTH.					AGE 6 MONTHS.				
Cement.	Sand.	Stone.	50% Voids, Screened Stone.	45% Voids, Crusher- Run Stone.	40% Voids, Bank-Run Gravel.	30% Voids, Graded Mixture.	20% Voids, Graded Mixture.	50% Voids, Screened Stone.	45% Voids, Crusher- Run Stone.	40% Voids, Bank-Run Gravel.	30% Voids, Graded Mixture.	20% Voids, Graded Mixture.
1	1½	2	2 880	2 860	2 840	2 800	2 760	3 890	3 870	3 840	3 780	3 730
		3	2 780	2 750	2 720	2 670	2 610	3 750	3 710	3 680	3 600	3 530
		4	2 680	2 650	2 610	2 540	2 460	3 620	3 570	3 520	3 430	3 330
1	2	3	2 560	2 540	2 510	2 460	2 410	3 460	3 420	3 390	3 320	3 250
		4	2 480	2 440	2 410	2 350	2 290	3 340	3 300	3 250	3 170	3 090
		5	2 400	2 350	2 310	2 230	2 170	3 230	3 180	3 120	3 010	2 930
		6	2 320	2 260	2 230	2 140	2 060	3 130	3 060	3 010	2 890	2 780
1	2½	3	2 370	2 340	2 320	2 270	2 230	3 200	3 160	3 130	3 070	3 020
		4	2 290	2 260	2 230	2 180	2 110	3 090	3 050	3 010	2 940	2 850
		5	2 210	2 180	2 130	2 070	2 000	2 980	2 940	2 880	2 790	2 700
		6	2 140	2 100	2 060	1 980	1 910	2 890	2 830	2 780	2 670	2 570
1	3	4	2 120	2 090	2 060	2 020	1 970	2 860	2 830	2 780	2 720	2 660
		5	2 060	2 030	1 990	1 930	1 870	2 780	2 740	2 690	2 610	2 530
		6	1 990	1 950	1 910	1 840	1 770	2 680	2 630	2 580	2 480	2 390
		8	1 860	1 810	1 770	1 680	1 600	2 510	2 440	2 390	2 280	2 160
1	4	6	1 710	1 680	1 650	1 590	1 530	2 310	2 270	2 220	2 140	2 070
		7	1 660	1 620	1 590	1 530	1 460	2 240	2 190	2 150	2 060	1 980
		8	1 610	1 570	1 530	1 460	1 400	2 170	2 120	2 070	1 970	1 880
		10	1 510	1 460	1 420	1 340	1 260	2 040	1 980	1 920	1 810	1 700
1	5	10	1 310	1 270	1 230	1 160	1 090	1 770	1 720	1 660	1 570	1 470
1	6	12	1 060	1 020	980	910	840	1 430	1 380	1 320	1 230	1 140

compressive strength of mortars, established the following principle: "For any series of plastic mortars made with the same binding material and inert sands, the resistance to compression after the same length of set under identical conditions, whatever may be the nature and size of the sand and the proportions of the elements of which each is composed, is solely a function of the ratio $\frac{c}{w+a}$ or $\frac{c}{1-(c+s)}$, in which c =the absolute volume of the cement in a unit of volume of concrete, s =the absolute volume of the sand, w =the absolute volume of the water voids, and a =the absolute volume of the air voids." Taylor and Thompson* modified this principle to make it applicable to concrete, and from the results of various experiments deduced a formula by which, knowing the compressive strength of any one proportion, the approximate compressive strength of any other proportion can be computed. By this method the above authors prepared Table 32, which shows the relative compressive strength of portland-cement concrete of different proportions at one month and at six months. Notice that the broken stone or gravel having the greatest per cent of voids gives concrete of the greatest strength. This anomaly is due to the fact that the broken stone having the greatest per cent of voids requires the greatest amount of cement per unit of volume of concrete, and the greater amount of cement has more influence in increasing the strength than the greater per cent of voids has in decreasing it.

401. Increase of Compressive Strength with Age. Messrs. Taylor and Thompson in the investigation referred to in the previous paragraph deduced† the ratios shown in Table 33 which are useful in determining the effect of age upon the compressive strength of concrete. Of course such results can be only approximate in any

TABLE 33.

EFFECT OF AGE ON THE STRENGTH OF PORTLAND-CEMENT CONCRETE.

REFERENCE NUMBER.	AGE OF THE CONCRETE.	RELATIVE COMPRESSIVE STRENGTH.
1	7 days.	0.76
2	1 month.	1.00
3	3 months.	1.25
4	6 months.	1.35
5	1 year.	1.44

* Taylor and Thompson's Concrete Plain and Reinforced, ed. 1905, p. 237-44.

† *Ibid.*, p. 241.

particular case, owing to the difference in the conditions between the case in hand and the experiments from which the ratios were deduced.

402. Crushing Strength under Concentrated Load. All the preceding results for the crushing strength are for a compressive force applied over the entire upper surface of the test specimen; but if the load is applied upon only the central portion of the upper surface, a greater unit load will be required to crush the specimen, because the outer portions will support the interior portion and materially increase the crushing resistance of the specimen.

In a series of experiments,* thirty-six 12-inch cubes of 1 : 0 : 2 and 1 : 2 : 4 concrete were crushed at different ages by applying the load over the entire upper surface of the cube, and the same number of companion cubes were crushed by applying the pressure over an area of 10 by 10 inches, and a third set by applying the stress over an area of 8 by 8.25 inches. The second series gave a strength per unit of loaded area 112 per cent of the first, and the third 128 per cent. Different ages or different proportions seem to make no difference in the above per cents.

For additional data concerning the difference between a distributed and a concentrated load, see § 657.

403. Safe Crushing Strength. The safe crushing strength depends upon the character and the age of the concrete and upon the method of applying the load—whether distributed or concentrated. The results of laboratory tests are higher than is likely to be realized in actual practice, because of the difference in the conditions under which the work is done. For this reason it is not wise to assume that the ultimate crushing strength of a 1 : 2 : 4 portland-cement concrete made under reasonably good working conditions is more than about 2,000 pounds per square inch at 30 days; and for other proportions this value may be reduced according to the ratios in Table 32, page 198, and for other ages it may be increased according to the quantities given in Table 33, page 199. In any important work the strength should be determined for the actual conditions under which the concrete is to be used. On account of the difficulty of securing uniformity in concrete work, it is customary to assume a comparatively large factor of safety.

Table 34 gives the values of the safe crushing strength of a 1 : 2 : 4 portland-cement concrete made where the materials and workmanship are carefully inspected. If good materials and careful workmanship are not assured, smaller values should be chosen. Values for other proportions and other ages can be deduced from those given in Table 34 by applying the ratios of Tables 32 and 33, pages

* Tests of Metals, 1899, p. 734-40.

TABLE 34.

MAXIMUM SAFE CRUSHING STRENGTH OF A GOOD 1 : 2 : 4 PORTLAND-CEMENT CONCRETE 1 MONTH OLD.

REF. No.	METHOD OF APPLYING THE STRESS.	LB. PER Sq. IN.	TONS PER Sq. FT.
1	Bearing of steel on concrete where the width of the bearing area is not more than 50 per cent of the width of the upper face of the concrete.....	1 000	72
2	Bearing of bridge seat subject to shock	500	36
3	Bearing on mass concrete and in column pedestals 2 ft. square or over	700	50
4	Maximum compressive stress in reinforced concrete beams or on the toe of dams, retaining walls, etc.	600	43
5	Direct compression on thin plain-concrete walls or plain-concrete columns whose length does not exceed twelve diameters	400	29

198 and 199, respectively. The dimensions of a massive concrete structure seldom depend upon the strength of the concrete. For example, the dimensions of a concrete foundation are determined by the bearing power of the soil; and many times a richer mixture is employed than is necessary to support the load—sometimes to secure a water-tight foundation, sometimes to secure resistance to frost, but often through ignorance or indifference. But in the design of reinforced concrete buildings the crushing strength of the concrete is an important factor; and a rich mixture is preferred not only because of its greater strength, but also because it insures greater adherence to the steel, makes possible the earlier removal of the forms and their earlier use elsewhere, and gives greater security against inferior sand and imperfect mixing. The cost of the additional cement is not a very large per cent of the total cost of the building.

404. CRUSHING STRENGTH OF CINDER CONCRETE. Table 35, page 202, is the summary of fifty-two tests of portland-cement cinder-concrete cubes.* The cinders were used as they came from the furnace without sifting, the larger clinkers only having been broken.†

* Tests of Metals, etc, Watertown Arsenal, 1898, p. 415, 417, 561-72; 1903, p.547 1904, p. 340.

† Tests of Metals, 1899, p. 734-40.

TABLE 35.
COMPRESSIVE STRENGTH OF PORTLAND-CEMENT AND CINDER
CONCRETE.

REF. No.	PROPORTIONS BY VOLUMES.			CRUSHING STRENGTH, POUNDS PER SQUARE INCH.	
	Cement.	Sand.	Cinders.	One Month.	Three Months.
1	1	1	3	1 686	2 417
2	1	2	4	1 343	1 328
3	1	2	5	687	1 302
4	1	3	6	823	788

405. TENSILE STRENGTH OF CONCRETE. A knowledge of the tensile strength of concrete is much less important than that of its compressive strength, for in massive construction the tensile strength is of no importance, and in the construction of slabs, beams, and girders no dependence is placed upon the tensile strength of concrete

TABLE 36.
TENSILE STRENGTH OF CONCRETE.

REFER- ENCE NUMBER.	PROPORTIONS BY VOLUMES.			AGE WHEN TESTED. Months.	NUMBER OF TESTS.	TENSILE STRENGTH, lb. per sq. in.	AUTHORITY.
	Cement.	Sand.	Broken Stone.				
1	1	2 *	4	1	10	207	Woolson †
2	1	2	4	1	3	161	Woolson †
3	1	2	4	1	9	205	Henby ‡
4	1	2	4	1	4	311	Hatt ¶
5	1	2	5	1	1	237	Hatt ¶
6	1	2	5	1	3	215	Henby ‡
7	1	3	6	1	5	115	Henby ‡
8	1	2	4	3	2	158	Henby ‡
9	1	2	5	3	1	359	Hatt ¶
10	1	2	5	3	3	121	Henby ‡
11	1 : 5 gravel			1	1	253	Hatt ¶
12	1 : 5 gravel			3	1	290	Hatt ¶

* Limestone screenings.

† Prof. Ira H. Woolson, *Engineering News*, vol. liii, p. 561-66.

‡ Mr. W. H. Henby, *Jour. Assoc. Eng'g Soc.*, vol. xxv, p. 147-51.

¶ Prof. W. K. Hatt, *Jour. West. Soc. Eng'rs*, vol. ix, p. 234.

on account of its brittleness and its liability to crack from shrinkage. However, a knowledge of the tensile strength of concrete is important in problems relating to the use of reinforced concrete (Chap. VIII), and hence will be briefly considered.

Table 36, gives values of the tensile strength as determined by three experimenters. All of the tests were made upon gigantic briquettes.

TABLE 37.

TRANSVERSE STRENGTH OF CONCRETE OF VARIOUS PROPORTIONS.*
Age when tested, 112 days.

REF. No.	PROPORTIONS BY WEIGHT.			NUMBER OF TESTS.	MODULUS OF RUPTURE, lb. per sq. in.
	Cement.	Screenings.	Stone.		
1	1	0	0	6	926
2	1	1	0	6	586
3			1	6	484
4			2	6	479
5			3.5	6	433
6			5		278
7	1	2	0	6	461
8			3	6	307
9			5	8	218
10			7.5	4	249
11	1	3	2	3	231
12			4	8	170
13			7	4	169
14	1	4	0	6	225
15			3	3	203
16			6	10	135
17			9	3	115
18	1	5	0	3	164
19	1	6	7	6	126
20			12	2	93

406. The tensile strength of concrete is usually obtained by determining the transverse strength of concrete beams and computing the stress upon the extreme fiber (the modulus of rupture) under the assumption that the neutral axis is at the center of the beam. Table 37 gives the modulus of rupture of concretes of various proportions of portland cement, stone screenings, and

* Fuller and Thompson in Trans. Amer. Soc. of C. E., vol. lix, p. 94-95.

crusher-run stone from 0.1 to 2.25 inches in diameter. The age of the concrete when tested was 112 days.

Table 38 shows the modulus of rupture of concrete made with four different aggregates and three degrees of wetness, tested at four ages. Each result is the mean of three experiments.

TABLE 38.

TRANSVERSE STRENGTH OF CONCRETE OF VARIOUS AGGREGATES AND AGES.*

Modulus of Rupture in pounds per square inch.

REF. No.	AGGREGATE.	PROPORTIONS BY VOLUMES.	CONSISTENCY.	AGE IN WEEKS.		
				4	13	26
1	Cinders	1 : 2 : 5	wet	175	240	246
2			medium	198	231	277
3			damp	198	225	250
4	Granite	1 : 2 : 4	wet	375	501	539
5			medium	475	536	566
6			damp	499	591	618
7	Gravel	1 : 2 : 4	wet	391	380	435
8			medium	451	477	520
9			damp	426	495	496
10	Limestone	1 : 2 : 4	wet	422	487	507
11			medium	458	541	566
12			damp	537	521	589

The determination of the transverse strength of beams affords a convenient method of comparing the strength of concretes of different proportions and ages. Tables 37 and 38 are given partly to permit of such comparisons. Compare the relative transverse strengths for different proportions and ages as given in Tables 37 and 38 with the relative compressive strengths as given in Table 32, page 198, and Table 33, page 199.

407. Ratio of Tensile to Compressive Strength. The ratio of the tensile to the compressive strength of concrete usually varies from 6 to 12 when the compressive strength is determined by crushing cubes. Candlot gives the results of forty sets of experiments on cement mortars of various proportions, tested at ages varying from 1 week to 3 years, in which the ratio varies from 5 to 12½, which ratio seems to be independent of the proportion or of the age.

* Bul. 344 of the U. S. Geological Survey—Results of Tests made at the Structural-Materials Testing Laboratories, p. 36-41.

408. SHEARING STRENGTH. The shearing strength of concrete is of no importance in massive structures, but is important in the design of reinforced concrete beams. It is difficult to arrange an experiment to determine the shearing strength of concrete without involving cutting action or bending stress. In Bulletin No. 8 of the University of Illinois Engineering Experiment Station the various methods employed to determine the shearing strength of concrete are discussed, and the conclusion is drawn that most of the methods are deceptive and give results which are too small.

TABLE 39.

RELATIVE SHEARING AND CRUSHING STRENGTH OF CONCRETE.*
Tests made by Professor Talbot at University of Illinois.

FORM OF SPECIMEN.	PROPORTIONS OF THE CONCRETE.	METHOD OF STORING.	NUMBER OF TESTS.	SHEARING STRENGTH. lb per sq. in.	CRUSHING STRENGTH OF CUBES. lb per sq. in.	RATIO OF SHEAR TO COMPRESSION.
Plain plate	1:3:6	Air	9	679	1 230	0.55
	1:3:6	Water	7	729	1 230	.59
	1:3:6	Damp sand	4	905	2 428	.37
	1:3:6	Damp sand	1	968	1 721	.56
	1:2:4	Damp sand	5	1 193	3 210	.37
Recessed block	1:3:6	Air	17	796	1 230	0.65
	1:3:6	Water	5	879	1 230	.71
	1:3:6	Damp sand	4	1 141	2 428	.47
	1:3:6	Damp sand	1	910	1 721	.53
	1:2:4	Damp sand	5	1 257	3 210	.39
Reinforced recessed block	1:3:6	Air	4	1 051	1 230	0.86
	1:3:6	Damp sand	4	1 821	2 428	.75
	1:3:6	Damp sand	1	1 555	1 721	.90
	1:2:4	Damp sand	5	2 145	3 210	.67
Restrained beam	1:3:6	Damp sand	4	1 313	2 428	0.54
	1:3:6	Damp sand	1	1 020	1 721	.59
	1:2:4	Damp sand	6	1 418	3 210	.44

Table 39 gives the results obtained by Professor Talbot; and Table 40, page 206, shows results obtained by Professor Spofford at the Massachusetts Institute of Technology. These two series of experiments are much the most satisfactory of any that have been made, and give results much larger than any former experiments. Professor Talbot used four methods of testing,—in three of which a hole was punched through a plate (for details see Table 39), and

* Bulletin No. 8 of University of Illinois Engineering Experiment Station, p. 24.

in the other the ends of a square beam were securely clamped between stiff metal blocks and the load was applied through a flat bearing block. Professor Spofford used a cylindrical beam the ends of which were clamped in cylindrical bearings, the load being applied through a semi-cylindrical bearing.

TABLE 40.

RELATIVE SHEARING AND CRUSHING STRENGTH OF CONCRETE.*

Tests made by Professor Spafford at Massachusetts Institute of Technology.

PROPORTIONS.	METHOD OF STORING.	SHEARING STRENGTH. lb. per sq. in.			CRUSHING STRENGTH OF CUBES. lb. per sq. in.	RATIO OF SHEAR TO COMPRES- SION.
		Maximum.	Minimum.	Average.		
1 : 2 : 4	Air	1 630	960	1 310	2 070	0.63
1 ; 2 : 4	Water	2 090	1 180	1 650	2 620	0.63
1 : 3 : 5	Air	1 590	890	1 240	1 310	0.94
1 : 3 : 5	Water	1 380	840	1 120	1 360	0.82
1 : 3 : 6	Air	1 450	950	1 180	950	1.25
1 : 3 : 6	Water	1 200	1 030	1 120	1 270	0.88

409. MODULUS OF ELASTICITY. The modulus of elasticity is the ratio of the unit stress to the corresponding unit elastic deformation, and is an important factor in the design of reinforced concrete structures. The value of the modulus increases with the age and the richness of the concrete, and decreases with the increase of the load. Apparently the modulus is the same for tension as for compression.

Different experimenters have obtained very different results for the modulus, owing partly to variations in the concrete, partly to the different stresses between which the modulus is taken, partly to the difficulties of measuring the very small deformations, and partly to whether gross or net deformations are used. The net deformations give the larger values for the modulus. Values have been obtained ranging from 1,500,000 to 5,000,000 lb. per sq. in.

Table 41 gives the modulus for different proportions and different ages. These values were deduced in connection with the crushing tests described in § 398, which see. In computing the results in Table 41 net deformations (the total deformations minus the set) were used.

410. ELASTIC LIMIT. Concrete shows a permanent set under small loads, and hence concrete can hardly be said to have an elastic

* Bulletin No. 8, University of Illinois Engineering Experiment Station, p. 8.

limit in the usual sense. However, there appears to be a limit to the stress which can be repeated indefinitely without continuing to add to the deformation, and for practical purposes this may be taken as the elastic limit. This limit is from 50 to 60 per cent of the ultimate compressive strength.

411. WEIGHT. The weight of concrete varies with the unit weight of the ingredients, the proportions, the maximum size and the grading of the aggregate, the amount of the water, the amount of ramming, and the age. The maximum difference between portland and natural cement concrete, due to the greater weight of portland cement, is 4 or 5 lb. per cu. ft. The best grade of 1 : 2 : 4 concrete when dry weighs about as follows: trap 155 lb. per cu. ft., conglomerate or gravel 152 lb. per cu. ft., limestone 150 lb. per cu. ft., sandstone 145 lb. per cu. ft., cinder 110 lb. per cu. ft.; and a 1 : 3 : 6 mixture when dry weighs as follows: trap 150 lb. per cu. ft., conglomerate or gravel 145 lb. per cu. ft., cinder 105 lb. per cu. ft.* Concrete made of blast-furnace slag weighs from 110 to 120 lb. per cu. ft.; and that made of coke from 80 to 90 lb. per cu. ft.

TABLE 41.
MODULUS OF ELASTICITY OF CONCRETE.†

REFERENCE NUMBER.	COMPOSITION.			Age.	MODULUS OF ELASTICITY BETWEEN LOADS PER SQUARE INCH OF			Compressive Strength. lb. per sq. in.
	Cement.	Sand.	Stone.		100 and 600 lb.	600 and 1 000 lb.	1 000 and 2 000 lb.	
1	1	2	4	7 days	2 593 000	2 054 000	1 351 000	1 730
2				1 mo.	2 662 000	2 445 000	1 462 000	2 567
3				3 mos.	3 671 000	3 170 000	2 158 000	2 975
4				6 mos.	3 646 000	3 567 000	2 582 000	3 989
5	1	3	6	7 days	1 869 000	1 530 000	1 511
6				1 mo.	2 438 000	2 135 000	1 219 000	2 260
7				3 mos.	2 976 000	2 656 000	1 805 000	2 741
8				6 mos.	3 608 000	3 503 000	1 868 000	3 068
9	1	6	12	1 mo.	1 376 000	1 146
10				3 mos.	1 642 000	1 364 000	1 359
11				6 mos.	1 820 000	1 522 000	1 592

412. COST OF CONCRETE. The cost of concrete depends upon the following: (1) the unit cost of the materials; (2) the proportions;

* Tests of Metals, etc., Watertown Arsenal, 1897, 1898, 1899, 1903, 1904.

† Tests of Metals, U. S. A., 1899, p. 741.

(3) the character of the work—whether foundation work, mass concrete above ground, or reinforced-concrete building work;—(4) the magnitude of the job; (5) the cost of labor per hour; (6) the hours worked per day; (7) the character of the labor; (8) the space available for the storage and the handling of the materials; (9) the time of the year; (10) the probable weather conditions; (11) the amount of time allowed for doing the work, etc. In making an estimate of the probable cost of any proposed work, each of these items must be carefully studied; and in using published data on cost of concrete, attention should be given to the conditions under which the work was done.

413. Cost of Materials. The cost of concrete depends much more upon the character of the construction and the conditions under which the work is done than upon the first cost of the materials.

414. The Cement. The price of cement (§ 127–29) varies with the conditions of the market and with the locality, and hence it is wise to consult the dealers before making an estimate. Further, freight is a considerable part of the delivered price, and hence quotations should be secured f.o.b. the point of delivery. The cost of wagon haul will usually vary from 15 to 20 cents per ton-mile depending upon the locality, the season, and the character of the roads; and assuming for this purpose that a barrel of portland cement weighs 400 pounds, the wagon haul will vary from 3 to 4 cents per barrel per mile.

The amount of cement required for a cubic yard of concrete can be obtained from Table 28, page 158, and hence the cost delivered at the work can easily be computed.

415. The Sand. The cost of sand varies greatly with the locality, since in some places sand may be found comparatively near the work, while in others it must be transported a long distance (see § 203). If the sand is found near the work, the cost of haul will be the cost of loading, which for large jobs is about one hour's labor per cubic yard and for small jobs about $1\frac{1}{2}$ hours per cubic yard, plus the cost of transportation, which is about 1 cent per 100 feet of distance. If the sand is hauled a few miles instead of a few hundred feet, the cost of loading is relatively small and may be included in the cost of hauling, which is from 15 to 20 cents per ton-mile. The cost of haul per unit of distance is more for short distances than for long ones because of the proportionally greater loss of time on account of the detention of the wagon or cart at the pit. For distances under 250 to 300 feet, sand can be hauled in wheelbarrows more economically than in carts or wagons. In computing the cost of wagon haul, we may assume sand to weigh $1\frac{1}{2}$ tons per cubic yard; and hence the wagon haul will cost from 22 to 30 cents per cubic yard

per mile. Table 28, page 158, gives the amount of sand required per cubic yard of concrete.

416. *The Aggregate.* If the aggregate is gravel, the data in the preceding section are applicable also in this case. Broken stone is bought by the ton or by the cubic yard, and for this purpose a yard of stone may be assumed to weigh $1\frac{1}{4}$ tons. For data on the price of crushed stone, see § 218.

417. *Cost of Forms.* Under this head will be included only the cost of forms for mass concrete, no reference being made to the forms employed in reinforced-concrete buildings, since that subject is too complicated to be treated in the space here available. For a little data on the cost of forms for reinforced-concrete buildings, see the left-hand side of Table 46, page 258.

The cost of the forms of mass concrete is materially affected by nearly all the items affecting the cost of the concrete (see § 412), and in addition the cost of the forms depends also upon the following: (1) the outlines of the structure, which govern the amount of labor required in erecting and removing the forms and the loss in cutting the lumber; (2) the consistency of the concrete, which determines the length of time the forms must remain in place and hence governs the amount of lumber required for any particular job; (3) the details of the design of the forms—whether the facing planks have square edges, beveled edges, or are tongued and grooved, or whether the forms are sectional or not, etc.; (4) the composition of the form-building gang—whether all are high-priced and expert carpenters or low-priced unskilled laborers, or whether there is an economic proportion of each; (5) the care employed in taking down the forms; (6) the number of times the lumber may be used; and (7) the surface finish required on the completed concrete. The forms sometimes support the runway used in delivering the concrete, in which case part of the cost of the forms is strictly not chargeable to form-work proper.

The cost of forms is usually given per cubic yard of concrete, but this form of statement does not discriminate between thin and thick masses, nor between structures having a regular or irregular contour. It would be of advantage to all concerned, if the cost of materials and of labor for forms were each stated in three ways, viz.: (1) per cubic yard of concrete; (2) per square yard of finished surface; and (3) per thousand feet of lumber used. Unfortunately, the records of the cost of work are seldom kept in this form, and the published data seldom give any detailed information as to the cost of the forms.

There is greater diversity in the cost of the forms than in any other element of the cost of concrete. In eighteen cases of culverts,

bridge abutments, retaining walls, arches, canal locks, and reservoirs, the cost of lumber ranged from \$16 to \$20 per thousand feet. The amount of lumber varied from 6 to 70 feet per yard of concrete, usually from 12 to 25; and the cost of lumber ran from 9 to 88 cents per cubic yard of concrete, in most cases from 25 to 55. The cost of labor varied from \$7 to \$10 per thousand feet of lumber; and from 28 cents to \$1.10 per cubic yard of concrete, without any uniformity about any intermediate values. In the eighteen cases the total cost of forms ranged from 32 cents to \$1.95 per cubic yard, six being below 75 cents, six between 75 cents and \$1.00, and six between \$1.00 and \$1.95.

In making estimates for bridge and culvert construction on a prominent western railway system, the cost of forms is taken at 35 to 85 cents per cubic yard, depending upon the cost of lumber and the contour of the structure.

418. Cost of Hand Mixing. The cost of labor in mixing concrete by hand and putting the same into place, exclusive of the cost of forms and of finishing the surface of the concrete, may be divided as follows: (1) loading the cement, sand, and stone into the wheelbarrows, buckets, or cars employed to transport the materials from the stock piles to the mixing board; (2) transporting and dumping the materials; (3) mixing the materials; (4) loading the concrete;

COST OF LABOR IN MIXING AND PLACING CONCRETE BY HAND.

ITEMS.	COST PER Cu. Yd.
1. Loading sand, stone, and cement	\$0.17
2. Wheeling 60 ft. in barrows (4 cents + 1 cent for each 30 ft.) .	.06
3. Mixing, 6 turns at 5 cents each30
4. Loading concrete into barrows12
5. Wheeling 30 ft. (4 cents + 1 cent for each 30 ft.)05
6. Dumping barrows (1 man helping the barrow-man).....	.05
7. Spreading and heavy ramming15
Total cost of productive labor	\$0.90
Foreman at \$2.70 a day10
Total cost of labor exclusive of forms and finishing surface	\$1.00

(5) transporting the concrete to place; (6) dumping; (7) spreading and ramming; (8) superintendence; (9) finishing the surface; and (10) general expense, including building cement house, sand bin, runways, etc., and interest, depreciation, etc. Gillette's Handbook of Cost Data, pages 269-80, analyzes each of the first seven items above, and presents the above summary, "under the assumption

that the concrete is to be put into a deep foundation requiring wheeling a distance of 30 ft., that the stock piles are on plank 60 ft. distant from the mixing board, that the specifications call for 6 turns of gravel concrete thoroughly rammed in 6-in. layers, and that a gang of sixteen men at \$1.50 a day each is to work under a foreman receiving \$2.70 a day."

"To estimate the daily output of this gang of laborers, divide the daily wages of the 16 men, expressed in cents, by the labor cost of the concrete in cents, and the quotient will be the cubic yards of output of the gang."

"In street-paving work where no man is needed to help dump the wheelbarrows, and where it is usually possible to shovel concrete direct from the mixing board into place, and where half as much ramming as above assumed is usually satisfactory, we see that items 4 to 7, instead of amounting to 37 cts., are only one half of the last item, viz., $7\frac{1}{2}$ cts. This makes the total cost of labor only 60 cts., instead of 90 cts. If we divide 2,400 cents (the total day's wages of 16 men) by 60 cents (the labor cost per cu. yd.), we have 40, which is the cubic yards of output of the 16 men. This greater output of the 16 men reduces the cost of superintendence to 7 cts. per cu. yd."

The above examples are fairly representative of well organized work, but if the superintendence is inefficient the cost of labor may easily be 25 per cent more; and if the job is large, or if the men have long been in the gang, the above cost may be reduced a little.

In making estimates on a prominent western railroad system the cost of labor in mixing and placing concrete in bridge and culvert construction is taken at 90 per cent of the price paid per day for common labor. This includes the cost of unloading all concrete material and tools, building concrete-mixing platforms and runways, mixing by hand and placing; but does not include the cost of excavating, the cost of forms or of train service.

419. Cost of Machine Mixing. When concrete is mixed by machinery, the ingredients and the concrete are sometimes handled by hand and sometimes the materials are fed into the mixer by machinery and the concrete is transported in buckets or cars moved by power. In the first case, the only economy of machine mixing over hand mixing is in the reduction of the cost of the mixing; but in the second case, nearly every item is materially reduced. The cost of machine mixing will depend upon the size of the mixer; but under ordinary circumstances the cost of mixing with hand feeding and bearing away will be about 10 cents per cubic yard; while with gravity feed from bins and power transportation the cost of mixing, exclusive of interest, depreciation, and cost of setting up and taking

down the machine, may be as low as 3 cents per cubic yard, and a cost of 2 cents has been claimed.* With the price of labor stated in § 418, machine mixing with manual attendance will save about 20 cents per cubic yard; but ordinarily the men who do the mixing will receive more than the minimum wages, and hence the difference between hand and machine mixing will usually be greater than 20 cents per cubic yard; and if the price of labor is more than in § 418, the saving will be still greater. In Chicago the cost of machine mixing, under four different foremen on five or six jobs each of 200 to 500 cubic yards each, ranged from 28.5 to 38.5 cents per cu. yd., the average being 33.9; and for hand mixing under four foremen on several jobs, the range was from 49.0 to 58.3 cents per cu. yd., the average being 53.0.†

420. Examples of Cost. A few examples showing the cost of concrete in massive construction immediately follows; and for additional data, consult the index under the title of the particular structure, as Abutment, Arch, Building, Culvert, Pier, Retaining Wall, etc., or the heading: Concrete, Cost of.

421. Foundation for Sea-Wall. The following is the analysis of the composition and cost of the concrete employed for the foundations of the sea-wall at Lovell's Island, Boston Harbor: ‡

Cement	0.83 bbl.	@ \$1.54 =	\$1.26
Sand.....	0.25 cu. yd.	@ .70 =	.17
Gravel.....	0.90 cu. yd.	@ .27 =	.24
<i>Total materials</i>	1.27 cu. yd.		\$1.67
<hr/>			
Labor, mixing mortar.....	0.06 days	@ 1.20 =	0.08
Labor, mixing concrete	0.11 days	@ 1.20 =	.13
Labor, transporting concrete.....	0.06 days	@ 1.20 =	.08
Labor, ramming concrete.....	0.03 days	@ 1.20 =	.04
<i>Total labor</i>	0.26 days		.33
<hr/>			
Tools, implements, etc.....			.11
<i>Total cost 1 cu. yd. of concrete in place</i>			\$2.11

The proportions for this concrete were 1 cement, 3 sand, and 4 gravel. It was unusually cheap, owing partly to the use of pebbles instead of broken stone. If the broken stone had been used, it would have

* For an illustrated description of representative concrete power-mixing and handling plants with records of their cost of operation, see *Engineering-Contracting*, vol. xxvii, p. 165-68—April 17, 1907.

† *Engineering-Contracting*, vol. xxix, p. 221.

‡ Compiled from Gillmore's Limes, Hydraulic Cements and Mortars, p. 247.

cost probably 4 to 6 times as much as the gravel. The amount of labor required was also unusually small, this item often being 2 to 2½ times as much as in this case.

422. Foundation for Blast Furnace. The following is the analysis* of the cost of nearly 10,000 yards of concrete as laid for the foundations of a blast furnace plant near Troy, N. Y. The concrete consisted of 1 volume of packed cement to 7 of sand, gravel, and broken stone. The concrete was carried from 15 feet below the surface to 13 feet above the surface. No forms were used. The labor was performed by men who had worked about the blast furnace and who expected that kind of work again as soon as the repairs were completed; and the price per day paid for the labor in mixing and placing the concrete was unusually small, but the time per cubic yard was proportionally larger than usual—compare this example with that in § 421 and § 423.

Cement, 1.23 bbl.....	0.18 cu. yd.	@ \$1.00=	\$1.23
Sand.....	0.10 “	@ 0.30=	.03
Gravel.....	0.36 “	@ 0.30=	.11
Broken stone.....	0.74 “	@ 1.41=	1.04
<i>Total materials</i>	<u>1.38 “</u>		<u>\$2.41</u>
Labor, handling cement.....	0.02 day	@ 1.00=	.02
“ unloading stone.....	0.14 “	@ 1.00=	.14
“ mixing.....	0.85 “	@ 1.00=	.85
“ superintendence.....	0.01 “	@ 9.61=	.10
<i>Total labor</i>	<u>1.02 “</u>		<u>\$1.11</u>
<i>Total cost of yard of concrete in place</i>			<u>\$3.52</u>

423. Retaining Wall. The following is the cost of constructing the concrete retaining wall on the Chicago Sanitary Canal.† The average height of the wall was 10 ft. in Sec. 14, and 22 ft. in Sec. 15. The thickness on top was 6 ft., and at the bottom it was equal to half the height. The stone was taken from the adjacent canal excavation. The body of the wall was made with natural cement, but the coping and facing, each 3 inches thick, were made with portland cement. The proportions were 1 volume of cement, 1½ volumes of sand, and 4 volumes of unscreened limestone. The cost of plant employed in Sec. 14 was \$9,600, and in Sec. 15 was \$25,420. The contract price for the concrete in Sec. 14 was \$2.74, and in Sec. 15 \$3.40 per cu. yd.

* Trans. Am. Soc. of C. E., vol. xv, p. 875.

† Jour. West. Soc. of Eng'rs, vol. iii, p. 1310-32.

ITEMS OF EXPENSE.	COST PER CUBIC YARD.	
	SEC. 14	SEC. 15
Labor, general.....	\$0.078	\$0.082
“ on the wall.....	.108	.116
“ mixing concrete.....	.121	.250
“ placing and removing forms.....	.150	.142
“ transporting materials.....	.142	.081
“ quarrying stone.....	.303	.275
“ crushing stone.....	.073	.128
<i>Total for labor.....</i>	<u>\$0.975</u>	<u>\$1.074</u>
Material, cement, natural @ \$0.65 per bbl.	0.863	0.930
“ portland @ \$2.25 “ “	.305	.180
sand@ \$1.35 per cu. yd.	.465	.476
<i>Total for materials.....</i>	<u>\$1.633</u>	<u>\$1.586</u>
Machinery, cost of operating.....	.407	.567
<i>Total cost per cu. yd.....</i>	<u>\$3.015</u>	<u>\$3.227</u>

424. *Arch Culverts.* Table 42 shows the cost of concrete in five arch culverts built under a railroad trestle by negro labor.* The proportions of the concrete were 1 : 3 : 6. The mixing

TABLE 42.
COST OF CONCRETE IN ARCH CULVERTS.

SPAN OF ARCH.	10-ft.	12-ft.	12-ft.	12-ft.	16-ft.
CONCRETE IN EACH.	354 cu. yd.	292 cu. yd.	406 cu. yd.	1217 cu. yd.	986 cu. yd.
Materials:					
Cement, per cu. yd.	\$2.26	\$1.82	\$2.10	\$1.85	\$2.02
Sand, “ “ “	.18	.18	.19	.14	.14
Stone, “ “ “	.47	.53	.46	.34	.58
Lumber, “ “ “	.47	.43	.30	.30	.55
Total, “ “ “	<u>\$3.38</u>	<u>\$2.96</u>	<u>\$3.05</u>	<u>\$2.63</u>	<u>\$3.29</u>
Labor:					
Unloading material	.18	.18	.16	.11
Building forms61	.47	.73	.55	.41
Mixing and placing concrete.....	1.69	1.35	1.22	.42	1.26
Total	<u>\$2.48</u>	<u>\$2.00</u>	<u>\$2.11</u>	<u>\$1.08</u>	<u>\$1.67</u>
Grand total	<u>\$5.86</u>	<u>\$4.96</u>	<u>\$5.16</u>	<u>\$3.71</u>	<u>\$4.96</u>

* Trans. Eng'g Assoc. of the South, vol. xvii, p. 32-39.

and placing were done by hand, except that in the last 12-foot culvert the mixing was done with a machine.

425. Cost of Mixing and Placing. Table 43 gives the details of the cost per cubic yard of the labor required in mixing and laying concrete for the Buffalo, N. Y., breakwater.* The total amount of concrete laid was 14,587 cu. yd. The conditions under which the work was done varied considerably from year to year, which accounts for the difference in the cost. The work summarized in Table 43 was done by day's work, and is unusually high; but in 1902 under a contractor most of the work of transporting and mixing was done by machinery, when the cost of mixing and placing was reduced to 45 cents per cubic yard exclusive of fuel, forms, and plant rental.† The latter is about the usual cost when most of the work is done by machinery.

TABLE 43.
COST OF MIXING AND LAYING CONCRETE.

REF. No.	ITEMS OF EXPENSE.	CONCRETE MIXED BY		
		Hand.	Machinery.	
			1888	1887
1	Transporting cement from store-house.....	\$0.078	\$0.128	\$0.098
2	Measuring cement.....	} .212	.26	.024
3	Mixing cement paste.....		.186	.084
4	Measuring sand and pebbles.....	.172	.285	.116
5	Measuring broken stone.....	.070	.198	.101
6	Mixing concrete.....	.557	.152	.103
7	Transporting concrete.....	.185	.445	.166
8	Spreading and ramming concrete.....	.270	.502	.392
9	Placing forms.....	.240	.176	.263
10	Building temporary railway.....181
	<i>Total per cu. yd.....</i>	\$1.790	\$2.098	\$1.528

426. Labor to Mix and Lay. Table 44, page 216, gives the details of the labor required in mixing and laying concrete in the construction of the Boyd's Corner dam in New York and a reservoir in St. Louis, Mo.‡

427. Economic Concrete. Sometimes there is a question as to the relative economy of concrete made with natural cement and with

* Report of Chief of Engineers, U. S. A., for 1890, p. 2808-35.

† *Engineering News*, vol. 1, p. 312-13.

‡ *Trans. Amer. Soc. C. E.*, vol. iii, p. 360.

portland, although owing to the great decrease in the price of portland cement in the past few years, portland-cement concrete is usually the more economical. However, if such an investigation is to be made, proceed as follows: The crushing strength of both natural-cement and portland-cement concrete is given in Table 29, page 195, with both broken stone and gravel. A study of these results shows that the relative strength of natural and portland concrete is different at different ages. For example, taking averages for 10 days, the portland concrete was 6 times as strong as the natural concrete; while at a year the portland concrete was only 3 times as strong as the natural concrete. At 45 days and also at 6 months, the portland

TABLE 44.
LABOR REQUIRED IN MIXING AND LAYING CONCRETE.

KIND OF LABOR.	LABOR PER CUBIC YARD.						
	New York Storage Reservoir.				St. Louis Reservoir.		
	Mixed on level and wheeled in.		Hoisted by steam and run on cars.		All work on level — wheeled in.		
	From 27 to 10 feet below surface.	From 10 below to 6 above surface.	From 6 to 28 feet above surface.	From 28 to 45 feet above surface.			
Mixers — hand work, days	} 0.223	} 0.227	0.145	0.121	0.603	0.537	0.399
Derrick and car men, days			0.088	0.070			
Engine, hours			0.152	0.108			
Handling sand, days	} 0.161	} 0.114	0.065	0.071	} 0.183	} 0.134	} 0.250
Handling stone, days			0.127	0.098			
Carts, days	0.065	0.076	0.046	0.035	0.088	0.057	0.068
Ramming, days	0.125	0.078	0.071	0.073	0.125	0.107	0.128

concrete was 4 times stronger than the natural concrete; and at 3 months 5 times as strong. Taking averages for like dates and compositions, the portland-cement concrete was 3.7 times as strong as natural-cement concrete. Table 28, page 158, may be employed to find the ingredients per cubic yard for natural cement as well as for portland; and hence the cost of materials for each may be easily computed. If the cost of a cubic yard of portland-cement concrete is more than 3.7 times that of a cubic yard of natural-cement concrete, then the latter is on the average the more economical; but if the portland-cement concrete costs less than 3.7 times that of the nat-

ural-cement concrete, then the former is on the average the more economical.

However, uniformity of product is more important than average strength, and for this reason alone portland cement is usually preferred to natural. Of course the relative cost will vary with the condition of the cement market and with the locality.

428. Sometimes a similar question arises as to the relative economy of gravel or broken stone for concrete. The relative strengths of gravel and broken-stone concretes are stated in § 284. The relative economy of concrete made with broken stone and gravel will vary with the cost of each; but as a rule, when gravel costs less than 80 per cent of that of broken stone, gravel is more economical. However, some engineers prefer broken stone to gravel, because of the danger that the latter may be unduly dirty—see § 286.

429. The following example, from actual practice, illustrates the possibilities in the way of combinations between portland and natural cements, and gravel and broken stone. The specifications called for a concrete composed of 1 volume of natural cement, 2 volumes of sand, and 4 volumes of broken stone. The contractor found that at current prices a concrete composed of 1 volume of portland cement and 9 volumes of gravel would cost about the same as the concrete specified. A test of the strength of the two concretes showed that at a week the portland-gravel concrete was 1.52 times as strong as the natural-cement and broken-stone concrete; and at a month 1.59 times as strong. Therefore the portland-gravel concrete was the more economical, and was used.

CHAPTER VIII

REINFORCED CONCRETE

431. DEFINITION. Reinforced concrete is usually, though somewhat inaccurately, defined as a combination of steel and concrete in which the steel takes the tension and the concrete the compression. For example, if one or more steel rods be imbedded near the tension side of a concrete beam, the steel will resist the tension and the concrete the compression. Concrete is stronger in compression than in tension, while steel is stronger in tension; and hence in the above combination each material is serving the purpose for which it is best adapted.

The preceding definition of reinforced concrete is defective since the steel is sometimes employed to resist shear, as at the ends of short or heavily loaded beams, and is also sometimes employed to take direct compression, as in columns. Furthermore, steel is sometimes embedded in concrete to prevent contraction cracks due to changes of temperature. Therefore, it is more exact to say that reinforced concrete is concrete having metal embedded in it so that the two materials assist each other in supporting the stresses imposed upon the structure.

The term reinforced concrete does not include those combinations of steel and concrete in which the steel is designed to carry all of the load, as, for example, a steel column encased in concrete. In such combinations the concrete is intended only to protect the steel from corrosion and fire, the steel being designed to support the concrete as well as the other loads; but in reinforced concrete the proportions and positions of the steel and the concrete are designed to distribute the loads between the two materials.

432. Formerly there was a great diversity of names applied to this combination of steel and concrete, among them being steel-concrete, armored concrete, and concrete-steel; but in the last few years the term reinforced concrete has been almost universally adopted.

433. HISTORY. Apparently the first use of reinforced concrete was in a row-boat built by J. L. Lambert in France in 1850. This boat was exhibited at the Paris Exposition in 1855, and in 1902 was still in good condition and in use. In 1865, Jean Monier, a Frenchman, made large concrete flower-pots which were strengthened by an

embedded wire net; and in 1867 he took out a patent for reinforced concrete flower-pots, pipes, tanks, etc. Later he took out patents for the use of reinforced concrete in bridge construction; and in 1875 built a reinforced concrete arch-bridge, probably the first in the world. Monier is frequently referred to as the father of reinforced concrete construction. However, reinforced concrete construction had made but little progress in Europe before 1887, but after this date it made rapid progress—at first chiefly through the efforts of Hennebique.

In 1875, W. A. Ward built a dwelling at Port Chester, N. Y., in which the walls, floors, and roof were made of reinforced concrete. This building was in perfect condition in 1905. However, reinforced concrete construction made practically no progress in America until 1885–90 when Ransome built a reinforced concrete arch-bridge and several notable reinforced concrete buildings in and near San Francisco. Reinforced concrete construction was not extensively used in America before 1900.

434. Since the uses described above, many systems of reinforcement have been proposed and many patents have been granted; and reinforced concrete has come into extensive use in all kinds of engineering and architectural construction. Reinforced concrete has been more extensively used in Europe than in America, chiefly because during the last three decades of the last century the price of cement was much more favorable to the development of concrete construction in Europe than in America; but the recent development of the portland-cement industry in America has greatly stimulated the use of concrete, and in the last few years reinforced concrete has been extensively used in America. The use of reinforced concrete is the most important step in structural engineering since the introduction of steel for building purposes.

435. PORTLAND VS. NATURAL CEMENT. In some localities it is sometimes economical to use natural cement in some forms of massive concrete construction; but for somewhat obvious reasons it is not wise to attempt reinforced concrete construction with natural cement. Portland cement is universally used in reinforced concrete.

436. ADVANTAGES OF REINFORCED CONCRETE. Reinforced concrete has a number of strong points as a structural material. It is a combination of two important building materials in which each is used for that purpose for which it is best adapted. Volume for volume, steel costs about fifty times as much as concrete, and for the same cross section steel will support about 300 times as much in tension as concrete and about thirty times as much in compression; and hence to support a load in tension by concrete will cost about six times as much as with steel, but to support a load in compression

by concrete will cost only about six tenths as much as with steel. Therefore, in reinforced concrete each material not only resists the kind of stress to which it is best adapted, but the principles of economic design are also fulfilled.

Reinforced concrete has a comparatively high degree of elasticity, so that it can be deformed considerably without serious result—an important property for a structural material.

Reinforced concrete has high fire-resisting qualities, and has a less first cost than other fire-proof construction.

Reinforced concrete is a form of masonry which has as much strength in tension as in compression.

437. OBJECTION TO REINFORCED CONCRETE. The most serious objection to the use of reinforced concrete relates to its permanency. Concrete is weak in tension, and consequently when reinforced concrete is subjected to any considerable tension, the concrete is likely to crack, and may permit the entrance of water or acid gases which may corrode and finally destroy the steel. It is certain that steel embedded in ordinary concrete not subject to bending stresses or temperature changes, is protected reasonably well, if not perfectly; but this does not prove that tensile stresses may not open cracks wide enough for the penetration of water or acid gases. However, the danger is not very great, since in the first place the cracks are exceedingly small and hence neither water nor gases in any appreciable quantities is likely to reach the steel; and in the second place, even if the crack extends to or past the reinforcement, the steel is likely to be protected by the film of cement which usually covers the metal; and in the third place, any acid gas that does enter the cracks is likely to be neutralized by the alkali of the cement.

Obviously this danger is much greater with such structures as dams, retaining walls, and footings, than with buildings and certain classes of bridges; but the danger of the deterioration of the steel in most reinforced concrete structures is not serious, and most engineers believe that reinforced concrete in at least most positions will be indefinitely preserved. Notice that the use of waterproof concrete or of a waterproof coating would not prevent the cracks, although the incorporation in the concrete of a water-repelling compound (§ 373-75) might prevent the penetration of water. Of course a water-tight shield (§ 384) would keep water away from the steel.

438. The quality of the concrete depends upon the materials and the workmanship employed in it, but these are matters easily understood and easily guarded against. However, reinforced concrete work requires greater care than mass concrete work, since

the chief field of usefulness of reinforced concrete is in the construction of comparatively small units, such as beams, floors and columns, where a single batch made of poor materials or badly mixed might endanger the whole structure.

Formerly there was much discussion as to the correct methods to be employed in computing the stresses in reinforced concrete; but within the past few years experiments have established the principles involved, and now the strength of a reinforced concrete structure can be computed about as accurately as that of any other similar construction.

439. CLASSIFICATION OF REINFORCED CONCRETE STRUCTURAL MEMBERS. Reinforced concrete structural members may be divided into (1) beams, (2) columns, (3) arches, and (4) pipes. Slabs, such as are used for the floors of buildings and of some bridges and for roofs, are simply beams of relatively small depth and great breadth. Although concrete arches are usually only curved beams, the principles of mechanics and of construction involved are so different from those for simple beams as to justify the classification of reinforced concrete arches as distinct structural members. The theory of the resistance of pipes, whether subject to internal or external pressure, is at present but little understood, and will not be considered in this volume.

The theory of reinforced concrete beams and columns will be discussed in the next two articles of this chapter; and concrete arches will be discussed in Chapter XXIII.

ART. 1. REINFORCED CONCRETE BEAMS.

440. THEORY OF FLEXURE OF CONCRETE BEAMS. The theory of flexure for a homogeneous material, like steel or wood, is based upon two fundamental principles, viz.: (1) a plane cross section of an unloaded beam remains a plane after bending, and hence the unit deformations of the fibers at any section of a beam are proportional to their distances from the neutral surface; and (2) the stress is proportional to the strain or deformation, and hence the unit stresses in the fibers at any section of a beam are proportional to their distances from the neutral surface.

Fig. 22, page 222, represents these two laws as applied to a beam when subject to a vertical load acting down upon it. According to the first law, if ab represents the unit shortening at the top face of the beam, ef will be the deformation at a distance ae below the upper surface; and similarly, if cd represents the unit extension of the lower fiber, gh will be the extension of a fiber at a distance dh above the bottom. According to the second law, if ab represents the com-

pressive stress in a fiber at the top of the beam, ef will be the compressive stress on a fiber at a distance ae below the top.

441. In concrete the deformations are not proportional to the stresses producing them, and consequently the second law as above is not applicable to concrete beams. Fig. 23 shows the characteristic relation between the deformations and the stresses for a material

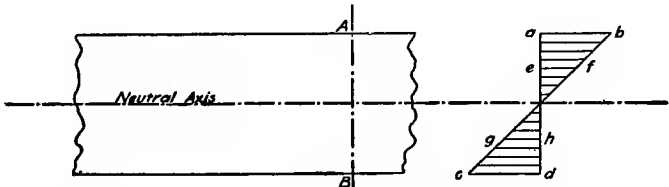

FIG. 22.—STRESS-DEFORMATION DIAGRAM FOR A HOMOGENEOUS MATERIAL.

in which the deformations are not proportional to the stresses producing them. The deformations are obtained by testing specimens in direct compression and also in direct tension. Fig. 23 is drawn by plotting unit stresses as abscissas and unit deformations as ordinates.

Fig. 24 shows the stress diagram corresponding to the stress-deformation curve of Fig. 23. Fig. 24 is constructed as follows: Since, according to principle 1 above, the deformations of the fibers are proportional to the distances from the neutral axis, the distances $O1$, $O2$, $O3$, and OA will represent to some scale the deformations; and if the unit deformation at the point 1 in Fig. 24 is represented by $O1$, the corresponding stress can be determined from the stress-deformation diagram in Fig. 23 by using the proper scale. The distance $1a$ in Fig. 24 represents the stress at the point 1, and similarly for points 2, 3, and A. The lower branch of the curve is determined in a similar manner. Connecting the points $A'cbaOB'$

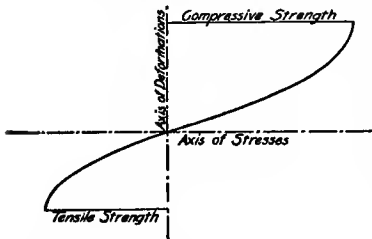

FIG. 23.—STRESS-DEFORMATION DIAGRAM FOR A NON-HOMOGENEOUS MATERIAL.

gives the stress-deformation diagram for the section AB . Notice that the stress-deformation diagram of Fig. 24 is really only the stress-deformation curve of Fig. 23 drawn to a new scale.

442. **PRINCIPLES OF MECHANICS APPLICABLE TO CONCRETE.** From the mechanics of beams we have the three following principles:

1. The total compression, C , and the total tension, T , of the

compressive resistance must be equal to the area oBB' , and oaa' is such an area. Hence the stress diagram for the ultimate strength of the beam is $a'OB'$, and aa' is the compression in the upper fiber at the time of rupture of the beam on the tension side. Fig. 25 shows the wastefulness of using plain concrete as a beam, for the compression, aa' , on the upper fiber when the beam fails on the tension side is only about one tenth of AA' , the crushing strength of the concrete. The area OAA' represents the compressive strength of the concrete that is available, while only the portion oaa' is used. The purpose of adding steel reinforcement is to make available the whole of the compressive resistance of the concrete. The exact amount of steel required to utilize the entire compressive strength of the concrete depends upon the elastic properties of the steel and of the concrete, but steel having a cross sectional area equal to from 1 to 2 per cent of the total area of the beam will develop the entire compressive resistance of the concrete.

444. FORMULAS FOR BENDING OF REINFORCED CONCRETE BEAMS.

Reasons for Differences. Numerous formulas have been proposed for the strength of reinforced concrete beams; but they may be grouped into two classes, viz.: (1) empirical formulas, those that express the results of experiments; and (2) rational formulas, those that are based upon the principles of mechanics and the laws of the strength of materials involved. Only the latter will be considered here.

The numerous rational formulas differ among themselves for three reasons, viz.: (1) according to the amount of the tensile resistance of the concrete considered; (2) according to the distribution of the compressive fiber stresses assumed; and (3) according to the method employed of applying the factor of safety.

1. When the load is first applied to a reinforced concrete beam, the tensile resistance of the beam is the sum of the tension in the steel and that in the concrete; but as the load increases, the concrete cracks on the lower side of the beam, and thus decreases the amount of tension taken by the concrete. When the beam fails, these cracks extend nearly to the neutral axis; and hence the unbroken tensile area is quite small, and as it is quite near the neutral axis the moment of its resistance is practically negligible. It is the almost universal custom to neglect in formulas for practice, the effect of the tensile resistance of the concrete.

2. As shown in Fig. 25, the stress-deformation curve for concrete in compression is nearly a straight line up to and even beyond ordinary working stresses, and the most common working formulas are based upon a straight-line stress-deformation relation. In experimental work it is usually necessary to use the curved stress-deformation relation; but some engineers have added useless com-

plication by taking account of the curvature of the stress-deformation diagram in deducing working formulas. When the curvature is taken into account, the stress-deformation curve is usually assumed to be the arc of a parabola with its vertex at A' (Fig. 25) or above.

3. There are employed two methods of applying the factor of safety. One is to apply the factor to the ultimate strength of the concrete and of the steel, and employ the safe working strength in the formula for the safe strength of the beam; and the other method is to deduce a formula for the ultimate strength of the beam, and then apply a factor of safety to this result to determine the safe load for the beam. The second method was formerly the more common; but the first is the more simple and the more logical, and has now become the more common. One objection to the use of formulas for the ultimate strength is that most of them do not take account of the curvature of the stress-deformation line; and the few that do, thereby add complication without compensating advantage.

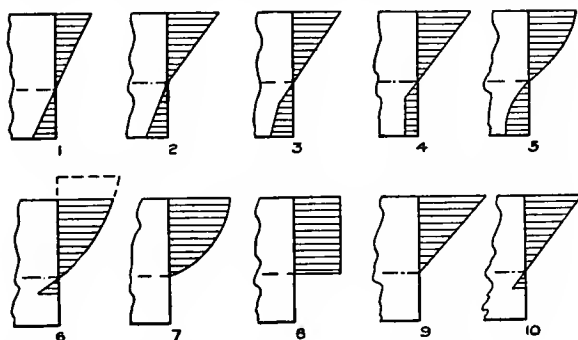

FIG. 26.—DISTRIBUTION OF FIBER STRESS IN REINFORCED CONCRETE BEAMS.

445. Fig. 26 shows the distribution of fiber stress in the concrete, assumed in different formulas for reinforced concrete beams.* No. 9 represents the distribution usually assumed and the one employed in this volume.

446. **Formulas for Safe Working Strength.** We are now prepared to deduce formulas for the safe working strength of a reinforced concrete beam, in accordance with the preceding principles and under the following assumptions:

1. The tensile resistance of the concrete is neglected.
2. The stress diagram for compression is a straight line up to the safe compressive strength of the concrete.

* The first nine are from Turneure and Maurer's Principles of Reinforced Concrete Construction, p. 53.

3. There are no temperature or shrinkage stresses in either the steel or the concrete.

447. The following nomenclature will be used:*

- f_s = unit fiber stress in the steel;
- f_c = unit fiber stress in the concrete at its compressive face;
- e_s = unit elongation of the steel due to the stress f_s ;
- e_c = unit shortening of the concrete due to the stress f_c ;
- E_s = modulus of elasticity of the steel;
- E_c = modulus of elasticity of the concrete in compression;
- n = ratio $E_s \div E_c$;
- T = total tension in the steel at any section of the beam;
- C = total compression in the concrete at any section of the beam;
- M_s = resisting moment as determined by the steel;
- M_c = resisting moment as determined by the concrete;
- M = bending moment or resisting moment in general;
- b = breadth of a rectangular beam;
- d = distance from the compressive face to the plane of the steel;
- k = ratio of the depth of the neutral axis of a section below the top to the distance d ;
- j = ratio of the arm of the resisting couple to the distance d ;
- A = area of cross section of the steel;
- $p = A \div b d$, and is called the steel ratio.

448. *Position of Neutral Axis.* The first step is to determine the position of the neutral axis. Since cross sections that were plane before bending remain plane after bending, the unit deformations of the fibers vary as their distances from the neutral axis; and hence, in Fig. 27,

$$\frac{e_s}{e_c} = \frac{d - kd}{kd}$$

But $e_s = \frac{f_s}{E_s}$, and $e_c = \frac{f_c}{E_c}$, and therefore

$$\frac{e_s}{e_c} = \frac{f_s}{E_s} \frac{E_c}{f_c} = \frac{f_s}{n f_c} = \frac{d - kd}{kd} = \frac{1 - k}{k} \quad \dots \dots \dots (1)$$

For simple bending the total tension is equal to the total compression and hence

$$f_s A = \frac{1}{2} f_c b kd \quad \dots \dots \dots (2)$$

*The notation and the formulas are from Turneure and Maurer's Principles of Reinforced Concrete Construction, John Wiley and Sons, New York City, 1907, by permission. This is much the best treatment of the subject the author has seen, and was freely used in preparing what immediately follows. The reader is referred to that volume for a fuller discussion of the subject than that attempted here.

Combining equations 1 and 2, substituting $p = A \div bd$, and solving, gives:

$$k = \sqrt{2pn + (pn)^2} - pn \quad \dots \quad (3)$$

Equation 3 shows that the position of the neutral axis depends only upon the proportion of the steel and the ratio of the moduli of elasticity. For values of $n = 15$ and of p between 0.75 and 1 per cent, k varies from 0.38 to 0.42; but is ordinarily taken as $\frac{3}{8}$.

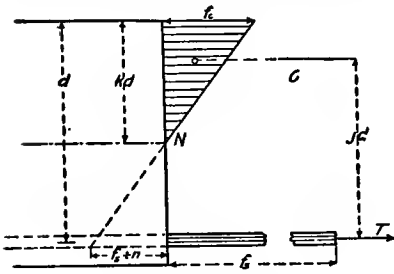

FIG. 27.

449. Arm of Resisting Couple. To find the arm of the resisting couple, jd , Fig. 27, notice that the distance of the centroid of the compressive

stress from the top of the beam is $\frac{1}{3} kd$; and therefore the arm of the couple, $jd = d - \frac{1}{3} kd$ or

$$j = 1 - \frac{1}{3} k \quad \dots \quad (4)$$

It should be noticed that j does not vary much with p , and that for $n = 15$ and p between 0.75 and 1.0 per cent—common values,—the average value of j is about $\frac{7}{8}$.

450. Resisting Moment. If the amount of reinforcement is insufficient to utilize the full compressive resistance of the concrete, then the resisting moment of the beam depends upon the steel, and is

$$M_s = T jd = f_s A jd = f_s p j b d^2 \quad \dots \quad (5)$$

On the other hand, if the beam is over-reinforced, its resisting moment depends upon the concrete and is

$$M_c = C jd = \frac{1}{2} f_c b kd jd = \frac{1}{2} f_c k j b d^2 \quad \dots \quad (6)$$

To find the actual resisting moment in any particular case, the two values of M must be computed, and the smaller one taken.

451. Application of Preceding Equations. The preceding equations are all that are really necessary in solving problems involving the bending moment of reinforced concrete beams.

To determine the unit fiber stress on the steel for a given bending moment, M , solve equation 5 thus:

$$f_s = \frac{M}{A jd} = \frac{M}{p j b d^2} \quad \dots \quad (7)$$

To find the fiber stress on the concrete, solve equation 6 thus:

$$f_c = \frac{2M}{k j b d^2} \quad \dots \quad (8)$$

To find the value of f_c in terms of f_s , eliminate M between equations 7 and 8, and find

$$f_c = \frac{2f_s p}{k} \dots \dots \dots (9)$$

To determine the amount of steel required, solve equations 1 and 9, and then

$$p = \frac{\frac{1}{2}}{\frac{f_s}{f_c} \left(\frac{f_s}{nf_c} + 1 \right)} \dots \dots \dots (10)$$

Equation 10 shows that for the same values of $\frac{f_s}{f_c}$ and $\frac{E_s}{E_c}$, the ratio of the area of the steel to that of the concrete above the center of the steel is the same for all sizes of beams; that is, the amount of steel depends only upon the two ratios above.

To find the area of the beam: If the value of p adopted is less than that given by equation 10, then the area of the beam should be determined from equation 5, that is, from the relation

$$bd^2 = \frac{M}{f_s p j} \dots \dots \dots (11)$$

but if the value of p selected is more than that determined by equation 10, then the area of the beam should be determined from equation 6, that is, from the relation

$$b d^2 = \frac{2 M}{f_c k j} \dots \dots \dots (12)$$

452. Additional Information. For a description and discussion of three series of carefully conducted and comprehensive experiments, giving much interesting and instructive information concerning the strength and theory of flexure of reinforced concrete beams, see Bulletins No. 1, 4, and 14 of the University of Illinois Engineering Experiment Station.

453. T-BEAMS. Sometimes in the construction of concrete floors for buildings and bridges, the slab and the reinforced beam supporting it are constructed as a monolith; and consequently a portion of the slab on each side of the beam acts as compression area to balance the tension in the steel in the lower part of the beam. Such a member is usually called a T-beam, but sometimes a ribbed slab. In a T-beam the slab is called the flange, and the beam proper the stem.

The formulas for T-beams are more complicated than those for simple beams, because the neutral axis may be in either the flange or the stem, and it is not possible to determine which except by

trial. The computations for T-beams are further complicated by the fact that such beams are often made continuous over the supports, which produces tension on the upper side of the beam at the support and requires the introduction of reinforcement at this point.

For formulas for T-beams, see Turneaure and Maurer's Principles of Reinforced Concrete Construction, pages 78-84; and for a description and discussion of a series of carefully conducted experiments on T-beams, see Bulletin No. 12 University of Illinois Engineering Experiment Station.

454. BEAMS REINFORCED FOR COMPRESSION. Ordinarily it is more economical to carry compressive stresses by concrete than by steel; but occasionally the depth of the reinforced beam is so limited that the desired bending moment requires so much tensile reinforcement that the concrete can not safely give sufficient compressive resistance to counterbalance the tension in the steel, and consequently it is necessary to reinforce the concrete also for compression. Again, steel is sometimes placed in the compression side of a continuous beam to provide for possible negative moment; and if this steel is properly embedded, it may also take a portion of the compression. For the formulas for beams reinforced for compression, see Turneaure and Maurer's Principles of Reinforced Concrete, pages 84-89.

455. BOND BETWEEN STEEL AND CONCRETE. In order that the reinforcement and the concrete may act in unison, it is necessary that there be adhesion or bond between the steel and the concrete. Obviously, for a beam uniformly loaded the tension on the steel is a maximum at the center of the beam and decreases each way toward the end, the difference in the tension between any two points being transmitted to the concrete by the bond between the steel and the concrete. This increment (or decrement) of the tension in the steel is finally transferred to the compression area of the concrete, and becomes an increment (or decrement) to the compressive stress in the concrete above the neutral axis.

To find a formula for the bond stress proceed as follows: Let V = the total vertical shear at any section, that is, the reaction at the end support minus the load between the support and the section; and x = distance along the beam.

Differentiating equation 5, page 227,

$$\frac{dM}{dx} = \frac{dT}{dx} jd \dots \dots \dots (13)$$

But from the principles of mechanics of beams $\frac{dM}{dx} = V$; and

substituting V and transposing

$$\frac{dT}{dx} = \frac{V}{jd} \dots \dots \dots (14)$$

$\frac{dT}{dx}$ is the rate of change in the total tensile stress in the reinforcement at the section under consideration, and is for a unit of length of the beam; and measures the force that is transmitted to the concrete by the bond or adhesion. If

B = the bond per unit of area of the surface of the bar,

m = the number of reinforcing bars,

s = the surface of a bar per unit of length,

then

$$B m s = \frac{V}{jd} \dots \dots \dots (15)$$

V can be determined when the condition of loading is known, and jd can be found by equation 4, page 227, or really by equation 3, page 227; and therefore the bond stress required per unit of surface of the reinforcing rods can be determined by equation 15 above. It should be noticed that the bond stress depends upon j , which in turn depends upon the steel ratio and upon the ratio of the coefficient of elasticity of the steel to that of the concrete.

Equation 15 is for horizontal reinforcement, and if the reinforcing bars are inclined or bent up from the horizontal, the above differentiation is no longer true, since jd then becomes a variable. However, for reasons that will appear in the next section, this limitation is not important.

456. The bond is due to the adhesion of the cement and also to the gripping action of the concrete in setting; and may be determined either by applying a direct pull or push to a bar embedded in concrete, or by applying the preceding formula to the results obtained by testing a reinforced concrete beam. The following conclusions concerning bond are the results of experiments.* Difference in the size of the reinforcing rods makes little or no difference in the bond resistance. Flat bars give considerably less resistance than round ones; and bars having a surface as they come from the rolls give about twice the resistance of those having a polished surface. The bond resistance is greater for wet than for dry concrete, and is greater for rich than for lean mixtures; and increases with the age of the concrete. Since concrete setting in air contracts while that setting in water expands, it is probable that the bond is greater for

*Turneure and Maurer's Principles of Reinforced Concrete Construction, p. 33-35; Bulletin No. 8, University of Illinois Engineering Experiment Station, p. 28-33; Jour. West. Soc. Eng'rs, vol. xii, p. 100-17

concrete setting in air than in water; but this has not been proved by experiment. A small amount of rust on the steel increases the bond resistance; but if the rust is thick enough to form scales, it greatly decreases the bond. After the bond has been broken, plain rods give a frictional resistance of about two thirds of the original bond resistance.

The bond stress for plain round mild steel rods in beams failing by tension of the steel varied from 70 to 193 lb. per sq. in.; while applying a direct pull to similar bars embedded in similar concrete gave bond resistances from 200 to 500 lb. per sq. in.* Other experimenters get results for the direct tests running as high as 750 lb. per sq. in. for plain round rods, while the results for deformed bars (§ 465) are still higher. Only a few experiments have been made to determine the bond resistance developed in a beam under stress, but apparently the value thus determined is only about 70 per cent of that obtained by direct experiment. However, it is safe to conclude that a beam reinforced with plain round steel bars is ordinarily in no danger of failing through insufficient bond between the steel and the concrete; in other words, at the time when a beam fails by tension in the steel, the factor of safety of the bond resistance is $2\frac{1}{2}$ to 4 for ordinary structural steel, and $1\frac{3}{4}$ to $2\frac{1}{2}$ for steel having an elastic limit of 55,000 lb. per sq. in.†

457. Before the laws of flexure of reinforced concrete were clearly understood, there were introduced a number of special or deformed bars whose surface has such a shape as to increase the bond stress considerably. Several of the more common of these bars are shown in Fig. 28, page 236. Since plain bars ordinarily give more than enough bond resistance to develop the elastic limit of the steel, it is clear that generally there is no advantage in these special forms, the only exception being for short, heavily loaded beams in which there is not space for sufficient embedment of the rods to develop the required bond stress with plain steel rods (see § 472). Some constructors employ deformed bars where the concrete is to set under water (see § 456).

A misinterpretation of the cause of failures of reinforced concrete beams seemed to show that the failure was due to the slipping of the reinforcing rod in the concrete; but the true interpretation probably is that the slipping was the result and not the cause of the failure, i.e., the slipping took place after failure due to some other cause.

458. VERTICAL SHEAR. In the common theory of flexure it is assumed that the vertical shear is uniformly distributed over a vertical cross section of the beam, and that therefore the unit shearing stress

* Bulletin No. 4, University of Illinois Engineering Experiment Station, p. 25.

† Prof. A. N. Talbot in Jour. West. Soc. of Eng'rs, vol. ix, p. 404.

at any section is equal to the total vertical shear divided by the area of the section. But it is known that at any point of a beam there exists both vertical and horizontal shearing stresses which vary in intensity from the neutral surface to the tension and compression sides of the beam, and that at any point the vertical shearing unit stress is equal to the horizontal shearing unit stress. The common theory of flexure neglects the horizontal shearing stresses, and thereby errs on the side of safety. It is proposed to make an investigation to see whether or not the horizontal shearing stresses may be neglected in reinforced concrete beams.

In a reinforced concrete beam, the bond stresses transmitted to the concrete are the increments of the tensile stress in the reinforcing bars, and the horizontal shearing stress in the concrete transfers these tensile increments to the compressive increments of the compression area of the concrete. The amount of horizontal tensile stresses transmitted from the reinforcing bars per unit of length of beam is, by equation 15, page 230,

$$B m s = \frac{V}{jd}.$$

This stress is distributed over a horizontal section of the beam just above the reinforcing bars, and is uniform between the top of the bars and the neutral axis. From the principles of the mechanics of a beam, the horizontal shear is a maximum at the neutral axis; and therefore the above is the maximum horizontal shear. Calling v the maximum horizontal unit shearing stress, and b the breadth of the beam, the maximum resistance per unit of length of the beam then is bv . Therefore, $bv = B m s$, and

$$v = \frac{V}{bjd} \quad \dots \quad (16)$$

Since j is usually about $\frac{7}{8}$, $v = \frac{8V}{7bd}$ approximately; or the actual maximum unit vertical shearing stress is about one seventh more than if the shearing stress were considered as being uniformly distributed over a vertical section extending from the top of the beam to the center of the reinforcement.

The maximum unit shearing stresses developed in reinforced concrete beams, as computed by equation 16 above, is very much less than the shearing strength of concrete. In a series of eleven beams, v varied from 86 to 151 lb. per sq. in.; and in another series of nine beams, from 66 to 126;* while the shearing strength of the concrete was eight or ten times the largest of these values (see Tables

* Bulletin No. 4, University of Illinois Engineering Experiment Station, p. 48, 50.

39 and 40, pages 205 and 206). Therefore, in view of the above, and also since the conditions in the beam are more favorable for developing a high value of the shearing stress than in any form of direct test yet devised, it is not likely that a reinforced concrete beam will fail by shear.

459. DIAGONAL TENSION. Reinforced concrete beams are sometimes said to fail by shear when they really fail by diagonal tension. The latter method of failure will now be considered.

In treatises on the mechanics of materials, it is shown that at any point in a beam there are not only the vertical and horizontal shearing stresses discussed in the preceding section, but also tensile or compressive stresses in every diagonal direction. It is proved in treatises on mechanics of materials that if z = the horizontal unit tensile stress at any point in a beam, v = the vertical (or horizontal) unit shearing stress, and t = the maximum tensile stress at that point, then

$$t = \frac{1}{2}z + \sqrt{\frac{1}{4}z^2 + v^2} \quad . \quad . \quad . \quad (17)$$

The direction of the maximum diagonal stress makes an angle with the horizontal equal to half of the angle whose tangent is $\frac{2v}{z}$.

In computing the maximum bending moment, only the horizontal component of the diagonal tension was considered, because at the point where the maximum bending occurs the vertical component is zero; and in computing the maximum shear in the preceding section, the tension in the concrete was omitted because its effect in the distribution of the shear is very small. But in investigating certain methods of failure of reinforced concrete beams, it is necessary to consider the diagonal tension.

When the diagonal tensile stress in a reinforced concrete beam becomes as great as the tensile strength of the concrete, the beam will fail in diagonal tension, provided there is no metallic web reinforcement. The characteristic form of failure by diagonal tension is a crack near the quarter point, starting at the lower side of the beam and running diagonally upward toward the center. In computing the maximum resisting moment of a reinforced concrete beam, it is rightly assumed that the steel takes all of the tension; but at points near the end of the beam the bending moment is less than at the center and the concrete may resist some of the horizontal tension.

To illustrate an approximate method of computing this stress, assume that the stress in the steel at a particular point is 3,000 lb. per sq. in., that the modulus of elasticity of the steel is 30,000,000 and of the concrete 1,500,000, and that the unit shearing stress in the lower part of the beam at the same section is 100 lb. per sq. in. Then

the horizontal tension on the concrete at the level of the steel will be

$$3,000 \times \frac{1,500,000}{30,000,000} = 150 \text{ lb. per sq. in.};$$

and from equation 17 above, the maximum diagonal tension

$$t = \frac{1}{2} (150) + \sqrt{\frac{1}{4} (150)^2 + (100)^2} = 200 \text{ lb. per sq. in.}$$

This stress is at least approaching the ultimate tensile strength of concrete (see Table 36, page 202), and shows the possibility of a beam's failing by diagonal tension. Only relatively short and deep beams are likely to fail by diagonal tension. The above diagonal stress makes an angle with the horizontal of $26\frac{1}{2}^\circ$ —half the angle whose tangent is $2v \div z$.

The diagonal tensile stresses may be reduced by keeping the horizontal tension in the concrete, z , low by the use of a large area of steel at points where the shear is great, or by making the depth of the beam great and thereby reducing the unit vertical shear, v . A beam may be reinforced for diagonal tension in either of two ways, viz.: (1) by bending up part of the reinforcing rods at the ends of the beams into a diagonal position, or (2) by introducing special web reinforcement, which may be either vertical or inclined (see § 466).

460. THE REINFORCEMENT. There are numerous systems of reinforcing concrete, which differ from each other in regard to the form, quality, or position of the metal used; but as many of the systems were proposed before the fundamental principles governing the strength of reinforced concrete were discovered, no description of them will be given here.*

461. Quality of the Steel. Various grades of steel are used. The physical properties of the three grades ordinarily employed are as follows:

	Soft.	Medium.	Hard.
Elastic Limit, lb. per sq. in.	30-35,000	35-40,000	50-60,000
Ultimate Strength, lb. per sq. in.	50-60,000	60-70,000	80-100,000

Experiments with reinforced concrete beams show that the elastic limit, and not the ultimate strength, is the proper basis for determining the working load on the steel or for fixing the factor of safety,—as was to be expected.

462. There has been considerable discussion as to the relative merits of soft and hard steel for reinforcement, although the advantages seem to be in favor of soft steel.

The advantages of hard steel are: 1. Its greater elastic limit

* For an extended account of the various systems, particularly those employed in Europe, see Christophe's *Le Béton Armé et ses Applications*, 1902, p. 10-72. This is the first book published on reinforced concrete.

permits a greater unit working stress, and hence allows the use of a less amount of steel. However, the smaller the diameter of the rod, the higher the price per pound. 2. For the same sizes, hard or high-carbon steel is usually 10 or 15 per cent cheaper than soft steel, since it is usually made by re-rolling Bessemer steel rails.

The advantages of soft steel are: 1. It is more uniform in quality, and hence more reliable. 2. It is ordinarily more easily obtained. 3. It is more readily bent or welded. 4. Soft steel resists impact stresses better. 5. The concrete is less likely to crack. The modulus of elasticity for all grades of steel is substantially the same, and hence the stretch of any grade of steel will be proportional to the unit working load; and, therefore, since the concrete and the steel stretch together, the use of soft steel with a lower unit working stress is less likely to produce unsightly cracks on the tension side of the beam. 6. For the same size of rods, soft steel gives the larger ratio of adhesive strength or bond resistance to tensile strength.

463. Amount of Steel. The amount of steel required to resist the bending moment of a beam can be computed by equation 10, page 228; and is dependent solely upon the ratios of the unit working stresses in the concrete and the steel, and of the coefficients of elasticity of these two materials. The amount of steel used in ordinary practice for balanced reinforcement (that in which the steel is just enough to develop the full strength of the concrete) varies from 1 to $1\frac{1}{2}$ per cent of the area of the concrete above the center of the reinforcement for soft steel, and from 0.75 to 1 per cent for high carbon steel. However, repeated experiments * show that the latter amount is insufficient to develop the full compressive resistance of a well-made concrete composed of 1 volume loose portland cement, 3 volumes well-graded sand, and 6 volumes of well-graded limestone (for packed cement the above proportions are equivalent to $1 : 3\frac{1}{2} : 7\frac{1}{2}$).

464. Beam Reinforcement. The reinforcing steel must be of such form and size that it can easily be encased in the concrete; and to prevent undue concentration of stress on the concrete, the steel should be in comparatively small sections. However, if the rods are made extremely small, they are likely to be so close together as to interfere with the placing of the concrete. Round rods are preferable to either square or flat bars, since they can be embedded in the concrete more easily and more completely. The rods should be straight or nearly so, as otherwise a pull will straighten and lengthen them, and thereby break the bond with the concrete. Wire cables are sometimes used as reinforcement; but for the reason just stated, they are not as suitable as solid rods. The reinforcement for beams is usually rods varying from $\frac{1}{4}$ or $\frac{3}{8}$ inch in diameter to $1\frac{1}{2}$ or 2 inches.

* Bulletin No. 4, University of Illinois Eng'g Exp't Station, p. 24.

465. Before the relations existing in a reinforced-concrete beam between the shearing strength, the bond stress, and the resisting moment were clearly understood, there were introduced in this country a number of patented bars having surfaces designed to increase the bond between the steel and the concrete. Such bars,

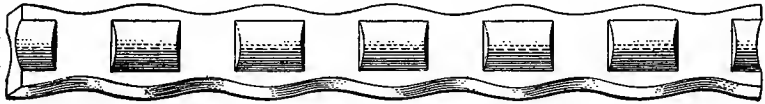

a. Corrugated Flat Bar.

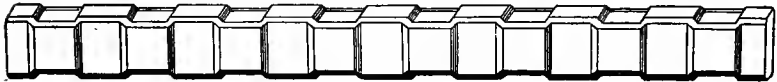

b. Corrugated Square Bar.

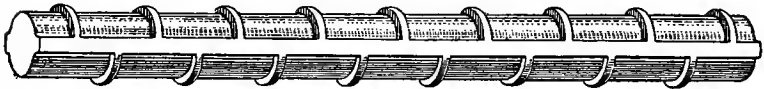

c. Corrugated Round Bar.



d. Diamond Bar.

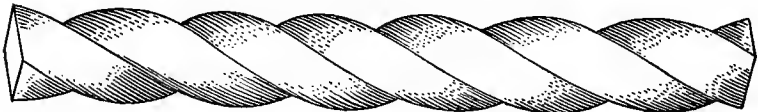

e. Twisted Bar.

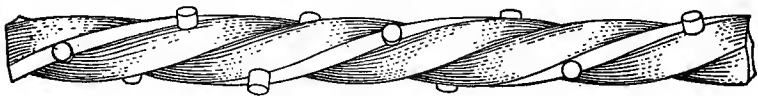

f. Twisted Lug Bar.

FIG. 28.—TYPICAL DEFORMED BARS.

usually called deformed bars, have been used extensively in America, but hardly at all in Europe. Fig. 28 shows six of the many deformed bars on the market. Notice that the first is flat, the second square, and all of the others round, although *e* and *f* were square before being twisted. Deformed bars are required as a rule only for short, heavily loaded beams (§ 456).

466. Web Reinforcement. In § 459 it was shown that under certain conditions, beams are liable to fail by diagonal tension unless provided with web reinforcement. Theoretically, the best method of reinforcing against diagonal tension failures is to place the steel in the line of the greatest stress; but as the direction of the diagonal tension changes from point to point, this condition can not be exactly fulfilled. However, it is enough to place sufficient steel so that it will carry a considerable component of the diagonal tension. There are several methods of placing web reinforcement.

1. The most common method is to use several rods for the horizontal reinforcement, and bend one or more of them upward as they approach the end of the beam,—where they are not needed to resist bending and where they are needed to resist diagonal tension. Two of the many variations of this method are shown in *a* and *b*, Fig. 29, page 238. The bent rods often pass over the support and thus aid in fixing the end of the beam, in which case the rods at the top and near the ends of the beam resist tension. An objection to using the bent rod to resist diagonal tension is, that to have a sufficient number of bent rods requires so many horizontal rods that near the center of the beam they are so close together as to interfere with the placing of the concrete.

2. Short rods, vertical or inclined, may be placed at points along the beam and extend from the horizontal reinforcing rods up into the concrete. It is desirable, but not vitally necessary, that they be fastened to the main rods. On account of the difficulty of placing the short rods, this is not a common method of web reinforcement.

3. In Europe a very common form of web reinforcement consists of some form of loops made of a bar or band, usually called stirrups, placed vertically with the loop passing under the horizontal reinforcing rods. The horizontal distance between these stirrups decreases from the center toward the end of the beam. Four of the most common arrangements of stirrups are shown in *c* and *d*, Fig. 29. The Hennebique system, which has been frequently used both in Europe and America, combines the bent rod and the stirrup. The stirrups would be more efficient if leaned at 45° toward the end of the beam, but it is difficult to put and keep them in this position. Sufficient experimental work has not been done to discover the law of the size and the spacing of the stirrups. The only rule in use for spacing the stirrups is the following somewhat indefinite empirical one: Make the distance of the first stirrup from the end of the beam one fourth of the depth of the beam, the second from the first one half of the depth, the third from the second three quarters of the depth, and the fourth from the third equal to the depth of the beam. Sometimes the stirrups are placed only near the end of the beam as

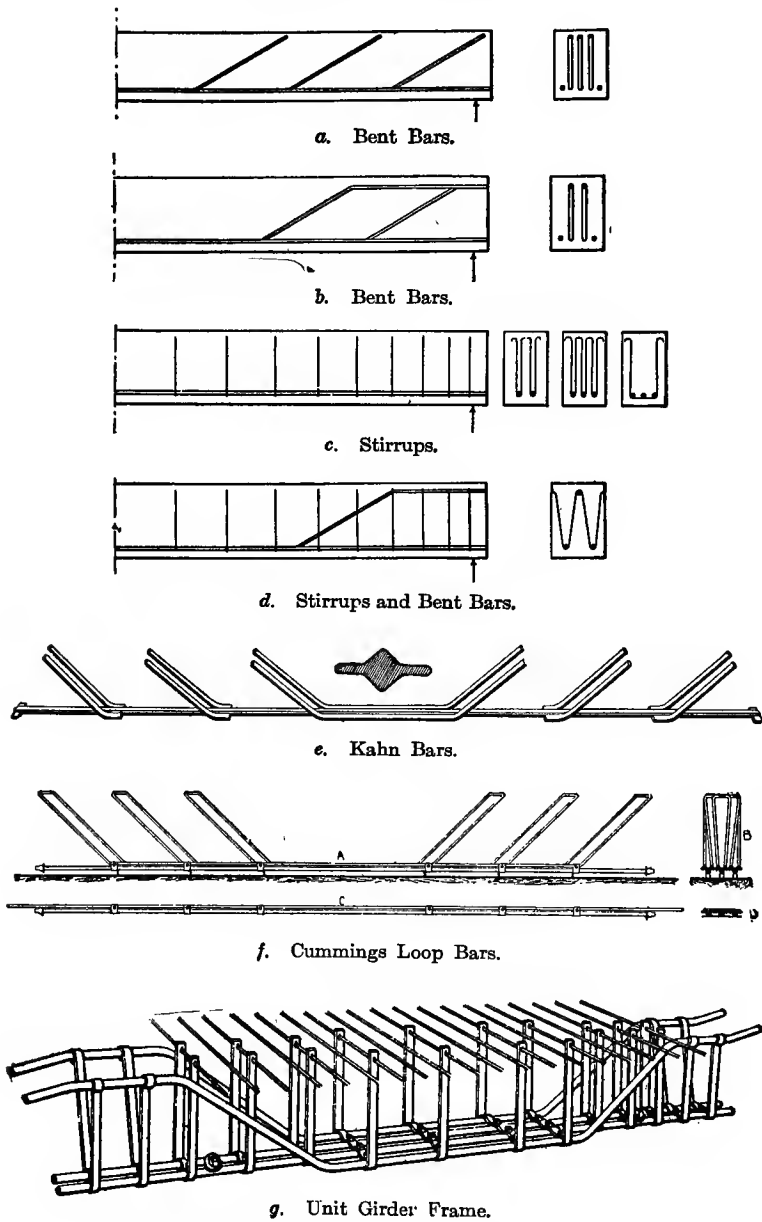

FIG. 29.—TYPICAL EXAMPLES OF WEB REINFORCEMENT.

above, and sometimes they are spaced equally distant from the fourth one as above to the center of the beam. Obviously the distance between the stirrups should vary somewhat with the span, but the law has not been worked out. The efficiency of a stirrup depends upon its bond resistance; and hence, as its length is not great, it should be looped or anchored at its upper end.

4. *e*, Fig. 29, shows the Kahn bar which resists both horizontal and diagonal tension. It is in effect a system of inclined stirrups firmly attached to the body of the bar. The bar is rolled of the cross section shown, after which the fins are sheared from the bar for a portion of their length and then bent to the desired angle. This bar is in very common use in America. It is frequently bent up at its ends as described in paragraph 1 above.

5. *f*, Fig. 29, shows the Cummings loop bars. *A* shows the bars in position to receive the concrete, *B* is an end view, and *C* and *D* show the bars knocked down ready for shipment. These bars are made in a variety of sizes, widths, and lengths.

6. The difficulty of placing a number of bent bars properly led to the invention of the system shown in *g*, Fig. 29, called the unit girder-frame system.

7. There is a more elaborate form of the type shown in *g*, Fig. 29, in which the individual members of a frame are connected to each other by a pin, and the ends of two adjoining frames are connected together by a link and pin. This is known as the pin-connected girder-frame system.

467. Slab Reinforcement. The reinforcement for slabs is usually rods, woven or welded wire-net, or expanded metal. In one style of floor construction the reinforced concrete slab rests upon the beams or girders, in which case the reinforcing rods may run in one direction or in two directions at right angles to each other. In another, but less common, form of construction, called the mushroom system, there are no beams or girders; and the reinforcing rods run from column to column in two directions at right angles to each other and also from column to column in both diagonal directions.

In reinforced concrete floor-construction the slabs are frequently fixed at all four edges, in which case the calculation of the stress is quite difficult and somewhat uncertain. For an approximate solution of this problem, see Turneaure and Maurer's *Principles of Reinforced Concrete Construction*, pages 240-44. The formulas for a steel plate fixed at two or four edges (see Lanza's *Applied Mechanics*, 9th ed., pages 909-22) are frequently applied to continuous concrete slabs, although there is serious question whether they are applicable, since steel has equal tensile and compressive resistance in all direc-

tions and on both faces, while reinforced concrete does not have. Taylor and Thompson's Concrete Plain and Reinforced, pages 317-17c, gives tables of safe loads for slabs fixed at two and at four edges.

468. THE CONCRETE. The best grade of concrete should be used in reinforced concrete, since the higher the allowable compressive stress the shallower and usually the cheaper the beam. Some slightly approximate computations* seem to show that it is better to use a 1 : 2 : 4 mixture for which the safe working stress at a month is 500 lb. per sq. in. than a 1 : 3 : 6 mixture for which the safe working stress is 350 lb. per sq. in., unless the latter is 10 per cent the cheaper. A rich mixture is particularly desirable, if no metallic web reinforcement is used, to lessen the danger of failure in diagonal tension.

The maximum size of the aggregate is usually limited to $\frac{3}{4}$ or 1 inch, and the concrete is mixed wet or sloppy.

469. WORKING STRESS FOR BEAMS. Impact of Live Load. It is well known that the live load, owing to its motion or impact, produces greater stresses than the same load at rest; but the amount of this increased effect is largely a matter of judgment. The effect of the live load will depend chiefly upon the relative live-load and dead-load stresses on the member under consideration. In computing the stresses in certain parts of railroad bridges, the impact effect of the live load is assumed to add 100 per cent to the stresses; but in reinforced concrete work, the effect of impact is likely to be much less than this. *In fixing safe unit working stresses it will be assumed that the live load has been increased by some per cent of itself to reduce it to an equivalent static load.*

470. Tension in Steel. The safe working stress of the steel is usually taken at 40 per cent of the elastic limit, or for soft steel (see § 462) at 15,000 or 16,000 lb. per sq. in. There is only a little gain in economy in using steel having a high elastic limit at a greater stress than 16,000 lb. per sq. in.

471. The Joint Committee on Reinforced Concrete of four national engineering societies recommend that "the tensile stress in the steel shall not exceed 16,000 lb. per sq. in."†

472. Bond Stress. The ultimate bond strength of plain round soft steel bars is about 250 to 400 lb. per sq. in. of surface of contact, and the usual working stress is 75 lb. per sq. in. Assuming a bond stress of 75 and a tensile stress of 15,000, the length a round rod must be embedded if it is to develop its full working stress is $(15,000 \times \frac{1}{4}d^2) \div (75 \times d) = 50$ diameters. For a large rod and a short beam it might be impossible to secure an embedment that would develop the entire strength of the rod, in which case the end of the rod should

* Trans. Amer. Soc. C. E., vol. lvi, p. 385.

† Proc. Amer. Soc. of C. E., February, 1909, p. 106-07.

be anchored by bending a short piece at the end at right angles to the body of the bar or better by passing the rod through a steel plate, or a deformed bar should be used. The bending of the rod to make it act as web reinforcement also increases its bond resistance.

473. The Joint Committee recommend: "The bond stress between concrete and plain reinforcing bars may be assumed at 4 per cent of the compressive strength at 28 days, or 80 lb. per sq. in. for 2000-lb. concrete; and in the case of drawn wire, 2 per cent or 40 lb. per sq. in. for 2000-lb. concrete."

474. Compression in Concrete. The safe working stress on the extreme fiber of the concrete at a month is usually assumed at 500 or 600 lb. per sq. in., and occasionally at 700 lb. per sq. in. Numerous tests of beams failing by compression in the concrete show a compressive strength greater than that usually obtained with cubes. On the other hand, the strength of concrete for a repeated load is less than for a once-applied load. Of course, the concrete grows stronger with age; but if the reinforcement is designed to develop the full strength of the concrete at a month, the safe strength of the steel limits the safe strength of the beam, and hence the strength of the beam does not increase with age. Apparently this relation is sometimes overlooked.

475. The recommendation of the Joint Committee is: "The extreme fiber stress of a beam, calculated on the assumption of a constant modulus of elasticity for concrete under working stresses, may be allowed to reach 32.5 per cent of the compressive strength at 28 days, or 650 lb. per sq. in. for 2000-lb. concrete. Adjacent to the support of continuous beams stresses 15 per cent higher may be used."

476. Shear in Concrete. If a beam has no web reinforcement, the unit vertical shear should be kept low to prevent failure by diagonal tension; but if the beam has web reinforcement, the unit vertical shear may be considerably larger. For the first case the unit vertical shear, as computed by equation 16, page 232, may be taken at 40 lb. per sq. in.; and for the second case at 100 lb. per sq. in.

477. The Joint Committee recommend: "Where pure shearing stress occurs, that is, uncombined with compression normal to the shearing surface, and with all tension normal to the shearing plane provided for by reinforcement, a shearing stress of 6 per cent of the compressive strength at 28 days, or 120 lb. per sq. in. on 2000-lb. concrete, may be allowed. In calculations of beams in which diagonal tension is considered to be taken by the concrete, the vertical shearing stresses should not exceed 2 per cent of the compressive strength at 28 days, or 40 lb. per sq. in. for 2000-lb. concrete."

478. Coefficient of Elasticity of Concrete. Table 41, page 207, shows the values of the coefficient of elasticity as obtained from compression tests of 12-inch cubes. These results are given to show the effect of age and composition upon the coefficient; but they are not as suitable for use in beam formulas as results deduced from experiments upon beams, since the restraint upon the concrete in the two cases is quite different, and also since the coefficient deduced from beam experiments has been employed in adjusting the constants in the formulas for the strength of beams to make the computed results agree with those obtained by experiments.

Numerous beam experiments by Professor Talbot* show that for a 1 : 3 : 6 limestone concrete about 60 days old and the straight-line stress-deformation relation, the coefficient should be taken at not more than 2,000,000 lb. per sq. in. Turneaure and Maurer recommend 2,000,000 as a minimum (apparently for a 1 : 3 : 6 concrete) and 3,000,000 as a maximum (apparently for a 1 : 2 : 4 concrete). It is usual to consider the coefficient = 2,000,000, i.e., to consider $E_s \div E_c = 15$.

479. FIREPROOFING. It is usual to make the concrete below the reinforcement $1\frac{1}{2}$ to 2 inches thick in beams, and $\frac{1}{2}$ to 1 inch in slabs. This layer of concrete frequently acts as fireproofing, and is often so called; but it also has another important function—that of holding the steel reinforcement in place and enabling it to transmit stress to the concrete above it. The above allowance gives reasonable protection from fire, and is sufficient to hold the steel in place.

480. ECONOMIC DESIGN OF BEAMS. The most economic proportion of steel depends upon (1) the relative cost of a cubic unit of the steel and the concrete, (2) the ratio of the coefficients of elasticity of the two materials, and (3) the unit working stress for each material. The problem of determining the most economical proportion of steel is capable of a mathematical solution; but different results are obtained according to which one of the two following initial assumptions is made: (A) the stress in the concrete is constant or (B) the stress in the steel is constant; and also according to which one of the three following limiting conditions of design is assumed; (a) breadth of beam constant, (b) depth of beam constant, (c) ratio of breadth to depth constant. Finally the results differ still further according to the beam formula employed (§ 445).

The only practicable method of solving the problem is to make a solution for both of the conditions A and B for each of the conditions a, b, and c, using the values for the ratios 1, 2, and 3 above that fit the case in hand; and then by inspection select the most economical result. For an example of such a solution, see

* Bulletin No. 4, University of Illinois Eng'g Exp. Station, p. 71-72.

TABLE 45.
STRENGTH OF PLAIN CONCRETE COLUMNS.*

REF. No.	PROPORTIONS OF CONCRETE.	AVERAGE AGE WHEN TESTED, days.	NO. OF TESTS.	AVERAGE ULTIMATE STRENGTH, lb. per sq. in.
1	1 : 1½ : 3	64	2	2 300
2	1 : 2 : 4	65	7	1 740
3	1 : 3 : 6	62	2	1 032
4	1 : 4 : 8	63	2	575
5	1 : 2 : 4	192	6	2 025
6	1 : 2 : 3½	14 mo.	2	2 710

Fig. 30 shows that cement is an effective reinforcing material. For example, a cubic yard of 1 : 2 : 4 concrete will require 0.42 barrel of cement more than a 1 : 3 : 6 mixture, and will therefore cost 10 or 15 per cent more; but the strength of the 1 : 2 : 4 column is 168 per cent of that of a 1 : 3 : 6 mixture. If only compressive resistance is required, it is more economical to use an increased amount of cement than to employ any form of steel reinforcement; but in practice columns are subjected to bending moments, and plain concrete, owing

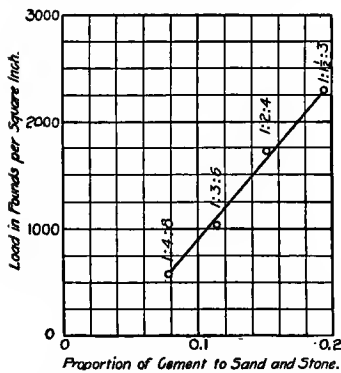

FIG. 30.—RELATION BETWEEN THE STRENGTH OF CONCRETE COLUMNS AND THE AMOUNT OF CEMENT.

to its small tensile strength, is not suitable for use where tensile stresses are to be resisted. Therefore steel reinforcement, which will aid the column in resisting bending moments, is advantageous. Further, steel is a more reliable material than concrete; and hence steel reinforcement is particularly advantageous in small columns, where spots of improperly proportioned or badly mixed concrete are relatively more serious.

485. COLUMN REINFORCEMENT.

Columns are reinforced in either of two ways: (1) by longitudinal rods extending the full length of the column, and (2) by circumferentially wound metal. In the first case the steel supports a portion of the load directly; and in

* Bulletin No. 20, University of Illinois Eng'g Exp. Station, p. 20.

the second the steel gives lateral support to the concrete and thereby increases its load-carrying power.

The longitudinal reinforcement may be either plain rods, deformed bars, or Kahn bars; and is occasionally a light lattice column, made heavy enough to carry the forms of the story above.* If only one rod is used, it is placed at the center; and if several are used, they are placed symmetrically about the center and usually about 2 inches from the outside of the column. The circumferential reinforcement is usually either a succession of hoops or a spirally wound wire or round rod or flat bar; but sometimes it is a cylinder of wire net or expanded metal. The circumferential reinforcement is placed outside of the column proper, although in practice about 2 inches of concrete or mortar is placed outside of the steel for fire protection.

Usually the two methods are used together, the longitudinal rods being bound together transversely at intervals, and the hoops or the spiral being held in position by vertical spacing-bars which are often so large as to give considerable longitudinal reinforcement.

486. THEORY OF LONGITUDINAL REINFORCEMENT. To compute the strength of a column having longitudinal reinforcement, let

A = the total cross section of the column,

A_s = the cross section of the steel,

f_c = the unit working stress in the concrete,

n = ratio of the modulus of elasticity of the steel to that of the concrete at a stress f_c as determined from gross deformation = $E_s \div E_c$,

P = the total safe strength of the column,

p = the ratio of steel to total area = $A_s \div A$.

Assuming that the steel and the concrete adhere together, the ratio of the unit stress in the steel to that in the concrete will be equal to the ratio of the coefficient of elasticity of the steel to that of the concrete for the stress f_c as determined from gross deformations; and therefore the unit stress in the steel will be $n f_c$, and the total stress in the steel will be $n f_c A_s = n f_c pA$. The area of the concrete is $A - pA$, and the total stress in the concrete is $f_c A (1-p)$. Consequently the total strength of the column,

$$P = n f_c pA + f_c A (1 - p)$$

$$= A f_c [1 + (n - 1) p] \quad . \quad . \quad . \quad (2)$$

The above equation shows that the strength of a reinforced concrete column varies as the unit stress in the concrete, but not

* For illustrations of examples see Trans. Amer. Soc. C. E., vol. lx, p. 443-504, particularly p. 445, 483-86.

directly, since the higher f_c for any particular grade of concrete the lower E_c and hence the lower n . A high grade concrete which will permit the use of a higher value of f_c , will give a higher value of E_c and hence a higher value of n .

The term $(n-1)p$ shows the effect of the steel. For example, if $n = 15$ and $p = 0.01$, $(n-1)p = 0.14$, which shows that 1 per cent of reinforcement adds 14 per cent to the strength of the plain concrete column. The greatest relative effect of the steel occurs with poor concrete of low modulus. The unit stress in the steel = $n f_c$; and since n usually varies from 10 to 15, and f_c from 300 to 500, the stress in the steel will vary from 3,000 to 7,500 lb. per sq. in., and consequently the stress in the steel reinforcement will always be relatively low.

487. Experiments show that there is no material difference in the strength of a column whether it is reinforced with plain, deformed, or Kahn bars; and also that there is practically no difference between weak and strong lateral connection between the longitudinal reinforcing bars.

488. THEORY OF CIRCUMFERENTIAL REINFORCEMENT. If a material is subjected to compression and restrained laterally, lateral compressive stresses will be developed which tend to neutralize the principal compressive stresses and thus increase the resistance to rupture. If the lateral stresses were equal to the principal stresses, there would be no rupture because there could be no shear. The effectiveness of the lateral restraint depends upon the ratio of the lateral to the longitudinal deformation of the material. This ratio is known as Poisson's ratio. Apparently the only experiments made to determine Poisson's ratio for concrete are those by Prof. A. N. Talbot, which gave values from 0.10 to 0.16 for a 1 : 2 : 4 concrete 60 days old at ordinary working loads, with values as high as 0.25 or 0.30 near the ultimate strength.*

Knowing Poisson's ratio it is possible to deduce the relation between the lateral and the longitudinal stresses, and also the portion of the longitudinal stress left unbalanced. Let

u = Poisson's ratio,

C = the total longitudinal unit stress, in lb. per sq. in.,

c = the excess of the longitudinal over the lateral compressive unit stress—the only portion of C that is significant,

f_s = the unit tensile stress in the steel, in lb. per sq. in.,

p = the ratio of the area of the steel to the total area of the column, the steel being considered as a thin cylinder surrounding the concrete,

* Bulletin No. 20, University of Illinois Eng'g Exp. Station, p. 47.

n = the ratio of moduli of elasticity determined as in § 486.
It can be shown* that

$$C = c \left(1 + \frac{u n p}{2 + n p (1 - 2u)} \right) \quad \dots \quad (3)$$

$$f_s = \frac{2 u n c}{2 + n p (1 - 2u)} \quad \dots \quad (4)$$

If there is no reinforcement $p = 0$, and hence from equation 3, $C = c$. If $p = 0.01$ (1 per cent), and u be taken at 0.16 (its maximum value for working stresses) and n at 20 (its maximum), then $C = 1.015c$. In other words, under the most favorable circumstances, steel equivalent to 1 per cent of the area of the column increases the working strength of the concrete only 1.5 per cent; whereas 1 per cent of longitudinal reinforcement increased the strength 14 per cent (see § 486). From equation 4 it is seen that with the values assumed above, the unit stress in the steel is only $3.00c$, or say $3.00 \times 500 = 1,500$ lb. per sq. in. These examples are extreme cases chosen to show (1) that circumferential reinforcement is not nearly as efficient as the same amount of metal used as longitudinal reinforcement, and (2) that with circumferential reinforcement only comparatively small stresses can be developed in the steel with ordinary working stresses in the concrete. These conclusions are borne out by experiments. Tests made by Professor Talbot† show that with a 1 : 2 : 4 concrete 60 days old, a stress of 800 lb. per sq. in. in the concrete developed only 1,100 lb. per sq. in. in the steel.

However, although circumferential reinforcement adds but little to the safe working strength of a column, it adds materially to its ultimate strength. When the load on the column reaches the ultimate strength of the corresponding plain concrete column, the amount of shortening increases very rapidly and the lateral expansion increases correspondingly rapidly. During this stage the elasticity of the reinforcement imparts to the column as a whole a considerable degree of elasticity. The shortening of the circumferentially reinforced column at its maximum load is six to twelve times that of a plain concrete column at its maximum load. The effect of circumferential reinforcement on the ultimate strength of the column is two to three times as great as would be caused by the same amount of longitudinal reinforcement; but the excessive amount of shortening and the liability to lateral deflection make it doubtful whether this increase in strength can be utilized

* Turneure and Maurer's Principles of Reinforced Concrete Construction, p. 110-11.

† Bulletin No. 20, University of Illinois Eng'g Exp. Station, p. 29.

to any great extent in ordinary practice. Circumferentially reinforced columns exhibit a greater toughness near their maximum load than either plain or longitudinally-reinforced concrete columns, but do not have as great stiffness at working loads.

489. Empirical Formulas for Circumferentially Reinforced Columns. The ultimate compressive strength of a 1 : 2 : 4 concrete column reinforced with bands is expressed by the empirical formula

$$C = 1,600 + 65,000p \quad . \quad . \quad . \quad . \quad . \quad (5)$$

and that of columns having spiral reinforcement by

$$C = 1,600 + 100,000p^* \quad . \quad . \quad . \quad . \quad . \quad (6)$$

C and p have the significance stated in § 488. The first term of the above equations is the unit ultimate strength of a 1 : 2 : 4 plain concrete column; but the second terms are practically the same for a 1 : 1½ : 3 or a 1 : 4 : 8 concrete. There is no material difference between mild and high-carbon reinforcement.

490. WORKING STRESS FOR COLUMNS. Compression on Concrete. A comparison of the results in Table 45, page 244, with those in Tables 29 (page 195), 30 (page 196) and 31 (page 197) shows that concrete in the form of a column is not as strong as in a cube—doubtless because of the less restraint;—and a comparison of Table 45 with the results of tests of beams shows that the compressive strength of concrete is greater in a beam than in a column. In consideration of the above facts it is not safe to assume that the ultimate strength of a 1 : 2 : 4 concrete column 30 days old is more than 1,600 lb. per sq. in. To determine the strength of other proportions or other ages apply the proper ratio from Tables 32 (page 198) and 33 (page 199), respectively. In consideration of the effect of impact and of repetition of the load and also of the danger of improper proportions or of poor mixing, it is not safe to use a less factor of safety than four; and therefore the safe unit working stress for a 1 : 2 : 4 concrete 30 days old should not be taken at more than 400 lb. per sq. in.

491. The recommendation of the Joint Committee is: "For concentric compression on a *plain* concrete column or pier, the length of which does not exceed 12 diameters, 22.5 per cent of the compressive strength at 28 days, or 450 lb. per sq. in. on 2000-lb. concrete, may be allowed. For columns with the several types of reinforcement the following working stresses are recommended:

"*a.* Columns with longitudinal reinforcement only, the unit stress as in the paragraph above. Bars composing longitudinal reinforcement shall be straight, and shall have sufficient lateral support to be securely held in place until the concrete has set. In

* Bulletin No. 20, University of Illinois Eng'g Exp. Station, p. 43.

all cases, longitudinal steel is assumed to carry its proportion of stress.

“*b.* Columns with reinforcement of bands or hoops, stresses 20 per cent higher than given for *a.* Where bands or hoops are used, the total amount of such reinforcement shall not be less than 1 per cent of the volume of the column inclosed. The hoops or bands are not to be counted upon directly as adding to the strength of the columns. The clear spacing of such bands or hoops shall not be greater than one fourth of the diameter of the inclosed column. Adequate means must be provided to hold the bands or hoops in place, so as to form a column the core of which shall be straight and well centered.

“*c* Columns reinforced with not less than 1 per cent and not more than 4 per cent of longitudinal bars and with bands or hoops, stresses 45 per cent higher than given for *a.*

“*d.* Columns reinforced with structural steel-column units which thoroughly encase the concrete core, stresses 45 per cent higher than given for *a.*”

492. Tension in Steel. Since, for ordinary working stresses in the concrete, the stress in the steel with either longitudinal or circumferential reinforcement is much less than the ordinary working stress of even low steel, no consideration need be given here to the unit working stress of that material.

493. Coefficient of Elasticity of Concrete. The value of the modulus of elasticity of concrete to be used in computing the strength of a reinforced column is that for gross deformations for the unit working stress f_c , and is less than that computed from elastic deformations (Table 41, page 207); and since it is wise to employ a rich concrete in columns, the modulus should be taken at 2,500,000 to 3,000,000 lb. per sq. in. for concrete 30 days old.

494. Factor of Safety of Column. The unit stress in the steel of a longitudinally reinforced column is n times the unit stress in the concrete (see § 486), and since n increases as the stress in the concrete, it follows that at the ultimate load the steel takes a greater proportionate stress than at working loads; and consequently the ultimate strength of the column is greater than the working load multiplied by the factor of safety of the concrete, that is, the factor of safety of the column will be greater than the factor of safety of the concrete. A further result of the fact that as the load increases the stress taken by the steel increases, is that the factor of safety increases with the percentage of steel.

ART. 3. DETAILS OF CONSTRUCTION.

495. Within the space here available it is not possible to give a comprehensive discussion of this branch of the subject; and hence only a few general principles will be considered.

496. **THE FORMS.** Since reinforced concrete construction usually consists of slabs, beams, columns, or comparatively thin walls, the cost of the forms is at best a large part of the total cost of the structure, not infrequently running as high as 50 per cent; and hence the design, erection, and removal of the forms are important matters. In the main the statements that were made in § 320-30 concerning forms for mass concrete apply also to the forms for reinforced concrete; but with the latter there are a number of additional matters that require particular attention.

Since the forms constitute such a large part of the cost of a reinforced concrete structure, and since there is usually opportunity to use a form for any particular member a number of times, it is highly important that the forms shall be so designed as to permit rapid erection and easy removal at an early date without undue destruction of the forms or without damage to the concrete. It is desirable to remove the column forms without disturbing the supports of the beams and girders bearing on the columns, since then any defect in the column may be detected and remedied before any considerable load comes upon it. The bottoms of the forms for beams and girders must be left in place and be supported until the beam has gained strength enough to be self-supporting, but the sides

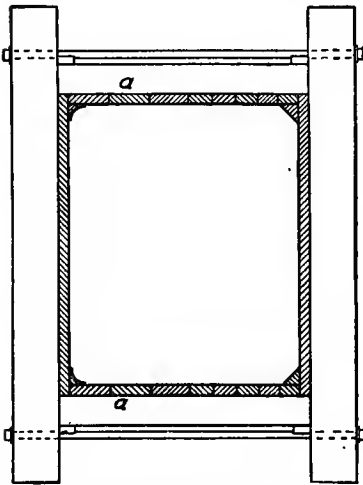

FIG. 31.—FORM FOR RECTANGULAR COLUMN.

may be removed as soon as the concrete has taken an initial set; and therefore the forms for beams and girders should be so designed that the sides may be removed without disturbing the bottoms. The supports for the forms for beams and girders should be designed so that they may be removed one at a time—beginning at the ends.

497. Fig. 31, 32, and 33 are forms used by a prominent construction company, and are designed to meet the require-

ments stated above. In Fig. 31 the sides of the columns are made in panels by nailing the planks to cleats; but the panels are held together by bolts instead of by nails or screws. The panel parallel to the bolt is held in place by spacing pieces, *a, a*, which rest against hard-wood wedges between the bolt and the form, and which are placed as near as possible to the end of the bolt. Cleats, plain or moulded, are nailed to one set of panels so as to give a chamfered or a fluted corner to the column. Some constructors also place a similar beveled strip in the corners of the beam and girder forms, chiefly to prevent the breaking off of the sharp corner in removing the forms. Notice the narrow strips on two opposite sides of Fig. 31, which are to facilitate the change of this dimension of the column from floor to floor. Some constructors secure adjustability of column forms by building the mould in eight pieces,—four corner

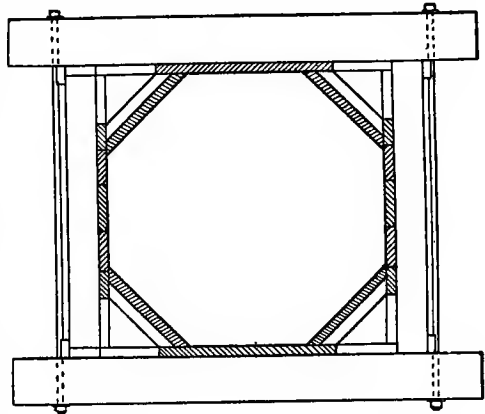

FIG. 32.—FORM FOR OCTAGONAL COLUMN.

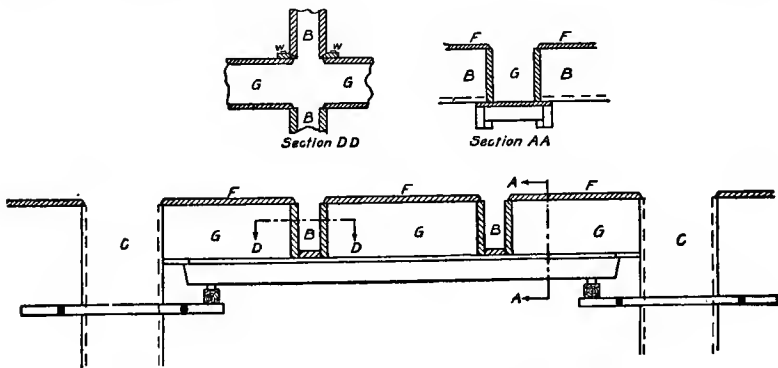

FIG. 33.—FORMS FOR COLUMN, GIRDER, BEAM, AND FLOOR.

pieces and four intermediate sides composed of plain plank, different widths of plank being used for different sized columns.

Fig. 32 is the form for an interior column, which is made octagonal partly for architectural appearance and partly to save concrete

when circumferential reinforcement is used. Many constructors use round columns instead of octagonal ones, but the forms for the latter are the cheaper. It is claimed that the extra cost of octagonal over rectangular forms is just about balanced by the saving of concrete.

In Fig. 33, *C* represents the column, *G* the girder, and *F* the floor slab. The special feature in Fig. 33 is the method of supporting (1) the floor form upon the beam forms, (2) the beam form upon the bottom of the girder form, and (3) the girder form upon the horizontal clamps of the column form. It is claimed for this method that all the forms for a floor may be erected before any of the posts to support the green concrete are put into place. (These posts are not shown in Fig. 33.) The form for the bottom of the floor slab is a panel which overlaps the beam forms, and therefore requires less accurate fitting than the usual box-shaped type, since any slight inaccuracies of dimensions are taken up at the junction between the floor slab and the beam where the error is inconspicuous. The edges of these panels are beveled to facilitate their removal in taking down the forms. Notice the wedge-shaped pieces, *w, w*, shown in the Section *D D*, which are inserted to facilitate the removal of the forms.

In taking down these forms the column forms are removed first. Next, the posts under the girders are taken down, when the girder bottom drops and is removed, and then the posts are replaced against the concrete to support it for a time longer. The nails are next drawn from the wedge-like keys, *w, w*, these keys are knocked out, the posts are removed from under the beams, and the beam form comes down in one piece. The girder sides, being beveled at the end, are easy to remove; and the bottom of the form for the floor slab, being beveled at all four edges, also comes out readily.

498. The above is a brief description of some of the requirements to be met, and also an explanation of one method of meeting them; but different constructors give different weight to the various requirements, and differ as to the best methods of meeting them. For detailed descriptions of the different methods employed in practice, see the books mentioned in § 510.

One of the recent innovations in form construction deserves special mention. In one case a reinforced concrete shell was used for forms for columns. Shells $1\frac{1}{2}$ inches thick, moulded in short sections, were set vertically end on end to the proper height, and were then filled with concrete. A similar plan was followed in conduit construction, short sections of reinforced concrete shells being used as both lining and centering for the concrete conduit. This method decreases the cost of forms and facilitates their erection; but such construction is lacking in transverse strength—one of the most

important advantages of good reinforced concrete columns and conduits.

499. PLACING THE REINFORCEMENT. There is always more or less difficulty and uncertainty in properly placing the reinforcement for beams and slabs when it consists of separate rods. Sometimes the steel is supported by chairs resting on the bottom of the forms and sometimes it is suspended by wires attached to rods resting upon the top of the forms. The chairs are sometimes blocks of cement mortar with a groove in the top, or sometimes a thin square steel plate about 4 inches on a side with a hole in its center, the two halves of which are bent to an angle of 60 to 90 degrees with each other to form feet for the chair, the hole forming a seat for the reinforcing rod.

Sometimes the steel is kept at the right distance above the bottom of the beam by first depositing say 2 inches of concrete in the forms and then laying the steel upon the concrete; but this procedure is objectionable since (1) the placing of the steel is likely to interfere with the placing of the concrete, (2) there is liability that the concrete in the bottom of the forms will set before the succeeding layer is added, and (3) a comparatively dry concrete is required which is more expensive to lay and does not give as good adhesion to the steel as a wet mixture.

500. It is sometimes necessary to splice the reinforcing rods. There are in common use four methods of doing this. 1. Simply lap the rods, and trust that the grip of the concrete will bind them firmly together. This is not very satisfactory. 2. The rods are lapped and wrapped with soft steel wire. With plain rods this is only a slight improvement upon lapping. 3. A better method is to lap the rods and fasten them together with a screw clamp. With deformed bars and a good clamp this is quite satisfactory. 4. For plain bars the best method is to thread the ends of the rods and use a screw coupling.

In anchoring rods by bending the end, short bends should be avoided, as otherwise there is a concentration of pressure on the concrete at the angle of the bend which will crush the concrete and prevent the effect sought.

501. PLACING THE CONCRETE. Before beginning to deposit concrete, it is important to see that all sticks, chips, shavings, and even sawdust are removed from the forms—particularly from column forms, where they are likely to accumulate and to be overlooked. The concrete should be wet enough to flow around the reinforcement. The best consistency is that in which it will flow from the shovel unless handled quickly. Concrete should not be dumped from the wheelbarrow directly against the form, but should be dumped upon the soft concrete. If the concrete is dumped directly into the

forms, the stones may become jammed between the side of the form and the steel, and form a pocket into which the mortar will not enter; but if the concrete is dumped upon concrete already in place, the mortar will flow ahead of the stones, and the stones following later will fall into the mortar and perfectly bed themselves.

Care should be taken that the work of depositing the concrete does not stop long enough for the concrete to begin to set, as otherwise there will be formed a surface of weakness. If the work can not proceed continuously, then a dam or bulkhead should be put in where the surface of weakness will do little or no harm, as for example vertically at the center of the length of a beam, or vertically over the longitudinal axis of a girder.

502. REMOVING THE FORMS. The length of time that should be allowed to elapse before removing the forms depends upon the weather and the load to which the member will be subjected when the form is removed.

With reference to the effect of the weather it should not be forgotten that concrete sets comparatively slowly in cold weather. To an experienced person, scratching the concrete with a knife or striking it with a hammer gives a rough idea of the amount of set, and therefore of its strength; but the only sure way to determine when the forms may safely be taken down is to make test specimens—either cubes or beams—at the same time the concrete is placed in the structure, taking care to get identical mixtures and to store the test specimens under similar conditions to those obtaining for the structure, and then test the specimens from time to time to determine the growth in strength. Such tests would also show whether the materials and the mixing were uniform.

As to the effect of the load upon the time to elapse before removing the forms, it may be said that the nearer the load to be immediately sustained approaches the load for which the member was designed, the longer the forms should remain in position. For example, roof forms should remain longer than floor forms, floor forms longer than column forms, column forms of an upper story longer than those of a lower story, and column forms longer than footing forms. In this connection see the last paragraph of § 497.

When the forms are removed, the work should be done gradually with close attention to the results, so that if there is any sign of weakness the supports may be replaced, or if imperfect workmanship is discovered it may be repaired.

503. EXPANSION AND CONTRACTION. The coefficient of expansion of steel and concrete are so nearly equal that there is no likelihood of any serious stresses being developed by differences of expansion and contraction of the steel and the concrete. The coefficient of

expansion for steel is 0.000,006,5 per 1° F., and that for concrete varies from 0.000,005,5 for a 1 : 2 : 4 mixture to 0.000,006,5 for a 1 : 3 : 6 concrete.

In large structures built of plain concrete it is necessary to provide joints to prevent unsightly contraction cracks (§ 385-86); but with reinforced concrete these joints may be farther apart, and in some cases are entirely omitted. There is no well-established practice as to the proper distance between expansion joints or as to the method of constructing them.

504. Reinforcing to prevent Contraction Cracks. Strictly speaking, no amount of reinforcement can prevent contraction cracks; but by the use of sufficient reinforcement the cracks can be forced to take place at such frequent intervals as to be quite invisible and consequently to be of no importance, either as affecting the appearance of the concrete or as permitting the entrance of water or gas sufficient to corrode the steel.

In determining the amount of reinforcement required to prevent contraction cracks, three stresses in the steel must be considered, viz.: (1) the stress due to the cooling of the cement after the rise of temperature caused by the chemical action of setting (§ 348); (2) for concrete setting in air the stress due to the shrinkage of the concrete in hardening (§ 385); and (3) the stress due to changes in temperature of the atmosphere.

1. The first stress would probably be appreciable only in a very thick wall built rapidly, and is usually neglected.

2. Concrete setting in air shrinks 0.000,4 per unit of length. At points where the tensile strength of the concrete is least, this shrinkage will cause tension in the steel; and at points where the concrete is strongest, it will cause compression. The maximum tension that can come upon the steel from this shrinkage is equal to the tensile strength of the concrete, say 200 lb. per sq. in. (§ 406); and the cross sectional area of steel required to prevent a crack from opening up is equal to the tensile strength of the concrete divided by the elastic limit of the steel, or $200 \div 30,000 = 0.0067 = 0.67$ per cent. Of course, if steel having a higher elastic limit is used, a proportionally smaller per cent will be required.

3. The amount of steel to prevent the opening up of cracks due to a change in the temperature of the atmosphere is computed as follows: For a drop in temperature of 100° F. the temperature stress in the steel will be $100 \times 0.000,006,5 \times 30,000,000 = 19,500$ lb. per sq. in. If the elastic limit of the steel is 30,000, then there is available to resist the tension produced by the shrinkage of the concrete $30,000 - 19,500 = 10,500$ lb. per sq. in.; and if the tensile strength of the concrete is assumed to be 200 lb. per sq. in., then the

steel required to prevent a contraction crack is $200 \div 10,500 = 0.019 = 1.9$ per cent. If steel having an elastic limit of 40,000 lb. per sq. in. is employed, only 0.97 per cent will be required; and if 60,000-pound steel, only 0.5 per cent will be required. These results are rather extreme, since a large change of temperature was assumed, and since a low elastic limit was assumed for the steel. If a steel having a high elastic limit is used, it may be wise to use a deformed bar so as to distribute the deformation as much as possible.

505. The conclusion of the above discussion is that to resist the stresses due to a change of temperature of 100° F. requires 1.9 per cent of mild steel. The above computations are only approximate since the shrinkage during hardening is not known accurately, and since the change of temperature of the mass of concrete is not usually known with any considerable accuracy. On account of these uncertainties and of the relatively large amount of steel required, it is comparatively rare that the attempt is made to prevent contraction cracks by reinforcing the concrete, although it has been done very successfully in a few cases.*

The steel to resist thermal stresses should be placed near the surface, particularly if only one face is exposed to the atmosphere. Obviously, the reinforcement inserted to resist contraction can not rightly be expected to resist also the stresses due to the load.

506. Contraction Joints. For the reasons stated above, the usual practice is to divide continuous reinforced-concrete structures into units separated by contraction joints. The units are usually made somewhat longer than the distance at which cracks occur in non-reinforced walls (§ 386), and each section is reinforced to take up the shrinkage and thermal stresses within itself. Formerly these expansion joints were placed not more than 25 feet apart; but now the distance between them is usually 50 or 60 feet. In reinforced concrete buildings, the contraction joints are usually spaced at equal distances both longitudinally and transversely, and extend from the foundation to the roof. They are usually formed by finishing a section of wall or floor against a vertical form and allowing the concrete to set before concreting the succeeding section. The joints are therefore simply planes of weakness, and divide the columns, girders and beams vertically into halves.

For the method of making expansion joints in more massive structures, see § 387.

507. SEPARATELY MOULDED MEMBERS. The usual method of constructing reinforced concrete buildings by moulding in place is expensive on account of the cost of the forms, and is also compara-

* For example, the Kelly & Jones building in Greensburg, Pa., a factory 60 by 300 feet, four stories high.

tively slow on account of the time that must be allowed for the concrete to harden. To overcome this objection buildings are sometimes built of members moulded separately in advance, the erection proceeding very much as with timber or steel construction. The beams must have both tension and compression reinforcement to permit of handling. Several types of patented beams specially designed for this form of construction have been put upon the market.

The important advantages of this form of construction are that many members can be moulded in the same forms, and the work can be done on the ground under cover in all kinds of weather with facilities for securing a good and economical product. The objection to this form of construction is the difficulty of securing rigid connections between the columns, girders, and beams. However, the joints are made with neat portland cement, and therefore the structure has a considerable degree of stiffness.

In Europe this method has been employed to a considerable extent, but has not attained much popularity in America. For an account of the most important example in this country, see *Engineering News*, Vol. lviii, pages 5-7,—July 4, 1907.

508. A recent extreme example of this form of construction was the moulding of the whole side of a building and erecting it in a single piece.* The building is a two-story mess hall, 76 by 170 feet, for the state militia at Camp Perry, Ohio, erected in the summer of 1908. The walls are 26 feet high and 4 inches thick with 10-inch pilasters. A platform of 2-inch lumber was laid upon a steel frame which was supported on screw-jacks operated by a tumbling-rod run by an engine. The reinforced-concrete window frames, door frames, cornice, etc., having been previously moulded separately, were placed in their proper position on the platform, the reinforcing rods of these being allowed to project to give a good bond with the body of the wall. Four-inch boards were set edgewise on the four sides of the platform to complete the forms, and half of the concrete for the wall proper was poured; and then the reinforcement consisting of $\frac{1}{4}$ -inch rods 6 inches apart both ways was placed, after which the remainder of the concrete was poured and then the surface was finished by troweling. Forty-eight hours after the concrete was placed, the wall was tilted into a vertical position upon the foundation by operating the screw-jacks. Two adjacent sides of the building were joined by building suitable forms at the corner and filling them with concrete, the reinforcement from the sides being allowed to project into this concrete. The interior columns, the

* *Concrete*, vol. viii, p. 19-21; or Monthly Bulletin No. 52, of the Universal Portland Cement Co., p. 6-9.

TABLE 46.
COST OF PLAIN AND REINFORCED CONCRETE IN BUILDING CONSTRUCTION.

REF. No.	CHARACTER AND LOCATION OF STRUCTURE.	COST OF FORMS, PER SQ. FT.				COST OF CONCRETE, PER CUBIC FOOT.							
		Car- penter	Lum- ber.	Nails and Wire.	Total.	Labor.			Cement.	Aggre- gate.	Teas- and Misc.	Plant.	Total.
						Concr.	General	Total.					
PLAIN CONCRETE COLUMNS.													
1	Office building, Portland, Me.....	\$0.133	\$0.039	\$0.001	\$0.173	\$0.064	\$0.004	\$0.068	\$0.087	\$0.084	\$0.012	\$0.022	\$0.273
2	Coal pocket, Lawrence, Mass.....	0.057	0.024	0.001	0.082	0.166	0.003	0.169	0.073	0.041	0.008	0.016	0.307
3	Mill, Southbridge, Mass.....	0.097	0.082	0.002	0.181	0.073	0.056	0.129	0.107	0.035	0.027	0.030	0.328
4	Mill, Attleboro, Mass.....	0.093	0.022	0.001	0.116	0.110	0.014	0.124	0.062	0.038	0.013	0.034	0.271
5	Mill, Southbridge, Mass.....	0.080	0.056	0.011	0.137	0.108	0.048	0.156	0.100	0.037	0.013	0.034	0.340
6	Coal pocket, Hartford, Conn.....	0.098	0.047	0.002	0.147	0.089	0.043	0.132	0.069	0.055	0.017	0.013	0.286
7	Garage, Brookline, Mass.....	0.071	0.051	0.002	0.124	0.070	0.028	0.098	0.072	0.058	0.041	0.020	0.289
8	Warehouse, Portland, Me.....	0.118	0.016	0.001	0.135	0.087	0.027	0.114	0.087	0.070	0.039	0.025	0.335
9	Textile Mill, Lawrence, Mass.....	0.061	0.013	0.001	0.075	0.095	0.019	0.114	0.109	0.027	0.018	0.015	0.283
10	Average for 9 structures.....	\$0.082	\$0.036	\$0.001	\$0.130	\$0.096	\$0.027	\$0.123	\$0.085	\$0.049	\$0.021	\$0.023	\$0.301
11	Highest.....	0.133	0.082	0.002	0.181	0.166	0.056	0.122	0.109	0.084	0.041	0.034	0.340
12	Lowest.....	0.057	0.013	0.001	0.075	0.064	0.003	0.067	0.062	0.027	0.008	0.013	0.271
REINFORCED-CONCRETE BEAM FLOORS.													
13	Average for 18 structures.....	0.070	0.045	0.002	0.116	0.111	0.020	0.131	0.106	0.063	0.025	0.024	0.354
14	Highest.....	0.165	0.107	0.004	0.275	0.186	0.035	0.221	0.194	0.101	0.052	0.055	0.470
15	Lowest.....	0.037	0.027	0.001	0.067	0.047	0.004	0.051	0.071	0.037	0.007	0.010	0.202

FLAT SLAB FLOORS.													
16	Average for 3 structures.....	0.071	0.038	0.002	0.111	0.097	0.009	0.106	0.096	0.070	0.019	0.024	0.315
17	Highest	0.078	0.039	0.003	0.018	0.146	0.017	0.163	0.109	0.084	0.026	0.039	0.374
18	Lowest	0.067	0.037	0.001	0.106	0.043	0.004	0.047	0.087	0.053	0.012	0.010	0.252
SLABS BETWEEN STEEL BEAMS.													
19	Average for 13 structures.....	0.061	0.032	0.002	0.095	0.102	0.019	0.121	0.128	0.068	0.024	0.017	0.359
20	Highest	0.110	0.071	0.003	0.184	0.144	0.048	0.192	0.208	0.080	0.064	0.046	0.428
21	Lowest	0.028	0.012	0.001	0.049	0.073	0.005	0.078	0.076	0.026	0.004	0.010	0.272
BUILDING WALLS ABOVE GRADE.													
22	Average for 17 structures	0.085	0.036	0.002	0.123	0.090	0.016	0.106	0.073	0.076	0.025	0.019	0.301
23	Highest	0.136	0.073	0.005	0.176	0.146	0.052	0.198	0.105	0.187	0.077	0.055	0.446
24	Lowest	0.046	0.016	0.001	0.079	0.042	0.004	0.046	0.034	0.043	0.007	0.005	0.174
FOUNDATION WALLS.													
25	Average for 14 structures.....	0.068	0.033	0.002	0.103	0.076	0.015	0.091	0.080	0.062	0.019	0.017	0.269
26	Highest	0.134	0.048	0.004	0.193	0.213	0.037	0.250	0.203	0.116	0.057	0.040	0.599
27	Lowest	0.032	0.009	0.001	0.056	0.040	0.002	0.042	0.038	0.027	0.003	0.010	0.148
FOOTINGS AND MASS FOUNDATIONS.													
28	Average of 10 structures	0.057	0.034	0.002	0.093	0.045	0.007	0.052	0.071	0.077	0.007	0.021	0.229
29	Highest	0.119	0.077	0.003	0.198	0.081	0.020	0.101	0.098	0.099	0.013	0.049	0.275
30	Lowest	0.016	0.006	0.001	0.018	0.025	0.001	0.026	0.047	0.043	0.003	0.010	0.181

girders, the floor beams, were separately moulded and hoisted into place. The cost of the building is said to have been only a little more than that of a wood one.

509. COST OF REINFORCED CONCRETE IN BUILDINGS. Table 46, page 258, shows the actual cost of materials and labor for reinforced concrete in buildings as determined by daily records made upon each of the several jobs.* Table 47 gives the cost of handling the steel after it was received at the site in the shape sold by the manufacturer, which includes fabricating it into units for columns or beams, bending the stirrups, placing in the forms, etc. The paper from which the above data is taken stated the character and location of all the buildings included in Tables 46 and 47, but they are not here included for lack of space. However, the first nine lines of Table 46 and the first twenty-one lines of Table 47 show the general char-

TABLE 47.
COST OF HANDLING THE REINFORCING STEEL.

REF. No.	CHARACTER AND LOCATION OF STRUCTURE.	TOTAL WEIGHT, Tons.	Cost.	
			Total.	Per Ton.
1	Office building, Portland, Maine . .	324.5	\$5 115.32	\$15.76
2	Fire station, Weston, Mass	8.5	40.26	4.74
3	Mill, Chelsea, Mass.	62.25	548.81	8.41
4	Coal bins, Dalton, Mass	8.5	61.75	7.26
5	Dam, Auburn, Maine	55.0	506.76	9.18
6	Filter, Warren, R. I.	19.0	102.59	5.40
7	Tank, Lincoln, Maine	8.5	69.38	8.16
8	Tar well, Springfield, Mass.	15.5	59.21	3.82
9	Monument, Provincetown, Mass. . .	24.5	136.84	5.58
10	Mill, Greenfield, Mass.	92.75	1 232.01	10.20
11	Machine shop, Milton, Mass.	20.25	177.16	8.75
12	Coal pocket, Lawrence, Mass.	28.0	461.16	16.47
13	Mill, Southbridge, Mass.	53.5	142.76	2.67
14	Mill, South Windham, Maine	293.0	3 079.60	10.51
15	Mill, Attleboro, Mass.	49.5	286.02	5.78
16	Garage, Newton, Mass.	20.0	86.55	4.33
17	Mill, Southbridge, Mass.	30.0	100.03	3.34
18	Coal pocket, Hartford, Conn.	195.0	2 316.60	11.88
19	Filter, Lawrence, Mass.	44.5	112.84	2.54
20	Warehouse, Portland, Me.	62.0	462.99	7.47
21	Standpipe, Attleboro, Mass.	199.5	1 547.00	7.75
	Average for 21 structures			\$8.52
	Highest			16.47
	Lowest			2.54

* A paper read at the Cleveland Convention of the National Association of Cement Users by Leonard C. Wason, President of the Aberthaw Construction Co., Boston, published in *Engineering Record*, vol. lix, p. 78-81.

acter and variety of locations of the structures included in the latter part of Table 46.

The materials and workmanship were strictly first-class in every case. The standard concrete mixture for lightly loaded floors was 1 : 3 : 6, for heavily loaded floors 1 : 2 : 4, for walls 1 : 3 : 6, and for columns 1 : 2 : 4. These tables contain very valuable data. Such information is usually known only to the manager of a construction company and is generally kept under lock and key. However, all such data are more valuable to the one who deduced them than to anyone else, since the former is acquainted with numerous details and conditions which can not be stated in any such summary as Tables 46 and 47.

510. BIBLIOGRAPHY. Each of the following volumes gives an illustrated account of numerous representative examples of reinforced concrete construction.

1. **REINFORCED CONCRETE**, by A. W. Buel and C. S. Hill, published in 1904 by Engineering News Publishing Co., New York City. 499 pages, 6 by 9 inches.

2. **CONCRETE PLAIN AND REINFORCED**, by F. W. Taylor and S. E. Thompson, published in 1907 by John Wiley & Sons, New York City. 585 pages, 6 by 9 inches.

3. **CONCRETE AND REINFORCED CONCRETE CONSTRUCTION**, by Homer A. Reid, published in 1907 by M. C. Clark Publishing Co., Chicago. 884 pages, 6 by 9 inches.

4. **CONCRETE CONSTRUCTION, METHODS AND COST**, by H. P. Gillette and C. S. Hill, published in 1908 by M. C. Clark Publishing Co., Chicago. 690 pages, 6 by 9 inches.

5. See the several Indexes of Current Engineering Literature for recent examples of reinforced concrete construction.

CHAPTER IX

CONCRETE BUILDING-BLOCKS AND ARTIFICIAL STONE

ART. 1. CONCRETE BUILDING-BLOCKS.

512. Under this head will be considered briefly the method of manufacture and the uses of comparatively small blocks of concrete employed as substitutes for brick or cut stone in buildings. Such blocks are usually hollow, and the term hollow concrete building-blocks is frequently used to designate this form of material. Owing to the thinness of the walls of many of the hollow blocks, it is impossible to use a coarse aggregate, and consequently the material is cement mortar rather than concrete; and therefore building-blocks are called cement blocks nearly as frequently as concrete blocks. Attempts have been made to introduce cement blocks of the size of ordinary brick; but the size is too small for economy and has no compensating advantage. Such material is appropriately called cement brick.

The concrete building-block is of quite recent origin, but it has developed very rapidly within the past few years, and has reached the position of an important building material. The two qualities which make the ordinary concrete blocks a valuable building material are their cheapness and the ease with which blocks of any size or form may be moulded. In many localities concrete blocks are cheaper per unit of volume than either brick or cut stone; and on account of their larger size concrete blocks are superior to bricks, either burned-clay or sand-lime, since the large size requires less skill and also costs less to lay, and secures a more uniform bearing and hence a stronger wall for materials of approximately the same strength.

Originally the concrete-block industry was stimulated by the numerous manufactures of patented machines for moulding the blocks. It was represented that any one could make concrete blocks; and as a result, the manufacture fell largely into the hands of men without any knowledge concerning either the selection of the materials or their combination, and consequently many poor blocks were put upon the market, which greatly injured the reputation of concrete blocks. Further, owing to inattention to the principles of correct

design, the artistic possibilities of concrete have been underestimated. Notwithstanding the mistakes and failures in the early history of the industry, concrete blocks are a valuable building material. The concrete block has an advantage over concrete built in situ, in that (1) the block can be moulded on the ground under factory conditions,

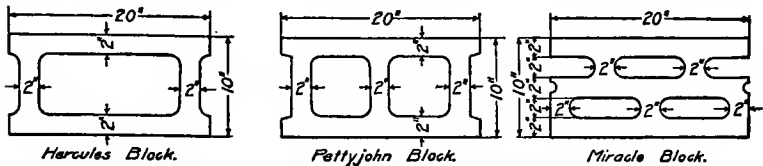

FIG. 34.—TOP VIEW OF BLOCKS SHOWING VERTICAL AIR SPACES.

(2) requires much less expense for forms, and (3) is simpler to erect. Of course, block construction can not compete with mass concrete in strength or cost, and can not be used where subjected to any considerable transverse stress.

513. SIZE. There is no standard size of concrete building-blocks. The length is 8, 16, 24, or 32 inches, the second or third being the most common; the height is 8 or 9 inches; and the thickness 8, 10, or 12 inches, according to the thickness of the wall desired. The smaller sizes are produced in the moulds for the larger sizes by inserting partitions or filling blocks. In moulding sills and lintels for buildings, and ring-stones and stones for the parapet walls of concrete arches, much larger sizes than the above are made.

514. FORM OF BLOCK. Concrete blocks may be classified as solid and hollow. The first concrete blocks were solid, but that form is not now much used, since the hollow blocks are cheaper and give better insulation against moisture and heat or cold. The hollow space usually runs vertically from the top to the bottom of the block, but in a few cases horizontally from end to end. Fig. 34 shows the top view of three common arrangements of vertical air spaces, and Fig. 35 is an end view of a wall showing the most common form of horizontal air spaces.

The blocks are usually made 12 inches high although they are sometimes 8 inches; and the other dimensions are about as shown in Fig. 34 and 35. The special advantage claimed for the Miracle

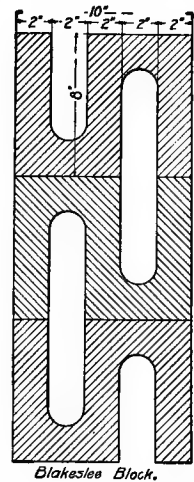

FIG. 35.—END VIEW SHOWING HORIZONTAL AIR SPACES.

block, Fig. 34, and also for the block shown in Fig. 35 is that each web is backed by an air space, and hence no portion of the solid concrete extends from the front to the back of the wall, the object sought being to prevent capillary attraction from drawing water to the interior of the building.

Concrete blocks may also be classified as one-piece, two-piece, or three-piece blocks. Fig. 34 and 35 are examples of one-piece blocks. Fig. 36 shows the top view of a wall built of two-piece

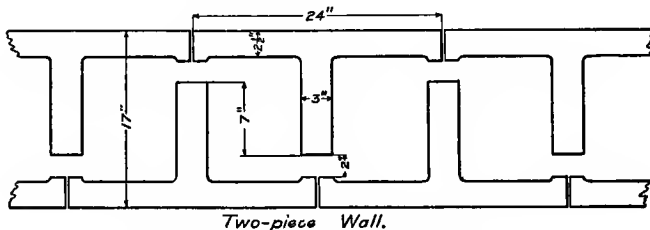

FIG. 36.—TOP VIEW OF TWO-PIECE WALL.

blocks. The block shown in Fig. 36 may be laid either with or without the continuous horizontal air space as shown. The continuous horizontal air space is to prevent the passage of water from the outside to the inside of the wall. The objects sought in the two-piece blocks are to overcome some of the difficulties encountered

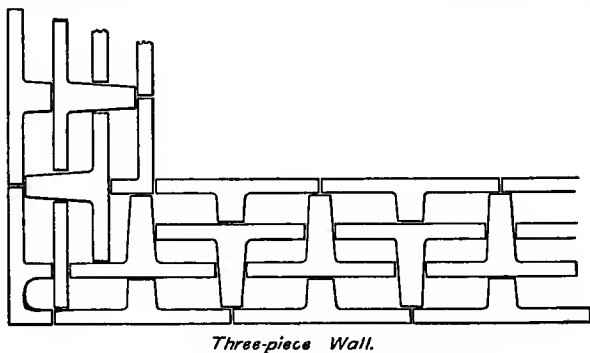

FIG. 37.—TOP VIEW OF THREE-PIECE WALL.

in the manufacture of one-piece blocks and also to afford better insulation against moisture and heat or cold. The two-piece and the three-piece blocks can be moulded by pressure much more satisfactorily than the one-piece block. Fig. 37 shows a method of

arranging the two-piece blocks to make a three-piece wall. The three-piece wall may be laid with continuous horizontal air spaces similar to those shown in Fig. 36.

There are numerous other forms of blocks, but the above are representative.

515. Several manufacturers make a bead on one side or on one end or on both sides and ends of a block, and a groove on the opposite side to give additional resistance to prevent one block's sliding horizontally on another. The beads and grooves are not shown in Fig. 34 to 37.

516. In blocks for buildings the object of the air space is to cheapen the product, and also to insulate the wall against the passage through it of water or heat; but in structures requiring great strength, the chief object of the air spaces is to permit a thorough bonding of the work by the filling of the hollow spaces with concrete after the blocks are set in position. For an example of the use of the latter principle in the piers, parapet walls, railings, etc., of a concrete arch, see Transactions of American Society of Civil Engineers, Vol. lix, pages 193-207, particularly 199-200; or *Engineering News*, Vol. lvii, pages 497-503.

In the ordinary commercial building blocks the hollow spaces are formed by removable metal cores (see § 521); but in the large blocks used in more massive engineering construction, the air spaces, have been formed by inserting paraffinated paper bags filled with sand.

517. Per Cent of Hollow Space. The open spaces usually occupy one third of the volume of the block, and occasionally run as high as one half. The building ordinances of the different cities usually limit the open spaces to 33 per cent for the walls of one- and two-story buildings and for the two or three upper stories of tall buildings, and to 20 or 25 per cent for the lower stories of high buildings. Some building laws also limit the minimum thickness of the webs and walls of hollow blocks to one quarter of the height of the block.

518. THE MATERIALS. No statement is required here concerning the materials other than to say that almost universally portland cement is used in concrete blocks. Either gravel or broken stone may be employed. The size of the largest pieces is usually not more than $\frac{1}{2}$ inch in diameter for the smaller hollow blocks, and 1 inch for the larger hollow blocks; while of course larger pieces may be used for solid blocks.

519. THE MANUFACTURE. Consistency. Concrete of three degrees of consistency is in somewhat common use: dry, quaking, and wet concrete (see § 334-37). The first is the most common, and the last the least. Dry concrete is most advantageous to the manu-

facturer, since the block can be removed from the form as soon as it is moulded, and hence fewer forms are required.

520. Mixing. No statement is required here concerning the proportions and the method employed in mixing the materials, as these subjects have already been considered in preceding portions of this volume (see § 338-41).

521. Method of Moulding. Ordinary concrete blocks are usually moulded in metal forms, but ornamental blocks, as capitals, balustrades, cornices, etc., are successfully cast by pouring liquid concrete into sand moulds, although the process is expensive on account of the labor of making a new mould for each piece. In making the ordinary plain building block, the dry mixture is always tamped, usually by hand and occasionally with a pneumatic tamper; plastic concrete is usually tamped, and occasionally pressed; and the wet mixture is poured. Tamping is the most common, and pressing the least. It is impossible to make a dense block by direct compression unless the pressure is applied to the face of a comparatively thin layer, which makes the method impracticable, except for a two-piece block (§ 514) in which the pressure is applied to pieces of no great thickness.

522. Moulding Machines. There are a great number of machines on the market for facilitating the moulding of concrete blocks, which differ according to the plasticity of the concrete used, the method of consolidating the block, and the conveniences for removing the cores and handling the block. For advertisements of such machines, consult the advertising pages of engineering journals, proceedings of engineering societies, etc. Blocks have been made successfully by tamping by hand in wooden moulds.

523. Face Finish. In the early history of the concrete building-block industry, it was customary to give the block a rich mortar face, partly to secure a more dense and more impervious surface, and partly to aid in forming the imitation rock-face then much in vogue; but now the facing mortar is frequently omitted, a satisfactory surface being obtained by using a wet mixture and "spading" the face (§ 353). The so-called rock-face was very unsatisfactory, being at best only a dull and monotonous imitation of pitch-faced natural stone. It is now conceded by architects and the better manufacturers that a plain face is the most satisfactory for concrete blocks. Some really handsome structures have been built wholly or in part of concrete blocks having plain faces.

If desired, the face of the block can be dressed with a stone-cutter's tool; but concrete is considerably more difficult to work than equally hard natural stone, probably because the fragments of the aggregate are not held as firmly as the grains of the natural

stone, and hence there is a slight movement of the aggregate under the chisel which materially decreases the effectiveness of the blow. The surface of the block may be treated by either of the processes described in § 359 and 360.

The color of the face may be varied by selecting different-colored aggregates or by using artificial coloring matter (see § 362).

524. Waterproofing. Since the chief use of concrete blocks is for buildings, it is important that they should be waterproof. Blocks may be made impermeable by any of the methods described in § 366-81. The penetration of water from the outside to the inside is reduced by placing an air space opposite each web member between the back and the face of the block (§ 514), and is prevented by making a continuous horizontal air space (Fig. 36).

525. Curing. It is important that the blocks should be properly cared for while the cement is hardening. They should not be allowed to dry too rapidly; and, particularly, the sun should not be allowed to shine upon the unseasoned block, as it not only will dry the block out unduly but will also make it spotted. The blocks should be kept in a humid atmosphere or should be sprinkled three or four times a day. When a dry concrete is used, the block should be sprinkled more frequently and more copiously and for a longer time than when a wet concrete is used. It is advantageous to cover the blocks with straw, excelsior, or burlaps, to retain the moisture and help secure uniformity of color and prevent hair cracks. While hardening, the blocks should not be in contact with one another.

Ordinarily, blocks should not be placed in the wall until they have seasoned for three weeks, and preferably four.

526. LAYING THE BLOCKS. Concrete blocks are laid very much as are bricks or blocks of natural stone. Before being laid, the block should be thoroughly moistened to prevent its absorbing the water from the mortar. Blocks are usually laid with joints $\frac{3}{16}$ to $\frac{1}{4}$ inch thick. The mortar is usually about 1 volume portland cement, 3 volumes of sand, and 1 volume lime paste or hydrated lime. Concrete blocks are used on the face of a wall, and are backed up with brick; and concrete blocks are also used as backing for pressed brick or cut stone.

ART. 2. ARTIFICIAL STONE.

527. Many formulas have been proposed for making artificial stone, as the records of the patent office show. Nearly all of the proposed substitutes for natural stone consist of ordinary hydraulic cement, sand, gravel or broken stone, and some ingredient that is claimed to confer some peculiar advantage to the product. In

many cases the peculiar ingredient is harmless and useless, in some it is only a coloring matter, and in others it adds a little initial strength; but the most valuable ingredients are only some form of waterproofing (§ 369-77).

Few, if any, of the artificial stones have any advantage over ordinary blocks of cement mortar or concrete made waterproof by careful selection of the ingredients and by proper manipulation, or by adding a waterproofing material.

However, there are two forms of artificial stone, the Ransome and the Sorel, which do not depend upon ordinary hydraulic cement for their strength and hardness, and are therefore of a little interest because of the form of cementing material employed, although they are not of much practical value. The patents on these two have long since expired.

528. RANSOME STONE. This is made by forming in the interstices of sand, gravel, or any pulverized stone, a hard and insoluble cementing substance, by the natural decomposition of two chemical compounds in solution. Sand and the silicate of soda are mixed in the proportion of a gallon of the latter to a bushel of the former and rammed into moulds, or it may be rolled into slabs for footpaths, etc. At this stage of the process the blocks or slabs may be easily cut into any desired form. They are then immersed, under pressure, in a hot solution of chloride of calcium, after which they are thoroughly drenched with cold water—for a longer or shorter period, according to their size—to wash out the chloride of sodium formed during the operation. In England grindstones are frequently made by this process.

529. SOREL STONE. Some years ago, M. Sorel, a French chemist, discovered that the oxychloride of magnesium possessed hydraulic energy in a remarkable degree. This cement is the basis of the Sorel stone. It is formed by adding a solution of chloride of magnesium, of the proper strength and in the proper proportions, to the oxide of magnesium. The strength of this stone, as well as its hardness, exceeds that of any other artificial stone yet produced, and may, when desirable, be made equal to that of the natural stone which furnishes the powder or sand used in its fabrication. The principal use of this process was in making emery wheels, but it is not used for even that now. It is not suitable for a building stone, since it does not resist the weather well.

CHAPTER X

STONE CUTTING

ART. 1. TOOLS.

531. In order to describe intelligibly the various methods of preparing stones for use in masonry, it will be necessary to begin with a description of the tools used in stone cutting, as the names of many kinds of dressed stones are directly derived from those of the tools used in dressing them.

With a view to securing uniformity in the nomenclature of building stones and of stone masonry, a committee of the American Society of Civil Engineers in 1877* prepared definitions of stone-cutting tools and a classification of dressed stone and of stone masonry, and recommended that all specifications be made in accordance therewith. The old nomenclature was very unsystematic and objectionable on many grounds. The new

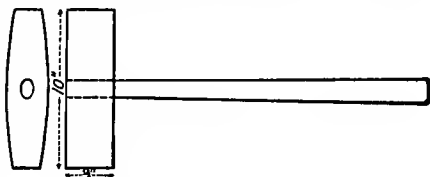

FIG. 38.—DOUBLE FACE HAMMER.

system is good in itself, is recommended by the most eminent authority, has been quite generally adopted by engineers, and should therefore be strictly adhered to. The following description of the *hand tools* used in stone cutting is from the report of the American Society's committee.

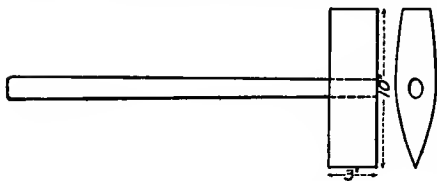

FIG. 39.—FACE HAMMER.

532. **HAND TOOLS.** "*The Double Face Hammer*, Fig. 38, is a heavy tool weighing from 20 to 30 pounds, used for roughly shaping stones as they come from the quarry and for knocking off

projections. This is used only for the roughest work.

"The *Face Hammer*, Fig. 39, has one blunt and one cutting end and is used for the same purpose as the double face hammer where

* Trans. Am. Soc. of C. E., vol. vi, p. 297-304.

less weight is required. The cutting end is used for roughly squaring stones, preparatory to the use of finer tools.

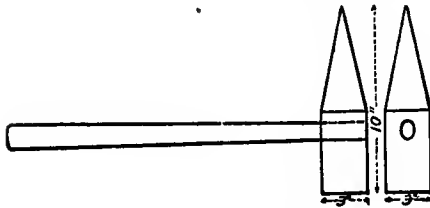

FIG. 40.—CAVIL.

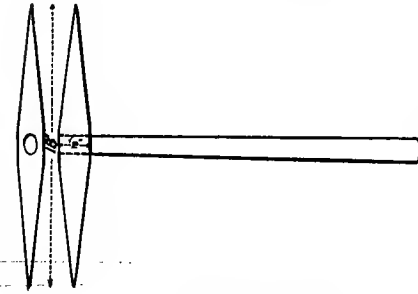

FIG. 41.—PICK.

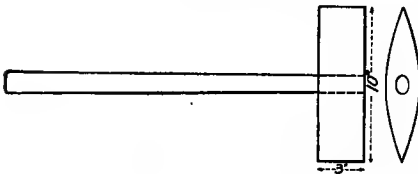

FIG. 42.—AX OR PEAN HAMMER.

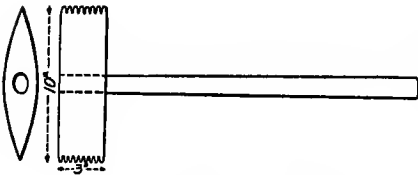

FIG. 43.—TOOTH AX.

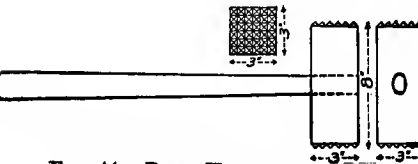

FIG. 44.—BUSH HAMMER.

“The *Cavil*, Fig. 40, has one blunt and one pyramidal, or pointed, end, and weighs from 15 to 20 pounds. It is used in quarries for roughly shaping stone for transportation.

The *Pick*, Fig. 41, somewhat resembles the pick used in digging, and is used for rough dressing, mostly on limestone and sandstone. Its length varies from 15 to 24 inches, the thickness at the eye being about 2 inches.

“The *Ax* or *Pean Hammer*, Fig. 42, has two opposite cutting edges. It is used for making draughts around the arris, or edge, of stones, and in reducing faces, and sometimes joints, to a level. Its length is about 10 inches, and the cutting edge about 4 inches. It is used after the patent hammer and before the

tooth ax, Fig. 43, is like the ax, except that its cutting edges are divided into teeth, the number of which varies with the kind of work required. This tool is not used on granite and gneiss.

“The *Bush Hammer*, Fig. 44, is a square prism of steel whose ends are cut into a number of pyramidal points. The length of the hammer is from 4 to 8 inches, and the cutting face from 2

to 4 inches square. The points vary in number and in size with the work to be done. One end is sometimes made with a cutting edge like that of the ax.

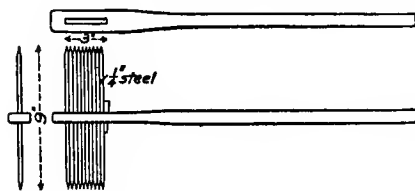

FIG. 45.—CRANDALL.

$\frac{1}{4}$ -inch square steel, 9 inches long, which are held in place by a key.

"The *Patent Hammer*, Fig. 46, is a double-headed tool so formed as to hold at each end a set of wide thin chisels. The tool is in two parts, which are held together by the bolts which hold the chisels. Lateral motion is prevented by four guards on one of the pieces. The tool without the teeth is $5\frac{1}{2}$ by $2\frac{3}{4}$ by $1\frac{1}{2}$ inches. The teeth are $2\frac{3}{4}$ inches wide. Their thickness varies from $\frac{1}{12}$ to $\frac{1}{8}$ of an inch. This tool is used for giving a finish to the surface of stones.

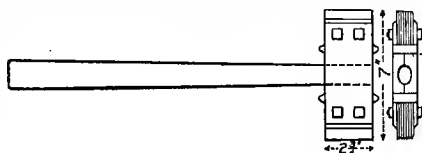

FIG. 46.—PATENT HAMMER.

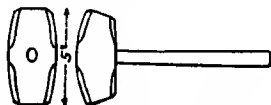

FIG. 47.—HAND HAMMER.

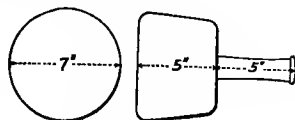

FIG. 48.—MALLET.

"The *Hand Hammer*, Fig. 47, weighing from 2 to 5 pounds, is used in drilling holes, and in pointing and chiseling the harder rocks.

"The *Mallet*, Fig. 48, is used when the softer limestones and sandstones are to be cut.

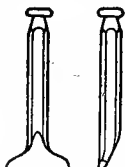

FIG. 49.—PITCHING CHISEL.

"The *Pitching Chisel*, Fig. 49, is usually of $1\frac{1}{8}$ -inch octagonal steel, spread on the cutting edge to a rectangle of $\frac{1}{8}$ by $2\frac{1}{2}$ inches. It is used to make a well-defined edge to the face of a stone, a line being marked on the joint surface to which the chisel is applied and the portion of the stone outside of the line broken off by a

blow with the hand hammer on the head of the chisel.

"The *Point*, Fig. 50, is made of round or octagonal rods of steel,

from $\frac{1}{4}$ inch to 1 inch in diameter. It is made about 12 inches long, with one end brought to a point. It is used until its length is reduced to about 5 inches. It is employed for dressing off the irregular surface of stones, either for a permanent finish or preparatory to the use of the ax. According to the hardness of the stone, either the hand hammer or the mallet is used with it.



FIG. 50.—POINT.



FIG. 51.—CHISEL.

“The *Chisel*, Fig. 51, of round steel of $\frac{1}{4}$ to $\frac{3}{4}$ inch in diameter and about 10 inches long, with one end brought to a cutting edge from $\frac{1}{4}$ inch to 2 inches wide, is used for cutting draughts or margins on the face of stones.

“The *Tooth Chisel*, Fig. 52, is the same as the chisel, except that the cutting edge is divided into teeth. It is used only on marbles and sandstones.

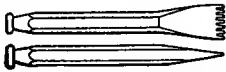

FIG. 52.—TOOTH CHISEL.

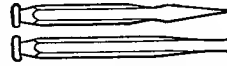

FIG. 53.—SPLITTING CHISEL.

“The *Splitting Chisel*, Fig. 53, is used chiefly on the softer, stratified stones, and sometimes on fine architectural carvings in granite.

“The *Plug*, a truncated wedge of steel, and the *Feathers* of half-round malleable iron, Fig. 54, are used for splitting unstratified stone. A row of holes is made with the *Drill*, Fig. 55, on the line on which the fracture is to be made; in each of these holes two feathers are inserted, and the plugs lightly driven in between them.

FIG. 54.—PLUG
AND FEATHER.

FIG. 55.—DRILLS.

The plugs are then gradually driven home by light blows of the hand hammer on each in succession until the stone splits.”

533. MACHINE TOOLS. In all large stone-yards machines are used to prepare the stone. There is great variety in their form; but

since the surface never takes its name from the tool which forms it, it will be neither necessary nor profitable to attempt a description of individual machines. They include stone-saws, stone-cutters, stone-planers, stone-grinders, and stone-polishers.

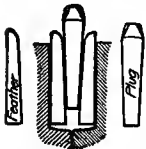
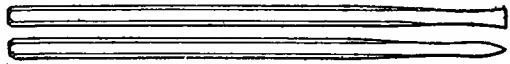
The saws may be either drag, circular, or band saws; and the cutting may be done by sand and water fed into the kerf, or by carbons or black diamonds. Several saws are often mounted side by side and operated by the same power.

The term "stone-cutter" is usually applied to the machine which attacks the rough stone and reduces the inequalities somewhat. After this treatment the stone goes in succession to the stone-planer, stone-grinder, and stone-polisher.

Those stones which are homogeneous, strong and tough, and comparatively free from grit or hard spots, can be worked by machines which resemble those used for iron; but the harder, more brittle stones require a mode of attack more nearly resembling that employed in dressing stone by hand. Stone-cutters and stone-planers employing both forms of attack are made.

Stone-grinders and stone-polishers differ only in the degree of fineness of the surface produced. They are sometimes called rubbing-machines. Essentially they consist of a large iron plate revolving in a horizontal plane, the stone being laid upon it and braced to prevent its sliding. The abradant is sand, which is abundantly supplied to the surface of the revolving disk. A small stream of water works the sand under the stone and also carries away the debris.

ART. 2. METHOD OF FORMING THE SURFACES.

534. It is important that the engineer should understand the methods employed by the stone-cutter in bringing stones to any required form. The surfaces most frequently required in stone cutting are plane, cylindrical, and warped; but sometimes helicoidal, conical, spherical, and irregular surfaces are required.

535. PLANE SURFACES. In squaring up a rough stone, the first thing the stone-cutter does is to draw a line, with iron ore or black lead, on the edges of the stone, to indicate as nearly as possible the required plane surface. Then with the hammer and the pitching-tool he pitches off all waste material above the lines, thereby reducing the surface approximately to a plane. With a chisel he then cuts a draft around the edges of this surface, i.e., he forms narrow plane surfaces along the edges of the stone. To tell when the drafts are in the same plane, he uses two straight-edges having parallel sides and equal widths—see Fig. 56. The projections on the surface are

then removed by the pitching chisel or the point, until the straight-edge will just touch the drafts and the intermediate surface when applied across the stone in any direction. The surface is usually left a little slack, i.e., concave, to allow room for the mortar; however, the surface should be but a very little concave.

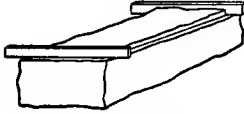

FIG. 56.—PLANE SURFACES.

The surface is then finished with the ax, patent hammer, bush hammer, etc., according to the degree of smoothness required.

536. To form a second plane surface at right angles to the first one, the workman draws a line on the cut face to form the intersection of the two planes; he also draws a line on the ends of the stone approximately in the required plane. With the ax or the chisel he then cuts a draft at each end of the stone until a steel square fits the angle. He next joins these drafts by two others at right angles to them, and brings the whole surface to the same plane. The other faces may be formed in the same way.

If the surfaces are not at right angles to each other, a bevel is used instead of a square, the same general method being pursued.

537. CYLINDRICAL SURFACES. These may be either concave or convex. The former are frequently required, as in arches; and the latter sometimes, as in the outer end of the face stones or ring stones of an arch. The stone is first reduced to a parallelepipedon, after which the curved surface is produced in either of two ways: (1) by cutting a circular draft on the two ends and applying a straight-edge along the rectilinear elements (Fig. 57); or (2) by cutting a draft

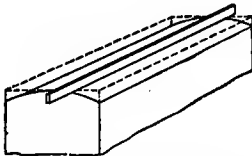

FIG. 57.—CYLINDRICAL SURFACES.

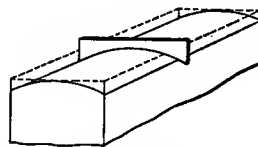

FIG. 58.—CYLINDRICAL SURFACES.

along the line of intersection of the plane and cylindrical surface, and applying a curved templet perpendicular to the axis (Fig. 58).

538. CONICAL SURFACES may be formed by a process very similar to the first one given above for cylindrical surfaces. Such surfaces are seldom used.

539. SPHERICAL SURFACES are sometimes employed, as in domes. They are formed by essentially the same general method as cylindrical surfaces.

540. WARPED SURFACES. Under this head are included what the stone-cutters call "twisted surfaces," helico'dal surfaces, and the

general warped surface. None of these are common in ordinary stone-work.

The method of forming a surface equally twisted right and left will be described, and by obvious modifications the same method can be applied to secure other forms. Two twist rules are required, the angle between the upper and lower edges being half of the required twist. Drafts are then cut in the ends of the stone until the tops of the twist rules, when applied as in Fig. 59, are in a plane. The remainder of the projecting face is removed, until a straight-edge, when applied parallel to the edge of the stone, will just touch the end drafts and the intermediate surface.

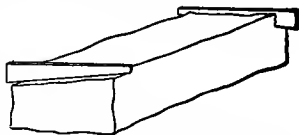

FIG. 59.—WARPED SURFACES.

If the surface is to be twisted at only one end, a parallel rule and a twist rule are used.

541. MAKING THE DRAWINGS. The method of making working drawings for constructions in stone will appear in subsequent chapters, in connection with the study of the structures themselves; but for detailed instructions, see any one of the three following text books on stereotomy or stone-cutting:

1. **DESCRIPTIVE GEOMETRY AS APPLIED TO THE DRAWING OF FORTIFICATIONS AND STEREOTOMY**, by D. H. Mahan; John Wiley & Sons, New York City, 1864. 60 pages 6 by 9 inches, and 8 folding plates.

2. **MODERN STONE-CUTTING AND MASONRY**, by J. S. Siebert and F. C. Biggin; John Wiley & Sons, New York City, 1896. 47 pages 6 by 9 inches, and 14 plates.

3. **STEREOTOMY**, by A. W. French and H. C. Ives; John Wiley and Sons, New York City, 1902. 115 pages 6 by 9 inches, and 21 folding plates.

ART. 3. METHODS OF FINISHING THE SURFACES.*

542. "All stones used in building are divided into three classes, according to the finish of the surface, viz.:

I. Rough stones that are used as they come from the quarry.

II. Stones roughly squared and dressed.

III. Stones accurately squared and finely dressed.

"In practice, the line of separation between them is not very distinctly marked, but one class gradually merges into the next.

543. I. " UNSQUARED STONES. This class covers all stones which are used as they come from the quarry, without other preparation

* This article is taken from the report of the committee of the American Society of Civil Engineers previously referred to (§ 531).

than the removal of very acute angles and excessive projections from the general figure. The term backing, which is frequently applied to this class of stone, is inappropriate, as it properly designates material used in a certain relative position in a wall, whereas stones of this kind may be used in any position.

544. II. "SQUARED STONES. This class covers all stones that are roughly squared and roughly dressed on beds and joints. The dressing is usually done with the face hammer or ax, or in soft stones with the tooth hammer. In gneiss it may sometimes be necessary to use the point. The distinction between this class and the third lies in the degree of closeness of the joints. Where the dressing on the joints is such that the distance between the general planes of the surfaces of adjoining stones is one half inch or more, the stones properly belong to this class.

545. "Three subdivisions of this class may be made, depending on the character of the face of the stones:

"(a) **Quarry-faced** stones are those whose faces are left untouched as they come from the quarry.

"(b) **Pitch-faced** stones are those on which the arris is clearly defined by a line beyond which the rock is cut away by the pitching chisel, so as to give edges that are approximately true.

"(c) **Drafted Stones** are those on which the face is surrounded by a chisel draft, the space inside the draft being left rough. Ordinarily, however, this is done only on stones in which the cutting of the joints is such as to exclude them from this class.

"In ordering stones of this class the specification should always state the width of the bed and end joints which are expected, and also how far the surface of the face may project beyond the plane of the edge. In practice, the projection varies between 1 inch and 6 inches. It should also be specified whether or not the faces are to be drafted.

546. III. "CUT STONES. This class covers all squared stones with smoothly dressed beds and joints. As a rule, all the edges of cut stones are drafted, and between the drafts the stone is smoothly dressed. The face, however, is often left rough where the construction is massive.

"In architecture there are a great many ways in which the faces of cut stone may be dressed, but the following are those that will usually be met in engineering work:

"**Rough-pointed.** When it is necessary to remove an inch or more from the face of a stone, it is done by the pick or heavy point until the projections vary from $\frac{1}{2}$ inch to 1 inch. The stone is then said to be rough-pointed (Fig. 60). In dressing limestone and granite, this operation precedes all others.

“**Fine-pointed.** (Fig. 61). If a smoother finish is desired, rough pointing is followed by fine pointing, which is done with a fine point. Fine pointing is used only where the finish made by

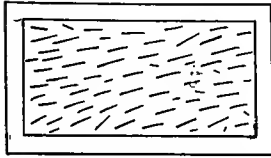

FIG. 60.—ROUGH-POINTED.

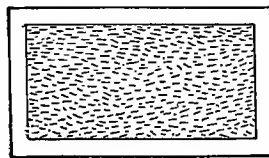

FIG. 61.—FINE-POINTED.



it is to be final, and never as a preparation for a final finish by another tool.

“**Crandalled.** This is only a speedy method of pointing, the effect being the same as fine pointing, except that the dots on the stone are more regular. The variations of level are about $\frac{1}{8}$ inch, and the rows are made parallel. When other rows at right angles to the first are introduced, the stone is said to be *cross crandalled*. Fig. 62 shows a crandalled and also a cross-crandalled surface.

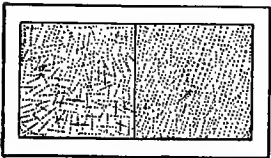

FIG. 62.—CRANDALLED.

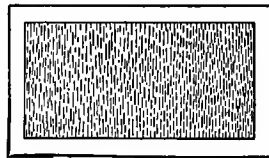

FIG. 63.—AXED.



“**Axed, or Pean-hammered, and Patent-hammered.** These two vary only in the degree of smoothness of the surface which is produced (see Fig. 63). The number of blades in a patent hammer varies from 6 to 12 to the inch; and in precise specifications the number of cuts to the inch must be stated, as 6-cut, 8-cut, 10-cut, or 12-cut. The effect of axing is to cover the surface with chisel marks, which are made parallel as far as practicable. Axing is a final finish.

“**Tooth-axed.** The tooth-ax is practically a number of points, and it leaves the surface of a stone in the same condition as fine pointing. It is usually, however, only a preparation for bush-hammering, and the work is then done without regard to appearance so long as the surface of the stone is sufficiently leveled.

“**Bush-hammered.** The roughnesses of a stone are pounded off by the bush hammer, and the stone is then said to be ‘bushed’

(see Fig. 64). This kind of finish is dangerous on sandstone or other soft stone, as experience has shown that stone thus treated is likely to scale off. In dressing limestone which is to have a bush-hammered finish, the usual sequence of operation is (1) rough-pointing, (2) tooth-axing, and (3) bush-hammering.

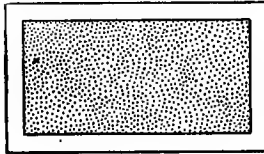

FIG. 64.—BUSH-HAMMERED.



FIG. 65.—RUBBED.



“**Rubbed.** In dressing sandstone and marble, it is very common to give the stone a plane surface at once by the use of the stone-saw [§ 533]. Any roughnesses left by the saw are removed by rubbing with grit or sandstone [§ 533]. Such stones, therefore, have no margins (see Fig. 65). They are frequently used in architecture for string courses, lintels, door jambs, etc.; and they are also well adapted for use in facing the walls of lock chambers and in other

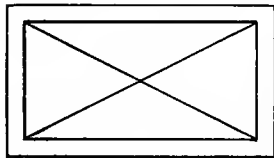

FIG. 66.—DIAMOND PANEL.



localities where a stone surface is liable to be rubbed by vessels or other moving bodies.

“**Diamond Panels.** Sometimes the space between the margins is sunk immediately adjoining them and then rises gradually until the four planes form an apex at the middle of the panel. In general, such panels are called diamond panels, and the one just described, Fig. 66, is called a sunk diamond panel. When the surface of the stone rises gradually from the inner lines of the margins to the middle of the panel, it is called a raised diamond panel. Both kinds of finish are common on bridge quoins and similar work. The details of this method should be given in the specifications.”

CHAPTER XI

STONE MASONRY

ART. 1. DEFINITIONS AND DESCRIPTIONS.

547. DEFINITIONS OF PARTS OF THE WALL. The following include all terms ordinarily used.

Batter. The slope of the surface of the wall.

Backing. The stone which forms the back of the wall.

Coping. A course of stone on the top of the wall to protect it.

Course. A horizontal layer of stone in the wall.

Cramps. Bars of iron having the ends turned at right angles to the body of the bar, which enter holes in the upper side of adjacent stones.

Dowels. Straight bars of iron which enter a hole in the upper side of one stone and also a hole in the lower side of the stone next above.

Face. The front surface of a wall; *back*, the inside surface.

Facing. The stone which forms the face or outside of the wall.

Filling. The interior of the wall.

Header. A stone whose greatest dimension lies perpendicular to the face of the wall.

Joints. The mortar layer between the stones. The horizontal joints are called *bed joints*, or usually simply *beds*; the vertical joints are sometimes called *builds*, but usually *joints*.

Quoin. A corner stone. A quoin is a header for one face and a stretcher for the other.

Stretcher. A stone whose greatest dimension lies parallel to the face of the wall.

548. DEFINITIONS OF KINDS OF MASONRY.* Stone masonry is classified (1) according to the degree of the finish of the face of the stones, as quarry-faced, pitch-faced, and cut-stone; (2) according to whether the horizontal joints are more or less continuous, as range, broken range, and random; and (3) according to the care employed in dressing the beds and joints, as ashlar, squared-stone, and rubble.

549. Classification According to Finish of Face. *Quarry-faced*

* The definitions under this head are in accordance with the recommendations of the Committee of the American Society of Civil Engineers previously referred to, and conform to the best practice. Unfortunately, they are not universally adopted.

Masonry. That in which the face of the stone is left as it comes from the quarry—see Fig. 67.

Pitch-faced Masonry. That in which the face edges of the beds are pitched to a right line—see Fig. 68. Notice that the outer edge of a horizontal joint of pitch-faced masonry is straight, while in quarry-faced it is not.

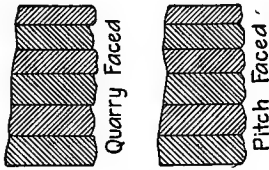

FIG. 67.

FIG. 68.

Cut-stone Masonry. That in which the face of the stone is finished by any one of the methods described in § 545-46, as rough-pointed, fine-pointed, crandalled, axed, bush-hammered, rubbed, etc.

550. Classification According to Continuity of Courses. *Range.* Masonry in which a course is of the same thickness throughout—see Fig. 69.

Broken Range. Masonry in which a course is not continuous throughout—see Fig. 70.

Random. Masonry which is not laid in courses at all—see Fig. 71. Random masonry is sometimes designated as one-against-two or two-against-three, the first term indicating that there is one stone on one side of a vertical joint and two on the other, and similarly for the second term.

Any one of these three terms may be employed to designate the coursing of either ashlar (§ 551) or square-stone masonry (§ 552), but can not be applied to rubble (§ 553).

551. Classification According to Thickness of Joints. *Ashlar.* Cut-stone masonry, or masonry composed of any of the various kinds

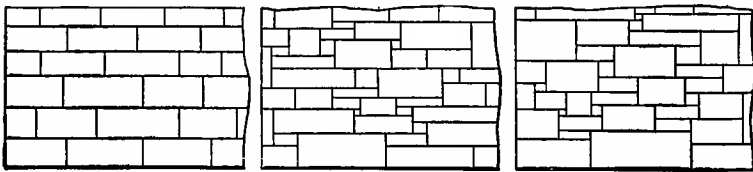

FIG. 69.—RANGE.

FIG. 70.—BROKEN RANGE.

FIG. 71.—RANDOM.

of cut-stone mentioned in § 545-46. According to the Report of the Committee of the American Society of Civil Engineers, "when the dressing of the joints is such that the distance between the general planes of the surfaces of adjoining stones is one half inch or less, the masonry belongs to this class." From its derivation ashlar apparently means large, square blocks; but practice seems to have made it synonymous with "cut-stone," and this secondary meaning has been retained for convenience. The coursing of ashlar is described by prefixing range, broken range, or random; and the

finish of the face is described by prefixing a name to designate the finish of the face of the stone (see § 545-46) of which the masonry is composed.

Small Ashlar. Cut-stone masonry in which the stones are less than one foot thick. The term is not often used.

Rough Ashlar. A term sometimes given to squared-stone masonry (§ 552), either quarry-faced or pitch-faced, when laid as range work; but it is more logical and more expressive to call such work range squared-stone masonry.

Dimension Stone. Cut stone, all of whose dimensions have been fixed in advance. "If the specifications for ashlar masonry are so written as to prescribe the dimensions to be used, it will not be necessary to make a new class for masonry composed of dimension stones."

552. Squared-stone Masonry. Work in which the stones are roughly squared and roughly dressed on beds and joints (§ 544). The distinction between squared-stone masonry and ashlar (§ 551) lies in the degree of closeness of the joints. According to the Report of the Committee of the American Society of Civil Engineers, "when the dressing on the joints is such that the distance between the general planes of the surface of adjoining stones is one half inch or more, the stones properly belong to this class"; nevertheless, such masonry is often classed as ashlar or cut-stone masonry.

553. Rubble Masonry. Masonry composed of unsquared stone (§ 543).

Uncoursed Rubble. Masonry composed of unsquared stones laid without any attempt at regular courses—see Fig. 72.

Coursed Rubble. Unsquared-stone masonry which is leveled off at specified heights to an approximately horizontal surface. It may be specified that

the stone shall be roughly shaped with the hammer, so as to fit approximately—see Fig. 73.

554. Other Classifications. The preceding classification is based on the quality of the masonry; but railway engineers sometimes classify masonry according to its use,—as bridge masonry, arch masonry, culvert masonry, etc. However, it is more logical and also more expressive to use the classification according to quality, and if desired add a term to indicate the purpose of the masonry,

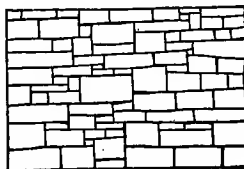

FIG. 72.—UNCOURSED
RUBBLE.

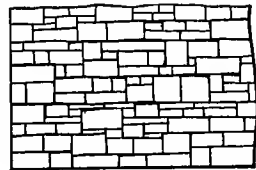

FIG. 73.—COURSED
RUBBLE.

as, for example, arch ashlar masonry, bridge squared-stone masonry, culvert rubble. However, the terms defined in § 548-53 are sufficient to give a reasonably complete definition of any ordinary kind of masonry. The following are examples of the method of using these terms: pitch-faced random ashlar masonry, or bush-hammered range ashlar masonry; quarry-faced broken-range squared-stone masonry; coursed rubble masonry.

Formerly, railway engineers frequently classified masonry as first-class, second-class, and third-class, which corresponded approximately to ashlar, squared-stone, and rubble respectively; but such a classification is now seldom used.

555. Dry Masonry. The three preceding classes of masonry, ashlar, squared-stone and rubble, are laid with mortar; and there are three other grades of what may be called dry masonry, which are laid without mortar. These are slope-wall masonry, stone paving, and riprap.

556. Slope-wall Masonry. A thin layer of dry masonry, built against the slope of embankments, excavations, river banks, etc., to preserve them from rain, waves, or weather.

557. Stone Paving. Dry masonry used for the invert of culverts, for protecting the lower end of culverts from undermining, for foundations for stone-box culverts, etc.

558. Riprap. Stone thrown in promiscuously about the base of piers, abutments, etc., to prevent scour, or placed on banks of rivers and canals to prevent wash.

559. GENERAL RULES. The following general principles apply to all classes of stone masonry.

1. The largest stones should be used in the foundation to give the greatest strength and lessen the danger of unequal settlement.

2. A stone should be laid upon its broadest face, since then there is better opportunity to fill the spaces between the stones.

3. For the sake of appearance, the larger stones should be placed in the lower courses, the thickness of the courses decreasing gradually toward the top of the wall.

4. Stratified stones should be laid upon their natural bed, i.e., with the strata perpendicular to the pressure, since they are then stronger and more durable.

5. The masonry should be built in courses perpendicular to the pressure it is to bear.

6. To bind the wall together laterally, a stone in any course should break joints with or overlap the stone in the course below; that is, the joints parallel to the pressure in two adjoining courses should not be too nearly in the same line. This is briefly comprehended by saying that the wall should have sufficient lateral bond.

7. To bind the wall together transversely, there should be a considerable number of headers extending from the front to the back of thin walls or from the outside to the interior of thick walls; that is, the wall should have sufficient transverse bond.

8. The surface of all porous stones should be moistened before being bedded, to prevent the stone from absorbing the moisture from the mortar and thereby causing it to become a friable mass.

9. The spaces between the back ends of adjoining stones should be as small as possible, and these spaces and the joints between the stones should be filled with mortar.

10. If it is necessary to move a stone after it has been placed upon the mortar bed, it should be lifted clear and be reset, as attempting to slide it is likely to loosen stones already laid and destroy the adhesion, and thereby injure the strength of the wall.

11. An unseasoned stone should not be laid in the wall, if there is any likelihood of its being frozen before it has seasoned.

560. ASHLAR MASONRY. This is masonry in which the thickness of the bed joints is one half inch or less. According to the finish of the face of the stones, ashlar may be divided into either pitch-faced, drafted, or cut-stone masonry (§ 545-46); and according to the arrangement of the course it may be range, broken range, or random masonry (§ 550).

Ashlar is the best quality of stone masonry, and is employed in all important structures. It is used for piers, abutments, arches, and parapets of bridges; for hydraulic works; for facing quoins, and string courses; for the coping of inferior kinds of masonry and of brick work; and, in general, for works in which great strength and stability are required.

Its strength depends upon the size of the stones, upon the accuracy of the dressing, and upon the bond.

561. Size of Stones. The dimensions of the blocks should vary with the character of the stone employed. With the weaker sandstone and granular limestones, the length of any stone should not be greater than three times its depth, as otherwise it is likely to be broken across; but with the stronger stones, the length may be four or five times the depth. With the weaker stones the breadth may range from one and a half to two times the depth; and for the stronger stones from three to four times the depth.

562. Dressing. The dressing consists in cutting the side and bed joints to plane surfaces, usually at right angles to each other. The accurate dressing of the bed joints to a plane surface is exceedingly important. If any part of the surface projects beyond the plane of the chisel draft, that projecting part will have to bear an undue share of the pressure, the joint will gape at the edges,—constituting

what is called an *open joint*,—and the whole will be wanting in stability. On the other hand, if the surface of the bed is concave, having been dressed down below the plane of the chisel draft, the pressure is concentrated on the edges of the stone, to the risk of splitting them off. Such joints are said to be *flushed*. They are more difficult of detection, after the masonry has been built, than open joints; and are often executed by design, in order to give a neat appearance to the face of the building. Their occurrence must therefore be guarded against by careful inspection during the progress of the stone cutting.

Great smoothness is not desirable in the joints of ashlar masonry intended for strength and stability; for a moderate degree of roughness adds at once to the resistance to displacement by sliding, and to the adhesion of the mortar. When the stone has been dressed so that all the small ridges and projecting points on its surface are reduced nearly to a plane, the pressure is distributed nearly uniformly, for the mortar serves to transmit the pressure to the small depressions. Each stone should first be fitted into its place dry, in order that any inaccuracy of figure may be discovered and corrected by the stone-cutter before it is finally laid in mortar and settled in its bed.

The entire bed area of a stone should be dressed to a plane; but, unless the wall is so thin that the stones extend clear through, it is not necessary to dress the entire area of the ends of the stones; and it is not necessary to dress any portion of the back side of the stones. The specifications should state the distance back from the face of the stone that the end is to be dressed to a plane surface. This distance is sometimes stated in inches and sometimes as a fractional part of the thickness of the course (see § 23 of Appendix III).

Sometimes specifications permit the vertical joints to be wider than the bed joints. This decreases the cost of cutting, and may not materially reduce the strength of the masonry; but may slightly affect the durability and the architectural appearance.

No cutting should be allowed after the stone has been set in mortar, for fear of breaking the adhesion of the cement.

The thickness of mortar in the joints of the very best ashlar masonry—for example, the United States post-office and custom-house buildings in the principal cities—is about $\frac{1}{2}$ of an inch; in first-class railroad masonry—for example, important bridge piers and abutments, and large arches—the joints are from $\frac{1}{4}$ to $\frac{1}{2}$ of an inch.

A chisel draft $1\frac{1}{2}$ or 2 inches wide is usually cut at each exterior corner. In the best work, as fine cut-stone buildings, all projecting courses, as window sills, water tables, cornices, etc., have grooves,

or "drips" cut in the under surface a little way back from the face, so as to cause rain-water to drop from the outer edge instead of running down over the face of the wall and disfiguring it.

563. Bond. The bond is the arrangement or overlapping of the stones to tie the wall together longitudinally and transversely, and is of great importance to the strength of the wall. No joint of any course should be directly above a joint in the course below; but the stones should overlap, or break joint, from one to one and one half times the depth of the course, both along the face of the wall and also from the front to the back. The effect is that each stone is supported by at least two stones of the course below, and assists in supporting at least two stones of the course above. The object is twofold: first, to distribute the pressure, so that inequalities of load on the upper part of the structure (or of resistance at the foundation) may be transmitted to and spread over an increasing area of bed in proceeding downwards (or upwards); and second, to tie the building together, i.e., to give it a sort of tenacity, both lengthwise and from face to back, by means of the friction of the stones where they overlap.

The strongest bond is that in which each course at the face of the structure contains a header and a stretcher alternately, the outer end of each header resting on the middle of a stretcher of the course below, so that rather more than *one third* of the area of the face consists of ends of headers. This proportion may be deviated from when circumstances require it, but in every case it is advisable that the ends of headers should not form less than *one fourth* of the whole area of the face of the structure. A header should be over the middle of the stretcher in the course below. In a thin wall a header should extend entirely through the wall.

A trick of masons is to use "blind headers," or short stones that look like headers on the outside but do not go deeper into the wall than the adjacent stretchers. When a course has been put on top of these short headers, they are completely covered up; and, if not suspected, the fraud will never be discovered unless the weakness of the wall reveals it.

Where very great resistance to displacement of the masonry is required (as in the upper courses of bridge piers, or over openings, or where new masonry is joined to old, or where there is danger of unequal settlement), the bond is strengthened by dowels or by cramp irons (§ 547) of, say, $1\frac{1}{4}$ -inch round iron set with cement mortar.

564. Backing. Ashlar is usually backed with rubble masonry (§ 574), which in such cases is specified as coursed rubble. Special care should be taken to secure a good bond between the rubble back-

ing and the ashlar facing. Two stretchers of the ashlar facing having the same width should not be placed one immediately above the other. The proportion and the length of the headers in the rubble backing should be the same as in the ashlar facing. The "tails" of the headers, or the parts which extend into the rubble backing, may be left rough at the back and sides; but their upper and lower beds should be dressed to the general plane of the bed of the course. These "tails" may taper slightly in breadth, but should not taper in depth.

The backing should be carried up at the same time with the face-work, and in courses of the same depth; and the bed of each course should be carefully built to the same plane with that of the ashlar facing. The rear face of the backing should be lined to a fair surface.

565. Pointing. In laying masonry of any character, whether with lime or cement mortar, the exposed edges of the joints will naturally be deficient in density and hardness. The mortar in the joints near the surface is especially subject to dislodgment, since the contraction and expansion of the masonry is liable either to separate the stone from the masonry or to crack the mortar in the joint, thus permitting the entrance of rain-water, which upon freezing forces the mortar from the joints. Therefore, it is usual, after the masonry is laid, to refill the joints as compactly as possible, to the depth of at least an inch, with mortar prepared especially for this purpose. This operation is called pointing.

The very best cement mortar should be used for pointing, as the best becomes dislodged all too soon. Clear portland-cement mortar is the best, although 1 volume of cement to 1 of sand is frequently used in first-class work. The mortar, when ready for use, should be rather incoherent and quite deficient in plasticity.

Before applying the pointing, all mortar in the joint should be dug out to a depth of at least 1 inch; or, better, in setting the stones, the mortar should be kept back an inch or more from the face, and thus save the labor of digging out the joints preparatory to pointing. For the *bed joints* this may be accomplished by keeping the mortar back from the face of the wall about 3 inches, and then when the stone is put into place the mortar will probably be forced out to about 1 or 1½ inches from the face of the joint, and consequently little or no labor will be required to dig out the mortar. Frequently in laying a stone the mortar is spread to the very edge of the joint; and then when the pointing is done, it is so difficult to dig out the mortar that the joint is cleared only about half an inch deep, which depth does not give the pointing sufficient hold, and consequently it soon drops out. The difficulty of digging out the mortar from the *vertical joints* may be obviated by bending a strip of

tin or thin steel to the form of a U having one leg considerably longer than the other, and nailing the long leg to the side of a light strip of wood so that the closed end of the U will project beyond the edge of the wood a distance equal to the depth of the pointing, and then inserting the closed end of the U in the vertical joint before it is filled with mortar.

When the surplus mortar has been removed, the joint should be cleansed by scraping and brushing out all loose material, and then it should be well moistened. The mortar is applied with a mason's trowel, and should be well "set in" with a calking iron and hammer. The joint should be rubbed smooth and finished even with the pitch line or with the face of the stone. In the very best work, the joint is also rubbed smooth with a steel polishing tool. Walls should not be allowed to dry too rapidly after pointing; and therefore pointing in hot weather should be avoided.

566. There are four general forms of finishing the edges of the horizontal joints of cut-stone masonry—whether or not they are formally pointed as above described. Fig. 74 shows these four forms. When the horizontal joints are finished as in either of the first two examples in Fig. 74, it is customary to finish the vertical joints by the first method; but when either of the last two methods is employed, it is used for both the vertical and the horizontal joints.

Occasionally in cut-stone masonry, and frequently in brick masonry, the weather joint is improperly made to slope in the opposite direction, due to the fact that the mason stands at the back of the wall and "strikes" the joint by reaching down and resting the edge of the trowel on the stone below the joint. If the mason stands behind the wall, it is not comfortable to make the weather joint as shown in Fig. 74, at the time the masonry is laid. The grooved joint is frequently called a tuck-pointed joint, and is sometimes made with a

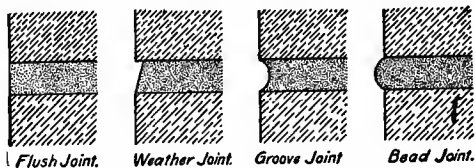

FIG. 74.—METHODS OF FINISHING HORIZONTAL JOINTS.

V-like face. The beaded joint is not very durable, since the projecting portion soon becomes detached. In making the beaded joint, the beading tool is sometimes guided by a straight edge, called a "rod," and the joint is then said to be "rodded."

567. **Amount of Mortar Required.** The amount of mortar required for ashlar masonry varies with the size of the blocks, and also with the closeness of the dressing. With $\frac{3}{8}$ - to $\frac{1}{2}$ -inch joints and 12- to

20-inch courses, there will be about 2 cubic feet of mortar per cubic yard; with larger blocks and closer joints, i.e., in the best masonry, there will be about 1 cubic foot of mortar per yard of masonry. Laid in 1 to 2 mortar, the former will require $\frac{1}{4}$ to $\frac{1}{3}$ of a barrel of cement per cubic yard of masonry exclusive of the rubble backing (for which see § 577); and the latter about half as much.

For the quantities of cement and sand required for a cubic yard of mortar of different compositions, see Table 22, page 120.

568. Specifications. For complete specifications of ashlar masonry, see Appendix III.

569. SQUARED-STONE MASONRY. This is masonry in which the joints are more than one half inch thick and less than about one inch (§ 552). Squared-stone masonry may be classified according to the finish of the face as either quarry-faced or pitch-faced, and according to the arrangement of the courses as range, broken range, or random. The quoins and the sides of openings are usually reduced to a rough-smooth surface with the face-hammer, the ordinary ax, or the tooth-ax. This work is a necessity where door or window frames are inserted; and it greatly improves the general effect of the wall, if used wherever a corner is turned.

Squared-stone masonry is distinguished, on the one hand, from ashlar in having less accurately dressed beds and joints; and, on the other hand, from rubble in being more carefully constructed. In ordinary practice, the field covered by this class is not very definite. The specifications for "second-class masonry" as used on some railroads usually conform to the above description of quarry-faced range squared-stone masonry; but sometimes this grade of masonry is designated "superior rubble."

Squared-stone masonry is employed for the piers and abutments of highway bridges, for small arches, for box culverts, for basement walls, etc.

570. Backing. The statements concerning backing of ashlar (§ 564) apply substantially to squared-stone masonry.

571. Pointing. As the joints of squared-stone masonry are thicker than those of ashlar, the pointing should be done proportionally more carefully; while as a rule it is done much more carelessly. The mortar is often thrown into the joint with a trowel, and then trimmed top and bottom to give the appearance of a thinner joint. Such work is called *ribbon pointing*. Trimming the pointing adds to the appearance but not to the durability. When the pointing is not trimmed, it is called *dash pointing*.

572. Specifications. The specifications for squared-stone masonry should be about as follows:

The stones shall be of durable quality; and shall be free from seams, powder cracks, drys, or other imperfections.

The courses shall be not less than 10 inches thick.

Stretchers shall be at least twice as wide as thick, and at least four times as long as thick. Headers shall be at least five times as long as thick, and at least as wide as thick. There shall be at least one header to three stretchers. Joints on the face shall be broken at least 8 inches.

The beds and the vertical joints for 8 inches back from the face of the wall shall be dressed to make joints one half to one inch thick. The front edge of the joint shall be pitched to a straight line. All corners and batter-lines shall be hammer-dressed.

The backing shall consist of stones not less in thickness than the facing. At least one half of the backing shall be stones containing at least 2 cubic feet. The backing shall be laid in full mortar beds; and no spalls shall be allowed in the bed joints. The vertical spaces between the large stones shall be filled with spalls set in mortar.

The coping shall be formed of large flat stones of such thickness as the engineer may direct, but in no case to be less than eight inches. The upper surface of the coping shall be bush-hammered, and the joints and beds shall be dressed to one half inch throughout. Each coping stone must extend entirely across the wall when the wall is not more than four feet thick.

573. Amount of Mortar Required. The amount of mortar required for squared-stone masonry varies with the size of the stones and with the quality of the masonry; and will be a little more than twice that required for ashlar—see § 567.

For quantities of cement and sand required for mortars of various compositions, see Table 22, page 120.

574. RUBBLE MASONRY. This is the lowest grade of masonry laid with mortar. Rubble is built of unsquared stones, that is, of stones as they come from the quarry without other preparation than the removal of very acute angles and excessive projections from the general figure. The only classes of rubble are coursed and uncoursed (see § 553).

Rubble is sometimes designated as *one-man* or *two-man rubble* according to the number of men required to handle a stone.

Sometimes, when rubble is built of very large blocks of stone, concrete instead of mortar is employed to fill the vertical spaces between the stones, in which case the masonry is called *concrete rubble* (see § 579).

Rubble masonry is sometimes laid without any mortar, as in slope walls (§ 556), paving (§ 557), etc., in which case it is called dry rubble; but as such work is much more frequently designated as slope-wall masonry and stone-paving, it is better to reserve the term rubble for undressed stone laid in mortar. Occasionally box culverts are built of the so-called dry rubble; but as such construc-

tion is not to be commended, there is no need of a term to designate that kind of masonry.

575. Laying. The stone used for rubble masonry is prepared by simply knocking off all the weak angles of the block. It should be cleansed from dust, etc., and moistened, before being placed on its bed. This bed is prepared by spreading over the top of the lower course an ample quantity of good, ordinary-tempered mortar in which the stone is firmly embedded. The vertical joints should be carefully filled with mortar. The interstices between the larger masses of stone are filled by thrusting small fragments or chippings of stone into the mortar.

Careful attention should be given to bonding the wall laterally and transversely. It is frequently specified that one fourth or one fifth of the mass shall be headers. The corners and jambs should be laid with hammer-dressed or cut stones.

A very stable wall can be built of rubble masonry without any dressing, except a draft on the quoins by which to plumb the corners and carry them up neatly, and a few strokes of the hammer to spall off any projections or surplus stone. This style of work is not generally advisable, as very few mechanics can be relied upon to take the proper amount of care in leveling up the beds and filling the joints; and as a consequence, one small stone may jar loose and fall out, resulting probably in the downfall of a considerable part of the wall. Some of the naturally bedded stones are so smooth and uniform as to need no dressing or spalling up; and a wall of such stones is very economical, since there is no expense of cutting and no time is lost in hunting for the right stone, and yet strong, massive work is assured. However, many of the naturally bedded stones have inequalities on their surfaces, and in order to keep them level in the course it becomes necessary to raise one corner by placing spalls or chips of stone under the bed, and to fill the vacant spaces well and full with mortar. It is just here that the disadvantage of this style of work becomes apparent. Unless the mason places these spalls so that the stone rests firmly, i.e., does not rock, it will work loose, particularly if the structure is subject to shock, as the walls of cattle-guards, etc. Unless these spalls are also distributed so as to support all parts of the stone, it is liable to be broken by the weight above it. A few such instances in the same work may occasion considerable disaster.

One of the tricks of masons is to put "nigger-heads" (stones from which the natural rounded surface has not been taken off) into the interior of the wall. In order to secure good rubble, great skill and care are required on the part of the mason, and constant watchfulness on the part of the inspector.

576. Rubble masonry is employed for the abutments of the smaller highway bridges, for small culverts, for unimportant retaining walls, for foundations for buildings, etc., and for the backing of ashlar and squared-stone masonry.

When carefully executed with good mortar, rubble possesses all the strength and durability required in structures of an ordinary character, and is much less expensive than either ashlar or squared-stone masonry. But it is difficult to get rubble well executed. The most common defects are (1) not bringing the stones to an even bearing; (2) leaving large unfilled vertical openings between the several stones; (3) laying up a considerable height of the wall dry, with only a little mortar on the face and back, and then pouring mortar on the top of the wall; (4) using insufficient cement, or that of a poor quality. The only way to prevent the first defect is to have an inspector on the job all of the time. The second and third defects can be detected by probing the wall with a small pointed steel rod. To prevent the fourth defect it is customary for the owner to furnish the cement to the contractor. Apparently it is commonly believed that the rougher the stones and the poorer the grade of masonry, the poorer the cement or the leaner the mortar should be. The principal object of the mortar is to equalize the pressure; and the more nearly the stones are reduced to closely fitting surfaces, the less important is the mortar. Consequently, when a substantial rubble is required, it would not be amiss to use a first-class cement mortar, particularly if the stones are comparatively small. The extreme of this rule is the use of a first-class cement mortar with crushed stone to make concrete; and owing to the success of this practice and the decrease in the cost of portland cement in recent years, concrete has been largely substituted for all kinds of masonry, particularly rubble.

577. Amount of Mortar Required. The amount of mortar required varies greatly with the character of the surfaces with which the stone quarries out. If the stone is stratified sandstone or limestone yielding flat-bedded stones with good end surfaces, the rubble may not require much if any more mortar than ashlar built of the more refractory stones; but if the rubble is built of stone that quarries out in irregular chunks and is difficult to dress, a very large per cent of mortar may be required. The amount of mortar required can be considerably reduced by packing spalls into the vertical spaces between the stones,—a proceeding that is always economical since spalls are always much cheaper than cement mortar. However, when the cement is furnished by the owner, the mason is apt to fill the joints entirely with mortar since it requires less time.

If rubble masonry is composed of small and irregularly shaped

stones, about one third of the mass will consist of mortar; and if laid in 1 : 2 mortar will require about 1 barrel of portland cement per cubic yard, and if laid in 1 : 3 about 0.8 barrel. If the stones are large and regular in form, one fifth to one quarter of the mass will be mortar; and the rubble will require about 0.7 barrel per cubic yard for 1 : 2 mortar and 0.6 barrel for 1 : 3.

For the amount of cement and sand required for mortar of various compositions, see Table 22, page 120.

578. Specifications. The following requirements, if properly complied with, will secure what is generally known among railroad engineers as superior rubble.*

Rubble masonry shall consist of coursed rubble of good quality laid in cement mortar. No stone shall be less than six inches in thickness, unless otherwise directed by the engineer. No stone shall measure less than twelve inches in its least horizontal dimension, or less than its thickness. At least one fourth of the stone in the face shall be headers, evenly distributed throughout the wall. The stones shall be roughly squared on joints, beds, and faces, laid so as to break joints and in full mortar beds. All vertical spaces shall be flushed with good cement mortar and then be packed full with spalls. No spalls will be allowed in the beds. Selected stones shall be used at all angles, and shall be neatly pitched to true lines and laid on hammer-dressed beds. Drafts lines may be required at the more prominent angles.

The top of parapet walls, piers, and abutments shall be capped with stones extending entirely across the wall, and having a front and end projection of not less than four inches. Coping stones shall be neatly squared, and be laid with joints of less than one half inch. The steps of wing-walls shall be capped with stone covering the entire step, and extending at least six inches into the wall. Coping and step stones shall be roughly hammer-dressed on top, their outer faces pitched to true lines, and be of such thickness (not less than six inches) and have such projections as the engineer may direct.

The specifications for rubble masonry will apply to rubble masonry laid dry (see §555), except as to the use of the mortar.

579. CONCRETE RUBBLE. Sometimes in building large structures, as dams, the rubble is made of cyclopean blocks, and wet concrete is used instead of mortar. The large stones are placed in the wall by means of a derrick, and concrete is deposited from a bottom-dump bucket. This form of construction is a recent innovation; and is specially applicable in building a dam, in which the faces are laid in ashlar, squared-stone, or rubble, and serve as forms in which to place the concrete-rubble filling. This form of masonry has several obvious advantages over either ordinary rubble or concrete.

580. Rubble Concrete. This is ordinary concrete in which large irregular stones, sometimes called plums, are embedded. This form

*For specifications of rubble masonry for railroad work, see Appendix III.

of masonry is adapted to moderately massive construction. The "plums" decrease the cost of crushing the stone and also decrease the amount of cement required, and increase the density of the mass. The "plums" are usually limited to about 40 per cent of the entire volume, to insure that they shall be surrounded by concrete. If the concrete is wet, there is little or no trouble in getting the large stones thoroughly bedded, and consequently this form of masonry is as good as or better than ordinary concrete.

Unfortunately, there is no uniformity as to the terms employed to designate either of the two above types of masonry. Each is frequently referred to as concrete rubble, and also as rubble concrete. It will add to clearness if the term *concrete rubble* be reserved for that form of masonry which consists chiefly of large stones surrounded by concrete, and the term *rubble concrete* for that type which consists of concrete in which are embedded a comparatively few large stones. Of course the two forms shade one into the other.

ART. 2. STRENGTH AND COST.

581. STRENGTH OF STONE MASONRY. The results obtained by testing small specimens of stone (see § 16) are useful in determining the relative strength of different kinds of stone, but are of no value in determining the ultimate strength of the same stone when built into a masonry structure. The strength of a mass of masonry depends upon the strength of the stone, the size of the blocks, the accuracy of the dressing, the proportion of headers to stretchers, and the strength of the mortar. A variation in any one of these items may greatly change the strength of the masonry. The importance of the mortar as affecting the strength of masonry to resist direct compression is generally overlooked. The mortar acts as a cushion (§ 14) between the blocks of stone, and if it has insufficient strength it may squeeze out laterally and produce a tensile stress in the stone. It is certain that usually weak mortar causes the stone to fail either by direct tension or by tension due to flexure rather than by compression.

No experiments have ever been made upon the strength of stone masonry under the conditions actually occurring in masonry structures, owing to the lack of a testing machine of sufficient strength. Experiments made upon brick piers (§ 622) 12 inches square and from 2 to 10 feet high, laid in mortar composed of 1 volume portland cement and 2 sand, show that the strength per square inch of the masonry is only about one sixth of the strength of the brick. An increase of 50 per cent in the strength of the brick produced no appreciable effect on the strength of the masonry; but the substitution of cement mortar (1 portland and 2 sand) for lime mortar

(1 lime and 3 sand) increased the strength of the masonry 70 per cent. The method of failure of these piers indicates that the mortar squeezed out of the joints and caused the brick to fail by tension. Since the mortar is the weakest element, the less mortar used the stronger the wall; therefore the thinner the joints and the larger the blocks, the stronger the masonry, provided the surfaces of the stones do not come in contact.

It is generally stated that the working strain on stone masonry should not exceed one twentieth to one tenth of the strength of the stone; but it is clear, from the experiments on the brick piers referred to above, that the strength of the masonry depends upon the strength of the stone only in a remote degree. In a general way it may be said that the results obtained by testing small cubes may vary 50 per cent from each other (or say 25 per cent from the mean) owing to undetected differences in the material, the cutting, and the manner of applying the pressure. Experiments also show that stones crack at about half of their ultimate crushing strength. Hence, when the greatest care possible is exercised in selecting and bedding the stone, the safe working strength of the stone alone should not be regarded as more than three eighths of the ultimate strength. A further allowance, depending upon the kind of structure, the quality of mortar, the closeness of the joints, etc., should be made to insure safety. Experiments upon even comparatively large monoliths give but little indication of the strength of masonry. The only practicable way of determining the actual strength of masonry is to note the loads carried by existing structures. However, this method of investigation will give only the load which does not crush the masonry, since probably no structure ever failed owing to the crushing of the masonry. After an extensive correspondence and a thorough search through engineering literature, the following list is given as showing the maximum pressure to which the several classes of masonry have been subjected.

582. Pressure Allowed. Early builders used much more massive masonry, proportional to the load to be carried, than is customary at present. Experience and experiments have shown that such great strength is unnecessary. The load on the monolithic piers supporting the large churches in Europe does not usually exceed 30 tons per sq. ft. (420 lb. per sq. in.),* or about one thirtieth of the ultimate strength of the stone alone, although the columns of the Church of All Saints at Angers, France, is said to sustain 43 tons per sq. ft. (600 lb. per. sq. in.).† The stone-arch bridge of 140 ft.

* In this connection it is convenient to remember that 1 ton per square foot is equivalent to nearly 14 (exactly 13.88) pounds per square inch.

† *Engineering News*, vol. xiii, p. 349.

span at Pont-y-Prydd, over the Taff, in Wales, erected in 1750, is supposed to have a pressure of 72 tons per sq. ft. (1,000 lb. per sq. in.) on hard limestone rubble masonry laid in lime mortar.* Rennie subjected good hard limestone rubble in columns 4 feet square to 22 tons per sq. ft. (300 lb. per sq. in.).† The granite piers of the Saltash Bridge sustain a pressure of 9 tons per sq. ft. (125 lb. per sq. in.).

The maximum pressure on the granite masonry of the towers of the Brooklyn Bridge is about $28\frac{1}{2}$ tons per sq. ft. (about 400 lb. per sq. in.). The maximum pressure on the limestone masonry of this bridge is about 10 tons per sq. ft. (125 lb. per sq. in.). The face stones ranged in cubical contents from $1\frac{1}{2}$ to 5 cubic yards; the stones of the granite backing averaged about $1\frac{1}{2}$ cu. yd., and of the limestone about $1\frac{1}{4}$ cu. yd. per piece. The mortar was 1 volume of Rosendale natural cement and 2 of sand. The stones were rough-axed or pointed to $\frac{1}{2}$ -inch bed-joints and $\frac{1}{2}$ -inch vertical face-joints.‡ These towers are very fine examples of the mason's art.

In the Rookery Building, Chicago, granite columns about 3 feet square sustain 30 tons per sq. ft. (415 lb. per sq. in.) without any signs of weakness.

In the Washington Monument, Washington, D. C., the normal pressure on the lower joint of the walls of the shaft is 20.2 tons per sq. ft. (280 lb. per sq. in.), and the maximum pressure brought upon any joint under the action of the wind is 25.4 tons per sq. ft. (350 lb. per sq. in.).¶

The pressure on the limestone piers of the St. Louis Bridge was, before completion, 38 tons per sq. ft. (527 lb. per sq. in.); and after completion the pressure was 19 tons per sq. ft. (273 lb. per sq. in.) on the piers and 15 tons per sq. ft. (198 lb. per sq. in.) on the abutments.**

The limestone masonry in the towers of the Niagara Suspension Bridge failed under 36 tons per sq. ft., and were taken down,—however, the masonry was not well executed and was subjected to flexure.††

At the South Street Bridge, Philadelphia, the pressure on the limestone rubble masonry in the pneumatic piles is 15.7 tons per sq. ft. (220 lb. per sq. in.) at the bottom and 12 tons per sq. ft. at the top. "This is unusually heavy, but there are no signs of weakness."‡‡ The maximum pressure on the rubble masonry (laid in cement mortar) of some of the large masonry dams is from 11 to 14

* The Technograph, University of Illinois, No. 7, p. 27.

† Proc. Inst. of C. E., vol. x, p. 241.

‡ F. Collingwood, asst. engineer, in Trans. Am. Soc. of C. E.

¶ Report of Col. T. L. Casey, U. S. A., engineer in charge.

** History of St. Louis Bridge, p. 370-74.

†† Trans. Am. Soc. of C. E., vol. xvii, p. 204-12.

‡‡ *Ibid.*, vol. vii, p. 305-6.

fourth side and by the depth; if more than 3 feet, the two opposite sides are taken, and to each side 18 inches for each jamb is added to the lineal measurement thereof, and the whole multiplied by the smaller side and by the depth."

A well-established custom has all the force of law, unless due notice is given to the contrary. The more definite, and therefore the better, method is to measure the exact solid contents of the masonry, and pay accordingly. In "net measurement" all openings are deducted; in "gross measurement" no openings are deducted.

The quantity of masonry is usually expressed in cubic yards. The perch is occasionally employed for this purpose; but since the supposed contents of a perch vary from 16 to 25 cubic feet, the term is very properly falling into disuse. The contents of a masonry structure are obtained by measuring to the neat lines of the design. If a wall is built thicker than specified, no allowance is made for the masonry outside of the limiting lines of the design; but if the masonry does not extend to the neat lines a deduction is made for the amount it falls short. Of course a reasonable working allowance must be made when determining whether the dimensions of the masonry meet the specifications or not.

In engineering construction it is a nearly uniform custom to measure all masonry in cubic yards; but in architectural construction it is customary to measure water-tables, string-courses, etc., by the lineal foot, and window-sills, lintels, etc., by the square foot. In engineering, all dressed or cut-stone work, such as copings, bridge seats, cornices, water-tables, etc., is paid for in cubic yards, with an additional price per square foot for the surfaces that are dressed.

586. COST OF MASONRY. Labor Required in Quarrying.* "The following table shows the labor required in quarrying the stone [gneiss] for the Boyd's Corner dam on the Croton River near New York City. The stone to be cut was split out with plugs and feathers."

LABOR REQUIRED IN QUARRYING GNEISS.

KIND OF LABOR.	DAYS PER CUBIC YARD.	
	Rough stone.	Stone to be cut.
Foreman	0.041	0.114
Drillers	0.339	0.917
Laborers	0.140	0.429
Blacksmiths	0.036	0.102
Tool-boy	0.035	0.108
Teams	0.141	0.620
Labor loading teams	0.077	0.284

* J. James R. Croes, in Trans. Am. Soc. of C. E., vol. iii, p. 363.

587. Market Price of Stone. Any general statement concerning the market price of stone can not be of much value, since market conditions vary with the locality, and since the forms of the blocks vary greatly for different classes of stones and for different quarries. Further, although stone is nominally sold by the cubic yard or the cord, it is usually measured by weight; and the weight given for a cubic yard by one quarry frequently lays 20 per cent more wall than the same nominal quantity of a similar stone from another quarry. The following prices (f.o.b. quarry) are given mainly to show the relative cost of different grades of stone.

Granite—rough	\$0.40 to \$0.50	per cubic foot.
Limestone—common rubble	1.00 “	1.50 per cubic yard.
“ good range rubble	1.50 “	2.00 “ “ “
“ bridge stone	2.00 “	3.00 “ “ “
“ dimension stone.....	.25 “	.35 per cubic foot.
“ copings20 “	.35 “ “ “
Sandstone35 “	1.00 per cubic yard.

588. Cost of Cutting Granite. *Boyd's Corner Dam.** “The average day's work of a man in cutting the face of granite pitch-faced, range, squared-stone masonry of the Boyd's Corner dam, as deduced from three and a half years' work in which 5,200 cubic yards were cut, was 6.373 square feet, the dimensions of the stones being 1.8 feet rise, 3.6 feet long, and 2.7 feet deep; and the average day's work in cutting the beds to lay $\frac{3}{4}$ -inch joints was 18.7 square feet. The granite coping, composed of two courses—one of 12-inch rise, 30-inch bed, and $3\frac{1}{2}$ -feet average length, and one of 24-inch rise, 48-inch bed, and $2\frac{1}{2}$ -feet average length,—the top being pean-hammered, the face being rough with chisel draft around it, and the beds and joints cut to lay $\frac{1}{4}$ -inch joints, required 6.1 days' work of the cutter per cubic yard.

“In cutting the granite for the gate-houses of the Croton Reservoir at Eighty-sixth Street, New York City, in 1861-2, the minimum day's work for a cutter was fixed at 15 superficial feet of joint. This included also the cutting of a chisel draft around the face of the stone, which costs per linear foot about one fourth as much as a square foot of joint, making the actual limit equivalent to about 17.7 square feet of joint. On this work, the proportion to be added to the cost of the cutters to give the total cost was as follows, the average for 19 months' work: for superintendence 8 per cent; sheds and tools 7; sharpening tools 11; labor moving stone in yard 10; drillers plugging off rough faces 4; making a total of 40 per cent to be added.”

* J. James R. Croes, in *Trans. Am. Soc. of C. E.*, vol. iii, p. 363-64.

589. *New York Docks*.* "Below is given the cost of cutting several kinds of masonry for the New York Department of Docks, in 1874-5. Between December 1873 and May 1875 with an average force of 40 stone-cutters, 2,065 yards of granite of the following kinds were cut in the Department yard:

"1,524 yards of dimension stone were cut into headers and stretchers. This stone was cut to lay $\frac{1}{4}$ -inch beds and joints, the faces being pointed work, with a chisel draft $1\frac{1}{2}$ inches wide. The headers averaged 2 feet on the face by 3 feet in depth; and the stretchers averaged 6 feet long by 2 feet deep, the rise being 20, 22, and 26 inches for the different courses. The average time of stone-cutter cutting one cubic yard was 4.53 days of 8 hours; and the average cost of cutting was \$27.54 per cubic yard (\$1.02 per cubic foot).

"310 yards of coping were cut to lay $\frac{1}{4}$ -inch beds and joints, pointed on the face with chisel draft same as headers and stretchers, and 8-cut patent-hammered on top, with a round of $3\frac{1}{2}$ inches radius, the dimensions being 8 feet long, 4 feet wide, and $2\frac{1}{2}$ feet rise. The average time of stone-cutter cutting one cubic yard was 6.26 days, and the average cost of cutting \$38.07 per cubic yard (\$1.41 per cubic foot).

"231 yards of springers, keystones, etc., for the arched pier at the Battery, were cut. These stones were of various dimensions, part being pointed work and part 6-cut patent-hammered. The average time of stone-cutter cutting one cubic yard was 6.88 days, and the average cost of cutting was \$41.85 per cubic yard (\$1.55 per cubic foot).

"The above cost of cutting includes, besides stone-cutter's wages, labor of moving stone, all material used—such as timber for rolling stone, new tools, etc.—sharpening tools, superintendence, and interest on stone-cutter's sheds, blacksmith shop, derrick, and railroad. These expenses, in per cents of the total cost of cutting, are as follows: superintendence 5; sharpening tools 15; labor rolling stones 30; interest on sheds, derrick, and railroad 1; new tools and timber for rolling stone 1; total 52 per cent, which, added to the wages paid stone-cutters, gives the total cost. During the last year stone-cutters were required to do at least 12 superficial feet per day of beds and joints, or its equivalent in pointed or fine-cut work. The average day's work of each stone-cutter, during one year and a half in which 118,383 superficial feet of beds and joints were cut, was 13.6 square feet per day, for which he received \$4.00.

"Table 48, page 300, shows the amount of granite that a stone-cutter can cut in a day of 8 hours."

* Wm. W. Maclay, in *Trans. Am. Soc. of C. E.*, vol. iv, p. 310-11.

TABLE 48.
LABOR REQUIRED IN CUTTING GRANITE.

KIND OF WORK.	NUMBER OF SUPERFICIAL FEET.		
	Constituting a day's work of 8 hours in stone-yards and contract-work done in vicinity of New York City.	Required as a minimum day's work by the Department of Docks, New York City.	Averaged per day of 8 hours by stone-cutters in the Department of Docks, New York City.
Beds and joints	16	12	13.6
Pointed work with chiseled margin, lines all round	10	7.5	8.5
Peen-hammered	7.27	5.45	6.15
6-cut patent-hammered	6.15	4.61	5.22
8-cut " "	5	3.75	4.24

590. *Merchants' Bridge, St. Louis.* The cost of dressing 36,000 cu. ft. of granite to half-inch joints was 20 cents per sq. ft., not including blacksmithing, handling, etc.*

591. **Cost of Cutting Limestone and Sandstone.** The cost of dressing Kankakee limestone (a medium soft coarse-grained stone) with a bush hammer or tooth chisel is 25 cents per sq. ft. of dressed surface.* The cost of fine-pointing the beds and the joints of Medina sandstone to lay half-inch joints is about 13 cents per sq. ft.† The cost of cutting 246 cu. yd. of sandstone to half-inch joints for bridge piers was \$2.65 per cu. yd.†

592. **Cost of Cutting Stone for U. S. Public Buildings.** Table 49

TABLE 49.
COST OF CUTTING STONE FOR U. S. PUBLIC BUILDINGS.

KIND OF SURFACE.	GRANITE.		MARBLE.		LIMESTONE AND SANDSTONE.	
	Min.	Max.	Min.	Max.	Min.	Max.
Beds and joints, per sq. ft.	\$0.30	\$0.35	\$0.20	\$0.25	\$0.12	\$0.15
Peen-hammered, " " "	45	50	30	35	15	20
Plain face, 6-cut, " " "	65
" " 8-cut, " " "	75
" " 10-cut, " " "	88
" " 12-cut, " " "	1.10
Rubbed, " " "	40	20	25
Tooled, " " "	50	25	30

* R. J. Cooke, '90, Bachelor's Thesis, University of Illinois; abstract in *The Technograph*, No. 4, p. 8-10.

† Gillette's *Handbook of Cost Data*, p. 197-98.

gives the average contract price for cutting the stone for the United States government buildings:*

593. Cost of Laying Cut Stone.† Table 50 shows the amount of labor required in laying the cut-stone masonry of the Boyd's Corner Dam on the Croton River near New York City. "Most of the cut stone was laid by one mason, more than two not being employed at any time. The mason's gang also shifted derricks. The cost of hauling stone to the work varied with the position of the blocks in the yard and whether they were assorted there into courses or lay promiscuously."

TABLE 50.
LABOR REQUIRED IN LAYING CUT-STONE MASONRY.

KIND OF LABOR.	AMOUNT PER CUBIC YARD.			
	Hoisted by Hand.		Hoisted by Steam.	
	5 ft.	10 to 20 ft.	20 to 30 ft.	30 to 50 ft.
Mason, days	0.120	0.119	0.082	0.108
Laborers, days.....	0.184	0.188	0.145	0.155
Mortar mixer, days.....	0.100	0.82	0.076	0.101
Derrick and car men, days	0.327	0.341	0.235	0.261
Engine, hours	0.462	0.490
Teams from yard, days	0.100	0.056	0.056	0.110
Labor loading teams, days	0.184	0.223	0.223	0.086
Number of cubic yards laid ...	1,070		2,270	2,530

594. Total Cost of Masonry. *Ashlar Bridge-Pier.* The following are the details of the cost, to the contractor, of heavy first-class limestone masonry for bridge piers erected in 1887 by a prominent contracting firm:

Cost of stone (purchased).....	\$4.50
Sand and cement	52
Freight	1.79
Laying	1.40
Handling materials	65
Derricks, tools, etc.	40
Superintendence, office expense, etc.....	68

Total cost per cubic yard \$9.94

The following data concerning the cost of granite piers—two fifths cut-stone facing and three fifths rubble backing—are furnished by the same firm. The rock was very hard and tough.

* American Architect, vol. xxii, p. 6-7.

† J. James R. Croes, in Trans. Am. Soc. of C. E., vol. iii, p. 363-64.

<i>Facing:</i>	
Quarrying, including opening quarry	\$3.75
Cutting to dimensions.....	6.75
Laying.....	1.76
Transportation 2 miles, superintendence, and general expenses	2.05
	\$14.31
<i>Backing:</i>	
Quarrying.....	\$3.10
Dressing	3.60
Laying.....	1.75
Sundries	2.05
	\$10.50

595. The first-class limestone masonry in the piers of the bridges across the Missouri at Plattsmouth (1879-80) cost the company \$18.60 per cubic yard, exclusive of freight, engineering expenses, and tools.*

596. Ashlar Arch-Culvert. Table 51 shows the details of the cost of the sandstone arch culvert (613 cu. yd.) at Nichols Hollow, on the Indianapolis, Decatur and Springfield Railroad, built in 1887. Scale of wages per day of 10 hours: foreman, \$3.50; cutters, \$3.00; mortar mixer, \$1.50; laborer, \$1.25; water-boy, 50 cents; carpenters, \$2.50.†

597. Rubble. The following is the cost of the rubble masonry in the cellar walls and boiler foundations of an electric power-plant at Pittsburg, Pa.‡ The stone was sandstone of a size that two men could easily handle, and was roughly shaped with a hammer. The mortar was 1 part Louisville natural cement to 3 parts sand. The walls were 2 feet 9 inches thick, 672 feet long, and 8 feet high; and the boiler foundation varied from 2 to 3½ feet thick. The total volume of the masonry after deducting all openings was 659 cubic yards.

Sandstone (purchased)	1.00 cu. yd. at \$2.50....	\$2.50
Louisville cement	0.64 bbl. at 1.25....	0.80
Sand	0.32 cu. yd. at 1.30....	0.42
Mason.....	0.37 day at 3.60....	1.33
Common labor unloading stone, mixing mortar, etc.	0.37 day at 1.75....	0.63
		\$5.68

598. The following is the cost of the limestone rubble retaining wall on the Chicago Sanitary Canal.¶ The limestone occurred in

* Report of the chief engineer, Geo. S. Morison.

† Data furnished by Edwin A. Hill, chief engineer.

‡ E. T. Chibas, in *The Polytechnic*, vol. vii, p. 145.

¶ J. W. Beardsley, in *Jour. West. Soc. Eng'rs.* vol. iii, p. 1318-20.

TABLE 51.

COST OF ARCH MASONRY ON INDIANAPOLIS, DECATUR AND SPRINGFIELD RAILROAD.

ITEMS OF EXPENSE.	Cost.	
	Total.	Per cu. yd.
<i>Materials:</i>		
Stone—613 cu. yd. of sandstone @ \$1.50.....	\$919.50	\$1.50
Cement—130 bbl. German portland @ \$3.17 = \$412.50		
40 “ English “ @ 3.25 = 130.00		
30 “ Louisville natural @ .96 = 28.75		
	571.25	94
Sand—7 car-loads @ \$5.50	38.50	06
Total for materials	\$1 529.25	\$2.50
<i>Cutting:</i>		
Cutters and helpers	\$1 370.48	\$2.24
Templates, bevels, straight-edges, etc.....	11.00	01
Repairs of cutters' tools	52.39	09
Water-boy	11.75	02
Total for cutting	\$1 445.62	\$2.36
<i>Laying:</i>		
Masons, 110 days @ \$3.50	\$384.87	\$0.63
Masons' helpers	453.66	74
Mortar mixer	121.72	20
Water-boy	11.75	02
Arch centers, building and erecting	37.65	06
Derrick, stone chute, etc.	14.63	02
Laying track	7.70	01
Total for laying	\$1 032.08	\$1.68
<i>Pointing</i>	\$30.00	\$0.05
GRAND TOTAL:		
Total for labor	\$2 507.60	\$4.09
Total for materials	1 529.25	2.50
Total cost of masonry	\$4 036.85	\$6.59

strata, and black powder was used to shake up the ledges; and then the stone was barred and wedged out. The beds of the stones required no dressing. The courses were about 15 inches thick. The wall averaged 24 feet high, 12 feet wide at the base and 4 feet wide for 8 feet down from the top. The mortar including pointing was 1 : 2 natural cement. The mortar averaged only about 13¼ percent of the mass, which shows that the beds and end joints were very good. The day was 10 hours. The cost given below is the average for 93,500 cu. yd.; but does not include the cost of stripping the

quarry, or of preparing the bed of the foundation of the wall, and does not include the expenses of general superintendence, installation and wrecking of machinery, materials for repairs, pumping, interest on capital invested, delays caused by strikes and lack of material, insurance of property or persons, storage, etc., nor is any allowance made for salvage. The total first cost of the machinery, tools, etc., was 32.3 cents per cubic yard.

QUARRY FORCE:		COST PER CU. YD.
0.01 General foreman	at \$4.75	\$0.002
1.00 Foreman	at 3.50	0.078
2.11 Derrickmen	at 1.50	0.075
8.42 Quarrymen	at 1.65	0.312
1.10 Enginemen	at 2.25	0.052
0.04 Firemen	at 1.75	0.002
2.28 Laborers	at 1.50	0.080
0.33 Water-boy	at 1.00	0.007
0.27 Blacksmiths	at 2.50	0.013
0.18 Blacksmiths' helpers	at 1.75	0.007
0.36 Drill runners	at 2.00	0.023
0.07 Drill helpers	at 1.50	0.002
0.04 Watchmen	at 1.50	0.001
0.29 Teams and carts	at 3.50	0.028
1.12 Derricks	at 1.25	0.040
0.36 Drills	at 1.25	0.015
Total quarry force		<u>\$0.737</u>
WALL FORCE:		
General foreman	at \$4.75	\$0.002
1.00 Foreman	at 4.25	0.113
4.20 Masons	at 3.37	0.354
1.46 Masons' helpers	at 1.50	0.058
1.81 Mortar mixers	at 1.50	0.073
0.66 Mortar laborers	at 1.50	0.027
1.82 Hod-carriers	at 1.50	0.073
1.77 Derrickmen	at 1.50	0.071
1.00 Enginemen	at 2.25	0.054
0.06 Firemen	at 1.75	0.003
1.62 Laborers	at 1.50	0.065
0.45 Water-boy	at 0.87	0.009
0.86 Teams and carts	at 3.00	0.078
0.07 Blacksmiths	at 2.50	0.002
0.06 Blacksmiths' helpers	at 1.75	0.001
0.09 Carpenters	at 2.37	0.005
0.02 Carpenters' helpers	at 1.75	0.000
0.04 Machinists	at 3.75	0.003
1.59 Derricks	at 1.50	0.042
Total wall force		<u>\$1.033</u>
MATERIALS:		
0.30 bbl. of natural cement	at \$0.80 per bbl.	\$0.239
0.09 cu. yd. sand	at 1.35 cu. yd.	0.126
Total materials		<u>\$0.365</u>
Total cost as above		<u>\$2.136</u>
First cost of machinery, tools, etc.		0.323
GRAND TOTAL		<u>\$2.459</u>

599. *U. S. Public Buildings.* Table 52 shows the contract price for the masonry of several U. S. public buildings.*

TABLE 52.
COST OF MASONRY IN U. S. PUBLIC BUILDINGS.

KIND OF WORK.	PLACE.	DATE.	COST PER CU. FT.
Random rubble, limestone	Harrisburg, Va.	1885	\$0.20
“ “ “	Cincinnati, O.	1884	.20
“ “ “	Denver, Col.	1883	.20
“ “ sandstone	Pittsburg, Pa.	1886	.35
Squared-stone masonry, limestone	“ “	1885	.60
Coursed masonry, limestone	“ “	1885	.70
Squared-stone masonry, limestone	Columbus, O.	1884	.68
“ “ granite	Memphis, Tenn. ...	1886	.30
Rock-face ashlar “	Pittsburg, Pa.	1886	1.38
“ “ and cut-stone granite, avg.	“ “	1886	1.60
Cut granite, basement and area walls	“ “	1886	2.00
Rock-face ashlar, and cut and moulded trimmings, Stony Point, Mich., sandstone. .	Fort Wayne, Ind. .	1885	1.52
Trimmings, Bedford limestone, bid	“ “	1885	1.65
Rock-face ashlar, granite, retaining wall ...	Memphis, Tenn. .	1886	1.00
Dressed coping, “ “	“ “	1886	2.50
White sandstone,—furnished only	Dallas, Tex.	1885	.35
Armijo “ “	Denver, Col.	1885	.73
Cut and moulded sandstone of superstructure.	Council Bluffs, Ia. .	1885	1.91
“ “ “ average bid	“ “ “	1885	2.12
“ “ “ limestone, lowest bid	“ “ “	1885	1.87
“ “ “ average bid	“ “ “	1885	2.33
Rock-face ashlar, cut and moulded trimmings			
Middlesex brownstone	Rochester, N. Y. .	1884	2.41
Cut and moulded, Bedford limestone	Louisville, Ky. ...	1885	2.00
“ “ “ sandstone	Dallas, Tex.	1885	2.46
“ “ “ limestone	Hannibal, Mo.	1885	1.83
“ “ “ sandstone	Des Moines, Ia. .	1887	2.27
“ “ “ granite, superstructure ...	Pittsburg, Pa.	1886	3.00

600. **Bibliography.** For detailed statements of the cost of stone masonry, see pages 188–247 of *HANDBOOK OF COST DATA*, by H. P. Gillette; M. C. Clark Publishing Co., Chicago, 1905. For more recent examples consult any of the several Indexes of Current Engineering Literature.

* *American Architect*, vol. xxii, p. 6, 7.

CHAPTER XII

BRICK MASONRY

601. Brick masonry is employed chiefly for buildings, and in this country bricks are more extensively used for this purpose than any other material except wood, but it is not unlikely that in the future the use of brick will greatly increase here owing to the rapid consumption of our forests.

Good bricks (§ 72-82) have the following qualities to recommend them as a building material. 1. Bricks are practically indestructible, since they are not acted upon by fire, the weather, or the acids in the atmosphere. 2. Bricks may be had in most localities of almost any shape, size, or color. 3. Bricks are comparatively easy to put into place in the wall. 4. In most localities brick masonry is cheaper than stone masonry—even rubble,—and under some conditions is a competitor with concrete.

The disadvantages of brick as a building material are: 1. Owing to the smallness of the unit, bricks are comparatively expensive to lay, and require considerable skill to secure a strong and good-appearing wall. 2. Ordinarily brick masonry is not durable, since a considerable part of the face of the wall is mortar, which is not as durable as the brick. The recent decreased cost of portland cement makes this objection less important at present than formerly, but does not entirely remove it, owing to the difficulty of handling cement mortar with the ordinary mason's trowel (§ 262).

Bricks are likely to continue to be an important material for the construction of buildings, sewers, tunnel linings, reservoir walls, etc.

In the past bricks have been regarded only as a cheap building material, and comparatively little consideration has been given to the artistic possibilities of brick masonry; but recently attention has been given to the architectural effect of different sizes and colors of the brick, varieties of bond, color of the mortar, thickness of the joints, etc. However, only the factors which affect the utilitarian value of brick masonry will be considered here.

602. THE MORTAR. The functions of the mortar are: (1) to form a cushion to take up any inequalities in the brick and thus distribute the pressure evenly; (2) to bind the whole wall into one solid mass; and (3) to fill the interstices between the brick to keep

out water and to prevent changes of temperature. To satisfy the first condition the mortar should be soft and somewhat plastic, and the mortar bed should be thick enough to prevent the bricks from touching each other at any point. To satisfy the second condition the mortar should possess the properties of hardening after a time and of adhering to the brick. To satisfy the third condition the mortar itself should be dense and impervious, and enough of it should be used to entirely fill all the joints and spaces between the bricks. Brick buildings are nearly always built with lime mortar, although occasionally natural cement is added to the lime; but cement mortar, made either of natural or of portland cement, is usually employed in the brick-work of sewers, linings of tunnels, arches, bridge piers, reservoir walls, etc.

If the forces acting upon a wall were only direct compression, the strength of the mortar would in most cases be of comparatively little importance, for the crushing strength of average quality mortar is higher than the dead load which under ordinary circumstances is put upon a wall; but, as a matter of fact, in buildings the load is rarely only that of a direct crushing weight. Thus the roof tends to throw the walls out, the rafters being generally so arranged as to produce a considerable outward thrust against the wall. The action of the wind also produces a side strain which is practically of more importance than either of the others. In many cases the contents of a building exert an outward thrust upon the walls; for example, barrels piled against the sides of a warehouse produce an outward pressure against the walls.

603. Thickness of Joints. To prevent dislodgement of the mortar by the action of frost and the weather, the thinner the joints the better; but to secure rapid work and to insure a proper bedding of the brick, the joints should be at least $\frac{1}{4}$ to $\frac{3}{8}$ of an inch thick. If the joints are thin, the tendency of the mason is to spread a little mortar for the bed joint at the back of the brick, and then before laying the brick to apply a small quantity of mortar to the front edges of the brick, in which case it will not be well supported and is likely to crack.

Common bricks in exterior walls of buildings are laid with joints varying from $\frac{1}{4}$ to $\frac{3}{8}$ of an inch, and for interior walls from $\frac{3}{8}$ to $\frac{1}{2}$ inch; and pressed brick with joints from $\frac{1}{8}$ to $\frac{3}{16}$ of an inch. In engineering structures the thickness of the joints depends upon the quality of the bricks and upon the grade of work desired; and usually the joints are thicker than in buildings, partly because the bricks are harder and therefore rougher, and partly because cement mortar is employed, which is not as plastic and can not easily be laid in as thin joints as lime mortar.

604. BOND. Bond is the arrangement of the bricks in successive courses to tie the wall together both longitudinally and transversely. The primary purpose of bond is to give strength to the masonry, but architects employ various longitudinal bonds to improve the appearance of the wall. Although numerous bonds are employed for artistic effect, in the construction of ordinary brick masonry only three bonds are used, the common, the English, and the Flemish, the first being much the more common.

As in ashlar masonry, so in brick-work, a *header* is a brick whose length lies perpendicular to the face of the wall; and a *stretcher* is one whose length lies parallel with the face. Brick should be made of such a size that two headers and a mortar-joint will occupy the same length as a stretcher.

605. Common Bond. The usual bond in ordinary brick-work consists of four to seven courses of stretchers to one of headers. In ordinary practice the custom is to lay four to six courses of stretchers to one of headers. The proportionate numbers of the courses of headers and stretchers should depend on the relative importance of transverse and longitudinal strength. The proportion of one course of headers to two of stretchers is that which gives equal tenacity to the wall lengthwise and crosswise.

606. If the wall is more than one brick thick, it should be bonded transversely as well as longitudinally. The exact arrangement of the transverse bond varies with the thickness of the wall, but is easily worked out if a little attention is given to it. The face bond is likely to receive more attention than the transverse bond, and it can be readily inspected after the completion of the wall; but the transverse bond can not be examined after a course is laid on top of it, and therefore it should be carefully looked after as the work progresses.

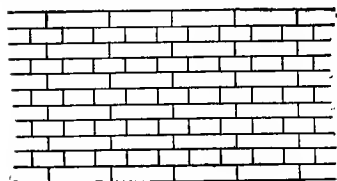

FIG. 75.—ENGLISH BOND.

607. English Bond. English bond consists of alternate courses of stretchers and headers—see Fig. 75.

In building brick-work in English bond, it is to be borne in mind that there are twice as many vertical or side joints in a course of headers as there are in a course of stretchers; and that unless in laying the headers great care be taken to make these joints very thin, two headers will occupy a little more space than one stretcher, and the correct breaking of the joints—exactly a quarter of a brick—will be lost. This is often the case in carelessly built brick-work, in which at intervals vertical joints are seen nearly or exactly above each other in successive courses.

608. Flemish Bond. This consists of a header and a stretcher alternately in each course, so placed that the outer end of each header lies on the middle of a stretcher in the course below (Fig. 76). The number of vertical joints in each course is the same, so that there is no risk of the correct breaking of the joints by a quarter of a brick being lost; and the wall presents a neater appearance than one built in English bond. The latter, however, when correctly built, is stronger and more stable than Flemish bond.

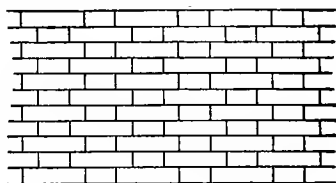

FIG. 76.—FLEMISH BOND.

609. Brick Veneer. Not infrequently a brick wall is seen which appears to consist entirely of stretchers, but which in fact is only a veneer of pressed brick on the front of a wall of common brick. There are several methods in use for bonding the stretcher veneer to the body of the wall. 1. Pieces of hoop iron are laid flat in the bed joints, about two inches at the rear end being turned at right angles to the length of the strip and inserted into a vertical joint. 2. Strips of galvanized iron, corrugated so as to afford a good hold of the mortar, are laid in the bed joint. 3. A wire bent in the form of a letter S is laid in the horizontal joint. 4. A triangular piece is broken off from each inner corner of all the stretchers in one course, and common brick are laid diagonally across the wall with one corner in the vacant space between two adjoining bricks of the veneer.

The reasons for using a veneer consisting wholly of stretchers are: 1. The thickness of common and pressed brick is not the same, and hence there is alleged difficulty in bringing the face and the backing to the same height. However, with a little care it is possible to bring the face and the back to the same level, and thus permit a course of headers. This can usually be accomplished by varying the thickness of the joints of the backing, or by laying one more or one less number of courses of common brick than of face brick. 2. The face brick are the more expensive, and hence the desire is to use as few of them as possible. 3. It is sometimes claimed that an all-stretcher veneer looks better; but this claim is not in accordance with the principles of good architectural design.

The building regulations of some cities do not allow the counting of a stretcher veneer as supporting any of the load; and it should not be so counted unless it is well bonded to the backing.

610. LAYING THE BRICK. Since most bricks have a great avidity for water, it is best to dampen them before laying. If the mortar is stiff and the bricks are dry, the latter absorb the water so rapidly that

the mortar does not set properly, and will crumble in the fingers when dry. Neglect in this particular is the cause of most of the failures of brick-work. Since an excess of water in the brick can do no harm, it is best to thoroughly drench them with water before laying. Lime mortar is sometimes made very thin, so that the brick will not absorb all the water. This process interferes with the adhesion of the mortar to the brick. Watery mortar also contracts excessively in drying (if it ever does dry), which causes undue settlement and, possibly, cracks or distortion. Wetting the brick before laying will also remove the dust from the surface, which otherwise would prevent perfect adhesion.

When the very strongest work is desired, as in brick sewers, it is customary to require that the brick shall be immersed in water for 3 to 5 minutes before being laid. Wetting in the pile is not as effective as immersion, since in the pile the water is not likely to reach all of the surfaces of all of the bricks. Masons very much dislike to lay wet brick, since the water softens the skin on their fingers and causes it to wear away rapidly. The softer the bricks the more necessary that they should be thoroughly wet when laid. In freezing weather, care should be taken that the water does not form a film of ice on the brick.

611. The bricks should not be merely *laid*, but every one should be pressed down in such a manner as to force the mortar into the pores of the brick and produce the maximum adhesion. This is more important and also more difficult to accomplish with cement than with lime mortar. The increased value of the cement mortar can be attained only by bringing the brick and the mortar into close contact; and this is more difficult to do, since cement mortar is not as plastic as that made with lime. The mason is apt either (1) to butter the edges of the brick, and thus secure a joint that looks well after the brick is laid; or (2) to place insufficient mortar to make a full bed joint of the required thickness, run the point of his trowel through the middle of the mass making an open channel with a sharp ridge of mortar on each side, and then lay the brick upon the top of these two ridges, thus leaving the center of the brick unsupported. The first method is the one employed with thin joints, which is a reason why they should not be required; the second method is popular because it requires less exertion and is more rapid than fully bedding the brick.

If strength or imperviousness is a matter of any moment, care should be taken to see that the vertical joints are filled solidly full of mortar. This is called *slushing* the joints. Unless slushing is insisted upon, masons are apt to butter the end joints, lightly bed the brick, throw a little mortar into the top of the vertical joints, and

scrape off the excess above the top of the brick, thus leaving the major portion of the vertical joints open; and sometimes little or no attempt is made to fill the vertical joint between adjacent tiers of stretchers, thus leaving also long and high unfilled vertical spaces.

For the best work it is specified that the brick shall be laid with a "shove joint"; that is, that the brick shall first be laid so as to project over the one below, both at the end and the side, and be pressed into the mortar, and then be shoved into its final position. Masons are very reluctant to lay brick with a shove joint, partly because it is hard work and partly because many of them have not acquired the art. If brick are not laid with a shove joint, it is highly improbable that the lower part of the vertical joints will be filled with mortar, and consequently the wall will not be as strong or as impervious to water, air and heat as it would otherwise be.

612. The brick should be laid in a truly horizontal position. Masons are apt to lay brick with the back edge higher than the front, so as to tip the top edge of the front face out a little and thus give a projecting edge upon which to rest the trowel while finishing the joint (see § 613). If the brick are laid in this way, the wall has a rough irregular appearance. This defect is more common with pressed than with common brick, since with the latter it is not customary to attempt to finish the joint except to knock off any projecting mortar.

The top edge of the face should be laid to a stretched string. The joints should be kept of uniform thickness throughout. The horizontal joints should be truly horizontal. Care should be taken to preserve the bond.

613. Pointing. In laying inside walls that are to be plastered, the mortar that is forced out when the brick is pressed into position is merely cut off with the trowel; but for outside walls and also for inside walls that are to be left exposed, the joints should be more carefully finished. In laying common brick the mortar in the vertical

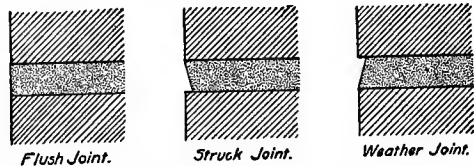

FIG. 77.—METHODS OF POINTING BED JOINTS OF COMMON BRICKWORK.

joints is simply pressed back with the flat face of the trowel; but there are three methods of pointing or finishing the bed joints, viz.: (1) flush joints, (2) struck joints, and (3) weather joints.

Flush pointing consists in pressing the mortar flat with the trowel, thus making the edge of the joint flush with the face of the wall—see Fig. 77.

The struck joint is formed by resting the *lower* edge of the blade of the trowel upon the edge of the brick below the joint and drawing the trowel along the joint, which smoothes the face of the joint and slightly consolidates the mortar, and leaves the joint as shown in the center of Fig. 77.

The weather joint is formed, as shown in right-hand side of Fig. 77, by pressing the mortar back with the *upper* edge of the trowel. This form of finish is much more durable than the struck joint, since water will not lodge in the joint and soak into the mortar, and on freezing dislodge the mortar; but this form of joint is much more difficult to make, since the mason stands above and back of the brick he is laying. If the weather joint is desired, it must be distinctly specified and the inspector must be watchful to see that it is secured.

Brick masonry is usually laid with lime mortar or with lime-cement mortar, the lime giving cohesive strength to the mortar so that enough mortar stays in the joint to permit of its being successfully struck; but when cement mortar or mortar containing but little lime is used, the mortar is so lacking in cohesion that enough does not remain in the joint to permit of striking it, and hence with cement mortar it is necessary to formally point the masonry. For description of methods of pointing applicable to brick masonry, see § 565.

614. Pressed brick are usually laid with a mortar made of one volume of stiff lime paste (called lime putty) and one volume of fine sand; and when this mortar is used, the brick is buttered, i.e., a little mortar is spread upon only the edges of the brick before it is laid. If the above mortar were spread over the entire surface of the brick, the joint could not be made as thin as is usually specified; but some of the better architects specify thicker joints for pressed work so that the bricks can be laid otherwise than by being buttered. If the mortar is to be spread in the usual way, it should consist of 1 volume of lime paste to about 2 volumes of rather fine sand. Some architects specify 1 volume lime paste, 1 volume natural cement, and 2 volumes of fine sand. Some contractors prefer to substitute at their own expense a rich natural-cement mortar and lay thicker joints rather than lay thin buttered joints, since the brick mason can lay more brick with the former than with the latter.

The joints of pressed-brick work are finished by grooving or beading (see Fig. 74, page 287), the former being the more common. The grooved joint is preferred to the flush joint, because of the variation in light and shade that the former gives to the face of a wall.

615. COPING. A brick wall whose top surface is to be exposed to

the weather should be finished with some protective covering to prevent water from penetrating to the interior of the wall. This covering may consist of a layer of lime or cement mortar, or a coping of stone or vitrified clay. The latter is made with a crowned upper surface, over-lapping joints, and a lip to project downward past the face of the wall.

616. IMPROVEMENTS IN BRICKLAYING. The methods of bricklaying in common use at present are substantially the same as those employed from time immemorial, with the exception of the comparatively recent modification of the so-called English bond by using one course of headers to each five or six courses of stretchers instead of alternate courses of headers and stretchers; but very recently three innovations have been proposed which seem to be important improvements in the methods of laying brick. These innovations are: 1. The packet system of handling the brick from the car or wagon to the wall. 2. A special scaffold for holding the packets of brick within easy reach of the mason. 3. A fountain trowel which facilitates the spreading of the mortar.

1. The packet is a small wooden frame or tray upon which two rows of ten bricks each are placed on edge in such a position that the mason can put his fingers under the brick while it is upon the packet. The bricks are placed upon the packets at the car or the wagon, and are transported on the packets to the scaffold. An important feature of the packet system is the sorting of the bricks as they are placed upon the packets, brick suitable for the face of the wall being placed upon one packet, chipped bricks and bats upon another packet, etc.

2. The special scaffold is virtually a shelf or bench about $2\frac{1}{2}$ feet above the platform upon which the mason stands, upon which packets of brick are placed. The mason lifts a packet of brick from the shelf and places it within easy reach upon the wall. The scaffold and the packet do away with the necessity of the mason's stooping over and picking up each brick from the floor upon which he stands, and also further economizes the mason's time in that he does not have to spend any time in selecting the kind of brick he wants.

3. The fountain trowel is a metal can shaped something like an oxford shoe. The heel is used to scoop up the mortar from the box, and the toe has a narrow opening about 4 inches long through which the mortar is poured upon the brick. The fountain trowel makes it possible to spread a much greater quantity of mortar in a given time, and also permits the use of a softer mortar, which fills the joints better—not only by running down into the unfilled joints of the course below, but also by permitting the laying of the brick with a shove which fills the joints of the course being laid.

It is claimed that by the use of these three improvements an ordinary brick mason can lay two or three times as many bricks as with the usual appliances.

617. CRUSHING STRENGTH OF BRICK MASONRY. A considerable number of experiments have been made on the crushing strength of brick-masonry piers; and the results are of interest not only as showing the strength of brick masonry, but also as revealing certain laws which are more or less applicable to stone masonry. The last is particularly valuable since no experiments have ever been made upon the strength of stone masonry.

618. Method of Failure. The first sign of distress of a brick pier is a snapping or popping sound. With strong cement mortar these sounds do not usually occur until after half the ultimate load has been applied; but with lime and weak cement mortar the snapping sounds occur a little before half of the ultimate load is reached. If the piers are less than a day or two old, the snapping sounds occur much earlier than stated above.

The first sign of approaching failure is the formation of cracks in the brick opposite the end joints in the adjacent courses. With strong cement mortars, these cracks do not appear until shortly before complete failure; while with weak mortar, the cracks appear a little longer before entire collapse of the pier. As the load increases these cracks gradually widen and increase in length, and finally failure occurs by the partial crushing of some of the bricks and the further enlargement of the longitudinal cracks. The bricks break transversely because of their irregularities of form and because of the unequal distribution of the mortar in the joints—doubtless chiefly the first.

619. It is interesting to note that when a small pier rests upon a larger one, or a thin wall upon a wider one, that it is the larger or wider one that fails, even though the pressure per square inch upon it may not be more than one third or one fourth of that upon the smaller section. Apparently the failure is due to the compression of that portion of the bottom section directly under the top section, thereby causing the compressed portion to shear off from the uncompressed part of the base section.

620. Effect of Irregularity of Form. Tests made with the testing machine at the U. S. Arsenal at Watertown, Mass.,* give significant evidence as to the effect of irregularities of form of the brick upon the strength of the masonry. Hard-burned *common* brick having a crushing strength of 18,337 lb. per sq. in. when laid with lime mortar gave masonry having a strength of 1,814 lb. per sq. in.; while *face* brick having a strength of only 13,925 lb. per sq. in. gave a strength

* Tests of Metals, 1884, p. 69-124.

of 1,941 lb. per sq. in. The quality of the brick is indicated somewhat by the fact that the face brick were laid with $\frac{1}{8}$ -inch joints, and the common brick with $\frac{1}{4}$ -inch. The first brick were practically 30 per cent the stronger, while the masonry was nearly 10 per cent the weaker. With Rosendale natural-cement mortar the *face* brick gave 15 per cent greater strength; and with portland-cement mortar the face brick gave masonry 34 per cent stronger than the stronger common brick. In other words, the weaker but more regular brick gave the stronger masonry.

621. Lime vs. Cement Mortar. Seven experiments with the Watertown testing machine,* seem to show that piers made of both common and face brick laid in lime mortar and tested when from 2 to 6 months old are on the average only 37 per cent as strong as when laid in neat portland cement; and when laid in a 1 : 3 portland-cement mortar, they are only 74 per cent as strong as those laid in neat portland cement. Bricks laid in a very poor 1 : 2 Rosendale natural-cement mortar are 18 per cent stronger than when laid in a fair lime mortar; and when laid in a 1 : 2 portland cement mortar are 66 per cent stronger than in lime mortar. Another series of experiments with the same machine† show that masonry laid in mortar composed of 1 part natural cement and 2 parts sand is 56 per cent stronger than when laid in mortar composed of 1 part lime and 4 parts sand.

622. Data on Crushing Strength. *Watertown Tests.* Experiments made with the testing machine of the U. S. Arsenal at Watertown, Mass., gave the results in Table 53, page 316.

The bricks were quite strong, averaging from 13,000 to 15,000 lb. per sq. in. tested flatwise between steel. The piers were built by a common mason, with only ordinary care; and they were from a year and a half to two years old when tested. Their strength varied with their height; and in a general way the experiments show that the strength of a prism 10 ft. high, laid in either lime or cement mortar, is about two thirds that of a 1-foot cube. A deduction derived from so few experiments (22 in all) is not, however, conclusive. The different lengths of the piers tested occurred in about equal numbers. The piers began to show cracks at one half to two thirds of their ultimate strength. The mortar was tested when fourteen months old.

Unfortunately the mortar was very poor, being but a little stronger in compression than such mortar should have been in tension. "The cement was purchased in the open market, and was not tested."

* Tests of Metals, 1893, 1904, 1905.

† Report of Experiments on Building Materials for the City of Philadelphia with the U. S. testing machine at Watertown, Mass., p. 32-33.

On account of the poor mortar the results are less than those given on subsequent pages for younger masonry; but the results in Table 53 are of interest as showing the strength that may be obtained in actual practice unless the utmost care is taken.

TABLE 53.
CRUSHING STRENGTH OF BRICK PIERS.*
Age when tested, 1½ to 2 years.

REF. No.	KIND OF MORTAR.	No. of Tests	CRUSHING STRENGTH OF THE MASONRY. Lb. per sq. in.	STRENGTH OF THE MASONRY IN TERMS OF THAT OF	
				Brick Flatwise.	Cubes of Mortar.
1	1 lime paste, 3 sand	21	1 551	0.10	12.5
2	1 Rosendale natural cement, 2 sand	36	1 825	0.13	11.3
3	1 portland cement, 2 sand	8	2 540	0.16	4.7
4	Neat portland	1	2 315	0.15	0.7
5	1 Rosendale natural cement, 2 lime mortar	1	1 646	0.12	9.0
6	1 portland cement, 2 lime mortar	1	1 411	0.10	7.3

In interpreting tests of the strength of brick masonry, it is convenient to remember that the best brick-work weighs about 144 lb. per cu. ft., and that therefore each foot in height of a brick wall gives a pressure at its base of one pound per square inch. On this basis the masonry in the first line of Table 53 failed under a compression equivalent to that of a prismatic wall 1,551 feet high—more than a quarter of a mile.

623. Later tests with the Watertown machine gave results as in Table 54. The tests of the bricks used in these experiments are reported in Table 8, page 42.

Notice in Table 54 that in several cases the strength at one month is greater than that at six months. The only explanation is that the anomaly is due to undetected variations in making and testing the piers. A considerable variation in the results is one of the characteristics of tests on brick and brick masonry.

The highest strength of brick masonry tested at Watertown preceding June 30, 1907, was 5,608 lb. per sq. in., for a pier 12 inches square consisting of hard-burned common brick laid in neat portland

* Tests of Metals, 1883, 1884, 1886, 1891, 1893.

mortar, tested when seven days old. A number of piers have stood more than 4,000 lb. per sq. in.

TABLE 54.

CRUSHING STRENGTH OF BRICK PIERS.*
Age when tested, 6 months except as noted.

No. of the Brick in Table 8, page 42.	POUNDS PER SQUARE INCH.			PER CENT OF THE MEAN CRUSHING STRENGTH OF THE BRICK.		
	Neat Portland.	1 Portland 3 Sand.	1 Lime Paste 3 Sand.	Neat Portland.	1 Portland 3 Sand.	1 Lime Paste 3 Sand.
	FACE BRICK.					
1	4 021	2 410*	1 420	31	19	11
2	2 880*	2 400	1 517	26	21	13
3	1 925	1 670	1 260	28	25	19
	COMMON BRICK.					
4	4 700*	1 800*	994	42	16	9
5	1 969	1 800	733	44	40	16
6	1 400	1 411	718	24	24	12
7	1 510*	1 519	732	23	23	11
8	1 061	1 224	465*	20	23	9
Mean	2 063	1 671	1 065			

* Strength at one month.

624. *Cornell Tests.* Six experiments made at Cornell University † on piers 13 inches square (one and a half brick), laid in 1 : 2 portland-cement mortar, gave an average crushing strength of 821 lb. per sq. in. for brick having a crushing strength of 3,270 lb. per sq. in. when tested flatwise with plastered surfaces, the average strength of the masonry being 0.25 of that of the brick. The same series of experiments gave 894 lb. per sq. in. for brick having a crushing strength of 3,750 lb. per sq. in., the average strength of masonry being 0.23 of the strength of the brick. The piers varied from eleven to thirty-four courses high, but the difference in height seemed to make no appreciable difference in the strength. The thickness of the mortar joints ranged from 0.22 to 0.28 inch.

* Tests of Metals, etc., 1904, p. 449.

† Trans. Assoc. of Civil Engineers of Cornell University, vol. vi, p. 157.

625. Toronto Tests. Nine tests made in Toronto, Canada,* on piers composed of common brick having a crushing strength flatwise from 1,222 to 5,372 lb. per sq. in., laid in *lime mortar*, gave an average crushing strength of 339 lb. per sq. in. when 2½ months old. The average strength of the masonry was 0.16 of the strength of the brick.

626. University of Illinois Tests. Table 55 shows the results of the tests of fourteen brick piers made at the University of Illinois.† The piers were 12½ inches square, and practically 10 feet high. With the vitrified shale brick the thickness of the joints varied from 0.30 to 0.40 inch, and with the under-burned surface-clay brick from 0.44 to 0.46 inch. All of the piers were forty-three courses high, except two which were forty and three which were forty-two. The age when tested varied from 62 to 69 days.

TABLE 55.

TESTS OF BRICK COLUMNS MADE AT UNIVERSITY OF ILLINOIS.

Age when tested, 66 days.

REF. No.	CHARACTERISTIC OF COLUMNS.	No. OF TESTS.	CRUSHING STRENGTH lb. per sq. in.	CRUSHING STRENGTH OF THE COLUMN IN TERMS OF THE CRUSHING STRENGTH OF		
				The Brick Flatwise.	6-inch Cubes of the Mortar.	Column No. 1.
VITRIFIED SHALE BUILDING BRICK						
1	Well-laid, 1:3 portland cement	3	3 367*	0.31	1.17†	1.00
2	Poorly-laid, 1:3 portland cement.	2	2 920	0.27	1.05†	0.87
3	Well-laid, 1:5 portland cement	2	2 225	0.21	1.30	0.66
4	Well-laid, 1:3 natural cement	1	1 750	0.16	5.75	0.52
5	Well-laid 1:2 lime mortar.	2	1 450	0.14	0.43
UNDER-BURNED SURFACE-CLAY BUILDING BRICK.						
6	Well-laid, 1:3 portland cement	2	1 060	0.27	0.37†	0.31

* Two companion piers at 6 months gave an average of 3,950 lb. per sq. in.
 † Based on thirteen tests of 1:3 mortar 69 days old.

627. Conclusions from Preceding Tests. The preceding tests show (1) that the strength of piers built of the same brick is closely

* Digest of Physical Tests, vol. i, p. 219.

† Bulletin No. 27, University of Illinois Eng'g. Exper. Station, p. 26.

proportional to the strength of the mortar; and (2) that the strength of piers built with the same mortar varies as the crushing strength of the brick. The only exceptions to these conclusions are abnormal cases where an unusually strong mortar is used with a very weak brick, or where a very weak mortar is used with a very strong brick.

Since brick masonry gives evidence of distress when the load is about half the ultimate strength (§ 618), the factor of safety should be based upon this value rather than upon the load producing complete collapse. The nominal pressure that may be safely allowed upon brick masonry depends upon (1) the quality of the materials employed; (2) the degree of care with which the work is executed; whether it is for a temporary or permanent, an important or unimportant structure; and, (3) the care with which the nominal maximum load is estimated.

628. Pressure Allowed in Practice. The pressure allowed on brick masonry was considerably smaller formerly, when the bricks were soft and were usually laid in lime mortar, than at present, when the ordinary brick is much better than the best formerly and when brick masonry is usually laid in cement mortar where great strength is required.

The pressure at the base of a brick shot-tower in Baltimore, 246 feet high, is estimated at $6\frac{1}{2}$ tons per sq. ft. (about 90 lb. per sq. in.). The pressure at the base of a brick chimney at Glasgow, Scotland, 468 ft. high, is estimated at 9 tons per sq. ft. (about 125 lb. per sq. in.); and in heavy gales this is increased to 15 tons per sq. ft. (210 lb. per sq. in.) on the leeward side. Twenty years ago the leading architects of Chicago were counted as good authorities in such matters, and did not consider it safe to allow more than 10 tons per square foot (139 lb. per sq. in.) on the best brick laid in 1 : 2 portland-cement mortar; but now this value is frequently greatly exceeded (§ 629).

629. A large committee of leading architects and engineers of Chicago in June, 1908, recommended the following values for incorporation in the building laws of that city.

Paving brick in 1 : 3 portland-cement mortar	350 lb. per sq. in.
Pressed and sewer brick having a crushing strength of 5 000 lb. per sq. in., in 1 : 3 portland mortar . .	250 lb. per sq. in.
Select hard common brick having a strength of 2 500 lb. per sq. in.:	
in 1 : 3 portland mortar	200 lb. per sq. in.
in 1 portland cement, 1 lime paste and 3 sand . .	175 lb. per sq. in.
Common brick having a strength of 1 800 lb. per sq. in.:	
in portland cement mortar	175 lb. per sq. in.
in natural-cement mortar	150 lb. per sq. in.
in lime and cement mortar	125 lb. per sq. in.
in lime mortar	100 lb. per sq. in.

In view of the values obtained in experiments, the above recommendations seem quite conservative; but it should be remembered that it is likely that a better grade of work will be obtained in making test specimens than in actual work, particularly if the work is let to the lowest bidder and is not subject to rigid inspection during construction.

630. TRANSVERSE STRENGTH OF BRICK MASONRY. Occasionally the transverse strength of brick-work is of importance. For example, if a wall is to be built upon a beam spanning an opening, it is necessary to know the load that will come upon the beam; or again, if an opening is to be cut through an old wall, it is important to know whether the wall will be self-supporting over the opening. Since the adhesion of mortar is much less than the tensile strength of either the mortar or the brick (see § 256), the transverse strength of brick-work is dependent upon the adhesion of the mortar. While experiments show that the adhesion of any kind of mortar to either brick or stone is small in comparison with its cohesive or tensile strength, experience in demolishing old walls shows that ordinary masonry has a considerable transverse strength.

Not many experiments have been made to determine the transverse strength of brick masonry, the following being all the records of tests that can be found: *Engineer and Architect's Journal*, Vol. i, p. 30, 45, 102, 135 (1837); Vol. xi, p. 294 (1848); Vol. xiv, p. 510 (1851). *Engineering*, Vol. xiv, p. 1 (1872); *Indian Engineering*, Jan. 9, 1892, or *Railroad Gazette*, Feb. 26, 1892. Several of the above experiments were made to determine the effect of hoop-iron bonding straps, and the remainder give no information as to the quality of the mortar; and hence none of the results are applicable to plain brick masonry, and the details of the experiments are so meagre that the experiments are of no practical value.

Five experiments under the direction of the author* gave a mean transverse strength of 120 lb. per sq. in. for a good-quality soft-mud building brick laid in a poor 1 : 2 natural-cement mortar, tested when 50 days old. The results of eleven tests of this series seemed to indicate that brick beams bonded as regular masonry have a modulus of rupture equal to about twice the tensile strength of the mortar when built with ordinary care, and about three times when built with great care. When the beams are constructed as piers, i. e., with no interlocking action, the modulus of rupture is about equal to the tensile strength of the mortar.

Four tests under the direction of the University of Illinois Engineering Experiment Station† gave a mean modulus of rupture of

* Thesis of Earl and Loomis, 1893, Library, University of Illinois.

† Thesis of Brand and Bushnell, 1908, Library, University of Illinois.

on the lintel as the weight of all the masonry above the opening; but as the wall is likely to be several days in building, the masonry first laid attains considerable strength before the wall is completed; and hence, owing to the cohesion of the mortar, the final weight on the girder can not be equal to, or be compared with, any fluid volume. This method always gives a result that is too great.

The other extreme consists in assuming the pressure to be the weight of the masonry included in a triangle of which the opening is the base and whose sides make 45° with this line. This method gives a load $\frac{2R}{S}$ times that which takes account of the transverse strength of the brick-work. If R is relatively large and S is small, this fraction will be more than unity, under which conditions this method is safe; but if R is small and S is large, then this fraction is less than one, which shows that under these conditions this method is unsafe.

633. MEASUREMENT OF BRICK-WORK. The method of determining the quantity of brick masonry is governed by voluminous trade rules or by local customs, which are even more arbitrary than those for stone masonry (§ 585, which see).

The quantity is sometimes computed in perches, but there is no uniformity of understanding as to the contents of a perch. It ranges from $16\frac{1}{2}$ to 25 cubic feet.

Brick-work is occasionally measured by the square rod of exterior surface. No wall is reckoned as being less than a brick and a half in thickness (13 or $13\frac{1}{2}$ inches), and if thicker the measurement is still expressed in square rods of this standard thickness. Unfortunately the dimensions adopted for a square rod are variable, the following values being more or less customary: $16\frac{1}{2}$ feet square or $272\frac{1}{4}$ square feet, 18 feet square or 324 square feet, and $16\frac{1}{2}$ square feet.

The contents of a brick wall are frequently found by multiplying the number of cubic feet in the wall by the number of brick which it is assumed make a cubic foot; but as the dimensions of brick vary greatly (see § 83), this method is objectionable. A cubic foot is often assumed to contain 20 brick, and a cubic yard 600. The last two quantities are frequently used interchangeably, although the assumed volume of the cubic yard is *thirty* times that of the cubic foot. The former value is about correct for the average brick.

The volume of brick masonry is frequently stated in thousand bricks, the contents being obtained by measuring the area of the face of the wall and allowing a certain number of bricks to each square foot, the number varying with the thickness of the wall. A 4-inch wall (thickness = width of one brick) is frequently assumed to

contain 7 bricks per sq. ft.; a 9-inch wall (thickness = width of two bricks), 14 bricks per sq. ft.; a 13-inch wall (thickness = width of three bricks), 21 bricks per sq. ft., etc.; the number of brick per square foot of the face of the wall being seven times the thickness of the wall in terms of the width of a brick. The size of bricks differs materially in different localities, but not infrequently the above relations are employed even though they are considerably in error for a particular size of brick.

Not infrequently the contents of the wall and also the number of bricks laid are stated in thousands of bricks *wall measure*, in which case the volume is computed as in the preceding paragraph; and sometimes the number of bricks laid is stated in thousands of brick *kiln count*, i.e., the number of brick actually purchased which, on account of breakage, is 1 to 5 per cent more than the number actually laid, according to the quality of the bricks and the number and the size of openings.

634. Since well-established custom has all the force of law, unless due notice to the contrary is given, the only relief from such arbitrary, uncertain, and indefinite customs is to specify that the masonry will be paid for by the cubic yard,—gross or net measurement, according to the structure or the preference of the engineer or architect.

635. DATA FOR ESTIMATES. Number of Brick Required. Since the size of brick varies greatly (§ 83), it is impossible to state a rule which shall be equally accurate in all localities. If the brick be of standard size ($8\frac{1}{4} \times 4 \times 2\frac{1}{4}$ inches) and laid with $\frac{1}{2}$ - to $\frac{5}{8}$ -inch joints, a cubic yard of masonry will require about 410 brick; or a thousand brick will lay about $2\frac{1}{2}$ cubic yards. If the joints are $\frac{1}{4}$ - to $\frac{3}{8}$ -inch, a cubic yard of masonry will require about 495 brick; or a thousand brick will lay about 2 cubic yards. With face brick ($8\frac{3}{4} \times 4\frac{1}{8} \times 2\frac{1}{4}$ inches) and $\frac{1}{8}$ -inch joints, a cubic yard of masonry will require about 496 brick; or a thousand face brick will lay about 2 cubic yards.

In making estimates for the number of bricks required, an allowance must be made for breakage, and for waste in cutting brick to fit angles, etc. With good brick, in massive work this allowance need not exceed 1 or 2 per cent; but in buildings 3 to 5 per cent is none too much.

636. Amount of Mortar Required. The proportion of mortar to brick will vary with the size of the brick and with the thickness of the joints. With the standard size of brick ($8\frac{1}{4} \times 4 \times 2\frac{1}{4}$ inches), a cubic yard of masonry, laid with $\frac{1}{2}$ - to $\frac{5}{8}$ -inch joints, will require from 0.35 to 0.40 cu. yd. of mortar; or a thousand brick will require 0.80 to 0.90 cu. yd. If the joints are $\frac{1}{4}$ to $\frac{3}{8}$ inch, a cubic yard of masonry will require from 0.25 to 0.30 cu. yd. of mortar; or a thousand brick will require from 0.45 to 0.55 cu. yd. If the joints

are $\frac{1}{8}$ of an inch, a cubic yard of masonry will require from 0.10 to 0.15 cu. yd. of mortar; or a thousand brick will require from 0.15 to 0.20 cu. yd.

With the above data, and Table 22, page 120, the amount of cement and sand required for a specified number of brick, or for a given number of yards of masonry, can readily be determined.

Ordinarily 0.75 barrel of unslaked lime or 1 barrel of lime paste and 0.75 cu. yd. of sand will lay a thousand bricks.

637. Cost. Labor Required. "A bricklayer, with a laborer to keep him supplied with materials, will lay on an average, in common house-walls, about 1,500 bricks per day of 10 working hours; in the neater outer faces of brick buildings, from 1,000 to 1,200; in good ordinary street fronts, from 800 to 1,000; and in the very finest lower-story faces used in street fronts, from 150 to 300 according to the number of angles, etc. In plain massive engineering work, he should average about 2,000 bricks per day, or 4 cu. yd. of masonry; and in large arches, about 1,500, or 3 cu. yd." *

In the United States Government buildings the cost of labor per thousand, including tools, etc., is estimated at seven eighths of the wages for ten hours of mason and helper.

Table 56 and Table 57 give the actual labor, per cubic yard, required on some large and important jobs.

TABLE 56.
LABOR REQUIRED FOR BRICK MASONRY.†

LOCATION AND DESCRIPTION OF THE MASONRY.	WORK REQUIRED, IN DAYS PER CUBIC YARD.
High Bridge enlargement, N. Y. City— Lining wall and flat arches laid with very close joints . . .	0.714
Washington (D. C.) Aqueduct— Circular conduit, 9 feet in diameter with walls 12 inches thick	0.439
St. Louis Water Works— Semi-circular conduit, 6 feet in diameter	0.364
New York City Storage Reservoir— Lining of gate-house walls and arches—rough work	0.304

638. Table 57 shows the cost of the labor for five brick buildings forming part of a large manufacturing plant.‡ Buildings No. 1 and 2 were long and low, with about equal amounts of 9-inch and 13-inch walls; buildings No. 3 and 4 had larger proportion of

* Trautwine's Engineer's Pocket-Book, 16th ed., p. 671.

† Trans. Am. Soc. C. E., vol. iii, p. 366.

‡ *Engineering-Contracting*, vol. xxv, p. 100-01.

13-inch wall; buiding No. 5 contained more brick than any of the others, and had 13-inch walls, with some 17-inch and 22-inch walls.

TABLE 57.
COST OF LABOR PER 1 000 BRICK.

KIND OF LABOR AND PRICE.	BUILDING NO.					AVERAGE.
	1	2	3	4	5	
Bricklayers, 60 ct. per hour* ...	\$5.56	\$4.49	\$4.57	\$4.68	\$3.68	\$4.16
Helpers, 17½ ct. per hour.....	1.95	1.67	2.14	1.95	2.00	1.87
Carpenters, 21¼ ct. per hour....	.70	.71	.88	1.15	.67	.77
Handling materials.....	1.16	1.16	1.16	1.16	1.16	1.16
Total for labor.....	\$9.37	\$8.03	\$8.75	\$8.94	\$7.51	\$7.96

* On Building No. 1 bricklayers received 50 ct. per hr.

On building No. 1 local bricklayers were used at 50 cents per hour, but for the other buildings city bricklayers at 60 cents per hour were imported. The latter did better work and more of it, as shown by the table. About two or three weeks after the 60-cent bricklayers started work, the inspector, being dissatisfied with the way the work was going, began preparing careful estimates of the brick laid each week and of the cost per 1,000 for bricklayers and helpers. Within three weeks after the first estimate, the output per bricklayer had increased over 40 per cent, and about 30 per cent increase was maintained.

The total average cost of the brick masonry is as follows:

ITEMS.	COST PER CU. YD.
<i>Labor:</i>	
Masons	\$2.08
Helpers—hod-carriers and mortar mixers.....	.93
Carpenters building scaffolds39
Common labor handling materials58
Total for labor	\$3.98
<i>Materials:</i>	
Brick, 459 at \$5.08 per M	\$2.33
Freight56
Cement, 0.22 bbl. at \$2.0044
Sand, 0.25 cu. yd. at \$0.4611
Freight06
Lime, 1 bushel at \$0.2020
Total for materials	\$3.70
Total for materials and labor	\$7.68

639. Total Cost of Brick Masonry. The following is the cost of 660 cu. yd. (net) of brick masonry (307,000 brick) in a wall 18 inches thick and 25 feet high. The joints were $\frac{1}{4}$ to $\frac{3}{8}$ of an inch thick; and 465 brick laid a cubic yard.*

ITEMS:	COST PER CU. YD.
Red bricks	465 at \$7.50 per 1 000.....\$3.49
Quicklime	0.40 bbl. at \$0.50..... 0.20
Sand	0.28 cu. yd. at \$1.30..... 0.36
Bricklayers	0.41 day at \$4.50..... 1.84
Helpers	0.52 day at \$2.00..... 1.04
Total cost per cubic yard.	\$6.93

640. SPECIFICATIONS FOR BRICK MASONRY. For Buildings. There is not even a remote approach to uniformity in the specifications for the brick-work of buildings. Ordinarily the specifications for the brick masonry are very brief and incomplete. The following conform closely to ordinary construction. Of course, a higher grade of workmanship can be obtained by more stringent specifications.

The brick in the exterior walls must be of good quality, hard-burned; fine, compact, and uniform in texture; regular in shape, and uniform in size. One fourth of the brick in the interior walls may be what is known as soft or salmon brick. The brick must be thoroughly wet before being laid. The joints of the exterior walls shall be from $\frac{1}{4}$ to $\frac{3}{8}$ inch thick.† The joints of interior division walls may be from $\frac{3}{8}$ to $\frac{1}{2}$ inch thick. The mortar shall be composed of 1 part of fresh, well-slacked lime and $2\frac{1}{2}$ to 3 parts of clean, sharp sand.‡ The lime paste and the sand shall be thoroughly mixed before using. The joints shall be well filled with the above mortar; and no grout shall be used in the work. The bond must consist of five courses of stretchers to one of headers, and shall be so arranged as to thoroughly bind the exterior and interior portions of the wall to each other.

The contractor must furnish, set up, and take away his own scaffolding; he must build in such strips, plugs, blocks, scantling, etc., as are required for securing the wood-work; and must also assist in placing all iron-work, as beams, stairways, anchors, bed-plates, etc., connected with the brick-work.

641. For Sewers. The following are the specifications employed in the construction of brick sewers in Washington, D. C.:

“The best quality of whole new brick, burned hard entirely through, free from injurious cracks, with true even faces, and with a crushing strength of not

* E. J. Chibas, *The Polytechnic*, vol. vii, p. 146.

† For the best work, omit this item and insert the following: *The outside walls shall be faced with the best brick of uniform color, laid in colored mortar, with joints not exceeding one eighth of an inch in thickness.*

‡ For masonry that is to be subjected to a heavy pressure, omit this item and insert the following: *The mortar must be composed of 1 part lime paste, 1 part cement, and 2 parts of clean, sharp sand.* Or, if a heavier pressure is to be resisted, specify that some particular grade of cement mortar is to be used—see § 622 and § 629.

less than 5,000 pounds per square inch, shall be used, and must be thoroughly wet by immersion immediately before laying. Every brick is required to be laid in full mortar joints, on bottom, sides, and ends, which for each brick is to be performed by one operation. In no case is the joint to be made by working in mortar after the brick has been laid. Every second course shall be laid with a line, and joints shall not exceed three eighths of an inch. The brick-work of the arches shall be properly bonded, and keyed as directed by the engineer. No portion of the brick-work shall be laid dry and afterwards grouted.

"The mortar shall be composed of cement and dry sand, in the proportion of 300 pounds of cement and 2 barrels of loose sand, thoroughly mixed dry, and a sufficient quantity of water afterwards added to form a rather stiff paste. It shall be used within an hour after mixing, and not at all if once set.

"The cement shall conform to the standard specification of the American Society for Testing Materials.

"The sand used shall be clean, sharp, free from loam, vegetable matter, or other dirt, and capable of giving the standard results with the cement.

"The water shall be fresh, and clean, free from earth, dirt, or sewage.

"Tight mortar-boxes shall be provided by the contractor, and no mortar shall be made except in such boxes.

"The proportions given are intended to form a mortar in which every particle of sand shall be enveloped by the cement; and this result must be attained to the satisfaction of the engineer and under his direction. The thorough mixing and incorporation of all materials (preferably by machine labor) will be insisted upon. If by hand labor, the dry cement and sand shall be turned over with shovels by skilled workmen not less than six times before the water is added. After adding the water, the paste shall again be turned over and mixed with shovels by skilled workmen not less than three times before it is used."

642. WATERPROOF BRICK MASONRY. It is often necessary to prevent the percolation of water through brick walls. This may be accomplished in any of three ways, viz.: (1) by surrounding the wall with an impervious shield of tarred paper or bituminous felt, or (2) by making the masonry itself impermeable, or (3) by applying a waterproof coating to the face of the wall.

1. For a discussion of the first method, see § 384.

2. The second method requires the use of hard impermeable brick and the filling of all the joints with waterproof mortar. The mortar may be made waterproof by (1) securing a well-graded sand, (2) using enough cement to fill the voids, and (3) thoroughly mixing the ingredients (see § 369-77). Owing to the difficulty of getting all of the joints filled solidly full of mortar, more care and attention is required to make brick-work impervious than to make concrete waterproof (§ 363-84).

3. The waterproof coating may be a plaster of impervious mortar (§ 382), or a coat of bituminous mastic, or an impervious wash (§ 379-81) or paint. It is somewhat easier to make a plaster of cement mortar adhere to a brick wall than to a concrete surface (§ 382), but

considerable care is required to secure success with the former. One of the most common methods of rendering brick-work water-proof is to apply successive coats of alum and soap solutions. For the method of preparing and applying these solutions, see § 379. These washes have long been in successful use for making brick masonry impervious. The Transactions of the American Society of Civil Engineers, Vol. i. pages 203-08, contains an account of the stopping of leakage through a brick wall under a head of 36 feet by an application of "four coatings."

643. EFFLORESCENCE. Brick masonry, particularly in a moist climate or in damp places—as under a leaky gutter or in cellar walls—is frequently disfigured by the formation on the surface of a white deposit, which is called efflorescence. This deposit generally originates with the mortar, but frequently spreads over the entire face of the wall. The water which is absorbed by the mortar dissolves the salts of soda, potash, magnesia, etc., contained in the lime or cement, and on evaporating deposits these salts as a white efflorescence on the surface. With lime mortar the deposit is frequently very heavy, particularly on plastering; and, usually, it is heavier with natural than with portland cement. The efflorescence sometimes originates in the brick, particularly if the brick was burned with sulphurous coal, or was made from clay containing iron pyrites; and when the brick gets wet, the water dissolves the sulphates of lime and magnesia, and on evaporating leaves the crystals of these salts on the surface. Frequently the efflorescence on the brick is due to the absorption by the brick of the impregnated water from the mortar.

This efflorescence is objectionable chiefly because of the unsightly appearance which it often produces, but also because the crystallization of these salts within the pores of the mortar and of the brick or stone causes disintegration which is in many respects like frost.

As a palliative, Gillmore recommends* the addition of 100 lb. of quicklime and 8 to 12 lb. of any cheap animal fat to each barrel of cement. The lime is simply a vehicle for the fat, and should be thoroughly incorporated with the cement before slaking. The object of the fat is to saponify the alkaline salts. The method is not entirely satisfactory, since the deposit is only made less prominent and less effective, and not entirely removed or prevented.

As a preventative, make the wall as impervious as possible by using some of the methods mentioned in § 642. If the wall stands in damp ground, one or more of the horizontal joints should contain a layer of tarred paper or bituminous felt to prevent the wall's absorbing moisture from below. Particular care should be taken during the erection of the building to see that the roof, cornice, and

* "Limes, Hydraulic Cements, and Mortars," p. 296.

gutters are made water-tight; and all ducts that carry water or steam pipes should be waterproofed on their inner surfaces. After the building is finished, if the efflorescence appears, first of all any leakage of water into the wall must be stopped; and if the efflorescence is due to the penetration of rain-water through the exterior face of the wall, then the face may be rendered impervious by the application of one or more pairs of the Sylvester washes (§ 379), which will not materially darken or discolor the bricks.

Efflorescence will gradually be blown away by the winds and be washed off by the rains, but it can be entirely removed with scrubbing-brushes and hydrochloric acid mixed with at least four or five times its volume of water. Before applying the acid, the wall should be well dampened; and after being scrubbed, the wall should be thoroughly washed with clear water.

PART III
FOUNDATIONS

CHAPTER XIII

INTRODUCTORY

645. DEFINITIONS. The term foundation is frequently used indifferently for either the lower courses of a structure of masonry or the artificial arrangement, whatever its character, on which these courses rest. For greater clearness, the term *foundation* will here be restricted to the artificial arrangement, whether timber or masonry, which supports the main structure; and the prepared surface upon which this artificial structure rests will be called the *bed of the foundation*. There are some cases in which this distinction can not be adhered to strictly.

646. IMPORTANCE OF THE SUBJECT. The foundation, whether for the more important buildings or for bridges and culverts, is the most critical part of a masonry structure. The failures of works of masonry due to faulty workmanship or to an insufficient thickness of the walls are rare in comparison with those due to defective foundations. When it is necessary, as so frequently it is at the present day, to erect gigantic edifices—as high buildings or long-span bridges—on weak and treacherous soils, the highest constructive skill is required to supplement the weakness of the natural foundation by such artificial preparations as will enable it to sustain such massive and costly burdens with safety.

Probably no branch of the engineer's art requires more ability and skill than the construction of foundations. The conditions governing safety are generally capable of being calculated with as much practical accuracy in this as in any other part of a construction; but, unfortunately, practice is frequently based upon empirical rules rather than upon a scientific application of fundamental principles. It is unpardonable that any liability to danger or loss should exist from the imperfect comprehension of a subject of such vital importance. Ability is required in determining the conditions of stability; and greater skill is required in fulfilling these conditions, that the cost

of the foundation may not be proportionally too great. The safety of a structure may be imperiled, or its cost unduly increased, according as its foundations are laid with insufficient stability, or with provision for security greatly in excess of the requirements. The decision as to what general method of procedure will probably be best in any particular case is a question that can be decided with reasonable certainty only after long experience in this branch of engineering; and after having decided upon the general method to be followed, there is room for the exercise of great skill in the means employed to secure the desired end. The experienced engineer, even with all the information which he can derive from the works of others, finds occasion for the use of all his knowledge and best common sense.

The determination of the conditions necessary for stability can be reduced to the application of a few fundamental principles which may be studied from a text-book; but the knowledge required to determine beforehand the method of construction best suited to the case in hand, together with its probable cost, comes only by personal experience and a careful study of the experiences of others. The object of Part III is to classify the principles employed in constructing foundations, and to give such brief accounts of actual practice as will illustrate the applications of these principles.

647. PLAN OF PROPOSED DISCUSSION. In a general way, soils may be divided into three classes: (1) ordinary soils, or those which are capable, either in their normal condition or after that condition has been modified by artificial means, of sustaining the load that is to be brought upon them; (2) compressible soils, or those that are incapable of directly supporting the given pressure with any reasonable area of foundation; and (3) semi-liquid soils, or those in which the fluidity is so great that they are incapable of supporting any considerable load. Each of the above classes gives rise to a special method of constructing a foundation.

1. With a soil of the first class, the bearing power may be increased by compacting the surface or by drainage; or the area of the foundation may be increased by the use of masonry footing courses, inverted masonry arches, or one or more layers of timbers, railroad rails, iron beams, etc. Some one of these methods is ordinarily employed in constructing foundations on land; as, for example, for buildings, bridge abutments, sewers, etc. Usually all of these methods are inapplicable to bridge piers, i.e., for foundations under water, owing to the scouring action of the current and also to the obstruction of the channel by the greatly extended base of the foundation.

2. With compressible soils, the area of contact may be increased by supporting the structure upon piles of wood or iron, which are

sustained by the friction of the soil on their sides and by the direct pressure on the soil beneath their bases. This method is frequently employed for both buildings and bridges.

3. A semi-fluid soil must generally be removed entirely and the structure founded upon a lower and more stable stratum. This method is specially applicable to foundations for bridge piers.

There are many cases to which the above classification is not strictly applicable.

For convenience in study, the construction of foundations will be discussed, in the three succeeding chapters, under the heads *Ordinary Foundations*, *Pile Foundations*, and *Foundations under Water*. However, the methods employed in each class are not entirely distinct from those used in the others.

CHAPTER XIV

ORDINARY FOUNDATIONS

648. In this chapter will be discussed the method of constructing the foundations for buildings, bridge abutments, culverts, or, in general, for any structure founded upon dry, or nearly dry, ground. This class of foundations could appropriately be called Foundations for Buildings, since these are the most numerous of the class.

This chapter is divided into three articles. The first treats of the soil, and includes (a) the methods of examining the site to determine the nature of the soil, (b) a discussion of the bearing power of different soils, and (c) the methods of increasing the bearing power of the soil. The second article treats of the method of designing the footing courses, and includes (a) the method of determining the load to be supported, and (b) the method of increasing the area of the foundation. The third contains a few remarks concerning the practical work of laying the foundation.

ART. 1. THE BED OF THE FOUNDATION.

649. EXAMINING THE SITE. The nature of the soil to be built upon is evidently the first subject for consideration, and if it has not already been revealed to a considerable depth, by excavations for buildings, wells, etc., it will be necessary to make an examination of the subsoil preparatory to deciding upon the details of the foundation. Except for the heaviest structures, it will usually be sufficient, after having dug the foundation pits or trenches, to examine the soil by driving a steel rod or boring a hole with a post-auger from 3 to 5 feet further, the depth depending upon the nature of the soil and the weight and importance of the intended structure; but for the largest structures it is necessary to examine the soil to greater depths, in which case more elaborate devices must be employed. Some of the methods used for this purpose are: (1) driving an open pipe; (2) boring with an auger; (3) "washing a hole down" with a pipe and a water jet; (4) drilling with either a percussion or a rotary drill.

650. Driving a Pipe. In soft soil, soundings 20 or 30 feet deep can be made by driving a rod or sections of gas-pipe with a ham-

mer or maul from a temporary scaffold, the height of which will of course depend upon the length of the rod or of the sections of the pipe.

Good judgment is required in interpreting the results of such tests, particularly if the structure is to be a bridge abutment or pier in a stream liable to deep scour. A layer of compact sand or cemented gravel, which may be scoured away, may be mistaken for a ledge of rock; but the difference can usually be detected by striking the rod or pipe with a hammer, since rock will give a decided rebound while gravel or sand will not. A boulder may be mistaken for bed rock; but the difference can usually be detected by making one or more additional tests, and accurately noting the depths at which rock is struck.

If samples of the soil are desired, use a 2-inch pipe open at the lower end. If much of this kind of work is to be done, it is advisable to fit up a hand pile-driving machine (see § 751), using a block of wood for the dropping weight.

651. Boring with Auger. Borings 50 to 100 feet deep can be made very expeditiously in common soil or clay with a common wood-auger, turned by men with levers 3 or 4 feet long. Or the boring may be made with any one of several earth augers having a spoon-like form for bringing up samples of the soil. An auger will bring up samples sufficient to determine the nature of the soil, but not its compactness, since it will probably be compressed somewhat in being cut off.

When the testing must be made through sand or loose soil, it may be necessary to drive down a steel tube to prevent the soil from falling into the hole. The sand may be removed from the inside of this tube with an auger, or with the "sand-pump" used in digging artesian wells.

652. Washing a Hole Down. In soft soil or clay that can be washed with a stream of water, a hole can be sunk rapidly by driving a pipe, inserting a smaller pipe inside of it, and forcing water down the inside pipe, the débris and water flowing up between the two pipes.

653. Drilling. When the subsoil is composed of various strata, particularly if there are strata of hard soil or rock, it is necessary to use a percussion or "chopping" drill in connection with some form of core drill; and in extreme cases the diamond drill is sometimes employed. Great care is needed in interpreting the results of such borings. In using the percussion drill, care must be taken that a stratum sufficiently hard to serve as a foundation is not passed by unnoticed. This can be prevented by taking dry cores at frequent intervals. In using a core drill care must be taken to discriminate between erratic boulders and native ledge rock.

654. TESTING BEARING POWER. If the builder desires to avoid, on the one hand, the unnecessarily costly foundations which are frequently constructed, or, on the other hand, those insufficient foundations evidences of which are often seen, it may be necessary, after opening the trenches, to determine the supporting power of the soil by applying a test load.

In the case of the capitol at Albany, N. Y., the soil was tested by applying a measured load to a square foot and also to a square yard. The machine used was a mast of timber 12 inches square, held vertical by guys, with a cross-frame to hold the weights. For the smaller area, a hole 3 feet deep was dug in the blue clay at the bottom of the foundation, the hole being 18 inches square at the top and 14 inches at the bottom. Small stakes were driven into the ground in lines radiating from the center of the hole, the tops being brought exactly to the same level; then any change in the surface of the ground adjacent to the hole could readily be detected and measured by means of a straight-edge. The foot of the mast was placed in the hole, and weights applied. No change in the surface of the adjacent ground was observed until the load reached 5.9 tons per sq. ft., when an uplift of the surrounding earth was noted in the form of a ring with an irregularly rounded surface, the contents of which, above the previous surface, measured 0.09 cubic feet. Similar experiments were made by applying the load to a square yard with essentially the same results. The several loads were allowed to remain for some time, and the settlements observed.*

Similar experiments were made in connection with the construction of the Congressional Library Building, Washington, D. C., with a frame which rested upon 4 foot-plates each a foot square. The frame could be moved from place to place on wheels, and the test was applied at a number of places.

Tests have been made of the soil under a river bed by forcing a 3-inch closed pipe into the ground by hydraulic pressure.†

655. In interpreting the results of tests of bearing power, the fact should not be overlooked that a small area will bear a larger load per unit of area for a short time than a larger area perpetually; and hence, the area tested should be as large as practicable and the test should continue as long as possible.

656. BEARING POWER OF SOILS. It is scarcely necessary to say that soils vary greatly in their bearing power, ranging as they do from the condition of hardest rock, through all intermediate stages, to a soft or semi-liquid condition, as mud, silt, or marsh. The best method of determining the load which a specific soil will bear is by

* W. J. McAlpine, the engineer in charge, in *Trans. Am. Soc. C. E.*, vol. ii, p. 287.

† *Trans. Am. Soc. C. E.*, vol. ii, p. 33.

direct experiment (§ 654-55); but good judgment and experience, aided by a careful study of the nature of the soil—its compactness and the amount of water contained in it—will enable one to determine, with reasonable accuracy, its probable supporting power. The following data are given to assist in forming an estimate of the load which may safely be imposed upon different soils.

657. Rock. The ultimate crushing strength of stone, as determined by crushing small *cubes*, ranges from 150 tons per square foot for the softest stone—such as are easily worn by running water or exposure to the weather—to 2,000 tons per square foot for the hardest stones (see Table 2, page 11). The crushing strength of slabs, i. e., of prisms of a less height than width, increases as the height decreases. A prism one half as high as wide is about twice as strong as a cube of the same material. If a slab be conceived as being made up of a number of cubes placed side by side, it is easy to see why the slab is stronger than a cube. The exterior cubes prevent the detachment of the disk-like pieces (Fig. 1, page 10) from the sides of the interior cubes; and hence the latter are greatly strengthened, which materially increases the strength of the slab. In testing cubes and slabs the pressure is applied uniformly over the entire upper surface of the test specimen; and, reasoning from analogy, it seems probable that when the pressure is applied to only a small part of the surface, as in the case of foundations on rock, the strength will be much greater than that of cubes of the same material.

Table 58 contains the results of experiments made by the author, and shows conclusively that a unit of material has a much greater power of resistance when it forms a portion of a larger mass than when isolated in the manner customary in making experiments on crushing strength.

The ordinary "crushing strength" given in next to the last column of Table 58 was obtained by crushing cubes of the identical materials employed in the other experiments. The concentrated pressure was applied by means of a hardened steel die thirty-eight sixty-fourths of an inch in diameter (area = 0.277 sq. in.). All the tests were made between self-adjusting parallel plates. No cushions were used in either series of experiments; that is, the pressed surfaces were the same in both series. However, the block of limestone 7 inches thick (Experiments No. 8 and 13) is an exception in this respect. This block had been sawed out and was slightly hollow, and it was thought not to be worth while to dress it down to a plane. As predicted before making the test, the block split each time in the direction of the hollow. If the bed had been flat, the block would doubtless have shown a greater strength. The concentrated pressure was generally applied near the corner of a large block, and the

distance from the center of the die to the edge of the block as given in the table is to the nearest edge. Frequently the block had a ragged edge, and therefore these distances are only approximate. The quantity in the last column—"Ratio"—is the unit crushing

TABLE 58.

COMPRESSIVE STRENGTH WHEN THE PRESSURE IS APPLIED ON
ONLY A PART OF THE UPPER SURFACE.

REFERENCE NO.	MATERIAL.	THICKNESS OF BLOCK.	CENTER OF DIE FROM EDGE.	No. OF TRIALS.	CRUSHING STRENGTH LB. PER SQ. IN.— CONCENTRATED PRESSURE.	No. OF TRIALS.	CRUSHING STRENGTH LB. PER SQ. IN.— DISTRIBUTED PRESSURE.	RATIO.
1	Lime Mortar . . .	$\frac{1}{2}$ in.	2 in.	4	3 610	3	1 340	2.7
2	Marble	1 "	2 "	4	18 050	3	10 500	1.7
3	"	2 "	2 "	3	36 100	3	10 100	3.6
4	Brick	$2\frac{1}{4}$ "	2 "	11	11 801	13	2 654	5.1
5	Limestone	3 "	2 "	4	31 046	3	3 453	9.0
6	Sandstone	3 "	2 "	2	51 600	3	3 696	14.0
7	Limestone	4 "	2 "	3	75 361	2	4 671	16.0
8	"	7 "	2 "	2	64 077	5	3 453	18.5
6	Sandstone	3 "	2 "	2	51 600	3	3 696	14.0
9	"	3 "	3 "	1	59 204	"	"	16.0
10	"	3 "	4 "	1	75 810	"	"	20.5
7	Limestone	4 "	2 "	3	75 361	2	4 761	16.0
11	"	4 "	3 "	3	102 900	"	"	22.0
12	"	4 "	4 "	1	111 188	"	"	24.0
8	"	7 "	2 "	2	64 077	5	3 453	18.5
13	"	7 "	4 "	1	87 720	"	"	25.0
14	Clay, which for years has safely carried, without appreciable settlement, buildings concentrating $1\frac{1}{2}$ to 2 tons per square foot (20 to 28 pounds per square inch), when tested in the form of cubes was crushed with 4 to 8 pounds per square inch. In this case the average "ratio" is 4.3.							

load for concentrated pressures *divided by* the unit crushing load for uniform pressure.

The experiments are tabulated in an order intended to show that the strength under concentrated pressure varies (1) with the thickness of the block and (2) with the distance between the die and the edge of the material being tested. It is clear that the strength increases very rapidly with both the thickness and the distance from the edge to the point where the pressure is applied. Therefore we

conclude that the compressive strength of cubes of a stone gives little or no idea of the ultimate resistance of the same material when in thick and extensive layers in its native bed.

658. The safe bearing power of rock is certainly *not less* than one tenth of the ultimate crushing strength of *cubes*; that is to say, the safe bearing power of solid rock is *not less* than 18 tons per sq. ft. for the softest rock and 180 for the strongest. It is safe to say that almost any rock, from the hardness of granite to that of a soft crumbling stone easily worn by exposure to the weather or to running water, when well bedded will bear the heaviest load that can be brought upon it by any masonry construction.

It scarcely ever occurs in practice that rock is loaded with the full amount of weight which it is capable of sustaining, as the extent of base necessary for the stability of the structure is generally sufficient to prevent any undue pressure coming on the rock beneath.

659. Corthell cites* five examples of structures that have stood without settlement in which the pressure on "hard pan" ranged from 3.0 to 12.0 tons per sq. ft., the average being 8.7 tons.

660. Clay. The clay soils vary from slate or shale, which will support any load that can come upon it, to a soft, wet clay which will squeeze out in every direction when a moderately heavy pressure is brought upon it. Foundations on clay should be laid at such depths as to be unaffected by the weather; since clay, at even considerable depths, will gain and lose considerable water as the seasons change. The bearing power of clayey soils can be very much improved by drainage (§ 671), or by preventing the penetration of water. If the foundation is laid upon undrained clay, care must be taken that excavations made in the immediate vicinity do not allow the clay under pressure to escape by oozing away from under the building. When the clay occurs in strata not horizontal, great care is necessary to prevent this flow of the soil. When coarse sand or gravel is mixed with the clay, its supporting power is greatly increased, being greater in proportion as the quantity of these materials is greater. When they are present to such an extent that the clay is just sufficient to bind them together, the combination will bear nearly as heavy loads as the softer rocks.

661. The following data on the bearing power of clay will be of assistance in deciding upon the load that may safely be imposed upon any particular clayey soil.

Experiments made on the clay under the piers of the bridge across the Missouri River at Bismarck, with surfaces $1\frac{1}{2}$ inches square, gave an average ultimate bearing power of 15 tons per sq. ft. Clay in thick compact beds, without any admixture of loam or vegetable

* E. L. Corthell's Allowable Pressures on Deep Foundations, p. 7.

matter, has carried 10 tons per sq. ft. without appreciable settlement. In the case of the Congressional Library (§ 654), the ultimate supporting power of "yellow clay mixed with sand" was $13\frac{1}{2}$ tons per sq. ft.; and the safe load was assumed to be $2\frac{1}{2}$ tons per sq. ft.

The stiffer varieties of clay, when kept dry, will safely bear from 4 to 6 tons per sq. ft.; but the same clay, if allowed to become saturated with water, can not be trusted to bear more than 2 tons per sq. ft. From the experiments made in connection with the construction of the capitol at Albany, N. Y., as described in § 654, the conclusion was drawn that the extreme supporting power of that soil was less than 6 tons per sq. ft., and that the load which might be safely imposed upon it was 2 tons per sq. ft. "The soil was blue clay containing from 60 to 90 per cent of alumina, the remainder being fine siliceous sand. The soil contains from 27 to 43, usually about 40, per cent of water; and various samples of it weighed from 81 to 101 lb. per cu. ft."

At Chicago it was formerly the custom to found upon the clay, and the load ordinarily put on a thin layer of clay (hard above and soft below, resting on a thick stratum of quicksand) was $1\frac{1}{2}$ to 2 tons per sq. ft.; and the settlement, which usually reached a maximum in a year, was about 2 to $2\frac{1}{2}$ inches per ton of load. Experience in central Illinois shows that, if the foundation is carried down below the action of frost, the clay subsoil will bear $1\frac{1}{2}$ to 2 tons per sq. ft. without appreciable settling.

Corthell cites* sixteen examples of structures that have stood without material settlement in which the pressure on clay ranged from 2.0 to 8.0 tons per sq. ft., the mean being 5.2 tons; and gives five other examples in which there was notable settlement with pressures on "hard clay" between 4.5 and 5.6 tons per sq. ft. with an average of 5.08. For corresponding data for "hard pan" see § 659.

662. The stiff blue clay of London seems not to be able to support more than 5 tons per sq. ft., for three bridges across the Thames—the old Westminster, the Blackfriars, and the "new" London (built in 1831)—each gave a pressure of about 5 tons per sq. ft. upon the clay and each settled badly.

663. Sand. The sandy soils vary from coarse gravel to fine sand. The former when of sufficient thickness forms one of the firmest and best foundations; and the latter when saturated with water is practically a liquid. Sand when dry, or wet sand when prevented from spreading laterally, forms one of the best beds for a foundation. Porous, sandy soils are, as a rule, unaffected by stagnant water, but are easily removed by running water; in the former case they present

* Allowable Pressures on Deep Foundations, p. 7.

no difficulty, but in the latter they require extreme care at the hands of the constructor, as will be considered later.

664. Compact gravel or clean sand, in beds of considerable thickness, protected from being carried away by water, may be loaded with 8 to 10 tons per sq. ft. with safety. In an experiment in France, clean river-sand compacted in a trench supported 100 tons per sq. ft. Fine sand well cemented with clay and compacted, if protected from water, will safely carry 4 to 6 tons per sq. ft.

The piers of the Cincinnati Suspension Bridge are founded on a bed of coarse gravel 12 feet below low-water, although solid limestone was only 12 feet deeper; if the friction on the sides of the pier* be disregarded, the maximum pressure on the gravel is 4 tons per sq. ft. The New York pier of the Brooklyn Suspension Bridge is founded 44 feet below the bed of the river, upon a layer of sand 2 feet thick resting upon bed-rock, the maximum pressure being about $6\frac{1}{2}$ tons per sq. ft.

At Chicago sand and gravel about 15 feet below the surface are successfully loaded with 2 to $2\frac{1}{2}$ tons per sq. ft. At Berlin the safe load for sandy soil is generally taken at 2 to $2\frac{1}{2}$ tons per sq. ft. The Washington Monument, Washington, D. C., rests upon a bed of *very* fine sand two feet thick underlying a bed of gravel and boulders, the ordinary pressure on certain parts of the foundation being not far from 11 tons per sq. ft., which the wind may increase to nearly 14 tons per sq. ft.

Corthell cites † ten examples of structures that give pressures on fine sand ranging from 2.25 to 5.8 tons per sq. ft., the average being 4.5 tons; thirty-three examples of pressures on coarse sand and gravel ranging from 2.40 to 7.75 tons with an average of 5.1 tons; and ten examples on sand and clay from 2.5 to 8.5 tons per sq. ft., the average being 4.9 tons—all without settlement. The same author gives three examples in which pressures of 1.8 to 7.0 tons per sq. ft. (average 5.2) on fine sand gave notable settlement; and three examples where pressures of 1.6 to 7.4 tons per sq. ft. (average 3.3) on sand and clay gave undesirable settlement.

665. Semi-Liquid Soils. With a semi-liquid soil, as mud, silt, or quicksand, it is customary (1) to remove it entirely, or (2) to sink piles, tubes, or caissons through it to a solid substratum, or (3) to consolidate the soil by adding earth, sand, stone, etc. The method of performing these operations will be described later. Soils of a soft or semi-liquid character should never be relied upon for a foundation when anything better can be obtained; but a heavy

* For the amount of such friction, see § 853-54 and § 887.

† Allowable Pressures on Deep Foundations, p. 7.

superstructure may be supported by the upward pressure of a semi-liquid soil, in the same way that water bears up a floating body.

According to Rankine,* a building will be supported when the pressure at its base is $w h \left(\frac{1 + \sin \alpha}{1 - \sin \alpha} \right)^2$ per unit of area, in which

expression w is the weight of a unit volume of the soil, h is the depth of immersion, and α is the angle of repose of the soil. If $\alpha = 5^\circ$, then according to the preceding relation the supporting power of the soil is $1.4 w h$ per unit of area; if $\alpha = 10^\circ$, it is $2.0 w h$; and if $\alpha = 15^\circ$, it is $2.9 w h$. The weight of soils of this class, i.e., mud, silt, and quicksand, varies from 100 to 130 lb. per cu. ft. Rankine gives this formula as being applicable to any soil; but since it takes no account of cohesion, for most soils it is only roughly approximate, and gives results too small. The following experiment seems to show that the error is considerable. "A 10-foot square base of concrete resting on mud, whose angle of repose was 5 to 1 [$\alpha = 11\frac{1}{2}^\circ$], bore 700 lb. per sq. ft."† This is $2\frac{1}{2}$ times the result by the above formula, using the maximum value of w .

Large buildings have been securely founded on quicksand by making the base of the immersed part as large and at the same time as light as possible. Timber in successive layers (§ 705) is generally used in such cases. This class of foundations is frequently required in constructing sewers in water-bearing sands, and though apparently presenting no difficulties, such foundations often demand great skill and ability.

666. It is difficult to give results of the safe bearing power of soils of this class. A considerable part of the supporting power is derived from the friction on the vertical sides of the foundation, and hence the bearing power depends to a considerable degree upon the area of the side surface in contact with the soil; and with this class of soils it is particularly important that the area tested should be as large as possible. Furthermore, it is difficult to determine the exact supporting power of a plastic soil, since a considerable settlement is certain to take place with the lapse of time.

Some careful and extensive experiments on the alluvial soil of Calcutta showed that loads not exceeding 2,700 lb. per sq. ft. caused no greater settlement than 0.19 to 0.31 inch.‡

Corthell¶ gives seven examples of structures founded on alluvium and silt in which the pressure ranged from 1.5 to 6.2 tons per sq. ft.,

* See Rankine's Civil Engineering, p. 379.

† Proc. Inst. of C. E., vol. xviii, p. 493.

‡ Engineering (London), vol. xx, p. 103; also Engineering News, vol. xxi, p. 116.

¶ Allowable Pressures on Deep Foundations, p. 7.

the average being 2.9 tons, in which there was no settlement; and two examples in which there was notable settlement under pressures varying from 1.60 to 7.60 tons per sq. ft. The experience at New Orleans with alluvial soil and a few experiments* that have been made on quicksand seem to indicate that with a load of $\frac{1}{2}$ to 1 ton per square foot the settlement will not be excessive.

667. Summary. Gathering together the results of the preceding discussion, we have Table 59.

TABLE 59.

SAFE BEARING POWER OF SOILS.

KIND OF MATERIAL.	SAFE BEARING POWER IN TONS PER SQ. FT.	
	Min.	Max.
Rock—the hardest—in thick layers, in native bed (§657-59).	200	—
“ equal to best ashlar masonry (§ 657-59).....	25	30
“ “ “ brick “ “ “	15	20
“ “ “ poor “ “ “	5	10
Clay, in thick beds, always dry (§ 660-62)	6	8
“ “ “ moderately dry (§ 660-62)	4	6
“ soft (§ 660-62).....	1	2
Gravel and coarse sand, well cemented (§ 663-64)	8	10
Sand, dry, compact and well cemented, “	4	6
“ clean, dry	2	4
Quicksand, alluvial soils, etc. (§ 665-66).....	0.5	1

668. Conclusion. It is well to notice that there are some practical considerations that modify the pressure which may safely be put upon a soil. For example, the pressure on the foundation of a tall chimney should be considerably less than that of the low massive foundation of a fire-proof vault. In the former case a slight inequality of bearing power, and consequent unequal settling, might endanger the stability of the structure; while in the latter no serious harm would result. The pressure per unit of area should be less for a light structure subject to the passage of heavy loads—as, for example, a railroad viaduct—than for a heavy structure subject only to a quiescent load, since the shock and jar of the moving load are far more serious than the heavier quiescent load.

The determination of the safe bearing power of soils, particularly when dealing with those of a semi-liquid character, is not the only question that must receive careful attention. In the foundations

* Trans. Am. Soc. of C. E., vol. xiv, p. 182; *Engineering*, vol. xx, p. 103; Proc. Inst. of C. E., vol. xvii, p. 443; Cleeman's Railroad Practice, p. 103-4.

for buildings, it may be necessary to provide a safeguard against the soil's escaping by being pressed out laterally into excavations in the vicinity. For example, in Chicago some of the largest and finest buildings have settled owing to the flow of the plastic clay into foundations opened across the street. In New York City one of the largest buildings settled because of the pumping of fine sand from an artesian well on the site in getting water for the boilers of the building. A still more remarkable case occurred in London where 700 feet of the walls of the East India Dock settled in consequence of the sinking of a foundation at the Midland Dock 1,500 feet away, and the source of the trouble was not discovered until a "sand blow" at the latter place revealed the connection.

In the foundations for bridge abutments, it may be necessary to consider what the effect will be if the soil around the abutment becomes thoroughly saturated with water, as it may during a flood; or what the effect will be if the soil is deprived of its lateral support by the washing away of the soil adjacent to the abutment. The provision to prevent the wash and undermining action of the stream is often a very considerable part of the cost of the structure. The prevention of either of these liabilities is a problem by itself, to the solution of which any general discussion will contribute but little.

669. IMPROVING THE BEARING POWER OF THE SOIL. When the soil directly under a proposed structure is incapable, in its normal state, of sustaining the load that will be brought upon it, the bearing power may be increased (1) by increasing the depth of the foundation, (2) by draining the site, (3) by compacting the soil, or (4) by adding a layer of sand.

670. Increasing the Depth. The simplest method of increasing the bearing power is to dig deeper. Ordinary soils will bear more weight the greater the depth reached, owing to their becoming more condensed from the superincumbent weight. Depth is especially important with clay, since it is then less liable to be displaced laterally owing to other excavations in the immediate vicinity, and also because at greater depths the amount of moisture in it will not vary so much. However, occasionally the soil grows more moist as the depth increases beyond a moderate distance, in which case increasing the depth is undesirable. For example, in Chicago the clay grows softer after a depth of about 12 to 14 feet below the sidewalk is reached.

In any soil, the bed of the foundation should be below the reach of frost. Even a foundation on bed-rock should be below the frost line, else water may get under the foundation through fissures, and, freezing, do damage.

671. Drainage. Another simple method of increasing the bearing

power of a soil is to drain it. The water may find its way to the bed of the foundation down the side of the wall, or by percolation through the soil, or through a seam of sand. In most cases the bed can be sufficiently drained by surrounding the building with a tile drain laid a little below the foundation.

In more difficult cases, the expedient is employed of covering the site with a layer of gravel—the thickness depending upon the plasticity of the soil,—the gravel serving the double purpose of distributing the concentrated loads of the footings to a larger area of the native soil and of improving the drainage of the bed of the foundation. In extreme cases, it is necessary to inclose the entire site with a puddle-wall to cut off drainage water from a higher area.

672. Springs. In laying foundations, springs are often met with and sometimes prove very troublesome. The water may sometimes be excluded from the foundation pit by driving sheet piles, or by plugging the spring with concrete. If the flow is so strong as to wash the cement out before it has set, a heavy canvas covered with pitch, etc., upon which the concrete is deposited, is sometimes used; or the water may be carried away in temporary channels, until the concrete in the artificial bed shall have set, when the waterways may be filled with semi-fluid cement mortar. Below is an account of the method of stopping a very troublesome spring encountered in laying the foundation of the dry-dock at the Brooklyn Navy Yard.

“The dock is a basin composed of stone masonry resting on piles. The foundation is 42 feet below the surface of the ground and 37 feet below mean tide. In digging the pit for the foundation, springs of fresh water were discovered near the bottom, which proved to be very troublesome. The upward pressure of the water was so great as to raise the foundation, however heavily it was loaded. The first indication of undermining by these springs was the settling of the piles of the dock near by. In a day it made a cavity in which a pole was run down 20 feet below the foundation timbers. Into this hole were thrown 150 cubic feet of stone, which settled 10 feet during the night; and 50 cubic feet more, thrown in the following day, drove the spring to another place, where it burst through a bed of concrete 2 feet thick. This new cavity was filled with concrete, but the precaution was taken of putting in a tube so as to permit the water to escape; still it burst through, and the operation was repeated several times, until it finally broke out through a heavy body of cement 14 feet distant. In this place it undermined the foundation piles. These were then driven deeper by means of followers; and a space of 1,000 square feet around the spring was then planked, forming a floor on which was laid a layer of brick in dry cement, and on that a layer of brick set in mortar, and

the foundation was completed over all. Several vent-holes were left through the floor and the foundation for the escape of the water. The work was completed in 1851, and has stood well ever since."

673. Consolidating the Soil. The bearing power of a soft or compressible soil may be improved in any one of several ways, viz.: (1) by adding a layer of sand, (2) by driving wood piles, (3) by using sand piles, or (4) by the compressol system.

674. By Adding Sand. The simplest method of improving the bearing power of a compressible soil is to spread sand or gravel or broken stone over the bed of the foundation, and pound it into the soil, thus forming a comparatively compact stratum upon which to found the structure. This method is not very effective, since at best the effect of the blow can not extend very deep, while the heavy masses of the masonry make themselves felt at great depths.

A more efficient way is to make an excavation a little larger than the proposed structure and cover the bed of the foundation with a layer of sand or gravel. The sand should be deposited in successive layers, each of which should be thoroughly tamped before laying the next. The sand should be moist, so it will pack well. Sand, when used in this way, possesses the valuable property of assuming a new position of equilibrium and stability should the soil on which it is laid yield at any of its points; and not only does this take place along the base of the sand bed, but also along its edges or sides. The bed of sand must be thick enough to distribute the pressure on its upper surface over the entire base of the trench. Some authors attempt to determine the proper thickness of the layer by assuming that the pressure is uniformly distributed over an area bounded by planes extending downward from the lower edges of the wall at the natural angle of repose of the material used for filling; but the results of such computations are worthless, since the validity of this assumption is open to serious objections. The thickness to be employed is entirely a matter of judgment, or of experiment in each particular case.

The following example, cited by Trautwine, is interesting as showing the surprising effect of even a thin layer of sand or gravel: "Some portions of the circular brick aqueduct for supplying Boston with water gave a great deal of trouble when its trenches passed through running quicksands and other treacherous soils. Concrete was tried, but the wet quicksand mixed itself with it and killed it. Wooden cradles, etc., also failed; and the difficulty was overcome by simply depositing in the trenches about two feet in depth of strong gravel."

675. By Driving Wood Piles. If the soil is very soft, it can be consolidated to a considerable depth by driving wood piles, for which

purpose many small ones are preferable to fewer but larger ones. It is customary to employ piles about 6 feet long and about 6 inches in diameter, since this size can be driven with a hand maul or by dropping a heavy block of wood with a tackle attached to any simple frame, or by a hand pile-driver (§ 751). They may be driven as close together as necessary, although 2 to 4 feet in the clear is usually sufficient.

In this connection it is necessary to remember that clay is compressible, while sand is not, and that hence this method of consolidating soils is not applicable to sand, and is not very efficient in soils largely composed of it.

676. When the piles are driven primarily to compact the soil, it is customary to load them and also the soil between them, either by cutting the piles off near the surface and laying a tight platform of timber on top of them (see § 721), or by depositing a bed of concrete between and over the heads of the piles (see § 720).

If the soil is very soft or composed largely of sand, this method is ineffective; in which case long piles are driven as close together as is necessary, the supporting power being derived either from the resting of the piles upon a harder substratum or from the buoyancy due to immersion in the semi-liquid soil. This method of securing a foundation by driving long piles is very expensive, and is seldom resorted to for buildings, since it is generally more economical to increase the area of the foundation.

677. *By Using Sand Piles.* Experiments show that in compacting the soil by driving wood piles, it is better to withdraw them and *immediately* fill the holes with sand, than to allow the wooden piles to remain. This advantage is independent of the question of the durability of the wood. When the wooden pile is driven, it compresses the soil an amount nearly or quite equal to the volume of the pile, and when the latter is withdrawn this consolidation remains, at least temporarily. If the hole is immediately filled with sand this compression is retained permanently, and the consolidation may be still further increased by ramming in the sand in thin layers, owing to the ability of the latter to transmit pressure laterally. And further, the sand pile will support a greater load than the wooden pile; for, since the sand acts like innumerable small arches reaching from one side of the hole to the other, more of the load is transmitted to the soil on the sides of the hole. To secure the best results, the sand should be fine, sharp, clean, and of uniform size.

678. *By the Compressol System.* This method consists in forming a hole in compressible soil by dropping a heavy conical iron weight, or "perforator," from a considerable height, and then filling the hole with concrete upon which is to rest a column or beam which

carries the superstructure. This is a comparatively new method of founding which has been employed to a considerable extent in Europe in the last few years. The perforator usually has a base of $2\frac{1}{2}$ to 3 feet, and weighs about 2 tons; and frequently has a fall of 20 to 30 feet. Holes have been sunk 50 feet deep by this process. The perforator compresses the soil laterally, and thereby greatly increases its water-tightness; and by dropping a little lime or clay into the hole before each fall of the perforator, it is usually possible to make the hole absolutely water-tight, since the lime or clay is plastered and compacted on the sides of the hole. Sometimes bowlders are rammed into the soil at the bottom of the hole, by dropping a pear-shaped weight upon them, thus still further consolidating the soil. Finally the hole is filled with concrete, the thorough tamping of which enlarges the hole and still further consolidates the soil, the amount of concrete put into the hole frequently being three or four times the original volume of the hole.

This method of founding has a number of marked advantages.

1. No excavations are required, and therefore there is no danger of disturbing the equilibrium of the soil.
2. It eliminates all danger to men working below the surface of the ground.
3. It is comparatively cheap, since all the operations are performed by machinery.
4. It is quite rapid, since a hole from 25 to 30 feet deep can be sunk and filled in 3 or 4 hours.
5. It is possible to sink a hole as deep and as large as required by the desired bearing power.

ART. 2. DESIGNING THE FOUNDATION.

679. LOAD TO BE SUPPORTED. The first step is to ascertain the load to be supported by the foundation. This load consists of three parts: (1) the building itself, (2) the movable loads on the floors and the snow on the roof, and (3) the part of the load that may be transferred from one part of the foundation to the other by the force of the wind.

680. Dead Load. The weight of the building is easily ascertained by calculating the cubical contents of all the various materials in the structure. If the weight is not equally distributed, care must be taken to ascertain the proportion to be carried by each part of the foundation. For example, if one vertical section of the wall is to contain a number of large windows while another will consist entirely of solid masonry, it is evident that the pressure on the foundation under the first section will be less than that under the second.

In this connection it must be borne in mind that concentrated pressures are not transmitted, undiminished, through a solid mass in the line of application, but spread out in successively radiating

lines; and hence, if any considerable distance intervenes between the foundation and the point of application of this concentrated load, the pressure will be nearly or quite uniformly distributed over the entire area of the base. The exact distribution of the pressure can not be computed.

Table 60, gives the weight of different kinds of masonry.

TABLE 60.
WEIGHT OF MASONRY.

KIND OF MASONRY.	WEIGHT IN LB. PER CU. FT.
Brick-work, pressed brick, thin joints	145
“ ordinary quality	125
“ soft brick, thick joints	100
Concrete, 1 cement, 3 sand, and 6 broken stone	140
Granite—6 per cent more than the corresponding limestone
Limestone, ashlar, largest blocks and thinnest joints	160
“ “ 12- to 20- inch courses and $\frac{3}{8}$ - to $\frac{1}{2}$ -inch joints. . .	155
“ squared-stone.....	150
“ rubble, best	140
“ “ rough.....	135
Sandstone—14 per cent less than the corresponding limestone

Ordinary lathing and plastering weighs about 10 lb. per sq. ft. The weight of floors is approximately 10 lb. per sq. ft. for dwellings; 25 lb. per sq. ft. for public buildings; and 40 or 50 lb. per sq. ft. for warehouses. The weight of the roof varies with the kind of covering, the span, etc.; but a shingle roof may be taken at 10 lb. per sq. ft., and a roof covered with slate or corrugated iron at 25 lb. per sq. ft.

681. Live Load. The movable load on the floor depends upon the nature of the building. For dwellings, it does not exceed 10 lb. per sq. ft.; for large office buildings, it is usually taken at 30 lb. per sq. ft., but is seldom if ever that high; * for churches, theatres, etc., the maximum load—a crowd of people—may, but seldom does,* reach 100 lb. per sq. ft.; for stores, warehouses, factories, etc., the load will be from 100 to 400 lb. per sq. ft., according to the purposes for which they are used.

682. The preceding loads are the ones to be used in determining the strength of the floor, and not in designing the footings; for there is no probability that each and every square foot of floor will have its maximum load at the same time. The amount of moving load to be considered as reaching the footings in any particular case is a matter of judgment.

* C. H. Blackall in *American Architect*, vol. xli, p. 129-31.

At Chicago in designing tall steel-skeleton office buildings, hotels, and retail stores, it is the practice to assume that nearly all of the maximum live load reaches the girders, that a smaller per cent reaches the columns of the upper story and a decreasing amount the columns of the succeeding stories downward, and that no live load reaches the footings. In wholesale stores and warehouses a portion of the total live load is assumed to reach the footings, the exact amount being a matter of judgment and varying with the circumstances. In many cities the building law specifies the proportion of live load to be assumed as reaching the footing.

On a compressible soil it is very important that the live load assumed as reaching the footings shall be neither over- nor underestimated. The dead load can be estimated with sufficient accuracy, and as the load on the footings under the walls is chiefly dead load, this part of the foundation is likely to receive the assumed load. But the possible maximum on the footings of interior columns is made up largely of live load, and if the live load reaching these footings is taken too large, the footings are likely to be made too great and consequently the columns will not settle as much as the walls; and on the other hand, if the live load reaching the column footings is taken too small, the columns will settle more than the walls. Experience in Chicago—extended both in time and in number of buildings—in founding upon a compressible soil shows that the settlement of the columns and walls of eight- and ten-story office buildings, hotels, retail stores, etc., are almost exactly the same when designed on the assumption that no live load reaches the footings.

In the larger cities the building laws specify the proportion of the maximum live load that is to be included in determining the area of the footings; but some of these laws entirely ignore the principle of the preceding paragraph. Of course, on a non-compressible foundation an error in the amount of live load assumed to reach the footings is of no consequence; but no soil is absolutely non-compressible, and hence in all cases except when the foundation is on solid rock, the above principle should be applied.

683. Attention must be given to the manner in which the weight of the roof and floors is transferred to the walls. For example, if the floor joists of a warehouse run from back to front, it is evident that the back and front walls alone will carry the weight of the floors and of the goods placed upon them, and this will make the pressure upon the foundation under them considerably greater than under the other walls. Again, if a stone-front is to be carried on an arch or on a girder having its bearings on piers at each side of the building, it is manifest that the weight of the whole superincumbent structure, instead of being distributed equally on the foundation under the

front, will be concentrated on that part of the foundation immediately under the piers.

684. AREA REQUIRED. Having determined the pressure which may safely be brought upon the soil, and having ascertained the weight of each part of the structure, the area required for the foundation is easily determined by dividing the latter by the former. Then, having found the area of foundation, the base of the structure must be extended by footings of masonry, concrete, timber, etc., so as to (1) cover that area and (2) distribute the pressure uniformly over it. The two items will be considered in inverse order.

685. CENTER OF PRESSURE AND CENTER OF BASE. In constructing a foundation the object is not so much to secure an absolutely unyielding base as to secure one that will settle as little as possible, and uniformly. All soils will yield somewhat under the pressure of any building, and even masonry itself is compressed by the weight of the load above it. The pressure per square foot should, therefore, be the same for all parts of the building, and particularly of the foundation, so that the settlement may be uniform. This can be secured only when the axis of the load (a vertical line through the center of gravity of the weight) passes through the center of the area of the foundation. If the axis of pressure does not coincide exactly with the axis of the base, the ground will yield most on the side which is pressed most; and, as the ground yields, the base assumes an inclined position, and carries the lower part of the structure with it, thus producing unsightly cracks, if nothing more.

The coincidence of the axis of pressure with the axis of resistance is of the greatest importance. The principle is almost self-evident, and yet the neglect to observe it is the most frequent cause of failure in the foundations of buildings.

Fig. 78 is an example of the way in which this principle is violated.

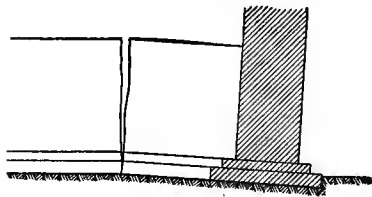

FIG. 78.

The shaded portion represents a heavily loaded exterior wall, and the unshaded portion a lightly loaded interior wall. The foundations of the two walls are rigidly connected at their intersection. The center of the load is under the shaded section, and the center of the resisting area is at some point farther to the left; consequently the exterior wall is caused to incline outward, producing cracks at or near the corners of the building. The two foundations are connected in the belief that an increase of the bearing surface is of advantage; but the true principle is that the

coincidence of the axis of pressure with the axis of resistance is of more importance.

Fig. 79 is another illustration of the same principle. The foundation is continuous under the opening, and hence the center of the foundation is to the left of the center of pressure; consequently the wall inclines to the right, producing cracks, usually over the opening.

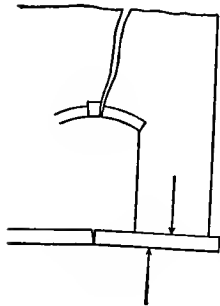

FIG. 79.

686. One conclusion to be drawn from the above examples is that the foundation of a wall should never be connected with that of another wall either much heavier or much lighter than itself, as both are equally objectionable. A second conclusion is that the axis of the load should strike a little *inside* of the center of the area of the base, to make sure that it will not be *outside*. Any inward inclination of the wall is rendered impossible by the interior walls of the building, the floorbeams, etc.; while an outward inclination can be counteracted only by the bond of the masonry and by anchors. A slight deviation of the axis of the load outward from the center of the base has a marked effect, and is not easily counteracted by anchors.

The center of the load can be made to fall inside of the center of foundation by extending the footings outwards, or by curtailing the foundations on the inside. The latter finds exemplification in the properly constructed foundation of a wall containing a number of openings. For example, in Fig. 80, if the foundation is uniform under the entire front, the center of pressure must be outside of the center of the base; and consequently the two side walls will incline outward, and show cracks over the openings. If the width of the foundation under the openings be decreased, or if this part of the foundation be omitted entirely, the center of pressure will fall inside of the center of base and the walls will tend to incline inwards, and hence be stable.

The two conclusions above may be summarized in the following important principle: *All foundations should be so constructed as to compress the ground slightly CONCAVE upwards, rather than CONVEX upwards.* On even slightly compressible soils, a small difference in the pressure on the foundation will be sufficient to cause the bed

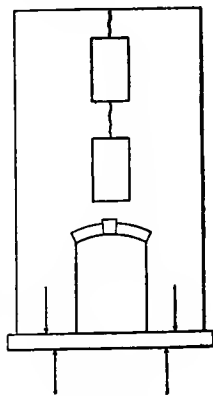

FIG. 80.

The two conclusions above may be summarized in the following important principle: *All foundations should be so constructed as to compress the ground slightly CONCAVE upwards, rather than CONVEX upwards.* On even slightly compressible soils, a small difference in the pressure on the foundation will be sufficient to cause the bed

to become convex upwards. At Chicago, in buildings founded upon soft clay an omission of 1 to 2 per cent of the weight (by leaving openings) usually causes sufficient convexity to produce unsightly cracks. With very slight differences of pressure on the foundation, it is sufficient to tie the building together by careful bonding, by hoop-iron built in over openings, and by heavy bars built in where one wall joins another.

687. INDEPENDENT PIERS. The art of constructing foundations on a compressible soil was brought to a high degree of development by the architects of Chicago between 1870 and 1890, when the principal buildings were founded upon a bed of soft clay. The special feature of the practice in that city is what is called "the method of independent piers"; that is, each tier of columns, each pier, each wall, etc., has its own independent foundation, the area of which is proportioned to the load on that part. The interior walls are fastened to the exterior ones by anchors which slide in slots.

688. The opposite extreme is to rest the structure upon a platform of concrete, timber, or steel beams so strong as to resist local settlement. This method is not usually successful; and when it is successful, it is exceedingly expensive and usually needlessly extravagant. The post-office building erected in Chicago in 1875 rested upon a bed of concrete 3 feet thick over the entire site; but the concrete was insufficient to resist the unequal loading, and the building settled so badly and so unevenly that it was necessary to demolish it after it had stood only seventeen years. It is said that some noted buildings in Europe rest upon beds of concrete 8 or 10 feet thick.

In a number of the cities of the United States are monumental buildings whose exterior walls rest upon continuous platforms built of heavy longitudinal and transverse steel beams, the object being to prevent even small cracks in the masonry by unequal settlement. In most cases, it is not expected that the platform will prevent all settlement, or even any unequal settlement; but it is intended that the platform shall be strong enough to bridge over any weak spot in the foundation and make the slope in the foundation from the point of greatest settlement to the point of least settlement so gradual as not to cause cracks in the stone facing, particularly in lintels and sills.

689. EFFECT OF THE WIND. The preceding discussion refers to the total weight that is to come upon the foundation. The pressure of the wind against towers, tall chimneys, etc., transfers the point of application of the load to one side of the foundation, and may affect the stability of the structure.

690. Amount of Wind Pressure. The maximum horizontal pressure of the wind is usually taken as 50 lb. per sq. ft. on a flat surface perpendicular to the wind, and on a cylinder at about 30 lb. per sq. ft. of the projection of the surface. The pressure upon an inclined surface, as a roof, is about 1 lb. per sq. ft. per degree of inclination to the horizontal. For example, if the roof has an inclination of 30° with the horizontal, the pressure of the wind will be about 30 lb. per sq. ft.

691. Overturning Effect. The method of computing the position of the center of the pressure on the foundation under the action of the wind is illustrated in Fig. 81, in which $ABED$ represents a vertical section of the tower; a is a point horizontally opposite the center of the surface exposed to the pressure of the wind and vertically above the center of gravity of the tower; C is the position of the center of pressure when there is no wind; N is the center when the wind is acting.

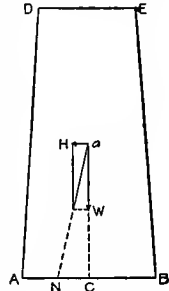

FIG. 81.

For convenience, let

P = the maximum pressure on the foundation, per unit of area;

p = the pressure of the wind per unit of area;

H = the total pressure of the wind against the exposed surface;

W = the weight of that part of the structure above the section considered,—in this case, AB ;

S = the area of the horizontal cross section;

I = the moment of inertia of this section;

l = the distance $A B$;

h = the distance $a C$;

d = the distance $N C$;

M = the moment of the wind.

When there is no horizontal force acting, the load on AB is uniform; but when there is a horizontal force acting—as, for example, the wind blowing from the right,—the pressure is greatest near A and decreases towards B . To find the law of the variation of this pressure, consider the tower as a cantilever beam. The maximum pressure at A will be that due to the weight of the tower *plus* the compression due to flexure; and the pressure at B will be the compression due to the weight *minus* the tension due to flexure.

The uniform pressure due to the weight is $\frac{W}{S}$. The stress at A due

to flexure is, by the principles of the resistance of materials, $\frac{Ml}{2I}$.

Then the maximum pressure per unit of area at *A* is

$$P = \frac{W}{S} + \frac{Ml}{2I}, \quad \dots \dots \dots (1)$$

and the minimum pressure at *B* is

$$P = \frac{W}{S} - \frac{Ml}{2I} \quad \dots \dots \dots (2)$$

Equations 1 and 2 are applicable to any symmetrical vertical section and to any horizontal cross section, and also to any system of horizontal and vertical forces. In succeeding chapters they will be employed in finding the unit pressure in masonry dams, bridge piers, arches, etc.

The value of *I* in the above formulas is given in Fig. 82 for the sections occurring most frequently in practice. Notice that *l* is the dimension parallel to the direction of the wind, and *b* the dimension perpendicular to the direction of the wind.

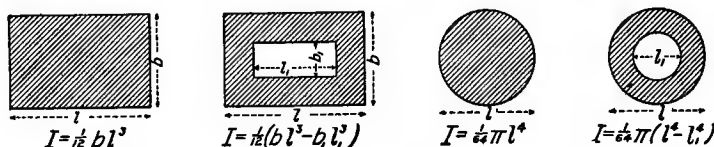

FIG. 82.—MOMENT OF INERTIA OF VARIOUS CROSS SECTIONS.

692. If the area of the section *AB*, Fig. 81, is a rectangle, $S = lb$, and $I = \frac{1}{12} b l^3$. Substituting these values in equation 1 gives

$$P = \frac{W}{lb} + \frac{6M}{b l^2} \quad \dots \dots \dots (3)$$

The moment of the wind, *M*, is equal to the product of its total pressure, *H*, and the distance, *h*, of the center of pressure above the horizontal section considered; or $M = H \cdot h$. *H* is equal to the pressure per unit of area, *p*, multiplied by the area of the surface exposed to the pressure of the wind. Substituting the above value of *M* in equation 3 gives

$$P = \frac{W}{lb} + \frac{6H \cdot h}{b l^2} \quad \dots \dots \dots (4)$$

To still further simplify the above formula, notice that Fig. 81 gives the proportion

$$H : W :: NC : aC,$$

from which

$$H \cdot aC = W \cdot NC;$$

or, changing the nomenclature,

$$H h = W d.$$

Notice that the last relation can also be obtained directly by the principle of moments.

Substituting the value of $H h$, as above, in equation 4 gives

$$P = \frac{W}{l b} + \frac{6 W d}{b l^2}, \quad . \quad . \quad . \quad . \quad (5)$$

which is a convenient form for practical application.

An examination of equation 5 shows that when $d = NC = \frac{1}{6}l$, the maximum pressure at A is twice the average. Notice also that under these conditions the pressure at B is zero. This is equivalent to what is known, in the theory of arches, as the principle of the middle third. It shows that as long as the center of pressure lies in the middle third, the maximum pressure is not more than twice the average pressure, and that there is no tendency to produce tension at B .

The above discussion of the distribution of the pressure on the foundation is amply sufficient for the case in hand; but the subject is discussed more fully in the chapter on Masonry Dams (see Chapter XVII).

693. The average pressure per unit on AB has already been adjusted to the *safe* bearing power of the soil, and if the maximum pressure at A does not exceed the *ultimate* bearing power, the occasional maximum pressure due to the wind will do no harm; but if this maximum exceeds or is dangerously near the ultimate strength of the soil, the base must be widened.

694. Sliding. The pressure of the wind is a force tending to slide the foundation horizontally. This is resisted by the friction caused by the weight of the entire structure, and also by the earth around the base of the foundation; and hence there is no need, in this connection, of considering this manner of failure.

695. SPREAD FOOTINGS. The term *footing* is usually understood as meaning the bottom course or courses of masonry which extend beyond the faces of the wall. It will be used here as applying to the material—whether masonry, timber, or iron—employed to increase the area of the base of the foundation. Whatever the character of the soil, footings should extend beyond the face of the wall (1) to add to the stability of the structure and lessen the danger of the work's being thrown out of plumb, and (2) to distribute the weight of the structure over a larger area and thus decrease the

settlement due to the compression of the ground. To serve the first purpose, footings must be securely bonded to the body of the wall; and to produce the second effect, they must have sufficient strength to resist the transverse strain to which they are exposed. In ordinary buildings the distribution of the weight is more important than adding to the resistance to overturning, and hence only the former will be considered here.

There are four methods in more or less common use for increasing the width of footings: (1) extend the successive courses of the masonry at the bottom of the wall, (2) rest the wall or column upon a reinforced concrete slab, (3) use one or more layers of timbers or steel I-beams, or (4) support the structure upon inverted masonry arches.

696. Masonry Footings. The area of the foundation having been determined and its center having been located with reference to the axis of the load (§ 686), the next step is to determine how much narrower each footing course may be than the one next below it. The projecting part of the footing resists as a beam fixed at one end and loaded uniformly. The load is the pressure on the earth or on the course next below. The off-set of such a course depends upon the amount of the pressure, the transverse strength of the material, and the thickness of the course.

To deduce a formula for the relation between these quantities, let P = the pressure, in tons per square foot, at the bottom of the footing course under consideration;

R = the modulus of rupture of the material, in pounds per square inch;

o = the greatest possible off-set or projection of the footing course, in inches;

t = the thickness of the footing course, in inches;

f = the factor of safety.

The part of the footing course that projects beyond the one above it, is a cantilever beam uniformly loaded. From the principles of the resistance of materials, we know that the upward pressure of the earth against the part that projects *multiplied by* one half of the length of the projection *is equal to* the continued product of one sixth of the modulus of rupture of the material, the breadth of the footing course, and the square of the thickness. Expressing this relation in the above nomenclature and reducing, we get the formula

$$o = t \sqrt{\frac{R}{41.6 P f}} \quad \dots \quad (6)$$

or, with sufficient accuracy,

$$o = \frac{1}{6} t \sqrt{\frac{R}{P f}} \quad \dots \quad (7)$$

Hence the projection available with any given thickness, or the thickness required for any given projection, may easily be computed by equation 7.

697. The margin to be allowed for safety will depend upon the care used in computing the loads, in selecting the materials for the footing courses, and in bedding and placing them. If *all* the loads have been allowed for at their probable maximum value, and if the material is to be reasonably uniform in quality and laid with care, then a comparatively small margin for safety is sufficient; but if *all* the loads have not been carefully computed, and if the job is to be done by an unknown contractor, and neither the material nor the work is to be carefully inspected, then a large margin is necessary. As a general rule, it is better to assume, for each particular case, a factor of safety in accordance with the attendant conditions of the problem than blindly to use the results deduced by the application of some arbitrarily assumed factor. Table 61 is given for the convenience of those who may wish to use 10 as a factor of safety.

TABLE 61.

SAFE OFF-SET FOR MASONRY FOOTING COURSES, USING 10 AS A FACTOR OF SAFETY.

For limitations, see § 698-701.

KIND OF STONE.	R, IN LB. PER SQ. IN.	OFF-SET IN TERMS OF THE THICKNESS OF THE COURSE FOR A PRESSURE, IN TONS PER SQ. FT., ON THE BOTTOM OF THE COURSE OF		
		0.5	1.0	2.0
<i>Stone:</i>				
Bluestone, North River	5 026*	5.2	3.7	2.6
Granite	1 849*	3.1	2.2	1.6
Limestone	1 377*	2.7	1.9	1.4
Sandstone	1 378*	2.7	1.9	1.4
<i>Brick-work:</i>				
Good building brick in poor 1 : 2 natural- cement mortar, age 50 days	120†	0.8	0.6	0.3
Under-burned building brick in 1 : 3 port- land-cement mortar age 76 days	89†	1.9	1.4	0.9
Vitrified building brick in 1 : 3 portland- cement mortar, age 76 days	298†	4.9	3.1	2.2
<i>Concrete:</i>				
1 : 2 : 4 portland cement at 1 month	300†	1.2	0.9	0.6
“ “ “ 6 months	400†	1.6	1.0	0.7

* From Table 3, page 13.

† From § 630, page 320.

‡ From Tables 37 and 38, pages 203 and 204.

698. Stone Footings. Strictly, the above computations when applied to stone-masonry footing courses are correct only for the lower off-set, and then only when the footing is composed of stones whose thickness is equal to the thickness of the course and which project less than half their length, and which are also well bedded. The resistance of two or more courses to bending, if bedded in good cement mortar, probably varies about as the square of their combined depth, and the bending due to the uniform pressure on the base increases as the square of the sum of the projections; and therefore the successive off-sets should be proportional to the thickness of the course; or, in other words, the values as above are applicable to any of the several projecting courses, provided no stone projects more than half its length beyond the end of the top course.

The preceding results will be applicable to built footing courses only when the pressure above the course is less than the safe crushing strength of the mortar (see § 106 and § 255). The proper projection for rubble masonry lies somewhere between the values for stone and for concrete. If the rubble consists of large stones well bedded in good strong portland-cement mortar, then the values for this class of masonry will be but little less than those given for stone in Table 61; but if the rubble consists of small irregular stones laid with portland-cement mortar, the projection should not much exceed that given for concrete. Footing courses should not be laid of small stones in either natural-cement or lime mortar.

699. Brick Footings. The off-sets in Table 61 for brick-work are the combined off-sets of one or more projections in terms of the total thickness of the one or more projections.

700. Plain Concrete Footings. A concrete footing should be built as a monolith for its full depth, since the deeper the beam the greater its strength; but the outer upper corner may be stepped to save concrete, provided the combined projection in any case does not exceed that given by Table 61 or a similar computation.

701. After the safe length of the off-set of the footing has been determined, it should be examined to see if it is safe against failure by shearing. Footings are subjected to heavy loads and consequently to great shearing stress, which should be carefully provided for. For the shearing resistance of stone, see § 20; for brick, see § 82; and for concrete, see § 408.

702. Eccentric Footing. It is frequently desired to place the outer face of the wall upon the exterior boundary of the lot; and in such cases, if it is impossible to secure permission of the adjacent owner to extend the footings into the adjoining property, it becomes necessary to support the wall upon an eccentric footing somewhat as shown in Fig. 83. Of course, with this arrangement the pressure

upon the soil will not be uniform along the line AB . The pressure at A may be computed by equation 1, page 354, and that at B by equation 2, page 354, by noticing that $M = W e$. W is to be regarded as the weight of a unit length, say 1 foot, of the wall and the footing; and S in the above equations is the area of a unit of length of the footing, which in this case $= 1 \times AB = l$. The value of e is shown in Fig. 83.

Since the pressure at A is considerably more than the average upon the footing (see § 692), this method can not be employed for a heavy building upon a soft soil; and it should never be used except as a last resort, since better results are likely to be obtained when the pressure upon the soil is uniform under the footing.

703. Cantilever Footing. A modification or rather an improvement upon the eccentric footing described in the preceding section was developed at Chicago. The improvement was devised especially for tall steel-skeleton buildings, and is usually employed to support columns rather than walls. The lower end of an exterior column, which supports the heavy exterior walls, rests upon the short arm of a gigantic cantilever beam which in turn is supported upon a foundation built at a considerable distance inside of the lot line, a lighter-loaded interior column resting upon the long arm of the cantilever. This method has been frequently employed in Chicago and elsewhere. Obviously it could be used to support a masonry wall by building the wall upon a longitudinal beam or girder and supporting the latter at intervals upon a series of transverse cantilevers.

704. Reinforced Concrete Footing. In designing a reinforced concrete footing for a wall, the first step is to adopt a ratio of the working stress of the steel to that of the concrete (§ 470-71 and 474-75); and the next is to assume a depth for the beam and compute the per cent of steel, p , by equation 10, page 228, and also the position of the neutral axis, k , by equation 3, page 227, and then compute the resisting moment by both equation 5 and 6, page 227. If the safe resisting moment of the cantilever does not agree with the moment of the pressure on the soil, which in the nomenclature of § 696, is $\frac{1}{2} P e^2$, then a new depth must be assumed and the computations as above must be repeated.

After the off-set has been adjusted to resist the bending moment, its shearing strength should be tested (see § 458 and 476-77). The bond stress should also be tested (see § 455-57 and 472-73).

The upper outer edge of the footing may be stepped to save

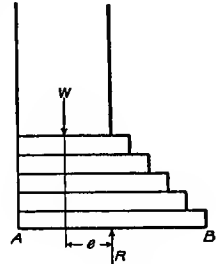

FIG. 83.

concrete; but as each reinforcing bar is likely to extend the full width of the footing, each off-set need be tested only for shear.

The above relates to the footing under a wall; and if a square footing for a column is to be designed, notice that the corners will have a projection of 1.4 times that of the sides, and that therefore the thickness of the footing should be equal to approximately 1.4 times that for a wall giving the same average pressure on the soil, and in a diagonal unit section there should be approximately as much steel as in a section perpendicular to the side of the footing.

705. Timber Footing. In very soft earth it would be inexpedient to use masonry footings, since the foundation would be very deep or occupy the space usually devoted to the cellar, and besides the weight of a masonry footing would add materially to the load on the soil. One method of overcoming this difficulty consists in constructing a timber grating, sometimes called a *grillage*, by placing a series of heavy timbers on the soil, and laying another series transversely on top of these. The timbers may be fastened at their intersections by spikes or drift-bolts (§ 795) if there is any possibility of sliding, which is unlikely in the class of foundations here considered. The earth should be packed in between and around the several beams. A flooring of thick planks, often termed a *platform*, is laid on top of the grillage to receive the lowest course of masonry. In extreme cases, the timbers in one or more of the courses are laid close together. Timber should never be used except where it will always be wet.

The amount that a course of timber may project beyond the one next above it can be determined by equation 7, page 356. Taking R in that equation equal to 1,000—the value ordinarily used for oak or yellow pine—and $f = 10$, and solving, we obtain the following results for the *safe* projection: If the pressure on the foundation is 0.5 ton per sq. ft., the safe projection is 7.5 times the thickness of the course; if the pressure is 1 ton per square foot, the safe projection is 5.3 times the thickness of the course; and if the pressure is 2 tons per square foot, the safe projection is 3.7 times the thickness of the course.

The above method is not strictly correct, since, owing to the flexure of the timber beam, the pressure is not uniform as virtually assumed above, nor is the maximum moment at the edge of the wall as assumed above.

The above method of computation is not applicable to two or more courses of timber, if one is transverse to the other, since the deflection of the timber materially affects the distribution of the pressure on the different courses of the footing. For references to methods of solving an analogous problem, see § 708.

706. This method of increasing the area of the footing was formerly much used at New Orleans. The custom-house at that place is founded upon a 3-inch plank flooring laid 7 feet below the street pavement. A grillage, consisting of timbers 12 inches square laid side by side, is laid upon the floor, over which similar timbers are placed transversely, 2 feet apart in the clear.

707. Steel-Beam Footing. The use of steel beams to increase the area of footings was devised in Chicago, and was used for nearly all of the large buildings built there from 1878 to 1898. The city is situated on a clay bed, the upper 10 or 12 feet of which is moderately hard, but below this crust the clay is quite soft. Before 1878 stepped limestone footings resting on this crust were used, but they occupied valuable space and left no room for the necessary elevator and other machinery; and to meet these objections, a thin steel-grillage footing was devised, and has been called the raft or floating foundation. This steel-grillage foundation consisted of a row of steel beams placed side by side and embedded in rich concrete; and on top of this and at right angles to it is placed a shorter row, and above this, one and sometimes two other rows. At first, on account of the artificially high price of steel I-beams, railroad rails were used, but later I-beams have been employed, as they have a more economical cross section.

Steel is superior to timber for this purpose, in that the latter can be used only where it is always wet, while the former is not affected by variations of wetness and dryness. Twenty years' experience in this use of steel at Chicago shows that after a short time the surface of the metal becomes encased in a coating which prevents further oxidation. The most important advantage, however, in this use of steel is that the off-set can be much greater with steel than with wood or stone; and hence the foundations may be shallow, and not occupy the cellar space.

708. The proper projections for the steel beams can be computed by a formula somewhat similar to that of § 696; but the steel footing is appropriately a part of the steel-skeleton construction, and hence will not be considered here. For a description of a typical steel-rail foundation and a presentation of the method of computations formerly employed in Chicago, see *Engineering News*, Vol. xxvi, page 122; and for adverse criticisms thereon, see *ibid.*, pages 265, 312, 415, and Vol. xxxii, page 387. Concerning the effect of the strength of the base of the column, see Johnson's *Modern Framed Structures*, pages 444-46. For a discussion which considers the deflection of the several beams, see *Engineering Record*, Vol. xxxix, pages 333-34, 354-56, 383, 407-8. The last is the most exact method of analysis, and also secures the greatest economy of material.

709. Inverted Arch. Inverted arches are frequently built under

and between the bases of piers, as shown in Fig. 84. Employed in this way, the arch simply distributes the pressure over a greater area; but it is not well adapted to this use, for (1) it is nearly impossible to prevent the end piers of a series from being pushed outward



FIG. 84.

by the thrust of the arch, and (2) it is generally impossible, with inverted arches, to make the areas of the different parts of the foundation proportional to the load to be supported (see § 685). The only advantage the inverted arch has over

masonry footings is in the shallower foundations obtained.

710. DEEP FOUNDATIONS. In the preceding sections have been described the methods of supporting a structure upon soft or compressible soil by increasing the area of the footing; but under the head of "deep foundations" will be described the methods of founding upon a hard stratum or bed-rock underlying the soft soil.

711. Piles. One of the most common methods of founding upon a soft soil is to drive piles; but this method has already been briefly referred to in § 675, and will be discussed at length in the next chapter, and hence will not be considered here.

712. Concrete Piers. Instead of trying to extend the footings sufficiently to support a heavy load upon a soft soil, wells are sometimes dug through the soft soil to a hard sub-stratum, the structure being founded directly upon the latter. If the soil contains much water, then some of the methods described in Chapter XVI—Foundations under Water—must be employed; but if the soil is fairly compact clay, a method devised at Chicago may be used. This consists in sinking a shaft to hard pan or bed-rock, and filling the well with concrete. The shafts are sunk as open wells 3 to 8 feet in diameter, and are usually lined with 2- by 6-inch tongue-and-groove planks from 4 to 6 feet long, which are supported by two and sometimes three interior iron sectional hoops. A section about 6 feet deep is excavated and then lined. The intention is to make the excavation only large enough to get the lagging into place, to prevent settlement of adjoining buildings; and if the excavation is accidentally made too large, clay is packed behind the lagging as the latter is put into position. If beds of quicksand or other soft material are encountered, steel sheet piles (§ 748-49) or steel cylinders are used instead of wood lining. The bearing power of the concrete column may be increased, by bellng out the lower end of the well. After the excavation is completed, the hole is filled with concrete. The rings are taken out as the concreting progresses, except in soft swelling clay; but the lagging is usually left in place.

This method is now employed in Chicago almost exclusively for

all large buildings. The usual practice there is to mix the concrete rather dry and put it into wells 60 to 100 feet deep by shoveling it in at the top and allowing it to drop freely, an attempt being made to drop it from the shovel in such a manner that the shovelful will go down without being broken up. Such columns safely carry 20 to 25 tons per square foot of top area—usually the former.

At Chicago this method is usually called *concrete caissons*, but the term *concrete piers* is better, and is used to some extent.

713. A marked advantage of this method as employed in Chicago is that the wells are sunk without vacating any part of the old building except the basement. The wells are filled with concrete to within 40 to 50 feet of the sidewalk level, and then the steel columns for the new two- or three-story basement are put into place on top of the concrete columns before the basement is excavated; and finally when the old building is demolished, the work of construction may proceed upward and downward at the same time.

714. Hydraulic Caisson. A few deep foundations of buildings in New York City have been sunk to bed-rock by the hydraulic caisson method. This consists of sinking steel cylinders without interior excavation by means of hydraulic jets. A riveted steel cylinder is attached at its lower end to an annular cast-iron cutting edge of hollow triangular cross section having numerous small perforations along its lower edge; and the hollow cast-iron cutting section is connected with a force pump by pipes and flexible hose. The cylinder is heavily loaded with cast iron, the pump is started, and the numerous jets of water issuing from the cutting edge scour away the soil and form an annular trench into which the cylinder descends. As the sinking progresses, another section of the cylinder is added at the top. When a hard substratum is reached, the pump is stopped, the soil in the interior cylinder dug or dredged or "washed" out. If the cutting edge of the cylinder stops in clay, probably little or no water will leak into the cylinder; but if it stops upon bed-rock which is irregular or not level, it may be necessary to seal the cylinder by depositing concrete under water.

The objection to this method is that in some cases it does not permit an inspection and proper preparation of the bed of the foundation. The pneumatic method—see Art. 4 of Chapter XVI—permits inspection and proper preparation of the underlying hard stratum, and in recent years has frequently been used, particularly in New York City, in sinking foundations for buildings. The only advantage of the hydraulic caisson over the pneumatic method is that the former is sometimes the cheaper.

ART. 3. PREPARING THE BED.

715. ON ROCK. To prepare a rock bed to receive a foundation it is generally only necessary to cut away the loose and decayed portions of the rock, and to dress it to a plane surface as nearly perpendicular to the direction of the pressure as is practicable. If there are any fissures, they should be filled with concrete. A rock that is very much broken can be made amply secure for a foundation by the liberal use of good concrete. The piers of the Niagara Cantilever Bridge are founded upon the top of a bank of boulders, which were first cemented together with concrete.

Sometimes it is necessary that certain parts of a structure start from a lower level than the others. In this case care should be taken (1) to keep the mortar joints as thin as possible, (2) to lay the lower portions in cement, and (3) to proceed slowly with the work; otherwise the greater quantity of mortar in the wall on the lower portions of the slope will cause greater settling there and a consequent breaking of the joints at the stepping places. The bonding over the offsets should receive particular attention.

716. ON FIRM EARTH. For foundations in such earths as hard clay, clean dry gravel, or clean sharp sand, it is only necessary to dig a trench from 3 to 6 feet deep, so that the foundation may be below the disturbing effect of frost. Provision should also be made for the drainage of the bed of the foundation.

With this class of foundations it often happens that one part of the structure starts from a lower level than another. When this is the case great care is required. All the precautions mentioned in the second paragraph of § 715 should be observed, and great care should also be taken so to proportion the load per unit of area that the settlement of the foundation may be uniform. This is difficult to do, since a variation of a few feet in depth often makes a great difference in the supporting power of the soil.

717. IN WET GROUND. The difficulty in soils of this class is in disposing of the water, or in preventing the semi-liquid soil from running into the excavation. The difficulties are similar to those met with in constructing foundations under water—see Chapter XVI. Three general methods of laying a foundation in this kind of soil will be briefly described.

718. Cofferdam. If the soil is only moderately wet—not saturated,—it is sufficient to inclose the area to be excavated with sheet piles (boards driven vertically into the ground in contact with each other). Ordinary planks 8 to 12 inches wide and $1\frac{1}{2}$ or 2 inches thick are used. This curbing is a simple form of a coffer-dam (Art. 1,

Chap. XVI). The boards should be sharpened wholly from one side; this point being placed next to the last pile driven causes them to crowd together and make tighter joints. The sheeting may be driven by hand, by a heavy weight raised by a tackle and then dropped, or by an ordinary pile-driver (§ 751-52). Unless the amount of water is quite small, it will be necessary to drive a double row of sheeting, breaking joints. It will not be possible to entirely prevent leaking. The water that leaks in may be bailed out, or pumped—either by hand or by steam (see § 818-23).

To prevent the sheeting from being forced inward, it may be braced by shores placed horizontally from side to side and abutting against wales (horizontal timbers which rest against the sheet piles). The bracing is put in successively from the top as the excavation proceeds; and as the masonry is built up, short braces between the sheeting and the masonry are substituted for the long braces which previously extended from side to side. Iron screws, somewhat similar to jack-screws, are used, instead of timber shores, in excavating trenches for the foundations of buildings, for sewers, etc.

If one length of sheeting will not reach deep enough, an additional section can be placed inside of the one already in position, when the excavation has reached a sufficient depth to require it.

For a more extended account of the use of coffer-dams, see Chapter XVI—Foundations Under Water, Art. 1, Coffers-Dams.

719. In some cases the soil is more easily excavated if it is first drained. To do this, dig a hole—a sump—into which the water will drain and from which it may be pumped. If necessary, several sumps may be sunk, and deepened as the excavation proceeds.

Quicksand or soft alluvium may sometimes be pumped out along with the water by a centrifugal or a mud pump (§ 823 and § 877). On large jobs, such material is sometimes taken out with a clam-shell or orange-peel dredge (§ 845-46).

720. Concrete. Concrete can frequently be used advantageously in foundations in wet soils. If the water can be removed, the concrete should be deposited in layers (§ 342-44); but if the water can not be removed, the concrete may be deposited under the water (see § 347), although it is more difficult to insure good results by this method than when the concrete is deposited in the open air.

721. Piles. If the semi-liquid soil extends to a considerable depth, or if the soft soil which overlies a solid substratum can not be removed readily, a substantial foundation may be constructed either by driving wood piles at uniform distances over the area and constructing a timber *grillage* (see § 793-95) on top of them, or by driving concrete piles (see § 736-45) and depositing a concrete cap (see § 796) on top of them. Of course, wood piles should be sawed off

(§ 791) below low-water, which usually necessitates a coffer-dam (§ 718, and Art. 1 of Chapter XVI) and the excavation of the soil a little below the low-water line.

722. In excavating shallow pits in sand containing a small amount of water, dynamite cartridges have been successfully used to drive the water out. A hole is bored with an ordinary auger and the cartridge inserted and exploded. The explosion drives the water back into the soil so far that, by working rapidly, the hole can be excavated and a layer of concrete placed before the water returns.

723. CONCLUSION. It is hardly worth while here to discuss this subject further. It is one on which general instruction can not be given. Each case must be dealt with according to the attendant circumstances, and a knowledge of the method best adapted to any given conditions comes only by experience.

CHAPTER XV

PILE FOUNDATIONS

724. DEFINITIONS. Although a pile is generally understood to be a round timber driven into the soil to support a load, the term has a variety of applications which it will be well to explain.

Bearing Pile. One used to sustain a vertical load. This is the ordinary pile, and usually is the one referred to when the word pile is employed without qualification. It may be made of either wood, cast iron, steel, or concrete.

Sheet Piles. Thick boards or timbers or steel sections driven in close contact to inclose a space to prevent leakage.

Screw Pile. An iron shaft to the bottom of which is attached a broad-bladed screw having only one or two turns.

Disk Pile. A bearing pile near the foot of which a disk is keyed or bolted to give additional bearing power.

Pneumatic Pile. A metal cylinder which is sunk by atmospheric pressure. This form of pile will be discussed in the next chapter (see § 863-66).

Sand Pile. For an account of the method of using sand as a pile, see § 677.

ART. 1. DESCRIPTION OF PILES.

725. Piles may be divided into bearing piles and sheet piles.

726. BEARING PILES. Bearing piles may be composed of wood, iron or steel, or concrete.

727. Wood Piles. These are very important factors in foundations on soft or swampy soil. All kinds of timber are employed. Spruce and hemlock answer very well, in soft or medium soils, for foundation piles or for piles always under water; the hard pines, elm, and beech, for firmer soils; and the hard oaks, for still more compact soils. Where the pile is alternately wet and dry, white or post oak and yellow or Southern pine are generally used. Piles should never be less than 6 inches, and preferably not less than 8 inches, in diameter at the small end, and never more than 18 inches, and preferably not more than 14 inches at the large end. A pile should be straight, and

should be trimmed close; and sometimes it is required that piles employed in foundations shall have the bark removed.

728. *Pile Hood and Shoe.* To prevent bruising and splitting in driving, 2 or 3 inches of the head is usually chamfered off. As an additional means of preventing splitting, the head is often hooped with a strong iron band, 2 to 3 inches wide and $\frac{1}{2}$ to 1 inch thick. The expense of removing these bands and of replacing the broken ones, and the consequent delays, led to the introduction, recently, of a hood for the protection of the head of the pile. The hood consists of a cast-iron block with a tapered recess above and below, the chamfered head of the pile fitting into the lower recess and a cushion piece of hard wood, upon which the hammer falls, fitting into the upper one. The hood preserves the head of the pile, adds to the effectiveness of the blows (see Table 64, page 390), and keeps the pile head in place to receive the blows of the hammer. The device, above called a hood, is usually called a cap, which is unfortunate, since the word cap is applied to a heavy horizontal timber placed on top of a row of piles.

A further advantage of the pile hood is that it saves piles. In hard driving, without the hood the head is crushed or broomed to such an extent that the pile is adzed or sawed off several times before it is completely driven, and often after it is driven a portion of the head must be sawed off to secure sound wood upon which to rest the grillage or platform (§793-96). In ordering piles for any special work where the driving is hard, allowance must be made for this loss.

Piles are generally sharpened before being driven; but many competent engineers claim that sharpening is of no advantage and is sometimes harmful. Sometimes, particularly in stony ground, the point is protected by an iron shoe; but some engineers claim that a shoe is no advantage. The shoe may be only two V-shaped loops of bar iron placed over the point, in planes at right angles to each other, and spiked to the piles; or it may be a wrought- or cast-iron socket, of which there are a number of forms on the market.

729. *Splicing Piles.* It frequently happens, in driving piles in swampy places, for false-works, etc., that a single pile is not long enough, in which case two are spliced together. A common method of doing this is as follows: After the first pile is driven its head is cut off square, a hole 2 inches in diameter and 12 inches deep is bored in its head, and an oak tree-nail, or dowel-pin, 23 inches long, is driven into the hole; another pile, similarly squared and bored, is placed upon the lower pile, and the driving continued. Spliced in this way the pile is deficient in lateral stiffness, and the upper section is liable to bounce off while driving. It is better to reinforce

the splice by flattening the sides of the piles and nailing on, with say, 8-inch spikes, four or more pieces 2 or 3 inches thick, 4 or 5 inches wide, and 4 to 6 feet long. In the erection of the bridge over the Hudson at Poughkeepsie, N. Y., two piles were thus spliced together to form a single one 130 feet long.

Piles may be made of any required length or cross section by bolting and fishing together, sidewise and lengthwise, a number of squared timbers. Such piles are frequently used as guide piles in sinking pneumatic caissons (§ 885). Hollow-built piles, 40 inches in diameter and 80 feet long, were used for this purpose in constructing the St. Louis Bridge (§ 889). They were sunk by pumping the sand and water from the inside of them with a sand pump (§ 877).

730. Cost of Wood Piles. The cost of wood piles varies greatly with locality, and has been going up rapidly in recent years. The chief value of the following prices is to show the difference for different lengths and qualities. In 1908, in the North Central States, prices were about as follows: White or burr oak, 6-inch top and 12-inch butt, 20 to 30 feet long, 16 to 18 cents per foot; same, 40 to 60 ft. long, 21 to 25 cents according to length. Long-leaf yellow pine, 40 to 60 ft. long, 18 to 23 cents; and short-leaf pine, 14 to 15 cents; other soft woods 1 to 2 cents per foot less.

731. Iron Piles. Cast-iron piles were formerly used to a limited extent in the prairie States for supports for highway bridges; but have been abandoned—largely because of the introduction of concrete for piles and as a substitute for stone masonry. The horizontal cross section was cruciform, lugs or flanges were cast on the sides of the piles to which to attach sway braces; and after being driven, a cap with a socket in its lower side was placed upon the pile to receive the load. The advantages claimed for cast-iron piles are: (1) they are not subject to decay; (2) they are more readily driven than wooden ones, especially in stony ground or stiff clay; and (3) they possess greater crushing strength, which, however, is an advantage only when the pile acts as a column (see § 771). The principal disadvantage is that they are deficient in transverse resistance to a suddenly applied force, which objection applies only to the handling of the piles before being driven and to such as are liable after being driven to sudden lateral blows, as from floating ice, logs, etc.

Wrought-iron and steel sections were used to a limited degree for piles for supporting highway bridges, but their use was discontinued in favor of massive concrete substructures.

732. Steel tubes have been used as bearing piles to a limited extent, chiefly in New York City. The diameter varies from 6 to 16 inches, the thickness from $\frac{1}{4}$ to $\frac{1}{2}$ inch, the length from 60 to 80 feet. The tubes are made in sections, the ends faced in a lathe, and

the sections screwed together. They are sunk with a pneumatic hammer, and the material is removed from the inside of the tube with a water jet. If bowlders or hard pan are encountered, a chopping drill is operated through the tube. After the pipe reaches the bed-rock, all the soil is removed from the inside of the tube, and reinforcing rods held apart by separators are placed inside, and then the tube is filled with cement mortar or rich concrete made of fine stone.

733. Screw Piles. Screw piles are employed chiefly in anchoring buoys and signal stations in marine surveying, in founding small lighthouses on a sandy sea-shore, for piers, etc.; and for supports for light bridges.*

The screw pile usually consists of a rolled-iron shaft, 3 to 10 inches in diameter, having at its foot one or two turns of a cast-iron screw, the blades of which may vary from $1\frac{1}{2}$ to 5 feet in diameter. The piles ordinarily employed for lighthouses exposed to moderate seas or to heavy fields of ice have a shaft 3 to 5 inches in diameter and blades 3 to 4 feet in diameter, the screw weighing from 600 to 700 pounds. For bridge piers, the shafts are from 6 to 10 inches and the blades from 4 to 5 feet in diameter, the screw weighing from 1,500 to 4,000 pounds.†

For founding beacons, etc., the screw pile has the special advantage of not being drawn out by the upward force of the waves against the superstructure. Even when all cohesion of the ground is destroyed in screwing down a pile, a conical mass, with its apex at the bottom of the pile and its base at the surface, would have to be lifted to draw the pile out. The supporting power also is considerable, owing to the increased bearing surface of the screw blade. Screw piles have, therefore, an advantage in soft soil. They could also be used advantageously in situations where the jar of driving ordinary piles might disturb the equilibrium of adjacent structures.

734. These piles are usually screwed into the soil by men working with capstan bars. Sometimes a rope is wound around the shaft and the two ends pulled in opposite directions by two capstans, and sometimes the screw is turned by attaching a large cog-wheel to the shaft by a friction-clutch, which is rotated by a worm-screw operated by a hand crank. Horse-power, steam, and hydraulic power have been used for this purpose.‡

The screw will penetrate most soils. It will pass through loose

* For illustrated accounts of the founding of a railroad bridge-pier upon screw piles, see *Engineering News*, vol. xiii, p. 210-12; vol. xxviii, p. 116.

† For illustrations and dimensions of screw piles for highway and interurban electric railways, see Cooper's Specifications for Foundations and Substructures of Highway and Electric Railway Bridges, Plate 12.

‡ For an illustrated description of a hydraulic pile screwing-machine, see *Engineering News*, vol. xlv, p. 90.

pebbles and stones without much difficulty, and push aside boulders of moderate size. Ordinary clay does not present much obstruction; but clean, dry sand gives the most difficulty. The danger of twisting off the shaft limits the depth to which they may be sunk. Screw piles with blades 4 feet in diameter have been screwed 40 feet into a mixture of clay and sand. The resistance to sinking increases very rapidly with the diameter of the screw; but under favorable circumstances an ordinary screw pile can be sunk very quickly. Screws 4 feet in diameter have, in less than two hours, been sunk by hand labor 20 feet in sand and clay, the surface of which was 20 feet below the water. For depths of 15 to 20 feet, an average of 4 to 8 feet per day is good work for wholly hand labor.

735. Disk Piles. These differ but little from screw piles, a flat disk, instead of a screw, being keyed or bolted on at the foot of the iron stem.* Disk piles are sunk by the water-jet (§ 757-59). One of the few cases in which they have been used in this country was in founding an ocean pier on Coney Island, near New York City. The shafts were wrought-iron, lap-welded tubes, 8½ inches outside diameter, in sections 12 to 20 feet long; the disks were 2 feet in diameter and 9 inches thick, and were fastened to the shaft by set-screws. Many of the piles were 57 feet long, of which 17 feet was in the sand.†

736. Concrete Piles. There are two general types of concrete piles—those that are moulded before driving, and those that are moulded in place.

737. Piles Moulded before Driving. The first type must be reinforced to permit of handling, and the reinforcement may be any of the forms used for reinforced concrete columns (see § 485).‡ Such piles may be driven with a drop hammer (§ 751-54) or a water jet (§ 757-59). In the former case, the pile is provided with a cast-iron point, and the top is provided with a cushioned head to prevent the crushing of the pile. If the pile is to be sunk by a water jet, either an iron pipe is set in the center of the concrete or a hole is moulded in the longitudinal center of the pile. One contractor makes longitudinal grooves on the exterior surface of his piles to give an outlet for the water when sunk by means of a jet and also to increase the surface exposed to friction. In this country concrete piles are moulded in either a horizontal or a vertical position, although in Europe the latter seems to be the custom. The progress can be

* For illustrations and dimensions of disk piles, see Cooper's Specifications for Foundations and Substructures of Highway and Electric Railway Bridges, Plate 11.

† For a detailed and illustrated description of this work, see an article by Charles Macdonald, in *Trans. Am. Soc. of C. E.*, vol. viii, p. 227-37.

‡ For an illustrated description of the method of moulding, reinforcing, and driving several forms of piles, see *Engineering News*, vol. li, p. 233-36.

inspected better when moulded in a horizontal position; but when moulded in the vertical position, any laminations are perpendicular to the load. Vertical moulding is the more expensive, but only a little more with suitable facilities.

738. The *Chenoweth concrete pile* is made by plastering a woven wire net with cement mortar or concrete and rolling the combination about a mandrel to form a cylinder. The mortar is mixed rather dry, but the rolling squeezes out part of the water and secures an intimate contact between the mortar and the reinforcement, thus making a dense and strong pile.

739. *Piles Moulded in Place.* There are several forms of concrete piles that are moulded in place, the three best-known being the Simplex, the Raymond, and the Pedestal—all of which are patented.

740. The *Simplex concrete pile* is formed by driving a heavy steel tube, 16 inches in diameter, having at the bottom either (1) an "alligator tip" or (2) a cast-iron or concrete point. The former is an automatic bottom which keeps closed while the tube is being driven, but which opens and allows concrete to pass through when the tube is drawn up. After the tube has been driven to the desired depth, it is drawn up about 2 feet, concrete enough to fill about 3 feet of the tube is deposited in the bottom by means of a bottom-dump cylindrical bucket, and the concrete is tamped with a hammer dropped through the tube. The tube is then raised again, and the above operation is repeated until the top of the concrete reaches the desired height. This pile may be reinforced by dropping into the casing any unit system of reinforcing.

The advantages claimed for this form of pile are: 1. The cylindrical form gives a large bearing upon the harder substratum. 2. The ramming of the concrete forces part of it into the soil, which enlarges the hole and still further consolidates the soil, and also increases the friction between the concrete and the sides of the hole. The disadvantage urged against this form is that the more fluid portions of the concrete are liable to be lost in a porous stratum of soil. This objection is sometimes eliminated by inserting a casing of sheet iron inside of the driving tube for a part or all of the depth.

741. The *Raymond concrete pile* is formed and placed as follows: A tapering shell of sheet iron (usually No. 20) is placed upon a collapsible steel core, and the two are driven with an ordinary pile driver. After the shell and core are driven, the core is collapsed and withdrawn; and then the shell is filled with concrete. The piles are made from 20 to 40 feet long, from 6 to 8 inches in diameter at the small end, and from 18 to 20 inches at the large end.

This pile may be reinforced by inserting reinforcement which is securely fastened together before being placed in the casing.

Notice that the taper is considerably greater than with wood piles, which the inventor claims is an advantage. An objection to this form of pile is that the thin shell is likely to be wholly or partially closed by the lateral pressure of the soil before it can be filled with concrete.

742. The *Pedestal concrete pile* is formed by driving together into the ground a cylindrical casing and a core 2 or 3 feet longer than the casing; and then the core is removed, concrete to the depth of 2 or 3 feet is deposited in the bottom of the casing, the core is driven into the casing, which compresses the concrete and forces it out into the soil below the casing. Concrete is added and rammed successively until the projecting part of the pile has any desired diameter, usually 2 or 3 feet; and then the casing is filled to the top with concrete, and finally the casing is withdrawn.

743. Concrete piles, both bearing and sheet, have been used to a considerable extent in Europe for foundations, wharves, quay walls, etc.; and are rapidly coming into use, particularly bearing piles, in this country.

744. *Cost of Concrete Piles.* The following is the cost of making and placing 172 Raymond concrete piles in Massachusetts in 1906, exclusive of interest, general expense, and the cost of moving the plant. The minimum length was 14 ft., the maximum 37 ft., and the average 20 ft. The piles were driven until the penetration produced by eight or ten blows was 1 inch.*

ITEMS.	COST PER FOOT.
Labor driving forms and placing concrete.....	\$0.16
Concrete material.....	0.123
Steel shell, 94 lb. at 3 cents.....	0.145
Coal, oil, etc.....	0.011
Total, exclusive of interest, general expense, etc.	\$0.439

745. **Concrete vs. Wood Piles.** Of course, when exposed to the air, or in sea-water infested with marine borers, concrete is much more durable than wood. In some cases concrete tops have been placed upon wooden piles to prevent the decay of the wood above the water line or to prevent the attack of sea worms above the ground line. Concrete piles cost more than wooden ones (see the next paragraph), and on account of their size will support a greater load, it being claimed that usually one concrete pile will support as much load as two or three wooden ones; but it is not always wise or possible to decrease the number of piles and proportionally increase the load on each. Concrete piles are superior to wooden ones for foundation

* *Engineering-Contracting*, vol. xxvii. p. 65.

work in that they need not be cut off below the water's surface, and hence the more expensive masonry structure need not start as low with concrete piles as with wooden ones.

The following exhibit shows the actual cost in 1904 of the concrete-pile foundations for the physics building of the United States Naval Academy at Annapolis, Md., and also the estimated cost of an equivalent wood-pile foundation.*

ITEMS.	CONCRETE PILES.	WOOD PILES.
Piles	855 at \$20.00 = \$17 100.00	2 193 at \$9.50 = \$20 835.50
Excavation, cu. yd. .	1 038 at .40 = 415.00	4 542 at .40 = 1 816.80
Concrete, cu. yd.	986 at 8.00 = 7 888.00	3 250 at 8.00 = 26 000.00
Steel I-beams, lb.	5 222 at .04 = 208.00
Shoring and pumping	4 000.00
Total.....	\$25 403.00	\$52 861.18

746. SHEET PILES. Sheet piles are piles with square edges driven successively edge to edge to form a vertical sheet for the purpose of preventing the soil from flowing into the foundation pit or of guarding a foundation against the undermining action of the water. Formerly

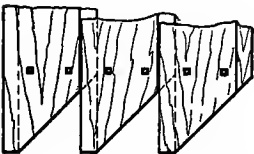
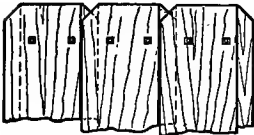
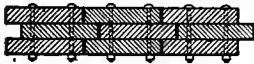

FIG. 85.—WAKEFIELD SHEET PILE.

sheet piles were always of wood, but recently both steel and concrete have been used.

747. Wood Sheet Piles. Ordinarily wood sheet piles are simply thick planks, sharpened and driven edge to edge. Sometimes a thinner plank is driven outside of the thick one to cover the joint and prevent leakage; and sometimes two rows of thick planks are driven. Sheet piles should be sharpened wholly, or at least mainly, from one side, and the long edge should be placed next to the pile already driven, to cause the piles to crowd together and make comparatively close joints.

Formerly, when greater strength was required than one or two thicknesses of plank, heavy sawed timbers were employed as sheet piles, wooden blocks or iron lugs being fastened on the edges to assist in guiding them into position, or a tongue and groove was formed by nailing two strips on the edges of one side of the pile and one strip in the middle of the other edge; but now the Wakefield pile is usually employed when a wood pile is used and when greater strength is required than is afforded by a single plank.

* The Inspector in Charge, in *Engineering Record*, vol. li, p. 277.

The Wakefield pile, the patent on which has expired, consists of three planks bolted or spiked together so as to form a tongue on one edge and a corresponding groove on the other. Fig. 85 shows a cross section of the Wakefield pile. The planks are usually 10 or 12 inches wide, and 10 to 16 feet long.

748. Steel Sheet Piles. Steel sheet piles were first used in 1902 at Chicago; but already a considerable number of forms have been pat-

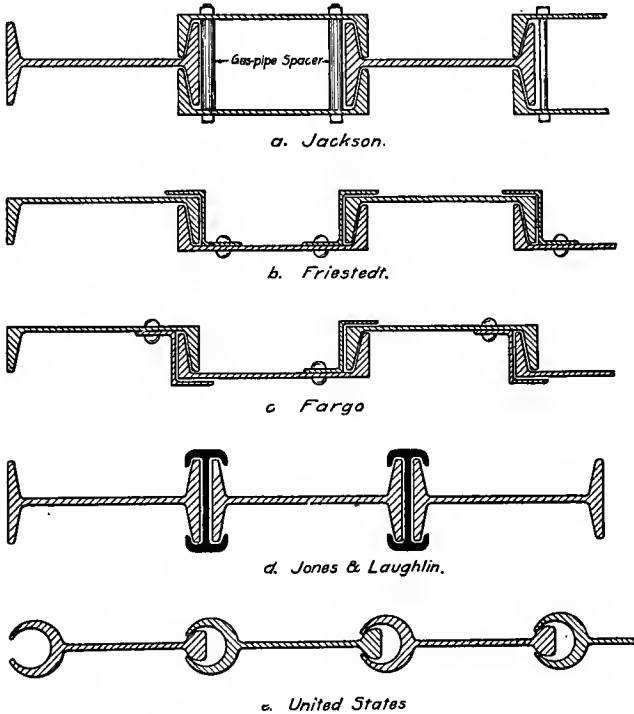

FIG. 86.—TYPICAL FORMS OF STEEL SHEET PILES.

ented. They may be divided into two general classes, viz.: those built up from standard structural shapes, and those consisting of special shapes. Fig. 86, shows several of each class. There are several other forms of the same general character as the last one in Fig. 86; but they are not in as general use. One patent consists of a clip to be riveted at intervals to I-beams, whereby a wall may be built by driving I-beams base to base; and a somewhat similar form consists of two separate locking devices one of which is placed on the bottom of the I-beam to be driven and one on the top of the I-beam already

driven. However, the interlocking steel piles are usually preferred as making a tighter wall.

Form *a*, Fig. 86, may be made of any size of channels and I-beams, although the 12-inch or the 15-inch are ordinarily used. With this form of pile, the space between the channels can be tamped full of clay and thus make the wall water-tight. Form *b* is made with two weights of 12-inch and also with two weights of 15-inch channels. There is another variety of this form in which there is an angle on each edge of the intermediate channel to form a calking joint, but such a joint is seldom necessary. Form *d* is made of a 12-inch I-beam and a 5-inch locking piece or a 15-inch I-beam and a 7-inch locking piece. Form *e* is made in three sizes—12-inch 40-pound, 12-inch 35-pound, and 6-inch 11-pound. With this form of pile a half-round wooden strip may be driven in the joint, which upon absorbing water expands and prevents leakage. It has been proposed to run grout into the interlock of sheet piles to prevent or stop leaks.

A great variety of forms of steel sheet piles has been proposed, the catalogue of one manufacturer showing twenty-seven different forms exclusive of special corner pieces; but the above are the forms in most common use, and are fairly representative.

By the use of special corner pieces, a right-angled corner can be turned with any of the steel sheet piling; and some of the regular forms can be used to inclose a comparatively small circular area. Steel sheet piles are ordinarily driven by allowing the pile hammer to strike directly against the end of the pile; but in hard driving a cast-iron or steel hood, into the under side of which fits the top end of the pile, is sometimes used. These hoods are furnished by the makers of the piles.

749. Steel sheet piles are superior to wooden ones in that they make tighter work, are easier to drive, may be used repeatedly, and some forms have nearly their original value as standard sections when no longer required as piles, and all forms have value as scrap when they can no longer be used as piles. Steel sheet piles are more easily pulled out than wooden ones, since a hook can readily be inserted in a hole near the top. Steel sheet piles require less bracing across the coffer-dam than wooden ones. Steel sheet piles may be spliced by driving one section on top of another; and, by varying the length of the members, a stout wall of almost any depth may be built. Most forms of steel sheet pile speedily become water-tight in muddy water; and usually all are easily made tight in clear water by throwing sawdust, paper pulp, manure, etc., near a leak.

In selecting a type form of steel sheet pile, attention should be given to the clearance between the members and also to the lateral stiffness of the pile. To secure tightness the clearance should be as

small as possible, but too little clearance makes trouble in driving, owing to kinks and bends in the members. Lateral stiffness is important in hard driving; and depends upon the cross section of the pile.

Some forms of steel piling are provided with cast-iron points to facilitate driving in hard or stony ground; but usually the pile is driven without sharpening or without a shoe.

ART. 2. PILE DRIVING.

750. PILE-DRIVING MACHINES. Pile-driving machines may be classified according to the character of the driving power, which may be (1) a falling weight, (2) the force of an explosive, or (3) the erosive action of a jet of water. Piles are sometimes set in holes bored with a well-auger, and the earth rammed around them. This is quite common in the construction of small highway bridges in the prairie States, a 10- or a 12-inch auger being generally used. The various pile-driving machines will now be briefly described and compared.

751. Drop-hammer Pile-driver. The usual method of driving piles is by a succession of blows given with a heavy block of wood or iron—called a ram, monkey, or hammer—which is carried by a rope or cable passing over a pulley fixed at the top of an upright frame and allowed to fall freely on the head of the pile. The machine for doing this is called a drop-hammer pile-driver, or a monkey pile-driver—usually the former. The machine is generally placed upon a car or a scow.

The frame consists of two uprights, called *leaders*, from 10 to 60 feet long, placed about 2 feet apart, which guide the falling weight in its descent. The leaders are either wooden beams or iron channel-beams, usually the former. The hammer is generally a mass of iron weighing from 500 to 4,000 pounds (usually about 2,000) with grooves in its sides to fit the guides and a staple in the top by which it is raised. The rope employed in raising the hammer is usually wound up by a steam engine placed on the end of the scow or car, opposite the leaders.

A car pile-driver is made especially for railroad work, the leaders resting upon an auxiliary frame, by which piles may be driven 14 to 16 feet in advance of the end of the track; and the frame is pivoted so that piles may be driven on either side of the track. This method of pivoting the frame carrying the leaders is also sometimes applied to a machine used in driving piles for foundations.

In railroad construction, it is not possible to use the pile-driving car with its steam engine in advance of the track; hence, in this

kind of work, the leaders are often set on blocking and the hammer is raised by horses hitched directly to the end of the rope. Portable engines also are sometimes used for this purpose. Occasionally the weight is raised by men with a windlass, or by pulling directly on the rope.

A machine used for driving sheet piles differs from that described above in one particular, viz.: it has but one leader, in front of which the hammer moves up and down. With this construction, the machine can be brought close up to the wall of a coffer-dam (§ 718 and § 804), and the pile already driven does not interfere with the driving of the next one.

752. There are two methods of detaching the weight, i.e., of letting the hammer fall: (1) by a nipper, and (2) by a friction-clutch.

1. The *nipper* consists of a block which slides freely between the leaders and which carries a pair of hooks, or tongs, projecting from its lower side. The tongs are so arranged that when lowered onto the top of the hammer they automatically catch in the staple in the top of the hammer, and hold it while it is being lifted, until they are disengaged by the upper ends of the arms striking a pair of inclined surfaces in another block, the *trip*, which may be placed between the leaders at any elevation, according to the height of fall desired.

With this form of machine, the method of operation is as follows: The pile being in place, with the hammer resting on the head of it and the tongs being hooked into the staple in the top of the hammer, the rope is wound up until the upper ends of the tongs strike the trip, which disengages the tongs and lets the hammer fall. As the hoisting rope is unwound the nipper block follows the hammer, and, on reaching it, the tongs automatically catch in the staple, and the preceding operations may be repeated. This method is objectionable owing to the length of time required (*a*) for the nipper to descend after the hammer has been dropped, and (*b*) to move the trip when the height of fall is changed. Some manufacturers of pile-driving machinery remove the last objection by making an adjustable trip which is raised and lowered by a light line passing over the top of the leaders. This is a valuable improvement.

When the rope is wound up by steam, the maximum speed is from 6 to 14 blows per minute, depending upon the distance the hammer falls. The speed can not be increased by the skill of the operator, although it could be by making the nipper block heavier.

2. The method by using a *friction-clutch*, or friction-drum, as it is often called, consists in attaching the rope permanently to the staple in the top of the hammer, and dropping the hammer by setting free the winding drum by the use of a friction-clutch. The advan-

tages of this method are (a) that the hammer can be dropped from any height, thus securing a light or heavy blow at pleasure; and (b) that no time is lost in waiting for the nipper to descend or in adjusting the trip.

When the rope is wound up by steam, the speed is from 20 to 30 blows per minute, but is largely dependent upon the skill of the man who controls the friction-clutch. The hammer is caught on the rebound, is elevated very rapidly, and hence the absolute maximum speed is attained. The rope, by which the hammer is elevated, retards the falling weight; and hence, for an equal effect, this form requires a heavier hammer than when the nipper is used. Although the friction-drum pile-driver is much more efficient, it is not as generally used as the nipper driver. The former is a little more expensive in first cost.

753. Steam-hammer Pile-driver. As regards frequency of use, the next machine is probably the steam-hammer pile-driver. It consists essentially of a steam cylinder (stroke about 3 feet), the piston-rod of which carries a striking weight of 3,000 to 5,000 pounds. The steam-cylinder is fastened to and between the tops of two I-beams about 8 to 10 feet long, the beams being united at the bottom by a piece of iron in the shape of a frustum of a cone, which has a hole through it. The under side of this connecting piece is cut out so as to fit the top of the pile. The striking weight, which works up and down between the two I-beams as guides, has a cylindrical projection on the bottom which passes through the hole in the piece connecting the feet of the guides and strikes the hammer. The steam to operate the hammer is conveyed from the boiler through a flexible tube. Fig. 87 shows one of the latest forms of steam-hammer.

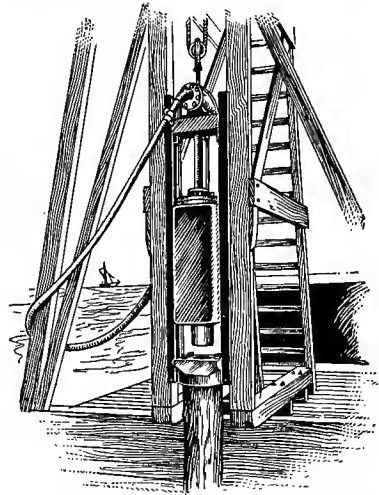

FIG. 87.—STEAM-HAMMER PILE-DRIVER.

The whole mechanism can be raised and lowered by a rope passing over a pulley in the top of the leaders. After a pile has been placed in position for driving, the machine is lowered upon the top of it and entirely let go, the pile being its only support. When steam is admitted below the piston, it rises, carrying the striking weight with

it, until it strikes a trip (on the back side of the hammer), which cuts off the steam, and the hammer of the newer form descends under its own weight and the pressure of the steam. At the end of the down stroke the valves are again automatically reversed, and the stroke repeated. By altering the adjustment of this trip-piece, the length of stroke (and thus the force of the blows) can be increased or diminished. The admission and escape of steam to and from the cylinder can also be controlled directly by the attendant, and the number of blows per minute is increased or diminished by regulating the supply of steam. The machine can give 60 to 80 blows per minute.

754. Drop-hammer vs. Steam-hammer. The drop-hammer is capable of driving the pile against the greater resistance. The maximum fall of the drop-hammer is 40 or 50 feet, while that of the steam-hammer is about 3 feet. The drop-hammer ordinarily weighs about 1 ton, while the striking weight of the steam-hammer usually weighs about $1\frac{1}{2}$ tons. The energy of the maximum blow of the drop-hammer is 45 foot-tons ($= 45 \text{ ft.} \times 1 \text{ ton}$), and the energy of the maximum blow of the steam-hammer is 4.5 foot-tons ($= 3 \text{ ft.} \times 1\frac{1}{2} \text{ tons}$). The energy of the maximum blow of the drop-hammer is, therefore, about 10 times that of the steam-hammer.

However, the effectiveness of a blow does not depend alone upon its energy. A considerable part of the energy is invariably lost by the compression of the materials of the striking surfaces, and the greater the velocity the greater this loss. An extreme illustration of this would be trying to drive piles by shooting rifle-bullets at them. A 1-ton hammer falling 45 ft. has 10 times the energy of a $1\frac{1}{2}$ -ton hammer falling 3 ft., but in striking, a far larger part of the former than of the latter is lost by the compression of the pile head. In constructing the foundation of the Brooklyn dry-dock, it was practically demonstrated that "there was little, if any, gain in having the fall more than 45 feet." The loss due to the compression depends upon the material of the pile, and whether the head of it is bruised or not. The drop-hammer, using the pile-hood and the friction-drum, can drive a pile against a considerably harder resistance than the steam-hammer.

It is frequently claimed that the steam-hammer can drive a pile against a greater resistance than the drop-hammer. As compared with the old style drop-hammer, i.e., without the friction-drum and the pile-hood, this is probably true. The striking of the weight upon the head of the pile splits and brooms it very much, which materially diminishes the effectiveness of the blow (for an example, see Table 64, page 390). In hard driving with the drop-hammer, without the pile-hood, the heads of the piles, even when hooped, will crush, bulge out, and frequently split for many feet below the hoop. For this

reason, it is sometimes specified that piles shall not be driven with a drop-hammer.

The rapidity of the blows is an important item as affecting the efficiency of a pile-driver. If the blows are delivered rapidly, the soil does not have sufficient time to recompact itself about the pile. With the steam-driver the blows are delivered in such quick succession that it is probable that a second blow is delivered before the pile has recovered from the distortion produced by the first, which materially increases the effectiveness of the second blow. In this respect the steam-hammer is superior to the drop-hammer, and the friction-clutch driver is superior to the nipper driver.

In soft soils, the steam-hammer drives piles faster than either form of the drop-hammer, since after being placed in position on the head of the pile it pounds away without the loss of any time.

755. In a rough way the first cost of the two drivers—exclusive of scow or car, hoisting engine, and boiler, which are the same in each—is about \$80 for the drop-hammer driver, and about \$800 for the steam-driver. Of course these prices will vary greatly. The per cent for wear and tear is greater for the drop-hammer than for the steam-hammer. For work at a distance from a machine-shop the steam-driver is more liable to cause delays, owing to breakage of some part which can not readily be repaired.

756. Driving Piles with Dynamite. Occasionally piles are driven by exploding dynamite placed directly upon the top of the pile. It is a slow method, but might prove valuable where only a few piles were to be driven, by saving the transportation of a machine; or it might be employed in locations where a machine could not be operated. The higher grades of dynamite are most suitable for this purpose.

757. Driving Piles with Water Jet. Although the water jet is not strictly a pile-driving machine, the method of sinking piles by its use deserves careful attention, because it is often the cheapest and sometimes the only means by which piles can be sunk in mud, silt, or sand.

The method is very simple. A jet of water is forced into the soil just below the point of the pile, thus loosening the soil and allowing the pile to sink, either by its own weight or with very light blows. The water may be conveyed to the point of the pile through a flexible hose held in place by staples driven into the pile; and after the pile is sunk, the hose may be withdrawn for use again. An iron pipe may be substituted for the hose. It seems to make very little difference, either in the rapidity of the sinking or in the accuracy with which the pile preserves its position, whether the nozzle is exactly under the middle of the pile or not.

The water jet seems to have been first used in engineering in 1852, at the suggestion of General Geo. B. McClellan. It has been extensively employed on the sandy shores of the Gulf and South Atlantic States, where the compactness of the sand makes it difficult to drive piles for foundations for lighthouses, wharves, etc. Another reason for its use in that section is that the palmetto piles—the only ones that will resist the ravages of the teredo—are too soft to withstand the blows of the drop-hammer pile-driver. By employing the water jet the necessity for the use of the pile-hammer is removed, and consequently palmetto piles become available. The jet has also been employed in a great variety of ways to facilitate the passage of common piles, screw and disk piles, cylinders, caissons, etc., through earthly material; and also to loosen the soil around piles preparatory to pulling them out.

758. The efficiency of the jet depends upon the increased fluidity given to the material into which the piles are sunk, the actual displacement of material being small. Hence the efficiency of the jet is greatest in clear sand, mud, or soft clay; in gravel, or in sand containing a large percentage of gravel, or in hard clay, the jet is almost useless. For these reasons the engine, pump, hose, and nozzle should be arranged to deliver large quantities of water with a moderate force, rather than smaller quantities with high initial velocity. In gravel, or in sand containing considerable gravel, some benefit might result from a velocity sufficient to displace the pebbles and drive them from the vicinity of the pile; but it is evident that any practicable velocity would be powerless in gravel, except for a very limited depth, or where circumstances favored the prompt removal of the pebbles.

The error most frequently made in the application of the water jet is in using pumps with insufficient capacity. Both direct-acting and centrifugal pumps are frequently employed. The former affords the greater power; but the latter has the advantage of a less first cost, and of not being damaged as greatly by sand in the water used.

The pumping plant used in sinking the disk-piles for the Coney Island pier (see § 735), "consisted of a Worthington pump with a 12-inch steam cylinder, 8½-inch stroke, and a water cylinder 7½ inches in diameter. The suction hose was 4 inches in diameter; and the discharge hose, which was of four-ply gum, was 3 inches. The boiler was upright, 42 inches in diameter, 8 feet high, and contained 62 tubes 2 inches in diameter. An abundance of steam was supplied by the boiler, after the exhaust had been turned into the smoke-stack and soft coal used as fuel. An average of about 160 pounds of coal was consumed in sinking each pile. With the power above described, it was found that piles could be driven in clear sand

at the rate of 3 feet per minute to a depth of 12 feet; after which the rate of progress gradually diminished, until at 18 feet a limit was reached beyond which it was not practicable to go without considerable loss of time. It frequently happened that the pile would 'bring up' on some tenacious material which was assumed to be clay, and through which the water jet, unaided, could not be made to force a passage. In such cases it was found that by raising the pile about 6 inches and allowing it to drop suddenly, with the jet still in operation, and repeating as rapidly as possible, the obstruction was finally overcome; although in some instances five or six hours were consumed in sinking as many feet."*

759. Jet vs. Hammer. It is hardly possible to make a comparison between a water-jet and a hammer pile-driver, as the conditions most favorable for each are directly opposite. For example, sand yields easily to the jet, but offers great resistance to driving with the hammer; on the other hand, in stiff clay the hammer is much more expeditious. For inland work the hammer is better, owing to the difficulty of obtaining the large quantities of water required for the jet; but for river and harbor work the jet is the most advantageous. Under equally favorable conditions there is little or no difference in cost or speed of the two methods.

The jet and the hammer are often advantageously used together, especially in stiff clay. The efficiency of the water jet can be greatly increased by bringing the weight of the pontoon, upon which the machinery is placed, to bear upon the pile by means of a block and tackle.

760. COST OF DRIVING BEARING PILES. There are a number of items which materially affect the cost of pile driving, which it is impossible to include in a brief summary, but which must not be forgotten in using such data in making estimates. Among these items are: the closeness to the driver of the place of delivery of the piles, the facilities for handling the piles, the length of the piles, the hardness of the driving, the accuracy of the required position of the pile, the number driven, the distance apart, etc.

761. Railroad Construction. The following is a summary of the cost, to the contractor, of labor in driving piles (exclusive of hauling) in the construction of the Chicago branch of the Atchison, Topeka and Santa Fé R. R. The piles were driven, ahead of the track, with a horse-power drop-hammer weighing 2,200 pounds. The average depth driven was 13 feet. The table includes the cost of driving piles for abutments for Howe truss bridges and for the false work for the erection of the same. These two items add considerably to the average cost. The contractor received the same

* Chas. Macdonald, in *Trans. Am. Soc. of C. E.*, vol. viii, p. 227-37.

price for all classes of work. The work was as varied as such jobs usually are, piles being driven in all kinds of soil. Owing to the large amount of railroad work in progress in 1887, the cost of material and labor was about 10 per cent higher than the average of the year before and after. Cost of labor on pile-driver: 1 foreman at \$4 per day, 6 laborers at \$2, 2 teams at \$3.50; total cost of labor = \$23 per day.

COST OF PILE DRIVING IN RAILROAD CONSTRUCTION.

Number of piles included in this report.....	4 409
“ “ lineal feet included in this report	109 568
Average length of piles, in feet	24.8
Number of days employed in driving	494
“ “ lineal feet driven per day	221.8
Cost of driving, per pile	\$2.53
“ “ “ “ foot	10.4 cts.

762. Bridge Repairs. In Table 62 are the data of pile driving for repairs to bridges on the Indianapolis, Decatur and Springfield R. R. The work was done from December 21, 1885, to January 5, 1886. The piles varied from 12 to 32 feet in length, the average being a little over 21 feet. The average distance driven was about 10 feet. The hammer weighed 1,650 pounds; the last fall was 37 feet, and the corresponding penetration did not exceed 2 inches. The hammer was raised by a rope attached to the draw-bar of a locomotive—comparatively a very expensive way.

TABLE 62.

COST OF PILES FOR BRIDGE REPAIRS.

ITEMS OF EXPENSE.	TOTAL.	PER PILE.	PER FOOT.
<i>Labor:</i>			
Loading and unloading piles 7½ days	\$16.00	\$0.08	0.4 cts.
Bridge gang, driving, 12 days	153.75	0.78	3.7
Engine crew, transportation and driv'g, 13 days	45.90	0.23	1.1
Train crew, transportation and driving, 13 days	71.50	0.37	1.6
<i>Supplies:</i>			
Engine supplies	23.49	0.13	0.5
6 pile rings and 2 plates.....	13.29	0.06	0.3
Repairs	11.04	0.05	0.3
<i>Total expense for driving</i>	<i>\$334.97</i>	<i>\$1.70</i>	<i>7.9 cts.</i>
<i>Material:</i>			
4,191 feet oak piles at 13½ cts.....	\$565.92	\$2.86	13.5 cts.
TOTAL COST.....	\$900.89	\$4.56	21.4 cts.

On the same road, 9 piles, each 20 feet long, were driven 9 feet, for bumping-posts, with a 1,650-pound hammer dropping 17 feet. The hammer was raised with an ordinary crab-winch and single line, with double crank worked by four men. The cost for labor was 8.3 cents per foot of pile, and the total expense was 21.8 cents per foot.

763. Bridge Construction. Table 63 gives the cost of labor in driving the piles for the Northern Pacific R. R. bridge over the Red River, at Grand Forks, N. Dakota, constructed in 1887. The soil was sand and clay. The penetration under a 2,250-pound hammer falling 30 feet was from 2 to 4 inches. The foreman received \$5 per day, the stationary engineer \$3.50, and laborers \$2.

TABLE 63.

COST OF LABOR IN DRIVING PILES IN BRIDGE CONSTRUCTION.

KIND OF LABOR.	PILE BRIDGE ON LAND.	TEMPORARY BRIDGE.	DRAW FENDER AND ICE BREAKER.	PIVOT PIER.	RIVER PIER.
Preparation and repair of plant...	\$68.95	\$63.65	\$53.50	\$37.00	\$61.60
Driving.....	432.70	252.92	430.50	215.45	565.80
Sawing and straightening.....	78.75	47.50	179.80*	131.90†
Total cost.....	\$580.40	\$316.57	\$531.50	\$432.25	\$759.30
Number of piles in the structure..	224	102	104	121	167
Total number of feet remaining in the structure.....	7 238	3 710	7 023	4 639	7 316
Average length of piles remaining in the structure.....	32.3	38.2	38.4	43.8
Average length of piles cut off ...	1.1	4.1	6.6	3.7
Cost per foot of pile remaining in the structure.....	8.0 cts.	8.5 cts.	7.6 cts.	9.3 cts.	10.4 cts.
Average cost for driving per foot remaining in the structure = 8.8 cents.					

* Sawed off under 8 feet of water.

† Including \$70.25 for excavating and bailing in order to get at the sawing.

764. On the Chicago and Eastern Illinois Railroad in 1902 the cost of driving piles on sixteen jobs ranged between 10.7 and 2.4 cents per ft., the average being 4.4 cents. There were 436 piles driven, the average number per job being 27. The shortest pile was 14 ft., and the longest was 42 ft., the average being 24.2 ft. The greatest number in any one job was 74 and the smallest 8. The pile-driver was self-propelling. All the men with driver were com-

mon laborers except the foreman, the engineman, and the fireman. The engineman received \$2.50 per day, and the fireman \$1.50.*

765. Foundation Piles. The contract price for the foundation piles—white oak—for the railroad bridge over the Missouri River, at Sibley, Mo., was 22 cents per foot for the piles and 28 cents per foot for driving and sawing off below water. They were 50 feet long, and were driven in sand and gravel, in a coffer-dam 16 feet deep, by a drop-hammer weighing 3,203 pounds, falling 36 feet. The hammer was raised by steam power.

766. The average cost of excavation and driving piles for bridge abutments in connection with track elevation in Chicago by a railroad for the year 1907, is as follows:

ITEM.	PER CU. YD.
EXCAVATION, 3 675 cu. yd.:	
<i>Labor:</i> Removing earth	\$1.367
Shoring020
Pumping054
Cutting off piles.....	.034
Engine service005
Total for labor	\$1.480
<i>Material:</i> Sheet piling109
Total for excavation	\$1.589
 PILE DRIVING, 27 552 lin. feet:	
<i>Labor:</i> Driving	0.032
Handling	0.007
Equipment	0.006
Engine service	0.033
Total for labor	\$0.078
<i>Material:</i> Cost of piles	0.095
Total for piles in place	\$0.173

For similar data for the same road for retaining walls, see Table 79, page 533.

767. Harbor and River Work. In the shore-protection work at Chicago, done in 1882 by the Illinois Central R. R., a crew of 9 men, at a daily expense, for labor, of \$17.25, averaged 65 piles per 10 hours in water 7 feet deep, the piles being 24 feet long and being driven 14 feet into the sand. The cost for labor of handling, sharpening, and driving, was a little over 26 cents per pile, or 1.9 cents per foot

* Report of 1902 convention of Association of Railway Superintendents of Bridges and Buildings.

of distance driven, or 1.1 cents per foot of pile.* Both steam-hammers and water jets were used, but not together. Notice that this is very cheap, owing (1) to the use of the jet, (2) to little loss of time in moving the driver and getting the pile exactly in the pre-determined place, (3) to the piles not being sawed off, and (4) to the skill gained by the workmen in a long job.

On the Mississippi River, under the direction of the U. S. Army engineers, the cost in 1882 for labor for handling, sharpening, and driving, was \$3.11 per pile, or 20 cents per foot driven. The piles were 35 feet long, the depth of water 15.5 feet, and the depth driven 13.6 feet. The water jet and drop-hammer were used together. The large cost was due, in part at least, to the current, which was from 3 to 6 miles per hour.†

768. COST OF DRIVING SHEET PILES. The cost of driving sheet piles differs considerably from that of bearing piles,—on the one hand because the former is usually driven in softer ground, which tends to make the cost less; and on the other hand, because the former must be fitted together, which tends to make the cost more.

769. Steel Pile. The cost of driving 130 United States steel sheet piles 11½ feet into coarse sand and gravel in constructing a coffer-dam for a bridge pier was 7.2 cents per ft.; and the cost of pulling the same was 4.0 cents per ft. These costs include a charge for fuel, the use of machinery, etc., and also the cost of straightening piles that were bent or warped in driving; but does not include general oversight by the contractor. The wages of common laborers varied from 17½ to 20 cents per hour; and enginemen and derrickmen received 22½ cents per hour.‡

In Chicago the cost of driving 156 pieces of United States sheet piling, each 16 ft. long, 14 ft. below water which was 3 to 6 ft. deep, into coarse gravel ranging in size from ¼ to 8 inches in diameter, was 42.5 cents per piece, exclusive of fuel, rental of plant, braces, and waling.¶

ART. 3. BEARING POWER OF PILES.

770. Two cases must be distinguished: that of columnar piles or those whose lower end rests upon a hard stratum, and that of ordinary bearing piles or those whose supporting power is due to the friction of the earth on the sides of the pile. In the first case, the bearing power is limited by the strength of the pile considered as a column.

* Report of the Chief of Engineers, U. S. A., for 1883, p. 1266-70.

† *Ibid.*, p. 1260.

‡ *Engineering-Contracting*, vol. xxv, p. 132.

¶ *Ibid.*, p. 157.

771. BEARING POWER OF COLUMN PILES. It is seldom, if ever, necessary to consider foundation piles as acting as a column, since the surrounding earth prevents lateral deflection, at least to a considerable degree; and hence the supporting power of such a pile will usually approximate the crushing strength of the timber. If a considerable portion of a pile is exposed to the air, it is likely to be braced so as to have sufficient lateral stiffness to develop the supporting power of the soil, and hence usually such piles need not be considered as columns. But if a pile is driven through a considerable depth of water, the supporting power of the pile may be limited by its strength as a column, particularly if the upper portion of the soil into which it is driven is soft and gives but little lateral support. Such a pile acts as a column fixed at the base and free at the top. The ultimate bearing power of such a column is

$$P = 9 \pi^2 E I \div 4 l^2$$

in which P is the ultimate load, E the coefficient of elasticity, I the moment of inertia of the cross section, and l the unsupported length. If the diameter is 12 inches or less, and the free length (the length from the top to the point where the pile is firmly held by the lateral support of the soil) is more than 25 or 30 feet, the ultimate load by the above formula may be less than the load often placed upon piles. The safe buckling strength of a pile is only a fractional part of the value given by the above formula; and hence the conclusion is that if a pile is to have any considerable unsupported length, it should be tested by the above formula to determine its buckling strength.

The safe end bearing-power of wood varies from 1,200 to 1,600 lb. per sq. in., and hence the safe crushing strength of a pile in pounds from 900 to 1,250 *multiplied by* the square of the diameter of the pile in inches.

772. BEARING POWER OF FRICTION PILES. There are two general methods of determining the supporting power of ordinary bearing piles: (1) by considering the relation between the supporting power and the length and the size of the pile, the weight of the hammer, the height of fall, and the distance the pile was moved by the last blow; or (2) by applying a load or direct pressure to each of a number of piles, observing the amount each will support, and expressing the result in terms of the depth driven, size of pile, and kind of soil. The first method is applicable only to piles driven by the impact of a hammer; the second is applicable to any pile, no matter how driven.

1. If the relation between the supporting power and the length and size of pile, the weight of the hammer, the height of fall, and the distance the pile was moved by the last blow can be stated in a

formula, the supporting power of a pile can be found by inserting these quantities in the formula and solving it. The relation between these quantities must be determined from a consideration of the theoretical conditions involved, and hence such a formula is a *rational formula*.

2. By applying the second method to piles under all the conditions likely to occur in practice, and noting the load supported, the kind of soil, the amount of surface of pile in contact with the soil, etc., data could be collected by which to determine the supporting power of any pile. A formula expressing the supporting power in terms of these quantities is an *empirical formula*.

773. Rational Formulas. Many attempts have been made to express the relation between the supporting power of a pile and the weight of the hammer, the height of the fall, and the penetration; but, owing to the uncertainty of the data involved, it is doubtful whether any theoretical formula can be deduced which will be of any practical value. Among the uncertain elements in the problem of deducing a rational formula are the following:

1. There is no way of determining the amount of energy lost by the friction of the hammer against the air and the guides. The per cent of loss will vary with the weight of the hammer, the height of fall, and the fit and the lubrication of the guides. It has been proved practically that there is no gain in effectiveness by making the height of fall more than 40 or 45 feet; and part of the greater loss with the high fall of the hammer is doubtless due to friction against the air and the guides.

2. With a friction-clutch pile driver, the drag of the rope materially retards the fall of the hammer, and under ordinary conditions decreases the effectiveness of the blow from $\frac{1}{4}$ to $\frac{1}{3}$; but there is no way of determining this effect except by trial for each particular case, and hence this factor can not be included in a general formula.

3. Only a portion of the energy in the descending hammer when it strikes the head of the pile, is used in actually driving the pile into the ground; and there is no way of determining how much of this is lost in the elastic compression of the hammer and of the pile. In hard driving considerable energy is thus consumed, as is shown by the rebound of the hammer from the head of the pile. Owing to this bouncing, the energy in the hammer is employed in striking several light blows instead of a single heavy one. There is doubtless some loss from this cause even though there is no visible bouncing; and in any case, the loss will vary with the weight and form of the hammer, the height of the fall, the length, diameter, and material of the pile, and the hardness of the driving. The loss due to the elastic compression of the pile also depends upon whether the resistance to

driving is chiefly friction on the sides of the pile or resistance to penetration at the foot of the pile; for if it is the former, the compressing force upon the pile is a maximum at the head and zero at the foot of the pile, while if it is the latter the compressive force is uniform over the entire length of the pile. As illustrating the possible value of this element, mention may be made that in driving the piles for the public library in Chicago it was claimed to have been proved that a blow directly upon a pile 54 feet long having an average diameter of 13 inches driven 52 feet into a uniform bed of soft clay was twice as effective as when an oak follower (a stick probably 8 to 10 inches in diameter and 6 feet long) was used, whether the hammer was a steam one or a drop hammer.*

4. Some energy is usually consumed in crushing or brooming the head of the pile; and in hard driving this loss is very great. It is impossible to compute the amount of this loss; but Table 64 shows in a striking way the difference in effectiveness of a blow

TABLE 64.

EFFECT OF BROOMING UPON THE PENETRATION OF A PILE.†

3d foot of penetration required.....	5 blows.
4th " " " "	15 "
5th " " " "	20 "
6th " " " "	29 "
7th " " " "	35 "
8th " " " "	46 "
9th " " " "	61 "
10th " " " "	73 "
11th " " " "	109 "
12th " " " "	153 "
13th " " " "	257 "
14th " " " "	684 "
Head of the pile adzed off.	
15th foot of penetration required.....	275 "
16th " " " "	572 "
17th " " " "	832 "
18th " " " "	825 "
Head of the pile adzed off.	
19th foot of penetration required.....	213 "
20th " " " "	275 "
21st " " " "	371 "
22d " " " "	378 "
<hr/>	
Total number of blows.....	5 228

* *Engineering News*, vol. xxx, p. 3.† *Trans. Am. Soc. C. E.*, vol. xii, p. 442.

upon comparatively sound wood and upon wood that is badly bruised. The pile was green Norway pine, and it was driven with a steam hammer, the ram of which weighed 2,800 pounds. Notice that the average penetration per blow was $2\frac{1}{2}$ times greater during the 15th foot than during the 14th; and nearly 4 times greater in the 19th than in the 18th. It does not seem unreasonable to believe that the first blows after adzing off the head were correspondingly more effective than the later ones; consequently, it is probable that the first blows for the 15th foot of penetration were more than 5 times as efficient as the last ones for the 14th foot, and also that the first blows for the 19th foot were 8 or 10 times more efficient than the last ones for the 18th foot. Notice also that since the head was only "adzed off," it is highly probable that the spongy wood was not entirely removed; and therefore if the blow had been struck upon really sound wood, the useful effect would have been very much greater. The amount of brooming is greater with a drop hammer than with the steam hammer, and will vary with the weight of the hammer, the height of the fall, the diameter of the pile, and the hardness of the driving.

5. There is no way of determining how much energy is consumed in overcoming the inertia of the pile and of the soil at the point of the pile. During the first stage of the blow this inertia has a retarding effect, but during the last stage it tends to increase the penetration; but we can know nothing about either the relative or the absolute amounts of these two effects.

774. The uncertainties in some of the above cases could be reduced somewhat by deducing a formula for a particular case, as for example a fixed height of fall; but such limitations would greatly detract from the value of such a formula, and at best some of the sources of error mentioned could not thus be eliminated. Therefore, most, if not all, engineers are agreed that a rational pile-driving formula is impracticable.

Not only are the usual theoretical formulas for the bearing power of a pile uncertain, but they are inapplicable to concrete piles or to piles sunk with a water jet. Such formulas are inapplicable to concrete piles owing to the uncertainty as to the energy consumed by the cushion driving-head; and obviously a formula involving the weight of a hammer can not be applied to piles sunk with the water jet, since no hammer is used.

In former editions of this volume the author made an attempt to deduce a rational pile-driving formula. For the most elaborate and a very able attempt to establish a rational formula for bearing power of piles, see an article by E. P. Goodrich, in *Transactions of American Society of Civil Engineers*, Vol. XLVIII, pages 150-219.

Incidentally the writer of that paper reviews the principal rational formulas for bearing power of piles.

775. Empirical Formulas. Numerous empirical formulas have been proposed for the bearing power of piles, several of which claim to be "deduced from experiments"; but in former editions of this volume the author showed that nearly all of them were so defective as to be useless, either because they were of the wrong form, or because the constants were incorrectly determined, or because the limits of the experiments from which they were deduced made them inapplicable to practical pile driving.

Of all the empirical formulas proposed practically only one—the *Engineering News* formula—is used by American engineers.

776. *Engineering News* Formula. This formula was proposed in 1888 by A. M. Wellington, editor of *Engineering News*, and is occasionally referred to as Wellington's formula. For a pile driven with a *drop* hammer, the formula is

$$P = \frac{2 W h}{s + 1} \quad \dots \dots \dots (1)$$

in which P is the *safe* load in pounds, W the weight of the hammer in pounds, h the fall of the hammer in *feet*, and s the penetration or sinking in *inches*, under the last blow, assumed to be sensible and at an approximately uniform rate. The sinking, s , must be measured only when there is no visible rebound of the hammer and only when the last blow is struck upon practically sound wood. This formula is supposed to give a factor of safety of six; and is also claimed to be safe, for ordinary weights of hammer and the usual height of fall.

The form to use for a pile driven with a single-acting steam hammer is

$$P = \frac{2 W h}{s + 0.1} \quad \dots \dots \dots (2)$$

The form to use for a pile driven with a double-acting steam hammer is

$$P = \frac{2 h (W + a p)}{s + 0.1} \quad \dots \dots \dots (3)$$

in which a is the effective area of the piston in square inches, and p the mean effective steam pressure in pounds per square inch.

777. The above formulas are based upon the relation $Ps = 12 W h$. This equation would be strictly true if none of the energy of the descending weight were lost; but as there is always considerable loss, the proposer of the formula assumed that the use of a factor of safety of 6 would be sufficient to cover the effect of such loss. If the denominator of either of the above formulas contained s alone, then the formula would give an infinite bearing power when $s = 0$; and hence to eliminate this absurdity, the denominator of the formula

for a drop-hammer pile-driver was made $s + 1$ and that for the steam hammer $s + 0.1$.

The reliability of the formula can be judged somewhat by an inspection of Table 65, page 394. The record of the first eight experiments is taken from an article in Transactions of American Society of Civil Engineers, Vol. xxvii, pages 146-60; and the last four from *Engineering Record*, Vol. xliii, page 450. The first reference contains partial details of four tests not included in Table 65, and also gives the particulars of the power required to pull each of five other piles.

Unfortunately the data are not as full as is necessary for a reliable test of the formula. In most of the cases nothing is said as to the length of time which elapsed between the driving and the loading of the pile,—a factor that often has a very marked effect upon the bearing power (see the first paragraph of § 778). Further, the condition of the head of the pile when the test blow was struck is not stated in any of the cases, which also is an important factor (see Table 64, page 390).

On account of the lack of information on both of the above matters, the comparison in Table 65 is not entirely conclusive, but it is the best that can be done with such experiments as have been made. Careful and comprehensive experiments on the actual supporting power of piles are very much needed.

However, notice that the computed bearing power is safe, that is, is less than the actual bearing power in all cases except for the second trial for No. 3, and for the first trial for No. 8; and hence the preponderance of the evidence is in favor of the safety of the formula, although in a few cases it gives results extravagantly safe.

778. Factors Affecting the Computed Bearing Power. Experience uniformly shows that, whatever the nature of the soil, a pile has a much less bearing power at the time the driving ceases than after the pile has been allowed to stand a few hours, and sometimes even a few minutes makes a material difference. Not uncommonly piles that gave a penetration of 1 or 2 feet under the last blow and which according to the usual formulas have almost no supporting power, support a load of 10 to 15 tons without settlement. Therefore, the test pile should be allowed to rest for a time after the driving is completed before applying the test load. The proper time a pile should be allowed to stand before testing should be a subject for experiment in each particular case. The effect of rest is usually greatest in fine, soft, wet earth, and least in coarse gravel and sand.

Again the blows of the friction-clutch pile-driver are usually more effective than those of the nipper driver, because the former

TABLE 65.
COMPARISON OF ACTUAL AND COMPUTED BEARING-POWER OF PILES.

REF. No.	LENGTH OF PILE, FEET.	WEIGHT OF HAMMER, POUNDS.	HEIGHT OF FALL, FEET.	LAST PENETRATION, INCHES.	LOAD.		CHARACTER OF SOIL.	LOCALITY.
					Observed, pounds.	Computed, pounds, $\frac{2W^2}{s+1}$		
1	53	2 000	4.0	8.5	13 333	1 690	Creek bottom, almost fluid mud.....	Aquia Creek, Va.
2	...	1 600	9.67	22.0	13 333	1 680	Soft river mud	Philadelphia, Pa.
3	25?	1 600	36.0	18.0	14 560*	6 060	Soft muddy bottom covered with water	East St. Louis, Ill.
4	35	1 700	25.0	3.0	22 400	27 400	Mud 30 ft. deep	Perth Amboy, N. J.
5	30	1 900	25.0	2.0	44 800	28 300	Alluvial deposit	Fort Delaware
6	35	910	6.0	1.0	> 47 375	11 400	Mud, sand, and clay †	Proctorsville, La.
7	...	1 900	5.0	0.35	62 500	6 740	Stiff clay ‡	Buffalo, N. Y.
8	70	1 900	29.0	1.5	75 000	44 100	Vegetable mould lying upon soft clay	Lake Pontchartrian, La.
9	91	2 300	30.0	3.0 ¶	> 22 400	37 500	with occasional streaks of sand ...	Annapolis, Md.
10	73	2 300	22.0	12.0	> 22 500	11 500	Water 12 ft., mud 60 ft., fine sand 6 ft.	Annapolis, Md.
11	30	2 300	1.75	1.5	75 000	36 800	" " " fine sand 12 ft.	Annapolis, Md.
12	33	2 300	1.5	3.75	85 000	40 500	Water 12 ft., mud 61 ft.	Annapolis, Md.
			33.5	2.0	34 000	32 500	Sand	Annapolis, Md.
			22.0	1.0	38 000	33 700	Sand	Annapolis, Md.
			22.0	1.0	110 000	50 600	Sand	Annapolis, Md.

* Five hours after driving. Under 20,160 lb. it sunk $\frac{3}{4}$ in.; and under 33,600 lb. it sunk 5 ft.

† See the first paragraph of § 783.

‡ See the second paragraph of § 783.

¶ Piles sunk 5 to 8 ft. by their own weight.

are more rapid; and therefore, if the penetration is taken when driving ceases, piles driven with a series of rapid blows will ultimately have a greater bearing power than those driven with a series of slower blows, other things being the same.

There is still another reason why the penetration should not be taken immediately after driving ceases, for some seeming unimportant condition may affect the ease of driving but not the ultimate bearing power. For example, a stream of water discharged against the pile at the ground line materially increases the penetration. In driving piles for a foundation in Chicago, the piles were "snaked" out of the river and allowed to lie upon the ground for about half an hour. A 40-foot pine pile driven in the ordinary way required 295 blows of a drop hammer to drive it, and a similar 45-foot pile required only 164 blows, the only difference being that a garden hose discharged a gentle stream of water at the surface of the ground against the latter pile while it was being driven. The soil is a moderately soft blue clay; and this example seems to be fairly representative of experience under similar conditions. Tests with a hammer after 24 hours seemed to show no difference in the supporting power of a pile driven "wet" and of one driven "dry." A pool of tar or of clay puddle around the base of the pile is said to be used in Russia to lubricate the pile while being driven.

779. In driving piles with a friction-clutch driver care should be taken that the operator does not hold the hammer to reduce the apparent penetration. It needs close observation to detect this trick. In making the test blow with a friction-clutch pile-driver, the hoisting cable should be detached from the hammer to give a free fall.

If the hammer bounces to any considerable extent, the fall is too great, or the pile has struck a solid obstacle, or the hammer is too light. Under such circumstances, careful trials and discriminating judgment are required to determine the cause of the bouncing. Frequently, decreasing the fall will decrease the bouncing and also increase the effectiveness of the blow. If the pile has struck an impenetrable stratum, and the driving is continued, it is probable that there will be a small and continuous apparent penetration due to the mashing of the foot of the pile. Not infrequently when piles are dug out or pulled up, the foot is found badly bruised, and sometimes the body of the pile is crushed. Of course, after the point is bruised or the body crushed, further driving is useless. In hard driving there is likely to be a little rebound of the hammer, owing to the elastic compression of the pile; but in making the test blow there should be only a very little bouncing.

If the penetration is at an uneven rate, it is probable that the pile is passing boulders or logs. If the penetration is practically

zero, it is probable that the pile is against an impenetrable stratum or is already crushed. When the penetration has reached a small amount, say, $\frac{1}{4}$ or $\frac{1}{2}$ inch per blow, and the hammer rebounds considerably, it is safe to conclude that the limit of safe driving of that pile has been reached. The penetration to be used in the formula should not be taken unless it has been at a reasonably uniform or uniformly decreasing rate. Of course, the apparent penetration due to the brooming of the head, or to the crushing of the body of the pile, or to the bruising of the point should not be used in the formula for computing the bearing power.

Care should be taken that the test blow is struck on sound wood, as otherwise the computed bearing power may be greatly in error (see paragraph 4 of § 773). A slightly broomed head may absorb half to three quarters of the energy of the blow, and increase proportionally the computed supporting power. This shows how unscientific it is to prescribe a limit of the penetration without specifying the accompanying condition of the head of the pile, as is often done. Piles driven close together in quicksand or semi-fluid soil will sometimes rise a little when other piles are subsequently driven near them; but usually this phenomenon need cause no anxiety, as the lower material is already solidly in contact with the piles, and therefore the piles have as great bearing power as the nature of the soil makes possible.

Of course, in making the test blow the hammer should drop vertically.

780. SUPPORTING POWER DETERMINED BY EXPERIMENT. It is not certain that the bearing power of a pile when loaded with a continued quiescent load will be the same as that during the very short period of the blow. The friction on the sides of the pile will have a greater effect in the former case, while the resistance to penetration of the point will be greater in the latter. This, and the fact that the supporting power of piles sunk by the water jet can be determined in no other way, show the necessity of experiments to determine the bearing power under a steady load.

Unfortunately no extended experiments have been made in this direction. We can give only a collection of as many details as possible concerning the piles under actual structures and the loads which they sustain. In this way, we may derive some idea of the sustaining power of piles under various conditions of actual practice.

781. Ultimate Load. In constructing a light-house at Proctorsville, La., in 1856-57, a test pile, 12 inches square, driven 29.5 feet, bore 29.9 tons without settlement, but with 31.2 tons it "settled slowly." The soil, as determined by borings, had the following character: "For a depth of 9 feet there was mud mixed with sand;

then followed a layer of sand about 5 feet thick, next a layer of sand mixed with clay from 4 to 6 feet thick, and then followed fine clay. By draining the site the surface was lowered about 6 inches. The pile, by its own weight, sank 5 feet 4 inches." The above load is equivalent to a frictional resistance of 600 lb. per sq. ft. of surface of pile in contact with the soil. This pile is No. 6 of Table 65, page 394.

At Philadelphia in 1873, a pile was driven 15 ft. into "soft river mud, and 5 hours after 7.3 tons caused a sinking of a very small fraction of an inch; under 10 tons it sank $\frac{3}{4}$ of an inch, and under 16.8 tons it sank 5 ft." The above load is equivalent to 360 lb. per sq. ft. of surface of contact. This pile is No. 2 of the table on page 394.

"In the construction of a foundation for an elevator at Buffalo, N. Y., a pile 15 inches in diameter at the large end, driven 18 ft., bore 25 tons for 27 hours without any ascertainable effect. The weight was then gradually increased until the total load on the pile was $37\frac{1}{2}$ tons. Up to this weight there had been no depression of the pile, but with $37\frac{1}{2}$ tons there was a gradual depression which aggregated $\frac{5}{8}$ of an inch, beyond which there was no depression until the weight was increased to 50 tons. With 50 tons there was a further depression of $\frac{7}{8}$ of an inch, making the total depression $1\frac{1}{2}$ inches. Then the load was increased to 75 tons, under which the total depression reached $3\frac{1}{8}$ inches. The experiment was not carried beyond this point. The soil, in order from the top, was as follows: 2 ft. of blue clay, 3 ft. of gravel, 5 ft. of stiff red clay, 2 ft. of quicksand, 3 ft. of red clay, 2 ft. of gravel and sand, and 3 ft. of very stiff blue clay. All the time during this experiment there were three pile-drivers at work on the foundation, thus keeping up a tremor in the ground. The water from Lake Erie had free access to the pile through the gravel." * This is equivalent to a frictional resistance of 1,850 lb. per sq. ft. This is pile No. 7 of the table on page 394.

782. In the construction of the dock at the Pensacola navy yard, a pile driven 16 feet into clean white sand sustained a direct pull of 43 tons without movement, while 45 tons caused it to rise slowly; and 46 tons were required to draw the pile. This is equivalent to a frictional resistance of 1,900 lb. per sq. ft.

783. In making some repairs at the Hull docks, England, several hundred *sheet piles* were drawn out. They were 12 by 10 inches, driven an average depth of 18 feet in stiff blue clay, and the average force required to pull them was not less than 35.8 tons each. The frictional resistance was at least 1,875 lb. per sq. ft. of surface in contact with the soil. †

* From private correspondence of John E. Payne and W. A. Haven, engineers in charge; by courtesy of John C. Trautwine, Jr.

† Proc. Inst. of C. E., vol. lxiv, p. 311-15.

784. Summary. A summary of the ultimate frictional resistance developed in the preceding five examples is as follows:

Soft river mud.....	360 lb. per sq. ft.
Marsh.....	600 lb. per sq. ft.
Stiff clay.....	1 850 lb. per sq. ft.
Clean white sand.....	1 900 lb. per sq. ft.

The last is the value obtained in pulling a pile.

785. Safe Load. The piles under the bridge over the Missouri at Bismarck, Dakota, were driven 32 ft. into the sand, and sustain 20 tons each,—equivalent to a frictional resistance of 600 lb. per sq. ft. The piles at the Plattsmouth Bridge, driven 28 ft. into the sand, sustain less than $13\frac{1}{2}$ tons, of which about one fifth is live load,—equivalent to a frictional resistance of 300 lb. per sq. ft.

At the Hull docks, England, piles driven 16 ft. into “alluvial mud” sustain at least 20 tons, and according to some, 25 tons; for the former, the friction is about 800 lb. per sq. ft. The piles under the Royal Border Bridge “were driven 30 to 40 ft. into sand and gravel, and sustain 70 tons each,”—the friction being about 1,400 lb. per sq. ft.

786. SUPPORTING POWER OF SCREW AND DISK PILES. The supporting power depends upon the nature of the soil and the depth to which the pile is sunk. A screw pile “in soft mud above clay and sand” supported 1.8 tons per sq. ft. of blade.* A disk pile in “quicksand” stood 5 tons per sq. ft. under vibrations.† Charles Macdonald, in constructing the iron ocean-pier at Coney Island, assumed that the safe load upon the flanges of the iron disks sunk into the sand, was 5 tons per sq. ft.; but “many of them really support as much as 6.3 tons per sq. ft. continually and are subject to occasional loads of 8 tons per sq. ft., without causing any settlement that can be detected by the eye.”‡

787. FACTOR OF SAFETY. On account of the many uncertainties in connection with piles, a wide margin of safety is recommended by all authorities. The factor of safety ranges from 2 to 12 according to the importance of the structure and according to the faith in the formula employed or the experiment taken as a guide. At best, the formulas can give only the supporting power at the time when the driving ceases. If the resistance is derived mainly from friction, the supporting power generally increases for a time after the driving ceases, since the coefficient of friction is usually greater after a period of rest. If the supporting power is derived mainly from the resistance

* Proc. Inst. of C. E., vol. xvii, p. 451.

† *Ibid.*, p. 443.

‡ Trans. Am. Soc. C. E., vol. viii, p. 236.

to penetration of a stiff substratum, the bearing power for a steady load will probably be smaller than the force required to drive it, as most materials require a less force to change their form slowly than rapidly. If the soil adjoining the piles becomes wet, the supporting power will be decreased; and vibrations of the structure will have a like effect.

The factor to be employed should vary with the nature of the structure. For example, the abutments of a stone arch should be constructed so that they will not settle at all; but if a railroad pile trestle settles no serious damage is done, since the track can be shimmed up occasionally.

788. In conclusion, it should not be overlooked that the bearing power of a piled area is not necessarily equal to the bearing power of one pile multiplied by the number of piles in that area. If the stratum below the piles is at all yielding, the supporting capacity of the foundation is the bearing power of the area on the soft stratum below *plus* the friction on the outer side surface of the entire mass surrounding the piles.*

ART. 4. ARRANGEMENT OF THE FOUNDATION.

789. DISTANCE BETWEEN THE PILES. The length of the piles to be used is determined by the nature of the soil, or the conveniences for driving, or the lengths most easily obtained. The safe bearing power may be determined by equation 1 or 2, § 776, or from the data presented in § 780-85, or, better, by driving a pile and applying a test load. Then, knowing the weight to be supported, and having decided upon the length of piles to be used, and having ascertained their safe bearing power, it is an easy matter to determine how many piles are required. Of course, the number of piles under the different parts of a structure should be proportional to the weights of those parts.

If the attempt is made to drive piles too close together, they are liable to force each other up. To avoid this, the centers of the piles should be, at least, $2\frac{1}{2}$ or 3 feet apart. Of course, they may be farther apart, if a less number will give sufficient supporting power, or if a greater area of foundation is necessary to prevent overturning.

When a grillage (§ 793) is to be placed on the head of the piles, great care must be taken to get the latter in line so that the lowest course of grillage timber, called *capping*, may rest squarely upon all the piles of a row. In driving under water, a convenient way of marking the positions of the piles is to construct a light frame of

* For an extensive classified Bibliography of Piles and Pile Driving, see Bulletin No. 107 (January, 1909) of Am. Ry. Eng'g and M-of-W. Assoc., p. 53-67.

narrow boards, called a *spider*, in which the position of the piles is indicated by a small square opening. This frame may be held in place by fastening it to the sides of the coffer-dam, or to the piles already driven, or to temporary supports. Under ordinary circumstances, it is reasonably good work if the center of the pile is somewhere under the cap. Piles frequently get considerably out of place in driving, in which case they may sometimes be forced back with a block and tackle or a jack-screw. When the heads of the piles are to be covered with concrete, the exact position of the piles is comparatively an unimportant matter.

In close driving, it is necessary to commence at the center of the area and work towards the sides; for if the central ones are left until the last, the soil may become so consolidated that they can scarcely be driven at all.

790. LATERAL YIELDING. Sometimes a pile foundation is used under a structure subject to considerable lateral pressure, in which case there may be danger of the foundation as a whole being pushed over sidewise. If the piles reach a firm subsoil, it will help matters a little to remove the upper and more yielding soil from around the tops of the piles and fill in with broken stone. Or a wall of piles may be driven around the foundation—at some distance from it,—and timber braces be placed between the wall of piles and the foundation. When the foundation can not be buttressed in front, the structure may be prevented from moving forward by rods which bear on the face of the wall and are connected with blocks of concrete embedded in the earth at a distance behind the wall (see § 1033), or the thrust of the earth against the back of the wall may be decreased by constructing relieving arches against the back of the wall (see § 1034).

791. SAWING OFF THE PILES. When piles are driven, it is generally necessary to saw them off either to bring them to the same height, or to get the tops lower than they can be driven, or to secure sound wood upon which to rest the timber platform that carries the masonry. When above water, piles are usually sawed off by one man using an ordinary hand saw or by two men using a cross-cut saw; and when below water, by machinery—usually a circular saw on a vertical shaft held between the leaders of the pile driver or mounted upon a special frame, and driven by the engine used in driving the piles. The saw-shaft is sometimes attached to a vertical shaft held between the leaders by parallel bars, by which arrangement the saw can be swung in the arc of a circle and several piles be cut off without moving the machine. The piles are sometimes sawed off with what is called a pendulum saw, i.e., a saw-blade fastened between two arms of a rigid frame which extends into the water and is free to swing about an axis above, the saw being swung

by men pushing on the frame. The first method is the better, particularly when the piles are to be sawed off under mud or silt.

Considerable care is required to get the tops cut off in a horizontal plane. It is not necessary that this shall be done with mathematical accuracy, since if one pile does stand up too far the excess load upon it will either force it down or crush the cap until the other piles take part of the weight. Under ordinary conditions, it is a reasonably good job if piles on land are sawed within half an inch of the same height; and under water, within one inch. When a machine is used on land, it is usually mounted upon a track and drawn along from pile to pile, by which device, after having leveled up the track, a whole row can be sawed off with no further attention. When sawing under water, the depth below the surface of the water is indicated by a mark on the saw-shaft, or a target on the saw-shaft is observed upon with a leveling instrument, or a leveling rod is read upon some part of the saw-frame. In sawing piles off under water; from a boat, a great deal of time is consumed (particularly if there is a current) in getting the boat into position ready to begin work.

Piles are frequently sawed off under 10 to 15 feet of water, and occasionally under 20 to 25 feet.

792. FINISHING THE FOUNDATION. There are two cases: (1) when the heads of the piles are not under water; and (2) when they are under water.

1. When the piles are not under water there are again two cases: (a) when a timber *grillage* is used; and (b) when *concrete* alone is used.

2. When the piles are sawed off under water, the timber structure which intervenes between the piles and the masonry (in this case called a *crib*) is put together first, and then sunk into place. The construction is essentially the same as when the piles are not under water, but differs from that case in the manner of getting the timber into its final resting place. The methods of constructing foundations under water, including that by the use of timber cribs, will be discussed in Art. 2 of the next chapter.

793. Grillage. A grillage is a stout frame of one or more courses of timber drift-bolted or pinned to the tops of wood piles and to each other, upon which a floor of thick boards or heavy timbers is placed to receive the bottom courses of masonry. For illustrated examples, see Fig. 134, page 544, Fig. 136, page 546, and Fig. 149, page 562.

The timbers which rest upon the heads of the piles, called *caps*, are usually about 1 foot square, and are fastened by boring a hole through each and into the head of the pile and driving into the hole a plain rod or bar of iron having a slightly larger cross section than the hole. (A rod so used is called a *drift bolt*—see § 795.) Old bridge timbers, timbers from false works, etc., are frequently used

in constructing the grillage and are ordinarily as good for this purpose as new. As many courses may be added as is necessary, each perpendicular to the one below it. The timbers are sometimes laid close together and sometimes with spaces between them. Sometimes the spaces are left open to cheapen the construction, and sometimes they are filled with gravel or broken stone to aid in sinking the grillage. The timbers of the top course are laid close together, or a floor of thick boards is added on top to receive the masonry. Of course no timber should be used in a foundation, except where it will always be wet.

794. Objection is sometimes made to the platform or grillage as a bed for a foundation because, owing to the want of adhesion between wood and mortar, the masonry might slide off from the platform if any unequal settling should take place. However, there is but slight probability that a foundation will ever fail on account of the masonry's sliding on timber, since ordinarily this could take place only when the horizontal force is nearly half of the downward pressure.* This could occur only with dams, retaining walls, or bridge abutments, and rarely, if ever, with these. Any possibility of slipping can be prevented also by omitting one or more of the timbers in the top course—the omitted timbers being perpendicular to the direction of the forces tending to produce sliding,—or by building the top of the grillage in the form of steps, or by driving drift bolts into the platform and leaving their upper ends projecting.

795. Drift Bolts. Drift bolts are rods of steel driven into a hole slightly smaller than the rod, the difference in the diameter of the rod and the hole being called the drift. Drift bolts are frequently used in engineering construction for holding large timbers together, the case mentioned in § 793 being a very common one. Formerly square rods were used as drift bolts, the corners being jagged or barbed; but universal experience shows that smooth round rods hold much better than either plain or barbed square ones. The ends of drift bolts are usually rounded a little with a hammer—only enough to remove any burr or sharp edge.

The holding power of drift bolts varies with the amount of the drift, the diameter of the rod, and the kind of timber. According to experiments made under the author's direction,† the average holding power of a 1-inch round rod driven into a $\frac{1}{8}$ -inch hole in pine, perpendicular to the grain, is 501 pounds per linear inch (3 tons per linear foot); and under the same conditions the holding power of oak is 1,300 pounds per linear inch (7.8 tons per linear foot). The

* See Table 74, page 464.

† Selected Papers of the Civil Engineers' Club, No. 4, University of Illinois, p. 53-58.

holding power of a bolt driven parallel to the grain is almost exactly half as much as when driven perpendicular to the grain. If the holding power of a 1-inch rod in a $\frac{1}{8}$ -inch hole be designated as 1, the holding power in a $\frac{1}{4}$ -inch hole is 1.69, in a $\frac{3}{8}$ -inch hole 2.13, and in a $\frac{1}{2}$ -inch hole 1.09. The holding power decreases very rapidly as the bolt is withdrawn.

In some experiments made at the Poughkeepsie bridge (§ 847), it was found that a 1-inch rod driven into a $\frac{1}{8}$ -inch hole in hemlock required on the average a force of $2\frac{1}{2}$ tons per linear foot of rod to withdraw it; and a 1-inch rod driven into a $\frac{3}{4}$ -inch hole in white or Norway pine required 5 tons per linear foot of rod to withdraw it.

796. Concrete Cap. A thick layer of concrete, resting partly on the heads of the piles and partly on the soil between them, is frequently employed instead of the timber grillage as above. One advantage of the concrete cap over the timber grillage is that there is less danger of the concrete's sliding off. A second advantage is that the concrete adds materially to the supporting power of the foundation, since it utilizes the bearing power of the soil between the piles as well as the supporting power of the piles themselves. Another advantage of this form of construction is that the concrete can be laid without exhausting the water or sawing off the piles. A fourth advantage is that with concrete there is less excavation, and consequently less trouble and expense during construction in keeping the foundation pit dry. In recent years in most localities concrete is cheaper than timber.

The substitution in recent years of concrete for block masonry has practically eliminated this method of finishing a pile foundation. However, the concrete of the masonry superstructure is frequently deposited around and over the heads of the piles; for example, see Fig. 116 (page 527), Fig. 118 (page 528), Fig. 142 (page 557), Fig. 148 (page 561), and Fig. 150 (page 563).

797. Cushing Pile Foundation. The desire to utilize the cheapness and efficiency of ordinary piles as a foundation for bridge piers, and at the same time secure greater durability than is possible with piles alone, led to the introduction of what is known as Cushing pile foundation, first used in 1868, at India Point, Rhode Island. It consists of square timber piles driven close together or in intimate contact with each other. Surrounding the pile cluster is an envelope of cast or wrought iron, sunk in the mud or silt only deep enough to protect the piles, all voids between piles and cylinders being filled with concrete.

Several such foundations have been used, and have proved satisfactory in every respect. The only objection that has ever

been urged against them is that the piles may rot above the water line; but experience seems to show that this is not likely.

In making a foundation according to the Cushing system, the piles may be driven first and the cylinder sunk over them, or the piles can be driven inside the cylinder after a few sections are in place. In the latter case, however, the cylinders may be subjected to undue strains and to subsequent damage from shock and vibration; and besides, the sawing off of the piles would be very difficult and inconvenient, and they would have to be left at irregular heights and with battered tops. On the other hand, if the piles are driven first, there is danger of their spreading and thereby interfering with the sinking of the cylinder.

The special advantages of the Cushing piers are: (1) cheapness, (2) ability to resist scour, (3) small contraction of the waterway, and (4) rapidity of construction.

798. The railroad bridge over the Tenas River, near Mobile, rests on Cushing piers. There are thirteen, one being a pivot pier. Each, excepting the pivot pier, is made of two cast-iron cylinders, 6 feet exterior diameter, located 16 feet between centers. The cylinders were cast in sections 10 feet long, of metal $1\frac{1}{2}$ inches thick, and united by interior flanges 2 inches thick and 3 inches wide. The sections are held together by 40 bolts, each $1\frac{1}{4}$ inches in diameter. The lower section in each pier was provided with a cutting edge, and the top section was cast of a length sufficient to bring the pier to its proper elevation.

The pivot pier is composed of one central cylinder 6 feet in diameter, and six cylinders 4 feet in diameter arranged hexagonally. The radius of the pivot circle, measuring from the centers of cylinders, is $12\frac{1}{2}$ feet. Each cylinder is capped with a cast-iron plate $2\frac{1}{2}$ inches thick, secured to the cylinder with twenty 1-inch bolts.

The piles are sawed pine, not less than 10 inches square at the small end. They were driven first, and the cylinder sunk over them. In each of the large cylinders, 12 piles, and in each of the smaller cylinders, 5 piles were driven to a depth not less than 20 feet below the bed of the river. The piles had to be in almost perfect contact for their whole length, which was secured by driving their points in contact as near as possible, and then pulling their tops together and holding them by 8 bolts $1\frac{1}{2}$ inches in diameter. In this particular bridge the iron cylinders were sunk to a depth not less than 10 feet below the river bed; but usually they are not sunk more than 3 to 7 feet. The piles were cut off at low water, the water pumped out of the cylinder, and the latter then filled to the top with concrete.

CHAPTER XVI

FOUNDATIONS UNDER WATER

802. The class of foundations to be discussed in this chapter could appropriately be called Foundations for Bridge Piers and Abutments, since these are the principal ones that are laid under water. The principles to be considered apply to foundations in water-bearing soils. In this class of work the chief difficulty is in excluding the water preliminary to the preparation of the bed of the foundation and the construction of the artificial structure. This usually requires great resources and care on the part of the engineer. Sometimes the preservation of the foundation from the scouring action of the current is an important matter.

Preventing the undermining of the foundation is generally not a matter of much difficulty. In quiet water or in a sluggish stream but little protection is required, in which case it is sufficient to deposit a mass of loose stone, or riprap, around the base of the pier. If there is danger of the riprap's being undermined, the layer must be extended farther from the base, or be made so thick that, if undermined, the stone will fall into the cavity and prevent further damage. A willow mattress sunk by placing stones upon it is an economical and efficient means of protecting a structure against scour. A pier may be protected also by inclosing it with a row of piles and depositing loose rock between the pier and the piles. In minor structures the foundation may be protected by driving sheet piles around it.

If a large quantity of stone be deposited around the base of the pier, the velocity of the current, and consequently its scouring action, will be increased. Such a deposit is, however, an obstruction to navigation, and therefore is seldom permitted. In many cases the only absolute security is in sinking the foundation below the scouring action of the water. The depth necessary to secure this adds to the difficulty of preparing the bed of the foundation.

803. The principal difficulty in laying a foundation under water consists in excluding the water. If necessary, masonry can be laid under water by divers; but this is very expensive and is rarely resorted to.

There are five methods in use for laying foundations under water:

(1) the method of excluding the water from the bed of the foundation by the use of a coffer-dam; (2) the method of founding the pier, without excluding the water, by means of a timber crib surmounted by a water-tight box in which the masonry is laid; (3) the method of sinking iron tubes, timber cribs, or masonry wells to a solid substratum by excavating inside of them; (4) the method in which the water is excluded by the presence of compressed air; and (5) the method of freezing a wall of earth around the site, inside of which the excavation can be made and the masonry laid. These several methods will be discussed separately in the order named.

ART. 1. COFFER-DAM PROCESS.

804. A *coffer-dam* is an inclosure from which the water is pumped and in which the masonry is laid in the open air. This method consists in constructing a coffer-dam around the site of the proposed foundation, pumping out the water, preparing the bed of the foundation by driving piles or otherwise, and laying the masonry on the inside of the coffer-dam. After the masonry is above the water the coffer-dam can be removed.

This method is applicable only where the soil at the bottom of the dam is nearly impervious, for if there is much of an inflow of water it will be impossible, or at least expensive, to pump it out. The difficulties in the use of the coffer-dam method increase rapidly with the depth of the water. For wood sheet piles it is usually claimed that the limiting depth is 30 or 35 feet. Steel sheet piles were introduced so recently that practice has not established a corresponding limit, but they have been successfully used in coffer-dams at more than twice the above depth. However, at such great depths, some other method is usually preferable.

805. CONSTRUCTION OF THE DAM. The construction of coffer-dams varies greatly. In still shallow water, a well-built bank of clay and gravel is sufficient. If there is a slow current, a wall of bags partly filled with clay and gravel does fairly well; and a row of cement barrels filled with gravel and banked up on the outside has been used. If the water is too deep for any of the above methods, a single or double row of plank may be driven and banked up on the outside with a deposit of impervious soil sufficient to prevent leaking. If there is much of a current, the puddle on the outside will be washed away; or, if the water is deep, a large quantity of material will be required to form the puddle-wall; and hence the preceding simple methods are inapplicable where there is much current or where the water is more than 3 or 4 feet deep.

The more elaborate coffer-dams may consist of a wall of either

wood or steel sheet piles, or of two rows of sheet piles with a puddle wall between them, or of a timber crib.

806. Wood Sheet-Pile Cofferdam. For shallow depths the sheet piles may be simply plank, and for greater depths either thick tongued-and-grooved plank or Wakefield piles (§ 747). Sheet piles should be sharpened wholly from one side, and the long edge should be placed next to the last pile driven to cause the piles to crowd together and make closer joints. In hard soil at small depths, or in soft soil at moderate depths, the sheeting may be driven by hand with a wooden maul or an iron sledge; but for any considerable depth a power pile-driver must be employed, although sometimes where only a few piles are to be driven a hand pile-driver is rigged up with a block of wood for a hammer. The sheeting should be driven at least a foot or two below the lowest excavation inside of the dam; and in soft soil the sheet piles should be driven at least 3 or 4 feet below the proposed excavation to prevent leakage under the bottom.

If the sheet piles are to resist a head of more than 4 or 5 feet of water or a semi-fluid soil, their tops should be supported by wales (horizontal timbers on the inside of the dam against the top of the sheeting), which in turn are braced at their ends by the wales on the adjacent sides of the dam or at intermediate points by horizontal timbers across the dam; and in deep dams similar wales and cross braces are inserted at vertical intervals as the excavation progresses. Sometimes, in comparatively shallow water and with a suitable bottom, the waling pieces are supported by ordinary bearing piles driven inside of the dam, thus eliminating the braces across the dam, and therefore facilitating the excavation and the laying of the masonry.

Sometimes the top and the bottom waling pieces are framed together respectively, and the upper and lower waling frames are separated from each other by small vertical posts placed between them and joined to them. This frame is sunk in the desired position, and the sheet piles are driven around it.

807. The thickness of the sheet piling required in any particular case is usually a matter of judgment based upon past experience; but the strength required can be closely approximated by regarding the sheet pile as a beam either fixed at one end and free at the other, or as supported at both ends. The amount of the lateral pressure against the pile is one half of the continued product of the weight of a cubic foot of water, the width of the pile in feet, and the depth of the water in feet; and the point of application of this pressure is two thirds of the depth of the water from the top. Of course, the weight of liquid mud is more than that of water; but extreme accuracy is impossible, and hence the above method is probably sufficient for the purpose.

808. Steel Sheet-Pile Cofferdam. The introduction of interlocking steel sheet piles has materially cheapened the cost of cofferdams, and has also increased the depth to which a cofferdam may be economically sunk. The various forms of steel sheet piles are described in § 748, and the relative merits of steel and wood sheet piles are stated in § 749. The general construction of cofferdams with steel sheet piles is substantially the same as with wood sheeting (§ 806-07).

809. Puddle-Wall Cofferdam. Before the introduction of interlocking steel sheet piles, the usual method of constructing a cofferdam in deep water was to drive two lines of wood sheet piles and fill in between them with impervious soil, called *puddle*. The general form of such a dam is shown in Fig. 88. The area to be inclosed is

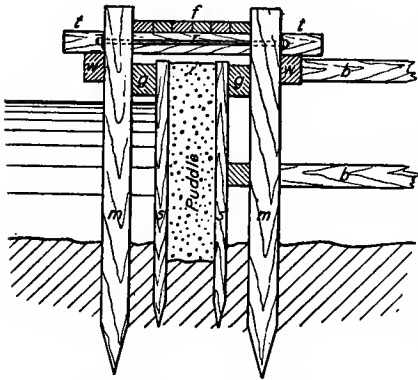

FIG. 88.—PUDDLE-WALL COFFER-DAM.

first surrounded by two rows of ordinary piles, *m, m*. On the outside of the main piles, a little below the top, are bolted two longitudinal pieces, *w, w*, called *wales*; and on the inside are fastened two similar pieces, *g, g*, which serve as guides for the sheet piles, *s, s*, while being driven. A rod, *r*, connects the tops of the opposite main piles to prevent spreading when the puddle is put in. The timber, *t*, is put on primarily to carry the footway, *f*, and is sometimes notched over, or otherwise fastened to, the pieces *w, w*, to prevent the puddle space from spreading. *b* and *b* are braces extending from one side of the cofferdam to the other. These braces are put in position successively from the top as the water is pumped out; and as the masonry is built up, they are removed and the sides of the dam braced by short struts resting against the pier.

The resistance to overturning is derived principally from the main piles, *m, m*. The distance apart and also the depth to which they should be driven depend upon the kind of bottom, the depth of water, and the danger from floating ice, logs, etc. Rules and formulas are here of but little use, judgment and experience being the only guides. The distance between the piles in a row is usually from 6 to 10 feet.

810. The dimensions of the sheet piles (§ 807) employed will depend upon the depth and the number of longitudinal waling pieces

used. Two thicknesses of ordinary 2-inch plank are generally employed. Sometimes, for the deeper dams, the sheet piles are timbers 10 or 12 inches square.

The thickness of the dam will depend upon (1) the width of gangway required for the workmen and machinery, (2) the thickness required to prevent overturning, and (3) the thickness of puddle necessary to prevent leakage through the wall. The thickness of shallow dams will usually be determined by the first consideration; but for deep dams the thickness will be governed by the second or third requirement. If the braces, b, b , are omitted, as is sometimes done for greater convenience in working in the coffer-dam, then the main piles, m, m , must be stronger and the dam wider in order to resist the lateral pressure of the water.

811. Thickness of Puddle Wall. An old rule for the thickness of the puddle wall, which is frequently quoted, is: "For depths of less than 10 feet make the width 10 feet, and for depths over 10 feet give an additional thickness of 1 foot for each additional 3 feet of wall." Another rule, also frequently quoted, is: "Make the thickness of the puddle wall three fourths of its height, but in no case is the wall to be less than 4 feet thick." Judged by ordinary experience both of the above rules are extravagant, for numerous coffer-dams from 20 to 30 feet deep have been built in which the thickness of the puddle varied from 3 to 5 feet, or say one sixth of the depth. Of course, the thickness of the puddle wall should vary with the tightness of the sheet piling and the imperviousness of the puddle (§ 812); and under ordinary conditions a thickness of one sixth to one quarter of the depth is sufficient.

812. The Puddle. The puddle should consist of impervious soil, of which gravelly clay is best. It is a common idea that clay alone, or clay and fine sand, is best. With pure clay, if a thread of water ever so small finds a passage under or through the puddle, it will steadily wear a larger opening. On the other hand, with gravelly clay, if the water should wash out the clay or fine sand, the larger particles will fall into the space and intercept first the coarser sand, and next the particles of loam which are drifting in the current of water; and thus the whole mass puddles itself better than the engineer could do it with his own hands. An embankment of gravel is comparatively safe, and becomes tighter every day; while a clay embankment may be tighter at first than a gravelly one, it is always liable to breakage.

Before putting in the puddling, all soft mud and loose soil should be removed from between the rows of sheet piles, for the most common cause of trouble with puddle-wall coffer-dams is a leak between the natural surface and the puddle.

The puddling should be deposited in layers, and compacted as much as is possible without causing the sheet piles to bulge so much as to open the joints.

813. Crib Cofferdam. Cofferdams are sometimes made by building a crib and sinking it. For shallow water, the crib is sometimes made of uprights framed into caps and sills, and covered on the outside with tongued-and-grooved planks. The crib is built on land, launched, towed to its final place, and sunk by piling stones on top or by throwing them into cells constructed for that purpose. The dam is made water-tight at the bottom either by driving sheet piles outside it or by using canvas. The upper edge of the canvas may be nailed to the crib near the bottom or above the water; and the outer edge may be spread out upon the river bed and be loaded with stone or sand. The chief advantage of the above form of construction is that the area of possible leakage is reduced to the space below the crib, where leakage may be prevented by the use of sheet piles and clay or of canvas.

The crib is sometimes made of squared timbers laid one on top of the other, and drift-bolted together. The timbers must be securely fastened together vertically, or the buoyancy of the water will lift off the upper courses. The joints between the timbers may be made water-tight by placing cement grout between them during the construction of the crib, or by driving oakum into the joints after the crib is built. A crib made in this way in combination with sheet piles can be used in water 10 or 12 feet deep. The principal advantage of this form of construction is that there are no braces across the dam to interfere with the excavation and the laying of the masonry.

814. Either of the above forms of crib cofferdam can be used upon a moderately level rock bottom, by driving wood sheet piles outside of the crib until the point is bruised enough to make a fairly good fit against the rock and then depositing a bank of clay against the bottom of the piles.

815. Movable Cofferdam. A movable or floating crib cofferdam has been used, and was considered to have been a success.* It consisted of a crib with double walls built of squared timbers; and had several pockets into which stone could be thrown to sink it, and also several water-tight compartments to facilitate its movement from place to place. It was made in halves to allow of its removal from around the finished pier. The halves were joined together by fitting timbers between the projecting courses of the crib, and then passing long bolts vertically through the several courses.

816. Double Cofferdam. Sometimes two cofferdams are employed, one inside of the other, the outer one being used to keep out

* Proc. Engineers' Club of Philadelphia, vol. iv, p. 240-42.

the water, and the inner one to keep the soft material from flowing into the excavation. The outer one may be constructed in any of the ways described above. The inner one is usually a frame-work sheeted with boards, or a crib of squared timbers built log-house fashion with tight joints. The inner crib is sunk (by weighting it with stone) as the excavation proceeds. The advantages of the use of the inner crib are: (1) the coffer-dam is smaller than if the saturated soil were allowed to take its natural slope from the inside of the dam to the bottom of the excavation; (2) the space between the crib and the dam can be kept full of impervious material in case of any trouble with the outside dam; (3) the feet of the sheet piling are always covered, which lessens the danger of undermining or of an inflow of water and mud under the dam; and (4) it also reduces to a minimum the material to be excavated.

817. LEAKAGE. A serious objection to the use of coffer-dams is the difficulty of preventing leakage under or through the dam. One of the simplest devices to prevent leaks is to deposit a bank of gravel around the outside of the dam; then if a vein of water escapes below the sheet piling, the weight of the gravel will crush down and fill the hole before it can enlarge itself enough to do serious damage. If the coffer-dam is made of crib-work, short sheet piles may be driven around the bottom of it; or hay, willows, etc., may be laid around the bottom edge, upon which puddle and stones are deposited; or a broad flap of tarpaulin may be nailed to the lower edge of the crib and spread out loosely on the bottom, upon which stones and puddle are placed. A tarpaulin is frequently used when the bottom is very irregular,—in which case it would cost too much to level off the site of the dam; and it is particularly useful where the bottom is rocky and sheet piles can not be driven.

When the bed of the river is rock, or rock covered with but a few feet of mud or loose soil, a coffer-dam only sufficiently tight to keep out the mud is constructed. The mud at the bottom of the inclosed area is then dredged out, and a bed of concrete deposited under the water (§ 347). Before the concrete has set, another coffer-dam is constructed, inside of the first one, the latter being made water-tight at the bottom by settling it into the concrete or by driving sheet piles into the concrete. However, the better and more usual method is to sink the masonry upon the bed of concrete by the **crib and open-caisson process**—see Art. 2 of this chapter.

It is nearly impossible to prevent considerable leakage, unless the bottom of the crib rests upon an impervious stratum or the sheet piles are driven into such a stratum. Water will find its way through nearly any depth or distance of gravelly or sandy bottom. Trying to pump a river dry through the sand at the bottom of a coffer-dam

is expensive. However, the object of a coffer-dam is not to prevent all infiltration, but only to so reduce it that a moderate amount of pumping will keep the water out of the way. Probably a coffer-dam was never built that did not require considerable pumping; and not infrequently the amount is very great,—so great, in fact, as to make it clear that some other method of constructing the foundation should have been chosen.

Seams of sand are very troublesome. Logs or stones under the edge of the dam are also a cause of considerable annoyance. It is sometimes best to dredge away the mud and loose soil from the site of the proposed coffer-dam; but, when this is necessary, it is usually better to construct the foundation without the use of a coffer-dam,—see Art. 2 of this chapter. Cofferdams should be used only in very shallow water, or when the bottom is clay or some material impervious to water.

818. Pumps. In constructing foundations, it is frequently necessary to do considerable bailing or pumping. The method to be employed in any particular case will vary greatly with the amount of water present, the depth of the excavation, the appliances at hand, etc. The pumps generally used for this kind of work are the direct hand-lift foundation-pump, the diaphragm pump, the steam siphon, the pulsometer, and the centrifugal pump. Direct-acting steam pumps are not suitable for use in foundation work, owing to the deleterious effect of mud and sand in the water to be pumped.

819. Hand Pumps. When the lift is small, water can be bailed out faster than it can be pumped by hand; but the labor is proportionally more fatiguing, and therefore bailing is not often resorted to.

The direct hand-lift foundation-pump consists of a straight tube at the bottom of which is fixed a common flap valve, and in which works a piston carrying another flap valve. The tube is either a square wooden box or a sheet-iron cylinder,—usually the latter, since it is lighter and more durable. The pump is operated by applying the power directly to the upper end of the piston-rod, the pump being held in position by wooden stays or ropes. The only advantage of the wood-box hand-lift pump is that it may be improvised on the job; and the disadvantage for foundation work of all pumps having flap-valves is the danger that straw, sticks, mud, etc., will interfere with the action of the valves.

820. The diaphragm pump is the usual form of hand pump for foundation work. This pump consists of a short cast-iron cylinder having a rubber hose connected to its lower end, and being divided about midway of its height by a flexible horizontal rubber diaphragm. The central portion of the diaphragm is connected to a bent-lever

handle, and there is a valve in the center of the rubber disk. The rise and fall of the center of the disk acts as a piston. A pump of this form throws a large amount of water, allows sand and gravel to pass without choking, is not easily clogged by straw, leaves, etc., and is easily unclogged. It is made in various sizes, the smallest having a capacity of 25 gallons per minute and usually costing about \$20.

821. Steam Siphon. The steam siphon is the simplest of all pumps, since it has no movable parts whatever. It consists essentially of a discharge pipe—open at both ends—through the side of which enters a smaller pipe having its end bent up. The lower end of the discharge pipe dips into the water; and the small pipe connects with a steam boiler. The steam, in rushing out of the small pipe, carries with it the air in the upper end of the discharge pipe, thus tending to form a vacuum in the lower end of that pipe; the water then rises in the discharge pipe and is carried out with the steam. Although it is possible by the use of large quantities of steam to raise small quantities of water to a great height, the steam siphon is limited practically to lifting water only a few feet. Its cheapness and simplicity are recommendations in its favor, and its efficiency is not much less than that of other forms of pumps. One of the advantages of the steam siphon is that frequently it can be improvised on the work from ordinary pipe and fittings. Several forms and sizes of steam siphons are upon the market, ranging in capacity from 5 to 200 gallons per minute, and are much better than one made from pipe. A steam siphon, or jet pump as it is usually called by the manufacturer, having a capacity of 100 to 125 gallons per minute can usually be had for something like \$35. A common form of the steam siphon resembles, in external appearance, the Eads mud-pump (§ 877) represented in Fig. 94, page 438.

822. Pulsometer. The pulsometer is an improved form of the steam siphon. It may properly be called a steam pump which dispenses with all movable parts except the valves. The height to which it can lift water is practically unlimited. It is in very common use for pumping out coffer-dams. For an illustration showing the external appearance, see the advertising pages of any engineering newspaper.

There are several other forms of automatic vacuum pumps on the market which have substantially the same merits as the pulsometer.

823. Centrifugal Pump. All of the preceding pumps are suitable only for handling comparatively small quantities of water, but where large amounts of water must be pumped in a short time the centrifugal pump must be used. The centrifugal pump consists of a set of blades revolving in a short cylindrical case which connects at its center with a suction (or inlet) pipe, and at its circumference

with a discharge pipe. The blades being made to revolve rapidly, the air in the case is carried outward by the centrifugal force, tending to produce a vacuum in the suction pipe; the water then enters the case and is discharged likewise. The distance from the water to the pump is limited by the height to which the ordinary pressure of the air will raise the water; but the height to which a centrifugal pump can lift the water is limited only by the velocity of the outer ends of the revolving blades. Since there are no valves in action while the pump is at work, the centrifugal pump will allow sand and large gravel—in fact almost anything that can enter between the arms—to pass. Pumps having a 6-inch to 10-inch discharge pipe are the sizes most frequently used in foundation work.

The centrifugal pump requires more labor to install and more care to operate than any form of steam siphon.

824. DREDGING. Sometimes there is silt or mud as well as water to be removed from the coffer-dam. If there is not much solid material and if plenty of water is available, the solid matter may be pumped out along with the water by a centrifugal pump, by keeping the end of the suction pipe close to the mud. Under ordinary conditions, the water thus pumped will carry 10 per cent of fine sand or silt.

If there is much solid material to be removed, as in clearing the site for a large coffer-dam, it is advisable to employ either a dipper dredge or a sand digger, which may usually be hired by the day. If solid material is to be removed from a deep coffer-dam, an orange-peel or clam-shell dredge (§ 845) may be employed.

Sometimes the mud is removed with a scoop made of sheet steel, handled by a derrick and a winding engine.

825. However, in most cases, on account of the small amount to be excavated, it is most economical to throw the earth out by hand in successive lifts rather than to install a plant for doing the work by power.

826. PREPARING THE BED OF THE FOUNDATION. After the water is pumped out, the bed of the foundation may be prepared to receive the masonry by throwing out, usually with hand shovels, the soft material. The masonry may be started directly upon the hard substratum, or upon a timber grillage resting on the soil (§ 721) or on piles (§ 793-95).

827. COST OF COFFER-DAM FOUNDATIONS. It is universally admitted that estimates for the cost of foundations under water are very unreliable, and none are more so than those contemplating the use of a coffer-dam. The estimates of the most experienced engineers frequently differ greatly from the actual cost. The difficulties of the case have already been discussed (§ 817).

828. Examples. The following example is interesting as showing the cost under the most favorable conditions. The data are for a railroad bridge across the Ohio River at Point Pleasant, W. Va.* There were three 250-foot spans, one 400-foot, and one 200-foot. There were two piers on land and four in the water; and all extended about 90 feet above low water. The shore piers were founded on piles—driven in the bottom of a pit—and a grillage, concrete being rammed in around the timber. The foundations under water were laid by the use of a double coffer-dam (§ 816). The water was 10 feet deep; and the soil was 3 to 6 feet of sand and gravel resting on dry, compact clay. The foundations consisted of a layer of concrete 1 foot thick on the clay, and two courses of timbers. The quantities of materials in the six foundations, and the total cost, are as follows:

Pine timber in cribs inside of coffer-dams, and in foundations	273 210 ft. B.M.
Oak timber in coffer-dams, main and sheet piling . . .	244 412 " "
Poplar timber in coffer-dams	3 597 " "
Round piles in foundation and coffer-dams	13 571 lin. ft.
Excavation in foundations	4 342 cu. yd.
Concrete " "	649 " "
Riprap	997 " "

The total cost of foundations, including labor of all kinds, derricks, barges, engines, pumps, iron, tools, ropes, and everything necessary for the rapid completion of the work, was \$64,652.62.

In the construction of the bridge over the Missouri River, near Plattsmouth, Neb., a concrete foundation 49 feet long, 21 feet wide, and 32 feet deep, laid on shore, the excavation being through clay, bowlders, shale, and soapstone, to bed-rock (32 feet below surface of the water), cost \$39,607.23, or \$42.81 per yard for the concrete laid.†

829. The following example gives the details of the actual cost, exclusive of contractor's profits, of a coffer-dam and concrete pier on a pile foundation in water averaging 5 feet deep.‡ The coffer-dam consisted of triple-lap sheet piling of the Wakefield pattern, the planks being 2 inches thick and giving a coffer-dam wall 6 inches thick. The coffer-dam inclosed an area 14 by 20 feet, giving a clearance of 1 foot all around the base of the concrete pier, and a clearance of 2 feet between the coffer-dam and the outer edge of the nearest pile. The sheet piles were 18 feet long, were driven 11 feet deep into sand, and projected 2 feet above the surface of the water.

* *Engineering News*, vol. xiii, p. 338.

† Exclusive of cost of buildings, tools, and engineering expenses. These items amounted to 6 per cent of the total cost of the entire bridge.

‡ *Engineering-Contracting*, May 27, 1907, p. 237-38.

There were twenty-four foundation piles, which were 40 feet long and which were driven 33 feet. Upon the heads of the piles rested a concrete base, 12 by 18 feet at the bottom, 7 feet thick, and 9 by 15 feet on top. The concrete pier was 7 by 13 feet at the bottom and 5 by 11 feet at the top. There were 100 cu. yd. of concrete in the pier and the base. The detailed cost of the work, which is typical of similar work, is as follows:

ITEMS.	TOTAL COST.
<i>Coffer-dam:</i> Lumber, 7 900 ft. B.M., at \$20.00 ..	\$158.00
Labor—\$16.00 per M of lumber.....	126.00
Total—\$36.00 per M, exclusive of salvage.....	<u>284.00</u>
<i>Excavation:</i> 58 cu. yd. at 57 ct. per cu. yd.	33.00
<i>Foundation piles:</i> Material, 960 lin. ft. at 10 ct..	\$96.00
Driving—8½ ct. per lin. ft.....	80.00
Total—960 ft. at 18½ ct. per lin. ft.	<u>176.00</u>
<i>Forms:</i> Material, 2 400 ft. B.M. plank at \$25.00	\$60.00
1 000 ft. B.M. studding at \$20.00	20.00
Nails, wire, etc.	2.00
Labor 8 days at \$3.00	24.00
Total—100 cu. yd. concrete at \$1.06 exclusive of salvage	<u>106.00</u>
<i>Concrete:</i> Materials at \$3.20.....	\$320.00
Labor at \$1.46.....	146.00
Total—100 cu. yd. at \$4.66	<u>466.00</u>
<i>Plant:</i> Transportation.....	\$20.00
Setting up and taking down	70.00
Rental, 20 days at \$5.00	100.00
Total for plant	<u>190.00</u>
Total cost, exclusive of salvage	<u>\$1 255.00</u>

If the cost of the plant be distributed among the other items in proportion to the time employed, the additional cost will be as follows: Coffer-dam—\$74.00 or \$9.00 per M. ft. B. M., making a total cost of \$45.00 per M. ft. B. M. Excavation—\$21.00 or 36 cents per cu. yd., making a total cost of 93 cents per cu. yd. Foundation piles—\$42.00 or \$1.75 per pile, making a total cost of \$5.08 per pile for driving, or a total cost of 12.7 cents per lin. ft. Concrete—\$53.00 or 53 cents per cu. yd., making a total cost of \$5.19 per cu. yd., or \$6.25 including forms.

830. For data on the relative cost of different methods of constructing foundations, see Art. 6, page 456.

831. CONCLUSION. Uncertainty as to what trouble and expense a coffer-dam will develop usually causes engineers to choose some

other method of laying the foundations for bridge piers. Cofferdams are applicable in shallow depths only; hence one objection to founding bridge piers by this process, particularly in rivers subject to scour or liable to ice gorges, is the danger of their being either undermined or pushed off the foundation. When founded in mud or sand, the first mode of failure is most to be feared. This danger is diminished by the use of piles or large quantities of riprap; but such a foundation needs constant attention. When founded on rock, there is a possibility of the piers being pushed off the foundation; for, since it is not probable that the coffer-dam can be pumped perfectly dry and the bottom be thoroughly cleaned before laying the masonry or depositing the concrete, there is no certainty that there is good union between the base of the pier and the bed-rock.

Coffer-dams are frequently and advantageously employed in laying foundations in soft soils not under water, as described in § 718-19.

ART. 2. CRIB AND OPEN-CAISSON PROCESS.

832. DEFINITIONS. Unfortunately there is an ambiguity in the use of the word *caisson*. Formerly it always meant a strong, water-tight box having vertical sides and a bottom of heavy timbers, in which the pier is built and which sinks, as the masonry is added, until its bottom rests upon the bed prepared for it. With the introduction of the compressed-air process, the term *caisson* was applied to a strong, water-tight box—open at the bottom and closed at the top—upon which the pier is built, and which sinks to the bottom as the masonry is added. At present, the word *caisson* generally has the latter meaning. In the pneumatic process, a water-tight box—open at the top—is usually constructed on the roof of the working chamber (“pneumatic chamber”), inside of which the masonry is built; this box also is called a *caisson*. The *caisson* open at the bottom is sometimes called an *inverted caisson*, and the one open at the top an *erect caisson*. The latter when built over an inverted, or pneumatic, *caisson*, is sometimes called a *coffer-dam*. For greater clearness the term *caisson* will be used for the inverted, or pneumatic, *caisson*; and the erect *caisson*, which is built over a pneumatic *caisson*, will be called a *coffer-dam*. A *caisson* employed in other than pneumatic work will be called an *open caisson*.

833. PRINCIPLE. This method of constructing the foundation consists in building the pier in the interior of an open *caisson*, which sinks as the masonry is added and finally rests upon the bed prepared for it. The masonry usually extends only a foot or two below extreme low water, the lower part of the structure being composed

of timber crib-work, called simply a *crib*. The open caisson is built on the top of the crib, which is practically only a thick bottom for the box. The timber is employed because of the greater facility with which it may be put into place, as will appear presently. Timber, when always wet, is as durable as masonry; and ordinarily there is not much difference in cost between timber and stone.

If the soil at the bottom is soft and unreliable, or if there is danger of scour in case the crib were to rest directly upon the bottom, the bed is prepared by dredging away the mud (§ 839) to a sufficient depth or by driving piles which are afterwards sawed off (§ 791) to a horizontal plane.

834. CONSTRUCTION OF THE CRIB. The crib is a timber structure below the caisson, which transmits the pressure to the bed of the foundation. A crib is essentially a grillage (see § 705 and § 793) which, instead of being built in place, is first constructed and then sunk to its final resting place in a single mass. A crib is usually thicker, i. e., deeper, than the grillage. If the pressure is great, the crib is built of successive courses of squared timbers in contact; but if the pressure is small, it is built more or less open. In either case, if the crib is to rest upon a soft bottom, a few of the lower courses are built open so that the higher portions of the bed may be squeezed into these cells, and thus allow the crib to come to an even bearing. If the crib is to rest upon an uneven rock bottom, the site is first leveled up by throwing in broken stone, although this is a poor method. If the bottom is rough or sloping, the lower courses of the crib are sometimes made to conform to the bottom as nearly as possible, as determined from soundings; but this method requires care and judgment to prevent the crib from sliding off from the inclined bed, and should be used with great caution, if at all.

The crib is usually built afloat. Owing to the buoyancy of the water, about one third of a crib made wholly of timber would project above the water, and would require an inconveniently large weight to sink it; therefore, it is best to incorporate considerable stone in the crib-work. If the crib is more or less open, this is done by putting a floor into some of the open spaces or pockets, which are then filled with stone. If the crib is to be solid, about every third timber is omitted and the space filled with broken stone.

The timbers of each course should be securely drift-bolted (§ 795) to those of the course below to prevent the buoyancy of the upper portion from pulling the crib apart, and also to prevent any possibility of the upper part's sliding on the lower.

835. CONSTRUCTION OF THE CAISSON. **Wood Caisson.** The construction of the caisson differs materially with its depth. The simplest form is made by erecting studding by toe-nailing or tenoning

them into the top course of the crib and spiking planks on the outside. For a caisson 6 or 8 feet deep, which is about as deep as it is wise to try with this simple construction, it is sufficient to use studding 6 inches wide, 3 inches thick, and 6 to 8 feet long, spaced 3 feet apart, mortised and tenoned into the deck course of the crib. The sides and floor (the upper course of the crib) should be thoroughly calked with oakum. The sides may be braced from the masonry as the sinking proceeds. When the crib is grounded and the masonry is above the water, the sides of the box or caisson are knocked off.

When the depth of water is more than 6 to 8 feet, the caisson is constructed somewhat after the general method shown in Fig. 89. The sides are formed of timbers framed together and a covering of

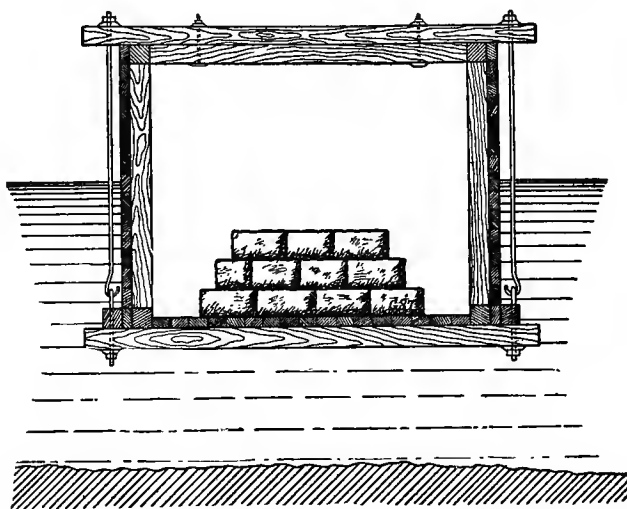

FIG. 89.—DIAGRAMMATIC REPRESENTATION OF OPEN-CAISSON AND PIER.

thick planks on the outside. The joints are carefully calked to make the caisson water-tight. In deep caissons, the sides can be built up as the masonry progresses, and thus not be in the way of the masons. The sides and bottom are held together only by the heavy vertical rods; and after the caisson has come to a bearing upon the soil, and after the masonry is above the water, the rods are detached and the sides removed, the bottom only remaining as a part of the permanent structure.

For an illustration of the form of caisson employed in sinking a foundation by the compressed-air process, see Fig. 92 and 93, page 432 and 434.

836. The caisson should be so contrived that it can be grounded, and afterwards raised in case the bed is found not to be accurately leveled. To effect this, a small sliding gate is sometimes placed in the side of the caisson for the purpose of filling it with water at pleasure. By means of this gate, the caisson can be filled and grounded; and by closing the gate and pumping out the water, it can be set afloat. The same result can be accomplished by putting on and taking off stone.

Since the caisson is a heavy, unwieldy mass, it is not possible to control the exact position in which it is sunk; and hence it should be larger than the base of the proposed pier, to allow for a little adjustment to bring the pier to the desired location. The margin to be allowed will depend upon the depth of water, size of caisson, facilities, etc. A foot all round is probably none too much under favorable conditions, and generally a greater margin should be allowed.

837. Masonry Caisson. In one case at least, there was no caisson or coffer-dam, the outer edge of the brick pier being built up ahead of the center and serving as a coffer-dam.* Sometimes the caisson itself is made of concrete, which after being sunk in place is filled with concrete or gravel—the latter in constructing a breakwater.

838. TIMBER IN FOUNDATIONS. The free use of timber in foundations is the chief difference between American and European methods of founding masonry in deep water. The consideration that led to the introduction of timber in foundations was its cheapness. Many of the more important bridges built before 1870 rest upon crib-work of round logs notched at their intersection and secured by drift-bolts; but at present, cribs are always built of squared timber. Until about the beginning of this century, there was not much difference between the cost of timber and masonry in foundations, the principal advantage in the use of timber being the facility with which it was put into place; but with the rapidly decreasing supply of timber and its consequent rapid increase in cost, and with the marked decrease in the cost of concrete, it is probable that in this country in the future not much timber will be used in foundations. Soft wood or timber which in the air has comparatively little durability, is equally as good for this purpose as the hard woods. It has been conclusively proved that any kind of timber will last practically forever, if completely immersed in water.

839. EXCAVATING THE SITE. When a pier is to be founded in a sluggish stream, it is necessary only to excavate a hole in the bed of the stream, in which the crib (or the bottom of the caisson) may rest. The excavation is usually made with a dredge, any form of which can be employed. The dipper dredge is the best, but the clam-

* Proc. Eng'g Assoc. of the South, vol. xvii, p. 77.

shell or the endless chain and bucket dredge is sometimes used. If the bottom is sand, mud, or silt, the soil may be removed (1) by pumping it with the water through an ordinary centrifugal pump (§ 823),—the suction hose of which is kept in contact with, or even a little below, the bottom,—or (2) by the Eads mud-pump (§ 877). With either of these methods of excavating, a simple frame or light coffer-dam may be sunk to keep part of the loose soil from running into the excavation.

840. If the stream is shallow, the current swift, and the bottom soft, the site may be excavated or scoured out by the river itself. To make the current scour, construct two temporary wing-dams, which diverge up-stream from the site of the proposed pier. The wings can be made by driving stout stakes or small piles into the bed of the stream, and placing solid panels—made by nailing ordinary boards to light uprights—against the piles with their lower edge on the bottom. The wings concentrate the current at the location of the pier, increase its velocity, and cause it to scour out the bed of the stream. This process requires a little time, usually one to three days, but the cost of construction and operation is comparatively slight.

When the water is too deep for the last method, it is sometimes possible to suspend the caisson a little above the bed of the stream, in which case the current will remove the sand and silt from under it. At the bridge over the Mississippi at Quincy, Ill., a hole 10 feet deep was thus scoured out. However, if the water is already heavily charged with sediment, it may drop the sediment on striking the crib and thus fill up instead of scour out. Notwithstanding the hole is liable to be filled up by the gradual action of the current or by a sudden flood before the crib has been placed in its final position, this method is frequently more expeditious and less expensive than using a coffer-dam.

841. If the crib should not rest squarely upon the bottom, it can sometimes be brought down with a water jet (§ 757-58) in the hands of a diver. However, the engineer should not employ a diver unless absolutely necessary, as the expense is very great.

842. If the soft soil extends to a considerable depth, or if the necessary spread of foundation can not be obtained without an undesirable obstruction of the channel, or if the bottom is likely to scour, then piles may be driven, upon which the crib or caisson may finally rest. Before the introduction of the compressed-air process, this was a very common method of founding bridge piers in our Western rivers; and it is still frequently employed for small piers. The method of driving and sawing off the piles has already been described—see Chapter XV.

The mud over and around the heads of the piles may be sucked off with a pump, or it may be scoured out by the current (§ 840). The attempt is sometimes made to increase the bearing power of the foundation by filling in between the heads of the piles with broken stone; but this is not good practice as the stone does but little good, is difficult to place, and is likely to get on top of the piles and prevent the crib from coming to a proper bearing.

ART. 3. DREDGING THROUGH WELLS.

843. A timber crib is frequently sunk by excavating the material through compartments left for that purpose, thus undermining the crib and causing it to sink. Hollow iron cylinders or wells of masonry with a strong curb, or ring, of timber or iron beneath them are sunk in the same way.

This method is applicable to foundations both on dry land and under water. It is also sometimes employed in sinking shafts in tunneling and mining.

844. The advantage of this method for foundations under water is that it is applicable to greater depths than any other method except the freezing process; and the disadvantage is that the descent of the crib or cylinder is liable to be stopped by logs, bowlders, etc.

845. EXCAVATORS. The soil is removed from under the crib with a clam-shell or an orange-peel dredge, or with an endless chain and bucket dredge, or with the Eads pump (§ 877).

The clam-shell dredge consists of the two halves of a hemispherical shell, which rotate about a horizontal diameter; the edges of the shell are forced into the soil by the weight of the machine itself, and the pull upon the chain to raise the excavator draws the two halves together, thus forming a hemispherical bucket which incloses the material to be excavated. A similar device consists of two quadrants of a short cylinder, hinged and operated similarly to the above. The orange-peel dredge (shown at A in Fig. 90, page 424) appears to have the preference for this kind of work. It consists of a frame from which are suspended a number of spherical triangular spades which are forced vertically into the ground by their own weight. The pull upon the excavator to lift it out of the mud draws these triangles together and incloses the earth to be excavated.

846. In one case in France, the soil was excavated by the aid of compressed air. An 8-inch iron tube rested on the bottom, with its top projecting horizontally above the water; and compressed air was discharged through a small pipe into the lower end of the 8-inch tube. The weight of the air and water in the tube was less than an equal height of the water outside; and hence the water in the

tube was projected from the top, and carried with it a portion of the mud, sand, etc. Pebbles and stones of considerable size were thus thrown out. See § 876 for another use of a similar device.

847. NOTED EXAMPLES.—Poughkeepsie Bridge. The Poughkeepsie Bridge, which crosses the Hudson at a point about 75 miles above New York City, is founded upon cribs, and is the boldest example of timber foundation on record. It was erected in 1886-87, and is remarkable both for the size of the cribs and for the depth of the foundations.

There are four river piers. The crib for the largest is 100 feet long, 60 feet wide at the bottom and 40 feet at the top, and 104 feet high. It is divided, by one longitudinal and six transverse walls, into fourteen compartments through which the dredge worked. The side and division walls terminate at the bottom with a 12- by 12-inch oak stick, which served as a cutting edge. The exterior walls and the longitudinal division wall were built solid, of triangular cross section, for 20 feet above the cutting edge, and above that they were hollow. The gravel used to sink the crib was deposited in these hollow walls. The longitudinal walls were securely tied to each other by the end and cross division walls, and each course of timber was fastened to the one below by 450 1-inch drift-bolts 30 inches long. The timber was hemlock, 12 inches square. The fourteen compartments in which the clam-shell dredges worked were 10 by 12 feet in the clear. The cribs were kept level while sinking by excavating from first one and then the other of the compartments. Gravel was added to the pockets as the crib sunk. When hard bottom was reached, the dredging pockets were filled with concrete deposited under water from boxes holding one cubic yard each and opened at the bottom by a latch and trip-line.

After the crib was in position, the masonry was started in a floating caisson which finally rested upon the top of the crib. Sinking the crib and caisson separately was a departure from the ordinary method. Instead of using a floating caisson, it is generally considered better to construct a coffer-dam on top of the crib, in which to start the masonry. If the crib is sunk first, the stones which are thrown into the pockets to sink it are likely to be left projecting above the top of the crib and thus prevent the caisson from coming to a full and fair bearing.

The largest crib was sunk through about 53 feet of water, 20 feet of mud, 45 feet of clay and sand, and 17 feet of sand and gravel. It rests, at 134 feet below high water, upon a bed of gravel 16 feet thick, overlying bed-rock. The timber work is 110 feet high, including the floor of the caisson, and extends to 14 feet below high water (7 feet below low water), at which point the masonry commences

and rises 39 feet. On top of the masonry a steel tower 100 feet high is erected. The masonry in plan is 25 by 87 feet, and has nearly vertical faces. The lower chord of the channel span is 130 feet and the rail is 212 feet above high water.

The other piers are nearly as large as the one here described. The cribs each contain an average of 2,500,000 feet, board measure, of timber and 350 tons of wrought iron.

848. Atchafalaya Bridge. This bridge is over the Atchafalaya bayou or river, at West Melville, La., about 80 miles west of New Orleans. The soil is alluvial to an unknown depth, and is subject to rapid and extensive scour; and no stone suitable for piers could be found within reasonable distance. Hence iron cylinders were

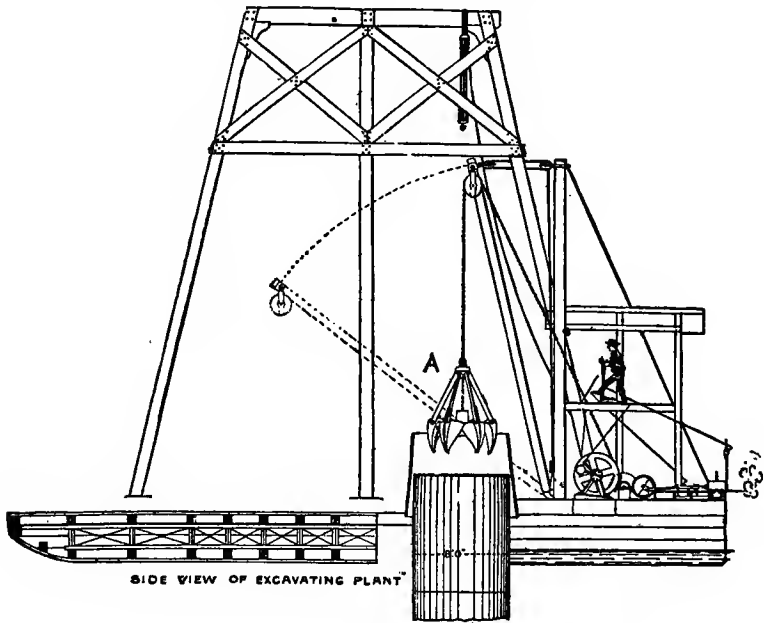

FIG. 90.—SINKING IRON TUBE BY DREDGING THROUGH IT.

adopted. They are foundation and pier combined. The cylinders were sunk 120 feet below high water—from 70 to 115 feet below the mud line—by dredging the material from the inside with an orange-peel excavator. Fig. 90 shows the excavator, A, and the appliances for handling the cylinders.

The cylinders are 8 feet in outside diameter. Below the level of the river bed, they are made of cast iron $1\frac{1}{4}$ inches thick, in lengths

of $10\frac{1}{2}$ feet, the sections being bolted together through inside flanges with 1-inch bolts spaced 5 inches apart. Above the river bottom, the cylinders are made of wrought-iron plates $\frac{3}{8}$ inches thick, riveted together to form short cylindrical sections with angle-iron flanges. The bolts and spacing to unite the sections are the same as in the cast-iron portions.

The cylinders were filled with concrete and capped with a heavy cast-iron plate. Two such cylinders, braced together, form the pier between two 250-foot spans of a railroad bridge.

The only objection to such piers relates to their stability. These have stood satisfactorily since 1883.

849. Hawkesbury Bridge. The bridge over the Hawkesbury River in south-eastern Australia is remarkable for the depth of the foundation. It is founded upon elliptical iron caissons 48 by 20 feet at the cutting edge, which rest upon a bed of hard gravel 126 feet below the river bed, 185 feet below high water, and 227 feet below the track on the bridge. The soil penetrated was mud and sand. The caissons were sunk by dredging through three tubes, 8 feet in diameter, terminating in bell-mouthed extensions, which met the cutting edge. The spaces between the dredging tubes and the outer shell were filled with gravel as the sinking progressed. The caissons were filled to low water with concrete, and above with cut-stone masonry.

850. As these caissons were to be sunk to an unprecedented depth, it was considered wise to construct them with a flare at the bottom, that is, to make the bottom larger than the upper portion, so as to decrease the resistance due to friction. Experience showed that making the bottom larger was a mistake, since it seriously increased the difficulty of guiding the caisson in its descent.

851. Brick Cylinders. In Germany a brick cylinder was sunk 256 feet for a coal shaft. A cylinder $25\frac{1}{2}$ feet in diameter was sunk 76 feet through sand and gravel, when the frictional resistance became so great that it could be sunk no farther. An interior cylinder, 15 feet in diameter, was then started in the bottom of the larger one, and sunk 180 feet further through running quicksand. The soil was removed without exhausting the water.

A brick cylinder—outer diameter 46 feet, thickness of wall 3 feet—was sunk 40 feet in dry sand and gravel without any difficulty. It was built 18 feet high (on a wooden curb 21 inches thick), and weighed 300 tons before the sinking was begun. The interior earth was excavated slowly, so that the sinking was about 1 foot per day,—the walls being built up as it sank.

852. In Europe and India masonry bridge piers are sometimes sunk by this process, a sufficient number of vertical openings being

left through which the material is brought up. It is generally a tedious and slow operation. To lessen the friction a ring of masonry is sometimes built inside of a thin iron shell. The last was the method employed in putting down the foundations for the present Tay bridge.*

853. FRICTIONAL RESISTANCE. Values from Experiments. The friction between cylinders and the soil depends upon the nature of the soil, the depth sunk, and the method used in sinking. If the cylinder is sunk by either of the pneumatic processes (§ 859 and 860), the flow of the water or the air along the sides of the tube greatly diminishes the friction. It is impossible to give any very definite data.

Table 66 gives the values of the coefficient of friction for materials and surfaces which are likely to occur in sinking foundations for bridge piers. Each result is the average of at least ten experiments.

TABLE 66.

COEFFICIENT OF FRICTION OF MATERIAL AND SURFACES USED IN FOUNDATIONS.*

KIND OF MATERIALS.	FOR DRY MATERIALS.		FOR WET MATERIALS.	
	At Beginning of Motion.	During Motion.	At Beginning of Motion.	During Motion.
Sheet iron without rivets on gravel and sand	0.40	0.46	0.33	0.44
“ “ with “ “ “ “ “	0.40	0.49	0.47	0.55
Cast iron (unplaned) on gravel and sand	0.37	0.47	0.36	0.50
Granite (roughly worked) on gravel and sand	0.43	0.54	0.41	0.48
Pine (sawed) on gravel and sand	0.41	0.51	0.41	0.50
Sheet iron without rivets on sand	0.54	0.63	0.37	0.32
“ “ with “ “ “	0.73	0.84	0.52	0.50
Cast iron (unplaned) on sand	0.56	0.61	0.47	0.38
Granite (roughly worked) on sand	0.65	0.70	0.47	0.53
Pine (sawed) on sand	0.66	0.73	0.58	0.48

* By A. Schmoll in "Zeitschrift des Vereines Deutscher Ingenieure," as republished in Selected Abstracts of Inst. of C. E., vol. lii, p. 298-302.

"All materials were rounded off at their face to sledge shape and drawn lengthwise and horizontally over the gravel or sand, the latter being leveled and bedded as solid as it is likely to be in its natural position. The riveted sheet iron contained twenty-five rivets on a surface of 2.53 by 1.67 = 4.22 square feet; the rivet-heads were half-round and $\frac{1}{8}$ inch in diameter." Notice that for dry materials and also for wet gravel and sand, the frictional resistance

* For an illustrated account, see *Engineering News*, vol. xiv, p. 66-68.

at starting is smaller than during motion, which is contrary to the ordinary statement of the laws of friction.

854. Values from Practice. Cast Iron. During the construction of the bridge over the Seine at Orival, a cast-iron cylinder, standing in an extensive and rather uniform bed of gravel, and having ceased to move for thirty-two hours, gave a frictional resistance of nearly 200 lb. per sq. ft.* At a bridge over the Danube near Stadlau, a cylinder sunk 18.75 feet into the soil (the lower 3.75 feet being "solid clay") gave a frictional resistance of 100 lb. per sq. ft.* According to some European experiments, the friction of cast-iron cylinders in sand and river mud was from 400 to 600 lb. per sq. ft. for small depths, and 800 to 1,000 for depths from 20 to 30 feet.† At the first Harlem River Bridge, New York City, the frictional resistance of a cast-iron pile, while the soil around it was still loose, was 528 lb. per sq. ft. of surface; and later 716 lb. per sq. ft. did not move it. From these two experiments, McAlpine, the engineer in charge, concluded that "1,000 lb. per sq. ft. is a safe value for moderately fine material."‡ At the Omaha Bridge, a cast-iron pile sunk 27 feet in sand, with 15 feet of sand on the inside, could not be withdrawn with a pressure equivalent to 254 lb. per sq. ft. of surface in contact with the soil; and after removal of the sand from the inside, it moved with 200 lb. per sq. ft.§

Wrought Iron. A wrought-iron pile, penetrating 19 feet into coarse sand at the bottom of a river, gave 280 lb. per sq. ft.; another, in gravel, gave 300 to 335 lb. per sq. ft.**

Masonry. In the silt on the Clyde, the friction on brick and concrete cylinders was about $3\frac{1}{2}$ tons per sq. ft.†† The friction on the brick piers of the Dufferin (India) Bridge, through clay, was 900 lb. per sq. ft.‡‡

Pneumatic Caissons. For data on the frictional resistance of pneumatic caissons, see § 887.

Piles. For data on the frictional resistance of ordinary piles, see § 781-84, p. 398.

855. COST. It is difficult to obtain data under this head, since but comparatively few foundations have been put down by this process. Furthermore, since the cost varies so much with the depth of water, strength of current, kind of bottom, danger of floods,

* Van Nostrand's *Engin'g Mag.*, vol. xx, p. 121-22.

† Proc. Inst. of C. E., vol. 1, p. 131.

‡ McAlpine in Jour. Frank. Inst., vol. lv, p. 105; also Proc. Inst. of C. E., vol. xxvii, p. 286

§ Van Nostrand's *Engin'g Mag.*, vol. viii, p. 471.

** Proc. Inst. of C. E., vol. xv, p. 290.

†† *Ibid.*, vol. xxxiv, p. 35.

‡‡ *Engineering News*, vol. xix, p. 160.

requirements of navigation, etc., no such data are valuable unless accompanied by endless details.

856. For the relative cost of different methods, see Art. 6 of this chapter.

857. CONCLUSION. A serious objection to this method of sinking foundations is the possibility of meeting wrecks, logs, or other obstructions, in the underlying materials; but, with the possible exception of the freezing process (see Art. 5 of this chapter), the method by dredging through tubes or wells is the only one that can be applied to depths which much exceed 100 feet—the limit of the pneumatic process.

ART. 4. PNEUMATIC PROCESS.

858. The principle involved is the utilization of the difference between the pressure of the air inside and outside of an air-tight chamber. The air-tight chamber may be either a pneumatic pile—an iron cylinder which becomes at once foundation and pier,—or a pneumatic caisson—a box, open below and air-tight elsewhere, upon the top of which the masonry pier rests. The pneumatic pile is seldom used now. There are two methods of utilizing this difference of pressure,—the vacuum process and the plenum or compressed-air process.

859. VACUUM PROCESS. The vacuum process consists in exhausting the air from a cylinder, and using the pressure of the atmosphere upon the top of the cylinder to force it down. Exhausting the air allows the water to flow past the lower edge into the air-chamber, thus loosening the soil and causing the cylinder to sink. By letting the air in, the water subsides, after which the exhaustion may be repeated and the pile sunk still farther. The vacuum should be obtained suddenly, so that the pressure of the atmosphere shall have the effect of a blow; hence, the pile should be connected by a large flexible tube with a large air-chamber—usually mounted upon a boat,—from which the air is exhausted. When communication is opened between the pile and the receiver, the air rushes from the former into the latter to establish equilibrium, and the external pressure causes the pile to sink.

To increase the rapidity of sinking, the cylinders may be forced down by a lever or by an extra load applied for that purpose. In case the resistance to sinking is very great, the material may be removed from the inside by a sand-pump (§ 877), or an orange-peel or clam-shell dredge (§ 845); but ordinarily no earth is removed from the inside. Cylinders have been sunk by this method 5 or 6 feet by a single exhaustion, and 24 feet in 6 hours.

860. COMPRESSED-AIR PROCESS. The plenum or compressed-air process consists in pumping air into the air-chamber, so as to exclude the water, and forcing the pile or caisson down by a load placed upon it. An air-lock (§ 864) is so arranged that the workmen can pass into the caisson to remove the soil, logs, and bowlders, and to watch the progress of the sinking, without releasing the pressure. The vacuum process is applicable only in mud or sand; but the compressed-air process can be applied in all kinds of soil.

Many times in sinking foundations by the vacuum process, the compressed-air process was resorted to so that men could enter the pile to remove obstructions; and finally the many advantages of the compressed-air process caused it to entirely supersede the vacuum process. At present the term pneumatic process is practically synonymous with compressed-air process.

861. HISTORY. The first foundations sunk entirely by the compressed-air process were the pneumatic piles for the bridge at Rochester, England, put down in 1851. The depth reached was 61 feet.

The first pneumatic caisson was employed about 1870, at Kehl on the eastern border of France, for the foundations of a railroad bridge across the Rhine.

862. The first three pneumatic pile foundations in America were constructed in South Carolina between 1856 and 1860. Immediately after the civil war, a number of pneumatic piles were sunk in Western rivers for bridge piers. The first pneumatic caissons in America were those for the St. Louis Bridge (§ 889), put down in 1870. At that time these were the largest caissons ever constructed, and the depth reached—109 ft. 8½ in.—was not exceeded until 1911 (§ 884).

863. PNEUMATIC PILES. Pneumatic piles were once considerably used for bridge piers, but have now been superseded for that purpose by pneumatic caissons. Since 1894 the compressed-air process has been frequently employed in constructing foundations for tall buildings on Manhattan Island, New York City, and in some cases the pneumatic pile has been used, although it is there usually called a caisson. The following description applies more particularly to the pneumatic piles formerly used for bridge piers,—the practice in New York City being considered later.

The cylinders were made of either wrought or cast iron. The wrought-iron cylinders were composed of plates, about half an inch thick, riveted together and strengthened by angle irons on the inside, and reinforced at the cutting edge by plates on the outside both to increase the stiffness and to make the hole a little larger so as to diminish friction. The cast-iron cylinders were composed of sections, from 6 to 10 feet long and 2 to 8 feet in diameter, bolted together by inside flanges, the lower section being cast with a sharp edge to

facilitate penetration. Two of these tubes, braced together, were employed for ordinary bridge piers; and six small ones around a large one for a pivot pier. They were filled with concrete, with a few courses of masonry or a heavy iron cap at the top.

Fig. 91 shows the arrangement of the essential parts of a pneumatic pile. The apparatus as shown is arranged for sinking by the plenum process; for the vacuum process the arrangement differs only in a few obvious particulars. The upper section constitutes the *air-lock*. The doors *A* and *B* both open downwards. To enter the cylinder, the workmen pass into the air-lock, and close the door *A*. Opening the cock *D* allows the compressed air to enter the lock; and when the pressure is equal on both sides, the door *B* is opened and the workmen pass down the cylinder by means of a ladder. To save loss of air, the air-lock should be opened very seldom, or made very small if required to be opened often.

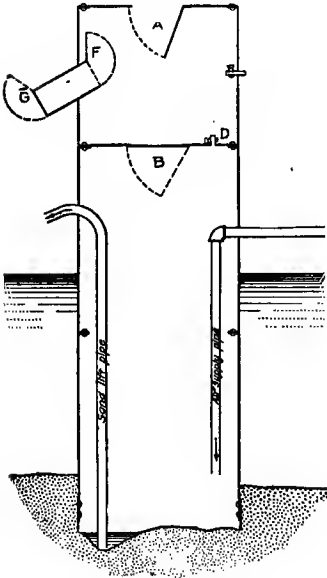

FIG. 91.—PNEUMATIC PILE.

The air-supply pipe connects with a reservoir of compressed air on a barge. If the air were pumped directly into the pile without the intervention of a storage reservoir, as was done in the early applications

of the plenum process, even a momentary stoppage of the engine would endanger the lives of the workmen.

864. The soil was excavated by ordinary hand tools, elevated to the air-lock by a windlass and bucket, and passed out through the main air-lock. Sometimes a double air-lock with one large and one small compartment was used, the former being opened only to let gangs of workmen pass and the latter to allow the passage of the skip, or bucket, containing the excavated material. Sometimes an auxiliary lock, *F G*, was employed. The doors *F* and *G* are so connected by parallel bars (not shown) that only one can be opened at a time. The excavated material is thrown into the chute, the door *F* is closed, which opens *G*, and the material discharges itself on the outside.

Mud and sand are blown out with the sand-lift (§ 876) or mud-pump (§ 877) without the use of any air-lock.

865. The cylinders were guided in their descent by a framework resting upon piles or upon two barges. One of the chief difficulties in sinking pneumatic piles was to keep them vertical. If the cylinder became inclined, it was righted (1) by placing wooden wedges under the lower side of the cutting edge, or (2) by excavating under the upper side so that the air could escape and loosen the material on that side, or (3) by drilling holes through the uppermost side of the cylinder through which air could escape and loosen the soil, or (4) by straining the top over with props or tackle. If several pneumatic piles are to form a pier, they should be sunk one at a time, for when sunk at the same time they are liable to run together.

866. After the cylinder had reached the required depth, concrete enough to seal it was laid in compressed air; and when this had set, the remainder was laid in the open air. A short section at the top was usually filled with good masonry, and a heavy iron cap was put over all.

867. PNEUMATIC CAISSONS. A pneumatic caisson is an immense box—open below, but air-tight and water-tight elsewhere,—upon the top of which the masonry pier is built. The essential difference between the pneumatic pile and the pneumatic caisson is one of degree rather than one of quality. Sometimes the caisson envelops the entire masonry of the pier; but in the usual form the masonry envelops the iron cylinder and rests upon an enlargement of the lower end of it. The pneumatic pile is sunk to the final depth before being filled with concrete or masonry; but with the caisson the masonry is built upward while the whole pier is being sunk downward, the masonry thus forming the load which forces the caisson into the soil. A pneumatic caisson is, practically, a gigantic diving-bell upon the top of which the masonry of the pier rests.

The principles involved in the construction of pneumatic caissons can be best explained in connection with a description of a few noted examples.

868. Blair Bridge. Fig. 92, page 432, is a section of a channel pier of the bridge across the Missouri River near Blair, Nebraska, and shows the form of construction employed by Mr. George S. Morison on a number of large bridges erected by him.

The apartment in which the men are at work is known as the *working chamber* or the *air-chamber*. The mass of timber between the top of the air-chamber and the lowest course of masonry is called the roof of the caisson. The shaft (shown in black) through the roof of the caisson, and connecting with a similar shaft (shown in white) through the pier, is called the air-shaft, and is for the ascent and descent of the men. The *air-lock*—situated at the junction of the two cylinders which form the air-shaft—consists of a short section

of a large cylinder which envelops the ends of the two sections of the air-shaft, both of which communicate with the air-lock by doors. The small cylinders shown on each side of the air-shaft are employed in

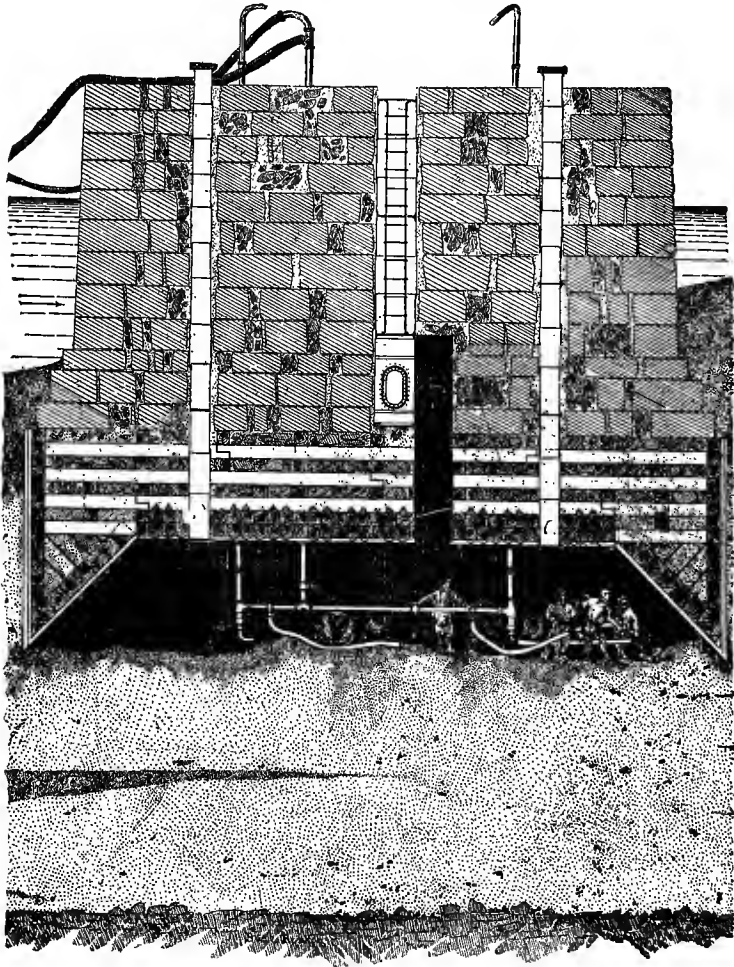

FIG. 92.—PNEUMATIC CAISSON. CHANNEL PIER BLAIR BRIDGE.*

supplying concrete for filling the working chamber when the sinking is completed. The pipes seen in the air-chamber and projecting above the masonry are employed in discharging the mud and sand, as will

* From the report of Geo. S. Morison, chief engineer of the bridge.

be described presently. The timbers which appear in the lower central portion of the working chamber are parts of the trusses which support the central portions of the roof of the caisson.

869. The main portion of the caisson is built of timbers 12 inches square drift-bolted together. Some of the roof timbers are omitted and the space is filled with stone or concrete to facilitate the floating of the caisson from the place of construction to the bridge site. The side walls of the working chamber in this form of caisson are unusually strong. The timbers forming the inclined face are 17 inches square, and are continuous from one outside wall to the opposite one, being cut to a 12-inch square having vertical sides where they enter the outside wall and also where they intersect the other inclined wall. Mr. Morison thought this construction was necessary, but experience seems not to justify the expense of this type of construction.

The masonry is usually begun about 2 feet below low water, the space intermediate between the masonry and the roof of the working chamber being occupied by timber crib-work, either built solid or filled with concrete. In Fig. 92 the masonry rests directly upon the roof of the air-chamber, which construction was adopted for the channel piers of this bridge to reduce to a minimum the obstruction to the flow of the water.

Frequently a coffer-dam is built upon the top of the crib (see Fig. 93, page 434); but in this particular case the masonry was kept above the surface of the water, hence no coffer-dam was employed. When the coffer-dam is not used, it is necessary to regulate the rate of sinking by the speed with which the masonry can be built, which is liable to cause inconvenience and delay. When the coffer-dam is dispensed with, it is necessary to go on with the construction of the masonry whether or not the additional weight is needed in sinking the caisson.

870. **Havre de Grace Bridge.** Fig. 93, page 434, and Fig. 94, page 438, show the construction of the caisson, crib, and coffer-dam employed by Gen. William Sooy Smith in 1884 in sinking pier No. 8 of the Baltimore and Ohio R. R. bridge across the Susquehanna River at Havre de Grace, Md. This is the type formerly employed, by that engineer in a number of large bridges erected by him, and in a general way is the ordinary form used by American engineers for pneumatic caissons for bridge work.*

* For detailed drawings of the caissons of the Williamsburg bridge over East River, New York City (built in 1896-98), see *Engineering-Contracting*, vol. xxvi, p. 34-36; for detailed drawings of the caissons of the bridge over the St. Lawrence River at Quebec (foundations sunk in 1897-1902), see *Engineering News*, vol. xlix, p. 92-98, or *Engineering Record*, vol. xl, p. 74-76; for illustration and detailed description of the caissons for the Manhattan bridge across East River, New York City (built in 1901-09), see *Engineering News*, vol. xlv, p. 171-73, or *Engineering Record*, vol. xliii, p. 194-96.

The caisson shown in Fig. 93 has a slight flare, but subsequent experience has shown this to be undesirable, since the caisson can be guided more certainly when it has vertical sides.

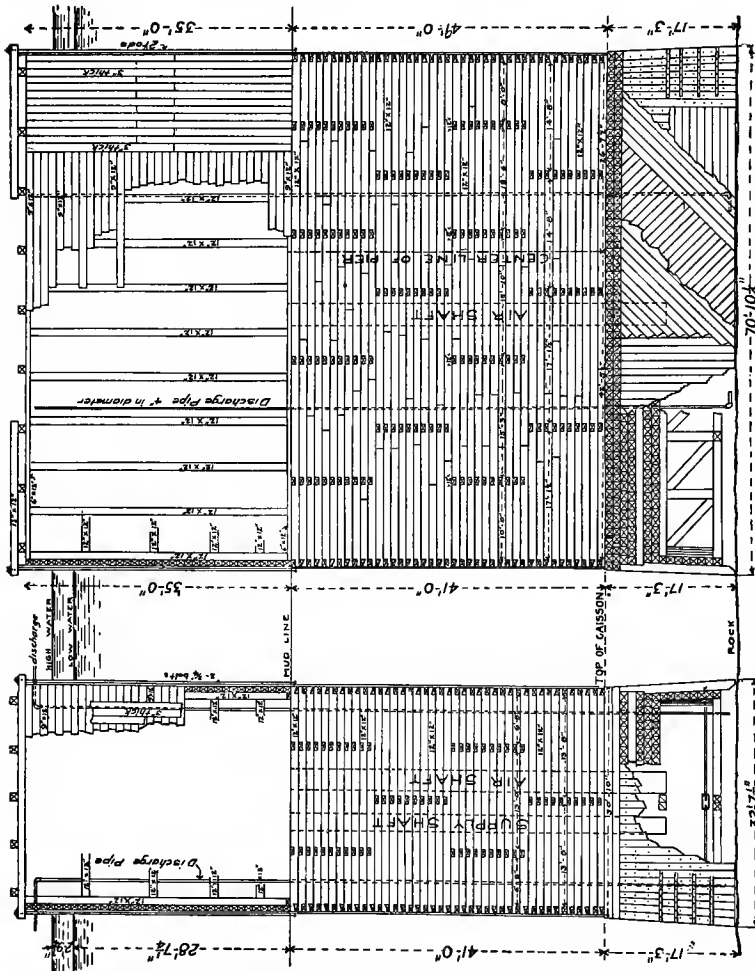

FIG. 93.—CAISSON, CRIB, AND COFFER-DAM OF HAVRE DE GRACE BRIDGE.

871. Table 67 gives the dimensions and quantities of materials in the pneumatic foundations of this bridge, and Table 69 (page 449) gives the cost.

872. **POSITION OF THE AIR LOCK.** Before the construction of the Eads Bridge (§ 889) at St. Louis, Mo., in 1870-74, the air-lock had

always been placed at the top of the air-shaft, and was of such construction that to lengthen the shaft, as the caisson sunk, it was necessary to detach the lock, add a section to the shaft, and then replace the lock on top. This was not only inconvenient and an interruption to the other work, but required the men to climb the entire distance under compressed air, which is exceedingly fatiguing (see § 895). To overcome these objections, Eads placed the air-lock at the bottom of the shaft in the air-chamber. This position is objectionable, since in case of a "blow-out," i.e., a rapid leakage of air,—not an unfrequent occurrence,—the men may not be able to get into the lock in time to escape drowning. If the lock is at the top, they can get out of the way of the water by climbing up in the shaft.

At the Havre de Grace Bridge (§ 870-71), the air-shaft was constructed of wrought iron, in sections 15 feet long. The air-lock was

TABLE 67

DIMENSIONS AND QUANTITIES OF MATERIALS IN FOUNDATIONS OF HAVRE DE GRACE BRIDGE.*

DESCRIPTION	NUMBER OF THE PIER.				
	II.	III.	IV.	VIII.	IX.
<i>Dimensions:</i>					
Caissons: length at bottom in feet	63.3	67.3	79.4	70.9	78.2
width " " " "	25.9	25.9	32.8	32.6	42.3
height from cutting edge, in feet.....	17.2	17.2	17.2	17.2	19.3
height of working chamber, in feet..	9.2	9.2	9.2	9.2	9.2
Crib: length, in feet.....	61.5	61.5	77.6	69.1	76.4
width, " "	24.2	24.2	31.1	30.8	40.5
height, " "	40.0	42.0	22.2	41.0	32.8
<i>Quantities:</i>					
Timber in the caisson, feet, board measure	203 473	215 565	316 689	281 540	465 125
Timber in the crib, feet, board measure	179 939	197 910	143 993	219 680	203 824
Timber in the coffer-dam, feet, board measure	2 068	31 517	108 518	85 759	126 532
Concrete in working chamber, cubic yards	330	401	631	559	839
Concrete in crib, shafts, etc., cubic yards	1 649	1 893	1 635	2 581	3 172
Concrete below cutting edge, cubic yards	000	623	126	526	624
Iron, screw-bolts, pounds	11 313	15 651	32 881	31 026	33 435
drift-bolts, "	34 181	36 832	40 909	44 861	59 245
spikes, "	4 638	700	11 730	10 039	11 237
cast washers, "	2 472	2 572	3 392	3 235	3 535

* The data by courtesy of SooySmith & Co., contractors for the pneumatic foundations.

made by placing diaphragms on the inside flanges of the opposite ends of the top section. A new section and a third diaphragm could be added without disturbing the air-lock; and when the third diaphragm was in place, the lower one was removed preparatory to using it again. Some engineers compromise between these two positions, and leave the air-lock permanently at some intermediate point in the pier near the bottom (see Fig. 92, page 432).

873. It will be shown presently (§ 897) that with deep foundations it is very desirable to have an elevator for carrying the workmen up and down, and hence it is better to have the air-lock near the bottom of the shaft; but for the safety of the men it should not be in the working chamber. However, an elevator for the men is a comparatively recent invention, and is used only in the deepest work.

874. EXCAVATION. In the early application of the pneumatic method, the material was excavated with shovel and pick, elevated in buckets or bags by a windlass, and stored in the air-lock. When the air-lock was full, the lower door was closed, and the air in the lock was allowed to escape until the upper door could be opened, and then the material was thrown out. This method was expensive and slow.

875. Auxiliary Air-Lock. In the first application of the pneumatic process in America (§ 862), Gen. Wm. Sooy Smith invented the auxiliary air-lock, *F G*, Fig. 91 (page 430), through which to let out the excavated material. The doors, *F* and *G*, are so connected to each other that only one of them can be opened at a time. The excavated material being thrown into the chute, the closing of the door *F* opens *G* and the material slides out. This simple device is said to have increased threefold the amount of work that could be done.

876. Sand-lift. This is a device, first used by Gen. Wm. Sooy Smith, for forcing the sand and mud out of the caisson by means of the pressure in the working chamber. It consists of a pipe, reaching from the working chamber to the surface (see Fig. 91, 92, and 93), controlled by a valve in the working chamber. The sand is heaped up around the lower end of the pipe, the valve opened, and the pressure forces a continuous stream of air and sand up and out. Mud or semi-liquid soil may be removed by this means by immersing the lower end of the tube and opening the valve; but this method is most effective with sand.

The sand-lift is eight to ten times as expeditious as the auxiliary air-lock. Of course, the efficiency of the sand-lift varies with the depth, i.e., with the pressure. The "goose-neck," or elbow at the top of the discharge pipe, is worn away very rapidly by the impact of the ascending sand and pebbles. At the Havre de Grace Bridge,

it was of chilled iron 4 inches thick on the convex side of the curve, and even then lasted only two days. At the Brooklyn Bridge, the discharge pipe terminated with a straight top, and the sand was discharged against a block of granite placed in an inclined position over the upper end.

Although the sand-lift is efficient, there are some objections to it: (1) forcing the sand out by the pressure in the caisson decreases the pressure, which causes, particularly in pneumatic piles or small caissons, the formation of vapors so thick as to prevent the workmen from seeing; (2) the diminished pressure allows the water to flow in under the cutting edge; and (3) if there is much leakage, the air-compressors are unable to supply the air fast enough.

877. Mud-pump. During the construction of the St. Louis Bridge, Capt. James B. Eads invented a mud-pump, which is free from the above objections to the sand-lift, and which in mud or silt is more efficient than it. This device is generally called a sand-pump, but is more properly a mud-pump.

The principle involved in the Eads pump is the same as that employed in the atomizer, the inspirator, and the injector, viz.: the principle of the induced current. This principle is utilized by discharging a stream of water with a high velocity on the outside of a small pipe, which produces a partial vacuum in the latter, when the pressure of the air on the outside forces the mud through the small pipe and into the current of water by which the mud is carried away. The current of water is the motive power.

Fig. 94, page 438, is an interior view of the caisson of the Baltimore and Ohio R. R. bridge at Havre de Grace, Md., and shows the general arrangement of the pipes and the mud-pump. The pump itself is a hollow pear-shaped casting, about 15 inches in diameter and 15 inches long, a section of which is shown in the corner of Fig. 94. The water is forced into the pump at *a*, impinges against the conical casing, *d*, flows around this lining and escapes upwards through a narrow annular space, *f*. The interior casing gives the water an even distribution around the end of the suction pipe. The flow of the water through the pump can be regulated by screwing the suction pipe in or out, thus closing or opening the annular space, *f*. To prevent the too rapid feeding or the entrance of lumps, which might choke the pipe, a strainer—simply a short piece of pipe, plugged at the end, having a series of $\frac{1}{2}$ -inch to $\frac{3}{4}$ -inch holes bored in it—was put on the bottom of the suction pipe. The discharge pipe of the mud-pump terminates in a "goose-neck" through which the material is discharged horizontally.

The darkly shaded portions of the section of the pump wear away rapidly; and hence they are made of the hardest steel and

constructed so as to be readily removed. Different engineers have different methods of providing for the renewal of these parts, the outline form of the pump varying with the method employed. The pump used at the St. Louis Bridge was cylindrical in outline, but otherwise essentially the same as the above.

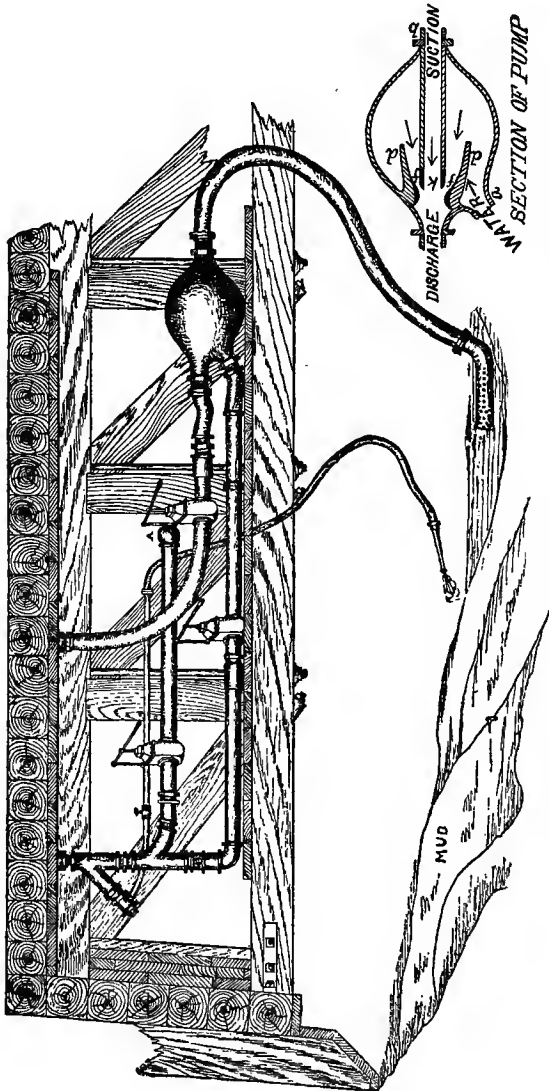

FIG. 94.—INTERIOR VIEW OF PNEUMATIC CAISSON OF HAVRE DE GRACE BRIDGE.

878. In order to use the mud-pump, the material to be excavated is first mixed into a thin paste by playing upon it with a jet of water. This pump is used only for removing mud, silt, and soil containing small quantities of sand; pure sand or soil containing large quantities of sand is "blown out" with the sand-lift.

The water is delivered to the mud-pump under a pressure, ordinarily, of 80 or 90 pounds to the square inch. At the St. Louis Bridge it was found that a mud-pump of $3\frac{1}{2}$ -inch bore was capable of raising 20 cubic yards of material 120 feet per hour, the water pressure being 150 pounds per square inch.*

879. Clay-Hoist. Neither the sand-lift nor the mud-pump is suitable for the excavation of stiff clay; and, as at the Memphis Bridge the caissons were large and were to be sunk a considerable distance through stiff clay, Mr. George S. Morison invented a device for hoisting clay in a bucket by means of compressed air. The clay-hoist consisted of a cylinder and piston placed at one side of the top of the material shaft. The piston was actuated by air pressure, and was connected to a cable to which was attached a bucket working up and down through the material shaft. At the top of the shaft were two doors operated by levers from the outside. The bucket held $6\frac{1}{2}$ cu. ft. The device was very effective.

880. Moran Air-Lock. Moran's air-lock consists of a lock, at the top of the material shaft, closed at both top and bottom by a pair of sliding doors so arranged as to permit of hoisting buckets of material out of the air-chamber by means of a derrick and cable. The doors are moved by compressed air, and are inter-locked so that one can not be opened until the other is closed. On the cable is a stuffing-box which fits into a semicircular groove in the edges of the two halves of the upper door, and permits the bucket to be raised or lowered while the upper door is closed. This lock is very effective, since in ordinary operations the bucket usually passes the lock with only about 5 seconds delay, and can do it with a delay of only 2 seconds.

881. Water-column. A combination of the pneumatic process and that of dredging in the open air through tubes has been employed

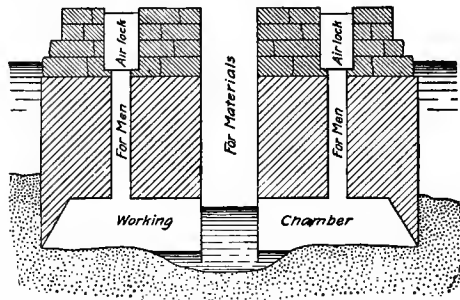

FIG. 95.—WATER-COLUMN. BROOKLYN BRIDGE.

* History of the St. Louis Bridge, p. 213.

extensively in Europe. It seems to have been used first at the bridge across the Rhine at Kehl. The same method was used at the Brooklyn Bridge. The principle is rudely illustrated in Fig. 95, page 439. The central shaft, which is open top and bottom, projects a little below the cutting edge, and is kept full of water, the greater height of water in the column balancing the pressure of the air in the chamber. The workmen simply push the material under the edge of a water shaft from whence it is excavated by an orange-peel or clam-shell dredge (§ 845).

882. Blasting. Boulders or points of rock may be blasted in compressed air without any appreciable danger of a "blow out" or of injuring the ear-drums of the workmen. This point was settled in sinking the foundations of the Brooklyn Bridge; and since then blasting has been resorted to in many cases. Boulders are sometimes "carried down," that is, are allowed to remain on the surface of the soil in the working chamber as the excavation proceeds, and subsequently imbedded in the concrete with which the air-chamber is filled.

883. RATE OF SINKING. The work in the caisson usually continues day and night, winter and summer. The rate of progress varies, of course, with the size of the caisson, the rapidity with which the masonry can be placed, the kind of soil, and particularly with the number of boulders encountered. At the Havre de Grace Bridge, the average rate of progress was 1.37 ft. per day; at the Plattsmouth bridge, 2.22 ft.; and at the Blair Bridge 1.75 ft. per day. Speeds of 6 and 8 feet per 24 hours have been maintained for a few consecutive days with large caissons.

The above rates of sinking were greatly exceeded in the case of the small caissons for column foundations of tall buildings. In constructing the Broad Exchange Building, New York City, 88 caissons were sunk an average of 30 feet in 47 days, one being sunk 27 feet in 20 hours and 2 feet in 1 hour.

884. MAXIMUM DEPTH. The maximum depth to which the pneumatic process has been applied is 113 feet, in 1911, at the Municipal Bridge across the Mississippi River at St. Louis; and the next deepest was at the Eads Bridge in St. Louis (§ 889). At the first Memphis bridge (§ 891) the depth was 106.4 feet. In the last two cases the pressure was continued at or near the maximum for several days. At the Williamsburg Bridge over East River, in New York City, the maximum depth was 107.5 feet, but this depth extended over only a very small area and the maximum pressure was for only a few minutes. Except in these instances, the compressed-air process has never been applied at a greater depth than about 90 feet. The pneumatic process is limited to depths not much greater than 100 feet owing to the deleterious effect of the compressed air upon the workmen (see § 895-98).

Theoretically, the depth, in feet, of the lower edge of the caisson below the surface divided by 33 is equal to the number of atmospheres of pressure (15 lb. per sq. in.); but the depth does not always indicate the pressure. In sand or silt the pressure may be either a little more or a little less than that corresponding to the depth, and in clay the pressure may be considerably less than the theoretical amount. At the Eads Bridge the actual pressure varied between 45 and 50 pounds for 53 working days, and at Memphis from 40 to 47 pounds for 75 days.

885. GUIDING THE CAISSON. Formerly it was the custom to control the descent of the caisson by suspension screws connected with a framework resting upon piles or pontoons. In a strong current or in deep water, it may be necessary to support the caisson partially in order to govern its descent; but ordinarily, the suspension is needed only until the caisson is well imbedded in the soil. The caisson may be protected from the current by constructing a breakwater above and producing dead water at the pier site.

After the soil has been reached, the caisson can be kept in its course by removing the soil from the cutting edge on one side or the other of the caisson. In case the caisson does not settle down after the soil has been removed from under the cutting edge, a reduction of a few pounds in the air pressure in the working chamber is usually sufficient to produce the desired result. At the Havre de Grace Bridge (§ 870), it was found that by allowing the discharged material to pile up against the outside of the caisson, the latter could be moved laterally almost at will. The top of the caisson was made 3 feet larger, all round, than the lower course of masonry, to allow for deviation in sinking. The deviation of the caisson, which was founded 90 feet below the water, was less than 18 inches, even though neither suspension screws nor guide piles were employed.

In sinking the foundations for the bridge over the Missouri River near Sibley, Mo., it was necessary to move the caisson considerably in a horizontal direction without sinking it much farther. This was accomplished by placing a number of posts—12 inches square—in an inclined position between the roof of the working chamber and a temporary timber platform resting on the ground below. When these posts had been wedged up to a firm bearing, the air pressure was released. The water flowing into the caisson loosened the soil on the outside, and the weight of the caisson coming on the inclined posts caused them to rotate about their lower ends, which forced the caisson in the desired direction. In this way, a lateral movement of 3 or 4 feet was secured while sinking about the same distance.

A caisson is also sometimes moved laterally, while sinking, by attaching a cable which is anchored off to one side and kept taut.

886. A method of controlling the descent of the caisson has occasionally been used, which is specially valuable in swift currents or in rivers subject to sudden rises. It was used first in the construction of the piers for a bridge across the Yazoo River near Vicksburg, Miss. A group of 72 piles, each 40 feet long, was driven into the river bed, and sawed off under the water; the caisson was then floated into place, and lowered until the heads of the piles rested against the roof of the working chamber. As the work proceeded, the piles were sawed off to allow the caisson to sink. One of the reasons for employing piles in this case, was that if the caisson did not finally rest upon bed-rock, they would assist in supporting the pier.

That such ponderous masses can be so certainly guided in their descent to bed-rock, is not the least valuable nor least interesting fact connected with this method of sinking foundations.

887. FRICTIONAL RESISTANCE. At the Havre de Grace Bridge (§ 870), the normal frictional resistance on the timber sides of the pneumatic caisson was 280 to 350 lb. per sq. ft. for depths of 40 to 80 feet, the soil being silt, sand, and mud; when boulders were encountered, the resistance was greater, and when the air escaped in large quantities the resistance was less. At the bridge over the Missouri River near Blair, Neb. (§ 868-69), the frictional resistance usually ranged between 350 and 450 lb. per sq. ft., the soil being mostly fine sand with some coarse sand and gravel and a little clay. At the Brooklyn Bridge (§ 890), the frictional resistance at times was 600 lb. per sq. ft. At Cairo, in sand and gravel, the normal friction was about 600 lb. per sq. ft. At Memphis (§ 891), in sand, the friction was 400 lb. per sq. ft.

For data on the friction of iron cylinders and masonry shafts, see § 853-54; and for data on the friction of ordinary piles, see § 781-84.

888. FILLING THE AIR-CHAMBER. When the caisson has reached the required depth, the bottom is leveled off—by blasting, if necessary,—and the working chamber and shafts are filled with concrete. Sometimes only enough concrete is placed in the bottom to seal the chamber water-tight, and the remaining space is filled with sand. This was done at the east abutment of the Eads Bridge, St. Louis, Mo., the sand being pumped in from the river with the pump previously used for excavating the material from under the caisson.

889. NOTED EXAMPLES. Eads Bridge. The foundations of the steel-arch bridge over the Mississippi at St. Louis are the deepest ever sunk by the pneumatic process, and at the time of construction (1870) they were also very much the largest. The caisson of the east abutment was an irregular hexagon in plan, 83 by 70 feet at the base,

and C4 by 48 feet at the top—14 feet above the cutting edge. The working chamber was 9 feet high. The cutting edge finally rested on the solid rock 94 feet below low water. The maximum emersion was 109 feet $8\frac{1}{2}$ inches, the record depth for pneumatic work until 1911 (see § 884). The other caissons were almost as large as the one mentioned above, but were not sunk so deep.

The caissons were constructed mainly of wood; but the side walls and the roof were covered with plate iron to prevent leakage, and strengthened by iron girders on the inside. This was the first pneumatic caisson constructed in America; and the use of large quantities of timber was an important innovation, and has become one of the distinguishing characteristics of American practice. In all subsequent experience in this country (except as mentioned in § 890), the iron lining for the working chamber has been dispensed with. The masonry rested directly upon the roof of the caisson, i. e., no crib-work was employed. In sinking the first pneumatic foundation an iron coffer-dam was built upon the top of the caisson; but the last—the largest and deepest—was sunk without a coffer-dam,—a departure from ordinary European practice, which is occasionally followed in this country (see § 868-69).

890. Brooklyn Bridge. The foundations of the towers of the first suspension bridge over the East River, between New York City and Brooklyn, sunk in 1869-72, are the largest ever sunk by the pneumatic process. The foundation of the New York tower, which was a little larger and deeper than the other, was rectangular, 172 by 102 feet at the bottom of the foundation, and 157 by 77 feet at the bottom of the masonry. The caisson proper was $31\frac{1}{2}$ feet high, the roof being a solid mass of timber 22 feet thick. The working chamber was $9\frac{1}{2}$ feet high. The bottom of the foundation is 78 feet below mean high tide, and the bottom of the masonry is $46\frac{1}{2}$ feet below the same. From the bottom of the foundation to the top of the balustrade on the tower is 354 feet, the top of the tower being 276 feet above mean high tide.

To make the working chamber air-tight, the timbers were laid in pitch and all seams calked; and in addition, the sides and the roof were covered with plate iron. As a still further precaution, the inside of the air chamber was coated with varnish made of rosin, menhaden oil, and Spanish brown.

891. Memphis Bridge. The two river piers of the first bridge across the Mississippi River at Memphis, which stand between the 790-foot and one of the two 621-foot spans, rest upon pneumatic caissons 92 by 47 feet which were sunk to a depth of 104 and 106.4 feet, respectively, through water and sand, and a short distance into clay. To prevent scour, a woven willow mat 240 by 400 feet was

first sunk at the site of the pier, and then the caisson was grounded upon it and sunk through it.

892. Forth Bridge. The bridge across the Firth of Forth, near Edinburgh, Scotland, is the longest span in the world; and the caissons, sunk in 1883-84, differ from those described above (1) in being made almost wholly of iron, (2) in an elaborate system of cages for hoisting the material from the inside, and (3) in the use of interlocked hydraulic apparatus to open and close the air-locks. Each of the two deep-water piers consists of four cylindrical caissons 70 feet in diameter, the deepest of which rests 96 feet below high tide.

893. PNEUMATIC FOUNDATIONS FOR BUILDINGS. The pneumatic process was devised for laying foundations of bridges under considerable depths of water or water-bearing soil, and for a number of years was used exclusively for that purpose and in tunneling; but since 1894 the pneumatic process has been used extensively in laying foundations for buildings in New York City, and has there been carried to a great degree of refinement. In addition to the advantages of the pneumatic process for foundations in general (§ 908), the two conditions which primarily led to the introduction of the pneumatic process for building-foundations were: (1) the tall buildings required so great a supporting power that it was necessary to carry the foundation to bed-rock, which is from 60 to 80 feet below the street surface, and (2) the necessity of using a process of excavating through the water-bearing soil that would not disturb the soil under adjacent buildings. For many of the large buildings at the lower end of Manhattan Island, a pneumatic pile or caisson was sunk for each column.

In some cases, the so-called caisson was virtually a pneumatic pile (§ 863-66) made of wood, stone masonry, or steel plates; but in most cases the foundation consists of a pneumatic caisson proper made of wood or steel plates surmounted by brick masonry or concrete. The steel caisson is usually preferred because the thinner sides give greater space in the working chamber, and also because the caisson can be brought to the building ready for sinking. The method of operation is the same as in bridge foundations except in three particulars, viz.: 1. Since the caissons are comparatively small, have vertical sides, and are sunk all the way through earth, the weight of the masonry on the caisson was insufficient to overcome the friction and the upward pressure of the compressed air, and hence extra weight is usually required to sink the caissons. 2. To prevent the soil from escaping from under the shallower foundations of adjacent buildings, it is necessary to make the excavation without reducing the air pressure. 3. The sinking must be continuous, as

otherwise the soil will settle around the caisson and make it impossible to start again without releasing the air pressure.*

894. For an account of recent improvements in the details of pneumatic foundations for buildings, see Transactions of the American Society of Civil Engineers, Vol. LXI (1908), pages 211-37. The more important of these improvements are: (1) the elimination of the roof of the caisson, (2) the doing away with the coffer-dam; (3) the elimination of the shaft-lining, (4) the substitution of cylindrical for rectangular caissons, and (5) surrounding the foundation area with a row of pneumatic caissons which together act as a coffer-dam.

895. PHYSIOLOGICAL EFFECT OF COMPRESSED AIR. In the application of the compressed-air process, the question of the ability of the human system to bear the increased pressure of the air becomes very important.

After entering the air-lock, as the pressure increases, the first sensation experienced is one of great heat. As the pressure is still further increased a pain is felt in the ear, arising from the abnormal pressure upon the ear-drum. The tubes extending from the back of the mouth to the bony cavities over which this membrane is stretched are so very minute that compressed air can not pass through them with a rapidity sufficient to keep up the equilibrium of pressure on both sides of the drum (for which purpose the tubes were designed by nature), and the excess of pressure on the outside causes the pain. These tubes can be distended, thus relieving the pain, (1) by the act of swallowing, or (2) by closing the nostrils with the thumb and finger, shutting the lips tightly, and inflating the cheeks, or (3) by taking enough snuff to cause sneezing. Either action facilitates the passage of the air through these tubes, and establishes the equilibrium desired. The relief is only momentary, and the act must be repeated from time to time, as the pressure in the air-lock increases. This pain is felt only while the air in the lock is being "equalized," i.e., while the air is being admitted; and is most severe the first time compressed air is encountered, a little experience generally removing all unpleasant sensations. A drop of oil in each ear is a material help in obstinate cases. The passage through the lock, both going in and coming out, should be slow; that is to say, the compressed air should be let in and out gradually, to give the pressure time to equalize itself throughout the various parts of the body.

When the lungs and whole system are filled thoroughly with the denser air, the general effect is rather bracing and exhilarating. The increased amount of oxygen breathed in compressed air very

* For an illustrated account of the pneumatic-foundation work for the tallest building in the world—the Singer Building, New York City—see Trans. Amer. Soc. C. E., vol. lxiii, p. 1-52.

much accelerates the organic functions of the body, and hence labor in the caisson is more exhaustive than in the open air; and on getting outside again, a reaction with a general feeling of prostration sets in. At moderate depths, however, the laborers in the caisson, after a little experience, feel no bad effects from the compressed air, either while at work or afterwards.

In passing through the air-lock on leaving the air-chamber, the workman experiences a great loss of heat owing (1) to the expansion of the atmosphere in the lock, (2) to the expansion of the free gases in the cavities of the body, and (3) to the liberation of the gases held in solution by the liquids of the body. Hence, on coming out the men should be protected from currents of air, should drink a cup of hot strong coffee, dress warmly, and lie down for a short time.

896. Working Time. For depths less than 40 or 50 feet, it is usual for the men to work eight hours per day in the compressed air, with a visit to the open air for lunch at the middle of the shift; but when the pressure becomes greater the working time is materially shortened. At the Eads Bridge (§ 889), at pressure from 45 to 50 lb. per sq. in., corresponding to a theoretical depth of 104 to 115 ft., the men were able to remain in the compressed air only four hours per day in shifts of two hours each, and even then they worked only part of the time they were in the air-chamber. At Memphis the time was: between 80 and 90 ft. depth, two shifts of 2 hours each; and below 90 ft., three shifts of 1 hour each.

At the Williamsburg Bridge (§ 902) across the East River, New York City, the working time and wages were as follows:

From	0 to 55	feet below	mean high	water	\$2.50 for 8 hours.
"	55 " 70	"	"	"	2.75 " 6 "
"	70 " 80	"	"	"	3.00 " 4 "
"	80 " 90	"	"	"	3.25 " 2 "
"	90 " 100	"	"	"	3.50 " 1 hour.
"	100 " 107.5	"	"	"	3.75 " 1 "

When placing concrete in the air chamber, the price was increased 25 cents per shift. In 1906 in New York City, the rates were 20 per cent more than the above.

897. Caisson Disease. Remaining too long under heavy pressure causes a form of paralysis, called by the physicians caisson disease and by the workmen bends, which is sometimes fatal. The attack occurs only after returning to atmospheric pressure, and particularly after coming through the air-lock quickly; and ordinary cases are cured or greatly relieved by returning to the compressed air and coming out very slowly. With reasonable care, the pneumatic process can be applied at depths less than 80 or 90 feet without

serious consequences. At great depths the danger can be greatly decreased by observing the following precautions, in addition to those referred to above: (1) in hot weather cool the air before it enters the caisson; (2) in cold weather warm the air in the lock when the men come out; and (3) raise and lower them by machinery. On account of the effect of compressed air upon the workmen it is generally held that the pneumatic process is limited to depths not much exceeding 100 feet (see § 896).

The injurious effect of compressed air is much greater on men addicted to the use of intoxicating liquors than on others. Only sound, able-bodied men should be permitted to work in the caisson.

898. For an exhaustive account of the various aspects of this subject, see an article by Drs. Hill and Macleod in *Journal of Hygiene*, Vol. III, p. 401-45, a full abstract of which is published in *Engineering News*, Vol. LI, p. 436-40.

899. COST OF PNEUMATIC FOUNDATIONS. Of course, the cost will vary with the depth, the character of the soil, the size of the caisson, etc.

900. Blair Bridge. Table 68, page 448, gives the details of the cost of the pneumatic caissons of the bridge across the Missouri River near Blair, Neb. The caissons (Fig. 92, page 432) were 54 feet long, 24 feet wide, and 17 feet high. In the two shore piers, No. I and IV of the table, the caissons were surmounted by cribs 20 feet high; but in the channel piers, the masonry rested directly upon the roof of the caisson. The work was done, in 1882-83, by the bridge company's men under the direction of the engineer.

901. Havre de Grace Bridge. Table 69, page 449, gives the details of the cost of the pneumatic foundation of the Baltimore and Ohio Railway Bridge over the Susquehanna River at Havre de Grace, Md., built in 1884 (§ 870-71).

902. Williamsburg Bridge. Table 70, page 450, gives the details of the cost of the pneumatic foundations on the Brooklyn side of the Williamsburg Bridge across the East River, New York City, built in 1896-98. Each caisson is 63 by 79 ft., and each supports four of the eight legs of the steel tower. The south caisson is 39 ft. high, and the north one 53 ft. The south caisson was sunk 86 ft. below mean high water, and the north 107.5 ft. For the schedule of wages and working hours, see the last paragraph of § 896.

903. Moderate Depth. Table 71, page 452, shows the cost of the foundations for a large pivot pier and of the two rest piers for a 240-ft. single-track railroad bridge. The work was done by a contractor working on a percentage basis, and the values given are the actual costs to the contractor. The material penetrated was a very uniform bed of fine sand. The pressure men received \$3.50 per day.

904. Plattsmouth Bridge. The foundations for the channel piers of the bridge over the Missouri at Plattsmouth, Neb., built in 1879-80, cost as follows: One foundation, consisting of a caisson 50 ft. long, 20 ft. wide, and 15.5 ft. high, surmounted by a crib 14.15 ft. high, sunk through 13 ft. of water and 20 ft. of soil, cost \$19.29 per cubic yard of net volume. Another, consisting of a caisson 50 ft. long,

TABLE 68.

COST OF PNEUMATIC FOUNDATIONS OF BLAIR BRIDGE.*

ITEMS.	NUMBER OF THE PIER.			
	I.	II.	III.	IV.
Total distance caisson was lowered after completion	55.6 ft.	54.5 ft.	56.2 ft.	68.5 ft.
Final depth of cutting edge below surface of water	51.9 "	52.3 "	53.4 "	57.0 "
Final depth of cutting edge below mud line	47.7 "	51.0 "	49.4 "	54.7 "
Caisson and filling	\$11 753.51	\$12 386.56	\$13 819.34	\$11 252.45
per cubic yard	14.31	15.12	16.74	13.77
Crib and filling	7 368.16			6 303.46
per cubic yard	8.85			7.59
Air-lock, shafts, etc.	1 481.60	1 567.42	1 536.80	1 521.08
Sinking caisson, including erection and removal of machinery	5 772.52	5 629.37	6 888.16	7 084.26
Per cubic yard of displacement below position of cutting edge when caisson was completed	2.16	2.16	2.56	1.92
Per cubic yard of displacement below surface of water.	2.32	2.24	2.67	2.59
Per cubic yard of displacement below mud line	2.51	2.29	2.92	2.70
Total cost of foundation †	\$26 375.79	\$19 583.35	\$22 244.30	\$26 161.25
per cubic yard †	15.98	23.87	27.08	15.85
Average cost of the foundations, per cubic yard † \$20.70.				

20 ft. wide, and 15.5 ft. high, surmounted by a crib 36.25 ft. high, sunk through 10 ft. of water and 44 ft. of soil, cost \$14.45 per cubic yard of net volume.‡

905. Pneumatic Piles. In 1869-72, thirteen cylinders were sunk by the plenum-pneumatic process for the piers of a bridge over the

* Compiled from the report of Geo. S. Morison, chief engineer of the bridge.

† Exclusive of engineering expenses and cost of tools, machinery, and buildings. In a note to the author, Mr. Morison, the engineer of the bridge, says: "It is impossible to divide the buildings, tools, and engineering expenses between the substructure and other portions of the work. The bulk of the items of tools and machinery [\$12,369.88], however, relates to the foundations." The engineering expenses and buildings were nearly 3 per cent of the total cost of the entire bridge. The cost of tools and machinery was equal to a little over 13 per cent of the cost of the foundations as above. Including these items would add nearly one sixth to the amounts in the last three lines.

‡ Compiled from the report of Geo. S. Morison, chief engineer of the bridge.

Schuylkill River at South Street, Philadelphia. There were three piers, one of which was a pivot pier. There were two cylinders, 8 feet in diameter and 82 feet long, sunk through 22 feet of water and 30 feet of "sand and tough compact mud intermingled with

TABLE 69.

COST TO THE R. R. CO. OF FOUNDATIONS OF HAVRE DE GRACE BRIDGE.*

ITEMS.	NUMBER OF THE PIER.				
	II.	III.	IV.	VIII.	IX.
Depth of cutting edge below low water, feet	68.3	70.7	59.9	76.0	65.0
Depth of cutting edge below mud line, feet	55.5	58.7	32.3	55.2	32.6
Displacement below low water, cu. ft.	112 124	123 402	159 588	189 578	231 691
Displacement below mud line, cu. ft.	94 504	106 269	84 014	127 586	107 836
<i>Caisson:</i>					
Timber, @ \$46.80 per M	\$9 522.54	\$10 088.44	\$14 820.94	\$13 176.07	\$21 767.85
Iron, @ 5½ ct. per lb.	1 456.12	1 587.15	2 596.23	2 242.40	3 295.38
Concrete @ \$17.50 per cu. yd.	5 775.00	7 017.50	13 247.50	18 987.50	25 602.50
Total cost	\$16 953.66	\$18 693.09	\$30 664.47	\$24 404.97	\$50 665.73
Per net cu. yd.	16.82	18.37	19.19	24.34	22.10
<i>Crib:</i>					
Timber, @ \$46.80 per M.	8 421.14	9 262.19	6 738.87	8 936.58	9 538.96
Iron, @ 5½ ct. per lb.	1 291.14	1 454.85	1 179.36	1 749.35	1 445.93
Concrete @ \$8.50 per net cu. yd.	14 016.50	16 090.50	13 897.50	21 943.51	26 962.00
Total cost	\$23 745.60	\$26 825.91	\$21 834.89	\$32 653.77	\$37 968.99
Per cu. yd.	10.76	11.10	10.91	9.91	10.09
<i>Coffer-dam:</i>					
Timber, @ \$46.80 per M	96.78	1 375.00	5 078.64	4 013.52	5 921.70
Iron, @ 5½ ct. per lb.	14.45	226.15	892.29	684.20	899.22
Total	\$111.23	\$1 611.15	\$5 970.93	\$4 697.72	\$6 820.92
Sinking, @ 20 ct. per cu. ft. of displacement below low water ..	\$22 424.80	\$24 680.40	\$31 917.60	\$37 915.60	\$46 338.20
Concrete below cutting edge, @ \$17.50	000	10 902.50	2 205.00	9 205.00	10 920.00
Total cost of foundation	\$63 018.47	\$71 792.18	\$90 368.93	\$109 648.72	\$141 772.44
Total cost per cu. yd. of foundation below masonry, including coffer-dams	19.93	21.58	25.20	23.30	23.44

Average total cost of the foundation, to R. R. Co., per net cubic yard. \$22.69.

bowlders"; two cylinders, 8 feet in diameter and 57 feet long, sunk through 22 feet of water and 5 feet of soil as above; one cylinder, 6 feet in diameter and 64 feet long, sunk through 22 feet of water and 18 feet of soil as above; and 8 columns, 4 feet in diameter and

* Data by courtesy of Scoysmith & Co., contracting engineers for the pneumatic foundations.

TABLE 70.
COST OF BROOKLYN FOUNDATIONS OF WILLIAMSBURG BRIDGE, NEW YORK CITY.*

ITEMS.	SOUTH PIER.			NORTH PIER.		
	Quantity.	Rate.	Cost.	Quantity.	Rate.	Cost.
<i>Caissons:</i>						
Timber, yellow pine, ft. B. M.	765 M	\$18.50	\$14 140	980 M	\$18.50	\$18 120
Iron—bolts, rods, etc.	76.6 tons	35.00	2 679	90.5 tons	35.00	3 168
Oakum, pitch, paint, tar	765 M	.33	250	980 M	.81	302
Labor, building, calking, and launching.	765 M	14.75	11 275	980 M	13.61	13 362
Plant, rental and labor	765 M	3.50	2 675	980 M	2.68	2 617
General expenses, superintendence, etc. 10% ..	765 M	4.00	3 102	980 M	3.83	3 757
Total cost of caisson	765 M	44.57	\$34 119	980 M	42.12	\$41 326
Per gross cu. yd.	7 189 cu. yd.	4.75	8 766 cu. yd.	4.83
<i>Coffer-dam:</i>						
Timber, yellow pine	309 M	\$19.00	\$5 870	228 M	\$19.00	\$4 335
Iron—rods, bolts, etc.	24.5 tons	35.00	858	23.5 tons	35.00	823
Oakum	48 bales	2.50	120	48 bales	2.50	120
Labor, building and removing	309 M	20.64	6 364	228 M	25.40	5 779
Plant	309 M	1.48	458	228 M	1.54	351
General expenses, 10 per cent	4.43	1 367	5.00	1 141
Total for coffer-dam	309 M	48.66	\$15 037	228 M	55.00	\$12 549
<i>Concrete (1 P : 2½ S : 6 BS):</i>						
Above roof	3 827 cu. yd.	\$5.59	\$21 372	5 692 cu. yd.	\$4.73	\$26 935
In shaft holes.	541 cu. yd.	5.43	2 943	576 cu. yd.	6.47	3 737
In working chamber	1 435 cu. yd.	12.73	18 343	1 566 cu. yd.	11.73	18 362
Total cost of concrete	\$42 658	\$49 034

<i>Sinking:</i>								
Sand with bowlders,—depth 53-56 feet	509 cu. yd.	\$6.55	\$3 330					
Sand with bowlders,—depth 56-67 feet	1 929 cu. yd.	6.10	11 749					
Clay and stratified clay,—depth 67-71 feet	839 cu. yd.	7.31	6 126					
Clay—stratified,—depth 71-80 feet	1 648 cu. yd.	8.42	13 851					
Gneiss—sound rock,—depth 80-81 feet	195 cu. yd.	35.20	6 863					
Stratified clay stripping,—depth 81-83 feet	380 cu. yd.	26.90	10 243					
Incidentals			2 132					
Total	5 500 cu. yd.	\$9.87	\$54 292					
Mud, sand, gravel,—depth 51-57 feet								1 714 cu. yd. \$2.35 \$4 035
Fine sand,—depth 57-69 feet								2 175 cu. yd. 2.31 5 021
Clay and stratified clay,—depth 69-73 feet								866 cu. yd. 4.50 3 896
Stratified clay,—depth 73-81 feet								1 493 cu. yd. 7.20 10 752
Stratified clay,—depth 81-90 feet								1 621 cu. yd. 9.25 15 002
Gneiss—sound rock,—depth 83-91 feet								84 cu. yd. 78.40 6 581
Stratified clay,—depth 91-95 feet								702 cu. yd. 17.55 12 324
Gneiss—benching,—depth 91-95 feet								253 cu. yd. 65.80 16 709
Stratified clay,—depth 95-107.5 feet †								435 cu. yd. 25.00 11 337
Incidentals								715
Total								9 343 cu. yd. \$9.03 \$84 372
Total cost of foundation	7 189 cu. yd.	\$18.93	\$136 106					8 766 cu. yd. \$21.36 \$187 281

* Compiled from *Engineering Contracting*, vol. xxvi, p. 33-36, 40-41, 46-48, which gives the cost in minute detail.

† Maximum depth over only a small area. Only 2 cu. yd. below 106 ft., and only 21 cu. yd. below 104 ft.

aggregating 507 feet, sunk through 22 feet of water and 18 feet of soil as above. A 10-foot section of the 8-foot cylinder weighed 14,600 pounds, of the 6-foot, 10,800 pounds, and of the 4-foot, 6,800 pounds. The cylinders rested upon bed-rock, and were bolted to it. The actual cost to the contractor, exclusive of tools and machinery, was as in Table 72.

TABLE 71.

COST OF PNEUMATIC FOUNDATION AT MODERATE DEPTH.*

ITEMS.	PIVOT PIER.		REST PIER.		REST PIER.	
	Total.	Per Cu. Yd.	Total.	Per Cu. Yd.	Total.	Per Cu. Yd.
Dimensions at cutting edge.	30×30 feet		16×34 feet		16×34 feet	
Height of caisson	15 feet		15 feet		15 feet	
Depth sunk below water . .	55 feet		53 feet		38 feet	
Depth sunk below ground . .	45 feet		47 feet		47 feet	
Displacement below ground	1 500 cu. yd.		947 cu. yd.		766 cu. yd.	
Plant, proportionate cost. . .	\$2 525	\$1.68	\$1 262	\$1.33	\$1 262	\$1.65
Platform and derrick, setting up	100	.07	90	.10	120	.16
Pipe left in caisson	130	.09	100	.10	150	.20
Iron left in caisson @ 5ct. per lb.	300	.20	300	.32	300	.39
Lumber in caisson @ \$20 per per M	1 576	1.05	1 020	1.08	1 000	1.31
Lumber in coffer-dam @ \$20 per M	180	.12				
Iron in cutting edge @ 4½ct.	675	.45	585	.62	585	.76
Rods, drift-bolts, etc., @ 2½"	230	.16	200	.21	200	.26
Boat spikes, etc.	172	.11	136	.14	136	.18
Oakum @ 4 ct. per lb.	80	.05	60	.06	60	.08
Rubber packing @ 70 ct. per lb.	70	.05	70	.07	70	.09
Building coffer-dam @ \$2.97 per day	235	.16				
Building caisson @ \$2.96 per day	1 439	.96	945	1.00	938	1.22
Sinking caisson @ \$2.99 per day	5 094	3.39	2 929	3.09	2 646	3.45
Coal @ \$3.00 per ton	660	.44	300	.32	360	.47
Piles @ 10 ct. per lin. ft.	60	.04				
Driving piles @ 12 ct. per ft.	72	.05				
Concrete @ \$4.25 per cu.yd.	2 805	1.93	1 190	1.25	1 190	1.55
Supplies	185	.12	109	.11	124	.16
Supt. and office expenses . .	700	.47	440	.47	440	.57
Total	\$17 288	\$11.59	\$9 736	\$10.27	\$9 581	\$12.50

* Compiled from *Engineering-Contracting*, vol. xxvii, p. 204-05, 220-21, where minute details are given.

TABLE 72.

COST OF PNEUMATIC PILES AT PHILADELPHIA IN 1869-72.*

ITEMS OF EXPENSE.	DIAMETER OF CYLINDERS.		
	4-ft.	6-ft.	8-ft.
Cast iron, @ \$59.50 per ton.....	\$11 239.36	\$2 053.75	\$13 577.90
Bolts, @ 9½ cents per lb.....	489.84	93.31	670.02
Grouted rubble masonry (exclusive of labor), @ \$5.40 per cu. yd.	1 266.79	358.40	2 779.97
Sinking and laying masonry	693.50	911.88	9 036.51
Total cost of the cylinders in place	\$19 689.49	\$3 417.34	\$26 064.40
Iron per lineal foot of cylinder	\$23.10	\$33.54	\$ 51.25
Materials for masonry per lineal foot of cylinder	2.50	5.60	10.00
Sinking and laying masonry per lineal foot of cylinder	13.20	14.25	32.51
Total cost,* per lineal foot of cylinder in place	\$38.80	\$53.39	\$93.76

* Exclusive of tools and machinery.

906. European Examples. The following † is interesting as showing the cost of pneumatic work in Europe:

“At Moulins, cast-iron cylinders, 8 feet 2½ inches in diameter, with a filling of concrete and sunk 33 feet below water into marl, cost \$62.94 per lineal foot, or \$29.71 for the iron work, and \$33.23 for sinking and concrete. At Argenteuil, with cylinders 11 feet 10 inches in diameter, the sinking alone cost \$42.12 per lineal foot [nearly \$10 per cubic yard], where a cylinder was sunk 53½ feet in three hundred and ninety hours. [The total cost of this foundation was \$34.09 per cubic yard, Table 73, page 457.] At Orival, where a cylinder was sunk 49 feet in twenty days, the cost of sinking was \$36.83 per lineal foot. At Bordeaux, with the same-sized cylinders, a gang of eight men conducted the sinking of one cylinder, and usually 34 cubic yards were excavated every twenty-four hours. The greatest depth reached was 55½ feet below the ground, and 71 feet below high water. In the regular course of working, a cylinder was sunk in from nine to fifteen days, and the whole operation, including preparations and filling with concrete, occupied on the

* Compiled from an article by D. McN. Stauffer, engineer in charge, in *Trans. Am. Soc. of C. E.*, vol. vii, p. 287-309.

† By Jules Gaudard, as translated from the French by L. F. Vernon-Harcourt, *Proc. of the Institute of Civil Engineers (London)*, vol. 1, p. 112-47.

average 25 days. One cylinder, or a half pier, cost on the average \$11,298.40, of which \$1,461 was for sinking. M. Morandière estimates the total cost of a cylinder sunk like those at Argenteuil, to a depth of 50 feet, at \$7,012.80.

907. "Considering next the cost of piers of masonry on wrought-iron caissons of excavation, the foundations of the Lorient viaduct over the Scorff cost the large sum of \$24.11 per cubic yard, owing to difficulties caused by the tides, the labor of removing the bowlders from underneath the caisson, and the large cost of plant for only two piers. The foundation of the Kehl Bridge cost still more, about \$28.23* per cubic yard; but this can not be regarded as a fair instance, being the first attempt [see § 861] of the kind.

"The foundations of the Nantes bridges, sunk 56 feet below low-water level, cost about \$14.84 per cubic yard. The average cost per pier was as follows:

Caisson (41 feet 4 inches by 14 feet 5 inches), 50 tons of wrought iron @ \$116.88	\$5 844
Coffer-dam, 3 tons of wrought iron @ \$58.44.....	175
Excavation, 916 cubic yards @ \$4.47	4 091
Concrete	4 188
Masonry, plant, etc.	1 870
Average cost per pier	\$16 168

"One pier of the bridge over the Meuse at Rotterdam, with a caisson of 222 tons and a coffer-dam of 94 tons, and sunk 75 feet below high water, cost \$70,858, or \$13.97 per cubic yard.

"The Vichy Bridge has five piers built on caissons 34 feet by 13 feet, and two abutments on caissons 26 feet by 24 feet. The foundations were sunk 23 feet in the ground, the upper portion consisting of shingle and conglomerated gravel, and the last 10 feet of marl. The cost of the bridge was as follows:

Interest for eight months, and depreciation of plant worth \$19,480	\$3 896
Cost of preparations, approach bridge, and staging	4 904
Caissons (seven), 150½ tons @ \$113.38	17 108
Sinking	9 823
Concrete and masonry	5 303
Contractor's bonus and general expenses	6 107
Total cost of five foundations	\$47 141

The cost per cubic yard of the foundation below low water was \$16.69, of which the sinking alone cost \$3.50 in gravel, and \$4.37 in marl.

* Notice the slight inconsistency between this quantity and the one in the third line from the last of the table on page 457, both being from the same article.

"At St. Maurice, the cost per cubic yard of foundation was \$15.94, exclusive of staging."

908. CONCLUSION. Except in very shallow or very deep water, the compressed-air process has almost entirely superseded all others. The following are some of the advantages of this method. 1. It is reliable, since there is no danger of the caisson's being stopped before reaching the desired depth, by sunken logs, bowlders, etc., or by excessive friction, as in dredging through tubes or shafts in cribs. 2. It can be used regardless of the kind of soil overlying the rock or ultimate foundation. 3. It is comparatively rapid, since the sinking of the caisson and the building up of the pier go on at the same time. 4. It is comparatively economical, since the weight added in sinking is a part of the foundation and is permanent, and the removal of the material by blowing out or by pumping is as uniform and rapid at one depth as at another,—the cost only being increased somewhat by the greater depth. 5. This method allows ample opportunity to examine the ultimate foundation, to level the bottom, and to remove any disintegrated rock. 6. Since the rock can be laid bare and be thoroughly washed, the concrete can be commenced upon a perfectly clean surface; and hence there need be no question as to the stability of the foundation.

ART. 5. FREEZING PROCESS.

909. PRINCIPLE. The presence of water has always been the great obstacle in foundation work and in shaft sinking, and it is only comparatively recently that any one thought of transforming the liquid soil into a solid wall of ice about the space to be excavated. The method of doing this consists in inclosing the site to be excavated, by driving into the ground a number of tubes through which a freezing mixture is made to circulate. These consist of a large tube, closed at the lower end, inclosing a smaller one, open at the lower end. The freezing mixture is forced down the inner tube, and rises through the outer one. At the top, these tubes connect with a reservoir, a refrigerating machine, and a pump. The freezing liquid is cooled by an ice-making machine, and then forced through the tubes until a wall of earth is frozen around them of sufficient thickness to stand the external pressure, when the excavation can proceed as in dry ground.

910. HISTORY. This method was invented by F. H. Poetsch, M. D., of Aschersleben, Prussia, in 1883. The process has been used many times in sinking shafts in mining operations. "Shaft Sinking in Difficult Cases" by J. Reimer, translated from the German by J. W. Brough 1907, gives a list of 64 examples, most of which are in Germany and France, only one being in the United States. One

shaft has been sunk by this process 816 ft., and several have been sunk over 300 ft. The Transactions of the American Society of Civil Engineers, Vol. LII, pages 365-450, contains an illustrated resumé of the literature of the freezing process to February, 1904, and also a discussion of the same.

This process seems to have been valuable for sinking shafts through quicksand and other water-bearing soil under difficult circumstances, but has not been applied in foundation work.

911. APPLICATION TO FOUNDATIONS UNDER WATER. Two methods of applying this process for foundations under water have been proposed. One of these consists in combining the pneumatic and freezing processes. A pneumatic caisson is to be sunk a short distance into the river bed; and then the congealing tubes are applied, and the entire mass between the caisson and the rock is frozen solid. When the freezing is completed, the caisson will be practically sealed against the entrance of water, and the air-lock can be removed and the masonry built up as in the open air.

The other method consists in sinking an open caisson to the river bed, and putting the freezing tubes down through the water. When the congelation is completed, the water can be pumped out and the work conducted in the open air.

912. Advantages Claimed. It is claimed for this process that it is expeditious and economical, and also that it is particularly valuable in that it makes possible an accurate estimate of the total cost before the work is commenced—a condition of affairs unattainable by any other known method in equally difficult ground. It has an advantage over the pneumatic process in that it is not limited by depth.

913. Difficulties Anticipated. Two difficulties are anticipated in applying it to sink foundations for bridge piers in river beds; viz. (1) the difficulty in sinking the pipes, owing to striking sunken logs, bowlders, etc.; and (2) the possibility of encountering running water, which will thaw the ice-wall. These difficulties are not insurmountable, but experience only can demonstrate how serious they are.

ART. 6. COMPARISON OF METHODS.

914. The comparison of the different methods in Table 73 is from an article by Jules Gaudard on Foundations, as translated by L. F. Vernon-Harcourt,—Proceedings of the Institute of Civil Engineers (London), Vol. L, page 145. Except as showing approximate relative costs in Europe, it is not of much value, owing to improvement made since the article was written, to the differences between European and American practice, and to differences in cost of materials in the two countries.

915. "M. Croizette Desnoyers has framed a classification of the methods of foundations most suitable for different depths, and also an estimate of the cost of each. These estimates, however, must be considered merely approximate, as unforeseen circumstances produce considerable variations in works of this nature.

TABLE 73.
COST OF VARIOUS KINDS OF FOUNDATIONS IN EUROPE.

KIND OF FOUNDATION.	DEPTH IN FEET.		COST PER CUBIC YARD.	
	Min.	Max.	Min.	Max.
On piles after compression of the ground, shallow depth	20	33	\$2.92	\$4.39
On piles after compression of the ground, greater depth	33	50	4.39	7.30
By sinking wells	33	50	7.30	9.00
By pumping		20	2.92	4.39
By pumping under favorable circumstances	26	33	4.39	13.39
By pumping under unfavorable circumstances	26	33	14.85	17.77
On concrete under water, small amount of silt	20	33	4.37	9.00
On concrete under water, large amount of silt	20	33	9.00	11.93
By means of compressed air * under favorable circumstances			13.39	16.17
By means of compressed air under unfavorable circumstances:				
Lorient Viaduct	[50 ft.]		\$24.11	
Kehl Bridge †	[70 ft.]		29.71	
Argenteuil Bridge	[50 ft.]		34.09	
Bordeaux Bridge			40.17	

* See also §906-07.

† See footnote on p. 454.

"When the foundations consist of disconnected pillars or piles, the above prices must be applied to the whole cubic content, including the intervals between the parts; but of course at an equal cost solid piers are the best.

916. "For pile-work foundations the square yard of base is probably a better unit than the cubic yard. Thus the foundations of the Vernon Bridge, with piles from 24 to 31 feet long, and with cross-timbering, concrete, and caisson, cost \$70 per square yard of base. According to estimates made by M. Picquenot, if the foundations had been put in by means of compressed air, the cost would have been \$159.64; with a caisson, not water-tight, sunk down, \$66.27; with concrete poured into a space inclosed with sheeting, \$62.23; and by pumping, \$83.56 per square yard of base."

PART IV
MASONRY STRUCTURES

CHAPTER XVII

MASONRY DAMS

917. Dams are employed to hold back water for municipal supply, for power, and for irrigation; and are made of earth, wood, steel, loose rock, or masonry. Only masonry dams will be considered here; and the discussion will be limited to questions that relate to the stability of the structure, without including gate chambers, waste weir or spillway, roll-ways, scouring sluices, regulators, fish ladders, etc., which are discussed in treatises on water supply, power development, and irrigation. The fundamental principles of stability that are to be considered apply also to retaining walls, bridge abutments, bridge piers, and arches. The discussions of this chapter are applicable to masonry dams, reservoir walls, or to any wall which counteracts the pressure of water mainly by its weight.

918. There are two ways in which a masonry dam may resist the thrust of the water, viz.: (1) by the inertia of its masonry, and (2) as an arch. 1. The horizontal thrust of the water may be held in equilibrium by the resistance of the masonry to sliding forward or to overturning. A dam which acts in this way is called a *gravity dam*. 2. The thrust of the water may be resisted by being transmitted laterally to the side-hills (abutments) by the arch-like action of the masonry. A dam which acts in this way is called an *arched dam*.

Masonry dams of the gravity type are quite common, but only three dams of the pure arch type have ever been built. The almost exclusive use of the gravity type is due to the uncertainty of our knowledge concerning the laws governing the stability of masonry arches. This chapter will be devoted mainly to gravity dams, those of the arch type being considered only incidentally. Arches will be discussed in Chapters XXII and XXIII.

ART. 1. STABILITY OF GRAVITY DAMS.

919. METHODS OF FAILURE. A gravity dam may fail in either of three ways, viz.: (1) by sliding along a horizontal joint or shearing along any section; (2) by overturning about the front of a horizontal joint; and (3) by the crushing of the masonry either (*a*) at the down-stream edge of a horizontal section when the reservoir is full, or (*b*) at the up-stream edge when the reservoir is empty.

The above methods of failure relate to the body of the dam and not to the foundation. Of the elements of stability here considered, the most frequent cause of failure of masonry dams has been defective foundation, the only failures on record of masonry dams of note being due to this cause.* However, as the method of securing a firm foundation has already been discussed in Part III, this subject will be considered here only incidentally.

920. In the discussions of this article it will be necessary to consider only a section of the wall included between two vertical planes—a unit distance apart—perpendicular to the face of the wall, and then so arrange this section that it will resist the loads and pressure put upon it; that is, it is sufficient, and more convenient, to consider the dam as only a unit, say 1 foot, long.

921. NOMENCLATURE. The following nomenclature will be used throughout this chapter:

- b = the batter of the wall, i.e., the inclination of the surface per foot of rise — b' being used for the batter of the up-stream face and b_1 for that of the down-stream face.
- d = the distance the center of pressure deviates from the center of the base.
- f = the factor of safety.
- h = the height of the water above the base of the dam.
- H = the horizontal pressure, in pounds, of the water against a section of the back of the wall 1 foot long and of a height h .
- k = the height of water above the top of the dam when the water flows over the crest.
- l = the length of the base, i.e., $l = AB$, Fig. 96.
- q = the height of the masonry above the water in a dam not overflowed; for example, in Fig. 96, $q + h$ = the height of the dam.
- μ = the coefficient of friction (see Table 74, page 464).

* For a brief description of three such failures, see Trans. Amer. Soc. C. E., vol. xxxiv, p. 509-11; and for an account of a fourth, see *Engineering News*, vol. lxiii, p. 244-46, 250-54, 290-91, 308-9, 412-13; or *Engineering Record*, vol. xli, p. 340-42, 372-74.

V = the vertical pressure, in pounds, of the water against a section of the back of the wall 1 foot long and of a height h .

W = the weight, in pounds, of a section of the wall 1 foot long.

w = the weight, in pounds, of a cubic foot of the masonry (see Table 60, page 348).

\bar{x} = the distance from the down-stream face of any joint to the point in which a vertical through the center of gravity of the wall pierces the plane of the base. In Fig. 96 $A g = \bar{x}$.

62.5 = the weight, in pounds, of a cubic foot of water.

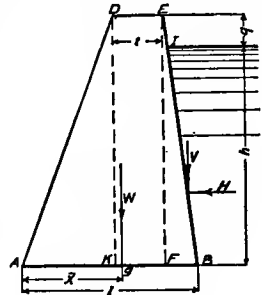

FIG. 96.

922. STABILITY AGAINST SLIDING. The horizontal pressure of the water tends to slide the dam forward, and is resisted by the friction due to the weight of the wall.

923. Sliding Force. The horizontal pressure, H , of the water against a unit section of the wall is equal to the area of the section multiplied by half the height of the water, and that product by the weight of a cubic unit of water; or

$$H = h \times 1 \times \frac{1}{2} h \times 62.5 = 31.25 h^2 \quad \dots \quad (1)$$

924. If the water flows over the top of the dam, as in a waste-weir,

$$H = 31.25 (h^2 - k^2) \quad \dots \quad (2)$$

in which k is the height of the water above the crest of the dam.

For possible additional forces tending to produce sliding, see § 956.

925. Resisting Forces. The resisting forces are the weight of the dam and the vertical component of the pressure of the water against the inclined surface of the dam.

The weight of a unit section of the dam, W , is equal to the area of the vertical cross section multiplied by the weight of a cubic unit of the masonry, w . Then the weight of the dam shown in Fig. 96 is

$$W = w [t (h + q) + \frac{1}{2} b' (h + q)^2 + \frac{1}{2} b_1 (h + q)^2] \quad \dots \quad (3)$$

The vertical pressure, V , of the water on the inclined face, IB , Fig. 96, is equal to the horizontal projection of that area multiplied by the distance of the center of gravity of that surface below the top of the water and also by the weight of a cubic unit of water.

$$V = 31.25 h^2 b' \quad \dots \quad (4)$$

If the earth rests against the heel of the dam (the bottom of the

inside face), it will increase the pressure on the foundation, since earth weighs more than water; but the difference is not very great, and is compensated for in part by the fact that under such condition the horizontal pressure of the water will not be so much as assumed above, and hence it will be assumed that the water extends to the foundation of the dam.

If the permanent water level on the down-stream side is above the foundation, the back pressure of this water should be deducted from the value of H as computed above.

926. If the water finds its way under and around the foundation of the wall, even in very thin sheets, it will decrease the pressure of the dam on the foundation, and consequently decrease the stability of the wall. The effective weight of the submerged portion of the dam will be decreased $62\frac{1}{2}$ lb. per cu. ft. However, it is not likely that water in hydrostatic condition will find its way under or into a dam in appreciable quantities, and hence the effect of buoyancy will not be included.

For a discussion of a closely related phase of this subject, see § 942.

927. **Condition for Equilibrium.** In order that the wall may not slide, it is necessary that the product found by multiplying the coefficient of friction by the sum of the weight of the dam and the vertical pressure of the water shall be greater than the horizontal pressure of the water; or in mathematical language, in order that the dam may not slide it is necessary that

$$H < \mu (W + V) \dots \dots \dots (5)$$

or

$$f H = \mu (W + V) \dots \dots \dots (6)$$

By stating H and V in terms of the height of the water and of the weight of a cubic unit of water (see equation 1 and 4, page 460) and giving W in terms of the dimensions of the dam, it is easy by means of equation 6 to determine the factor of safety in any particular case. Values of the coefficient of friction are given in Table 74, page 464.

However, it is not wise to attempt to compute the factor of safety against sliding, since the value obtained is dependent upon the value of the coefficient of friction assumed. Therefore, it is better either (1) to state the relative values of the resisting forces and of the forces tending to produce sliding, or (2) to state the tangent of the angle which the resultant pressure makes with the normal to the base.

928. To secure economy of material in the construction of the dam, it is customary to make the up-stream surface nearly or quite

vertical; and hence the vertical pressure of the water on the up-stream face is comparatively small, and is usually neglected—an approximation which is on the safe side.*

929. The preceding discussion assumes that a masonry dam may fail by the sliding of one stone upon another along a horizontal joint; but neglects two important elements of stability. First, the stones are laid with mortar which gives a considerable resistance of cohesion in addition to the frictional resistance. Second, masonry dams, at least high ones, are built of random rubble masonry, the stones of which interlock in every direction; and hence the tendency to slide is resisted by the shearing strength of the individual stones (§ 20) as well as by friction. If the dam is built of coursed masonry, which is very improbable, the courses could be inclined downward toward the up-stream side.

If the dam is constructed of concrete, the tendency to slide will be resisted by the combined effect of the shearing strength of the concrete (§ 408) and of friction.

Again, the earth on the toe of the dam and also that in front of it, add somewhat to the resistance to sliding.

If the stability against sliding is computed by equation 6, either with or without omitting the vertical component of the water, the three factors as above give additional security. In view of the above, there is no probability of a dam's failing by sliding, except possibly upon the foundation.

930. A low dam may be founded upon the soil, but a high one should rest upon bed-rock. When the dam must be founded upon the soil, the resistance to sliding on the foundation can be increased (1) by driving a row of inclined piles in front of the dam or (2) by sinking a comparatively narrow tongue of the wall below the level of the main foundation. In the latter case, the maximum resistance attainable *is equal* to the weight of the dam multiplied by the coefficient of friction of masonry on the particular soil *plus* the weight of the soil which would be moved if the dam slid forward *multiplied by* the coefficient of friction of the soil upon itself. The surface along which motion of the soil should be assumed to take place will depend upon the profile of the natural surface below the dam, and may be either a horizontal line or one inclined up, according to which one of these is the line of least resistance. This neglects the cohesion of the soil, i.e., assumes that the resistance to shear is the same as the

* Increased safety generally requires increased cost of construction, and hence it is not permissible to use approximate data simply because the error is on the side toward safety. It will be shown that there is no probability of any dam's failing by sliding, and that the size, and consequently the volume and cost, are determined by the dimensions required to prevent crushing and overturning; and hence this approximation involves no increase in the cost.

resistance to sliding; but as the former is the greater, the assumption is on the safe side, although there is not a great deal of difference between the two.

If the dam is founded upon bed-rock, the resistance to sliding on the foundation may be greatly increased by leaving the bed rough; and, in case the rock quarries out with smooth surfaces, one or more longitudinal trenches may be excavated in the bed of the foundation, and afterwards be filled with the masonry. In building the New Croton Dam (§ 964), two trenches 6 feet deep and 10 feet wide were excavated in the bed-rock, the surface of the foundation was thoroughly cleaned and carefully painted with a grout of neat portland cement, and then cyclopean granite rubble masonry laid in a 1 : 2 portland-cement mortar was started.

The weight of the masonry and the gravel upon the foundation of the New Croton Dam are 2.46 times the net horizontal thrust of the water; in other words, $W + V = 2.46 H$, or $H = 0.41 (W + V)$. This means that if the coefficient of friction is 0.41, the dam will be on the point of sliding; and consequently, if the actual coefficient of friction is 0.75 (see Table 74, page 464), the nominal factor of safety is $0.75 \div 0.41 = 1.8$. But the tendency to slide is resisted by the cohesion of the mortar and by the interlocking of the stones (§ 929) as well as by friction, and consequently the real factor of safety is considerably more than that computed above.

931. Coefficient of Friction. The values of the coefficient of friction most frequently required in masonry computations are given in Table 74, page 464. There will be frequent reference to this table in subsequent chapters; and therefore it is made more full than is required in this connection. The values have been collected from the best authorities, and are believed to be fair averages.

932. STABILITY AGAINST OVERTURNING. The horizontal pressure of the water tends to tip the wall forward about the front of any joint, and is resisted by the moment of the weight of the wall. For the present, it will be assumed that the wall rests upon a rigid base, and therefore can fail only by overturning as a whole.

The conditions necessary for stability against overturning can be completely determined either by considering the moments of the several forces, or by the principle of resolution of forces. In the following discussion the conditions will be first determined by moments, and afterward by resolution of forces.

933. A. ALGEBRAIC SOLUTION. Overturning Moment. The pressure of the water is perpendicular to the pressed surface. If the water presses against an inclined face, then the pressure makes the same angle with the horizontal that the surface does with the vertical. Since there is a little difficulty in finding the arm of this force, it is

more convenient to deal with the horizontal and vertical components of the pressure.

The overturning effect of the pressure of the water is equal to the moment of the horizontal component minus the moment of the vertical component.

TABLE 74.
COEFFICIENTS OF FRICTION FOR MASONRY.

DESCRIPTION OF THE MASONRY.	COEFFICIENT.
Soft limestone on soft limestone, both well dressed	0.75
Brick-work on brick-work, with slightly damp mortar	0.75
Hard brick-work on hard brick-work, with slightly damp mortar	0.70
Point-dressed granite on like granite	0.70
Point-dressed granite on well-dressed granite	0.65
Common brick on common brick	0.65
Common brick on hard limestone	0.65
Hard limestone on hard limestone, with moist mortar	0.65
Concrete blocks on like concrete blocks	0.65
Fine cut granite on pressed concrete blocks	0.60
Well-dressed granite on well-dressed granite	0.60
Polished limestone on polished limestone	0.60
Well-dressed granite on like granite, with fresh mortar	0.50
Common brick on common brick, with wet mortar	0.50
Polished marble on common brick	0.45
Point-dressed granite on gravel	0.60
Point-dressed granite on dry clay	0.50
Point-dressed granite on sand	0.40
Point-dressed granite on moist clay	0.33
Well-dressed limestone on wrought iron	0.50
Well-dressed limestone on wrought iron, wet	0.25
Limestone on oak, flatwise	0.65
Limestone on oak, endwise	0.40

The horizontal component can be found by equation 1, page 460. The arm of this force is equal to $\frac{1}{3} h$, and hence the moment tending to overturn the wall is equal to

$$\frac{1}{3} H h = \frac{1}{3} 31.25 h^3 = 10.42 h^3 (7)$$

which, for convenience, represent by M_1 .

The amount of the vertical pressure against the up-stream face is given by equation 4, page 460. It acts vertically between I and B , Fig. 96, page 460, at a distance from B equal to $\frac{1}{3} IB$; and its arm is $l - \frac{1}{3} h b'$. Therefore, the moment of the vertical pressure on the inclined face is

$$31.25 lb' h^2 - 10.4 b'^2 h^3 \dots \dots \dots (8)$$

which, for convenience, represent by M_2 . Of course, if the pressed face is vertical, M_2 will be equal to zero.

The net overturning moment is the sum of equations 7 and 8, or $M_1 - M_2$.

934. The moment of the pressure of the water, $M_1 - M_2$, can be determined directly by considering the pressure of the water as acting perpendicular to IB at $\frac{1}{3} IB$ from B . The arm of this force is a line from A perpendicular to the line of action of the pressure. If the cross section were known, it would be an easy matter to measure this arm on a diagram; but, in designing a dam, it is necessary to know the conditions requisite for stability before the cross section can be determined, and hence the above method of solution is the better.

935. Resisting Moment. The moment of the weight of the dam is the moment resisting overturning. The weight of the dam may be computed by equation 3, § 925. This force acts vertically through the center of gravity of the dam.

The center of gravity can be found algebraically or graphically. There are several ways in each case, but the following graphical solution is the simplest. In

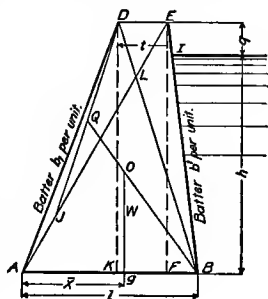

FIG. 97.

Fig. 97, draw the diagonals DB and AE , and lay off $AJ = EL$; then draw DJ , and mark the middle of it, Q . The center of gravity, O , of the area $ABED$ is at a distance from Q towards B equal to $\frac{1}{3} QB$. This method is applicable to any four-sided figure.

The position of the center of gravity can also be found algebraically by the principle that the moment of the entire mass about any point, as A , is equal to the moment of the part ADK plus the moment of the portion $DEFK$ plus the moment of the part EBF ,—all about the same point, A .

The arm of the weight of the dam is $Ag (= \bar{x})$, and therefore the moment of the weight is

$$W \times Ag = w(h + q) [t + \frac{1}{2}(h + q)(b' + b_1)] \bar{x} \dots (9)$$

which, for convenience, represent by M_3 .

936. Factor of Safety. In order that the wall may not turn about the front edge of a joint, it is necessary that the overturning moment, $M_1 - M_2$, as found by equations 7 and 8, shall be less than the resisting moment, M_3 , as found by equation 9; or, in other words, the factor against overturning

$$f = \frac{M_3}{M_1 - M_2} \dots \dots \dots (10)$$

In computing the stability against overturning, the vertical pressure of the water against the inside face is frequently neglected; i.e., it is assumed that M_2 , as above, is zero. This assumption is always on the safe side. Computed in this way, the factor of safety against overturning for the New Croton Dam (§ 964), the next to the largest masonry dam in the world, varies between 2.07 and 3.68.

937. B. GRAPHICAL SOLUTION. If the actual cross section of the dam is known, or if a cross section of the proposed dam be assumed, the stability against overturning may be determined graphically by either of the two following processes.

In Fig. 98, Q is the center of pressure of the water on the back of the wall. $QB = \frac{1}{3} IB$. The point C is the center of gravity of the section — found as described in § 935; and m is the middle of the base AB . H is the horizontal component of the water pressure, and V the vertical component. W is the weight of a section of the dam a unit long. By moments, it is found that the resultant of V and W pierces the base AB in the point g ; and by the triangle of forces it is found that the resultant of H and $W + V$ pierces the base AB at r . As long as r lies within the base, the dam will not overturn.

938. The stability may also be determined by using the normal pressure F without resolving it into its components. Through Q , Fig. 99, draw a line, Qa , perpendicular to EB ; through c , the center of gravity of the cross section, draw a vertical line ca . To any convenient scale lay off ab equal to the total pressure of the water against IB , and to the same scale make af equal to the weight of a unit section of the wall. Complete the parallelogram $abef$. The diagonal ae intersects the base of the wall at r ; and as long as the center of pressure r lies between A and B , the wall will not overturn.

939. Factor of Safety. In connection with the graphical determination of the stability of a dam against overturning, three inconsistent methods of finding the factor of safety are used, or rather three distinct definitions of the factor of safety are employed.

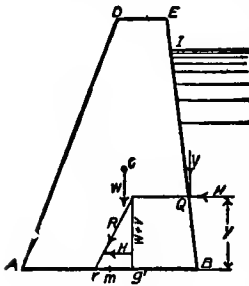

FIG. 98.

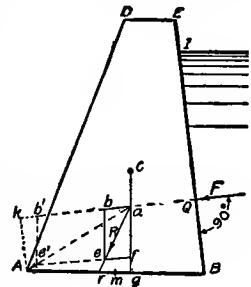

FIG. 99.

1. If the factor of safety against overturning be defined as the ratio of the resisting moment to the overturning moment, then in Fig. 98, for moments about A

$$\text{the factor of safety} = \frac{(W + V) \cdot Ag'}{H \cdot y} \quad \dots \quad (11)$$

Since $(W + V) : H :: y : rg'$, $\frac{W + V}{H \cdot y} = \frac{1}{rg'}$; and hence equation 11 becomes,

$$\text{the factor of safety} = \frac{Ag'}{rg'} \quad \dots \quad (12)$$

If the problem is solved as in Fig. 99,

$$\text{the factor of safety} = \frac{W \cdot Ag'}{F \cdot Ak} \quad \dots \quad (12')$$

This value of the factor will not agree with that from equation 12, since in the former the vertical component of the pressure is included in the overturning force while in the latter it is considered as a resisting force.

2. If the factor of safety be defined as the ratio of the force that would just overturn the dam to the force tending to overturn it, then from Fig. 99 the factor of safety is $F' \div F = ab' \div ab$; or

$$\text{the factor of safety} = \frac{ab'}{ab} \quad \dots \quad (12'')$$

This value of the factor agrees with that found by equation 12'; but does not agree with the value found by equation 12.

3. In the above methods of determining the factor of safety, no special account is taken of the fact that, owing to the unsymmetrical cross section of the dam, the point in which the vertical through the center of gravity of the dam pierces the base, g , is on the right-hand side of m , the middle of the base; and consequently when there is no water pressure against the dam, there is a tendency to overturn to the right instead of to the left, for any eccentricity of pressure upon the foundation shows a tendency to overturn. Therefore the factor of safety found as above counts, as it were, from the *initial* condition of the dam. In the following method it counts from what may be called the *neutral* condition of the dam.

If the factor of safety be defined as the ratio of the moment that

would just overturn the dam about its toe, A , Fig. 98, to the actual moment tending to overturn it, then the value of the factor may be found as follows: Let H_1 = that portion of H which will cause the resultant to pierce the base at m , its middle point; and let $H_2 = H - H_1$. Conceiving only H_1 as acting, there is no tendency to overturn about A ; and hence the resultant of the vertical forces may be considered as acting through m . If now H_2 be conceived as coming into action, the resultant of $(W + V)$ and H_2 must pierce AB at r , and $H_2 \cdot y = (W + V) rm$. Then, according to the above definition,

$$\text{the factor of safety} = \frac{(W + V) Am}{H_2 \cdot y} = \frac{Am}{rm} \quad . \quad (13)$$

In the ordinary meaning of the term, equation 13 does not give the true factor of safety, although the result may under some conditions approximate the true factor. This value will be called the approximate factor of safety. Equation 13 is strictly correct (1) when the resultant of the forces normal to the base pierces the base at its center, i.e., when the vertical cross-section is symmetrical and the external forces are horizontal or the vertical component of the external force is disregarded, since then it gives $f = \infty$, as it should; and (2) when the resultant of all the forces passes through A , since then it gives $f = 1$, as it should.

940. Frequently equation 13 is more convenient than equation 12, 12', or 12'', since the point r must always be determined to find the crushing stress and since the point m is very easily found, while a special construction is required for equations 12, 12', and 12''.

The approximate value of the factor of safety, i.e., the value given by equation 13, is much used in discussions of the stability of dams, retaining walls, and arches. For example, a very common statement in considering the stability of such structures is: "If the center of pressure lies within the middle third of any section, the factor of safety against overturning is at least 3." This statement assumes that equation 13 gives the true factor of safety against overturning, and that therefore if the center of pressure is within the middle third of any section, rm is equal to or less than $\frac{1}{3}l$; and hence, as $Am = \frac{1}{2}l$, equation 13 gives $f = 3$ or more. For dams and retaining walls, particularly the former, equation 13 frequently gives 3 for a factor of safety, when the true value is approximately 2; and hence the approximate formula should not be used for these structures. The approximate factor of safety is universally employed in discussions of the stability of arches in

which the stresses are found by the thrust theory (the older and more common theory); but the formula is usually more accurate for arches than for dams and retaining walls, and besides the theory of the arch itself is not mathematically exact.

941. Factor of Safety against Sliding. Although the discussion immediately in hand is the stability against overturning, it is interesting to note that Fig. 99, page 466, affords an easy method of determining the factor of safety against sliding.

The wall can not slide horizontally, when the angle *rag* is less than the angle of repose, i.e., when *tan rag* is less than the coefficient of friction. The factor against sliding is equal to the coefficient of friction divided by *tan rag*, which is only a different form of the principle stated in equation 6, page 461.

942. Effect of Percolating Water. Both of the preceding investigations of the stability of a dam against overturning are based upon the assumption that water in hydrostatic condition does not find its way into the masonry of the dam; and if this assumption is not true, the preceding conclusions must be materially modified.

It is nearly, if not quite, impossible to make masonry absolutely impermeable under a high head; but the water which forces its way through reasonably good masonry or concrete is in a capillary state and not likely to exert any considerable hydrostatic pressure. If cracks are formed, due to poor construction or to settlement or to temperature changes, which are large enough to permit water to enter them under hydrostatic condition, the area subject to such pressure is so small in comparison with the whole horizontal section of the dam that the effect may be neglected. This view seems to be sustained by experience with masonry dams, which shows that although all dams leak more or less, the water which comes through is not under any appreciable pressure.* However, there is a considerable difference of opinion among engineers as to the possibility of making masonry water-tight or of preventing cracks and fissures which will give the water a free path into the body of the dam.

943. Some engineers claim that although the percolating water is not under pressure at the down-stream face, it is likely to be at the up-stream surface, and that therefore the percolating water should be assumed to be under full hydrostatic pressure at the up-stream face and decrease to zero at the down-stream face.

In support of this view reference is frequently made to some experiments conducted in 1888 † which showed that water pressure was communicated, almost undiminished, through a layer of 1 : 2 portland-cement mortar 1 foot thick. However, these experiments

* Trans. Amer. Soc. C. E., vol. xxxiv, p. 511-12, 513-14.

† J. B. Francis, Trans. Amer. Soc. C. E., vol. xix, p. 147-70.

base of a vertical section of the dam; or AB may represent the rectangular base (whose width is a unit) of any two bodies which are pressed against each other by any forces whatever.

M = the moment about A of the water pressure = $M_1 - M_2$,
(see equations 7 and 8, pages 464 and 465).

W = the weight of a section of the dam 1 foot long.

V = the vertical component of the water pressure.

P = the maximum pressure, per unit of area, at A .

p = the change in unit pressure, per unit of distance, from A towards B .

x = any distance from A towards B .

$P - px$ = the pressure per unit at a distance x from A towards B .

Y = a general expression for a vertical force.

l = the length of the base of the section considered = AB .

d = the distance the center of pressure deviates from the center of the base = rm .

\bar{x} = the distance from the down-stream edge of any horizontal joint or section to the point in which the vertical through the center of gravity pierces the section = Ag .

Taking moments about A gives

$$M - W\bar{x} + \int_0^l (P - px) dx = 0; \quad \dots \quad (14)$$

$$M - W\bar{x} + \frac{1}{2} P l^2 - \frac{1}{3} p l^3 = 0 \quad \dots \quad (15)$$

For equilibrium, the sum of the forces normal to AB must also be equal to zero; or

$$\Sigma Y = -W - V + \int_0^l (P - px) dx = 0 \quad \dots \quad (16)$$

from which

$$p l^2 = 2 P l - 2 W - 2 V \quad \dots \quad (17)$$

Combining equations 15 and 17, gives

$$P = \frac{4(W + V)}{l} - \frac{6 W \bar{x}}{l^2} + \frac{6 M}{l^2} \quad \dots \quad (18)$$

If the overturning moment is determined algebraically, i.e., by equations 7 and 8, pages 464 and 465, then M is known; and therefore P can be computed by equation 18.

947. If the stability against overturning is determined graphically by resolution of forces, equation 18 can not be employed to determine the stability against crushing, since M is not then known. To meet this case, equation 18 may be transformed as follows:

M , the moment of the water pressure, is equal to the moment of the weight of the dam minus the moment of the reaction of the soil; or taking moments about A , $M = W. Ag - (W + V) Ar$. From Fig. 100, page 470, $Ag = \bar{x}$; and $Ar = \frac{1}{2} l - d$.

Substituting the above values of x and M in equation 18, gives

$$P = \frac{W + V}{l} + \frac{6 (W + V) d}{l^2} \quad (19)$$

Equation 19 is suitable for computing P when the stability against overturning is determined by resolution of forces.

948. *Discussion of Equations 18 and 19.* Equation 18 is the equivalent of equation 1, page 354, except that (1) in the latter case there is no vertical component of the external force, and (2) equation 1 is applicable to any form of cross section while equation 18 is limited to a rectangular cross section.

If the wall is symmetrical, $\bar{x} = \frac{1}{2} l$, and if $V = 0$, equation 18 becomes

$$P = \frac{W}{l} + \frac{6 M}{l^2} \quad (20)$$

which is the same as equation 3, page 354, except that equation 20 is for a unit length of the wall, and hence the dimension corresponding to b in equation 3 does not appear.

If there is no external overturning force, $V = 0$ and $M = 0$, and then equation 18 becomes

$$P = \frac{4 W}{l} - \frac{6 W \bar{x}}{l^2} \quad (21)$$

In equation 21 if $\bar{x} = \frac{1}{2} l$, that is, if the resultant vertical force passes through the center of the base, $P = W \div l$, as it should, since the pressure on the base should then be uniform. If $\bar{x} = \frac{1}{3} l$, $P = 2 W \div l$, which shows that the maximum unit pressure on the base of a right-angled triangle cross section is twice the average pressure. If $\bar{x} = \frac{2}{3} l$, $P = 0$, as it should, since this is the case of a dam having a right-angle at B , and consequently the pressure per unit of area at A is zero.

949. In equation 19, if $d = 0$, the load is symmetrical, and the

pressure is uniform, as it should be. Notice that d is plus when r is on the same side of the center as A , i.e., as the point for which the pressure P is desired, and minus when on the other side of the center. For example, if the dam is a right-angled triangle with the right angle at B and the reservoir is empty, $gB = \frac{1}{3} l$, $d = -\frac{1}{3} l$, and the

pressure at A is $P = \frac{W}{l} - \frac{W}{l} = 0$, that is, there is no pressure at A ,

which is as it should be; and for the point B , $d = \frac{1}{3} l$, and the pressure is

$$P = \frac{W}{l} + \frac{6 W d}{l^2} = \frac{W}{l} + \frac{W}{l} = \frac{2 W}{l}$$

or P is twice the mean, which also is as it should be.

The last relation is known as the principle of the middle third; that is, as long as the center of pressure lies within the middle third of the joint, the maximum pressure is not more than twice the mean, and there is no tension in any part of the joint.

The first term of the right-hand side of equation 19 gives the uniform pressure on the base due to the weight of the dam and the vertical component of the water pressure, and the second term gives the effect upon the maximum pressure on the base of *any system of forces that causes the centre of pressure to depart from the middle of the base*, i.e., that causes the resultant pressure (R , Fig. 100, page 470) to intersect the base at a distance d from the center.

In other words, the term $\frac{6 W d}{l^2}$ is the increase of pressure on the base due to the eccentricity of the center of pressure, r ,—whether that eccentricity is due to an unsymmetrical vertical cross section or to the overturning effect of external forces, or to both.

Therefore, equation 19 is a perfectly general expression for the pressure between any two plane rectangular surfaces pressed together by any system of forces.

950. Equation 19 may be written thus:

$$P = \frac{W + V}{l} \pm \frac{6 W d}{l^2} \dots \dots \dots (22)$$

The $+$ sign gives the maximum pressure at A , Fig. 100, page 470, for any given deviation of the center of pressure, r , from the middle of the base, m ; and the $-$ sign the corresponding minimum at B , d being taken without regard to algebraic sign. Equation 22 gives the maximum and minimum pressures at the two extremes of the base whether the deviation d is caused by the form of the wall or by forces tending to produce overturning, or by both.

951. Case II. Reservoir Empty. If the vertical cross section of the dam is symmetrical, the pressure upon the base is uniform and equal to $W \div l$; but if the cross section is not symmetrical, there will be a concentration of pressure at one side of the base and an equal diminution on the other. All of the formulas deduced for Case I apply to Case II by making M equal to zero. Equation 22 gives the pressure at the two ends of the base section, d being the horizontal distance between the center of the base and the vertical through the center of gravity of the vertical section of the dam.

952. Tension in Masonry. In general, if AK , Fig. 101, represents the pressure at A and BL that at B , then any ordinate of the trapezoid $ABLK$ will represent the pressure on the corresponding point of AB ; and the area of $ABLK$ will represent the total pressure on AB . If the center of pressure departs more than $\frac{1}{6}l$ from the center of the base, there will be a minus pressure, i.e., tension, at the opposite side of base; in other words, if d in equation 22, page 473, is more than $\frac{1}{6}l$, the maximum pressure will be more than twice the mean and the minimum pressure will be minus, i.e., tension. If AK' represents the compression at A when d is more than $\frac{1}{6}l$, and BL' represents the corresponding tension, i.e., the minus pressure at B , then the ordinates of the triangle ANK' represent the pressures at the several points along AN ; and similarly the ordinates of the triangle BNL' represent the tensions at the several points along BN .

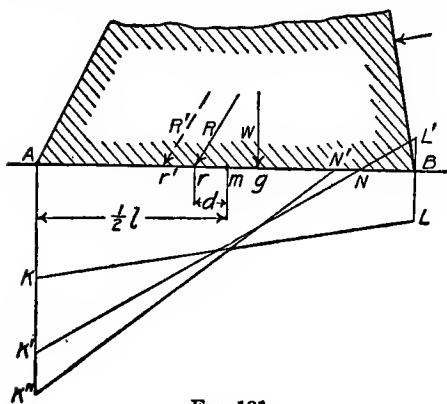

FIG. 101.

If a good quality of cement mortar is used, it is not unreasonable to count upon a little resistance from tension. As a general rule, it is more economical to increase the quantity of stone than the quality of the mortar; but in dams it is necessary to use a good mortar to prevent (1) leakage, (2) disintegration on the water side, and (3) crushing. Therefore, equation 22 will give the maximum pressure or maximum tension on the base AB up to the point at which the masonry fails either by tension or compression. It is customary to limit the maximum pressure in dams to twice the mean, which is equivalent to specifying that no part of the masonry shall be in

tension or that the center of pressure shall not deviate more than $\frac{1}{6} l$ from the center of any real or imaginary joint.

953. If the masonry be considered as incapable of resisting by tension, or if it is considered unwise to depend upon tension to help resist overturning, then when d in equation 22 exceeds $\frac{1}{6} l$, the total pressure will be borne on AN' , Fig. 101. If AK'' represents the maximum pressure, P , then the area of the triangle $AN'K''$ will represent the total normal pressure $W + V$. The center of gravity of the triangle $AN'K''$ must be under r' , the center of pressure; and hence $AN' = 3 Ar'$. Then the area of $AN'K'' = \frac{1}{2} AK'' \times AN' = \frac{1}{2} P \times 3 Ar' = \frac{3}{2} P (\frac{1}{2} l - d) = W + V$; or

$$P = \frac{2(W + V)}{3(\frac{1}{2}l - d)} \dots \dots \dots (23)$$

To illustrate the difference between equations 22 and 23, assume that the distance from the resultant to the center of the base is one quarter of the length of the base, i.e., assume that $d = \frac{1}{4} l$. Then, by equation 22, the maximum pressure at A is

$$P = \frac{W + V}{l} + \frac{6 W l}{4 l^2} = 2\frac{1}{2} \frac{W}{l} + \frac{V}{l}; \dots \dots (24)$$

and by equation 23 it is

$$P = \frac{2(W + V)}{3(\frac{1}{2}l - \frac{1}{4}l)} = 2\frac{2}{3} \frac{W}{l} + 2\frac{2}{3} \frac{V}{l} \dots \dots (25)$$

Notice that equation 25 gives a larger value of P than equation 24.

Notice that equation 25 is not applicable when d is less than $\frac{1}{6} l$; in that case, equation 24 must be used.

954. The discussion in the preceding section is, practically, not applicable to masonry dams, since it is not wise to subject the masonry on the water side to tension; but the results are directly applicable in determining the maximum pressure on the joints of a voussoir arch (Chap. XXII).

955. LIMITING PRESSURE. In determining the stability against crushing, it is not wise to compute the factor of safety, since the computed value of the factor will depend upon the value assumed as the crushing strength of the masonry; and therefore it is better to state the maximum pressure and limit it to twice the mean.

As a preliminary to the actual designing of the section, it is necessary to fix upon the maximum pressure per square unit to which

it is proposed to subject the masonry. Of course, the allowable pressure depends upon the quality of the masonry, and also upon the conditions assumed in making the computations. It appears to be the custom, in practical computations, to neglect the vertical pressure on the inside face of the dam, i.e., to assume that M_2 , equation 8, page 465, is zero. This assumption is always on the safe side, and makes the maximum pressure on the toe appear greater than it really is. Computed in this way, the maximum pressure on cyclopean rubble masonry in cement mortar in some of the great dams of the world is from 11 to 15 tons per sq. ft. (150 to 200 lb. per sq. in.).

The New Croton Dam (§ 964) was designed for a maximum pressure of 16.6 tons per sq. ft. (230 lb. per sq. in.) on massive rubble in portland-cement mortar, which pressure occurs when the reservoir is empty.

For data on the strength of stone and brick masonry, see § 581-84 and § 617-29, respectively.

956. The actual pressure at the toe will probably be less than that computed as above. It was assumed that the weight of the wall was uniformly distributed over the base; but if the batter is considerable, it is probable that the pressure due to the weight of the wall will not vary uniformly from one side of the base to the other, but will be greater on the central portions. The actual maximum will, therefore, probably occur at some distance back from the toe. Neither the actual maximum nor the point at which it occurs can be determined.*

Professor Rankine claims that the limiting pressure for the toe should be less than for the heel. Notice that the preceding method determines the maximum vertical pressure. When the maximum pressure on the heel occurs, the only force acting is the vertical pressure; but when the maximum on the toe occurs, the thrust of the water also is acting, and therefore the actual pressure is the resultant of the two. With the present state of our knowledge, we can not determine the effect of a horizontal component upon the vertical resistance of a block of stone, but it must weaken it somewhat.

957. FURTHER REFINEMENT. The preceding theory of the stability is the one ordinarily used, but there are a few matters not included therein that require a brief mention.

The force of the wind was not included. If the wind blows up-stream, the stability of the dam will be increased when the reservoir is full and decreased when it is empty. If the wind blows down-stream, it will not affect the stability when the reservoir is empty;

* For an interesting investigation of this question, using a dam made of an elastic mass composed of carpenter's glue and molasses, see *Trans. Assoc. of Civil Engineers of Cornell University*, vol. viii, p. 30-42.

but when the reservoir is full, the wind will produce waves rather than add directly to the pressure against the back of the dam.

The importance of wave action will depend upon the location of the dam and the area of the reservoir. The pressure due to waves has not been investigated thoroughly, but their effect has been studied by noticing the size and the weight of bowlders that have been moved by the waves, and also by observing in a single locality the pressure recorded by a dynamometer.* By the latter method, on the shore of the open ocean, the pressure due to waves 20 feet high was found to be 6,083 lb. per sq. ft. on a dynamometer "near the surface" and 2,856 lb. per sq. ft. on a similar instrument "several feet lower;" and waves 6 feet high gave pressures of 1,256 and 3,041 lb. per sq. ft., respectively.

If ice forms on the water in the reservoir, it will exert a horizontal thrust against the dam which will increase the sliding force and also the tendency to overturn down stream. Of course, the thrust from the ice will depend upon the altitude and the latitude of the location of the reservoir. The pressure due to ice in any particular case is almost wholly a matter of judgment. A Board of Experts in 1888 recommended that the Quaker Bridge Dam, virtually the same as the New Croton Dam (§ 964), situated 30 miles north of New York City, be designed to resist an ice thrust of 43,000 pounds per lineal foot;† but the recommendation was not adopted. The moment of the thrust of the ice should be added to the moment of the overturning forces in the preceding analysis. The pressure of the ice may be eliminated by frequently breaking up the ice next to the up-stream face of the dam. The pressure of ice caused the failure of a masonry dam at St. Paul, Minn.; but none of the details are known.

958. The preceding analysis considers only shear in a horizontal plane and compression on a horizontal section; but it is proved in the mechanics of materials that a shear combines with a compression normal to it, and produces a greater compression in an inclined plane (see § 459). Therefore after a dam has been designed according to the foregoing analysis, to be perfectly sure of its stability it should be tested for shear along inclined planes and also vertical planes—particularly near the toe (the down-stream portion near the base). For a brief discussion of this phase of the subject, see Wegmann's *Design and Construction of Dams*, fifth edition, pages 8–10; *School of Mines Quarterly*, Vol. xxvii, pages 33–39; and *Proceedings Institute of Civil Engineers (London)*, Vol. clxxii, page 105, 126–29.

It is not known that any dam was ever designed in accordance with this modification of the ordinary theory; and it has not been

* Thomas Stevenson's *Design and Construction of Harbors*, p. 50–51.

† Wegmann's *Design and Construction of Dams*, 5th ed., p. 160.

proved that dams designed by the ordinary theory are unstable when tested by the more refined method of analysis just referred to.

ART. 2. OUTLINES OF THE DESIGN.

959. WIDTH ON TOP. Except for the effect of waves and ice (§ 957), the width on top could be zero. But in practice the top of the dam is generally used for a footway or a roadway, and hence a considerable width is required independent of any question of stability. Schuyler says that the top width need not be more than one tenth of the height, unless the top is used for a roadway.* For the top dimensions of a few of the highest masonry dams, see § 964-66.

960. THE PROFILE. In designing the vertical cross section of a gravity dam to resist still water, it is necessary to fulfill three conditions: (1) to prevent sliding forward, equation 6, page 461, must be satisfied; (2) to resist overturning, equation 10, page 466, must be satisfied; and (3) to resist crushing, equation 22, page 473, must give safe maximum pressures when the reservoir is full and also when it is empty, and must also give a positive minimum pressure (i.e., must not give tension) when the reservoir is either full or empty. Limiting equation 22 to positive values is equivalent to keeping d less than $\frac{1}{3}l$, or equivalent to saying that the center of pressure shall always lie within the middle third of any horizontal joint. As the three equations of conditions really involve only three variables—viz.: h , b_1 , and b' ,—the height of the dam and the batter of the two faces,—they can be satisfied exactly. However, as there is little or no danger of a dam's failing by sliding, provided it is safe against overturning and crushing, there are practically only two conditions to be fulfilled. Further, in a dam of the pure gravity type (the form here under consideration), there is no reason why the up-stream face may not be exactly vertical; and hence there are really only two variables— h and b_1 .

To design a dam it is necessary to satisfy the equation of condition for successive comparatively thin horizontal layers, and use the dimensions of each elementary layer in finding the dimensions of the next lower one. The equations of condition may be satisfied either (1) by direct computation or (2) by trial.

1. The direct computation may be made either algebraically or graphically. To make a solution by the first method, state the condition for stability against overturning (equation 10, page 466) in terms of the length of the joint (l), the thickness on top (t), the height of the dam ($h + q$), the depth of the water (h), the batter of the up-stream and down-stream faces (b' and b_1 , respectively), the

* Schuyler's Reservoirs for Irrigation, Water Power, and Domestic Supply, p. 119.

weight of a cubic unit of water, and the weight of a cubic unit of masonry; and solve for l . Then test the joint by equation 22, page 473. This method involves the solution of a quadratic of considerable complexity.

To solve the problem graphically, draw the section and determine the position of the center of pressure as in Fig. 98 or 99, page 466; and then apply equation 22.

One or the other of the above processes is to be repeated successively for each of the several layers beginning at the top.

2. To satisfy the conditions by trial, proceed as follows: The width at the top being known, assume dimensions for the first elementary horizontal layer, and test its stability by equations 10 (page 466) and 22 (page 473), the latter with and without the water pressure acting against the dam. If the first dimensions do not give results in accordance with the limiting conditions, other dimensions must be assumed and the computations be repeated. A third approximation will rarely be needed.

961. The second method of satisfying the equations of condition is the one employed in the design of the New Croton Dam (§ 964); but later the equations for the first method of solution were worked out, and employed in checking the previously determined dimensions.

962. It is not necessary to attempt to satisfy these equations precisely, since there are a number of unknown and unknowable factors, as the weight of the stone, the quality of the mortar, the character of the foundation, the quality of the masonry, the hydrostatic pressure under the mass, the amount of elastic yielding, the force of the waves and of the ice, etc., which have more to do with the ultimate stability of a dam than the mathematically exact profile. It is therefore sufficient to assume a trial profile, being guided in this by the cross sections of existing dams (§ 963-67) and by the principle stated in the next paragraph, and test it at a few points by applying the preceding equations; a few modifications to satisfy more nearly the mathematical conditions or to simplify the profile is as far as it is wise to carry the theoretical determination.

Prof. Wm. Cain has shown* that the equations of conditions are nearly satisfied by a cross section composed of two trapezoids, the lower and larger of which is the lower part of a triangle having its base on the foundation of the dam and its apex at the surface of the water, and the upper trapezoid having for its top the predetermined width of the dam on top, and for its sides nearly vertical lines which intersect the sides of the lower trapezoid. The width of the dam at the bottom is obtained by applying the equations of condition as above. The relative batter of the up-stream and down-stream

* *Engineering News*, vol. xix, p. 512-13.

faces depends upon the relative factors of safety for crushing and overturning. The above section gives a factor of safety which increases from bottom to top—an important feature.

963. Examples. The following descriptions give the principal dimensions of the profiles of a few of the highest gravity masonry dams in the world at the present time (1909).

964. New Croton Dam. This dam was built, in 1892–1907, about 30 miles north of New York City, to store water for that municipality. Fig. 102 shows the profile of the maximum section and also some of the data concerning its stability. The height from the

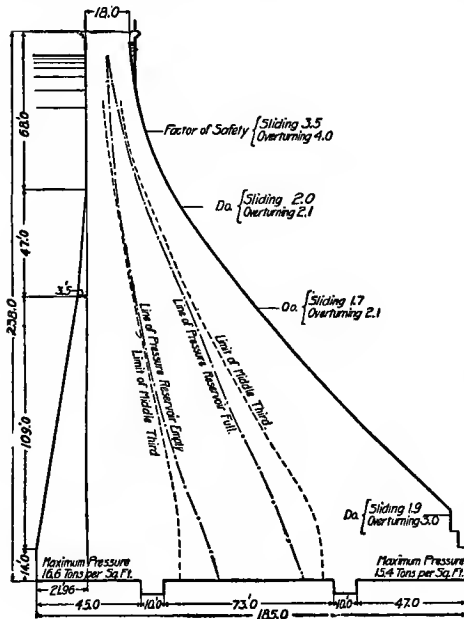

FIG. 102.—PROFILE OF NEW CROTON DAM.

lowest point of the foundation to the top of the parapet is 297 ft., and the depth of the water impounded is 150 ft. The profile is substantially that designed for a dam proposed in 1888 for a site about 1 mile further downstream, known as the Quaker Bridge Dam, which was not built. Fig. 102 shows that the line of resistance (the line joining the centers of pressure of the several joints) always lies within the middle third of the length of any imaginary horizontal joint.

The nominal factor of safety for sliding and the true factor of safety for overturning when the reservoir is full are given for

a few points; and also the maximum unit pressure at the toe when the reservoir is full and at the heel when the reservoir is empty are shown. The maximum coefficient of friction required to prevent sliding is 0.597 at a section 121 ft. above the base of the dam.

The main dam is straight in plan and about 600 ft. long. For a detailed description, see Reports of the New Croton Aqueduct from 1895–1907, pages 90–102; or Wegmann's Design and Construction of Dams, pages 162–84.

965. U. S. Reclamation Service Dams. The United States Government, through its Reclamation Service, a branch of the U. S.

Geological Survey, now (1909) has in progress three notable masonry dams,—the Roosevelt, the Shoshone, and the Pathfinder.

The *Roosevelt Dam* is situated in the canyon of Salt River, just below the mouth of Tonto Creek, about 70 miles above Phoenix, Arizona, and is to store water for irrigation. Fig. 103 shows the profile of the maximum vertical cross section. Notice that Fig. 103 is similar to, but less heavy than, Fig. 102. The height of the spillway above mean low water is 220 ft., the height of the roadway above the general foundation level is 260 ft.; and the top of the parapet is 284 ft. above the lowest point of the foundation. The length of the crest is 780 ft. In plan the dam is curved to a radius of 400 ft. The roadway is 16 ft. in the clear.

The *Shoshone Dam* is an irrigation dam situated on the Shoshone River in Wyoming. It has a maximum height of 305 ft. above the foundation, and a flow line 295 ft. above the foundation; and it impounds water 235 ft. deep. The dam has a top width of 10 ft., and both sides of the profile are straight lines, the up-stream face having a batter of 0.15 to 1 and the down-stream 0.25 to 1.

The dam will be about 168 ft. long on top, and is curved in plan to a radius of 150 ft.

The *Pathfinder Dam* is situated on the North Platte River in Wyoming, 4 miles below the mouth of the Sweetwater, and is to impound water for irrigation. The maximum height above the foundation is 210 ft., the flow line is 200 ft. above the foundation, and the maximum depth of water is 195 ft. The length on top is 160 ft., and the center line of the crest is curved to a radius of 150 ft.

966. Other High American Dams. The *Wachusett Dam*, near Clinton, Mass., built in 1900–06 to store water for the Metropolitan District of Boston, is a straight gravity dam 850 ft. long, having a flow line 185 ft. above the foundation and a total height of 205 ft.

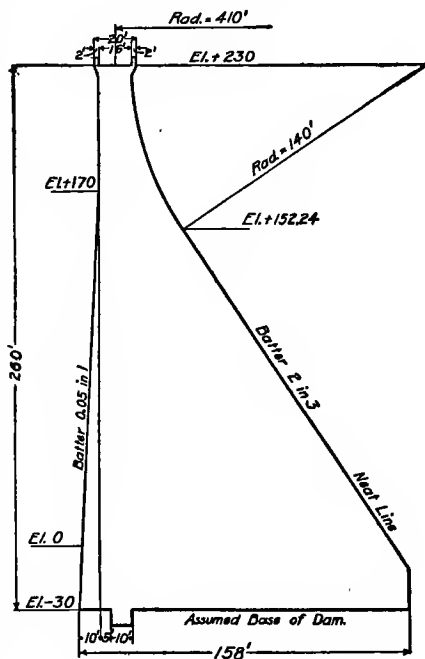

FIG. 103.—PROFILE OF ROOSEVELT DAM.

The depth of water stored is 95 ft. The profile has the same general character as that of the New Croton Dam. The extreme width on top is 25 ft. 9 in.

The *Cheesman Dam* impounds water for the city of Denver, Colorado, and was built in 1900-04. It has a flow line 227 ft. above the foundation and a total height of 231 ft. The dam is 675 ft. long on top, is curved in plan, and has a profile of the type of the New Croton Dam.

The *Olive Bridge Dam*, which forms the Ashokan Reservoir of the Catskill Water Supply of New York City, is to be 220 ft. above the foundation, and will impound water 130 ft. deep. The profile is of the same general form as that of the New Croton Dam.

967. Foreign Dams. The preceding six dams are the largest in America, and are considerably larger than any other in the world. For a list of forty-six masonry dams higher than 100 feet, fifteen of which are in the United States, see Wegmann's *Design and Construction of Dams*, page 400. The profiles of many of the high masonry dams, particularly the older ones, are exceedingly extravagant.

968. THE PLAN. If the wall is to be one side of a rectangular reservoir, all the vertical sections will be alike; and therefore the heel, the toe, and the crest will all be straight. If the wall is to be a dam across a narrow valley, the height of the masonry, and consequently its thickness at the bottom, will be greater at the center than at the sides. In this case the several vertical cross sections may be placed (1) so that the crest will be straight, or (2) so that the heel will be straight in plan, or (3) so that the toe will be straight in plan. Since the up-stream face of the theoretical profile is nearly vertical, there will be very little difference in the form of the dam whether the several cross sections are placed in the first or the second position as above. If the crest is straight, the heel, in plan, will be nearly so; if the crest is straight, the toe, in plan, will be the arc of a circle such that the middle ordinate to a chord equal to the span (length of the crest) will be equal to the maximum thickness of the dam; and if the toe is made straight, the crest will become a circle of the same radius. This shows that strictly speaking it is impossible to have a straight gravity dam across a valley, since either the crest or toe must be curved. The question then arises as to the relative merits of these two forms.

969. Straight Crest vs. Straight Toe. 1. The amount of masonry in the two forms is the same, since the vertical sections at all points are alike in both.* 2. The stability of the two forms, considered

* If the valley across which the dam is built has any considerable longitudinal slope, as it usually will have, there will be a slight difference according to the relative position of the two forms. If the two ends remain at the same place, the straight toe throws the dam farther up the valley, makes the base higher, and consequently slightly decreases the amount of masonry.

only as gravity dams, is the same, since the cross sections at like distances from the center are the same. 3. The form with a curved crest and straight toe will have a slight advantage due to its possible action as an arch.

However, it is not necessary to discuss further the relative advantages of these two types, since it will presently be shown that both the toe and the crest of a gravity dam should be curved.

970. Gravity vs. Arch Dams. A dam of the pure gravity type is one in which the sole reliance for stability is the weight of the masonry. A dam of the pure arch type is one relying solely upon the arched form for stability. With the arched dam, the pressure of the water is transmitted laterally through the horizontal sections to the abutments (side hills). The thickness of the masonry is so small that the resultant of the horizontal pressure of the water and the weight of the masonry passes outside of the toe; and hence, considered only as a gravity dam, is in a state of unstable equilibrium. If such a dam fails, it will probably be by the crushing of the masonry at the ends of the horizontal arches. In the present state of our knowledge concerning the elastic yielding of masonry, we can not determine, with any considerable degree of accuracy, the distribution of the pressure over the cross section of the arch.

If it were not for the incompleteness of our knowledge of the laws governing the stability of masonry arches, the arch dam would doubtless be the best type form, since it requires less masonry for any particular case than the pure gravity form. The best information we have in regard to the stability of masonry arches is derived from experience. The largest vertical voussoir arch in the world has a span of 295 feet, and the longest vertical concrete arch has a span of 280 feet, while most masonry dams have spans several times as long.

The experience with large arches is so limited (see Table 90, page 648, and Table 99, page 703), as to render it unwise to make the stability of a dam depend wholly upon its action as an arch, except under the most favorable conditions as to rigid side-hills and also under the most unfavorable conditions as to cost of masonry.

971. Examples of Arch Dams. Apparently there are only three dams of the pure arch type in the world—the Zola, the Bear Valley, and the Upper Otay. A fourth dam—the Sweetwater—closely approaches the arch type. Fig. 104, page 484, shows the profiles of these four dams, and also the position of the resultant pressure on the foundation. The position of the resultant shows that no one of the pure arch-type dams is as stable as a gravity dam; and the stability of the Sweetwater Dam is at least doubtful when considered only as a gravity dam. The stability of the Bear Valley and of the

Sweetwater Dam has been tested practically. Water stood for several days within a "few inches" of the flow line of the Bear Valley Dam; and for several days water 22 inches deep flowed over the crest of the Sweetwater Dam, which was 5.5 feet more than it was designed to carry. In neither case was any damage done by the unexpectedly high water.

The *Bear Valley Dam* was built in 1884 in the Bernardino Mountains in California to store water for irrigation. The arch type was adopted because of the excessive cost of transporting cement from

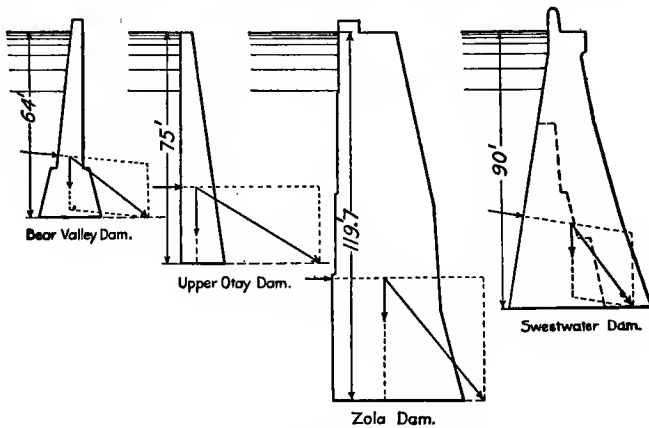

FIG. 104.—PROFILES OF ARCH DAMS.

the railroad to the site (\$10.00 per barrel). The crest of the dam is about 300 ft. long, and is curved up-stream with a radius of 335 ft.

The *Upper Otay Dam* is situated about 20 miles southeast of San Diego, California. The length of the dam on top is 350 ft., the radius being 359 ft. The up-stream face is vertical. The dam was completed several years ago, but the catchment area is so limited that the reservoir has never been full, nor will it likely ever be filled.

The *Zola Dam*, named after the designer—the father of the noted novelist,—was built in 1843 to form a reservoir for supplying water to the city of Aix, France. The length on top is 205 ft., and the radius at the crown is 158 ft.

The *Sweetwater Dam* was constructed about 12 miles southeast of San Diego, California, in 1887–88, to store water for irrigation and municipal supply. At first the dam had a height of 60 ft. and the profile shown in Fig. 104 by the dotted line. The length on top is 380 ft., and the radius of the top of the up-stream face 222 ft.

972. Curved Gravity Dams. Although it is not generally wise to make the stability of a dam depend entirely upon its action as an arch, a gravity dam should be built in the form of an arch, i.e., with both crest and toe curved, and thus secure some of the advantages of the arch type. The vertical cross section should be so proportioned as to resist the water pressure by the weight of the masonry alone, and then any arch-like action will give an additional margin for safety. If the section is proportioned to resist by its weight alone, arch action can take place only by the elastic yielding of the masonry under the water pressure; but it is known that masonry will yield somewhat, and that therefore there will be some arch action in a curved gravity dam. Since but little is known about the elasticity of stone, brick, and mortar (see § 21), and almost nothing at all about the elasticity of actual masonry, it is impossible to determine accurately the amount of arch action, i.e., the amount of pressure that is transmitted laterally to the abutments (side-hills).*

973. In addition to the increased stability of a curved gravity dam due to arch action, the curved form has another advantage. The pressure of the water on the back of the arch is everywhere perpendicular to the up-stream face, and can be decomposed into two components—one perpendicular to the chord (the span) of the arch, and the other parallel to the chord of the arc. The first component is resisted by the gravity and arch stability of the dam, and the second throws the entire up-stream face into compression. The aggregate of this lateral pressure is equal to the water pressure on the projection of the up-stream face on a vertical plane perpendicular to the span of the dam. This pressure has a tendency to close all vertical cracks and to consolidate the masonry transversely—which effect is very desirable, as the vertical joints are always less perfectly filled than the horizontal ones. This pressure also prepares the dam to act as an arch earlier than it would otherwise do, and hence makes available a larger amount of stability due to arch action.

The compression due to these lateral components is entirely independent of the arch action of the dam, since the arch action would take place if the pressure on the dam were everywhere perpendicular to the chord of the arc. Further, it in no way weakens the dam, since considered as a gravity dam the effect of the thrust of the water is to relieve the pressure on the back face, and considered as an arch the maximum pressure occurs at the sides of the down-stream face.

* For a method of computing this distribution for the Shoshone and Pathfinder Dams, see an article by Messrs. Wisner and Wheeler in *Engineering News*, vol. liv, p. 141; and for a similar discussion for the Cheesman Dam, see *Trans. Amer. Soc. C. E.*, vol. liii, p. 108-32.

The curved dam is a little longer than a straight one, and hence would cost a little more. The difference in length between a chord and its arc is given, to a close degree of approximation, by the formula

$$a = c + \frac{c^3}{24 r^2} = c \left(1 + \frac{c^2}{24 r^2} \right),$$

in which a = the length of the arc, c = the length of the chord, and r = the radius. This shows that the increase in length due to the arched form is comparatively slight. For example, if the chord is equal to the radius, the arc is only $\frac{1}{24}$, or 4 per cent, longer than the chord. Furthermore, the additional cost is less, proportionally, than the additional quantity of masonry; for example, 10 per cent additional masonry will add less than 10 per cent to the cost.

974. Finally, a curved dam can resist changes of temperature better than a straight dam. The expansion and contraction of masonry is something like 1 inch per 100 feet per 100° F. change of temperature, and a drop in the temperature of the dam of 20° would cause a tension of something like 500 lb. per sq. in. Since such a change might occur—particularly when the reservoir was partly empty,—and since no masonry could stand that tension, it is wise to prevent the possibility of any such stress by building a gravity dam convex up-stream. The face of a curved gravity dam is likely to be in compression due to the overturning effect, and the back in compression due to the arch action; that is, the tendency of the overturning moment is to produce compression in the down-stream face, while the tendency of the arch action is to produce compression in the up-stream face. However, there is not likely to be much of either action above the surface of the water—the portion exposed to the greatest changes of temperature,—but nevertheless the possibility of some such action is worth a little additional cost. The limitations of space prevent a discussion of the matter.

975. There are forty-six masonry dams in the world over 100 ft. high; and of the forty-four whose plans are known, two are of the pure arch type, twenty-eight of the curved gravity type, and fourteen of the straight gravity type.

976. OVERFALL DAMS. The preceding discussion relates to dams which are not submerged. An overfall or submerged dam must resist, in addition to the hydrostatic forces that tend to slide or overturn it, the dynamic action of large volumes of water flowing over it. The pounding and erosive action of the overflow may be diminished by giving the down-stream face such a curve as will cause the water to slide or roll down it with the least disturbance.

The theory of the best cross section for an overfall dam is not

fully settled; but Fig. 105 shows the cross section of a dam near Atlanta, Georgia, which is representative of good practice.

977. SOLID VS. HOLLOW DAMS. The preceding discussion relates solely to a solid dam, in which for economy the cross section is as narrow as consistent with stability, and the batter of the up-stream face is relatively quite small. In this form of dam, the horizontal thrust of the water is resisted chiefly or wholly by the weight of the masonry, i.e., the vertical component of the water pressure is an unimportant factor of the stability. Such a dam might with propriety be called an *upright dam*.

Since the invention of reinforced concrete, a new type of dam has been introduced, viz.: a hollow dam having a very broad base and a relatively great batter on the up-stream

face. In this form, the vertical component of the pressure of the water on the back of the dam is an important factor of the stability. Such a dam could with propriety be called an *inclined dam*, and is with less propriety often called a *pressure dam*.

978. The inclined dam consists of a series of vertical abutments spaced 10 to 15 feet apart, covered on the up-stream side with a continuous deck. If the dam is submerged, there may or may not be a rollway on the down-stream side. The abutments may be braced by horizontal struts between them; and sometimes intermediate floors are laid between the buttresses, electric machinery, etc., being placed in the compartments thus formed. Fig. 106 shows the cross section of a hollow reinforced-concrete dam. The advantages of this form, which is patented, are: (1) being hollow it requires only about 40 per cent as much concrete as a solid dam; (2) being light it gives a less pressure upon the foundation; and (3) on account of the great slope of the up-stream face, it gives a nearly uniform pressure on the foundation.

For the complete analysis of the stresses in such a dam, see *Engineering News*, Vol. LIX, pages 452-53.

979. QUALITY OF THE MASONRY. It is a well-settled principle that any masonry structure which sustains a vertical load should have no continuous vertical joints. Dams support both a horizontal

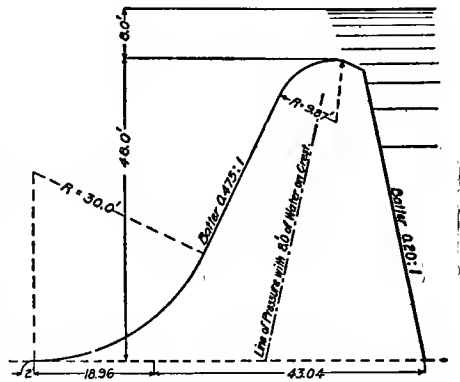

FIG. 105.—ROLLWAY OF ATLANTA DAM.

and a vertical pressure, and hence neither the vertical nor the horizontal joints should be continuous. This requires that the masonry shall be broken ashlar (Fig 70, page 280) or random squared-stone masonry (Fig. 71, page 280), or uncoursed rubble (Fig. 72, page 281). In the past, the last was generally employed, particularly for large dams; but recently rubble concrete (§ 580) seems to be preferred, since it is more easily laid and requires 3 to 5 per cent less cement. Sometimes, however, one or both faces of the dam are laid with cut stone, and the interior is filled with concrete or rubble concrete, the face masonry being carried up ahead of the concrete

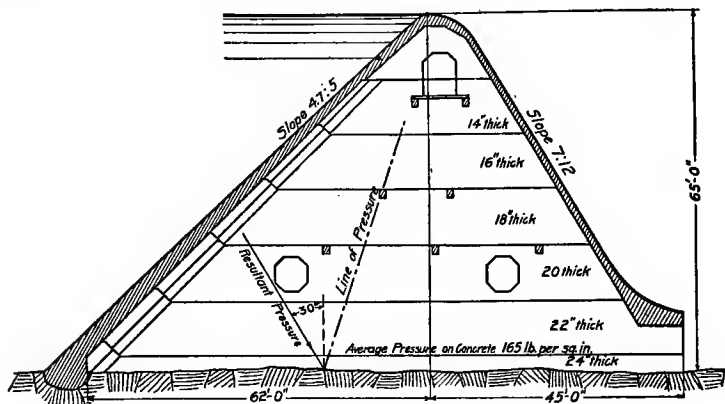

FIG. 106.—ELLSWORTH (MAINE) HOLLOW DAM.

to act as forms. The joints on the faces should be as thin as possible, to diminish the effect of the weather on the mortar and also the cost of repointing. In ordinary walls, much more care is given to fill completely the horizontal joints than the vertical ones; but in dams and reservoir walls, it is equally important that the vertical joints also shall be completely filled.

980. BIBLIOGRAPHY. For an elaborate treatise on dams—masonry, earth, rock-fill, timber, and steel—and also the principal movable dams, see Wegmann's *Design and Construction of Dams* (John Wiley and Sons, New York, 1907), which also contains an exhaustive classified bibliography of dams.

CHAPTER XVIII

RETAINING WALLS

982. DEFINITIONS. *Retaining wall* is a wall of masonry for sustaining the pressure of earth deposited behind it after it is built. A retaining wall is sometimes called a revetment wall, although that term ordinarily means a face or slope wall (see the next paragraph).

Face wall, or *slope wall*, is a species of retaining wall built against the face of earth in its undisturbed and natural position. Obviously it is much less important and involves less difficulties than a true retaining wall.

Buttresses are projections in the front of the wall to strengthen it. They are not often used, on account of their unsightliness, except as a remedy when a wall is seen to be failing.

Counterforts are projections at the rear of the wall to increase its strength. They are of doubtful economy with block in course masonry, but are valuable in a reinforced concrete wall.

Land-ties are long iron rods which connect the face of the wall with a mass of masonry, a large iron plate, or a large wooden post bedded in the earth behind the wall, to give additional resistance to overturning.

Surcharge. If the material to be supported slopes up and back from the top of the wall, the earth above the top is called the *surcharge*.

983. Retaining walls are frequently employed in railroad work, on canals, about harbors, etc.; and the principles involved in their construction have more or less direct application in arches, in tunneling and mining, in timbering of shafts, and in the excavation of deep trenches for sewers, etc., and in military engineering.

ART. 1. THEORY OF STABILITY.

984. METHODS OF FAILURE. A retaining wall proper may fail (1) by sliding on the plane of any horizontal joint, or (2) by overturning about the front edge of any horizontal joint, or (3) by crushing at the front edge of any horizontal section. The preceding methods of failure refer to the body of the wall and not to the foundation.

A wall which is held at the top may fail by bulging out near the center; but such a wall is not rightly called a retaining wall, and is not considered in this connection. Such a wall acts as a masonry beam, and not by its weight as a true retaining wall.

985. DIFFICULTIES OF THE PROBLEM. In the discussion of the stability of dams, it was shown that in order to determine the effect of the thrust of the water against the wall, it is necessary to know (1) the amount of the pressure, (2) its point of application, and (3) the direction of its line of action. Similarly, to determine the effect of the thrust of a bank of earth against a wall, it is necessary to know (1) the amount of the pressure, (2) its point of application, and (3) its line of action.

In the present state of our knowledge but little is known concerning the amount, the point of application, or the line of action of the lateral pressure of earth against a retaining wall. The difficulties in the matter may be briefly explained as follows: AC , Fig. 107, represents the back of a retaining wall, and

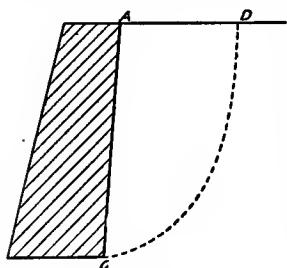

FIG. 107.

AD the surface of the ground. The earth has a tendency to break away and come down some line, as CD . The force tending to bring the earth down is its weight; and the forces tending to keep it from coming down are the friction and the cohesion along the line CD , and the resistance of the wall. The pressure against the wall depends upon the form of the line CD . If the constants of weight, friction, and cohesion of any particular ground were known, possibly the form of CD , and also the amount, point of application, and line of action of the thrust on the wall could be determined; but at present there are no adequate experimental data on this subject.

Notwithstanding the fact that since the earliest ages constructors have known by practical experience that a mass of earthwork will exert a severe lateral pressure upon a wall or other retaining structure, there is probably no other subject connected with the constructor's art in which there exists the same lack of exact experimental data. On the other hand, there is almost no other phase of construction in which there is proportionally an equal amount of theoretical mathematical investigation. Apparently, each new investigator has recognized the inadequacy of former theories, and has sought to present a new one with the hope that it might be more satisfactory. Of course, mathematical investigations unsupported by experiments or experience are a very uncertain guide.

986. THEORIES OF LATERAL PRESSURE OF EARTH. The numerous theories of the lateral pressure of earth may be divided into two classes, viz.:

1. The first class consists of those theories that assume that when a retaining wall fails, a prism of earth severs its connection from the bank and slides on a plane surface called the plane of rupture. The first theory of this class was proposed by Coulomb in 1773; and it has since been elaborated by Poncelet (1840) and Scheffler (1857), and ingenious graphical solutions have been proposed by Moh. and von Ott. This theory is frequently used; and is usually called Coulomb's theory, but sometimes the "theory of the prism of maximum pressure."

2. The theories of the second class are founded upon what is called the principle of conjugate pressures, whereby the differential equations representing the equilibrium of a particle in the interior of the supported earth are first established, and then by integration the total resultant earth pressure is deduced. This theory was proposed by Rankine in 1858, and has since been elaborated by Levy, Winkler, Mohr, and Weyrauch (1878); and ingenious graphical solutions have been proposed by Culmann, Greene, Scheffler, von Ott, and Winkler. This theory is usually called Rankine's, but some times "the theory of conjugate stresses."

987. The several theories of the lateral pressure of earth will be considered under three heads, viz.: (1) theories for the amount of the pressure; (2) theories for the direction of the pressure; and (3) theories for its point of application.

988. Theories for the Amount of the Lateral Pressure. Although it is frequently claimed that the two classes of theories are essentially different in their fundamental assumptions, and although the mathematical processes employed in the two cases are entirely different, the formulas for both classes of theories are only special cases of a single general equation, as will now be shown.

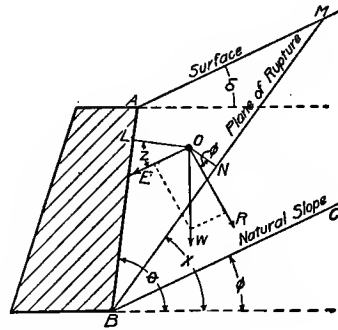

FIG. 108.

In Fig. 108, AB is the back of a wall which makes an angle θ with the horizontal; BC is the natural slope, which makes an angle ϕ with the horizontal; BM is the plane of rupture, which makes an unknown angle x with the horizontal; O is any point in the supported earth; W is the weight of the prism ABM ; OL is perpendicular to AB , and ON is perpendicular

to *BM*. The force *W* is resolved into two components *E* and *R*, the former making an unknown angle *z* with the normal to the back of the wall and the latter an angle ϕ with the normal to the plane of rupture.

h = the vertical height of the wall;

E = the pressure of the earth against the back of the wall, the angle between *E* and the normal to the back of the wall being *z*;

w = the weight of a cubic unit of the earth;

W = the weight of the earth prism, per unit of length of the wall, causing the maximum lateral pressure;

θ = the angle between the back of the wall and the horizontal;

ϕ = the angle of repose of earth, i.e., the angle between the natural slope and the horizontal;

x = the unknown angle between the plane of rupture and the horizontal;

z = the unknown angle between the resultant earth pressure and the normal to the back of the wall;

It is assumed that the earth prism *ABM*, Fig. 108, is in equilibrium under the action of three forces: (1) the weight of the mass; (2) the resultant reaction of the wall, which is equal and opposite to *E*; and (3) the resultant reaction of the plane *BM*, which is equal and opposite to *R*. Under these assumptions,

$$E = W \frac{\sin WOR}{\sin WRO} \dots \dots \dots (1)$$

$$W = w (\text{area } ABM) = \frac{1}{2} w \cdot AB \sin ABM \cdot BM \\ = \frac{1}{2} w h^2 \frac{\sin (\theta - \delta) \sin (\theta - x)}{\sin^2 \theta \sin (x - \delta)}$$

The angle *WOR* = *x* - ϕ , and the angle *WRO* = $\theta + z - x + \phi$. Substituting these values in equation 1 gives

$$E = \frac{1}{2} w h^2 \frac{\sin (\theta - \delta) \sin (\theta - x) \sin (x - \phi)}{\sin^2 \theta \sin (x - \delta) \sin (\theta + z - x + \phi)} \dots (2)$$

To find the greatest thrust of the earth against the wall, differentiate equation 2 with reference to *E* and *x*, and find the maximum value of *E*. To differentiate equation 2, all of the terms containing *x* must first be reduced to the form $\cot (\theta - x)$. This transformation and the subsequent differentiation and reduction are too long to be presented here. The maximum value of *E* is

$$E = \frac{\frac{1}{2} w h^2 \sin^2 (\theta - \phi)}{\sin^2 \theta \sin (\theta + z) \left(1 + \sqrt{\frac{\sin (\phi - \delta) \sin (\phi + z)}{\sin (\theta - \delta) \sin (\theta + z)}} \right)^2} \dots (3)$$

989. Equation 3 is a general formula for the maximum lateral pressure of earth against a retaining wall in terms of z , the unknown angle between the resultant earth pressure and the normal to the back of the wall.* Obviously equation 3 is limited to values of δ not greater than ϕ , and to values of θ greater than ϕ . The angle δ may be either plus or minus; and $\bar{\theta}$ may be more or less than 90° . A trial will show that E increases with both θ (the angle of the back of the wall with the horizontal) and δ (the angle of the surcharge).

For an investigation as to the reliability of theoretical formulas, see § 998-1013.

990. *Coulomb's Formula.* If we assume (1) that the earth surface is horizontal, i.e., that $\delta = 0$, (2) that the back of the wall is vertical, i.e., that $\theta = 90^\circ$, and (3) that the resultant earth pressure is normal to the back of the wall, i.e., that $z = 0$, then equation 3 becomes

$$E = \frac{1}{2} w h^2 \tan^2 (45^\circ - \frac{1}{2}\phi) \dots \dots \dots (4)$$

which is the well-known expression first deduced by Coulomb in 1773.

991. *Rankine's Formulas.* If we assume that the resultant earth pressure makes an angle with the normal to the back of the wall equal to the angle of repose of earth on earth, that is, if we assume that the angle of friction between the earth and the back of the wall is the same as that of earth on earth, then $z = \phi$, and equation 3 becomes

$$E = \frac{\frac{1}{2} w h^2 \sin^2 (\theta - \phi)}{\sin^2 \theta \sin (\theta + \phi) \left(1 + \sqrt{\frac{\sin (\phi - \delta) \sin 2 \phi}{\sin (\theta - \delta) \sin (\theta + \phi)}} \right)^2} \dots (5)$$

which is Rankine's formula for the pressure against a wall having an inclined back.

If we assume further that the back of the wall is vertical, and also that the line of action of the resultant lateral pressure of the earth is parallel to the surface of the earth, then $\theta = 90^\circ$ and hence $z = \delta$, and equation 3 becomes

$$E = \frac{\frac{1}{2} w h^2 \cos^2 \phi}{\cos \delta \left(1 + \sqrt{\frac{\sin (\phi + \delta) \sin (\phi - \delta)}{\cos^2 \delta}} \right)^2} \dots \dots \dots (6)$$

which is Rankine's general formula for the pressure against a vertical wall carrying a surcharge at an angle δ .

If $\delta = \phi$, as is usually assumed, then

$$E = \frac{1}{2} w h^2 \cos \phi \dots \dots \dots (7)$$

* Apparently this formula was first deduced by Prof. Mansfield Merriman—see page 35 of his Retaining Walls and Masonry Dams, John Wiley and Sons, New York, 1892.

which is Rankine's formula for a surcharge at the angle of repose.

992. Weyrauch's Formula. If it be assumed that the earth pressure is normal to the back of the wall, then $z = 0$, and equation 3 becomes

$$E = \frac{\frac{1}{2} w h^2 \sin^2 (\theta - \phi)}{\sin^3 \theta \left(1 + \sqrt{\frac{\sin (\phi - \delta) \sin \phi}{\sin (\theta - \delta) \sin \theta}} \right)^2} \dots (8)$$

which is one of the formulas proposed by Weyrauch in 1878.

993. Poncelet's Formula. If it be assumed that $z = \phi$, $\delta = 0$, and $\theta = 90^\circ$, then equation 3 becomes

$$E = \frac{\frac{1}{2} w h^2 \cos \phi}{(1 + \sqrt{2} \sin \phi)^2} \dots (9)$$

which is the expression deduced by Poncelet in 1840.

994. Theories for the Point of Application of the Pressure. In all theories, the amount of the lateral pressure is given by equation 3, page 492, or by an equation easily derived therefrom; and since by that formula the pressure varies as h^2 , i.e., as the square of the vertical height of the wall, it is always assumed in theoretical investigations that the lateral pressure of earth follows the law of liquid pressure and that therefore the point of application is $\frac{1}{3} h$ from the bottom of the wall. For a comparison between theory and experiment on this point, see § 1001-8.

995. Theories for the Direction of the Pressure. Equation 3, page 492, gives the maximum lateral pressure in terms of z , the unknown angle between the resultant pressure and the normal to the back of the wall. The real value of z can not be determined theoretically; and hence different investigators have assumed different values for this angle.

It seems reasonable to assume that the true value of z must lie between 0° and the angle of friction of the earth against the back of the wall; but the angle of friction against the rough back of a stone-block wall is not known, and hence it is usual to assume values of z between 0 and ϕ . For a level bank of earth, i.e., for $\delta = 0$, the value of E is less for $z = \phi$ than for $z = 0$; but for a surcharge, i.e., for large values of δ , E is larger for $z = \phi$ than for $z = 0$.

Usually the advocates of the theory of the prism of maximum thrust have assumed that the resultant pressure is normal to the wall, i.e., that z in equation 3 is equal to zero; and usually those who use the principle of conjugate pressures have assumed that the resultant pressure is parallel to the surface of the supported earth, i.e., that z in equation 3 is equal to $90^\circ - \theta + \delta$.

996. Angle of Repose. To apply any of the preceding formulas for the lateral thrust of earth, it is necessary to know ϕ , the angle of repose of the earth. This angle may be determined as follows: Thoroughly pulverize a mass of earth so as to destroy all cohesion between its particles; and then slowly pour it vertically upon a horizontal surface, thus forming a cone. The angle of the sides of this cone with the horizontal is ϕ , the angle of repose or the angle of natural slope. The particles of earth on such a slope are held in equilibrium by the force of gravity and by friction.

Table 75 gives rough average values of the angle of repose and also of the weight of various kinds of earth. Slight variations in the amount of moisture make great differences in the value of the angle of repose and of the weight. The results in Table 75 are about those usually given in discussions of the theory of the stability of retaining walls; but it will presently be shown that any such results are not of much value.

TABLE 75.

ANGLE OF REPOSE, COEFFICIENT OF FRICTION, AND WEIGHT OF EARTH.

KIND OF EARTH.	ANGLE OF REPOSE.		COEFFICIENT OF FRICTION, TAN ϕ .	WEIGHT, LB. PER CU. FT.
	ϕ	Slope.		
Alluvium	18°	3 to 1	0.32	90
Clay, dry	26°	2 to 1	0.50	110
Clay, damp.....	45°	1 to 1	1.00	120
Clay, wet	15°	3.2 to 1	0.31	130
Gravel, coarse	30°	1.7 to 1	0.58	110
Gravel, graded sizes.....	40°	1.2 to 1	0.84	120
Loam, dry	40°	1.2 to 1	0.84	80
Loam, moist.....	45°	1 to 1	1.00	90
Loam, saturated.....	30°	1.7 to 1	0.58	110
Sand, dry.....	35°	1.4 to 1	0.70	100
Sand, moist.....	40°	1.2 to 1	0.84	110
Sand, saturated	30°	1.7 to 1	0.58	120

997. COEFFICIENT OF COHESION. The term cohesion will be employed for the force uniting the particles of the earth, whether that force be adhesion or true cohesion. Friction resists the separation of surfaces only when motion is attempted parallel to the surface of contact, while cohesion resists motion in any direction. Cohesion is proportional to the area of contact, depends upon the nature of the materials, and is independent of the normal pressure.

The coefficient of cohesion, i.e., a measure of the cohesion of earth, may be obtained as follows: Dig a number of trenches of different depths with vertical sides, and lengths several times their widths. Examine the trenches from time to time, and after several days it will be observed that all over a certain depth will have caved along a line something like CD , Fig. 109. Measure the distance EC , being careful to choose a trench in which C is at least some little distance above the bottom of the trench. If $h = EC$, $w =$ the weight of a cubic unit of the earth, $\phi =$ the angle of repose, and $C =$ the coefficient of cohesion, then*

$$C = \frac{h w (1 - \sin \phi)}{4 \cos \phi} \dots \dots \dots (10)$$

If $w = 100$ lb. per cu. ft., and $\phi = 30^\circ$, then $C = 14.4 h$, which shows that in ordinary soil cohesion is equal to 14.4 lb. per sq. ft. per linear foot of vertical rupturing depth. This value of the coefficient of cohesion is for earth under comparatively light compression; but experiment and experience show that compression increases the cohesion, and therefore the value of C deduced as above is too small for any practical retaining wall.

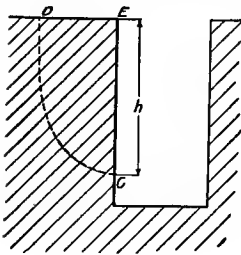

FIG. 109.

Equation 10 was deduced on the assumption that the surface of rupture is a plane, but it is near enough correct to show that under ordinary conditions cohesion is great enough to affect materially the formulas for the lateral thrust of earth. All formulas for earth pressure assume that the material to be supported is clean, dry sand—a material that is seldom, or never, found in practice,—and as all other soils possess considerable cohesion, all formulas for earth pressure must be regarded as approximate owing to the disregard of cohesion.

998. RELIABILITY OF THEORETICAL FORMULAS. There is a great difference of opinion among recognized authorities as to the reliability of the theories of earth pressure. Some contend that the results are of little or no practical value, while others claim that the theories are as trustworthy as the theoretical analysis relating to any other branch of construction. It is proposed to consider the preceding theoretical formulas in the light of experience and experiments.

All theories of earth pressure are based upon three assumptions, each of which has been seriously questioned. The first of these

* Merriman's Walls and Dams, p. 6.

assumptions is that the surface of rupture is a plane; the second that the point of application of the resultant pressure is at $\frac{1}{3}$ of the height of the wall from the bottom; and the third relates to the angle between the back of the wall and the resultant pressure. For convenience, each of these assumptions will be considered separately, although they are not entirely independent.

999. Surface of Rupture a Plane. All theories assume that the surface of rupture, *CD*, Fig. 107, page 490, is a plane; or, in other words, all theories assume that if a mass of earth is just sustained by a wall, there is a certain plane along which the prism of earth is on the point of sliding. This is equivalent to assuming that the soil is devoid of cohesion, and is homogeneous and non-compressible.

This assumption is most nearly correct in the case of dry, clean sand, and most in error with a tough, tenacious clay. In practice, sand is seldom either dry or clean; and usually the material behind the wall is not even approximately pure sand. Therefore, in most cases this assumption is considerably in error. It is common experience that banks of earth will frequently stand, at least for some time, at an angle considerably greater than the frictional angle of repose, which is proof that under ordinary conditions the cohesion of the earth is sufficient to modify materially the theoretical results for the lateral pressure.

Further, universal experience shows that when a bank of earth breaks away, as when a trench caves in (whether or not it is sheeted), or when a retaining wall fails, the surface of rupture is not a plane, but is nearly vertical near the top, and has a decided curvature at the bottom, i.e., has a form somewhat like the curve *CD* in Fig. 107, page 490.* In a rough way the line of fracture on the surface *AD*, Fig. 107, is usually at a distance back from the vertical face equal to about half the height of the face. The surface of rupture is substantially the same whether the earth is in its natural undisturbed position or is an artificial fill, unless the latter is freshly made and composed of nearly dry material. Of course, any bank of earth will in time take a slope at approximately the so-called angle of repose; but even then the surface of repose is not strictly a plane, since at its upper edge the surface is convex upward and at its lower edge is concave upward. However, this natural slope is not due to any cleavage plane in the material, but to the action of rain and wind, and perhaps also of frost.

The preceding shows that the assumption that the surface of rupture is a plane is not in accordance with ordinary practical conditions. At the time the earth is deposited behind a retaining wall,

* For numerous examples by various engineers, see *Trans. Amer. Soc. of C. E.*, vol. ix, p. 1-100.

it has the least cohesion and most nearly conforms to the theory; and hence the theory most nearly represents the most dangerous condition. But as the soil is deposited, the weight of the upper portion and the rain consolidate the lower strata and thereby increases the cohesion; and hence, unless the bank is built rapidly of dry earth during a dry time, the assumption that the surface of rupture is a plane does not closely represent the facts.

1000. All theories assume that the coefficient of friction in the interior of the earth mass is the same as on the exterior slope; or in other words, all theories assume that the coefficient of internal friction is equal to the tangent of the angle of the natural surface slope. Experiments show that the angle of internal friction differs materially from the angle of surface slope, and probably varies somewhat with the pressure.* The resistance of particles of earth or sand to moving on an exposed slope is probably rolling friction rather than sliding, while the resistance involved in the lateral pressure of earth is sliding friction. This is the reason why there is a difference between surface friction and internal friction.

Table 76 shows the values of the tangent of the angle of internal friction and also of the angle of the surface of repose for identical materials by the same observer.† There seems to be no constant relation between the two sets of values; but Table 76 shows that the angle of internal friction for most materials is considerably smaller than the angle of natural slope. The angle of internal friction seems to depend upon the size of the particles and to increase with the pressure and the moisture; but additional experiments are required to determine the law of its variation.

TABLE 76.

COMPARISON OF ANGLES OF INTERNAL FRICTION AND OF SURFACE SLOPE.

REF. No.	KIND OF MATERIAL.	TANGENT OF ANGLE OF		ANGLE OF	
		Internal Friction.	Surface Slope.	Internal Friction.	Surface Slope.
1	Bank sand.....	1.423	1.45 to 0.60	55°	55°-31°
2	Riprap.....	1.097	1.00	48°	45°
3	Sand, 50-100.....	0.549	0.85	29°	40°
4	Cinders.....	0.474	0.86	25°	41°
5	Gravel, $\frac{1}{4}$ -inch.....	0.350	0.85	19°	40°
6	Sand, 30-50.....	0.258	0.68	14°	34°

* E. P. Goodrich, Trans. Amer. Soc. of C. E., vol. liii, p. 296-302.

† E. P. Goodrich, Trans. Amer. Soc. of C. E., vol. liii, p. 301.

Table 77 gives various values of the angle of internal friction, including those in Table 76. The angle of internal friction (Table 77) rather than the angle of repose (Table 75) should be used in formulas for the lateral pressure of earth.

TABLE 77.
COEFFICIENT OF INTERNAL FRICTION.*

REF. No.	KIND OF MATERIAL.	TANGENT OF ANGLE OF INTERNAL FRICTION.	APPROXIMATE CORRESPONDING:		AUTHORITY.
			Angle.	Slope.	
1	Coal, shingle, ballast, etc.	1.423	54°	0.7 to 1	B. Baker
2	Bank sand	1.423	54°	0.7 to 1	Goodrich
3	Riprap	1.097	48°	0.9 to 1	Goodrich
4	Earth	1.097	48°	0.9 to 1	B. Baker
5	Sand, 100-up	0.895	42°	1.1 to 1	Goodrich
6	Clay.	0.895	42°	1.1 to 1	B. Baker
7	Sand, 50-100	0.750	37°	1.3 to 1	Goodrich
8	Earth	0.750	37°	1.3 to 1	Steel
9	Bank sand	0.750	37°	1.3 to 1	Wilson
10	Sand, 50-100	0.549	29°	1.8 to 1	Goodrich
11	Bank sand	0.549	29°	1.8 to 1	Goodrich
12	Clay	0.474	25°	2.1 to 1	Goodrich
13	Cinders	0.474	25°	2.1 to 1	Goodrich
14	Gravel, $\frac{1}{2}$ -inch	0.474	25°	2.1 to 1	Goodrich
15	Gravel, $\frac{1}{4}$ -inch	0.350	19°	2.9 to 1	Goodrich
16	Bank sand	0.350	19°	2.9 to 1	Goodrich
17	Sand, 30-50	0.258	14°	3.9 to 1	Goodrich
18	Sand, 20-30	0.179	10°	5.6 to 1	Goodrich

1001. Point of Application. All theories assume that the point of application is $\frac{1}{3}$ of the height of the wall from the base. The only argument advanced in support of this view is the following: The formula for the total pressure shows the pressure to vary as the square of the height, which is the same as liquid pressure; and, therefore, the point of application must be at the same point as for liquid pressure, i.e., at $\frac{1}{3}$ of the height above the base. But it has not been proved beyond question that the pressure varies as the square of the height, and hence it can not be concluded that the point of application is certainly at $\frac{1}{3}$ of the height.

In deducing the formula for the amount of the pressure, it was assumed that the prism of earth between the plane of rupture and the back of the wall acted like a solid wedge sliding on the plane of rupture; and hence there is reason for claiming that the pressure

* E. P. Goodrich, Trans. Amer. Soc. of C. E., vol. liii, p. 301.

on the back of the wall is uniformly distributed, and that the result is applied at the center of the height.

Since earth is neither a liquid nor a solid, it is probable that neither of the above assumptions is correct, and that the true position somewhere between these two extremes.

1002. Experiments with Sand. Experiments show that clean dry sand under pressure does not act even approximately as a liquid. For example, in one experiment* fine, clean, dry sand under a pressure of 2,250 lb. per sq. ft. in a box 4 ft. by 6 ft. by 6 ft. would not flow through a horizontal hole tapering from 3 inches at the inside to 2 inches at the outside; a hole at 30° with the horizontal would flow only about one third full; and a hole at 45° would flow nearly full. A vertical hole in the bottom discharged freely, but a slight

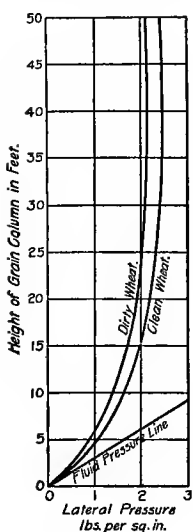

FIG. 110.

pressure of the hand was sufficient to stop the flow. In another experiment† substantially the same results were found under a pressure of 22½ tons per sq. ft. Since clean sand did not act as a liquid in these experiments, it should not be assumed that earth supported by a retaining wall acts as a liquid; and consequently it should not be assumed that the point of application of the resultant is at ⅓ of the height from the base.

1003. Experiments with Grain. All accurate experiments with various kinds of grain and seeds uniformly show that neither the vertical nor the lateral pressure varies directly with the head—as do fluids. Fig. 110 shows the curves for the lateral and vertical pressures of wheat obtained by observations on a circular reinforced concrete bin 11 ft. 3 in. in diameter and 54 ft. 9 in. deep.‡ The pressures were measured with a rubber diaphragm and a mercury column. The line marked “fluid pressure” shows the pressure of a liquid having the same weight per cubic

foot as the clean wheat. The work of other experimenters shows that these curves are typical of the results obtained with bins 12 to 24 feet in diameter and 60 to 80 feet high; and hence these results may be taken as representative of the pressure in large masses of granular material which is devoid of cohesion.

* By Lincoln Bush, *Engineering News*, vol. 1, p. 596-99.

† *Engineering News*, vol. li, p. 62.

‡ Erckhardt Lufft, *Engineering News*, vol. lii, p. 532. Notice that the curves in the top bend a little to the left, which is probably an error of observation (compare with Fig. 111) or an error of transcription. Fig. 110 is certainly in accordance with the copy from which it was taken.

Fig. 111 shows the relation between the depth and the lateral and vertical pressures for wheat and also for clean sharp dry river sand.* These results were obtained from experiments with a model bin 12 inches in diameter and 6 ft. 6 in. high; but as the curves for wheat are representative of the values obtained with large bins, it is probably safe to assume that the curve for sand is representative of the pressure of sand in large masses.

Since all accurate experiments with such granular masses as wheat, corn, peas, flaxseed, and sand show that the pressure of such materials does not follow the law of liquid pressure, it is incorrect to assume liquid pressure to determine the point of application of the lateral thrust of earth. Several steel grain bins designed according to the former theories for the pressure of granular masses, failed by the buckling of the sides near the bottom, showing that the sides carried a considerable vertical component of the weight of the grain; and many wooden bins stand without any signs of failure in defiance of the ordinary formulas for the lateral thrust of granular masses.

∠ In Fig. 110 and 111 the area between the curves for lateral pressure and the vertical line through zero is proportional to the total pressure, and the center of gravity of the area gives the height of the point of application of the resultant; and consequently, the more nearly this area approaches a rectangle, the more nearly the lateral pressure is uniformly distributed and the more nearly the center of pressure approaches the center of the height.

1004. The most instructive results of the experiments with high heads of grain are: (1) the pressure increases very little after a depth of $2\frac{1}{2}$ to 3 times the diameter of the bin has been reached; (2) the lateral pressure is from 0.3 to 0.6 of the vertical pressure according to the kind of grain, its moisture, the material of the bin, etc.; and (3) the vertical pressure on the bottom of the bin is greatest near the center and decreases toward the side of the bin, where it is

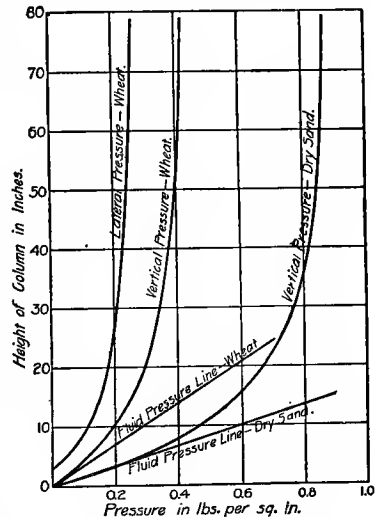

FIG. 111.

* J. A. Jamieson, Trans. Canadian Soc. of C. E., vol. xvii, p. 554-654; abstract in *Engineering News*, vol. li, p. 241.

practically equal to the lateral pressure on the side of the bin. These results show that the only pressure on the bottom of the bin and also on the sides of the bin near the bottom is that due to a dome-shaped mass of grain immediately above the bottom, and that all grain above this mass is carried entirely by friction between the grain and the sides of the bin. The pressures depend upon the rise of this dome-shaped mass, which varies with the horizontal dimensions of the bin, the kind and the dryness of the grain, the material of the bin, etc. When grain is drawn out from below this dome, the space is filled by grains dropping from the under side of the dome, and as these drop others take their place in the dome.

The knowledge that a mass consisting of comparatively small and smooth particles is supported by arch-like action over the relatively large space between the walls of a bin, is important in interpreting the results of experiments on retaining walls and on the pressure of grain in bins, and also in designing structures to resist the pressure of earth.

1005. *Point of Application Determined Experimentally.* Several direct experiments have been made to determine, among other things, the point of application of the resultant earth thrust against a retaining wall. M. Leygue,* Mr. George Darwin,† and M. Gobin‡ have made such experiments, but their apparatus was upon such a small scale and of such a character that their results are not trustworthy, chiefly on account of the possible arch action of the sand and millet seed experimented with. However, according to Leygue's experiments, the point of application of the resultant for sand varies from $0.38 h$ to $0.50 h$ and for millet seed from $0.382 h$ to $0.450 h$.

1006. Mr. A. A. Steel¶ measured the pressure against two boards 12 inches square, due to earth in a pit which at the bottom was 6 ft. 6 in. from front to rear and 7 ft. long, and at the top was 7 ft. front to rear and 9 ft. long. The maximum head of earth against the upper board was 12.5 ft. The pressures were measured by a lever whose long arm acted against a spring balance. The curves for the lateral pressure for dry loam were uniformly of the same general form as the curves in Fig. 111, page 501. The observed pressures upon the upper board were from 70 to 80 per cent greater than those upon the lower board, probably owing to greater arch action at the lower board. The lower edge of one board was 0.5 ft. and of the other 1.5 ft. above the bottom of the pit. For dry loam weighing 80 lb. per cu. ft. and having an angle of repose of $35^{\circ} 29'$, the point of application of the resultant pressure was 0.40 of the head above the

* *Annales des Ponts et Chaussées*, Nov. 1885.

† *Proc. Inst. of C. E.*, vol. lxxi, p. 350.

‡ *Annales des Ponts et Chaussées*, 1883.

¶ *Engineering News*, vol. xlii, p. 261-63.

bottom; for the same earth slightly moist 0.39, and when saturated 0.38.

1007. Mr. E. P. Goodrich* by using a box 3 ft. by 3 ft. square and 6 ft. deep, found the point of application for slightly moist bank sand to be 0.38 of the head, and by measuring the deflection of the sheeting of a trench in fine beach sand 0.39 and 0.40 for two different days. In discussing these and the preceding results, Goodrich says that these experiments "tend to show that for retaining walls from 6 to 10 ft. high, the resultant should be considered as applied at a point 0.4 of the head from the bottom; and with walls less than 6 ft. high, the resultant should be applied still higher; while with walls more than 10 ft. high, the point of application will approach the one third point."

Another conclusion from these experiments was that the lateral thrust decreased with time and with repeated applications of the load.

A further conclusion, but one not so well established, was that in building a wall to restrain quicksand it is necessary to provide only for the pressure of the water.

1008. Dr. H. Müller-Breslau, Professor in the Technical High School, Berlin, in an elaborate series of experiments † used the most scientific and most sensitive apparatus yet devised. He made his experiments with sand in a box 40 inches wide and 80 inches long, having one end 30 inches high and the opposite one 75 inches. He measured the pressure against the low end, which was 30 inches by 40 inches. The sand was such as is used for building purposes in Berlin, and was sharp and thoroughly dry. The apparatus gave, simultaneously and with great accuracy and for practically an infinitesimal movement, the horizontal pressure at the top and the bottom of the pressed surface and also the vertical component of the pressure, from which he could deduce the amount, the direction, and the point of application of the resultant pressure. Observations were made (1) with the upper surface of the sand sloping down from the top of the "wall" at the angle of repose and (2) at half the angle of repose, (3) with the upper surface horizontal, (4) with the upper surface horizontal and carrying a vertical load both near to and remote from the wall, and (5) with the upper surface sloping up at the angle of repose.

Since the head was so small, i.e., since the observations were made so near the origin of the curves shown in Fig. 110 and 111, pages 500 and 501, the results are not of much value as showing the amount of the thrust; but the experiments give important information concerning other features of the problem.

* Trans. Amer. Soc. of C. E., vol. liii, p. 295.

† Zweiter Abschnitt, Erddruck auf Stützmauern, Alfred Kroner, Stuttgart, 1906.

These experiments are very valuable as showing the position of the point of application of the resultant. For sand sloping down from the wall at the angle of repose, the point of application was $0.313 h$ from the bottom; when sloping down at half the angle of repose, $0.331 h$; when level, $0.352 h$; when level and carrying a vertical load remote from the wall, varied from $0.380 h$ to $0.420 h$; and when level and carrying a load near the wall, varied from $0.360 h$ to $0.466 h$. In other ways, the observations show that as the head increases the point of application rises, which is in accordance with the results recorded in Fig. 110 and 111, pages 500 and 501.

Dr. Müller-Breslau says: "It is especially important to notice that, contrary to the Rankine theory, the slope of the upper surface of the sand has no effect upon the direction of the resultant."

Another interesting feature of these experiments was that the angle of friction of the sand against a sheet of plate glass was about three fourths of the angle of repose of the sand, which shows that with a very smooth back to the wall, the resultant makes a considerable angle with the normal.

The experiments also show that as an external load is successively applied and removed, the point of application rises.

The experiments are to be continued with the view of determining (1) the pressure upon oblique walls for different inclinations of the upper surface, (2) the pressure for different kinds of soils, (3) the effect of repeatedly loading the back filling, (4) the influence of moving loads, and (5) the effect of shocks.

1009. Direction of Resultant Pressure. The results by the different theories differ chiefly because of the different assumptions as to the direction of the resultant earth pressure.

Rankine's theory assumes that the pressure is always parallel to the earth slope; but this does not seem reasonable, since the direction of the pressure should be the same as that of the motion, which is parallel to the plane of rupture and nearly independent of the surface slope. According to this theory, a wall may be more stable with a surcharge than with a level top surface, because of the difference in direction of the thrust. Experiments with sand (§ 1008) and with grain (§ 1003-4) show that the surcharge has little or no effect upon the lateral pressure, except for small heads; and hence for this reason Rankine's theory is not general. Müller-Breslau's experiments (§ 1008) with very sensitive apparatus show that the slope of the upper surface has no appreciable effect upon the direction of the pressure.

By both Rankine's and Coulomb's theory, one or the other of which is generally used when any theory is employed, when the back of the wall is vertical and the upper surface of the earth is level, the

usual case in practice, the resultant thrust is perpendicular to the back of the wall, which seems to be inconsistent with the theory of a wedge of earth sliding down the back of the wall. Further, experience and experiments with the pressure of grain in bins show that the pressure against the side of the bin greatly influences the amount of the resultant pressure; and hence it is safe to conclude that the friction against the back of the wall is an important factor in the stability of a retaining wall. Including the friction on the back of the wall materially increases the theoretical stability of the wall.

Some authors, in deducing the formula for lateral pressure, consider the wall as replacing a similar mass of earth, and then assume that because the pressure across any plane in a homogeneous mass of earth is normal to that plane, the resultant pressure will be normal to the back of a wall. But whether the earth is thrown in loosely or is rammed in behind a retaining wall, the settlement or the compression causes it to slide down the back of the wall and develop friction; and hence the state of stress between the compressible earth and the unyielding wall is entirely different from that between any two adjacent portions of the imaginary homogeneous mass of indefinite extent. Experience uniformly shows that earth, whether deposited loosely or rammed behind a retaining wall, always settles, and hence friction against the back of the wall is always developed. This friction may disappear if the earth shrinks by drying out, in which case it is probable that enough cohesion is developed to render the earth self-supporting.

1010. Other Objections to Theory. All of the theories for earth pressure contain logical contradictions or inconsistencies. For example, all of them assume that the point of application on the back of the wall is at $\frac{1}{3}h$ from the bottom, while the other conditions of the solution give the point of application on the plane of rupture at a different point, except for the special case of a vertical wall.

Again, Weyrauch's formula, of which several others are special cases, is deduced for a wall leaning away from the earth to be supported, and is claimed to be perfectly general; and yet, if applied to a wall leaning toward the earth to be supported, it gives a lateral thrust which increases with the backward inclination of the wall.

Nearly all of the theories are inconsistent when applied to special cases. For example, according to Rankine's theory* for a vertical wall, and for earth standing at a slope of $1\frac{1}{2}$ to 1, and for a level top surface, $E = 0.28 (\frac{1}{2} w h^2)$; and for a surcharge at the angle of repose, $E = 0.83 (\frac{1}{2} w h^2)$. The last result is practically three times the first; and if the back of the wall be considered to lean away

*Howe's Retaining Walls for Earth, 4th Edition, 1907.

from the earth supported, the value of E for a surcharge as above is four times that for a level top surface. These results are contrary to reason, to ordinary experience, and to careful experiments (see § 1008), which shows that the theory is fundamentally wrong. Rankine, who proposed this theory, said of it: "For want of precise experimental data, its practical utility is doubtful."

The preceding examples illustrate that most, if not all, theories are logically self-contradictory, either in their fundamental assumptions or in their application to special cases. These inconsistencies crop out in one place in one theory and in another place in another theory, which shows that the underlying assumptions are inconsistent.

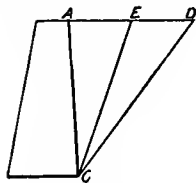

FIG. 112.

1011. Most of the theories are at variance with experiments and experience. For example, all theories agree that for a level earth surface and a wall with a vertical back, the pressure of the earth against the wall AC , Fig. 112, is equal to the pressure of the prism ACE sliding down the perfectly smooth plane, CE , which bisects the angle between the back of the wall and the natural slope, CD ; whereas "experiments show that the lateral pressure of the prism ACE between two boards AC and CE against AC is quite as much when the board EC is at the slope of repose, $1\frac{1}{2}$ to 1, as when it is at half that angle; and there was hardly any difference whether the board was horizontal or at a slope of $\frac{1}{2}$ to 1, or at any intermediate slope."*

Sir Benjamin Baker used Coulomb's formula, equation 4, page 493, to interpret indirect experiments, and regarded the theoretical pressure of the earth as that of a liquid having a weight per cubic unit $= w \tan^2 (45^\circ - \frac{1}{2} \phi)$. If $w = 100$ lb. per cu. ft., and $\phi = 34^\circ$ (natural slope $1\frac{1}{2} : 1$), then the theoretical pressure against the back of the wall is that of a liquid weighing 28 lb. per cu. ft. He found for his different practical examples that the pressure producing overturning was equal to that of a liquid weighing from 7.4 to 11 lb. per cu. ft.; and comparing these with the corresponding theoretical pressure, he found the factor of safety to vary from 2.1 to 3, and concluded that a wall which by Coulomb's formula was on the point of overturning has a factor of safety of at least two.* One of the author's students experimented with fine shot, which appears to

* Sir Benjamin Baker in "The Actual Lateral Pressure of Earth" in Proc. Inst. of C. E., vol. lxxv, p. 140-241, or Van Nostrand's Science Series, No. 56, or Van Nostrand's *Engineering Magazine*, vol. xxv, p. 333-42, 353-71, and 492-505. This is an interesting and instructive account of twenty-three direct or prearranged experiments and of thirty-two unintentional experiments or examples occurring in practice showing the actual lateral pressure of earth. The most interesting feature is that the article shows how an eminently successful engineer sought to interpret and reduce to rule the examples coming within his knowledge.

fulfill the fundamental assumptions of this theory, and found that the observed resistance was 1.97 times that computed by Coulomb's formula.* The uncertainties of the fundamental assumptions and the questionableness of a portion of the mathematical process are sufficient explanation of the difference between theory and practice.

1012. Conclusion. It is generally conceded that for a level earth surface and a vertical back, the most common case, the ordinary theories do not greatly differ, and that all give results that are safe. Not infrequently a wall is designed according to some one of the common theories without any factor of safety on the assumption that the errors in the theory amount to a sufficient factor of safety. Apparently, the ordinary formulas give a value for the lateral pressure that is much greater than the real pressure, and assume the point of application lower than it is in fact, the error in the one case neutralizing, in part at least, that in the other; but apparently the first error is so great that the net overturning moment by the ordinary theories is two or three times greater than the real moment.

The ordinary theoretical formulas are of but little value in designing retaining walls. The problem of the retaining wall is not one that admits of an exact mathematical solution, since the conditions can not be expressed in algebraic formulas. Something must be assumed in any event, and it is far more simple and direct to assume the thickness of the wall at once than to derive the latter from equations based upon a number of uncertain assumptions.

1013. Theoretical investigations of many engineering problems which in every-day practice need not be solved with extreme accuracy, are useful in determining the relations of the various elements involved, and thus serve as a guide to the judgment and as a skeleton upon which to group the results of experience; but the preceding discussion shows that the present theories of the stability of retaining walls are not sufficiently exact to serve even this purpose. Furthermore, the stability of a retaining wall is not a purely mathematical problem. Often the wall is designed and built before the nature of the backing is known; and the variation of the backing, due to rain, frost, shock, extraneous loads, etc., can not be included in any formula.

1014. EMPIRICAL RULES FOR THICKNESS OF RETAINING WALLS. Below are three well-known empirical rules for the thickness of masonry retaining walls which are also applicable to walls of plain concrete. Notice that the first gives the lightest wall and the last the heaviest.

1015. Fanshawe's Rule. "Hundreds of revetments have been built by royal engineer officers in accordance with General Fanshawe's

* See M. Fargusson's Bachelor's Thesis, University of Illinois.

rule of some fifty years ago, which was to make the thickness of a rectangular brick wall, retaining ordinary material, 24 per cent of the height for a batter of $\frac{1}{8}$, 25 per cent for $\frac{1}{6}$, 26 per cent for $\frac{1}{5}$, 27 per cent for $\frac{1}{4}$, 28 per cent for $\frac{1}{3}$, 30 per cent for $\frac{1}{2}$, and 32 per cent for a vertical wall.*

1016. Baker's Rule. Sir Benjamin Baker, who had large experience in all kind of soils in building 9 miles of retaining walls of heights up to 45 ft. and with 34 miles of trenches of depths down to 54 ft. says:† “Experience has shown that a wall [to sustain earth having a level top surface], whose thickness is one fourth of its height, and which batters 1 or 2 inches per foot on the face, possesses sufficient stability when the backing and foundation are both favorable. This allows a factor of safety of about two to cover contingencies. It has also been proved by experience that under no ordinary conditions of surcharge or heavy backing, is it necessary to make a retaining wall on a solid foundation more than double the above or one half of the height in thickness. Within these limits the engineer must vary the strength according to the conditions affecting the particular case. Outside of these limits, the structure ceases to be a retaining wall in the ordinary acceptance of the term. As a result of his own experience, the writer [Sir Benjamin Baker] makes the thickness of retaining walls in ground of an average character equal to one third of the height from the top of the footings. The whole of the walls on the District railway [the Metropolitan District underground railways of London] were designed on this basis, and there has not been a single instance of settlement or overturning or sliding forward.”

1017. Trautwine's Rule. Trautwine‡ recommends that “the thickness on the top of the footing course of a vertical or nearly vertical wall which is to sustain a backing of sand, gravel, or earth level top surface, when the backing is deposited loosely (as when dumped from cars, carts, etc.), for railroad practice, should not be less than the following:

Wall of cut-stone, or of first-class large-ranged rubble in mortar,	35 per cent
“ “ good common scabbled mortar-rubble, or brick.....	40 per cent
“ “ well scabbled dry rubble.....	50 per cent

When the backing is somewhat consolidated in horizontal layers each of these thicknesses may be reduced; but no rule can be given for this. Since sand or gravel has no cohesion, the full dimension as above should be used, even though the backing be deposited in

* Sir Benj. Baker, Proc. Inst. of C. E., vol. lxxv, p. 184.

† Ibid., p. 183-84.

‡ Engineer's Pocket-book, ed. 1885, p. 683.

layers. A mixture of sand, or earth with pebbles, paving stones, bowlders, etc., will exert a greater pressure against the wall than the materials ordinarily used for backing; and hence when such backing has to be used, the above thicknesses should be increased, say, about $\frac{1}{8}$ to $\frac{1}{6}$ part."

1018. FACTOR OF SAFETY. Since the applied force is not known definitely, it is impossible to compute the factor of safety with any considerable accuracy.

1019. Overturning. Some designers consider a wall as safe against overturning if the theoretical factor of safety as computed by equation 12, page 467, is three or more; or if the theoretical center of pressure lies within the middle third of the base, i.e., if the approximate theoretical factor of safety as computed by equation 13, page 468, is three or more. Not infrequently walls are built which by the ordinary theories are on the point of overturning, under the belief that the error in the theory provides a sufficient factor of safety; and such walls seem to stand satisfactorily.

1020. Sliding. There is but little danger of a stone- or brick-masonry retaining wall's failing by sliding. For example, assuming the coefficient of friction to be 0.65 (Table 75, page 495), a wall 10 ft. high, having an average thickness of 25 per cent of the height, and weighing 150 lb. per cu. ft., will have a resistance to sliding due to friction alone = $0.25 \times 10 \times 150 \times 0.65 = 2,437$ lb. per lin. ft.; while according to Coulomb's theory (eq. 4, page 493) the horizontal thrust is only about 1,400 lb., or the factor of safety is nearly two. But there is certainly a vertical component of the earth pressure which is neglected in the above computation; and besides the effect of the cohesion of the mortar has been neglected. Further, it is claimed, with a considerable show of reason, that equation 4 gives a result twice or more too great. Hence the real factor of safety against sliding is probably considerably more than four.

Upon the showing of some such investigation as above, it has been customary to pay little or no attention to the factor of safety against sliding for stone or brick masonry walls; and now that retaining walls are usually built of concrete, there is still less need of considering the stability against sliding, unless perhaps upon the foundation, a subject which will be investigated presently (§ 1025-28).

1021. Crushing. As a rule, it seems to be customary to assume that the only load upon the base of the wall is the weight of the masonry, and also to assume that the center of pressure is to be kept within the middle third of the base, and that consequently the maximum pressure is not more than twice the mean. Computed in this way, there is no likelihood that the masonry of an ordinary

retaining wall will fail by crushing. For example, the base of a prismatic column consisting of 1 : 2 : 6 portland cement concrete one month old would about be upon the point of failing by crushing if the column were 2,000 feet high (Table 31, page 197); and hence such concrete would be upon the point of crushing under a retaining wall 1,000 feet high, and a prismatic wall one tenth as high would have a factor of safety of ten, and a wall thicker at the bottom than at the top would have a greater factor of safety, which shows that with any ordinary retaining wall there is no probability of the masonry's failing by crushing.

On account of the showing of some such computations as the above, little or no attention is usually given in the design of a retaining wall to the factor of safety against crushing. Apparently, this has frequently led to the neglect of an adequate consideration of the maximum pressure on the soil under the foundation (§ 1026-28).

1022. STABILITY OF REINFORCED-CONCRETE RETAINING WALL.

The preceding empirical rules for the thickness of a retaining wall are applicable primarily to stone-block masonry, and could be safely used for plain-concrete retaining walls; but are not applicable to reinforced-concrete walls, and there has not yet been sufficient experience with this form of construction to establish similar empirical rules. The stability of a reinforced-concrete wall may be determined in either of two ways, viz.: (1) by using a theoretical formula for the thrust of the earth; or (2) by making the stability against rotation equal to that of a solid wall that is known to be safe.

1023. By Theoretical Formula for Earth Pressure. The thrust of the earth against the back of the wall may be computed by any of the theoretical formulals, the direction being taken in accordance with the theory, and the force being applied at $\frac{1}{3}$ of the height of the wall. For example, if Coulomb's formula for a level earth surface and a vertical back to the wall (equation 4, page 493) be used, the pressure is assumed to be horizontal and to be applied at $\frac{1}{3}$ of the height from the top of the footing. Knowing the amount, direction, and point of application of the earth thrust, the dimensions of the wall can then be obtained as will be explained later (see § 1038-43).

Instead of computing the resultant earth pressure as above, the coefficient of h^2 in the several formulas for earth pressure may be regarded as the weight per cubic unit of a liquid giving an equal lateral pressure; and the wall may be designed to support this liquid pressure. For example, Coulomb's formula (equation 4, page 493) gives a pressure equivalent to that of a liquid weighing 25 to 28 lb. per cu. ft., according to the weight of the earth and the angle of repose assumed.

1024. By Comparison with a Solid Wall. The overturning resistance of the lightest wall which experience has shown to be safe, may be regarded as the maximum overturning moment of the earth; and a reinforced-concrete wall, or other new form of construction for which experience has not established safe dimensions, may be designed to have an equal stability. For an example of this method, see § 1051.

ART. 2. DETAILS OF CONSTRUCTION.

1025. FOUNDATION. It is universally admitted that a large majority—by some put at nine out of ten, and by others at ninety-nine out of a hundred—of failures of retaining walls are due to defects in the foundation. The general method of securing a good foundation has already been considered in Part III, and has been referred to incidentally in § 930.

The most frequent cause of the failure of retaining walls is the unequal settlement of the foundation. Since the height is much greater than its thickness, a comparatively small inequality of settlement at the two edges of the foundation produces a relatively large lateral displacement of the top of the wall, which is at least unsightly and which may change the conditions under which the stability was determined; and therefore the utmost care must be taken to secure a nearly uniform distribution of pressure on the foundation, and consequently a nearly equal settlement. Of course, if the soil is incompressible, or if the retaining wall rests upon a substantial pile foundation, a uniform distribution of the pressure on the foundation is unimportant; but otherwise it is very important.

1026. The projection of the footing should be determined primarily with reference to the bearing power of the soil. When the foundation is compressible, the width of the footing may properly be considerably wider than the base of the wall proper. Apparently the failure to appreciate this principle has caused retaining walls to be made heavier than was necessary. Because the top of a retaining wall tips forward does not prove that the body of the wall is too light, since the tilting may be due to the footing's being too narrow. If a wall tips forward, an examination should be made to determine whether the movement is due to overturning at the top of the footing or to an unequal settlement of the soil under the footing. If the former, the body of the wall is not heavy enough; but if the latter, the footing does not project far enough in front.

It is not uncommon to find cases where a wall without a footing upon a compressible soil has tipped forward; and a second wall, designed in the light of the experience with the first one, has been

made heavier but also without a footing. If, instead of enlarging the body of the first wall, part of the masonry had been placed in a footing, its stability would have been increased without additional masonry and perhaps with less. By the above process of reasoning, walls without footings and having a width at the bottom equal to 45 per cent of their height have been declared to be too light; while walls having a width of 25 per cent on top of an ample footing have stood successfully in similar soil. Of course, the weight of the wall is useful in resisting overturning and sliding; but it is as useful for this purpose in the footing as in the body of the wall, and far more economical of material. Sometimes, on account of the high price of land, it is desirable to place the front of the wall on, or at least near, the property line, in which case the footing can not project in front. Under these circumstances, an eccentric footing (§ 702) wide enough to reduce the pressure on the soil to a reasonable amount must be constructed, or land ties (§ 1033) or relieving arches (§ 1034) must be employed.

1027. Retaining walls founded upon a compressible soil have tipped forward, apparently partly at least because of an error in the earth pressure formula used. The most common case in practice is a wall to retain earth having a level top surface; and for these conditions, the formulas ordinarily employed assume that the earth pressure is horizontal. This assumption fails to take account of the vertical component of the earth pressure, which comparatively recent experiments (see particularly §1002, §1003-4, and §1008) have shown to exist; and consequently the ordinary method of solution makes the pressure on the soil, particularly under the toe of the wall, less than it really is. In other words, it is usually assumed, in effect at least, that the total pressure on the foundation of a retaining wall is only the weight of the wall; while in reality it includes also a considerable part of the weight of the retained earth—not only of the earth vertically above the footing, but also part of the earth beyond the vertical through the heel of the footing. Of course, if the equivalent uniform pressure is underestimated by a certain per cent, the maximum pressure is under-estimated by considerably more than that per cent, possibly more than twice as much.

1028. The matters considered in the two preceding sections (§ 1026 and 1027) probably explain why many retaining walls founded upon a compressible soil have tilted forward. The tilting of such walls can be prevented by placing the footing so that the center of pressure on the soil shall be inside or back of the center of the footing, thus making the pressure under the heel of the footing a maximum and producing a tendency of the top of the wall to crowd against the back-filling. The earth has a greater passive resistance than an active thrust; and hence the crowding inward of the wall

is not likely to do any harm, and in any case is preferable to a tendency to tilt outward.

Unfortunately, in the present state of our knowledge of the theory of earth pressure, it is not possible to determine certainly the center of pressure; and hence all that can be done is to determine it as accurately as possible, and then provide a liberal factor of safety by making the footing large enough to reduce the uniform pressure on the soil to a reasonably safe value. The center of the footing should be placed as near the center of pressure as possible, but preferably on the outside,—for the reason stated in the preceding paragraph.

Sometimes it is impossible to extend the footing in front of the face of the wall on account of conflicting property interests, in which case it is necessary (1) to use piles or their equivalent under the toe of the wall, or (2) to build relieving arches (§ 1034) against the back of the wall, or (3) to build the back of the wall on a batter so flat as to throw the center of pressure at a considerable distance from the toe of the wall. It is hardly possible to secure the last solution without building a hollow wall or using a reinforced-concrete counterforted wall (§ 1051).

1029. DRAINAGE. Next to a settlement of the foundation, water behind the wall is the most frequent cause of the failure of retaining walls. The water not only adds to the weight of the backing material, but also softens the material and changes the angle of repose so as to greatly increase its lateral thrust. With clayey soil, or any material resting upon a stratum of clay, this action becomes of the greatest importance. Further, the freezing of undrained back-filling and the consequent expansion is a potent cause of the failure of retaining walls.

To guard against the possibility of the backing's becoming saturated with water, holes, called *weepers*, or *weep holes*, are left through the wall. When retaining walls were built of stone-block masonry, the usual rule was to allow one weep-hole, two or three inches wide and the depth of a course of masonry, for each four or five square yards of front of the wall. When the wall is constructed of concrete, a 3- or 4-inch tile should be built into the wall at intervals along the base of the wall according to the climate and the retentiveness of the back-filling—in the north Central States not usually more than 10 or 15 feet apart.

When the backing is clean sand, the weep-holes will allow all the water to escape; but if the backing is retentive of water, a vertical layer of broken stone or coarse gravel or cinders is sometimes placed next to the wall to act as a drain. Sometimes vertical lines of tiles with open joints or of perforated wrought-iron pipe are in-

serted behind the wall to conduct the water to the weepers. Sometimes both the porous back-filling and the vertical drains are used together.

1030. When the backing is likely to be reduced to quicksand or mud by saturation with water, and when this liability can not be removed by efficient drainage, one way of making provision to resist the additional pressure which may arise from such saturation is to calculate the requisite thickness of the wall as if the earth were a fluid (see the third paragraph of § 1007). A puddle-wall is sometimes built against the back of dock-walls to keep out the water.

1031. CONTRACTION JOINTS. For the method of making contraction joints in plain concrete walls, see § 385-87; and for the methods of providing for contraction in reinforced concrete walls, see § 503-06.

1032. METHOD OF PLACING BACK-FILLING. The manner of depositing the back-filling has a very important effect upon the stability of a retaining wall, but usually receives little or no consideration. If the back-filling is dumped so as to slide or flow toward the wall, the pressure against the wall is likely to be much greater than for a static load, since the flow develops surfaces of cleavage which cause large masses of earth to slide down against the wall as the back-filling settles. This tendency to form surfaces of separation may be due to a difference in the material of the back-filling, or to a difference in fineness, or to the effect of rain, or to all combined. When the back-filling is first deposited, the thrust is a maximum, because the cohesion is then a minimum, and usually the masonry is then weaker than it will be later, because the cement has not fully set; and hence it is particularly unwise to deposit the earth in such a manner as to greatly increase the thrust. The back-filling should be deposited in horizontal layers or be dumped so as to flow away from the wall. Not infrequently, by depositing the back-filling so as not to slide against the wall in settling, a light wall of inferior materials and workmanship may be made to stand, where if the earth is dumped in such a manner as to slide against the wall a heavier section of superior materials and workmanship fails.

If the back-filling is deposited before the cement has fully hardened, it is wise either (1) to tamp the earth in thin layers which are horizontal or slope away from the wall, or (2) to support the wall temporarily by shores solidly wedged up.

Particular care should be taken in depositing the back-filling of a wall built near a steep undisturbed slope of earth or rock, since either an excessively heavy earth wedge may be formed or the earth may arch and thereby throw a heavy lateral thrust near the top of the wall.

It is always more economical to increase the stability of a retaining wall by drainage and care in depositing the back-filling than by increasing the cross section.

1033. LAND TIES. Retaining walls may have their stability increased by being tied or anchored by iron rods to blocks of concrete imbedded in a firm stratum of earth at a distance behind the wall. "The holding power, per foot of breadth, of a rectangular vertical anchoring plate, the depths of whose upper and lower edges below the surface are respectively x_1 , and x_2 , may be approximately calculated from the following formula:

$$H = w \frac{x_2^2 - x_1^2}{2} \frac{4 \sin \varphi}{\cos^2 \varphi} \dots \dots \dots (11)$$

in which H is the holding-power of the plate in pounds per foot of breadth, w is the weight in pounds of a cubic foot of the earth, and φ its angle of repose. The center of pressure of the plate is about two thirds [really between two thirds and one half] of its height below its upper edge,—at which point the tie-rod should be attached.

"If the retaining wall depends on the tie-rods alone for its security, against sliding forward, they should be fastened to plates on the face of the wall in the line of the resultant pressure of the earth behind the wall, that is, at one third [see § 1001] of the height of the wall above its base. But if the resistance to sliding forward is to be distributed between the foundation and the tie-rods, the latter should be placed at a higher level. For example, if half the horizontal thrust is to be borne by the foundation and half by the tie-rods, the latter should be fixed to the wall at two thirds of its height above the base.*"

1034. RELIEVING ARCHES. In extreme cases, the pressure of the earth may be sustained by relieving arches. These consist of a row of arches having their axes and the faces of their piers at right angles to the face of a bank of earth. There may be either a single row of them or several tiers; and their front ends may be closed by a vertical wall,—which then presents the appearance of a retaining wall, although the length of the archways is such as to prevent the earth from abutting against it. Fig. 113 represents a front view and a vertical transverse section of such a wall, with two tiers of relieving arches behind it.

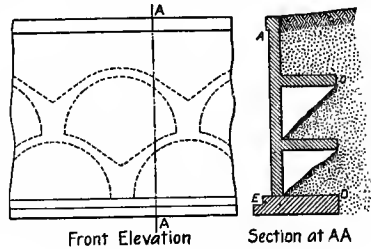

FIG. 113.—RELIEVING ARCHES.

* Rankine's Civil Engineering, p. 411.

To determine the conditions of stability of such a structure as a whole, the horizontal pressure against the vertical plane OD may be determined, and compounded with the weight of the combined mass of masonry and earth $O A E D$, to find the resultant pressure on the foundation.

1035. ECONOMICAL VERTICAL SECTION. The resistance to sliding depends only upon the weight of the wall and the coefficient of friction, and hence is independent of the form of the vertical cross section. The resistance to crushing depends upon the relative position of the center of pressure and the center of the base, and varies approximately as the stability against rotation; and hence the form of the vertical cross section that gives greatest stability against rotation also gives the greatest stability against crushing. The resistance to overturning depends upon the moment of the weight of the wall, and for a given amount of masonry the longer the moment arm the greater the stability; and hence the nearer the center of gravity of the wall is to the earth to be supported, the greater is the economy of material, which requires that the back of the wall shall lean toward the earth. But in order that the wall may be self-supporting before the back-filling is deposited, the center of pressure should preferably fall within the base, although with care, particularly with monolithic concrete, the center of pressure may safely fall a little outside of the base. However, in localities where the ground freezes, it would not be wise to build a retaining wall leaning toward the earth, on account of the heaving action of the frost—unless the back-filling is thoroughly drained.

The above shows that in discussing the stability of a retaining wall, it is not sufficient to give simply the thickness at the base in terms of the height, as is usually done. A wall whose vertical cross section is a right-angled triangle has exactly twice as much stability when the earth is against the vertical side as when it is against the hypotenuse, if the vertical component of the earth pressure be neglected.

1036. Sometimes attention must be given to the available area above and behind the retaining wall, and then the cost of land also must be considered. It may be that the price of land is such as to make a wall with vertical front and inclined back on the whole the most economical, for the saving in the cost of land may more than balance the expense of the extra masonry.

It is usual to build the face of the wall with a small batter and to step or slope the back so as to maintain a constant ratio between the width at any point and the height of the wall above that point. Retaining walls usually have a top width of 18 inches or 2 feet to give resistance against frost and lateral blows.

1037. FROST BATTER. In the days when retaining walls were built

of stone or brick masonry, it was necessary, in localities where there was considerable freezing, to build the upper portion of the wall with a considerable slope away from the supported earth, to prevent the freezing earth from lifting the top courses of the masonry. A batter of 2 or 3 inches to the foot was usually enough to prevent damage, the frozen earth then sliding up the slope instead of lifting the stones and breaking the joints.

Some engineers use the frost batter with concrete walls (see Fig. 130, page 540, and Fig. 132, page 541), but it does not seem necessary where there is only moderate freezing, provided the concrete is good or the top of the back of the wall is finished with a solid surface. It is claimed that when ordinary earth freezes to a depth of 5 ft., its grip upon concrete is equivalent to a vertical lifting force of 1000 lb. per sq. ft. of surface of concrete in contact with the frozen earth.*

1038. DESIGN OF REINFORCED-CONCRETE RETAINING WALLS.

There are two types of reinforced-concrete retaining walls, viz.: (1) a vertical stem which resists the thrust of the earth by virtue of its strength as a cantilever beam; and (2) a comparatively thin face or curtain wall which is supported at intervals by counterforts. The first is ordinarily called a *cantilever retaining wall*, and the second a *counterforted retaining wall*. The first type is most suitable for comparatively low walls, and the second for high ones.

A wall of each of these types will be designed—the cantilever wall by use of a formula for the earth pressure (§ 1022–23) and the counterforted wall by giving it a stability equal to that of a solid wall (§ 1022 and § 1024).

1039. Design of a Cantilever Reinforced-Concrete Retaining Wall.

Assume that a wall is to be designed to restrain an earth bank 10 ft. high, and assume also that the foundation is to be 3 ft. below the natural surface. Assume that the width on top, exclusive of the projection of the coping, is to be 12 inches, and also that the face of the wall is to have a batter of $\frac{1}{2}$ an inch to 1 foot; then the thickness at the bottom of the stem will be 18 inches. The appearance of the wall requires a coping, but that does not materially affect the stability which alone is under consideration here. The thickness of the footing can not be determined in advance of the solution of the remainder of the problem; but for the present it will be assumed to be 12 inches. Then the height of the stem above the top of the footing will be 12 ft. The length of the footing can not be determined in advance, but it will be tentatively assumed at 6.0 feet. The most economical position of the back of the wall along the line *AB*, Fig. 114, can not be determined except by trial. As the stem is moved nearer the front of the footing, the resisting moment of the weight of the stem is decreased, and the

* *Engineering News*, vol. lix, p. 260.

maximum pressure on the soil under the footing is increased; but sometimes it is necessary to place the face of the wall as near the property line as possible, in which case it is not possible to have the footing project in front. In the case in hand, it will be assumed that

the footing projects 2.5 ft., i.e., $BL = 2.5$ ft. The effect of the earth above AF is neglected, which increases the stability of the wall.

We will assume that the section is perfectly rigid, and determine its stability as a unit; and later inquire into its structural integrity.

1040. Stability against Overturning. To find the thrust of the earth against the wall, Coulomb's formula (equation 4, page 493) will be used. It will be assumed (1) that the surface of the back-filling is level; (2) that the natural slope is $1\frac{1}{2}$ to 1, i.e., $\phi = 34^\circ$; (3) that $w = 100$ lb. per cu. ft.; (4) that $h = 12$ ft.; and (5) that the weight of concrete = 150 lb. per cu. ft. Then

$$E = \frac{1}{2} w h^2 \tan^2 (45^\circ - \frac{1}{2} \phi) = 2,040 \text{ lb.}$$

The weight of the concrete in the stem $FLIH = 1\frac{1}{4} \times 12 \times 150 = 2,250$ lb. This force acts 10.40 inches = 0.87 ft. from F , or 2.87 feet from A . The weight of the earth vertically

above $LB = 2\frac{1}{2} \times 12 \times 100 = 3,000$ lb., and it acts 1.25 ft. to the right of L , or 4.75 ft. from A . The weight of the concrete in the footing = $6 \times 1 \times 150 = 900$ lb., and it acts 3.00 ft. from A . Taking moments about C and dividing by the sum of the weights, it is found that the resultant vertical force acts 3.81 ft. from C .

The tangent of the angle which the resultant makes with the vertical is $2,040 \div 6,150 = 0.33$; and the horizontal distance from K to the point in which the resultant pierces the line $CD = (4.00 + 1.00) \times 0.33 = 1.66$ ft.; or the distance from $C = 3.81 - 1.66 = 2.15$ ft., which is greater than $\frac{1}{3}$ of 6.00, i.e., than 2.00; and hence the resultant cuts the base of the footing within the middle third. Therefore, the approximate factor of safety against overturning (equation 13, page 468) is more than 3.

1041. Pressure on the Soil. To determine the pressure on the soil, use equation 22, page 473,

$$P = \frac{W}{l} \pm \frac{6 W d}{l^2}$$

in which $W = 6,150$ lb., $l = 6.0$ ft., $d = \frac{1}{2} l - 2.15 = 3.00 - 2.15 = 0.85$ ft. The maximum pressure on the soil, that at C , is found

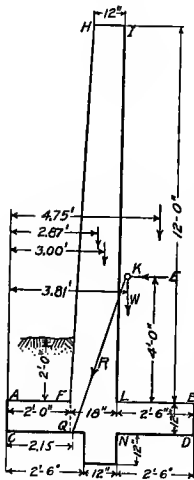

FIG. 114.

by using the plus sign; and the minimum, that at D , by using the minus sign. The pressure at $C = 1,897$ lb. per sq. ft., and that at $D = 153$ lb. per sq. ft. Whether or not this maximum pressure is safe depends upon the character of the soil; but as almost any soil will bear a ton per sq. ft. (see Table 59, page 342), it will be assumed that it is safe. One advantage of a reinforced-concrete retaining wall is that the wall itself is light, and hence the pressure upon the soil is less than that of a solid wall.

1042. If, as is claimed, the ordinary theory of earth pressure gives the overturning moment greater than it is in fact, the difference between the computed maximum and minimum pressure under the footing as computed above is too great. For example, for a particular retaining wall the maximum pressure according to the ordinary theory is 5,600 lb. per sq. ft., and the minimum 0.0; but if the theory is assumed to give a moment twice too great, then the maximum pressure is 4,200 lb. per sq. ft., and the minimum 1,400. The two solutions give a marked difference between the pressures at the heel and the toe; and the tendency of the wall to tip would be very different in the two cases.

1043. Stability against Sliding. The horizontal thrust of the earth is 2,040 lb. If the soil is dry clay, the coefficient of friction may be taken at 0.50 (Table 75, page 495); and the frictional resistance to sliding will then be $(2,250 + 3,000 + 900) \times 0.50 = 3,075$ lb. Under this assumption, the wall is reasonably safe, particularly since no account has been taken of the resistance of the soil in front of the wall.

However, if the soil is clay and should become wet, the coefficient of friction would then be 0.31, in which case the frictional resistance to sliding would be only 1,906 lb. Under this condition, the wall would barely be safe; and therefore it would probably be wise to construct a projection on the under side of the footing as shown in Fig. 114, page 518, to increase the bearing against the soil in front of the wall. To determine the ultimate resistance of the soil in front of the wall, draw from the lowest point of the foundation an indefinite straight line making an angle with the horizontal equal to the angle of internal friction (§ 1,000), and then the resistance is equal to the weight of the soil above this line multiplied by the coefficient of friction. To make this force effective, the soil in front of the projection, the footing, and the wall should be solidly tamped.

The lack of stability against sliding in this case illustrates a disadvantage of a reinforced-concrete retaining wall, viz.: that the wall is so light that there is a lack of frictional resistance to resist sliding.

1044. Reinforcement in the Stem. The bending moment of a

section of the stem 1 ft. long about any point in the plane AB , Fig. 114, is $2,040 \times 4 = 8,160$ ft.-lb. = 97,920 in.-lb. The moment of the tension in the steel, T , is $T \cdot jd$ (equation 5, page 227); or $M = T \cdot jd$. Ordinarily j can be taken at $\frac{7}{8}$ (see equation 4, page 227); and $d = 18 - 2 = 16$ inches. Substituting the above values of M , j , and d in the above equation for T , gives $T = 7,000$ lb. per lin. ft. of wall. If $f_s = 12,000$, there will be required $7,000 \div 12,000 = 0.58$ sq. in. of steel per linear foot of wall. This condition could be satisfied by using $\frac{5}{8}$ -inch plain round rods spaced 6 inches center to center, or $\frac{1}{2}$ -inch round rods spaced 4 inches.

To find the fiber stress in the concrete use equation 8, page 227, which is

$$f_c = \frac{2M}{k j b d^2}$$

Substituting the values as above and solving this equation, gives $f_c = 193$ lb. per sq. in.

The above value of f_c is small in comparison with the value assumed in computing k ; but a comparatively small change in the thickness of the bottom of the stem makes a large difference in f_c . For example, if the width at the bottom were reduced to 12 inches, f_c would be increased 2.56 times. Whether or not it is considered safe to reduce the width of the bottom of the stem to 12 inches, depends upon the amount of faith in the theory employed in deducing the moment of the earth thrust. However, reducing the width of the stem increases the amount of steel required, and hence involves the relative cost of concrete and steel, and may or may not be economical in any particular case.

For a high wall, it is customary to insert a fillet—either stepped or sloped—in the corners at L and F , and sometimes also to insert diagonal rods in the fillet at L . For an example, see Fig. 121, and Fig. 123, page 531.

1045. All of the reinforcement need not be carried to the top of the wall. The amount at any point, say half way up, could be computed as above; but it is not possible in practice to secure an exact mathematical relationship between the moment and the reinforcement. The amount of steel depends mainly upon the moment, which varies as the cube of the depth; and hence the reinforcement can decrease very rapidly toward the top. Since the rods should be continuous for their entire length, at least in a wall of this height, the decrease in the reinforcement is usually made by stopping a series of rods at some particular height; and the more numerous the rods, i.e., the smaller the rods used, the more nearly the actual amount of steel can be made to conform to the theoretical amount.

If $\frac{5}{8}$ -inch rods spaced 6 inches apart are used, one series of rods 12 inches apart may run to the top of the wall, and a second series may run only half way up; or if $\frac{1}{2}$ -inch rods 4 inches apart are used, one series 12 inches apart may run to the top, a second series two thirds of the way up, and a third one third up.

For the value of f_s used above, the rods should be embedded forty diameters below the base of the stem in order to develop the requisite amount of bond stress, which for the $\frac{1}{2}$ -inch rods would require an embedment of 20 inches—more than the thickness of the footing. Sometimes the rods are anchored by bending them at right angles about one of the horizontal reinforcing rods, but this is very unsatisfactory. A better method is to form a complete loop about the horizontal rod; but the best method is to pass them through a horizontal plate or angle, and put a nut above and below the angle, the former to insure that the latter has a firm bearing against the angle. The plate or angle has the further advantage of locating the rod properly and holding them in position during the placing of the concrete. In the particular case shown in Fig. 114, page 518, the vertical rods would be sufficiently anchored by being extended through the projection on the bottom of the footing.

1046. Reinforcement in Front Part of Footing. The portion *AFQC*, Fig. 114, page 518, of the footing acts as a cantilever to transmit pressure to the soil; and should therefore be reinforced on the lower side. Strictly, the whole footing should be considered as a continuous beam; but considering the portion *AF* as a cantilever is sufficiently exact, and the error is on the safe side. The unit pressure at *C* is 1,947 lb. per sq. ft., and at *D* is 103 lb. per sq. ft. (§ 1041); and therefore the pressure at *Q* is:

$$153 + (1,897 - 153) \times \frac{4.0}{6.0} = 153 + 1,162 = 1,315 \text{ lb. per sq. ft.}$$

The center of gravity of the pressure on *CQ* is 1.06 ft. from *Q*, and the moment about *Q* is:

$$M = 1,606 \times 2 \times 1.06 = 3,405 \text{ ft.-lb.} = 40,860 \text{ in.-lb.}$$

As before, $T = M \div jd$. $d = 12 - 2 = 10$ inches. $j = 0.875$ as before. Hence $T = 40,860 \div (0.875 \times 10) = 4,670$ lb. per linear ft. of wall. The area of steel required = $4,670 \div 12,000 = 0.39$ sq. in. per linear foot of wall, which can be satisfied by using $\frac{1}{2}$ -inch round rods spaced 6 inches center to center. These rods can be sufficiently anchored by allowing them to project into the concrete to the right of *Q* 20 inches.

The fiber stress in the concrete, f_c , computed as in § 1044, is 208 lb. per sq. in.

1047. To provide for the differences in the bearing power of the soil longitudinally along the wall, reinforcing rods are frequently inserted in the bottom of the footing parallel to the face of the wall. The amount of this reinforcement is wholly a matter of judgment; and not infrequently the longitudinal reinforcement in the footing is one third to one half as much as the transverse reinforcement.

1048. Reinforcement in Rear Part of Footing. The portion *BDNL*, Fig. 114, page 518, of the footing will be assumed to act as a cantilever, and not as part of a continuous beam. This cantilever carries a uniform downward pressure upon its upper face, in addition to its own weight; and also a uniformly varying upward pressure on its lower face. The moment of the downward pressure about $L = 3,000 \times 1\frac{1}{2} = 3,750$ ft.-lb. The weight of the footing is $1 \times 2\frac{1}{2} \times 150 = 375$ lb.; and its moment about $L = 375 \times 1\frac{1}{4} = 469$ ft.-lb. The total downward moment then is $3,750 + 469 = 4,219$ ft.-lb.

The upward pressure at *D* is (§ 1041) 153 lb. per sq. ft., and the pressure at *N* $= 153 + (1,897 - 153) \times \frac{2.5}{6.0} = 153 + 728 = 881$ lb. per sq. ft. The center of this pressure is 0.96 ft. from *N*. The upward moment then is, $M = 517 \times 2\frac{1}{2} \times 0.96 = 1,234$ ft.-lb. The downward moment being 4,219 and the upward 1,234, the net downward moment at *L* is $4,219 - 1,234 = 2,985$ ft.-lb. = 35,820 in.-lb.

The area of steel required $= M \div (jd \times 12,000) = 35,820 \div (0.875 \times 10 \times 12,000) = 0.34$ sq. in. per linear ft. of wall, which is satisfied by using $\frac{1}{2}$ -inch round rods spaced 6 inches center to center. These rods will develop enough bond stress, if they project 10 inches to the left of the *L*.

1049. Resistance to Shear. To prevent the stem from shearing along the top of the footing, there is an area of concrete $= 12 \times 18 = 216$ sq. in.; and the safe unit shearing strength is at least 25 lb. per sq. in. (§ 476-77 and also § 458), giving a safe resistance of $216 \times 25 = 5,400$ lb. per linear foot of wall, which is more than $2\frac{1}{2}$ times the computed sliding force, and therefore there is no danger of failure in this respect.

To prevent the footing from shearing vertically at the face of the stem, there is a shearing resistance of $12 \times 12 \times 25 = 3,600$ lb. per linear foot of wall, while the shearing force is 3,212 lb.; and hence there is no danger of failure. Since there is no danger of failure by shear at the face of the wall, there is none at the back.

1050. Temperature Reinforcement. To prevent unsightly temperature cracks, the wall should be provided either with contraction joints (§ 385-87) to localize the cracks, or with longitudinal reinforcement sufficient to resist temperature stresses and thereby equalize the strain between different sections along the length of the

wall and cause it to stretch as a homogeneous material (§ 503-6). The percentage of steel required to prevent temperature cracks will depend upon probable range of temperature, the thickness of the wall, and the position of the exposed surface. In § 504, it was shown that a change of temperature of 100° F. in the concrete would require 0.5 per cent of steel having an elastic limit of 60,000 lb. per sq. in. It is usually assumed that high-carbon steel equal to 0.3 to 0.4 per cent of the cross section of the wall is sufficient to prevent objectionable contraction cracks in the North Central States. The temperature reinforcement should be placed near the exposed face; and an equal amount is required both horizontally and vertically.

1051. Design of a Counterforted Reinforced-Concrete Retaining Wall.

A wall of this type consists of a thin vertical curtain wall supported at intervals by vertical ribs or counterforts, both the curtain wall and the counterforts resting upon and being connected to a base plate or footing. The curtain wall is usually only 6 or 8 inches thick at the top and 10 or 12 at the bottom; and the counterforts are usually of about the same dimensions as the curtain wall, and are spaced 5 to 10 feet center to center. For high walls the counterforted type is more economical of material than the cantilever type; but the cost of constructing the forms is more, the net result being, however, in favor of the counterforted type for walls more than about 20 ft. high.

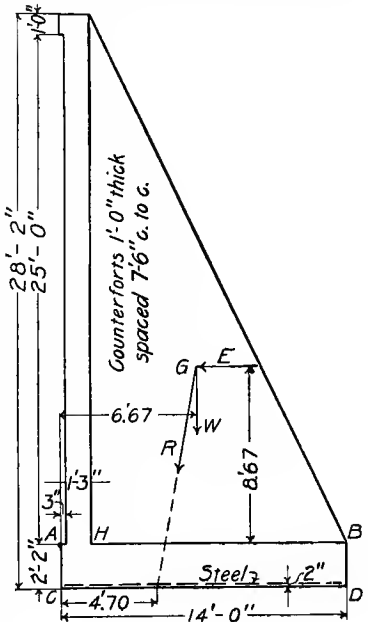

FIG. 115.

1052. It will be assumed (1) that a wall 28 feet high is to be designed, (2) that the face of the wall is to be brought as close as possible to the property line, and (3) that the stability is to be equal to that of a standard solid wall. It will be assumed also that both the standard solid wall and the proposed wall rest upon piles, as is nearly necessary if the structure stands upon compressible soil and the footing can not project in front. Fig. 115 shows the trial dimensions of the proposed counterforted wall which is to have the same stability as the standard plain concrete wall of the New York Central Railroad shown in Fig. 116, page 527.

The wall shown in Fig. 116 contains 205.7 cu. ft. of concrete per linear ft., and its weight at 150 lb. per cu. ft. is 30,850 lb. The weight of the earth vertically above the back of the wall is 7,890 lb. The sum of the moments of these two weights about the left-hand end of the middle third of the base is 80,969 ft.-lb. which will be assumed to be the moment of the earth pressure. If the earth pressure be considered that due to a liquid weighing w' lb. per cu. ft., then the above moment, $80,969 = \frac{1}{2} w' h^2 \times \frac{1}{3} h = \frac{1}{6} w' h^3$. Solving gives $w' = 22.2$ lb. per cu. ft., which means that the solid wall can sustain the pressure of a liquid weighing 22.2 lb. per cu. ft. with an approximate factor of safety against overturning of 3. The problem then is to design a reinforced concrete wall that will support the pressure of a liquid weighing 22 lb. per cu. ft.

1053. Stability of Proposed Design. The total weight of earth and concrete per bay = 306,590 lb., and its center of gravity is 6.67 ft. from C . The total horizontal pressure above B against the vertical plane through $DB = \frac{1}{2} w' h^2 b = \frac{1}{2} \times 22 \times 26^2 \times 7.5 = 55,770$ lb. The tangent of the angle which the resultant makes with the vertical = $55,700 \div 306,590 = 0.182$. The distance to the left of G where the resultant pierces the base of the footing = $10.83 \times 0.182 = 1.97$ ft.; or the distance from $C = 6.67 - 1.97 = 4.70$ ft.; and the distance from the center of the footing = $7.00 - 4.70 = 2.30$ ft. This shows that the center of pressure is practically at the limit of the middle third, and hence the approximate factor of safety (eq. 13, page 468) against overturning is 3.

If this wall were founded upon the soil and not upon piles, the maximum pressure on the soil, by equation 22, page 473, would be:

$$P = \frac{W}{l} \pm \frac{6 W d}{l^2} = 42,485 \text{ lb. per bay} = 5,666 \text{ lb. per sq. ft.};$$

and the minimum pressure would be 42 lb. per sq. ft.

The tendency to slide is 55,770 lb., and the resistance to sliding, irrespective of the piles, for a coefficient of friction of 0.50 is: $306,590 \times 0.50 = 153,295$ lb. Hence the wall is abundantly safe against this method of failure.

1054. The Reinforcement. The curtain wall is really a slab supported at its two vertical edges and at the bottom; but it is customary to design it as being composed of independent horizontal beams fixed at their ends, the error being on the safe side. Rods will be needed near the middle of the bay on the front of the wall to take the direct moment, and at the back of the wall near the counterfort to take the contrary moment. The former are usually made continuous, but the latter may be comparatively short. The reinforcing

rods are sometimes so bent that a single rod serves both purposes, its end being near the back of the wall next to the counterfort and its middle portion being near the face of the wall midway between the counterforts.

The footing or floor of the bay may be regarded as being made up of horizontal beams fixed at the ends, carrying the downward weight of the earth upon their upper face and the upward reaction of the soil on their lower face. The reaction of the soil below the footing increases from *D* toward *C*, and is computed as in § 1041.

1055. The reinforcement in the counterforts which ties together the face wall and the footing may be placed either vertically and horizontally, or diagonally. The first is the more common, but the latter is the more scientific and the more economical of material.

According to the first method, the counterfort may be regarded as a cantilever anchored to the footing and also as a *T*-beam the flange of which is the curtain wall. Under this assumption the horizontal rods bind together the curtain wall and the counterfort, and the vertical rods connect the footing and the counterfort, and the reinforcement parallel to the long side of the counterfort resists the bending of the counterfort. For an example of this method of construction, see Fig. 124, page 531. The amount of steel required at any point of the free edge of the cantilever can be determined approximately by erecting a perpendicular at the point and taking moments about the point where this perpendicular intersects the center line of the front wall.

The second method is to regard the counterfort as being made up of diagonal beams, each carrying one or more longitudinal rods which tie the vertical curtain wall to the footing, these beams being wider at their junction with the front wall than at their connection with the footing. For example, for each foot of width on the footing, these tie-beams will be $30 \div 9 = 3.3$ ft. deep at the front wall. The equivalent liquid pressure against each successive 3.3-foot section of the front wall can readily be computed, and from that the area of the steel required to resist this stress can easily be determined. The rod at its connection with the curtain wall may be diagonal, or may start horizontal and be curved to a direction parallel to the outer edge of the counterfort on a radius of about 20 times its diameter since with this curvature the side pressure of the rod upon the concrete will not exceed a safe limit. At the lower end, the rod may be diagonal or may start vertically and be curved to a line parallel to the outer edge of the counterfort to the same radius as above. The vertical pressure is always greater than the horizontal, and hence there is plenty of resistance to hold the lower end of these rods. The ends of these rods should be looped around the reinforcing

rods in the footing and the face, or, better, should be passed through a plate or an angle to give sufficient anchorage. For an example of this form of construction, see Fig. 125, page 532.

Both horizontal and vertical temperature reinforcement should be placed in the face of the curtain wall (see § 1050).

1056. EXAMPLES OF PLAIN-CONCRETE RETAINING WALLS. New York Central Standard. Fig. 116 shows the standard plain-concrete retaining wall of the New York Central and Hudson River Railroad.* This type is used for track elevation, and hence carries a train on the back-filling near the wall. The official drawing contains the following notes. "1. The coping is to be made of 1 : 2 : 4 portland cement concrete, the body of the wall of 1 : 3 : 6, and the footing (the lower 4 ft.) of 1 : 4 : 7½. 2. The foundation is to be made to suit local conditions, but is never to be less than 4 ft. deep, unless good rock is found. Old railroad rails, 10 to 12 inches centers, are to be used when soft material is encountered. When piles are used in soft material, the outside pile under the toe is to be battered out 1 to 6. 3. Four-inch weep holes are to be left not more than 15 ft. apart, and are to have vertical blind drains running to the top of the wall. 4. The top of the coping is to slope ½ inch to the rear. 5. All exposed corners and edges are to be rounded to 1-inch radius. 6. Expansion joints are to be provided 50 ft. apart by inserting one layer of tarred paper between the sections, the edges of the paper being kept ⅝ inch from the face of the wall and the joint being marked on the face by a triangular groove ½ inch deep made by nailing a strip on the inside of the form."

1057. Fig. 117 shows the forms used in constructing a considerable length of the wall shown in Fig. 116. The sheeting was 2-inch yellow pine laid with a ship-lap of ½ inch and an open joint of ⅓ inch. The form for the front of the wall was lined with thin sheet steel. The forms were made in panels 51 feet long, were shifted by a locomotive crane, and were removed after the concrete had set over night.

1058. Illinois Central Wall. Fig. 118, page 528, shows the wall used by the Illinois Central Railroad on one side of its depressed line through Grant Park, formerly Lake Front Park, Chicago; and Fig. 119 shows the forms used in constructing the wall.† The wall was designed for an 8-foot surcharge. The concrete was laid in three courses, as shown by the dotted line in Fig. 119. The lower course was laid without joints, the second course had tongue and groove contraction joints every 108 ft., and the third course every 54 ft. A sheet of hydrex felt was inserted in the contraction joint to prevent

* By courtesy of Geo. W. Kittredge, chief engineer.

† By courtesy of R. E. Gaut, bridge engineer.

adhesion between the two sections. The horizontal sections were keyed by a tongue and grooved joint as shown in Fig. 119, page 529.

It is claimed that a wall stepped on the back, as shown in Fig. 119, is more advantageous than one having a straight back, since with the

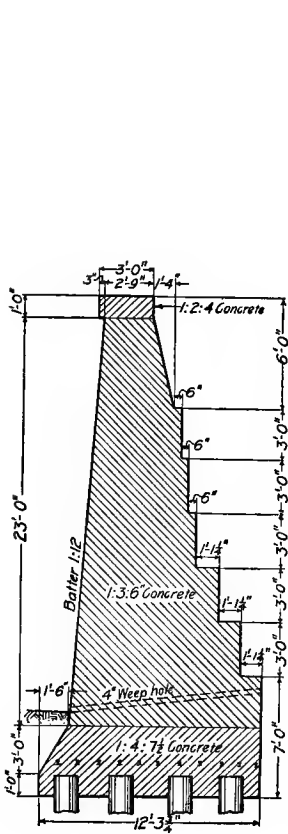

FIG. 116.—STANDARD RETAINING WALL. N. Y. C. R. R.

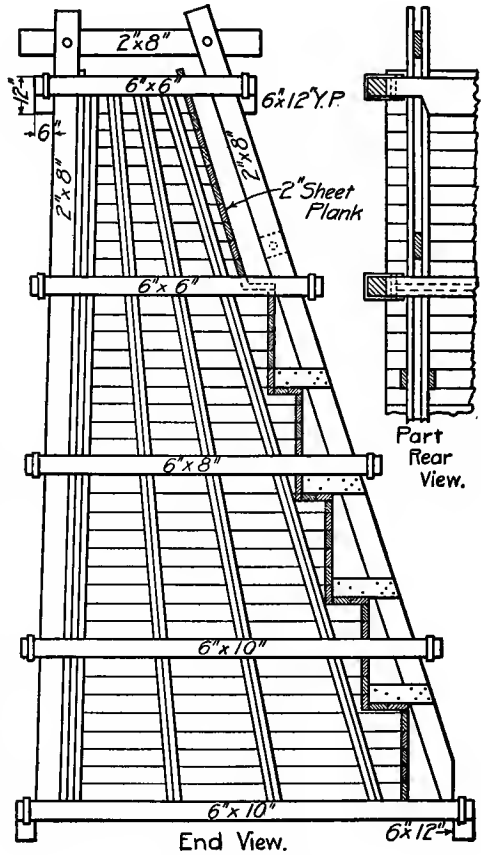

FIG. 117.—FORM FOR NEW YORK CENTRAL WALL.

former the lower part of the form can be more easily taken down and be moved ahead before the upper part can be removed. This advantage is greatest in cool weather when the cement sets slowly.

1059. Chicago and North Western Wall. Fig. 120, page 530, shows the forms and, incidentally, the dimensions of the wall employed by the Chicago and North Western Railroad in track elevation in Chicago

and elsewhere.* A horizontal section 35 ft. long was built complete from top to bottom in a day; and on account of the pressure due to this height of wet concrete, frequent tie rods and strong bracing were

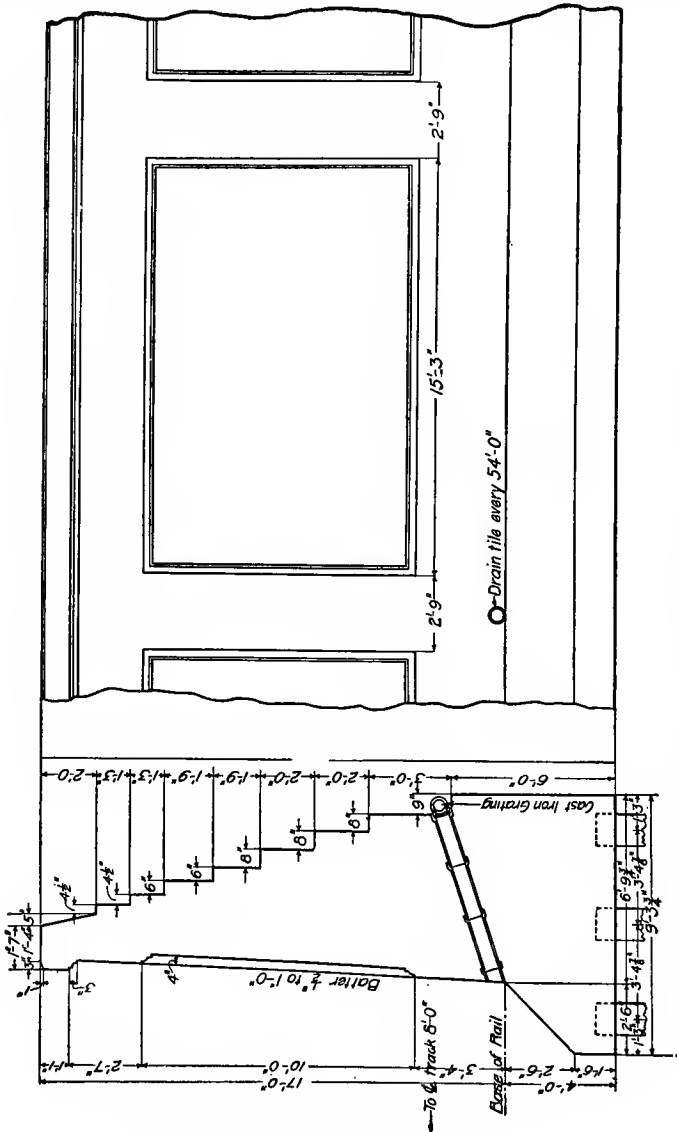

FIG. 118.—RETAINING WALL, ILLINOIS CENTRAL RAILROAD.

* Concrete-Engineering, Jan. 1, 1907, p. 12.

required to keep the forms from spreading. The rods and bracing shown in Fig. 120 were entirely satisfactory. The 2-inch pipe were old boiler flues, and consequently cost but little more than the expense of cutting. The end of the pipe was 2 inches from the surface of the wall.

Compare Fig. 117, 119, and 120 as to the manner of building the forms to secure the off-sets on the back of the wall.

1060. EXAMPLES OF REINFORCED-CONCRETE RETAINING WALLS. C. B. & Q. Standard. Fig. 121, page 531, shows the typical cross-section of the retaining wall employed by the Chicago, Burlington and Quincy Railway in track elevation in Chicago.* The portion above the angle in the back is the same for all heights. Fig. 122, page 531, shows the method of constructing and bracing the forms used in building the wall shown in Fig. 121.*

A retaining wall having a section similar to that in Fig. 121 has frequently been used. Notice that this type is really intermediate between a reinforced-concrete cantilever wall (Fig. 114, page 518, or Fig. 123, page 531) and a plain concrete wall (Fig. 116, page 527, or Fig. 118, page 528).

The forms are a combination of continuous and sectional. The sectional portion consists of two parts: (1) the studding for the face, and the forms for the coping and for the flat slope near the bottom; and (2) the form for the back of the wall. Ordinary sheeting is used on the face between the forms for the coping and for the flat slope at the bottom. No attempt was made to use sectional forms for the main part of the face, because the sections become battered and warped with use and do not fit well, and hence leave the wall rough.

* L. J. Hotchkiss, asst. engineer, in Jour. West. Soc. of Eng'rs, vol. xii, p. 349-53.

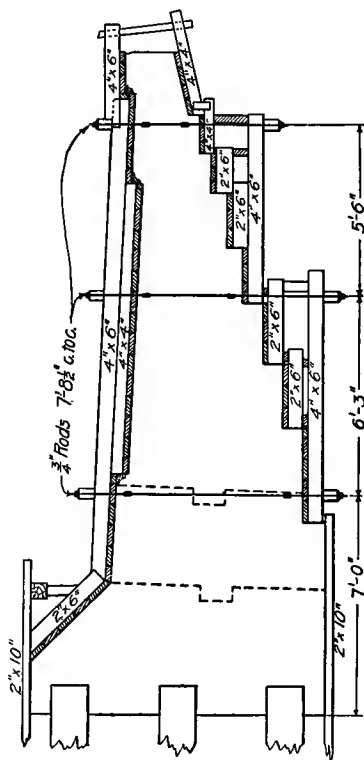

FIG. 119.—FORMS FOR ILL. CENT. WALL.

Notice the method of bracing the forms, particularly the interior inclined tie rod.

1061. Corrugated Bar Co's Standards. Fig. 123 shows the cross section of the standard cantilever reinforced-concrete retaining wall designed by the company controlling the patent for the corrugated bar (\$ 465); and Fig. 124 shows the standard design for a counterforted wall by the same company.

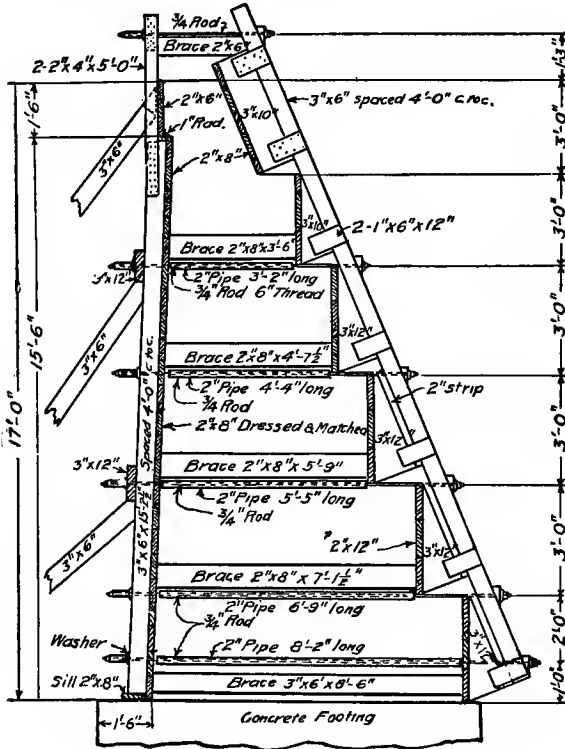

FIG. 120.—FORM FOR C. & N. W. RETAINING WALL.

1062. Pittsburg Wall. Fig. 125, page 532, shows the cross section of a counterforted wall built by the City of Pittsburg, Pa. The footing is 24 inches thick, and the face wall 18 inches; the counterforts are 12 inches thick, and 10 feet apart center to center. The reinforcement in the floor is 1½-inch plain round rods spaced about 7 inches apart; and the reinforcement in the face wall is plain round rods varying from ⅜ inch at the bottom to ½ inch at the top of the

wall, the spacing increasing from 3 inches at the bottom to 6 inches at the top. The rods are bent in such a way that at their ends next to the counterforts they are near the face of the wall, while in their middle portion they are near the back of the wall. The reinforce-

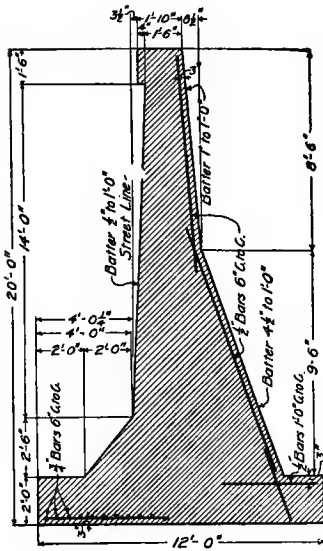

FIG. 121.—C. B. & Q. RETAINING WALL.

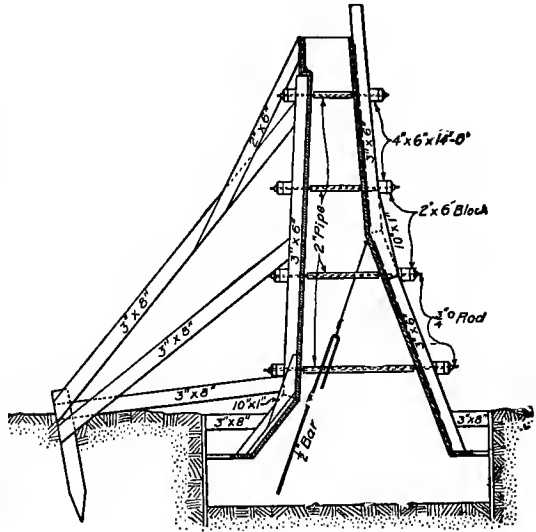

FIG. 122.—FORM FOR C. B. & Q. WALL.

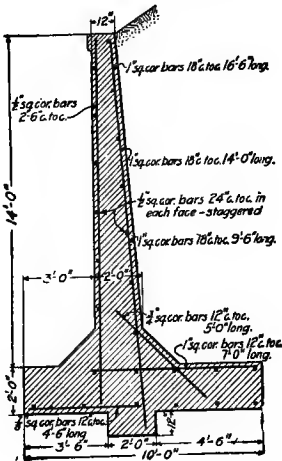

FIG. 123.—CANTILEVER WALL.

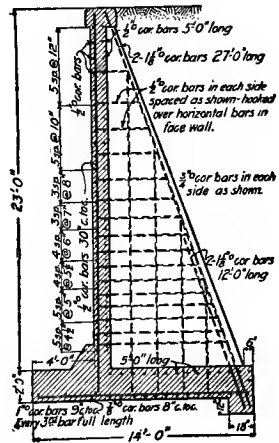

FIG. 124.—COUNTERFORT WALL.

ment in the counterfort consists of plain round rods varying from 1 to $1\frac{1}{2}$ inches in diameter, connected to plates bedded in the floor and in the curtain wall by pins through forked ends. These anchor plates are $\frac{3}{8}$ inch thick and from 8 to 11 inches wide, and have three lines of holes in them, one for the rods in the counterfort, and the two others for the rods in the floor on each side of the counterfort. Two nuts are used on each end of each rod in the floor and in the face wall.

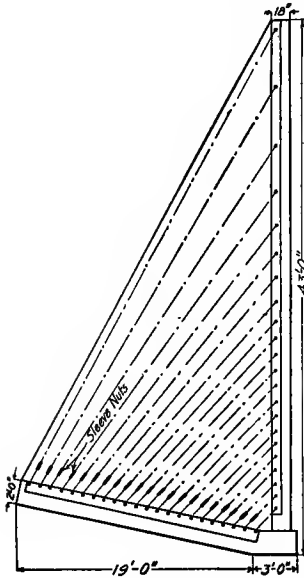

FIG. 125.—PITTSBURG RETAINING WALL.

1063. COST OF CONCRETE RETAINING WALLS. Plain Concrete. For a discussion of the various items in the cost of concrete, see § 412-19; and for an example of the cost of a plain concrete retaining wall, see § 423. Table 78 shows the cost (exclusive of excavation) of a plain concrete retaining wall containing 427 cubic yards, built by the Delaware, Lackawanna and Western R. R. at Scranton, Pa., in 1907.

1064. Reinforced Concrete. Table 79 gives the average cost of the reinforced-concrete retaining walls

TABLE 78.

COST OF A PLAIN CONCRETE RETAINING WALL.

REF. No.	ITEMS OF EXPENSE.	COST.	
		Per Cubic Yard.	Per Cent of Total.
1	Broken stone at \$0.70 per ton	\$0.72	16.7
2	Sand at \$0.55 per cu. yd.	0.24	5.4
3	Cement at \$0.85 per bbl.	1.06	24.6
4	Lumber—charged at $\frac{1}{2}$ value48	11.3
5	Labor—mixing and placing concrete	1.03	23.4
6	Labor—building forms53	12.3
7	Labor—unloading materials17	3.8
8	Depreciation of wheelbarrows04	1.0
9	Superintendence—30 hr. at 50 ct03	0.6
10	Office expense—\$20.0004	0.9
	Total	\$4.34	100.0

of the type shown in Fig. 121, page 531, built in Chicago by a railroad in connection with track elevation during the year 1907. The work was done by company force.

TABLE 79.

COST OF REINFORCED-CONCRETE RETAINING WALL.

ITEMS OF EXPENSE.	PER CU. YD. OF CONCRETE.
<i>Excavation:</i> 4 528 cu. yd.,	
Removing earth, 0.48 ct. per cu. yd. of excavation	\$0.384
Shoring, 0.06 per cu. yd. of excavation045
Pumping, 0.03 ct. per cu. yd. of excavation021
Cutting off piles, 0.01 ct. per cu. yd. excavation004
Engine service, 0.02 ct. per cu. yd. of excavation013
Total for labor	<u>\$0.467</u>
Sheet piling, 0.07 ct. per cu. yd. of excavation057
Total for excavation	<u>\$0.534</u>
<i>Pile Foundation:</i> 14, 616 lin. feet.	
Cost of piles, 10 ct. per lin. ft.	\$0.26
Driving piles, 18 ct. per lin. ft.46
Total for foundation	<u>\$0.72</u>
<i>Concrete:</i> 5 608 cu. yd.	
Materials—lumber	\$0.49
form materials other than lumber07
cement	1.75
gravel03
steel reinforcement62
Total for materials	<u>\$2.96</u>
Labor—building forms	\$1.10
removing forms23
placing reinforcement05
handling concrete materials23
mixing and placing concrete72
cleaning concrete03
finishing surface03
frost protection01
track changes03
engine services05
equipment26
Total for labor	<u>\$2.74</u>
Grand Total	<u>\$6.95</u>

1065. Cost of Plain- vs. Reinforced-Concrete Retaining Wall. Of course, to make a fair comparison both forms of wall should be equally well designed and both should be equally stable. The concrete in the reinforced wall will cost more per cubic yard because of the greater cost of the forms (particularly for the counterforted wall) and also because of the interference of the steel in placing the concrete. Further, the cost of the excavation per cubic yard of

concrete is considerably more for the reinforced wall than for the plain wall, because of the smaller number of cubic yards in the former and also because the base of the former is usually considerably longer than that of the latter and consequently the excavation is proportionally greater. A reinforced wall will, of course, cost more per cubic yard, because steel costs more than an equivalent volume of concrete. On the other hand, a reinforced wall will contain considerably less concrete than a plain wall.

Not infrequently, the costs of the concrete in these two forms of walls are compared as being proportional to the areas of the two cross sections, and the claim is made that the reinforced-concrete wall is 40 to 60 per cent the cheaper, varying with the height; but such a method of comparison is greatly in error. Again, the cost of the concrete in these two forms of walls is sometimes compared by adding from 10 to 50 cents per cubic yard to cover the extra cost of the reinforced concrete, and the claim is made that the reinforced wall is from 35 to 45 per cent the cheaper; but such an allowance for extra cost is entirely too small. Because of one or the other of the above errors, many of the estimates of the relative cost of these two forms of walls are misleading.

On a leading railroad the cost of a large amount of work showed that, exclusive of excavation and of company haul on materials, the cantilever reinforced-concrete retaining wall was 19 per cent cheaper than the plain concrete wall; and two other prominent railroads estimate that high counterforted reinforced retaining walls are 25 per cent cheaper than plain concrete ones.

CHAPTER XIX

BRIDGE ABUTMENTS

1067. DEFINITIONS. There are four forms of abutments in more or less general use. 1. A plain wall parallel to the current, shown in elevation at Fig. 126, with or without the wings ADF and BEG . The slopes may be finished with an inclined coping, as AD , or offset at intervals, as BE . When abutments were made of stone masonry, the latter was the usual method of finishing; but since abutments are generally built of concrete, the former is the more common. The abutment shown in Fig. 126 is called a *straight abutment* or less appropriately an abutment with straight wings. 2. The wings may be swung around into the bank at any angle, as shown (in plan) in Fig. 127. The angle φ is usually about 30° . This form

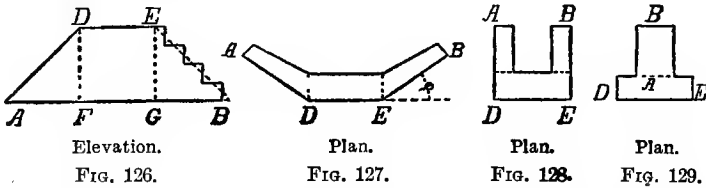

is known as the *wing abutment* or an abutment with splayed wings. 3. When φ of Fig. 127 becomes 90° , the result is Fig. 128, which is called the *U abutment*. 4. If the wings of Fig. 128 are moved to the center of the head-wall the result is Fig. 129, which is known as the *T abutment*.

1068. COMPARISON OF FORMS. The form of the abutment to be adopted for any particular case will depend upon the locality,—whether the bridge is over a waterway or over a street or railway. If for the former, the form of abutment depends upon whether the banks are low and flat, or steep and rocky; whether the current is swift or slow; and also upon the relative cost of earthwork and of masonry.

Fig. 126 is the usual form for a street or railway crossing; but is not suitable for a stream crossing, owing to the danger of the water's flowing along immediately behind the wall.

Fig. 127 is the usual form for a stream crossing, particularly where there is a contraction of the waterway at the bridge site, since deflecting the wing walls, on both the up-stream and down-stream side, slightly increases the amount of water that can pass. This advantage can be obtained, to some degree, with the straight abutment (Fig. 126) by thinning the wings on the front and leaving the back of the wings and abutments in one straight line. Not only there is no hydraulic advantage, but there is a positive disadvantage, in increasing the deflection of the wings beyond, say, 10° or 15° . The more the wing departs from the face line as it swings round into the embankment, the greater its length and also the greater is the thrust upon it. The wings are not usually extended to the toe, *B*, of the embankment slope, but stop at a height, depending upon the angle of deflection of the wing and the slope of the embankment, such that the earth in flowing around the end of the wall will not get into the channel of the stream. It can be shown mathematically that, if the toe of the earth which flows around the end of the wing is to be kept three or four feet back from the straight line through the face of the abutment, an angle of 25° to 35° is best for economy of the material in the wing walls. This angle varies slightly with the proportions adopted for the wing wall and with the details of the masonry. This form of construction is objectionable, since the foot of the slope in front of the wing is liable to be washed away; but this could be remedied somewhat by riprapping the slope, or, better, by making the wing longer.

Fig. 126 is one extreme of Fig. 127, and Fig. 128 is the other. As the wing swings back into the embankment the thrust upon it increases, reaching its maximum at an angle of about 45° ; when the wing is thrown farther back the outward thrust decreases, owing to the filling up of the slope in front of the wing. Bringing the wings perpendicular to the face of the abutment, as in Fig. 128 also decreases the lateral pressure of the earth, owing to the intersection of the surfaces of rupture for the two sides, which is equivalent to removing part of the "prism of maximum thrust." If the banks of the stream are steep, the base of the wing walls of Fig. 128 may be stepped to fit the ground, thereby saving masonry. Under these conditions, also the wing abutment, Fig. 127, can be treated in the same way; but the saving is considerably less. When the masonry is stepped off in this way, the angle thus formed becomes the weakest part of the masonry; but, as the masonry has a large excess of strength, there is not much probability of danger from this cause, provided the work is executed with reasonable care.

Fig. 129 contains more masonry than any of the other forms. The more massive the masonry, the cheaper it can be constructed;

and, for this reason, it is probable that the simple T abutment is cheaper than the U abutment, although the latter may have less masonry in it. However, if built of concrete the cost of forms will be considerably more for the U abutment than for the T abutment. For equal amounts of masonry, wing abutments give better protection to the embankments than T abutments. The latter are more stable, because the center of gravity of the masonry is farther back from the line of the face of the abutment, about which line the abutment must turn or along which it will first crush. The amount of masonry in tall T abutments can be decreased by building the tail wall hollow or by introducing either transverse or longitudinal arches in it. (Fig. 137 and 138, page 547.) High T abutments are sometimes built of reinforced concrete with comparatively thin outside walls and with vertical and horizontal partitions, thus securing a very light and comparatively cheap structure.

1069. THEORY OF STABILITY OF AN ABUTMENT. The abutment of an ordinary bridge has two offices to perform, viz.: (1) to support one end of the bridge, and (2) to keep the earth embankment from sliding into the water. In Fig. 126, the portion *DEGF* serves both these purposes, while the wings *ADF* and *BEG* act only as retaining walls. In Fig. 127 and 128, the portion *DE* performs both offices, while the wings *AD* and *BE* are merely retaining walls. In Fig. 129 the head *DE* supports the bridge, and the tail, or stem, *AB* carries the train; hence the whole structure acts as a retaining wall and also supports the load. The abutment proper may fail (1) by sliding forward, (2) by overturning, or (3) by crushing.

The top dimensions of the body of the abutment must be sufficient for the bridge seats, which will vary with the style and the span of the bridge, and must also allow room for a vertical wall on the back edge of the abutment to sustain the roadway, which wall is variously called a *dirt wall*, a *parapet wall*, or a *back wall*. Theoretically, the bottom dimensions of the body may be determined by a consideration of the lateral pressure of the earth; but the mathematical theory of the pressure of earth is a much less perfect guide for designing bridge abutments than for simple retaining walls owing to the effect of the moving load—both on account of its weight and its motion, particularly of a railway train—to increase the lateral pressure against the abutment. Obviously, the effect of the weight of the bridge in resisting the overturning of the abutment is greater for low abutments than high ones, and for long spans than short ones.

Again, the bridge acts more or less as a strut between the two abutments to prevent sliding or overturning, the exact effect depending upon the weight of the bridge and upon whether one end rests

upon sliding plates or expansion rollers. Further, the wings assist in preventing overturning, except in the straight abutment.

In view of the uncertainties of the mathematical theory of the pressure of earth (§ 998–1013), it is not customary to attempt to compute the stability of an abutment, but to take the thickness of the body at the top of the footing at 0.40 or 0.45 of the height of the earth fill. In applying this empirical rule, little or no distinction is made between highway and railway bridges, i.e., little or no account is taken of the effect of the moving load; and no account is ever taken of the difference in weight of different bridges, or of the strut-like action of the bridge. Apparently, it is more common to make the thickness 0.40 of the height than 0.45; but the latter is employed by some of the largest and best railway systems in this country (see Fig. 132, page 541). In several cases, abutments having a thickness of $\frac{1}{3}$ the height have failed. The thickness of wing walls is frequently made 0.3 of the height of the earth above the point, and seem to stand satisfactorily.

1070. FOUNDATION. Ordinarily, only comparatively little difficulty is encountered in securing a foundation for a bridge abutment. Frequently, by doing the work at the time of low water, the foundation can be put down without the use of a coffer-dam or at most by the use of a light curbing. When the ground is soft or likely to scour, a pile foundation and grillage may be employed. For the method of procedure in such cases, see Art. 4, Chapter XV; and for examples of this kind of foundation, see Fig. 134 (page 544), Fig. 136 (page 546), Fig. 148 (page 561), Fig. 149 (page 562).

Where there is no danger of underwashing, and where the foundation will at all times be under water, the masonry may be started upon a timber platform consisting of timbers from, say, 8 to 12 inches thick, laid side by side upon sills, and covered by one or more layers of timbers or thick planks, according to the depth of the foundation and the magnitude of the structure. For an example of a foundation of this class, see Fig. 149 page 562. For a discussion of the method of failure by sliding on the foundation, see § 930 and 1043.

1071. Experience has determined the safe thickness of an abutment at the top of the footing within comparatively narrow limits; but the width of the footing is subject to wide variation, as it depends upon the bearing power of the soil. Since the moment tending to overturn the abutment is not definitely known, neither the distribution of the pressure on the soil under the footing nor the maximum pressure can be found with any considerable accuracy; and therefore, if the soil is even slightly compressible, the dimensions of the footing must be determined with the utmost care. The decision

as to what will be a safe and not extravagant area of the footing, or rather what will be a safe and not extravagant projection of the footing in front of the wall, is a matter of judgment based upon past experience and a careful study of all the conditions of the particular case in hand. For a few suggestions, applicable in this connection, see § 1025-28.

1072. KIND OF MASONRY. Formerly bridge abutments were usually built of either range ashlar (§ 560) or squared-stone masonry (§ 569) according to the importance of the structure, although occasionally rubble (§ 574) was employed; but at present concrete is nearly always used—partly because it is ordinarily cheaper, and partly because the monolithic construction is less affected by frost and the shock of passing loads. In the past it has been quite common for masonry railroad abutments to be shaken to pieces by the passage of trains.

Bridge abutments are usually built of massive plain concrete,—sometimes with a comparatively small amount of steel reinforcement under the bridge seats, at reëntrant angles, and at other places where there is danger of cracks. Different parts of an abutment are sometimes built of different grades of concrete according to the stress imposed—see Fig. 135, page 545, for example. Ordinarily bridge abutments depend for their stability mainly upon the weight of the concrete; but occasionally abutments are constructed of comparatively thin walls and buttresses of reinforced concrete (see Fig. 133, page 543), and such abutments depend for their stability mainly upon the strength of the reinforced concrete.

1073. STRAIGHT ABUTMENTS. Fig. 130, page 540, shows a straight abutment used by the Lehigh Valley Railroad, for an overhead railway crossing.* The drawing shows the dimensions of the abutment proper, and also the arrangement of the parapet or back-wall for a skew crossing.

For another straight abutment for a steam railway, see § 1076 and Fig. 132, page 541.

1074. Note that the wings in Fig. 130 have a plane top, while those in Fig. 132 have a curved upper surface.

1075. WING ABUTMENTS. Cooper's Standard. Fig. 131, page 541, shows an abutment with splayed wings recommended for country highway and electric railway bridges.† The variable dimensions of the top of the abutment are given in Table 80, page 540. This form is intended to be built of either masonry or plain concrete.

1076. New York Central Standard. Fig. 132, page 541, shows

* By courtesy of Walter G. Berg, chief engineer.

† Cooper's Specifications for Foundations and Substructures of Highway and Electric Railway Bridges.

TABLE 80.
TOP DIMENSIONS FOR THE ABUTMENT SHOWN IN FIG. 131.

SPAN.	DISTANCE u .	DISTANCE l .
<i>For Country Highway and Single-Track Electric Railway Bridges:</i>		
50 feet	2 feet 6 inches	Clear roadway + 4 feet 0 inches.
100 "	2 " 8 "	" " + 5 " 0 "
150 "	3 " 0 "	" " + 5 " 9 "
200 "	3 " 4 "	" " + 6 " 6 "
250 "	3 " 6 "	" " + 7 " 0 "
<i>For Double-Track Electric Railway Bridges:</i> Add 1 foot to the above values of l .		

the standard straight and also the splayed-wing, plain-concrete abutments of the New York Central and Hudson River Railroad.* Ordinarily the form with straight wings is used for street crossings and that with splayed wings for stream crossings. Notice that the wing

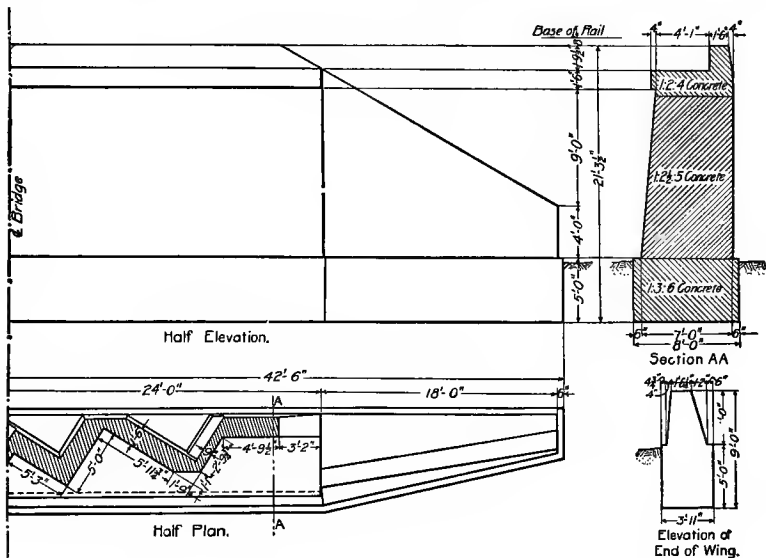

FIG. 130.—STRAIGHT SKEW ABUTMENT. LEHIGH VALLEY RAILROAD.

has a coping and that the top face is curved. Compare the finish of this wing with that of Fig. 130.

The following are notes from the official drawing: "1. The dimension y , see top of Section, varies with the superstructure, but is not

* By courtesy of W. J. Wilgus, vice president and former chief engineer.

less than 3 feet for girders and trusses or 2 feet 6 inches for solid floors. 2. The dimension x , see top of Section, is at least half the

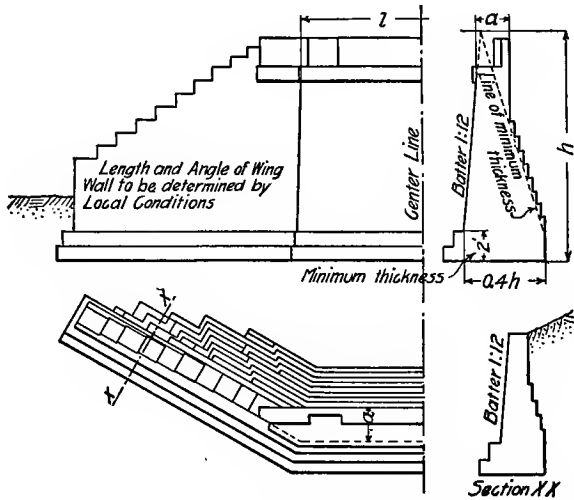

FIG. 131.—WING ABUTMENT FOR HIGHWAY AND ELECTRIC RAILWAY BRIDGES.

distance from the bridge seat to the base of the rail. 3. The frost batter, see upper right-hand corner of Section, is to slope 6 inches in

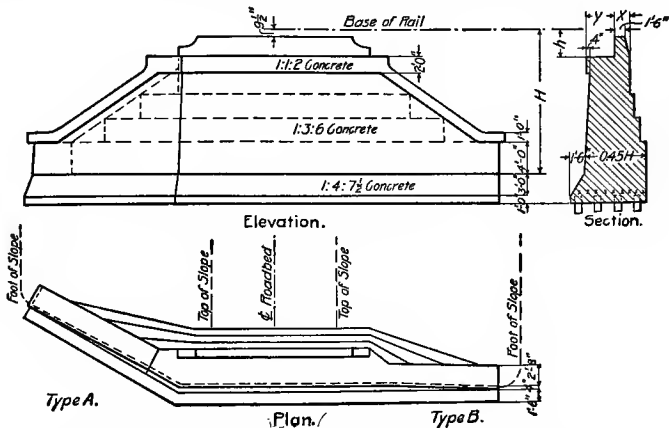

FIG. 132.—STRAIGHT AND SPLAYED ABUTMENTS. N. Y. C. & H. R. R. R.

5 feet. 4. The angle of the face of the wing with the face of the abutment is varied to suit the local conditions. 5. The foundation is

made to suit local conditions, but must not be less than 4 feet deep unless good rock is found. 6. Old rails 10 to 12 inches center to center are to be used where a soft foundation is found; and where piles are not used, the base of the rails is to be 6 inches from the bottom. Where splicing of rails in the foundation is necessary, they shall be fully bolted with two splice bars, and be laid with broken joints. 7. The back filling is to be cinders or other porous material. 8. All exposed corners and edges are to be rounded to a 1-inch radius. 9. The bridge seat is reinforced with a sheet of Clinton galvanized wire cloth, having 3- by 8-inch mesh, made of No. 8 and 10 wires, or with No. 8 Clinton wire netting having 1- by 2-inch mesh."

1077. Reinforced-Concrete Wing Abutment. Fig. 133 shows a typical form of reinforced-concrete bridge abutment built by the Wabash Railway at Monticello, Ill.* The figure shows the dimensions and the general form of construction. On the face of the abutment proper and of the wings is a little ornamentation, in the shape of a rectangle, produced by nailing a half-round strip on the inside of the forms. This ornamentation is not shown in Fig. 133. In this particular structure the counterforts (the vertical walls behind the face wall) are parallel to the roadway, but sometimes the counterforts to the wings are perpendicular to the face wall.

One of the two abutments like that shown in Fig. 133 contains 160 cu. yd. of concrete and 9,581 lb. of $\frac{3}{4}$ -inch square corrugated steel reinforcing bars, and the other 182 cu. yd. of concrete and 13,043 lb. of steel, both being practically 60 lb. per cu. yd.

1078. In § 1065 is a discussion of the relative cost of plain- and reinforced-concrete retaining walls, all of which is applicable to abutments; but the more complicated form of the reinforced-concrete abutment makes the additional cost of forms and the extra trouble of depositing concrete around the reinforcement greater for abutments than for retaining walls; and hence it is probable that under ordinary conditions the plain-concrete abutment is the cheaper. Further, on account of the possibility of the rusting of the reinforcement, the plain-concrete abutment is more durable.

1079. U ABUTMENT. A. T. & S. F. Standard. Fig. 134, page 544, shows the standard U abutment employed by the Atchison, Topeka and Santa Fe Railroad System.† This design was made when abutments were constructed of block-stone masonry; but it has been used without material modification since abutments are usually built of plain concrete. In the early history of this road the T abutment was the standard, but it was abandoned and the U abutment was adopted. At present the U abutment is preferred for a new

* By courtesy of A. O. Cunningham, chief engineer.

† By courtesy of W. B. Storey, Jr., chief engineer.

line; but when an abutment is required under a track in operation, the wing abutment is preferred, since the track can be supported more easily.

The specifications under which these abutments were built, when

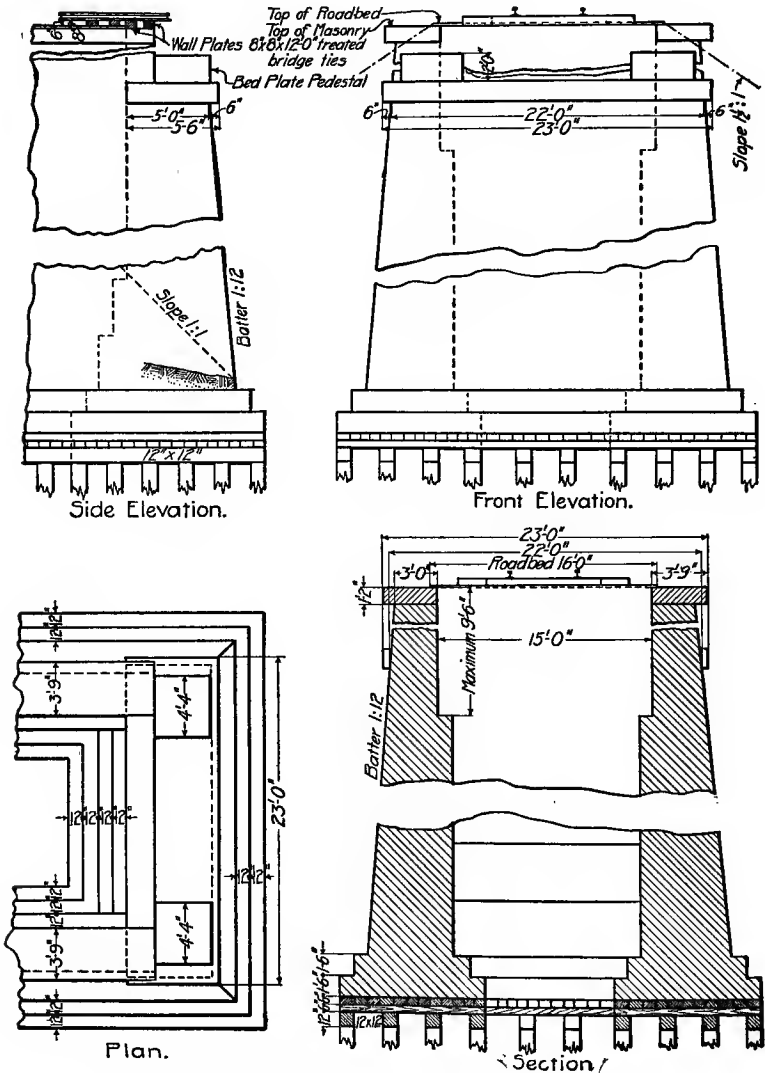

FIG. 134.—STANDARD U ABUTMENT. A. T. & S.-F. R. R.

block-stone masonry was the material of construction, required as follows: "1. Bed-plate pedestal blocks to be 2 feet thick, and placed symmetrically with regard to the plates. 2. Coping under pedestal blocks to be 18 inches thick for all spans exceeding 100 feet, 16 inches for 90 feet, and 14 inches for spans under 90 feet,—said coping to be through stones, and spaced alike from both sides of abutment. 3. Distances from front of dirt wall to front of bridge

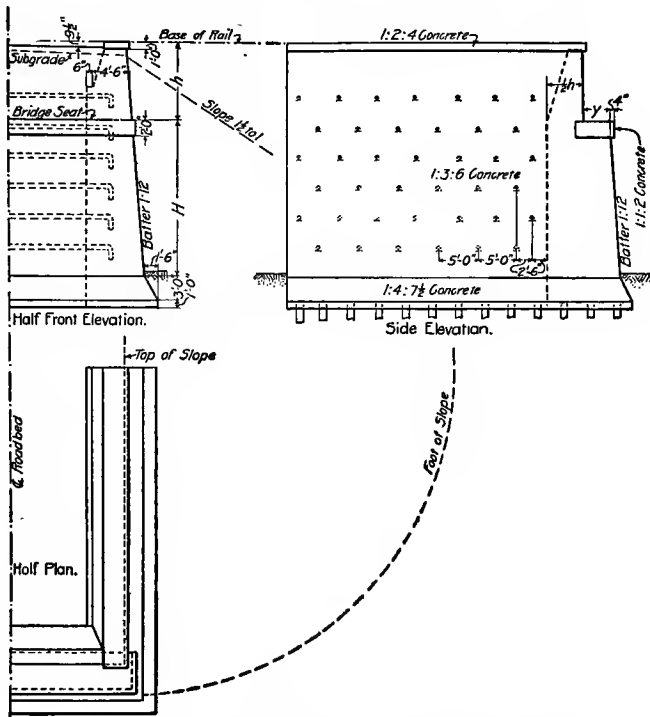

FIG. 135.—U ABUTMENT. N. Y. C. & H. R. R. R.

seat, and from grade line to top of bridge seat, and thickness of dirt wall, to vary for different styles and lengths of bridges. 4. Front walls to be 22 feet wide under bridge seat for all spans of 100 to 160 feet inclusive. 5. Total width of bridge seat to be 5 1/2 feet, for all spans. 6. Steps on back of walls to be used only when necessary to keep thickness $\frac{4}{10}$ of the height. 7. In case piling is not used, footing courses may be added to give secure foundation. 8. Length of wing walls to be determined by a slope of 1 1/2 to 1 at the back end of the walls—as shown by dotted line in front elevation,—thence by a slope of 1 to 1 down the outside—as shown on side elevation—to the

intersection of the ground line with face of abutment. This rule may be modified in special cases. 9. Dimensions not given on the drawing are determined by the style and length of bridge, and are to be found on special sheet."

1080. Abundant drainage should be provided for the material between the wings of the U abutment, by inserting farm tile or per-

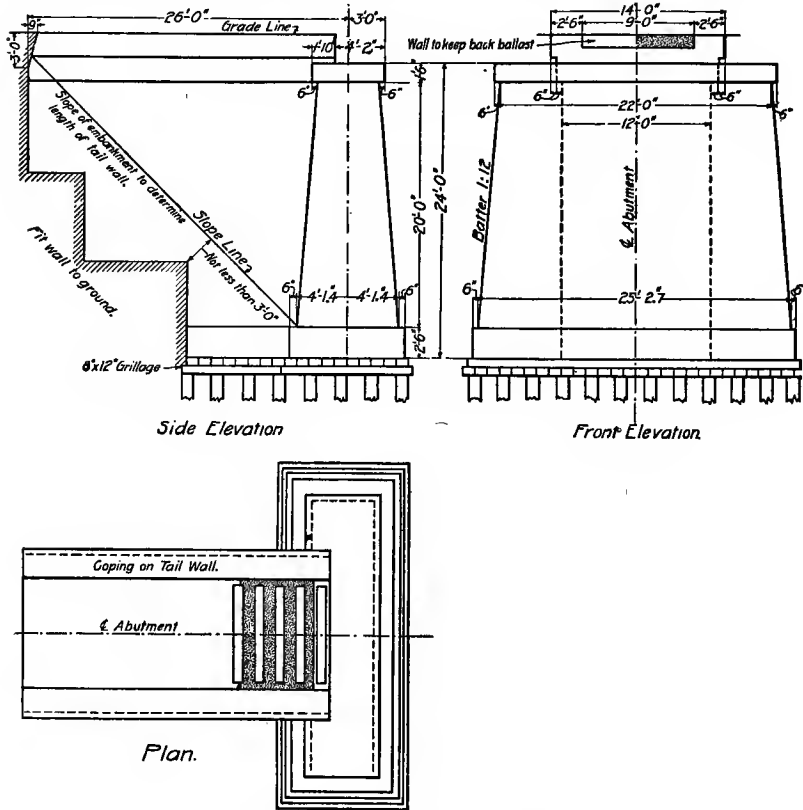

FIG. 136.—STANDARD T ABUTMENT.

forated iron pipe vertically at intervals along the back of the wings and allowing them to discharge through weep holes through the face of the wing or connecting them to horizontal tile or pipes in the filling near the bottom which can discharge at the free end of the wings. Cinders or sand and gravel are sometimes used to fill in between the wing walls to give a better drainage, and also to decrease the lateral thrust of the filling.

1081. New York Central Standard. Fig. 135, page 545, shows the standard U abutment of the New York Central and Hudson River Railroad.*

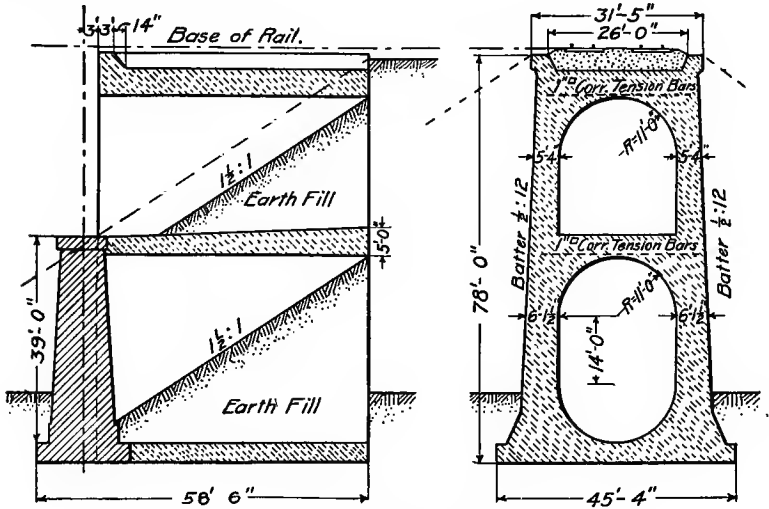

FIG. 137.—T ABUTMENT WITH LONGITUDINAL ARCHES.

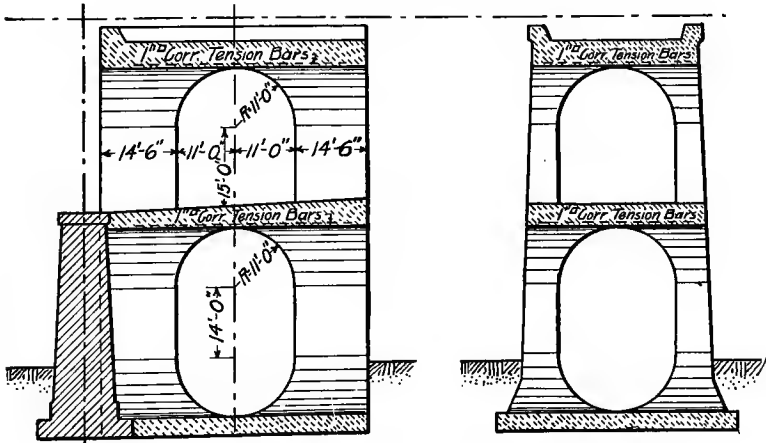

FIG. 138.—T ABUTMENT WITH TRANSVERSE AND LONGITUDINAL ARCHES.

The official drawing contains the following notes: "1. For depth of 9 ft. from the top of the coping, the thickness of the wing is to be in accordance with the standard retaining wall [§ 1056]; and from

* By courtesy of W. J. Wilgus, vice president and former chief engineer.

that point down, the back of the wing is to be plumb. 2. The back filling is to be cinders or other porous material. 3. Weep holes are to be provided with vertical blind drains in the rear."

In addition to the items in the preceding paragraph, items 1 and 5 to 9 of § 1076 also apply to this abutment.

1082. T ABUTMENT. Fig. 136, page 546, shows the type of T abutment ordinarily used by railroads when such structures were made of coursed stone masonry. The tail wall is usually 10 or 12 ft. wide, and of such length that the foot of the slope of the embankment will just reach to the back of the head wall. The batter on the head

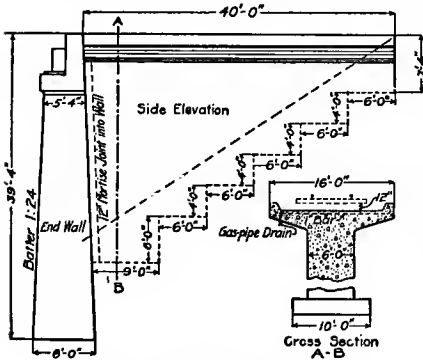

FIG. 139.—REINFORCED-CONCRETE T ABUTMENT.

wall is 1 to 12 or 1 to 24 all around. The tail wall is generally built vertical on the sides and the end. Notice the batter at the top of the free end of the tail wall. This is known as the "frost batter," and is to prevent the frost from dislocating the corner of the masonry. The drainage of the ballast pocket should be provided for by leaving a space between the ends of two stones. Formerly the tail wall was sometimes only 7 or 8 feet wide, in which

case the ties were laid directly upon the masonry without the intervention of ballast; but this practice has been abandoned, as being very destructive of both rolling stock and masonry.

According to the common theories for retaining walls, T abutments with dimensions as above have very large factors of stability against sliding, overturning, and crushing.

1083. Fig. 137 and 138, page 547, show two methods of decreasing the amount of masonry in a T abutment. The designs were made for an abutment in the Cairo Bridge approach on the Illinois Central Railroad to be built against a pier already constructed.* The plan and the front elevation of these two designs are identical, and the earth fill required is almost exactly the same. Fig. 137 was adopted. The estimate for Fig. 137 was as follows:

Concrete, 2 660 cu. yd. at \$7.25.....	\$19 285.00
Piles, 337 at \$8.50	2 864.50
Reinforcing bars	300.00
Total	\$22 449.50

* W. M. Torrance, *Engineering News*, vol. lv, p. 36-40.

The estimate for Fig. 138 was as follows:

Concrete, 1 935 cu. yd. at \$7.50	\$14 512.00
Piles, 337 at \$8.50	2 864.50
Reinforcing bars	600.00
Total	\$17 976.50

Another modification of the U abutment proposed for the same position consisted in making the side walls lighter than in the ordinary U abutment and in tying them together at intervals with rods. The

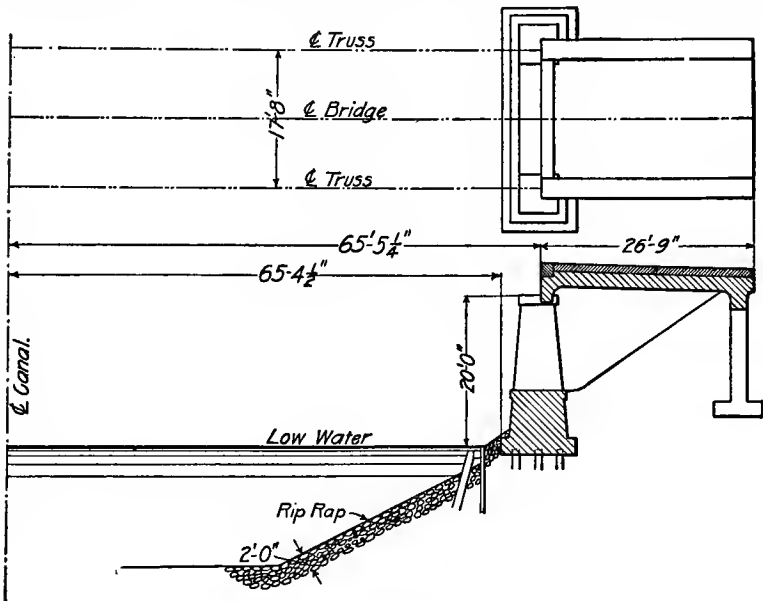

FIG. 140.—PIER ABUTMENT.

rods were to be encased in concrete which was to be supported by light concrete arches resting on the side walls. The estimate for this design was:

Concrete, 3 636 cu. yd. at \$6.00	\$21 876.00
Piles, 420 at \$8.50	3 570.00
Reinforcing rods	50.00
Earth fill, 4 000 cu yd. at 30 ct.	1 200.00
Total	\$26 663.00

1084. Reinforced-Concrete T Abutment. Fig. 139 shows a modified form of T abutment employed on the South Bend and Southern Michigan Railway (electric interurban).*

* A. J. Hammond, chief engineer, in *Engineering News*, vol. Ivii, p. 187.

1085. PIER ABUTMENT. Fig. 140, page 549, shows what may be called a pier abutment, i.e., a pier that takes the place of an abutment. Fig. 140 is the design prepared by the State Engineer of New York for highway bridges crossing the Barge (the enlarged Erie) Canal. The unshaded portion of the pier consists of two pyramidal pedestals, each supporting a corner of the reinforced-concrete slab which constitutes the approach span. Each of the two corners of the shore end of the approach span rests upon a square column. The general form of this design has long been used with highway bridges to obviate the use of either a longer span or a more expensive abutment; and the only new feature in Fig. 140 is the use of a reinforced-concrete slab for an approach span, which made possible the use of columns under each corner of the approach span instead of a continuous wall under each end.

Table 81 gives the cost of the approaches and the piers for two bridges built under one contract in 1907, exclusive of the cost of plant. The copings, girders, columns, and the slab were made of 1 : 2 : 4 concrete; and the remainder of the structure of a 1 : 2 : 5 mixture.

TABLE 81.

COST OF APPROACH SPAN AND PIER ABUTMENT ON ERIE CANAL.*

REF. No.	ITEMS OF EXPENSE.	ROBERTS ROAD BRIDGE		BENDICK ROAD BRIDGE	
		Quantity.	Cost per Cu. Yd.	Quantity.	Cost per Cu. Yd.
	<i>Materials:</i>				
1	Lumber at \$25 per M.	7 000 ft. B. M.	\$0.69	7 000 ft. B. M.	\$0.64
2	Cement at \$1.50 per bbl.	340 bbl.	2.01	370 bbl.	2.02
3	Sand at \$1.25 per cu. yd.	100 cu. yd.	.50	110 cu. yd.	.50
4	Broken Stone at \$1.40 per cu. yd.	200 cu. yd.	1.10	220 cu. yd.	1.12
5	Steel at 2½ cts. per lb.	9 884 lb.	.97	10 616 lb.	.97
	Total for materials		\$5.27		\$5.25
	<i>Labor:</i>				
6	Construction, erection, and removal of forms at \$35.93 per M ft. B. M.		1.98		2.06
7	Mixing and placing concrete, and placing steel		2.20		2.25
8	Excavating, and driving 42 piles48		.48
9	Hauling materials91		1.03
10	Total for labor		\$5.57		\$5.82
11	Total for labor and materials	2 535 cu. yd.	\$10.84	2 535 cu. yd.	\$11.07

* Emil Low, in *Engineering-Contracting*, vol. xxvii, p. 22-15.

CHAPTER XX

BRIDGE PIERS

1087. The selection of the site of the bridge and the arrangement of the spans, although important in themselves, do not properly belong to the part of the problem here considered; therefore they will be discussed only briefly. The location of the bridge is usually a compromise between the interests of the railroad or the highway, and of the river. On navigable streams, the location of a bridge, its height, position of piers, etc., are subject to the approval of engineers appointed for the purpose by the United States Government. The law requires that the bridge shall cross the main channel nearly at right angles, and that the abutments shall not contract nor the piers obstruct the waterway. For the regulations governing the various streams, and also reports made on special cases, see the various annual reports of the Chief of Engineers, U. S. A.

The arrangement of the spans is determined mainly by the relative expense for foundations, and the increased expense per linear foot of long spans. Where the piers are low and foundations easily secured, with a correspondingly light cost, short spans and an increased number of piers are generally economical, provided the piers do not dangerously obstruct the current or the stream is not navigable. On the other hand, where the cost of securing proper foundations is great and much difficulty is likely to be encountered, long spans and the minimum number of piers is best. Sound judgment and large experience are required in comparing and deciding upon the plan best adapted to the local conditions.

Within a few years it has become necessary to build bridge piers of very great height, and for economical considerations steel has been substituted for stone. The determination of the stability of such piers is wholly a question of finding the stresses in frame structures,—the consideration of which is foreign to our subject.

1088. FUNCTIONS OF A BRIDGE PIER. A bridge pier has two functions: (1) it must support the bridge, and (2) it must permit water to pass with the least possible disturbance to that water. The first concerns the stability of the pier, which depends upon its vertical cross section; and the second concerns the form of the horizontal cross section of the pier.

1089. THEORY OF STABILITY. A bridge pier may fail in either of two ways: (1) by sliding or overturning down stream, i.e., longitudinally, or (2) by sliding or overturning laterally.

1090. Longitudinal Stability. The forces that tend to slide or overturn a pier down stream are the wind, the current of water, and a floating field of ice.

1091. Effect of Wind. The pressure of the wind against the truss alone is usually taken at 50 lb. per sq. ft. against twice the vertical projection of one truss, which for well-proportioned trusses will average about 10 sq. ft. per linear foot of span. The pressure of the wind against the truss and train together is usually taken at 30 lb. per sq. ft. of truss and train. The train exposes about 10 sq. ft. of surface per linear foot. The pressure of the wind against any other than a flat surface is not known with any certainty; for a cylinder, it is usually assumed that the pressure is two thirds of that against its vertical projection.

The center of pressure of the wind on the truss is practically at the middle of its height; that of the wind on the train is 7 to 9 feet above the top of the rail, according to whether the train is for freight or passengers; and that of the wind on the pier is at the middle of the exposed part.

1092. Effect of Current. For the pressure of the current of water against an obstruction, Weisbach's *Mechanics of Engineering* (page 1,030 of Coxe's edition) gives the formula,

$$P = s w k \frac{v^2}{2g}, \quad . \quad . \quad . \quad . \quad . \quad (1)$$

in which P is the pressure in pounds, s the exposed surface in sq. ft., k a coefficient depending upon the ratio of width to length of the pier, w the weight of a cubic foot of water, v the velocity in ft. per sec., and g the acceleration of gravity. For piers with rectangular cross section, k varies between 1.47 and 1.33, the first being for square piers and the latter for those 3 times as long as wide; for cylinders, $k =$ about 0.73. The law of the variation of the velocity with depth is not certainly known; but it is probable that the velocity varies as the ordinates of an ellipse, the greatest velocity being a little below the surface. Of course, the water has its maximum effect when at its highest stage.

The center of pressure of the current is not easily determined, since the law of the variation of the velocity with the depth is not accurately known; but it will probably be safe to take it at one third the depth.

1093. Floating Ice. The pier is also liable to a horizontal pressure due to floating ice. The formulas for impact are not applicable to

this case. The assumption is sometimes made that the field of ice which may rest against the pier will simply increase the surface exposed to the pressure of the current. The greatest pressure possible will occur when a field of ice, so large that it is not stopped by the impact, strikes the pier and plows past, crushing a channel through it equal to the greatest width of the pier. The resulting horizontal pressure is equal to the area crushed multiplied by the crushing strength of the ice. The latter varies with the temperature; but since ice will move down stream in fields only when melting, we desire its minimum strength. The crushing strength of floating ice is sometimes put at 20 tons per sq. ft. (300 lb. per sq. in.); but in computing the stability of the piers of the St. Louis steel-arch bridge, it was taken at 600 lb. per sq. in. (43 tons per sq. ft.). According to experiments made under the author's direction,* the crushing strength of ice at 23° F., varies between 370 and 760 lbs. per sq. in.

The arm for the pressure of the ice should be measured from high water.

Occasionally a gorge of ice may form between the piers and dam the water back. The resulting horizontal pressure on a pier will then be equal to the hydrostatic pressure on the width of the pier and half the span on either side, due to the difference between the level of the water immediately above and below the bridge opening. A pier is also liable to blows from rafts, boats, etc.; but as these can not occur simultaneously with a field of ice, and will probably be smaller than that, it will not generally be necessary to consider them.

1094. Sometimes a bridge pier is subjected to a heavy shove from the expansion of freezing ice; but the usual method of protecting the pier is to break up the ice immediately around the pier.

1095. Resisting Forces. The force resisting sliding is the friction due to the combined weight of the train, the bridge, and the part of the pier above the section considered. For the greatest refinement, it would be necessary to compute the forces tending to slide the pier for two conditions, viz.: (1) with a wind of 50 lb. per sq. ft. on truss and pier, in which case the weight of the train should be omitted from the resisting forces; and (2) with a wind of 30 lb. per sq. ft. on truss, train, and pier, in which case the weight of a train of *empty box* cars should be included in the resisting forces. If the water can find its way under the foundation in hydrostatic condition, the weight of the part of the pier that is immersed in the water will be diminished by $62\frac{1}{2}$ lb. per cu. ft. by buoyancy; but if it finds its way under any section by absorption only, then no allowance need be made for buoyancy.

* The Technograph, University of Illinois, No. 9 (1894-95), p. 38-48.

The forces resisting overturning are the weight of the pier above the section considered and the combined weight of the truss and the train.

1096. Conclusion. The factor of safety against sliding and overturning can easily be computed similarly as for dams. However, in computing the maximum compressive stress in bridge piers the formulas employed for dams can not be applied, since they are applicable only to elementary rectangular sections, while in computing the maximum compressive stress in bridge piers the entire cross section must be considered, and as a rule it is not a rectangle. Equations 1 and 2, page 354, are applicable to bridge piers, in which case I is the moment of inertia of the horizontal cross section about an axis through its center of gravity and perpendicular to its long axis.

1097. In the former editions of this book an example was given of the method of computing the stability of a bridge pier. That investigation was made for an unusually high pier standing between two unusually long single-track railroad spans (Fig. 143, page 558), and the most dangerous conditions were assumed. The result of that computation was that any pier which has sufficient room on top for the bridge seat and which has a batter of 1 in 12 or 1 in 24 is safe against any mode of failure from longitudinal forces; in other words, the length required on the top for the bridge seat, together with a slight batter for appearance, generally give sufficient longitudinal stability of a single-track pier against sliding, overturning, and crushing. This conclusion is especially true for a double-track bridge, and for a pier of truly monolithic concrete.

1098. Transverse Stability. The forces that tend to produce sliding or overturning transverse to the length of the pier, i.e., parallel to the bridge, are: (1) the dynamic action of the moving load, (2) the expansion of the bridge, and (3) the action of the wind against the side of the pier. The first applies only to railroad bridges, but the second and third occur with all bridges. The possibility of a pier's failing by sliding or overturning laterally is usually considerably greater than that of its failing by sliding or overturning longitudinally.

1099. Dynamic Action of Train. The locomotive in drawing a train, particularly up a steep approach, exerts a pull which must finally be balanced by the resistance of a pier to sliding and overturning in a direction opposite to the motion of the train; and if brakes are applied to the moving train while upon the bridge, a force will be developed which tends to slide and overturn a pier in the same direction as the motion of the train. The latter is the larger, since it may be one fifth of the weight of the entire train upon any one span. This force acts at the level of the rail. The

moment of this force about the edge of any horizontal cross section is resisted by the moment of the combined weight of the truss, the train, and the pier.

1100. Expansion of Bridge. The expansion or contraction of the bridge may exert a lateral pull on the pier. If the rollers or sliding plates at the free end of the bridge are in good working condition, this force is comparatively unimportant; but if the rollers become blocked by cinders and rust, as they frequently do, or if the sliding plates become rusted, as they often do, the force developed by the expansion or contraction of the bridge may be quite important. The force developed is equal to the weight of the bridge multiplied by the coefficient of friction. This force may act either with or against the dynamic action of the train; but of course the former is the condition to be considered.

The coefficient of rolling friction for bridge rollers in good condition, or of sliding plates in good condition is comparatively small; but if the rollers fail to work or the plates become rusted, the bridge is compelled to slide, when the coefficient of friction may become 0.15 to 0.20 or even more for high unit pressures.

1101. Wind on Side of Pier. The amount and point of application of the force of the wind against a pier has been considered in § 1091, and hence nothing need be said here on that subject.

1102. Resultant Stability. The resultant tendency to slide is equal to the square root of the sum of the squares of the longitudinal and of the transverse forces tending to produce sliding.

Similarly, the resultant force tending to overturn the pier is equal to the square root of the sum of the squares of the longitudinal and of the transverse forces; but ordinarily the factor of safety for the resultant moment will be greater than that for the transverse moment, because the arm of the resisting moment is considerably greater, being half of a diagonal diameter of the pier instead of half of the shortest diameter.

Strictly, the formula for the maximum crushing stress (equation 1, page 354) should be applied in the plane of the resultant moment, in which case I would represent the moment of inertia of the horizontal cross section with reference to an axis through the center of gravity of the section and perpendicular to the plane of the resultant moment; but ordinarily the following approximate solution is sufficient. The maximum compressive stress due to the forces acting longitudinally upon the pier occurs at the down-stream end of a horizontal section, and that due to the forces acting transversely upon the pier occur at one side of a horizontal section; and therefore the resultant compressive stress will be approximately the sum of the maximum longitudinal and of the maximum transverse forces.

If the down-stream end of the horizontal cross section is square, this approximate solution will be more nearly correct than if the down-stream end is pointed.

1103. FORM OF CROSS SECTION. The dimensions on the top will depend somewhat upon the form of the cross section of the pier, and also upon the style and span of the bridge. The examples presented later give representative dimensions. Theoretically the dimensions at the bottom are determined by the area necessary for stability; but the top dimensions required for the bridge seat, together with a slight batter for the sake of appearance, usually gives sufficient stability.

In a sluggish stream, the form of the horizontal cross section is not of much moment; but in a strong current it is important.

The up-stream end of a pier, and to a considerable extent the down-stream end also, should be rounded or pointed to serve as a cut-water to turn the current aside and to prevent the formation of whirls which act upon the bed of the stream around the foundation, and also to prevent shock from ice, logs, boats, etc. In some respects the semi-ellipse is the best form for the ends; but as it is more expensive to form, the ends are usually finished to intersecting arcs of circles or with semicircular ends. For an example of the former, see Fig. 143 (page 558); and of the latter, see Fig. 145 (page 559). Above the high-water line a rectangular cross section is as good as a curved outline, except possibly for appearance.

A cheaper, but not quite as efficient, construction is to form the two ends, called starlings, of two inclined planes. As seen in plan,

the sides of the starlings usually make an angle of about 45° with the sides of the pier (see Fig. 144, page 558). A still cheaper construction, and the one most common for the smaller piers, is to finish the up-stream end, below the high-water line, with two inclined planes which intersect each other in a line having a batter of from

3 or 4 inches per foot, and to build the other three sides and the part of the up-stream face above the high-water line with a batter of 1 in 12 or 1 in 24 (see Fig. 141 and 142).

1104. The portion of the pier above high water is sometimes built as two independent pedestals; and sometimes the pedestals

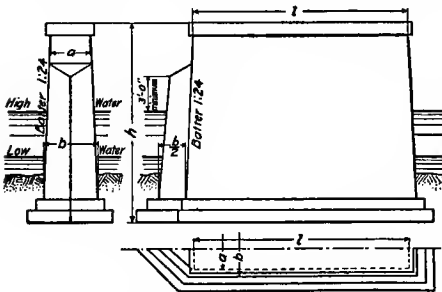

FIG. 141.—COOPER'S HIGHWAY BRIDGE PIER.

are connected all the way up by a thin vertical wall, but sometimes only at the top by an arch.

1105. EXAMPLES OF MASONRY OR PLAIN-CONCRETE PIERS. Highway and Electric-Railway. Fig. 141 shows the form for a plain concrete or masonry pier for highway and electric railway bridges, and Table 82 gives the dimensions for various spans.*

TABLE 82.
TOP DIMENSIONS FOR THE PIER SHOWN IN FIG. 141.

SPAN.	DISTANCE <i>a</i> .	DISTANCE <i>L</i> .
<i>For Country Highway and Single-Track Electric Railway Bridges:</i>		
50 feet	2 feet 8 inches	Clear roadway + 4 feet 0 inches
100 "	3 " 2 "	" " + 5 " 0 "
150 "	3 " 8 "	" " + 5 " 9 "
200 "	4 " 4 "	" " + 6 " 6 "
250 "	4 " 10 "	" " + 7 " 0 "
300 "	5 " 4 "	" " + 7 " 6 "
<i>For Double-Track Electric Railways: Add 1 foot to the above values of L.</i>		

1106. New York Central Pier. Fig. 142 shows the standard pier employed by the New York Central and Hudson River Railroad for piers 40 ft. high or less.† The up-stream end is the same

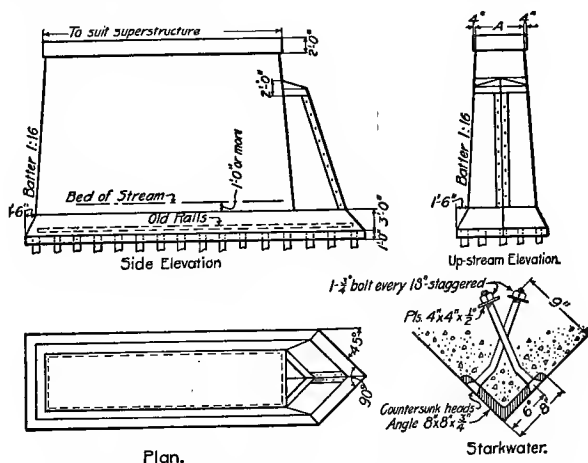

FIG. 142.—STANDARD PIER. N. Y. C. & H. R. R. R.

* Cooper's Specifications for Foundations and Substructures of Highway and Electric-Railway Bridges.

† By courtesy of W. J. Wilgus, Vice President and former Chief Engineer.

as the down-stream, except where the stark-water is necessary. The coping and the stark-water cap are made of 1 : 1 : 2 portland cement concrete, and the remainder of the pier of 1 : 3 : 6. Items 5, 6, 8, and 9 of the specifications for standard abutments (see the second paragraph of § 1076) apply also to the piers. For square crossings and spans of 40 ft. or less, the width on top, *A*, is 4 ft., and it increases 6 inches for each 20-ft. increase in the length of the span

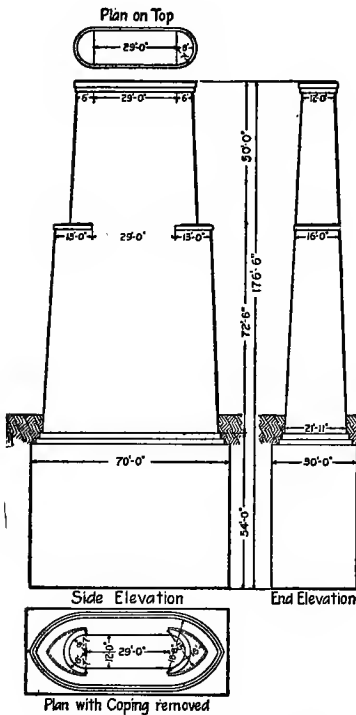

FIG. 143.—CHANNEL PIER, CAIRO BRIDGE, I. C. R.R.

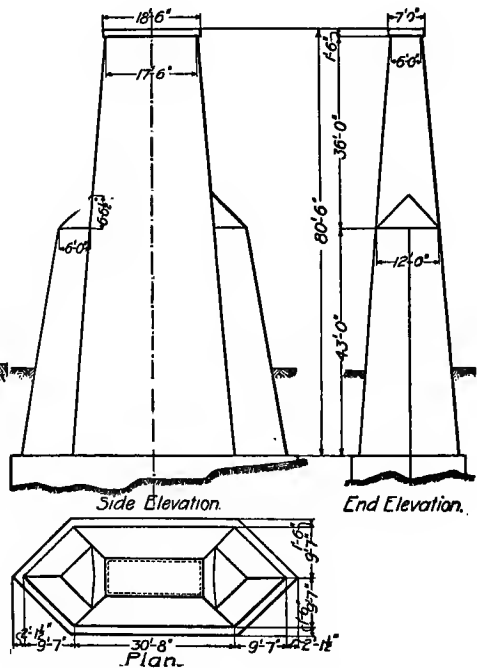

FIG. 144.—PLAIN-CONCRETE PIER. A. T. & S. F. R.R.

up to 100 ft., and then the same amount for each 25-ft. increase up to 250 ft. If the pier is more than 30 ft. high, it has a corbel course under the coping; or, in effect, the pier has one coping as shown, and upon that another coping which projects 4 inches.

1107. Cairo Bridge Pier. Fig. 143 shows the dimensions of a stone-block masonry pier of the Illinois Central Railway's single-track bridge over the Ohio River at Cairo, Ill. This pier stands between two 523-foot spans, and stands upon a bed of sand of in-

definite depth. This is the pier that was used in the computations referred to in § 1097.

1108. Santa Fé Railroad. Fig. 144 shows a plain concrete bridge pier built on the Atchison, Topeka, and Santa Fé Railway

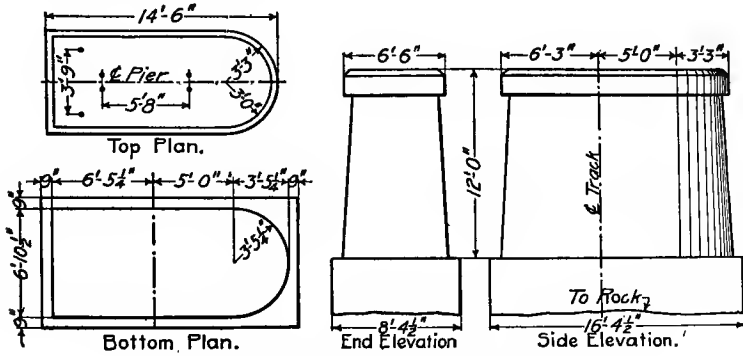

FIG. 145.—CONCRETE PIER. K.-C. M. & O. R.R.

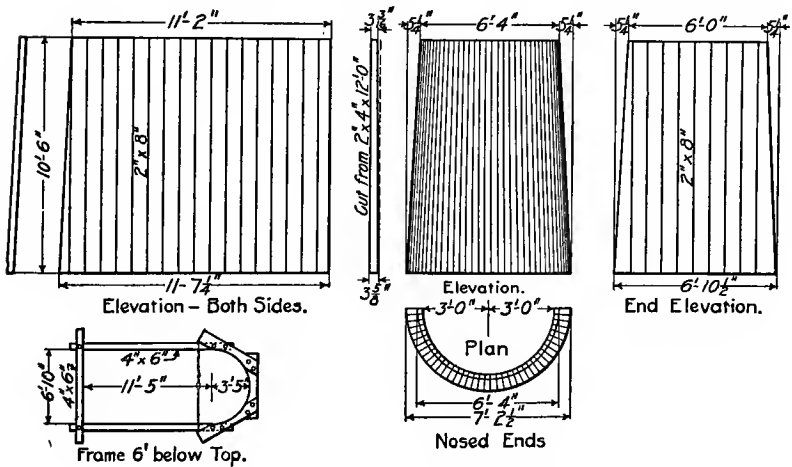

FIG. 146.—FORMS FOR CONCRETE PIER. K.-C. M. & O. R.R.

System in an uninhabited mountain region of New Mexico.* The pier stands between two 100-foot plate girders. The stream is ordinarily dry, but is subject occasionally to severe floods.

1109. Kansas City, Mexico and Orient Railroad. Fig. 145 shows the outlines of one of several concrete piers for a railroad

* By courtesy of W. B. Storey, Jr., Chief Engineer.

plate girder bridge on the Kansas City, Mexico and Orient Railroad; and Fig. 146 and 147 show the method of constructing the forms for the shaft of the pier.* For the cost of these piers, see § 1110.

The curved ends of these piers were made by smooth wood forms; but often the form is made polygonal, and a sheet of thin steel is nailed on the inside of the wood form to give a uniform curvature and a smooth surface.

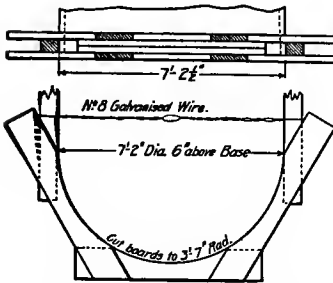

FIG. 147.—FORM FOR NOSE OF PIER.

1110. Cost of Plain-Concrete Piers.

Below is the cost of the piers shown in Fig. 145-47. The piers were sunk in coffer-dams made of wood sheet piles through 12 to 18 feet of sand to bed rock. The concrete was mixed on shore by machinery, and placed in dump boxes on push cars which ran by gravity to the pier. The concrete for the base of the pier was deposited in the coffer-dam. The cost per cubic yard of concrete was as follows:

Material and labor for coffer-dams at \$57.67 per 1 000 ft. B. M.	\$1.60
Excavating in coffer-dam.49
Materials and labor for forms at \$52.12 per 1 000 ft. B. M.36
Cement—1.13 bbl. at \$1.50	1.69
Freight, unloading and storing32
Sand—0.48 cu. yd. at 20 cts.10
Freight, unloading and storing48
Broken stone—0.80 cu. yd. at 45 cts.36
Freight, unloading, and storing52
Mixing and placing concrete	1.53
Machinery and supplies69
Miscellaneous67
Total cost, per cu. yd. of concrete	\$8.80

1111. EXAMPLE OF REINFORCED CONCRETE PIER. Illinois Central Railroad. Fig. 148 shows one of the reinforced concrete channel piers of the Illinois Central Railway's double-track bridge across the Tennessee River, at Gilbertsville, Ky.†

The reinforcement throughout consists of $\frac{3}{4}$ -inch square corrugated bars (*b*, Fig. 28, page 236). In the foundation the bars are placed 6 inches above the bottom, in each direction midway between consecutive lines of piles. The entire pier is reinforced by horizontal rings, about 6 inches from the outside of the concrete, spaced ver-

* *Engineering-Contracting*, April 3, 1907, p. 143.

† By courtesy of R. E. Gaut, Bridge Engineer.

tically 2 ft. center to center, except that there are three rings in the coping and corbel course. The coping has bars spaced 2 ft. center to center each way 6 inches under the top surface. The pier also has a system of vertical rods spaced 2 ft. center to center all around the pier, except in the footing and foundation where the spacing is a little greater. Joints in adjacent lines of reinforcement are not less than 5 ft. apart. At their junction the bars are lapped at least 18

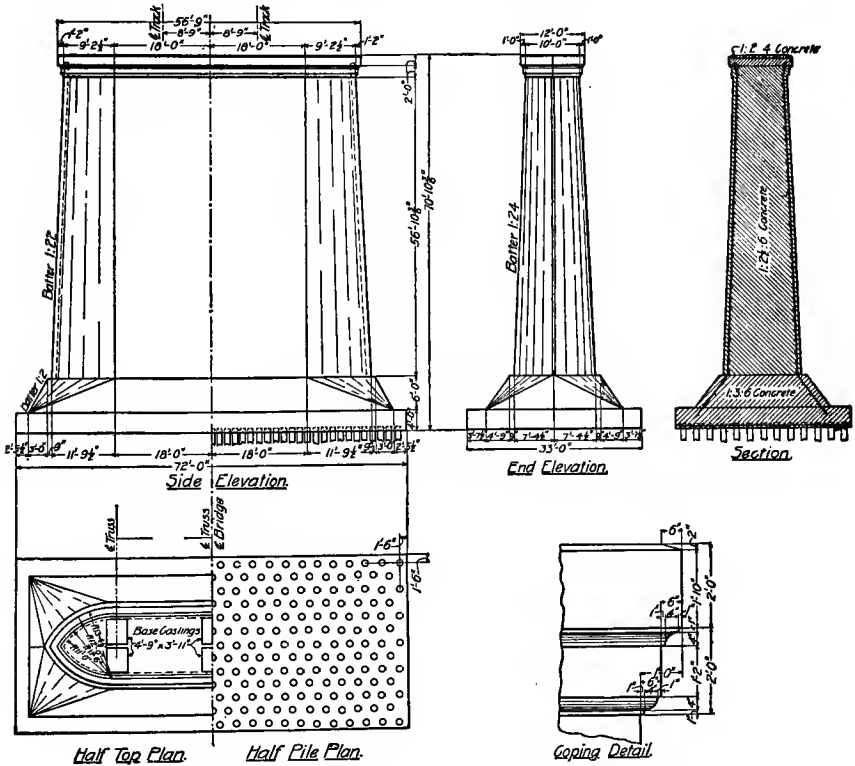

FIG. 148.—PIER TENNESSEE RIVER BRIDGE. ILLINOIS CENTRAL R.R.

inches and are tied with at least two turns of a No. 16 galvanized wire. All intersections are tied likewise.

The forms were constructed of sheeting, studding, and horizontal wales. The opposite waling pieces were bolted together with rods running through the pier, each rod being in three pieces with a sleeve-nut near the surface of the concrete on each side. The curved ends of the piers were formed somewhat as shown in Fig. 145-47.

1112. The following is the actual cost of excavating 433 cu. yd. of earth and placing 130 cu. yd. of plain concrete for a highway bridge pier near Huntley, Montana, during weather so cold as to necessitate the heating of the water, sand, and gravel.* The forms were made of 2-inch lumber dressed on one side and beveled on the edges.

Excavating 433 cu. yd. of earth, including pumping and	\$37.58	
for coffer-dam, per cu. yd. of concrete		\$1.04
Lumber for forms—6 600 ft. B. M. at one third cost34
Nails for forms—2 kegs at \$3.2005
Labor on forms		1.03
Mixing and placing concrete		1.30
Cement—1.18 bbl. at \$1.86		2.20
Sand—0.39 cu. yd. at \$0.6626
Gravel—0.97 cu. yd. at \$0.6664
Coal—3 tons at \$3.2508
Steel—110 lb. at \$2.88 ct.02
Superintendence21
Total cost per cu. yd. of concrete		\$6.14

1113. **PIVOT PIERS.** Pivot piers, i.e., the center piers for swing bridges, differ from piers for fixed spans only in that they are

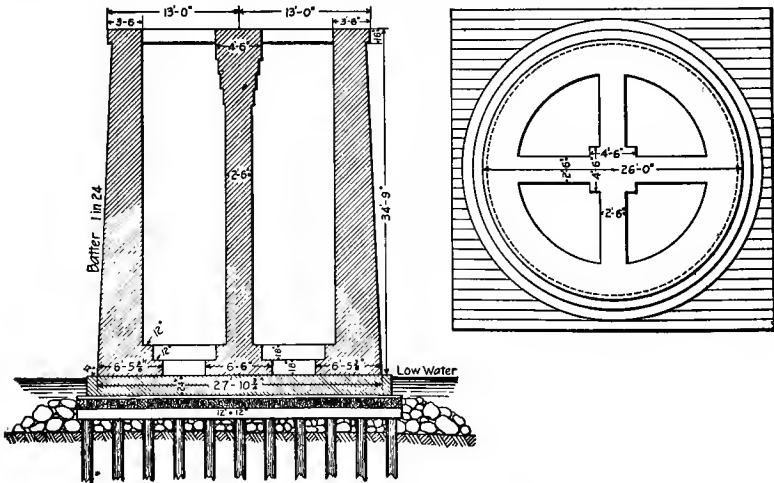

FIG. 149.—PIVOT PIER. NORTHERN PACIFIC R.R., GRAND FORKS, N. D.

circular, are larger on top, and usually have plumb sides. Pivot piers are protected from the pressure of ice and from shock by boats,

* *Engineering-Contracting*, vol. xxx, p. 445,—Dec. 30, '08.

etc., by an ice breaker which is entirely distinct from the pier. The ice breaker is usually constructed by driving a group of 60 or 70 piles in the form of a V (the sharp end up stream), at a short distance above the pier. On and above these piles a strong timber crib-work is framed so as to form an inclined ridge up which the cakes of ice slide and break in two of their own weight. Between the ice breaker and the pier two or three rows of piles are driven, on which a comparatively light crib is constructed for the greater security of the pier and also for the protection of the river craft.

Fig. 149 shows the masonry of the pivot pier for the Northern Pacific R. R. bridge over the Red River at Grand Forks, N. Dak. The specifications for the grillage were as follows: "Fasten the first course of timbers together with $\frac{3}{4}$ -inch by 20-inch drift bolts, 18 inches apart; fasten second course to first course with drift bolts of same size at every other intersection. Timbers to be laid with broken joints. Put on top course of 4-inch by 12-inch plank, nailed every 2 feet with $\frac{7}{16}$ -inch by 8-inch boat spikes. The last course is to be thoroughly calked with oakum."

Fig. 150 shows the pier of the swing span of the Illinois Central Railway's bridge across the Tennessee River at Gilbertsville, Ky.* The pier is reinforced the same as the piers of the fixed spans—see § 1111.

*By courtesy of R. E. Gaut, Bridge Engineer.

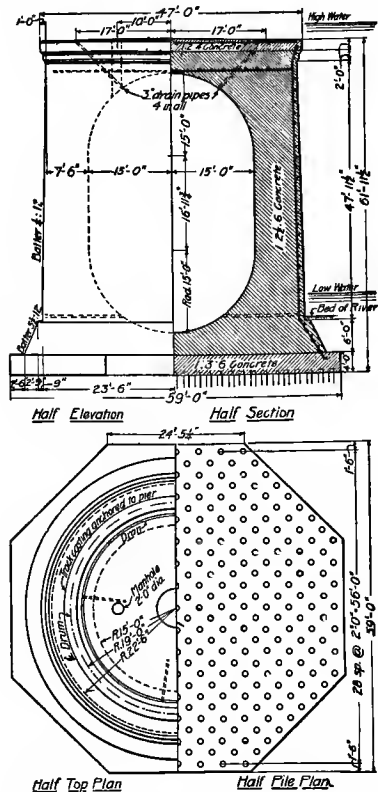

FIG. 150.—PIVOT PIER, ILLINOIS CENTRAL R.R.

CHAPTER XXI

CULVERTS

1115. A culvert is a structure through a railroad or highway embankment to carry a small stream. The term is usually restricted to structures that are built according to general plans which vary only with the area of waterway and without regard to the height of the embankment. When the span is more than 15 or 20 feet, a special design is usually made for the structure; and therefore the term culvert is properly applied only to structures having a waterway less than 15 or 20 feet wide.

ART. 1. WATERWAY REQUIRED.

1116. The determination of the amount of waterway required in any given case is a problem that does not admit of an exact mathematical solution. Although the proportioning of culverts is in a measure indeterminate, it demands an intelligent treatment. If the culvert is too small, it is likely to cause a washout, entailing possibly loss of life, interruptions of traffic, and cost of repairs. On the other hand, if the culvert is made unnecessarily large, the cost of construction is needlessly increased. Any one can make a culvert large enough; but it is the province of the engineer to design one of sufficient but not extravagant size.

1117. THE FACTORS. The area of the waterway required depends upon (1) the rate of rain-fall, (2) the kind and condition of the soil, (3) the character and inclination of the surface, (4) the condition and inclination of the bed of the stream, (5) the shape of the area to be drained and the position of the branches of the stream, (6) the form of the mouth and the inclination of the bed of the culvert, and (7) whether it is permissible to back the water up above the culvert, thereby causing it to discharge under a head.

1. It is the maximum rate of rain-fall during the severest storms which is required in this connection. This certainly varies greatly in different sections; but there are almost no data to show what it is for any particular locality, since records generally give the amount per day, and rarely per hour, while the duration of the storm is seldom recorded. Further, probably the longer the series of observations, the larger will be the maximum rate recorded, since the

heavier the storm the less frequent its occurrence; and hence a record for a short period, however complete, is of but little value in this connection. Further, the severest rain-falls are of comparatively limited extent, and hence the smaller the area, the larger the possible maximum precipitation. Finally, the effect of the rain-fall in melting snow would have to be considered in determining the maximum amount of water for a given area.

2. The amount of water to be drained off will depend upon the permeability of the surface of the ground, which will vary greatly with the kind of soil, the degree of saturation, the condition of cultivation, the amount of vegetation, etc.

3. The rapidity with which the water will reach the water courses depends upon whether the surface is rough or smooth, steep or flat, barren or covered with vegetation, etc.

4. The rapidity with which the water will reach the culvert depends upon whether there is a well-defined and unobstructed channel, or whether the water finds its way in a broad thin sheet. If the water course is unobstructed and has a considerable inclination, the water may arrive at the culvert nearly as rapidly as it falls; but if the channel is obstructed, the water may be much longer in passing the culvert than in falling.

5. Of course, the waterway depends upon the amount of area to be drained; but in many cases the shape of this area and the position of the branches of the stream are of more importance than the amount of the territory. For example, if the area is long and narrow, the water from the lower portion may pass through the culvert before that from the upper end arrives; or, on the other hand, if the upper end of the area is steeper than the lower, the water from the former may arrive simultaneously with that from the latter. Again, if the lower part of the area is better supplied with branches than the upper portion, the water from the former will be carried past the culvert before the arrival of that from the latter; or, on the other hand, if the upper portion is better supplied with branch water courses than the lower, the water from the whole area may arrive at the culvert at nearly the same time. In large areas the shape of the area and the position of the water courses are very important considerations.

6. The efficiency of a culvert may be materially increased by so arranging the upper end that the water may enter it without being retarded (see § 1127). The discharging capacity of a culvert can also be increased by increasing the inclination of its bed, *provided* the channel below will allow the water to flow away freely after having passed the culvert. The last, although very important, is frequently overlooked.

7. The discharging capacity of a culvert can be greatly increased by allowing the water to dam up above it. A culvert will discharge twice as much under a head of 4 feet as under a head of 1 foot. This can safely be done only with a well-constructed culvert through a water-tight embankment.

1118. METHODS OF DETERMINING WATERWAY. There are two methods of determining the area of the waterway required: (1) by the use of an empirical formula, and (2) by direct observation. The first method is the only one that can be employed in a new country or where there are no other structures over the stream; while the second method is applicable on a line already open or in a territory well settled up.

The determination of the values of the different factors entering into the problem is almost wholly a matter of judgment. An estimate for any one of the factors mentioned in the preceding section may be in error from 100 to 200 per cent, or even more, and of course any result deduced from such data must be very uncertain. Fortunately, mathematical exactness is not required by the problem, nor warranted by the data. The question is not one of 10 or 20 per cent of increase; for if a 2-foot pipe is insufficient, a 2½-foot pipe will probably be the next size—an increase of 50 per cent,—and if a 6-foot arch culvert is too small, an 8-foot will be used—an increase of 80 per cent. The real question is whether a 2-foot pipe or an 8-foot arch culvert is needed.

1119. Empirical Formulas. Numerous empirical formulas have been proposed; but at best they are all only approximate, since no formula can give accurate results with inaccurate data. The several formulas for area of waterway, when applied to the same problem, give very discordant results, owing (1) to unavoidable errors in estimating the various factors mentioned in § 1117 and (2) to the formulas' having been deduced for localities differing widely in the essential characteristics upon which the results depend. For example, a formula deduced for a dry climate, as India, is wholly inapplicable to a humid and swampy region, as Florida; and a formula deduced from an agricultural region is inapplicable in a city.

However, an approximate formula, if simple and easily applied, may be valuable as a nucleus about which to group the results of personal experience. Such a formula is to be employed more as a guide to the judgment than as a working rule; and its form, and also the value of the constants in it, should be changed as subsequent experience seems to indicate.

1120. There are two classes of these formulas, one of which purports to give the quantity of water to be discharged per unit of drainage area, and the other the area of the waterway in terms of

the area of the territory to be drained. The former, often called run-off formulas, give the amount of water supposed to reach the culvert; and the area, slope, form, etc., of the culvert must be adjusted to allow this amount of water to pass. There are no reliable data by which to determine the discharging capacity of a culvert of any given form, and hence the use of the formulas of the first class adds complication without securing any compensating reliability. Such formulas will not be considered here.*

Of the formulas giving directly the area of the waterway in terms of the territory to be drained, Myers's and Talbot's are the only ones in common use.

1121. Myers's Formula. This formula was proposed by E. T. D. Myers in 1887, and is said to be the one most used by engineers in the New England and Atlantic States. It is:

$$\text{Area of waterway, in square feet} = C \sqrt{\text{Drainage area, in acres}},$$

in which C is a variable coefficient to be assigned. For slightly rolling prairie, C is usually taken at 1; for hilly ground at 1.5; and for mountainous and rocky ground at 4. For most localities, at least, this formula gives too large results for small drainage areas. For example, according to the formula, a culvert having a waterway of one square foot will carry the water from only a single acre. Further, if the preponderance of the testimony of the formulas for the quantity of water reaching the culvert from a given area can be relied upon, the area of waterway increases more rapidly than the square root of the drainage area as required by this formula. Hence, it appears that neither the constants nor the form of this formula were correctly chosen; and, consequently, for small drainage areas it gives the area of waterway too great, and for large drainage areas too small.

1122. Talbot's Formula. This formula was proposed by Prof. A. N. Talbot in 1888,† and is the one most generally employed by engineers. It is:

$$\text{Area of waterway, in square feet} = C \sqrt[4]{(\text{Drainage area, in acres})^3}$$

* For several such formulas, as well as much valuable information concerning the relation of area of waterway to the rain-fall and to the drainage area, see any one of the following articles: 1. Waterways for Culverts and Bridges, by G. H. Bremner and others in *Jour. Western Soc. of Engineers*, April, 1906, p. 137-90. 2. The Requisite Waterway for Railway Culverts by H. W. Parkhurst, Bulletin No. 75, American Railway Engineering and Maintenance of Way Association, May, 1906, p. 10-19. 3. The Best Method of Determining the Size of Waterways, Appendix B to the Report of the Committee on Roadway of the American Railway Engineering and Maintenance of Way Association, Bulletin No. 108, February, 1909, p. 89-146.

† Selected Papers of the Civil Engineers' Club of the University of Illinois, No. 2, p. 14-17.

in which C is a coefficient which varies from 1 to $\frac{1}{2}$. Data from various States give values for C as follows: "For steep and rocky ground, C varies from $\frac{2}{3}$ to 1. For rolling agricultural country subject to floods at times of melting of snow, and with the length of valley three or four times its width, C is about $\frac{1}{2}$; and if the stream is longer in proportion to the area, decrease C . In districts not affected by accumulated snow, and where the length of the valley is several times the width, $\frac{1}{3}$ or $\frac{1}{4}$, or even less, may be used. C should be increased for steep side slopes, especially if the upper part of the valley has a much greater fall than the channel at the culvert."

The author has tested the above formula by numerous culverts and small bridges in a small city and also by culverts under highways in the country (all slightly rolling prairie), and finds that it agrees fairly well with the experience of fifteen to twenty years. In these tests, it was found that waterways proportioned by this formula will probably be slightly flooded, and consequently be compelled to discharge under a small head, once every four or five years.

1123. In both of the preceding formulas it will be noticed that the large range of the "constant" C affords ample opportunity for the exercise of good judgment, and makes the results obtained by either formula almost wholly a matter of opinion; in other words, the above formulas with their variable coefficients should be regarded as giving the probable maximum and minimum area of waterway, and should be used more as a guide to the judgment than as an infallible mathematical rule.

1124. Direct Observation. Valuable data on the proper size of any particular culvert may be obtained (1) by observing the existing openings on the same stream, (2) by measuring—preferably at time of high water—a cross section of the stream at some narrow place, and (3) by determining the height of high water as indicated by drift and the evidence of the inhabitants of the neighborhood. With these data and a careful consideration of the various matters referred to in § 1117, it is possible to determine the proper area of waterway with a reasonable degree of accuracy.

Ordinarily it is wise to take into account a probable increase of flow as the country becomes better improved. However, in constructing any structure, it is not wise to make it absolutely safe against every possible contingency that may arise, for the expenditure necessitated by such a course would be an unjustifiable extravagance. Washouts can not be prevented altogether, nor their liability reduced to a minimum, without an unreasonable expenditure. It has been said—and within reasonable limits it is true—that if some of a number of culverts are not carried away each year, they are not well designed; that is to say, it is only a question

of time when a properly proportioned culvert will perish in some excessive flood. It is easy to make a culvert large enough to be safe under all circumstances, but the difference in cost between such a structure and one that would be reasonably safe would probably much more than overbalance the losses from the washing out of an occasional culvert. It is seldom justifiable to provide for all that may possibly happen in the course of fifty or one hundred years. One dollar at 5 per cent compound interest will amount to \$11.47 in 50 years and to \$131.50 in 100 years. Of course, the question is not purely one of finance, but also one of safety to human life; but even then it logically follows that, unless the engineer is prepared to spend \$131.50 to avoid a given danger now, he is not justified in spending \$1 to avoid a similar danger 100 years hence. This phase of the problem is very important, but is foreign to the subject of this volume.

1125. In the construction of a new railroad, considerations of first cost, time, and a lack of knowledge of the amount of future traffic as well as ignorance of the physical features of the country, usually require that temporary structures be first put in, to be replaced by permanent ones later. In the meantime an incidental but very important duty of the engineer is to make a careful study of the requirement of the permanent structures which will ultimately replace the temporary ones. The high-water mark of streams and the effect of floods, even in water courses ordinarily dry, should be recorded. With these data the proper proportioning of the waterway of the permanent structures becomes a comparatively easy task.

Most of the older railroads, as a result of their experience, have tables or formulas for waterways which are quite accurate for their particular territory and forms of culverts. For several such formulas and tables, see Bulletin No. 108 of the American Railway Engineering and Maintenance of Way Association, February, 1909, page 89-146.

ART. 2. PIPE CULVERTS.

1126. GENERAL DESIGN OF CULVERTS. Any culvert consists of two distinct parts, the trunk and the head-walls or wings at the ends of the trunk; and consequently the design of any culvert consists of (1) the arrangement of the head-walls or wings so as to protect the embankment and facilitate the flow of the water through the culvert, and (2) the proportioning of the cross section of the trunk or barrel of the culvert. The first is substantially the same for all forms of culverts.

1127. Design of Ends. There are three methods of finishing

the ends of culverts—either box or arch. 1. The culvert is finished with a straight wall at right angles to the axis of the culvert (see Fig. 151). 2. The wings are placed at an angle of 30° with the axis of the culvert (see Fig. 152). 3. The wing walls are built parallel to the axis of the culvert, the back of the wing and the abutment being in a straight line and the only splay or flare being derived from thinning the wings at their outer ends (see Fig. 153). The first

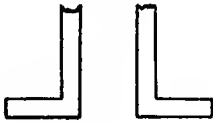

FIG. 151.

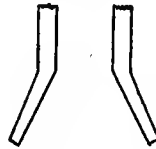

FIG. 152.



FIG. 153.

method is shown to a larger scale in Fig. 154, page 573, and Fig. 156, page 584; the second at the up-stream end of Fig. 157, page 585; and the third at the down-stream end of Fig. 157, and in Fig. 161, page 587.

The quantity of masonry required for these three forms of wings does not differ materially, Fig. 153 requiring the least and Fig. 151 the most. The most economical angle for the wings of Fig. 152 is about 30° with the axis.

The position of the wings shown in Fig. 152 is by far the most common and is better than either of the others. Fig. 151 is objectionable for hydraulic considerations, and also because it is more likely to become choked than either of the others. Fig. 153 does not have splay enough to admit the natural width of the stream at high water, and does not give sufficient protection to the toe of the embankment. However, if the culvert is ever to be extended to accommodate another track, the straight wing has a decided advantage.

1128. The wings, both straight and splayed, are usually stepped or sloped to conform to the side slope of the embankment; but occasionally the straight wings are built with a level top surface under the belief that with such wings the culvert is less likely to become clogged by drift than if the wings were sloped or stepped, since even though drift may partially or entirely stop the flow of the water between the ends of the wings the water may pour over the drift into the well thus formed and still find its way into the culvert. The need of this construction is usually not very great, nor is the benefit of it certain; but the extra cost is not very great, since it is a little cheaper to construct a wing with a level top than one with a stepped or sloped upper surface.

Sometimes posts are set in the channel a little above the mouth of the culvert, to catch the drift, which accomplish somewhat the same purpose as building the wing walls up square.

1129. Usually the two ends of the culvert are finished alike; but sometimes the up-stream end has wings as in Fig. 152, and the down-stream end wings as in Fig. 153, which is very good practice. For examples of this construction, see Fig. 157 (page 585), and Fig. 174 (page 598).

1130. PIPE CULVERTS. The simplest form of a culvert is a pipe of burned clay, cast iron, or concrete. Owing to the undesirability of openings through an embankment, very small openings are not made, the water being conducted along the side of the roadway until it can be discharged into a proportionally large stream through the embankment. Therefore, the smaller sizes of drain and sewer tiles and cast-iron pipes are not used for culverts.

Pipe culverts are durable, and on account of the smoothness of their inner surface are hydraulically efficient. They are also comparatively cheap, and are readily put into place—particularly in an opening that has temporarily been lined with wood—without disturbing the roadbed.

1131. VITRIFIED PIPE CULVERTS. Vitrified sewer pipes are extensively employed for small culverts under highways, although in the Northern States, monolithic concrete seems to be displacing the larger sizes. Formerly, such culverts were quite common under steam railroads; but in recent years many of the railroads, at least in the Northern States, have discontinued their use because of frequent breakages due either to the pipe's being laid too near the track or to the action of frost in the soil around the culvert, or to unexplainable causes, or because of the disjuncting of the pipes due to the settlement and the consequent spreading of the earth embankment. Vitrified pipes are extensively employed for culverts by highways and railways in the Southern and Southwestern States, where stone suitable for either masonry or concrete is scarce and not to be had at reasonable prices.

The pipe employed for culverts is that known to the trade as culvert pipe or "extra heavy" or "double strength" sewer pipe, which is 20 to 40 per cent (varying with the maker and the size) heavier than the quality ordinarily employed for sewers. When double-strength sewer pipe was first made, it was generally believed that such pipe would be abundantly strong for culverts for either highways or railways, provided a culvert under a highway had at least 1 foot of earth over it and under a railway 3 feet of earth and ballast; but experience has shown that under present loads this is not enough in either case. Part of the disrepute of vitrified pipe

for highway culverts is due to the fact that the ends of shallow culverts have not been protected by a masonry head-wall, and consequently the pipes have been broken progressively from the end of the culvert by the wheels of passing vehicles. With proper methods of construction, vitrified pipe of less diameter than 30 inches will give satisfactory results for highway culverts, provided in all cases there is at least 18 inches of earth over the tile, and provided where 8- or 10-ton traction engines are in common use there is at least 24 inches.

1132. Construction. In laying the pipe, the bottom of the trench should be rounded out to fit the lower half of the body of the pipe, with proper depressions for the sockets. The earth should be rammed carefully, but solidly, around the lower part of the pipe. Apparently the pipe is sometimes broken by too vigorous ramming over the pipe with a too heavy rammer; and therefore care should be taken to determine the effect of any particular tamping. If it is desired that the culvert shall discharge under much of a head, the joints should be calked with cement mortar to prevent the possibility of the water's being forced out at the joints and washing away the soil from around the pipe.

The end of the culvert should be protected with a timber or masonry or concrete bulkhead. Of course, a head wall of masonry or of concrete is better than a timber one. The foundation of the bulkhead should be deep enough not to be disturbed by frost. In constructing the end wall, it is well to increase the fall near the outlet to allow for a possible settlement of the interior sections. The upper end of the culvert should be so protected that the water will not readily find its way along the outside of the pipes, in case the mouth of the culvert should become submerged. When concrete and brick bulkheads are too expensive, a fair substitute can be made by setting posts in the ground and spiking on plank. When planks are used, it is best to set them with considerable inclination towards the road-bed to prevent their being crowded outward by the pressure of the embankment.

The freezing of water in the pipe, particularly if more than half full, is liable to burst it; consequently the pipe should have a sufficient fall to drain itself, and the outlet should be so low that there is no danger of back-water's reaching the pipe.

When the capacity of one pipe is not sufficient, two or more may be laid side by side. Although two small pipes do not have as much discharging capacity as a single large one of an equal cross section, yet there is an advantage in laying two small ones side by side, since then the water need not rise so high to utilize the full capacity of the two pipes as would be necessary to discharge itself through a single one of larger size.

1133. Example. Fig. 154 shows the standard for vitrified and cast-iron pipe culverts of the New York Central and Hudson River R. R.* Table 83 gives the dimensions for the various

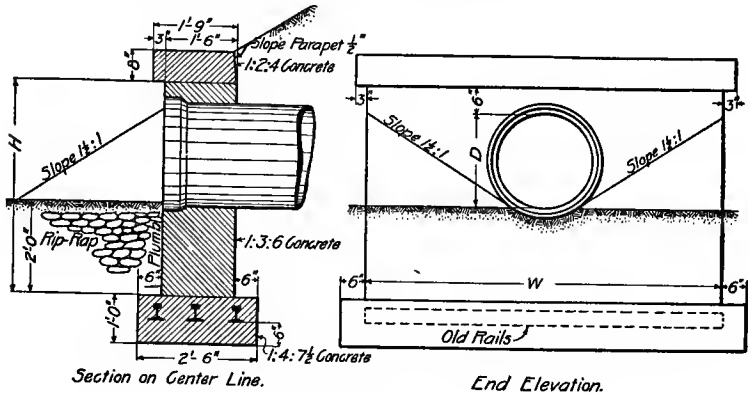

FIG. 154.—STANDARD PIPE CULVERT. N. Y. C. & H. R. R. R.

diameters of pipe. Fig. 154 shows a head wall perpendicular to the barrel of the culvert; but this road also builds pipe culverts with wings splayed at an angle of 30° with the axis of the culvert.

The following notes are from the official drawing for Fig. 154.

TABLE 83.

DIMENSIONS OF HEAD WALLS FOR DIFFERENT SIZES OF PIPE.

Diameter of Pipe, Inches.	SINGLE LINE OF PIPE.			DOUBLE LINE OF PIPE.		
	H.	W.	Cu. Yd. in one Head Wall.	H.	W.	Cu. Yd. in one Head Wall.
10	3' 4"	3' 8"	1.22	3' 4"	5' 0"	1.60
12	3' 6"	4' 0"	1.34	3' 6"	5' 6"	1.78
16	3' 10"	5' 4"	1.83	3' 10"	7' 4"	2.43
18	4' 0"	6' 0"	2.09	4' 0"	8' 0"	2.69
20	4' 2"	6' 6"	2.31	4' 2"	8' 8"	2.96
24	4' 6"	7' 6"	2.75	4' 6"	10' 0"	3.51
30	5' 0"	9' 2"	3.53	5' 0"	12' 2"	4.46
36	5' 6"	10' 10"	4.38	5' 6"	14' 4"	5.50

"1. The grade of the pipe not to be less than 3 inches in 12 feet, if conditions permit. 2. Old rails 10 to 12 inches center to center to be used where soft material is found; and, where splicing of rails

*By courtesy of H. Fernstrom, Chief Engineer.

is necessary, they are to be fully bolted with two angle bars, and the splices in adjoining rails are to break joint. 3. Pipe joints to be made water-tight with neat portland cement and oakum. 4. The back filling in rear of pipe ends to consist of stone or other porous material. 5. All exposed corners and edges to be rounded to a 1-inch radius."

1134. Formerly, steam railroads sometimes laid vitrified culvert pipe upon a bed of concrete; but such a practice is no longer wise, since the cost of concrete has so decreased as to make it cheaper and better to construct a concrete pipe culvert or a monolithic concrete culvert (see § 1140, and also Art. 3—Box Culverts—and Art. 4—Arch Culverts). However, if the vitrified pipe is to be used, and it can not be bedded firmly, then it may be necessary to lay a foundation of concrete, in which case the concrete should envelop the lower third, or even the whole lower half, of the pipe so as to distribute the pressure and thus to diminish the possibility of longitudinal cracks.

1135. Cost. Prices of vitrified pipe vary greatly with the conditions of trade, and with competition and freight. Current (1909) prices for ordinary culvert pipe, in car-load lots f.o.b. at the factory, are about as in Table 84. Sewer pipe usually cost about 20 per cent less than culvert pipe. The standard length is 2 ft. for 24-inch pipe and less, and 2½ ft. for 27-inch pipe and over.

TABLE 84.
COST AND WEIGHT OF VITRIFIED CULVERT PIPE.

INSIDE DIAMETER.	PRICE PER FOOT.	AREA.	WEIGHT PER FOOT.	AMOUNT IN A CAR LOAD.
12 inches.	\$0.19	.78 sq. ft.	54 lbs.	500 feet.
14 "	.27	1.07 " "	64 "	400 "
16 "	.35	1.40 " "	80 "	350 "
18 "	.40	1.76 " "	100 "	300 "
20 "	.50	2.18 " "	110 "	250 "
22 "	.75	2.64 " "	150 "	230 "
24 "	1.15	3.14 " "	170 "	200 "
27 "	1.30	4.00 " "	215 "	120 "
30 "	1.65	4.80 " "	300 "	110 "
33 "	2.25	6.00 " "	350 "	90 "
36 "	2.80	7.00 " "	390 "	80 "

1136. CAST-IRON PIPE CULVERTS. Formerly cast-iron pipes were considerably used for culverts in localities where there was no stone suitable for masonry, when a waterway was required greater than could be obtained with a vitrified pipe. Cast-iron pipe from 12 to 48 inches in diameter, in sections 6, 8, and 12 feet long, was used

by all the railroads of the Mississippi Valley. Some cast their own pipe, while others bought water pipe. In recent years most roads make a pipe which is heavier than the ordinary water pipe. The dimensions differ on different roads, but the following seem to be the heaviest in common use.

TABLE 85.
DIMENSIONS OF CAST-IRON CULVERT PIPE.

INSIDE DIAMETER.	WEIGHT PER FOOT.	THICKNESS.	WEIGHT PER LINEAL FOOT PER SQ. FT. OF AREA.
12 inches.	75 lbs.	0.52 inch.	96 lbs.
18 "	167 "	0.73 "	94 "
24 "	250 "	1.00 "	80 "
30 "	334 "	1.06 "	68 "
36 "	450 "	1.12 "	64 "
42 "	600 "	1.38 "	62 "
48 "	725 "	1.44 "	57 "

At present there is a tendency to discontinue the use of cast-iron pipe culverts for two reasons, viz.: (1) The larger sizes of cast-iron pipe frequently crack under either comparatively low or very high embankments; and (2) concrete culverts can usually be made which are stronger and cheaper. But in localities where materials for making concrete are scarce, cast-iron pipe will doubtless continue to be used.

1137. Construction. In constructing a cast-iron culvert, the points requiring particular attention are: 1. Form a depression for the socket, so the pipe may not be supported at its two ends and possibly break as a beam. 2. Shape the soil to fit the bottom of the pipe, so that it may have a uniform support on the bottom. 3. Since the pipe is nearly certain to settle more under the middle of the roadway than at the ends, the center of the pipe should be laid a little above a straight line joining the two ends. 4. Tamp the soil in tightly under and along the sides of the pipe to give a firm lateral support. 5. Protect the two ends by a suitable head wall. 6. If necessary lay riprap or construct an apron at the lower end to prevent scour at the outfall.

Ordinary cast-iron pipes are strong enough to support any ordinary embankment, if the pipe is properly bedded and if the earth is thoroughly tamped against the side; but breakages do sometimes occur where the pipe is not carefully bedded, or where the earth is dumped on one side and allowed to slide down against the pipe.*

* Data of tests of cast-iron culvert pipe, see Bulletin No. 22, University of Illinois Eng'g Exp. Sta.

Some railroads limit the larger sizes of cast-iron pipe culverts to banks more than 8 or 10 ft. high and less than 25 or 30 ft.

The amount of masonry required for the end walls depends upon the relative width of the embankment and the number of sections of pipe used. For example, if the embankment is, say, 40 feet wide at the base, the culvert may consist of three 12-foot lengths of pipe and a light end wall near the toe of the bank; but if the embankment is, say, 32 feet wide, the culvert may consist of two 12-foot lengths of pipe and a comparatively heavy end wall well back from the toe of the bank. The smaller sizes of pipe usually come in 12-foot lengths, but sometimes a few 6-foot lengths are included for use in adjusting the length of culvert to the width of the bank. The larger sizes are generally 6 feet long.

1138. Examples. Fig. 155 shows the method employed on the Atchison, Topeka and Santa Fé R. R. in putting in cast-iron pipe culverts.* Table 86 gives the dimensions of the end walls for the various sizes. The length of pipe is determined by taking the

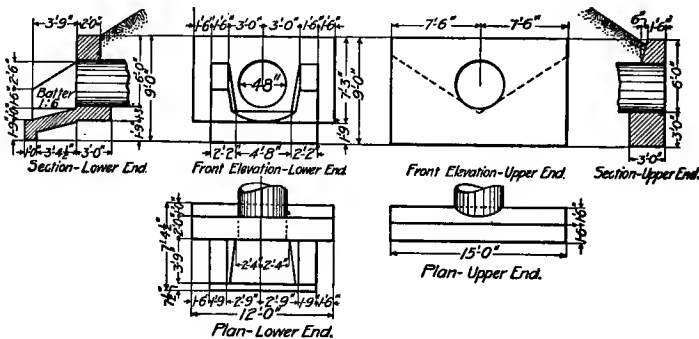

FIG. 155.—CAST-IRON PIPE CULVERT. A. T. & S. F. R. R.

multiple of 6 feet next larger than the length given by the position slope as in Fig. 155. To allow for settling, the pipe is laid to a vertical curve having a crown at the center of 1 inch for each 5 feet in vertical height from bottom of pipe to profile grade.

Fig. 154, page 573, shows the standard cast-iron pipe culvert of the New York Central and Hudson River Railroad.

1139. Cost. The price of cast-iron pipe varies with the condition of trade, but is about 1 1/2 cents per pound, f.o.b. at the foundry. In constructing a branch railroad in Southern Illinois, on which 590 tons of cast-iron pipe were used, the average cost of unloading was 33 cents per ton, of wagon haul was 44 cents per ton per mile, and

* By courtesy of W. B. Storey, Jr., chief engineer A. T. & S. F. R. R. System.

of laying was 55 cents per ton, the cost of laying being more per ton for the smaller sizes than for the larger.

Table 85 (page 575) shows that the average weight of the pipe per foot per square foot of waterway is about 70 pounds; and hence the cost of the trunk of a cast-iron pipe culvert, exclusive of transportation and labor, is about $70 \times 1\frac{1}{2} = \1.05 per lineal foot per sq. ft. of area. The cost of vitrified culvert pipes is, from Table 84

TABLE 86.

DIMENSIONS OF END WALLS FOR CAST-IRON PIPE CULVERTS SHOWN IN FIG. 155.

Dimensions not given below are the same, for all sizes, as those given in Fig. 155.

ITEMS.	INSIDE DIAMETER OF PIPE.					
	18 in.	24 in.	30 in.	36 in.	42 in.	48 in.
HEAD WALL, length.....	6'3"	8'0"	9'9"	11'6"	13'3"	15'0"
thickness, upper end,						
bottom.....	2'0"	2'0"	2'3"	2'6"	2'9"	3'0"
lower end, bottom....	2'6"	2'6"	3'0"	3'0"	3'0"	3'0"
top.....	1'6"	1'6"	2'0"	2'0"	2'0"	2'0"
height.....	6'3"	6'9"	7'6"	8'0"	8'6"	9'0"
APRON, length.....	3'0"	3'0"	3'6"	3'6"	4'0"	4'4 $\frac{1}{2}$ "
width.....	5'4"	6'8"	6'9"	7'6"	8'0"	9'0"
WING WALL, length.....	2'7 $\frac{1}{2}$ "	2'7 $\frac{1}{2}$ "	3'0"	3'0"	3'4 $\frac{1}{2}$ "	3'9"
height at outer end ...	0'6"	1'0"	1'0"	1'6"	1'6"	1'6"
height at inner end ...	2'3"	2'9"	3'0"	3'6"	3'9"	4'0"
CONTENTS, upper head wall, cu. yd....	2.75	3.50	5.50	7.00	9.00	11.25
lower head wall, cu. yd....	3.00	3.50	5.25	6.75	7.50	9.25

(page 574), about 30 cents per foot per square foot of waterway. The cost of the head walls required for vitrified and for cast-iron pipe culverts is substantially the same; and hence the above data show approximately the relative cost of the two forms of culvert. According to this showing, cast-iron is considerably more expensive than vitrified clay; but this difference is partly neutralized by the greater ease with which the iron pipe can be put into place either in new work or in replacing a wooden box culvert.

1140. CONCRETE PIPE CULVERTS. Concrete pipes both plain and reinforced have been employed for culverts. Plain concrete is most suitable for small sizes, but it has been used for pipes 48 inches inside diameter. There are three reasons why plain concrete is less

desirable for culvert pipe than reinforced concrete, viz.: 1. The plain concrete is heavier for the same strength, and hence is more difficult to handle. 2. The plain concrete is more likely to be broken in handling. 3. Plain concrete is unable to stand any considerable distortion of its cross section without collapse.

1141. Plain Concrete Culvert Pipe. Plain concrete culvert pipe are on the market. They have either square-butting or beveled-telescoping joints. The latter are likely to crack on account of the unequal settlement of adjacent pipes. For a description of the forms and the dimensions of plain concrete culvert pipe, see Journal Western Society of Engineers, Vol. XII, p. 83-88.

1142. Reinforced Concrete Culvert Pipe. Recently reinforced concrete pipe 2, 3, and 4 feet in inside diameter have been used by railroads in culvert construction. The pipes usually have a bell and spigot joint; and have a hoop reinforcement which is near the interior surface at the top and bottom of the pipe, and near the exterior surface at the sides of the pipe. The 48-inch pipe is 4 inches thick, and the reinforcement consists of hoops spaced 3 inches center to center and longitudinal bars spaced 8 inches, both being $\frac{1}{4}$ -inch square corrugated bars. The smaller pipes are reinforced with wire net. The pipes are made in 8-ft. lengths. Such pipe can be rolled from the cars on skids the same as cast-iron pipe

The strength of reinforced concrete pipe will vary with the amount of reinforcement and with the age of the concrete. Some tests made by bedding a 48-inch pipe in sand in a strong box and applying a load as nearly uniform as possible over the horizontal projection of the pipe, gave an average breaking load of 6,960 lb. per sq. ft., for pipe about 180 days old and containing approximately 1 per cent of reinforcement.* The strength of a 48-inch cast-iron pipe 1.50 inches thick was 13,000 lb. per sq. ft.† This shows that the cast-iron pipe is nearly twice as strong as the reinforced concrete. However, the strength of the concrete pipe could be materially increased at very little expense by adding a little concrete on the compression side at the top, bottom, and sides of the pipe. Under ordinary conditions, the 48-inch concrete pipe costs only about 60 per cent as much as the cast-iron and the 36-inch about 75 per cent; and for sizes less than 36 inches cast-iron pipe is more economical.

1143. STRENGTH OF PIPE CULVERTS. The data in the preceding section seem to show that the breaking load of the cast-iron pipe is the equivalent of the pressure of a bank of earth 130 feet high, and of the reinforced concrete pipe is the equivalent of a bank 70 feet

* Eng'g Exp't Sta., University of Illinois, Bulletin No. 22, p. 45; or Jour. West. Soc. of Eng'rs, vol. xiii, p. 413.

† *Ibid.*, p. 42, or p. 411, respectively.

high; but it should be remembered that these are the results when dry sand was packed around the pipes as carefully as possible, and that any variation from the conditions of the experiment may materially affect the load the pipe will support. For example, if the bedding is such as to give as much thrust at the sides of the pipe as vertical load at the crown, there will be no bending moment in an annular cross section, and hence the pipe will carry a maximum load. Again, if the pressure is uniform over the horizontal projection, the pipe will carry twice as much as if the pressure is concentrated along a line at the top and the bottom. The last relation suggests that in bedding the pipe in firm ground the trench should be so shaped that the pipe will surely be free at the bottom, even after settlement occurs. The nature of the filling and the method of depositing it have a great influence upon the strength of the pipe; but in every case it is wise to attend carefully to the bedding of the pipe, particularly to securing (1) a uniform support under the pipe, (2) a considerable horizontal thrust at the sides, and (3) a uniform pressure on top.*

ART. 3. BOX CULVERTS.

1144. Box culverts, i.e., culverts having a rectangular waterway, were formerly often built of timber or stone, and are at present often made of plain or reinforced concrete.

There are two forms of box culverts: one having only roof and side walls, and one having floor, roof, and side walls. Strictly speaking, the first should be called an open box, and the second a closed box; but ordinarily, the first is referred to as an open box, and the second simply as a box culvert. In the open box culvert the side walls have independent footings which carry the load; and in the closed box the floor carries the load, although the so-called floor may project outside of the side walls.

1145. Timber is not much used now for culverts owing to its high price and perishable nature; and stone-box culverts are not much used now owing to the difficulty of obtaining suitable stone within a reasonable distance. Wood culverts should be considered only temporary, and the area of the waterway should be so much larger than actually required that a permanent culvert can be constructed inside of the timber one before the latter decays.

Stone-box culverts were made by resting slabs of stone upon side walls which were sometimes laid up dry and sometimes with mortar. The span of the cover stones varied from 2 to 4 feet, and the thickness from 10 to 16 inches. The former editions of this volume

* For a discussion of the strength of culvert pipes under different conditions of loading, see Bulletin No. 22 of University of Illinois Eng'g Exp't Sta., p. 4-22.

contain a full discussion of box culvert and also illustrations of the standard stone-box culvert employed on several railroads.

Plain concrete is not economical for use in box culverts, since both the roof and the floor, and probably also the sides, must resist a force tending to produce tension in the concrete—a stress which the material can not economically carry.

Reinforced concrete is, therefore, the only material that is economical and durable for use in box culverts. The reinforced concrete box section is used also for cattle passes, for undergrade highway crossings, etc.

1146. For spans of less than 15 or 20 feet, the box culvert is usually superior to an arch culvert for four reasons, viz.:

1. The space occupied is only a few feet more than the clear span, and hence the box culvert can be put in with less excavation and less disturbance to the embankment than is necessary for an arch culvert.
2. The box does not concentrate the load upon the foundation as does the arch, and hence the box culvert can be founded directly upon a soft soil where an arch culvert would require piling.
3. The foundation is immediately under the span, and hence it is much easier to drive piles for the foundation of a box culvert than for an arch, particularly if the culvert is to occupy the major portion of a panel of a wood-pile trestle—as is often the case.
4. The form work is more simple for the box than for the arch culvert.

1147. REINFORCED CONCRETE BOX CULVERTS. In recent years reinforced concrete has come into great favor for small culverts and also for larger culverts where the head room is not sufficient to permit the use of an arch. Generally the closed-box type is employed; but occasionally, when the foundation is very firm and not likely to scour, the open-box is used.

1148. Indefiniteness of Data. It is not possible to secure mathematical accuracy in the design of the cross section of a culvert for the following reasons:

1. The law of the pressure of earth is not known (see § 998–1011). The relation between the pressure and the depth of earth is not known for a homogeneous mass devoid of cohesion; and in any particular case the load upon the roof of the culvert varies greatly with the nature of the filling and the method of depositing it. It is possible that under certain conditions a considerable part of the prism of earth vertically above the culvert may be supported by arch-like action against the sides of the excavation; and on the other hand, it is possible that the culvert may support a mass of earth which is wider at the surface than the span of the culvert. However, it is reasonably certain that the higher the embankment, the less the proportionate load upon the culvert top, and that at some unknown

height any increase in height will not increase the load upon the culvert.

2. The effect of the rail, the ballast, and the earth in distributing the live load parallel to the track is not known. It is reasonably certain that the live load is transmitted downward in diverging lines; but there is no experimental data as to the law of this distribution. However, since the weight of the maximum train is nearly the same as the weight of the largest locomotive, it is safe and reasonably correct to assume that the live load is uniformly distributed along the track and is transmitted vertically downward to the culvert top.

3. The effect of the tie, the ballast, and the earth in distributing the live load perpendicular to the track is not known. It is frequently assumed that the live load is carried down at a slope of $\frac{1}{2}$ horizontal to 1 vertical, from the end of the tie.

4. The effect of the live load upon the horizontal component of the earth thrust is not known. Some designers in computing the horizontal component of the earth pressure assume that the live load is equivalent to an equal weight of earth; while experiments seem to show that the live load does not materially affect the horizontal component (§1008).

5. There are no experimental data as to a reasonable allowance for the effect of impact due to the motion of a railroad train. The allowance should be greatest for a short span under a shallow bank, and least for a long span under a high bank. The allowance by different designers varies greatly, some allowing 100 per cent for shallow banks and decreasing as the height increases; and a designer who is frequently quoted, either directly or indirectly, allows 50 per cent for impact on all banks up to 40 ft. high. It is probable that the effect of impact upon culvert tops is not very great, since (1) the elasticity and inertia of the earth neutralize a considerable part of the effect of impact, and since (2) experiments show that the repetition of the load develops cohesion, and hence part of the load will be carried by the beam-like action of the earth filling. Probably any allowance for impact, except possibly for spans of, say, not more than 10 feet under banks less than 5 feet high, is largely an illusion.

6. The degree of restraint of the four sides of the reinforced concrete box culvert is not known. Some designers assume that the cover and the bottom have fixed ends, while others assume them to have free ends. Further, when the top and the bottom are assumed to be monolithically connected to the sides, the effect of the resulting moment is usually neglected in determining the resistance of the sides to the horizontal component of the earth pressure.

Because of the different assumptions made in each of the above cases, and also because of differences in the theories concerning the

resistance of reinforced concrete (§ 444), there is a considerable difference in the results obtained by different designers.

1149. Design of Cross Section. To illustrate the method of designing a reinforced concrete box culvert, assume that the culvert is under a railroad, and consider only a section one foot long under the center of the track. Assume that the live load is uniformly distributed laterally by the ties over 8 feet of width, and that it is not distributed longitudinally. For example, if a length of locomotive equal to the span of the culvert weighs 10,000 lb. per lin. ft., then under the above assumption the unit live load on the culvert top is $10,000 \div 8 = 1,250$ lb. per sq. ft.

Let d = the thickness of the slab, in inches;

E = the load of earth, in lb. per sq. ft.;

H = the height of the embankment above the upper limit of the waterway, in feet;

h = the clear height of the waterway, in feet;

L = the live load, in lb. per sq. ft.;

M = the maximum bending moment, in inch-pounds;

S = the clear span of the culvert, in feet;

w = the weight of a unit volume of the earth = 100 lb. per cu. ft.;

W = the weight of a unit of volume of the concrete = 150 lb. per cu. ft.;

1150. Top of the Culvert. Considering the top slab as a beam fixed at the ends, the maximum bending moment occurs at the top side over the inside face of the side wall, and is equal to one twelfth of the total load multiplied by the span; or

$$\begin{aligned} M &= \frac{1}{12} S (E + L) 12 S + \frac{1}{12} (W - w) \frac{d}{12} S (12 S) \\ &= S^2 (100 H + L) + \frac{1}{12} (W - w) d S^2 \\ &= S^2 (100 H + L) + 50 \frac{d}{12} S^2 \\ &= S^2 \left(100 H + L + 50 \frac{d}{12} \right) \dots \dots \dots (1) \end{aligned}$$

The bending moment on the cover can be easily determined for any particular case by equation 1. To use equation 1 as it stands, it is necessary first to compute the approximate thickness of the slab, omitting the term involving d ; and then recompute the thickness using the approximate thickness for d . However, it is hardly worth while to include the unknown thickness of the slab, d , in

equation 1; in other words, it is sufficiently exact to omit the term containing d .

1151. The amount of steel to be used is 1 to 1.5 per cent of soft steel, or 0.75 to 1.00 per cent of high carbon steel (§ 463). The working stress in the steel may be assumed from 12,000 to 16,000 lb. per sq. in. for soft steel (§ 470). The working stress in the concrete may be taken at 650 lb. per sq. in. (§ 474) for the best concrete, provided the full load is not applied until the concrete has set for at least 30 days.

The thickness of the slab may then be determined by equation 11 or by equation 12, page 228, according to whether the amount of steel adopted is less or more than that given by equation 10, page 228. Assuming that the adopted steel ratio is less than that required by equation 10, the thickness of the slab is given by equation 11, which is

$$d^2 = \frac{M}{b f_s p j}, \dots \dots \dots (2)$$

the b in equation 11 becoming 1 since only a portion of the cover one foot long is under consideration. M is the value of the moment from equation 1 above, f_s is the adopted unit stress in the steel, p is the steel ratio, and $j = 0.875$ approximately.

The thickness of the slab can readily be computed by equation 2. To the net thickness as thus computed should be added 1 to 2 inches for the proper embedment and protection of the steel.

1152. Owing to the difficulty of really fixing the ends of a beam, it is quite common, in computing the stresses in reinforced concrete beams having nominally fixed ends, to assume that the maximum bending moment is more than that for a beam having ends absolutely fixed. One method is to compute the moment on the assumption that the beam has free ends, and then use eight tenths of the computed moment in making the design, which is equivalent to assuming that the maximum moment in the beam is $\frac{1}{10}$ of the total load multiplied by the span, while the maximum moment in a beam having fixed ends is $\frac{1}{2}$ of the total load multiplied by the span. This method is frequently employed in the design of reinforced concrete box culverts, and is often specified, directly or indirectly, in the building ordinances of many cities as the method to be employed in computing the strength of a reinforced concrete beam having nominally fixed ends.

1153. *Bottom of the Culvert.* The bottom slab is usually made the same as the top, since the load is substantially the same; and hence the floor requires no new computations.

1154. *Sides of the Culvert.* The horizontal component of the

earth pressure may be assumed as one third of the weight of the earth; or the horizontal pressure at the top of the side wall is $\frac{1}{3} w H$, and at the bottom $\frac{1}{3} w (H + h)$, and the average is $\frac{1}{3} w (2 H + h)$. The moment at the center of the side then is with sufficient accuracy

$$M = \frac{1}{2} w (2 H + h) h^2$$

$$= 1.4 (2 H h^2 + h^3) \dots \dots \dots (3)$$

Knowing the bending moment, the thickness of the side wall may be computed by equation 2, page 583. If the culvert is built monolithic, then it is proper to take M in equation 2, page 583, as 0.8 of the value computed by equation 3 above.

If the sides and the top are rigidly connected, the actual moment in the side will be less than that given by equation 3; because the flexure of the top produces a moment in the sides contrary to that due to the horizontal pressure of the earth.

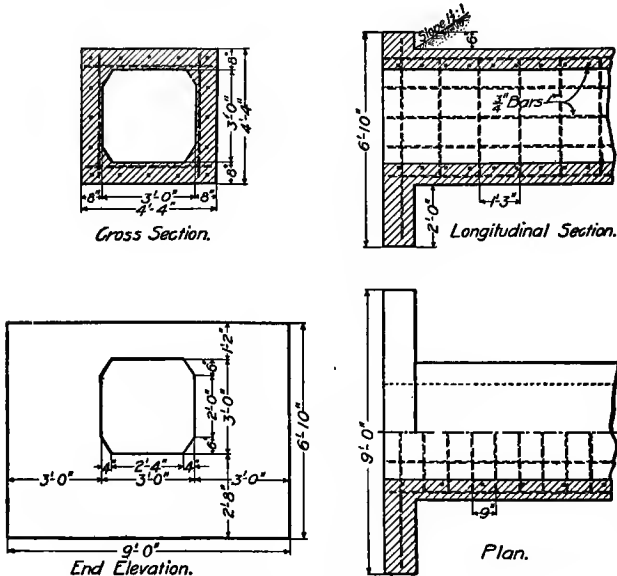

FIG. 156.—K.-C., M. & O. RY. BOX CULVERT.

1155. Decrease of Section toward Ends. The preceding design has been limited to a unit section under the track; but beyond the ends of the ties the load decreases, and hence toward the ends of the culvert the amount of reinforcement and the thickness of the concrete could be made less than under the track. This decrease would probably not pay except in a comparatively long culvert.

1156. Shear in Concrete. Since the span is comparatively short, the shear is small; and hence no provisions need be made for resisting shear except to bend up part of the main reinforcing bars.

1157. Bond Stress. All plain rods should have an embedment beyond the point of maximum moment of 50 diameters (see § 472).

1158. Longitudinal Reinforcement. If the supporting power of the earth is not uniform, a box culvert may act as a beam spanning the weak places; and hence in such cases longitudinal reinforcement may be advantageous. Longitudinal reinforcement would also resist the formation of contraction cracks, but the range of temperature for a culvert is comparatively small, and hence no great amount of temperature reinforcement (§ 503-6) is required.

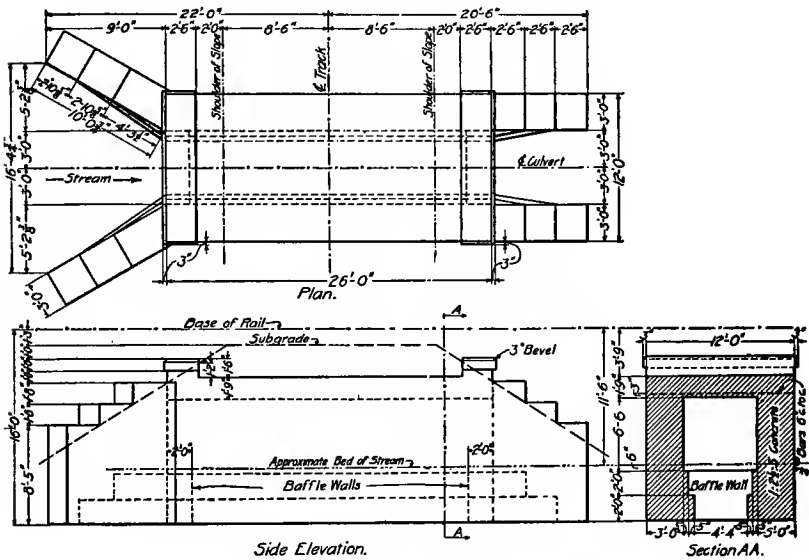

FIG. 157.—L. S. & M. S. RY. BOX CULVERT.

1159. Examples. K.-C., M. & O. Ry. Fig. 156 shows a 3- by 3-foot reinforced concrete box culvert employed by the Kansas City, Mexico and Orient Railway.* Notice that this culvert has the perpendicular head wall, but on this road all sizes above this have splayed wings at both ends.

1160. L. S. & M. S. Ry. Fig. 157 shows the 6- by 6-foot box culvert employed by the Lake Shore and Michigan Southern Railway.† Notice the splayed wings at the up-stream end and

* *Railway Age*, Jan. 8, 1904, p. 49.

† By courtesy of B. R. Leffler, Bridge Engineer.

the straight wings at the down-stream end. Notice also that there is no floor or pavement, but that there are cross walls or baffle walls which prevent scour and also act somewhat as struts to hold the side wall in position. This road finds that it is frequently called upon to lower the waterway of its culverts, and as a floor or pavement

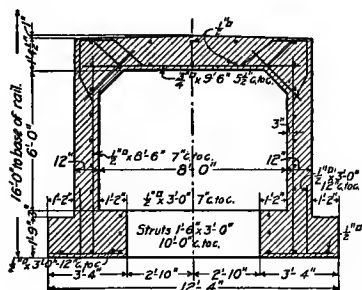

FIG. 158.—OPEN BOX CULVERT.

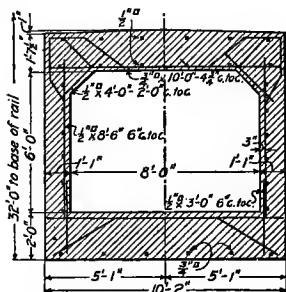

FIG. 159.—CLOSED BOX CULVERT.

interferes with this more than the cross walls has adopted the latter instead of the former. Notice that there are no shear bars in the roof. This road omits shear bars, because of the difficulty of getting them properly placed; but keeps the shear in the concrete within a safe limit.

1161. *C. M. & St. P. Ry.* Fig. 158,* shows the cross section of an 8-by 6-foot open-box culvert employed by the Chicago, Milwaukee

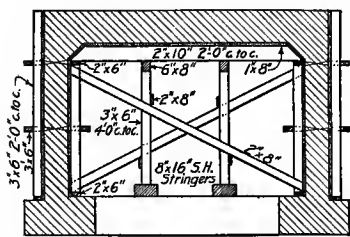

FIG. 160.—FORMS FOR BOX CULVERT.

and St. Paul Railway as designed for a 16-foot fill; and Fig. 159 shows an 8- by 6-foot closed box culvert as designed by the same road for a 32-foot fill. However, the unit stresses were not assumed to be the same in the two cases. For example, in the roof for the 16-foot bank the stress in the steel was limited to 12,600 lb. per sq. in., and that in the concrete to 500 lb. per sq. in., while for the 32-foot bank the corresponding limits were 14,900 and 600, respectively; and for the side walls, the limits were 13,200 and 15,000 lb. per sq. in. for the steel, and 400 and 450 lb. per sq. in. for the concrete, respectively. Such discrimination is hardly justified by the indefinite character of the data (see § 1148).

* Report of the Committee on Reinforced Concrete Culverts of the American Railway Bridge and Building Association,—*Railway and Engineering Review*, Nov. 7, 1908, p. 898-99.

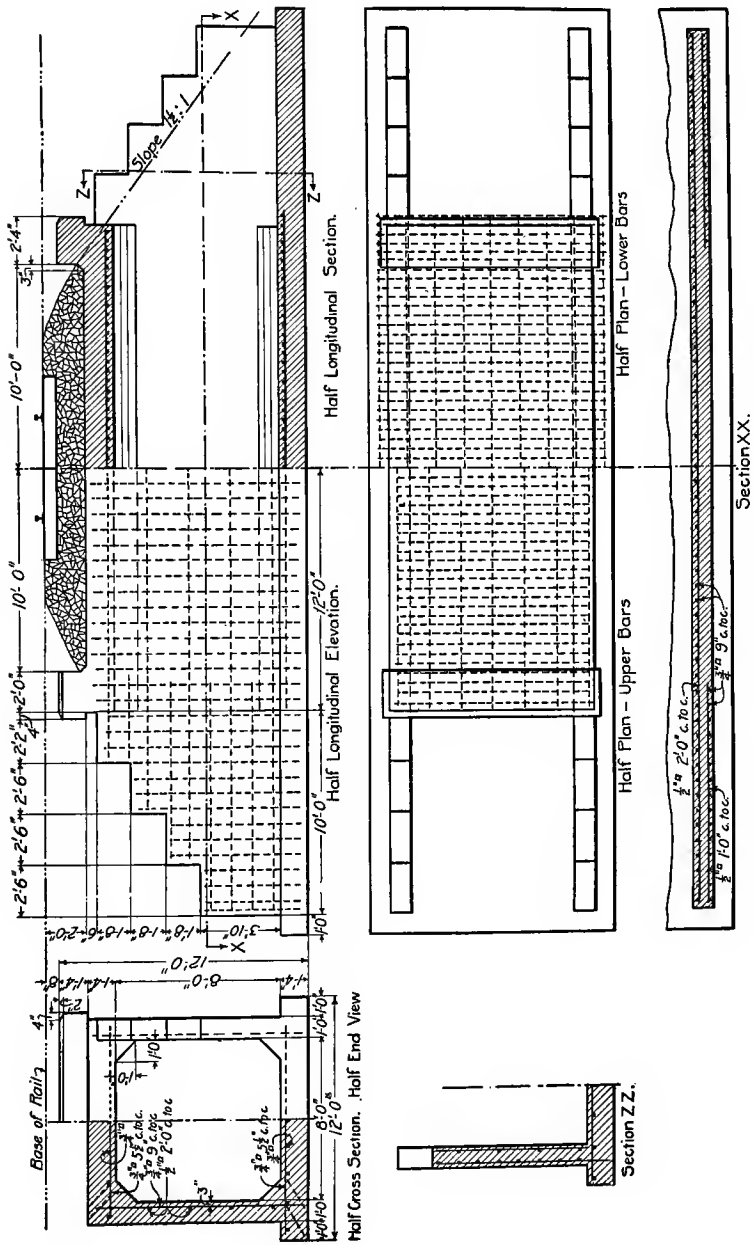

FIG. 161.—ILLINOIS CENTRAL REINFORCED CONCRETE BOX CULVERT.

Fig. 160, page 586, shows the forms employed in the construction of the culverts shown in Fig. 158 and 159.

1162. *Illinois Central R. R.* Fig. 161, page 587, shows the standard 8- by 8-foot box culvert of the Illinois Central Railroad. The culvert shown has straight wings at both ends, but this road also builds culverts with splayed wings and with head walls perpendicular to the axis of the culvert. Notice, in the right-hand portion of Section XX, that bars are placed

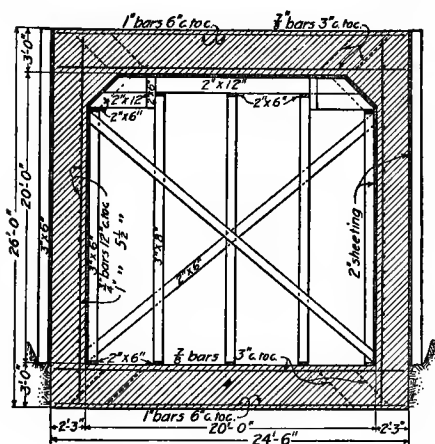

FIG. 162.—C. B. & Q. BOX CULVERT.

on both sides of the wing, the additional bars being in anticipation of the extension of the culvert to accommodate a second track. All the reinforcement is corrugated bars (§ 465), and is 3 inches from the nearest surface of the concrete.

1163. *C. B. & Q. R. R.* Fig. 162 shows the cross section, of a 20- by 20-ft. box culvert employed by the Chicago, Burlington and Quincy Railroad, and also the forms used in constructing the culvert.* This road

builds single box culverts of all dimensions from 4 by 4 feet to 20 by 20 feet; and, when a greater waterway is required than can be secured with a single box, builds a double box, one of which is shown in Fig. 163.†

Fig. 163 illustrates the difficulty of securing in structures of such magnitude, such a distribution of the pressure upon the foundation as will prevent unequal settlement. This culvert was designed for a bank 30 feet high above the top of the culvert, and consequently the load was considerably more under the track than under the toe of the bank. To secure a foundation under the body of the culvert that should decrease in area from the center toward the ends of the culvert, a solid concrete floor is laid over the entire width of the waterway under the track and a gradually increasing portion of the floor is omitted as the ends of the culvert are approached. This method of procedure was reasonably successful, although minute cracks showed that the ends of the culvert did not settle quite as

* L. J. Hotchkiss, asst. engineer, in Jour. West. Soc. of Engineers, vol. xii, p. 350—June, 1907.

† Chas. H. Cartlidge, bridge engineer, in Jour. West. Soc. of Eng'rs, vol. ix, p. 266.

much as the center. The wing walls must be designed to resist overturning, and the area of the base required for this purpose is so great as to make it impossible to secure a pressure per unit of area which shall be uniform under both the trunk of the culvert and the wings; and therefore it is the practice of this road to attach the wings to the body by a tongue and groove slip joint so that the two may settle independently. Sometimes temporary wings of piles and planks are put in, and after the culvert has settled, permanent wings of concrete are built; but this is not necessary unless the foundation is very soft.

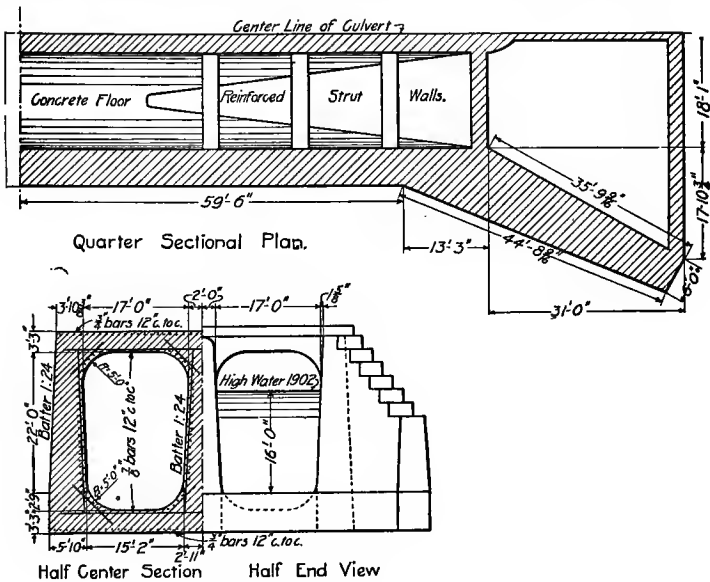

FIG. 163. C. B. & Q. DOUBLE BOX CULVERT.

1164. Highway Culvert. Fig. 164, page 590, shows the standard design for a highway culvert published by the company controlling the corrugated bars (*b* and *c*, Fig. 28, page 236). The live load was assumed to be a 20-ton road roller.

This design was made for a fill of 2 feet of earth over the culvert; and it was assumed that the culvert top supported a prism of earth which was *H* ft. (in this case 2 ft.) wider than the clear span of the culvert (see paragraph 3, § 1148). The top, bottom, and sides were assumed to act as beams having fixed ends; and the flexure in the sides due to the bending of the top and bottom was neglected. Notice the longitudinal reinforcing rods near both surfaces of all

four sides to prevent cracks due to unequal settlement. Notice also the reinforcement at the corners, and the provision for shear in the roof and the floor of the culvert.

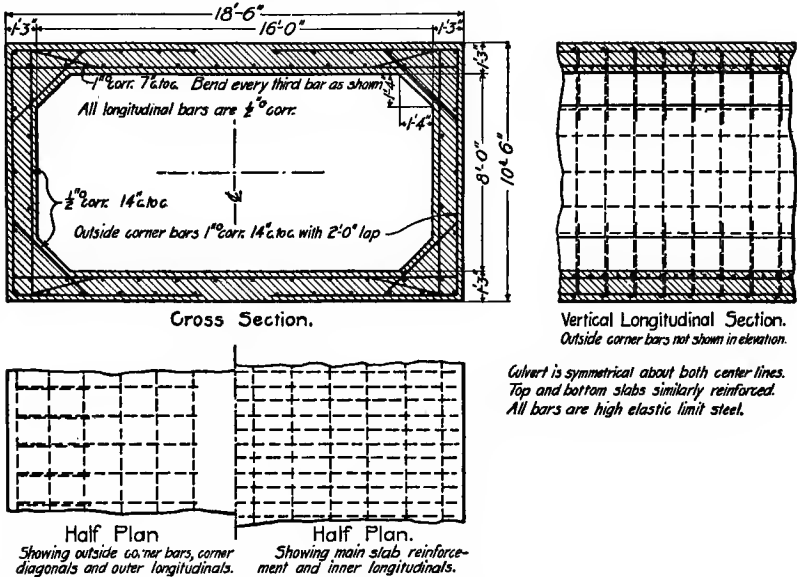

FIG. 164.—CORRUGATED BAR Co's. BOX CULVERT.

1165. Rail-Top Culverts. In the early use of concrete for culverts, particularly before the principles of reinforced concrete were well understood, culverts were sometimes built with a considerable

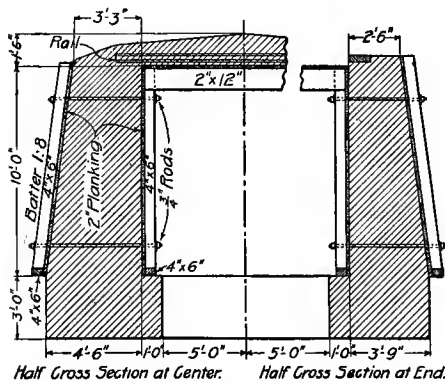

FIG. 165.—C. M. & ST. P. RAIL-TOP CULVERT.

number of railroad rails in the lower sides of the roof slab, transversely across the opening. These rails acted as beams and also as reinforcement in the lower side of the roof slab; but steel rails have too large sections to be efficient reinforcement and are not in the right form for economy, and consequently such construction has for the most part been discontinued in favor of ordinary reinforced concrete

box culverts. However, it sometimes happens that it is necessary to provide a considerable waterway through a shallow embankment, in which case it is desirable to make as thin a roof for the culvert as possible; and under these circumstances rail-top culverts are still built. Fig. 165 shows the cross section of a rail-top culvert on the Chicago, Milwaukee and St. Paul Railway, and also the forms used in the construction.* The rails, usually old ones, are placed upon their bases nearly in contact, and should extend at least 12 inches over the inside edge of the side walls. Usually about 2 inches of rich mortar, or concrete containing only fine stone, is placed below the base of the rail to protect the steel from corrosion; and usually at least 6 inches of concrete is placed above the top of the rails.

Sometimes when the distance between the upper side of the waterway and the base of the rail is limited to 18 or 24 inches, six or eight rails are set with bases down and as close together as possible under each rail of the track, and other rails are turned base up between them, thus making a nearly solid course of rails under each rail of the track.

Sometimes, instead of railroad rails, steel I-beams are used, which because of their greater depth are more economical as beams and permit better embedment in the concrete.

TABLE 87.

COST OF 8- BY 6-FOOT REINFORCED CONCRETE BOX CULVERTS

For the cross section of the culverts, see Fig. 158 and 159, page 586.

ITEMS OF EXPENSE.	16-FT. FILL.		32-FT. FILL.	
	Amount per Lin. Ft.	Cost per Lin. Ft.	Amount per Lin. Ft.	Cost per Lin. Ft.
CONCRETE: roof at \$6.50 . . .	0.53 cu. yd.	\$3.44	0.63 cu. yd.	\$4.10
side walls at \$7.50	0.47 " "	3.52	0.51 " "	3.82
footings at \$6.50	0.55 " "	3.58	0.76 " "	4.94
Total	1.55 cu. yd.		1.90 cu. yd.	
STEEL: transverse	83.8 lb.		134.2 lb.	
longitudinal	25.5 "		21.7 "	
Total at 4 cts . . .	109.3 lb.	4.37	155.9 lb.	6.24
FORMS: at 4.5 cts. per sq. ft.	100 ft. B. M.	4.50	90 ft. B.M.	4.05
Total cost		\$19.41		\$23.15

* Jour. West. Soc. of Eng'rs, vol. vi, p. 66-72

1166. Cost of Concrete Box Culverts. For data concerning the various elements of the cost of concrete, see § 412-28.

1167. Reinforced Concrete Box Culverts. Table 87, page 591, shows the estimated cost of the reinforced concrete culverts shown in Fig. 158 and 159, page 586, as given by the Committee.* The price of the concrete includes the cost of the excavation and of mixing and placing. The cost of the forms is figured at 2½ cents per foot, B. M., for the original cost of the lumber, which it is assumed will be used twice, making the actual cost of the lumber 1½ cents per foot, B. M.; and the cost of labor is considered 3¼ cents per foot.

1168. The following is the cost to the contractor of a 14- by 15-ft. box culvert 250 ft. long built near Kansas City, Mo., in 1905.†

ITEMS.	COST PER YARD OF CONCRETE
Excavation, pumping, etc.....	\$1.84
Piles, 389 = 8,647 lin. feet.....	2.71
Cement, 0.87 bbl. at \$1.58.....	1.37
Sand, 0.49 cu. yd. at \$0.70.....	.34
Stone, 0.90 cu. yd. at \$1.25.....	1.10
Lumber, at \$15.00 per M ft., B. M.....	0.76
Reinforcement, 109 lb. at 2.35 cts.....	2.56
Labor.....	2.48
Wire, nails, water, etc.....	.18
Total cost.....	\$13.34

1169. The following is the cost of a reinforced concrete box culvert to carry an irrigation canal under a creek, built in Montana in 1906.‡

ITEMS.	PER CU. YD. OF CONCRETE.
Excavating and backfilling, 2,083 cu. yd.:	
excavating and backfilling at.....	\$0.56 per cu. yd.
pumping, labor.....	.16 " " "
supplies.....	.03 " " "
Total for excavating.....	\$0.75 " " "
Forms:	
materials—one third of cost.....	0.56
labor, building and removing.....	2.43
pumping to remove forms.....	.21
Total for forms.....	3.20
Concrete, 369 cu. yd.:	
cement, 1.19 bbl. at \$1.86.....	\$2.20
sand, 0.91 cu. yd. at \$1.06.....	.96
gravel, 0.39 cu. yd. at \$1.06.....	.42
Total for materials.....	3.60

* See foot-note on page 586

† *Railway Age*, Aug. 2, 1907.

‡ *Engineering-Contracting*, June 10, 1908.

installing plant.....	\$0.33	
labor mixing and placing	2.14	
supplies10	
Total for mixing and placing		\$2.57
Reinforcement:		
material, 129 lb., at 2.88 cts.....	\$3.71	
hauling06	
bending23	
placing.....	.26	
Total for steel.....		4.26
Grand Total, per cu. yd. of concrete..		\$13.63

1170. Rail-Top Culvert. The following is the cost of a rail-top culvert containing 113 cu. yd. of concrete and requiring 36 cu. yd. of excavation, built in Scranton, Pa., in 1907, for the Delaware, Lackawana and Western R. R. by contract.*

ITEMS.		PER CU. YD. OF CONCRETE.
Excavation, 36 cu. yd. at \$1.29.....		\$0.41
Cement, 1.21 bbl. at \$0.85.....	\$1.03	
Stone, 1.0 ton at \$0.70.....	.70	
Sand, 0.42 cu. yd. at \$0.55.....	.23	
Total for concrete materials		1.96
Forms, lumber	\$0.46	
labor67	
Total for forms		1.13
Rails and bolts32
Mixing and placing concrete		1.25
Handling material50
Superintendence and office expense12
Total cost		\$5.69

ART. 4. ARCH CULVERTS.

1171. In this article will be discussed what may be called the theory of the arch culvert in contradistinction to the theory of the stability of the masonry arch. The latter will be considered in the next chapter.

By the theory of the arch culvert is meant an exposition of the method of disposing a given quantity of masonry so as to secure (1) maximum discharging capacity, (2) minimum liability of being choked by drift, and (3) maximum strength. The structures here considered are arch culverts which are usually built according to standard plans without reference to the height of the embankment above them. When the bank is so high as to require especial consideration, the principles of one of the two succeeding chapters must be employed.

* *Engineering-Contracting*, Jan. 1, 1908, p. 16.

Both plain and reinforced concrete are employed for arch culverts, the latter the more frequently.

1172. GENERAL FORM OF CULVERT. Splay of Wings. There are three common ways of disposing the wing walls at the end of the arch culvert, which are the same as discussed in Art. 2, Pipe Culverts—see § 1126-29.

1173. Junction of Wings and Body. The most common position of the wings of arch culverts is at an angle of about 30° with the axis of the barrel; and for this position, there are two general methods of joining the wings to the body of the culvert, which are shown in plan in Fig. 166 and 167.

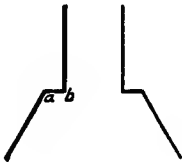

FIG. 166.

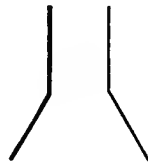

FIG. 167.

When culverts were made of stone-block masonry, the form shown in Fig. 166 was very common. Apparently the inner end of the wings was set back from the side of the waterway, so that the wing could be carried up outside of the arch ring without the latter interfering with the bonding of the wing to the head wall (see Fig. 168); but the corners thus formed at *a* and *b* are very objectionable, since they reduce the capacity of the culvert and add to its cost. The angles at *a* and *b*, Fig. 166, materially decrease the amount of water which can enter under a given head and also the amount which can be discharged. It is a well-established fact in hydraulics that the discharging capacity of a pipe can be increased 200, or even 300, per cent simply by giving the inlet and outlet forms somewhat similar to Fig. 167. Although nothing like this increase can be obtained with a culvert, one finished at both the upper and the lower end like Fig. 167 will discharge considerably more water than one like Fig. 166. The capacity of Fig. 167 decreases as the angle between the wing and the axis increases; hence, the less splay the better, provided the outer ends of the wings are far enough apart to accommodate the natural width of the stream at high water. Also the less the splay, the less the probability of the culvert's being choked with drift. Fig. 166 is very bad for both the admission and the discharge of water, and also on account of the great liability that drift and rolling stones will catch in the angles between the wings and the end walls. With a culvert having a ground plan like Fig.

166, the wings sometimes had a vertical face and sometimes a battered face; and with the latter form of wings, the arrangement shown in Fig. 166 was sometimes slightly (but only slightly) improved by moving the wing forward as shown in Fig. 168.

1174. Four methods have been employed to eliminate the corners *a* and *b*, Fig. 166, in an arch culvert with flared wings. 1. When culverts were built of coursed masonry, the face of the wing was built vertical at its intersection with the vertical face of the side wall and battered elsewhere; or in other words, the face of the wing below the springing line of the arch was warped. With rock-face masonry this would not be very objectionable; but with con-

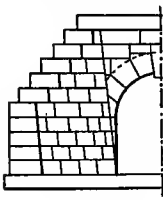

FIG. 168.

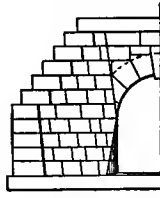

FIG. 169.

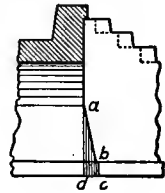

FIG. 170.

crete it would be quite objectionable, since it would complicate the building of the forms. 2. Occasionally the wing was moved inward until the battered face intersected the face of the head wall at the springing line of the arch, and then the corner of the wing which would otherwise project into the waterway was rounded off to a gentle curve, as shown in Fig. 169. This solution is better for masonry than for concrete. 3. A solution somewhat similar to the last consists in placing the wing as in Fig. 169 and cutting off the portion that would project into the waterway by extending the plane of the inside face of the vertical side wall. The surface of the portion so cut away is shaded in Fig. 170. For an illustration of this method as applied in practice, see Fig. 184, page 604, in which illustration the portion of the wing that is cut away is shown by the shaded portion *abcd*. This method complicates a trifle the construction of the concrete forms. 4. Not infrequently the face of the side wall is battered and intersects the battered face of the wing wall in a right line which passes through the springing line. For an example of this form of construction, see Fig. 173, page 597, and Fig. 175, page 599.

1175. At present, concrete arch culverts are usually built of the general form shown in Fig. 167, except that either the face of the wing is vertical or the face of the wall at the side of the waterway has the same batter as the face of the wing.

1176. Semicircular vs. Segmental Arches. When arch culverts were built of coursed masonry, there was considerable discussion as to the relative merits of semi-circular and segmental arch culverts.

The segmental arch gave the greatest waterway for a given quantity of arch masonry; or for the same width of waterway required less arch masonry. Theoretically, the segmental arch should be the thicker; but the thickness of the arch ring of culverts is usually greatly in excess of that required for strength, and consequently the relative thickness was not considered.

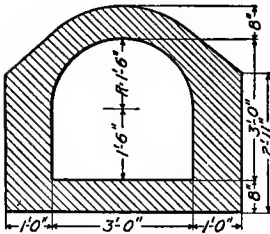

FIG. 171. — ARCH CULVERT, PENNSYLVANIA LINES.

With concrete arches, the concrete in the arch costs no more per cubic unit than that in the remainder of the structure, and hence there is little or no difference between semicircular and segmental arch culverts. However, it is sometimes claimed that the center for the semicircular arch is more easy for an ordinary carpenter to comprehend and construct than that for a segmental arch.

1177. EXAMPLES OF PLAIN CONCRETE ARCH CULVERTS. Pennsylvania Lines.

Fig. 171 shows the cross section of a 3- by 3-ft. plain concrete arch culvert built by the Pennsylvania Lines on a coal branch in southern Indiana.* The section is lighter than is commonly built by railroads (for example, see Fig. 172), but in this case it seems to have been sufficiently strong.

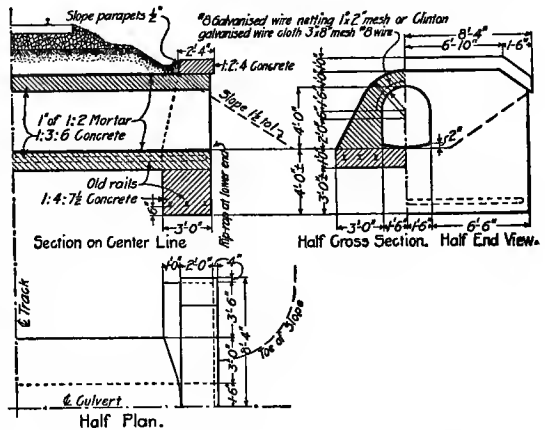

FIG. 172.—N. Y. C. & H. R. R.R. ARCH CULVERT.

1178. N. Y. C. & H. R. R.R.

Fig. 172 shows the complete drawings of a standard 3- by 4-ft. arch culvert of the New York Central and Hudson River Railroad.† The following are notes from the official drawing. “1. The foundations are not to be shallower

* *Engineering News*, vol. lviii, p. 145,—Aug. 8, 1907.

† By permission of W. J. Wilgus, Chief Engineer.

than shown, but are to be carried deeper if necessary. 2. Old railroad rails are to be used where soft material is found; and, where splicing is necessary, they are to be fully bolted with two angle bars, and the joints in adjoining rails are to be staggered. 3. The back of the arch is to be coated with straight-run coal-tar pitch $\frac{1}{8}$ inch

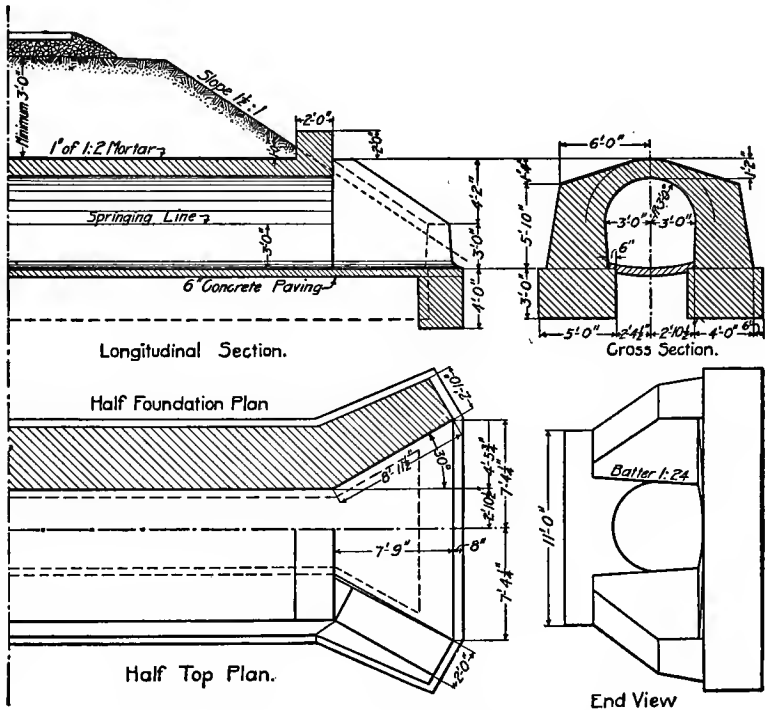

FIG. 173.—C. C. & O. RY. PLAIN CONCRETE ARCH CULVERT.

thick. 4. All exposed corners and edges are to be rounded to 1-inch radius."

1179. C. C. & O. Ry. Fig. 173 is the standard 6-foot plain concrete arch culvert on the Carolina, Clinchfield, and Ohio Railway.* The depth of foundations shown is the minimum. The down-stream wings may be either straight or flared. Notice that the inside face of the side wall ("bench wall") has the same batter as the face of the wing.

1180. Erie Railroad. Fig. 174, page 598, shows the standard

* *Railway and Engineering Review*, March 13, 1909, p. 206.

10-ft. arch culvert of the Erie Railroad.* Notice that the inside face of the wing wall is vertical. The New York Central and Hudson River Railroad, the Nashville, Chattanooga, and St. Louis Railway, and the Union Pacific Railroad have a somewhat similar standard.*

1181. Illinois Central. Fig. 175 shows the standard 16-foot plain concrete culvert of the Illinois Central Railroad.† Notice that the inside face of the wing and of the bench wall are both battered. The wings shown are flared, but this road also builds

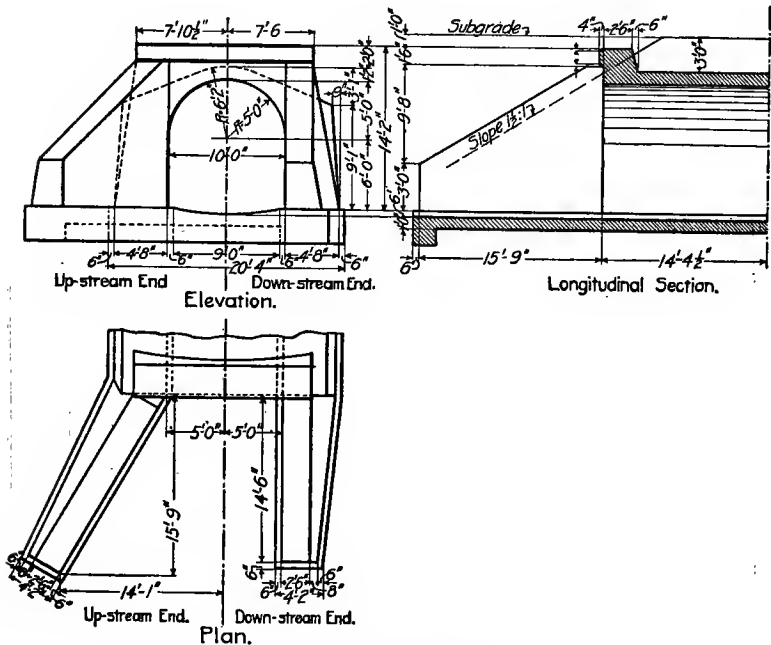

FIG. 174.—ERIE STANDARD PLAIN CONCRETE ARCH CULVERT.

straight wings. The top face of the wing is sloped, but the road also builds stepped wings. This road also builds culverts with a straight head wall parallel to the track.

1182. Porto Rico Highway. Fig. 176, page 600, shows the form of plain concrete highway culvert constructed by the Engineer Corps, U. S. A., in Porto Rico.‡

* Bulletin No. 105 (Nov. 1908), Amer. Ry. Eng'g and M. of W. Assoc., p. 6.

† By courtesy of R. E. Gaut, Bridge Engineer.

‡ *Engineering News*, vol. lxxv, p. 203.

1183. EXAMPLES OF REINFORCED-CONCRETE ARCH CULVERTS. C. M. & St. P. Ry. Fig. 177 and 178, page 600, show the cross sections of two 8-foot reinforced-concrete semicircular arch culverts as built by the Chicago, Milwaukee and St. Paul Railway, and Fig.

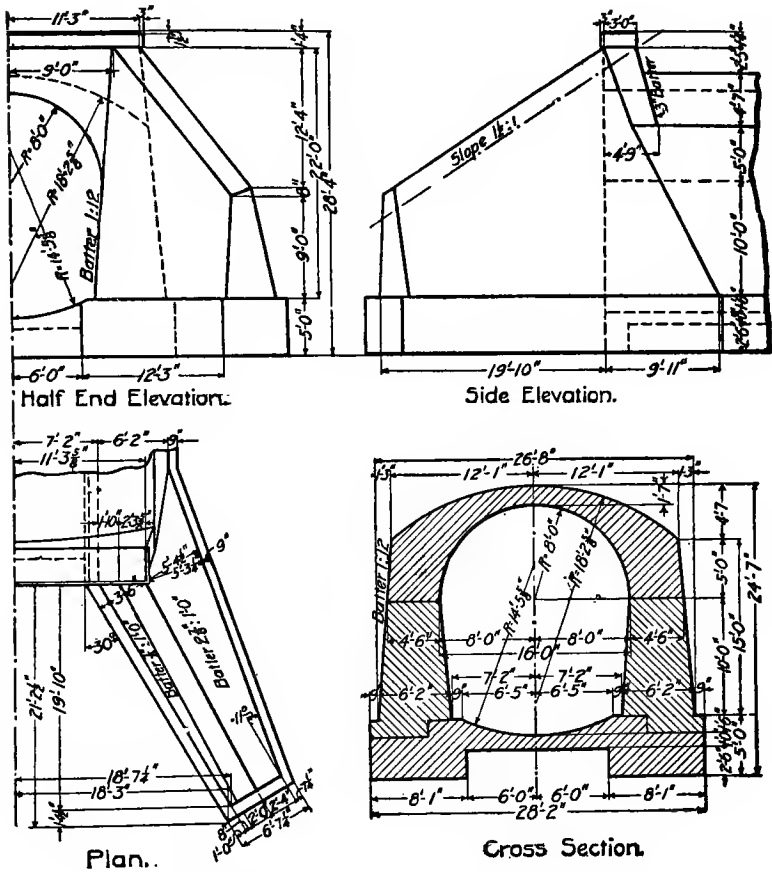

FIG. 175.—ILLINOIS CENTRAL PLAIN CONCRETE ARCH CULVERT.

179 shows the cross section of a three-centered arch culvert on the same road.* Fig. 177 was designed for a 16-ft. embankment, and Fig. 178 for a 32-ft. fill; and Fig. 179 also was designed for a 16-ft.

* Report of Committee on Reinforced Concrete Culverts at 1908 convention of the American Railway Bridge and Building Association—*Railway and Engineering Review*, Nov. 7, 1908, p. 900.

embankment. Fig 177 is supposed to give a bearing on the soil of 1.9 tons per sq. ft., and Fig. 178 and 179 are supposed to give 1.8 tons per sq. ft. The relative cost of the first two is shown in Table

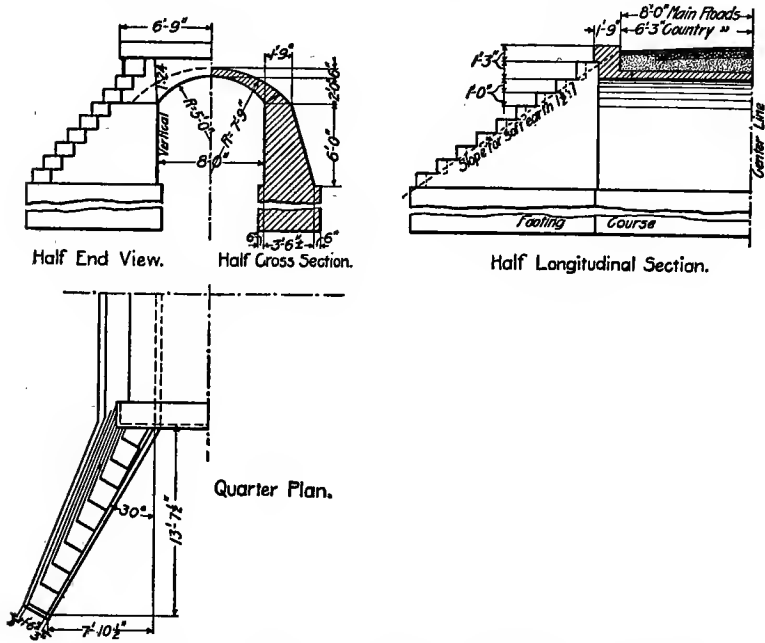

FIG. 176.—PLAIN CONCRETE HIGHWAY ARCH CULVERT, PORTO RICO.

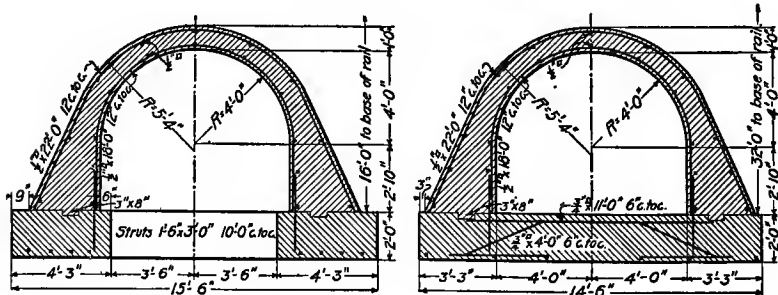

FIG. 177.—C. M. & St. P. Rr.

FIG. 178.—C. M. & St. P. Rr.

88, page 605, and the center and forms used in constructing the third is shown in Fig. 180.

1184. Illinois Central R. R. Fig. 181, page 602, shows the com-

plete drawings for a 16-ft. reinforced-concrete under-grade highway crossing built by the Illinois Central at Gilbertsville, Ky., which is representative of the practice of that road except that for a culvert proper the wings would usually be flared.* Notice that the inside face of the bench wall and of the wing are vertical, and compare

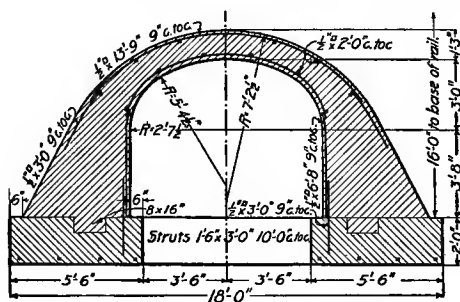

FIG. 179.—C. M. & St. P. Ry.

with Fig. 175, page 599. On account of this structure's being in a city, false joints were marked on the arch ring, by nailing triangular strips on the inside of the concrete forms. Fig. 182, page 603, shows the details of the cornice; and Fig. 183, page 603, shows the method of finishing all exposed edges. All exposed faces of the arch ring and parapet wall have a $1\frac{1}{2}$ -inch coat of facing mortar.

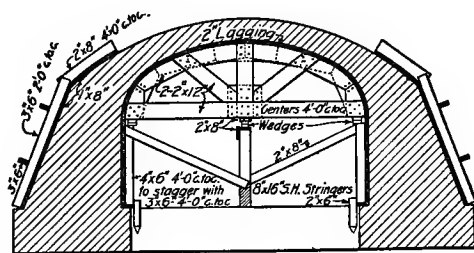

FIG. 180.—FORMS FOR C. M. & St. P. CULVERT.

The structure shown in Fig. 181, page 602, contains 195 cu. yd. of concrete and 11,764 lb. of corrugated bars or 65 lb. per cu. yd.

1185. L. S. & M. S. Ry. Fig. 184, page 604, shows a 20-ft. reinforced-concrete arch culvert as built by the Lake Shore and Michigan Southern Railway.† Notice that the side wall is plumb

* By courtesy of A. S. Baldwin, Chief Engineer.

† By courtesy of B. R. Leffler, Bridge Engineer.

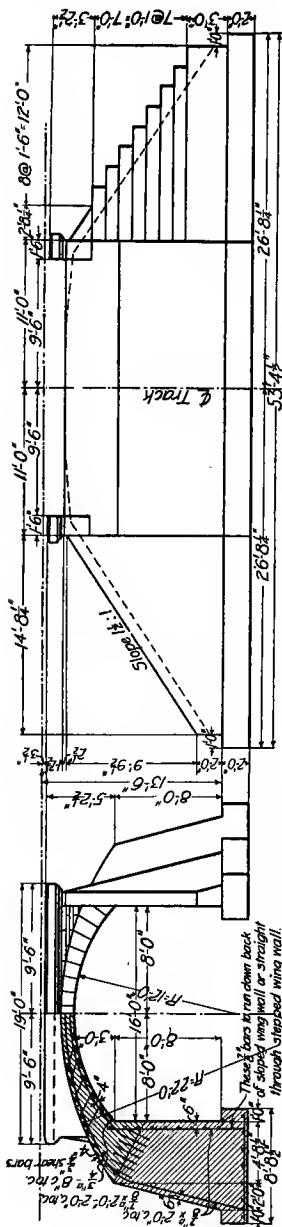

Half Section.

Half Elevation.

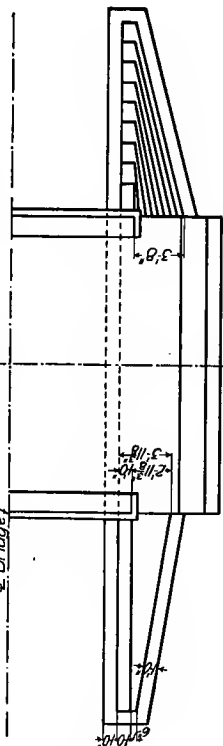

Elevation.

Half Plan.

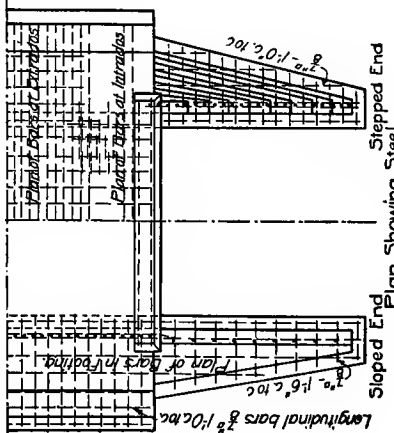

Half Section.

Half Elevation.

Half Plan.

Sloped End Plan Showing Steel.

Stepped End Plan.

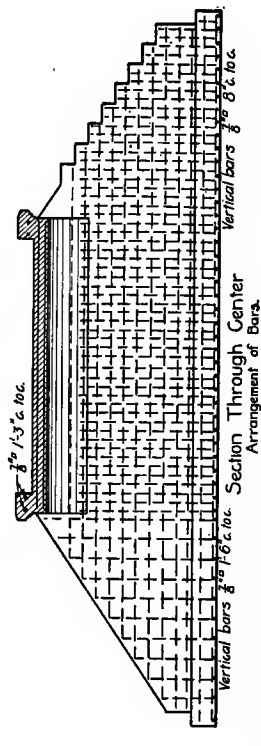

Section Through Center

Arrangement of Bars.



on the inside and that the face of the wing is battered, the portion of the wing projecting beyond the plane of the inside of the bench wall being cut away, as shown by the shaded portion *abcd*.

This structure was built against the end of an old arch, the barrel of the new arch being 75 ft. 7 in. long. The structure contains 943 cu. yd. of concrete in the arch ring and 132 in the wing walls, a total of 1,075 cu. yd.; and the arch ring contains 33,689 lb. of

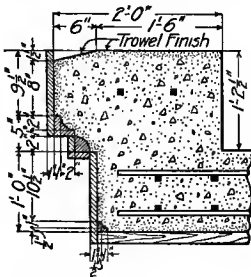

FIG. 182.—DETAIL OF CORNICE.

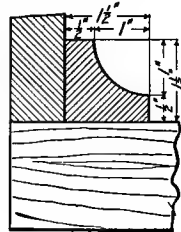

FIG. 183.

corrugated bars, and the footings 1,008 lb., a total of 34,697 lb. of steel. The arch ring contains 37 lb. of steel per cu. yd., and the footing 7 lb. The concrete was mixed 1 : 2½ : 5, and required 5,590 sacks of cement, 495 cu. yd. of sand, and 990 cu. yd. of stone.

1186. COST OF ARCH CULVERTS. For the cost of several plain concrete arch culverts, see Table 42, page 214.

1187. The cost of the *plain concrete* culvert shown in Fig. 171; page 596, is as follows.*

ITEMS	COST PER	
	LIN. FT.	CU. YD.
Cement, \$1.97 per bbl.....	\$1.01	\$2.34
Stone and screenings, 50 ct. per cu. yd.25	.60
Forms04	.09
Labor.....	1.45	3.35
Total	\$2.75	\$6.38

1188. The following is an accurate account of the cost of a semi-circular arch culvert of 26 ft. span containing 1,493 cubic yards of concrete, built under traffic for a railroad near Pittsburg, Pa. The wages paid were as follows: Foreman mason in general charge, 40 cents per hour; laborers, 15 cents per hour; foreman, 25 cents per hour; carpenters, 22.5 to 25 cents. "The general conditions were probably as favorable as any likely to be found for similar work." †

* *Engineering News*, vol. lviii, p. 145,—Aug. 8, 1907.

† Bulletin No. 2, Amer. Ry. Eng'g and M. of W. Assoc., p. 8-10.

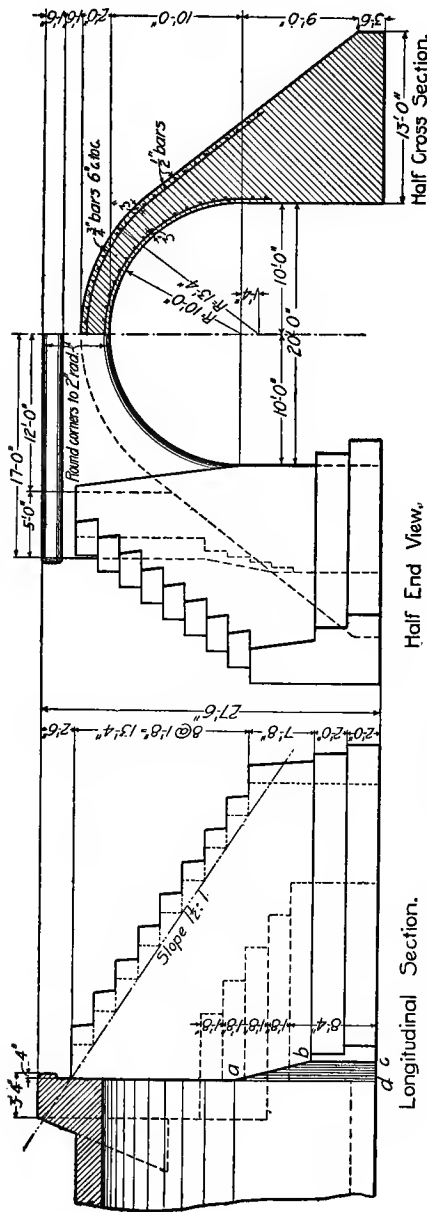

Half End View.

Longitudinal Section.

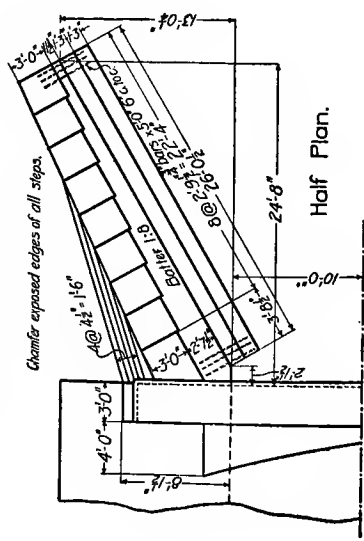

Half Plan.

FIG. 184.—L. S. & M. S. REINFORCED ARCH CULVERT.

ITEMS.	COST PER CU. YD.
<i>Materials:</i>	
Coarse gravel, 1.03 tons at 19 cents per ton	\$0.19½
Fine gravel, 0.40 ton at 21 cents per ton08½
Sand, 0.32 ton at 36 cents per ton11½
Cement, 0.95 bbl. at \$1.60 per barrel	1.53½
Lumber43
Tools and other storehouse accounts078
Total for materials	<u>\$2.438</u>
<i>Labor:</i>	
Preparing site and cleaning up after completion of structure, at 15.5 cents per hour	\$0.21
Forms, at 23 cents per hour28
Platforms and buildings, at 23 cents per hour05
Changing trestle, including service of work train and steam derrick car08½
Excavation, foundations, at 15.5 cents per hour31
Handling material, at 15.5 cents per hour038
Mixing and laying on concrete, at 15.5 cents per hour	1.44
Total for labor	<u>\$2.413</u>
Total cost per cubic yard of concrete	<u>\$4.85</u>

1189. Table 88 gives the Committee's estimate of the cost of the reinforced-concrete semicircular 8-foot arch culverts shown in Fig. 177 and 178, page 600. The lumber in the forms is estimated to cost 2½ cents per ft., B. M., and it is assumed to be used twice, thus making the net cost 1½ cents per ft.; and the labor on the forms is figured at 3½ cents per ft., B. M., for ordinary forms and 5½ cents for arch centers. The cost of the concrete includes the excavation.

TABLE 88.

COST OF 8-FT. SEMICIRCULAR REINFORCED CONCRETE ARCH
CULVERTS.

For cross sections of the culverts, see Fig. 177 and 178, page 600.

ITEMS.	16-FT. FILL.		32-FT. FILL.	
	Amount per Lin. Ft.	Cost per Lin. Ft.	Amount per Lin. Ft.	Cost per Lin. Ft.
CONCRETE: arch ring	0.65 cu.yd.	\$4.90	0.68 cu.yd.	\$5.10
side walls	0.50 "	2.50	0.50 "	2.50
footing	0.75 "	3.80	1.07 "	7.00
Total	<u>1.90</u>		<u>2.25</u>	
REINFORCEMENT: transverse	39.1 lb.		111.7 lb.	
longitudinal	25.5 "		30.1 "	
Total	<u>64.6 lb.</u>	2.60	<u>141.8 lb.</u>	5.70
FORMS	110 ft. B.M.	6.10	105 ft. B.M.	5.80
GRAND TOTAL		<u>\$19.90</u>		<u>\$26.10</u>

CHAPTER XXII

VOUSSOIR ARCHES.

1190. An arch is a structure which under the action of the load exerts outward thrusts against its end supports (abutments).

1191. CLASSIFICATION OF ARCHES. Masonry arches may be divided into voussoir arches and monolithic arches, according to whether the arch ring is composed of several separate stones or consists of a monolithic mass of concrete. The separate arch stones or voussoirs may be blocks of natural stone dressed to the required shape or of concrete moulded to proper form.

Arches may be divided also into hinged and hingeless, according to whether or not there are one or more joints or hinges in the arch ring. Of course, a hingeless arch is one having fixed ends. Hinged arches may have one hinge at the crown, or one at each abutment; or one at each abutment and one at the crown. However, hinged arches usually have either two hinges or three. Both voussoir and monolithic arches may be built with or without hinges; but hinges are used only in very large arches. The chief advantage of the hinges is that their use permits a more accurate analysis of the stresses, and consequently makes possible a saving of material; and the disadvantages are that the hinges themselves are expensive, and the hinged arch is not as stable nor as durable as an arch without hinges. Hinged masonry arches are somewhat common in Europe, but are hardly used at all in America. Hinged arches will be briefly considered in the next chapter.

1192. DEFINITIONS. Parts of an Arch. The following are the definitions of the essential parts of a masonry arch.

Abutment. A skewback and the masonry which supports it.

Arch Sheeting. The arch stones which do not show at the ends of the arch.

Backing. The masonry outside and above the arch stones, which usually has joints horizontal or nearly so.

Crown. The highest part of the arch.

Coursing Joint. The joint between two adjoining string courses. It is continuous from one end of the arch to the other.

Extrados. The convex curve which bounds the outer extremities of the joints between the voussoirs. See Fig. 185.

Haunch. The indefinite part of the arch between the crown and the skewback.

Heading Joint. A joint in a plane at right angles to the axis of the arch. It is not continuous.

Intrados. The concave line of intersection of a vertical plane with the lower surface of the arch. See Fig. 185.

Keystone. The center or highest voussoir or arch stone.

Ring Course. The stones between two consecutive series of heading joints.

Ring Stones. The arch stones which show at the ends of the arch.

Rise. The vertical distance between the highest part of the intrados and the plane of the springing lines.

Skewback. The inclined surface or joint upon which the end of the arch rests.

Soffit. The lower or interior cylindrical surface of the arch.

Springer. The lowest voussoir or arch stone.

Springing Line. The inner edge of the skewback.

Spandrel. The indefinite space between the extrados and the roadway. The wall at the end of the arch above the extrados is called the *spandrel wall*; and the material between the end walls and above the extrados is called the *spandrel filling*.

String Course. A course of voussoirs extending from one end of the arch to the other.

Voussoir. One of the wedge-shaped stones of which the arch is composed; also called an arch stone. The voussoirs which show at the ends of the arch are called *ring stones*; and those which do not thus show are called *arch sheeting*.

1193. Forms of Arches. According to the curve formed by the intersection of a vertical plane with the soffit, arches are divided into circular, elliptical, basket-handle, and pointed. If the intrados is a semicircle, the arch is a *semicircular* or *full-centered arch*; and if the intrados is less than a semicircle, it is a *segmental arch*. A *basket-handle arch* is one in which the intrados is composed of several arcs of circles tangent to each other; and a *pointed arch* is one in which the intrados consists of two arcs of circles intersecting above the middle of the span.

According to whether or not the end walls are at right angles

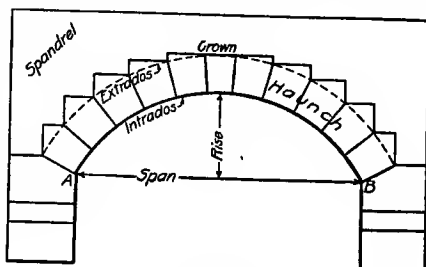

FIG. 185.

to the axis, arches are divided into right arches and skew arches. A *right arch* is one terminated by two planes, termed *heads*, at right angles to the axis of the arch; and a *skew arch* is one whose heads are oblique to the axis. Voussoir skew arches were never very common, on account of the difficulty of dressing the complicated voussoirs required; and since the introduction of concrete in arch construction, they are never built.

ART. 1. THEORY OF STABILITY.

1194. There are two classes of theories of the stability of the masonry arch—the line of thrust theories and the elastic deformation theories. The line of thrust theory considers the stability of the arch ring as depending upon the friction and the reactions between the several arch stones; while the elastic theory regards the arch as a curved beam which depends for its stability upon the internal stresses developed in the material of the arch. Both theories can be applied to either a voussoir or a continuous arch, although usually the line of thrust theory is employed for the voussoir arch, and the elastic theory for the monolithic arch. There is no great difference between the two theories, although the elastic theory is a little more complicated but a little more accurate. In this chapter the voussoir arch will be investigated by the line of thrust theory; and in the next chapter the monolithic arch will be considered by the elastic theory.

1195. LINE OF RESISTANCE DEFINED. A clear comprehension of the nature of the line of resistance is fundamental in the theory of the voussoir arch.

If the action and reaction between each pair of adjacent arch stones be replaced by single forces so situated as to be in every way the equivalent of the distributed pressures, the line connecting the points of application of these several forces is the *line of resistance* of the arch. For example, assume that the half arch shown in Fig. 186 is held in equilibrium by the horizontal thrust T —the reaction of the right-hand half of the arch—applied at some point a in the joint CH . Assume also that the several arch-stones fit mathematically, and that there is no adhesion of the mortar. The forces F_1 , F_2 , F_3 , and F_4 represent the resultants of all the forces (including the weight of the stone itself) acting upon the several voussoirs. The arch stone $CIGH$ is in equilibrium under the action of the three forces, T , F_1 , and the reaction of the voussoir $IJEG$. Hence these three forces must intersect in a point, and the direction of R_1 —the resultant pressure between the voussoirs $CIGH$ and $IJEG$ —can be found graphically as shown in Fig. 186. The point of application of R_1 is at b —the point where R_1 intersects the joint

GI. The voussoir $IJEG$ is in equilibrium under the action of R_1 , F_2 , and R_2 —the resultant reaction between $JEGI$ and $JEDK$,—and hence the direction, the amount, and the point of application (c) of R_2 can be determined as shown in the figure. R_3 and R_4 are determined in the same manner as R_1 and R_2 .

The points a , b , c , d , and e , called *centers of pressure*, are the points of application of the resultants of the pressure on the several joints; or they may be regarded as the *centers of resistance* for the several joints. In the former case the line $abcde$ would be called the *line of pressure*, and in the latter the *line of resistance*.

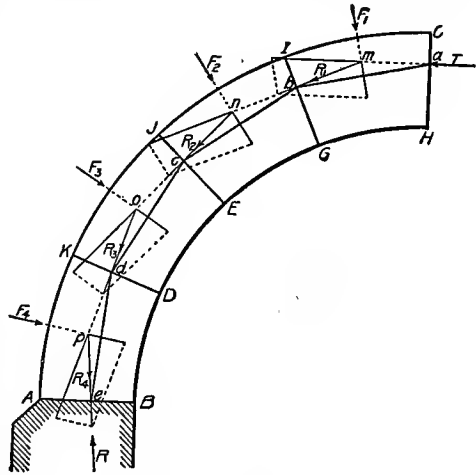

FIG. 186.

Strictly speaking, the line of resistance is a continuous curve circumscribing the polygon $abcde$. The greater the number of joints the nearer the polygon $abcde$ approaches this curve. Occasionally the polygon mno is called the line of resistance. The greater the number of joints the nearer this line approaches the line of resistance as defined above.

If the four geometrical lines ab , bc , cd , and de were placed in the relative position shown in Fig. 186, and were acted upon by the forces T , F_1 , F_2 , F_3 , F_4 , and R , as shown, they would be in equilibrium; and hence the line $abcde$, or rather a curve passing through the points a , b , c , d , and e , is sometimes called a *linear arch*.

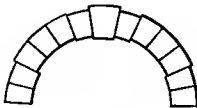

FIG. 187.

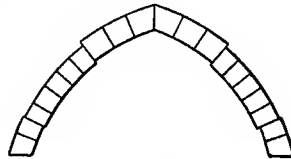

FIG. 188.

1196. METHOD OF FAILURE OF ARCHES. A voussoir arch may yield in any one of three ways, viz.: (1) by the crushing of the stone, or (2) by the sliding of one voussoir on another, or (3) by rotation about an edge of some joint. 1. An arch will fail if the pressure on

any part is greater than the crushing strength of the material composing it. 2. Fig. 187 and 188, page 609, represent the second method of failure. In the former the haunches of the arch slide out and the crown slips down, and in the latter the reverse is shown. If the rise is less than the span and the arch fails by the sliding of one voussoir on the other, the crown will usually sink; but if the rise is more than the span, the haunches will generally be pressed inward and the crown will rise. 3. Fig. 189 and 190 show the two methods by which

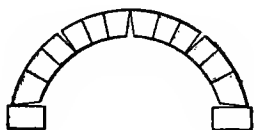

FIG. 189.

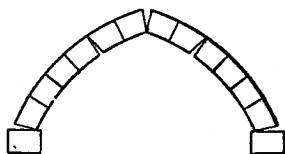

FIG. 190.

an arch may give way by rotation about the joints. As a rule the first case is most frequent for flat arches, and the second for pointed ones.

1197. There are three criteria, corresponding to the three modes of failure, by which the stability of an arch may be judged. (1) To prevent overturning, it is necessary that the line of resistance shall everywhere lie between the intrados and the extrados. (2) To prevent crushing, the line of resistance should intersect each joint far enough from the edge so that the maximum pressure will be less than the crushing strength of the masonry. (3) To prevent sliding, the angle between the line of resistance and the normal to any joint should be less than the angle of repose ("angle of friction") for those surfaces; that is to say, the tangent of the angle between the line of resistance and the normal to any joint should be less than the coefficient of friction (§ 931).

1198. Stability against Rotation. An arch composed of incompressible voussoirs can not fail by rotation as shown in Fig. 189, unless the line of resistance touches the intrados at two points and the extrados at one higher intermediate point (see Fig. 193, page 618); and an arch can not fail by rotation as shown in Fig. 190, unless the line of resistance touches the extrados at two points and the intrados at one higher intermediate point (see Fig. 193). The approximate factor of safety against rotation (§ 939) at any joint is equal to half the length of the joint divided by the distance between the center of pressure and the center of the joint; that is to say,

$$\text{the approximate factor of safety} = \frac{\frac{1}{2}l}{d}, \quad \dots \quad (1)$$

in which l is the length of the joint and d the distance between the center of pressure and the center of the joint. For example, if the center of pressure is at one extremity of the middle third of the joint, $d = \frac{1}{3}l$; and, by equation 1, the factor of safety is three. If the center of pressure is $\frac{1}{4}l$ from the middle of the joint, the factor of safety is two.

It is customary to require that the line of resistance shall lie within the middle third of the arch ring, which is equivalent to specifying that the approximate factor of safety for rotation shall not be less than three.

1199. Stability against Crushing. The method of determining the pressure on any part of a joint has already been discussed in the chapter on masonry dams (see pages 470-76). When the total pressure and its center are known, the maximum pressure at any part of the joint is given by formula 19, page 472. It is

$$P = \frac{W}{l} + \frac{6 W d}{l^2}, \dots \dots \dots (2)$$

in which P is the maximum pressure on the joint per unit of area; W is the total normal pressure on the joint per unit of length of the arch; l is the depth of the joint, i.e., the distance from intrados to extrados; and d is the distance from the center of pressure to the middle of the joint. This formula is general, provided the masonry is capable of resisting tension; and if the masonry is assumed to be incapable of resisting tension, it is still general, provided d does not exceed $\frac{1}{2}l$.

For the case in which the masonry is incapable of resisting tension and d exceeds $\frac{1}{2}l$, the maximum pressure is given by formula 23, page 475. It is

$$P = \frac{2 W}{3 (\frac{1}{2}l - d)}. \dots \dots \dots (3)$$

If the line of resistance for any arch can be drawn, the maximum pressure can be found by (1) resolving the resultant reaction perpendicular to the given joint, and (2) measuring the distance d from a diagram of the arch similar to Fig. 186 (page 609), and (3) substituting these data in the proper one of the above formulas (the one to be employed depends upon the value of d), and computing P . This pressure should not exceed the safe compressive strength of the masonry.

1200. Unit Pressure. In the present state of our knowledge it is not possible to determine the value of a safe and not extravagant unit working pressure. The customary unit appears less extravagant when it is remembered (1) that the crushing strength of masonry

is considerably less than that of the stone or brick of which it is composed (see § 581; and § 622-23 respectively), and that we have no definite knowledge concerning either the ultimate or the safe crushing strength of stone masonry (§ 582-84) and but little concerning that of brickwork in large masses (§ 622-29); and (2) that all the data we have on crushing strength are for a load perpendicular to the pressed surface, while we have no experimental knowledge of the effect of the component of the pressure parallel to the surface of the joint, although it is probable that this component would have somewhat the same effect upon the strength of the voussoirs as a sheet of lead has when placed next to a block of stone subjected to compression (§ 14).

On the other hand, there are some considerations which still further increase the degree of safety of the usual working pressure. (1) When the ultimate crushing strength of stone is referred to, the crushing strength of cubes is intended, although the blocks of stone employed in actual masonry have less thickness than width, and hence are much stronger than cubes (see § 17, § 78, and § 657). To prevent the arch stones from flaking off at the edges, the mortar is sometimes dug out of the outer edge of the joint. This procedure diminishes the area under pressure, and hence increases the unit pressure; but, on the other hand, the edge of the stone which is not under pressure gives lateral support to the interior portions, and hence increases the resistance of that portion (see § 657). It is impossible to compute the relative effect of these elements, and hence we can not theoretically determine the efficiency of thus relieving the extreme edges of the joint. (2) The preceding formulas (2 and 3) for the maximum pressure neglect the effect of the elasticity of the stone; and hence the actual pressure must be less, by some unknown amount, than that given by either of the formulas.

1201. Notice that the distance which the center of pressure may vary from the center of the joint without the masonry's being crushed depends upon the ratio between the ultimate crushing strength and the mean pressure on the joint. In other words, if the mean pressure is very nearly equal to the ultimate crushing strength, then a slight departure of the center of pressure from the center of the joint may crush the voussoir; but, on the other hand, if the mean pressure is small, the center of pressure may depart considerably from the center of the joint without the stone's being crushed. This can be shown by equation 2, page 611. If both P and $W \div l$ are large, d must be small; but if P is large and $W \div l$ small, then d may be large. Essentially the same result can be deduced from equation 3, page 611.

Even though the line of resistance approaches so near the edge

of the joint that the stone is crushed, the stability of the arch is not necessarily endangered. For example, conceive a block of stone resting upon an incompressible plane, AB , Fig. 191; and assume that the center of pressure is at N . Then the pressure is applied over an area projected in AV , such that $AN = \frac{1}{3} AV$. The pressure at A is represented by AK , and the area of the triangle AKV represents the total pressure on the joint. Assume that AK is the ultimate crushing strength of the stone, and that the center of pressure is moved to N' . The pressure is borne on an area projected in AV' . The pressure in the vicinity of A is uniform and equal to the crushing strength AK ; and the total pressure on the joint is represented by the area of the figure $AKGV'$, which has its center of gravity in the vertical through N' . Eventually, when the center of pressure approaches so near A that the area in which the stone is crushed becomes too great, the whole block will give way, and the arch will fall.*

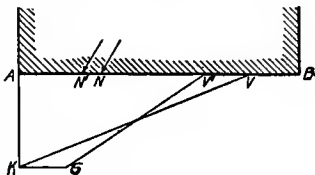

FIG. 191.

1202. Open Joints. It is frequently prescribed that the line of resistance shall pass through the middle third of each joint, "so that the joint may not open on the side most remote from the line of resistance." If the line of resistance departs from the middle third, the remote edge of the joint will be in tension; but since cement mortar is now quite generally employed, if the masonry is laid with ordinary care the joint will be able to bear considerable tension; and hence it does not necessarily follow that the joint will open.

If the line of pressure departs from the middle third and the mortar is incapable of resisting tension, the joint will open on the side farthest from the line of resistance. For example, if the center of pressure is at N , Fig. 191, then a portion of the joint AV ($= 3 AN$) is in compression, while the portion VB has no force acting upon it; and hence the yielding of the portion AV will cause the joint to open a little at B . This opening will increase as the center of pressure approaches A , and when the material at that point begins to crush the increase will become comparatively rapid.

* Rankine says: "It is true that arches have stood, and still stand, in which the centers of resistance of joints fall beyond the middle third of the depth of the arch ring; but the stability of such arches is either precarious now, or must have been precarious while the mortar was fresh." The above is one reason why the stability of the arch is not necessarily precarious, and other reasons are found in § 1200 and also in the subsequent discussion. A reasonable theory of the arch will not make a structure appear instable which shows every evidence of security.

Notice that if there are open joints in an arch, it is certain that the actual line of resistance does not lie within the middle third of such joints. Notice, however, that the opening of a joint does not indicate that the stability of the arch is in danger. In most cases, an open joint is no serious matter, particularly if it is in the soffit. If in the extrados, it is a little more serious, since water might get into it and freeze. To guard against this danger, it is customary to cover the extrados with a layer of puddle or some coating impervious to water.

1203. Stability against Sliding. If the effect of the mortar is neglected, an arch is stable against sliding when the line of resistance makes with the normal an angle less than the angle of friction. According to Table 74 (page 464), the coefficient of friction of masonry under conditions the most unfavorable for stability—i.e., while the mortar is wet—is about 0.50, which corresponds to an angle of friction of about 27° . Hence, if the line of pressure makes an angle with the normal of more than 27° , there is a possibility of one voussoir's sliding on the other. This possibility can be eliminated by changing the joints to a direction more nearly at right angles to the line of pressure.

However, there is no probability that an arch will receive its full load before the mortar has begun to set; and hence the angle of friction is virtually much greater than 27° . It is customary to arrange the joints of the arch at least nearly perpendicular to the line of resistance, in which case little or no reliance is placed on the resistance of friction or the adhesion of the mortar.

1204. Conclusion. From the preceding discussion, it will be noticed that the factors of stability for rotation and for crushing are dependent upon each other; while the factor for sliding is independent of the other conditions of failure, and is dependent only upon the direction given to the joints. A theoretically perfect design for an arch would be one in which the three factors of safety were equal to each other and uniform throughout the arch. But as arches are ordinarily built, the factor for rotation is about three, or a little more; the nominal factor for crushing is ten to forty; and the nominal factor for sliding is one and a half to two.

It is evident that before any conclusions can be drawn concerning the strength or stability of a masonry arch, the position of the line of resistance must be known; or at least, limits must be found within which the true line of resistance must be proved to lie. But before the line of resistance can be found, the external forces and also the crown thrust must be determined.

1205. THE EXTERNAL FORCES. It is clear that before we can find the stresses in a proposed arch and determine its dimensions,

we must know the load to be supported by it. In other words, the strength and stability of a masonry arch depend upon the position of the line of resistance; and before this can be determined, it is necessary that the external forces acting upon the arch shall be fully known, i.e., that (1) the point of application, (2) the direction, and (3) the intensity of the forces acting upon each voussoir shall be known. Unfortunately, the accurate determination of the external forces is, in general, an impossibility.

1206. Pressure of Water. If the arch supports water or other liquid, the pressure upon the several voussoirs is perpendicular to the extrados, and can easily be found; and combining this with the weight of each voussoir gives the several external forces. This case seldom occurs in practice.

1207. Pressure of Masonry. If the arch is surmounted by a masonry wall, as is frequently the case, it is impossible to determine, with any degree of accuracy, the effect of the spandrel walls upon the stability of the arch. It is usually assumed that the entire weight of the masonry above the soffit presses vertically upon the arch; but it is known certainly that this is not the case, for with even dry masonry a part of the wall will be self-supporting. The load supported by the arch can be computed roughly by the principle of § 631; but, as this gives no idea of the manner in which this pressure is distributed, it is of but little help. The error in the assumption that the entire weight of the masonry above the arch presses upon it, is certainly on the safe side; but if the data are so rudely approximate, it is useless to attempt to compute the stresses by mathematical processes. The inability to determine this pressure constitutes one of the limitations of the theory of the arch.

Usually it is virtually assumed that the extradosal end of each voussoir terminates in a horizontal and vertical surface (the latter may be zero); and therefore, since the masonry is assumed to press only vertically, there are no horizontal forces to be considered. But as the extrados is sometimes a regular curve, there would be active horizontal components of the vertical pressure on this surface; and this would be true even though the spandrel masonry were divided by vertical joints extending from the extrados to the upper limit of the masonry. Further, even though no active horizontal forces are developed, the passive resistance of the spandrel masonry—either spandrel walls or spandrel backing—materially affects the stability of an arch. Experience shows that most arches sink at the crown and rise at the haunches when the centers are removed (see Fig. 189, page 610), and hence the resistance of the spandrel masonry will materially assist in preventing the most common form of failure. The efficiency of this resistance will depend upon the execution of

the spandrel masonry, and will increase as the deformation of the arch ring increases. It is impossible to compute, even roughly, the horizontal forces due to the spandrel masonry.

Further, in computing the stresses in the arch, it is usually assumed that the arch ring alone supports the masonry above it; while, as a matter of fact, the entire masonry from the intrados to the top of the backing acts somewhat as an arch in supporting its own weight.

1208. Pressure of Earth. If the arch supports a mass of earth, we can know neither the amount nor the direction of the earth pressure with any considerable degree of accuracy (see Chap. XVIII—Retaining Walls,—particularly § 1008).

In the theory of the masonry arch, the pressure of the earth is usually assumed to be wholly vertical, even though it is well known that the pressure of earth, in general, gives active horizontal forces. An examination of Fig. 186 (page 609) will show how the horizontal forces add stability to an arch ring whose rise is equal to or less than half the span. It is clear that for a certain position and intensity of the thrust T , the line of resistance will approach the extrados nearer when the external forces are vertical than when they are inclined. We know certainly that the passive resistance of the earth adds materially to the stability of masonry arches; for the arch rings of many sewers which stand without any evidence of weakness are in a state of unstable equilibrium, if the vertical pressure of the earth immediately above the ring be considered as the only external force acting upon it.

1209. The value and position of the horizontal components of the external forces are somewhat indeterminate. According to Rankine's theory of earth pressure, the horizontal pressure of earth at

any point can not be *greater* than $\frac{1 + \sin \phi}{1 - \sin \phi}$ times the vertical pres-

sure at the same point, nor *less* than $\frac{1 - \sin \phi}{1 + \sin \phi}$ times the vertical

pressure,— ϕ being the angle of repose.* If $\phi = 30^\circ$, the above expression is equivalent to saying that the horizontal pressure can not be greater than three times the vertical pressure nor less than one third of it. Evidently the horizontal component will be greater the greater the cohesion and the harder the earth spandrel-filling is rammed into place. The condition in which the earth will be deposited behind the arch can not be foretold; but it is probable that at least the minimum value, as above, will always be realized. Hence we will assume that the horizontal intensity is at least *one*

* Rankine's Civil Engineering, p. 320.

third of the vertical intensity; that is to say, $h = \frac{1}{3} e d l$, in which e is the weight of a cubic unit of earth—which may be assumed at 100 lb. per cu. ft.,— d the depth of the center of pressed surface below the top of the earth filling, and l the vertical dimension of the surface. On this assumption the values and the positions of the horizontal forces acting on the several voussoirs of any particular arch can readily be determined.

It would be more logical in determining the horizontal component of the earth pressure, to use the angle of internal friction (§ 1000) instead of the angle of repose as above; but the laws of earth pressure are not known, and the above value of the horizontal component has been employed by the author in testing numerous voussoir arches, and seems to give results in accordance with experience; and hence it will be employed in this chapter.

1210. HYPOTHESES FOR THE CROWN THRUST. From § 1195 it is clear that the position of the line of resistance can not be known until the amount, the direction, and the point of application of the crown thrust are known.

Each value for the intensity of the thrust at the crown gives a different line of resistance. For example, in Fig. 186 (page 609), if the thrust T be increased, the point b —where R_1 intersects the plane of the joint GI —will approach I , and consequently c , d , and e will approach J , K , and A respectively. If T be increased sufficiently, the line of pressure will pass through A or K (usually the former, this depending, however, upon the dimensions of the arch and the values and directions of F_1 , F_2 , and F_3), and the arch will be on the point of rotating about the outer edge of one of these joints. This value of T is then the maximum thrust at a consistent with stability of rotation about the outer edge of a joint, and the corresponding line of resistance is the line of resistance for maximum thrust at a . Similarly, if the thrust T be gradually decreased, the line of resistance will approach and finally intersect the intrados, in which case the thrust is the least possible consistent with stability of rotation about some point in the intrados. The lines of resistance for maximum and minimum thrust at a are shown in Fig. 192 (page 618).

If the point of application of the force T be gradually lowered and at the same time its intensity be increased, a line of resistance may be obtained which will have one point in common with the intrados. This is the line of resistance for maximum thrust at the crown joint. Similarly, if the point of application of T be gradually raised, and at the same time its intensity be decreased, a line of resistance may be obtained which will have one point in common with the extrados. This is the line of resistance for minimum thrust

at the crown joint. The lines of resistance for maximum and minimum thrust at the crown are shown in Fig. 193.

Similarly each direction of the thrust T will give a new line of resistance. In short, every different value of each of the several factors, and also every combination of these values, will give a different position for the line of resistance. Hence, the problem is to determine which of the infinite number of possible lines of resist-

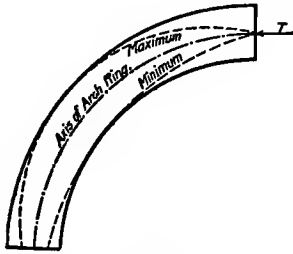

FIG. 192.

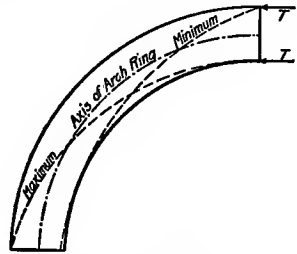

FIG. 193.

ance is the actual one. This problem is indeterminate, since there are more unknown quantities than conditions (equations) by which to determine them. To meet these difficulties and make a solution of the problem possible, various hypotheses have been made. Four of these hypotheses will now be considered briefly.

1211. Hypothesis of Least Pressure. Some writers have assumed the true line of resistance to be that which gives the smallest absolute pressure on any joint. This principle is a metaphysical one, and leads to results unquestionably incorrect. Of the four hypotheses here discussed this is the least satisfactory, and the least frequently employed. It will not be considered further.

For an explanation of Claye's method of drawing the line of pressure according to this theory, see *Van Nostrand's Engineering Magazine*, Vol. xv, p. 33-36. For a general discussion of the theory of the arch founded on this hypothesis, see an article by Professor Du Bois in *Van Nostrand's Engineering Magazine*, Vol. xiii, p. 341-46, and also Du Bois's "Graphical Statics," Chapter xv.

1212. Winkler's Hypothesis. Professor Winkler, of Berlin,—a well-known authority—published in 1879 in the *Zeitschrift des Architekten und Ingenieur Vereins zu Hannover*, page 199, the following theorem concerning the position of the line of resistance: "For an arch ring of constant cross section that line of resistance is approximately the true one which lies nearest to the axis of the arch ring, as determined by the method of least squares."*

* This theorem was first brought to the attention of American readers in 1880, by Prof. G. F. Swain in an article in *Van Nostrand's Engineering Magazine*, vol. xxiii. p. 265-76.

The only proof of this theorem is that by it certain conclusions can be drawn from the voussoir arch which harmonize with the accepted theory of solid elastic arches. The demonstration depends upon certain assumptions and approximations, as follows: 1. It is assumed that the external forces acting on the arch are vertical; whereas in many cases, and perhaps in most, they are inclined. 2. The loads are assumed to be uniform over the entire span; whereas in many cases the arch is subject to moving concentrated loads, and sometimes the permanent load on one side of the arch is heavier than that on the other. 3. The conclusions drawn from the voussoir arch only approximately agree with the theory of elastic arches. 4. A masonry arch does not ordinarily have a constant cross section as required by the above theorem; but it usually, and properly, increases toward the springing. 5. The phrase "as determined by the method of least squares" means that the true line of resistance is that for which the sum of the squares of the *vertical* deviations is a minimum. Since the joints must be nearly perpendicular to the line of resistance, the deviations should be measured normal to that line. For a uniform load over the entire arch, the lines of resistance are comparatively smooth curves; and hence, if the sum of the squares of the vertical deviations is a minimum, that of the normal also would probably be a minimum. But for eccentric or concentrated loads, it is by no means certain that such a relation would exist. 6. The degree of approximation in this theorem is less the flatter the arch.

To apply Winkler's theorem, it is necessary to (1) construct a line of resistance, (2) measure its deviations from the axis of the arch, and (3) compute the sum of the squares of the deviations; and it is then necessary to do the same for all possible lines of resistances, the one for which the sum of the squares of the deviations is least being the "true" one.

1213. Instead of applying Winkler's theorem as above, many writers employ the following principle, which it is asserted follows directly from that theorem: "If any line of resistance can be constructed within the middle third of the arch ring, the true line of resistance lies within the same limits, and hence the arch is stable." This assertion is disputed by Winkler himself, who says it is not, in general, correct.* It does not necessarily follow that because one line of resistance lies within the middle third of the arch ring, the "true" line of resistance also does; for the "true" line may coincide very closely with the axis in one part of the arch ring and depart considerably from it in another part, and still the sum of the

* Prof. G. F. Swain's review of Winkler's Theorem—*Van Nostrand's Engineering Magazine*, vol. xxiii, p. 275.

squares of the deviations be a minimum. This method of applying Winkler's theorem is practically nothing more or less than an application of the conclusions derived from the hypothesis of least pressure (§ 1211), and will not be considered further.

1214. Navier's Principle. Navier's principle is: The tangential stress at any point of a circle pressed by normal forces is equal to the normal pressure per unit of area multiplied by the radius of curvature of the surface. Rankine applied the above principle to voussoir arches as follows: "The condition of an arch of any form at any point where the pressure is normal is similar to that of a circular rib of the same curvature under a normal pressure of the same intensity; and hence the following theorem: *The thrust at any normally pressed point of a linear arch is the product of the radius of curvature by the intensity of the pressure at that point.* Or, denoting the radius of curvature by ρ , the normal pressure per unit of length of intrados by p , and the thrust by T , we have

$$T = p \rho." \quad (4)$$

At best, the above formula gives only the amount and by implication the direction of the crown thrust; but tells nothing about its point of application. Rankine employed the above crown thrust to find two points of the line of resistance; and assumed that if a line of resistance can be drawn anywhere within the middle third of the arch ring, that the arch was stable (§ 1245). The use of this principle determines the line of resistance only within limits; and in general gives no information as to the stability of the arch against sliding or crushing, and gives a result for the stability against overturning at only two joints. Rankine's theory (§ 1245) of the arch is the only one that employs this principle, and hence it will not be considered further here.

1215. Hypothesis of Least Crown Thrust. This is the last of the four hypotheses to be considered, and is the one almost universally employed in theories of the voussoir arch.* According to this hypothesis the true line of resistance is that for which the thrust at the crown is the least possible consistent with equilibrium. This assumes that the thrust at the crown is a passive force called into action by the external forces; and that, since there is no need for a further increase after it has caused stability, it will be the least possible consistent with equilibrium. This principle alone does not limit the position of the line of resistance; but, if the external forces are known and the direction of the thrust is assumed, this hypothesis

* First proposed by Moseley in 1837,—see Moseley's Principles of Engineering and Architecture, p. 431 of second American edition.

furnishes a condition by which the line of resistance corresponding to a minimum thrust can be found by a tentative process.

1216. TO FIND THE CROWN THRUST. To find the crown thrust that will satisfy the above hypothesis proceed as follows: The portion of the arch shown in Fig. 194 is held in equilibrium by (1) the vertical forces, $w_1, w_2,$ etc., (2) by the horizontal forces $h_1, h_2,$ etc., (3) by the reaction R at the abutment, and (4) by the thrust T at the crown. The direction of R is immaterial in this discussion. Let a and b represent the points of application of T and $R,$ respectively, although the location of these points is yet undetermined. Let

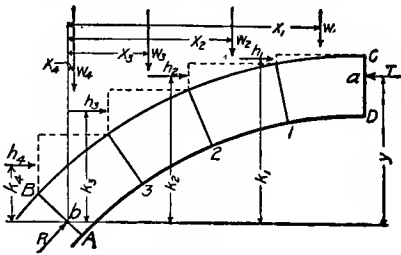

FIG. 194.

T = the thrust at the crown;

x_1 = the horizontal distance from b to the line of action of w_1 ;

x_2 = the same for w_2 ; etc.;

y = the perpendicular distance from b to the line of action of T ;

k_1 = the perpendicular distance from b to the line of action of h_1 ; k_2 = the same for h_2 ; etc.

Then, by taking moments about $b,$ we have

$$Ty = w_1 x_1 + w_2 x_2 + \text{etc.} + h_1 k_1 + h_2 k_2 + \text{etc.}; \quad (5)$$

hence

$$T = \frac{\Sigma w x}{y} + \frac{\Sigma h k}{y}. \quad \dots \dots (6)$$

1. The value of T depends upon $\Sigma h k$ —the sum of the moments of the horizontal component of the external forces. In discussing and applying this principle, the term $\Sigma h k$ is usually neglected. Ordinarily this gives an increased degree of stability; but this is not necessarily the case. The omission of the effect of the horizontal component makes the computed value of T less than it really is, and causes the line of resistance found on this assumption to approach the *intrados* at the haunches nearer than it does in fact; and hence the conditions may be such that the actual line of resistance will be unduly near the *extrados* at the haunches, and consequently endanger the arch in a new direction.

2. From equation 6 it appears that, other things remaining the same, the larger y the smaller T ; and hence, for a minimum value of $T,$ a should be as near C as is possible without crushing the stone. Usually it is assumed that aC is equal to one third of the thickness

of the arch at the crown, and hence the average pressure per unit of area is to be equal to one half of the assumed unit working pressure; i.e., twice the thrust T divided by the thickness of the crown is to be equal to the maximum unit compressive stress at the crown.

3. To determine y , it is necessary that the direction of T should be known. It is usually assumed that T is horizontal. If the arch is symmetrical and is loaded uniformly over the entire span, this assumption is reasonable; but if the arch is subject to a moving load which is heavy in comparison with the weight of the arch and the spandrel filling, the thrust at the crown is not horizontal and hence can not be determined directly (see § 1237).

4. If the joint AB is horizontal, then b is to be taken as near A as is consistent with the crushing strength of the stone, or at, say, one third of the length of the joint AB from A . Notice that if the joint AB is inclined, as in general it will be (see the last paragraph of § 1217 and of § 1222), moving b toward A decreases x and at the same time increases y and k . Hence the position of b corresponding to a minimum value of T can be found only by trial. It is usual, however, to assume that Ab is one third of AB , whatever the inclination of the joint.

1217. Joint of Rupture. In the preceding section, the points a and b , Fig. 194, page 621, were chosen with a view of making T the smallest possible; but it now remains to find a value of T that shall be consistent with the equilibrium of the semi-arch. If T is too small, some one of the joints 1, 2, 3, etc., Fig. 194, may open at the extrados; and on the other hand, if T is too large, some one of the joints may open at the intrados. Neither of these conditions would be consistent with the condition of equilibrium assumed, i.e., with the assumption that the center of pressure is to remain within the middle third of any joint. If the center of pressure remains within the middle third, every part of all joints will be under compression, and hence no joint can open at either the extrados or the intrados. It remains then to find a value of T that shall keep the center of pressure within the middle third of every joint.

If b , the origin of moments for equation 5, page 621, be taken successively at the inner or lower end of the middle third of each joint, the corresponding value of T will be the crown thrust for which that particular joint is on the point of opening at the extrados; and if under this condition the greatest value of T that will prevent any joint from opening on the intrados be found, then that value is the crown thrust required by the hypothesis, for a less value will permit one or more joints to open at the extrados and a greater value will cause one or more joints to open at the intrados.

The joint for which the tendency to open at the extrados is the

greatest is called the *joint of rupture*. The joint of rupture of an arch is analogous to the dangerous section of a beam. Practically, the joint of rupture is the springing line of the arch, the arch masonry below that joint being virtually only a part of the abutment. Therefore the first step in testing the stability of a given arch is to find the joint of rupture.

1218. Example of the Method of Determining the Joint of Rupture.

Assume that it is required to determine the joint of rupture of the 16-foot arch shown in Fig. 195 which is the arch of the standard voussoir-arch culvert formerly employed on the Chicago,

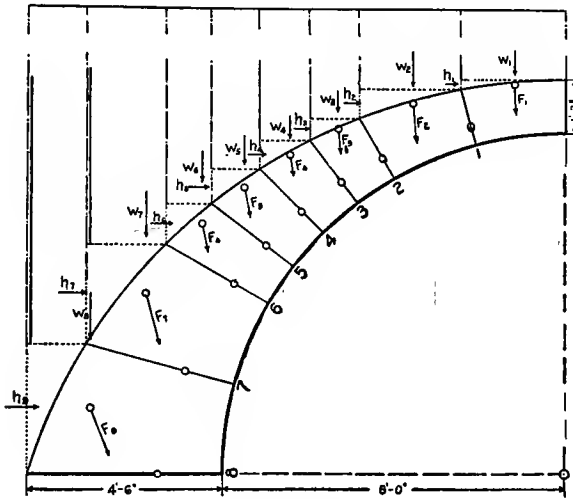

FIG. 195.

Rock Island and Pacific Railroad. Assume that the arch supports an embankment of earth extending 10 feet above the crown, and that the earth weighs 100 pounds per cubic foot and the masonry 160. For simplicity, consider a section of the arch only a foot thick perpendicular to the plane of the paper. The half-arch ring and the earth embankment above it are divided into eight sections, which for a more accurate determination of the joint of rupture are made smaller near the supposed position of that joint.

1219. The Vertical Forces. The weight of the several sections of the arch and of the earth above them can readily be computed. The sums of these weights, w_1, w_2, w_3 , etc., are given in Table 89, page 624.

The center of gravity of each voussoir may be determined as explained in § 935; but the center of gravity of the prism of earth

TABLE 89.
DATA FOR DETERMINING THE JOINT OF RUPTURE OF THE ARCH RING SHOWN IN FIG. 195, PAGE 623.

No. of the Joint Counting from the one next to the Crown.	VERTICAL FORCES, POUNDS.								HORIZONTAL FORCES, POUNDS.								y	lb.	lb.	lb.	Total Crown Thrust.
	Arms of Vertical Forces, Feet.								Arms of Horizontal Forces, Feet.												
	x ₁	x ₂	x ₃	x ₄	x ₅	x ₆	x ₇	x ₈	k ₁	k ₂	k ₃	k ₄	k ₅	k ₆	k ₇	k ₈					
1	1.00								1.08								0.76	3 866	94	3 960	
2	3.07 0.70							1.76 1.31									1.44	7 744	302	8 046	
3	4.06 1.69 -0.06							2.32 1.87 1.25									2.00	8 488	424	8 912	
4	4.97 2.60 0.84 -0.28							3.01 2.56 1.94 1.33									2.69	8 705	572	9 278	
5	5.78 3.41 1.65 0.53 -0.52							3.80 3.35 2.73 2.12 1.37									3.48	8 631	738	9 369	
6	6.51 4.14 2.38 1.26 0.21 -0.76							4.71 3.26 3.64 3.03 2.28 1.41									4.39	8 373	886	9 259	
7	7.65 5.28 3.52 2.40 1.35 0.38 -0.92							6.74 6.29 5.67 5.06 4.31 3.44 1.82									6.42	7 479	1 407	7 886	
8	8.30 5.93 4.17 3.05 2.00 1.03 -0.27 -1.55							9.15 8.70 8.08 7.47 6.72 5.85 4.23 1.55									8.83	5 809	1 994	8 803	

resting upon each arch stone may, without material error, be taken as acting through its medial vertical line. The center of gravity of the combined weights can be determined by moments. The position of each of the resultants of the several combined weights is shown in Fig. 195.

The moment arm of each of the combined weights with reference to the several origins of moments is measured in Fig. 195, and then entered in Table 89. For example, the 1.00 in the column headed x_1 , is the arm of w_1 about the lower end of the middle third of joint 1; similarly 3.07 is the arm of w_1 about the lower end of the middle third of joint 2; and 0.70 in the column headed x_2 is the arm of w_2 about the origin of moments in joint 2, etc.

1220. The Horizontal Forces. The horizontal thrust of the earth can be computed as stated in § 1209. The values of h_1 , h_2 , etc., the horizontal components of the earth thrust, are given in Table 89.

The forces h_1 , h_2 , etc., are applied at the middle of the vertical projections of the upper ends of the respective voussoirs. The moment arms of h_1 , h_2 , etc., are measured in Fig. 195, and then entered in Table 89. For example, 1.08 in the column headed k_1 is the arm of h_1 about the origin of moments in joint 1; 1.76 is the arm of h_1 about the origin of moments in joint 2; etc.

1221. The Value of y . The crown thrust T is assumed to be applied at the upper end of the middle third of the crown joint. The arm y is the distance from T to the origin of moments for the several joints. For example, 0.76 in the column headed y in Table 89 is the vertical distance from the upper end of the middle third of the crown joint to the lower end of the middle third of joint 1; and similarly for the other values.

1222. The Joint of Rupture. The crown thrust according to equation 6, page 621, for the several joints is given in the last column of Table 89. An inspection of the results shows that the crown thrust for joint 5 is greater than that for any other joint; and therefore joint 5 is the joint of rupture, and all the arch masonry below joint 5 is virtually only part of the abutment.

The angular distance of the joint of rupture from the crown is called the *angle of rupture*.* In Fig. 195, page 623, the angle of rupture is $46^\circ 30'$. The angle of rupture is usually between 45° and 60° .

1223. Any increase in the assumed intensity of the horizontal components increases the computed value of the angle of rupture. For example, if the quantities in the next to the last column of Table 89 be doubled, the thrust for joint 7 will be the maximum.

* There is some ambiguity as to where this angle is to be measured. It will be here assumed that the angle of rupture is the angle between the radius through the crown and the radius which passes through the inner end of the middle third.

Probably this condition could be realized by tightly tamping the earth spandrel-filling.

Notice that the preceding discussion of the position of the joint of rupture is for a uniform stationary load. The angle of rupture for a concentrated moving load will differ from the results found above; but the mathematical investigation of the latter case is too complicated and too uncertain to justify attempting it.

1224. Incorrect Method of Finding Joint of Rupture. There is a method of determining the joint of rupture in somewhat common use which is inaccurate because of the omission of the horizontal components of the earth pressure and also because of two errors in the mathematical work. This method virtually assumes that the crown thrust is correctly given by the first term of the right-hand side of equation 6, page 621; and proceeds to find the joint of rupture as follows:

Let W = the total weight resting on any joint; \bar{x} = the horizontal distance of the center of gravity of this weight from the origin of moments; and y = the arm of the crown thrust. Then equation 6 becomes

$$T = \frac{W\bar{x}}{y} \dots \dots \dots (7)$$

To determine the condition for a maximum, it is assumed that W , \bar{x} , and y are independent variables. Differentiating equation 7, regarding T , y , and $W\bar{x}$ as independent variables,

$$\frac{dT}{dy} = \frac{1}{y} \frac{d(W\bar{x})}{dy} - \frac{W\bar{x}}{y^2};$$

but $d(W\bar{x}) = Wdx + dW \cdot \frac{1}{2} d\bar{x} = Wdx$, and hence

$$\frac{dT}{dy} = \frac{W}{y} \frac{dx}{dy} - \frac{W\bar{x}}{y^2} \dots \dots \dots (8)$$

Therefore the condition for a maximum crown thrust is

$$\frac{dx}{dy} = \frac{\bar{x}}{y} \dots \dots \dots (9)$$

A common method of differentiating equation 7 is more simple but less accurate, and arrives at the same conclusion.*

The usual interpretation of equation 9 is: "The joint of rupture is that joint at which the tangent to the intrados passes through the intersection of T and the resultant of all the vertical forces above the joint in question." The position of the joint of rupture can be found by the above principle only by trial; and this method possesses

* For example, see Sonnet's Dictionnaire des Mathématique Appliquées, p.1084-85.

no advantage over the one explained in § 1218-23, and is less convenient to apply.

The preceding investigation is approximate for the following reasons: 1. The effect of the horizontal forces is omitted. 2. W , \bar{x} , and y are dependent variables, and not independent as assumed. 3. In the interpretation of equation 9, instead of "the tangent to the intrados," should be employed *the tangent to the line of resistance*.

1225. In applying this method, a table, computed by M. Petit, which gives the angle of rupture in terms of the ratio of the radii of the intrados and the extrados, is generally employed. The table involves the assumption that a , Fig. 194 (page 621), is in the extrados and b in the intrados; and also that the intrados and extrados are parallel. According to this table, "a semicircular arch of which the thickness is uniform throughout and equal to the span divided by *seventeen and a half* is the thinnest or lightest arch that can stand. A thinner arch would be impossible." If the line of resistance is restricted to the middle third, then, according to this theory, the thinnest semicircular arch which can stand is one whose span is *five and a half* times the uniform thickness. Many arches in which the thickness is much less than one seventeenth of the span stand and carry heavy loads without showing any evidence of weakness. For example, the span of arch No. 23 of Table 90, page 648, is 93 times the thickness of the arch ring, and still it has stood since 1750 without any signs of failure.

Owing to the approximations involved, and also to the limitations to arches having intrados and extrados parallel, the ordinary tables for the position of the joint of rupture have little, if any, practical value. The only satisfactory way to find the angle of rupture is by trial by equation 6, page 621, as explained in § 1218-23.

According to M. Petit's table, if the thickness is one fortieth of the span, the angle of rupture is $46^{\circ} 12'$; if the thickness is one twentieth, the angle is $53^{\circ} 15'$; and if one tenth, $59^{\circ} 41'$.

1226. In conclusion, notice that the investigations of both this and the preceding section show that an arch of more than about 90° to 120° central angle is impossible.

1227. THEORIES OF THE ARCH. Various theories have been proposed from time to time, which differ greatly in the fundamental principles involved. Unfortunately, the underlying assumptions are not usually stated; and, as a rule, the theory is presented in such a way as to lead the reader to believe that each particular method "is free from any indeterminateness, and gives results easily and accurately." Every theory of the voussoir arch is approximate, owing to the uncertainty concerning the amount and distribution of the external forces (§ 1205), to the indeterminateness of the position

of the true line of resistance (§ 1210-23), to the neglect of the influence of the adhesion of the mortar and of the elasticity of the material, and to the lack of knowledge concerning the strength of masonry; and, further, the stresses in a voussoir arch are indeterminate owing to the effect of variations in the material of which the arch is composed, to the effect of imperfect workmanship in dressing and bedding the stones, to the action of the center—its rigidity, the method and rapidity of striking it,—to the spreading of the abutments, and to the settling of the foundations. These elements are indeterminate, and can never be stated accurately or adequately in a mathematical formula; and hence any theory can be at best only an approximation. The influence of a variation in any one of these factors can be approximated only by a clear comprehension of the relation which they severally bear to each other; and hence a thorough knowledge of theoretical methods is necessary for the intelligent design and construction of arches.

Three of the most important theories will now be considered.

1228. To save repetition, it may be mentioned here, once for all, that every theory of the arch is but a method of verification. The first step is to assume the dimensions of the arch outright, or to make them agree with some existing arch or conform to some empirical formula. The second step is to test the assumed arch by the theory, and then if the line of resistance, as determined by the theory, does not lie within the prescribed limits—usually the middle third,—the depths of the voussoirs must be altered, and the design must be tested again.

1229. RATIONAL THEORY. The following method of determining the line of resistance is based upon the hypothesis of least crown thrust (§ 1215), and recognizes the existence of the horizontal components of the earth pressure. Two forms of loading will be considered, viz.: a symmetrical and an unsymmetrical load.

1230. Symmetrical Load. As an example of the application of this theory, let us investigate the stability of the semi-arch shown in Fig. 196 under a symmetrical dead load. Two solutions will be given for a symmetrical load, viz.: I, a general solution; and II, a special solution which is shorter when the location of the joint of rupture can be foretold by inspection.

1231. I. General Solution. The first step is to determine the line of resistance. The maximum crown thrust was computed in Table 89 (page 624), as already explained (§ 1218-22). To construct the force diagram, a line T is drawn to scale to represent the maximum thrust as found in the fifth line of the last column of Table 89. From the right-hand end of T , w_1 is laid off vertically upwards; and from its extremity, h_1 is laid off horizontally to the left. Then the line

from the left-hand extremity of h_1 to the lower end of w , (not shown in this particular case) represents the direction and amount of the external force F_1 , acting upon the first division of the arch ring; and the line R_1 from the upper extremity of F_1 represents the resultant pressure of the first arch stone upon the one next below it. Similarly, lay off w_2 vertically upwards from the left-hand extremity of h_1 , and lay off h_2 horizontally to the left; then a line F_2 from the lower end of w_2 to the left-hand end of h_2 rep-

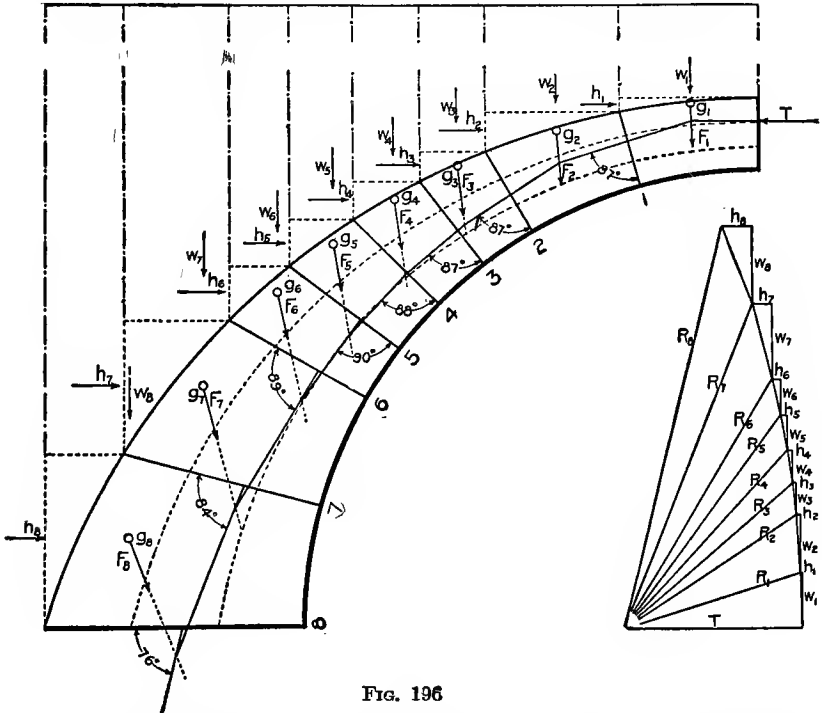

FIG. 196

resents the resultant of the external forces acting on the second divisions of the arch, and a line R_2 from the upper extremity of F_2 represents the resultant pressure of the second arch stone on the third. The force diagram is completed by drawing lines to represent the other values of w , h , F , and the corresponding reactions.

In the diagram of the arch, the points in which the horizontal and vertical forces acting upon the several arch stones intersect, are marked g_1, g_2 , etc., respectively; and the oblique line through each of these points, drawn parallel to F_1, F_2 , etc., of the force diagram, shows the direction of the resultant external force acting on each arch stone.

To construct the line of resistance, draw through the upper limit of the middle third of the crown joint a horizontal line to an intersection with the oblique force through g_1 ; and from this point draw a line parallel to R_1 , and prolong it to an intersection with the oblique force through g_2 . In a similar manner continue to the springing line.

Then the intersection of the line parallel to R_1 with the first joint gives the center of pressure on that joint; and the intersection of R_2 with the second joint gives the center of pressure for that joint, —and so on for the other joints. A line connecting these centers of pressure would be the line of resistance; but the line is not shown in Fig. 196.

1232. Notice, for example, that to get an intersection of the line parallel to R_7 with joint 7, the line must be projected backward from its intersection with the oblique line through g_7 . Care is required to prevent mistakes in such cases. Notice also that the line of resistance must pass through the inner end of the middle third of the joint of rupture. This relation affords a valuable check upon the accuracy of the work of drawing the line of resistance.

1233. Stability against Overturning. Since the line of resistance lies within the middle third of the arch ring, and touches the outer limit of the middle third at the crown and the inner limit at joint 5, the *approximate* factor of safety against rotation (equation 13, page 468) is 3.

The true factor of safety (equation 12, page 467) is $Ag' \div rg'$, Fig. 98, page 466. To apply this formula it is necessary to find g' for a particular joint, i.e., it is necessary to find the center of pressure for the resultant of the normal forces. To find the point g' , proceed as follows: From the point of intersection of the F and the R corresponding to the particular joint, draw a line perpendicular to the joint; and then the point in which this normal component pierces the joint is the center of pressure of the normal forces, i.e., the point g' . In this connection, it is important to remember that the point A is the edge of the joint on the opposite side of r (the point in which the resultant of all the forces pierces the joint) from g' . Proceeding as above, the true factor of safety (equation 12, page 467) and also the approximate factor (equation 13, page 468) are computed as below:

NO. OF JOINT.	FACTOR OF SAFETY.	
	TRUE VALUE.	APPROXIMATE VALUE.
1	$6.00 + 0.50 = 12$	$8.00 + 2.62 = 3$
2	$9.87 + 0.62 = 16$	$9.75 + 0.75 = 13$
3	$12.87 + 0.12 = 107$	$11.00 + 2.00 = 5.5$
4	$15.87 + 0 = \infty$	$12.5 + 3.37 = 3.7$
5	$18.62 + 0 = \infty$	$14.37 + 4.12 = 3.5$

The above values show that at some points there is a marked difference between the true and the approximate factor of safety.

1234. Stability against Crushing. Since the center of pressure is always within the middle third, there is no tension in any joint, and therefore the unit crushing stress may be found by equation 2, page 611. It is not always possible by inspection to tell which joint has the maximum unit crushing stress; and therefore it is usually necessary to compute the stress at several joints. In the case in hand, the maximum pressure will be found for three joints—the crown, joint 5, and the springing.

At the crown, $d = \frac{1}{8} l$, and hence $P = 2W \div l$; or, since $W = 9,369$ lb. and $l = 1.25$ ft., $P = 14,990$ lb. per sq. ft. = 103 lb. per sq. in.

At joint 5, $W =$ the component of R_5 normal to the joint = 13,900 lb., $l = 2.42$ ft., and $d = 0.40$ ft.; and therefore

$$P = \frac{13,900}{2.42} + \frac{6 \times 13,900 \times 0.40}{(2.42)^2} = 5,740 + 5,720 = 11,460,$$

i.e., $P = 11,460$ lb. per sq. ft. = 80 lb. per sq. in.

Similarly, at the springing $W = 21,090$ lb., $l = 4.5$ ft., and $d = 0.16$ ft.; and therefore $P = 5,680$ lb. per sq. ft. = 39 lb. per sq. in.

Except for a particular kind of stone and a definite quality of masonry, it is impossible even to discuss the probable factor of safety; but it is certain that in this case the nominal factor is excessive (see § 582-84), while the real factor is still more so (see § 1200-02).

If the maximum pressure at the most compressed joint had been more than the safe bearing power of the masonry, it would have been necessary to increase the depth of the arch stones and repeat the entire process. Notice that the total pressure on the joints increases from the crown toward the springing, and that hence the depth of the arch stones also should increase in the same direction.

1235. Stability against Sliding. To determine the degree of stability against sliding, notice that the angle between the resultant pressure on any joint and the joint is least at the springing joint; and hence the stability of this joint against sliding is less than that for any other. The nominal factor of safety is equal to the coefficient of friction divided by $\tan(90^\circ - 76^\circ) = \tan 14^\circ = 0.25$. An examination of Table 74 (page 464) shows that when the mortar is still wet the coefficient is at least 0.50; and hence the nominal factor for the joint in question is at least 2, and probably more, while the real factor is still greater. The nominal factor for joint 7 is at

least 4.6, and that for joint 3 is about 6. There is little or no probability that an arch will be found to be stable for rotation and crushing, and unstable for sliding. If such a condition should occur, the direction of the assumed joint could be changed to give stability.* The actual joints should be as nearly perpendicular to the line of resistance as is consistent with simplicity of workmanship and with stability. For circular arches, it is ordinarily sufficient to make all the joints radial. In Fig. 196, page 629, the joints are radial to the intrados; but if they had been made radial to the extrados or to an intermediate curve, the stability against sliding, particularly at the springing joint, would have been a little greater.

1236. II. Special Solution. The special feature of the following method is that it enables one to draw a line of resistance without previously having computed the crown thrust, and also enables one to find a line of resistance which will pass through two predetermined points; and one of the most useful applications of this method is in determining the line of resistance for a segmental arch having a central angle so small as to make it obvious that the joint of rupture is at the springing line.

For example, assume that it is required to draw the line of resistance for the circular arch shown in Fig. 197. The span is 50 feet, the rise 10 feet, the depth of voussoir 2.5 feet, and the height of the earth above the summit of the arch ring is 10 feet. The angular distance of the springing from the crown is $43^{\circ} 45'$; and since the angle of rupture is nearly always more than 45° , it is safe to assume that the joint of rupture is at the springing. The problem then is to find a line of resistance that will pass through U (the upper end of the middle third of the crown joint) and through b (the lower end of the middle third of the springing joint).

The first step is to compute the external forces similarly as in § 1205-09, which see.

Next construct a load line, as shown in the force diagram, Fig. 197, by laying off w_1 and h_1 , and w_2 and h_2 , etc., in succession, and drawing F_1, F_2 , etc. Since the crown thrust has not yet been determined, the position of the pole is not known, and hence a trial position must be assumed. Since the load is symmetrical, we may assume that the thrust at the crown is horizontal; and hence we may choose a pole at any point, say P' , horizontally opposite O . Draw lines from P' to the extremities of F_1, F_2 , etc. Construct a trial equilibrium polygon by drawing through U a line parallel to the line $P'O$, of the force diagram, and prolong it to an intersection with F_1 ; from this point draw a line parallel to R_1 , and prolong it to an

* Strictly any change in the direction of the joints will necessitate a recomputation of the entire problem; but, except in extreme cases, such revision is unnecessary..

intersection with F_2 , etc., continuing to an intersection, b' , with the springing line prolonged.

Prolong the side of the trial equilibrium polygon through b' to g where it intersects the line of the crown thrust prolonged. According to the principles of graphic statics, g is a point on the resultant of the forces F_1, F_2, F_3, F_4, F_5 , and F_6 .

The section of the arch from the crown joint to joint 6 is at rest under the action of the crown thrust T , the resultant of the external forces, and the reaction of joint 6. Since the first two intersect at g , and since it has been assumed that the center of pressure for joint 6 is at b —the inner extremity of the middle third,—a line bg must represent the direction of the resultant reaction of joint 6; and hence

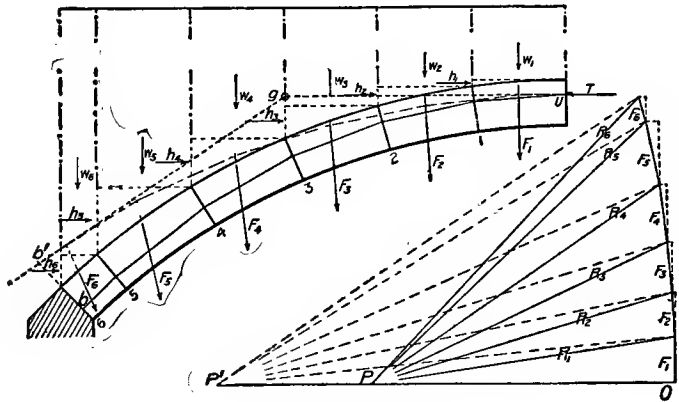

FIG. 197.

the line R_6 , in the force diagram drawn from the upper extremity of F_6 , parallel to bg , to an intersection with $P'O$, represents, to the scale of the load line, the amount of the reaction of joint 6. Then PO , to the same scale, represents the crown thrust corresponding to the line of resistance passing through U and b ; and a line—not shown in Fig. 197—from the upper extremity of F_6 to the lower extremity of F_1 , would represent, in both direction and amount, the resultant of F_1, F_2, F_3, F_4, F_5 , and F_6 .

Having found the thrust at the crown, complete the force diagram by drawing the lines R_1, R_2, R_3 , etc.; and then construct a new equilibrium polygon exactly as was described above for the trial equilibrium polygon. The equilibrium polygon shown in Fig. 197 by a solid line was obtained in this way.

The points in which the sides of the new equilibrium polygon cut the corresponding joints are the centers of pressure on the respec-

tive joints. The stability of the arch may be discussed as in § 1233-35.

1237. Unsymmetrical Load. The design for an arch ring should not be considered perfect until it is found that the criteria of safety (§ 1197) are satisfied for the dead load and also for every possible position of the live load. A direct determination of the line of resistance for an arch under an unsymmetrical load is impossible. To find the line of resistance for an arch under a symmetrical load, it was necessary to make some assumption concerning (1) the amount of the thrust, (2) its point of application, and (3) its direction; but when the load is unsymmetrical, we neither know any of these items nor can make any reasonable hypothesis by which they can be determined. For an unsymmetrical load we know nothing concerning the position of the joint of rupture, and know that the thrust at the crown is neither horizontal nor applied at one third of the depth of that joint from the crown; and hence the preceding methods can not be employed. When the load is not symmetrical, the following method may be employed to find a line of resistance; but it gives no indication as to which of the many possible lines of resistance is the true one.

Let it be required to test the stability of a symmetrical arch having a uniform live load covering only half the span. The problem could be solved by determining the external forces as in § 1219-20; but for variety and to explain a method of determining the loads that is frequently used, in one form or another, in discussions of the stability of voussoir arches, a different method of determining the vertical forces will be employed. This method consists in reducing the actual load upon an arch (including the weight of the arch ring itself) to an equivalent homogeneous load of the same density as the arch ring. The upper limit of this imaginary loading is called the *reduced-load contour*.

1238. To find the Reduced-Load Contour. Assume that it is required to find the reduced-load contour for the dead load on the arch in Fig. 198. Assume that the weight of the arch ring is 160 pounds per cubic foot, that of the rubble backing 140; and that of the earth 100. Then the ordinate at a to the load contour of an equivalent load of the density of the arch ring is equal to $ab + bc \frac{140}{160} + cd \frac{100}{160} =$, say, gf . The value of gf is laid off in Fig. 199. Computing the ordinates for other points gives the line EF , Fig. 199, which is the reduced-load contour for the load shown in Fig. 198. The area between the intrados and the reduced-load contour is proportional to the dead load on the arch.

In a similar manner, a live load (as, for example, a train) can be reduced to an equivalent load of masonry,—in which case the reduced-load contour would consist of a line GH above and parallel to EJ for that part of the span covered by the train; while for the remainder of the span, the line JF is the reduced-load contour.

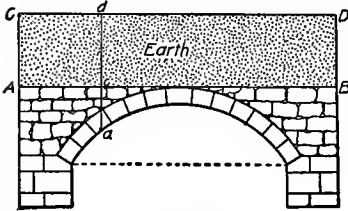

FIG. 198.

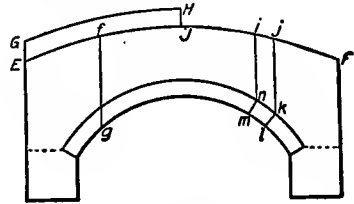

FIG. 199.

To utilize the reduced-load contour, draw the arch and its reduced-load contour upon thick paper or card-board, to a large scale; and divide the arch into any number of imaginary voussoirs, and erect verticals from the upper ends of the imaginary joints. Then measure, with a planimeter or otherwise, the area of each voussoir and its load, from which the weight of each voussoir and its load can be easily determined. Next, with a sharp knife, carefully cut out the area representing the load on each arch stone. The center of gravity of each piece, as $ijklmn$, Fig. 199, can be found by balancing it on a knife-edge successively in two positions at right angles to each other; and then the position of the center of gravity is to be transferred to the drawing of the arch.

1239. To find the Line of Resistance. Assume that it is desired to find the line of resistance for the arch shown in Fig. 200, page 636, whose reduced-load contour is as shown. Assume that the vertical forces have been determined as explained in the preceding section; and also assume that the horizontal component of the earth pressure is one third of the vertical intensity, and that it has been computed as in § 1208.

An equilibrium polygon can be made to pass through any three points; and therefore we may assume three points for a trial equilibrium polygon,—as, for example, (1) the lower limit of the middle third of the joint at the abutment A , (2) the middle, C , of the crown joint, and (3) the upper limit of the middle third of the joint at B .

Construct a force diagram by laying off the external forces successively from O in the usual way, selecting a pole, P' , at any point, and drawing lines connecting P' with the points of division of the load line. Draw a line from O to s , and then Os is the resultant of all the loads upon the arch. Then commencing at A , one of the

given points, construct a preliminary equilibrium polygon $AC'B'$ by the method explained in § 1231. Draw the closing line AB' ; and in the force diagram draw a line HP' , through P' parallel to AB' . Then OH and $H8$ are the reactions at A and B , respectively.

The next step is to find a pole such that the equilibrium polygon will pass through C and B instead of C' and B' . In the force diagram draw a line from O to 4 , which is the resultant of the four forces to the right of C . Through C draw a line CC' parallel to the line $O4$. Connect the points A and C , and also A and C' ; and then the lines AC and AC' are the closing lines of the equilibrium polygons for the forces to the right of C . Through P' draw a dividing ray parallel to AC' cutting $O4$ at K ; and then OK and $K4$ represent the reactions

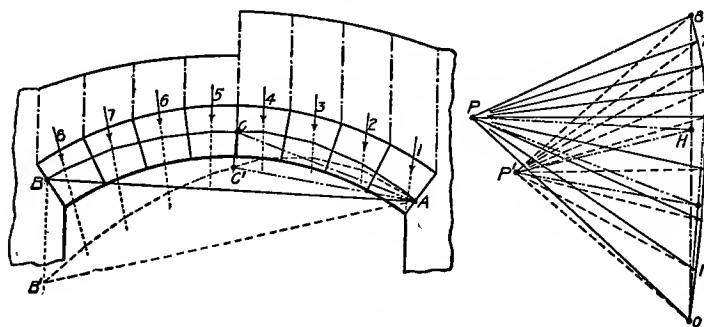

FIG. 200.

of the forces to the right of C , acting at A and C respectively. The point H is common to all force polygons for the given system of forces; and the point K is common to all force polygons for the forces to the right of C . If the polygon is to pass through C , then AC is a closing line; and consequently the pole of the force diagram must lie on a line through K parallel to AC . Similarly, if the polygon is to pass through B , then AB is the closing line; and consequently the pole must lie on a line through H parallel to AB . Therefore, if from H and K lines be drawn respectively parallel to AB and AC , their intersection, P , is the pole of the polygon which will pass through A , C , and B . This polygon is shown in Fig. 200.

1240. If a line of resistance can not be drawn within the prescribed limits, then the section of the arch ring must be changed so as to include the line of resistance within the desired limits.

1241. Criterion. If the line of resistance, when constructed by any of the preceding methods, does not lie within the middle third of the arch ring, the following process may be employed to determine whether or not it is possible to draw a line of resistance in the middle

third. This method is strictly applicable only for vertical forces, and hence is approximate when horizontal forces are considered; but it is sufficiently exact for the purpose.*

"Assume, for example, that the line of resistance of Fig. 201 lies outside of the middle third at a and b . Next draw a line of resistance through c and d , the points where normals from a and b intersect the outer and inner boundary of the middle third respectively. To pass a line of resistance through c and d , it is necessary to determine the value and point of application of the corresponding crown thrust. The condition which makes the line of resistance pass through c is: the thrust MULTIPLIED BY the vertical distance of its point of application above c IS EQUAL TO the load on the joint at c MULTIPLIED BY its horizontal distance from c . The condition that makes the line of resistance pass through d is: the thrust MULTIPLIED BY the sum of the distance its point of application is above c and of the vertical distance between c and d IS EQUAL TO the load on the joint at d MULTIPLIED BY its horizontal distance from d . These conditions give two equations which contain two unknown quantities—the thrust and the distance its point of application is above c . After solving these equations, the line of resistance can be drawn by any of the methods already explained.

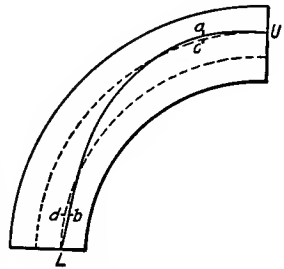

FIG. 201.

"If this new line of resistance lies entirely within the prescribed limits, it is plain that it is possible to draw a line of resistance therein; but if the second line does not lie within the prescribed limits, it is not at all probable that a line of resistance can be drawn therein. The possibility of finding, by a third or subsequent trial, a line of resistance within the limits can not, in general, be answered definitely, since such a possibility depends upon the form of the section of the arch ring.

"If the line of resistance drawn through U and L goes outside of [the middle third of] the arch ring beyond the extrados only, as at a , the second line of resistance should be drawn through c and L ; and if, on the other hand, it goes outside below the intrados only, as at b , the second line should be drawn through U and d ."

1242. SCHEFFLER'S THEORY. This theory is the one most frequently employed. It is based upon the hypothesis of least crown thrust (§ 1215), and assumes that the external forces are vertical.

* This process was devised by Dr. Scheffler; but the following statement of it is from Lanza's Applied Mechanics, p. 617-18.

In Scheffler's theory the joint of rupture is found by trial substantially as explained in § 1218-22; and the crown thrust is, for example, the maximum value in the third to the last column of Table 89, page 624. In other words, Scheffler's theory is the same as the Rational Theory (§ 1229-41), except that it neglects the horizontal components of the earth pressure, and therefore uses a smaller crown thrust and usually also a different joint of rupture. For the arch in Fig. 195, page 623, according to Scheffler's theory joint 4 is the joint of rupture, and 8,706 lb. is the crown thrust (see Table 89). The line of resistance is determined exactly as for the rational theory except that the load line for Scheffler's theory is straight. The lines of resistances (not the equilibrium polygon) for both the rational and Scheffler's theory for the arch shown in Fig. 195, page 623, are given in Fig. 202. In this particular case, the difference between the two lines above the joint of rupture is not material; but the difference below that joint has an important effect upon the thickness of the arch at the springing, and also upon the thickness of the abutment (§ 1246).

If the maximum ratio of the horizontal to the vertical component of the external forces (see last paragraph on page 616) had been employed in determining the crown thrust and the line of resistance, there would have been a greater difference in the position of both the joint of rupture and the line of resistance. Although the horizontal components of the external forces can not be accurately determined, any theory that disregards them is needlessly inaccurate.

1243. Erroneous Application. Not infrequently the principle of the joint of rupture is entirely neglected in applying this theory; that is to say, the crown thrust employed in determining the line of resistance is that which would produce equilibrium of rotation about the *springing line*, instead of that which would produce equilibrium about the *joint of rupture*. For example, instead of employing the *maximum* value in the third to the last column of Table 89, page 624, the *last* quantity in that column is used. The line of resistance obtained by this method is shown in Fig. 202 by the dotted line, the crown thrust (5,990, as computed in Table 89) being laid off from the lower end of *w*, to *E*, to the scale employed in laying off the load line.

The amount of the error is illustrated in Fig. 202. According to this analysis, the line of resistance is tangent to the intrados, which seems to show that the arch can not stand for a moment. However, many such arches do stand, and carry a heavy railroad traffic without any signs of weakness; and further, any reasonable method of analysis shows that the arch is not only safe, but even extravagantly so (§ 1234). This method of analysis certainly ac-

counts for some, and perhaps many, of the excessively heavy arches built in the past.

1244. Reliability of Scheffler's Theory. The author has determined the line of resistance of a great number of actual arches, and has frequently found arches that had given no signs of failure, which

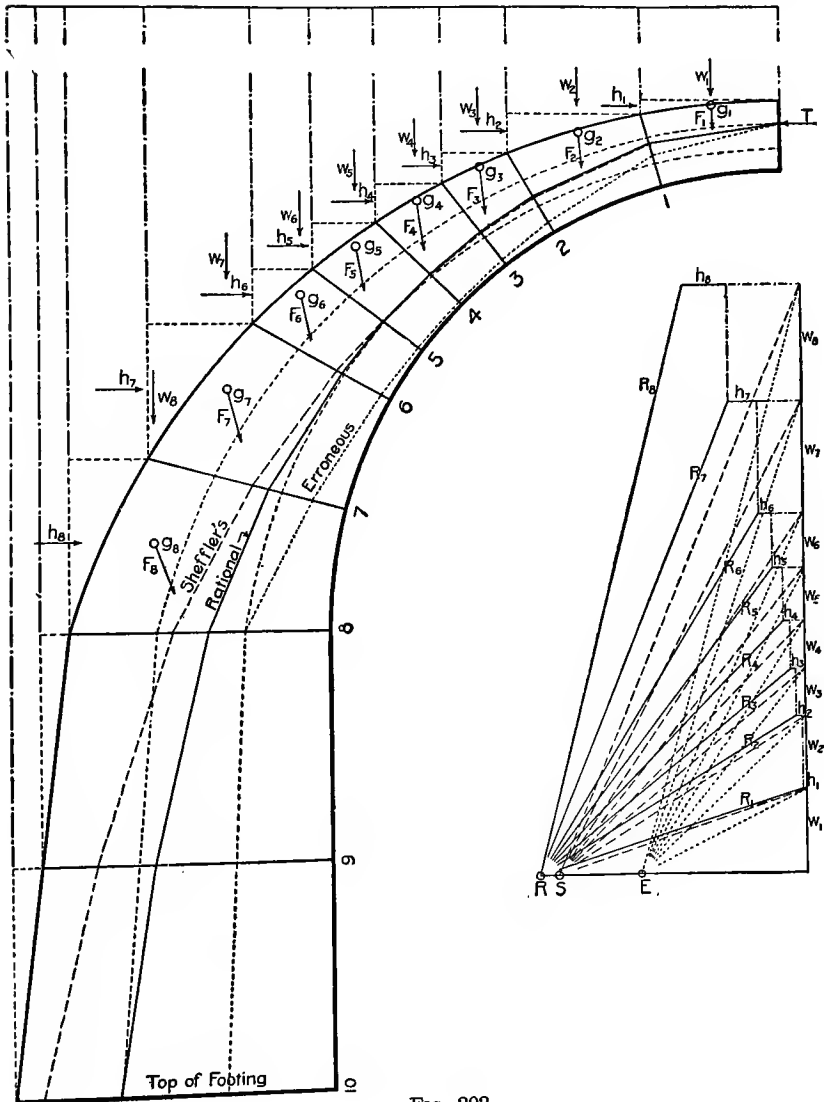

FIG. 202.

were unstable according to Scheffler's theory; but he has found none which were unstable by the rational theory. Of course, an arch may be made so heavy as to be stable by an approximate theory; but the fact that some arches were unstable by Scheffler's theory, and stable by the rational theory, seems to show that the latter is the more accurate.

1245. RANKINE'S THEORY. Rankine's theory of the arch recognizes the existence of the horizontal component of the earth pressure, and in the mathematical work leaves nothing to be desired; but he does not make it clear that his mathematical theory can be applied in practice. He employs Navier's principle (§ 1214) to find the crown thrust; and determines the position of the joint of rupture by means of a differential equation; but it is not clear that the relationship between the several variables in this equation can be stated for any practical case in a manageable mathematical form. Rankine does not work out any numerical example; but in an illustration of the method of determining the stability of any proposed arch he virtually assumes that the portion of the semi-arch above the joint of rupture is acted upon by only three forces—the crown thrust, the weight of the arch, and the reaction at the joint of rupture.* This is erroneous (a) because it neglects the horizontal components of the external forces; and (b) because it finds a new value for the thrust at the crown which, in general, will differ from that employed in finding the position of the joint of rupture. At best Rankine's theory determines the line of resistance within limits at only two points; and hence gives no definite information as to the degree of stability against sliding, overturning, or crushing at these points, and gives no information at all for other points.

Although this theory has long been before the public, it is comparatively little employed in practice. This is probably due, in part at least, to the fact that Rankine's presentation of it is not very simple nor very clearly stated, besides being distributed throughout various parts of his books—"Civil Engineering" and "Applied Mechanics."

1246. STABILITY OF ABUTMENTS. The stability of the abutments is in a measure indeterminate, since it depends upon the position of the line of resistance of the arch. The stability of the abutment may be determined most easily by treating it as a part of the arch, i.e., by extending the load line so as to include the forces acting upon it and drawing the reactions in the usual way.

In Fig. 202 (page 639) is shown the line of resistance for the abutment according to the rational theory of the arch (§ 1229-41), and also that according to Scheffler's theory (§ 1242-44), the former

* Rankine's Civil Engineering, p. 421-22.

by the solid line and the latter by the broken one. Since to overestimate the horizontal components of the external forces would be to err on the side of danger, in applying the former theory in Fig. 202 the horizontal component acting against the abutment was disregarded on the assumption that the abutment might be set in a pit without greatly disturbing the surrounding earth and consequently there might not be any appreciable horizontal earth thrust against the abutment. If the horizontal component had been considered, the difference between the lines of resistance for the two theories would have been still greater. Notice that the analysis which recognizes the existence of the horizontal forces, i.e., the rational theory, permits a lighter abutment than the theory which assumes the external forces to be entirely vertical.

The omission of the horizontal components assumes that the only object of the abutment is to resist the thrust of the arch; and that consequently the flatter the arch the greater the thrust and the heavier the abutment. Ordinarily the abutment must resist the thrust of the arch tending to overthrow it and to slide it outward, and must act also as a retaining wall to resist the lateral pressure of the earth tending to overthrow it and to slide it inward. For large arches the former is the more important; but for small arches, particularly under high embankments, the latter is the more important. Hence, for a large arch or for an arch having a light surcharge, the abutment should be proportioned to resist the thrust of the arch; but for a small arch under a heavy surcharge of earth, the abutment should be proportioned as a retaining wall (Chap. XVIII).

Although the horizontal pressure of the earth can not be computed accurately, there are many conditions under which the horizontal components should not be omitted. For example, if the abutment is high, or if the earth is deposited artificially behind it, ordinarily it would be safe to count upon the pressure of the earth to assist in preventing the abutment from being overturned outward. Finally, although it may not always be wise to consider the earth pressure as an active force, there is always a passive resistance which will add greatly to the stability of the abutment, and whose intensity will increase rapidly with any outward movement of the abutment.

ART. 2. EMPIRICAL RULES.

1247. In the preceding article it was shown that every theory of the arch requires certain fundamental assumptions, and that hence the best theory is only an approximation. Further, since it is practically impossible, by any theory to include the effect of passing loads,

(§ 1237-41), theoretical results are inapplicable when the moving load is heavy compared with the stationary load. It was shown also that the stability of a voussoir arch does not admit of exact mathematical solution, but is to some extent an indeterminate problem. At best the stresses in a masonry arch can never be computed as accurately as those in metallic structures. However, this is a less serious matter, since the material employed in the former is comparatively cheap.

Considered practically, the designing of a voussoir arch is greatly simplified by the many examples furnished by existing structures which afford incontrovertible evidence of their stability by safely fulfilling their intended duties, to say nothing of the history of those structures which have failed and thus supplied negative evidence of great value. In designing arches, theory should be interpreted by experience; but experience should be studied by the light of the best theory available.

This article will be devoted to the presentation of current practice as shown by approved empirical formulas and practical rules, and by examples.

1248. EMPIRICAL FORMULAS FOR THE PROPORTIONS OF ARCHES.

Numerous formulas derived from existing structures have been proposed for use in designing voussoir arches. Such formulas are useful as guides in assuming proportions to be tested by theory, and also as indicating what actual practice is and thus affording data by which to check the results obtained by theory.

As proof of the reliability of such formulas, they are frequently accompanied by tables showing their agreement with actual structures. Concerning this method of proof, it is necessary to notice that (1) if the structures were selected because their dimensions agreed with the formula, nothing is proved; and (2) if the structures were designed according to the formula to be tested, nothing is proved except that the formula represents practice which is probably safe.

At best, a formula derived from existing structures only indicates safe construction, but gives no information as to the degree of safety. Such formulas usually state the relation between the principal dimensions; but the stability of an arch can not be determined from the dimensions alone, for it depends upon various attendant circumstances—as the condition of the loading (if earth, upon whether loose or compact; and if masonry, upon the bonding, the mortar, etc.), the quality of the materials and of the workmanship, the manner of constructing and striking the centers, the spreading of the abutments, the settlement of the foundations, etc. The failure of an arch is a very instructive object lesson, and should be most carefully studied, since it indicates the least degree of stability consistent with safety.

Many masonry arches are excessively strong; and hence there are empirical formulas which agree with existing structures, but which differ from each other 300 or 400 per cent. All factors of the problem must be borne in mind in comparing empirical formulas either with each other or with theoretical results.

A number of the more important empirical formulas will now be given, but without any attempt at comparisons, owing to the lack of space and of the necessary data.

1249. Thickness of the Arch at the Crown. In designing an arch, the first step is to determine the thickness at the crown, i.e., the depth of the keystone.

- Let d = the depth at the crown, in feet;
- ρ = the radius of curvature of the intrados, in feet;
- r = the rise, in feet;
- s = the span, in feet.

1250. American Practice. Trautwine's formula for the depth of the keystone for a *first-class cut-stone* arch, whether circular or elliptical, is

$$d = \frac{1}{4} \sqrt{\rho + \frac{1}{2} s} + 0.2. \quad \dots \quad (10)$$

"For *second-class work*, this depth may be increased about one eighth part; and for *brick work* or *fair rubble*, about one third."

1251. English Practice. Rankine's formula for the depth of keystone for a *single* arch is

$$d = \sqrt{0.12 \rho}; \quad \dots \quad (11)$$

for an arch of a *series*,

$$d = \sqrt{0.17 \rho}; \quad \dots \quad (12)$$

and for *tunnel arches*, where the ground is of the firmest and safest,

$$d = \sqrt{0.12 \frac{r^2}{s}}; \quad \dots \quad (13)$$

and for soft and slipping materials twice the above.

The segmental arches of the *Rennies* and the *Stephensons*, which are generally regarded as models, "have a thickness at the crown of from $\frac{1}{8}$ to $\frac{1}{3}$ of the span, or of from $\frac{1}{28}$ to $\frac{1}{36}$ of the radius of the intrados."

1252. French Practice.* Perronnet, a celebrated French engineer, is frequently credited with the formula,

$$d = 1 + 0.035s, \quad \dots \quad (14)$$

as being applicable to arches of all forms—semicircular, segmental, elliptical, or basket-handled—and to railroad bridges or arches

* From "Proportions of Arches from French Practice," by E. Sherman Gould in *Van Nostrand's Engineering Magazine*, vol. xxix, p. 450.

sustaining heavy surcharges of earth. "Perronnet does not seem, however, to have paid much attention to the rule; but has made his bridges much lighter than the rule would require." Other formulas of the above form, but having different constants, are also frequently credited to the same authority. Evidently Perronnet varied the proportions of his arches according to the strength and weight of the material, the closeness of the joints, the quality of mortar, etc.; and hence different examples of his work give different formulas. However, it is remarkable that according to all formulas credited to Perronnet the thickness at the crown is independent of the rise, and varies only with the span.

1253. Dejardin's formulas, which are frequently employed by French engineers, are as follows:

For circular arches,

$$\text{if } \frac{r}{s} = \frac{1}{2}, \quad d = 1 + 0.100 \rho; \quad (15)$$

$$\text{if } \frac{r}{s} = \frac{1}{6}, \quad d = 1 + 0.050 \rho; \quad (16)$$

$$\text{if } \frac{r}{s} = \frac{1}{8}, \quad d = 1 + 0.035 \rho; \quad (17)$$

$$\text{if } \frac{r}{s} = \frac{1}{10}, \quad d = 1 + 0.020 \rho; \quad (18)$$

For elliptical and basket-handled arches,

$$\text{if } \frac{r}{s} = \frac{1}{3}, \quad d = 1 + 0.070 \rho. \quad (19)$$

By Dejardin's formulas the thickness at the crown decreases as the rise decreases, which seems contrary to reason.

1254. Croizette-Desnoyers, a French authority, recommends the following formulas:

$$\text{if } \frac{r}{s} > \frac{1}{6}, \quad d = 0.50 + 0.28\sqrt{2} \rho; \quad (20)$$

$$\text{if } \frac{r}{s} = \frac{1}{6}, \quad d = 0.50 + 0.26\sqrt{2} \rho; \quad (21)$$

$$\text{if } \frac{r}{s} = \frac{1}{12}, \quad d = 0.50 + 0.20\sqrt{2} \rho; \quad (22)$$

1255. Notice that in none of the above formulas does the character of the material of the arch ring enter as a factor. Notice also that none of them has a factor depending upon the amount of the load—either live or dead.

1256. Thickness of the Arch at the Springing. If the loads are vertical, the horizontal component of the compression on the arch ring is constant; and hence, to have the mean pressure on the joints uniform, the vertical projection of the joints should be constant. This principle leads to the following formula, which is frequently employed: *The length, measured radially, of each joint between the joint of rupture and the crown should be such that its vertical projection is equal to the depth of the keystone.* In algebraic language, this rule is

$$l = d \sec a, \dots \dots \dots (23)$$

in which l is the length of the joint, d the depth at the crown, and a the angle the joint makes with the vertical.

1257. Trautwine gives a formula for the thickness of the abutment, which determines also the thickness of the arch at the springing (see § 1258).

"The augmentation of the thickness at the springing line is made, by the Stephensions, from 20 to 30 per cent; and by the Rennies about 100 per cent."

1258. Thickness of the Abutment. Trautwine's formula is

$$t = 0.2 \rho + 0.1 r + 2.0, \dots \dots \dots (24)$$

in which t is the thickness of the abutment at the springing, ρ the radius, and r the rise—all in feet. "The above formula applies equally to the smallest culvert or the largest bridge—whether circular or elliptical, and whatever the proportions of rise and span—and to any height of abutment. It applies also to all the usual methods of filling above the arch, whether with solid masonry to the level of the top of the crown, or entirely with earth. It gives a thickness of abutment which is safe in itself without any backing of earth behind it, and also against the pressure of the earth when the bridge is unloaded. It gives abutments which alone are safe when the bridge is loaded; but for small arches, the formula supposes that earth will be deposited behind the abutments to the height of the roadway. In small bridges and large culverts on first-class railroads, subject to the jarring of heavy trains at high speed, the comparative cheapness with which an excess of strength can be thus given to important structures has led, in many cases, to the use of abutments from one fourth to one half thicker than those given by the preceding rule. If the abutment is of rough rubble, add 6 inches to the thickness by the above formula, to insure full thickness in every part."*

To find the thickness of the abutment at the bottom, lay off, in Fig. 203, $on = t$ as computed by the above equation; vertically above n lay off $an =$ half the rise; and horizontally from a lay off $ab =$ one

forty-eighth of the span. Then the line *bn* prolonged gives the back of the abutment, *provided* the width at the bottom, *sp*, is not less than two thirds of the height, *os*. "In practice, *os* will rarely exceed this limit, and only in arches of considerable rise. In very high abutments, the abutment as above will be too slight to sustain the earth pressure safely."*

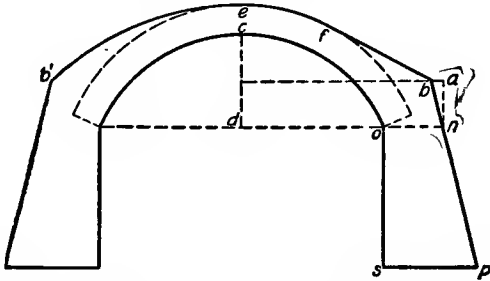

FIG. 203. TRAUTWINE'S RULE FOR THICKNESS OF ABUTMENT.

To find the thickness of the arch, compute the thickness *ce* by equation 10, page 643, draw a curve through *e* parallel to the intrados, and from *b* draw a tangent to the extrados; and then will *bfe* be the top of the masonry filling above the arch. Or, instead of drawing the extrados as above, find by trial a circle which will pass through *b*, *e*, and *b'*, the latter being a point on the left abutment corresponding to *b* on the right.

Trautwine's rule, or a similar one, for proportioning the abutment and the backing is frequently employed.

1259. Rankine says that in some of the best examples of bridges the thickness of the abutment ranges from *one third* to *one fifth* of the radius of curvature of the arch at its crown.

The following formula is said to represent *German* and *Russian practice*,

$$t = 1 + 0.04 (5 s + 4 h), \quad \dots \dots (25)$$

in which *h* is the distance between the springing line and the top of the foundation.

1260. DIMENSIONS OF ACTUAL ARCHES. Table 90, page 648. shows the dimensions of a number of the longest voussoir arche in the world, which may be taken as representative of good practice. Because of the impossibility of obtaining all of the dimensions, a few arches have been omitted whose spans are greater than some of those given. Unfortunately, there is a difference in the recorded dimensions of some of the arches.

* Trautwine's Engineer's Pocket-book.

No. 1 is the largest masonry span in the world. For further details see § 1284.

No. 3, the third largest masonry arch (whether voussoir or concrete) in the world, was built in 1377—a very interesting fact. However, the dates and the dimensions of this arch are somewhat uncertain. The data in the table is said to be derived from about 20 feet of each abutment that remained standing in 1838. Some

TABLE 91.

DIMENSIONS OF ABUTMENTS FROM FRENCH RAILROAD PRACTICE.*

Ref. No.	DESIGNATION OF BRIDGE.	Span.	Rise.	Depth of Keystone.	Height of Abutment.	Mean Thickness of Abutment.
		feet.	feet.	feet.	feet.	feet.
CIRCULAR ARCHES.						
1	De crochet, chemin de fer de Paris à Chartres	13.2	1.65	13.20	4.95
2	De Long-Sauts, chemin de fer de Paris à Chartres	16.5	1.81	9.90	5.90
3	D'Enghien, chemin de fer du Nord	24.4	1.95	6.60	6.93
4	De Pantin, canal St. Martin	27.0	2.47	11.85	10.55
5	De la Bastille, canal St. Martin	36.3	3.95	20.75	9.90
6	De Basses-Granges, Orleans à Tours	49.4	3.95	6.60	12.50
SEGMENTAL ARCHES.						
7	Des Fruitières, chemin de fer du Nord	13.2	2.31	1.81	13.20	5.94
8	De Paisia	16.5	2.64	1.72	6.60	5.61
9	De Méry, chemin de fer du Nord	25.2	2.97	2.14	14.20	11.71
10	De Couturette, at Arbois	42.9	6.13	2.97	6.60	17.16
11	Over the Salat	46.1	6.27	3.63	24.49	19.14
12	De la rue des Abattoirs, at Paris, chemin de fer de Strasbourg	52.9	5.11	2.97	12.96	33.00
13	Over the Forth, at Stirling	53.5	10.25	2.75	20.75	16.00
14	St. Maxence, over the Oise	77.2	6.40	4.80	27.85	38.94
15	Over the Oise, chemin de fer du Nord	82.7	11.75	4.60	17.90	31.65
16	De Dorlaston	87.0	13.50	3.50	16.55	32.20
ELLIPTICAL OR FALSE-ELLIPTICAL ARCHES						
17	De Charolles	19.8	7.55	1.95	1.30	5.25
18	Du Canal St. Denis	39.5	14.85	2.95	10.20	12.35
19	De Château-Thierry	51.3	17.10	3.75	13.65	15.00
20	De Dôle, over the Doubs	52.4	17.50	3.75	1.35	11.85
21	Wellesley, at Limerick	70.0	17.50	2.00	12.00	16.50
22	D'Orléans, chemin de fer de Vierzon	79.5	26.30	3.95	2.85	18.40
23	De Trilport	80.7	27.80	4.45	6.40	19.30
24	De Nantes, over the Seine	115.2	34.40	6.40	3.20	28.90
25	De Neuilly, over the Seine	128.0	32.00	5.35	7.55	35.50

* E. Sherman Gould in *Van Nostrand's Engineering Magazine*, vol. xxix, p. 450.

TABLE 90.
DIMENSIONS OF LARGE VOUSSOIR ARCHES.

Ref. No.	NAME, LOCATION AND DESCRIPTION.	Engineer.	Date Completed.	Curve of Intrados.	Radius of Crown.	Span.	Rise.	THICKNESS.	
								Crown.	Springing.
1	Syrs, Plauen, Saxony. Highway. Hard slate. See § 1284.	Leibold	1903	3c	344.5	295.3	59.5	feet.	feet.
2	Luxemburg, Germany. Street. † See § 1285.	Sejourné	1903	C	173.8	277.7	101.7	4.9	11.2
3	Treze, Italy. Highway. Granite. Destroyed in 1416. See § 1260.	1377	C	133.6	4.7	4.0	7.2
4	Marbegno, Italy. Railway. Granite. †	1903	3c	246	229.8	32.8	4.9	7.2
5	Cabin John, Washington, D. C. Granite. See § 1286	Meigs	1859	C	134.3	220	57.3	4.2	6.2
6	Pruth, Jarnetze, Austria. Railway. Sandstone. †	Huss	1893	126	213.2	59.0	6.9	10.2
7	Gutsch, Neustadt-Donneschingen railway, Germany. Sandstone. †	1901	210	52.5	6.6	9.2
8	Isar River, Bogenhausen, Bavaria. Highway. Limestone	Fischer	1902	209.9	21.4	3.4	4.2
9	Lavour, France. Railway	Sejourné	1888	202	90	5.4	12.5
10	Grosvenor, Chester, England. Highway. Sandstone. 2 lead hinges.	Hartley	1883	C	140	200	42	4.5	7.0
11	Gour Noir, Uzereche, France. Railway. Granite	Daigremont	1888	C	118	196.8	52.8	5.6	13.8
12	Schwaedenholz, Coppel, Germany. Railway. Sandstone	1901	187	55.8	5.9	8.5
13	Ballochmoyie, Scotland. Railway	Millar	1844	C	90	180	90	4.5	6.0
14	Main Street, Wheeling, West Va. Railway. Soft stone.	Hoge & White	1892	C	125.4	159	28.4	4.5	6.0
15	Jamma Bridge, Galicia, Austria. Railway. †	Huss	1893	157	39.2	5.6	8.5
16	Antoinette, France	Sejourné	155.5	36	5.0	7.5
17	London Bridge over Thames, London, England. Street. Granite	Rennie	1830	E	162.0	152	37.7	4.8	10.0
18	Chaix, Grenoble, France. Highway	1811	C	82.0	150.2	54.4	3.2
19	East Arch, Elyria, Ohio. Street. Soft sandstone	Kinney	1886	C	208.7	150	27	3.8	4.5
20	Bellefield, Pittsburg, Pa. Street. Sandstone † See § 1287	Rust	1897	C	95.0	150	36.6	4.0	6.0
21	Pont-du-Ceret, Perpignan, France. Highway	1836	2c	73.8	147.6	73.8	4.6	13.1
22	Putney, England. Highway. Granite	Bazalgette	1882	144.0	144	19.3	4.5	5.5
23	Pont-y-Frydd, Newbridge, Wales. Highway. Sandstone. See § 1288.	Edwards	1755	C	88.0	140	35	1.5	1.5
24	Bellows Falls, Vermont. Railway	Cheever	1899	C	132.6	140	20	4.0	4.0
25	Caistalet arch, France	135	36	4.0	8.2
26	Waldi-Tobel, Bludenz, Austria. Railway	Huss	1884	134.5	42.6	5.6	10.2
27	First Worochta Bridge, Galicia, Austria. Railway. †	Huss	1893	131.2	32.8	4.6	7.2
28	North Ave., Baltimore, Md. Skew. Street and Electric R. R. Brick.	Smith	1895	E	130	26	5.0	8.4
29	Echo Bridge, Newton Upper Falls, Mass. Aqueduct. Granite	Fitzgerald	1876	67.5	129	42.3	6.0

30	Maidenhead, England. Railway. Brick in cement	Brunel	1838	E	169.0	128	24.3	5.3	7.5
31	Bourbonnais, France. Railway. Granite. \$1260	Vaudray	C	255.7	124	6.9	2.7	3.6
32	Watnoo Bridge, London, England. Street. Granite	Rennie	1817	E	120	34.6	4.5	10.0
33	Fairmount Park, Philadelphia, Pa. Sewer. Sandstone	Webster	1892	116	21.2	3.5	4.5
34	Second Worochta Bridge, Galicia, Austria. Railway. †	Huss	1883	20	113.5	56.8	4.2	6.7
35	West Arch, Elyria, Ohio. Street. Soft sandstone	J'cks'ndBunce	1894	112	19.5	3.5	4.3
36	Nagold, Wurttemberg, Germany. Highway	108.8	10.8	3.3
37	Murg, Baisersbrunn, Germany. Highway. 3 lead hinges	Leibbrand	1889	108.2	10.8	2.0
38	Wisshackton, Philadelphia, Pa. Highway. Gneiss	Thayer	1897	110	11.0	3.0
39	Murr, Marbach, Germany. Highway	Leibbrand	1887	C	140.2	105	10.2	3.9	4.9
40	Moldau, Prague, Bohemia. Highway. Granite	Reiter	1878	105	16.2	4.0
41	Creuse, Pont-de-Files, France. Railway. Sandstone	Payeur	1847	E	70.8	103.8	40.5	4.3	4.3
42	Rutherglen, Glasgow, Scotland. Highway	Crouch & Hogg	1895	C	97.6	100	12.6	4.0	4.0
43	Wellington, Leeds, England. Highway. Sandstone	Rennie	1819	C	90.8	100	15.0	4.0	7.0
44	Bishop Aukland, England. Highway	1388	C	100	22.0	5.5	5.5
45	Etherow, England	Haskoll	C	100	25.0	4.0	4.0
46	Margherita, Rome, Italy. Highway	Vescovali	1891	50	99	16.5	5.0	5.0
47	Saône, Chatrey, France. Highway	Mocquery	1888	C	104.5	98.4	12.3	3.8	4.9
48	Trinity, Florence, Italy. Highway. Marble	Ammanati	1569	E	95.8	16.0	3.2	3.2
49	Enz, Hofen, Germany. Highway. Sandstone. Three lead hinges	Leibbrand	1885	C	119.4	91.9	9.2	3.3	4.9
50	Jena, Paris, France. Street. Sandstone	Lamandé	1812	C	102.0	91.8	10.8	4.7	8.0
51	Cathedral of St. John the Divine, New York City	86	55.0	18.5	14.0
52	Elkader, Iowa. Highway. Limestone	Tschirgi	1888	C	45.5	84	27.9	3.0	4.0
53	Stuls, Albulal Railroad, Eastern Switzerland	C	41.0	82	41	3.3	4.9
54	Crucette, Marvejois, France. Railway	3c	41.0	82	41	4.2	8.2
55	Forbach, Baisersbrunn, Germany. Highway. Three lead hinges	Leibbrand	1890	82	9.8	2.0	2.6
56	Schuykill Falls, Philadelphia, Pa. Railway	Nichols	1890	C	43.8	80	26	3.0	3.0
57	Painsville, Ohio. Railway	2c	40	80	40	3.0	3.0
58	Conemaugh, Viaduct Sta., Pa. § Railway. Sandstone	2c	40	80	40	3.0	3.5
59	Conewego, Pa. Railway	Brow	1892	2c	40	80	40	3.5	3.5
60	High Bridge, New York City, N. Y. Aqueduct	Jervis	1842	2c	40	80	40	2.5	2.5
61	Hyde Park, Readville, Mass. Railway. Three lead hinges. Skew	C	78	14.3	2.5	3.0

* C = circular; E = elliptical; 2c = two-centered; 3c = three-centered.
 † Transverse spandrel arches. ‡ Spandrel arches.
 § Destroyed by Johnstown Flood in 1889.

claim that the bridge was never completed and that it is not even known whether there was to be one or more spans.

No. 5 is the largest voussoir arch in this country. For additional details, see §1286.

No. 23 is a remarkable bridge. For details see § 1288.

No. 31 is noted for its boldness. This design was tested by building an experimental arch—at Soupes, France—of the proportions given in the table, and 12 feet wide. The center of the experimental arch was struck after four months, when the total settlement was 1.25 inches, due mostly to the mortar joints, which were about one quarter inch; and it was not injured by a distributed load of 500 pounds per square foot, nor by a weight of 5 tons falling 1.5 feet on the key.

1261. It is interesting to notice that most of the arches given in Table 90, page 648, are comparatively recent. It is also interesting to notice that some of the older arches compare very favorably with the most recent. For example, compare No. 23 with the next one above and also with the one next below it; and compare No. 22 with the one above it. However, possibly the later designer was influenced by the work of the older designer.

1262. DIMENSIONS OF ABUTMENTS. Table 91, page 647, gives the dimensions of a number of abutments representative of French railroad practice.

ART. 3. ARCH CENTERS.

1263. DEFINITIONS. A *center* is a temporary structure for supporting an arch while in process of construction. It usually consists of a number of frames (commonly called *ribs*) placed a few feet apart in planes perpendicular to the axis of the arch, and covered with narrow planks (called *lagging*) running parallel to the axis of the arch, upon which the arch stones rest. The center is usually wood—either a solid rib or a truss,—but for small arches is sometimes a curved rolled-iron beam. In a trussed center, the pieces upon which the laggings rest are called *back-pieces*.

Centers may be divided into two classes, viz.: (1) those in which the supports are so arranged as to give a clear opening under the arch for the passage of vehicles or shipping; and (2) those whose supports may be arranged in any way that judgment or economy may dictate. Centers of the first class are usually called *cocket centers*.

1264. THE PROBLEM OF CENTER CONSTRUCTION. The framing, setting up, and removing of the center is an important feature of the construction of an arch. Since the center is a temporary structure, it should be made with the least possible expenditure for materials

and labor, and with the greatest salvage of useful material after the arch is completed. On the other hand, the center must remain as nearly as possible immovable in position and invariable in form, for any change in the position or in the shape of the center, due to insufficient strength or improper bracing, will be followed by a change in the curve of the intrados and consequently of the line of resistance, which may endanger the safety of the arch itself; and when the time comes to remove the center, it must move altogether and without shock. The problem then is to build a structure that shall be immovable until movement is desired, and that shall then move at will.

1265. Load to be Supported. If there were no friction, the load to be supported by the center could be computed exactly; but friction between the several arch stones and between these and the center renders all formulas for that purpose very uncertain. Fortunately, the exact load upon the center is not required; for the center is only a temporary structure, and the material employed in its construction is not entirely lost. Hence it is wise to assume the loads to be greater than they really will be. Some allowance must be made for the accumulation of material on the center and for the effect of jarring during erection. The following analysis of the problem will show roughly what the forces are and why great accuracy is not possible.

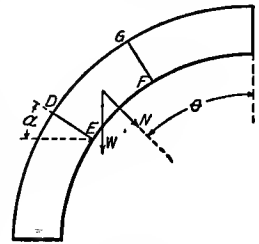

FIG. 204.

To determine the pressure on the center, consider the voussoir *DEFG*, Fig. 204, and let

α = the angle which the joint *DE* makes with the horizontal;
 μ = the coefficient of friction (see Table 74, page 464), i.e.,
 μ is the tangent of the angle of repose;

θ = the angular distance of any point from the crown;

W = the weight of the voussoir *DEFG*;

N = the radial pressure on the center due to the weight of *DEFG*.

If there were no friction, the stone *DEFG* would be supported by the normal resistance of the surface *DE* and the radial reaction of the center. The pressure on the surface *DE* would then be $W \cos \alpha$, and the pressure in the direction of the radius $W \sin \alpha$.

Friction causes a slight indetermination, since part of the weight of the voussoirs may pass to the abutment either through the arch ring or through the back-pieces (perimeter) of the center. Owing to friction, both of these surfaces will offer, in addition to the above, a resistance equal to the product of the perpendicular pressure and

the coefficient of friction. If the normal pressure on the joint DE is $W \cos \alpha$, then the frictional resistance is $\mu W \cos \alpha$. Any frictional resistance in the joint DE will decrease the pressure on the center by that amount; and consequently, with friction on the joint DE , the radial pressure on the center is

$$N = W (\sin \alpha - \mu \cos \alpha) (26)$$

On the other hand, if there is friction between the arch stone and the center, the frictional resistance between these surfaces will decrease the pressure upon the joints DE , as computed above; and consequently the value of N will be greater than in equation 26.

Notice that in passing from the springing toward the crown the pressure of one arch stone on the other decreases. Near the crown this decrease is rapid, and consequently the friction between the voussoirs may be neglected. Under this condition, the radial pressure on the center is

$$N = W \cos \theta (27)$$

1266. The value of the coefficient to be employed in equation 26 is somewhat uncertain. Disregarding the adhesion of the mortar, the coefficient varies from about 0.4 to 0.8 (see Table 74, page 464); and, including the adhesion of good cement mortar, it may be nearly, or even more than, 1. (It is 1 if an arch stone remains at rest, without other support, when placed upon another one in such a position that the joint between them makes an angle of 45° with the horizontal.) If the arch is small, and consequently laid up before the mortar has time to harden, probably the smaller value of the coefficient should be used; but if the arch is laid up so slowly that the mortar has time to harden, a larger value could, with equal safety, be employed. As a general average, we will assume that the coefficient is 0.58, i.e., that the angle of repose is 30° .

Notice that by equation 26, $N = 0$, if $\tan \alpha = \mu$; that is to say, $N = 0$, if $\alpha = 30^\circ$. This shows that as the arch stones are placed upon one another they would not begin to press upon the center rib until the plane of the lower face of the top one reaches an angle of 30° with the horizon.

Table 92 gives the value of the radial pressure of the several portions of the arch upon the center; and also shows the difference between applying equation 26 and equation 27. As a rough approximation, for a full-centered arch, equation 27 may be applied for the first 30° from the crown, although it gives results slightly greater than the real pressures; and for the second 30° , equation 26 may be employed, although it gives results less than the actual pressure;

and for the third 30°, the arch stones may be considered self-supporting.

1267. Example. To illustrate the method of using Table 92, assume that it is required to find the pressure on a back-piece of a 20-foot semicircular arch which extends from 30° to 50° from the horizontal, the ribs being 5 feet apart, and the arch stones being 2 feet deep and weighing 150 pounds per cubic foot. Take the sum of the decimals in the middle column of Table 92, from 30° to 50° inclusive, which is 2.20. This must be multiplied by the weight of the arch resting on 2° of the centre. An arc of 1° is equal to 0.0175 times the radius. The radius to the middle of the voussoir is 11 feet, and the length of 2° of arc is 0.38 feet. The volume of 2° is $0.38 \times 5 \times 2 = 3.8$ cubic feet; and the weight of 2° is $3.8 \times 150 = 570$ pounds. Therefore the pressure on the back-piece is $570 \times 2.20 = 1,254$ pounds.

TABLE 92.

**THE RADIAL PRESSURE OF THE ARCH STONES
OF A SEMI-ARCH, ON THE CENTER.**

ANGLE OF THE LOWER FACE WITH THE HORIZONTAL.	RADIAL PRESSURE IN TERMS OF THE WEIGHT OF THE ARCH STONE.	
	By Equation 26.	By Equation 27.
30°	0.00
32°	0.04
34°	0.08
36°	0.12
38°	0.16
40°	0.20
42°	0.24	0.67
44°	0.28	0.69
46°	0.32	0.72
48°	0.36	0.74
50°	0.40	0.76
55°	0.45	0.82
60°	0.54	0.86
65°	0.91
70°	0.94
80°	0.98
90°	1.00

1268. OUTLINE FORMS OF CENTERS. Solid Wooden Rib. For flat arches of 10-foot span or under, the rib may consist of a plank, *aa*, Fig. 205, page 654, 10 or 12 inches wide and $1\frac{1}{2}$ or 2 inches thick, set edgewise, and another, *b*, of the same thickness, trimmed to the curve of the intrados and placed above the first. The two should be

fastened together by nailing on two cleats of narrow boards as shown. These centers may be placed 2 or 3 feet apart.

1269. Built Wooden Rib. For flat arches of 10 to 30 feet span, the rib may consist of two or three thicknesses of short boards, fitted and nailed (or bolted) together as shown in Fig. 206. An iron plate is often bolted on over the joints (see Fig. 226, page 669), which adds materially to the rigidity of the rib. Centers of this form have an astonishing strength. Trautwine gives the two following examples which strikingly illustrate this.

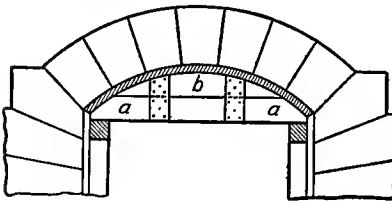

FIG. 205.

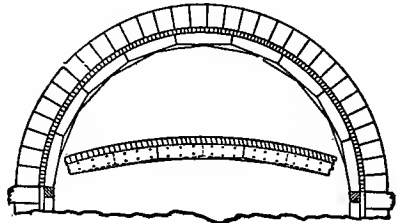

FIG. 206.

“In the first of these examples, this form of center was employed for a semicircular arch of 35 feet span, having arch stones 2 feet deep. Each rib consisted of two thicknesses of 2-inch plank, in lengths of about 6.5 feet, treenailed together so as to break joint. Each piece of plank was 12 inches deep at the middle, and 8 inches at each end, the top edge being cut to suit the curve of the arch. The treenails were 1.25 inches in diameter, and 12 of them were used to each length. These ribs were placed 17 inches apart from center to center, and were steadied together by a bridging piece of 1-inch board, 13 inches long, at each joint of the planks, or about 3.25 feet apart. Headway for traffic being necessary under the arch, there were no chords to unite the opposite feet of the ribs. The ribs were covered with close board-lagging, which also assisted in steadying them together transversely. As the arch approached about two thirds of its height on each side, the ribs began to sink at the haunches and rise at the crown. This was rectified by loading the crown with stone to be used in completing the arch, which was then finished without further trouble.”

The other example was an elliptic arch of 60 feet span and 15 feet rise, the arch stones being 3 feet deep at the crown and 4 feet at the springing. “Each frame of the center was a simple rib 6 inches thick, composed of three thicknesses of 2-inch oak plank, in lengths (about 7 to 15 feet) to suit the curve and at the same time to preserve a width of about 16 inches at the middle of each

length and 12 inches at each of its ends. The segments broke joints, and were well treenailed together with from ten to sixteen treenails to each length. There were no chords. These ribs were placed 18 inches from center to center, and were steadied against one another by a board bridging-piece, 1 foot long, at every 5 feet. When the arch stones had approached to within about 12 feet of each other, near the middle of the span, the sinking at the crown and the rising at the haunches had become so alarming that pieces of 12- by 12-inch oak were hastily inserted at intervals and well wedged against the arch stones at their ends. The arch was then finished in sections between these timbers, which were removed one by one as the arch was completed."

Although the above examples can not be commended as good construction—the flexibility of the ribs being so great as to endanger the stability of the arch during erection and to break the adhesion of the mortar, thus decreasing the strength of the finished arch,—they are very instructive as showing the strength attainable by this method of construction.

1270. The above form of center is frequently employed, particularly in tunnels, for spans of 20 to 30 feet, precautions being taken to have the pieces break joints, to secure good bearings at the joints, and to nail or bolt the several segments firmly together. The centers for the 25-foot arch of the Musconetcong (N. J.) tunnel on the Lehigh Valley R. R. consisted of segments of 3-inch plank, 5 feet 8 inches long, 14 inches wide at the center, and 8 inches at the ends, bolted together with four $\frac{1}{2}$ -inch and four $\frac{3}{4}$ -inch bolts each, and 14- by 8-inch pieces of plate-iron over the joints. Where the center was required to support the earth also, a three-ply rib was employed; but in other positions two-ply ribs, spaced 4 to 5 feet apart, were used. Centers of this form have successfully stood in very bad ground in the Musconetcong and other tunnels;* and hence we may infer that they are at least sufficiently strong for any ordinary arch of 30 feet span.

Although not necessary for stability, it is wise to connect the feet of the rib by nailing a narrow board on each side, to prevent the end of the rib from spreading outwards and pressing against the masonry—thus interfering with the striking of the center—and also to prevent deformation in handling it.

1271. Braced Wooden Rib. For semicircular arches of 15 to 30 feet span, a construction similar to that shown in Fig. 226 (page 669) may be employed. The segments should consist of two thicknesses of 1- or 2-inch plank, according to span, from 8 to 12 inches wide at the middle, according to the length of the segments. The hori-

* Drinker's Tunneling, p. 548.

zontal chord and the vertical tie may each be made of two thicknesses of the plank from which the segments are made.

For greater rigidity, the rib may be further braced by any of the methods shown in outline in Figs. 207, 208, 209, or by obvious modifications of them. The form to be adopted often depends upon the passageway required under the arch. Fig. 207 is supported



FIG. 207.



FIG. 208.



FIG. 209.

by a post under each end; Fig. 208 may be supported at the middle point also; and Fig. 209 may be supported at both middle points as well as at the ends.

Since the arch masonry near the springing does not press upon the center, that portion of the arch may be laid with a template before the center is set up; and hence frequently the center of a semicircular arch does not extend down to the springing line. For examples, see Figs. 222 and 226 (page 667 and 669).

Center frames are usually put together on a temporary platform or the floor of a large room, on which a full-size drawing of the rib is first drawn.

1272. Trussed Center. When the span is too great to employ any of the centers described above, it becomes necessary to construct

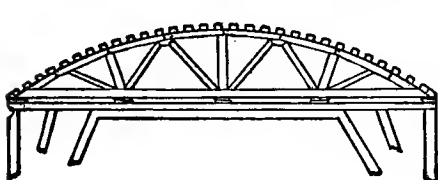

FIG. 210.

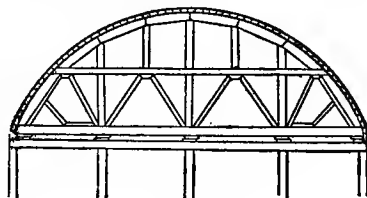

FIG. 211.

trussed centers. It is not necessary here to discuss the principles of trussing, or of finding the stresses in the several pieces, or of determining the sections, or of joining the several pieces,—all of which are fully described in treatises on roof and bridge construction. There is a very great variety of methods of constructing such centers. Figs. 210 and 211 show two common, simple, and efficient general forms. For detailed examples, see Fig. 218 (page 663), Fig. 222 (page 667), and Fig. 226 (page 669).

1273. CAMBER. Strictly, the center should be constructed with a camber just equal to the amount it will yield when loaded with the arch; but, since the load is indeterminate, it is impossible to compute accurately what this will be. Of course, the camber depends upon the unit strain in the material of the center. The rule is frequently given that the camber should be *one four-hundredth of the radius*; but this is too great for the excessively heavy centers ordinarily used. It is probably better to build the centers true, and guard against undue settling by giving the frames great stiffness; and then if unexpected settling does take place, tighten the striking wedges slightly.

The two sides of the arch should be carried up equally fast, to prevent distortion of the center.

1274. STRIKING THE CENTER. The Method. The ends of the ribs or center-frames usually rest upon a timber lying parallel to, and near, the springing line of the arch. This timber is supported by wedges, preferably of hard wood, resting upon a second stick, which is in turn supported by wooden posts—usually one under each end of each rib. The wedges between the two timbers are used in removing the center after the arch is completed, and are known as *striking wedges*. They consist of a pair of folding wedges—1 to 2 feet long, 6 inches wide, and having a slope of from 1 to 5 to 1 to 10—placed under each end of each rib. It is necessary to remove the centers slowly, particularly for large arches; and hence the striking wedges

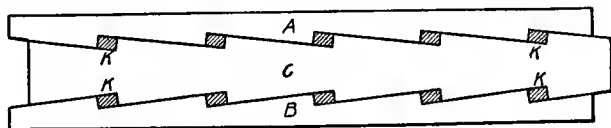

FIG. 212.

should have a very slight taper,—the larger the span the smaller the taper.

The center is lowered by driving back the wedges. To lower the center uniformly, the wedges must be driven back equally. This is most easily accomplished by making a mark on the side of each pair of wedges before commencing to drive, and then moving each the same amount.

1275. Instead of separate pairs of folding wedges, as above, a compound wedge, Fig. 212, is sometimes employed. The pieces *A* and *B* are termed striking plates. The ribs rest upon the former, and the latter is supported by the wooden posts before referred to. The wedge *C* is held in place during the construction of the arch by the keys, *K, K*, etc., each of which is a pair of folding wedges.

To lower the center, the keys are knocked out and the wedge *C* is driven back. The piece *C* is usually as long as the arch, and supports one end of all the ribs. With large arches, say 80 to 100 feet span, it is customary to support each rib on a compound wedge running parallel to the chord of the center (perpendicular to the axis of the arch). The piece *C* is usually made of an oak stick 10 or 12 inches square. The individual wedges are from 4 to 6 feet long.

For the larger arches, the compound wedge is driven back with a heavy log battering-ram suspended by ropes and swung back and forth by hand. The inclined surfaces of the wedges should be lubricated when the center is set up, so as to facilitate the striking.

1276. An ingenious device, first employed in 1855 at the Pont d'Alma arch, Paris, France,—141 feet span and 28 feet rise,—consisted in supporting the center-frames on wooden pistons or plungers, the feet of which rested on sand confined in plate-iron cylinders 1 foot in diameter and about 1 foot high. Near the bottom of each cylinder there was a plug which could be withdrawn and replaced at pleasure, by means of which the outflow of the sand was regulated, and consequently also the descent of the center. This method is particularly useful for large arches, owing to the greater facility with which the center can be lowered. For an example of its use, see Fig. 222, page 667. The sand should be clean, fine, and dry; and the space between the plunger and the cylinder should be relatively small, or should be filled with a ring of neat cement mortar.

Another ingenious device for lowering arch centers has recently been employed several times in Austria.* The special feature is a crushing block of soft wood of the shape shown in Fig. 213. The two feet of the block have sufficient bearing area to hold up the load during erection without sensible crushing; but it is so shaped that by sawing off the end portions of the block, the bearing area may be successively reduced, and thus cause the ends to crush down and allow the centers to settle away from the arch.

For still another ingenious method, see item 3 of § 1367.

1277. The Time. There is a great difference of opinion as to the proper time for striking the centers of voussour arches. Some hold that the center should be struck as soon as the arch is completed and the spandrel filling is in place; while others contend that the mortar

* *Engineering News*, vol. lix, p. 587,—May 28, 1908.

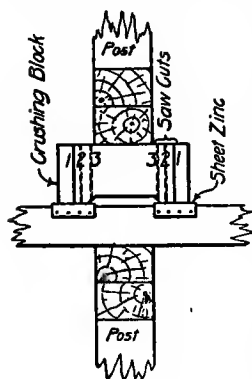

FIG. 213.

should be given time to harden. It is probably best to slacken the centers as soon as the keystone is in place, so as to bring all the joints under pressure. The length of time which should elapse before the centers are finally removed should vary with the kind of mortar employed, and also with its amount. In brick and rubble arches a large proportion of the arch ring consists of mortar; and if the center is removed too soon, the compression of this mortar might cause a serious or even dangerous deformation of the arch. Hence the centers of such arches should remain until the mortar has not only set, but has attained a considerable part of its ultimate strength,—this depending somewhat upon the maximum compression in the arch.

Frequently the centers of bridge arches are not removed for three or four months after the arch is completed; but usually the centers for the arches of tunnels, sewers, and culverts are removed as soon as the arch is turned and about half of the spandrel filling is in place.

ART. 4. DETAILS OF CONSTRUCTION.

1278. In this article a few details of construction will be briefly considered, and illustrations will be given of actual arches and centers.

1279. BACKING. Backing is masonry of inferior quality laid outside and above the arch stones proper, to give additional security. The backing is ordinarily coursed or random rubble, but sometimes concrete. Sometimes the upper ends of the arch stones are cut with horizontal surfaces, in which case the backing is built in courses of the same depths as these steps and bonded with them. The backing is occasionally built in radiating courses, whose beds are prolongations of the bed-joints of the arch stones; but it usually consists of rubble, laid in horizontal courses abutting against the arch ring, with occasional arch stones extending into the former to bond both together. The radial joints possess some advantages in stability and strength, particularly above the joint of rupture; but below that joint the horizontal and vertical joints are best, since this form of construction the better resists the overturning of the arch outward about the springing line. Ordinarily, the backing has a zero thickness at or near the crown, and gradually increases to the springing line; but sometimes it has a considerable thickness at the crown, and is proportionally thicker at the springing.

It is impossible to compute the degree of stability obtained by the use of backing; but it is certain that the amount ordinarily employed adds very greatly to the stability of the arch ring. In fact, many arches are little more than abutting cantilevers; and it is probable that often the backing alone would support the structure, if the arch ring were entirely removed.

1280. HOLLOW SPANDELS. Since the roadway must not deviate greatly from a horizontal line, a considerable quantity of material is required above the backing to bring the roadway level. Ordinarily this space is filled with earth, gravel, broken stone, cinders, etc.

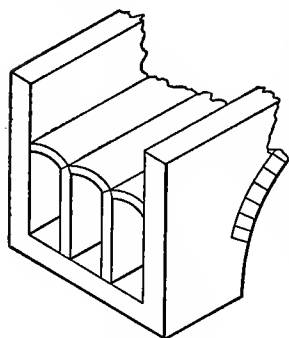

FIG. 214.

Sometimes, to save filling and also to lighten the load upon the arch, small arches are built over the haunches of the main arch, as shown in Fig. 214. The interior longitudinal walls may be strengthened by transverse walls between them. To distribute the pressure uniformly, the feet of these walls should be expanded by footings where they rest upon the back of the arch.

1281. When the load is entirely stationary—as in an aqueduct or canal bridge—or nearly so—as in a long span arch under a high railroad embankment—the materials of the spandrel filling and the size and position of the empty spaces may be such as to cause the line of resistance to coincide, at least very nearly, with the center of the arch ring.

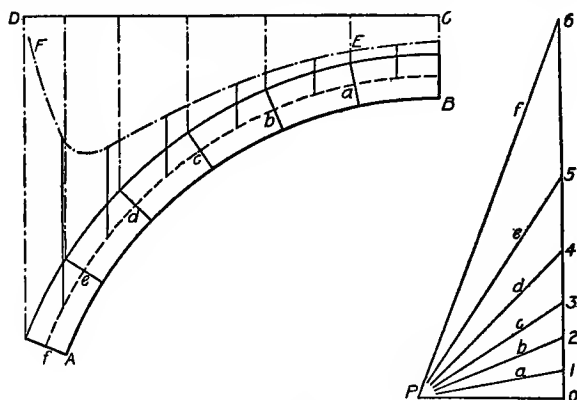

FIG. 215.

For example, $ABCD$, Fig. 215, represents a semi-arch for which it is required to find a disposition of the load that will cause the line of resistance to coincide with the center line of the arch ring. Divide the arch into any convenient number of voussoirs, and also divide the load into a corresponding number of divisions by vertical lines as shown. From P draw radiating lines parallel to the tangents of the center line of the arch ring at a , b , c , etc.; and then at such a

distance from P that $O1$ shall represent, to any convenient scale, the load on the first section of the arch ring (including its own weight), draw a vertical line through O ; and then the intercepts $O-1$, $1-2$, $2-3$, etc., represent, to scale, the loads which the several divisions must have to cause the line of resistance to coincide with the center of the arch ring. Lay off the distances $O-1$, $1-2$, etc., at the centers of the respective sections vertically upwards from the center line of the arch ring, and trace a curve through their upper ends. The line thus formed— EF , Fig. 210, page 656—shows the required amount of homogeneous load; i.e., EF is the contour of the homogeneous load that will cause the line of resistance to pass approximately through the center of each joint.

Hence, by choosing the material of the spandrel filling and arranging the empty spaces so that the actual load shall be equivalent in intensity and distribution to the reduced load obtained as above, the voussoirs can be made of moderate depth.

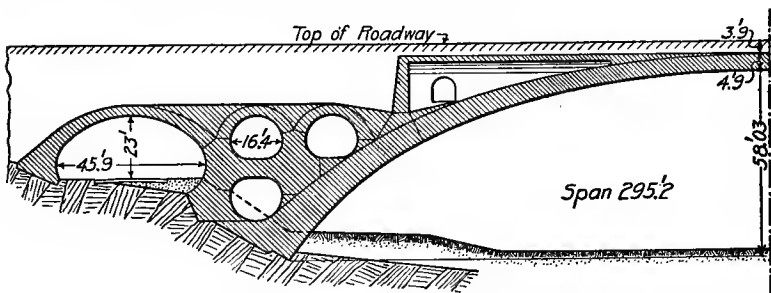

FIG. 216. PLAUEN ARCH.

For three different methods of lightening the haunches, see Fig. 217, page 662, Fig. 219, page 664, and Fig. 220, page 665.

1282. Notice that the lines radiating successively from P , Fig. 215, will intercept increasing lengths on the load-line; and that, therefore, the load which will keep a circular arch in equilibrium must increase in intensity per horizontal foot, from the crown towards the springing, and must become infinite at the springing of a semi-circular arch. Hence it follows that it is not practicable to load a circular arch, beyond a certain distance from the crown, so that the line of resistance shall coincide with the center line of the arch ring.

1283. EXAMPLES OF VOUSOIR ARCHES. A few illustrations of actual arches will be given to show some of the details of construction of arches and of centers. Space will not permit a full presentation of all important details, but a few examples will be given to illustrate

the general principles discussed in the preceding portions of this chapter.

1284. Plauen Arch. Fig. 216, page 661, shows a half section of the largest masonry arch in the world—see Table 90, pages 648.

The total span is 295.3 ft. and the total rise is 59.5 ft.; but the span of the arch proper is 213.3 ft., and the rise 21.2 ft. The largest of the transverse arches through the haunch is for the passage of a street. Between the crown and the transverse arches are longitudinal arches.*

1285. Luxemburg Arch. Fig. 217 shows a half cross section of the second largest voussour arch in the world—see Table 90, pages 648. Nominally the span is 277.7 ft., and the rise 101.7

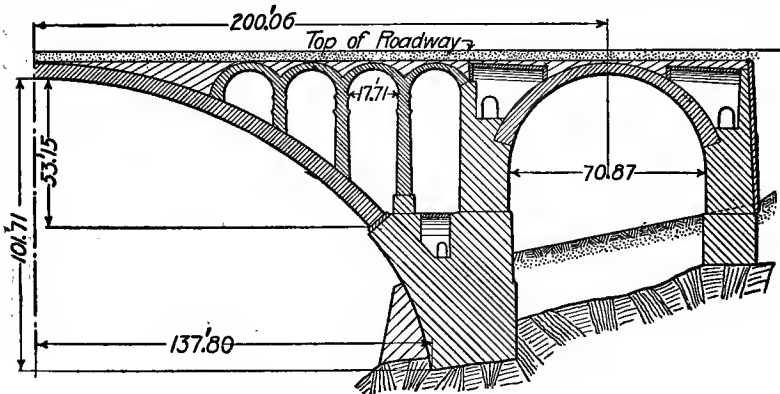

FIG. 217. LUXEMBURG ARCH.

ft.; but really the span of the arch, counting from the top of the curved abutment, is only 233 ft., and the rise only 53 ft. The bridge carries a 32-ft. roadway and two 10-ft. sidewalks. The arch consists of two parallel ribs each approximately 18 ft. wide, set approximately 18 ft. apart, with a reinforced concrete floor slab spanning the distance between them. This is an original and truly noteworthy conception. The advantages of this feature are: 1. The amount of masonry, and consequently the cost, is reduced nearly one third. 2. By dividing the arch it was possible to complete an arch ring in a single working season. 3. The centers for the first arch ring can be moved over and be used again for the second.

The design has been criticized adversely for the following reasons: 1. The full arch is not visible, or rather the skewback is invisible, which gives an inartistic effect. 2. The curved abutment looks like

* For additional data and illustrations of the arch and the center, see *Engineering News*, vol. li, p. 73-77 (Jan. 28, 1904); *ibid.* vol. liv, p. 155-57 (Aug. 17, 1905).

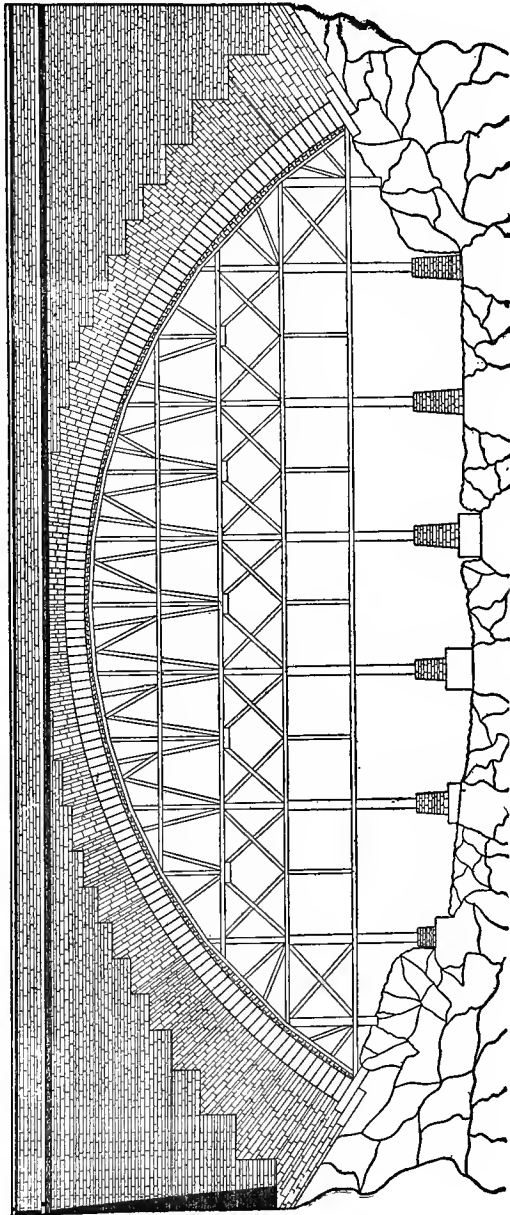

FIG. 218. CABIN JOHN ARCH.

a column that is bending under its load, and tends to give an impression of instability.*

1286. **Cabin John Arch.** Fig. 218,† page 663, shows the elevation of the Cabin John voussoir arch, near Washington, D. C. It was completed in 1859. The arch is a circular arc of 110°; and

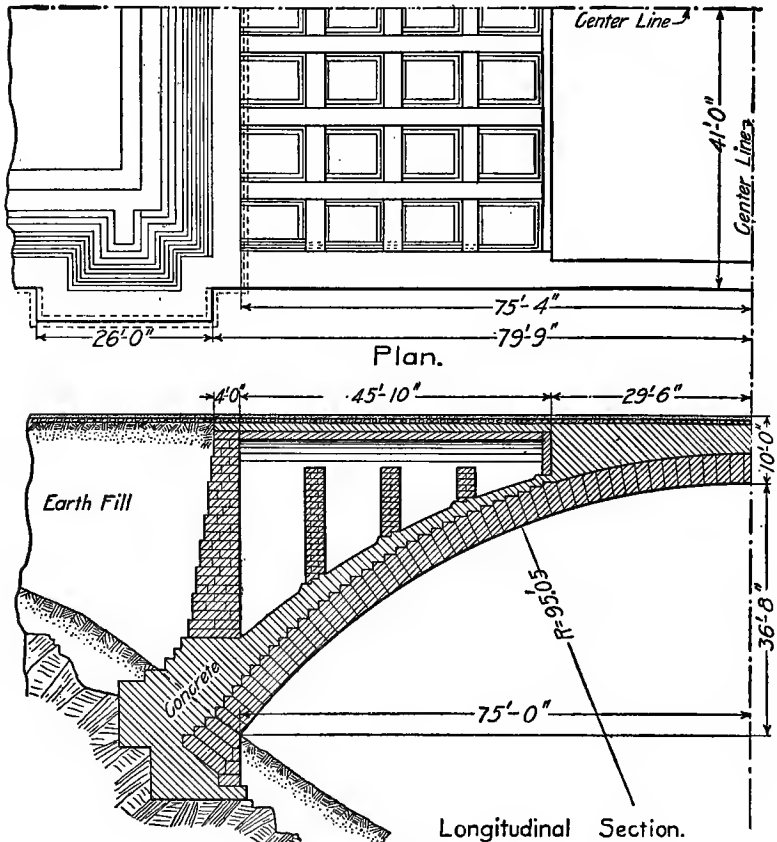

FIG. 219. BELLEFIELD ARCH.

carries a conduit (clear diameter 9 feet) and a carriage-way (width 20 feet). The top of the roadway is 101 feet above the bottom of the ravine. The voussoirs are Quincy (Mass.) granite, and are 2 feet

* For additional data and illustrations of the arch and the center, see *Engineering News*, vol. xlvii, p. 179-180, 193, 254.

† Compiled from photographs taken during the progress of the work (1856-1860), by courtesy of Gen. M. C. Meigs, chief engineer.

thick, and 4 feet deep at the crown and 6 feet at the springing. The spandrel filling is composed of Seneca sandstone, which, for a distance above the arch of 4 feet at the crown and 15 feet at the springing, is laid in regular courses with joints radial to the intrados; and hence the effective thickness of the arch is about 8 feet at the crown and about 21 feet at the springing.

For more than forty years this was the largest masonry arch in the world; and at present it is the largest voussoir arch in this country. It is also the largest masonry arch in this country, except two concrete arches—see Nos. 1 and 2 of Table 99, page 703.

1287. Bellefield Arch. Fig. 219 shows a half section and partial plan of the main arch of Bellefield bridge at the entrance to Schenley Park, Pittsburg, Pa. For the main dimensions of the arch, see No. 20 of Table 90, page 648. Fig. 219 is given to show

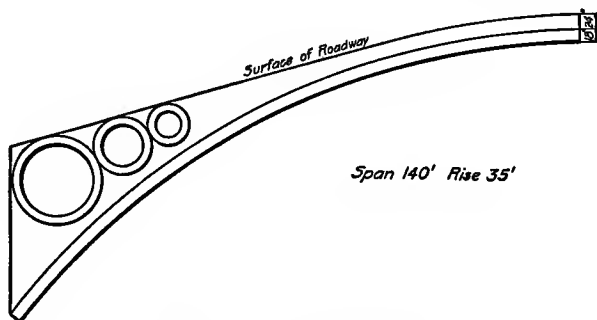

FIG. 220. PONT-Y-PRYDD ARCH.

the method of securing empty spaces in the spandrel filling. The spandrel walls parallel to the roadway are built of rubble masonry, and are connected at their top by brick arches; and the transverse spandrel walls, also built of rubble, are stopped on a level with the springing line of the brick arches. Notice the concrete backing near the crown between the extrados and the roadway.*

1288. Pont-y-Prydd Arch. Fig. 220 shows a half section of the Pont-y-Prydd bridge—see No. 25 of Table 90, page 648. This is a remarkable bridge. It was built by an “uneducated” mason in 1750; and although a very rude construction, is still in perfect condition. A former bridge of the same general design at the same place fell, on striking the centers, by the weight of the haunches forcing up the crown; and hence in building the present structure the load on the haunches of the arch was lightened by

* For additional data and illustrations, see *Engineering Record*, June 9, 1899; or *Engineering News*, June 22, 1899.

leaving horizontal cylindrical openings through the spandrel filling. The cylindrical arches extend from the face of one parapet wall to that of the other. In addition, the filling immediately over the arch and around the cylinders was charcoal. This is among the first applications of this method of lessening the load on the haunches. Between the surface of the roadway and the extrados is rubble masonry laid with horizontal joints. The outer, or showing, arch stones are 2.5 feet deep, and that depth is made up of two stones; and the inner arch stones are only 1.5 feet deep, and but from 6 to 9 inches thick. The stone quarried with tolerably fair natural beds, and received little or no dressing. It is a wagon-road bridge, and has almost no spandrel filling, the roadway being very steep. A stress sheet of the arch shows that the line of resistance remains very near

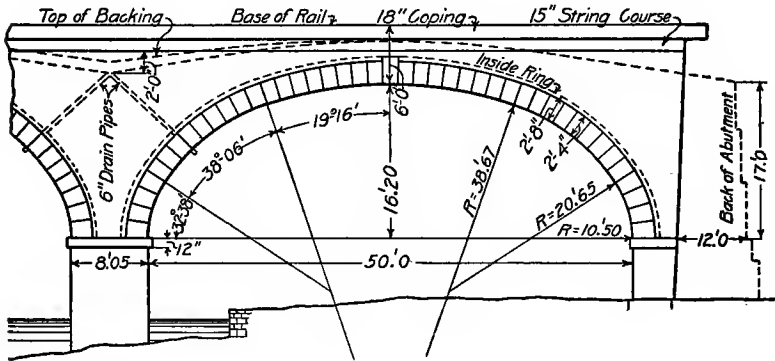

FIG. 221. LITTLE JUNIATA BRIDGE.

the center of the arch ring. The maximum pressure is about 1,025 pounds per square inch. It is an example of very creditable engineering.

1289. Pennsylvania R. R. Bridge. Fig. 221 shows one of the spans of Little Juniata Bridge No. 12 on the Pennsylvania Railroad; and is given mainly to show (1) the method of draining an arch and (2) the amount of backing that is ordinarily employed.* Formerly the backing was usually rubble masonry, but now it is generally concrete; and in either case, the amount is ordinarily enough to add materially to the strength of the structure, although the backing is not usually considered in computing the strength of the arch.

1290. EXAMPLES OF ARCH CENTERS. Fig. 222 shows the center designed for the 60-foot granite arches of the Washington Bridge

* By courtesy of William H. Brown, Chief Engineer.

over the Harlem River, New York City.* The bridge is 80 feet wide, and fifteen ribs were employed. Notice that the center does not extend to the springing line of the arch, the first fifteen feet of the arch being laid by a template.

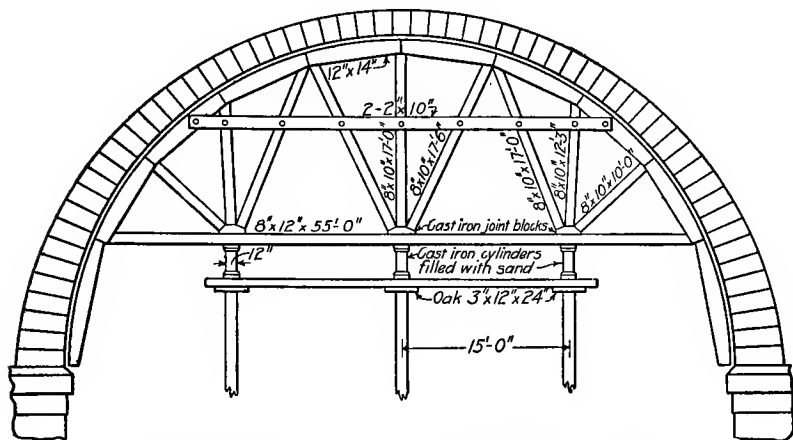

FIG. 222.—CENTER FOR ARCH IN WASHINGTON BRIDGE.

For other examples of arch centers, see Fig. 218, page 663, and Fig. 226, page 669.

1291. SPECIFICATIONS FOR STONE-ARCH MASONRY. See Appendix III, page 729, for the standard specifications of the American Railway Engineering and Maintenance of Way Association for stone-arch masonry.

ART. 5. BRICK ARCHES.

1292. Brick masonry is much used in constructing arched sewers and for arched tunnel lining. Owing to their great number of joints, brick arches are likely to settle much more than stone ones when the centers are removed; and hence are less suitable than stone for large or for flat arches. Nevertheless a number of brick arches of large span have been built. For some striking examples, see No. 28, and 30 of Table 90, page 648; and many brick arches having spans from 50 to 80 feet have been built. However, such large brick arches were built before plain and reinforced concrete became so common as at present.

1293. BOND IN BRICK ARCHES. The only matter requiring special mention in connection with brick arches is the bond to be

* By courtesy of Wm. R. Hutton, Chief Engineer.

employed. When the thickness of the arch exceeds a brick and a half, the bond from the soffit outward requires attention. There are three principal methods employed in bonding brick arches. (1) The arch may be built in concentric rings; i.e., all the brick may be laid as stretchers, with only the tenacity of the mortar to unite the several rings (see Fig. 223). This form of construction is frequently called *rowlock bond*. (2) Part of the brick may be laid as stretchers and part as headers, as in ordinary walls, by thickening the outer ends of the joints—either by using more mortar or by driving in thin pieces of slate—so that there shall be the same number of bricks in each ring (see Fig. 224). This form of construction is known as

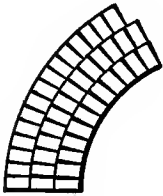

FIG. 223.

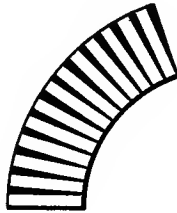

FIG. 224.

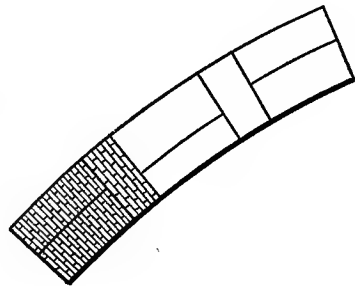

FIG. 225.

header and stretcher bond, or is described as being laid with *continuous radial joints*. (3) *Block in course bond* is formed by dividing the arch into sections similar in shape to the voussoirs of stone arches, and laying the brick in each section with any desired bond, but making the radial joints between the sections continuous from intrados to extrados. With this form of construction, it is customary to lay one section in rowlock bond and the other with radial joints continuous from intrados to extrados, the latter section being much narrower than the former (see Fig. 225).

1. The objection to laying the arch in concentric rings is that, since the rings act nearly or quite independently of each other, the proportion of the load carried by each can not be determined. A ring may be called upon to support considerably more than its proper share of the load. This is by far the most common form of bonding in brick arches, and that this difficulty does not more often manifest itself is doubtless due to the very low unit working pressure employed. The *mean* pressure on brick masonry arches ordinarily varies from 20 to 40 pounds per square inch, under which condition a single ring might carry the entire pressure (see § 622-27). The objection

to this form of bond can be partially removed by using the very best cement mortar between the rings.

The advantages of the ring bond, particularly for tunnel and sewer arches, are: *a.* It gives 4-inch toothings for connecting with the succeeding section, while the others give only 2-inch toothings along much of the outline. *b.* It requires less cement, is more rapidly laid, and is less liable to be poorly executed. *c.* It possesses certain advantages in facilities for drainage, when laid in the presence of water.

2. The objection to laying the arch with continuous radial joints is that the outer ends of the joints, being thicker than the inner, will yield more than the latter as the centers are removed, and hence

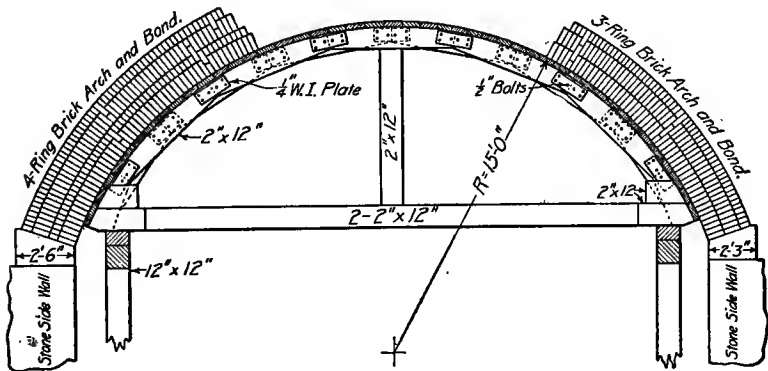

FIG. 226. BOND AND CENTERING FOR VOSBURG TUNNEL.

concentrate the pressure on the intrados. This objection is not serious when this bond is employed in a narrow section between two larger sections laid in rowlock courses (see Fig. 225).

3. When the brickwork is to be subject to a heavy pressure, some form of the block in course bond should be employed. For economy of labor, the "blocks" of headers should be placed at such a distance apart that between each pair of them there shall be one more course of stretchers in the outer than in the inner ring; but a moment's consideration will show that this would make each section about half as long as the radius of the arch,—which, of course, is too long to be of any material benefit. Hence, this method necessitates the use of thin bricks at the ends of the rings.

1294. EXAMPLE OF BRICK ARCH. Fig. 226 shows the bond and the center employed in arching the Vosburg tunnel on the Lehigh Valley Railroad.*

* Rosenberg's The Vosburg Tunnel, p. 45.

CHAPTER XXIII

ELASTIC ARCH

1296. An elastic arch is one which is considered to support its load by virtue of the internal stresses developed in the material. Any voussoir arch, whether made of stone or brick, will act as an elastic arch as long as the line of resistance remains within the middle third of every joint, i.e., as long as no tension is developed; and any arch, whether voussoir or monolithic, will act as an elastic arch as long as the maximum tension does not exceed the safe tensile strength of the mortar or the elastic limit of the concrete. In the preceding chapter, the arch, whether voussoir or monolithic, was considered as being held in equilibrium by compression and friction. In this chapter, the arch is to be considered as being held in equilibrium by its resistance to combined compression and bending, i.e., it is proposed to consider the arch ring as a curved beam.

The analysis of a plain concrete arch with fixed ends will first be considered and later will be discussed the modifications necessary for a reinforced concrete arch and for hinged arches.

ART. 1. PLAIN CONCRETE ARCH HAVING FIXED ENDS.

1297. All theories of the elastic arch, like those of the voussoir arch, are only methods of verification. The first step is to assume the dimensions of the arch ring outright or to make them agree with some existing arch or conform to some empirical formula; and the second step is to compute the stresses according to the theory. Then, if the computed stresses are greater than is considered safe, the dimensions must be altered and the arch tested again.

1298. THE EXTERNAL FORCES. All that was said under this head in § 1205-09 as to the difficulty and the uncertainty in finding the loads to be supported applies to elastic arches as well as to voussoir arches; and nothing further is required here concerning that phase of the subject.

1299. In finding the stresses in an elastic arch, it is the almost universal custom to consider the load as being entirely vertical. This is done because the omission of the horizontal components

greatly simplifies the problem. If the horizontal components are retained, it is practically impossible to compute the stresses by the graphical process; and since, for other reasons also, a graphic solution is more desirable than an algebraic one (see § 1340), it is customary to employ the graphical process and consider all the external forces as being vertical. The horizontal components are an element of stability, and hence the arch will have greater stability than that given by the usual graphical solution.

1300. CONDITIONS FOR AN ARCH HAVING FIXED ENDS. If the physical conditions are such as to fix the ends of the arch, then the three following mathematical conditions will be satisfied, viz.: 1. The inclination of the tangents at the ends of the neutral axis will not change when the load is applied. 2. The relative elevations of the two abutments will remain unchanged. 3. The length of span of the neutral axis of the arch ring will not change.

The problem of testing an arch according to the elastic theory consists in finding a line of resistance or a linear arch (§ 1195) that will satisfy the above conditions and at the same time give safe values for the stresses in the arch ring.

1301. Conditions Stated Mathematically. To make the above conditions available as instruments in the investigation of an arch, they must be stated in mathematical terms. To state them in algebraic form proceed as follows:

1302. First Condition. In Fig. 227, let $CDKH$ be an element of a curved beam ds long, whose end faces CD and HK are at right angles to the neutral axis FG . In the original position, the tangents to the neutral axis at the points F and G make an angle with each other of $d\theta$. Let

$d\phi$ = the change of angle between the end faces, or between the tangents at the ends, due to the bending caused by the load;

da = an element of the area of the cross section;

E = the coefficient of elasticity of the material;

I = the moment of inertia of the cross section about the neutral line;

M = the total bending moment of the external forces on one side of any section HK about G ;

s = the length of the neutral line of the arch ring;

z = the distance of any fiber from the neutral line;

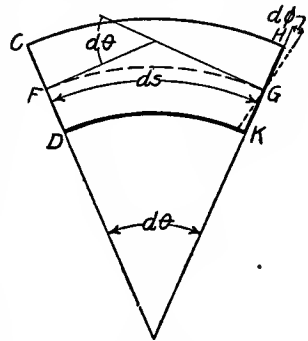

FIG. 227.

The change in length of a fiber at a distance z from the neutral axis will be equal to $z d\phi$, and the resulting stress per unit of area,

$$f = E \frac{z d\phi}{ds}, \text{ in which } ds \text{ is the original length of the fiber.}^*$$

The total moment of resistance then is

$$\int_K^H f z da = \int_K^H E z^2 da \frac{d\phi}{ds} \dots \dots (a)$$

The first member of this equation is equal to M ; and for any particular cross section, E and $\frac{d\phi}{ds}$ are constant. Hence

$$M = E \frac{d\phi}{ds} \int_K^H z^2 da = EI \frac{d\phi}{ds} \dots \dots (b)$$

which by transposition gives

$$d\phi = \frac{M ds}{EI} \dots \dots \dots (c)$$

The integral of equation c gives the total change of the angle between the tangents at the two ends of the arch AB , Fig. 228; but for an arch having fixed ends this change is zero, and hence

$$\int_A^B \frac{M ds}{EI} = 0 \dots \dots \dots (1)$$

Equation 1 is an algebraic statement of the first condition given in § 1300.

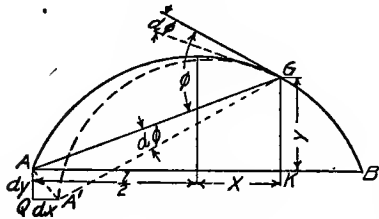

FIG. 228.

1303. *Second Condition.* In Fig. 228, let AGB represent the original position of the linear arch, and $A'GB$ the position it would take due to the stresses in the section at G , if the end A were free. From the similar triangles GAK and AQA' , we have $AQ : AA' :: AK : AG$, or $dy :$

$AG \cdot d\phi :: \frac{1}{2} l + x : AG$; and therefore $dy = (\frac{1}{2} l + x) d\phi$, and substituting the value of $d\phi$ from equation c and passing to the integral as in § 1302, we have for the equation for the second condition:

$$dy = \frac{M (\frac{1}{2} l + x) ds}{EI} \dots \dots \dots (d)$$

* This assumes the length of all fibers before distortion to be ds , while in fact each fiber has a different length; but as the depth of the arch ring is usually quite small in comparison with its radius of curvature, the error is very small.

The integral of equation *d* between the limits *A* and *B*, Fig. 228, is the total change of elevation along the arch ring due to the effect of the load; but for an arch having fixed ends, this change is zero, and hence

$$\int_A^B \frac{M x ds}{EI} = 0, \quad \dots \dots \dots (2)$$

which is the algebraic statement of the second condition in § 1300.

1304. Third Condition. In Fig. 228, from similar triangles we have $QA' : AA' :: GK : AG$, or $dx : AG \cdot d\phi :: y : AG$, and therefore $dx = y d\phi$; and by substituting the value of $d\phi$ from equation *c*, § 1302, we have

$$dx = \frac{M y ds}{EI} \quad \dots \dots \dots (e)$$

The integral of equation *e* between the limits *A* and *B* is the change of span due to the effect of the load; but for an arch having fixed ends, this change is zero, and hence

$$\int_A^B \frac{M y ds}{EI} = 0, \quad \dots \dots \dots (3)$$

which is the algebraic statement of the third condition in § 1300.

1305. Simplification of the Equations of Condition. To adapt the preceding equations of condition, equations 1, 2, and 3, to graphical computations, it is necessary to make certain modifications, as follows:

1306. To pass from Infinitesimals to Finites. To adapt the equations of condition, equations 1, 2, and 3, to graphical computations, it is necessary to use finite increments instead of differentials. Each of the equations of condition contains the term $ds \div I$. The value of ds varies from point to point according to the curvature of the arch ring; and I , the moment of inertia of the cross section, usually increases from the crown toward the springing, since the arch ring usually is deeper at the springing than at the crown,—as it should be, since the thrust in the arch increases toward the springing. Therefore, if the neutral line of the arch ring is divided into a number of short sections, Δs , such that $\Delta s \div I$ is constant, we may substitute in the equations of condition the finite and constant quantity $\Delta s \div I$ for the infinitesimal and variable quantity $ds \div I$. A method of dividing the arch ring so as to make $\Delta s \div I$ constant will be explained later (see § 1311).

1307. *E* Constant. The coefficient of elasticity of concrete varies with the unit load (§ 409), but within the ordinary working stress the variation for any particular concrete is not great; and

therefore E may be regarded as a constant, and may be placed before the sign of integration in the equations of condition.

1308. Equations of Condition Re-stated. By placing $ds \div I$ and $1 \div E$ outside of the integration sign, and using the summation sign, equations 1, 2, and 3 become, respectively,

$$\Sigma M = 0 \dots\dots\dots (4)$$

$$\Sigma M.x = 0 \dots\dots\dots (5)$$

$$\Sigma M.y = 0 \dots\dots\dots (6)$$

1309. Equations of Condition in Graphic Terms. To adapt the above equations to graphic computations, it is necessary to find M in graphic terms. To do this, let GJ in Fig. 229 be a portion of the arch, ab the neutral line, ac a vertical line, and ce be the adjacent side of the equilibrium polygon, and ae a line from a perpendicular to ce . Let R represent the magnitude of the force acting in the line ce , i.e., R is the length of the ray in the force diagram parallel to the

side ce of the equilibrium polygon; and let H be the horizontal component of R , i.e., H is the true pole distance.

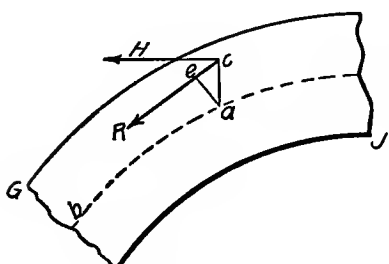

FIG. 229.

The force R , being eccentric, tends to bend the arch rib; and the amount of the bending, M , about a is $R.ae$. By similar triangles, $R.ae = H.ac$; that is, the bending moment at any section of an arch rib acted upon by vertical loads is equal to the true

pole distance multiplied by the vertical intercept between the true equilibrium polygon and the neutral line. Substituting the above value of M in equations 4, 5, and 6, and remembering that H is a constant for any particular system of loads, the equations of condition become, respectively,

$$\Sigma_{\Delta}^B ac = 0 \dots\dots\dots (7)$$

$$\Sigma_{\Delta}^B ac.x = 0 \dots\dots\dots (8)$$

$$\Sigma_{\Delta}^B ac.y = 0 \dots\dots\dots (9)$$

in which ac is a general expression for the intercept between the true equilibrium polygon and the neutral line of the arch ring, and x is

the horizontal distance of any point from the mid-span, and y is the vertical distance of any point above a horizontal line through the abutments.

1310. Method of Fulfilling the Equations of Condition. In Fig. 230, let $a_1 \dots a_8 \dots a_8$ represent the neutral line of an arch ring, $c_1 \dots$

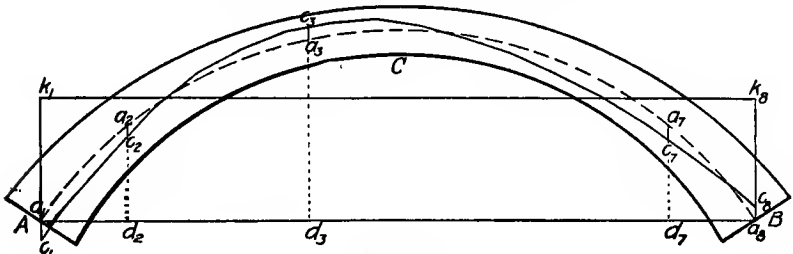

FIG. 230.

$c_3 \dots c_8$ the true equilibrium polygon, and $k_1 \dots k_8$ an axis of reference. Then at any point

$$ac = ck - ak \dots \dots \dots (e)$$

Taking the summation of equation e , and remembering that $\Sigma ac = 0$, we have:

$$\Sigma ac = \Sigma ck - \Sigma ak = 0; \text{ or } \Sigma ck = \Sigma ak \dots \dots \dots (10)$$

Multiplying equation e by x , and taking the summation,

$$\Sigma ac \cdot x = \Sigma ck \cdot x - \Sigma ak \cdot x = 0; \text{ or } \Sigma ck \cdot x = \Sigma ak \cdot x \dots \dots \dots (11)$$

Similarly

$$\Sigma ac \cdot y = \Sigma ck \cdot y - \Sigma ak \cdot y = 0; \text{ or } \Sigma ck \cdot y = \Sigma ak \cdot y \dots \dots \dots (12)$$

Therefore we see that the three equations of condition, equations 7, 8, and 9, will be satisfied, if equations 10, 11, and 12 are fulfilled. Furthermore, equations 10 and 11 will be fulfilled, if the axis $k_1 \dots k_8$ is taken so as to make

$$\Sigma ak = 0 \dots \dots \dots (13)$$

$$\Sigma ck = 0 \dots \dots \dots (14)$$

$$\Sigma ak \cdot x = 0 \dots \dots \dots (15)$$

$$\Sigma ck \cdot y = 0 \dots \dots \dots (16)$$

Hence the determination of an equilibrium polygon satisfying equations 7, 8, and 9, is accomplished by (1) dividing the arch ring into sections such that $\Delta s \div I$ is constant, (2) finding a reference

line for the arch ring such that $\Sigma ak = 0$ and $\Sigma ak \cdot x = 0$, and (3) constructing thereon an equilibrium polygon such that $\Sigma ck = 0$, $\Sigma ck \cdot x = 0$, and $\Sigma ck \cdot y = \Sigma ak \cdot y$.

1311. To MAKE $\Delta s \div I$ CONSTANT. The first step is to divide the neutral axis of the arch ring so that $\Delta s \div I$ will be a constant. Since the thrust increases from the crown toward the springing, the depth of the arch ring usually also increases toward the springing, which gives a variable moment of inertia. The moment of inertia increases as the cube of the depth; and hence a comparatively small change in the depth will cause a large change in the moment of inertia. Therefore, to keep $\Delta s \div I$ constant, it will be necessary to make Δs much greater near the springing than at the crown.

There are several methods of determining the successive divisions of the arch ring, but the following graphical process is the simplest. Divide the neutral line of the semi-arch ring into any number of equal parts, say, from 5 to 10; and measure the radial depth of the ring at each point of division. Rectify the neutral line, either by stepping around it with a pair of dividers or by computation, and lay off this distance to scale from A' to C' in Fig. 231; and divide the line $A'C'$ into the same number of equal parts as the semi-arch ring. At each point of division of $A'C'$ erect a vertical equal to the moment of inertia at the corresponding point on AC ; or since in a plain concrete arch the moment of inertia is proportional to the cube of the depth, we may lay off the latter quantity instead of the moment of inertia. Connect the tops of these verticals by a smooth curve DF , and then it may be assumed that any ordinate to the curve DF is proportional to the moment of inertia at the corresponding point of the arch ring.

To divide the neutral line of the arch ring into portions Δs so that $\Delta s \div I$ shall be constant, draw a line $C'a$ at any slope and then a line ab at the same slope, and continue the construction by drawing other isosceles triangles as shown, using always the same slope. This divides the rectified arch ring into a number of parts, Cb , bd , df , etc., such that the length of each part divided by the moment of inertia at its center is constant, i.e., $\Delta s \div I = 2 \tan a$, in which a is the angle between the sides of the isosceles triangles and the vertical. It is not important that a point of division shall fall exactly at A' , since many arches join the abutment by a gradually increasing section, and hence there is really no springing line, and also since most arches are so thick at the springing that the position of the line of resistance is mainly determined by the portion of the arch ring over the central half of the span.

1312. The arch ring can be divided into a predetermined number of parts only by successive approximations. To make the first

approximation, find the average value of the moment of inertia at several points, say, the equidistance points used in constructing DF , Fig. 231, i.e., find the average of the ordinates used in constructing Fig. 231, and designate the result I_a . Then if n = the number of parts into which AC or $A'C'$ is to be divided,

$$2I \tan a = \Delta s = s \div n.$$

$$\Sigma 2I \tan a = \Sigma \Delta s = s.$$

$$2n I_a \tan a = s.$$

$$\tan a = \frac{s}{2n I_a} = \frac{\Delta s}{2I_a}$$

The I_a found as above is not the average of the ordinates at a, c, e , etc.; and consequently a solution depending upon it will be only

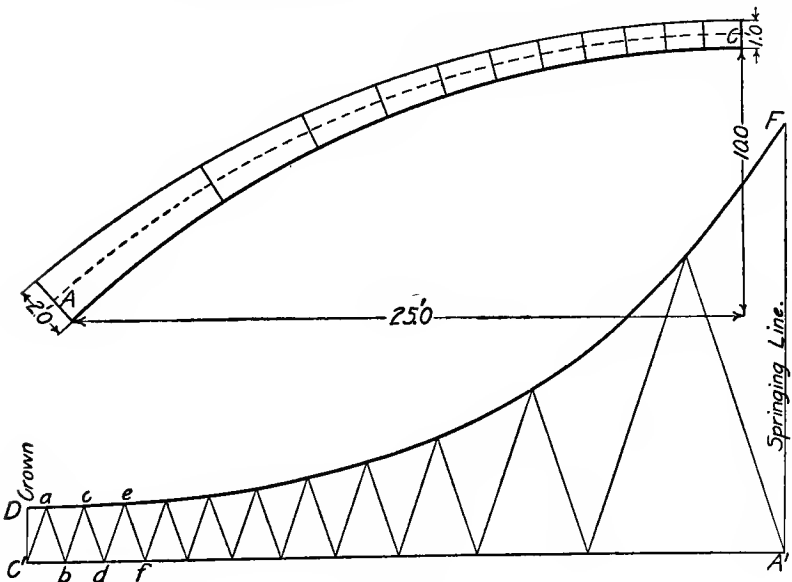

FIG. 231.

an approximation. To make a first approximation, lay off $\tan a$ a little smaller than the value computed above, and construct a series of isosceles triangles. By using a Brown and Sharp protractor these triangles can be constructed very quickly. To make a second approximation, find a new value of I_a by taking the mean of the ordinates at a, c, e , etc., and construct a new series of triangles. For a third approximation, determine a third value of I_a by measuring the or-

dinates at a, c, e , etc., of the second series of triangles. The third approximation is usually practically exact. In making the exact division, it is better to begin at A in constructing the isosceles triangles, since then the first side of each triangle intersects the curve DF more nearly at right angles, and hence the solution is more accurate.

1313. TO LOCATE THE LINE kk . The second step (§ 1310) is to locate the line kk , Fig. 230, page 675, so as to satisfy the conditions $\Sigma ak = 0$ and $\Sigma ak \cdot x = 0$. Since the line joining the abutments is horizontal, if a horizontal line k_1k_2 is drawn at a distance above AB equal to the average of the ordinates to the neutral line, then $\Sigma ak = 0$; that is, if $a_1 k_1 = \Sigma ad \div (n + 2)$ in which n is the number of sections in the arch ring (§ 1312), then equation 13, page 675, i.e., $\Sigma ak = 0$, is satisfied.

Since the arch is symmetrical with reference to a vertical line through the crown, and since the points of divisions of the arch ring are also symmetrical with reference to the crown, the line k_1k_2 drawn as above, also satisfies the equation 15, page 675, which is $\Sigma ak \cdot x = 0$.

Equations 14 and 16, page 675, and also equation 9, page 674, involve the equilibrium polygon, and hence they can not be satisfied until that is determined.

1314. TO FIND THE TRUE EQUILIBRIUM POLYGON. The third step (§ 1310) is to construct on the line kk , Fig. 230, page 675, an equilibrium polygon which will satisfy the conditions: $\Sigma ck = 0$, $\Sigma ck \cdot x = 0$, and $\Sigma ck \cdot y = \Sigma ak \cdot y$. The equilibrium polygon which satisfies these conditions is the true equilibrium polygon, and having this the stresses in the arch can readily be found. The method of finding the true equilibrium polygon can best be explained in connection with the working of an example.

1315. The Data. We will use for the illustration a segmental circular plain-concrete arch of the following dimensions: Span of the neutral line, 50 ft.; rise of the neutral line, 10 ft.; thickness at the crown, 2.0 ft.; thickness at the springing in the line of the radius of the neutral line, 5 ft.; depth of earth over the crown of the extrados, 2 ft.; live load over half the span, 100 lb. per sq. ft. The live load is taken over only half the span to illustrate a method of procedure for unsymmetrical loads. We will assume concrete to weigh 150, and earth 100 lb. per cu. ft. We will consider only a section of the arch ring 1 ft. long, i.e., 1 ft. perpendicular to the plane of the drawing. Fig. 232 shows the dimensions of the arch.

The first step is to divide the neutral line of the semi-arch into a number of parts such that the length of each part divided by the moment of inertia of the cross section shall be constant. By the

sided that it conforms closely to the pressure curve, or so construct the equilibrium polygon that its sides shall be tangent to the pressure curve at the points where the intercepts are to be measured. The first necessitates the dealing with numerous loads, and hence entails considerable work; while the second can be done without unnecessary labor.

TABLE 93.

DATA FOR MAKING $\Delta s \div I$ CONSTANT.

Ref. No.	Rectified Distance from Crown.	Δs	Depth of Arch Ring on Radius of Neutral Line at Middle of Δs .	Cube of Depth.	$I = \frac{1}{12} b d^3$.	$\frac{\Delta s}{I}$
0	0.00	0.00	2.000	8.00	0.66
1	1.54	1.54	2.004	8.04	0.67	2.30
2	3.13	1.59	2.02	8.24	0.69	2.31
3	4.82	1.69	2.07	8.87	0.73	2.32
4	6.72	1.90	2.14	9.80	0.81	2.34
5	8.95	2.23	2.27	11.69	0.95	2.35
6	11.80	2.85	2.46	14.88	1.22	2.34
7	16.02	4.22	2.80	21.95	1.81	2.33
8	27.58	11.56	3.91	59.78	4.97	2.33

Therefore, if we draw vertical lines through a_1, a_2, a_3 , etc., Fig. 232, page 679, the middle of the several divisions of the arch ring, and find the dead and live loads for each section, the resulting equilibrium polygon will have its sides almost exactly tangent to the pressure curve at the verticals through a_1, a_2 , etc., the points at which the intercepts are to be measured. Since the end section of the arch ring is rather long, it was divided into three portions and the load found for each. The loads for each of the several sections are stated in the upper portion of Fig. 232. These loads act at the center of gravity of each vertical slice, which may usually be taken midway between the vertical sides except possibly for a few slices near the springing. For the latter portions, the center of gravity may be found as in § 935.

1317. Trial Equilibrium Polygon. The first step toward finding the true equilibrium polygon is to draw a trial equilibrium polygon. The arch is loaded as shown in Fig. 232. The arch is re-drawn to a larger scale in Fig. 233—a folding sheet facing page 688.

To construct the trial equilibrium polygon proceed as follows: 1. Lay off a load line 1. . . . 19 to represent the loads. 2. Choose a trial pole, which may be at any point but which should preferably be at a point

such that the pole distance will be some round number as 10,000, 20,000, etc., and also approximately opposite the point on the load line that divides the load line into the two reactions. The true pole distance can be approximately determined by applying Navier's principle (§ 1214) to the crown of the arch. In the case in hand, the crown thrust as computed by Navier's principle is: $T = p\rho = (2 \times 150 + 2 \times 100 + 100) 36.25 = 21,749$ lb. Hence the trial pole distance was taken at 20,000 lb., and the trial pole was located a little below the center of the load line at P' . 3. Draw the several rays. 4. Construct the equilibrium polygon $b_1 \dots b_9 \dots b_{18}$. 5. Draw a line from $v_1 (= b_1)$ to $v_{18} (= b_{18})$; and drop vertical from b_2, b_3 , etc., upon v_1, v_{18} , and mark the points $v_2 \dots v_9 \dots v_{17}$.

1318. If the arch were either hinged or simply supported at A and B , there would be no moment at these points, and hence the closing line of the equilibrium polygon would be parallel to the line AB , and the true equilibrium polygon could readily be found; but as the arch under consideration has fixed ends, there is a moment at each abutment, and therefore the position of the closing line is not known, and hence the true equilibrium polygon can not be found by the usual method.

The first step toward finding the true equilibrium polygon is to find the position of the closing line, $m_1 \dots m_{18}$, of the trial equilibrium polygon, $b_1 \dots b_9 \dots b_{18}$. Since the summation of the moments at the various points of an arch ring having fixed ends is zero, and since the ordinates of an equilibrium polygon are proportional to the moments, the closing line should have such a position that the summation of the intercepts between it and the equilibrium polygon will be zero, i.e., the closing line should satisfy the condition $\Sigma M = 0$, or its equivalent

$$\Sigma (b_1 m_1 + b_2 m_2 + \dots + b_{17} m_{17} + b_{18} m_{18}) = 0.$$

But the above condition is not enough to fix the position of the closing line, since any number of lines can be drawn which will make the sum of the intercepts equal to zero. The other condition which may be employed to fix the closing line is that stated in equation 5, page 674, viz.: $\Sigma M \cdot x = 0$, or its equivalent

$$\Sigma (b_1 m_1 \cdot x_1 + b_2 m_2 \cdot x_2 + \dots + b_{17} m_{17} \cdot x_{17} + b_{18} m_{18} \cdot x_{18}) = 0.$$

To show how to utilize the above conditions in finding the closing line, the problem may be restated as follows: If the trial equilibrium polygon be considered without reference to the arch, the intercepts $b_1 v_1 \dots b_9 v_9 \dots b_{18} v_{18}$ may be regarded as forces; and then the problem of finding the closing line may be regarded as that to find what system of minus forces must be added to the positive forces $b_1 v_1 \dots b_9 v_9 \dots b_{18} v_{18}$ to satisfy the conditions $\Sigma M = 0$ and $\Sigma M \cdot x = 0$,

or their equivalents $\Sigma bm = 0$ and $\Sigma bm \cdot x = 0$. Then, since the summation of the moments is to be made equal to zero, i.e., since we are to have $\Sigma bm = 0$, the total minus forces must be equal to the total positive forces; and since we are also to have $\Sigma bm \cdot x = 0$, the resultant of the minus forces must lie in the same line as the resultant of the positive forces.*

The preceding principles make it possible to find (1) the resultant of the positive forces and (2) the closing line of the trial equilibrium polygon.

1319. To find the Resultant. The first step toward finding the closing line is to determine the amount and the position of the resultant R' , of the intercepts bv when considered as forces.

Table 94 gives the values of the coordinates x and y to the points of intersection of the lines of action and neutral line of the arch ring, and also various intercepts and products employed in the solution to follow. (Taking the origin of coordinates at the middle of the span gives smaller values of x and otherwise materially shortens the subsequent work.)

To find the magnitude of R' , the resultant of the forces represented by the intercepts bv , take the sum of $b_1v_1 \dots b_{18}v_{18}$, which is shown in Table 94 to be 164.71 ft.†

To find the position of the resultant, compute the successive products $bv \cdot x$, and divide their sum by the sum of the intercepts bv . The several products $bv \cdot x$ are given in Table 94; and their sum is -19.4 , which divided by 164.71 gives -0.12 ft. Hence, R' acts 0.12 ft. to the left of C , i.e., on the side toward the abutment that has the heavier load; or $\bar{x} = -0.12$ ft. Or, since the position of the intercepts bv is symmetrical about the crown, the equation of moments may be stated thus:

$$R \cdot \bar{x} = (b_2v_2 - b_{17}v_{17})x_2 + (b_3v_3 - b_{16}v_{16})x_3 \dots (b_9v_9 - v_{10}b_{10})x_9.$$

In solving the problem on a drawing board, this formula affords a method of finding the position of the resultant which is a little shorter than the preceding one.

1320. To find the Closing Line of the Trial Equilibrium Polygon. The next step is to find a closing line such that if the ordinates from it to $v_1 \dots v_9 \dots v_{18}$ are treated as forces, their resultant will be equal to R' in magnitude and coincide with it in position. We will assume a trial closing line n_1n_{18} parallel to v_1v_{18} , such that v_1n_1 is equal to the average of the bv ordinates, i.e., $v_1n_1 = v_{18}n_{18} = R' \div (16 + 2) = +9.15$ ft. (The line n_1n_{18} could be drawn in

* Regarding the intercepts bv as forces is only a device for making more clear the various steps in the solution immediately to follow, i.e., that in § 1319-22.

† Notice that although the ordinates have been considered as forces, they are really linear distances.

TABLE 94.
DATA FOR FINDING THE TRUE EQUILIBRIUM POLYGON.

Points.	NEUTRAL LINE OF ARCH RING.		TRIAL EQUILIBRIUM POLYGON.				TRUE EQUILIBRIUM POLYGON.					
	Coordinates from Center of Span Line.		Intercepts.		Products.		Intercepts.		Products.		$\frac{\sum ak.y}{bm} = \frac{\sum bm.y}{ck}$	
	x	y	bv	$n_1 F^2 v_1 = f$	bv.x	f.x	bm	ak	bm.y	ak.y		
1	-25.00	0.00	0.00	9.14	-	0.0	-228.5	+9.31	+7.57	+ 0.00	+ 0.00	+7.81
2	-20.48	3.68	4.82	7.49	-	98.8	-153.4	+4.49	+3.89	+16.52	+14.31	+3.77
3	-13.53	7.40	9.28	4.97	-	125.6	-67.3	-0.03	+0.17	- 0.22	+ 1.26	-0.02
4	-10.22	8.54	10.59	3.75	-	108.3	-38.4	-1.36	-0.97	-11.60	- 8.28	-1.14
5	- 7.77	9.18	11.28	2.83	-	87.7	-22.0	-2.06	-1.61	-18.92	-14.79	-1.73
6	- 5.74	9.57	11.64	2.09	-	66.8	-12.0	-2.46	-2.00	-23.53	-19.14	-2.06
7	- 3.97	9.80	11.86	1.44	-	47.1	- 5.7	-2.68	-2.23	-26.27	-21.87	-2.24
8	- 2.32	9.94	11.94	0.85	-	27.7	- 2.0	-2.79	-2.37	-27.72	-23.55	-2.34
9	- 0.77	9.999	11.99	0.28	-	9.2	- 0.2	-2.82	-2.43	-28.20	-24.30	-2.36
Crown	0.00	10.00										
10	+ 0.77	9.999	11.92		+ 9.2			-2.78	-2.43	-27.80	-24.30	-2.33
11	+ 2.32	9.94	11.81		+ 27.4			-2.68	-2.37	-26.63	-23.55	-2.25
12	+ 3.97	9.80	11.63		+ 46.2			-2.50	-2.23	-24.50	-21.87	-2.10
13	+ 5.74	9.57	11.35		+ 65.2			-2.25	-2.00	-21.52	-19.14	-1.88
14	+ 7.77	9.18	10.90		+ 84.7			-1.83	-1.61	-16.82	-14.79	-1.53
15	+10.22	8.54	10.20		+104.3			-1.13	-0.97	- 9.65	- 8.28	-0.95
16	+13.53	7.40	8.90		+120.6			+0.12	+0.17	+ 0.89	+ 1.26	+0.10
17	+20.48	3.68	4.60		+ 94.2			+4.40	+3.89	+16.19	+14.31	+3.70
18	+25.00	0.00	0.00		+ 0.0			+8.97	+7.57	+ 0.00	+ 0.00	+7.53
Σ			164.71		- 19.4		-529.5	-0.08	+0.04	-229.78	-192.72	-0.02

any position, but drawing it parallel to v_1v_{18} and making $v_1n_1 = R \div (16 + 2)$ simplifies the subsequent work).

We have said that the ordinates $v_1n_1 \dots v_{18}n_{18}$ may be regarded as representing the negative forces which must be added to the given forces to give the closing line n_1n_{18} ; and similarly, if lines n_1v_1 , n_1v_{18} , and $n_{18}v_{18}$ be drawn, the total negative load may be regarded as being represented by the ordinates to the two triangles $n_1v_{18}v_1$ and $n_1n_{18}v_{18}$. Designate the resultant of the forces represented by the triangle $n_1v_{18}v_1$ as trial T_l , and the resultant for the triangle $n_1n_{18}v_{18}$ as trial T_r . (The subscript of T indicates whether the resultant lies to the right or to the left of the center line $C'D'$). It is required to find the magnitude and position of T_l and T_r .

1321. The magnitude of trial T_l is the sum of the ordinates of the triangle $n_1v_{18}v_1$. Since the line n_1n_{18} was drawn parallel to v_1v_{18} , the triangles $n_1v_{18}v_1$ and $n_1n_{18}v_{18}$ are equal; and therefore trial $T_r = \text{trial } T_l = \frac{1}{2} R' = \frac{1}{2} (164.71) = 82.35$ ft.; and trial T_r is as far to the right of C' as trial T_l is to the left. Let \bar{x}_r represent the distance of trial T_r from C' . As just stated $\bar{x}_r = \bar{x}_l$.

The position of trial T_l is most conveniently found by taking moments of the intercepts about C' , and dividing by the sum of the intercepts. If a line be drawn from v_1 to F' (the point where n_1v_{18} crosses the vertical through C'), then the moment of the triangle $F'v_{18}D'$ is equal to that of $F'v_1D'$; and consequently the moment of $n_1v_{18}v_1$ about F' is equal to the moment of $n_1F'v_1$ about the same point. The intercepts of the triangle $n_1F'v_1$ are given in Table 94, page 683, as also the moments of these intercepts about F' , the former being designated f and the latter $f.x$. Forming the equation of moments as above and solving, we get $\bar{x}_l = \frac{\sum f.x}{\frac{1}{2} R'} = -6.44$ ft. Hence $\bar{x}_r = +6.44$ ft.

By taking moments about a point in trial T_l , we have: true $T_r \cdot (\bar{x}_l + \bar{x}_r) = R' \cdot (\bar{x}_l - \bar{x}) = 2 \text{ trial } T \cdot (\bar{x}_l - \bar{x})$; and therefore

$$\frac{\text{true } T_r}{\text{trial } T} = \frac{2(\bar{x}_l - \bar{x})}{\bar{x}_l + \bar{x}_r} = \frac{\bar{x}_l - \bar{x}}{\bar{x}_l}$$

Similarly, by taking moments about a point in trial T_r , we get

$$\frac{\text{true } T_l}{\text{trial } T} = \frac{2(\bar{x}_r + \bar{x})}{\bar{x}_l + \bar{x}_r} = \frac{\bar{x}_r + \bar{x}}{\bar{x}_r}$$

1322. The magnitude of trial T_l is increased, if the point n_1 is moved vertically upward; and is decreased, if n_1 is moved down. Further, the position of trial T_l is not changed if n_1 is moved vertically,

since all ordinates will be increased proportional to their lengths and hence the sum of the moments divided by the sum of the forces will remain constant; i.e., the distance from trial T_l to C' remains unchanged if n_1 is moved vertically either up or down. The movement of n_1 does not affect either the position or magnitude of trial T_r , since neither the magnitudes of the several ordinates nor their position horizontally is altered. Similarly a movement of n_{18} alters the value of trial T_r , but not its position.

Therefore, if m_1m_{18} is the true closing line, we have the proportion: trial T_l is to true T_l as v_1n_1 is to v_1m_1 ; or

$$v_1 m_1 = \frac{\text{true } T_l}{\text{trial } T} v_1 n_1;$$

and substituting the value of $\frac{\text{true } T_l}{\text{trial } T}$ and $v_1 n_1$ from above, we have

$$v_1 m_1 = \frac{\text{true } T_l}{\text{trial } T} v_1 n_1 = \frac{\bar{x}_r + \bar{x}}{\bar{x}_r} v_1 n_1 = 1.02 v_1 n_1 = 9.33 \text{ ft.}$$

Similarly, trial T_r is to true T_r as $v_{18} n_{18}$ is to $v_{18} m_{18}$; and hence

$$v_{18} m_{18} = \frac{\text{true } T_r}{\text{trial } T} v_{18} n_{18} = \frac{\bar{x}_l - \bar{x}}{\bar{x}_l} v_{18} n_{18} = 0.98 v_{18} n_{18} = 8.97 \text{ ft.}$$

The value of $v_1 m_1$ and $v_{18} m_{18}$ having been found, the true closing line is obtained by drawing a line from m_1 to m_{18} . The lines $n_1 n_{18}$ and $m_1 m_{18}$ should intersect at the middle of the span—a check always wise to note. Notice that by the above method,* the magnitude of neither trial T_r and true T_r , nor trial T_l and true T_l are necessary, and also that the positions of trial T_r and trial T_l are the same for all systems of loads, both of which facts constitute an advantage of this method over the one ordinarily used.

1323. The position of the line $m_1 m_{18}$ has been made such that the sum of the ordinates from $v_1 v_{18}$ to $m_1 m_{18}$ is equal to the sum of the ordinates from $v_1 v_{18}$ to $b_1 b_{18}$, or $\Sigma vb = \Sigma vm$; and similarly, since the moments of the minus forces (represented by the ordinates vm) were made equal to the moment of the positive forces (represented by bv), the position of the line $m_1 m_{18}$ gives $\Sigma bv \cdot x = \Sigma mv \cdot x$. Hence $\Sigma bv - \Sigma mv = 0$, and $\Sigma bv \cdot x - \Sigma mv \cdot x = 0$. But $bv - mv = bm$; and hence $\Sigma bv - \Sigma mv = \Sigma bm = 0$, and $\Sigma bv \cdot x - \Sigma mv \cdot x = \Sigma bm \cdot x = 0$.

Since the intercepts bm are proportional to the moments, $\Sigma bm = 0$ is equivalent to $\Sigma M = 0$; and similarly $\Sigma bm \cdot x = 0$ is

* Due to B. R. Leffler and Prof. Wm. Cain, Trans. Amer. Soc. of C. E., vol. lv, p. 183-90.

equivalent to $\Sigma M . x = 0$. Therefore two of the three conditions to be fulfilled by the true equilibrium polygon are satisfied by the trial equilibrium polygon $b_1 b_9 b_{18} m_1 m_1 b_1$; that is, the trial equilibrium polygon for the given system of loads is the true equilibrium polygon for an undetermined system of loads.

If the construction has been correctly made, the summation of the vertical intercepts above the closing line between it and the trial equilibrium polygon is equal to the summation of the ordinates below that line—a test easy to apply. In the drawing of which Fig. 233, facing page 688, is a photographic reduction and which had a scale of 1 inch = 3 feet, the sums of the bm intercepts were: above, 27.37 ft.; below 27.29 ft.

1324. If in the force diagram, a line be drawn from the trial pole, P' , to the load line parallel to the closing line $m_1 m_{18}$, the intersection Q will divide the load line into the true reactions at the right and the left abutments. The true pole is at some point, as yet undetermined, on a horizontal line through Q .

It is a principle of the equilibrium polygon that moving the pole vertically does not alter either the magnitude or the position of the intercepts, but does change the direction of the closing line. Therefore if the trial pole is moved vertically to the horizontal line through Q , and a new equilibrium polygon be drawn, the closing line of the new equilibrium polygon will be horizontal; but the intercepts will not have changed either their magnitudes or their positions horizontally. (This equilibrium polygon is not drawn in Fig. 233, since it is of no special advantage and would therefore only encumber the drawing).

Since the span of the trial equilibrium polygon is equal to the span of the arch ring, and since moving the pole horizontally does not alter the position horizontally of the several ordinates of the trial equilibrium polygon, if verticals be drawn through q_r and q_l , the points in which the closing line and the trial equilibrium polygon intersect, the intersections of these verticals with the reference line $k_1 k_{18}$, k_r and k_l respectively, will be points on the true equilibrium polygon that is to be constructed upon the line $k_1 k_{18}$.

1325. True Pole Distance. The moment at any point is equal to the intercepts in the equilibrium polygon multiplied by the pole distance; and hence increasing the pole distance decreases the intercepts in the equilibrium polygon, and vice versa. The true equilibrium polygon must give $\Sigma ck . y = \Sigma ak . y$ (see equation 12, page 675); and hence the trial pole must be moved accordingly. If the trial pole is moved vertically to the horizontal line through Q , the closing line will be horizontal (§ 1324); and if then the trial pole is moved along the horizontal line through Q so as to change

$\Sigma bm \cdot y$ to $\Sigma ak \cdot y$, the new position will be the true pole for the given loading. Therefore

$$\text{the true pole distance} = \text{the trial pole distance} \times \frac{\Sigma bm \cdot y}{\Sigma ak \cdot y} \quad (17)$$

To solve equation 17 proceed as follows: In the trial equilibrium polygon, measure the several intercepts bm , and also measure the several ordinates, $ad (=y)$, from the neutral line to the span line, AB ; and compute

$$\Sigma bm \cdot y = \Sigma (b_1 m_1 \cdot y_1 + b_2 m_2 \cdot y_2 \dots \dots b_{18} m_{18} \cdot y_{18}).$$

The several values of bm and of y are given in Table 94, page 683. In the example in hand, $\Sigma bm \cdot y = -229.78$. On the line of action of each load, measure the several intercepts, ak , from the neutral line to the reference line $k_1 k_{18}$; and compute

$$\Sigma ak \cdot y = \Sigma (a_1 k_1 \cdot y_1 + a_2 k_2 \cdot y_2 \dots \dots a_{18} k_{18} \cdot y_{18}).$$

The values of ak and of y are given in Table 94, page 683. In the example in hand, $\Sigma ak \cdot y = -192.72$. Equation 17 then becomes:

$$\text{the true pole distance} = 20,000 \times \frac{-229.78}{-192.72} =$$

$$20,000 \times 1.192 = 23,840 \text{ lb.}$$

1326. True Equilibrium Polygon. Locate the true pole by measuring the true pole distance from Q ; and then beginning at, say, k_r draw the equilibrium polygon $c_1, c_2 \dots c_{18}$ which should pass through k_l .

The graphical construction of the equilibrium polygon can be checked as follows: Multiplying the pole distance is the same as dividing the intercepts of the equilibrium polygon, and hence we may compute the intercepts ck at once by dividing each bm intercept by the ratio $\Sigma bm \cdot y \div \Sigma ak \cdot y$, and lay off these quantities from the line $k_1 k_{18}$ vertically on the lines through the centers of the several sections into which the neutral line is divided, having regard to the sign of bm .

1327. The equilibrium polygon constructed as above is the true equilibrium polygon for the given loads. The proof is as follows:

By construction, $\Sigma ck \cdot y = \Sigma ak \cdot y$, which satisfies equation 12, page 675.

By construction, each ck has been made equal to the corresponding bm divided by a constant ratio, and in § 1323 it was shown that $\Sigma bm = 0$; and hence $\Sigma ck = 0$, which satisfies equation 14, page 675.

Each intercept ck is vertically over the corresponding intercept bm , and in magnitude each ck is equal to the corresponding bm divided by a constant ratio; and in § 1321 it was shown that $\sum bm \cdot x = 0$, and therefore $\sum ck \cdot x = 0$, which satisfies equation 16, page 675.

Therefore $c_1 \dots c_9 \dots c_{18}$ is the true equilibrium polygon for the given system of loads, and $k_1 k_{18}$ is the true closing line.

1328. STRESSES DUE TO DEAD AND LIVE LOADS. In Fig. 234, let GJ represent a portion of the arch, ab the neutral line, and ce the side of the true equilibrium polygon to the left of the point a , ac the vertical intercept between the neutral line and the equilibrium polygon, and ae is a perpendicular from a upon ce . Then ce is the line of action of the resultant, R , of all the external forces to left of the section ea , i.e., R is the resultant of the reaction at the left abutment and of all the loads between the left abutment and the section ea . The amount and the direction of R is given by the corresponding ray of the force diagram.

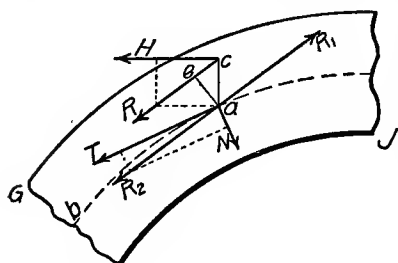

FIG. 234.

Assume that two opposite forces, R_1 and R_2 , each equal to R and parallel to that force, be applied at a . These forces will not disturb the equilibrium, and the single force R acting at c is then replaced by the couple $R R_1$ and a force R_2 acting at a . The force R_2 may be decomposed into two components— T tangent to the neutral line ab , and N normal to the neutral line. The couple $R R_1$

produces bending, the force T causes a shortening of the arch ring, and the force N produces shear in a normal section through a . The bending, the shortening, and the shear of the elastic arch are somewhat analogous to the tendency in the voussoir arch to overturn, to crush, and to slide.

To find the stresses in the arch ring, let

ac = the intercept between the neutral line and the true equilibrium polygon;

b = the breadth of the unit section of the arch, i.e., $b = 1$ ft.;

c = the distance of the most remote fiber from the neutral line;

d = the depth of the arch ring;

f = the unit fiber stress;

H = the true pole distance;

N = the component parallel to the radius at any point of the neutral line of all the forces to one side of the point;

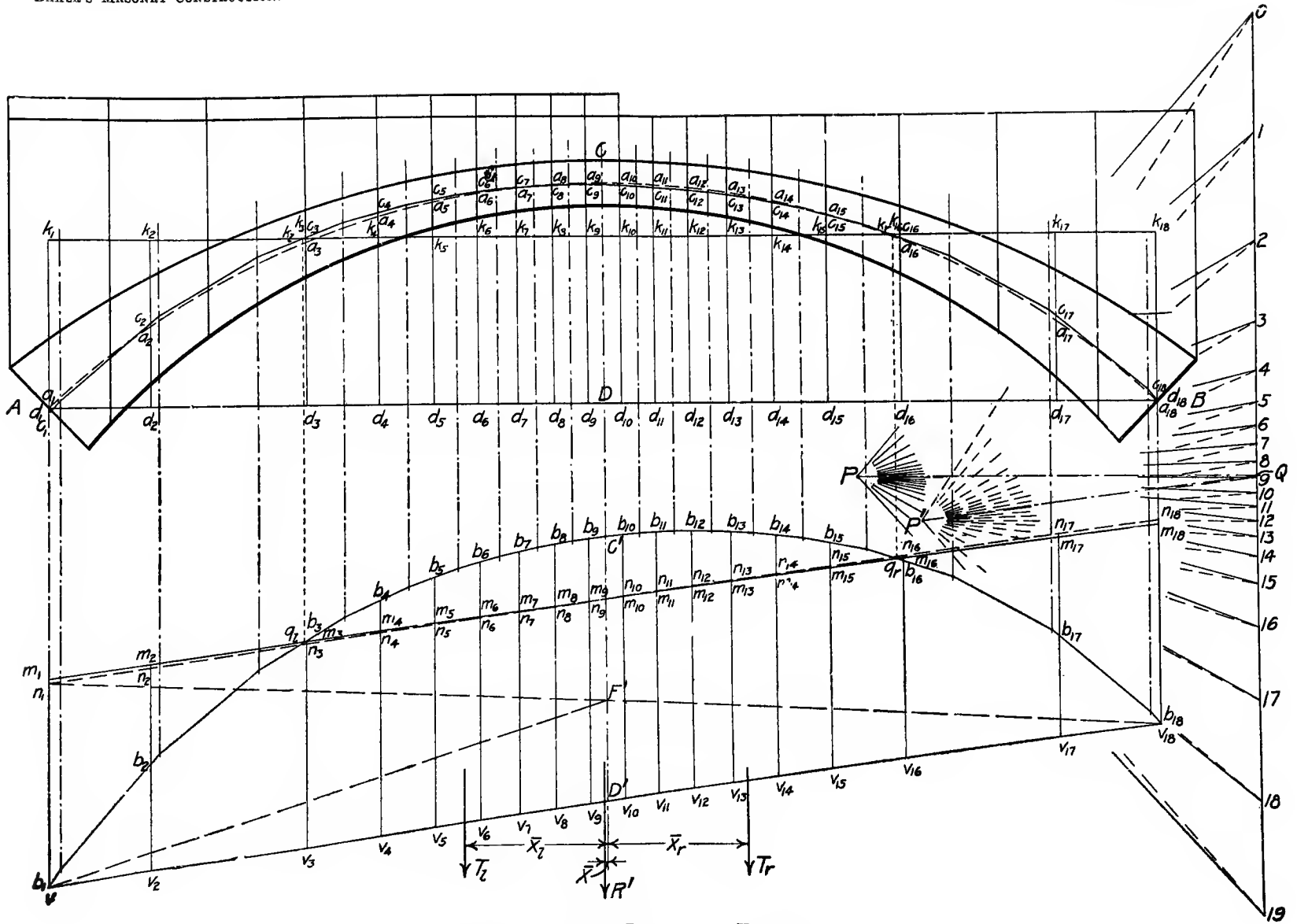

FIG. 233.—EQUILIBRIUM POLYGON FOR HINGELESS ARCH.

T = the component parallel to the tangent at any point of the neutral line of all the forces to one side of the point;

v = the unit shearing stress.

In Fig. 234, the moment of the couple is $R \cdot ae$; but if H is the horizontal component of R , i.e., is the true pole distance, then by similar triangles $R \cdot ae = H \cdot ac$. The value of H was computed in § 1325, and ac can be measured in Fig. 233, facing page 688; and therefore the bending moment at any point of the arch may be found. The maximum unit fiber stress in the section ae due to bending is

$$f_b = \frac{M c}{I} = \frac{H \cdot ac \cdot \frac{1}{2} d}{\frac{1}{12} b d^3} = \frac{6 H \cdot ac}{b d^2} = \frac{6 H \cdot ac}{d^2} \quad (18)$$

f_b is compression on the side next to R and tension on the side opposite.

The value of T can be found by resolving the ray in the force diagram that is parallel to the side of the equilibrium polygon adjacent to the point a , into a component parallel to the tangent at a . The unit compressive stress due to the force tending to shorten the rib is:

$$f_s = T \div \text{the area} = T \div bd = T \div d. \quad (19)$$

The force N is the component parallel to the radius at a ; and the unit shearing stress, v , is:

$$v = N \div \text{area} = N \div d. \quad (20)$$

1329. The total maximum fiber stress due to combined bending and shortening is:

$$f = f_s + f_b = \frac{T}{d} \pm \frac{6 H \cdot ac^*}{d^2} \quad \dots \quad (21)$$

The first term of the right-hand side of equation 21 is always compression. For the extrados, the last term is plus, i.e., compression, when the equilibrium polygon lies outside of the neutral line of the arch ring, and minus, i.e., tension, when inside; and for the intrados the stress is the reverse of that in the extrados. Ultimately the stress given by equation 21 must be combined with that due to a change of temperature of the arch ring.

In using equation 21, the intercepts ac should be measured in the verticals through a_1, a_2, a_3 , etc., the points at which $\Delta s \div I$ is constant, in accordance with the equations of condition, which also secures the greatest accuracy (see § 1316). The values of ac can be determined by taking the difference between ak and ck , which is more accurate than measuring the small quantity ac directly.

* This neglects a small moment due to the effect of the tangential force in shortening the arch ring, which will be considered later (see § 1336).

Equation 21 above is analogous to equation 2 (page 611) of the voussoir arch. The former is limited to the tensile strength of the concrete, while the latter is limited to the condition that the line of pressure must remain within the middle third of the depth.

1330. Numerical Results. Table 95 gives the stresses in the arch shown in Fig. 232, page 679, and Fig. 233, facing page 688. Later these stresses will be combined with those due to changes of temperature.

TABLE 95.

DEAD AND LIVE LOAD STRESSES.

+ signifies compression; - signifies tension.

Point Considered.	STRESS DUE TO				MAXIMUM STRESS.		
	Bending.		Thrust.		Intrados.	Extrados.	Shear.
	lb. per sq. ft.	lb. per sq. in.	lb. per sq. ft.	lb. per sq. in.	lb. per sq. in.	lb. per sq. in.	lb. per sq. in.
	*	*					
a_1	± 1 488	± 10.3	+ 9 080	+ 63.1	+ 74.4	+ 52.8	5.8
a_2	± 3 075	± 21.3	+ 9 120	+ 63.3	+ 42.0	+ 84.6	0.9
a_4	± 4 010	± 27.9	+ 10 040	+ 69.8	+ 41.9	+ 97.1	1.8
a_5	± 3 870	± 26.9	+ 10 675	+ 74.0	+ 47.1	+ 100.9	2.4
a_{10}	± 3 545	± 24.6	+ 11 880	+ 82.5	+ 107.1	+ 57.9	1.7
a_{11}	± 4 200	± 29.2	+ 11 830	+ 82.2	+ 111.4	+ 53.0	0.9
a_{15}	± 472	± 3.3	+ 10 010	+ 69.5	+ 72.8	+ 66.2	1.6
a_{18}	± 229	± 1.6	+ 7 080	+ 49.1	+ 47.5	+ 50.7	3.5

* For the extrados, the quantities in this column are plus when the equilibrium polygon lies outside of the neutral line, and minus when inside.

1331. Position of Live Load for Maximum Stress. No general law has been established for the position of the live load for a maximum stress at any particular point. According to equation 21 the stress at any point of the arch ring varies with (1) the tangential thrust, T ; (2) the true pole distance, H ; (3) the intercept ac ; and (4) the depth of the arch ring. Each of these quantities varies according to a different law; and it will be very difficult, if not impossible, to state a general law for the position of the live load which will give a maximum stress at any point. Practice varies considerably as to the positions of the live load employed in testing the stability of an arch. The less exacting engineers test the arch for only two positions of the live load, viz.: over half the span and over the whole span; while others test for four positions, viz.: over one quarter of

the span, one half, three quarters, and the whole span; and still others test for a live load over two fifths, one half, three fifths, and the whole span. Professor Wm. Cain suggests* that probably the following positions are the best: live load over three tenths of the span, half of the span, six tenths of the span, and the whole span.

To fully check the design of an arch, a table similar to the first four columns of Table 95 should be made out for each of the above positions of the live load; and then a table similar to the latter part of Table 95 should be made out showing the maximum stresses for any of the positions.

1332. EFFECT OF TEMPERATURE CHANGES. The temperature stresses in an arch ring having fixed ends may be quite high, and should therefore be carefully considered. To compute the temperature stresses, conceive that the arch is without weight and exactly fits between the skewbacks, without stress anywhere, at a certain mean temperature. Let

l = the span of the neutral line;

e = the expansion of concrete per unit of length per 1° Fahr.;

t° = the difference in degrees Fahrenheit between the mean temperature and the actual temperature of the arch ring.

Then the total change in length of the span of the neutral line is let° . As the abutments resist this change, a horizontal force and also a bending moment will be developed at each abutment. Conceive that the bending moment is resisted by a horizontal force, Q , applied at some distance, q , above each springing line, and that these forces act inward for a rise of temperature and outward for a fall; and also conceive that at each springing two horizontal forces, each equal to Q , act opposite to each other. The first Q and one of the latter form a couple whose bending moment at the abutment is $Q.q$, and the remaining Q at the springing resists the horizontal thrust (or pull) at the abutment.

We may regard the arch as being without weight and acted upon by the couples and by the horizontal thrusts, and that we are to find the resulting stresses in the arch ring. Since the arch has fixed ends, the three equations of condition, equations 4, 5, and 6 (page 674) must be satisfied.

1333. If the upper Q at each end be conceived as acting along the line k_1k_{18} , Fig. 233, i.e., if $q = dk$, then the bending moment at any point of the arch ring due to temperature changes is $Q.ak$. The bending moment at any point of the arch ring due to the external loads is $H.ac$. Hence, by analogy, we see that $Q.ak$ may replace $H.ac$ in equations 4, 5, and 6, page 674; and consequently the equations of condition for temperature stresses become

* Trans. Amer. Soc. C. E., vol. lv, p. 191-93.

$$\sum ak = 0 \dots\dots\dots (22)$$

$$\sum ak \cdot x = 0 \dots\dots\dots (23)$$

$$\sum ak \cdot y = 0 \dots\dots\dots (24)$$

The line k_1k_{18} : has been so located that $\sum ak = 0$, and also that $ak \cdot x = 0$; and therefore, if the yet unknown force Q acts along k_1k_{18} , equations 22 and 23 are thereby satisfied, i.e., the first two of the equations of conditions (§ 1300) are satisfied.

1334. To satisfy the third condition, notice that a rise of temperature tends to increase and a fall to decrease the span; and hence the forces Q at each abutment must be just sufficient to resist this tendency, and must act toward the center of the span to counteract a rise of temperature and from the center to counteract a fall. In § 1332 the change of span was shown to be $l e t^\circ$; and by equation e , page 673, the differential change of span is $\frac{M y ds}{E I}$. Hence

$$l e t^\circ = \int_A^B \frac{M y ds}{E I} = \frac{M y s}{E I} \dots\dots\dots (25)$$

Substituting the value of M from § 1333, and taking the summation for one half of the arch ring we get

$$l e t^\circ = Q \frac{\Delta s}{I} \frac{1}{E} \sum_A^B ak \cdot y \dots\dots\dots (26)$$

and by transposition

$$Q = \frac{E l e t^\circ}{\sum_A^B ak \cdot y} \cdot \frac{I}{\Delta s} \dots\dots\dots (27)$$

E in equation 27 is to be taken in accordance with the character of the concrete in the arch ring; and in the example in hand we will assume a 1 : 2 : 4 concrete, and take $E = 1,500,000$ lb. per sq. in. or $(1,500,000 \times 144)$ lb. per sq. ft. (see § 478 and 493). l is the span of the neutral line, and is known. In the example in hand, $l = 50$ ft. Different observers find values of e varying from 0.000,004,3 to 0.000,008,0 per 1° Fahr., although the more reliable results are between 0.000,004,3 and 0.000,006,5.* We will use 0.000,005,4, the value obtained by Professor W. D. Pence.† $I \div \Delta s$ is the reciprocal of $\Delta s \div I$, which was computed in determining the stresses due to external loads. For the example in hand, $I \div \Delta s$ is equal to the reciprocal of the mean of the quantities in the last

* For a summary of the various results, see Reid's Concrete and Concrete Construction, pp. 169-71; or Trans. Amer. Soc. C. E., vol. lvi, p. 406.
 † Jour. West. Soc. of Engineers, vol. vi, p. 549.

column of Table 93, page 680; or $I \div 4s = 1 \div 2.3275$. The value of $\Sigma ak.y$ is given in Table 94, page 683, and is equal to 192.72.

The proper value to be adopted for t is not easy to determine. Often the upper surface of the arch is covered with earth, and consequently does not vary much, if any, in temperature; and usually the lower surface of the arch is not exposed to the direct rays of the sun, and consequently the range of temperature of that surface is only that of the atmosphere. Owing to its high thermal conductivity steel will readily acquire the temperature of the air; but concrete is a very poor conductor of heat, and consequently the temperature of the interior of a concrete arch ring does not vary as much as the surface. Observations made under the author's direction * seem to show that concrete 4 to 6 inches below the surface does not follow the diurnal variations of atmospheric temperature. Observations for two years upon the width of cracks in the masonry near the top of the New Croton Dam (§ 964) seem to show that the coefficient of expansion was 0.000,003,1, or that the range of temperature of cut-stone and rubble masonry approximately 30 ft. thick, exposed to the atmosphere on both sides and the top, was only about half or two-thirds of that of the monthly mean of the atmosphere.† "Expansion joints in the most exposed cases do not show over $\frac{1}{4}$ inch motion per 100 ft., which assuming a coefficient of expansion of 0.000,006 is equivalent to a maximum change of temperature of not more than 35° F." ‡ "A self-recording thermometer placed in the ring of a reinforced concrete bridge having earth filling indicated that the total range of temperature did not exceed about 20° F. in some ten or twelve months."¶ In the design of the 280-ft. concrete arch now (1909) in process of construction in Cleveland, Ohio (see § 1346), the range of temperature was taken at $\pm 30^\circ$ F., the arch ring being 6 ft. thick at the crown and 11 ft. at the springing, and being exposed on both the intrados and the extrados. From a limited number of observations extending over nearly two years with thermophones embedded in the masonry of the Boonton (N. J.) Dam, before the water was admitted behind it, the following formula was deduced.**

$$R = \frac{135}{3\sqrt[3]{D}}$$

in which R is the total range of temperature on Fahrenheit degrees at any point within the mass, the numerator is the total atmospheric

* Harmon D. Brush, Jr., Bachelor's Thesis, University of Illinois, 1906.

† Trans. Amer. Soc. C. E., vol. lxi, p. 405.

‡ Trans. Amer. Soc. C. E., vol. lv, p. 195.

¶ Howe's Symmetrical Masonry Arches, p. 119.

** Trans. Amer. Soc. C. E., vol. lxi, p. 421.

range, and D is the distance in feet to the nearest exposed face of the dam. The above formula is true only for values of D between 0.5 ft. and 20 ft.

In the example under consideration, t will be assumed to be 20° Fahr. above a mean temperature of 60°, and 30° below. The sufficiency of this allowance will depend, of course, upon the locality and the exposure of the arch ring.

Substituting the above values in equation 27, gives for a maximum rise of temperature

$$Q = \frac{(1,500,000 \times 144) \times 50 \times 0.000,005,4 \times 20}{192.72 \times 2.3275} = 2,550 \text{ lb.}$$

That is, a rise of temperature of 20° F. in an arch ring 1 foot long exerts an outward thrust of 2,550 pounds upon the abutments; and similarly a fall of 30° F. will exert an inward pull upon the abutments of $\frac{30}{20} \times 2,550 = 3,825$ pounds.

1335. Temperature Stresses. The fiber stress due to temperature changes is, in the nomenclature of § 1328,

$$f_b = \frac{M c}{I} = \frac{Q \cdot a k \cdot c}{\frac{1}{2} b d^3} = \frac{6 Q \cdot a k}{d^2} \dots \dots \dots (28)$$

The stress due to the action of the tangential component of Q ,

$$f_s = \frac{T_t}{d} \dots \dots \dots (29)$$

in which T_t is the component of Q parallel to the tangent of the neutral line at the point where the stress is desired. The total fiber stress due to the combined bending and the thrust caused by a change of temperature is

$$f_t = f_s + f_b = \pm \frac{T_t}{d} \pm \frac{6 Q \cdot a k}{d^2} \dots \dots \dots (30)$$

The first term is + for a rise, and - for a fall of temperature. To aid in interpreting the character of the stresses given by the second term, consider only the left-hand half of the arch; and conceive that the right-hand half is removed and that its effect is replaced by the force Q along $k_1 k_{18}$ acting toward the left for a rise and toward the right for a fall. Then, if the point lies below the line $k_1 k_{18}$, as for example a_1 , for a rise the second term gives tension at the intrados and compression at the extrados, and for a fall gives compression at the intrados and tension at the extrados; and when the point lies above the line $k_1 k_{18}$, the above stresses are reversed. Table 96 shows the temperature stresses in the arch ring of Fig. 233.

TABLE 96.
TEMPERATURE STRESSES.
+ signifies compression; - signifies tension.

Point Considered.	FOR A RISE OF 20° F						FOR A FALL OF 30° F.											
	Bending.			Thrust.			Maximum Stress.			Bending.			Thrust.			Maximum Stress.		
	lb. per sq. ft.	lb. per sq. in.	lb. per sq. ft.	lb. per sq. in.	lb. per sq. ft.	lb. per sq. in.	In-trados.	Ex-trados.	Shear.	lb. per sq. in.	lb. per sq. ft.	lb. per sq. in.	In-trados.	Ex-trados.	Shear.	lb. per sq. in.	lb. per sq. ft.	lb. per sq. in.
a_1	± 4 620	± 32.1	+	368	+ 2.5	- 29.6	+ 34.6	2.5	2.5	± 6 930	± 48.1	± 48.1	- 3.8	+	44.3	- 51.9	3.6	3.6
a_3	± 330	± 2.3	+	854	+ 5.9	+ 3.6	+ 8.2	2.4	2.4	± 495	± 3.4	± 3.4	- 8.9	-	5.5	- 12.3	3.5	3.5
a_4	± 2 450	± 17.0	+	990	+ 6.9	+ 23.9	- 10.1	2.0	2.0	± 3 675	± 25.5	± 25.5	- 10.3	-	35.8	+ 15.2	3.1	3.1
a_6	± 4 760	± 33.1	+	1 097	+ 7.6	+ 40.7	- 25.5	1.7	1.7	± 7 140	± 49.5	± 49.5	- 11.4	-	60.9	+ 38.1	2.5	2.5
a_{10}	± 9 190	± 63.8	+	1 268	+ 8.8	+ 72.6	- 55.0	0.2	0.2	± 13 785	± 95.7	± 95.7	- 13.2	-	108.9	+ 82.5	0.3	0.3
a_{11}	± 8 850	± 61.5	+	1 258	+ 8.7	+ 70.2	- 52.8	0.6	0.6	± 13 275	± 92.2	± 92.2	- 13.1	-	105.3	+ 79.1	0.8	0.8
a_{15}	± 2 450	± 17.0	+	990	+ 6.9	+ 23.9	- 10.1	2.0	2.0	± 3 675	± 25.5	± 25.5	- 10.3	-	35.8	+ 15.2	3.1	3.1
a_{18}	± 4 620	± 32.1	+	368	+ 2.5	- 29.6	+ 34.6	2.5	2.5	± 6 930	± 48.1	± 48.1	- 3.8	+	44.3	- 51.9	3.6	3.6

* If the point is below the line $k_1 k_2 k_3$ then the stress in this column is compression on the extrados and tension on the intrados.

† If the point is below the line $k_1 k_2 k_3$ then the stress in this column is tension on the extrados and compression on the intrados.

1336. STRESS DUE TO SHORTENING OF ARCH RING. In determining the preceding stresses, the only effect of the tangential component considered was that of a force T uniformly distributed over the cross section, which force produced a shortening of the arch ring, and being uniformly distributed over the cross section did not affect the bending due to $R.ae$ or $H.ac$; but the shortening of the arch ring produces a bending, which effect is now to be considered.

If the unit compression due to the thrust T were constant for all cross sections; the effect would be the same as a fall in temperature. If $T \div A$ represents the average unit compressive stress, the shortening of the span is $\frac{T}{A} \frac{l}{E}$; and the shortening for a suppositious change of temperature t' is $t' l e$. Equating these two values, and solving we get:

$$t' = \frac{T}{A E e} \cdot \cdot \cdot \cdot \cdot \cdot \quad (31)$$

The proper value of $T \div A$ to be used in the above equation is somewhat uncertain, since the unit thrust varies from point to point, and is quite different in the two halves of the arch ring. For the example in hand, the value used will be the average of the unit thrust at a_1 , a_4 , and a_{10} (see the fifth column of Table 95, page 690), which is 71.8 lb. per sq. in. Substituting in equation 31, this value and also the values of E and e (see § 1334), we get:

$$t' = \frac{71.8}{1,500,000 \times 0.000,005,4} = 8.9^\circ \text{ Fahr.}$$

Therefore the shortening of the arch ring under the action of T , the tangential component due to the dead and live load, is equal to that due to a fall of temperature of 8.9° Fahr.; or the maximum stresses due to this shortening are $29\frac{1}{2}$ per cent ($= 8.9 \div 30$) of those due to a fall of 30° . The values of the maximum stresses due to the above shortening are given in the fourth and the fifth columns of Table 97.

The stress due to the shortening caused by the tangential component of the dead and live loads is usually neglected; but it is unwise, particularly for flat arches, and especially as the above method of computing such stresses is so simple and brief.

1337. There is a similar stress due to T_1 , the tangential component of the abutment reaction for temperature stresses, which can be computed as in § 1336. For the example in hand, this shortening is equivalent to a fall of temperature of 0.8° Fahr., which is almost exactly 11 per cent of the result in § 1336. Therefore the stresses due to this shortening are only about 11 per cent

TABLE 97.
 COMBINED STRESSES DUE TO DEAD AND LIVE LOADS AND TO TEMPERATURE
 Results in pounds per square inch.

+ signifies compression; - signifies tension.

Point Considered.	MAXIMUM DEAD AND LIVE LOAD STRESSES		MAXIMUM STRESSES DUE TO SHORTENING		FOR A RISE OF 20° F.			FOR A FALL OF 30° F.				
	Intrados.	Extrados.	Intrados.	Extrados.	Temperature Stresses.		Temperature Stresses.		Combined Stresses.			
					Intrados.	Extrados.	Intrados.	Extrados.	Intrados.	Extrados.		
a_1	+ 74.4	+ 52.8	+ 13.1	- 15.3	- 29.6	+ 34.6	+ 57.9	+ 72.1	+ 44.3	- 51.9	+ 131.8	- 14.4
a_3	+ 42.0	+ 84.6	- 1.6	- 3.6	+ 3.6	+ 8.2	+ 44.0	+ 89.2	- 5.5	- 12.3	+ 34.9	+ 68.7
a_4	+ 41.9	+ 97.1	- 10.6	+ 4.5	+ 23.9	- 10.1	+ 55.2	+ 91.5	- 35.8	+ 15.2	- 4.5	+ 116.8
a_5	+ 47.1	+ 100.9	- 18.0	+ 11.2	+ 40.7	- 25.5	+ 69.8	+ 86.6	- 60.9	+ 38.1	- 31.8	+ 150.2
a_{10}	+ 107.1	+ 57.9	- 32.1	+ 24.3	+ 72.6	- 55.0	+ 147.6	+ 27.2	- 108.9	+ 82.5	- 33.9	+ 164.7
a_{11}	+ 111.4	+ 53.0	- 31.0	+ 23.3	+ 70.2	- 52.8	+ 150.6	+ 23.5	- 105.3	+ 79.1	- 24.9	+ 155.4
a_{15}	+ 72.8	+ 66.2	- 10.6	+ 4.5	+ 23.9	- 10.1	+ 86.1	+ 60.6	- 35.8	+ 15.2	+ 26.4	+ 85.9
a_{18}	+ 47.5	+ 50.7	+ 13.1	- 15.3	- 29.6	+ 34.6	+ 31.0	+ 39.0	+ 44.3	- 51.9	+ 104.9	- 16.5

of the results in the tenth column of Table 97, page 697; and hence, in this case at least, they may be omitted.

1338. COMBINED STRESSES. Table 97, page 697, shows the maximum combined stresses due to dead and live loads and to temperature changes. The results are collected from Table 95 (page 690) and Table 96 (page 695). The stresses to be employed in checking the design of the arch ring are deduced as those in Table 97 using the maximum stresses for different positions of the live loads instead of those for a single position as in Table 95. Table 97 does not show the shearing stress, partly because it would unduly extend the table. The shearing stress due to the dead and live loads is shown in Table 95, page 690; and that due to temperature changes in Table 96, page 695. The latter is really too small, in this case at least, to be considered; and hence the only shearing stress to be considered in checking the design is that in Table 95.

By way of further illustration Table 98 is given to show the stresses at several points of a 100-ft. arch for several positions of the live load, and for a plain and a reinforced concrete arch ring, and also for three different end conditions.* The semi-arch ring was divided into 14 parts, beginning at the springing, such that $As \div I$ was constant; and "Point 1" is in the middle of the end section, and "Point 6" is about midway between it and the crown. To study the variation of the stress at any point due to the dead and live loads, consider only the quantities in the "D & L" columns in the upper portion of Table 98; and to study the variation of the combined gravity and temperature stresses consider only the stresses in the first four lines of the table. The remainder of Table 98 will be of interest in connection with the discussions in Art. 2 and 3 of this chapter.

1339. APPROXIMATE SOLUTIONS. The work of finding the stresses in an elastic arch having fixed ends is so long that numerous approximations have been used.

One of these consists in dividing the span into equal parts instead of dividing the neutral line into parts such that $As \div I$ is constant (§ 1311-12). If the span is divided into equal parts, the arch ring is divided into parts whose lengths increase as the secant of the angle with the horizontal; and consequently the divisions increase in length from the crown toward the abutment, but not as required to make $As \div I$ constant. This method is most nearly correct for a very flat arch having a nearly uniform depth. The method of dividing the neutral line as explained in § 1312 is so simple as not to make the above approximation of any great advantage.

Another approximation consists in assuming the loads at points

* Almon H. Fuller, Trans. Amer. Soc. C. E., vol. 1v, p. 193.

TABLE 98.

STRESSES IN CONCRETE ARCHES FOR VARIOUS CONDITIONS.

Span of neutral line, 100 ft. Rise of neutral line, 12 ft. Depth of arch ring: crown, 2.0 ft.; point 6, 2.29 ft.; point 1, 3.05 ft. Surcharge at crown, 2.3 ft. Live load, 140 lb. per sq. ft. Temperature variation, $\pm 26^\circ$. The minus sign below denotes tension.

Ref. No.	VARIABLE CONDITION.	STRESSES IN THE CONCRETE, POUNDS PER SQUARE INCH.																	
		HOR. THRUST.		Crown.			Point 6.			Point 2.			Point 1.						
		H for D. & L. Loads.	Q for Tem-para-ture.	D. & L.	T.	Max.	Min.	D. & L.	T.	Max.	Min.	D. & L.	T.	Max.	Min.				
VARIABLE POSITION OF LOAD. Fixed Ends. $\frac{3}{4}\%$ of Steel at Intrados and at Extrados.																			
1	Full live load	90 300	11 250	293	217	510	100	285	61	287	146	220	239	451	28 237	330	525	- 145	
2	Three fifths live load	85 800	11 250	...	217	449	15	313	61	315	94	237	239	476	- 13	272	330	560	- 194
3	Half live load	82 800	11 250	283	217	500	67	339	61	341	52	243	239	482	- 83	310	330	598	- 248
4	Two fifths live load	79 700	11 250	290	217	507	40	332	61	334	43	218	239	457	- 69	303	330	591	- 253
VARIABLE MATERIAL IN ARCH RING. Fixed Ends. Half Live Load.																			
5	$\frac{3}{4}\%$ steel at intrados and extrados	82 800	11 250	283	217	500	67	339	61	341	52	243	239	482	- 33	310	330	598	- 248
6	Plain concrete	82 800	8 650	351	214	565	120	400	57	405	53	274	239	513	- 22	356	309	630	- 233
VARIABLE END CONDITIONS. Half Live Load. $\frac{3}{4}\%$ of Steel at Intrados and at Extrados.																			
7	Fixed ends	82 800	11 250	283	217	500	67	339	61	341	52	243	239	482	- 33	310	330	598	- 248
8	Two hinges	82 900	960	296	94	390	116	405	62	462	- 15	256	20	272	124	197	9	206	188
9	Three hinges	82 800	250	...	250	250	250	370	...	370	82	263	...	263	137	196	...	196

on the arch independent of the division of the neutral line, which introduces errors in scaling the intercepts ac (see § 1316 and § 1329); but this approximation is necessary when the weight of the roadway and of the live load is transferred to the main arch by spandrel arches or by columns.

Sometimes, when the spandrel filling is earth, the horizontal components of the earth filling are included; but this violates one of the fundamental principles upon which the method of solution is based, viz.: that the bending moment is proportional to the *vertical* intercept in the equilibrium polygon, which principle is true only with vertical forces. Therefore including the horizontal components adds accuracy in one respect but introduces error in another; and on the whole is not wise, since usually the horizontal components are not included, and including them prevents a comparison of the results by this method with those by the ordinary method.

1340. GRAPHIC VS. ALGEBRAIC SOLUTION. The preceding solution is quite long and complicated; but it is shorter and simpler than an algebraic solution. Further, the graphic solution is self-checking at various intermediate steps; any errors in the graphic solution, being visible to the eye, are more easily detected than in an algebraic solution; and great errors are less likely in a graphic than in an algebraic solution.

1341. RELIABILITY OF ELASTIC THEORY. The chief sources of error in applying the elastic theory to a plain concrete arch are: 1. The uncertainty as to the coefficient of elasticity. The coefficient varies with the quality and the age of the concrete, and also with the unit stress; but not according to any definite law. 2. The uncertainty as to the temperature variations. The effect of temperature changes were entirely neglected by the older builders and by nearly all the modern builders; and as the older voussoir arches have stood for thousands of years without signs of distress, and as the newer concrete arches show no signs of approaching failure, it may be concluded that the stresses due to temperature changes are proportionally not very great, probably because the variation of the mean temperature of the arch ring is not very large. Accurate experiments on this phase of the subject are very much needed. 3. The uncertainty as to the coefficient of expansion of concrete (see § 1334). Accurate experiments are very much needed in this field. 4. The uncertainty as to the fixedness of the ends of the arch. The uncertainty as to the fixity of the ends can be greatly reduced or be entirely eliminated by taking the springing line for purposes of analysis at a plane where the ends of the arch are virtually fixed; and whenever there is no pronounced change of resisting section from abutments to arch ring, or whenever the abutments are so high

or of such a form that the ends of the arch are not really fixed, then the analysis should include the whole structure down to the foundation, where the unit pressure will likely be, or can be made, so low that the distortion due to the live load on the arch will be inappreciable. 5. When the spandrel filling is earth, the omission of the horizontal components of the pressure makes the computed stability less than the actual.

If the arch ring is built monolithic, the elastic theory applies reasonably well, and a small amount of tension may be permitted, say 50 lb. per sq. in. (see § 405-06); but if the arch ring is built in voussoirs, the bond between the two adjacent voussoirs is likely to be much less than the tensile strength of the concrete (see § 345), and consequently it is unwise to permit any tension in the arch ring.

The dimensions deduced by the elastic theory do not differ greatly from those for the thrust theory, particularly if the moving load is comparatively light; but the elastic theory permits a more accurate determination of the maximum live-load stresses.

1342. An elaborate series of instructive experiments on arches of various spans up to 75 ft., by the Austrian Society of Engineers and Architects* showed that the deflections of voussoir arches well within working limits conformed to the law of elasticity, and therefore the elastic theory is applicable to a voussoir arch provided the curve of pressure always lies within the middle third of the depth of the arch ring, i. e., provided there is no tension; but owing to the uncertainties of the properties of the composite arch ring, the degree of accuracy is not as great as in a plain concrete arch.

1343. PLACING THE CONCRETE. With a small arch the concrete can be laid at one operation, commencing at the abutments and working toward the crown, so that the arch ring is in fact monolithic; but with large arches this is impossible. There are two general methods of placing the concrete in a large arch ring, viz.: (1) constructing the arch in successive blocks or voussoirs each of which is continuous for the full width of the arch transverse to the span; and (2) building the arch ring as a number of successive parallel ribs continuous from abutment to abutment. Each method has its advocates.

In the first method, the voussoirs at each springing are laid first, next a block on each side intermediate between the springing and the crown, then the two voussoirs each side of the key, and next the intermediate blocks, and finally that at the crown. For the exact

* Bericht des Gewölbe-Ausschusses des Oesterreichischen Ingenieur- und Architekten-Vereins; large 4to, paper, pp. 131, 27 folding plates; Vienna, 1895. For a brief summary, see Howe's Treatise on Arches, p. 253-60; or *Engineering News*, vol. xxxv, p. 238-39.

order in a particular case, see Fig. 236, page 705, and Fig. 244, page 719. This method distributes the weight uniformly over the center and prevents its distortion by unequal compression or settlement.

In the second method, the width of the rib can be chosen so that a single arch rib may be built complete from abutment to abutment in a single day (except for very long spans), which as soon as the concrete sets is capable of bearing its own weight. Each rib built in this way has no joints, and hence is in better condition to resist bending stresses than though it had radial joints; but this is not an important matter if the line of pressure is always within the middle third, since then there is no tension at any point in the arch ring.

1344. EXAMPLES OF PLAIN CONCRETE ARCHES. We will close the consideration of plain concrete arches by giving a few details of some of the larger arches that have been built.

1345. Dimensions of Plain Concrete Arches. Table 99 gives the principal dimensions of some of the larger plain concrete arches having fixed ends. A comparatively few structures were omitted for the lack of complete data. Table 99 is valuable as showing the dimensions of arches that have stood successfully for a number of years, and are useful as a guide in assuming trial dimensions for a new structure.

1346. The Longest Concrete Arch. Fig. 235, page 705, shows the cross section of a 280-ft. concrete arch, the longest yet put under construction. For comparative data, see Table 99. This arch, now (1909) in process of construction, is the central span of a concrete bridge to carry Detroit Avenue, Cleveland, Ohio, over Rocky River. The central arch is flanked on one side by one 59-ft. and two 50-ft. arch spans, and on the other side by one 59-ft. and one 50-ft. arch spans. The bridge has a 40-ft. roadway and two 8-ft. sidewalks. The main arch consists of two parallel ribs, each 22 ft. wide and 11 ft. thick at the springing, and 18 ft. wide and 6 ft. thick at the crown. The space between the ribs at the crown is 16 ft., and is spanned by a reinforced slab (the only reinforced concrete in the bridge). The parallel twin construction is carried all through the spandrel arches, the piers, and the approach spans. The twin method of construction was first employed in the Luxemburg bridge—see No. 2, Table 90, page 648, and also § 1285. The advantages of this form of construction are: (1) it saves considerable load on the foundations; (2) lessens the amount of spandrel filling required; and (3) permits the same center to be used for the two parallel arches.

For a graphic solution of the stresses in the main arch and a tabular statement of the stresses for the dead load, for two positions of the live load, for the wind, and for temperature changes, see

TABLE 99.
DIMENSIONS OF PLAIN CONCRETE HINGELESS ARCHES.

Ref. No.	NAME, LOCATION, DESCRIPTION.	Engineer.	Date Completed.	Curve of Intradors.	Radius at Crown.	Span of Intradors.	Rise of Intradors.	THICKNESS.	
								Crown.	Springing.
1	Detroit Ave. over Rocky River, Cleveland, Ohio. See § 1346.	Felgate	1910	*	158.6	280.	80.8	6.0	11.0
2	Walnut Lane, Philadelphia, Pa., Street, Twin Arches. ²	Quimby	1908	3c	118.8	232.	70.2	5.5	9.5
3	Connecticut Ave. over Rock Creek, Washington, D. C. ³	Morison	1906	C	75.	150.	75	5.0	10.0
4	Vauxhall, London, England, Street. ⁴	Binnie	1899		144.6	18.6	18.6	3.9	3.9
5	Big Muddy, Grand Tower, Ill., Ill. Cent. R.R. See § 1347.	Parkhurst	1903	E	167	140.	30	7.0	20.0
6	Approach of bridge over Mississippi, Thebes, Ill. R.R. ⁵	Mojeski	1902	2c	50.	100.	50	4.5	11.0
7	Silver Lake, Pittsburg, Pa. Railroad. ⁷	Brown	1905	2c	50.	100.	50	4.0	4.0
8	San Leandro, Calif., Highway. ⁸		1901	5c	61.5	81.3	26	3.0	30.0
9	Ashtabula (Ohio) bridge on L. S. & M. R.R. ⁹	Beckwith	1904	2c	37.0	74.	37.	6.5	10.
10	Tanners Creek, West of Cin. on C. C. C. & St. L. R.R. ¹⁰	Kittredge	1904	5c	64	68.	17.	3.5	6.0
11	Pennypacker; Phila. & Reading R.R. See § 1348.	Hunter	1906	C	30	60.	30.	3	11.
12	Brighton, Tenn., Illinois Central R.R. ¹²	Parkhurst	1903	C	30	60	30	2.67	12.0
13	Broad Branch, Washington, D. C., Highway.	Douglas	1901		50.3	50.3	7.0	1.8	6.0
14	Ewarton Bridge, Jamaica, W. I., Railway. ¹⁴	Bell	1882		25.2	50	22.	2.0	3.0
15	Viaduct, Cannington, England, Light Railway. ¹⁵	Pain	1902	E	50	50	16.	2.5	2.5
16	Green Creek, Sigel, Ill., Illinois Central R.R. ¹⁶	Parkhurst	1900	C	20	40	20.	2.25	9.0
17	Pine Run, Sharpsville, Pa. Railway. ¹⁷	Geer	1900	2c	15.	30	15	2.5	25

* C = Circular; E = elliptical; 2c = two-centered, etc.
 2. *Engineering News*, Vol. 57, p. 117-18; Vol. 58, p. 108; *Engineering Contracting*, Vol. 31, p. 16-19. 3. *Engineering News*, Vol. 53, p. 571-73; *Engineering Record*, Vol. 52, p. 30-33. 4. *Engineering Record*, Vol. 39, p. 281. 6. Bachelor's Thesis, L. S. Keeler, '05, and H. M. Roy, '06, Library University of Illinois. 7. *Engineering Record*, Vol. 51, p. 528. 8. *Engineering News*, Vol. 50, p. 174. 9. *Railroad Gazette*, Vol. 38, p. 78-79. 10. *Engineering Record*, Vol. 49, 292-93. 12. R. E. Gaut, Bridge Engineer. 14. *Engineering Record*, Vol. 30, p. 79-80. 15. *Engineering Record*, Vol. 52, p. 470-72. 17. *Railroad Gazette*, Vol. 32, p. 750.

Engineering-Contracting, March 10, 1909, page 184-87. The main arch ribs are built of a 1 : 2 : 4 portland-cement concrete with slabs of stone embedded therein in a radial position quite close together; and most of the remainder of the bridge is built of a 1 : 3 : 5 rubble concrete. The rubble concrete of the arch rings was assumed to weigh 160 lb. per cu. ft., and the remainder of the concrete 150 lb. per cu. ft. The safe compressive strength of the concrete in the arch rings was assumed to be 600 lb. per sq. in. The center for the main ribs consists of two three-hinged steel trusses 23 ft. apart. The arch will be concreted in transverse sections (§ 1343).

1347. Big Muddy Bridge. One of the first large plain-concrete railway arches was the double-track bridge on the Illinois Central Railroad over the Big Muddy River, near Grand Tower, Ill.* The bridge consists of three elliptical arches, each of 140 ft. clear span and 30 ft. rise. For the dimensions of the main arches, see No. 5, Table 99, page 705. Each main arch is surmounted by ten transverse arches whose abutment walls are pierced by longitudinal arches. Only the spandrel arches were reinforced.

Fig. 236, opposite, shows the longitudinal section of one of the main arches. The arch ring was built in voussoirs approximately 8 ft. long on the intrados; and the numbers on the voussoirs in Fig. 236 show the order of placing the concrete. Each voussoir keys into the next one by two 4-inch by 12-inch projections on each side, made by timbers built into the block first completed. The face of the arch ring was divided into false voussoirs 4 ft. on the intrados by nailing triangular strips on the forms. Fig. 237, page 706, shows the centers employed in erecting the side spans. For the central span, to provide for possible drift, the middle portion of the center was supported upon 60-ft. plate girders which rested upon piles.

Observations were made from January 20 to May 23, 1903, with gages reading to thousandths of a foot, to determine the amount of expansion. The extreme movement in that time was 0.012 ft., which was equivalent to a temperature change of 16° F. if we assume the coefficient of expansion to be 0.000,005,4, or to 12° F. if we assume the coefficient to be 0.000,006,5 (see § 1334). No deflection of the arches or movement at the expansion joints could be detected during the passage of heavy trains.

1348. Pennypacker Bridge. Fig. 238, page 707, shows some of the details of the arch ring and of the center of one of the five 60-foot arches of the Pennypacker bridge on the Philadelphia and Reading Railroad.† The arch was constructed as a monolith. A 1 : 3 : 6

* By courtesy of A. S. Baldwin, Chief Engineer.

† *Engineering Record*, vol. liv, p. 396-97,—Oct. 13, 1906.

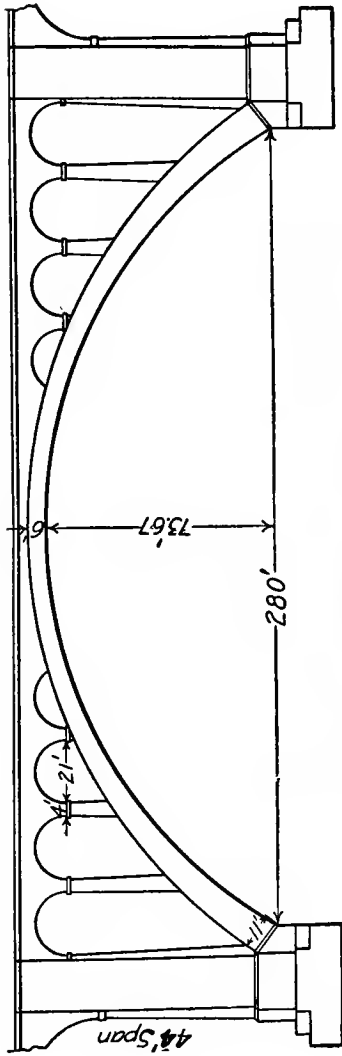

FIG. 235.—ELEVATION DETROIT AVENUE ARCH, CLEVELAND, OHIO.

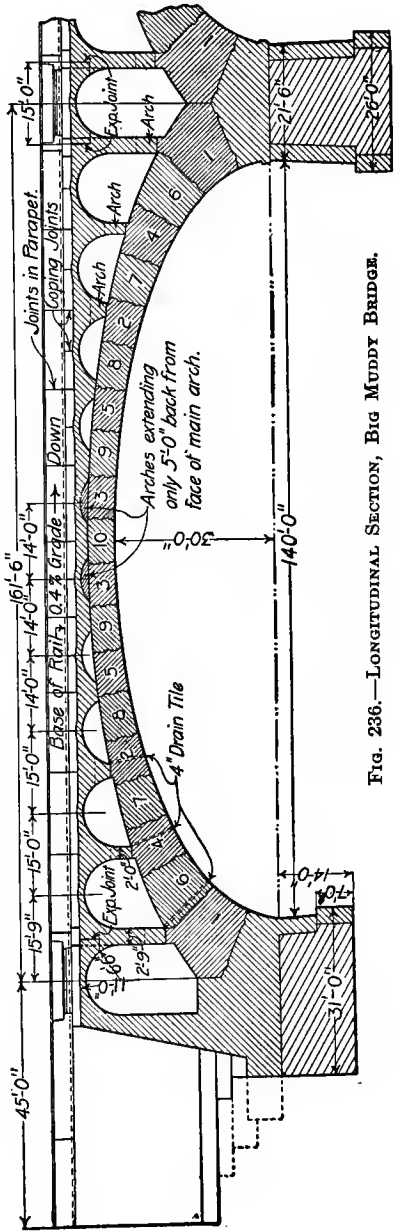

FIG. 236.—LONGITUDINAL SECTION, BIG MUDDY BRIDGE.

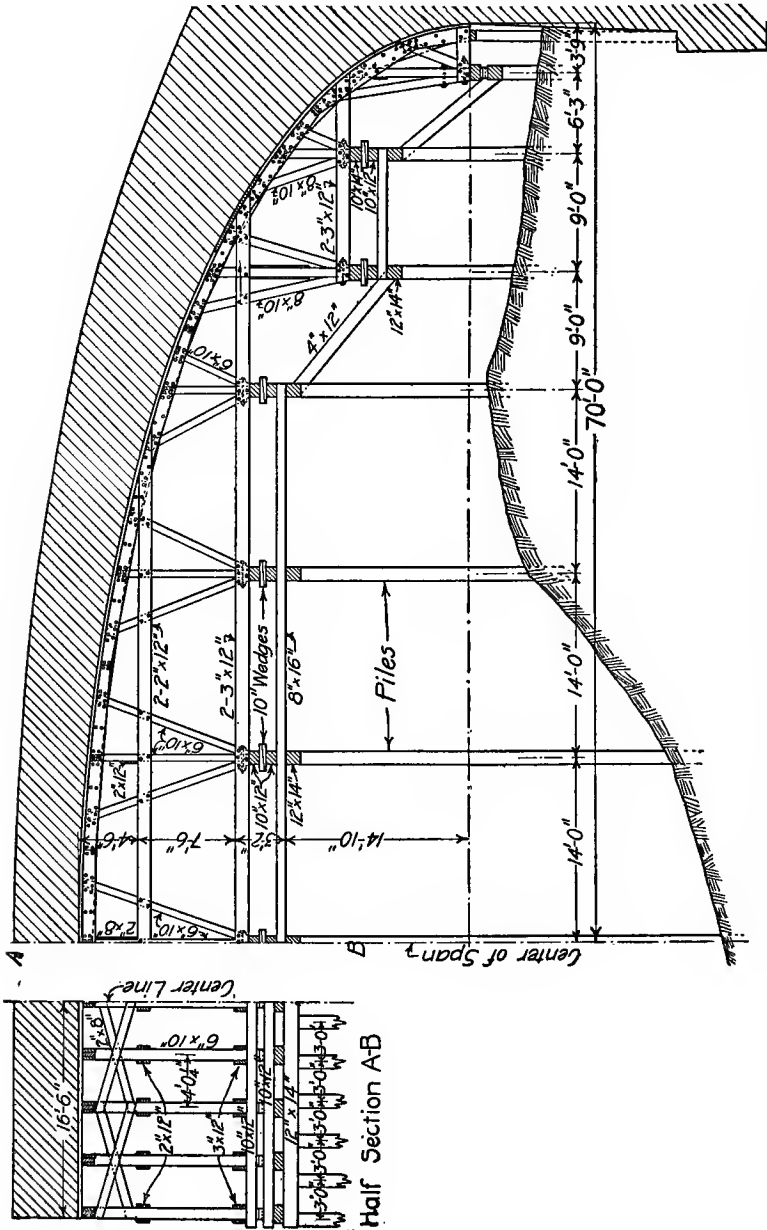

FIG. 237.—CENTER FOR THE SIDE ARCHES OF THE BIG MUDDY BRIDGE.

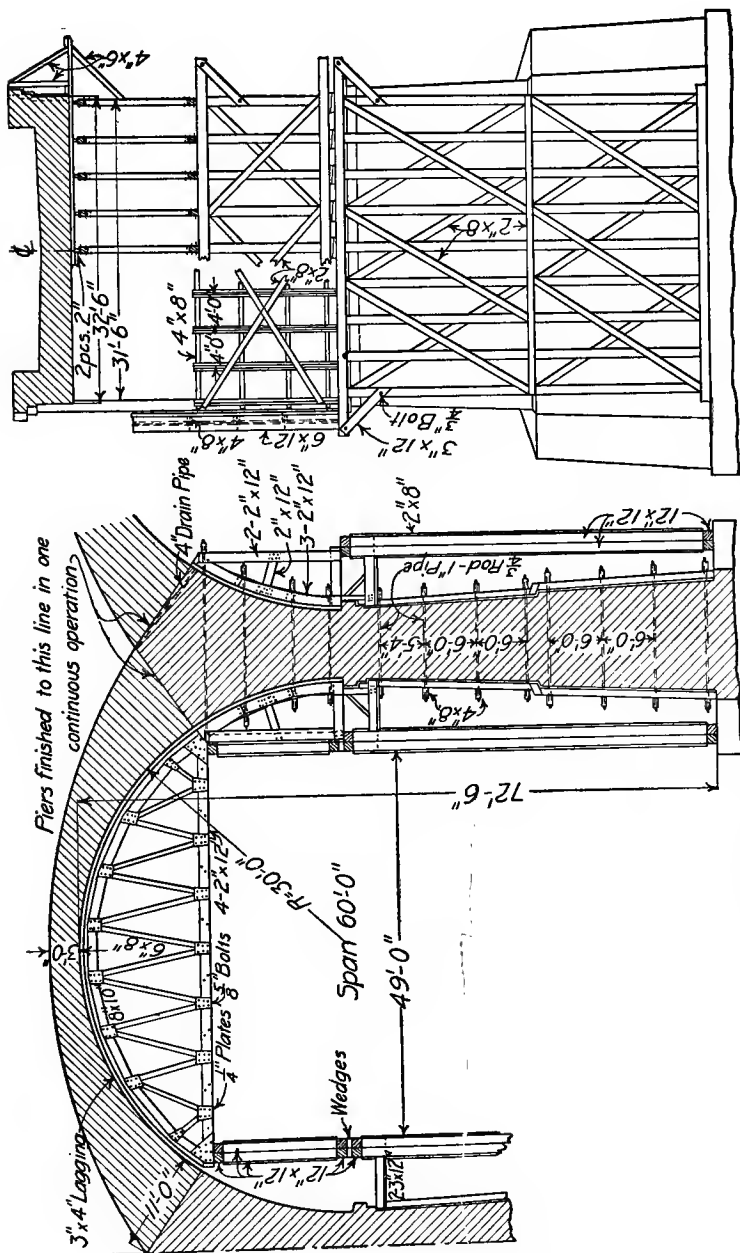

FIG. 238.—PENNYPACKER BRIDGE, PHILADELPHIA AND READING R.R.

concrete was used below the springing line, and a 1 : 2 : 4 above. The upper surface of the arch pitches 6 inches toward the axis of the bridge, and is drained by 4-inch pipes built into the concrete of each pier. Tongue and groove vertical transverse expansion joints are provided in the spandrel wall, two over each pier, extending from the haunches through the coping.

ART. 2. REINFORCED CONCRETE HINGELESS ARCH.

1349. ADVANTAGES OF THE REINFORCED ARCH. If the loads upon the arch were all fixed, it would be possible to design an arch ring so that the resultant pressure would pass through the center of each cross section, and consequently the entire arch ring would be in compression; but if part of the load is a moving one, or if the line of pressure does not pass exactly through the center of each cross section of the arch ring, there will be developed bending stresses as well as direct compression. When the arch ring is subjected to bending, the greatest economy is likely to be obtained by the use of reinforced instead of plain concrete. However, the gain in economy through the use of steel reinforcement in an arch is not very great. If the line of pressure does not depart from the middle third of the arch ring, no tension is developed; and therefore the steel reinforces only in compression, and steel is not as economical a material to resist compression as concrete. On the other hand, if the line of pressure departs from the middle third of the arch ring, the probabilities are that owing to the comparatively heavy direct compressive stress the resulting tension will be quite small, and hence the unit tensile stress in the steel will be very low. Of course, the unit stress in the steel could be increased by using a smaller per cent of it; but if the percentage of steel is quite small, to secure a proper distribution of it would necessitate the use of impossibly small cross sections.

Even though the economy of the use of steel in arches is not great, the reinforcement is practically of great value. Concrete is much more reliable in compression than in tension, and hence the use of steel to carry the tension adds to the reliability of the structure as a whole. Further, the steel is an economical insurance against uncertainties in the data, errors in the computations, shrinkage stresses, unequal settlement of the foundations, defective materials, and careless workmanship.

1350. ANALYSIS OF REINFORCED ARCH. The analysis of the reinforced concrete arch having fixed ends is substantially the same as that for a plain concrete arch, except that the moment of inertia

of the homogeneous cross section should be replaced by that of the composite cross section.

The differences between the solution for the plain concrete arch and that for the reinforced arch will be considered in order.

1351. Equations of Condition. It is customary to place the reinforcing steel symmetrically about the neutral surface of the arch ring. In § 1302 the fiber stress of the plain concrete section is stated

to be $f = E \frac{z d\phi}{ds}$; and for the symmetrically reinforced concrete

section, the fiber stress in the concrete is $f_c = E_c \frac{z d\phi}{ds}$ and that in

the steel is $f_s = E_s \frac{z d\phi}{ds}$. Similarly, the differential moment of the

stress in the plain concrete section is stated to be $f z da$; but for the reinforced section the elementary moment is $(f_c z da_c + f_s z da_s)$. Substituting in equation *a*, page 672, the above values for the reinforced concrete section, instead of the corresponding values for the plain concrete section, remembering that $E_s = n E_c$ (see § 447), and carrying the work through, equation *c*, page 672, becomes

$$d\phi = \frac{M ds}{E_c (I_c + nI_s)} \dots \dots \dots (c')$$

By analogy, the equations of conditions, equations 1, 2, and 3, then become

$$\int_A^B \frac{M ds}{E_c (I_c + nI_s)} = 0 \dots \dots \dots (1')$$

$$\int_A^B \frac{M x ds}{E_c (I_c + nI_s)} = 0 \dots \dots \dots (2')$$

$$\int_A^B \frac{M y ds}{E_c (I_c + nI_s)} = 0 \dots \dots \dots (3')$$

1352. To Make $I_s \div (I_c + nI_s)$ Constant. The neutral line of the arch ring must be divided so as to make $I_s \div (I_c + nI_s)$ constant. The method of making this division is the same for the reinforced section as that explained in § 1311 for the plain section. Proceeding as in the second paragraph of § 1311, construct a line similar to *DF*, Fig. 231, page 677, to represent $I_c + nI_s$. $I_c = \frac{1}{12} b(2d_c)^3$; and $I_s = \frac{1}{12} b d_1^3 + A_s d_s^2$ in which d_c is the depth of the concrete from the neutral axis, d_1 is the thickness of the steel in the direction of the radius of the arch, d_s is the distance from the neutral line to the center of the steel, and A_s is the sum of the area of the cross section of the steel on the two sides of the neutral axis. Since it is

customary to consider only a section of the arch a unit long, we may put $I_c = \frac{1}{12}(2d_c)^3$; and ordinarily we may take $I_s = A_s d_s^2$.

Next proceeding as in § 1312, divide the neutral line into a pre-determined number of parts.

1353. To Locate the Line kk . The method of locating the line kk for the reinforced arch is exactly the same as that for the plain concrete arch—see § 1313.

1354. To Find the True Equilibrium Polygon. The method of finding the true equilibrium polygon for the reinforced arch is exactly the same as that explained in § 1314–26.

1355. STRESSES DUE TO DEAD AND LIVE LOADS. In § 1351 it was shown that the fiber stress in the concrete due to bending $f_c = E_c z \frac{d\phi}{ds}$, and substituting the value of the fraction from equation c' , page 709, gives

$$f_c = \frac{Mz}{(I_c + nI_s)}$$

As we desire the maximum value of f_c , z must have its maximum value, i.e., $z = d_c$, the distance from the neutral line to the upper or the lower edge of the concrete. Further, from equation 18, page 689, $M = H \cdot ac$. Therefore for the maximum fiber stress in the concrete due to bending, the above equation becomes

$$f_c = \frac{H \cdot ac \cdot d_c}{I_c + nI_s} \quad \dots \quad (18')$$

Similarly, the maximum fiber stress in the steel due to bending is

$$f_s = \frac{H \cdot ac \cdot d_s}{I_c + nI_s} \quad \dots \quad (18'')$$

in which d_s is the distance from the neutral axis to the center of the steel.

To find the unit stress due to T , the tangential component of R (see § 1328), notice that the section is symmetrical and also that the steel takes n times as much stress as an equal area of concrete, and therefore the unit compressive stress due to T is

$$f_c = \frac{T}{A_c + nA_s} \quad \dots \quad (19')$$

Again, $f_s = nf_c$, and hence from equation 19'

$$f_s = \frac{nT}{A_c + nA_s} \quad \dots \quad (19'')$$

Adding equations 18' and 19', and substituting the values of I_c and I_s from § 1352, we have

$$f_c = \frac{T}{A_c + nA_s} \pm \frac{H \cdot ac \cdot d_c}{\frac{8}{12} d_c^3 + nA_s d_s^2} \cdot \cdot \cdot \cdot (21')$$

Similarly, by adding equations 18'' and 19'',

$$f_s = \frac{n \cdot T}{A_c + nA_s} \pm \frac{n \cdot H \cdot ac \cdot d_s}{\frac{8}{12} d_c^3 + nA_s d_s^2} \cdot \cdot \cdot \cdot (21'')$$

Equations 21' and 21'' are to be used exactly as equation 21, page 689, and the law governing the character of the stress is the same in both cases.

1356. SYSTEMS OF REINFORCED CONCRETE ARCH CONSTRUCTION.

There are a great variety of methods of reinforcing a concrete arch, most of which are patented. A few of the better known will be briefly described, in chronological order.

1357. Monier Arch. Mr. Jean Monier of Paris, France, in 1875, built the first reinforced concrete arch. He first embedded a wire net near the intrados; but later two nets were used, one near the intrados and one near the extrados. Monier arches have some serious defects, viz.: 1. The wire nets are very flexible, and hence are difficult to place properly. 2. The transverse wires do not aid in supporting the load, and hence add needlessly to the cost. 3. The closeness of the mesh prevents the use of even a moderately coarse aggregate, and hence adds to the cost of the concrete. Notwithstanding their defects many Monier arches have been built, particularly in Europe, some of which are quite remarkable for their delicate dimensions and surprising strength. The two most notable of these are:* 1. Three arches built in Switzerland in 1891 each having a span of 128 ft., rise 11 ft., thickness at the crown 6.67 in. and at the springing 10 in. 2. An arch built in Germany in 1890 in which the span was 132 ft., the rise 14.7 ft., and thickness at the crown 9.88 in.

1358. Wunsch System. This system, invented by Robert Wunsch of Budapest, Hungary, in 1884, consists of a straight rolled section, equal in length to the span, placed horizontally above the crown and a curved member placed parallel to the intrados, the two being connected by vertical members riveted to them. This is, strictly speaking, not an arch at all, but a reinforced abutting cantilever.

1359. Melan System. This system, invented in 1892 by Joseph Melan of Austria-Hungary, consists of embedding steel ribs, either solid rolled sections or built sections, in the concrete arch ring. The solid sections are used for small arches and the built for large ones.

1360. Hennebique System. The arch in this system, invented by Hennebique in 1893, is reinforced with solid rolled members parallel to the intrados and the extrados connected at frequent

* Trans. Amer. Soc. C. E., vol. xxxi, p. 441-42.

intervals by lattice bars. In this system, small bridges consist of parallel arch ribs built up solid to the level of the crown, which support a reinforced concrete slab resting directly upon the ribs; and in larger bridges the floor slab is supported by columns or spandrel arches resting on the extrados of the reinforced ribs.

1361. Thacher System. This system, invented by Edwin Thacher, New York City, in 1899, consists of flat steel bars in pairs, one parallel to the intrados and the other parallel to the extrados. The bars have no connection with each other except through the concrete; but are provided with projections, usually rivet heads, at short intervals to secure mechanical bond between the steel and the concrete.

1362. Common System. Recently in America the most common reinforcement for concrete arches consists of a series of plain or deformed bars (Fig. 28, page 236) parallel to and near the extrados and a similar series near the intrados, each series sometimes being connected at intervals by some form of stirrups (Fig. 29, page 238). The chief, if not the sole, purpose of the steel is to resist the bending; and hence the amount of reinforcement parallel to the neutral line should be from $\frac{3}{4}$ to $1\frac{1}{4}$ per cent (see equation 10, page 228), but it is frequently considerably greater than this. Not infrequently the concrete alone is able to carry the computed stresses with a fair degree of safety, the reinforcement being added only as an additional element of security.

For examples of what was above called the common system, see Fig. 239-41, page 713-16, and Fig. 243-44, page 717-19.

1363. EXAMPLES OF REINFORCED CONCRETE ARCHES. The consideration of reinforced concrete arches will be closed by giving some details of a few structures.

It is hardly possible to make a tabular exhibit of any value showing the dimensions of reinforced concrete arches as was done for voussoir and plain concrete arches, since the systems of reinforcement are so varied and the quality of the steel and its positions are so diverse. Further, reinforced concrete arches are built with either a solid arch ring or of ribs connected by a curtain wall. It is not possible to make a tabular statement of all these variables that will be of any particular value. Reasonably complete descriptions of many reinforced concrete arches can be found by consulting any one of the several indexes to current engineering literature. The following are representative examples of reinforced concrete arches having no hinges.

1364. Union Pacific Arch. Fig. 239 shows the typical reinforced

concrete arch for stream and highway crossings employed recently by the Union Pacific Railroad.* Fig. 239 is for a highway crossing near Omaha; and the form for stream crossings is the same except that the wings flare at 30°. The reinforcement consists of corrugated bars (§ 465); and this particular job contained 52.2 lb. of steel per cubic yard of concrete. No bar was placed nearer the surface of the concrete than 3 inches, and splices were lapped 2 feet.

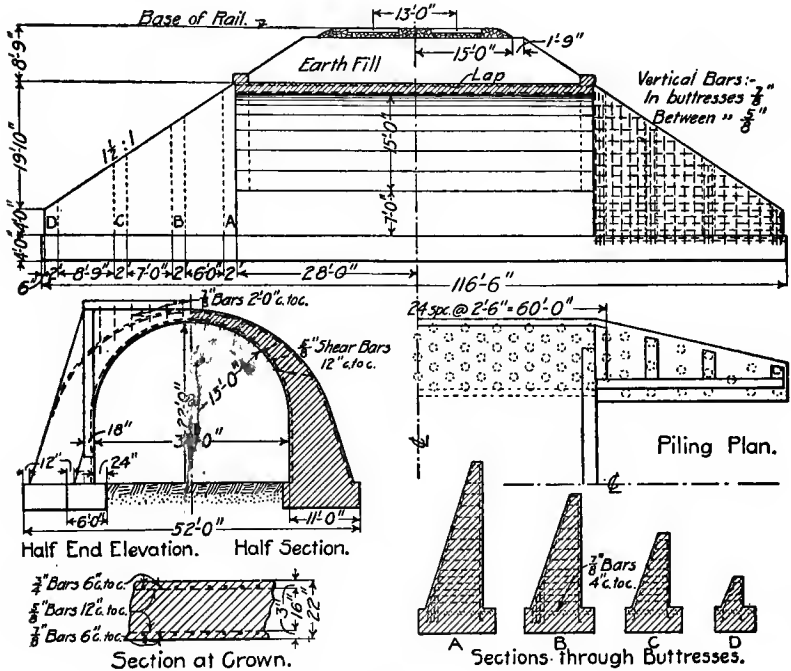

FIG. 239.—REINFORCED CONCRETE ARCH ON UNION PACIFIC R.R.

The arch ring is not necessarily built monolithic, but any joints are required to be on a radial line.

1365. Big South Fork Bridge. Fig. 240, page 714, shows one of the five equal spans of a skew bridge over the Big South Fork Branch of the Cumberland River on the Kentucky and Tennessee Railway.† The extrados and also the intrados are circular curves. The arch is designed for a train load equivalent to Cooper's E-40. The reinforcement is twisted steel bars (§ 465). The concrete in the arch ring and the spandrel walls is 1 : 2 : 4, in the footings 1 : 3 : 6, and

* *Engineering Record*, vol. lvii, p. 396,—April 4, 1908.

† Ward Baldwin, *Railroad Gazette*, vol. lii, p. 409-10,—March 22, 1907.

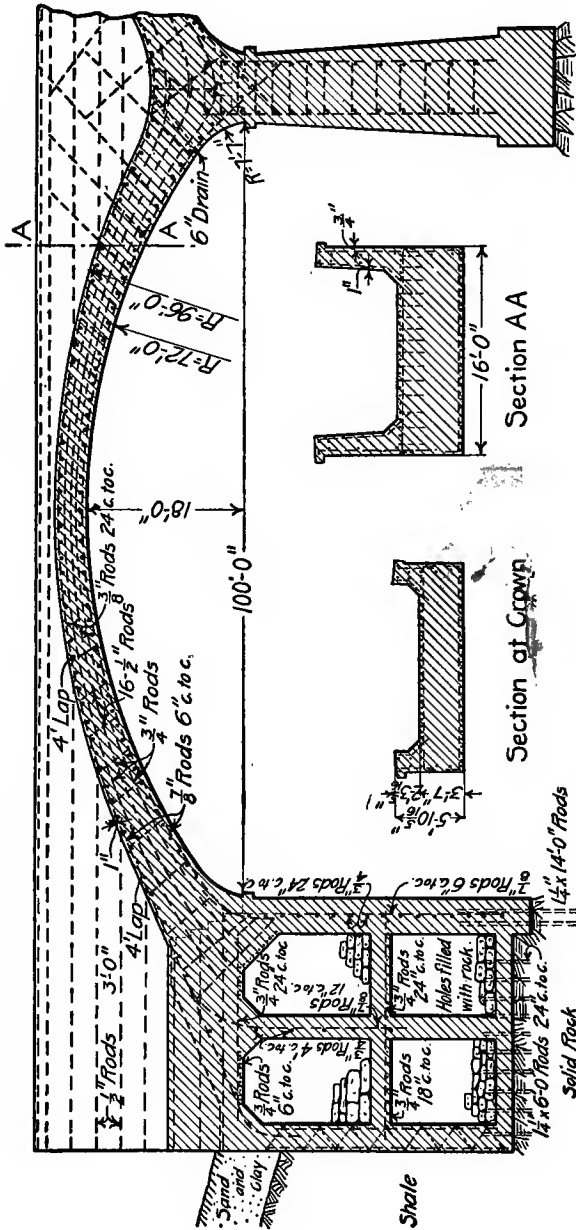

FIG. 240.—BIG SOUTH FORK BRIDGE, KENTUCKY AND TENNESSEE R.R.

in the body of the piers $1 : 2\frac{1}{2} : 5$. "The west abutment was built hollow and filled with stone. It was designed on the supposition that solid rock, which outcropped near the site of the abutment, would be found at a small depth; but solid rock was not found as expected, and to avoid the cost of extending the abutment so that its weight would make it stable against the thrust of the arch, anchors were cemented into the rock foundation to a depth of 6 ft. along the front edge of the abutment. In building this abutment it was found that the cost of the form-work was greater than the saving in concrete; and the contractor preferred to build the other abutment solid and omit much of the steel." The rods parallel to the neutral line between the reinforcement near the extrados and the intrados are quite unusual.

1366. Charley Creek Bridge. Fig. 241, page 716, shows one of the two 75-ft. arches carrying a highway over Charley Creek, near Wabash, Ind.; and Fig. 242, page 716, shows the center used in its erection.* This bridge differs from the two preceding ones in four noteworthy particulars, viz.: 1. The use of a special bar, the Kahn (*e*, Fig. 29, page 238) for the reinforcement, which give a rather remarkable arrangement of metal in the arch ring. The designer claims that the diagonal members, being solidly connected to the extradosal and intradosal bars, firmly anchor these bars and also tie together the concrete of the arch ring. 2. The complete reinforcement of the spandrel walls. The spandrel walls are designed as vertical cantilevers to hold in place the earth spandrel filling, the reinforcement being Kahn bars (§ 465) set upright; and are reinforced longitudinally for temperature stresses by round rods. 3. The bonding together of the arches and spandrel walls over the center pier. 4. It has frequently been stated that the curve of the arch ring of this bridge is a parabola; but an examination of the drawing shows that the intrados is a five-centered circular curve and the extrados a circular arc. The above statement, and many similar ones, must be interpreted to mean that the stresses were determined on the assumption that the center line of the arch ring was a parabola, i.e., the stresses were determined by the method proposed by Prof. C. E. Greene † for an arch whose neutral line is a parabola. Professor Greene adopted a parabola for the center line of the arch ring because a parabolic linear arch is stable under a load uniform along the span; but it is not proved that the parabolic arch is better than the more common forms, particularly as the dead load is not uniform along the span, and since the live load has a different position for the maxi-

* *Engineering News*, vol. lv, p. 290,—March 15, 1906.

† Pages 41-71 of his *Arches*—Part III, of his *Trusses and Arches*. John Wiley & Sons, New York, 1879.

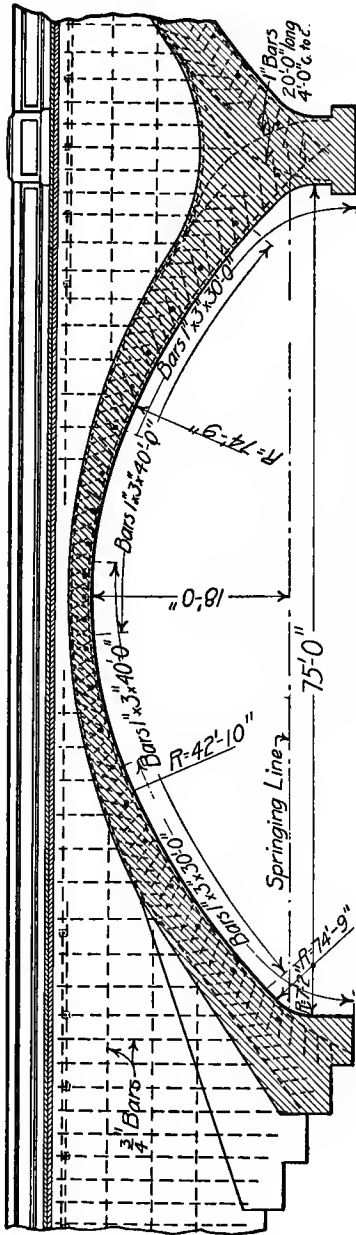

FIG. 241.—CHARLEY CREEK BRIDGE, WABASH, IND.

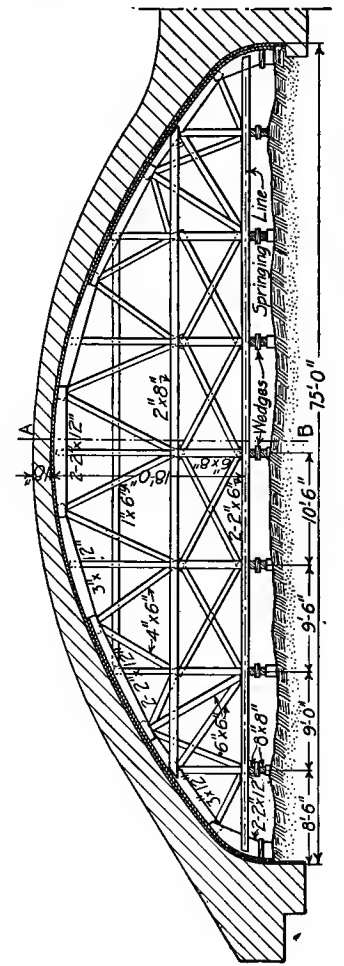
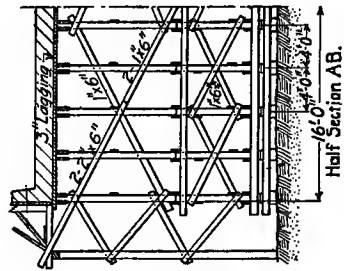

FIG. 242.—CENTER FOR THE CHARLEY CREEK ARCH.

imum stresses at different points along the arch, and further since temperature stresses are an important factor in the design of an arch and are independent of the curve of the neutral line.*

1367. Peru Bridge. Fig. 243 shows one of the seven arches across the Wabash River at Peru, Ind.† There are three noteworthy features of this bridge. 1. The arrangement of the reinforcement of the arch ring, whereby a rod is near the intrados at the crown and near the extrados at the springing, one third of the rods crossing the neutral line at the mid-point of the semi-arch, one third at the upper third-point, and one third at the lower third-point. This disposition of the steel is on the supposition that the unreinforced arch has a tendency to fail by tension in the intrados at the crown and by tension in the extrados near the springing—see Fig. 189, page 610. 2. A new method of balancing the thrust of unequal spans. The arch shown in Fig. 243 is flanked on the right by a 100-ft. span and on the left by an 85-ft. span. For the effect on the appearance of the bridge and also to increase the waterway, it was desired to make the spans increase from the shore toward the middle of the river; and to keep the roadway level and as low as possible and also to give a maximum waterway, it was not possible to balance

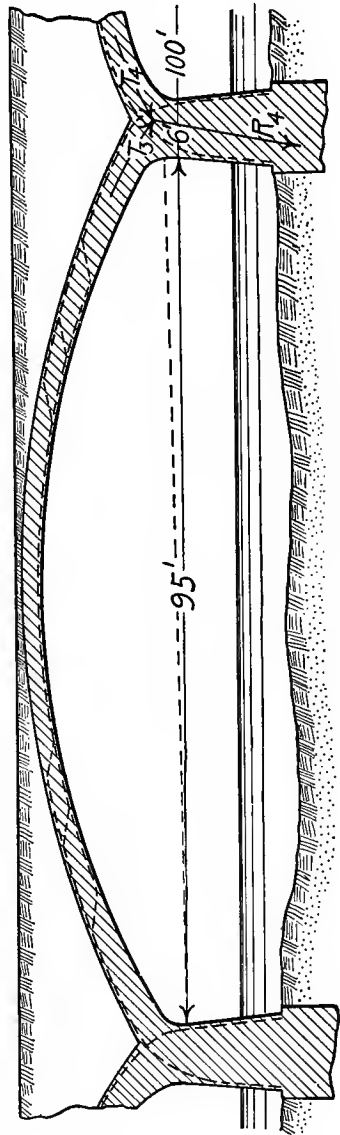

FIG. 243.—HIGHWAY BRIDGE OVER WABASH RIVER, PERU, IND.

* For an interesting and instructive detailed account of a 125-ft. true parabolic plain-concrete arch bridge over Piney Branch, Washington, D. C., see *Engineering News*, vol. liv, p. 510-12; vol. lv, p. 453; vol. lvii, p. 682-83.

† D. B. Luten, the designer of the bridge, in *Engineering News*, vol. lv, p. 347-49.

the thrust of the longer span in the usual way, i.e., by making the shorter span proportionally much flatter, as the shorter arch would be entirely submerged at highwater. The submergence of the end spans would not only decrease the waterway, but might through the effect of buoyancy cause a collapse of the adjoining spans. Further, it was not possible to make the piers heavy enough to support the unequal thrusts, without unduly reducing the waterway. These conditions were met by inclining each arch of a shorter span upwards toward the adjacent longer span, so that at any pier the shorter arch has virtually a higher springing than the longer arch, although the apparent springings are maintained at the same level by slightly distorting the curve of the shorter span at the pier. By this method a 75-ft. span is balanced by an 85-ft. span, an 85-ft. by a 95-ft., and a 95-ft. by a 100-ft., all on 6-ft. piers, although the rise of the several arches is practically constant, being 15 feet for the 100-ft. span and 13 feet for the 75-ft. The effect on the thrusts of the arches by inclining of the shorter span upward toward the longer is shown in Fig. 243, for the pier between the 95-ft. and the 100-ft. spans. The thrust T_3 of the 95-ft. arch meets the thrust T_4 of the 100-ft. span on that side of the center of the pier toward the greater span, by reason of the elevation of this end of the shorter span. The thrust T_4 of the 100-ft. arch being greater than T_3 , the resultant R_4 of the two thrusts is deflected across the center line of the pier, but is kept within the middle third of its base. 3. A new method of striking the centers. The centering was supported by 2- by 12-inch joists, which were too flexible to carry their load except when braced in both directions at the third points.* To strike the centers, one system of sway bracing was removed from the upright supports, which allowed them to buckle and thus relieve the centers.

1368. Danville Bridge. Fig. 244 shows half of the 100-ft. span and half of one of the two 80-ft. spans of the double-track reinforced-concrete arch bridge on the Cleveland, Cincinnati, Chicago and St. Louis Railway, near Danville, Ill.† The road also has a similar bridge near Robinson, Ill. The bridge is 42 ft. wide outside to outside of parapet walls, and 27 ft. inside to inside. The springing line of the intrados of the 100-ft. arch is 30 ft. above the bed of the stream. Note that the crowns of all three arches are at the same elevation, the springing lines of the smaller arches being higher than those of the larger one. The base of the rail is 19.75 ft. above the extrados of the crown of the main arches, and the track rests upon a cushion of earth 5 ft. deep. The spandrel arches have a

* For details of the computations, see *Engineering News*, vol. liii, p. 477,—May 11, 1905.

† *Engineering Record*, vol. liii, p. 238-43.

span of 8 ft., and a thickness at the crown of 2 ft., the space above the arches being filled with concrete to the level of the crown. The reinforcement is square corrugated bars. The steel in the main arches is 6 inches from the surface at the crown and 24 inches at the haunches. The series of spandrel arches are built in three sections, one over each of the main arches. Between each section of spandrel arches is an expansion joint, the details of which are shown in Fig. 244, page 719. The numbers on the arch rings show the order of the concreting.

1369. Hudson Memorial Arch. For a detailed description of the proposed Henry Hudson memorial reinforced-concrete arch of 703-ft. clear span over Spuyten Duyvil Creek, New York City, see *Engineering News*, Vol. LVIII (Nov. 21, 1907), pages 559-61; and for interesting editorial comments on the same, see page 555.

ART. 3. HINGED ARCH.

1370. A hinge in a masonry arch consists of two blocks of stone, cast iron, or steel, one having a plane or nearly plane surface of contact and the other having a cylindrical surface. Stone, cast iron, and steel hinges have been employed. Hinge-like joints are sometimes constructed by inserting a sheet of lead in the middle third of the joint, and then after the centers are struck the remainder of the joint is filled with mortar. There are three forms of hinged arches, viz.: (1) a hinge at the crown, (2) a hinge at each springing line, and (3) a hinge at each springing and also one at the crown; but only the last form is used for masonry arches.

The use of hinges in masonry arches was first proposed by Koepke of Dresden, Germany, in 1880; and a number of hinged arches, both voussoir and continuous, have been built in Europe, but almost none have been built in America (see § 1374). Hinged arches have been built of independent voussoirs, of plain concrete, and of reinforced concrete (see Table 100).

1371. ANALYSIS OF THE THREE-HINGED ARCH. The hingeless arch is statically an indeterminate structure, since the stresses can not be found except by a consideration of the elastic properties of the material of the arch ring; while the three-hinged arch is statically determinate. Each half is an independent structure, and the external reactions and internal stresses can easily be found by the usual methods of structural analysis; in other words, each half may be treated as a curved beam and the stresses found accordingly. The method of designing a hinged masonry arch consists in assuming the cross sections at the hinges and also the boundaries of the arch ring, and then computing the maximum stresses at a number of sections.

If the resulting stresses are not satisfactory, the dimensions are altered and the computations are repeated. For a general solution and detailed design of a three-hinged masonry arch of 236 ft. span, see an article by D. A. Molitor in Transactions of American Society of Civil Engineers, Vol. XL, pages 36-76.

1372. HINGED VS. HINGELESS ARCHES. The advantages claimed for the hinged masonry arch are: 1. The introduction of hinges eliminates the difficulties and the uncertainties in the analysis of the hingeless arch. 2. The hinges prevent undue stresses owing to an unequal settlement of the abutments. 3. The effect of temperature changes is less for hinged than hingeless arches. 4. The arch ring of the hinged arch is lighter than that of the hingeless arch.

The disadvantages urged against the hinged masonry arch are: 1. The hinges add cost and complication in the construction, and their maintenance requires attention. 2. The lack of perfect freedom of action of the hinge, due to friction and to dust and rust, introduces uncomputable stresses. 3. Any movement at the hinge changes the position of the line of pressure and hence changes the stresses. 4. The spandrel walls and the floor of an arch bridge interfere with the action of the hinges. 5. The amount of masonry in the arch ring is only a small part of that in the entire structure, and hence the saving of a small per cent of arch masonry is unimportant. 6. The hinged arch has greater deflections, and hence is less rigid than the hingeless arch. 7. The hinges lack durability—the most important feature of a masonry arch. It is agreed that hinges are more useful the larger and the flatter the arch.

American engineers almost unanimously prefer the hingeless arch.

1374. EXAMPLES OF HINGED ARCHES. Apparently there are only three hinged arches in America: 1. A 40-ft. three-hinged plain-concrete highway arch at Mansfield, Ohio, built about 1904 and having a rise of 7.5 ft. 2. A three-hinged 83-ft. elliptical plain-concrete arch in Brookside Park, Cleveland, Ohio. For an illustrated description, see *Engineering News*, Vol. LV, pages 507-08. 3. A 135-ft. three-hinged reinforced-concrete ribbed parabolic skew arch in Denver, Colorado. The hinged form was adopted largely because of the flatness of the arch and the 36° skew. For a detailed and illustrated description, see *Engineering Record*, Vol. LVII, pages 336-39,—March 21, 1906.

1375. Table 100, page 722, gives some of the particulars concerning the most noted hinged masonry arches in Europe.

TABLE 100.
DIMENSIONS OF THREE-HINGED MASONRY ARCHES.

Ref. No.	Span Feet.	Rise Feet.	No. of Spans.	Highway or Railway.	Date.	Material.	Reference.
1.	230	42	2	Hy.	1904	Rein. Conc.	<i>Eng'g News</i> , Vol. 53, p. 199.
2.	215		1	Hy.	1905	Pl. Conc.	<i>Eng'g News</i> , Vol. 55, p. 307.
3.	213	21		Hy.		Voussoirs	Balet's Anal. of Elast. Arches, p. 234.
4.	200	22.5				Voussoirs	ibid.
5.	200	20				Pl. Conc.	<i>Eng'g News</i> , Vol. 57, p. 480-81.
6.	211.6	36.7	2	Ry.	1907	Pl. Conc.	
7.	187.5	32.2	1	Ry.	1907	Concrete	
8.	165	18.7	1	Hy.	1903	Pl. Conc.	<i>Eng'g News</i> , Vol. 46, p. 215-16.
9.	165	13.5	1	Hy.	1893	Pl. Conc.	<i>Engineer</i> , Vol. 98, p. 650.
10.	164	16.4	1	Hy.	1893	Pl. Conc.	An. des Ponts et Chaussées, Vol. 14, p. 356. [383.
11.			2	Hy.	1904	Voussoirs	<i>Eng'g News</i> , Vol. 52, p. 373-74.
12.	141	14.4	1	Hy.	1896	Pl. Conc.	<i>Eng'g News</i> , Vol. 37, p. 241.
13.	131	18.2	2	Hy.	1895	Pl. Conc.	Trans. Am. Soc. C. E., Vol. 40, p. 34.
14.	112	16.8	2	Hy.	1899	Pl. Conc.	<i>Eng'g News</i> , Vol. 46, p. 61.
15.	108	14.4	1	Hy.	1900	Rein. Conc.	An. des Ponts et Chaussées, 1904.
16.	108	14.6	6	Hy.	1901	Pl. Conc.	<i>Eng'g News</i> , Vol. 50, p. 61-62.
17.	100	10	5	Hy.	1903	Pl. Conc.	<i>Engineer</i> , Vol. 97, p. 424.
18.	100	50			1896		<i>Eng'g Record</i> , Vol. 51, p. 528.
19.	74	8.2	2		1893		Trans. Am. Soc. C. E., Vol. 40, p. 34.
20.	69		3	Hy.	1898	Pl. Conc.	<i>Eng'g News</i> , Vol. 47, p. 35-36.

* Wrecked by slipping from the hinges shortly after striking the centers.

† Semi-hinges—lead plates $\frac{3}{4}$ -inch thick.

APPENDIX I

SPECIFICATIONS FOR CEMENT

The following are the standard specifications of the American Society for Testing Materials,* and have been approved by the American Railway Engineering and Maintenance of Way Association, and by the American Society of Civil Engineers. The headings and the numbering of the paragraphs are as in the original.

GENERAL OBSERVATIONS.

1. These remarks have been prepared with a view of pointing out the pertinent features of the various requirements and the precautions to be observed in the interpretation of the results of the tests.

2. The Committee would suggest that the acceptance or rejection under these specifications be based on tests made by an experienced person having the proper means for making the tests.

3. **Specific Gravity.** Specific gravity is useful in detecting adulteration. The results of tests of specific gravity are not necessarily conclusive as an indication of the quality of a cement, but when in combination with the results of other tests may afford valuable indications.

4. **Fineness.** The sieves should be kept thoroughly dry.

5. **Time of Setting.** Great care should be exercised to maintain the test pieces under as uniform conditions as possible. A sudden change or wide range of temperature in the room in which the tests are made, a very dry or humid atmosphere, and other irregularities vitally affect the rate of setting.

6. **Tensile Strength.** Each consumer must fix the minimum requirements for tensile strength to suit his own conditions. They shall, however, be within the limits stated.

7. **Constancy of Volume.** The tests for constancy of volume are divided into two classes, the first normal, the second accelerated. The latter should be regarded as a precautionary test only, and not infallible. So many conditions enter into the making and interpreting of it that it should be used with extreme care.

8. In making the pats the greatest care should be exercised to avoid initial strains due to moulding or to too rapid drying-out during the first twenty-four hours. The pats should be preserved under the most uniform conditions possible, and rapid changes of temperature should be avoided.

9. The failure to meet the requirements of the accelerated tests need not be sufficient cause for rejection. The cement may, however, be held for twenty-eight days, and a re-test be made at the end of that period, using a new sample. Failure to meet the requirements at this time should be considered sufficient

* Adopted Nov. 14, 1904. and amended slightly June 25, 1908.

cause for rejection, although in the present state of our knowledge it can not be said that such failure necessarily indicates unsoundness, nor can the cement be considered entirely satisfactory simply because it passes the tests.

SPECIFICATIONS.

1. General Conditions. All cement shall be inspected.

2. Cement may be inspected either at the place of manufacture or on the work.

3. In order to allow ample time for inspecting and testing, the cement should be stored in a suitable weather-tight building having the floor properly blocked or raised from the ground.

4. The cement shall be stored in such a manner as to permit easy access for proper inspection and identification of each shipment.

5. Every facility shall be provided by the contractor and a period of at least twelve days allowed for the inspection and necessary tests.

6. Cement shall be delivered in suitable packages with the brand and name of the manufacturer plainly marked thereon.

7. A bag of cement shall contain 94 pounds of cement net. Each barrel of portland cement shall contain 4 bags, and each barrel of natural cement shall contain 3 bags of the above net weight.

8. Cement failing to meet the seven-day requirements may be held awaiting the results of the twenty-eight-day tests before rejection.

9. All tests shall be made in accordance with the methods proposed by the Committee on Uniform Tests of Cement of the American Society of Civil Engineers, presented to the Society January 21, 1903, and amended January 20, 1904 and January 15, 1908. [The methods described in Chapter IV are substantially in accordance with that report.]

10. The acceptance or rejection shall be based on the following requirements:

NATURAL CEMENT.

11. Definition. The term natural cement shall be applied to the finely pulverized product resulting from the calcination of an argillaceous limestone at a temperature only sufficient to drive off the carbonic acid gas.

12. Fineness. It shall leave by weight a residue of not more than 10 per cent on the No. 100, and 30 per cent on the No. 200 sieve.

13. Time of Setting. It shall not develop initial set in less than ten minutes, and shall not develop hard set in less than thirty minutes, or in more than three hours.

14. Tensile Strength. The minimum requirements for tensile strength for briquettes one inch square in cross section shall be within the following limits, and shall show no retrogression in strength within the periods specified:

<i>Age.</i>	<i>Neat Cement.</i>	<i>Strength.*</i>
24 hours in moist air		50-100 lb.
7 days (1 day in moist air, 6 days in water)		100-200 "
28 days (1 day in moist air, 27 days in water)		200-300 "

One Part Cement, Three Parts Standard Sand.

7 days (1 day in moist air, 6 days in water)	25- 75 lb.
28 days (1 day in moist air, 27 days in water)	75-150 "

*The minimum requirement for neat cement at twenty-four hours should be some specified value within the limits of 50 and 100 pounds, and similarly for each period stated. If no special value is prescribed, the mean of the above values shall be taken as the minimum strength required.

15. Constancy of Volume. Pats of neat cement about three inches in diameter, one half inch thick at center, tapering to a thin edge, shall be kept in moist air for a period of twenty-four hours.

(a) A pat is then kept in air at normal temperature.

(b) Another is kept in water maintained as near 70° F. as practicable.

16. These pats are observed at intervals for at least 28 days; and, to satisfactorily pass the tests, should remain firm and hard and show no signs of distortion, checking, cracking, or disintegrating.

PORTLAND CEMENT.

17. Definition. This term is applied to the finely pulverized product resulting from the calcination to incipient fusion of an intimate mixture of properly proportioned argillaceous and calcareous materials, and to which no addition greater than 3 per cent has been made subsequent to calcination.

18. Specific Gravity. The specific gravity of the cement, ignited at a low red heat, shall be not less than 3.10; and the cement shall not show a loss on ignition of over 4 per cent.

19. Fineness. It shall leave by weight a residue of not more than 8 per cent on the No. 100, and not more than 25 per cent on the No. 200 sieve.

20. Time of Setting. It shall not develop initial set in less than thirty minutes, and must develop hard set in not less than one hour nor more than ten hours.

21. Tensile Strength. The minimum requirements for tensile strength for briquettes one inch square in section shall be within the following limits, and shall show no retrogression in strength within the periods specified:

<i>Age.</i>	<i>Neat Cement.</i>	<i>Strength.*</i>
24 hours in moist air	150-200 lb.
7 days (1 day in moist air, 6 days in water)	450-550 "
28 days (1 day in moist air, 27 days in water)	550-650 "

One Part Cement, Three Parts Sand.

7 days (1 day in moist air, 6 days in water)	150-200 lb.
28 days (1 day in moist air, 27 days in water)	200-300 "

22. Constancy of Volume. Pats of neat cement about three inches in diameter, one half inch thick at the center, and tapering to a thin edge, shall be kept in moist air for a period of twenty-four hours.

(a) A pat is then kept in air at normal temperature and observed at intervals for at least 28 days.

(b) Another pat is kept in water maintained as near 70° F. as practicable, and observed at intervals for at least 28 days.

(c) A third pat is exposed in any convenient way in an atmosphere of steam, above boiling water, in a loosely closed vessel for five hours.

23. These pats, to satisfactorily pass the requirements, shall remain firm and hard and show no signs of distortion, checking, cracking, or disintegrating.

24. Sulphuric Acid and Magnesia. The cement shall not contain more than 1.75 per cent of anhydrous sulphuric acid (SO₃), nor more than 4 per cent of magnesia (MgO).

*For example the minimum requirement for neat portland cement at twenty-four hours should be some specified value within the limits of 150 and 200 pounds, and similarly for each period stated. If no value is specified, the mean of the above values shall be taken as the minimum strength required.

APPENDIX II

SPECIFICATIONS FOR PORTLAND-CEMENT CONCRETE

The following are the standard specifications of the American Railway Engineering and Maintenance of Way Association:*

1. Cement. The cement shall be portland, either American or foreign, which will meet the requirements of the standard specifications adopted by the American Society for Testing Materials. [See Appendix I.]

2. Sand. The sand shall be clean, sharp, coarse, and of grains varying in size. It shall be free from sticks and other foreign matter, but it may contain clay or loam not to exceed five per cent. Crusher dust, screened to reject all particles over one quarter inch in diameter, may be used instead of sand, if approved by the engineer.

3. Stone. The stone shall be sound, hard and durable, crushed to sizes not exceeding two inches in any direction. For reinforced concrete, the sizes usually are not to exceed three quarter inch in any direction, but may be varied to suit the character of the reinforcing material.

4. Gravel. The gravel shall be composed of clean pebbles of hard and durable stone of sizes not exceeding two inches in diameter, free from clay and other impurities except sand. When containing sand in any considerable quantity, the amount per unit of volume of gravel shall be determined accurately to admit of the proper proportion of sand being maintained in the concrete mixture.

5. Water. The water shall be clean and reasonably clear, free from sulphuric acid or strong alkalies.

6. Mixing by Hand. (a) Tight platforms shall be provided of sufficient size to accommodate men and materials for the progressive and rapid mixing of at least two batches of concrete at the same time. Batches shall not exceed one cubic yard each, and smaller batches are preferable, based upon a multiple of the number of sacks to the barrel.

(b) Spread the sand evenly upon the platform, then the cement upon the sand, and mix thoroughly until of an even color. Add all the water necessary to make a thin mortar, and spread again; add the gravel if used, and finally the broken stone, both of which, if dry, should first be thoroughly wet down. Turn the mass with shovels or hoes until thoroughly incorporated, and until all the gravel and stone is covered with mortar, which will probably require the mass to be turned four times.

(c) Another method, which may be permitted at the option of the engineer in charge, is to spread the sand, then the cement, and mix dry; then the gravel or broken stone, add water, and mix thoroughly as above.

7. Mixing by Machine. A machine mixer shall be used wherever the volume

* Adopted first in 1902, see Proc., vol. iii, p. 304-06; modified in 1903, and modified and adopted as here in 1904, see vol. v, p. 610-13, 618, 619, 650-666. The headings and the numbering of the paragraphs are as in the original.

of work will justify the expense of installing the plant. The necessary requirements for the machine shall be that a precise and regular proportioning of materials can be controlled, and the product as delivered shall be of the required consistency and be thoroughly mixed.

8. Consistency. The concrete shall be of such consistency that when dumped in place it will not require much tamping. It shall be spaded down, and be tamped sufficiently to level it off, after which the water should rise freely to the surface.

9. Forms. (a) Forms shall be well built, substantial and unyielding, properly braced or tied together by means of wire or rods, and shall conform to the lines given.

(b) For all important work, the lumber used for face work shall be dressed on one side and both edges, and shall be sound and free from loose knots, secured to the studding or uprights in horizontal lines.

(c) For backing and other rough work, undressed lumber may be used.

(d) Where corners of the masonry and other projections liable to injury occur, suitable mouldings shall be placed in the angles of the forms to round or bevel them off.

(e) Lumber once used in forms shall be cleaned before being used again.

(f) The forms must not be removed within thirty-six hours after all the concrete in that section has been placed. In freezing weather, they must remain until the concrete has had a sufficient time to become thoroughly hardened.

(g) In dry but not freezing weather, the forms shall be drenched with water before the concrete is placed against them.

10. Depositing. (a) Each layer should be left somewhat rough to insure bonding with the next layer above; and, if the concrete has already set, it shall be thoroughly cleaned by scrubbing with coarse brushes and water before the next layer is placed upon it.

(b) Concrete shall be deposited in the moulds in layers of such thickness and position as shall be specified by the engineer in charge. Temporary planking shall be placed at the ends of partial layers, so that none shall run out to a thin edge. In general, excepting in arch work, all concrete must be deposited in horizontal layers of uniform thickness throughout.

(c) The work shall be carried up in sections of convenient length and the sections shall be completed without intermission.

(d) In no case shall work on a section stop within 18 inches of the top.

(e) Concrete shall be placed immediately after mixing, and any having an initial set shall be rejected.

11. Expansion Joints. In exposed work, expansion joints may be provided at intervals of thirty to one hundred feet, as the character of the structure may require.

(b) A temporary vertical form or partition of plank shall be set up, and the section behind shall be completed as though it were the end of the structure. The partition shall be removed when the next section is begun, and the new concrete shall be placed against the old without mortar flushing. Locks shall be provided, if directed or called for by the plans.

(c) In reinforced concrete the length of these sections may be materially increased at the option of the engineer.

12. Facing. (a) The facing may be made by carefully working the coarse stone back from the form by means of a shovel, bar or similar tool so as to bring the excess mortar of the concrete.

(b) About one inch of mortar (not grout) of the same proportions as used in the concrete may be placed next to the forms immediately in advance of the concrete, in order to secure a perfect face.

(c) Care must be taken to remove from the inside of the forms any dry mortar in order to secure a perfect face.

13. Proportions. The proportions of the materials in the concrete shall be as specifically called for by the contract, or as set forth herein, upon the lines left for that purpose, the volume of cement to be based upon the actual cubic contents of one barrel of specified weight.

STRUCTURE.	PARTS BY VOLUME.			
	Cement.	Sand.	Gravel.	Broken Stone.

14. Finishing. (a) After the forms are removed, which should generally be as soon as possible after the concrete is sufficiently hardened, any small cavities or openings in the face shall be neatly filled with mortar, if necessary in the opinion of the engineer. Any ridges due to cracks or joints in the lumber shall be rubbed down with chisel or wooden float. The entire face may then be washed with a thin grout of the consistency of whitewash, mixed in the same proportion as the mortar of the concrete. The wash shall be applied with a brush. The earlier the above operations are performed the better will be the result.

(b) The tops of bridge seats, pedestals, copings, wing walls, etc., when not finished with natural stone coping, shall be finished with a smooth surface composed of one part cement to two parts of granite or other suitable screenings or sand, applied in a layer $\frac{1}{2}$ to 1 inch thick. This must be put in place with the last course of concrete.

15. Waterproofing. Where waterproofing is required, a thin coat of mortar or grout shall be applied for a finishing coat, upon which shall be placed a covering of suitable waterproofing material.

16. Freezing Weather. Ordinarily concrete to be left above the surface of the ground shall not be constructed in freezing weather. Portland-cement concrete may be built under these conditions by special instructions. In this case the sand, water and broken stone shall be heated; and in severe cold, salt shall be added in the proportion of about 2 pounds per cubic yard.

17. Reinforced Concrete. Where concrete is deposited in connection with metal reinforcing, the greatest care must be taken to insure the coating of the metal with mortar and the thorough compacting of the concrete around the metal. Whenever it is practicable, the metal shall be placed in position first. This can usually be done where the metal occurs in the bottoms of the forms, by supporting the metal on transverse wires or otherwise, and then flushing the bottoms of the forms with cement mortar, so as to get the mortar under the metal and depositing the concrete immediately afterward. The mortar for flushing the bars shall be composed of one part cement and two parts sand. The metal, used in the concrete shall be free from dirt, oil or grease. All mill scale shall be removed by hammering the metal, or preferably by pickling the same in a weak solution of muriatic acid. No salt shall be used in reinforced concrete when laid in freezing weather.

APPENDIX III

SPECIFICATIONS FOR RAILWAY MASONRY

The following are the standard specifications of the American Railway Engineering and Maintenance of Way Association:*

GENERAL REQUIREMENTS.

1. Engineer. Where the term Engineer is used in these specifications, it refers to the engineer actually in charge of the work.

2. Cement. The cement shall conform to the requirements adopted by the Association [see Appendix I].

3. Stone. Stone shall be of the kinds specially designated and shall be hard and durable, free from seams or other imperfections, of approved quality and shape, and in no case shall have less bed than rise. When liable to be affected by freezing, no unseasoned stone shall be laid.

4. Dressing. Dressing shall be the best of the kind specified.

5. Beds and joints or builds shall be square with each other, and dressed true and out of wind. Hollow beds shall not be allowed.

6. Stone shall be dressed for laying on natural beds.

7. Marginal drafts shall be neat and accurate.

8. Pitching shall be done to true lines and exact batter.

9. Mortar. Mortar shall be mixed in a suitable box, and kept clean and free from foreign matter. Sand and cement shall be mixed dry and in small batches in proportions as directed by the engineer, water shall then be added, and the whole mixed until the mass of mortar is thoroughly homogeneous and leaves the hoe clean when drawn from it. Mechanical mixing to produce the same results may be permitted. Mortar shall not be re-tempered after it has begun to set.

10. Laying. The arrangement of courses and bond shall be as indicated on the drawings or as directed by the engineer. Stone shall be laid to exact lines and levels, to give the required bond and thickness of mortar in beds and joints.

11. Stone shall be cleansed and dampened before laying.

12. Stone shall be well bonded, laid on its natural bed and solidly settled into place in a full bed of mortar.

13. Stone shall not be dropped or slid over the wall, but shall be placed without jarring stone already laid.

14. Heavy hammering shall not be allowed on the wall after a course is laid.

15. Stone becoming loose after the mortar is set shall be relaid with fresh mortar.

16. Stone shall not be laid in freezing weather, unless directed by the engineer. If laid, it shall be freed from ice, snow or frost by warming; and the sand and water used in the mortar shall be heated.

* Adopted 1908—see Proc. vol. ix, p. 650-55, 659.

17. With precaution, a brine may be substituted for the heating of the mortar. The brine shall consist of one pound of salt to eighteen gallons of water, when the temperature is 32 degrees Fahrenheit; and for every degree of temperature below 32 degrees Fahrenheit, one ounce of salt shall be added.

18. Pointing. Before the mortar has set in beds and joints, it shall be removed to a depth of not less than one inch (1"). Pointing shall not be done until the wall is complete and mortar set, nor when frost is in the stone.

19. Mortar for pointing shall consist of equal parts of portland cement and sand sieved to meet the requirements. In pointing, the joints shall be wet and filled with mortar pounded in with a "set-in" or calking tool, and be finished with a heading tool of the width of the joint, used with a straight-edge.

ASHLAR MASONRY.

A. For Bridges and Retaining Walls.

20. Stone. The stones shall be large and well-proportioned.

21. Courses shall not be less than fourteen inches (14") or more than thirty inches (30") thick, thickness of courses to diminish regularly from bottom to top.

22. Dressing. Beds and joints or builds of face stone shall be fine-pointed, so that the mortar layer shall not be more than one half inch ($\frac{1}{2}$ ") thick when the stone is laid.

23. Joints in face stone shall be full to the square for a depth equal to at least one half the height of the course, but in no case less than twelve inches (12").

24. Exposed surfaces of the face stone shall be rock-faced, and the edges shall be pitched to true lines and exact batter. The face shall not project more than three inches (3") beyond the pitch line.

25. Chisel drafts one and one half inches ($1\frac{1}{2}$ ") wide shall be cut at exterior corners.

26. Holes for stone hooks shall not be permitted to show in exposed surfaces. None shall be handled with clamps, keys, lewis, or dowels.

27. Stretchers. Stretchers shall not be less than four feet (4') long and have at least one and a quarter times as much bed as thickness of course.

28. Headers. Headers shall not be less than four feet (4') long, shall occupy one fifth of face of wall, shall not be less than eighteen inches (18") wide in face, and, where the course is more than eighteen inches (18") high, width of face shall not be less than height of course.

29. Headers shall hold in heart of wall the same size shown in face, so arranged that a header in a superior course shall not be laid over a joint, and a joint shall not occur over a header; the same disposition shall occur in back of wall.

30. Headers in face and back of wall shall interlock when thickness of wall will admit.

31. Where the wall is three feet (3') thick or less, the face stone shall pass entirely through. Backing shall not be allowed.

32a.* Backing. Backing shall be large, well-shaped stone, roughly bedded and jointed; bed joints shall not exceed one inch (1"). At least one half of the backing stone shall be of same size and character as the face stone and with parallel ends. The vertical joints in back of wall shall not exceed two inches (2"). The interior vertical joints shall not exceed six inches (6"). Voids shall be thoroughly filled with *concrete or spalls fully bedded in cement mortar.*

32b.* Backing shall be of *concrete or headers and stretchers, as specified in paragraphs 28-30, and the heart of the wall shall be filled with concrete.*

* Paragraphs 32a and 32b are so arranged that either may be eliminated according to requirements. Each of these paragraphs also contains optional clauses, which are printed in italics.

33. Where the wall will not admit of such arrangement, stone not less than four feet (4') long shall be placed transversely in the heart of the wall to bond the opposite sides.

34. Where stone is backed with two courses, neither course shall be less than eight inches (8") thick.

35. **Bond.** The bond of stone in the face, back, and heart of the wall shall not be less than twelve inches (12"). The backing shall be laid to break joints with the face stone and with one another.

36. **Coping.** Coping stones shall be full size throughout, of dimensions indicated on the drawings.

37. Beds, joints and top shall be fine-pointed.

38. Location of joints shall be determined by the position of the bed plates, and be indicated on the drawings.

39. **Cramps.** Where required, coping stone, stone in the wings of abutments, and stone on piers shall be secured together with iron cramps or dowels, their position being indicated on the drawings.

B. For Arches.

40. **Arch Stones.** Voussoirs shall be full size throughout and dressed true to templet, and shall have bond not less than thickness of stone.

41. Joints of voussoirs and intrados shall be fine-pointed. Mortar joints shall not exceed three eighths inch ($\frac{3}{8}$ ").

42. Exposed surfaces of the ring stone shall be *smooth or rock-faced with a marginal draft.**

43. Number of courses and depth of voussoirs shall be indicated on the drawings.

44. Voussoirs shall be placed in the order indicated on the drawings.

45. **Backing.** Backing shall consist of *concrete or large stone shaped to fit the arch, bonded to the spandrel and laid in full bed of mortar.**

46. Where waterproofing is required, a thin coat of mortar or grout shall be applied evenly for a finishing coat, upon which shall be placed a covering of approved waterproofing material.

47. Centers shall not be struck until directed by the engineer.

48. **Bench Walls, etc.** Bench walls, piers, spandrels, parapets, wing walls, and copings shall be built under the specifications for Ashlar for Bridges and Retaining Walls.

RUBBLE MASONRY.

A. For Bridges and Retaining Walls.

49. **Stone.** The stone shall be roughly squared and laid in irregular courses. Beds shall be parallel, roughly dressed, and the stone laid horizontal in the wall. Face joints shall not be more than one inch (1") thick. Bottom stone shall be large, selected flat stone.

50. The wall shall be compactly laid, at least one fifth of the surface of back and face being headers arranged to interlock. All voids in the heart of the wall shall be thoroughly filled with *concrete or suitable stones and spalls fully bedded in cement mortar.**

B. For Arches.

51. **Voussoirs.** Voussoirs shall be full size throughout, and shall have bond not less than thickness of voussoirs.

52. Beds shall be roughly dressed to bring them to radial planes.

* Optional clauses are in italic.

53. Mortar joints shall not exceed one inch (1").
54. Exposed surfaces of the ring stone shall be rock-faced, and edges pitched to true lines.
55. Voussoirs shall be placed in the order indicated on the drawings.
56. Backing. Backing shall consist of *concrete or large stone, shaped to fit the arch, bonded to the spandrel, and laid in full bed of mortar.**
57. Where waterproofing is required, a thin coat of mortar or grout shall be applied evenly for a finishing coat, upon which shall be placed a covering of approved waterproofing material.
58. Centers shall not be struck until directed by the engineer.
59. Bench Walls, etc. Bench walls, piers, spandrels, parapets, wing walls and copings shall be built under the specifications for Rubble Masonry for Bridges and Retaining Walls.

CULVERT MASONRY.

60. Character of Masonry. Culvert masonry shall be laid in cement mortar. The character of stone and quality of work shall be the same as specified for Rubble Masonry for Bridges and Retaining Walls.
61. Side Walls. One half the top stones of the side walls shall extend entirely across the wall.
62. Cover Stones. Covering stone shall be sound and strong, at least twelve inches (12") thick, or as indicated on the drawings. They shall be roughly dressed to make close joints with each other, and lap their entire width or at least twelve inches (12") over the side walls. They shall be doubled under high embankments, as indicated on the drawings.
63. Coping. End walls shall be covered with suitable copings, as indicated on the drawings.

DRY MASONRY.

64. Dry Masonry shall include dry retaining walls and slope walls.
65. Retaining Walls. Retaining walls of dry masonry shall include all walls in which rubble stone laid without mortar is used for retaining embankments or for similar purposes.
66. Dressing. Flat stone at least twice as wide as thick shall be used. Beds and joints shall be roughly dressed square to each other and to face of stone.
67. Joints shall not exceed three quarter inch ($\frac{3}{4}$ ").
68. Stone of different sizes shall be evenly distributed over entire face of wall, generally keeping the largest stone in lower part of wall.
69. The work shall be well bonded and present a reasonably true and smooth surface, free from holes or projections.
70. Slope Walls. Slope walls shall be built of such thickness and slope as directed by the engineer. Stone shall not be used in this construction which does not reach entirely through the wall. Stone shall be placed at right angles to the slopes. The wall shall be built simultaneously with the embankment which it is to protect.

* Optional clauses are in italic.

INDEX

ABU - ARC

- Abutment, arch, dimensions from French practice, 647
empirical formulas for, 645
stability of, 640
bridge, forms, 535
foundations, 538
kind of masonry, 539
pier, 550
reinforced, 542, 549
stability, theory of, 537
straight, 539
 Lehigh Valley R.R., 540
 N. Y. Central R.R., 541
T-abutment, 548
 Illinois Central R.R., 548
 reinforced, 549
U-abutment, 542
 A. T. & S.-F. R.R., 542
 N. Y. Central, R.R., 545
wing, 539
 Cooper's highway, 539
 N. Y. Central, R.R., 539
 reinforced, 542
Aggregate for concrete, defined, 133
Air-chamber, filling, 442
Air-lock, pneumatic pile, 436
 pneumatic caisson, 434, 439
 position of, 434
Alkali, effect on concrete, 193
Alum and soap waterproofing, 186
Arch, abutment, backing, 659
 dimension from French practice, 647
 stability of, 640
 Big Muddy, 704
 Big South Fork, 713
brick, 667
 bond, 667
 example, 669
 specifications, 327
center of pressure, 609
centers, defined, 650
 examples, 663, 667, 669, 706, 707, 716
load to be supported, 651
outline form of, 653
 braced wooden rib, 655

ARC

- Arch, centers, outline form of, built
 wooden rib, 654
 solid wooden rib, 653
 trussed, 656
striking, 657
 method, 657
 time, 658
Charley Creek, 715
classification of, 607
Connecticut Ave., 703
culvert, see Culvert, arch.
Danville, 718
definitions, parts, 606
 kinds, 607
Detroit Ave., 702
dimensions of, 648, 703, 721
drainage, 666, 719
elastic, approximate solution, 698
 $\Delta s \div I$ constant, 676
 conditions for fixed ends, 671
defined, 670
loads for, 670
 placing the concrete, 701
 reliability of theory of, 700
equilibrium polygon for, 678
external forces, 614, 670
 earth pressure, 616
 masonry, 615
 water pressure, 615
forms of, 607
hinged, 720
 advantages of, 721
 analysis of, 720
 dimensions, 722
 examples, 721
Hudson memorial, 720
inverted, for foundation, 361
line of resistance, defined, 608
 location of, 637
line of pressure, 609
masonry, specifications for, 667, 731
method of balancing thrust, 717
Melan, defined, 711
Monier, defined, 711
Pennypacker, 704
Peru, 717
plain concrete, dimensions of, 703

ARC

ch, plain concrete, examples, 703
 shortening, stresses due to, 696
 stresses maximum, 690, 695
 due to shortening, 697
 temperature, 694, 695, 697
 reinforced, advantages of, 708
 analysis of, 708
 equations of condition, 709
 relieving, for retaining walls, 515
 in spandrel filling, 660
 skew, defined, 608
 specifications for arch masonry, 667, 731
 spandrel filling, 660
 systems of reinforcing, 711
 temperature changes in, 691
 temperature stresses in, 694, 695, 697
 Thacher, defined, 712
 voussoir, abutments, 670
 dimensions from French
 practice, 647
 stability of, 640
 thickness of, 645
 backing, 659
 hollow spandrels, 660
 centers, examples of, 663, 667, 669,
 706, 707, 716; see also Centers.
 crown thrust, 617, 621
 Navier's principle, 620
 theory of least, 620
 to find, 621
 theory of least pressure, 618
 Winkler's hypothesis, 618
 details of construction, 659
 dimensions, 648
 examples of, 661
 Bellefield, 665
 Cabin John, 664
 Luxemburg, 662
 Pennsylvania R.R., 666
 Plauen, 662
 Pont-y-Prydd, 665
 external forces, 614
 failure, methods of, 609
 joint of rupture, defined, 622
 correct method of finding, 623
 incorrect method of finding, 626
 location of, 625
 line of pressure, 609
 line of resistance, 609
 open joints, 613
 plain concrete, see Arch, elastic.
 proportions, formulas for, 642
 thickness at crown, 643
 at springing, 645
 stability, crushing, 611, 631
 unit pressure, 611
 empirical rules for, 641
 rotation, 610
 sliding, 614

ARC - BRI

Arch, voussoir, theory of, 608
 criterion, 610, 636
 theories, 628
 rational, 628
 symmetrical load, 628
 unsymmetrical load, 634
 Rankine's, 640
 Scheffler's, 637
 incorrectly applied, 638
 unit pressure, 611
 unreinforced, see Arch, elastic.
 Union Pacific, 712
 Wunsch, defined, 711
 Artificial Stone, 268
 Ashlar, 280, 283
 backing, 285
 bond, 285
 dressing, 283
 definition, 280
 finishing joints 287
 laying, 282
 pointing, 286
 mortar, amount required, 287
 size of stones, 283
 specifications, 730
 uses, 283
 A. T. and S.-F. R.R., abutment, 542
 culvert, cast-iron, 576
 pier, 559
 Atchafalaya bridge, foundation, 424
 Ax, 270

 Back wall, see Parapet wall.
 Batter, definition, 279
 Beams, reinforced concrete, economic de-
 sign of, 242
 working stress for, 240
 Bearing power, foundations, q.v., 336
 piles, q. v., 387
 soils, q. v., 335
 Big Muddy arch, 704
 Big South Fork Arch, 713
 Bituminous shield, 190
 Blair bridge, pneumatic foundation, 431
 cost, 447
 frictional resistance, 442
 rate of sinking, 440
 Bond, brick, arches, 667
 masonry, 308
 concrete with steel, 229
 stone masonry, 285
 Box culvert, see Culvert, box.
 Brick, absorptive power, 21, 39
 arch, bond, 667
 example, 669
 classification, 37
 clay, 34
 building, 35
 cost, 44

BRI - CAI

- Brick, clay, crushing strength, 40, 42
 manufacture of, 35
 requisite of good, 39
 shearing strength, 43
 sizes, 43
 transverse strength, 43
 crushing strength, method of testing, 40
 data on, 42, 46
 cylinders for bridge foundations, 425
 fire, 35
 manufacture, 35
 masonry, see Masonry, brick,
 requisites for good, 35
 sand-lime, absorption, 47
 characteristics, 46,
 cost, 48
 crushing strength, 46
 definition, 45
 fire, effect of, 48
 weather, effect of, 47
 manufacture, method of, 45
 transverse strength, 47
- Brick masonry, see Masonry, brick.
- Bridge abutment, see Abutment, bridge.
- Bridge pier, see Pier.
- Broken-stone, cost, 103
 screened vs. unscreened, 133
 sizes, 100
 voids, 99, 101, 102
 weight, 102
- Brooklyn bridge, foundation, 442, 443
- Building-blocks, concrete, 262
 form, 263
 hollow space, 265
 manufacture, 265
- Building-blocks, moulding machines, 266
 size, 263
 waterproofing, 267
- Building-stone, classification, 27
 requisites for good, 3
 tests, 5
 see also Stone.
- Buildings, concrete, cost of, 258, 260
 data for computing weight of, 347
 pneumatic foundation for, 444
- C. B. & Q. R.R., culvert box, single, 588
 double, 589
 retaining wall, 529
 forms for, 531
- C. C. & St. L. R.R., arch, reinforced
 concrete, 718
- C. C. & O. Ry., arch culvert, 597
- C. M. & St. P. Ry., culvert, arch, 599, 601
 box, 586
 rail-top, 590
- C. & N. W. R.R., retaining wall, 527
 forms for, 530
- Caisson, definition, 417, 428

CAI - OEM

- Caisson, disease, 446
 pneumatic, 431
 Blair bridge, 431
 first use of, 429
 guiding in sinking, 441
 Havre de Grace, 433
- Cairo bridge, pier, 558, 548
- Cavil, 270
- Cement, activity, 68
 amount for a yard of mortar, 119
 bibliography, 83
 chemical analysis, 66
 classification, 49, 54
 cost, 58
 data for estimates, 58, 118-20
 economy, relative, 82
 fineness, 61
 iron-ore, 54
 lime with cement, effect of, 128
 magnesia, 55
 mortar, data for estimates, 118, 119
 lime-cement, 128
 normal consistency, 72, 75
 see also Mortar, cement
 natural, description, 56
 cost, 58
 specifications, 724
 weight per barrel, 58
 normal consistency, 72
 pat test, 64
 portland, description, 55
 cost, 58
 specifications, 725
 weight per barrel, 58
 pozzolan, description, 56
 cost, 58
 weight, 58
 re-tempering, effect of, 128
 Rosendale, 56
 silica, 56
 slag, 57
 specifications, 83, 723
 specific gravity, 60
 strength of, 122
 sand, effect of, 123
 time, effect of, 122
 soundness, 63
 tests of, 64
 tensile strength, data on, 81, 82, 111,
 122, 123
 method of testing, 71
 tests, activity, 68
 briquette, form of, 76
 chemical analysis, 66
 color, 59
 constancy of volume, 63
 fineness, 61
 set, time of, 70
 soundness, 63

CEM - CON

- Cement, tests, soundness, accelerated**
 tests of, 65
 specific gravity, 60
 strength, 71, 124
 age when tested, 79
 data on, 81, 82, 111, 122, 123
 form of briquette, 76
 weight, 60
 testing, importance of, 58
 methods of, 59
 time of set, 70
 weight, 57, 60
- Center of gravity of trapezoid, to find, 465**
- Charley Creek arch, 715**
- Chisel, pitching, 271**
 splitting, 272
 tooth, 272
- Coefficient, cohesion of earth, 495**
 elasticity, concrete, 206, 242
 stone, 14
 expansion of concrete, 255
 friction, earth, 495, 498, 499
 foundation, 426, 442
 masonry, 464
- Coffer-dam, see Foundation, coffer-dam.**
- Columns, concrete, cement, effect of, 244**
 eccentric loads, 243
 factor of safety, 249
 plain, strength of, 244
 reinforced, 243
 circumferentially, 246
 longitudinally, 245
 strength of concrete, 243
 plain, 244
 reinforced, 243
 empirical formula for, 248
 strength, 243
- Compressed air, physiological effect, 445**
 foundations, *see* Foundations, pneumatic.
- Concrete, aggregate, defined, 133**
 alkali, effect of, 193
 alum and soap waterproofing, 186
 amount of water required, 169
 beams, plain, 223
 reinforced, 224
 T-beam, 228
 bituminous shield, 190
 bond with steel, 229
 bonding old to new, 173
 broken-stone *vs.* gravel, 134
 building-blocks, *see* Building-block.
 cement *vs.* strength, 139
 cinder, 136, 201
 coefficient of elasticity, 206, 242
 of expansion, 255
 columns, eccentric loads, 243
 cement, effect of, 244
 empirical formulas for, 248

CON

- Concrete, columns, reinforcement, 244**
 circumferential, 246
 longitudinal, 245
 strength of, 243
- consistency, 166**
- contraction and expansion, 254**
 joints, 190, 256
- cost, 207, 258, 260, 532, 533, 550, 560,**
 562, 591, 592, 593, 603, 605
 arch culverts, 214
 buildings, 258, 260
 examples of, 212, 258
 forms, 209, 258, 591, 592, 593, 603, 605
 foundation, 213, 258, 416
 labor, 215, 258, 416, 532, 533, 550, 560, 562, 592, 593, 603, 605
 materials, 208, 258, 416, 532, 533, 550
 560, 562, 592, 593, 603, 605
 mixing, hand, 210, 215
 machine, 211
 placing, 215
 retaining wall, 213
 sea wall, 212
- defined, 132**
- depositing under water, 174**
- density, 137**
vs. strength, 139
- diagonal tension, 233**
- dry *vs.* wet, 167**
- economic, 215**
- efflorescence, 192**
- elastic limit, 206, 242**
- elasticity, modulus of, 206**
- estimates, data for, 157**
- expansion and contraction, 254**
 joint, 190, 256
- finish of surface, 177**
- forms, 159, 250**
 bracing, 160
 cleaning, 165
 construction, ordinary, 159, 250, 527, 529, 530, 531
 improved, 163, 251
 column, 250, 258
 cost of, 166, 209, 258, 416, 591
 floor, 251, 258
 girder, 251
 plank, 162
 removing, 163, 254
 sectional, 163
 time to remove, 166, 254
- Fuller's rule for amount of ingredients, 158**
- ingredients for a yard, 157**
 Fuller's rule, 158
- laying, 172**
 in freezing weather, 175
 rubble concrete, 173

CON

- Concrete, machine mixers, 171
 mixing, 169
 modulus of elasticity, 206, 242
 oil, effect of, 194
 placing, 172
 freezing weather, 175
 proportioning, methods of, 142
 arbitrary assignment, 142
 sieve-analysis, 147
 trial, 146
 voids, 143
 units used, 154
 proportions, theory of, 138
 used in practice, 156
 reinforced, advantages of, 219
 amount of steel, 235
 beam for compression, 229
 beam, economic, 242
 formulas, 224
 bibliography, 261
 bond, 229
 stress, 240
 compressive stress, 241
 cost, 258, 260
 steel, handling, 260
 definition, 218
 diagonal tension, 233
 fireproofing, 242
 forms, 250; *see also* Concrete, forms.
 formulas for safe strength, 225
 history, 218
 objections to, 220
 placing, 253
 removing forms, 163, 254
 separately moulded members, 256
 shear, 231, 241
 T-beams, 228
 tension in steel, 240
 theory of flexure, 221
 reinforcing to prevent contraction
 cracks, 255
 reinforcement, 234
 kinds of, 236
 web, 237
 rubble, 173, 292
 sea water, effect of, 193
 shear, vertical, 231
 shearing strength, 205
 shrinkage in setting, 190, 255
 specifications, 726
 strength, 194
 age, effect of, 199
 cement, effect of, 139
 cinder, 201
 compressive, 195
 Dow's experiments, 195
 Kimball's experiments, 197
 other experiments, 198
 Rafter's experiments, 196

CON - CUL

- Concrete, strength, concentrated load, 200
 different proportions, 198
 plain beam, 223
 safe, 200
 shearing, 205
 tensile, 202
 transverse, 203, 204
 surface, finish of, 177
 acid, 181
 colored, 181
 honeycombed, 180
 mortar, 178
 plaster, 179
 rubbed, 180
 scrubbed, 180
 spaded, 178
 tooled, 181
 whitewashed, 179
 theory of proportions, 138
 units in proportioning, 154
 water required, 169
 waterproofing, 181
 ingredients, 184
 alum and soap, 186
 clay, 185
 lime, 185
 lime and soap, 187
 pozzolan cement, 185
 methods of, 183
 bituminous shield, 190
 dense concrete, 183
 waterproof coatings, 188
 waterproof ingredients, 184
 weight, 207
 Concrete and piles for foundations, 365
 Contraction joints, 190, 256
 Cooper's standard, abutment, 539
 bridge pier, 557
 Coping, 279, 312
 Cost, *see* the article in question.
 Coulomb's theory of earth pressure, 493
 Corrugated bar, 236
 Cracking crack, *see* Hair cracks.
 Cramps, 279
 Crandall, 271
 Orib for coffer-dam, 418
 Culverts, arch, concrete, cost of, 603
 design, 594
 junction body and wings, 594
 examples, 596
 C. C. & O. Ry., 597
 C. M. & St. P. Ry., 599
 Erie R.R., 597
 Illinois Central R.R., 598, 600
 L. S. & M. S. R.R., 601
 N. Y. Central R.R., 596
 Pennsylvania Lines, 596
 Porto Rico, 598
 plain concrete, examples, 596

CUL - DAM

- ulverts, arch, reinforced, examples, 599
 - theory, 593
- box, cost, 592
- defined, 579
- rail-top, 590
 - cost, 593
- reinforced concrete, 580
 - examples, 585-91
- definition, 564
- design, 569, 594
- pipe, 571
 - cast-iron, 574
 - concrete, 577
 - plain, 578
 - reinforced, 578
 - vitri-fied-pipe, 571
 - strength, 578
- waterway required, 564
 - factors, 564
 - formulas for, 566
 - Myer's, 567
 - Talbot's, 567
- ummings loop bars, 238
- ushing pile foundations, 403
- ut-stone, 276
 - bush-hammered, 277
 - crandalled, 277
 - diamond-panel, 278
 - drafted, 276
 - fine-pointed, 277
 - pitch-faced, 276
 - quarry-faced, 276
 - rough-pointed, 276
 - rubbed, 278
 - tooth-axed, 277
- am, arched, 458
 - examples, 483
 - Bear Valley, 484
 - Sweetwater, 484
 - Upper Otay, 484
 - Zola, 484
 - vs. gravity, 483
- bibliography, 488
- Cain's profile, 479
- classification, 458
- crushing, stability for, 470
 - limiting pressure, 475
 - maximum pressure, formula for, 473
 - tension in, 474
- curved gravity, 485
- examples, 480
 - Ashokan, 482
 - Cheesman, 482
 - New Croton, 480
 - Olive Bridge, 482
 - Pathfinder, 481
 - Quaker Bridge, 480
 - Reclamation Service, 480

DAM - EAR

- Dam, examples, Roosevelt, 481
 - Shoshone, 481
 - Wachusetts, 481
- failure, methods of, 459
 - gravity, 458; *see also* Dam, curved gravity above.
 - hollow vs. solid, 487
- ice, effect of, 477
- masonry, 458
- nomenclature, 459
- overfall, 486
- overturning, stability for, 463
 - algebraic solution, 463
 - graphical solution, 466
- plan, 482
 - arched vs. gravity, 483
 - curved gravity, 485
 - straight cress vs. straight toe, 482
- percolating water, effect of, 469
- pressure, allowable, 475
- profile, 478
 - Cain's, 479
 - examples, 480, 481, 484, 487, 488
 - method of finding, 478
 - quality of masonry, 487
 - sliding, stability against, 460
 - solid vs. hollow, 487
 - stability, crushing, 470
 - overturning, 463
 - sliding, 460
 - tension in masonry, 474
 - waves, effect of, 477
 - width on top, 478
 - wind, effect of, 476
- Danville arch, 718
- Deformed bars, 236
- Detroit Ave. arch, 702
- Diamond bar, 236
- Dimension stones, 281
- Dirt wall, *see* Parapet wall.
- Disk piles, 371
- Dowel, 279
- Dredges, 414
- Dredging, 414
- Dredging through wells, 422
- Drift bolts, 402
- Eads bridge, foundation, 442
- Earth, angle of friction, 498
 - angle of repose, 495, 499
 - coefficient of cohesion, 495
 - coefficient of friction, 495, 499
- Earth pressure, formulas for, 492
 - Coulomb's, 493
 - Poncelet's, 494
 - Rankine's, 493
 - Weyrauch's, 494
- reliability of formulas, 496
- results of experiment, 500

EFF - FOU

- Efflorescence, brickwork, 328
 concrete, 192
 Erie R.R., arch culvert, 597
 Excavator, compresses-air, 422; *see also*
 Dredges, and Pumps.
 Extrados, defined, 606
- Face hammer, 269
 Facing, 279
 Feather and plug, 272
 Fireproofing, 242
 Footing, brick, 358
 cantilever, 359
 concrete, plain, 353
 reinforced, 359
 eccentric, 358
 inverted arch, 361
 masonry, 356
 steel-beam, 361
 stone, 358
 timber, 360
- Forms, *see* Concrete, forms.
 Forth bridge, pneumatic caisson, 444
 Foundation, Atchafalaya bridge, 424
 bearing power, alluvium, 342
 clay, 338
 gravel, 342
 improving, methods of, 343
 quicksand, 342
 rock, 336
 sand, 339
 semi-liquid soil, 340
 summary, 342
 testing, methods of, 335
 bed of, defined, 330
 preparing, 364
 bridge, Atchafalaya, 424
 Blair, 431
 brick cylinders, 425
 Brooklyn, 440, 443
 Eads, 442
 Forth, 444
 Havre de Grace, 433
 Hawkesbury, 425
 Memphis, 443
 Poughkeepsie, 423
 Williamsburg, 440, 447, 450
 buildings, area required, 350
 bearing power of soil, 335-42
 improving, methods of, 343
 concrete and piles, 365
 consolidating soil, 345
 deep, 362
 drainage of, 343
 springs, 344
 examining the site, 333
 footing, 355; *see also* Footing.
 grillage, 365
 independent piers, 352

FOU

- Foundations, buildings, load to be sup-
 ported, 347
 pile, *see* Pile.
 piles and concrete, 365
 piles and grillage, 365
 preparing the bed, 364
 sand piles, 346
 sand in layers, 345
 springs, 344
 wind, effect of, 352
 center of base, 350
 coffer-dam, 406
 conclusion, 416
 construction, 406
 crib, 410
 double, 410
 movable, 410
 puddle-wall, 408
 construction, 408,
 puddle, 409
 thickness, 409
 steel-pile, 408
 wood-pile, 407
 cost, 414
 process for foundations, 406
 leakage, 411
 pumps, 412; *see also* Pumps.
 comparison of methods, 456
 compressed-air process, 429; *see also*
 pneumatic process *below*.
 consolidating the soil, 345
 crib and open-caisson process, 417
 construction, 418
 excavating site, 420
 principle, 417
 deep, 362
 concrete piers, 362
 hydraulic caisson, 363
 piles, 362
 definition, 330
 designing, 347
 drainage, 343
 dredging 414
 dredging through wells, 422
 examples, 423
 excavators, 422
 frictional resistance, 426
 conclusion, 428
 cost, 427
 dry ground, 333
 examining site, 333
 boring with auger, 334
 drilling, 334
 driving pipe, 333
 washing a hole, 334
 frictional resistance in sinking, 426, 442
 freezing process, 455
 advantages, 456
 difficulties, 456

FOU

foundations, freezing process, history, 455
 footing, *see* Footing.
 grillage, 365
 importance of, 330
 independent piers, 352
 inverted arch, 361
 lateral yielding, 400
 load on, dead, 347
 live, 348
 ordinary, 333
 plan of proposed discussion, 331
 pile, 345, 365; *see also* Pile.
 concrete cap, 365, 403
 distance between piles, 399
 finishing, 401
 grillage, 401
 pneumatic, described, 429
 cost, 448
 sawing off, 400
 pneumatic process, 428
 advantages of, 455
 buildings, 444
 caisson, described, 431
 Blair bridge, 431
 Havre de Grace bridge, 433
 caisson disease, 446
 cost, Blair bridge, 447
 European examples, 453
 Havre de Grace bridge, 447
 moderate depth, 447
 Plattsmouth bridge, 448
 pneumatic piles, 448
 Williamsburg bridge, 447, 450
 defined, 428
 effect of compressed-air, 445, 446
 examples, 442
 Blair, 431, 447
 Brooklyn, 443
 Eads, 442
 Forth, 444
 Havre de Grace, 433, 447
 Memphis, 443
 Plattsmouth, 440, 448
 excavation, 436
 clay hoist, 439
 Eads pump, 437
 Moran air-lock, 439
 mud pump, 437
 sand lift, 436
 water column, 439
 filling air-chamber, 442
 frictional resistance, 442
 guiding caisson, 441
 history, 429
 Havre de Grace bridge, 447
 maximum depth, 440
 physiological effect of compressed
 air, 445, 446

FOU - HYD

Foundations, pneumatic process, **Platts-**
 mouth bridge, 440
 plenum process, defined, 428
 position of air-lock, 434
 pile, 429
 rate of sinking, 440
 vacuum process, described, 428
 working time, 446
 pump, 412
 centrifugal, 413
 hand, 412
 pulsometer, 413
 steam syphon, 413
 spread footings, 355
 inverted arch, 361
 masonry footings, 356
 steel-rail footings, 361
 timber footings, 360
 timber in, 420
 under water, 405
 wind, effect on, 352
 Freezing of mortar, cement, 130
 lime, 108
 Freezing process for foundations, 455
 Freezing weather, laying concrete in,
 175
 laying masonry in, 108, 130
 Friction, coefficient of, for earth, 495, 499
 internal, 498, 499
 for masonry, 464
 Frost batter, 516

 Gilbertsville pier, 560
 highway crossing, 600, 602
 Grand Forks pivot pier, 562
 Granite, described, 29
 cost of cutting, 298
 Gravel, 97
 cleanness, 97
 data on, 99
 durability, 97
 requisites for good, 97
 size, 97
 voids, 97, 99
 Grout, 118
 wash for waterproofing, 189

 Hair cracks in concrete, 178
 Hammer, bush, 270
 face, 269
 hand, 271
 patent, 271
 Haunch of arch, defined, 607
 Havre de Grace bridge, foundation, 433,
 447
 Hawkesbury bridge, foundation, 425
 Hudson memorial arch, 720
 Hydraulic cement, *see* Cement.
 lime, *see* Lime.

ICE - MAS

- Ice, effect on dam, 477
 pier, 552
- Illinois Central R.R., abutment, 548
 arch, Big Muddy, 704
 culvert, arch, 598, 600
 box, reinforced concrete, 588
 pier, Cairo, 558, 548
 Gilbertsville, 560
 retaining wall, 526
 forms for, 529
- Intrados, defined, 607
- Inverted arch, 361
- Jet pile-driver, 381
 vs. hammer pile-driver, 383
- Joint of rupture, method of finding, 625
 correct, 623
 incorrect, 626
 Pitit's theory of, 627
- Kahn bar, 238
- K.-C., M. & O. R.R., culvert, box, 585
 pier, 559
- L. S. & M. S. Ry., culvert, arch, 601
 box, 585
- Lateral yielding, 400
- Lehigh Valley R.R., bridge abutment, 539
- Lime, classification of, 49
 cement with, 128
 cost, 53
 data for estimates, 53, 108
 description, 50
 hydrated, 52
 hydraulic, 53
 mortar, 104, *see also* Mortar.
 preserving, 52
 slacking, 104
 storing, 52
 tensile strength, 51, 122
 testing, method of, 52
 weight, 53
- Limestone, described, 30
- Map lines, *see* Hair cracks.
- Marble, described, 30
- Masonry, ashlar, 283; *see also* Ashlar.
 brick, coping, 312
 bond, 308
 cost, 324
 labor, 324
 materials, 326
 crushing strength, 314
 data for estimates, 323
 efflorescence, 328
 impervious to water, 327
 joints, finishing, 311
 thickness of, 307

MAS - MEL

- Masonry, brick, laying, 309
 improvements in, 313
 measurement, 322
 mortar, 306
 pointing, 311
 pressure allowed, 319
 shove joint, 311
 specifications for buildings, 326
 sewers, 327
 slushing the joints, 310
 strength, compressive, 314
 transverse, 320
 veneer, 309
 waterproof, 327
 coefficient of expansion of concrete, 355, 692
 cost, bibliography, 305
 cutting, granite, 298
 limestone, 300, 301
 sandstone, 300, 303
 U. S. public buildings, 301
 labor, brick, 324
 stone, 297, 303
 laying, 301, 303, 304
 quarrying, 304
 total, 301, 303
 ashlar, 302
 brick, 326
 rubble, 302
 U. S. public buildings, 305
 definition, 1
 footings, 356
 general rules for laying, 282
 measurement, brick, 322
 stone, 296
 mortar required per yard, 121
 paving, 282
 rubble, 289; *see also* Rubble.
 slope wall, 282
 squared-stone, 288; *see also* Squared-stone masonry.
 stone, ashlar, 238; *see also* Ashlar.
 classification of, 279
 cost, 297
 crushing strength, 293
 definitions of kinds, 279
 dry, 282
 kinds of, 279
 laying, general rules for, 282
 measurement, 296
 mortar required per yard, 119, 121
 pressure allowed, 294
 rubble, 289; *see also* Rubble.
 safe pressure, 296
 squared-stone, 288; *see also* Squared-stone masonry.
 strength, 293
 weight, 348
- Melan arch defined, 711

INDEX.

MOR - PEN

tar, amount to fill voids in stone, 144
 nout for various kinds of masonry, 121
 sorptive power, 21
 hesive strength, 124
 ment, data for estimates, 118, 120, 121
 density, 108
 vs. strength, 112
 cost, 126
 estimates, data for, 118, 120, 121
 freezing, effect of, 130
 lime in, 128
 mixing, 116
 ment, normal consistency, 72, 75
 proportioning, methods of, 114
 proportions, theory of, 110
 used in practice, 116
 quantities in a yard, 119, 120
 re-tempering, effect of, 128
 strength of, 121
 adhesive, 124
 cement, effect of, 111
 compressive, 124
 density, effect of, 112
 tensile, 121
 age, effect of, 122
 sand, effect of, 123
 time, effect of, 122
 theory of proportions, 110
 eezing, to prevent, 130
 ne, cement in, 128
 estimates, data for, 108
 freezing, effect of, 108
 mixing, 107
 proportions, 106
 strength, 51, 122
 uses of, 107
 antity for a yard of masonry, 121
 aterproof, 129
 -pump, 437
 York Central R.R., abutment, 547
 U-abutment, 547
 wing abutment, 539
 lvert, arch, 596
 pipe, cast-iron, 576
 vitrified, 573
 er, 557
 taining wall, 526
 forms for, 527
 hern Pacific R.R., pivot pier, 562
 effect on concrete, 194
 1 joints in an arch, 613
 pet wall, 539
 nt hammer, 271
 ng, stone, 282
 sylvania Lines, culvert, 596

PEN - PIL

Pennsylvania, R.R., arch, 666
 Pennypacker arch, 704
 Peru arch, 717
 Physiological effect of compressed-air, **445**
 Pier, bridge, abutment-pier, 550
 examples, plain concrete, 557
 A., T. & S.-F. R.R., 559
 Cairo, 548, 558
 Cooper's highway, 557
 K.-C., M. & O. R.R., 559
 N. Y. Central R.R., 557
 Santa Fé, R.R., 559
 reinforced, 560
 functions of a, 551
 horizontal section, 556
 location, 551
 pivot, 562
 reinforced, 560
 Gilbertsville, 560
 stability, theory of, 552
 longitudinal, 552
 current, effect of, 552
 ice, effect of, 552
 wind, effect of, 552
 transverse, 554
 expansion of bridge, 555
 motion of train, 554
 wind, 555
 Pile, bearing, defined, 367
 bearing power of, 387
 actual, 396
 columnar, 388
 computed, 393, 394
 disk, 398
 experimentally determined, 396
 factor of safety, 398
 formula for, 389, 392, 394
 safe, 398
 screw, 398
 wood, experiments on, 394, 396
 formula for, 392
 frictional resistance of, 398
 load, safe, 398
 ultimate, 396
 concrete, 371
 cap, 403
 cost, 373
 Chenoweth, 372
 Pedestal, 373
 Raymond, 372
 Simplex, 372
 vs. wood, 373
 cost of driving, *see* driving *below*.
 Cushing, 403
 definitions, 367
 disk, 371
 bearing power, 398
 driving, brooming, effect of, 390
 cost of, 383

PIL - POI

Pile, driving, cost of, bridge construction, 385, 548, 549
 bridge repairs, 384
 foundations, 386, 533
 harbor work, 386
 railroad construction, 383
 sheet, 387
 steel, 387
 drop-hammer, 377
 dynamite, driving with, 381
 steam-hammer, 379, 380
 water-jet, 381, 383
 foundation, *see* Foundation, pile.
 lateral yielding, 400
 pneumatic, 429
 sand, 346
 sawing off, 400
 screw, 370
 bearing power of, 398
 sheet, 374
 cost of driving, 387
 steel, 375
 Wakefield, 374
 wood, 374
 shoe, 368
 steel, described, 375
 cost of driving, 387
 Wakefield, 374
 wood, 367
 cost, 369
 hood, 368
 shoe, 368
 splicing, 368
 Pile-driving machine, 377
 drop-hammer, 377
 friction-clutch, 378
 nipper, 378
 steam vs. drop-hammer, 380
 dynamite, 381
 friction clutch, 378
 hammer vs. jet, 383
 jet of water, 381
 nipper, 378
 steam-hammer, 379
 water-jet, 381
 Pitching chisel, 271
 Pivot pier, 562
 Plattsmouth bridge, foundation, 415, 440, 448
 Plug and feather, 272
 Pneumatic foundation, *see* Foundation, pneumatic.
 Point, 271
 Pointing, brick masonry, 311
 stone masonry, 286, 288
 dash pointing, 288
 ribbon pointing, 288
 Point Pleasant bridge, cost of foundations, 415

POR - RET

Porto Rico, arch culvert, 598
 Poughkeepsie bridge, foundation, 423
 Pozzolan cement, 56
 Puddle, material for, 409
 Pulsometer, 413
 Pump, 412,
 centrifugal, 413
 hand, 412
 mud, 437
 pulsometer, 413
 sand, 436
 steam siphon, 413
 Quarrying, 297, 302, 304
 Quoin, defined, 279
 Rankine's, arch, theory of, 640
 earth pressure, theory of, 493, 504
 Ransome stone, 268
 Reinforcement, amount of steel, 235
 for concrete, 234
 placing, method of, 253
 cost of, 260
 various kinds of, 236, 338
 Relieving arches, 515
 Retaining wall, back-filling, method of placing, 514
 cost, plain-concrete, 532
 reinforced-concrete, 533
 Coulomb's theory of, 493
 design of a reinforced, 517
 cantilever, 517
 counterforted, 523
 definitions, 489
 difficulties in determining stability, 490
 dimensions, empirical rules for, 507
 drainage, 513
 empirical rules for, 507
 examples, plain-concrete, Chicago & Northwestern R.R., 527
 Illinois Central R.R., 526
 N. Y. Central R.R., 526
 reinforced concrete, C. B. & Q. R.R., 529
 Corrugated Bar Co., 530
 Pittsburg, 530
 factor of safety, 509
 foundation, 511
 land ties, 489, 515
 pressure of earth, 491
 amount of, 491
 direction of, 494
 point of application of, 494
 Rankine's theory of, 493, 504
 reliability of theories of, 496, 505
 point of application, 499
 direction of resultant, 505
 surface of rupture a plane, 497
 relieving arches, 515

INDEX.

RET - SPE

lining wall, stability, difficulties in theory of, 490
of concrete, 510
ickness, empirical rules for, 507
 Benj. Baker's, 508
 Fanshawe's, 507
 Trautwine's, 508
rtical cross section of, 516
eyrauch's theory, 494
ap, 282
k, compressive strength of bed-rock, 337
ble, 281, 289
ncrete, 292
nition, 281
ying, 282, 290
ortar, amount required, 291
ecifications, 292, 731
es, 291

i, amount per yard of mortar. 120
aring power, 339
ay, effect of, 87
anness, 86
st, 96
ta on, 93
rability, 85
ness, 88
quisites for good, 85
lecting, 95
arpness, 86
one screenings, 94
ids, 91
ashing, 88
ight, 96
l-lift, 436
l-pump, 437
lstone, 31
ffler's theory of voussoir arch, 637
enings, stone, substitute for sand, 94
w-piles, described, 370
oning of stone, 17
y bridge, guiding the caisson, 441
e-analysis, defined, 147
v arch, defined, 608
reinforcement, 239
e-wall masonry, 282
o and alum waterproofing, 186, 327
o and lime waterproofing, 187
 bearing power of, 335; *see also*
 Foundations, bearing power.
l stone, 268
adrel, definition of, 607
ling, for arches, 660
fications, ashlar, 730
ick masonry, buildings, 326
sewers, 327
ment, 723
ncrete, 726

SPE - STO

Specifications, masonry, 729
 ashlar, 730
 rubble, 292, 731
 squared-stone, 288
Splicing reinforcing bars, 253
Squared-stone masonry, 281, 288
 backing, 288
 definition, 281
 laying, 282
 mortar, amount required, 289
 pointing, 288
 specifications, 288
Steam siphon, 413
Steel reinforcement, cost of handling, 260
Stirrups, rule for, 237
Stone, absorptive power, 21
 artificial, 267
 Ransome, 268
 Sorel, 268
 bibliography, 26
 broken, *see* Broken-Stone.
 building, importance of durability, 4
 requisites for good, 3
 tests of, 5
 cost, 103, 298
 classification, 27
 crushing strength, data on, 11
 methods of determining, 7
 slabs, 12
cut, bush-hammered, 277
 crandalled, 277
 diamond-panel, 278
 drafted, 276
 fine-pointed, 277
 pitch-faced, 276
 quarry-faced, 276
 rough-pointed, 276
 rubbed, 278
 tooth-axed, 277
description, artificial, 268
 granite, 29
 limestone, 30
 marble, 30
 sandstone, 31
 trap, 29
durability, destructive agents, 15
 resisting agents, 17
 testing, 19
elasticity, 14
granite, description of, 29
hardness, 7
limestone, description of, 30
marble, description of, 30
masonry, *see* Masonry, stone.
preserving, methods of, 25
price of, 103, 298
sandstone, description of, 31
screenings, substitute for sand, 94
shearing strength, 14

STO - WAK

- Stone, specific gravity, 101
 strength, 11
 crushing, 11
 transverse, 12
 toughness, 7
 trap, 29
 weight, 6
- Stone-cutting, finishing surface, 275
 forming surface, 273
 flushed joint, 284
 making drawings, 275
 tools, 269
- Thacher system of arch reinforcement,
 712
- Timber in foundations, 420
- Tools, stone-cutting, 269
- Tooth-ax, 270
- Trap, 29
- Trémie, 174
- Twisted bar for reinforcement, 236
- Union Pacific arch, reinforced concrete,
 712
- Unit girder frame, 238
- Vitrified culvert pipe, 574
- Vousoir, definition of, 607
- Wabash R.R., abutment, reinforced con-
 crete, 542
- Wakefield sheet-pile, 374

WAL - ZOL

- Wall, definitions of parts of, 279
 retaining, *see* Retaining-Wall
- Water-jet pile-driver, 381
- Waterway for culverts, 564
 factors, 564
 formulas, 566
 Myer's, 567
 Talbot's, 567
- Weep holes, 513
- Weyrauch's theory of earth pressure, 494
- Weight, buildings, 347
 cement, per barrel, 58
 per cubic foot, 60
 concrete, 207
 earth, 495
 gravel 93, 99
 lime, 53
 masonry, 348
 pipe, cast-iron, 575
 vitrified, 574
 sand, 93, 96
 stone, 6
 broken, 102
- Whitewash, brickwork, 328
 concrete, 192
- Winkler's hypothesis for crown thrust, 618
- Wünsch arch defined, 711
- Yazoo river bridge, guiding the caisson,
 442
- Zela dam, 484

