

ENGEN.
LIBRARY

UC-NRLF



\$B 46 109

STANDARD INSTRUMENTS OF PRECISION

1918

C. L. BERGER & SONS

37 WILLIAMS STREET.

Boston, Mass., U.S.A.



Engineering
Library



Engineering
Library
NOTICE.

Prices—This Catalogue and Price List supersedes all former editions. We make no deduction from Catalogue Prices.

Payments—Customers ordering from a distance will please remit by registered letter, express or P. O. money order, or draft, made payable to us, or the goods will be sent C. O. D., the expense of collection to be borne by the purchaser. Accounts can only be opened with firms rated by commercial agencies or upon receipt of other satisfactory reference.

Ordering—When goods are ordered by telegraph our code should be used exclusively (see back pages of catalogue), and then patrons (excepting states municipalities, corporations, etc.) who are not known to us should also wire **simultaneously** whether goods are to be sent C. O. D. or whether payment is secured by bank draft on Boston or New York. (SEE "PAYMENTS," PAGE M OF CODE.) The order should then be confirmed by letter.

Address—Please be careful to add the COUNTY and STATE to your address.

Mail Orders—Small articles can be sent by mail, at the purchaser's risk, when the cost of postage, one cent for every ounce, is remitted in addition to the price.

Shipping—Our instruments are carefully packed in their boxes, which again are placed in packing boxes, as explained under "*Transportation of Instruments*," page 18. This insures safest delivery; and being in conformity with the rules of most of the large Express Companies, also enables us to express **Surveying Instruments as merchandise**, thus securing to our customers single rates.

PREFACE.

THE instruments enumerated in this catalog, and described in the Manual, are all of our own design and regular manufacture. Full supplies of Engineers' and Surveyors' Instruments will be kept on hand. The demand is at times so great, however, as to exhaust our supply. To secure an instrument in season, it is best to order it from four to eight weeks in advance of its intended use. Instruments varying from our customary designs, or those of rare inquiry, will be made to order only.

The mechanical features of our instruments are of the most simple and mechanically perfect design and the best that modern machinery and methods pursued in a most modern plant, equipped and operated wholly for this purpose, can produce.

The graduations of circles and verniers, being sharp, clean cut and easily read, are of rare excellence and in point of accuracy have no superior.

The optical qualities of our telescopes are in keeping with the fineness of every other part of the instruments in higher power permissible with greatest illumination and sharpest definition.

The spirit levels ground and used by us are selected in degree of sensitiveness so as to be strictly related to the whole character of the instruments.

A careful perusal of our catalog will convince that in the number of styles, sizes, new designs, and in the adaptation of the various instruments to the work for which they are intended, we offer instruments that only long training and a studious care of the needs of the engineering and surveying profession in all lines of practical application in the field, can produce.

Styles and sizes of the many kinds of instruments enumerated in this catalog cannot be varied from, since all the standard patterns from which the different parts are cast are made of brass to insure best and uniform results. Any change from them often would entail only extra expense, and lead to the sacrifice of other and equally important advantages, without securing to the customer any material benefit.

The combinations possible with each particular type of instrument are printed on the page opposite its cut, and as a rule are so complete as to meet special and general requirements.

We make no pretence at manufacturing cheap instruments—our prices are as low as consistent with thoroughness of workmanship and the use of the best materials. The aim of the firm in the future will be, as it has been since originally organized by the senior member in 1871, to create an American industry in the art of making field instruments unsurpassed either here or abroad, bringing to the task the judgment and experience of maturity.

Our full telegraphic Code, at back of this catalog, will enable to order from a distance at small expense, and our patrons may rely upon being served as conscientiously as if calling upon us in person.

We take this opportunity to thank our patrons for their confidence in the past, and assure them that their future orders will be executed with the same care and fidelity as heretofore.

C. L. BERGER & SONS.



CHARACTERISTIC FEATURES OF OUR INSTRUMENTS

1. **Simplicity in Manipulation.**
2. **Lightness, combined with strength.**
3. **Accuracy of division.**
4. **Achromatic telescope, with high power.**
5. **Steadiness of adjustments under varying temperatures.**
6. **Stiffness; to avoid any tremor even in a strong wind.**
7. **Fine workmanship throughout.**
8. **Adapted to tropical and arctic conditions.**
9. **Prices – EQUITABLE!**

PART I.

DESCRIPTION

OF THE

Essential Features of Our Instruments.

Graduation.

This very important part of a good instrument we guarantee *exact* and *accurately centered*, opposite verniers reading the same. The lines are straight, thoroughly black and uniform in width. There are two double verniers in every transit to read angles with great rapidity as well as to make four separate readings at every sight, when extreme accuracy in the repetition of angles is required. The horizontal circle is graduated from 0° to 360° with *two* sets of figures, running in opposite directions (unless ordered differently,) and the verniers are marked **A** and **B**. The figures are large and distinct, and to avoid mistakes in reading, the figures of these two sets of graduations, and those on the verniers, are *inclined* in opposite directions, thus indicating the directions in which the verniers should be read.

Instruments intended for mining and mountain use can have the verniers so placed that they may be read without changing the position of the engineer after sighting through the telescope.

Glass covers protect the arc and verniers from exposure. For ease in reading the verniers, we have added to most of our instruments *two plates of ground glass*, which cast a very clear light on the verniers, in any position. We recommend this addition to all of our more complete transits.

The graduations on our transits are either on brass and silvered, or else graduated on *solid silver*. The former we can only recommend for the more ordinary instruments, since imperfections in the brass or composition castings frequently impair the graduations, and the silvering is apt to tarnish with time and exposure.

To graduate on *solid silver* adds \$10 to the first outlay for the instrument, but its many advantages, great permanency and smoothness of surface render it the only satisfactory surface for fine graduations.

The Telescope.

All of its lenses are ground especially for us, by the best opticians. The telescope is perfectly *achromatic*, and designed to furnish a *large, flat* field of view with *high power* and yet without loss of light. For this purpose the curves of all our lenses are ground by special formulæ. The telescopes show objects right side up, unless ordered otherwise.*

The object-glass has a very large aperture, and is focussed by rack and pinion,† but the eye-piece is focussed by simply turning its head to the right or left in an improved screw-like manner.

By a method of construction peculiar to ourselves, we are enabled to guarantee the line of collimation correct for *all distances* without making use of the very objectionable adjustment for the object-slide by means of inner rings, which time and experience has proven to wear loose too readily, thus rendering this adjustment worse than none at all.

The eye-pieces are thoroughly achromatic, and their lenses are mounted in such a perfect manner (a method also peculiar to us) as to require no further adjustment with regard to the axis of telescope.

*It should be remembered that the focal length of the object glass is limited in engineering instruments and that a high power is obtained only at the sacrifice of light. To obtain the fullest satisfaction, telescopes intended for close work, as in stadia measurement, etc., should invariably be ordered to be inverting. The brilliancy with which objects appear in such a telescope, owing to the amount of light gained by saving two lenses in the eye-piece is very marked as compared with one of the same power and focal length showing objects erect.

†This rack and pinion motion is now so placed upon our telescopes that it is more easy of access by either hand than when placed at the side, as shown in most of our cuts.

The telescope of the transit reverses at both the eye and object ends, and is thoroughly balanced when focussed for a mean distance.

The telescope of the wye and dumpy level is also balanced *each way* from the center of the vertical axis when *focussed for mean distance* and with the *sun-shade attached to it*.

Spirit-Levels.

The Spirit Levels used in our instruments are carefully ground, filled and tested by us in person.

Those for the highest class of engineering work are sometimes provided with an air chamber by which the length of the bubble can be regulated according to temperature. The levels for astronomical instruments have air chambers, and are filled with ether, but in field instruments ether is not admissable, owing to the high degree of expansion and contraction in that fluid with changes of temperature. For these we use a composition fluid that we have found to be more sensitive and quick-acting than that used in instruments we have seen of other makers.

Our astronomical levels are so ground that a depression through one second of arc causes a displacement of the bubble through about $\frac{1}{50}$ of an inch. The curvature or sensitiveness of our levels for field instruments we adapt carefully to the instruments and the kind of work to which they are to be applied. With too sensitive a level the position of the bubble would be too uneasy to work with, while too low a sensitiveness would not reveal the full qualities of an instrument. Persons ordering instruments of us will confer a favor by stating for what purpose they are intended, whether for water works, for railroads, or for general use, so that we can use our judgment for their benefit.

Gradienter Screw.

[See page 45]

This is attached to the clamp of telescope of all of our transits except the plain transit. This attachment was first introduced by Prof. Stampfer, of the Vienna Polytechnic School. It does not add to the weight of the instrument, and once used we have found it to be universally approved by our customers. By means of it *grades* can be established, and *horizontal distances, vertical angles and differences of level* can be measured with great rapidity. Indeed this attachment to an engineer's transit is one of the most useful introductions in practical engineering. It is so universal in its application to railroad and general work, that when once used it *will afterwards form an indispensable part of an engineer's outfit*.

Fixed Stadia Wires for Distance Measurements.

We have specially devised an optical and mechanical apparatus for the purpose of placing fixed, or non-adjustable stadia wires so accurately upon the diaphragms of our telescopes that their distance apart will read 1' : 100' † on any leveling rod, as with the gradienter screw, thus dispensing with a special rod.

It is well known that adjustable stadia wires are so apt to change their distance apart with every change of temperature, that no reliance can be placed upon them unless previously adjusted. With fixed stadia wires, annoyances of this kind are obviated—they are *reliable at all times*.

As regards the degree of accuracy attainable by the use of fixed stadia wires, experiments with our powerful telescopes, made optically as perfect as the most advanced optical and mechanical skill enables us, warrant to say that with some experience and proper care the results obtained will approximate and even equal those obtained by chain measurements. The price for this accessory in any new instrument is only \$3.00, but if inserted into a telescope sent to us for that purpose, we must charge \$10.00. We advise to order both the gradienter screw and the fixed stadia wires, as each in itself, separately or jointly, will prove of great value.

† In all stadia work, the **instrument constant**, which is the distance from the center of the instrument to a point in front of the object-glass equal to its focal length, must be added to every measurement, whether 100 or 1000 feet, and does not vary.

Instrument Constant for					
Transit Nos. 1, 5 and 11	erect telescope	1.15 ft.	Transit No. 4	invert. telescope	.88 ft
" " " "	" invert. "	1.37 "	Wye Level, 18-inch	erect "	1.90 "
Transit Nos. 2, 3 and 6	erect "	.94 "	" " "	invert. "	2.14 "
" " " "	" invert. "	1.15 "	Wye Level, 14-inch	erect "	1.41 "
Transit No. 4	erect "	.74 "	Dumpy Level, 17½ inch	erect "	1.65 "
Dumpy Level, 15-inch				invert. telescope	1.12 ft.

To find the Wire Constant. First lay off from the center of the instrument, the instrument constant, which is the distance from a point in front of the object-glass, equal to its focal length measured from the center of the instrument. Then measure off 100 feet and place the rod truly vertical at this distance.

Determine the space on the level rod intercepted by the stadia wires. The difference between this reading and one foot will be the wire constant, which may be plus or minus, and this constant must be applied to every 100 feet measured, the amount varying with the distance measured.

Tangent Screws.

These are made of Aluminum bronze, or phosphor bronze, and sometimes of german silver, and are provided with strong *spiral springs* of german silver, which take up all the dead motion, no matter how long the screw may be in use, or how worn. They are *less* liable to get out of order, by blows or accidents, than any of the existing tangent screws, and require *little* or *no* attention on the part of the engineer. There is no *strain* on either plate when the instrument is clamped, so that the levels are unaffected. They are set and turned with the *greatest ease*, following the movements of the finger instantaneously with mathematical precision, and do not *scratch* the plate in revolving instrument. We confidently recommend this form of construction to those who have not used our instruments, as the best possible; superseding the usual methods by means of two opposing screws, or ball tangent screw, greatly in point of convenience and accuracy, and equaling them in point of steadiness. By this construction we are also able to fit our upper and lower circle plates so snugly that it is impossible for dust to enter between them. Our leveling instruments have the clamp and tangent screws so placed that they can be reached by either hand with the same readiness.

The Compass.

The Compass circles are graduated to half degrees in quadrants from 0° to 90° . The needles are made of superior steel, and tempered all over. A coil of fine wire attached to the end pointing South balances the needle for our latitude, which must be re-balanced if the instrument is used further north or south of this latitude, and must be entirely reversed if used on the southern hemisphere of our earth. At a cost of \$10.00 a variation plate can be placed upon our surveyors' transit to set off the variation of the needle for any particular locality. A stationary pointer just above the graduated ring at the North end, and protected by the glass cover of the compass, indicates the line joining the vertical plane of the line of collimation of the telescope. By means of a milled-headed screw and clamping nut, serving both as a handle and a clamp-screw, the graduated ring can be turned past this pointer towards East or West as the case may require.

If it is desired to set off the variation more closely than half degrees, say to minutes, this can be done on the horizontal plate. For more information concerning the operation of the variation plate, read latter part of the article on the compass, page 44.

Tripod.

The form we adopt for our instruments is an improvement over what is commonly termed the "split leg" tripod, used extensively in Europe, which unites the *greatest strength and steadiness* with the least weight. The tripod-head is cast in a single casting, to avoid all small screws, as well as to attain greater stiffness. For the legs we use the best fine grained white ash, taking particular pains that the grain of the wood runs in the direction of the leg. They are still further guarded against all possible accidents by wooden tongues inserted at their top. When folded, our tripod is better adapted than the ordinary form, for carrying on the shoulder without irritating the place on which it rests. The good qualities of this over the ordinary round leg tripod provided as that is with unyielding brass cheeks to "tighten" the legs, are so great that there is but one opinion regarding its *real advantages*, and we gladly bear the greater expense incurred in its manufacture. The cast-steel shoes have projections for the foot, to aid in pressing the legs into the ground. Our levels and transits both fit the same tripod, and are of equal length.

Shifting Tripod.

We have also adapted to *all* our engineers' transits the *shifting tripod* or *shifting center*, by which, after an approximate setting of the tripod, the transit can be immediately brought over a point on the ground. This device we also attach to our instruments with three leveling screws in a most perfect and simple manner, and without impairing their steadiness and portability.

Adjustable Plumb-Bob.

We furnish with all our transits a small brass chain and hook, which are connected to the centers of the instruments. The cord of the plumb-bob can be readily attached or detached from this hook, and by means of a neat, small and simple device, (also furnished with every instrument,) the plumb-bob can be adjusted over the ground at any height, with hardly any effort on the part of the engineer.

Illumination of Cross-Wires

For Mining and Tunnel Transits.

In our instruments this sometimes consists of a hole drilled through the transverse axis of the telescope, and closed at either end with small glass plates, to prevent dust entering the telescope. Then in the center of the telescope is placed a small adjustable reflector, by means of which the cross-wires can be very readily illuminated in the mine or tunnel by the reflection of the light of a lamp held in the hand or placed on a small table, which is attached to the standard. This lamp is provided with a ground lens. While this method is satisfactory, still the small mirror has to be placed at a point where the cone of rays from the object glass is small and consequently it cuts off much of the best part of the light, not to speak of the weight of the lamp and table at the side of the standard and the heat imparted. This method is not thought to be of as good repute as it was formerly. In all cases we would advise the use of our reflector, placed in front of the object glass in a tube like the sun-shade. This arrangement gives perfect satisfaction. This may be used in connection with an ordinary lamp or with the pocket electric lamp.

Arrangement for Offsetting at Right Angles.

A perfect line of sight can be had at right angles to the telescope by perforating the telescope axis and covering the ends with glass plates as described in the preceding paragraph. By simply sighting through the axis, offsets may be conveniently established without disturbing either clamp or telescope when the eye is brought close to the instrument; its application is, however, limited to even ground. To use it on an uneven ground it is necessary to place the eye at a distance of twelve or fifteen inches from the instrument. The head should then be moved until the eye is in line with the openings of the transverse axis. An offset can then be aligned irrespective of the height of the instrument.

Quick Leveling Attachment.

This we can apply to any of our Mining and Mountain Transits and Leveling Instruments. It adds about 1 lb. to the weight.

Protection to the Object-Slide, &c.

A rain and dust guard for the object-slide is now furnished with all of our telescopes, and to insure smooth working of the object slide and telescope tube both are made of a non-friction metal. The graduation of the horizontal circle, the centers and such other important parts that are liable to injury by the action of dust and water in the field-use of an instrument, are entirely protected.

General Construction.

In regard to the general construction of our instruments, the dead weight is removed wherever it is shown to be not essential to the stiffness of the instrument; but we have at the same time strengthened the parts most likely to be injured by an accident or fall. Thus the *base of the standards*, the *vernier plate and circle*, the *parallel plates for leveling screws*, the *telescope axis*, the *flanges of centers*, *cross-bar of level*, etc., are made especially rigid and provided with ribs. Instead of finishing the smaller pieces of an instrument separately and then joining them with small screws, or solder, each screw or joint being a *weak* place in an instrument, we have adopted the opposite principle, (at an increased expense to us,) and aim to unite as many pieces as possible in a single casting, which casting, by means of *ribs* is made as light as consistent with strength.

We also call attention to the exceptionally *hard bell-metal* and *phosphor bronze* used for our centers and telescope axis, which are *long and unyielding*, and the remaining parts are of a *composition metal*, which is itself *harder* than hammered brass, or red composition, used ordinarily for centers, etc. It is more difficult to work, but we avoid the objectionable softer brass in its use. Experience has proven that soft, or *hammered* yellow brass is unfit for a good field or astronomical instrument, since it is more liable to fretting and yielding generally, and in the hammered state its unequal expansion and contraction at different temperatures may be so marked as to impair the reliability of the adjustments.

Aluminum bronze containing 90% copper, is also extensively applied in our instruments on account of its great tensile strength.

Aluminum alloyed with small percentages of silver or copper must be used with caution on account of its softness. (See Aluminum for Instruments of Precision, page 23.)

The Finish.

It is a well-known fact that the black lacquer finish has one objection. It absorbs the heat readily, and therefore is apt to expand an instrument unequally, and thereby derange its adjustments. We therefore consider it necessary to finish certain parts of an instrument in a bright but *not glaring finish*—including the upper plate and the telescope in the transit; the cross-bar in the wye level, etc. All other portions may be finished and bronzed before lacquering. This finish gives a very fine appearance to the whole instrument.

Customers desiring to have their instruments finished entirely in a dark metal color, can do so by notifying us of their wishes.

Our Wear Resisting Leather Finish.

The principle is borrowed from astronomical instruments, where it is necessary to cover the surfaces with some non-conducting material in order to avoid disturbances in instrumental adjustments caused by suddenly varying temperatures.

We have adopted this principle with the view of securing the same results for our transits, wye and dumpy levels. Some of these levels are sensitive to a depression of a single second of arc.

The exterior surfaces of our instruments so finished have the appearance of being covered with Morocco leather of a smooth and even texture. Its close-grained surface has a most agreeable and soft pliable touch to the hand, and eliminates the disagreeable feeling experienced when metallic surfaces are touched in very cold temperatures or in the tropics.

Instruments finished in this manner heat up or cool down very gradually, causing a minimum derangement of the adjustments, and being a very dark color this finish unites all the advantages of bright lacquer finishes, with the convenience of having a dark colored instrument for use in the field, where it does not dazzle the eye of the observer in the strongest sunlight.

Parts so treated can be handled with impunity. This finish is impervious to dampness and dryness, or mine and salt water. Dust and dirt can be washed off and candle grease readily removed. Neither will it fade, nor crack, being wholly unlike the antiquated cloth finish introduced by our senior member in 1871. It is, indeed, entirely in strict keeping with our products.

It is difficult to determine the wearing qualities of leather and cloth finishes of scientific instruments. A good finish must withstand the hard usage of years. The leather finish as applied to our instruments was thoroughly tested for a number of years before being applied to instruments sent out on orders.

As regards durability, it is quite equal to the bright metal finish, and is superior to bronze or black metal finished surfaces. This, coupled with the fact that it can be restored at any time, same as the cloth finish formerly applied by us (to which latter it is incomparably superior), enables us to unite many parts of an instrument into one piece or casting and thereby secure greater rigidity, lightness and a more elegant appearance than hitherto attained in the instruments of this class as commonly designed and finished. The cloth finish heretofore applied will be used only to a very limited extent.

Packing.

In putting our instruments in their cases, none of them separate above the leveling screws. They stand *erect*, and are *ready for use* upon unlocking the case.

The cases are provided with rubber cushions, to check severe jarring arising from transportation over rough roads.

Care of Instruments.*

Do not allow the legs of your tripod to play loose on the tripod head; keep nuts and bolts always well tightened up against the wood. Examine the shoes from time to time, and sharpen them if necessary, also screw the shoes tight, if wear and tear loosen them. Be sure your instrument is well secured to its tripod before using it. Bring all four levelling screws to a seat before shouldering instrument. Let the needle down upon its pivot as gently as possible, and allow it to play only when in use; if too far out from its course, check movements of needle carefully by means of lifter. Never permit playing with the needle, especially not with knives, keys, etc. Be sure to arrest the needle after use, and screw it well up against the glass cover before shouldering the instrument.

As a rule the compass needle is balanced as nearly as possible for the latitude in which an instrument is to be used. If only a trifle out do not meddle, inasmuch as one can do more harm to the pivot than a small error from non-balancing would amount to, **but if the compass needle requires to be rebalanced proceed as follows:**

Remove the compass glass which is held down by a circular ring on top of the glass, which may be removed by inserting the blade of a knife where the two ends of this ring come together and prying gently upward. By means of a piece of beeswax slightly softened, the compass glass may be readily lifted. Then raise the needle up its entire length by means of the lifter and carefully remove it with a pair of tweezers. When the needle is balanced it should be as carefully placed back with the lifter up as before to retain the sharpness of the pivot. If the compass glass needs to be removed entirely, unfasten the two screws that screw the stud for the telescope tangent screw to the standards. Don't remove the telescope from its wyes.

Do not clean the glass cover or the lenses with a silk handkerchief; breathe over the compass-glass and reading lens if one is used, after cleaning. Examine the buttons of your coat with regard to iron that may be concealed in them, also beware of nickel-plated watch chains, etc. To clean the object-glass and the lenses use a fine camel-hair brush. If dust or sticky or fatty matter cannot be removed with the brush, take an old clean piece of soft linen, and carefully wipe it off. Do not unscrew the object-glass unnecessarily,—this is apt to disturb the adjustment of line of collimation. The lens nearest the eye of eye-piece, as well as the front side of the object-glass, need careful brushing with *fine brush* from time to time.

If dust settles on cross-hairs and becomes troublesome, unscrew the eye-piece and object-glass, and gently blow through the telescope tube, cover up both ends and *wait a few minutes* before inserting the eye-piece and object-glass. Be sure to have the object-glass cell *screwed well up against its shoulder*, and then examine the adjustment of line of collimation (see adjustment of line of collimation). Do not grease the object-slide of telescope, or screws that are exposed to dust; use a stiff tooth-brush to clean slides or threads if dusty.

To take out the eye-piece, unscrew the screw at the end of the main tube, take hold of the eye-piece and pull it out.

To focus the cross-hairs, take hold of the *eye-piece cap* and turn it in a screw-like manner until cross-hairs appear distinct, and as if fastened on the object when the head is being moved.

Should there be any fretting in the telescope slide, take it out, and endeavor to smooth the rough part with the back of a pocket knife.

If the **focussing slide** seems to work too hard, everything else being right, it is generally caused by the lubricant on the pinion hardening in cold weather, and the same cause may also make the focussing slide work too freely in hot weather by softening, i. e., when not staying in place when in a vertical position. If the slide moves too freely it should be tightened by running out the slide to its full length, then applying a screw-driver to the screw on top of the focussing screw and turning a very small part of a turn until the required friction is obtained. If the slide works too tightly run in the slide, unscrew the top screw one turn, gently tap it by the screw-driver handle to release it, and then tighten to the required stiffness.

To prevent the focussing slide from fretting, usually due to the inrush of air carrying dust and grit when slide is being run out causing momentarily a rarefied space, wrap a piece of chamois skin over the barrel in shape of tubular form and fasten by means of rubber bands or sewing. In an emergency fine watch-oil may be used to grease the slide should it continue to fret, until the instrument can be sent to the maker.—In case of rain during non-use, place the telescope vertical, object end up, and no water can enter the telescope.

Never use emery in any form about any part of a Transit or a Level, whether tangent screws, slides or centers. If anything must be used, a very little powdered pumice-stone mixed with fine watch-oil is all that is advisable, and after grinding, then clean thoroughly. The uninitiated are advised to do no grinding

* For additional suggestions see p. 11.

whatever. As a rule more harm than good comes to the instrument. It is only in case of emergency that such heroic treatment should be resorted to. When cleaning the slide and inside of main tube great care must be taken not to break the wires.

To focus the wires sharply turn the eye-piece slightly to the right or left as the case may be. **Remove parallax** as explained on page 54.

To clean the threads of leveling or tangent screws when *working hard*, use a stiff tooth brush to first clean the threads of all dust, then apply a little oil, and work the screw in and out with alternate brushing to remove dirt and all oil until it moves perfectly free and smooth.

Screws for the adjustment of cross-hairs should not be strained any more than necessary to insure a firm seat; all straining of such screws beyond this simply impairs the accuracy of instrument and reliability of adjustment.

When in the field always carry a Gossamer water-proof for the instrument in your pocket, to put over it in case of a shower or dust cloud. On reaching office, after use of instrument, dust it off generally with another fine brush; examine the centers and all other principal movements to see if they run perfectly free and easy, and oil them if necessary; also examine the adjustments. This will save expense and many hours of vexation in the field.

Care of Centers and Graduation.

As the centers, the telescope axis and the graduations require greater care to preserve their fine qualities, perhaps it is not amiss to say a few words concerning their treatment.

Upon finding that the centers do not revolve as free as usual after exposure of the instrument in an extremely hot or cold weather, they should be cleaned as soon as time permits, and then proceed as follows:

Unscrew the milled-head nut at the extreme end of the cylindrical tube containing a spiral spring, which is opposite the upper tangent screw. Do it somewhat cautiously, or the spring will fly out. Then unscrew a small cylindrical case, which also has a milled edge, and which is at the bottom of the centers. After unscrewing the nut attached to the inner center, a gentle pressure upwards will lift the vernier plate out from the lower part of the instrument. Take a fine camel hair brush, and with it clean the graduation, the verniers and the inner part of the instrument,—but do not rub the graduation, *especially not its edge*.—then take a stick of about the same taper as the inner center, wrap some wash-leather slightly soaked in fine oil around it, and clean the insides of the sockets as carefully as possible; then remove this piece of wash-leather and wrap a fresh piece *without* oil around the stick and clean dry. Proceed similarly with the centers and their flanges.

Before applying fresh and pure watch oil, however, care should be taken that not a particle of dust or other foreign matter is left in the sockets, on the centers, or on the graduation. This caution having been taken, the fresh oil should be well distributed on all the bearing parts. It will be well to also examine the arm of the clamp screw of the circle and telescope axis, and if necessary clean by removing washer. After the instrument is thoroughly cleaned and oiled, the nuts and springs screwed back to a *firm* seat, the instrument must turn perfectly free and yield at the slightest touch of the hand.

To remove dirt and oxyd that may have accumulated on the surface of a solid silver graduation, apply some fine watch-oil, and allow it to remain for a few hours; take a soft piece of old linen and slightly rub until dry, but without touching the edge of the graduations. If, after cleaning, the solid silver surface should show alternately brighter spots, which would interfere somewhat with the accurate reading of the graduation, barely moisten the finger with vaseline and apply the same to the surface; then wipe the finger dry and lightly rub it once or twice around the graduation. Avoid touching the edges as much as possible. Such cleaning, however, must only be resorted to when absolutely necessary, and then only with the greatest care, as it is too apt to reduce the minuteness of the graduation, and spoil its fine appearance. If, after such cleaning, dirt and grease has accumulated on the inner edge of the graduation and verniers, gently wipe clean before restoring the vernier-plate to its place. Remember, also, that the centering of the graduations of the circle and verniers is a most delicate adjustment to make. These should never be unscrewed from their flanges by anybody except a maker.

Care of Telescope Lenses.

As dust and moisture, as well as perspiration from the hands, will settle on the surface of the lenses of a telescope, it becomes necessary that they should be cleaned at times. A neglect to keep the lenses free from any film, scratches, etc., greatly impairs the clear sight through the telescope. To remove the dimness, produced by such a film, proceed thus:—Brush each lens carefully with a camel's hair brush, wipe gently with a clean piece of chamois leather moistened with alcohol, and wipe dry using a clean part of the chamois skin on every portion of the lens, to avoid grinding and scratching. When perfectly transparent brush again to remove any fiber that may adhere to the lens. The tubes in which the lenses fit should be brushed, and if damp should be dried; this done, restore each lens to its original place as marked. To remove dampness in the main tube of the telescope, take out the eye-piece, *cover the open end with cloth* and leave the instrument in a dry room for some time.

If an instrument has been exposed to a damp atmosphere, or water has penetrated the telescope, moisture may settle between the crown and flint glass of which the object-glass is composed. If such is the case expose the instrument to the sun for a few hours, but if in the winter, leave it in a warm room some distance from the stove, the moisture will then generally evaporate. However, if not successful, unscrew the object-glass from the telescope, and heat it slightly over a stove or open fire. If a film settles between these glasses nothing can be done except sending the instrument to the maker. The two glasses form one lens only and must not be disturbed, as upon their relation to each other the definition and achromaticity of the telescope depends. Much depends also on the stability, with which these lenses are mounted in their cell, as any looseness between them or the cell will affect the adjustment of line of collimation. — Of course, if at any time the object-glass has been unscrewed from the telescope, this latter adjustment must again be verified before the instrument is used.

Additional Instructions concerning the Care of Telescope Lenses, etc.

Ever since the introduction of the high power in the telescopes of geodetic instruments, now used by the best makers, complaints are frequently made of the loss of light in such telescopes and of the hazy appearance of objects viewed through them, the latter in particular when an instrument has seen service in the field for some time. Now, while the loss of light is wholly due to the greater power as compared with the low powers formerly in vogue, and to the use of erecting eye-pieces (see page 31), the "haziness" is produced principally by films of dirt, settled on or between the lenses of a telescope, and becomes even more marked as more lenses are used in a telescope.

Perhaps it is proper to say here, that when comparisons are made between low and high-powered telescopes of geodetic instruments, *other things being equal*, the first named, as a rule, will incite favor, because, as in spy-glasses, the image of an object seen through them has a brilliancy never attained by telescopes of higher power. But, whenever the results of stadia work, or finelevelling, as obtained with the more powerful telescope, are compared with those obtained by a lower power, it will be found that, though less brilliant, the defining power of a high-powered telescope is superior to the other within the customary range of distances had in the ordinary engineer's and surveyer's practice.

On the other hand, owing to the less amount of light with high powers, it is necessary that the fine qualities of the superior lenses required for them should be preserved, and on this account a more frequent inspection and a more careful treatment of them is needed than when lower powers are used,—inasmuch as the least impairment of these lenses by films, or dust, etc., will reduce the defining power accordingly. A little extra care, as consequent upon the use of high-powered lenses, is, therefore, imperative, but in so doing one is more than compensated by the satisfaction of having a finer and more penetrating telescope.

To prevent an untimely settling of a film on the lenses of a telescope, and particularly that apt to form on the inner surfaces of the lenses composing an object-glass that has not been cemented together—such film being so fatal in an object-glass because it cannot ordinarily be reached and without disarranging the cross-wire adjustments—the treatment of an instrument should be strictly in accordance with the instructions given under "Prevention better than Cure," page 17. Unless these conditions are complied with, the greater efficacy of a telescope composed of superior lenses will be entirely lost.

Upon finding that, after carefully cleaning the object-glass and the lenses of the eye-piece, the telescope is not as clear as when first received from the maker, then the cause of it is generally a film between the lenses of the object-glass—we take for granted that the lenses are not scratched or otherwise impaired—but, as a rule, it takes several years (with careful use sometimes many years) before such a film

has sufficiently developed to impair the transparency of these lenses. But whenever it is found that a film has settled between them, then it is best, if the distance is not too great, to send *the whole instrument to its maker*, and if this is not feasible, then the telescope, at least, well and soft packed in a box, should be sent.

Cemented Object-glasses. — To prevent the settling of a film between the lenses composing an object-glass, and to avoid disturbing reflections of light from their inner surfaces, such films and reflections imparting to an object viewed through a telescope the *hazy appearance* noticeable in high-powered telescopes, we now, since 1889, cement these lenses together, so as to form one lens only. The lenses so treated are more efficacious in many respects than when separated by three thin pieces of tin foil, as has been the custom of nearly all instrument makers up to date.

The cement, however, needs some five or six months to harden, and until it has hardened sufficiently, an exposure to a cold atmosphere causing a greater contraction of the metal cell than the glass, the lenses are very apt to *warp*, which may lead to a distortion of an object, when viewed through such an objective.

The proper treatment of an object-glass freshly cemented is to keep the instrument, when not in use, in a room having a mean temperature of about 68° F., or slightly above. The same treatment should be followed if it is found that the image formed of an object is slightly distorted; only in this case the temperature in which it is kept over night should be raised to about 75° or 80° F. This treatment applies only to normally mounted objectives. If they are too tightly fitted the lenses cannot be restored to their original efficacy without being attended to by a maker.

Object-glasses that are cemented are very apt to show some specks, or, with ill usage, cracks in the cement, but, unless the specks are very numerous, so as to cover almost the whole area of the object-glass, the opacity caused by them does not sensibly affect the efficacy of the telescope, and therefore need not disturb the mind. Our experience is that the usefulness of an instrument is greatly enhanced when these lenses are cemented together, and that a few specks that may appear after an exposure from a sudden change from hot to a very cold atmosphere, or vice versa, are a lesser evil, as compared with the ill effects produced by a film that in time will settle between these lenses if separated by pieces of tin foil, or even when brought in direct contact with each other, as such a film will have much the same effect as a fog, in preventing vision.

When, after carefully cleaning the lenses of a telescope, the object-glass of which has its lenses separated by pieces of tin foil, it is found that the image is not as clear as originally, it is a sure sign that there is a film between its lenses, and that it has been exposed to a damp or impure atmosphere, either by injudicious use in the field, or by being left too long a time in the packing box, in which it is protected by cushions of paper or shavings, both of which attract moisture, or by storing it away in its box in such an improper place as a basement or cellar. Such film being noticed, it will then be well to send the object-glass, or much better, the telescope, or, best, if the distance is not too great, the whole instrument, to the maker, in order that the lenses may be cleaned by him, and, if deemed advisable, be cemented. The slight expense incurred of a few dollars will be more than justified by the advantage gained.

When the object-glass, or telescope is returned after the cleaning or cementing of its lenses, the cross-wire, spirit level, and vertical arc adjustments of the instrument will require a thorough verification before it should be used. In case the whole instrument has been sent to the maker, these adjustments are attended to by him. If the object-glass has been cemented, the telescope should be watched for a year to see that there is no distortion of the image. If there is a distortion, it will indicate that the object-glass has been too tightly fitted, of which fact we should be informed, as also whether after cementing the object-glass the instrument retains its cross-wire adjustment the same as before the cementing took place. If the cross-wire adjustments have to be more frequently made than before the lenses were cemented, it indicates that the object-glass is not tightly fitted to its cell; and if such is the case it should be sent to us to be more tightly fitted, after a lapse of about ten or twelve months, when the cement will have sufficiently hardened to allow of a tighter fit of the object-glass in its cell.

In telescopes of very high power it is of a great importance to keep the lenses of the eye-piece free from grit and films as of the object-glass. Therefore, whenever the telescope does not appear to be clear, the lenses of the eye-piece need most careful cleaning (if necessary, every four weeks). The cleaning must be done by first wiping gently with a clean piece of old linen barely moistened with alcohol and then wiping dry, using a clean part of the linen on every surface of the lenses. (Please read the various articles on this point on pages 10, 11, and 31, of our handbook and catalogue.) To remove the eye-piece, unscrew the German-silver screw at the eye-end of the telescope. — Of course, after cleaning, every lens must be put back in its tube precisely as marked, and then the outer bearings of the eye-piece in the main tube must be greased with tallow before the German-silver screw is restored to its place.

Additional Suggestions Pertaining to the Care and Protection of Instruments in Field Use.

In field use, an instrument has to be necessarily exposed to the heat of the sun, and to the action of dust and water; all of these, however, singly or combined, have a tendency to affect its accuracy and endurance. While our instruments in particular have been designed to guard against injuries resulting from exposure of this kind, yet glaring abuses, such as to allow it to stand for hours in the hot sun, etc., without a covering or shelter of some sort, may often lead to a permanent injury to its most vital parts. To preserve the finer qualities of an instrument, viz., the telescope slide, the lenses, the edge of the graduation and verniers, the centers, etc., any undue unequal expansion of the different parts should be prevented. A bag thrown over the instrument when not in use, or any shelter that can be had, is to be recommended. While in use, an umbrella or screen held over it will insure greater permanency of its adjustments, and the results obtained will be more accurate and uniform than when carelessly exposed.

To protect an instrument from the effects of salt water, when used near the sea coast, a fine film of watch-oil rubbed over the exposed parts will often prevent the appearance of oxyd. To remove such oxyd-spots as well as possible, apply some watch-oil and allow it to remain for a few hours, then rub dry with a soft piece of linen. — To preserve the outer appearance of an instrument, never use anything for dusting except a fine camel's hair brush. To remove water and dust spots, first use the camel's hair brush, and then rub off with fine watch-oil, and wipe dry; to let the oil remain would tend to accumulate dust on the instrument.

Lubricating, etc. — An instrument used in a tropical or semi-tropical country, or during the warm season in a northern latitude, requires more frequent cleaning and oiling than in the more temperate climes and seasons; but so long as an instrument works well and the centers revolve freely, it is best not to disturb it. However, if necessary, proceed as described under "Care of Centers, etc." A few additional remarks we give here: Should the centers or the object-slide commence to fret, they should be examined as soon as possible. *Once commencing to fret, it grows worse rapidly and oftentimes is then beyond repairing.* Never use emery or emery-paper on them, as this will cause everlasting trouble afterwards. After a thorough cleaning of the slide and tube (taking care not to break the cross-wires), endeavor to smooth carefully the injured parts with the back of a pen-knife, and barely apply enough tallow to grease the surface of the injured part. If this does not remove the trouble, a little scraping of the roughened parts on the slide, and, if accessible, on the inside of the tube, may become necessary, and apply a mere trifle of finely-powdered pumice stone moistened with oil. Replace the slide and grind a little by moving it in and out; *clean thoroughly*, and with a piece of charcoal moistened with oil smooth the parts thus ground on the slide. This process of grinding is a most precarious operation, and generally requires the hand of a skillful workman; it should be resorted to only in case of utmost necessity. Whenever permissible, recourse should be had to a maker. These remarks apply equally to the centers.

The centers of a transit should always be lubricated with *fine watch-oil only*, and after a careful cleaning; never apply fresh oil before thoroughly wiping off old grit and oil. Rendered marrow is a most excellent lubricant for instruments made of brass and the many kindred alloys of copper and tin. In the varying climes of our northern latitudes this lubricant becomes rigid in cold weather, and an instrument so treated will often become unmanageable in the field. Its application, particularly to the centers of a transit, is therefore restricted to the warmer zones. The use of watch-oil for the finer parts of an instrument, involving freedom of motion, is *imperative in our latitudes*.

Many parts of an instrument, especially those whose metal compositions are closely related to each other, may sometimes cause trouble if simply oiled. If they begin to fret and grind, but are otherwise free from grit, etc., the judicious application of a little marrow may prove very beneficial, but it should be cleaned off again as much as possible. The rack and pinion motion and the telescope clamp should always be greased with marrow, but the clamp, tangent and leveling screws, should receive as little of it as possible in the Northern States.

Vaseline, not having as great a tendency to rigidity under similar circumstances, may prove an excellent substitute for marrow, and may often be applied to level-centers, where watch-oil would not give the necessary rigidity in the use of the more

ordinary instruments, but it must be renewed quite often. In the finer class of leveling instruments, the centers should be lubricated with oil only, as in transits.

A great deal of annoyance is caused to the engineer if the eye-piece or the object-slide of the telescope move too freely in their tubes, requiring a re-focussing of the cross-wires and object at every revolution of the telescope in altitude. If the eye-piece can be retained in its socket, with sufficient friction to keep it focussed to the cross-wires, no matter how much it may wobble otherwise, this imperfection (in old instruments) will not lead to any inaccuracy, but if there is not sufficient friction to keep it focussed to the wires, a little rendered tallow or marrow applied to its bearing surfaces in most cases will remedy this evil. Wabbling in the object-slide, however, leading to inaccuracy of collimation, or back-lash in its rack or pinion motion, can be remedied only by a maker; but if the object-slide moves too freely in and out of its tube only, this may be remedied by applying a little tallow to the bearing parts of the rack and pinion, or by tightening the screw in the pinion-head. If not entirely successful, a thin disk made of parchment, or a thin leather-washer, both greased with tallow, and inserted between the flanges of the pinion-head and its socket, will insure the desired result. — These latter remarks apply to transit and level telescopes of the customary design. In telescopes, where the object-glass is mounted permanently to the telescope-tube, the eye-piece tube, *containing the cross-wires*, becomes the slide with which to focus the object. Its motion must be in a line parallel to the optical axis. Any wabbling in this eye-piece slide would lead to inaccuracy in sighting through the telescope, hence it requires the most careful treatment on the part of the engineer.

Care in the Use of Spirit-Levels.

Spirit-levels are very susceptible to the least change in temperature, as will be readily seen by the difference in the length of its bubble in varying temperatures. Hence, to guard against inaccuracies from this source, it is necessary that the bubble should lengthen symmetrically from the center of its graduated scale (supposed to be made by the maker), and that both of its ends should be read. Sufficient time must also be allowed for the bubble to settle before a reading is made.

The fluid ordinarily used for levels is pure alcohol, and requires, according to curvature, diameter and length of tube and length of bubble, from twenty seconds to one minute to attain its equilibrium. The composition fluid used in our levels for field instruments requires only from five to fifteen seconds of time; those filled with pure ether, a few seconds only.

A great source of error in spirit-levels, however, increasing with their greater sensitiveness, is occasioned by an *unequal* heating of the level-tube, *as the bubble will always move towards the warmer spot or end*, thereby imparting to the instrument an inaccurate position. This must be attributed to a changed condition in the adhesiveness of the fluid in the level-tube, and not to a change in the form of the tube itself. Therefore, to guard against inaccuracy resulting from sudden changes of temperature, a spirit-level, while in use, should be protected from the sun, and no part of it or its mounting should ever be touched with bare fingers; neither should it be breathed upon, nor the face of the observer come too close to it. For this reason, in the finer instruments the mountings of our spirit-levels are cloth-finished, and if the levels are detachable they are provided with wooden handles, as the case may require, and glass covers are placed over them whenever deemed necessary.

If at any time during the progress of field-work a spirit-level has been improperly exposed, it is best to cover it with a cloth for from five to fifteen minutes, before proceeding with further work.

Mounting Spirit Levels. — To prevent any undue strain and change of curvature in spirit levels used in astronomical instruments, they are mounted by us in wyes, as shown in the cuts of these instruments, and are protected from injury, or inaccuracy caused by the breath of the observer and other air currents, by a cover of glass placed over them. Such a mounting, while most suitable for such delicate levels, would, however, require constant attention and expose a spirit level to breakage in field instruments. To guard against this danger and to lessen the expense and weight, the spirit levels for field instruments are mounted in a brass tube; but

owing to the difference existing in the expansion and contraction of glass and brass at different temperatures, a spirit level so mounted may sometimes become loose, involving inaccuracy and unreliability of adjustment. — Upon finding that the adjustment of a spirit level in an even temperature is not as stable as desirable, the level fastenings, tube, screws, etc. should be examined, to see if any of them are loose. If the trouble is in the screws, tighten them up; but if the spirit level can be shifted in its tube by a touch of the finger, take it apart; soften the plaster of paris in water, and remove it with a sharp pointed stick of wood. Cautiously move the spirit level with your finger, at first only a trifle to and fro, increasing the length of stroke little by little, until it can be safely taken out without breaking; — clean thoroughly. Cut pieces of white paper, of the width of the radius of the tube, and somewhat shorter than the length of the spirit level, but longer than the opening in the brass tube, and insert these of sufficient quantity at the bottom of the brass tube, to fill up the space intervening between the glass and the brass tube. The uppermost layer of paper should, however, be so wide, as to envelope the spirit level up to the opening in the brass tube. Now insert the spirit level, taking care not to touch the glass ends that are sealed up, and place the division or other marks, indicating where the level has been ground to a true curvature, uppermost in the brass tube. The level must be pushed in with sufficient friction to prevent slipping in the tube, yet not so tight as to cause a crack at a subsequent low temperature, as brass will contract more than glass. No part of the spirit level should touch any part of the metal tube. Now prepare some plaster of paris with water, of the consistency of paste, and pour in at each end enough to fill up the space between the end-pieces and the glass, stirring it sufficiently to make a perfect contact by it and the glass and the brass, but leaving the spirit level ends exposed. Now put the level together, and adjust as described elsewhere.

There are other causes, such as centers and flanges that have been bent by falls, etc., or that have been worn out — unequal expansion or contraction in different temperatures of the metals employed in the construction of an instrument, or a non-symmetrical lengthening or shortening of the air-bubble at different temperatures — all of which, singly or combined, tend to impair the adjustment of spirit levels on instruments. Of these we will not speak here, as it requires a most thorough mechanic and instrument-maker to trace the cause to its proper source.

Being assured that the level is mounted as explained above, our advice is, not to meddle too frequently with the adjustment of a spirit level. Though it may appear to be out one day, it may be in perfect adjustment other days. It is the function of a spirit level to indicate the changes taking place in an instrument, so that the engineer may make proper allowance and apply his corrections, as the character of his work may require. The finer an instrument, the more sensitive the spirit levels must be, in order to admit of corrections to arrive at closer results. As a rule, a spirit level that does not indicate changes taking place in an instrument, is too insensitive for the character of the instrument, and in many cases entirely unfit for reasonably good work.

Replacing Broken Cross-Wires.

The cross-lines in our telescopes are *bona fide* spider webs (except where platinum wires have been specially ordered). In case they should be broken, they may be restored in the following manner: clean the reticule frame of all foreign matter; put it on a sheet of white paper with the cuts on its surface uppermost. Prepare a little shellac by dissolving it in the best alcohol and waiting until it is of the consistency of oil. From the spider's cocoon, (those from a small black wood-spider preferred), which the engineer has prudently secured at some previous time, select two or three webs, each about two inches long and of the same appearance. Attach each end of these webs to a bit of paper or wood to act as weights, and immerse them in water for five or ten minutes. Remove one web from the water, and very gently pass it between the fore-finger and thumb nails, holding it vertically to remove any particles of moisture or dirt. Stretch the web carefully over two of the opposite cuts in the reticule frame. Fasten one end by a drop of the shellac, — let fall gently from a bit of pointed wood or the blade of a penknife. Wait a moment for this drop of shellac to harden. See that the web is stretched tight across the

frame, and apply another drop of the shellac to the opposite cut with its enclosed web. Wait several minutes before cutting off the two ends of the web, and then proceed in the same manner with the web which is to be placed at right angles to this one.

NOTE.—The fine spider-threads used were formerly taken from the cocoons of the small black wood-spider; now, however, we obtain them from the cocoons of a species of spider found in Michigan. These threads are almost opaque, and not apt to relax their tightness if properly placed on the diaphragm, and as they retain their elasticity, they are preferable to platinum wires, which have a tendency to break, owing to their great brittleness. The best spider-threads are those of which the spider makes its nest. These nests are yellowish-brown balls, which may be found hanging on shrubs, etc., in the late fall or early winter. The nest should be torn open and the eggs removed; if this is not done, the young spiders, when hatched, will eat the threads. The fibers next to the eggs are to be preferred on account of their fineness and darker color. As it is important to get the proper kind of spider-web, we subjoin an extract from a letter addressed to us on the subject by Prof. J. B. Davis, University of Michigan, Ann Arbor, Mich., to whom we are indebted for our supply.

“The species of spider of which I send you cocoons is not difficult to find in Ann Arbor—Lat. $42^{\circ} 26' N.$ —as far as my experience goes, and is numerous on Beaver Island, out in Lake Michigan—about $46^{\circ} N.$ —at St. James. I have also always succeeded in hunting it in our Michigan woods, in places of concealment,—under bark of dead trees, in cracks and holes, about old stumps, logs, and the like. It is especially partial to painted woodwork. It roosts high,—the higher the gable the more numerous the cocoons; but it is also found on fences quite numerous, as I am led to think it is quiet rather than security this spider seeks. The body of the female is three-fourths of an inch, I guess, long, and nearly half an inch wide across the abdomen. The male is about the same length, but far slimmer. They are both entirely harmless. I never knew any one to get bitten by either, and many persons in my observation have had them freely crawling over their hands, face and body. They may be certainly gently handled without the least harm. They both (male and female) bear a plain escutcheon design on the back of the abdomen; female much the more beautiful,—in browns. Colors all brown and yellowish brown. The cocoon is a snarl of webs, and is attached under ledges of window-sills, cornices, projections of gables, and the like partly sheltered places. The color of the threads you have is of a light corn-color, distinctly separating it from the white cotton-like cocoons so common everywhere. The threads are silky, not like cotton. Of late years I keep one or two nice cocoons where they can be reached. You know one can wrap them in a bit of paper and carry them in the pocket, or any such place, and they are always ready.”

Prevention Better than Cure.

It cannot be denied that instruments frequently meet with serious accidents which, with a little care on the part of the operator, could be prevented. It certainly does not betoken proper care to leave it standing *unguarded in a street, road, or pasture, or in close vicinity to blasting*, or to expose it unnecessarily to the burning rays of the sun, or to dust, dampness, or rain at any time. Such carelessness must inevitably result in deterioration of the accuracy and efficiency, not to speak of the durability, of an instrument.

It should be borne in mind that there are many parts of an instrument which, *if once impaired*, cannot be restored to their original efficiency; and when it is considered that a conscientious maker bestows no little care, time, and expense on his work in order to attain a high degree of perfection, such neglect seems like a wanton waste of human energy and skill.

Legs of tripods, if fitting too loose or too tight, and dull shoes are frequent sources of falls, and loose shoes tend to make an unsteady instrument. The test of the proper degree of the tightness of the legs is this, that if the leg is raised to a horizontal position and left free, it should gradually sink to the ground. If it drops abruptly it is too loose; if it does not sink it is too tight.

When taking an instrument from its box, it is not immaterial where and how to take hold of it. To lift it by the telescope, circles, standards, or wyes is improper, and while it may not be attended at once with any serious consequences, yet it may sometimes lead to some permanent injury, and it certainly is always fraught with danger to the permanency of the adjustments. In handling, it is always best to place the hand beneath the leveling base.

When mounting an instrument on the screw of its tripod, or screwing any of its parts together, it is important to turn the part in the direction of *unscrewing* until it is perceived by a slight jar that the threads have come to the point where they enter; the motion may then be reversed, and the parts screwed together.

To secure an even wear of tangent and micrometer screws, they should be used equally on all portions of their lengths.

Carrying an instrument in cold weather into a warm room, without the protection of its box or bag, will cause a sudden exchange of air within the hollow spaces, and carry with it dust and other substances through the minutest openings. The vapor, also, that will thus condense on the metal surfaces, if it were not protected, will have a tendency to settle a film on exposed graduations, making them indistinct and difficult to read.

Failure to protect the lenses of the eye-piece and object-glass of a telescope, when not in actual use, from the effects of moisture, dust, etc., by the covers provided for them (eyepiece-lid and cap) will result in a more frequent settling of a thin film, which, like the fatty substance left by the touch of the fingers, greatly impairs the clearness of vision. That the too frequent cleaning of the lenses must in the course of time be detrimental to their brilliant polish, and lead to a corresponding loss of transparency so essential to the proper working of a good telescope, is apparent. Too much care cannot be taken to guard the lenses, and particularly the inner surfaces of the lenses comprising the objective, against any film that may settle on them. The ill effects of such a film are especially noticeable in high-powered telescopes of first-class geodetic and astronomical instruments. In short, it should be remembered that the slightest film, scratch, or dirt will, according to their nature and location, impair the sight through a telescope, and often render it unfit for accurate work.

The glass covers protecting the compass, arc, and verniers from exposure need very careful brushing and cleaning, the same as the lenses, as any scratch or film will impair their transparency. If at any time the ground-glass shades should lose their pure whiteness, by either dirt or film, and will not act as *illuminators* of the verniers and graduation, take them out of their frames and simply wash them with soap and water.

To prevent loss of magnetism in the needle of instruments provided with a compass: when storing away, allow the needle to assume magnetic North and South; then, by means of the lifter, raise it from the center-point against the glass cover.

If an instrument has met with a fall, bending centers and plates, etc., it should not be revolved any more, in order to preserve the graduations from still further injury, but recourse should be had at once to the nearest competent maker.

If the box or tripod should have become wet, they should be rubbed dry, and the varnish should be renewed whenever found wanting.

Loose or detached resting-blocks in the instrument-box, or any looseness of the instrument in them, are very detrimental to the instrument and its adjustments. Cracks in the instrument-box, the absence of rubber cushions under it, worn-out straps and defective buckles, hinges, locks, and hooks, should never be tolerated, as the remedy is so easily applied by any mechanic. Such defects and imperfections are known to lead to injury of the instrument.

The place where instruments are kept or stored away should be thoroughly dry and free from gases. The placing of fused chloride of calcium, or caustic lime, in an open vessel in the instrument-box is to be recommended where there is dampness; and if the presence of sulphureted hydrogen is suspected, then, cotton saturated with vinegar of lead, placed in the box, will prove a preventive against the tarnishing of solid silver graduations.

Transportation of Instruments.

DURING the progress of field work the more ordinary and portable transits and levelling instruments, etc., can generally be carried on their tripods for ease and dispatch. Nothing in the way of precise instructions, however, as to the best method of carrying an instrument: whether on the tripod, in the arm without the tripod—placing the hand beneath the leveling base—or in the box, can be suggested here. The nature of the ground, the surroundings, the size and weight, and the distance to be traveled over, and last but not least the fineness of the instrument, will dictate to the engineer the best means of conveying it from point to point in order to protect it from injury, and its adjustments from derangement.

The finer and finest classes of field instruments, such as those provided with micrometer-microscopes, should always be placed in their boxes for safe conveyance — no matter how short the distance — for fear of improper handling, and because of danger of unequal expansion, temporary as it may be, of such parts as would come in contact with the body or fingers.

Carrying an instrument on its tripod **without slightly clamping** its principal motions, will wear out the centers. When carrying on its tripod, clamp telescope { in TRANSIT, when placed on a line with its centers;
in LEVEL, when hanging down.

When carrying an instrument in the box it is important that it be placed therein exactly in the position and manner designated by the maker. Therefore, upon receiving a new instrument, the first step should be to study its mode of packing, and if necessary a memorandum should be made for future guidance and pasted in the box. This will save time and vexation, as some of the boxes for field instruments must necessarily be crowded to be light and portable.

Before placing an instrument with four leveling screws in its box, the foot-plate should be made parallel to the instrument proper, and then brought to a firm bearing by the leveling screws. The instrument must also be well screwed to the slide-board, if one is provided, as is the case in most of our transits. Having put the instrument in the box in such a position, that no part of it will touch the sides, the principal motions are now to be checked by the clamp screws, to prevent motion and striking against the box. With instruments not standing erect in their boxes, but which are laid on their sides in resting-places, padded with cloth, specially provided for that purpose, their principal motions must not be clamped until the instrument has been secured in a complete state of repose in these receptacles, so as to be entirely free from any strain. Care must be taken, too, that all of the detached parts of an instrument, as well as its accessories, are properly secured to their receptacles before shutting the box.

When shipping an instrument over a long distance it is commendable to fill the hollow space between it and its box with small soft cushions made of paper, or of excelsior or shavings wrapped in soft paper, taking care not to scratch the metal surfaces, nor to bend exposed parts, nor to press against any adjusting screws.

For greater safety in transportation by express, the instrument-box itself should always be packed in a pine-wood box one inch larger all around. For the ordinary size of field instrument the packing-case should be provided with a strong rope handle, which, like the strap of the instrument box, should pass over the top of the case and through holes in the sides, the knots being within the case and strongly secured. In cases where the gross weight of the entire package, as prepared for shipment in the above manner, exceeds 40 or 50 lbs., then two men should handle it, and two strong rope handles, one at each end of the packing-case, should be provided. In order to check jars and vibrations while en route, the loose space between the instrument-box and the packing-case is to be filled with dry and loose shavings.

The cover bearing the directions should always be screwed on and marked in large black letters.

Example:

THIS SIDE UP.
HANDLE WITH GREAT CARE.
Scientific Instrument.

Mr. George Brown,
36 West Street,

Value \$

Cleveland,
Ohio.

From JOHN SMITH, Chicago, Illinois.

The upper halves of the four sides also should have 'CARE' and 'KEEP DRY' marked in large letters on them. These precautions are *indispensable* for safe conveyance while in the hands of inexperienced persons, as without them messengers will often carry them wrong side up.

The tripod needs packing simply in a close-fitting box. If not placed in a box, it often happens that legs or shoes are broken off while en route, or that the tripod head becomes bent.

Many hundreds of instruments, packed as explained above, have been shipped by us, travelling over thousands of miles, over rough roads, on stages and on horseback; and the instances are so rare where one has become injured (and then only through gross carelessness), that this mode of packing must be regarded as the only proper one for conveying instruments of precision by express or other public carriers.

Arriving at its destination, an instrument should not remain packed up with cushions, etc., any longer than absolutely necessary. The atmosphere in such boxes naturally must be close and often moist, and consequently has a tendency to produce the ill effects by moisture mentioned in preceding paragraphs.

Some Remarks Concerning Instrument Adjustments.

The mechanical and optical condition of instruments used in geodesy, and their adjustments, although satisfactory when they leave the maker's hand, are liable to become disturbed by use. It is therefore of vital importance that the person using an instrument should be perfectly familiar with its manipulations and adjustments. He should be able to test and correct the adjustments himself at any time, in order to save trouble and expense, as well as to possess a thorough knowledge of the condition of the instrument. It is evident that if the character of an instrument is not properly understood or if the adjustments are considerably out, the benefit due to superior design and workmanship may be entirely lost. Under these circumstances an instrument may be little better than one of lower grade.

In the best types of modern instruments the principal parts are so arranged that they can be adjusted by the *method of reversion*. This method exhibits an existing error to double its actual amount, and renders its correction easy by taking one-half the apparent error. Thus errors of eccentricity and inaccuracy in the graduations are readily eliminated by reading opposite verniers and *reversing* the vernier plate 180° on the vertical center and taking the mean of the readings, and by repeating the measurement of an angle by changing the position of the limb so that the measurement will come on different parts of the graduation. The striding levels and levels mounted on a metal base are readily tested by reversing their position end for end. In the transit plate-levels the adjustment is assured by turning the vernier plate 180° . Errors of the line of collimation are detected or eliminated by reversing the telescope over the bearings, or through the standards, as the case may be. In short, an instrument, the important parts of which are not capable of reversing in one way or another, cannot be examined quickly and accurately.

The adjustments of an instrument, and particularly those of its cross-wires, should be taken up successively in a systematic manner. The proper way is to select a place from which they can be conducted in succession without moving the instrument, as none of the adjustments should be completed independently of the others. This method is followed by the maker, and will save time and vexation. Any auxiliary apparatus that may be available, such as collimators, etc., will be of great service and expedite the work. One of the most important considerations in making adjustments (when the same are greatly disturbed, as when new wires are to be inserted), is to place all the respective parts in an approximate adjustment without introducing any strain except what properly belongs to the action of the adjusting screws themselves. The more natural the method, and the less internal strain introduced in bringing these adjustable parts into position, the more lasting will be the final adjustments, provided the instrument is otherwise in good condition.

It is important that all adjusting screws and nuts should fit truly on the surfaces against which they operate, with only a mere film of tallow between them, so as to insure a true metallic contact, and that they be brought to a firm bearing, yet without excessive strain. Opposing screws and nuts should always work somewhat freely, so that one can feel when they come to a true bearing. A moderate pressure

applied with an adjusting pin about one and one half inches long, and held between the thumb and forefinger, will then make a perfect contact. For instance, after the opposing capstan-headed screws of the cross-wire reticule have come to a bearing, it is only necessary to give them each a slight turn, say from 20° to 30° (with the usual pitch of these screws) in order to insure such a tightness that a moderate pressure of the finger upon these screws, or an accidental gliding of the hand over them, cannot change their relative position. On the other hand, if one pair of these opposing screws be fastened tightly during the tentative process of adjustment, there will be, in all likelihood, at the end, an excessive strain exerted upon the pair of opposing screws at right angles, which will make itself felt at any change of temperature, or whenever any external pressure may be momentarily applied to them. It is but natural that these continual changes in the resultant pressure must affect the adjustments in a like manner. To obviate such changes the procedure should be as follows:—

Having placed approximately in position the principal wire of an instrument: viz., in a transit, the vertical wire in a plane perpendicular to the horizontal axis of revolution, in a level, the horizontal wire in a plane perpendicular to the vertical axis of revolution, the other wire should be approximately adjusted for collimation, with the capstan-headed screws *only moderately tightened*. This accomplished, the capstan-headed screws of each pair in succession should be unscrewed about one-quarter turn, and again screwed tight the same amount. Now if the two pairs of opposing screws have exerted no undue strain upon themselves, the telescope tube, or the wire reticule, the principal wire will still be in the perpendicular plane; but if the screws have been used too much the wire will have slightly moved out of the perpendicular plane. Therefore all four capstan-headed screws will have to be released again, say about $\frac{1}{4}$ turn, so that they may be moved simultaneously until the principal wire is again in a plane perpendicular to the axis of revolution, and then each pair in succession must be again tightened an equal amount. The adjustment of the wires for collimation must now be made in turn—the less important wire should always be taken up first—by slightly releasing the capstan-headed screw *away* from which the wire must be moved, and tightening the opposite screw the same amount, and repeating this process until the adjustment is gradually perfected. If during this operation either or both of these wires have become so much displaced that the capstan-headed screws have to be moved more than a quarter turn, it would be advisable to slightly release all four of them again, in succession, and commence anew.

It should be said here, that the force applied by the capstan-headed screws cannot break or affect the tightness of the wires in any case, since the reticule, as made by us, although very light in weight, is of a very stiff form. Too great pressure exerted by the capstan-headed screws against the outer tube of the telescope may, however, change the form of the main tube, thereby affecting the true fitting of the object-slide, and creating friction of so serious a nature as to lead to the fretting of the object-slide mentioned in other paragraphs.

In following the above-described course, the cross-wire reticule occupies a position in the telescope free from any excessive side strain; the result of which is found in the greater permanency of these adjustments; and although it may require a little more time for an inexperienced person to make the adjustments in this manner, the satisfaction derived from their greater permanency will more than recompense for the extra time spent on them. The adjustments should be made at leisure, and should not be meddled with, unless they appear to be permanently deranged; when, ordinarily, the adjustments will merely require a very slight turn of the capstan-headed screws and opposing nuts *in the proper direction*.² Unequal exposure of the instrument to the sun, or exposure to sudden changes of temperature, may for a time expand some parts more than others, so that the instrument may seem to be slightly out of adjustment. In such a case it would be better to stop temporarily and cover the instrument with a bag to allow the temperature to become equalized, instead of attempting adjustments that would need to be repeated when the instrument is again in a normal condition. The use of metals of different co-efficients of expansion in the construction of corresponding parts of an instrument will naturally lead to a

¹ We refer here exclusively to the more common instruments of American manufacture, where the shoulders of the capstan-headed screws bear against the outer tube of the telescope, and where the adjusting threads are contained in the wire reticule. In other designs where, as in most instruments of Continental, Europe, the capstan-headed screws are made to butt against the wire reticule, the capstan-headed screws *towards* which the wire must be moved, must first be loosened. In the latter case this action is identical with that of opposing nuts used for the adjustment of most telescope levels on American instruments.

² See page 58.

permanent derangement of adjustment; such also will be the case when the temperature of an instrument is greatly altered after the adjustments have been completed. A similar result is caused if the bubble of a spirit level should not lengthen symmetrically from the center of its graduated scale in varying temperatures. These imperfections, however, seldom occur in instruments of modern make (or if they occur, they are generally caused because the principal constituents, glass and metal, are substances of widely differing co-efficients of expansion), and are generally so slight in well made instruments, as to be of little practical value, and may be overcome by adjusting the instrument while at a mean temperature of an entire season.

If an instrument does not remain in adjustment a reasonable length of time, the cause that leads to the trouble, such as a loose object-glass or cell, loose object-slide, worn out screws or bearings, etc., must be found and remedied. If this is beyond the scope of the operator the corrections should be made by an instrument maker.

Some Facts Worth Knowing.

The Line of Collimation.

The expression "Line of Collimation," usually defined vaguely in treatises on geodetic instruments, generally means any line of sight in a telescope given by the intersection of the cross-wires, whether they are in perfect adjustment or not. The term "Line of Collimation," should, however, be confined solely to the line of sight defined by the cross-wires when they are in perfect adjustment, with reference to the optical axis of the object glass; and any difference existing between the optical axis of an object glass and the actual line of sight as delineated by the geometrical axis of the instrument is the "Error of Collimation."

The principal optical axis of an object-glass is the line passing through the optical centers formed by the curvatures and the thickness of the two lenses composing it. Thus it will be seen that it is a well defined axis, giving direction to the light passing through an object glass, and that, when the intersection of the cross-wires is placed in its prolongation at the focus of the object glass, it becomes the axial or fundamental line by and from which all measurements by telescopic sighting are made. *It is the line of collimation.*

To make a good instrument, therefore, it is necessary that the outer circumference of the lenses composing an object glass shall be truly concentric with the optical centers. The aim of the maker is to so construct his instruments that this optical axis shall be truly concentric with the geometrical axis of the telescope and that the latter shall also occupy a normal position with regard to the geometrical axis of all other important parts: upon this depends the proper working of an instrument.

In the larger geodetic and stationary astronomical instruments, the telescopes of which are arranged only for distant sighting, this condition is readily obtained; but it becomes very difficult of attainment in the smaller geodetic instruments, since, owing to the varying position of the focussing slide when set for *different distances*, the optical axis may not always remain truly coincident with the geometrical axis of the telescope. Hence in these instruments, *carefully adjusted for distant sights*, there is frequently an error of collimation when nearer sights are taken. In the latter case the intersection of the cross-wires remains no longer exactly in the optical axis, its displacement being the cause of the error observed — disregarding momentarily the other and more complicated features of different instruments, upon which the line of collimation also depends.

In the Engineer's transit, however, the line of collimation must also lie exactly at right angles to the axis of revolution of the telescope, so that when this axis is placed in a horizontal position, the line of collimation shall describe a truly vertical plane, whether the telescope be mounted in the centre of the instrument or outside of the plates, or whether it be focussed for long or short sights. In the more common instruments of this class, where the telescope is situated in the center of the instrument, the intersection formed by the line of collimation and the horizontal axis of revolution is also required to lie truly in the prolongation of the vertical axis of revolution, so that there be no eccentricity between the vertical axis of revolution and the line of collimation when sights are taken at objects nearer than 200 feet.

In transits of this latter type, and in which the above conditions are fulfilled, the sights taken would at once define the true angle, and no reversing of the telescope would be necessary, were it not for other reasons. On account of the necessity for eliminating the eccentricity and error of graduation and verniers, as well as for eliminating errors arising from an inaccurate adjustment of the line of collimation and of the

adjustment of the telescope in the vertical plane, an instrument should be reversed and an angle should be repeated. These remarks apply equally to transits made with the telescopes in an eccentric position. If the line of collimation is truly at right angles to the horizontal axis of revolution, the amount of the offset from the line through the center of the instrument to the line of collimation will equal the eccentricity of the latter, and will remain the same whether the sights be long or short. As a rule, however, the small geodetic instruments of the latter class cannot be constructed with the same degree of perfection as those with the telescope in the center; and in consequence the engineer using such instruments will have to rely upon methods of observing that will eliminate all instrumental errors.

In the engineer's wye level the line of collimation must be truly concentric with the object-slide and outer rings; and it is also necessary that the telescope be well balanced from the center of the instrument, in order to project a truly horizontal line.

Difficult of attainment as the foregoing conditions may seem, it is proper to say that improved tools, and a generally better understanding of the principles governing a telescope and its relation to the instrument, have done so much toward the perfection of geodetic instruments, that while it may not always be possible to make an instrument in which the line of sight for both wires remains true for all distances, that result can generally be secured, for at least the principal wire, without requiring any other but the regular cross-wire adjustment.

By the foregoing explanation it will be readily understood that it is of great importance to have the focussing slide of such a telescope *truly fitted*, in order that the optical axis of the object-glass may coincide with the geometrical axis of the telescope, whether this slide moves in the main tube and carries the object-glass, as is the custom now in the smaller instruments; or whether it moves in special rings provided for it in the main tube at the eye-end, where it will contain the eye-piece and the cross-wires, as is the case in all larger instruments. Any lateral motion in the *focussing slide* that carries the *object-glass* or the *cross-wires*, will, therefore, derange the adjustment of the line of collimation. However, it is equally as clear that a wobbling of a focussing slide carrying an eye-piece which serves only the purpose of a compound microscope for close observations of the wires and the image of an object, is of no account save that such lateral motion may be so great that the obliquity which the optical axis of the eye-piece may at times have with respect to the optical axis of the telescope, may cause some parallax, if the wire and image under observation are not sharply focussed together. In concluding, it may not be considered amiss for a full understanding of this subject, to also mention in this connection, that any transparent substance, such as *prisms*,* *lenses*, or *shade-glasses*, introduced between the object sighted at and the object-glass, will deflect the line of sight from its true course, unless such parts can be made optically and mechanically perfect, which is rarely the case without elaborate adjusting apparatus. The introduction of a lens or lenses between the object-glass and wires, or that of a glass micrometer, will also have the tendency to deflect the optical axis and affect the line of collimation, not to speak of the consequent loss of light caused thereby and film forming on the surfaces. For this reason, "**Porro's telescope**," which requires a lens between the object-glass and the wires, complicates the above conditions of a measuring telescope; and while it may prove of some value in stadia-work—to enable to measure from the center of the instrument instead of from a point in front of the object-glass equal to its focal length—this feature can never be successfully adapted to the engineer's transit as long as the proper functions of the transit telescope, as explained above, are considered of the greatest importance. The successful performance of an instrument should not be sacrificed for the sake of some doubtful novelty.

The proper way of attaching prisms and colored glasses necessary to make sun and star observations is to put them upon the eye-piece of a telescope. After the rays from an object have passed through the object-glass and the plane containing the wires, the line of sight as fixed by the object, optical axis, and the wires, cannot be changed by additional refraction. The best way, therefore, is to apply prisms and shade-glasses between the eye and the lens nearest the eye.

Aluminum for Instruments of Precision.

In consequence of improvements in the production of pure aluminum and a corresponding great reduction in its cost, we frequently receive inquiries as to the adaptability of this metal for the manufacture of engineers' and surveyors' instruments.

We may be permitted to say, that while we are among the earliest advocates of aluminum and its alloys for mathematical instruments (see *Scientific American*, Feb. 1, 1868), we are not so sanguine concerning its adoption for every class of

* The object prism, so called, attachable to the object end of a mining telescope to aid in steep sighting, from its position between the object glass and the object sighted at, must of necessity be of very limited usefulness, since the slightest change of the prism or its mounting or a change of the position of the telescope itself or of its object slide will almost certainly deflect the line of sight from its true course and give no satisfactory results.

geodetic instruments, as these inquiries would warrant us to be. There are certain advantages derived from the use of the lighter aluminum instead of copper and its alloys,—the metals now employed for field-instruments; but the disadvantages are that pure aluminum, although very rigid, is nevertheless a very soft metal like tin, and that, when alloyed with 10 per cent. copper, to make it harder, it becomes very brittle, but when alloyed with 20 per cent. or 30 per cent. of copper, it becomes so brittle as to break like glass, therefore, it can be used only with great caution as a material for precise instruments.

An alloy of 95 parts aluminum and 5 parts of silver by weight has been found to give good results, being more rigid and harder than the pure metal, and but little heavier, while it is almost as resistant to corrosion, polishes well, and is said to be better for graduation; but, the fact that it contains silver, will, of necessity, limit its use to the more exceptional class of work.

Very little is gained in the way of reducing the weight of an instrument by employing aluminum bronze (90 per cent. copper and 10 per cent. aluminum). The parts of instruments made of the latter metal might be easily reduced somewhat in thickness on account of its greater rigidity as compared with copper alloys; yet to lessen the tendency to vibration, and also in order to withstand the wear and tear of the field use of an instrument, such parts need a little more mass, or dead weight as it may be called. It is then found that the weight of an instrument remains materially the same as ever. An exception to the rule may exist in the construction of the larger and stationary astronomical instruments, where aluminum bronze may be used to a certain extent to advantage. Its adoption is, however, restricted to non-revolving parts, since, when closely fitted into bearings made of the softer copper and tin alloys, the friction and wear of these parts is so marked that we would never think of substituting it for steel, bell metal or phosphor-bronze, or for any work requiring a smooth and accurate motion.

There can be no doubt that aluminum possesses great utility over brass in the construction of instruments of minor importance. Sextants, reflecting circles, and the more ordinary compasses* can be made of it to some extent, also parts of transits, plane-tables and other instruments, etc. We are using it very extensively, but for reasons already stated above, we are not prepared to advocate its general adoption for instruments of precision. It is only in cases where a judicious use of this metal will be a necessity for the successful construction of an instrument, as for instance in our new style of mining transit, permitting of vertical sights up and down a shaft without the use of an extra side telescope, where certain detachable parts of the instruments are mounted in an excentric position, and unless such parts are made of aluminum they would require a heavy counterpoise.

It is principally the indiscriminate use of aluminum that we would warn against. To make this fully understood, it will be necessary to explain that all the finer bearings of an instrument made of aluminum, such as *centers, object slides, leveling and micrometer screws*, etc., will have to be *bushed* with a harder and non-friction metal, to guard against friction and wear and to obtain the close fitting of such parts, and permanency of adjustments so necessary in instruments of precision. Now, to make the principal bearings of an instrument of different metals has the tendency to weaken the parts so treated, to make them less secure, and to render the adjustments more liable to derangement on account of unequal contraction and expansion between the two metals. It simply means, then, that the present high state of perfection in geodetic instruments, which retain their adjustment in the varying temperatures and climes of our zone, shall be abandoned, and we go back many years to when the indiscriminate use of widely different metals often made an instrument entirely unreliable, except when used in the temperature in which it was adjusted.

Modern instrument-making has, however, already achieved great results in reducing the weight of field instruments. By improved designs and by the use of harder metals in place of the soft brass, remarkable changes have been brought about in the weight of instruments. They are no longer the heavy and formless structures of soft or hammered brass as of yore, but are of the type and character of a long-span steel bridge, as compared with an old-fashioned wooden structure. Every important member of an instrument is now calculated with regard to its strength, and the materials are particularly chosen for the part they are to perform.

* Commercial Aluminum, unless obtained from reliable sources, often contains a small amount of iron.

Owing to the many improvements made in the designs, the use of better materials, the application of specially designed tools and machinery, it is no longer necessary to use large and heavy instruments. An instrument of about two-thirds the size and weight of those made formerly will now do the same class of work. It is by these methods that lightness has been gained, and to them we must look for advances in the future. Unless the size of an instrument is decreased, the resistance of its exposed surfaces to wind pressure, causing sudden vibrations or tremor in the instrument, will of necessity require a certain amount of weight to secure the needed steadiness, and if this weight is not in the instrument proper, it will have to be in its tripod legs. This is especially true in this era of high telescope powers and sensitive spirit-levels. What is needed is that engineers and surveyors should have more confidence in instruments of smaller size as made by the best makers.

Wherever less weight is of great importance our patrons should not hesitate to order our smaller Transits Nos. 2, 3, or 4, weighing $10\frac{1}{2}$ and 5 lbs. respectively, in preference to a larger instrument made of Aluminum and divided to single minutes, but of equal weight. These small instruments are just as durable and capable of doing just as close work as the larger ones. Being made of a like metal throughout, whose coefficient of expansion* is lower, they will retain their adjustments better than larger ones made in whole or in part of Aluminum. — Suppose an instrument is adjusted in-doors and immediately is taken into the cold atmosphere of winter: other things being equal, if the coefficient of expansion of some parts differ the adjustments will very likely be deranged. — Besides, the instrument being smaller, the boxes are likewise smaller, thus reducing the weight and making it more portable at the same time. The same, in a measure, can be said of the tripod, although it is against our convictions to use a lighter tripod with a small transit than is used on the larger ones.

The only exception to the above exists in the Telescope, which, of course, being correspondingly shorter in a small instrument, will have a smaller aperture and less power. However, to secure the same aperture and power for Transits Nos. 2 and 3 (No. 4 being inverting), as for our Transit No. 1, with an erecting eyepiece, it is only necessary to order an inverting telescope to attain these conditions.

In conclusion we wish to say that the future developments in alloying it as a base with other metals, or combination of metals, will be watched by us with due care, and that whenever such developments warrant their adoption for instruments, as already exemplified in many new types of instruments enumerated in our catalog, made in part or almost wholly of such alloys, we are glad to do so.

* *The Ideal metal for a Surveying Instrument is that which has a coefficient of expansion equal to that of its glass parts, so as to retain the adjustments in varying temperatures.*

Coefficient of glass per linear foot, for 1° F.	0.000054 inches.
“ “ steel “ “ “ “	0.000076 “
“ “ brass “ “ “ “	0.000125 “
“ “ aluminum per linear foot, for 1° F.	0.000143 “

Aluminum is farthest removed from the above requirements, steel or cast iron being nearest, and also lighter and harder than brass; and non-friction metals would be more generally adopted were it not for the use of the compass and the liability to rust in the field.

Repair of Instruments.

We are often applied to for correcting new and repairing old instruments made by other makers. We will here remark, that as workmanship, material and construction of different makers' instruments vary from one another, it is oftentimes impossible to repair them in an entirely satisfactory manner without going into an unwarrantably great expense, or without making such alterations as would practically make a new one. We will always guarantee in such cases to put the instrument in as good order and adjustment as the character of its construction, workmanship and material, the extent of damage and the general wear will permit, and that all repairs are promptly and conscientiously made. The charges will be according to time consumed, and as low as is consistent with good work. Parties sending instruments should point out in detail whatever parts they wish to have repaired; but the best course to be pursued is to have the instrument *put in thorough order and adjustment*, implying, as it does, that the firm should make such warrantable repairs as will make it as serviceable as possible. This course is always more expensive, but the most satisfactory to insure good work, and it is also the cheapest in the end. — Our own instruments, whenever practicable, should always be sent to us for repairs to insure fullest satisfaction. Much time and money is frequently saved by so doing, as we are in a position to duplicate parts from stock on hand. In sending an instrument to us from a distance it should be carefully placed in *its box* and then again in a *packing box*, as explained under “Transportation of Instruments,” Part I., in order to conform to the rules of most of the large Express Companies, which will admit it to single rates.



C.L. BERGER & SONS

Cross-section of spirit levels as used for instruments of precision (see pages 7 and 38), interior surface showing the barrel form with curvature ground to certain value of arc, diameter of arc depending on the degree of sensitiveness required.



C.L. BERGER & SONS

Cross-section of spirit levels as above, but provided with an air-chamber for adjusting length of the bubble for different temperatures as used in the leveling instruments of precision and for astronomical work.

TABLE

Showing movement of cross-hairs on rod for displacement of bubble for one division of level scale.

**AT DISTANCES OF
Feet**

50 100 150 200 300 400 500 1000

One division of scale
equals:—

Radius of curvature corresponding to sensitiveness and scale of level.

One division of scale
equals:—

Radius of curvature, etc.,
as above.

Sensitiveness of one division
of level scale.

Sec.

Feet

Inch

Feet

Inch

Feet

1	.000	.000	.000	.001	.001	.002	.002	.005	1/20	859		
5	.001	.002	.004	.005	.007	.010	.012	.024	1/10	344		
8	.002	.004	.006	.008	.012	.016	.019	.039	1/10	215	3/20	322
10	.002	.005	.007	.010	.015	.019	.024	.049	1/10	172	3/20	258
12	.003	.006	.009	.012	.017	.023	.029	.058	1/10	143	3/20	216
15	.004	.007	.011	.015	.022	.029	.036	.072	1/10	115	3/20	172
20	.005	.010	.015	.019	.029	.039	.048	.097	1/10	86	3/20	129
30	.007	.015	.022	.029	.044	.058	.073	.145	1/10	57	3/20	86
45	.011	.022	.033	.044	.065	.087	.109	.218	1/10	38		
60	.015	.029	.044	.058	.087	.116	.145	.291	1/10	29		
70	.017	.034	.051	.068	.102	.136	.170	.339	1/10	25		
80	.019	.039	.058	.078	.116	.155	.194	.388	1/10	22		
90	.022	.044	.066	.087	.131	.175	.218	.436	1/10	19		
7	.002	.003	.005	.007	.010	.014	.017	.034	2 m m	193		
8	.002	.004	.006	.008	.012	.016	.019	.039	2 m m	169		
20	.005	.010	.015	.019	.029	.039	.048	.097	2 m m	68		
25	.006	.012	.018	.024	.036	.048	.061	.121	2 m m	54		

Engineers' Instruments and Their Adjustments.

General Remarks.

THE OPTICAL PART.

In the construction of telescopes for engineers' instruments, several difficulties present themselves. To be portable, the telescope must be of small aperture, and of short focus. To make it of short focus and yet retain sufficient aperture to give the light necessary with the eye-pieces used, requires especial care on the part of the maker, both in securing the true curves for the crown and flint glass lenses, which make up the achromatic object-glass, and in adapting an eye-piece which will secure a flat field, with the least distortion.

After careful experiments with the formulas suggested by the distinguished astronomer, Sir George B. Airy, and the late Mr. Kellner, of Wetzlar, (the two best formulas known), we have adopted the latter. Mr. Kellner's formula employs four lenses, mounted separately, and so arranged as to secure a flat field of the sharpest definition, to the very edge.

The magnifying power of the telescope depends upon the relation between the focal length of the object-glass and the focal length of the eye-piece, considered as a single lens: Thus—

$$\begin{array}{l} \text{If} \\ \text{Then} \end{array} \quad \begin{array}{l} \mathbf{F} = \text{focal length of the object-glass,} \\ \mathbf{f} = \text{ " " " eye-piece,} \\ \frac{\mathbf{F}}{\mathbf{f}} = \text{magnifying power of telescope.} \end{array}$$

It is readily seen that the magnifying power may be increased or diminished by altering the focal length f , of the eye-piece; but if the maker increases the power too much, since only a fixed amount of light can enter the object-glass, this fixed amount of light is spread over too much surface in the field of view, and the object seen is therefore too faint. If the maker gets the magnifying power too small, then the engineer has a difficulty in pointing the telescope accurately. Some other points in regard to the magnifying power will be referred to in the description of the transit telescope. We have found about twenty-four diameters to be the most satisfactory power for our Engineers' Transit Telescope; and for levels the powers increase in proportion to the size of the instruments.

Very much depends upon the optical part of any instrument, and very little has been put into the hands of the practical engineer by which he may rigidly test it. The following suggestions may be found convenient.

The telescope should come sharply into focus, and a very little movement of the focussing screw, either way, should cause the image to blur. When it is sharply focussed, covering any part of the object-glass without altering the focus, should not alter the sharpness of definition but merely cut off light. The pencil of light which enters the object-glass, should come out at the eye end. To ascertain this, see whether a pointer which you place just in contact with the edge of the object-glass, can be wholly seen in the small disc of light which you will notice at the small opening of the eye end when you draw your head back some inches from the telescope, and point the telescope towards the sky. If the pointer cannot be seen up to the very edge, then the maker has inserted a diaphragm which cuts off light from the object-glass, and, very probably, to conceal the faults in making. In this

case the real aperture of the telescope is found by moving the pointer over the object-glass until its point is just visible, and measuring from the inner edge of the brass cell holding the object-glass to the pointer. Twice this distance subtracted from the distance between the two edges of the brass cell, will give the real or clear aperture of the telescope. The clear aperture, divided by the diameter of the small circle of light at the eye end, when the telescope is focussed on a distant object, will give the magnifying power of the telescope. Thus the clear aperture of a telescope, measured by means of a pair of dividers and a scale, was 1ⁱⁿ. 35, while the diameter of the circle of light at the eye end, was, 0ⁱⁿ. 06. In this case, the magnifying power of the telescope was $\frac{135}{6} = 22.5$ diameters.

Another way to determine the magnifying power, is to measure the angular distance between two points with a transit, and then measure the same distance with the telescope of which the power is to be ascertained, placed so that the transit must point into its object-glass and see the same angular distance through the second telescope inverted. Then calling the first angle **A**, and the angle as seen diminished through the introduction of the second telescope inverted **a**, we have the magnifying power of the second telescope = $\frac{\tan. \frac{1}{2} \mathbf{A}}{\tan. \frac{1}{2} \mathbf{a}}$. Thus the angle subtended by a window sash, several hundred feet away, was measured by a transit instrument direct, and found to be, 1° 58' 50". When a Y level, previously focussed on a distant object, was set before the transit, with its object-glass towards the transit, the same sash was measured and the angle was found to be but 3' 30". In this case, therefore,

$$\text{the magnifying power of Y level} = \frac{\tan. \left(\frac{1^{\circ} 58' 50''}{2} \right)}{\tan. \left(\frac{3' 30''}{2} \right)} = \frac{\tan. 0^{\circ} 59' 25''}{\tan. 0^{\circ} 1' 45''} = 34.0 \text{ diameters.}$$

Or, for an approximation, a card cut one inch wide may be set up across a room by the side of a measure graduated to inches. Then, the number of inches on the measure seen by one eye, covered by the image of the white card seen through the telescope by the other eye, will give, roughly, the magnifying power.

It is difficult, without months of use, to fully test an instrument in all its parts; but in choosing an instrument the engineer should bear in mind that the making of the transit and the level are considered to be feats of mechanical skill. It should be remembered that there is no machine so delicate that it can *finish* the essential parts of an instrument. The last stages in its making must depend upon the personal skill of some mechanic, who has a reputation for that particular work; and we are sorry to add, that so difficult is it to secure the mechanical skill and patience required in the finishing of the interior parts, the only essential ones, and so easy is it to add the lacquer and polish of the outside, that the market is full of instruments sold at a price enough lower than the best makers can work, to seem to effect a large saving of the first cost; but such a saving is money borrowed at the highest rate of interest, when the cost of annual repairs is considered. It is better at the outset to buy of a maker who is noted for the conscientious accuracy of his work. An imperfect rack motion; a screw turned home on the wrong thread; a wobbling of the object-slide or eye-piece; a slight space between the edge of the vernier and the limb of the circle; in fact, any mechanical defect, no matter how slight it may seem, may be taken as a pretty sure indication that the work has been slighted in other parts as well, and should have a strong influence in guiding the selection of an instrument, in the absence of a test by work in the field.

THE ENGINEER'S TRANSIT.

In the first part of this catalogue, the peculiarities and improvements in this instrument have been pointed out. In speaking of the adjustments of these instruments it is well for the engineer to remember that the construction is aimed to be such that if the telescope and levels are carefully adjusted they may remain so for even a number of years to come, if the instrument suffers no rough usage.

- 1 Tripod Head
 2 " Bolt
 3 " Nut
 4 " Washer
 5 " Leg
 6 Foot Plate
 7 Ball and Socket Joint
 8 Leveling Head
 9 " Screws
 10 " Screw Cups.
 11 Shifting Plate
 12 Plumb Bob Suspending Cup
 13 " Chain and Hook
 14 Repeating Center
 15 Clamp Collar
 16 Lower Clamp
 17 " Thumb Screw
 18 " Tangent Screw
 19 " Spring, Not Shown
 20 " Piston, Not Shown
 21 " Cap, Not Shown
 22 Inner Center
 23 Horizontal Circle
 24 Vernier-Plate Clamp
 25 " " Screw
 26 Vernier Plate
 27 " Tangent Bracket
 28 " " Screw
 29 " " Spring
 30 Tangent Spring Piston
 31 " " Cap
 32 Horizontal Vernier
 33 Vernier cover Glass
 34 " Shade Frame
 35 " Glass
 36 Compass cover Glass
 37 Needle
 38 " Pivot
 39 " Lifter
 40 " " screw Head
 41 Front Plate Level
 42 " " Vial
 43 " " Adjusting Nuts
 44 " " " Rocker
 45 Standard With Adjusting Screw
 46 " Adjustable Wye Bearing
 47 " Cap and Screws
 48 Side Level
 49 " " Adjusting Screw
 50 " " Fastening screw

- 51 Side Level Rocker
 52 " " Vial
 53 Telescope Axis
 54 " Barrel
 55 Eye Piece Mounting
 56 Spiral Groove Screw
 57 Terrestrial Eye Piece
 58 Eye Piece Cap
 59 " " Ring
 60 Wire Reticule
 61 " " Adjusting Screws
 62 Pinion and Washer, Not Shown
 63 " Head
 64 " " Screw
 65 " " Saddle
 66 " " Screws
 67 Object Slide
 68 " Head
 69 " Glass cell
 70 " Glass
 71 " slide Dust Guard
 72 Sun Shade
 73 Telescope Clamp
 74 " " Screw
 75 " " Washer
 76 " Tangent Screw
 77 Vertical Circle
 78 " " Guard
 79 " " " Screws
 80 Vertical Vernier
 81 " " " Screws

Fig. 1

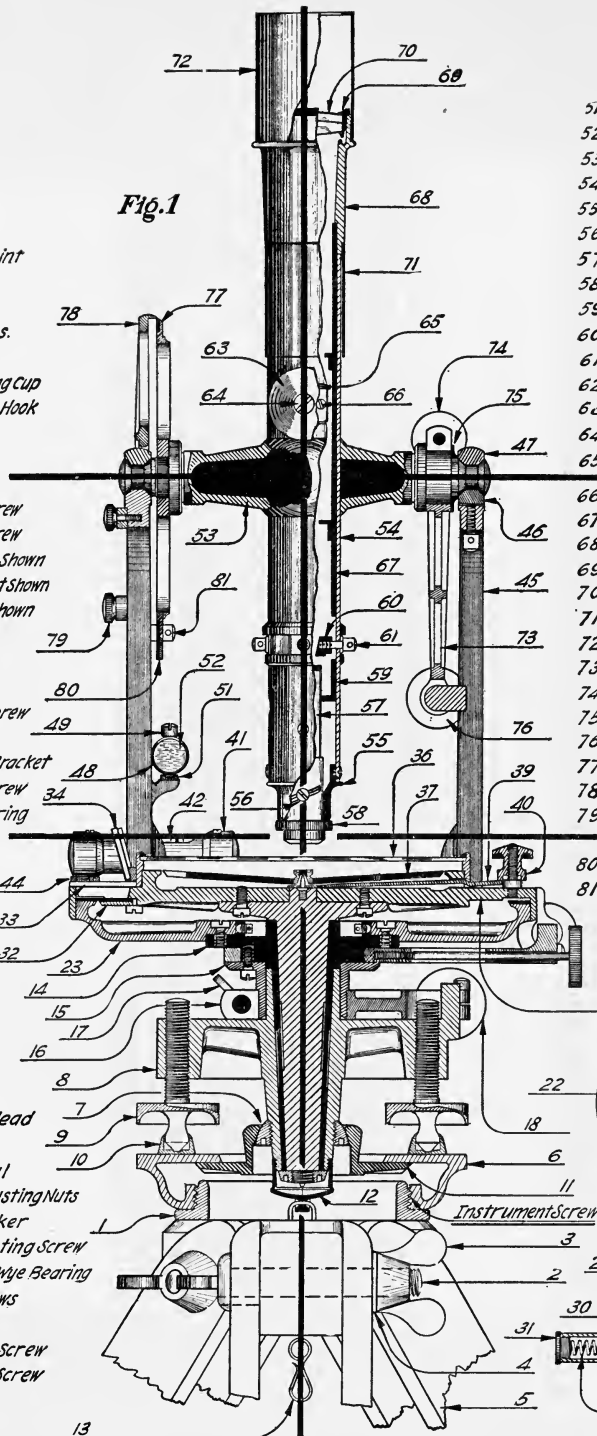
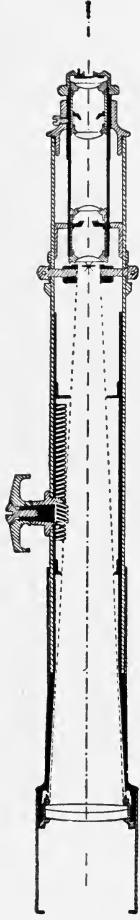


Fig. 2

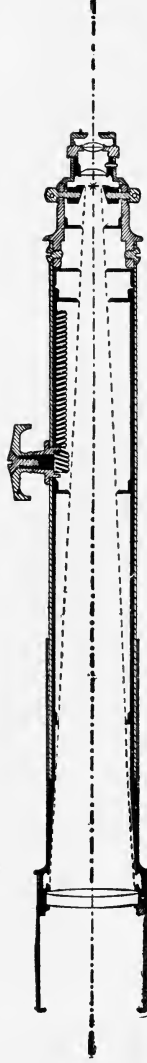
Cross Section of the Berger Transit.

The heavily drawn center line and the two parallel lines drawn at right angles to it in the above cut, indicate conditions required in a perfectly adjusted transit.



Cross section of the Berger Engineer's Transit Telescope with erect image.

Diagram shows the path of a pencil of rays in this telescope.



Cross section of the Berger Engineer's Transit Telescope with inverted image.

Diagram shows the path of a pencil of rays in this telescope.

Description of the Telescope.

THE object-glass is achromatic, being made of two lenses, one of crown and one of flint glass. Both these lenses are made of the celebrated "Jena" glass (introduced about 1885), which has a greater index of refraction and power of dispersion than known before this time. For the most part, that is, whenever the diameter of these lenses is not too large, we — since 1889 — cement them together so as to make one lens only. In so doing the disturbing reflections from their inner surfaces, and the settling of a film between them is prevented, besides securing to the telescope an additional amount of light equal to about 8 per cent. The curvatures are computed from special formulæ, so that the telescope may have the largest aperture possible with a short focal length.

The engineer will appreciate the slightest gain in the diameter of the object-glass, since the amount of light received from any object varies as the square of that diameter. Thus an object-glass $1\frac{1}{4}$ inches in diameter will admit half as much light again as an object-glass one inch in diameter.

The eye-piece, or ocular, as it is sometimes called, is the combination of lenses used in the telescope with which the image formed at the focus of the object-glass is viewed.

The simplest and most commonly used eye-piece in the telescopes of instruments of precision, where spider-threads and micrometers are used in making measurements, is the Ramsden astronomical or positive eye-piece. It consists of two plano-convex lenses, commonly of the same focus, placed apart at a distance of two-thirds the focal length of either, the convex sides facing each other. It has the advantage of being placed behind the focus of the object-glass. It is almost free from spherical aberration, and gives a perfectly flat field of view, so that the spider-threads can be seen distinctly throughout their entire length. Unfortunately it is not entirely free from chromatic aberration, that is, not strictly achromatic, and therefore the Kellner and Steinheil eye-pieces are frequently preferred, as in them the chromatic aberration is sensibly eliminated, so that a bright object viewed with a normal eye will appear achromatic, a condition as important in the eye-piece as in the object-glass.

The Kellner eye-piece, also, consists of two lenses. The one nearest the eye, or eye-lens, is a compound lens composed of crown and flint-glass, as in the objective. Both are cemented together so as to make one, to prevent loss of light consequent upon a ray passing from one substance into another. In its common form the eye-lens is plano-convex, with the plane side nearest the eye, while the second or field-lens is double-convex.

In the Steinheil eye-piece both lenses are compound, as in the eye-lens of the Kellner. The parts of each lens being cemented together, they form two double-convex lenses, and therefore it may be designated as an achromatic double eye-piece. There are some deviations in the construction of the three eye-pieces mentioned above, but mainly as to the proper curvature of the lenses and their proper distances apart, depending as they do on the index of refraction and power of dispersion of the glass used in the construction of the object-glass and eye-piece, but the principle as above explained, by which an achromatic image is obtained, underlies all of them.

The Ramsden eye-piece is generally preferred on account of its greater simplicity and its flat field of view, which latter condition is more difficult to be obtained with the Kellner and Steinheil eye-pieces in powerful telescopes of limited length, on account of the somewhat larger field of view possessed by these eye-pieces. Moreover, the compound lenses are liable to be affected after a while by opacities caused by a crystallization, as it were, of the cement uniting the parts composing them.

Objects seen through the above-mentioned eye-pieces are, however, inverted, and telescopes so constructed are often objected to on this account. It nevertheless is the most proper telescope to use where fine telescopic measurements must be made, as the image is more brilliant than when the objects are shown upright, and it requires but little practice to get accustomed to its use. The inverting telescope has some other advantages that should be mentioned here. The eye-piece being shorter, an object-glass of greater focal length is obtained in the same length of telescope, thereby favoring the conditions imposed to secure the best definition where the telescope must be short and powerful. Any increase in the focal length of an object-glass adds to the magnifying power in the direct way, without entailing the loss of light consequent upon the use of an eye-piece made unduly powerful. On the other hand, an increase in the magnifying power of the eye-piece magnifies the least imperfection that may exist in the object-glass, and makes the cross-wires appear too coarse.

In practice, however, many engineers prefer the erecting or terrestrial telescope. Such telescopes must be made with an eye-piece consisting of four lenses, as by adding two more lenses, objects are shown right side up, as viewed with the naked eye. In the construction of an erecting eye-piece the chromatic aberration can be corrected by the two additional lenses required to secure an upright image; but in the case of short and powerful telescopes the difficulties presenting themselves to secure a perfectly flat field of view are very great, and recourse must often be had to a compound lens. In the Kellner terrestrial eye-piece the third lens, reckoning from the eye, is therefore compound, and both parts are cemented together.

The Huyghenian eye-piece is used to a very limited extent in the more modern telescopes of instruments of precision. It is most frequently met with in the large telescopes used in physical astronomy, where objects are merely viewed, but no measurements made. The field of view is large, but not quite flat. The amount of light is greater than in the other eye-pieces. The eye-piece consists of two plano-convex lenses with their convex sides facing the object-glass. The main features are, that in this eye-piece the second lens is placed between the object-glass and its focus, and that it brings the image to a focus at a point half-way between the two lenses of the eye-piece. The focal length of the second lens is three times larger than that of the eye-lens, and they are placed apart at a distance equal to one-half their combined focal length. The image is viewed by the eye-lens. It is called a negative eye-piece, because the image is formed at a point between the lenses.

The magnifying power of a telescope must be proportional to the aperture. If the magnifying power is too high for the aperture, ordinary objects will appear too faint; and if the magnifying power is too low, the objects will appear so small that the engineer cannot point upon them with sufficient accuracy.

The magnifying power should be such that the least perceptible motion of the bubble of a level, or change in the reading of the verniers, should cause sufficient movement of the cross-wires over the object in the field of view to be readily noticeable. A higher power than this is worse than useless, since objects are less brilliant.

A lower power would not develop the full capacities of the instrument. We adapt, therefore, the magnifying power and aperture of our instruments to the sensitiveness of the levels, and the fineness of the graduation.

In our telescopes the main tube has a much smaller diameter than is usual in proportion to the size of aperture. This is accomplished without cutting off any light derived from the object-glass, since the pencil of light within the telescope is continually diminishing in diameter until it comes to a focus at the plane of the spider-lines. The danger of an increase of reflections caused by bringing the interior surface of the telescope-tube nearer to this pencil of rays is neutralized by the introduction of several more diaphragms properly placed, and by the use of a specially dead black coating for the interior. By this method of construction the weight of the telescope is greatly reduced compared with the large apertures used by us, and therefore there is less wear on the horizontal axis of revolution, and less friction of the object-slide. There is, also, on this account, less surface exposed to the wind, and the instrument is consequently more steady.

Concerning Apertures which are Abnormally Large in Proportion to their Focal Length, for the Telescope of Transits and Levels.

Having shown in the preceding article the value of the large apertures adopted for the telescopes of the instruments enumerated later in Part II, it seems but natural, in the desire to gain additional light, for those unacquainted with the construction of these telescopes to suggest an increase in the aperture of an object-glass given with a particular length of telescope and size of instrument,—that is, to wish to go beyond what in best practice must be considered the limit in diameter of aperture for a given focal length. Good practice allows a ratio of from 1 : 10 to 1 : 12, — meaning that an object-glass one inch in diameter should have a focus of from 10 to 12 inches to insure good light, sharp definition and giving the natural magnifying power of the telescope and not one obtained by applying a too powerful eye-piece and causing undue loss of light.

In order to reduce the size and weight of field instruments and make them more portable and efficient, modern practice has been to reduce this ratio very considerably by adopting as short a focal length as possible, and since the length of telescope is the chief factor in determining the size of an instrument, as will be seen by an inspection of the various instruments listed later on in this catalogue, the resulting optical and mechanical conditions involved are of a most difficult and strained character. Were these instruments designed merely for viewing objects, as in case of binoculars, opera glasses, etc., or for observing stars (which requires no change of focus), so that a short focussing slide would be sufficient, the construction would be a comparatively easy task; but since these instruments are designed for purposes of engineering and surveying, where angles between sighting poles and heights of measuring rods must be read at distances which vary from 5 feet to infinity, involving a continual change of the focussing slide, it is of the utmost importance that this slide-tube be of a length which is not only proportional to its diameter but also sufficiently long to insure an accurate movement in a straight line coinciding with the optical and the geometrical axes of the telescope, since any deviation in the motion of the slide-tube from a true straight line, whether caused by an insecure short slide or by wobbling or fretting due to too much weight at the object end, will directly affect the position of the line of sight and produce inaccurate results.

Abnormally Large Object-Glasses.

The foregoing will show some of the difficulties attending the construction of short telescopes having the largest apertures permissible for surveying instruments. These difficulties are much greater where a short telescope has an abnormally large object-glass. In order to accommodate the cone of light in this case the outer tube has to be greatly enlarged and consequently the focussing slide is then too short and out of proportion to its diameter, and the greater weight attached to it such that it cannot be depended upon for precise work. Furthermore such telescopes make an instrument top-heavy, enormously increase the wear on the centers and on the axis of revolution of the telescope, and greatly add to the surface exposed to wind pressure. To overcome some of these defects the focussing slide is often placed at the eye-end of the telescope for certain classes of work where the conditions are more favorable, but this is impossible in the regular engineers' transits, since the eye-piece must always reverse through the standards, and this cannot be done when the slide is drawn out for short distances.

So far only the mechanical features involved in this subject have been discussed, but it may not be amiss to mention that a telescope with an abnormally large aperture and having an abnormally short focal length very frequently lacks that sharp definition that a smaller object-glass will give. Therefore it is at least questionable whether an abnormally large aperture has sufficient advantage over the usual large aperture to warrant sacrificing the longer object-slide, its greater precision and magnifying power that are obtained when the focal length and the aperture have their normal relation. It should be mentioned also that the special kind of glass required for the largest objectives has not great power to resist the effects produced by moisture in the air, moisture from the fingers, etc., to which it is liable to be exposed in field work.

Hence it follows that the use of such abnormal apertures should be restricted to instruments for tunnel details or to plane-table alidades. In all cases where larger apertures are desired, larger instruments with longer telescopes should be chosen, so that the relation between focal length and aperture may be kept the same, and sharp definition, good light and high power thus insured. For if, in a telescope of short focal length, high power is secured by means of the eye-piece, the difficulty in focussing the wires becomes very marked, and is likely to become a source of annoyance, especially in the case of the very short eye-piece used in inverted telescopes. Furthermore such eye-pieces also magnify every imperfection of the object-glass as well as of the cross and stadia wires. This makes it difficult to procure wires of sufficient fineness, and the increased danger of their breaking makes their use almost prohibitive.

The Pancratic, or Changeable Power Eye-piece for the Erecting Telescope

This feature, long in use in commercial articles such as field-glasses, binoculars, etc., can be applied, in case of surveying instruments, to eye-pieces of erecting telescopes only, and is then desirable only in exceptional cases. Its use in a surveying instrument cannot be considered a distinct gain, since it complicates the mechanism of the telescope—even in its simplest form—by the introduction of a greater number of pieces, besides adding to the weight of the eye-piece. In practical use it requires one more operation than the regular eye-piece, but unless a person is thoroughly familiar with it, not infrequently two more operations are required when focussing on an object. In using it the first operation will be to set the magnifying power, by means of the movable lens, into the first position marked for it; the second, to sharply focus the wires; and the third, to bring the object into view. Whenever the power has been changed, by accident or otherwise, the wires will have to be brought again into focus by moving the whole eye-piece in the usual manner. Owing to the greater complexity of this eye-piece some of the lenses are not readily accessible for cleaning in the field or in the office, so that greater care is required to preserve clearness of vision. These lenses are likely therefore to be coated with a film after exposure, thus defeating the very object for which they are designed, viz., to give additional light by the use of a low power. Moreover, when applied to a transit the focal length of the object-glass has to be shortened by about one-half inch, thereby directly lessening the power unless the height of the standards be increased, which of course makes the instrument more top-heavy.

These are distinct disadvantages in a telescope. The power chosen for the telescope of a field instrument is generally the one best fitted for it and therefore should be permanent. To make it changeable in order to reduce this power lessens the degree of accuracy with which a measuring telescope can be pointed at a distant object, and will thwart the intention of the maker, who harmonized the power of the telescope with the sensitiveness of the levels and reading of the graduations. So, to reiterate, it is the discerning power of a telescope, obtained by a normal aperture combined with a sharp definition and high magnification of the object, that will make it possible to quickly and accurately read graduated rods and see staffs at great distances. A low power, therefore, would not reveal the capabilities of the instrument, and on this account the desire is more often expressed to increase the normally large power as explained above in order to read close at long range rather than to have it lessened.

The aim of the makers is to keep surveying instruments simple in design and free from incumbrances, so that the observer's whole attention may be given to the work before him. While we do not recommend the use of these variable power eye-pieces, when desired they can be applied to the larger size transits and levels when made to order.

The Graduations.

Engineers' transits have various graduations on their circles, according to the requirements of the different branches of civil engineering. These various graduations are read by opposite verniers, which may be either single or double. American instruments have usually double opposite verniers, commonly reading the circle to single minutes or to thirty seconds. For a higher grade of work, required in the larger cities and on extended land surveys, they should, however, read to twenty or ten seconds according to size of circle.

Transits intended for triangulation should have only single opposite verniers and one row of figures clockwise from 0 to 360°.

All instruments desired with graduations differing from those specified in this catalogue under each style and size, will be made to order only.

The customary graduations of C. L. Berger & Sons' instruments are as follows:—

The circle divided to	half degrees,	the verniers reading to	single minutes,	see	Fig. 1.
" " " "	twenty minutes,	" " "	" thirty seconds,	"	Fig. 2.
" " " "	fifteen minutes,	" " "	" twenty seconds,	"	Fig. 3.
" " " "	twenty minutes,	" " "	" twenty seconds,	"	Figs. 4, 5 and 6
" " " "	ten minutes,	" " "	" ten seconds,	"	Fig. 7.

To express the relation between the vernier and circle divisions, let d = the value of one division of the circle; d' = the value of one division of the vernier; $d - d'$ = the least count of the vernier, or, in other words, the smallest reading of the circle. n = the number of spaces of the vernier which correspond to $(n - 1)$ spaces of the circle.

We then have the three formulas;

$$(1.) \quad n = \frac{d}{d - d'}$$

$$(2.) \quad d' = \frac{n - 1}{n} d$$

$$(3.) \quad d - d' = \frac{1}{n} d$$

Thus, for example, suppose the circle was divided to $15'$, and it was desired to read to $20''$. Here, $d = 15'$
 $d - d'$, or, the least count = $20''$

Then, by formula (1)

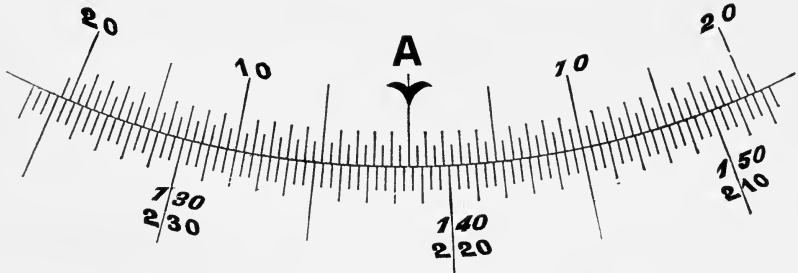
$$n = \frac{15'}{20''} = \frac{15 \times 60''}{20''} = 45$$

Therefore, 45 spaces of the vernier must correspond to 44 or $(n - 1)$ spaces of the circle.

Suppose again the arc to be divided to $20'$, and to be read to $30''$. In this case we have

$$n = \frac{20 \times 60}{30} = 40$$

Therefore, 40 spaces of the vernier must correspond to 39, or $(n - 1)$ spaces of the circle. These are the graduations which Messrs. C. L. Berger & Sons usually adopt for engineers' transits.



The cut shows a portion of the circle and vernier, to illustrate the method of reading to thirty seconds.

The lines marked 130, 140, and 150 denote 10° each. The shorter lines half way between them denote 135° and 145° . The next shorter lines denote whole degrees, while the shortest lines are one-third of a degree, or $20'$ apart.

The vernier comprises the upper series of lines. Of this series only that half lying to the right of the vertical arrow, or zero, and having the figures 10 and 20 inclined in the same direction as the 130, 140, and 150 of the arc, is to be used in connection with these figures. The vernier is double,—one half to be used with one set of graduations of the arc, the other half to be used when angles are laid off in the opposite direction, and then the lower set of figures, 210, 220, and 230 are used.

It is to be especially remembered that the figures on the vernier are inclined in the same direction as the figures on the arc to which they belong.

To read the vernier, first note the whole degrees, and $20'$ spaces lying between the last 10 degree division and the zero division of the vernier.

Thus in the cut, using the upper line of figures, the zero of the vernier has passed

the 130° division, and moved on until it is between the 20' and 40' space beyond the 138° mark. The first part of our reading will therefore be 138° 20'.

Second, look along the vernier, beginning from the zero point, and in the direction in which the graduation of the arc runs, until one line of the vernier is found which seems to be a prolongation of an opposite line on the arc.

Consider each of the vernier spaces between the vernier zero and such a line, as equal to 30" of arc.

Add the number of minutes and seconds thus obtained to the first reading. The result will be the reading of the circle.

Thus we notice that the vernier zero is a trifle over half-way of the distance between the 20' and 40' marks of the arc.

And looking along the vernier to the right, we notice that the lines of the vernier gradually approach the lines on the arc until the twentieth line of the vernier is precisely opposite a line on the arc. Of course, since each vernier space denotes 30", the alternate ones made a little longer in the cut will denote single minutes, and on the vernier therefore the twentieth line would correspond to 10' 00", and since our first reading was between 20' and 40', this vernier reading is to be added to that first reading.

Thus,	138° 20'	
	10' 00"	
	138° 30' 00"	will be the reading of the vernier,
		using the <i>upper</i> graduation.

In the same manner we proceed to the *left* in reading the lower graduation, in which the figures are inclined to the left. Thus in the cut, we should find the zero point of the vernier is beyond the 221° 20' mark, and the line of the vernier, which is seemingly a prolongation of a line of the arc, corresponds to 10' 00". Then we have

	221° 20'	
	10' 00"	
	221° 30' 00"	for the reading of the vernier, using
		the <i>lower</i> graduation.

Practically, in reading the vernier, the engineer decides which line is in coincidence by the position of the lines on both sides.

He first notices, roughly, what fractional part of a space on the limb lies between the vernier zero and the last graduation mark it has passed. This enables him to look immediately to that part of the vernier in which the coincidence occurs.

Thus in the figure the vernier zero is about half way between 221° 20' and 221° 40', the engineer therefore immediately looks about half way along the vernier and finds the 10' 00" division to be the one sought.

When the graduation is to thirty seconds, the engineer will find that if he only chooses, he can work to minutes with this graduation quite as rapidly as with a transit graduated to minutes, by simply disregarding the shortest lines of the vernier.

The second vernier, which is distant 180°, or exactly opposite the one read first, may also be read. Not so much to eliminate any eccentricity of the circle and verniers as to afford a valuable check upon the angle measured.

Greater accuracy in the measurement of any angle may be obtained by the principle of repetition. In this case, before and after an angle has been repeated a number of times, all four of the verniers should be read, and if, for example, the graduations proceed from right to left, the left hand side of each double vernier should be read as usual; but in the right hand side the line now marked 20 on the vernier should be considered 0, and the arrow on the vernier 20. Then, with this convention, only the minutes and seconds of the second vernier should be used.

But it should be here remarked that the repetition of angles is not now held in such repute by our best engineers, as it was before the present perfection of the art of graduating and centering the circles and verniers of engineering instruments.

The engineer who has not used them will find the ground-glass shades a great convenience in reading the vernier. They are so placed as not to be readily broken, and they shed a clear, white light upon the graduations.

Graduations on solid silver are much to be preferred to graduations on any known brass alloy. The surface of the silver can be worked very plane, since it is of uniform texture. The graduations can be cut with the utmost uniformity in width of line and spacing.

The graduations on a BERGER Transit are not mere scratches on German Silver; they are extremely accurate, have great depth of line, and are clearly cut and on 925/1000ths Sterling Silver, being easily read, even in a faint light; the lines are of just the proper length so as not to be fatiguing to the eye.

The figuring of the circles and verniers is unusually distinct.

The Customary Graduations of Circles and Verniers for C. L. Berger & Sons' Instruments.

Figures 1, 2, 3 and 4 illustrate graduations in which the horizontal circles have two rows of figures, from 0° to 360° , in opposite directions. The figures in the main row nearer the vernier increase clockwise, and in the other row increase in the opposite direction, so that angles may be read rapidly in either direction. Other figuring, such as 0° to 90° to 0° , 0° to 180° to 0° , will be made when specially ordered.

The vertical semicircle is figured from 0° to 90° in either direction for reading angles of elevation or depression, and the full vertical circle from 0° to 90° to 0° . For astronomical work the vertical circle will be figured clockwise from 0° to 360° when specially ordered.

Whenever a change is desired from the customary figuring, as given below, a diagram should be sent with the order.

The size of circle appropriate with the various graduations and verniers will be found in the description and extras of instruments in the catalogue and are the ones recommended. A larger size of circle than the one enumerated with the instrument would often prove of no value, while a smaller size may prove fatiguing to the eye to read.

The cuts below represent a graduation on a circle 13 inches in diameter.

Graduation Reading to Minutes.

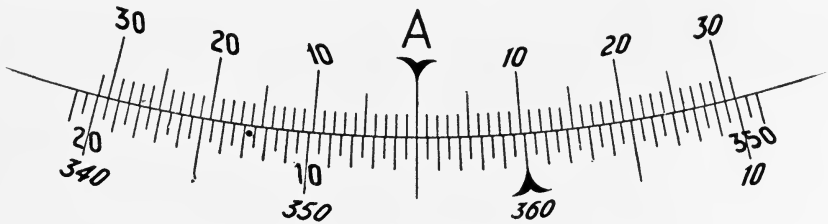


Fig. 1.

Fig. 1. Circle divided into $30'$ spaces.

Double Opposite Verniers to Horizontal and Vertical Circles, also for arcs (29 spaces into 30) reading to single minutes.

Note.—Sometimes when for want of space in some particular type of instrument a single reading folding vernier must be applied to a circle figured in opposite directions the single vernier has its zero point in the center and extends $15'$ each way. In reading this vernier, proceed to the right or left on the upper row of figures in the direction of the graduation used, and if the coincident line is not found before reaching the $15'$ line, continue on the lower line of figures on the other half of the vernier, so that the whole graduation from $0'$ to $30'$ lies in the same direction.

Graduation Reading to $30''$.

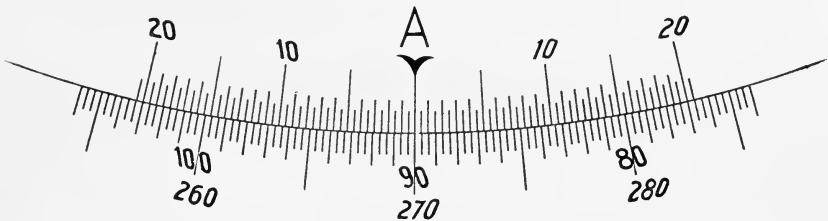


Fig. 2.

Fig. 2. Circle divided into $20'$ spaces.

Double Opposite Verniers to Horizontal Circle (39 spaces into 40) reading to $30''$.

Graduation Reading to 20".

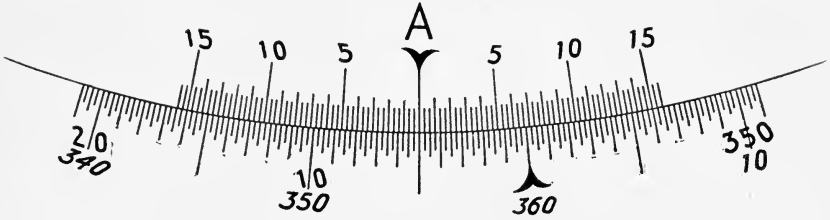


Fig. 3.

Usual Style of 20" Verniers for the Engineer's Transit.

Fig. 3. Circle divided into 15' spaces.

Double Opposite Verniers to Horizontal Circle (44 spaces into 45) reading to 20".

Note.—In figure 3 the lines on both the circle and the verniers are considerably closer than in those of figure 2. For this reason it will be seen that this graduation is more fatiguing to the eye to read. However this form is the only feasible one for the vernier opening when two rows of figures with zero in center of vernier are required, as in general engineering work where angles are to be read rapidly to right and left. For the best vernier for triangulation transits see figures 4 and 5.

Graduation Reading to 20".

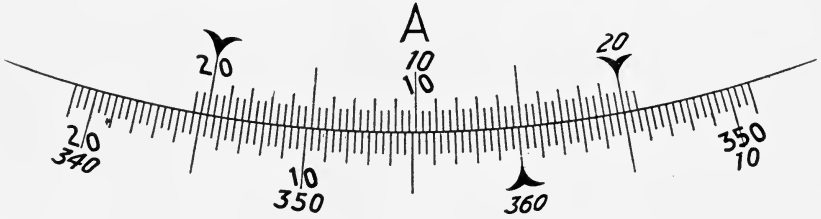


Fig. 4.

For the Engineer's Transit intended for Triangulation. Made to order only.

Fig. 4. Circle divided into 20' spaces.

Single Opposite Verniers reading to 20" (59 spaces into 60); two zero points to Verniers; two rows of figures.

Note.—This vernier has wider spacing on the circle and on this account is more easily read to 20", but has the disadvantage that when an engineer wants *double* opposite verniers, as shown in the verniers Figs. 1, 2, and 3, the opening of the vernier plate would have to be twice as long and therefore too large for the superstructure of the instrument. It is desirable in such cases where an engineer wants a 20" graduation on above limb with two rows of figures to provide verniers with *two* zeros, one at each end, as shown above, necessitating the inconvenience of first shifting the vernier plate from one zero to the other before angles can be read in the opposite direction.

This difficulty may be avoided, however, by using the 10' mark on the vernier as the zero point and reading angles in either direction as explained under figure 6.

Graduation Reading to 20".

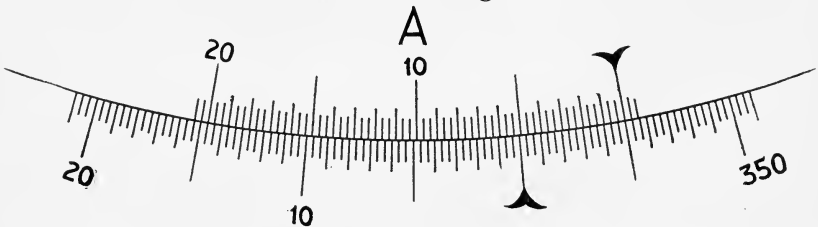


Fig. 5.

Usual Style Vernier for Transits intended for Triangulation.—Made to order only.

Fig. 5. Circle divided into 20' spaces.

Single Opposite Verniers reading to 20" (59 spaces into 60). One row of figures.

Graduation Reading to 20'.

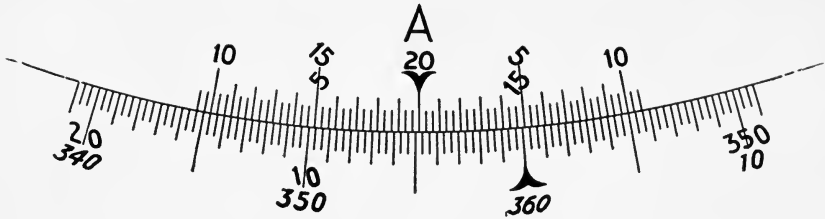


Fig. 6.

Folding Vernier. Made to order only.

Fig. 6. Circle divided into 20' spaces same as Nos. 4 and 5.

Single Opposite Verniers having one zero point in center with two rows of figures.

Note.—With this style of single vernier angles may be read to left or right. If angles are being read clockwise start with the zero point under A and continue to the left until the 10' mark is reached, then if no coincidence is found, continue by taking the 10' mark at the opposite end of the vernier (right end) and reading toward the 20' mark. In reading angles in the opposite direction use the figures which slope toward the right.

Graduation Reading to 10'' (on a 7 or 8-inch Circle).

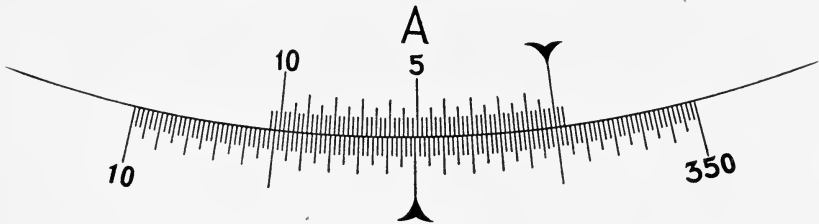


Fig. 7.

Usual Style of Verniers for Triangulation.

Fig. 7. Circle divided into 10' spaces.

Single Opposite Verniers reading to 10'' (59 spaces into 60).

Whenever desired double opposite verniers can be furnished, with two rows of figures on limb from 0° to 360° in opposite directions.

Note.—In cases where less weight and greater compactness and portability of instrument are desirable, as in instruments often furnished to the Government for use in mountains and in the tropics, a 10'' graduation can be placed upon a 6¼ inch circle. The spacing however is very close, and while this size of circle will give almost equally as accurate results, its reading must necessarily prove more fatiguing to the eye.

Graduation Reading to 5'' on 8-inch Circle.

Sometimes it is requested to graduate an 8-inch circle to read to 5'' direct, when the circle will be divided into 5' spaces and the vernier 59 spaces divided into 60 parts. As a rule this graduation is not desirable for vernier instruments on account of the close spacing on circle and verniers which of necessity must prove inconvenient in usual engineering practice because of its greater liability to error in reading.

Decimal Vernier Graduation.

For railroad work it is sometimes requested to graduate vernier **A** to read to minutes or $30''$, as usual, and vernier **B** to read to $\frac{1}{100}$ th of a degree.

If the circle is to read to minutes, vernier **A** will be as shown in figure 1. A decimal vernier for this graduation requires 49 spaces of the circle to be divided into 50 parts on the vernier, making a very long vernier, so that there is only room for a single vernier in the opening of the vernier plate. This vernier would either have two zero points as in figure 4, or would have the zero at the center, as shown in figure 6.

If one vernier is to read to $30''$ and the other to $\frac{1}{100}$ th of a degree, the circle would be divided into $15'$ spaces, and the **A** vernier would be as shown in figure 9. The decimal vernier for this graduation requires 24 spaces of the circle to be divided into 25 parts on the vernier as shown in figure 8.

The disadvantages of such graduations are, first, that the spacing of the circle is too close for rapid reading, and second, that mistakes are liable to be made in reading the verniers by confusing the $30''$ reading of vernier **A** with the $\frac{1}{100}$ th of a degree of vernier **B**. Another disadvantage is that when it is desired to read both verniers, **A** and **B**, as in repeating angles, this cannot be conveniently done with either of the above arrangements. For these reasons the two verniers **A** and **B**, should have the same graduation.

There are occasionally inquiries for transits provided with decimal vernier graduation. These can be furnished when desired, but must be specially made to order. On account of the great length of the double vernier, single opposite verniers of the folding pattern (fig. 6) are the only feasible ones. Although objections are often raised against them, still many engineers like folding verniers after becoming accustomed to them.

Decimal Vernier Graduation.

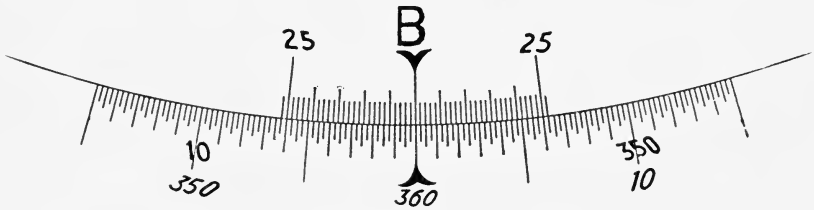


Fig. 8.

Fig. 8. Circle divided into $15'$ spaces.

Double vernier (24 spaces into 25) reading to hundredths of a degree.

Graduation Reading to $30''$.

On same limb with **B** vernier to read to 100ths of a degree as in Fig. 8, and **A** vernier reading to $30''$.

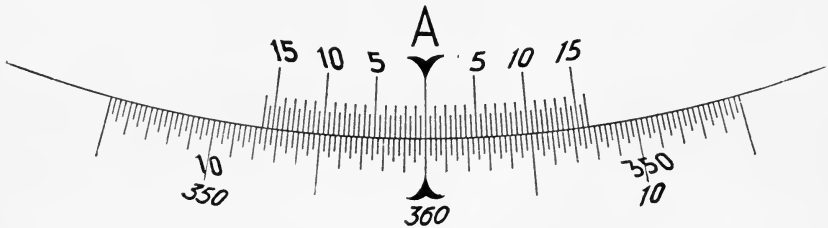


Fig. 9.

Fig. 9. Circle divided into $15'$ spaces.

Double vernier **A** (29 spaces into 30) reading to $30''$. **B** vernier reading to 100ths of a degree.

This vernier is not commonly used, but has the advantage that the double vernier occupies only a short space.

Graduation Reading to Hundredths of a Degree.

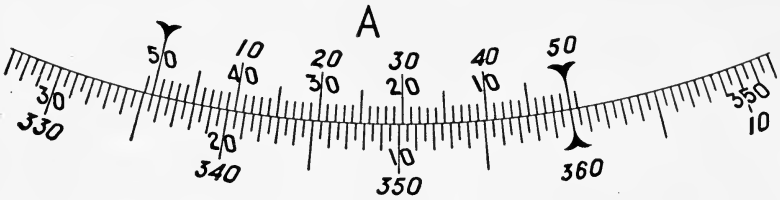


Fig. 10.

Fig. 10. Circle divided into 30' spaces.
Single vernier (49 spaces into 50) reading to hundredths of a degree.

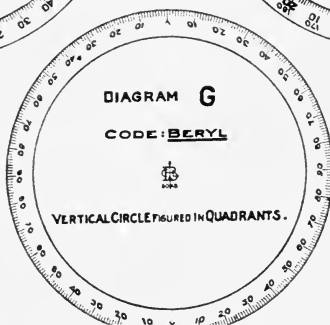
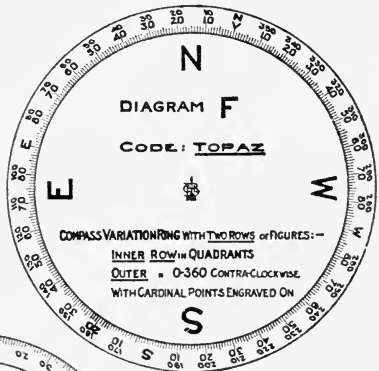
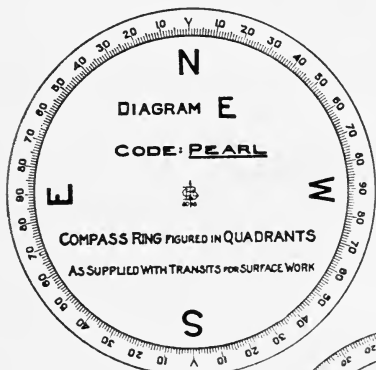
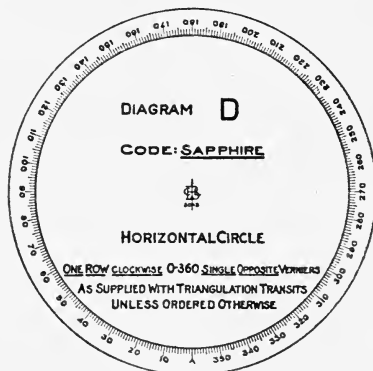
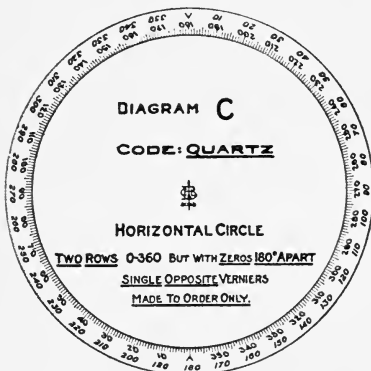
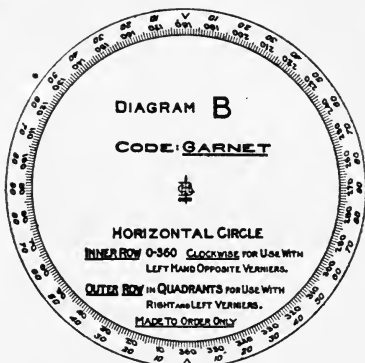
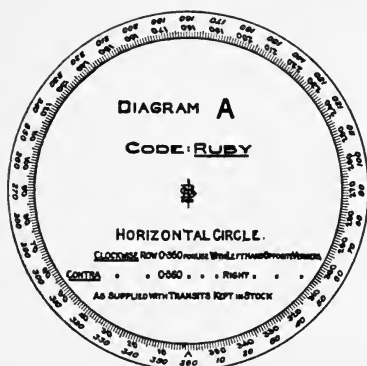
Two Zero Points to Verniers ; Two Rows of Figures.

Inclination and Color of Figures for Graduations.

All of the double verniers shown above require the limb to be provided with **two sets of figures in black**, as indicated in the diagrams and further illustrated in the diagrams of the various limbs on the following page. **To prevent mistakes, the figures of each row are inclined in the direction in which the verniers must be read.** It will be noticed that the figures above are inclined only enough to easily distinguish each row from the other. If the figures are inclined at too great an angle their distinctness would be impaired and considerable difficulty would be experienced in reading them correctly, and would be apt to lead to gross errors. The shape of the above figures is very plain, so as to stand out clearly. If desired, the figures of the contra-clockwise row, with the figures of its corresponding verniers, and those of the vertical circle, can be furnished, without extra cost, in a red color, to further distinguish them from the clockwise graduations. There is, however, no advantage in the red over the black figures, since the latter stand out very plainly on a silver surface, and are very distinct, even after the silver has somewhat tarnished, is soiled, or when the graduations must be read in a faint or artificial light, where the red figures will not show a marked contrast to the black.

If red figures are desired, the code word "**Reddish**" must be used, and such Transits will have to be especially made, not being kept in stock.

Figuring of Graduations.



The Centers.

Quite as important as the graduation, is the exact fitting of what the makers call the *centers* of the instrument; *i.e.*, the two vertical metal axis, about which the circle and the vernier plate turn.

Both axes must be exactly concentric with the center of the graduated circle, and the center of the horizontal axis of the telescope in any position of the instrument. The most sensitive level about the instrument should not show any displacement when the circle-plate is held, and the lower plate moved by the hand.

In the construction of the inner center, the hardest bell-metal should be used, and for the outer center a red composition metal of the best quality. To insure a true concentricity of the axis, and consequently of the limb and vernier, it is necessary that they should each be turned in a dead center lathe, each about its own axis. In fitting the centers, they should turn without the slightest play, and yet with very little friction.

We take the precaution of casting the outer center, circle and vernier plate in the same mould, to avoid any difference in the composition of the metal.

The upper plate should not be hammered, since this would also effect an unequal expansion of the metals in extreme temperatures, causing the vernier to read too long or too short.

After the plates are put together, the vernier and limb should revolve in the same plane, to avoid parallax. The space between the limb and vernier should have the appearance of a uniform, fine, black line.

The Compass.

In running old lines, and as a check in running new ones, the compass is frequently a very important part of the transit. Its needle should be tempered throughout, and of hard steel, to retain its magnetism. It should be thin, and yet at the same time have enough surface to be strongly magnetic. It should be swung upon a jewelled center, and so nicely fitted that when at rest, with the instrument levelled, the two extreme points should just clear the graduation of the compass box, and read precisely 180° different in any part of the graduated arc. The pivot on which it swings should be conical, and hardened so that it may swing upon a sharp point, without having this point weak.

The needle should also be so sensitive, that when drawn from its pointing by the outside attraction of a piece of iron held in the hand a foot or so away, it will settle to the same reading several times in succession.

This sensitiveness depends upon the form and sharpness of the pivot, the strength of its magnetism, and its bearing on the jewelled center.

If it should be found that a needle has lost its sensitiveness, it is probably not so much owing to its loss of magnetism, as to a dulling of the pivot. Since this may happen when the engineer is without access to the maker, and an instrument otherwise be in good condition, it should be remarked that the pivot can be sharpened after removing the needle, by taking a fine oil-stone, and while turning the instrument with one hand, grinding the pivot, with the oil-stone in the other; being careful to incline the grinding surface about 25° to the pivot. The pivot is originally turned and sharpened in a lathe, and in grinding by hand, great care should be taken to preserve its conical form.

The two extreme points which lie next the graduation, together with the point of suspension, should lie in one straight line.

The center of gravity of the needle should be as far below this line as possible.

The quivering of a needle so constructed is not annoying, since the center of its quivering motion is in the line through its two extreme points, which are, therefore, stationary.

To determine whether the transit itself has any iron in it to disturb the needle, it is a good plan, after setting the instrument so that both compass-needle and vernier reads 0° , to go round the circle, setting the vernier ten degrees ahead each time, and noting whether the compass-needle also describes an arc of precisely ten degrees. If it does not, there is some local attraction.

The graduations on the compass box should begin at the North point, and run 90° in both directions; then decrease to 0° again at the South point. In mine transits a second continuous row from 0° to 360° starting at North is placed on the compass ring. Other figurings are made especially to order. In order that the needle reading may indicate the direction of the telescope, the line joining the zeros of the ordinary compass ring must be in the same vertical plane, with the

line of collimation of the telescope; and the letters denoting the cardinal points, East and West, must be transposed; *i. e.*, when the letter N is towards the North, the letter W should be towards the East. Of course the needle indicates magnetic north, and in the case of instruments unprovided with means of setting off the local variation of the needle, all the readings of the needle must be corrected for this local deviation.

If the transit is provided with a variation plate and it is desired to set off the variation by means of the horizontal plate closer than half and quarter degrees — say to minutes — this can be done on the horizontal circle. The verniers of the Transit are set at zero of the graduation and clamped. The zero of the variation ring must also be made to coincide with the stationary pointer. The needle is then released and when at rest the zeros of the variation ring must be made to coincide with the needle ends by the lower tangent screw. To set off the variation, the vernier plate clamp is released and the vernier plate turned so that the telescope (pointing North) moves toward the actual East if the variation is West, and toward actual West if the variation is East, until the vernier reads the desired declination on the horizontal circle. The zero of the variation ring is now brought to coincide with the needle ends and the telescope will be pointing to the true North.

If great accuracy is not desired, the variation may be set off directly on the variation ring in the following manner: If the variation is East, move the zero point of the shifting compass ring the amount of variation for the locality toward the astronomical East (or toward the transposed W. point in the bottom of the compass box). Then clamp shifting ring. When the N. point of needle reads 0 on the graduated ring the telescope will then be pointing to the true North. If the declination is West, turn the shifting ring the proper amount toward the astronomical West, or toward E. point in bottom of compass box.

The variation plate of our Transits with yoke standard frame has a rack and pinion motion with a capstan-head-d nut for clamping when in position. To operate it, slightly unscrew the capstan-headed nut at side of milled head, set off the variation, and then again clamp this nut tightly.

Spirit-Levels.

The spirit levels, as regards their sensitiveness, should be in strict keeping with the optical power, and the graduations of the instrument, but the quality should be of the best. A level-bubble should move uniformly over the same distance, when the telescope is made to point on two objects alternately, differing slightly in altitude, by the leveling screws alone. In change of temperature the bubble should lengthen symmetrically from the center; and no matter what its length, it should move quickly, without any of the hitching, which is caused usually by a little dirt introduced when it is filled.

Of the three levels attached to the complete transit, the telescope level is the most sensitive. It should be sensitive enough for ordinary leveling, such as good railroad work. The level in front, or at right angles to the standards, should be sensitive enough to make a line plumb by it to any height; while the third level on the standard is used in leveling up the instrument, and to establish the zero-point for the vernier correctly when vertical angles must be measured.

The test of the fitness of the various levels for the capacity of the instrument should lie in this: that after carefully bi-sectioning an object in the field of view, in such a position of the instrument that all the levels can be read, and then slightly deranging them all with the leveling screws, the bi-section will be accurately made after restoring the levels to the exact position they before occupied, by the leveling screws alone.

Leveling Screws.

Messrs. C. L. Berger & Sons usually cut their leveling screws with 32 threads to an inch provide the usual four screws in opposing pairs. The plates once set firmly apart by tightening two of these screws on the *same side*, the leveling of the instrument is easily accomplished by turning the two screws of an *opposing* pair so that both thumbs shall move toward each other (when the bubble will go toward the right), or both thumbs away from each other, when the bubble will move toward the left. Instruments intended for triangulation, *i. e.*, reading to 10" or less, should however be supported on three, instead of upon four screws. In this case the instrument is rapidly leveled by bringing one level parallel to two of the screws, the other level will now be at right angles to it. Level both levels at the same time by turning one of the screws to which the first level is parallel and the screw which is at right angles to this level. Of course the instrument may now be reversed to guard against non-adjustment of the levels.

Three Leveling Screws versus Four.

To the student of the progress in Engineers' field instruments, the question often presents itself as to the comparative merits of an instrument provided with three, over one having four leveling screws. It should be here remarked that the greater portability existing in instruments provided with four leveling screws still commends itself to all using the more customary class of instruments. However, the finest class of field instruments, requiring spirit-levels corresponding to the fineness of graduation, cannot be advantageously manipulated with four leveling screws. The results thus obtained would be little better than those obtained with a more ordinary instrument. To insure the full benefit of a finer instrument, such as used in triangulation, the maker will prudently apply three leveling screws, mounted on a *basis larger* than is usual in instruments with four screws. So, while four leveling screws have the advantage of greater compactness and less weight three screws have the advantage for closer setting, giving better results. The maker will therefore adapt either the one or the other kind to his instruments as the case may require.

Quick Leveling Attachment.

[For illustration see page 118.]

As all devices of this kind detract more or less from the stability of an instrument, it seems they never have been regarded with much favor by the engineering profession at large. There are cases, however, where the use of such a device, in a mountainous country, or in underground work of a close character, becomes very desirable. Messrs. C. L. Berger & Sons' device, unlike devices of a similar kind forming a part of the instrument proper, consists of a coupling with a ball and socket joint which can be screwed between the instrument and tripod. As this intermediate piece forms no part of the instrument itself it can be readily attached or detached at will, thus adapting the instrument to the circumstances and to the class of work in hand. For this purpose the threads of this coupling or quick-leveling attachment, and those of the instrument and tripod are identical; and as all their transits and levels with four leveling screws are interchangeable on any of their tripods, one such coupling is sufficient for an engineer's outfit. In fact one extra tripod permanently provided with this quick-leveling attachment may be kept ready for occasional use in an office where there are a number of their instruments.

To use this quick-leveling attachment proceed as follows:—Screw it to the instrument, and then screw both to the tripod in the usual manner, taking care that the coupling becomes firmly fastened thereto. Now to operate it, slightly unscrew the instrument from its hold upon the flange of the coupling by means of the milled edges provided for this purpose, and move it approximately into a level plane, then again screw the instrument firmly to the coupling same as before. This being accomplished, move the instrument over the given point on the ground by means of the centering arrangement described later on, and level up carefully by the leveling screws alone. It will be seen that this quick-leveling attachment is operated entirely independent of the leveling screws or centering arrangement. Of course, when this device is to be used for several days in succession, it is not necessary to detach it from the tripod every time the instrument is to be removed. In such cases the instrument only should be detached from the coupling. Whenever it becomes desirable to detach the coupling from the tripod, it can best be performed by allowing the instrument to remain fastened to the coupling, then by taking hold of the milled edge of the coupling unscrew in the usual manner. In cases where the coupling has been permanently attached to a tripod, the small screws connecting it to the tripod head must first be removed.

To secure the greatest possible stability to the instrument, the outside diameter of the hollow hemisphere is equal to the distance between the leveling screws of the instrument; and to secure a smooth and ready action, leather washers are provided in the socket which act against the hemisphere. However, when the instrument is clamped to the flange of the coupling these washers recede, and the metal surfaces are brought into direct contact with each other.

The Gradienter Screw.

This very convenient attachment consists simply in a screw working against the clamping arm suspended from the horizontal axis, and on the opposite side from the vertical arc. A strong spiral spring is set directly opposite the screw, and presses the clamp arm against the end of it. This screw is cut with great care in a lathe. It has a large silvered head graduated into fifty equal parts. As the screw is turned, the head passes over a small silvered scale, so graduated that one revolution of the screw corresponds to one space of the scale.

Obviously then, the number of whole revolutions made by the screw, in turning the telescope through a vertical arc, can be ascertained from this scale. The clamp arm of the telescope has its clamping screw just above the horizontal axis, in the usual manner. When this screw is free, the telescope may be revolved; but when it is clamped, the telescope can only be moved by the gradienter screw, which thus takes the place of the ordinary vertical tangent screw. The screw is cut with such a value of a single revolution, as to cause the horizontal cross-line of the telescope to move over a space of $\frac{1}{100}$ of a foot, placed at a distance of 100 feet, when the screw is turned through one of the smallest spaces on its graduated head; and since there are fifty such spaces on the head, it follows that one revolution of the screw is equivalent to $\frac{50}{100}$ of a foot, at a distance of 100 feet. The numbered graduations on the screw head are then each equivalent to $\frac{1}{10}$ of a foot in 100 feet; and two entire revolutions of the screw would be twice $\frac{5}{10}$, or 1 foot to the 100. It is readily seen that grades can be established with great rapidity with this screw. It is only necessary after setting the gradienter screw to zero, and leveling and clamping the telescope, to move it up or down as many spaces of the head of the gradienter screw as there are hundredths of feet to the hundred, in the grade to be established. Thus, to establish a grade of $1^{\text{st}} 85$, the screw head is turned through three whole spaces of the scale, which corresponds to $1^{\text{st}} 50$, and through three of the numbered divisions, and five of the shortest ones to make up the entire reading of $1^{\text{st}} 85$.

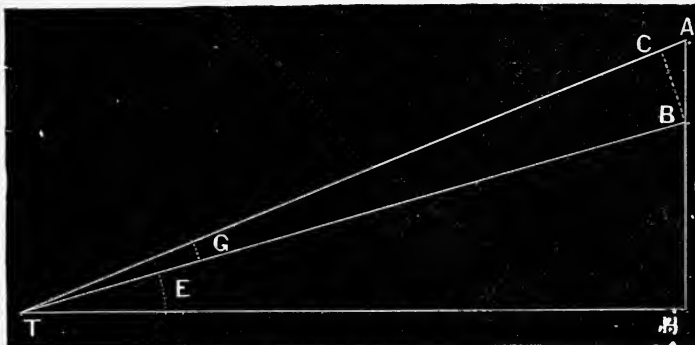
For measuring distances this screw takes the place of stadia lines, and is more convenient; since for any approximately horizontal distance, the space on an ordinary leveling rod expressed in hundredths of feet, included in two revolutions of the screw, will be the number of feet the level rod is distant from the center of the instrument. Thus the difference between two readings of the level rod was $2^{\text{st}} .965$ when the telescope was moved in altitude through two revolutions of the screw. The rod therefore was distant 296.5 feet.

It is unnecessary even that a leveling rod be used. A ranging pole or walking stick, or any arbitrary length which can afterwards be measured, will suffice. Thus a stick, which was afterwards measured and found to be $3^{\text{st}} .38$ long, was found to be subtended by $3\frac{3}{8}$ revolutions of the screw at an unknown distance.

In this case the distance was—

$$\frac{3.38}{1.58} \times 100 = 213.9 \text{ feet.}$$

In case, however, the distance to be measured is not approximately in the same level plane with the transit telescope, it is necessary to compute the distance, from the readings of the rod. In taking such readings at an altitude, it is customary to incline the rod towards the telescope, and by trial find the least space subtended by two stadia lines. A skilful rod-man will *plumb* a rod more readily than he can *incline* it at the proper angle, and a reading of the plumb rod can be taken with greater accuracy, and in less time than with the inclined rod; but it ordinarily involves some additional computing to reduce such vertical readings to horizontal distances. With the view of reducing the computation to a simple multiplication, the following table is appended with the trigonometrical argument on which it depends. The engineer will notice the solution is not rigorously exact, but is sufficiently so for all cases in practice.



In the above figure,

TH = the transit horizontal sight line.

The angle HTB = the angle of elevation of the telescope to the foot of the rod = E.

“ “ BTA = the angle subtended by any number of revolutions of the gradienter screw = G.

AB = the length of the rod included by the angle G, when the rod is vertical = R.

CB is drawn perpendicular to TB.

Then, CBA = BTH = E TAH = 90° - (E + G)

$$\frac{BC}{AB} = \sin \left(\frac{90^\circ - (E + G)}{\sin(90^\circ + G)} \right) = \frac{\cos E \cos G - \sin E \sin G}{\cos G}$$

$$\therefore BC = R (\cos E - \tan G \sin E)$$

$\tan G = \frac{nh}{a}$ where h is the height above a horizontal line, subtended by one revolution of the gradienter screw at a distance a .
 n is the number of revolutions made in any given case.

$$BT = \frac{n}{nh} BC = R \frac{a}{nh} (\cos E - \frac{nh}{a} \sin E)$$

$$\therefore BT = R \left(\frac{a}{nh} \cos E - \sin E \right) \dots \dots \dots I.$$

and

$$HT = BT \cos E$$

$$\therefore HT = R \left(\frac{a}{nh} \cos^2 E - \frac{1}{2} \sin 2E \right) \dots \dots \dots II.$$

Formulas I and II are general formulas for any gradienter screw. In C. L. Berger & Sons' transits the screw is cut and placed so that when $a = 100$, for $n = 2$ and $h = \frac{1}{2}$, by substitution these formulas become,

$$BT = R (100 \cos E - \sin E.)$$

$$HT = R (100 \cos^2 E - \frac{1}{2} \sin 2E.)$$

Where BT = the direct distance from the center of the horizontal axis of the transit to the foot of the vertical rod.

HT = the horizontal distance from the center of the horizontal axis of the transit to the plumb line dropped from the foot of the vertical rod.

R = the space included on the vertical rod by two revolutions of the gradienter screw.

E = the elevation of the foot of the rod above the horizontal sight line of the telescope.

When the angle **E** becomes an angle of depression instead of elevation, then the point **B** is the upper end of the part of the rod used, **AB**. The distance **BT** in this case is the direct distance between the center of the horizontal axis of the telescope and the upper reading of the vertical rod in the valley.

The distance **HT** is, as before, the horizontal distance between the center of the horizontal axis of the telescope, and the plumb line prolonged in this case upwards from the upper end of the vertical rod. The plumb line in all cases coincides with the direction of the rod.

By means of the following table, it is only necessary to multiply the factor opposite the angle of elevation, by the space included upon a vertical rod by two gradienter screw revolutions, to obtain either the direct or horizontal distance of the center of the horizontal axis of the telescope from the foot of the rod; or the same distance from the upper reading of the vertical rod in the case of an angle of depression.

Gradienter Screw Table I.

Factors to be multiplied by the space on the vertical rod expressed in feet and decimals, included in two revolutions of the gradienter screw, to find the distance of the foot of the rod from the center of the horizontal axis of the transit telescope.

Angle of Elevation E.	Factor for the Direct Distance (100 cos E - sin E)	Factor for the Horizontal Dist. (100 cos ² E - ½ sin 2 E)	Angle of Elevation E.	Factor for the Direct Distance. (100 cos E - sin E)	Factor for the Horizontal Dist. (100 cos ² E - ½ sin 2 E)
0			0		
0	100.00	100.00	15	96.33	93.05
1	99.96	99.94	15 30	96.09	92.59
2	99.90	99.84	16	95.85	92.14
3	99.81	99.67	16 30	95.60	91.66
4	99.69	99.45	17	95.34	91.17
5	99.53	99.15	17 30	95.07	90.66
6	99.34	98.80	18	94.80	90.17
7	99.13	98.39	18 30	94.51	89.63
8	98.89	97.93	19	94.22	89.09
9	98.61	97.41	19 30	93.93	88.54
10	98.31	96.81	20	93.63	87.98
10 30	98.15	96.51	20 30	93.32	87.41
11	97.97	96.17	21	93.00	86.83
11 30	97.79	95.82	21 30	92.67	86.22
12	97.60	95.47	22	92.34	85.62
12 30	97.41	95.11	22 30	92.01	85.01
13	97.21	94.73	23	91.66	84.37
13 30	97.01	94.33	23 30	91.31	83.75
14	96.79	93.92	24	90.94	83.08
14 30	96.56	93.48	24 30	90.59	82.43
15	96.33	93.05	25 00	90.21	81.76

In practically applying this table, it is preferable to take the mean of several readings of the rod in each position of the gradienter screw.*

Thus, with the target near the foot of the rod, and then moved to correspond to two revolutions of the gradienter screw, three readings in each position were as follows:

I.	II.
Altitude 18° 20'	
ft. 0.625	ft. 3.380
0.627	3.376
0.625	3.378
Means, . . . 0.626	3.378
	0.626
Difference,	2.752

Factor for direct distance for 18° = 94.80	For Horizontal Distance = 90.17
" " " 18°30' = 94.51	" " " = 89.63
Differences, . . . = 0.29	0.54

Therefore, the factor for 18°20' will be for the *direct* distance 94.80, — $\frac{2}{3}$ of 0.29 = 94.61, and for the horizontal distance, 90.17 — $\frac{2}{3}$ of 0.54 = 89.81.

Then we have, $2.752 \times 94.61 = 260.37 =$ the *direct* distance.
 $2.752 \times 89.81 = 247.15 =$ the *horizontal* distance.

This direct distance being the distance from the position of the foot of the rod or the lower target to the center of the horizontal axis of the telescope,† and the horizontal distance, the one usually desired, that distance reduced to a level line.

The mean value of two revolutions of the Gradienter Screw in arc. is 34' 23". Hence the value in arc of one of its smallest divisions on the head is 20" nearly. Vertical angles therefore may be laid off with facility when they are confined to the range of the screw.

*To insure at all times accurate results, the telescope axis should revolve free, but without any looseness in the bearings. The engineer should examine these bearings from time to time, and, if necessary, fresh and pure watch oil must be applied.

To make a measurement with a micrometer screw, its graduated head should be set back slightly, then bring it up to the readings in the same direction in which the measurement must be effected.

† Should the engineer desire the direct distance between the foot of the rod, and the point over which the plumb-bob is suspended, it may be found by the following formula.

$$x = \sqrt{d^2 + p^2 + 2pd \sin E.}$$

or putting it in a shape adapted for logarithmic computation,

$$x = \frac{(d-p)}{\cos q}. \quad \text{Where } \tan q = \frac{2 \sin \frac{1}{2}(E+90)}{(d-p)} \sqrt{dp}.$$

Where $x =$ the distance from the point under the plumb-bob to the foot of the vertical rod.

$d =$ the direct distance obtained as above.

$p =$ the distance from the center of the horizontal axis to the point under the plumb-bob,

$E =$ the angle of elevation of the foot of the rod, as above.

The subjoined table affords a ready means of expressing any number of revolutions, and parts of a revolution, in arc; and the converse, of degrees, minutes and seconds, in revolutions of the screw:

Gradienter Screw Table II.

To convert a reading of the Screw into Arc.				To convert Arc into a reading of the Screw.			
Gradienter Screw.	Arc.	Gradienter Screw.	Arc.	Arc.	Gradienter Screw.	Arc.	Gradienter Screw.
Rev. Div.	° ' "	Rev. Div.	° ' "	° ' "	Rev. Div.	° ' "	Rev. Div.
0 0	0 0 0	2 0	0 34 25	0 0 0	0 0.0	0 8 00	0 23.5
0 1	0 20	3 0	0 51 35	0 0 10	0 0.5	0 8 30	0 25.0
0 2	0 40	4 0	1 8 45	0 0 20	0 1.0	0 9 00	0 26.0
0 3	1 0	5 0	1 25 55	0 0 30	0 1.5	0 9 30	0 27.5
0 4	1 25	6 0	1 43 10	0 0 40	0 2.0	0 10 00	0 29.0
0 5	1 45	7 0	2 0 20	0 0 50	0 2.5	0 20 00	1 8.0
0 6	2 5	8 0	2 17 35	0 1 00	0 3.0	0 30 00	1 37.0
0 7	2 25	9 0	2 34 45	0 1 30	0 4.5	0 40 00	2 19.0
0 8	2 45	10 0	2 52 0	0 2 00	0 6.0	0 50 00	2 55.5
0 9	3 5	11 0	3 9 10	0 2 30	0 7.5	1 00 00	3 24.5
0 10	3 25	12 0	3 26 20	0 3 00	0 9.0	2 00 00	6 49.0
0 20	6 50	13 0	3 43 30	0 3 30	0 10.5	3 00 00	10 23.5
0 30	10 20	14 0	4 0 45	0 4 00	0 12.0	4 00 00	13 48.0
0 40	13 45	15 0	4 17 55	0 4 30	0 13.5	5 00 00	17 22.5
1 0	17 10			0 5 00	0 15.0		
1 10	20 40			0 5 30	0 16.0		
1 20	24 05			0 6 00	0 17.5		
1 30	27 30			0 6 30	0 19.0		
1 40	30 55			0 7 00	0 20.5		
2 0	34 25			0 7 30	0 22.0		

Thus, the telescope being leveled, the gradienter screw was turned through a space of $11^{\text{rev.}} 23^{\text{div.}}$ required the arc:

$$\begin{array}{rcl} 11 \text{ revolutions,} & = & 3^{\circ} \quad 9' \quad 10'' \\ 20 \text{ divisions,} & = & 0 \quad 6 \quad 50 \\ 3 \quad \quad \quad & = & 0 \quad 1 \quad 0 \end{array}$$

The whole arc, . . . = $3^{\circ} 17' 00''$

Conversely, it was desired to turn off a vertical angle of $4^{\circ} 35' 40''$.

Then we have —

$$\begin{array}{rcl} 4^{\circ} \quad 0' \quad 0'' & = & 13^{\text{rev.}} \quad 48^{\text{div.}} \cdot 0 \\ 30 \quad 0 & = & 1 \quad 37 \quad .0 \\ 5 \quad 0 & = & 15 \quad .0 \\ 40 & = & 2 \quad .0 \end{array}$$

The space on the head of the screw = $16^{\text{rev.}} \quad 2^{\text{div.}} \cdot 0$

The engineer will bear in mind that the examples given are purposely given in detail: that in practice the operations may be mental ones.

It will be seen that the vertical gradienter can be used for a variety of purposes; measuring distances, grades, differences of levels, vertical angles, and is a useful check against errors of rod or chain measurement.

Messrs. C. L. Berger & Sons have also applied the same principle to their horizontal tangent screws. By graduating a silver head attached to these screws subdivisions of one minute of arc are readily made.

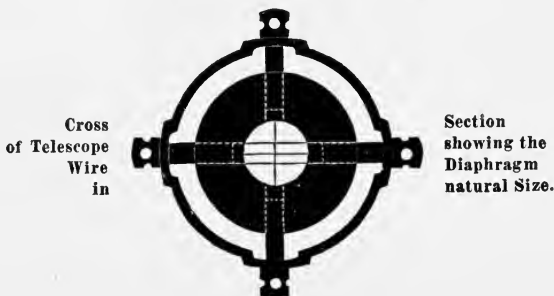
For constant use with these screws it is better to have a rod with two movable targets, or a rod painted with white and black squares as used in the coast survey.

Stadia Lines

The gradienter screw is so universal in its application and can be so readily used for angular, distance or grade measures, that it will generally be found best to have it upon transits designed for current work. There are some cases however where stadia lines are more expeditious in use than the gradienter screw, and give quite as exact results.

Stadia lines, for instance, where an instrument is to be used for distance measures alone, commend themselves for their greater simplicity. For such work, non-adjustable lines, in connection with an inverting eye-piece, give the best results. If the lines are adjustable, in the field usage of an instrument they may alter their distance apart; and there is a rapidity of work with fixed lines, and a rod graduated for telemetrical work, which is not reached in any other way.

These lines may be webs, or platinum, or they may be ruled on glass. The latter are extremely accurate, but the use of them is necessarily limited in the telescopes of field instruments for the following reasons: thin as the glass may be on which the lines are ruled, and intercepting only a small amount of light, yet the film of dampness and dirt soon collecting on it will intercept a great amount of light which in time may become a very serious impediment in the use of the telescope. Another objection to their general adoption consists in the fact that as the image of an object is focussed in the plane of these glass-lines, a portion of the light of the image will become reflected from the polished surfaces of this glass, causing at times a disturbance in the clearness of vision. Besides, this glass-“micrometer,” as placed in most telescopes, is very difficult of access and must needs be removed for cleaning, thereby increasing the liability of becoming broken, or detached from its mounting.



Plumbing and Centering Arrangements.

It now remains to speak of several conveniences of the instrument under consideration. By a simple mechanical contrivance the plumb-bob when suspended from the instrument can be set immediately at any desired height. It is suspended directly from the center of the instrument, and not from the tripod head. This precaution should be taken with every instrument, since otherwise, when there is difficulty in setting up an instrument, and the legs are unsymmetrically placed, the plumb-line will not pass through the center of the instrument.

The instrument is provided with the shifting tripod, better known as the shifting center, by means of which, when the plumb-bob of the instrument is within a fraction of an inch over a point on the ground, it may be brought immediately over it, by moving the body of the instrument on its lower level plate. This is probably the greatest time-saving arrangement which modern makers have introduced in engineers' transits.

Shifting Center for a Transit with Three Leveling Screws.

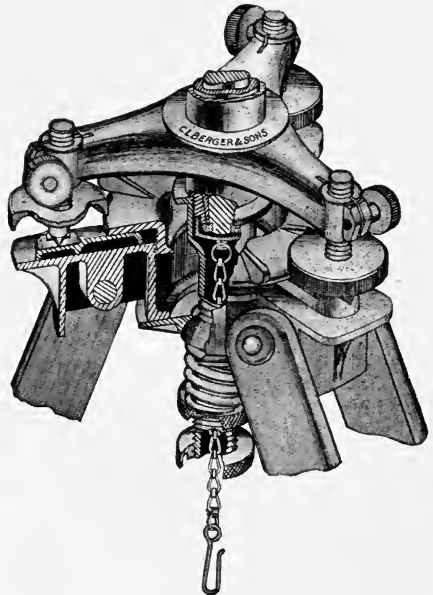
There are several methods of placing a level or transit with three leveling screws upon the tripod head. One is the tribrach style where the leveling screws rest in radial grooves in a triangular shaped foot-plate which screws on to the tripod. This method is used extensively in Europe, but, as the instrument rests only by its own weight in these grooves it is liable to changes in position during use and this instability becomes greatly aggravated when the leveling screws become worn.

Another method in transits is to rest the leveling screws, provided with small bearing cups or washers at their lower ends, directly upon the smooth top surface of the tripod head to allow centering of the instrument over a given point. The pressure of a spiral spring forming part of the instrument fastener is then applied to fix the position of instrument on the tripod head.

This latter method of connecting a transit to a tripod is very insecure, inasmuch as the slightest change in the position of the instrument, while reading a series of angles, will greatly affect the results.

Thus it is seen that a transit lacking the necessary stability on its tripod often proves almost useless in the finer field-work.

Messrs C. L. Berger & Sons make the leveling screws to rest in radial grooves in a separate piece made to slide on the tripod head as shown in cut. A clamp-nut, provided with a large flange and handles, serves to secure this sliding piece to the tripod in any position in the range of its lateral motion. The instrument fastener, being part of the tripod proper, has a large cylindrical hole in the threaded stem to allow the hook and chain, suspended directly from the transit center, to pass through and to swing freely in every direction, so that when the plumb-bob is attached its point will be truly in the continuation of the vertical center of the instrument. The milled head at the lower end of the fastener serves to screw the latter to the instrument, and a milled headed nut acting against a spiral spring secures the instrument to the tripod. In use, the pressure of this spring must be sufficient to take up the back lash or any loose-



ness that may exist in the leveling screws; but to secure the necessary stability of the instrument to the tripod, the clamp-nut should be well fastened to the sliding piece. To operate the shifting center, both the spiral-spring and the clamp-nut must be released slightly from their hold upon the tripod and the sliding piece, when the instrument can be moved over the given point on the ground. This device adds about 2 lbs. to the weight of the tripod.

Arrangement for Offsetting at Right Angles.

The most common off-set with the transit is one at 90° to the line of sight. Several methods have been proposed for doing this without disturbing the telescope.

Messrs. C. L. Berger & Sons have a very neat one; it consists in simply perforating the horizontal axis, so that by drawing the head back fifteen or twenty inches from one end of the axis, the eye may be placed so that the eye, the horizontal axis of the telescope, and a rod set beyond, may be readily placed in the same straight line, at right angles to the line of sight of the telescope, no matter at what altitude the telescope may be pointing.

In off-setting by the arrangement proposed above, the rod is made plumb by lining it with the plumb-line of the instrument itself. The advantage of this method is, that it holds equally well for any inclination of the telescope. The disadvantage is, that the engineer is obliged to leave the eye-end of the telescope at each off-set made.

Setting Up.

In setting up a transit, push the iron shoe of one leg firmly into the ground, by pressing on the other two legs near the tripod head. Having secured a firm foundation for this leg, separate the other two legs, at the same time drawing the tripod head toward you. Then set the two remaining legs in the same manner as the first one. If the ground is pretty level, merely noticing that the tripod feet are equidistant, will insure that no unsightly appearance will be given to the leveling screws. If the ground is uneven, however, nothing but practice can produce a graceful position of the instrument. The plumb-bob attached to the instrument should swing within say half an inch of the point on the ground, and the plate on which the leveling screws rest, if possible, should be approximately horizontal, when this stage is completed.

Now with the level screws not tightened up, after leveling approximately, bring the plumb-bob exactly over the point on the ground, by moving the body of the instrument on its shifting head. Then complete the leveling of the instrument, and it is ready for work.

The Adjusting of the Transit

If the instrument is out of adjustment generally, the engineer will find it profitable to follow the makers in not completing each single adjustment at once, but rather bring the whole instrument to a nice adjustment by repeating the whole series.

After setting up, bring the two small levels each parallel to a line joining two of the opposing leveling screws. Bring both bubbles to the center of the level tubes, by means of the leveling screws. In doing this, place the two thumbs on the inner edges of the two leveling screws, parallel to the bubbles, and the fore fingers of each hand on the outer edge. Turn the leveling screws so that both thumbs move inwards or both outwards. In the former case the bubble will move toward the right, in the latter case toward the left.

Now turn the instrument 180° in azimuth. If the small levels still have their bubbles in the center of their tubes, these levels are adjusted, and the circles are respectively as nearly horizontal and vertical as the maker intended them to be.

If the bubbles, however, are not in the center of their tubes, then bring them half way back by means of the leveling screws, and the remaining half by means of the adjusting screw at the end of each of the level tubes.

It may be necessary to repeat this adjustment several times, but when made, the instrument once leveled will have its small levels in the center of their tubes through an entire rotation of the circle.

To make the adjustment for Parallax. This adjustment common to all telescopes used in surveying instruments is that of bringing the cross hairs to a sharp focus, at the same time with the object under examination. Point the telescope to the sky, and turn the eye-piece until the cross hairs are sharp and distinct. Since the eye itself may have slightly accommodated itself to the eye-piece, test the adjustment by looking with the unaided eye at some distant point, and while still looking, bring the eye-piece of the telescope before the eye. If the cross hairs are sharp at the *first glance*, the adjustment is made. Now focus in the usual manner upon any object, bringing the cross hairs and image to a sharp focus by the rack-work alone. A point should remain bi-sected when the eye is moved from one side of the eye-piece to the other.

To make the vertical cross-line perpendicular to the plane of the horizontal axis, simply bi-sect some point at the lower edge of the field of view of the telescope by means of the tangent screw and note whether it continues bi-sected by this cross-line throughout its entire length when the telescope is moved in altitude. If it does not, and the point is to the right of the line in the upper part of the field, the adjustment is made by loosening the four capstan-headed screws, and rotating the reticule in the direction of a left-handed screw, until the point remains bi-sected and then tighten all four adjusting screws. Again, bi-sect the point by means of the tangent screw. It should now remain bi-sected throughout the length of the cross-line, if not, this operation must be repeated.

To adjust the horizontal wire proceed as follows: In transits of our make which have **erecting eye-pieces** the mechanical construction of the telescope is so perfect that the horizontal wire may be placed in the optical axis by simply placing it in the center of the field of view by the adjusting screws. See diagrams on page 58. However, in telescopes having **inverting eye-pieces** the horizontal wire can be placed in the optical axis only by rotating the telescope in improvised wyes.

To adjust the vertical wire which in the transit is the most important. When that is to be alone adjusted in the field, it is usually done according to the following simple directions: Level up the instrument approximately and select two distant points in opposite directions from the instrument, preferably in the same horizontal plane, such that the vertical cross-line will bi-sect them both when the telescope is pointed upon one, and then the telescope is reversed on its horizontal axis. After bi-secting the second point selected, revolve the instrument in azimuth and bi-sect the first point again by means of the tangent screw. Reverse the telescope on its horizontal axis again, and if the second point is now bi-sected the adjustment for collimation of the vertical wire is correct. If it is not bi-sected, move* the vertical wire **one-fourth of the distance between its present position and the point previously bi-sected**. Again bi-sect the first point selected, reverse the telescope and find a new point precisely in the new line of sight of the telescope; these two points will now remain bi-sected when the instrument is pointed upon them in the manner described above, if the adjustment is correctly made. If the two points are not now both bi-sected, the adjustment must be repeated until this be the case.

To determine whether the standards are of the same height, suspend a plumb-bob by means of a long cord from a height say of from thirty to forty feet. The plumb-bob may swing in a bucket of water to keep it steady. (Instead of a **plumb-line** the reflection of a church spire or edge of a tall building or any other convenient object may be viewed in a bucket of water.) Level the instrument carefully, and point upon the plumb-line at its base. If the plumb-line remains bi-sected throughout its entire length when the telescope is moved in altitude, and then the telescope reversed and again made to bi-sect the line throughout its length from its base upward, the adjustment is correct. Otherwise make the adjustment by means of the capstan-headed screw directly under one of the telescope wyes. Loosen the screws in the pivot caps and turn the vertical adjusting screw *right handed to raise the wye bearing one quarter of the error to be corrected*. If the telescope's axis is already too high, the vertical adjusting screw should be loosened a little more than needed and then by the screws of the pivot cap the wye bearing should be lowered until it just touches the vertical adjusting screw. The screws of the pivot cap must now again be loosened and the wye bearing raised by a right hand turn of the vertical adjusting screw, as explained above, until the telescope's axis is in the correct position. If this is not done the adjustable bearing is likely to stick and not rest on the adjusting screw, thus causing liability to derangement. The screws in the pivot cap should then be turned down just enough to prevent looseness in the bearings.

When there are **opposing nuts** in place of the vertical adjusting screw as is the case in almost all of our transits to secure a more ready, positive and above all a lasting adjustment — then while the *modus operandi* remains the same, the action of the adjusting nuts to raise or lower the wye bearings is just opposite from that described above.

Instead of using a plumb-line a **simpler method** having the advantage of not requiring the instrument to be leveled up carefully is as follows: Set up the instrument as near as may be convenient to a building, say about 20 feet, in order to get as high an altitude as possible. Level up only approximately, clamp and bi-sect a point at the base by the tangent screw. Then elevate the telescope and find a well-defined object as high as possible, only using the telescope's horizontal axis. Now reverse telescope and move instrument on its vertical center, again clamp, and bi-sect the point at the base. If when the telescope is elevated it bi-sects the high object selected the adjustment is correct. If it does not, proceed as described in the above method.

To adjust the level to the line of collimation of the horizontal wire one method is to use a sheet of water, or where that is not available, two stakes which are driven with their surfaces in the same level plane.*

To make the adjustment with the stakes, level up the transit half way between two points lying very nearly in a horizontal line, and say 300 feet apart. Drive a stake at one of these points, place the rod on it and take a reading, first bringing the bubble to the middle of its tube. Point the telescope in the opposite direction, again bring the bubble to the middle of its tube, and drive a second stake at the second point selected until the rod held upon the second stake gives the same reading as when held upon the first stake. The tops of these two stakes now lie in the same level line. Take up the transit and set it outside in line, as near as it can be focussed on the first stake and level up. Now read the rod upon the first stake with the bubble in the center and then upon the second. If the two readings agree, and the bubble is in the middle of its tube, the adjustment is correct. If the two readings do not agree, then by means of the telescope's tangent screw elevate or depress the telescope the amount required until the **horizontal wire reads the same on the distant rod.** Next refocus on the near rod, take a reading, then focus on the distant rod and see if the readings are the same, if not, by means of the tangent screw **again make the horizontal wire read the same as on the near rod.** Repeat this operation until both rods read the same. Now with the horizontal wire bi-secting the distant reading make the adjustment of the level by its capstan-headed nuts until the bubble is in the middle of its tube when the level will be parallel to the line of collimation.

Another method of adjusting the attached level to the Transit Telescope will be found on page 63.

To adjust the verniers of the vertical arc or full circle to read zero, in our Engineer's Transit having the vernier between the legs of the standard. First level up the instrument carefully so that the telescope's bubble will remain in the middle of its tube when turned 180° in azimuth. Then set the zero of the vernier to read within about $\frac{1}{4}$ minute right with zero of the vertical arc. Then by the vertical tangent screw place both zeros in coincidence and examine the 30' lines and if short the vernier must be moved inwardly so that both of the end lines in the double vernier will read right. If too long the vernier must be moved outwardly until this is attained; then fasten tightly. Now loosen only just enough the screws that hold the vertical arc or circle to the horizontal axis, to permit of a slight shift, and then with the bubble in the center slightly tap one of the spokes of the arc with the handle of the screw-driver, until the zero of the vernier and that of the vertical arc are in coincidence. This accomplished now fasten the vertical arc tightly to its flange. Again level up the telescope as described above and see if the adjustment is correct; if not, again slightly loosen the vertical arc, tap it into position, repeat the same operation over again until it is correct.

NOTE.—If the vernier for the vertical arc is single, made to read both ways, in reading it proceed to the right or left on the upper line of figures in the direction of the graduation used, and if the coincident line of the vernier is beyond the 15' line, continue on the lower line of figures on the other half of the vernier, so that the whole graduation from 0' to 30' lies in the same direction. The verniers of our vertical arcs are however, made mostly double as described on page 37.

The Adjustments of the Full Vertical Circle with Double Opposite Verniers.

When the vertical circle in the Engineers' Transit is provided with a vernier at eye-end or with double opposite verniers, the adjustment of the vernier zero for normal position should be made by the two opposing capstan-headed screws attached to the vernier frame at side of standard. Then to be lasting and to avoid any strain upon the frame and lugs carrying these adjusting screws, proceed as follows:—First level up the instrument so that the bubble of the telescope and plate levels remain in the center of their tubes when vernier plate is turned 180° in azimuth; then the zero of vernier "A," at eye-end, should be adjusted by the

* In general practice one will locate the stakes permanently at some convenient place near the

capstan-headed screw at left to read zero with the circle, by first releasing the opposing screw at right — which is now provided with a milled head — and then with the finger slightly pressing the vernier frame against the left hand capstan-headed screw, turn the latter until vernier "A" reads zero. Then carefully turn the milled headed opposing screw at right towards the stud until it barely touches. **It is best to leave even a little looseness between the stud and opposing screw rather than to have the least strain.** (Such minute looseness can be easily felt by the fingers but it should never affect the readings if the looseness is not excessive.) **In following this method we reiterate, that the above adjustment will keep for years and there being no strain between the opposing screws and stud, the telescope's axis will always revolve with perfect freedom in the wyes, nor will there be any danger to warp or fracture the frame.**

If the telescope is reversible over the bearings as in the Transit Theodolite, then the vernier frame requires a reversible tangent screw in place of the opposing adjusting screws just explained above. Then before a vertical angle can be taken, the adjustment of the vernier zeros for position must first be made by the vernier frame's tangent screw when the telescope's level bubble is in the center of its graduation. In this latter case it is not always necessary to carefully level up the whole instrument.

If a vertical circle has a level attached to its vernier frame as in most Transit Theodolites then the adjustment of this level and verniers for position must be made in the following manner:

Place the telescope in the horizontal plane by means of its tangent screw, then move the vernier frame's tangent screw until the zero line of the double verniers, marked A, is in coincidence with the zero line of the vertical circle, and now raise or lower the adjusting screw of this level, as the case may be, until the bubble is in the centre of its tube.

It is now supposed that the zero line of the double opposite verniers, marked B, is also in coincidence with that of the vertical circle. If not, the verniers marked B, can be moved after releasing the capstan-headed screws, until both zero lines on that side of the vertical circle are also in coincidence. However, this is a very laborious proceeding for those uninitiated in this work, and as it cannot always be made quite exact, owing to the mode of mounting the vertical circle on the telescope's axis, it will be found easiest to eliminate errors of excentricity in the graduation of the vertical circle and verniers by reversing the telescope and taking the mean of the readings. The vertical circle is generally graduated from 0° to 90° and back, and the verniers are double, so that angles of elevation and depression can be read with ease and dispatch.

The Striding Level resting on special collars between the standards of the Engineers' and Surveyors' Transit, sizes No. 1, 2 and 11.

In transits reading to minutes and half-minutes, the plate-level in front of the telescope is generally sufficiently sensitive to insure good work. However, an instrument of the class as shown and described under No. 1 d, should always be provided with a striding level, to insure a degree of accuracy in keeping with its greater capability. The sensitiveness of this striding level is equal to that of the long level on the telescope.

Thus it will be seen that in a transit of this description the plate-levels serve only the purpose of leveling up generally, and that in all cases where the objects vary considerably in height, the striding level only should be depended on at every sight. The striding level of this instrument rests on two cylinders of equal diameters, at points between the standards on the cross-axis of the telescope. As shown in the cut, the striding level can be left on the cross-axis when the telescope is revolved in altitude. — To verify the adjustment of the striding level (in other words, to make its axis parallel to the cross-axis) level up the transit and bring the bubble to the middle of its tube, reverse the striding level on the cylinders and see whether it reads the same; if not, remove half the error by the leveling screws, the other half by the capstan-headed screws at the end and repeat until corrected. To verify the side adjustment of the level, revolve the telescope 20° or 30° , and note whether the reading of the bubble remains the same, if not, correct the error by the capstan-headed screws at the side. To verify the adjustment of the cross-axis of the telescope for right angles to the vertical axis of the transit, revolve the instrument 180° in azimuth, and assuming that both cylinders, on which the striding level rests, are equal in diameter, a change in the reading of the bubble will indicate double the amount of error. To correct it, remove half the error by the leveling screws, the other half by the Wye adjustment of the standard. —

Adjustment of the Improved Transverse Striding Level resting on special collars for the Engineers' and Surveyors' Transits, sizes No. 1, 2 and 11.

This striding level differs from the one formerly made by us, and referred to in the preceding article, in several respects. It permits of a longer spirit-level in the same length of outer tube—so important in this case on account of the short available distance between the collars; and is simpler in design, so that after an adjustment has been once properly performed, barring accidents, it hardly ever needs to be repeated again.

To make a readjustment: first find out whether the level needs a **lateral adjustment** by placing it on its collars with instrument leveled up, and fastening it by the milled headed nut to the horizontal axis, place the bubble in the center of its tube by the leveling screws, and then elevate and depress the telescope 10° to 20° from 0; note carefully the amount of displacement of bubble, also which one of the two capstan-headed screws (one white and one red, to readily distinguish one from the other) must be moved one-half the error; move screw outwardly if bubble must be moved away from this screw, and inwardly if bubble must be raised towards it to make the level tube laterally parallel to the transverse axis of the telescope. Then move the *other adjusting screw an equal amount*, but *in the opposite direction* to retain the same height of leg, and repeat this adjustment until one-half the error is corrected. Before operating any of the adjusting screws first remove the level from the collars.

This accomplished, now make the **longitudinal adjustment**. Clamp the telescope in the horizontal position and reverse the level on its collars; note whether the leg with the screws should be raised or lowered to bring the bubble to the center of its tube, and then turn each screw, alternately, an amount equal to one-quarter the error (inwardly if the leg is to be raised, or outwardly if leg is to be lowered) in order to eliminate one-half the error of the level-tube sought to be corrected. Then again reverse the level on its collars, and repeat this adjustment if necessary. If the level has been considerably out of adjustment it will be well to again verify the lateral adjustment in the manner prescribed for it above, and also to repeat the longitudinal adjustment by again following the method just explained until completed.—Remember, that if the leg has to be raised, both screws must be moved inwardly towards the telescope, and that if it has to be lowered, both screws must be moved outwardly in equal amounts. This method has been prescribed by us as being the most simple to follow. One somewhat versed in making adjustments probably may succeed in making it quicker (if the level is considerably out) by noting mentally the amount of displacement of bubble for the longitudinal and lateral adjustments, and then correcting same simultaneously, or nearly so, with one of the screws alone, by moving it in the desired direction. To adjust the height of standards see page 54.

The Adjustments of the Telescope's Axis of Revolution in Transit-Theodolites by means of the Transverse Striding-Level resting on points of contact in the Wyes.

The striding-level of the finest class of instruments, such as Transit-Theodolites used for triangulation wholly, and Mining Transit used mainly for very steep sighting, will rest directly upon the cylindrical pivots of the transverse axis, at the circle of contact in the wyes.

Whenever exact vertical motion is desired, the striding-level in such instruments should be depended upon to the exclusion of the front plate-level. The latter is then entirely subordinate to the striding-level and should be depended upon merely for leveling the instrument approximately. The plate-levels are also useful in indicating quickly any large disturbances of position. When the objects sighted at do not differ much in altitude, the front plate-level is, in these instruments, sufficiently sensitive to give satisfactory results without using the striding-level.

The adjustment of the transverse axis of revolution. The striding-level having been carefully adjusted, level up the instrument generally with the plate-levels, put the striding-level in position and bring its bubble to the center of its graduation by means of the leveling screws, then turn the instrument 180° on its vertical axis and note whether the bubble of the striding-level remains in the center of the graduation. If it does, the adjustment is correct. If it does not, correct one-half the error by means of the leveling screws, and the other half by means of the wye adjustment of the standard. Repeat the process until the adjustment is correct. Observe also, in adjusting the wye adjustment of the standards, that it will be best performed and more lasting when the last turns of the lower capstan-headed screw are always applied in an upward direction.

To adjust the line of collimation in Erecting and Inverting Telescopes.

NOTE:—To adjust the line of collimation in a telescope showing objects erect, follow the simple rule that the diaphragm bearing the wires must be moved in the direction in which the error is observed (as if to increase the error); in telescopes showing objects inverted the wires must be moved in the direction lessening the error observed. See diagrams below.

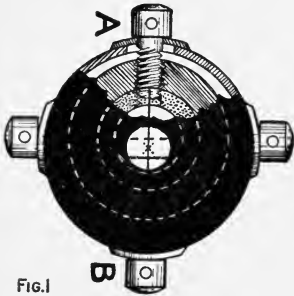


Fig.1

Erecting Telescope.

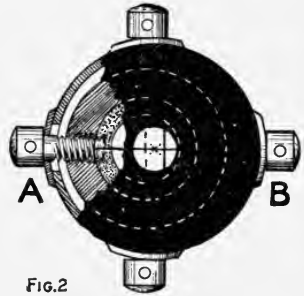


Fig.2

To move the horizontal wire for collimation explained above it must be understood that the dotted line in the upper half of the field or view, Fig. 1, shows the horizontal wire where it is actually situated on the reticule, but that through the reversing action of the erecting eye-piece the cross-wire image is reversed and therefore the horizontal wire is seen in the lower half as shown in the diagram. Therefore, if the horizontal wire seen in the lower half of the diagram must be moved upwards, then contrary to the appearance, screw **A** must be loosened, and **B** tightened an equal amount in order to bodily move the wire reticule towards the center of the stationary field of view (indicated by the dotted intersection) until **one-half of the error** is corrected when the wire will be adjusted and appear in the center of the field of view,—provided the optical axis of the eye-piece has been previously centered. To move the vertical wire for collimation explained on page 54, remember that the dotted line at the left, Fig. 2, shows the vertical wire where it is actually situated on the reticule, but that through the reversal of the cross-wire image by the use of an erecting eye-piece it is now seen at the right in the field of view in the diagram; therefore, adjusting screw **A** must be loosened and **B** tightened an equal amount in order that the reticule will bodily move towards **B**, when the vertical wire seen at the right will pass towards the center of the stationary field of view (indicated by the dotted intersection) until **one-quarter of the error** observed is removed, when the wire will be in complete adjustment at the optical axis.

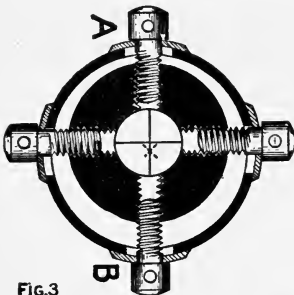


Fig.3

Inverting Telescope.

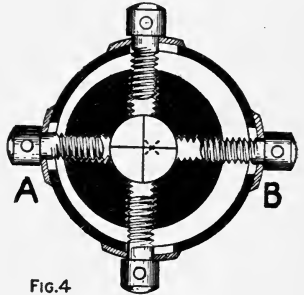


Fig.4

To move the horizontal wire for collimation, page 54, the observed error must be corrected by moving the wire reticule **one-half the amount** in the direction it is lessened, when the telescope is revolved in improvised wyes as in a wye level. Thus, Fig. 3, if the wire must be moved down, **A** must be loosened and **B** tightened an equal amount.

To move the vertical wire for collimation explained above, the observed error must be corrected by moving the wire reticule **one-quarter of the amount** in the direction it is lessened. Therefore, if the wire must come to the right, **A**, Fig. 4, must be loosened, and **B** tightened an equal amount until the object is attained.

THE WYE LEVEL.

The description of the telescope of the engineer's transit applies with the following modifications to the telescope of this level.

It has a clear aperture of $1\frac{3}{8}$ inches focus, and is 17 or 18 inches long over all, the sun-shade excluded.

The bell-metal collars which rest in the wyes are about $10\frac{1}{2}$ inches apart and $1\frac{3}{4}$ inches in diameter.

On account of the extreme length of the telescope tube, four capstan-headed screws are provided for centering the eye-piece.

The object-glass focussing screw is in the middle of the tube. The eye-piece is focussed by turning a milled ring at the eye-end. The level attached to the telescope is about 8 inches long, with about $5\frac{1}{2}$ inches exposed, and having a scale graduated on glass for reading the position of its bubble. The bubble is ground to a true curvature and barrel form. The sensitiveness of spirit level is graded to the class of work for which the instrument is intended. The level-tube is suspended from the telescope-tube in such a manner that at the object-glass end it can be moved in azimuth, with reference to the telescope axis, and at the eye-piece end it can be moved in altitude with reference to the same axis.

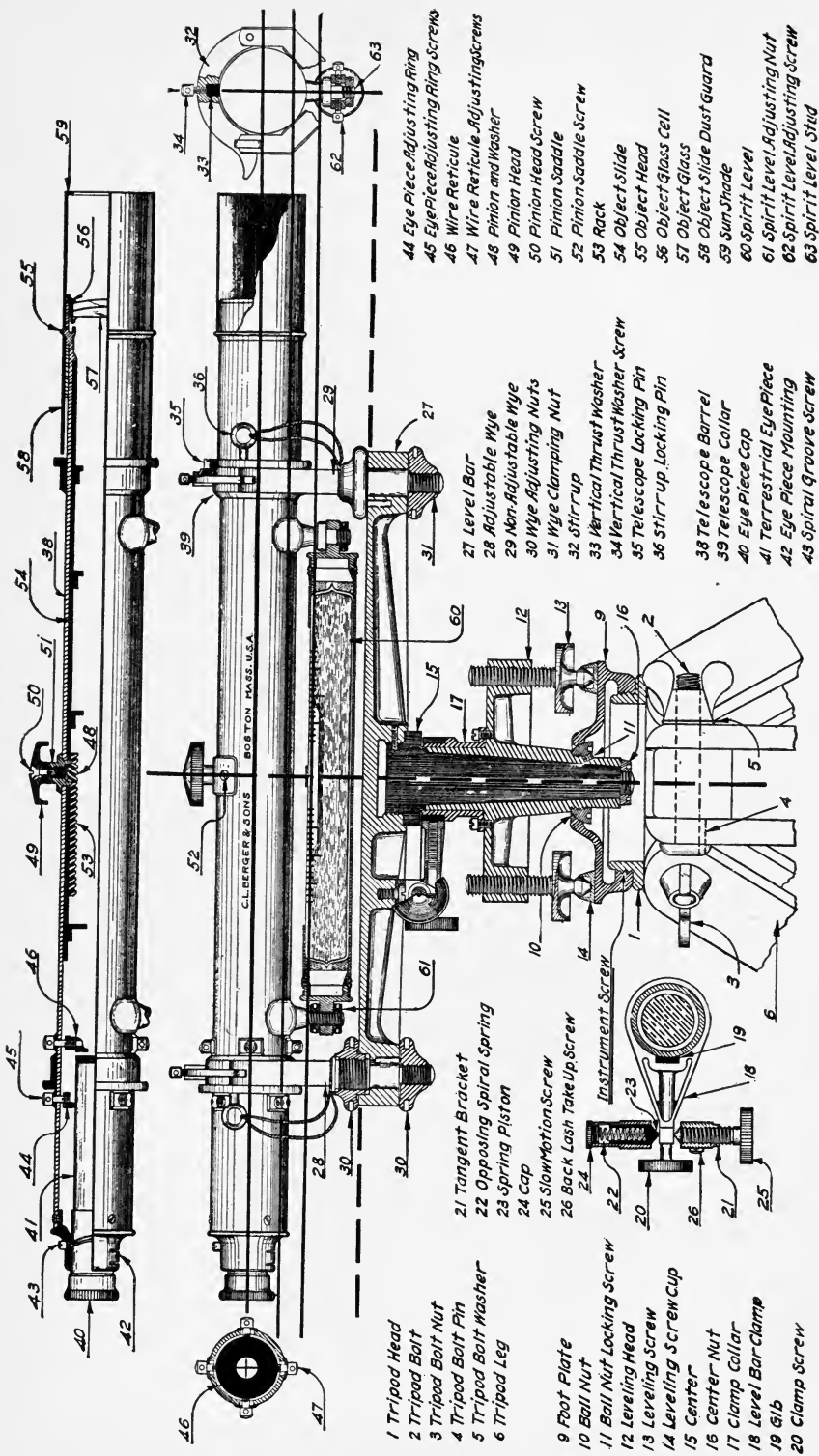
Its graduated scale is on the level vial tube, and numbered from 5 to 0 to 5 at each end of the bubble.

The level-bar is about 12 inches long over all, and at its two extremities supports the two wyes which rise about $3\frac{1}{2}$ inches from its upper surface. One of these wyes is adjustable in altitude. The level-bar is attached to a long conical center of the hardest bell-metal, which may be clamped to the leveling plate, and then a slow motion in azimuth may be given to the telescope, by a slow motion screw which presses the clamping bar against a stiff spiral spring. With the sun-shade on the telescope, the weight is equally distributed from the center, each way. This is necessary, since a sensitive level, in the nicest work, is affected by any unequal strain, though it may seem to be, practically, imperceptible.

The base, on which the leveling screws rest, has as great a diameter as portability will permit; and the leveling screws are cut with a fine thread. These two points add to the ease with which the instrument may be accurately leveled.

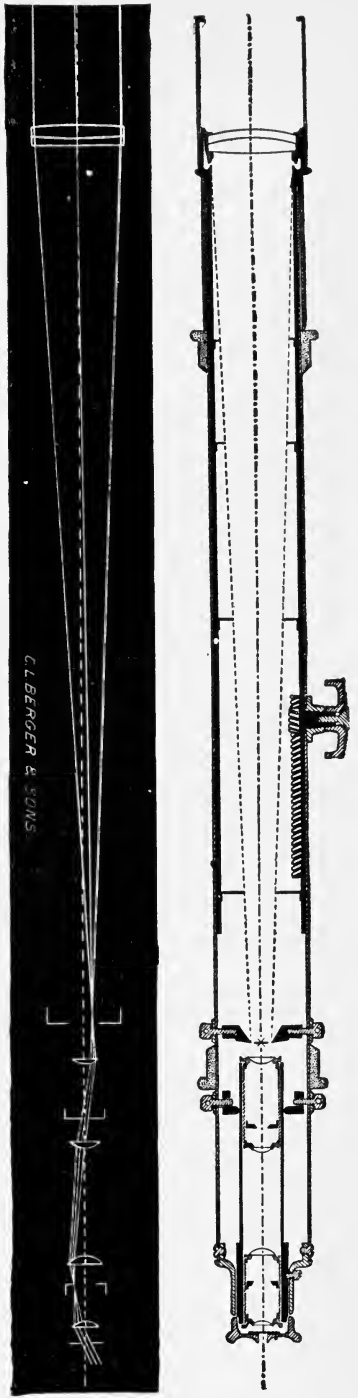
A stop is so arranged that the telescope may be readily set with its horizontal cross-line level, when the instrument is in adjustment.

The instrument complete is not separable when put into its box. This condition is necessary to protect one of the essential adjustments of the level—the adjustment of the wyes—from needless derangement.



Cross-section of the Berger 18-inch Wye Level.

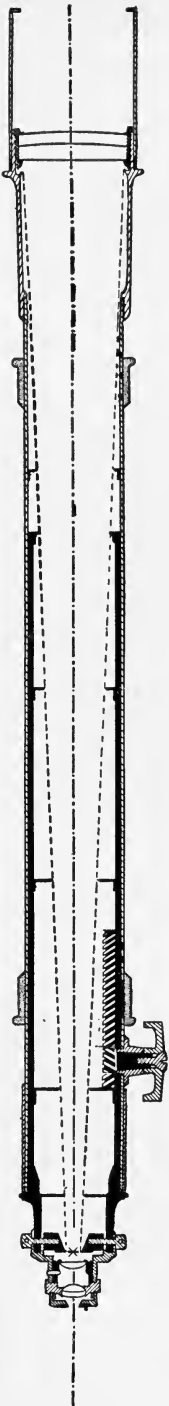
In the above cut the three heavily drawn parallel lines represent the principal adjustments to be made in a wye level. The heavily drawn vertical dotted line and the dotted line drawn at right angles to it represent the adjustments of the wyes to the center which is of secondary importance in a level.



C. BERGER & SONS

Cross section of the Berger Engineer's 18-inch Wye Level Telescope with erect image.

Diagram shows the path of a pencil of rays in this telescope.



C. BERGER & SONS

Cross section of the Berger Engineer's 18-inch Wye Level Telescope with inverted image.

Diagram shows the path of a pencil of rays in this telescope.

The Adjustment of the Wye Level.

After the engineer has set up the instrument and adjusted the eye-piece for **parallax**, as described under the engineer's transit, the **horizontal cross-wire** had better be made to lie in the plane of the **azimuthal rotation** of the instrument. This may be accomplished by rotating the reticule, after loosening the capstan-headed screws, until a point remains bi-sected throughout the length of the wire when the telescope is moved in azimuth. In making this adjustment, the level tube is to be kept directly beneath the telescope-tube. When made, the small set screw attached to one of the wyes may be set so that by simply bringing the projecting pin from the telescope against it, the cross-wires will be respectively parallel and perpendicular to the motion of the telescope in azimuth.

The first collimating of the telescope may be made using an edge of some building, or any profile which is vertical. Make the vertical cross-wire tangent to any such profile, and then turn the telescope half-way round in its wyes. If the vertical cross-wire is still tangent to the edge selected, the vertical cross-wire is collimated.

To make the adjustment of the horizontal wire, select some horizontal line, and cause the horizontal cross-wire to be brought tangent to it. Again rotate the telescope half-way round in its wyes, and if the horizontal cross-wire is still tangent to the edge selected, the horizontal cross-wire is collimated.

* Having adjusted the two wires separately in this manner, select some well-defined point which the cross-wires are made to bi-sect. Now rotate the telescope half-way round in its wyes. If the point is still bi-sected, the telescope is collimated. A very excellent mark to use is the intersection of the cross-wires of a transit instrument using same as a collimator.

To center the eye-piece by the four capstan-headed screws nearest the eye end: This is done by moving the opposite screws in the same direction until a distant object under observation is without the appearance of a rise or fall throughout an entire rotation of the telescope in its wyes. The telescope is now adjusted.

To adjust the spirit level to the telescope, bring the level bar over two of the leveling screws, focus the telescope upon some object about 300 feet distant, and put on the sun-shade. These precautions are necessary to a nice adjustment of the level tube. Throw open the two arms which hold the telescope down in its wyes, and carefully level the instrument over the two level screws parallel to the telescope. Lift the telescope out of its wyes, turn it end for end and carefully replace it. If the level tube is adjusted, the level will indicate the same reading as before. If it does not, correct half the deviation by the two leveling screws and the remainder by moving the level tube vertically by means of the two adjusting nuts which secure the level tube to the telescope tube at its eye-piece end. Loosen the upper nut with an adjusting pin, and then raise or lower the lower nut as the case requires, and finally clamp that end of the level tube by bringing home the upper nut. This adjustment may require several repetitions before it is perfect.

To make the lateral adjustment of the spirit level: The level is now to be adjusted so that its axis may be parallel to the axis of the telescope. Rotate the telescope about 20° in its wyes, and note whether the level bubble has the same reading as when the bubble was *under* the telescope. If it has, this adjustment is made. If it has not the same reading, move the end of the level tube nearest the object-glass in a horizontal direction, when the telescope is in its proper position, by means of the two small horizontal capstan-headed screws which secure that end of the level to the telescope tube. If the level bubble goes to the object-glass end when that end is to the engineer's right hand, upon rotating the telescope level toward him, then these screws are to be turned in the direction of a left-handed screw, as the engineer sees them, and *vice versa*. This accomplished the vertical adjustment of the spirit level for parallelism with the line of collimation of the horizontal wire must now again be verified. Having completed this adjustment, the level bar itself must now be made parallel to the axis of the level.

To make the adjustment of the level bar: Level the instrument carefully over two of its leveling screws, the other two being set as nearly level as may be; turn the instrument 180° in azimuth, and if the level indicates the same inclination, the level bar is adjusted. If the level bubble indicates a change of inclination of the telescope in turning 180° , correct half the amount of the change by the two level screws, and the remainder by the two capstan-headed nuts at the end of the level bar. Turn both nuts in the same direction, an equal part of a revolution, starting that nut first which is in the direction of the desired movement of the level bar. Many engineers consider this adjustment of little importance, preferring to bring the level bubble in the middle of its tube at each sight by means of the leveling screws alone, rather than to give any great consideration to this adjustment, should it require to be made.

THE DUMPY LEVEL.

(For description and cuts see pages 123 to 129.)

Adjusting.

Two-Peg Method.

A theoretically perfect dumpy level has the same points established that are mentioned under the head of wye level; but since its construction differs from the wye level, the methods of adjustment are not so convenient, resembling closely the adjustment of the transit telescope and its attached level. After attaching the sunshade remove **parallax** by pointing the telescope to the sky, and turn the eye-piece until the cross hairs are sharp and distinct. Since the eye itself may have slightly accommodated itself to the eye-piece, test the adjustment by looking with the unaided eye at some distant point, and while still looking, bring the eye-piece of the telescope before the eye. If the cross hairs are sharp at the *first glance*, the adjustment is made. Now focus in the usual manner upon any object, bringing the cross hairs and image to a sharp focus by the rack-work alone. A point should remain bi-sected when the eye is moved from one side of the eye-piece to the other.

To place the horizontal cross wire at right angles to the vertical center bi-sect some well-defined object such as a chimney top, top of roof, fence-rail or window-sill (the best views are against the sky for a background) and move the telescope on its vertical center. If the horizontal wire bi-sects the point throughout its entire field of view it is adjusted.

If it does not slightly loosen the four capstan-headed adjusting screws (in the **inverting** telescope those **nearest** the eye-piece or the **further** set from the eye when the telescope shows objects **erect**) and turn the wire diaphragm until the selected point remains bi-sected when the telescope is moved in azimuth throughout the entire field of view.

To adjust the level, bring the level over two of its foot screws, and bring the bubble to the middle of its tube by means of the foot screws alone. Revolve the instrument 180° in azimuth, and if the bubble remains in the middle it is adjusted, if it does not, then correct half its deviation by the capstan-headed adjusting screw of the spirit level, and the remaining half by the two foot screws. Repeat the operation over the other two screws, until the instrument may be revolved in any position, and the level bubble will remain in the middle of its tube.

To adjust the horizontal wire so that the line of sight will be parallel to the spirit level, one method is to use a sheet of water, or where that is not available, two stakes which are driven with their surfaces in the same level plane.

To make the adjustment with the stakes, set up the level half way between two points lying very nearly in a horizontal line, and say 300 feet apart. Drive a stake at one of these points, place the rod on it and take a reading, first bringing the bubble to the middle of its tube. Point the telescope in the opposite direction, again bring the bubble to the middle of its tube, and drive a second stake at the second point selected until the rod held upon the second stake gives the same reading as when held upon the first stake. The tops of these two stakes now lie in the same level line.

Take up the level and set it outside in line as near as it can be focussed on the first stake and level up. Now read the rod upon the first stake, and then upon the second. If the two readings agree, and the bubble is in the middle of its tube, the collimation is correct. If the two readings do not agree, **change the horizontal wire* to read the same on the distant rod** by means of the capstan-headed screws near the eye-piece in the inverting telescope and furthest from the eye-piece in the erecting telescope. Refocus on the nearest rod, take a reading, then focus on the distant rod and again by means of the capstan-headed adjusting screws, make the horizontal wire read the same. Repeat this operation until both rods read the same, with the bubble in the middle of its tube.

The telescope and uprights are in a single casting, which is finished and fitted to the level bar, so that **the line of collimation may be permanently parallel to it.**

The dumpy level will then be in adjustment, since the adjustment of its vertical cross line is of no importance.

Adjustment of the Dumpy Level¹—and attached level of Transit Telescope.

Two-Peg Method.

The following method is simple, direct, and geometrically accurate, requiring no approximate measurements from a peg to the center of lens, no trial setting of the telescope, no trials to drive a peg just enough and not too far, and no auxiliaries except level-rod and tape or chain.

¹Contributed by Prof. R. Fletcher, Thayer School Dartmouth College.

* See page 58.

The Surveyor's Solar Attachment.

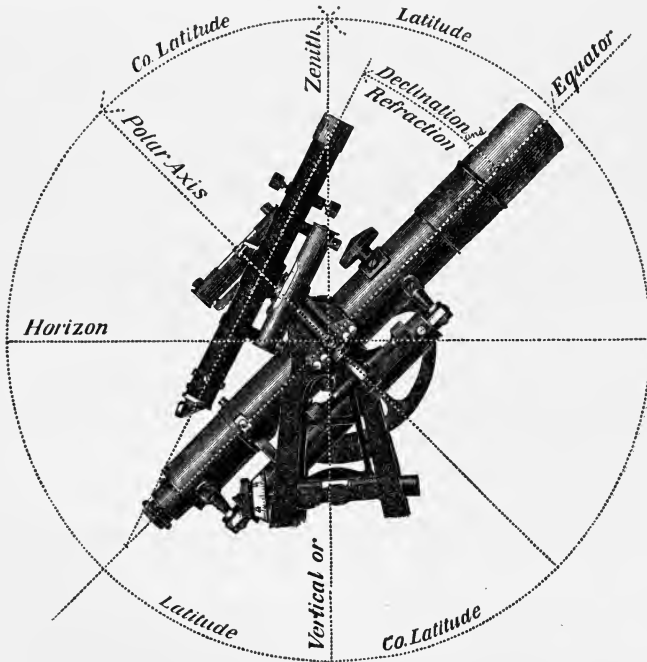
Written for this catalogue by H. C. PEARSONS, C. E., Ferrysburg, Mich.

The "Solar Attachment," of which the following is a description, is a modification of *Pearson's Solar Transit*.

With the view of reducing the weight and cost of this attachment, the declination arc is dispensed with, using, in its stead, the latitude arc for setting off the declination.

And to attain a greater degree of precision, a small telescope with cross-hairs, and a diagonal eye-piece have been introduced in place of the lens-bar and focal-plate.

This attachment is an appliance to the surveyor's transit for the purpose of finding the astronomical meridian. Combined with that instrument, it becomes purely astronomical in its character — indeed, a portable Equatorial, and an Alt.-Azimuth instrument combined, — hence a few astronomical definitions seem to be requisite.



In the accompanying cut, the instrument is represented in position for an observation; and in north latitude (as in these instructions we will suppose the observer to be) the view is as from the west.

(1.) The line through the vertical axis of the transit represents the pole of the horizon, and is called the *Vertical*.

The line perpendicular to this represents the *Horizon*.

(2.) The transit telescope, having its optical axis in the meridian, and having its south end (whether object-end or eye-end) elevated so that the vertical-arc reads the co-latitude, will have its optical axis in the plane of the equator also; viz. the optical axis of the telescope will then represent the intersection of the plane of the meridian, with that of the equator. This line is called the *Equator*.

(3.) The line perpendicular to the equator, — that around which the solar telescope revolves, in following the sun in his diurnal course, is the pole of the equator. — It is parallel with the earth's axis, and is called the *Polar Axis*.

(4.) The arc distance from the equator to the vertical is the *Latitude* of the observer, — whence the distance from the vertical to the polar axis, is the *Co-Latitude*.

It will be observed that these arcs occur alternately around the entire circle; so that the student should make himself familiar with their relative position with regard to the horizon, and the vertical, in order to avoid mistakes, when setting the polar axis of the instrument up to the pole of the equator.

(5.) *Astronomical Triangle.* The height of the sun is measured in a plane passing through the "Vertical" and the sun, and is called his *Altitude*, whence his distance from the "Vertical" is his *Co-Altitude*.

In the same manner, the distance from the sun to the "Pole," is his co-declination; and the distance from the "Vertical" to the pole, is the observer's *Co-Latitude*. These three compliments form what is called the *Astronomical Triangle*.

Thus we have the three sides of a spherical triangle, from which to find the several angles.

(6.) The angle at the Pole, contained between the meridian of the observer and that passing through the sun, is called the *Hour Angle*, as it gives the distance from the sun to the observer's meridian, in time or arc, and is usually represented by the letter H.

(7.) The angle at the "Vertical," or at the observer's zenith, contained between the meridian and a vertical plane passing through the sun, is called the *Azimuth Angle*, and is usually represented by the letter Z.

This angle is the one particularly important to surveyors, as from it the place of the meridian is readily determined.

Navigator's look for this angle every day, when an observation can be had, and solve the triangle for Z, by one or both of the following equations.

$$\cos \frac{1}{2} Z = \left(\frac{\cos S \cos (S-p)}{\cos L \cos h} \right)^{\frac{1}{2}} \quad \dots \quad (a.)$$

$$\sin \frac{1}{2} Z = \left(\frac{\sin (S-L) \sin (S-h)}{\cos L \cos h} \right)^{\frac{1}{2}} \quad \dots \quad (b.)$$

in which

L = Latitude.	Z = the required Azimuth
d = Declination.	p = Polar Distance = $90^\circ - d$.
h = Height of the sun's center, corrected for refraction and parallax.	
S = $\frac{1}{2} (L + h + p)$.	

NOTE. — The correction for parallax, which is usually about $6''$, and never exceeds $9''$, may be neglected except in work of great precision.

To solve these equations numerically requires much computation, but the *Solar Transit* solves them for Z, *mechanically*, with no more computation than that required to deduce the declination for the longitude and local time of the observer, from that given in the Nautical Almanac for the day.

From the above definitions, it is readily seen that the following conditions, or relation between the parts of the instrument, must be established.

(A.) The polar axis must be *Vertical*, when the vertical arc (latitude arc) reads zero, and, consequently, perpendicular to the cross axis of the transit telescope.

(B.) The horizontal cross-wire of the solar telescope must be parallel with the plane of its rotation around the polar axis; *i. e.* it must be parallel with the plane of the equator.

(C.) The plane passing through the vertical wire and the optical axis of the solar telescope must be at right angles to the cross axis of the solar telescope.

(D.) The bubble of the level-tube on the solar telescope must be in the middle of its tube, when the optical axis of that telescope is in the plane of the horizon.

These conditions are obtained by the following

Adjustments.

Having attached the "Solar" to the cross axis of the telescope, as directed under the head of "*Remarks*," and having leveled up the transit (supposed to be in perfect adjustment) carefully, set the vertical or latitude arc to zero, observing that, upon rotating the whole instrument 180° in azimuth, the bubble of the level of the transit telescope is in the middle of the tube. Bring the level bubble of the solar telescope to the middle of the tube by means of the clamp and opposing tangent screws of the solar telescope; then revolve the solar telescope on its polar axis 180° to see if its bubble remains in the center of its tube: if not, remove half its error by means of the opposing tangent screws, the other half by the milled capstan-headed screws below the base-plate, until it remains in the center of the tube. Repeat if necessary.

Turn the solar telescope 90° on its polar axis, and by the milled capstan-headed screw level the base-plate and bring the bubble to the center of the tube. Repeat the operation until the bubble of the solar telescope remains in the center of the tube upon revolving the solar telescope around its polar axis. (This condition must be attained before the polar axis can be set to the co-latitude of the observer; and being attained it needs no further attention than being examined at times for verification).

The adjustment of the polar axis to be truly at right angles to the line of sight of the main telescope is made by two milled capstan-headed screws and two opposing springs at right angles to each other below the base or leveling plate of the solar attachment. As will be seen in making this adjustment it is not necessary to place the solar telescope parallel or at right angles to the main telescope, but simply in the same vertical plane of each set of leveling screws and springs at the time. This adjustment is made by the manufacturer and thereafter needs only to be examined at times.

If the adjustments are properly made the *bubble of the level of the transit telescope* and those of the plate levels on the transit will all be in the center of their tubes, and the vertical arc will read zero.

Bisect some convenient object, and turn the solar telescope sufficiently to the right or left, around the polar axis, to make the image of the object traverse the field from one side of the tube to the other. The image should remain bisected by the wire. If not, loosen the four capstan-headed screws of the diaphragm till the above condition is attained, and fasten the screws securely.

The solar telescope showing usually objects inverted, requires the cross-wire diaphragm to be moved as described on page 58 of Manual.

Bisect any very *distant* object in the horizontal plane by the main telescope, and clamp. Then, by means of the clamp and opposing tangent screws on the solar telescope, bring its horizontal cross-wire to bisect the same object; then, by means of the capstan-headed screw of the solar telescope level bring the bubble to the middle of its tube. This being done, the optical axes of the two telescopes will lie in parallel planes for distant objects and the instrument is ready for use.

All these adjustments are made by the manufacturer, and need to be verified only occasionally.

Before the solar attachment is available for finding meridian, the observer must know his *Latitude*, and the sun's *Declination* for the day and hour of observation, corrected for refraction, whence the

Reduction of Declination and Refraction.

The sun's *Declination* is given for noon of every day in the year, in the Washington and Greenwich Ephemeris of the sun, for those meridians. The maps and charts in use will give the difference of *Longitude* to all the precision required, and tables in this manual give the required *Refraction*.

An example will best illustrate:

Required a declination table for the different hours of the day for April 25, 1885. Lat. 44° N., and Longitude 97° W. At 15° to the hour, 97° of longitude is about $6\frac{1}{2}$ hours of time, and as this longitude is W., 12 o'clock, or noon, at Greenwich will correspond to $5\frac{1}{2}$ A. M. at the place of the observer.

The declination, as given for that day, in the Greenwich Ephemeris, is $13^{\circ} 20' 04''$ N., and is shown to be *gaining* at the rate of $49''$ per hour (see column headed Difference for one Hour, with the signs + for sun going North, and — for sun going South).

If now, to the declination for $5\frac{1}{2}$ A. M., we add the hourly rate of change successively, we shall have the declination for the several hours of the day, observing that the first increment is for only half an hour, thus: —

Form of Daily Declination Table.

APRIL 25, 1885.

Hourly difference		Dec. + $49''$	Hourly difference + $49''$	
Dec. $5\frac{1}{2}$	A. M. N.	$13^{\circ} 20' 04'' +$	1 P. M. N.	Dec. = $13^{\circ} 26' 11'' +$
" 6	"	$13 20 28 +$	2 "	" = $13 27 00 +$
" 7	"	$13 21 17 +$	3 "	" = $13 27 49 +$
" 8	"	$13 22 06 +$	4 "	" = $13 28 38 +$
" 9	"	$13 22 55 +$	5 "	" = $13 29 27 +$
" 10	"	$13 23 44 +$	6 "	" = $13 30 16 +$
" 11	"	$13 24 33 +$	7 "	" = $13 31 05 +$
" M.	"	$13 25 22 +$		

The above table must be corrected for the effects of refraction, before it is set off on the vertical arc of the transit. Refraction increases the apparent altitude of an object, and thereby affects the declination of the object — $\left. \begin{array}{l} \text{increasing} \\ \text{diminishing} \end{array} \right\}$ the declination when of the $\left. \begin{array}{l} \text{same} \\ \text{different} \end{array} \right\}$ name with the latitude.

From the + sign of the "difference" of declination, we see that the declination is of the same name as the latitude, whence the correction is an *increment*, and accordingly the + sign as suffixed. This sign belongs to the refraction.

When the object is in the meridian, refraction affects declination by its full amount; but, if both the observer and the object were in the plane of the equator, refraction would have no effect on the object with regard to refraction; whence, between these limits, only a part of refraction is effective in changing the declination.

Just what portion is effective, is shown by table II. of this paper.

Thus, in the given Lat. 44°, and for, say 4 hours from noon, the percentage of refraction to be applied is .74 of that corresponding to the altitude of the object at the time of observation. The sign \pm to be used must be determined, as above, by considering whether the sun is going north or south at the time.

This part of the reduction of declination cannot, of course, be made till the altitude is found at the time of observation.

To Find the Latitude.

Having prepared the declination for the day, as above, level up the transit carefully. Level the main telescope, observing that the vertical arc reads zero, and set the polar axis to a vertical position by means of the solar telescope level.

These points being attained, set the main telescope, pointing south. Then for a north } declination, dip
south } elevate } the south end of the telescope, till the vertical arc indicates the declination thus found.

Then, having turned the solar telescope into a vertical plane parallel with that containing the optical axis of the main telescope, level it carefully and clamp it.

A few minutes before the time of the sun's culmination, bring the telescope into the vertical plane passing through the observer and the sun, and "*find the sun*" with the solar telescope. This is readily done by varying the altitude when the sun's image will appear on the diagonal eye-piece.

Having "found the sun," bisect his image with the vertical wire, by varying the azimuth with the tangent screw of the transit plate, or with that of the outer center; and, simultaneously, follow him in altitude — the horizontal wire bisecting the image — till it ceases to rise, then clamp and read the vertical arc. *This reading should be the sum of the co-latitude and refraction*, the refraction being that due to the meridian altitude of the sun, which is the algebraic sum of declination and co-latitude. From this reading the latitude is readily deduced. With the latitude and declination known, we are prepared

To Find the Meridian.

(a.) As for finding latitude, level up the instrument carefully, the vernier of plate clamped, reading zero.

(b.) Point the telescope to the sun to find his altitude for the refraction. This can be found with sufficient accuracy by turning the telescope, till the shadow of a pencil held across the end, or till the shadow of the screws on the side, are parallel with the tube.

(c.) The refraction corresponding to this altitude must be multiplied by the corresponding coefficient, for the time from noon and the latitude, and applied to the declination, as per instructions above, for the *corrected declination*.

(d.) Point the telescope to the south, dipping, }
elevating } the south end for north } decli-
south } }
nation, till the vertical arc reads the corrected declination, and clamp the vertical arc.

(e.) The main telescope being dipped to the corrected declination, level the solar telescope by means of its level, being careful to do so when it is in a vertical plane parallel with that containing the optical axis of the main telescope, for only when it is in this plane can the declination be properly set off.

(f.) Elevate the south end of the main telescope to the *co-latitude*, by means of the vertical arc, and turn the telescope approximately into the meridian, by means of the magnetic needle.

(g.) "Find the sun" with the solar telescope. This is done by turning the whole instrument in azimuth, on its outer center, simultaneously with a motion of the solar telescope in right ascension, till the sun's image is seen in the eye-end of solar telescope. Bisect the image, as nearly as may be, by the two motions above named — clamp and complete the bisection, by both wires, or by the wires forming a square, by means of the transit's lower tangent screw, and by that of the solar telescope. If the image of the sun should be so large that it cannot all be seen from one position of the eye.

look around it by moving the eye around it in such a manner as to see the entire circumference, and bring the cross-wires on the four sides of the image *normal* to their respective sides, by means of the motion in azimuth and the motion of the solar telescope, as above described. This being attained, *the optical axis of the main telescope should be in the astronomical meridian*. Refer to an azimuth mark, and repeat the operation. The above is called a *direct* observation.

(h.) To make a *reverse* observation. Having made the direct observation, turn the whole instrument 180° in azimuth, and set the co-latitude off on the opposite side of the vertical arc. Also turn the solar telescope 180° , and proceed as before. The object of repetition is to eliminate personal non-precision and possible errors in manipulation, while the object of reversing is to eliminate any possible remaining errors of adjustment of the instrument. The prudent surveyor will not trust his work without such verification, and he will take the mean of both observations.

Remarks.

(1.) To unscrew the solar attachment from the packing-piece in the box, first release the clamp and tangent screw, and then turn carefully the milled-edged disk or base plate a few turns to the left. To screw the solar attachment to the instrument, turn this milled-edged disk from left to right around the screw on top of the main telescope without revolving the solar attachment. To insure a perfect contact of screw-shoulder against the flange, on which depends the permanency of the adjustment of the polar axis to the main telescope, it is necessary that these parts be free from dust, grit, or dirt of any kind.

(2.) The auxiliary or latitude level, if one is ordered, attaches in the same manner to the end of the cross axis on the side of the vertical circle.

(3.) The latitude level is used to facilitate during repeated observations the resetting of the polar axis to the co-latitude, assuming that the polar axis has been previously set to be at right angles to the main telescope by its milled capstan-headed screws and the solar level, the polar axis being placed in its position for an observation with more facility and precision with this level than by reading the vertical arc.

(6.) The latitude having been found for the initial point of a survey, it may be found for other points within moderate limits by allowing 92 chains of northing or southing for $1'$ of latitude.

(7.) The object of bringing the main telescope into the meridian by means of motion on the outer spindle is to have the zero line of the horizontal plate in the meridian, so that the azimuth or bearing of lines can be referred to that line.

(8.) If for any cause one is obliged to work with an uncertain latitude, it is better to do so with the sun as far from the meridian as practicable, for the following reasons :

It is only when the sun is in the pole of the meridian that it has its maximum efficiency in pointing out the direction of the meridian.

Hence a large hour-angle, and a small declination, are conducive to the elimination of errors resulting from an incorrect latitude.

Indeed, with the sun precisely in the pole of the meridian, the meridian is determined independently of latitude.

(9.) In making the several adjustments, or rather in verifying them, the student should have a true meridian established by some other means than by the "solar transit," as from the North Star, by some of the methods given in works on surveying. He should compare the results of his observations with this meridian at different times in the day, and under different states of the atmosphere, till he has learned any peculiarity of the instrument and the utmost precision obtainable with it, as well as the ordinary limit of non-precision.

NOTE.—The great utility of this auxiliary, or level attachment, is seen in the *setting of grades*. Two of these levels being applied to the telescope of a pivot-levelling instrument—one on each side—or one on each end of the cross-axis of a transit telescope, and one of them being adjusted to the *up*, the other to the *down grade*, the engineer may work in either direction on his grade with the same facility that he would on a level line.

Degree of Precision Required.

(10.) This, of course, depends on the character of the work to be done. In the U. S. Public Land Surveys,—which are, without question, conducted on the best plan the world can afford,—only compass lines are required. As a consequence, a wide margin for non-precision is given.

In sub-dividing a block of townships, the surveyor in coursing a random of 6 miles, is required to make his objective point within 3 chains. Charging the half of this error to lineal measurement, we find the error of coursing *must be within 10' of the true course.*

(11.) In *Manitoba*, the authorities, having fallen in love with our system of Public Land Surveys, have adopted it; but they require greater precision. They require clear transit lines, projected with the best six-inch silver lined instruments, graduated to 10".

In coursing a 6 mile random in the sub-division of a township, the surveyor must make his objective point within *one chain*, in order to save reviewing his work, charging, as before, one half of this error to the lineal measurements, we find the maximum error allowed in coursing *to be between 3' and 4'.*

(12) With the "*New Solar*," as manufactured by Messrs. C. L. Berger & Sons, the surveyor will be surprised and delighted to see the *facility and certainty* with which *he can bring his work far within the above limit.*

Inclination of the Meridian.

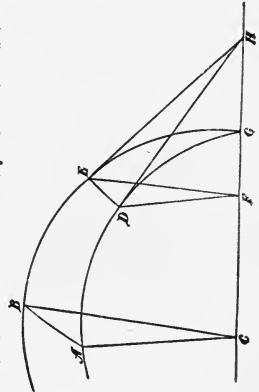
(13.) In projecting arcs of a great circle with the "solar transit," it is of the utmost importance that the surveyor be able to tell the inclination of the meridians for any latitude, and for any distance of eastings or westings.

As this problem is not treated in elementary works on surveying, perhaps the few following hints may be of use to the young student.

In the following figure, let the two arcs A G, and B G be two arcs of a quadrant of the meridian, 1° of longitude apart. Let A B = the arc of one degree of longitude on the equator = 69.16 miles.

Let D E be an arc of longitude on any parallel of latitude. Also, let E H and D H be the tangents of those meridians meeting in the earth's axis produced, and corresponding to the parallel of latitude D E.

Then the line E F = D F = cos L = cos A D or B E. Also, the angle D F E = 1°, and the angle D H E = the inclination of the meridians, which is the angle we wish to find, and which we will represent by X°. And because the two triangles F D E and D H E are on the same base E D, and isosceles, their vertical angles vary inversely as their sides; and we have the equation,



$$\begin{aligned}
 1^\circ \times EF &= X^\circ \times EH, & \text{But} \\
 EF &= \cos L, \text{ and } EH = \cot L, \text{ hence} \\
 X^\circ \cot L &= 1^\circ \cos L, \text{ or} \\
 X^\circ &= \cos L \div \cot L = \sin L, & \dots \dots \dots (a)
 \end{aligned}$$

That is to say,

The inclination of the meridians for any difference of longitude, varies as the sine of the latitude.

(14.) Since the sine of the latitude is the inclination in decimals of a degree, for one degree of longitude, if we multiply by 3600" we shall have the inclination in seconds of arc. Then, if we divide this by the number of miles in one degree of longitude on that latitude, we shall have the inclination due to one mile on that parallel. Thus, for

Latitude 43°	log. sine =	9.833783
Multiply by 3600"	" =	3.556303
		3.390086
Divide by 50 ^m 66, = 1° long. on that L, log. =		1.704682
48".46 = inclination for one mile of long.		1.685404

(15.) *The use of the Inclination*, as found by the preceding article, is to show the surveyor how much he must deflect a line of survey from the due east or west, to have it meet the parallel at a given distance from the initial point of the survey, — for it will be remembered that a parallel of latitude is laid out as a curve lying in a horizontal plane and having the cotangent of the latitude for its radius. And the line due east or west is the tangent of the curve.

Thus, on latitude 43° , I wish to project a six-mile line west, for the southerly line of a township.

Remembering that in an isosceles triangle, the angle at the base is less than a right angle by *half the angle at the vertex*, I deflect my line *towards the pole* by the inclination due to *three miles*,—or in this case $48''.46 \times 3 = 2'.25''$, *i. e.*, Deflection = $\frac{1}{2}$ Inclination.

(16.) *Table No. III*, which was computed from the formula (a) Art. 37, gives the *Inclination* for one mile, and for six miles on any parallel, from 10° to 60° of latitude; also the *Convergency* for six miles, on any latitude.

(17.) *The Convergency of the meridian* is readily found for any given distance from the corresponding inclination, by multiplying the *Sine* of the inclination by the given distance.

Thus, for latitude 43° , the inclination for one mile is $48''.46$; the sine of which is .000235. This, multiplied by the number of links in a mile, which = 8000, we have the convergency for one mile.=1.88 links.

Multiplying this by the number of miles in a township,=36, and we have the convergency for a township = 67.68 links. In this manner were the convergencies of table III computed.

(18.) *Deflection of Range-Lines from meridian*. The second column of table III shows the surveyor how much he must deflect the range lines between the several sections of a township from the meridian, in order to make the consecutive ranges of sections in a township of uniform width, for the purpose of throwing the effects of "convergency" into the most westerly range of quarter sections agreeably to law.

Thus, say between 45° and 55° of latitude, the inclination is practically 1' for every mile of easting or westing. Then, bearing in mind that in the U.S., the surveys are regarded as projected from the East and South to the West and North; the surveyor must project the *first range-line* between the sections of a township in those latitudes, 1' to the left of the meridian.

The second, 2'; the third, 3'; and so on to the fifth, which must be 5' to the left of the meridian on the east side of the township.

By this means all the convergency of the township is thrown into the *sixth*, or westerly range of sections, as the law directs.

The fourth column of the above table shows the amount of this convergency. This column is also useful in sub-dividing a block of territory embraced by two "standard parallels" and two "guide meridians" into townships. Thus, starting a meridian from a standard parallel on latitude 43° N, for the western boundary of a range of township,—say the first one west from the guide meridian,—and running North, say 4 townships, the surveyor must make a point that is *East* of the six-mile point on the northern "standard parallel" 4×67.7 links = 270.8 links. The second meridian should fall 8×67.7 links to the *right* of the twelve-mile point, etc.

(19.) *The Variation of the Needle*. This is easily determined by noting the reading of the needle when the solar transit telescope has been brought into the meridian.

Observation for Meridian with the Berger Solar Attachment.

Written for this catalogue by GEO. L. HOSMER, Massachusetts Institute of Technology.

CALCULATION.

Before beginning the observations the following computations must be made.

1. Take from the Nautical Almanac (table II, for the month) the sun's "apparent declination," for Greenwich Mean Noon of the date of the observation. If it is north prefix a + sign, if south, a - sign.
2. On the same line, in the next column to the right is the "difference for one hour," with the proper algebraic sign before it.
3. The local time corresponding to Greenwich Mean Noon may be found by subtracting the west longitude of the place from 12h, e. g. at the 75th meridian, this would give 7h A. M.; at the 90th, 6h A. M., etc.
4. Next compute the declination for each hour by adding algebraically the "difference for 1 h" to the declination for the preceding hour.
5. Next correct each of these declina-

tions for refraction, using the tables given in this catalogue, or such as are given in Prof. J. B. Johnson's work on surveying. Careful attention should be paid to signs.

We will assume for the present that the latitude is known, and proceed to the description of the

FIELD OPERATIONS.

1. Lay off on the vertical arc the declination setting for the time of observation, tipping the telescope in such a direction that the small telescope will point above or below the equator according as the declination is N. or S. 2. Level the small telescope by means of its attached level, and then clamp it. 3. Next change the setting of the vertical circle so that it reads the *co-latitude* of the place. 5. Using both the horizontal and the equatorial motions, point the small telescope at the sun, making the four segments cut off by the cross hairs equal. The main telescope is now in the meridian. To be certain that the settings are correct wait a few moments and see if the disc follows the equatorial wires perfectly. Both plates should be clamped while the image is in the center of the field. The line may then be brought down to the ground and marked.

EXAMPLE OF COMPUTATION.

Long. 5h. West., Lat. + 40°. Jan. 10, 1900.
Decl. for Gr. Mean Noon = — 21° 59' 04".
Diff. for 1h. = + 22".25.

TIME.	DECLINATION.	REFRACTION	SETTING.
7h. A.M.	21° 59' 04"		
8	58 42	5' 40"	21° 53' 02"
9	58 20	2' 51'	21 55 29
10	57 57	2' 07"	21 55 50
11	57 35	1' 51"	21 55 44
12 M.	57 13	(1' 47")	(21 55 26)
1 P.M.	56 51	1' 51"	21 55 00
2	56 28	2' 07"	21 54 21
3	56 06	2' 51"	21 53 15
4	55 44	5' 40"	21 50 04

The co-latitude may be found by measuring the altitude of the sun's lower limb at noon, i.e. by measuring the maximum altitude. This angle must be corrected for refraction, semi-diameter and declination. The result is the co latitude. The co-latitude may also be found, very nearly, as follows:— Make the angle between the telescopes equal to the declination setting *at noon* in the same way as for any other hour. Bring the telescopes into the same vertical plane, and point the small telescope at the sun. By varying the elevation angle of the main telescope keep the small telescope pointing at the sun until a maximum elevation is reached. This angle is the co-latitude, already corrected for refraction, semi-diameter and declination. This method is not quite as accurate as the former.

A TEST.

The following observations were made by the writer with the Berger Solar Attachment. The plates were clamped at zero degrees and the meridian found by solar observation. An angle was then turned to a mark $\frac{1}{4}$ mile away. The results are as follows:—

TIME.	AZ. ANGLE
A M.	
8:30	240° 07'
8:40	05½
8:50	05½
9:00	06
P.M.	
3:23	240° 05'
3:30	03

Clouds prevented further observations.

The true azimuth as found *afterward* by an observation on Polaris was 240° 05' 30".

Table I.

Mean Refraction of Celestial Objects for Temperature 50°,
and Pressure 29.6 inches.

Alt.	Refr.	Alt.	Refr.	Alt.	Refr.	Alt.	Refr.	Alt.	Refr.
0 0	33 0	5 30	9 8	12 0	4 23	23 0	2 14	46 0	0 55
10	31 22	40	8 54	20	4 16	20	2 12	47 0	0 53
20	29 50	50	8 41	40	4 9	40	2 10	48 0	0 51
30	28 23	6 0	8 28	13 0	4 3	24 0	2 8	49 0	0 49
40	27 0	10	8 15	20	3 57	20	2 6	50 0	0 48
50	25 42	20	8 3	40	3 51	40	2 4	51 0	0 46
1 0	24 29	30	7 51	14 0	3 45	25 0	2 2	52 0	0 44
10	23 20	40	7 40	20	3 40	20	2 0	53 0	0 43
20	22 15	50	7 30	40	3 35	40	1 58	54 0	0 41
30	21 15	7 0	7 20	15 0	3 30	26 0	1 56	56 0	0 38
40	20 18	10	7 11	20	3 26	20	1 55	58 0	0 35
50	19 25	20	7 2	40	3 21	40	1 53	60 0	0 33
2 0	18 35	30	6 53	16 0	3 17	27 0	1 51	62 0	0 30
10	17 48	40	6 45	20	3 12	30	1 49	64 0	0 28
20	17 4	50	6 37	40	3 8	28 0	1 47	66 0	0 25
30	16 24	8 0	6 29	17 0	3 4	30	1 45	68 0	0 23
40	15 45	10	6 22	20	3 1	29 0	1 42	70 0	0 21
50	15 9	20	6 15	40	2 57	30 0	1 38	72 0	0 18
3 0	14 36	30	6 8	18 0	2 54	31 0	1 35	74 0	0 16
10	14 4	40	6 1	20	2 51	32 0	1 31	76 0	0 14
20	13 34	50	5 55	40	2 47	33 0	1 28	78 0	0 12
30	13 6	9 0	5 48	19 0	2 44	34 0	1 24	80 0	0 10
40	12 40	10	5 42	20	2 41	35 0	1 21	82 0	0 8
50	12 15	20	5 36	40	2 38	36 0	1 18	84 0	0 0
4 0	11 51	30	5 31	20 0	2 35	37 0	1 16	86 0	0 6
10	11 29	40	5 25	20	2 32	38 0	1 13	88 0	0 2
20	11 8	50	5 20	40	2 29	39 0	1 10	90 0	0 0
30	10 48	10 0	5 15	21 0	2 27	40 0	1 8		
40	10 29	20	5 5	20	2 25	41 0	1 6		
50	10 11	40	4 56	40	2 23	42 0	1 3		
5 0	9 54	11 0	4 47	22 0	2 20	43 0	1 1		
10	9 38	20	4 39	20	2 18	44 0	0 59		
20	9 23	40	4 31	40	2 16	45 0	0 57		

Correction to the Mean Refraction given in the preceding Table.

Ap. Alt.	Height of the Thermometer.																											
	20° +''	24° +''	28° +''	32° +''	36° +''	40° +''	44° +''	48° +''	52° -''	56° -''	60° -''	64° -''	68° -''	72° -''	76° -''	80° -''												
0	0	2	4	2	18	1	55	1	33	1	11	51	31	10	10	29	48	1	7	1	25	1	43	2	12	19		
0	20	2	25	2	5	1	44	1	24	1	4	46	28	9	9	26	44	1	1	1	17	1	33	1	49	2	05	
0	40	2	11	1	53	1	34	1	16	58	42	25	8	8	24	39	55	1	10	1	24	1	38	1	38	1	53	
1	0	1	59	1	43	1	25	1	9	53	38	23	8	7	21	36	50	1	3	1	17	1	30	1	30	1	43	
1	20	1	48	1	33	1	17	1	3	48	34	21	7	6	19	32	45	57	1	9	1	9	1	21	1	33		
1	40	1	39	1	25	1	11	57	44	31	18	6	6	18	30	41	52	1	4	1	15	1	15	1	25			
2	0	1	31	1	18	1	5	53	39	29	17	6	5	16	27	37	48	58	1	8	1	8	1	18				
3	0	1	11	1	1	51	41	32	22	13	4	4	13	21	30	38	46	54	1	1								
4	0	58	49	41	33	26	18	11	4	4	10	17	24	31	37	44	50											
5	0	48	41	35	28	22	16	9	3	3	9	14	20	26	31	36	40											
6	0	41	35	30	24	19	13	8	3	2	7	12	17	22	26	31	35											
7	0	36	31	26	21	16	12	7	2	2	6	10	14	19	23	27	31											
8	0	32	27	23	19	15	10	6	2	2	5	9	13	16	20	24	27											
9	0	28	24	20	16	13	9	5	2	2	5	8	11	14	18	21	24											
10	0	26	22	18	15	12	8	5	2	1	4	7	10	13	16	19	22											
12	21	18	15	13	10	7	4	1	1	4	6	9	11	13	16	18												
14	18	16	13	11	8	6	4	1	1	3	5	7	9	11	14	16												
16	16	14	12	9	7	5	3	1	1	3	5	6	8	10	12	14												
18	14	12	10	8	6	5	3	1	1	2	4	6	7	9	10	12												
20	13	11	9	7	6	4	2	1	1	2	4	5	6	8	9	11												
25	10	8	7	6	5	3	2	1	1	2	3	4	5	6	7	8												
30	8	7	6	5	4	3	2	1	0	1	2	3	4	5	6	7												
35	7	6	5	4	3	2	1	0	0	1	2	3	4	5	6	7												
40	6	5	4	3	3	2	1	0	0	1	2	2	3	3	4	5												
45	5	4	3	3	2	2	1	0	0	1	1	2	2	3	3	4												
50	4	3	3	2	2	1	1	0	0	1	1	2	2	2	3	3												
55	3	3	2	2	2	1	1	0	0	1	1	1	2	2	2	3												
60	3	2	2	2	1	1	1	0	0	0	1	1	1	2	2	2												
65	2	2	2	1	1	1	0	0	0	0	1	1	1	1	2	2												
70	2	1	1	1	1	1	0	0	0	0	0	1	1	1	1	1												
80	1	1	1	0	0	0	0	0	0	0	0	0	0	1	1	1												
90	0	0	0	0	0	0	0	0	0	0	0	0	0	0	0	0												
Height of Barometer.				—	—	—	—	—	+	+	+	+	+															
				28'26	28'56	28'85	29'15	29'45	29'75	30'05	30'35	30'64	30'93															
				inches.	inches.	inches.	inches.	inches.	inches.	inches.	inches.	inches.	inches.															

EXAMPLE I.

What is the correction for refraction for an altitude of $8^{\circ} 5'$, the thermometer standing at 50.0° and the barometer at 29.6° inches?

Answer (by inspection) $6' 25''$:

and therefore,

Apparent altitude	=	$8^{\circ} 5'$
Refraction	=	$- 6 25''$
True altitude		<hr/> $7 58 35$

EXAMPLE II.

What is the correction for refraction for the same altitude, the thermometer standing at 44° and the barometer at 29.45 inches?

Thermometer correction for altitude $8^{\circ} 5'$	=	$+ 0 6$
Barometer ditto	=	$- 0 2$
Correction for both is	=	<hr/> $+ 0 4$
Mean Refraction	=	$- 6 25$
∴ True refraction	=	<hr/> $- 6 21$
		$o' \quad ''$
Apparent Altitude	=	$8 5 0$
True refraction	=	$- 6 21$
True altitude		<hr/> $7 58 39$

Table II.

Coefficients showing the per cent. of Refraction to be applied to the Sun's Declination.

Hours from the Meridian.							Hours from the Meridian.						
Lat.	1 H.	2 H.	3 H.	4 H.	5 H.	6 H.	Lat.	1 H.	2 H.	3 H.	4 H.	5 H.	6 H.
0							0						
10	56	33	24	20	18	17	36	94	82	71	64	60	59
12	63	39	28	24	22	21	38	95	85	74	67	63	62
14	69	45	33	27	25	24	40	95	87	77	70	65	64
16	74	50	38	31	29	28	42	96	88	79	72	68	67
18	78	55	42	35	32	31	44	96	89	81	74	71	69
20	81	60	46	39	35	34	46	97	90	83	77	74	72
22	84	64	50	42	38	37	48	98	91	85	79	76	74
24	87	68	54	46	42	41	50	98	92	86	81	78	76
26	89	70	57	49	45	44	52	98	93	88	83	81	79
28	90	72	60	51	48	47	54	99	94	90	85	83	81
30	91	74	63	54	51	50	56	99	95	91	87	85	83
32	92	77	66	57	54	53	58	99	96	92	88	86	85
34	93	80	69	61	57	56	60	99	97	93	90	88	87

For the construction of the above table, see p. 67.

Table III.

Inclination and Convergency of the Meridians.

Lat.	Inclination for one mile.	Inclination for six miles	Convergency for one township of 36 miles.	Lat.	Inclination for one mile.	Inclination for six miles	Convergency for one township of 36 miles.	Lat.	Inclination for one mile.	Inclination for six miles	Convergency for one township of 36 miles.
°	' "	' "	LINKS.	°	' "	' "	LINKS.	°	' "	' "	LINKS.
10	9.18	55	13.0	27	26.52	2 39	36.9	44	50.19	5 01	70.1
11	10.13	1 01	14.2	28	27.66	2 46	38.6	45	52.00	5 12	72.6
12	11.07	1 06	15.5	29	28.85	2 53	40.2	46	53.83	5 23	75.2
13	12.02	1 12	16.8	30	30.03	3 00	41.9	47	55.67	5 34	77.8
14	12.98	1 18	18.1	31	31.26	3 07	43.6	48	57.67	5 46	80.6
15	13.96	1 24	19.4	32	32.49	3 15	45.4	49	59.83	5 59	83.5
16	14.93	1 30	20.7	33	33.83	3 23	47.2	50	1 02.00	6 12	86.5
17	15.92	1 36	22.0	34	35.17	3 31	49.1	51	1 04.17	6 25	89.7
18	16.91	1 41	23.4	35	36.50	3 39	50.9	52	1 06.67	6 40	93.0
19	17.93	1 47	24.9	36	37.83	3 46	52.7	53	1 09.17	6 55	96.4
20	18.94	1 54	26.5	37	39.17	3 55	54.7	54	1 16.67	7 10	100.0
21	19.98	2 00	27.8	38	40.67	4 04	56.8	55	1 14.33	7 26	103.7
22	21.02	2 06	29.3	39	42.17	4 13	58.8	56	1 17.17	7 43	107.6
23	22.10	2 13	30.8	40	43.67	4 22	60.9	57	1 20.00	8 00	111.8
24	23.17	2 19	32.3	41	45.17	4 31	63.1	58	1 22.00	8 19	116.2
25	24.30	2 26	33.8	42	46.85	4 41	65.4	59	1 26.66	8 40	120.9
26	25.38	2 32	35.4	43	48.52	4 51	67.7	60	1 30.00	9 00	125.7

For the construction and use of the above table, see articles (13,) (14,) (15,) (17,) (18,) page 70.

For details of instruction in U. S. Government Surveying, see Hawes' *System of "Rectangular Surveying,"* and Burt's "Key to Solar Compass."

To Find the Meridian from "Polaris."

The north star, Polaris, being out of the pole of the equator, is in the meridian but twice in a stellar day — once above and once below the pole — called the upper and lower transits, or culminations.

It is also at its extreme distance, east and west, twice in a stellar day, called greatest *elongations*, east or west.

At the time of a culmination, it would be only necessary to get the bearing of the star to have the place of the true meridian. But this would require an exact knowledge of the time, an element not usually possessed by surveyors. Moreover, the observation must be made with certainty, at the instant, which is not always practicable. On this account, this method is not in favor with surveyors.

At elongation, the apparent motion of the star is tangent to the vertical, and therefore, for a few minutes, with regard to azimuth, it appears to stand still, thereby affording ample time for deliberate observation.

The distance of this star from the pole — called its polar distance, was $1^{\circ} 18' 16''$ on January 1, 1885, and is diminishing at the rate of about $19.06''$ per year, whence its distance in following years may be known.*

The azimuth of the star, corresponding to any polar distance, is variable with the latitude. Thus, an observer at the equator would see this star — say at eastern elongation — in the horizon, and at the distance of $1^{\circ} 18' 16''$ to the *right* of the pole, or true meridian.

If now the observer should go north, the azimuth of the star would increase with its altitude, till he should arrive at a latitude equal to the complement of the polar distance, when it would be N. 90° E. Between these limits, the bearing of the star, at elongation from the pole, would vary according to the following equation, in which Z = the azimuth, or bearing:

$$\sin Z = \frac{\sin \text{Polar Distance}}{\cosine \text{Latitude}}$$

As the telescope of the surveyor's transit is not usually of sufficient power to show the star in the daytime, the observation must be made at night, in which case the cross-wires of the telescope must be illuminated by light reflected into the tube. A piece of stiff white paper, with an opening large enough to admit of seeing the star through it, and held obliquely in front of the telescope, will make a good reflector.

As generally but one of the elongations can be seen, on the same night, it is important to know, which one is observed. Also the latitude must be known, at least approximately.

The pole is nearly in line between *Polaris* and the star *Mizar*, which is at the bend in the handle of the *Dipper*, so that when these two stars are nearly in a horizontal line and the dipper is $\left. \begin{array}{l} \text{east} \\ \text{west} \end{array} \right\}$ of the pole, *Polaris* is at his greatest elongation $\left. \begin{array}{l} \text{west} \\ \text{east} \end{array} \right\}$.

In sighting to the star, the observer must be careful to keep his transit level transversely, for the star is so high that inattention to this might introduce a serious error into the resulting azimuth.

A satisfactory sight having been obtained, the telescope should be brought down to fix a mark on the ground, at a distance of 300 to 400 yards from the transit.

This mark should be something clear and definite, like a nail set in a hub, driven into the ground, which may be located by means of a plummet lamp, or by means of a common lump in a box, having a vertical slit in one side of say $\frac{1}{4}$ or $\frac{1}{2}$ an inch in thickness, with a plumb-line suspended from the slit, and manipulated by an assistant.

The direction of the star being satisfactorily marked, compute the azimuth from the above equation, and set the resulting angle off to the $\left. \begin{array}{l} \text{right} \\ \text{left} \end{array} \right\}$ of the mark for western $\left\{ \begin{array}{l} \text{right} \\ \text{left} \end{array} \right\}$ elongation.

It may happen, that the resulting azimuth may have an odd number of seconds, or fraction of a minute, not convenient to be set off with a vernier graduated to

* Small corrections to the distances thus calculated are needed, but do not amount to more than $30''$ in all; see a Nautical Almanac.

single minutes. In this case, find the distance carefully between the transit and the mark, and multiply this distance by the tangent of the azimuth. The result set off to the $\left. \begin{array}{l} \text{right} \\ \text{left} \end{array} \right\} \text{ for } \left. \begin{array}{l} \text{western} \\ \text{eastern} \end{array} \right\} \text{ elongation, will point out the place of the true meridian.}$

Meridian from Equal Altitudes of the Sun.

If the direction of a star were observed with a transit when it had a certain altitude on the easterly side of the meridian and the direction again observed when it had an equal altitude on the westerly side, then the bisector of the angle would give the direction of the meridian.

If these observations are made on the sun an allowance must be made for the slight change in the sun's declination between the two observations. From about December 21 to about June 21 the sun is going north and from June 21 to December 21 it is going south. The table given below shows the number of seconds the sun moves in 1 hour on different days in the year.

To an observer in north latitude, when the sun is going north, the mean of the two vernier readings would lie to the west of south; if the sun is going south the mean would lie east of south. The correction to the mean of the vernier readings is found by the formula $\frac{D}{2 \cos \phi \sin t}$. In this formula D is the total increase or decrease in the sun's declination between the two observations; ϕ = the latitude; t = the hour angle, or very nearly $\frac{1}{2}$ the elapsed time.

Making the Observations.

1. In the forenoon, set up the transit, with the vernier set at 0° . Point at some object for an azimuth mark, preferably at the left of the sun, using the lower clamp and tangent screw.

2. Loosen the upper clamp and point the telescope toward the sun and find the sun's image in the field. Move the telescope slightly until the vertical and horizontal wires are found. The beginner is cautioned against mistaking a stadia wire for the middle wire.

In the forenoon the sun is rising and moving to the right. If the telescope has an inverting eye-piece these motions will of course appear to be reversed. If a prism is used the vertical motion will be contrary to what it would be without the prism, while the horizontal motion will not be affected.

3. Set the telescope at an altitude a little above the sun. Set the vertical wire on the *left* limb of the sun and follow it in azimuth, using the upper clamp and tangent screw, until the lower limb of the sun just touches the horizontal wire. At this instant stop following the motion in azimuth, note the time by a watch and then read the vernier. It will be well also to read the altitude.

4. In the afternoon turn the telescope toward the sun, *the altitude being the same as at the first observation*. When it comes into the field set the vertical wire tangent to the *right* limb of the sun. Follow it in azimuth until the lower edge of the sun again touches the horizontal wire. Note the time and read the vernier.

Calculations.

Take from the table the hourly change in declination for that day and multiply by the number of hours and fraction of an hour between the observations. The result is to be divided by twice the product of the cosine of the latitude by the sine of the hour angle. This gives the correction to the mean of the vernier readings. The hour angle is half the elapsed time and should be turned into degrees and minutes by multiplying by 15. Take the mean of the vernier readings and then subtract the correction if the sun is going north, add if it is going south. It is assumed that the circle reads from 0° to 360° in a clockwise direction.

REMARKS. If the instrument is not in a very stable condition it will be best to re-set on 0°, point at the azimuth mark again, and then re-set at the proper altitude as nearly as possible, before making the second observation.

The nearer the sun is to the east and west points the better the result. Observations near noon should be avoided. Observations at very low altitudes, say under 10° are unsatisfactory.

If only approximate results are desired the vertical wire may be made to bisect the sun's disc in both cases. This would avoid the mistake of getting the wrong limb.

EXAMPLE.

Date, April 10.		Latitude 43° N.	
		vernier A.	
Forenoon observation		13° 26'	right of mark
Afternoon "		148° 13'	" " "
		mean	80° 49' 30"
			diff. 9h. 30m.
Diff. 1h. = 54"			t = 4h. 45m.
54" × 9.5 h. = 513"			= 71° 15
cos φ = .7314			
sin t = .9469			
2 cos φ sin t = 1.3851			mean 80° 49' 30"
			corr 6' 10
$\frac{513}{1.3851} = 370."4 = 6' 10."4$			Angle between } 80° 43' 20"
			meridian and mark }

Hourly Motion of the Sun in Declination.

Day of Month.	Jan.	Feb.	March.	April.	May.	June.	July.	Aug.	Sept.	Oct.	Nov.	Dec.
	"	"	"	"	"	"	"	"	"	"	"	"
I	+ 12	43	57	58	45	21	10	38	54	58	48	23
5	17	46	58	56	43	17	14	41	56	58	46	19
10	22	49	59	54	39	12	19	44	57	57	42	14
15	28	52	59	52	36	7	24	47	58	56	38	8
20	32	54	59	49	31	+ 2	} 28	} 49	} 58	} 54	} 34	} - 2
25	37	56	59	47	27	- 4						
30	41	..	58	46	23	9	36	54	59	49	35	10

Transit Solar Attachment.

For running Meridian or other lines by the Sun.

Written for this catalogue with special reference to the wants of Public Land Surveyors, for both common and mineral lands, by J. B. Davis, Assistant Professor of Civil Engineering, University of Michigan.

1. Remarks. The attachment herein referred to is the Davis and Berger solar screen, prism, and colored shade glass, used for direct solar observation. These inventions have been devised by the Mr. Berger, of the firm of C. L. Berger & Sons, and by the writer. They are simply for the purpose of enabling one to make an observation directly upon the sun's centre. This observation being secured by readings of the horizontal and vertical circles, is reduced so as to give the direction of the line of sight of the transit at the instant of the observation. Thus knowing the direction of the line of sight at a given instant it becomes simply necessary to turn off the angle which this line of sight makes with the meridian, to ascertain the position of the meridian. This angle is what is obtained by reducing the observation, as above mentioned. A brief reference to the history of these devices will best explain them. It occurred to the writer to see if an image of the sun could be formed behind the eye-piece of a telescope at the same time an image of the cross-wires was, and the latter image be made to quarter the former, by allowing the sun to shine into the object end of the telescope and thence directly through it. The experiment was made by holding a piece of white paper behind the eye-piece, and adjusting the focus of the eye-piece and object glass. The very first trial was readily successful. The next thing was to see if the position of the instrument could be located by this means as near as the circles would read. By the same simple means it was soon found that a motion given to the telescope by either tangent screw might be so slight that the eye could not detect it upon the circles, but evidence of it would be apparent in the position of the images with reference to each other. This fact at once settled the question of whether this would be a sufficiently delicate means of observation. It showed that the observations would be closer than the circles would read. After some trials and some months rest these facts were brought to the notice of others, and finally were submitted to Mr. Berger for his opinion. He made a screen which the writer exhibited at the first annual convention of the association of Michigan Engineers and Surveyors at Lansing. The matter was further studied by Mr. Berger. The screen was much improved, and the mechanical construction of it brought to the standard of the work done by this firm. Mr. Berger soon conceived the idea of making the screen of ground white glass in a brass frame, as shown in figs. 1 and 2,*so one might observe the position of the images directly upon it, and thus secure not only the comfort of an easy position in observing, but the consequent accompanying accuracy. The arm of attachment was perfected from time to time. The screen of ground glass is mounted upon an arm that admits of all adjustments of position, and is so attached to the side of the telescope tube that it can be turned up out of the way when not needed. The reflecting prism can be screwed on to the eye-piece cap for observing at high altitudes. This also is adjustable so as to look in any desired direction from the telescope tube. The diagonal eye-piece also has its movable colored shade glass as above stated. With these attachments observations on the sun at all altitudes may be made in two ways. By looking directly at it through the simple colored glass for low altitudes, or through the prism and its shade glass for high altitudes. The other way is to receive on the screen the images of the cross-wires and the sun and make the image of the cross-wires just quarter the image of the sun by means of the slow motion screws to the circles of the instrument. For this method the colored shade glasses are not to be used. With this complete outfit one may work whichever way seems best.

* For Figures 1, 2, 3, 4, 5, 6 and 7 see page 175.

These devices are being more and more perfected, and will be protected by letters patent, and Messrs. C. L. Berger & Sons make and sell them exclusively.

2. Remarks. Certain precautions are necessary in the use of this method of finding the true direction of a line as well as in any other. It is not wise to observe the sun, read the circles, note down the readings and leave the instrument standing there while making the reductions. It will get out of place in some way, very likely. Therefore, as soon as the observation is completed and the readings of the circles noted, set the line of sight on some fixed point and read the plate again, noting this reading. Of course the two plate readings will give the horizontal angle from the sun to the line. This will enable the observer, after finding the direction of the line of sight when set on the sun, to readily ascertain its direction as set on the fixed point referred to, thus determining the direction of the line from the point over which the instrument is set to the fixed point. This line may be chosen before beginning the observation, and become the reference line for the work in hand.

3. Remarks. For the purposes of reduction the process by equations is used instead of one by rules. The introduction of symbols and signs is a much simpler matter than many suppose. It is nothing but this. We agree that a character of some sort or other shall represent a certain thing and nothing else. Whenever this character occurs, therefore, it simply means the thing we have set it for. That is all there is of symbolical representation. These very words here printed are all symbols. The method is universal. We here, as elsewhere in algebraic processes, make a special application of it. The rules for a case of this kind would be very cumbersome and give the user far more trouble than will be necessary for mastering the few equations given below. The record of the processes is hereby reduced to a few lines, and one has not to go searching through a page for a point here and there, but places his eye at once upon what he wants, where all will be found in a compact form. Of course one needs to read each word and each sign. Nothing must be slurred over or missed. The record as set forth below is exact, complete and reliable.

4. Remarks. All computations should be thoroughly checked, and check equations and devices are given. These should always be applied, without fail, as no one can implicitly trust a computation by a single process, unrepeatable, even if simple. No one should who is a surveyor or engineer. Several checks are given. One *used* is sufficient, usually. If one distrusts the check because it shows the work to be wrong, it may be of some satisfaction to use another or more than one.

5. Remarks. The *directions* prepared below are intended for use, word by word, and step by step. It is hoped that they will prove in convenient form for use as a chart to direct the efforts of the observer in his first use of these attachments and this method. Therefore, it is thought that one may safely do as told, trusting the next step to the next statement. They have been prepared with this view.

6. Using the Screen.

a. Directions. Set the instrument so the sun can shine in at the object end of the telescope, and directly through it. Run out the eye-piece and adjust the screen behind it, by its sliding arm, so that a distinct image of the cross-wires can be seen on the screen within the lighted spot made by the shining sun, as shown in fig. 2. Set the object glass so as to clearly define the image of the sun on the screen. Repeat these trials, and adjust the parts of the telescope and screen so that the clearest image of both the cross-wires and the sun will be obtained that the telescope will give. Mark the slide on the arm of the screen and the eye-piece, so they can be easily set thereafter for an observation.

b. Remarks. The eye-piece, when all is in exact position, will be found to be considerably farther out than for an ordinary sight. The marking of the sliding arm and eye-piece will save time in the future. These trials, when made with a new apparatus, should be conducted at leisure and with extra care, for the purpose of fitting the apparatus carefully to the telescope. A few trials may be needed at first in order to accustom the observer to recognize the best definition of the images.

This solar screen is especially adapted to the ordinary surveyors' and engineers' transit telescopes, with erecting eye-pieces. It is not adapted to be used with invert-

ing or astronomical telescopes, unless during an observation the aperture of the objective is cut down to $\frac{1}{2}$ inch diameter, by means of a diaphragm placed in front of it, when the image can be seen as sharply defined as those of the erecting telescope; or the observations must be made with the shade glasses and reflecting prism alone.

7. Using the Colored Shade Glass.

a. Directions. Attach the colored glass shown in fig. 4, to the eye-piece, to shield the eye from the sun and look directly at it, setting the cross-wires so as to quarter it.

b. Remarks. This will be found entirely satisfactory when the sun's altitude is so low as to enable the observer to bring his eye in apposition with the eye-piece of the telescope with ease.

8. Using the Diagonal Eye-piece.

a. Directions. Screw on the prism, as shown in fig. 3, to the end of the common eye-piece. Look directly through the shade-glass, if observing in that way, turning the prism either way so as to make it convenient to look into it. If any trouble is experienced in finding the sun with it, let the sun first shine through the telescope, the colored shade-glass being turned aside, till the brilliant light perceived in the aperture of this eye-piece shows the telescope to be rightly directed. Cover the aperture with its shade-glass and proceed.

b. Remarks. By attaching the reflecting prism to the eye-piece of the telescope, the light is reflected at right angles to the line of sight of the telescope, and it thus becomes what is termed a diagonal eye-piece.

This prism can be used for direct observation when the altitude of the sun is too great to allow the eye to be applied *directly* to the eye-piece of the telescope, and not so great as to bring the eye-piece too far over the plate, but through this range of altitudes the solar screen can be used without the prism, as shown in fig. 2, and it will usually be found advantageous to do so.

Since the prism in effect withdraws the eye about half an inch further from the eye-piece of the telescope than its natural position, that being about the distance traversed by the light in passing through the prism, the high magnifying power used in C. L. Berger & Sons' transit telescopes makes the use of the reflecting prism for *direct* observation a little awkward, and it will usually be found more satisfactory when using the prism to use the solar screen with it.

9. Using the Reflecting Prism and Solar Screen combined.

a. Directions. Attach the prism, and direct the telescope as in 8. Then, leaving the aperture of the prism uncovered, adjust the solar screen so as to receive the images of the sun and the cross-wires, as shown in fig. 1.

b. Remarks. For observing the sun at high altitudes it will be found that in this, otherwise most difficult of all positions, the use of the solar screen combined with the prism will enable the engineer to make his observation with the greatest ease and precision.

10. Making the Observations.

a. Directions. Direct the telescope to the sun, and by means of the slow motion screws, cause the image of the cross-wires to exactly quarter the sun's image. Read both circles and record the readings. Refer the position of the instrument to some fixed line, and once, *after* the above work, by another plate reading. Also note and record the exact instant of time of the observation by the watch.

b. Remarks. This observation with the watch may be used as hereafter indicated to simplify and lessen the amount of work in making the reductions. A fair watch of ordinary accuracy is sufficient. The entire work can be carried on without a watch at all, but it takes some more figuring.

11. Use of the Nautical Almanac.

a. Remarks. In order to use the observations, made as above directed, it is necessary to find the sun's apparent declination for the time of observation. This is done as directed below.

b. Conditions. Let all the algebraic signs be carefully observed throughout the work. Use the watch time.

c. Directions. For finding the Sun's apparent declination. Look in the table of Washington Solar Ephemeris against the date of the observation, and take out the following quantities. First, the sun's apparent declination, with its sign, + when N., — when S., from its column. Second, the hourly change, with its sign, from its column. Find from a map or otherwise, the difference in longitude between the place of observation and Washington, as near as one-half hour, or seven and one-half degrees. This is + when W. and — when E. of Washington. Add to this difference of longitude the time of the observation from noon, this time being + when the sun is W. and — when E. of the meridian. Multiply the hourly change by this result, in hours, noting all the signs. Apply this product, regarding its sign, to the sun's apparent declination as taken, from the table, for the sun's apparent declination at the time of the observation.

d. Example. Date, 1881—6—14. Hour, 9h—26m—24s, A.M. Longitude about 40 minutes East of Washington, considered in time.

☉'s apparent declination, 1881—6—14.	
Washington mean noon, +	23° 18' 15"
Hourly motion, +	7"
Time of observation from noon, —2 hours 30 minutes, about.	
Longitude East of Washington, — 40 minutes.	
Total time of correction, —3 hours 10 minutes, = 3½ hours.	
Amount of correction = —3½ × 7" = —22½"	
☉'s apparent declination from table, +	23° 18' 15"
☉'s apparent declination at time of observation, + 23° 17' 53" nearly.	

12. Reducing Observations.

a. Conditions. Let h' = the sun's altitude, as observed.

Let ϕ = the latitude of the place of observation.

Let δ = the sun's apparent declination at the time of observation, found as above directed.

Let z' = the sun's observed zenith distance.

Let z = the sun's true zenith distance, always +.

Let k and k' be two auxiliary angles used in the reductions.

Let A = the azimuth of the line of sight of the instrument at the instant of the observation, reckoned from the N. point of the horizon, either E. or W. as the sun is E. or W. of the meridian.

Let t = the sun's apparent hour angle at the time of the observation, that is the local apparent time from apparent noon plus the change in the sun's right ascension between apparent noon and the time of the observation. This is + when W. and — when E. of the meridian, or + for P.M. and — for A.M. times. The mean or watch time is sufficient for use in **2**.

Let p = an auxiliary angle used in some of the reductions.

Let all signs be faithfully regarded. Let logarithms be used.

b. Directions. For finding z from z' . Use the following equations.

$$z' = 90^\circ - h' \quad \dots \dots \dots (1)$$

$$z = z' + 55'' \tan z' \quad \dots \dots \dots (2)$$

c. Directions. For finding A when ϕ , δ and z are given.

$$\text{Find} \quad \tan \frac{1}{2} (k - k') = \cot \frac{1}{2} (\phi + \delta) \tan \frac{1}{2} (\phi - \delta) \cot \frac{1}{2} z \quad \dots (3)$$

$$\text{When } \phi < \delta \text{ and of the same name find } k = \frac{1}{2} z + \frac{1}{2} (k - k') \quad \dots (4)$$

$$\text{When } \phi > \delta \text{ and of the same name find } k' = \frac{1}{2} z - \frac{1}{2} (k - k') \quad \dots (5)$$

$$\text{When } \phi \text{ and } \delta \text{ have different names find } k' = \frac{1}{2} z - \frac{1}{2} (k - k') \quad \dots (6)$$

$$\text{Then find } A \text{ from } \cos A = \tan k \tan \phi \text{ or } \tan k' \tan \phi \quad \dots (7)$$

Checks.

$$\text{When (4) is used} \quad \frac{\sin \phi}{\sin \delta} = \frac{\cos k}{\cos k'} \quad \dots \dots \dots (8)$$

$$\text{or} \quad \frac{\sin \phi}{\cos k} = \frac{\sin \delta}{\cos k'} = \cos z \quad \dots \dots \dots (9)$$

When (5) or (6) is used $\frac{\sin \phi}{\sin \delta} = \frac{\cos k'}{\cos k}$ (10)

or $\frac{\sin \phi}{\cos k'} = \frac{\sin \delta}{\cos k} = \cos p$ (11)

Find $\sin p = \sin A \cos \phi$ (12)

Sin *p* and cos *p* are at the same place in the table.

d. Example. $\phi = 42^\circ 16' 30''$ N. $z = 52^\circ 43' 30''$
 $\delta = 18^\circ 13' 20''$ N. $\frac{1}{2} z = 26^\circ 21' 45''$
 $\phi + \delta = 60^\circ 29' 50''$
 $\phi - \delta = 24^\circ 3' 10''$
 $\frac{1}{2}(\phi + \delta) = 30^\circ 14' 55''$
 $\frac{1}{2}(\phi - \delta) = 12^\circ 1' 35''$

Checks.

Cot $\frac{1}{2}(\phi + \delta) = 0.2342195$	Tan $\phi = 9.9586273$.	Sin $\phi = 9.8278148$	Cos $\phi = 9.8691875$
Tan $\frac{1}{2}(\phi - \delta) = 9.3284570$	Tan $k' = 9.2477939$.	Cos $k' = 9.9933068$	Sin $A = 9.9943079$
Cot $\frac{1}{2} z = 0.3048785$	Cos $A = 9.2064212$.	Cos $p = 9.8345080$	Sin $p = 9.8634954$
Tan $\frac{1}{2}(k - k') = 9.8675550$	3894.	At same place in table.	
346	318.		
$\frac{1}{2}(k - k') = 36^\circ 23' 45''$	$A = 99^\circ 15' 22.75''$	Sin $\phi = 9.8278148$	Cos $k' = 9.9933068$
$\frac{1}{2} z = 26^\circ 21' 45''$		Sin $\delta = 9.4951325$	Cos $k = 9.6606232$
$k' = 10^\circ 2' 00''$		0.3326823	0.3326834
$k = 62^\circ 45' 30''$			

e. Remarks. Look out tan ϕ , cos ϕ , and sin ϕ , at one search. Use either check as may be preferred. This operation need not be performed oftener than the demands of the work require, the plate being used mean time.

13. Remarks.

The observations and reductions can be always made, according to the process given, without a watch, but the latitude of the place must be known. It must be carried on as the survey proceeds, by measurement, or an observation made to determine it with the instrument. If it becomes necessary to find the latitude it may be done as follows:

14. Finding the Latitude by the Sun.

a. Directions. For Observations. Near noon begin to observe the sun a little before it reaches its greatest altitude. By means of the slow-motion screws keep the sun's image exactly in place on the screen, or by direct sight keep the cross-wires exactly on the sun. As it moves upward just carefully follow it, recollecting that the object is to get its greatest altitude. Be careful to stop following it when it turns and begins to descend.

b. Directions. For Reductions. Find *z*, as in **12, b**. Find the sun's apparent declination, δ , as in **11, c**. Then

$z + \delta = \phi$, the required latitude. (13)

Be sure to observe the Algebraic signs, as δ may be + or -.

c. Remarks. Having the latitude in this way, the observations and reductions may be conducted according to the processes above given. The latitude once carefully ascertained by this or some other method, may be preserved by the distance traversed north or south of the point of the last observation for latitude. It will at once appear that the measurement and observation may be made to check each other. The method of reducing the change in latitude by linear measurement may be as follows:

15. Finding the Latitude by Linear Measurement.

a. Conditions. The latitude of the point measured from, or reckoned from, must be known. The measurements must be reduced to the north and south direction from the reference point. Let reduced distances north be +, and those south be -. Let all signs be observed. Let the true bearings, or directions of all lines with the meridian of the reference point, be given. Let any number of courses be run in any direction.

b. Directions. For reducing the north or south distances. Multiply the length of each course by the cosine of its bearing, the results being given signs as above indicated, + for northerly courses, and — for southerly courses. Sum these results regarding the signs.

c. Remarks. This sum will be the distance north or south of the reference point.

d. Directions. For reducing feet to minutes of Latitude. Find the length of a minute of latitude for the place by this equation.

$$m = 6076.36 \left(1 + \frac{\sin 2(\phi - 45^\circ)}{200} \right) \dots \dots \dots (14)$$

Then divide the traversed distance north or south of the reference point by the value of m found from this equation.

e. Remarks. The result will be the minutes and decimals of a minute of the new point from the reference point. This value of m will be in feet, hence the north or south distance must be in feet.

16. Remarks. The latitude may be dispensed with during a day's work after the first satisfactory observation. It may be for a longer period if the watch is to be depended upon. It will be well to find the latitude, and check the work occasionally, where the watch is used. In order to prepare the watch for this work, proceed as follows:

17. Correcting the Watch.

a. Directions. For correcting the Watch by a Noon Observation. Having ascertained the bearing of a line without the aid of the watch, as at first directed, near noon set the line of sight in a meridian. Set the telescope so the sun can be seen in it, or received on the screen as it passes the meridian. Note the time by the watch when the sun's west side comes in apparent contact with the vertical cross-wire. Note the watch time when the east side of the sun just touches the vertical wire. Find the time half way between these two noted times for the time of the meridian passage of the sun's center, or the time of apparent noon, by the watch.

b. Remarks. The time as above found should differ from exact noon by just the equation of time for that date and time as given in the Nautical Almanac. Observe the sign there attached to the equation of time. The watch may then be set to true time if not correct. That is, it may be set so that the time of the sun's meridian passage will be just the equation of time, with its sign, from exact noon.

c. Remarks. The watch may also be corrected directly from an observation, reduced as at first directed in 10 and 12. Here it will be necessary to take the watch time of the observation, as directed in 10. Having done so, and reduced the observation by 12, proceed as follows:

d. Directions. For correcting the Watch by an observation at any time. Having found A and z , and knowing δ , find t by the following equation.

$$\sin t = \frac{\sin A \sin z}{\cos \delta} \dots \dots \dots (15)$$

This being in arc, reduce it to time at the rate of four minutes of time to one degree of arc.

e. Remarks. This result should differ from the watch time of the observation from mean noon, by just the equation of time, with its sign. If it does not, set the watch so it would have done so had the observation been made with the corrected watch.

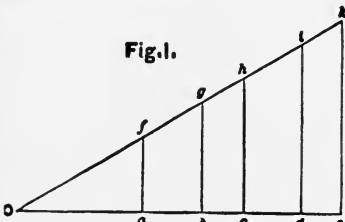
18. Remarks. Having corrected the watch by the last method, the value of t in time may be found from the value of t at this observation by noting the time by the watch of another observation, and thence finding the elapsed time. This applied to the first value of t will give its value for the last observation. Thus the value of t may be carried forward as long as the watch runs true. Of course it will occur to many at once that the watch can just as well be used to measure the elapsed time without being corrected. This is too careless. The better way is to keep a careful oversight of the watch by correction. Thereby it may be known how much the watch is to be trusted. It is always best to establish a routine system in these matters, as soon as practicable, and adhere faithfully to it.

On Stadia Measurement.

Written especially for this Catalogue by GEO. J. SPECHT, C. E., San Francisco, Cal.

A transit or theodolite, which is provided with the so-called stadia wires and a vertical circle, furnishes the means to obtain simultaneously the distance and the height of a point sighted at without direct measurement, and with the only use of a self-reading rod, held at the point of which the horizontal and vertical position is to be determined in reference to the instrument-point.

Besides the ordinary horizontal and vertical cross hairs of the diaphragm of the telescope, two extra horizontal hairs are placed parallel with the center one, and equally distant on each side of it, which, if the telescope is sighted at a leveling rod, will include a part of this rod or stadia-rod, proportional to the distance from the instrument to the rod. By this arrangement we have obtained an angle of sight, which remains always constant.



Supposing the eye to be in the point O (Fig. 1), the lines Oe and Ok represent the lines of sight from the eye through the stadia-wires to the rod, which stands consecutively at ke , id , hc , gb and fa . According to a simple geometrical theorem we have the following proportion:

$$Oa : Ob : Oc : Od : Oe = af : bg : ch : di : ek,$$

which means that the reading of the rod placed on the different points a , b , c , d and e is proportional to the distances Oa , Ob , Oc , Od and Oe .

The system of lenses which constitute the telescope do not allow the use of this proportion directly in stadia measurements, because distances must be counted from a point in front of the object glass at a distance equal to the focal length of that lens.

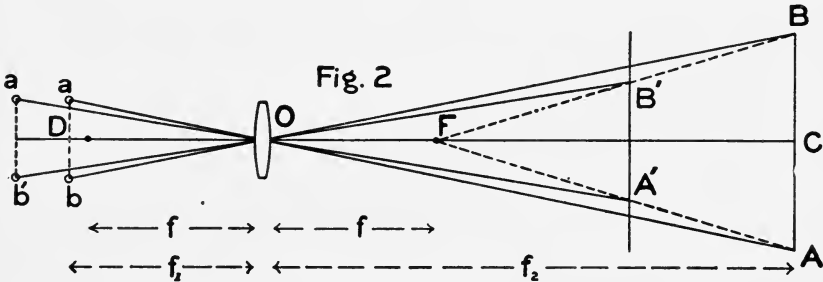


Figure 2 shows a section of a telescope provided with stadia wires.

In order to determine the distance of the rod from the instrument it will be necessary to use the following equations. From the "law of lenses" we have the relation

$$\frac{1}{f_1} + \frac{1}{f_2} = \frac{1}{f};$$

in which f_1 and f_2 are "conjugate foci" and f is the focal length of the object glass. From the diagram it is evident that $OC : AB = OD : ab$. If we let p = the distance of the stadia wires from each other, f_2 = distance OC and a = the space on the rod AB , and D the distance from the center of the instrument to the rod, then the second equation becomes $f_2 : a = f : p$. Eliminating f_1 from these equations we find:

$$f_2 = a \frac{f}{p} + f$$

or we may write, since $\frac{f}{p}$ is constant,

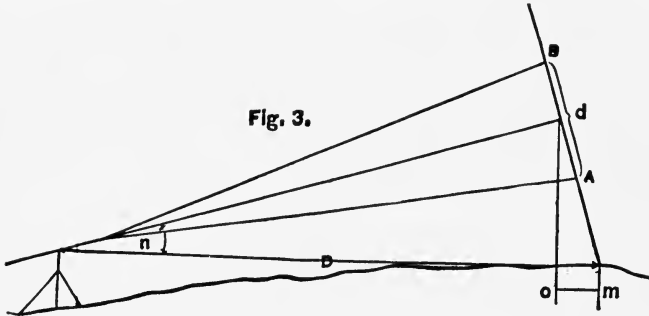
$$f_2 = ak + f.$$

From the center of the instrument to the rod the distance is

$$D = ak + (f + c)$$

c being the distance from the objective to the center of the instrument.

Since $(c + f)$ is practically a constant it is usually denoted by the single letter c , and is known as the "constant of the instrument."



When the line of sight is not level, but the stadia held at right angle to it, the formula for the horizontal distance is:

$$(2) \quad D = k.a.\cos n + c + om.$$

The member $\overline{om} = \frac{a}{2} \sin n$; for $a = 24'$, $n = 45^\circ$ the value of \overline{om} is but 8.4', and for $a = 10'$, $n = 10^\circ$ it is 0.86'; this shows that \overline{om} in most cases may safely be omitted.

Some engineers let the rodman hold the staff perpendicularly to the line of sight; they accomplish this by different devices, as, a telescope or a pair of sights attached at right angle to the staff. This method is not practicable, as it is very difficult, especially in long distances, and with greater vertical angles for the rodman to see the exact position of the telescopes, and furthermore, in some instances it is entirely impossible, when, for instance, the point to be ascertained is on a place where only the staff can stand, but where there is no room for the man. The only correct way to hold the staff is vertically.

In this case we have the following: (Fig. 4)

$$\begin{aligned} MF &= c + GF = c + k.C.D. \\ CD &\text{ must be expressed by AB.} \\ AB &= a. \quad AGB = 2m. \\ CD &= 2GF \tan m. \end{aligned}$$

And finally, after many transformations:

$$D = c.\cos n + a.k.\cos^2 n - a.k.\sin^2 n \tan^2 m.$$

The third member of this equation may safely be neglected, as it is very small even for long distances and large angles of elevation (for 1500', $n = 45^\circ$ and $k = 100$, it is but 0.02'). Therefore, the final formula for distances, with a stadia kept vertically, and with wires equi-distant from the center wire, is the following:

$$(3) \quad D = c.\cos n + a.k.\cos^2 n.$$

The value of $c.\cos n$ is usually neglected, as it amounts to but 1 or 1.5 feet; it is exact enough to add always 1.25' to the distance as derived from the formula

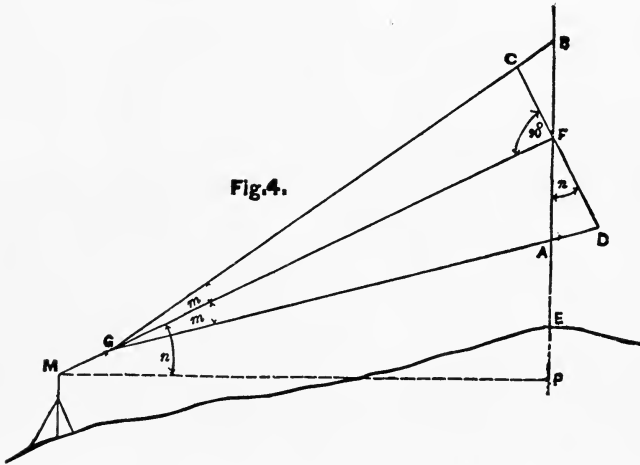
$$(3a) \quad D = a.k.\cos^2 n$$

without considering the different values of the angle n .

In order to make the subtraction of the readings of the upper and lower wire quickly, place one of the latter on the division of a whole foot and count the parts

included between this and the other wire; this multiply mentally by 100 (the constant k) which gives the direct distance D' .

In cases where it is not possible to read with both stadia wires, it is the custom to use but one of them in connection with the center wire, and then to double the reading thus obtained. With very large vertical angles, this custom is not advisable, as the error may amount to 0.50%.



To find the height of the point where the stadia stands above that one of the instrument, simultaneously with the distance, we have the following:

We assume in reference to figure 4,

q = height of instrument point above datum.

$MP = D$ = horizontal distance as derived from formula (3).

n = vertical angle.

$h = FE$ = stadia reading of the center wire.

Q = height of stadia point above datum; it is

$$Q = q + D \tan n - h.$$

The subtraction of h can be made directly by the instrument, by sighting with the center wire to that point of the rod, which is equal to the height of the telescope above the ground (which is in most cases = $4.5'$); q will be constant for one and the same instrument point; then the formula:

$$Q = D \tan n;$$

this in connection with formula (3) gives

$$Q = c \sin n + a.k. \cos n. \sin n.$$

or

$$Q = c \sin n + a.k. \frac{\sin 2n}{2}$$

The first term of the equation can be neglected, when the vertical angle is not too large; hence the final formula for the height is

$$(5) \quad Q = \frac{a.k. \sin 2n}{2}$$

The position of the stadia must be strictly vertical.

The error increases with the height of m ; (m = height of center wire on the rod). In shorter distances the result is seven-fold better when the center wire is placed as low as one foot than it is at $10'$; in longer distances this advantage is only double.

It is always better to place the center wire as low as possible. If the stadia is provided with a good circular level, the rodman ought to be able to hold it vertically

within 500"; that means, that the inclination of the stadia shall not be more than 0.023' in a 10' stadia, or 0.034' in a stadia of 15' length.

Determination of the two constant coefficients c and k . Although the stadia wires are usually arranged so that the reading of one foot signifies a distance of 100 feet, I will explain here, how to determine the value of it for any case. Suppose the engineer goes to work without knowing his constant, and not having adjustable stadia wires. The operation then is as follows:

Measure off on a level ground a straight line of about 1000' length; mark every 100', place the instrument above the starting point, and let the rodman place his rod on each of the points measured off; note the reading of all three wires separately, repeat this operation four times; the telescope must be as level as the ground allows; measure the exact height of the instrument. *i. e.*, the height of the telescope axis above the ground. Then find the difference between upper (o) and middle (m) wire; between middle (m) and lower (u) wire, and between upper (o) and lower (u) wire, from the four different values for each difference, determine the average value; then solve the equation for the horizontal distance (1) $D = k.a + c.$, with the different average values, and you find the value of k and c . In case the stadia wires should not be equi-distant from the center wire, there will be three different constants, one for the use of the upper and middle, one for the use of the middle and lower, and one for the upper and lower wire.

If the stadia wires are adjustable, the engineer has it in his power to adjust them so that the constant $k = 100$, or $k = 200$, which he accomplishes by actual trial along a carefully measured straight and level line.

The constant c , which is usually one and a half times the focal length of the object-glass, can be found closely enough for this purpose by focussing the telescope for a sight of average distance, and then measuring from the outside of the object-glass to the capstan-head screws of the cross-hairs. This constant must be added to every stadia sight; it may be neglected for longer distances.

Stadia Measurements.

Written for this catalogue and manual by H. C. PEARSONS, C. E., Ferrysburg, Mich.

In view of the great and growing interest in the subject of "*Stadia Measurements*," the following solution of the problem is offered, as applied to inclined measurements.

This solution is made from a different geometrical consideration than that usually employed, and it effectually does away with the necessity for any subsequent corrections, as with most schemes in use for inclined distances.

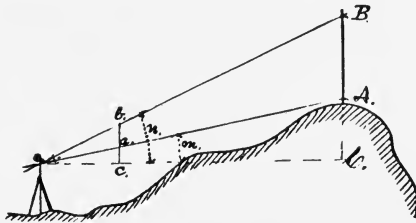
In the following discussion, let

R = the reading of the stadia rod;

D = the horizontal distance from plumb line of transit to stadia rod, which must be vertical.

m = the angle of elevation or depression to the *smaller* reading of the stadia rod.

n = the same angle to the *larger* reading.



Through the point c , at the distance of unity from the centre of instrument, draw the vertical cb . Then the rod AB , being also vertical, the triangles aob and AoB are similar, as are also the triangles cob and CoB . But the read-

ing, R , of the rod AB is the difference of the tangents of the angles of elevation, m and n . Also, the distance ab is the difference of the tangents of these angles, m and n , to distance unity, as given in the trigonometrical tables.

Whence, to find the horizontal $oC = D$, we have simply to divide the reading of the "Stadia Rod" by the difference of the tangents of the angles of elevation. Or, by formula,—

$$D = \frac{R}{\text{Tan. } n - \text{Tan. } m}$$

If one of the angles should be a depression or —, we must then divide by the sum of the tangents, and the formula would be

$$D = \frac{R}{\text{Tan. } n + \text{Tan. } m}$$

Example.—If $n = 12^\circ 16'$, nat. Tan. = .217426
 " $m = 10^\circ 10'$, " " = .179328

The difference of the tangents = .038098

Then, if $R = 12.26$ feet,

$$oC = D = \frac{12.26}{.038098} = 322 \text{ feet.}$$

It may happen that our transit has no vertical circle, or that we have no trigonometrical tables at hand. In either case, introduce an auxiliary rod, cb between the stadia rod and the plumb-line of transit, and at some known horizontal distance,—preferably 100 feet,—from the latter, and note the intercept ab .

This intercept is the analogue of the difference of tangents used in the former case, and must be used in the same manner, in dividing the reading of the stadia rod, when we shall have the distance, D , in terms of the distance of the auxiliary rod from the transit.

Example.—Suppose the intercept ab on the auxiliary rod, at distance 100 feet, is .845 foot, and that the reading R , of the stadia rod is 12 feet, then

$$oC = D = (12 \div .845) \times 100 = 1420 \text{ feet.}$$

If the height, H , of the foot of the stadia rod, above or below the height of instrument, be wanted, it may be had from the following equation:

$$H = \pm D \text{ Tan. } m,$$

in which the $+$ sign must be used for angles of elevation, and the $-$ sign for those of depression.

Or if the auxiliary rod be used instead of the vertical arc, note the intercept ab on this rod, between the level line oC and the line of sight to the foot of the stadia rod, and

Multiply this intercept by the ratio of D to oc .

Example—in the last case, if $ca = 1.06$ ft., oc being 100 feet, and $D = 1420$ ft. then

$$CA = H = ca \frac{D}{oc} = 1.06 \frac{1420}{100} = 15.05 \text{ feet.}$$

The Adjustments of the Auxiliary Telescopes of Mining Transits.

The Detachable Side-Telescope.

This telescope, illustrated on page 189, as ordinarily made, is attached to the transverse axis of the main telescope by means of a hub, which is screwed upon a prolongation of this axis beyond the standards. The hub contains an independent horizontal axis upon which the side-telescope may be revolved, and to which it may be clamped. The side-telescope is usually set parallel to the main telescope, and looking in the same direction, but it may be set so that it is inclined at a given vertical angle when the main telescope is horizontal. A counterpoise is attached to the other end of the transverse axis of the main telescope, so as to balance the weight of the side-telescope and retain that axis horizontal when the side-telescope is in use. The side-telescope is mainly intended as an auxiliary in measuring vertical angles, and it is on this account that the simple means of attaching it to the transit, here described, has been adopted by us as sufficient for the purpose, although it will be very difficult to place its line of collimation truly parallel to the main telescope for all focusing positions of the object-slide.

The adjustments of the detachable side-telescope are as follows:—

1. To place its vertical wire perpendicular to the transverse axis of the instrument. Attach the side-telescope and the counterpoise to the transverse axis. Clamp the side-telescope slightly to its hub, bisect a point by its vertical wire and move the main telescope on its horizontal axis of revolution. If the point remains bisected by the vertical wire of the side-telescope throughout its entire length this adjustment is correct. If not, loosen the capstan-headed screws and rotate the reticule bearing the wires, as explained on page 58, until the wire bisects the point throughout its entire length. Then slightly tighten the capstan-headed screws as explained in "Some Remarks Concerning Instrument Adjustments," page 20. Also see page 58.

2. To place the intersection of the cross-wires of the side-telescope in its line of collimation. This may be done in several ways.

(a) The side-telescope being detachable, it could be adjusted by rotating it in wyes, were any at hand. Such wyes, as we have shown before, may be improvised by cutting the proper shapes out of thin wood, and fastening a pair of them to a board in an upright position. The distance between them should be such that the telescope may rest upon the outside of the mounting of the object-glass and against its shoulder where the cap is placed, and upon the tube near the cross-wires when practicable. The improvised wyes being placed on a firm support and fastened so that they will not move, the side-telescope may be revolved in them, and the wires may be placed in the line of collimation as in a wye-level, using a distant point. The horizontal wire, being the more important one in the side-telescope, should be placed with some care.

(b) This adjustment for collimation may be made without removing the side-telescope, if for the adjustment of the horizontal wire a small spirit-level* mounted on a metal base, similar to those described on page 119, is at hand. Then proceed thus:

Adjustment of the horizontal wire. First, level up the instrument by its plate levels. Then, placing the main telescope in a horizontal position by its level, find a well-defined object, such as the target of a leveling rod, distant about 300 feet. Now clamp the side-telescope when in a nearly horizontal position to its hub, and placing the auxiliary level, which has been previously adjusted, longitudinally on the side-telescope bring its bubble to the center of the tube by means of the tan-

* Such a spirit-level mounted in a cast-iron frame, and good enough for this purpose if carefully selected, can be bought in any of the better equipped hardware stores.

gent screw of the main telescope and now, by turning the instrument on its vertical center see if the horizontal wire of the side-telescope bisects the object or target also. If so, this adjustment is made, but if not, it must be completed by moving the vertical capstan-headed screws as explained on page 58.

To verify this adjustment, the side-telescope may be reversed on its horizontal axis of revolution and clamped to its hub when nearly in the same level plane. Then turn the instrument a little more than 180° on its vertical center, place the auxiliary level on the side-telescope, same as before, and bring the bubble to the center of its tube by means of the vertical tangent screw. If now, when the side-telescope is in the reversed position the horizontal wire bisects the object also, this adjustment is completed, but if it does not then the horizontal wire must be moved again to a point half-way between the two readings.

This adjustment may also be made by the auxiliary level alone or by means of a striding-level without the aid of the main telescope (see page 140).

Adjustment of the vertical wire. Select a well defined object, as a church spire, distant 5 or 6 miles. Bisect it with the vertical wire of the main telescope, and without moving the instrument, look through the side-telescope and note whether the object is also bisected by its vertical wire. If not, make the adjustment by moving its vertical wire by the horizontal capstan-headed screws, until the object is bisected also. The distance between the two telescopes being only a few inches, the vertical wires will cover so great a width, if the object be sufficiently distant, that the effect of the excentricity of the side-telescope will be almost imperceptible and the same distant point may be used for each telescope.

(c) When a distant object is not available, measure with a pair of dividers the excentricity of the side-telescope, which is the distance between the centers of the two telescopes. Then transfer it to the face of a wall as far distant as practicable and make two marks whose horizontal distance apart is equal to this excentricity. Bisect one of these marks by the vertical wire of the main telescope and then look through the side-telescope and note whether the other mark is bisected by its vertical wire. If not, make it do so by moving the cross-wires of the side-telescope as described on page 58. The direction of the lines of sight should be at right angles to the surface upon which the two marks are made.

The position of the side-telescope with respect to the main telescope should be assured whenever the former is to be used. This may be done as follows: find a mark that is bisected by the horizontal wire of the main telescope. Then turn the instrument on its vertical axis and notice whether the horizontal wire of the side-telescope bisects the same mark. If so, firmly clamp the side-telescope to its hub. If not, gently tap one end of the side-telescope, which hitherto has only been loosely clamped, until its horizontal wire coincides with the mark and then clamp the side-telescope to its hub. The telescopes are now set to correspond with the zero of the vertical circle.

To place the telescopes at an angle with each other. Level up and fix a mark when the main telescope is level. Then raise or depress the main telescope the required angle and clamp the horizontal axis. Now move the side-telescope until its horizontal wire bisects the mark and clamp it firmly to its hub. During an extended operation with the side-telescope, the relative position of the two telescopes should be verified from time to time to detect any disturbance of the side-telescope.

Transits having the telescope mounted at the end of the horizontal axis of revolution are sometimes used in mines; or, as shown in the Alt.-Azimuths Nos. 14a and 15b, this construction is used in some instruments for geodetic and smaller astronomical work. The adjustment of such a telescope for collimation may therefore be explained in this connection. The following method is as simple as any:—

Select a well-defined object, as a church-spire, distant at least 5 or 6 miles. The instrument being leveled, bisect the object with the vertical wire and read the verniers of the horizontal limb. Then turn the vernier plate so as to read exactly 180° different from the previous reading, and revolve the telescope. If the vertical wire is adjusted for collimation it will again bisect the distant object, since the space covered by the cross-wires on an object at such a distance will be much greater than the change in the position of the telescope as caused by its excentricity from the center of the instrument. If it does not again bisect the object, correct one-half the error by means of the horizontal capstan-headed screws as explained on page 58.

The adjustment of the horizontal wire for collimation may be made by selecting one of the methods best adapted for a particular design of telescope.

These two adjustments should be repeated until both are correct.

To measure the eccentricity of the telescope, set up the instrument as near to a wall or other vertical object as possible. Draw a horizontal line upon the wall at a convenient height. Point the telescope exactly at right angles to the wall, mark where the vertical wire intersects the line just drawn, and read the verniers of the horizontal limb. Turn the vernier plate exactly 180° , revolve the telescope and make a second mark where the vertical wire now intersects the line. The distance between these two marks will be *twice* the eccentricity of the telescope.

When using an instrument of this description for short sights, it is very convenient to use sighting poles with excentric targets, or an offset at the foot of the pole corresponding to the excentricity of the telescope.

The Auxiliary Top Telescope,

Now superseded by the interchangeable auxiliary telescope, see style 1.

This auxiliary, as previously made by us, was mounted in adjustable wyes on standards permanently fixed to the main telescope, so that both lines of sight could be made parallel. The weight of the top telescope was balanced by a counterpoise attached to a stem also permanently fixed to the cross-axis of the main telescope. When the top telescope was not in use it was kept in the instrument box, while the standards and counterpoise stem were permanently fixed to the main telescope so as to avoid frequent and tedious adjustments. This feature made the instrument troublesome and unwieldy for the more ordinary work in mines, and still less convenient for surface work.

This improvement when first introduced by us superseded all other forms of top telescopes as made by others whose main object seemed to be simply to straddle another telescope above the main one (a mere commercial article, not an instrument of precision) for the purpose of steep sighting. But since the line of sight of such a telescope can never be placed truly at right angles to the cross-axis, the line of collimation does not move in a truly vertical plane, therefore horizontal angles measured between points differing greatly in elevation or in distance are never correct.

It can also be readily seen that the telescope of a solar attachment as commonly made, having no means of lateral adjustment to the main telescope, is insufficient in this respect (even leaving aside its low power and aperture) and cannot meet the requirements properly. The adjustment by which the line of collimation of top telescope is placed in the same vertical plane as that of the main telescope is just as important as that of the main telescope itself.

A most convenient and practical device having all the advantages of that former style, i. e., means of adjusting the line of collimation parallel to that of the main telescope, so that *after having been removed it will retain its adjustments when again attached*, is our new mounting of the top telescope by means of threaded studs. This enables the engineer to read horizontal angles when the main telescope cannot be used, obviating the making of corrections for the eccentricity of the telescope.

Patent Adjustable Top Telescope.

This device consists of an adjustable auxiliary telescope (see pages 189 and 193) and an open central pillar, which latter screws to a threaded stud cast on or permanently secured to the cross-axis of the main telescope. When not needed, the auxiliary telescope and its counterpoise may be returned to the box and the instrument is free of incumbrances, save the stem for the counterpoise and the stud to which the central pillar carrying the auxiliary telescope is attached, and is ready for surface work. If desired, the top telescope may be entirely unscrewed from the central pillar, leaving the latter attached to the main telescope.

The Adjustment of the Auxiliary Telescope used as a Top Telescope:—

It is assumed that all adjustments of the transit proper have been made, that is, that the plate and telescope levels, the line of collimation, the vertical plane, etc., have been verified and corrected, and that the verniers of the vertical circle read

zero when plates are leveled up and that the bubble of the telescope level is in the center of its graduation.

The adjustment of Line of Collimation of Auxiliary Telescope: First examine the coincidence of the intersection of the cross wires with the optical axis. This may be done by rotating the telescope in improvised wyes of wood (see p. 93), or by rotating it in the socket of the pillar [as sometimes made by us] by unscrewing it about one turn, when the adjustment is made by moving the capstan-headed screws as described on page 58. The telescope must now be screwed to its bearing in such a manner that the cross-wires are parallel to those of the main telescope—to be verified as explained in “To make the vertical wire perpendicular to the plane of the horizontal axis,” etc., p. 54.

To place the line of collimation of the auxiliary telescope in the same vertical plane with that of the main telescope. Bisect a distant object with the vertical wire of the main telescope; see if the vertical wire of the auxiliary telescope also bisects the same point. If not, move the auxiliary telescope by means of the pair of opposing milled-headed screws attached to its pillar nearer the eye-end until the distant object is bisected at the same time by both vertical wires. Now focus the main telescope on a near object and see if the vertical wire of the auxiliary telescope bisects the same point as the vertical wire of the main telescope. If not, make the adjustment by means of the pair of capstan-headed opposing screws on one side of the adjusting trivets of the pillar. Then re-examine both wires for coincidence with the distant object, using the milled-headed screws, and also repeat the adjustment for near object if necessary. The two lines of collimation are now in the same vertical plane.

To adjust the top telescope so that both horizontal wires bisect the same distant object. Bisect a distant object with the horizontal wire of the main telescope, and see whether the horizontal wire of the auxiliary telescope bisects the same point. If not, make the coincidence by means of the pair of opposing capstan screws in the trivets near the milled-headed screws. This being done, both these adjustments should be verified and repeated if necessary. These adjustments once carefully made assure the exact parallelism of both telescopes and will not require repetition except at long intervals, or after an injury.

The distance between the lines of sight of the two telescopes should be carefully measured by sighting at a vertical line on a wall—the telescopes being horizontal—when the distance between the intersections of the two horizontal wires on the line will be the eccentricity of the top telescope, for which every vertical angle measured with it should be corrected.

The Berger Style I Interchangeable Auxiliary Telescope (Patented).

See pages 189 and 193.

In this device Style I, the auxiliary telescope screws direct upon an open central vertical post cast in one piece with the transverse axis to secure great rigidity, the degree of accuracy of the result depending in a large measure upon the degree of accuracy with which the center of the pillar, and the line of collimation of the principal (then vertical) wire of the auxiliary telescope are made to lie in the same vertical plane as the optical axis of the main telescope or parallel to it. With the care given to it and special machinery used for it, this condition, difficult as it is, is secured to an extent which leaves little to be desired for all practical purposes. As the auxiliary telescope is interchangeable from top to side there is really need of but one wire, which we will designate as the principal wire. This, when the auxiliary is mounted on top, is the vertical wire, and when on the side becomes the horizontal wire. Therefore it will be seen that when the auxiliary is mounted on top the line of collimation of its horizontal wire is immaterial, as no vertical angles will then be measured. When the latter are to be measured the engineer will then mount the auxiliary on the side, when in turn the vertical wire becomes immaterial. The auxiliary telescope is provided with two milled-headed opposing screws for ranging in line with the main telescope. The auxiliary telescope's adjustment of collimation and coincidence of the cross-wires and optical axis must be verified by the use of improvised wooden wyes (see above), should it become necessary.

The success which the interchangeable auxiliary telescope has achieved, both here and abroad, since first invented by this firm in 1895 is somewhat phenomenal. It shows that this combination is the most applicable one in solving the difficult problems arising in mine engineering. For this reason every preparation has been made to meet the demand and new improvements are added as experience may suggest. All our top telescopes are therefore now made interchangeable.

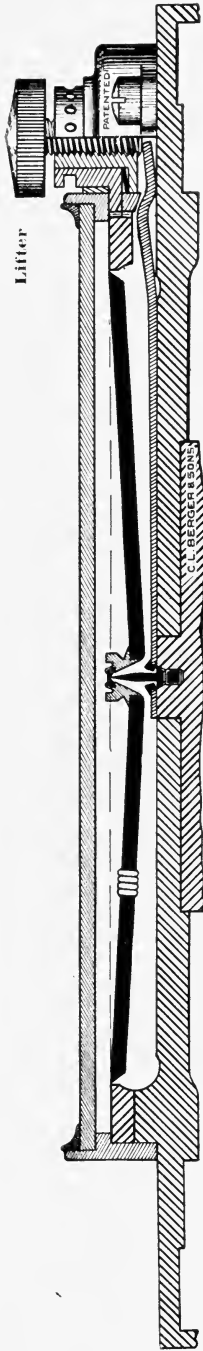
The Use of the Interchangeable Auxiliary Telescope for Astronomical Observations.

Besides its ordinary use for steep sighting in mines, the interchangeable auxiliary telescope, as described in the foregoing article, will at times be found very useful as an astronomical instrument. It is particularly advisable in making latitude observations by meridian altitude and in observing transits across the meridian for time. As a rule when the prism is attached to the eye-piece of the main telescope it is not possible with the engineer's mining transit to point the telescope at a greater angle of elevation than about 70° , consequently it would be impossible to make solar observations at a latitude lower than 40° when the sun is at its greatest declination or observation on stars near the zenith. However, by attaching the prism to the auxiliary telescope used as a top side telescope, these observations may be made with ease and this difficulty overcome.

In making latitude observations the interchangeable auxiliary telescope should be attached at the side; and its horizontal wire is then, by means of the two opposing tangent screws, made to correspond to the line of collimation of that of the main telescope by bisecting with both telescopes some distant and well-defined object: then, if a meridian mark is used (which is not absolutely necessary), the transit should be set up in the meridian by the main telescope and the pointing on the sun or star may be made with the auxiliary telescope with or without the prism, as conditions may require.

In observing transits the auxiliary telescope should be mounted on top and ranged into line with the vertical wire of the main telescope by using the two opposing screws as explained.

In making solar and stellar observations with the main telescope and prism attachment, the telescope should always be reversed through the standards with the objective down instead of up



Cross Section Showing Our Edge-bar Needle and Compass

— Likewise the watertight needle lifter combined with the toothed variation ring and pinion motion for instantaneously changing the graduation to any declination East or West.



Top View of Edge-bar Needle

Magnetic Needle of Edge-bar Form

The needle shown in the cross section of our Transit compass also in the top view on opposite page, represents the form adopted and preferred by us for all of our compass instruments, because it has its greatest dimensions in the vertical direction; hence its name. At the ends, where it is read, it is quite thin, but increases in thickness symmetrically towards the central part to give it the rigidity necessary to retain the true longitudinal shape and yet be very light of weight to minimize the dulling of the pivot on which it swings. The point of suspension in the steel cap* and the two ends of the needle are in a straight line, thereby forming the geometric axis.

The advantage derived from the edge-bar form, therefore, is that its magnetic axis must be contained in the geometric axis of the needle, whence it follows that there is no index error at its reading ends.

This cannot be claimed for a needle of the flat, oblong type, since its magnetic axis may follow the grain imparted to it in rolling the steel ingot. In such a needle the index error may be negligible or amount to a great deal, according to size and shape. Hollow, cylindrical, and elliptically shaped needles are not exempt from this error, and as their ends require brass extensions for reading the graduation in a surveyor's compass, the effective length of the needle is not only shortened, but the extensions in themselves may become an additional source of index error. As will be seen in the cross section, the center of gravity in the edge-bar form is very much below the point of suspension, which, together with the increasing weight of the needle toward its central part, makes it less sensitive to dip. The quivering of a needle so constructed is not annoying, since the center of its quivering motion is in line through its two extreme points, which are, therefore, stationary. Permanent magnet steel is used only in its construction, which, when properly hardened, will, at all times, retain sufficient magnetism to give the needle direction when resting on a sharp point. It is the dulling of the latter † which is commonly at fault when a needle does not settle repeatedly in the same place — not loss of magnetism as is generally supposed — and most of this difficulty may be obviated by carefully raising or lowering the needle and not allowing the needle to play when shouldering the instrument. To be light the steel cap is mounted in an aluminum cell.

* It is our belief that no advantage whatever is gained by suspending the needle on jewel bearings, but that a properly tempered steel bearing, resting on a steel pivot of a different temper, is superior to the jewel mounting. We find that in the instruments sent us for repair the jewels are almost always grooved by the wear of the pivot so that it is difficult, or impossible, to repair them satisfactorily. With steel bearings no such difficulty is encountered. As to danger of rusting, it is certainly no greater for the bearing than for the pivot, and the instruments sent in for repair do not often show signs of either bearing or pivot rusting.

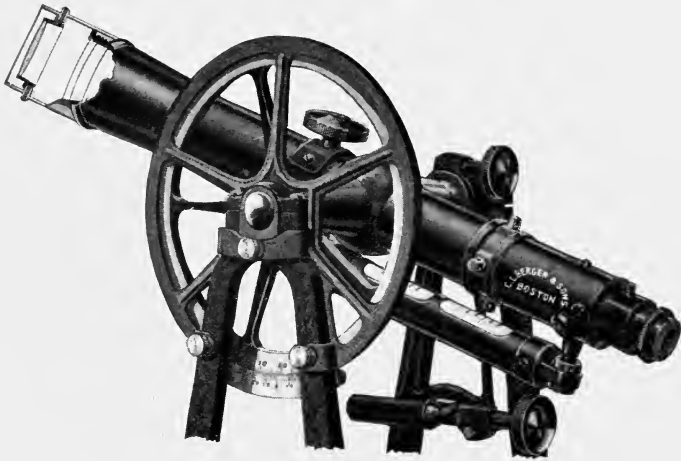
† In order to partially remedy the wearing on the point we sometimes, upon special request, furnish a needle of twisted form which can be made very light and be quite stiff in proportion to its weight. It is not of a strictly scientific shape but answers the requirements of a Surveyor's Compass. The needle consists of a flat bar of very thin permanent magnet steel. At the central portion of the bar, the blade is horizontal, while at the ends it is vertical as in the edge-bar form of needle. Between the center and the ends there are several twists in the bar. The points of the needle and the point of suspension are all in the same straight line in this new needle, as in the old. The center of gravity is placed as far below the point of suspension as the necessarily limited depth of the Transit compass permits, but owing to its extreme lightness the center of gravity should be carried much farther below than the old to counteract the dip to the same extent. In consequence **the needle of twisted form is more easily affected by change in latitude and its application is, therefore, limited, to use within latitudes differing not more than a few degrees.**

Caution.

The magnetic needle must always be lowered very gently on its pivot. The knob marked "Lifter" (see page 98) raises and lowers the needle. If the needle is lowered abruptly upon the pivot, its fine point may be dulled the first time, and the needle will then work sluggishly and not settle twice in the same place.

To use the Variation Plate, insert an adjusting pin into the castan-headed nut beneath the "Lifter," and by turning either way the desired declination may be set for East or West.

Berger Short Focus Lenses.



A sectional view of a Berger Short Focus Lens attached to an Erecting Transit Telescope.



No. 1 and 2 Lenses.



No. 1 Lens.

The above lenses may be attached separately or together, as shown; for a complete description see opposite page.

The Berger Short Focus Lens Attachment.

A very valuable addition to the engineer's outfit is found in the short focus lens attachment which has been brought out. The contrivance is simple, but, like many simple devices, is very effective in overcoming a practical difficulty. Probably every engineer has been annoyed by being obliged to sight a point a little too near for the telescope to focus. Most transit telescopes will not focus on a point much nearer than 5 or 6 feet (levels not nearer than 7 or 8 feet) away from the instrument, while it is frequently necessary to sight a point on the ground nearly under the transit, at a distance which is usually less than that.

In mine surveying as well as inside of factory buildings, one frequently needs to sight a point overhead or on the walls and very near the transit. Ordinarily the only way out of the difficulty is to focus as nearly as possible and do the rest by a guess. As a further instance, one often finds in leveling, that it will be necessary to take a reading on a point very near the instrument, and has to resort to various means (all of them inaccurate) of getting around the difficulty. The attachment mentioned consists of a small aluminum tube containing a simple lens, which is attached in front of the objective. The lens is so placed in the tube that it can be accurately centered by means of 4 adjusting screws. The effect of this lens is of course to bring rays to a focus nearer to the objective, and thus enable the observer to focus a nearer object than would otherwise be possible. When the telescope will focus no nearer than 6 feet, the attached lens, marked 1, is ground so that it will focus objects 6 feet away *when the objective tube is drawn away in*. This allows the entire motion of the focusing slide for distances between 6 and 4 feet. For distances nearer than 4 feet a second lens may take the place of the first and will focus up to about 2½ feet. If the two are used at once the distance is reduced to about two feet.

With this pair of lenses there is no distance between two feet and infinity at which objects cannot be focused. The accuracy of work done with this attachment is in no way affected by the centering of the attached lens itself, as this is capable of perfect adjustment. The only way in which error can occur is through the imperfection of the objective tube. If the cylindrical surface of the object-head of the telescope on which the attachment is placed is not concentric with the optical axis of the telescope this error will enter into the adjustment of the attached short focus lens. This error, however, is never large on an instrument sent out by our firm. But even admitting that there may be some error here, it must be remembered that this lens is never used for objects more than about 6 feet away; consequently the resulting error on the point is entirely negligible, and the convenience of the attachment in many cases is so great that it entirely outweighs any such consideration, since the work done at this distance will be entirely consistent with the work done with the instrument on the longer distances. The attachment fills a want that has long been felt by engineers and is certainly a step in advance in the perfection of instruments of precision.

To attach this device to their old instruments it will be necessary to send the instrument to them, as every lens attachment must be specially fitted and centered. However, it can be supplied with any of their new instruments, either Transits or Levels, made since 1899.

When attached to transits, No. 1 permits focusing objects to about 3½ feet, No. 2 permits focusing objects to about 2½ feet: both permit focusing objects to about 2 feet from center of instrument.

This is so important a feature that one trial will convince one that it is indispensable to the outfit of an engineer. The device is patented. The Messrs. Berger are also prepared to attach it to their Wye and Dumpy level, for focusing nearly as close as stated above for transits. For prices see catalogue, page 203.

NOTE.

In selecting instruments from catalogues, engineers should not be led so much by a simple comparison of prices, as by the advantage offered in superior merits, working capacity, and preservation of fine qualities in case of severe treatment. We can cite instances, where transits and levels of our manufacture had severe falls, resulting without injury to any part of instrument — not even disturbing the adjustments.

A larger outlay of \$10 or \$20 in the purchase of a superior article is a great saving in time and expense in the end.

Owing to the great variety of styles and combinations enumerated with our instruments (which combinations may easily be carried into the hundreds) the principal combinations only are provided for in the code at the back of the catalogue and Code names underlined indicate customary instruments which we intend to carry in stock. A large stock of these instruments is kept on hand, but owing to the very many combinations of sizes and styles and to the great demand, at times the instruments desired may have to be made specially, nevertheless. It is therefore advisable to order all instruments as far as possible ahead of the time intended for their use.

- CABLE-BERGER - BOSTON -

LABORE ET VIRTUTE



ESTABLISHED IN 1871

❁ PRICE LIST AND CATALOGUE ❁

OF
INSTRUMENTS
OF PRECISION FOR
SURVEYORS
ENGINEERS
AND **ASTRONOMERS**
MADE BY
C. L. BERGER & SONS
BOSTON, MASS.



PART II

RIBBING PARTS OF INSTRUMENTS.

Patrons will notice the omission in this edition of illustrations of the practice of ribbing and construction of parts of our instruments to gain strength and lightness.

We omit the illustrations of these improvements, introduced by us since 1871, because now they are in common use.

The cuts in this catalog show the lines on which we are advancing these improvements to an extent hitherto unknown.

ALUMINUM.

We omit cuts in former editions of parts of instruments made of aluminum alloys, because said cuts do not express the wider range of use to which these alloys are being applied by us today to instruments of special design for special purposes.

Nevertheless, in the present state of these alloys it is incumbent upon us to say that the opinion expressed in Part I of this catalogue must still generally be adhered to.

These alloys, in the construction of field instruments, must be used with extreme caution and judgment to give satisfaction.



The Berger Engineers' Dummy Level

15-inch Inverting Telescope.

[Patented]

For description and prices see Dummy Levels.



The Berger Engineers' 18-inch Wye Level.

Power 35 Diameters.

For description and prices see Wye Levels.



The Berger Complete Engineers' and Surveyors' Transit No. 1c.

For description and prices see Engineers' and Surveyors' Transit.

UNIVERSITY
OF CALIFORNIA



The Berger Complete Mine Transit No. 4.
With Style I interchangeable auxiliary telescope.
(Horizontal circle either 4 or 4½ inches.)

For description and prices see Mine Transits.





The Berger Complete Mine Transit No. 4 k.
With edge graduations and fully enclosed vertical circle.
For description and prices see Mine Transits.

— SIZES, WEIGHTS AND PARTICULARS — ENGINEERS — TRANSITS — SURVEYORS

SIZE	HORIZONTAL CIRCLE <small>AT EDGE OF GRADUATION</small>	TELESCOPE		COMPASS NEEDLE	WEIGHT		SHIPPING WEIGHT TWO BOXES	PAGE
		ERECT.	INVERT.		TRANSIT	TRIPOD		
N ^o 1	$\frac{1}{4}$ INCH = 159 <small>APERTURE $\frac{1}{4}$ INCH 31.5 mm LENGTH $1\frac{1}{2}$ INCH 292 POWER 28 DIA.</small>	$\frac{1}{4}$ INCH = 108 <small>APERTURE $\frac{1}{4}$ INCH 35 mm LENGTH $1\frac{1}{2}$ INCH 292 POWER 28 DIA.</small>	Lbs. KILOS 14 = 6.3	Lbs. KILOS 10 = 4.5	Lbs. KILOS 60 = 27	150		
"	$5\frac{8}$ IN. = 131 <small>APERTURE $\frac{1}{4}$ INCH 31.5 mm LENGTH $10\frac{3}{4}$ INCH 260 POWER 18 DIA.</small>	$3\frac{3}{4}$ IN. = 95 <small>APERTURE $\frac{1}{4}$ INCH 31.5 mm LENGTH $10\frac{3}{4}$ INCH 260 POWER 22 DIA.</small>	Lbs. KILOS 12 = 5.4	Lbs. KILOS 9 $\frac{1}{2}$ = 4.3	Lbs. KILOS 55 = 25	164		
"	SIZES: — SAME AS IN N ^o 2 TRANSIT							
"	$4\frac{1}{2}$ INCH = 114 <small>APERTURE $1\frac{1}{8}$ INCH 28.5 mm LENGTH $7\frac{1}{2}$ INCH 191 POWER 18 DIA.</small>	3 INCH = 75 <small>APERTURE $1\frac{1}{8}$ INCH 28.5 mm LENGTH $7\frac{1}{2}$ INCH 191 POWER 18 DIA.</small>	Lbs. KILOS 6 $\frac{1}{2}$ = 3	Lbs. KILOS 9 = 4	Lbs. KILOS 45 = 21	178		
"	4 IN. = 102	$2\frac{1}{2}$ IN. = 64	Lbs. KILOS 5 = 2.3			182		

MINING TRANSITS

"	SIZES: — SAME AS IN ENGINEERS AND SURVEYORS TRANSITS N ^o 4							182
"	SIZES: — SAME AS IN TRANSITS N ^o 1 AND N ^o 2							188

TUNNEL AND TRIANGULATION TRANSITS WITH YOKE STANDARD FRAME

"	$\frac{1}{4}$ INCH = 159 <small>ERECT. $\frac{1}{4}$ INCH 31.5 mm APERTUR $\frac{1}{4}$ INCH 31.5 mm LENGTH $1\frac{1}{2}$ INCH 292 POWER 24 DIA.</small>	$\frac{1}{4}$ INCH = 159 <small>INVERT. $\frac{1}{4}$ INCH 31.5 mm APERTUR $\frac{1}{8}$ INCH 35 mm LENGTH $1\frac{1}{2}$ INCH 292 POWER 28 DIA.</small>	Lbs. KILOS 14 = 6.3	Lbs. KILOS 10 = 4.5	Lbs. KILOS 60 = 27	212
"	7 IN. = 178 <small>ERECT. $1\frac{1}{4}$ INCH 38 mm APERTUR $1\frac{1}{4}$ INCH 368 LENGTH $14\frac{1}{2}$ INCH 368 POWER 32 DIA.</small>	$8\frac{1}{2}$ IN. = 203 <small>INVERT. $1\frac{1}{4}$ INCH 38 mm APERTUR $1\frac{1}{4}$ INCH 368 LENGTH $14\frac{1}{2}$ INCH 368 POWER 32 DIA.</small>	Lbs. KILOS 18 $\frac{1}{2}$ = 8.3	Lbs. KILOS 19 = 8.5	Lbs. KILOS 150 = 68	220

(CONTINUATION)

C. L. BERGER AND SONS BOSTON MASS.

LEVELING INSTRUMENTS

SIZE	TELESCOPE		SPIRIT LEVEL		WEIGHT		SHIPPING WEIGHT	PAGE
	ERECT.	INVERT.	LENGTH BETWEEN CENTERS OF SUPPORTING RINGS	SENSITIVENESS	INSTRUMENT	TRIPOD		

WYE LEVELS

18	INCH APERTURE $1\frac{3}{8}$ " 35 mm LENGTH 18" 457 POWER 35 DIA.	APERTURE $1\frac{3}{8}$ " 35 mm LENGTH 18" 457 POWER 40 DIA.	5 INCH 88 = 219	10-15-20	SECONDS	LBS. KILOS 11 = 5	LBS. KILOS 10 = 4.5	LBS. KILOS 55 = 24.8	134
14	APERTURE $1\frac{1}{4}$ " 31.5 mm LENGTH 14" 356 POWER 27 DIA.	APERTURE $1\frac{1}{4}$ " 31.5 mm LENGTH 14" 356 POWER 27 DIA.	3 IN. 54 = 146	15-20	SECONDS	LBS. KILOS 9 = 4	LBS. KILOS 9 1/2 = 4.3	LBS. KILOS 40 = 18	134

DUMPY LEVELS

17 1/2	APERTURE $1\frac{3}{8}$ " 35 mm LENGTH 17 1/2" 445 POWER 32 DIA.	APERTURE $1\frac{3}{8}$ " 35 mm LENGTH 15" 381 POWER 28 DIA.	7 3/4 IN. 197	10-15-20	SECONDS	LBS. KILOS 10 = 4.5	LBS. KILOS 10 = 4.5	LBS. KILOS 50 = 22.5	126
15	APERTURE $1\frac{1}{2}$ " 38 mm LENGTH 17" 432 POWER 40 DIA.	APERTURE $1\frac{1}{2}$ " 38 mm LENGTH 17" 432 POWER 40 DIA.	7 1/4 IN. 197	8-10	SECONDS	LBS. KILOS 11 1/2 = 5.2	LBS. KILOS 13 = 5.9	LBS. KILOS 60 = 27	139
12	APERTURE $1\frac{1}{2}$ " 38 mm LENGTH 17" 432 POWER 40 DIA.	APERTURE $1\frac{1}{2}$ " 38 mm LENGTH 17" 432 POWER 40 DIA.	7 1/4 IN. 197	2-3	SECONDS	LBS. KILOS 14 = 6.3	LBS. KILOS 15 = 6.8	LBS. KILOS 75 = 33.8	142

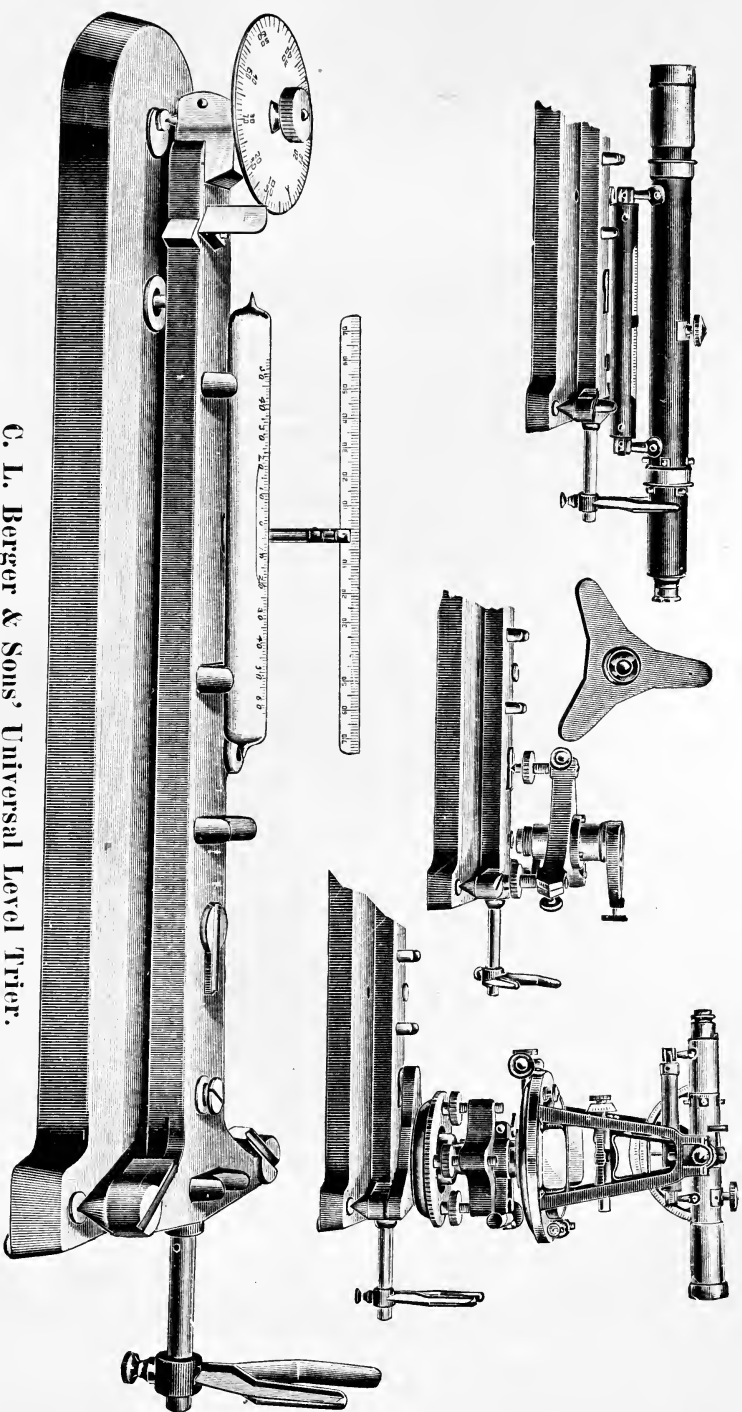
ENGINEERS PRECISE LEVEL

17	APERTURE $1\frac{1}{2}$ " 38 mm LENGTH 17" 432 POWER 40 DIA.	APERTURE $1\frac{1}{2}$ " 38 mm LENGTH 17" 432 POWER 40 DIA.	7 3/4 IN. 197	8-10	SECONDS	LBS. KILOS 11 1/2 = 5.2	LBS. KILOS 13 = 5.9	LBS. KILOS 60 = 27	139
----	--	--	------------------	------	---------	----------------------------	------------------------	-----------------------	-----

GEODETTIC LEVEL

17	APERTURE $1\frac{1}{2}$ " 38 mm LENGTH 17" 432 POWER 40 DIA.	APERTURE $1\frac{1}{2}$ " 38 mm LENGTH 17" 432 POWER 40 DIA.	9 IN. 229	2-3	SECONDS	LBS. KILOS 14 = 6.3	LBS. KILOS 15 = 6.8	LBS. KILOS 75 = 33.8	142
17	APERTURE $1\frac{3}{4}$ " 44 mm LENGTH 17" 432 POWER 40 DIA.	APERTURE $1\frac{3}{4}$ " 44 mm LENGTH 17" 432 POWER 40 DIA.	5 3/4 IN. 146	2	SECONDS	LBS. KILOS 14 = 6.3	LBS. KILOS 19 1/2 = 8.8	LBS. KILOS 120 = 54	144

U.S. COAST AND GEODETTIC SURVEY PRECISE LEVEL

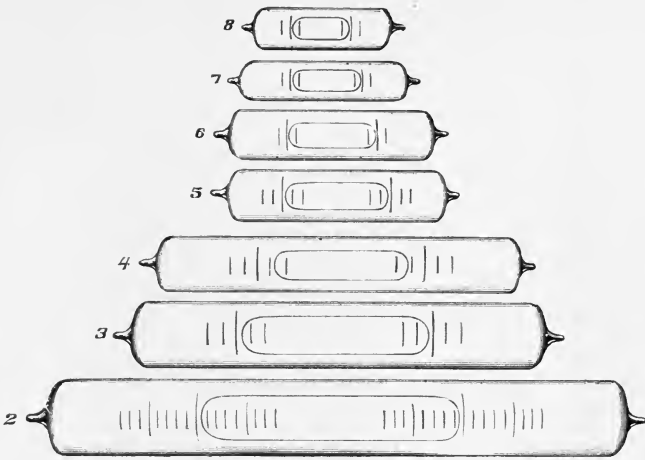


U. L. Berger & Sons' Universal Level Tryer.

With 21 inch iron base with fine micrometer screw, 1 div. = $2''$ of arc.
 For use in Engineering Schools, Physical Laboratories and Astronomical Observatories. Specially adapted for testing Spirit Levels on Engineer's Field Instruments without taking them apart.

Price of this Instrument, complete, as above - - \$43.00.

Price of this Instrument with auxiliary screw to allow repeating the same measurement on different parts of the screw and in ord. r to eliminate a possible eccentricity of the screw-point which would describe a small circle on the contact plate below it, and level to iron base. Extra, \$10.00.

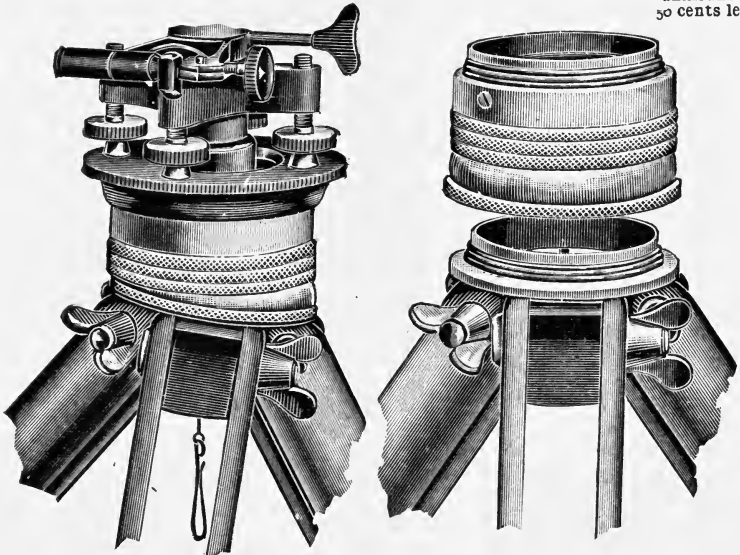


Spirit Levels.

For the benefit of our patrons we enumerate below the principal Spirit Levels we are prepared to supply at short notice. They are made by us, and are of the same superior quality as those furnished with our instruments. In the list below we give length, diameter, and degree of sensitiveness. They are graduated, as a rule, as shown above. — Levels different in size from this list can be made to order only, and will be furnished only when order is accompanied with *the tube or mounting for which one is intended, and also stating the kind of instrument it is for, and the degree of sensitiveness desired.* We will positively not make any levels upon written dimensions only, but require the tube to be sent in all cases, as otherwise we will not be responsible for any failure in that respect. Please read pages 6 and 15.

No.	Length from tip to tip in Inches.	Diameter in Inches.	Sensitiveness.	Price mounted, if tube is returned.
2.	6.50 to 6.60	0.75 to 0.80	One div. (0.10) = 10" to 20" of arc	\$4.50 to 5.00
3.	4.75	0.65 to 0.68	" (0.15) = 15" to 20" "	3.50 to 4.00
4.	4.10	0.58 to 0.60	" (0.15) = 15" to 20" "	3.50
5.	3.00	0.51 to 0.53	" (0.10) = 20" to 25" "	3.20
6.	2.40	0.51 to 0.53	" (0.10) = 60" "	1.50
7.	2.00 to 2.25	0.41 to 0.43	" (0.10) = 70" "	1.50
8.	1.68	0.41 to 0.43	" (0.10) = 75" "	1.50

Price unmounted, 50 cents less.



C. L. Berger & Sons' Quick Leveling Attachment.

Shown as applied to Levels and Transits.

(See page 45 of Manual.)

Code Word Entroba for use with Transit No. 4	\$20.00
Epilobium for all other sizes	15.00



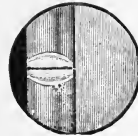
Code word . . . Oakadum.

Spirit-Level on Metal Base.

Ground Spirit-Level, one division of level about 20 sec. of arc; mounted on 8-inch metal base, provided with a handle. Level adjustable. In case.

Price, \$14.00

These levels are extensively used in machine shops for leveling up and testing fine machinery, etc., also used for leveling up apparatus in observatories, physical and chemical laboratories, and for setting weirs, etc.



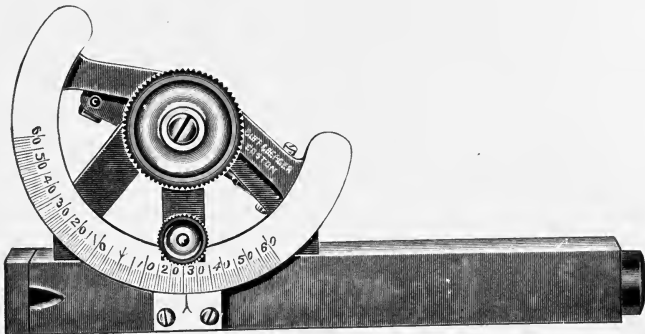
Code Word . . . Oakesia.

Locke's Hand-Level.

Brass or nickel-plated. In case

Price \$8.00

NOTE.—This consists of a brass tube 6 inches long, with a small level mounted on its top to the left of its center near the object end. Underneath the level is a horizontal wire stretched upon a frame. This frame is made adjustable by a screw and a spring working against each other, or by two opposing screws placed at the ends of the level mounting. In the tube directly below the level is placed a totally reflecting prism, acting as a mirror set at an angle of 45° to line of sight. The images of the bubble and wire are thus reflected to the eye. The prism divides the aperture in two halves, in one of which is seen the bubble and wire focussed sharply by a convex lens placed in the draw tube, while the other permits of an open view. Putting the instrument to the eye and raising and lowering the object-end until the bubble is bisected, natural objects can be seen through the open half at the same time, and approximate levels can then be taken. To prevent dust and dampness from entering the main tube, both the object and the eye ends are closed up with plain glasses. In preliminary work this is a very useful instrument.



Hand-Level and Clinometer.

Abney Level and Clinometer.

Price \$14.00.

NOTE.—This instrument is similar to the Locke's hand-level, but the small spirit level mounted on top can be moved in the vertical plane and clamped to a dial graduated in single degrees, thus the angles of slopes, etc., can be measured also.

Code Word . . . Oleander.

TRIPODS FOR LEVELS AND TRANSITS

We herewith list the sizes and weights of our customary Tripods so that additional ones may be ordered by mail or wire in case of loss or accident, etc. **The Instrument Number must always be given** to enable us to send the proper tripod. Price is not and includes special packing box. When ordering single legs, caps, or head complete with bolts, thumb-nuts and washers, it is only necessary to give the *Code Name* of the tripod for which the extra parts are needed together with the name and number of the parts desired.

				SPLIT LEG TRIPOD.				EXTENSION TRIPOD.					
				Material of Head	Weight	Price	Code	Weight	Price	Code	Weight	Price	Code
Tripod No. 1	for Dumpy Level,	page 126 (for instrument with four leveling screws)		Brass	10 lbs.	\$16.50	Tiarbus	11 1/2 lbs.	\$23.50	Timarbia	11 1/2 "	23.50	Timesdo
"	"	"	"	"	13 "	16.50	Tiaranth	11 1/2 "	23.50	"	"	"	"
"	"	"	"	"	10 "	24.50	Tiarella	"	"	"	"	"	"
"	"	"	"	"	9 1/2 "	16.50	Tibium	11 1/2 "	23.50	Timotra	"	"	"
"	"	"	"	"	13 "	27.00	Tibizando	"	"	"	"	"	"
"	"	"	"	"	13 "	27.00	Ticuna	"	"	"	"	"	"
"	"	"	"	"	10 "	16.50	Tietra	11 1/2 "	23.50	Tinarsum	"	"	"
"	"	"	"	"	14 "	32.00	Tidalis	15 "	39.00	Tincolinda	"	"	"
"	"	"	"	"	13 "	23.50	Titony	14 "	30.50	Tindaro	"	"	"
"	"	"	"	"	9 1/2 "	16.50	Tienillo	11 1/2 "	23.50	Tineldro	"	"	"
"	"	"	"	"	6 1/2 "	13.50	Tienso	6 1/2 "	19.50	Tinola	"	"	"
"	"	"	"	"	12 "	32.00	Tierbium	14 1/2 "	39.00	Tintis	"	"	"
"	"	"	"	"	11 "	23.50	Tigarda	13 1/2 "	30.50	Tionara	"	"	"
"	"	"	"	"	7 1/2 "	16.50	Tigelacum	9 1/2 "	23.50	Tipum	"	"	"
"	"	"	"	"	"	"	"	7 1/2 "	23.50	Tiputus	"	"	"
"	"	"	"	"	7 "	21.00	Tignadel	9 1/2 "	27.50	Tirabo	"	"	"
"	"	"	"	"	10 "	15.00	Tignumel	11 1/2 "	21.50	Tirica	"	"	"
"	"	"	"	"	10 "	16.50	Tigramot	"	23.50	Tirota	"	"	"
"	"	"	"	"	12 "	32.00	Tildaris.	13 1/2 "	39.00	Tisando	"	"	"
"	"	"	"	"	11 "	23.50	Tillable	13 "	30.50	Tisardum	"	"	"
"	"	"	"	"	22 1/2 "	"	Tillastis	"	"	"	"	"	"
"	"	"	"	"	"	"	Tilofa	"	"	"	"	"	"

Extra tripod caps of aluminum, \$1.50 each. Code, TixHo.

The full length split leg tripod enumerated with our Levels and Transits, used for surface work in cities and in the open country, is the only one recommended, inasmuch as it secures to an instrument of high power with very sensitive spirit level, maximum steadiness and freedom from tremor in a strong wind, that will enable to obtain the fullest benefit from a superior instrument, and as it is composed of fewer pieces than the extension tripod, it weighs less and ensures greater portability with the instrument on, and requiring but ordinary attention to prevent accidents. Sometimes an extra leg of the extension kind is desired for occasional use with the split leg tripod when surveying in a mountainous country. This is not advisable, since the form of our split leg tripod is not well adapted to receive an extension leg (having two clamps at the side) and because then such a tripod becomes subject to all the weak points of the extension tripod. The best practice, it would seem, is to order both kinds.

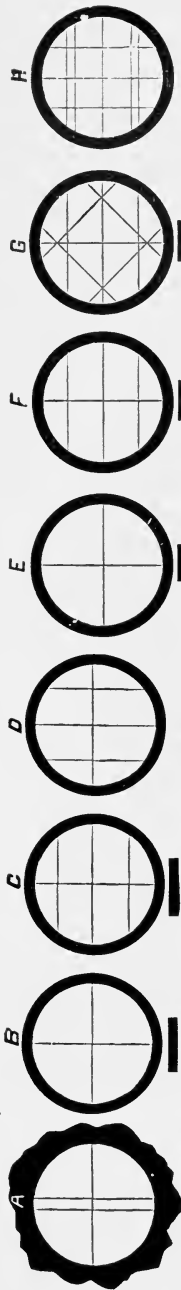
The Extension Tripod, although less steady, heavier and more subject to derangement than the split leg tripod just mentioned above, has the advantage of greater adaptability to ground, height and to the cramped conditions existing in underground work, and therefore it is the only proper one to use in subways, tunnels, sewers, mines, etc., or for surveying in the mountains.

The Half-Length Tripod, being shorter than the extension tripod, is often a necessity and of great convenience in cramped places in underground work.



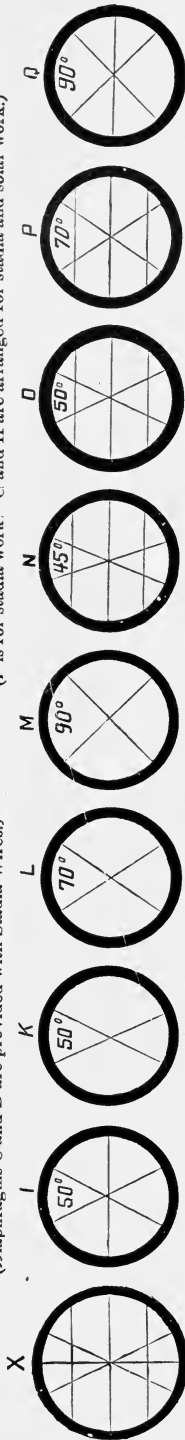
**Tripods for the Engineers' and Surveyors' Transits
and Levels.**

For description see page 7; for prices and weights, if extra ones are desired, see preceding page.



The Cross-Wire Arrangements for Dumpy and Wye Levels.
(Diaphragms C and D are provided with Stadia Wires.)

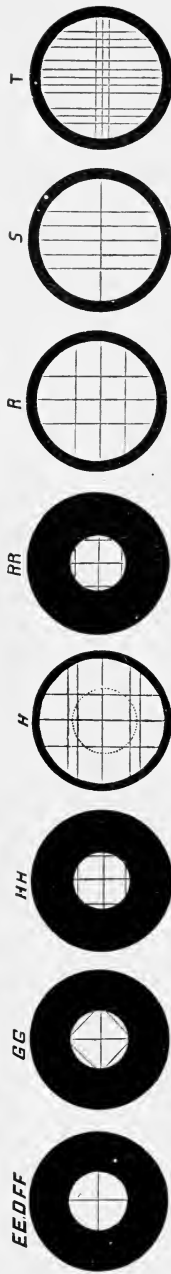
The Wires for Transits and Tachymeters.
(F is for stadia work. G and H are arranged for stadia and solar work.)



The Wires for Plain Triangulation Transits.

The Wires for Complete Triangulation Theodolites.
(N, O and P arranged for stadia work.)

Diaphragm, showing arrangement of wires as used with our transits, to distinguish center horizontal wire from stadia wires, to avoid mistakes in the dark.



The Sun's disc, as it appears when collimated by wires E, F, G and H
in Davis's Solar Attachments. (See pages 87 and 174.)

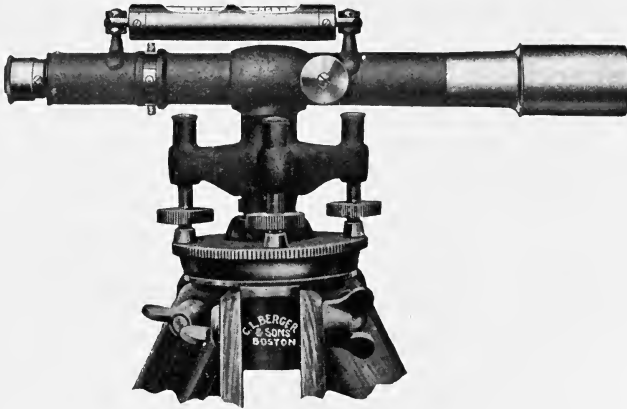
The Wire arrangement for Berger's Solar Attachment.

The Wires for Stellar Observations.

C. L. Berger & Sons' Sighting-Wire Diaphragms

As they appear in the Telescopes of the various Instruments.
Patented.

Road Builder's 12" MONITOR TYPE DUMPY LEVEL.



A sturdy, compact instrument of smaller size and less weight than our 14½" Monitor Type Dumpy Level.

This instrument has been designed by us to meet a growing want for the **highway** as well as for the **Drainage Engineer**. The degree of accuracy obtained with it is commensurate with the work required. The telescope is **erecting** and has lenses of **perfect definition** with a **large flat field of view** and is balanced from the center with sunshade attached. The **eye-piece cap is large** in diameter and made so that it affords a **protection** to the observer's eye in a **glaring sun**. It has been combined with a **dust-guard** which fully protects the eye-piece focussing slide.

The **spirit level** is very sensitive and is mounted on top of the telescope. It is protected by a **revolvable tube** to act as a guard to prevent breakage when not in use.

The **leveling head** is of a single casting of improved form, so that the center will not bind in the socket from any strain exerted by the four leveling screws which latter are protected from injury and dust.

We have adopted for this level our standard long stout center with which all of our instruments have been identified, thus adding to its stability.

This level will withstand rough treatment. The adjustments are few,*—when once made they are lasting—and above all the instrument is dependable at all times and free from any tremor even in a strong wind. Its rounded forms, together with the fine, dark and durable wear resisting leather finish applied to the exterior surfaces, appeal to anyone in sympathy with advanced instrument design.

SPECIFICATIONS:—

Telescope Erecting 12 inches long, aperture 1¼", power 24 dia. Focussing slide very long and provided with a dust guard.

Eye-piece with large flat field of view, provided with an improved screw arrangement permitting to focus the wires by simply turning its head slightly to right or left.

Spirit Level 5½ inches long between centers of suspending arms. The spirit level is very sensitive and accurately ground to a true curvature and barrel shape.

Center of hard bell metal.

Mahogany box provided with strap, lock, and hooks, contains sunshade wrench, screwdriver and adjusting pins.

Weight of instrument 7 lbs. Weight of tripod about 9 lbs.

Gross weight of instrument securely packed for shipment in two boxes about 35 lbs.

Code word: **Oleaster.**

Price as above **\$75.00**

Extras to 12" Monitor Type Dumpy Level.

Stadia Wires fixed in ratio 1:100	\$3.00
Gossamer water-proof bag to protect the instrument in case of rain or dust	1.00
Bottle of fine watch-oil to lubricate the lever center35

*—The above instrument, being of the Dumpy level type, has to be adjusted by the two peg

C. L. BERGER & SONS, BOSTON

14 $\frac{1}{2}$ " MONITOR TYPE DUMPY LEVEL.

Tubular Bar

A sturdy, compact instrument of precision. For use in the Army, about Fortifications, in Cities, Construction of Highways, Railroads, Tunnels, Mines, and about Factories, etc., where a smaller size and less weight is desirable.

In answer to many inquiries for a Dumpy Level to take the place of the frail and often badly designed 14 inch Wye Levels, commonly found on the market, we are offering this most advanced type.

The Monitor Type Dumpy Level is made to last. Its vital parts are strongly built in a stubby style. The center flange and the clamp and tangent screw are carried up very far into the hollow bar thus reducing the height of instrument to the tripod head and are protected from rain, dust, grit and injury. All this has been accomplished without sacrificing the standard long center with which all of our instruments have always been identified, thus adding to the stability of the instrument. **The hollow bar is tubular in form and therefore is deflection resisting.** A far greater amount of rigidity will be found in the Monitor type level bars which are greatly superior to those of the older familiar forms of same weight. These bars are not affected by temperature changes owing to the free circulation of air through and around the bar.

The telescope tube is made of a single casting and bored out to be truly cylindrical (not made of tubing, which is often oval in form, see page 128). The leveling head is also of a single casting of improved form, so that the center will not bind in the socket from any strain exerted by the four leveling screws. Owing to the peculiar construction of the socket the center-clamp screw cannot exert any pressure upon the center after the instrument is clamped to the socket, thus leaving the bubble undisturbed.

This Level will withstand all kinds of rough treatment when transported on mule-back, over mountains, impassable roads or through the wilderness. The adjustments are few,—when once made they are lasting — and above all the instrument is dependable at all times and free from any tremor even in a strong wind. Its rounded forms, together with the fine, dark and durable wear resisting leather finish applied to the exterior surfaces, appeal to anyone in sympathy with advanced instrument design. The telescope is erecting.

SPECIFICATIONS:—

Telescope Erecting 14 $\frac{1}{2}$ inches long, aperture 1 $\frac{3}{8}$, power 30 dia.

Focussing slide very long and provided with our collapsible dust guard, see page 128.

Eye-piece with large flat field of view, provided with an improved screw arrangement permitting to focus the wires by simply turning its head slightly to right or left. The eye-piece cap is large in diameter and made so that it affords a protection to the observer's eye in a glaring sun. It has been combined with a dust-guard which fully protects the eye-piece focussing slide.

Spirit Level 6 inches long between centers of suspending arms. The spirit level is very sensitive and accurately ground to a true curvature and barrel shape.

Center of hard bell metal.

Clamp and Tangent Screw.

Mahogany box provided with strap, lock, and hooks, containing sunshade, wrench, screwdriver and adjusting pins.

Weight of instrument 9 $\frac{1}{2}$ lbs. Weight of tripod about 9 lbs.

Gross weight of instrument securely packed for shipment in two boxes about 40 lbs.

Code word: **Alodol**

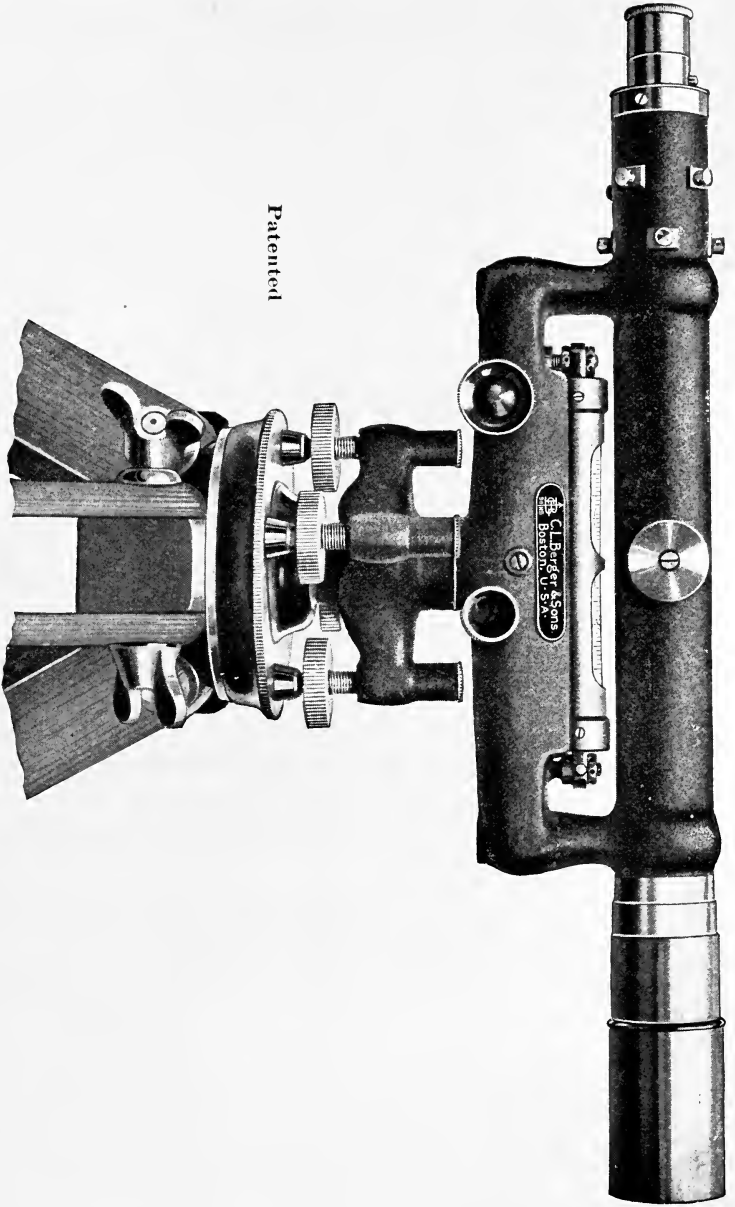
Price as above **\$115**

Extras to 14 $\frac{1}{2}$ inch Monitor Type Dumpy Level.

Stadia Wires fixed in ratio 1 : 100	\$3.00
Steel Center running in a cast iron socket to insure freest motion with perfect fit	10.00
Fine mirror mounted in case with universal joint. (This is readily attachable to either side of the instrument and facilitates the reading of the bubble on soft ground without stepping aside)	10.00
Gossamer water-proof bag to protect the instrument in case of rain or dust	1.00
Bottle of fine watch-oil to lubricate the lever center35

15" MONITOR TYPE DUMPY LEVEL.

Inverting Telescope. Aperture, Power and Price same as above. For description and cut see pages 126-127. (Code word: **Abardo.**)



Patented

Berger 14 1/2" Monitor Type Dumpy Level. (Tubular Bar.)

Erecting Telescope.

Aperture 1 3/8 inch, Power 30 dia.

This Level kept in stock. To save time may be ordered by telegraph using our code words.

Code Words for 14 1/2 inch Dumpy Levels.

- 14 1/2 inch erecting telescope
- 14 1/2 inch erecting telescope with fixed stadia wires

Alodol
Abadeno

15" AND 17½" MONITOR TYPE DUMPY LEVEL.

An instrument of **great precision**, superior to any Wye Level of same aperture, power of telescope, and same sensitiveness of spirit-level. **The best instrument for use in distant lands and rough country** on account of its **great compactness, simplicity, strength to withstand rough treatment, permanency of adjustments, and steadiness in a strong wind**, requiring **but ordinary attention and care to keep in working order**. For a fuller description, see page 128.

This new type of Dumpy Level with round, hollow, and very long cross-bar, must be considered the most perfect in this line. It stands low on the tripod, and its fine spirit-level, being placed in the hollow cross-bar, below the telescope, can be read from either side, and is entirely protected from accident and liability to derangement of adjustments, also from the disturbing influences of the heat of the sun, touch of fingers, breath, etc.—*These latter conditions are not fulfilled in instruments where the level is placed on top or at the side of the telescope, and are frequently causes of the incorrect reading of the bubble.*—This instrument is of **very strong build**, combined with a minimum of weight, and as it consists of a fewer number of pieces than the Wye Level, is less liable to derangement in case of accident. The adjustment once properly made by the two peg method (see adjustment of Dumpy Level, page 63) is apt to stay so for years, thus removing one of the chief objections as compared with those of a Wye Level. In making the adjustment of this Dumpy Level the engineer does not depend so much on mechanical perfection, as on his own superior skill and sense of accuracy.

To meet an **urgent demand** this type of Dumpy Level is now provided with a **clamp and tangent screw** to enable, in a strong wind, to keep the telescope upon an object, and, although it raises the price, it will prove an invaluable accessory, well worth the extra cost. This instrument is leather-finished.

The telescope can be **inverting or erecting**; see cuts on pages 127 and 129. The objective in either case will have the same aperture.

We recommend this instrument highly for all work of a high character, such as *bench leveling, water-works, railroad construction, also for reconnoissance.*

SPECIFICATIONS:—

Telescope { **Inverting 15 inch long, aperture 1⅜, power 28 dia.**
Erecting 17½ inch long, aperture 1⅜, power 32 dia.

Focussing slide very long and provided with a dust guard when run out for sights as near as about 12 feet.

Eye-piece with large flat field of view, provided with an improved screw arrangement permitting to focus the wires by simply turning its head slightly to right or left.

Spirit Level 7½ inches long between centers of suspending arms. The spirit level is very sensitive and accurately ground to a true curvature and barrel shape.

Center of hard bell metal is cast in one piece with the hollow cross bar.

Clamp and Tangent Screw

Mahogany box provided with strap, lock, and hooks, containing sunshade, wrench, screwdriver and adjusting pins.

Weight of instrument 10 lbs. Weight of tripod about 10 lbs.

Gross weight of instrument securely packed for shipment in two boxes about 50 lbs.

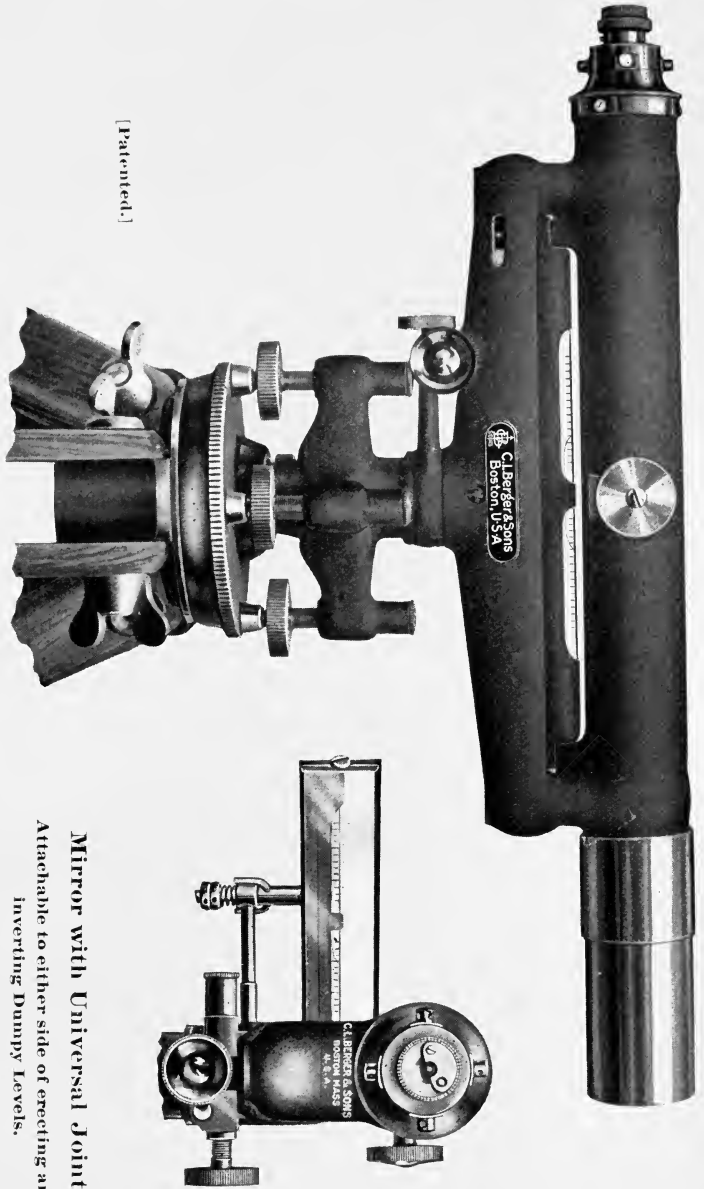
Code word: **15 inch inverting telescope** Abardo **Price, each as above, \$115**
 " " **17½" erecting** " Aenia

(For Code Words of Extras below, see page B of complete code at back.)

Extras to 15" and 17½" Dumpy Levels.

Stadia Wires fixed in ratio 1: 100	\$3.00
Steel Center running in a cast iron socket to insure freest motion with perfect fit, see page 134. (Made to order only.)	10.00
For quick leveling attachment see page 118.	15.00
Fine mirror mounted in case with universal joint. (This is readily attachable to either side of the instrument and facilitates the reading of the bubble on soft ground without stepping aside)	10.00
Gossamer water-proof bag, to protect the instrument in case of rain or dust	1.00
Bottle of fine watch-oil to lubricate the level center	.35

A detachable Vernier Compass, with variation setoff E & W and with 3½ inch needle, can be mounted on top of these Dumpy Levels at an extra expense of \$16.00. Made to order only.



[Patented.]

Berger 15" Monitor Type Dumpy Level.
Inverting Telescope.

Mirror with Universal Joint.
 Attachable to either side of erecting and
 Inverting Dumpy Levels.
 Code word—Mirror.

Code Words for Dumpy Levels.

15-inch Inverting Telescope	<u>Abardo</u>
15-inch Inverting Telescope with fixed stadia wires	<u>Abella</u>

(For Extras and changes from Abardo and Abello see page B of complete code at back.)

C. L. BERGER & SONS.

Monitor Type Dumpy Level.

Additional Information pertaining to its mechanical Construction.

From the illustrations, pages 127, 129, it will be seen that the mechanical parts of this Dumpy Level are few and can easily be made to be mechanically correct, and that there are no working strains whatever in the metal to exert an undue influence upon the adjustments with changes of temperature.

The telescope barrel and both uprights are cast in one piece of hard composition metal; and in order to arrive at a high degree of accuracy the barrel is bored out to be truly cylindrical, a condition never attained by the use of drawn tube. (For reasons mentioned later both ends of the outside tube are slightly larger in diameter, forming collars turned truly concentric to the bore, serving in principle the same object as collars of a Wye Level telescope.) This being accomplished, the bottom surface of the uprights is turned truly parallel to the bore. The strongly-ribbed cross-bar and instrument center are cast in one piece of hard bell-metal. At the time when the center about which the instrument revolves is fitted to its socket, the resting-places for the uprights are also turned off so as to be truly at right angles to it, from which follows that the geometrical axis of the telescope barrel when latter is placed upon them must also be at right angles to the center. The level casing, too, is a casting. The spirit-level itself is fastened into this casing by a superior method to preclude any strain, so that its true form may be preserved. The focusing slide is the only tube made of brass, turned and closely fitted in the lathe.

In adjusting this instrument in the shop it is treated like a Wye Level. The collars at the end of the telescope barrel serve to adjust the cross-wires for collimation by revolving the telescope in wyes. When this is accomplished the telescope barrel with its attached level is then firmly screwed to the cross-bar. The next step in the shop is to adjust the spirit-level to the line of collimation as described elsewhere. This being done, the adjuster in the shop now proves whether the geometric and optical axes of the telescope are really in the horizontal plane by revolving the instrument 180° on its center; should the bubble remain in the middle of its tube it must be assumed that it is; however, if not, he touches one of the uprights off until it does. As a rule the mechanical work is so correct that the geometric and optic axes coincide within a few division marks of the graduated level, requiring but a very few strokes with a fine file for final adjustment.

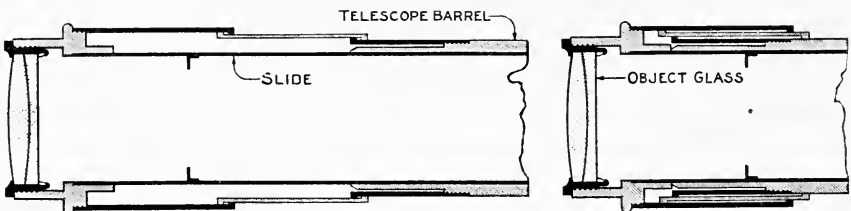
From the foregoing it will be seen that a leveling instrument so constructed, barring severe accidents, must hold its adjustments for years, and that all subsequent verifications of the line of collimation in the field by the two peg method must be made by the Engineer by slightly moving the cross-wires, and that the adjustment of the spirit-level is to be made in the customary manner by simply turning the instrument 180° on its center. An instrument so constructed needs but little care and therefore is better adapted to rough usage (to which it is subject at times) since its simplicity ensures greater freedom from derangement.

The Dumpy Level described above must stand as an example of good practice. Many Engineers prefer it to an ordinary Wye Level. The prevailing mistrust can generally be traced to the use of cheap commercial Dumpy Levels. The above information as to the method of construction in the shop has been given at great detail to show that this instrument may well rank with the best wye levels.

(For Price of this Instrument and Extras see page 126.)

Berger's Collapsible Dust Guard

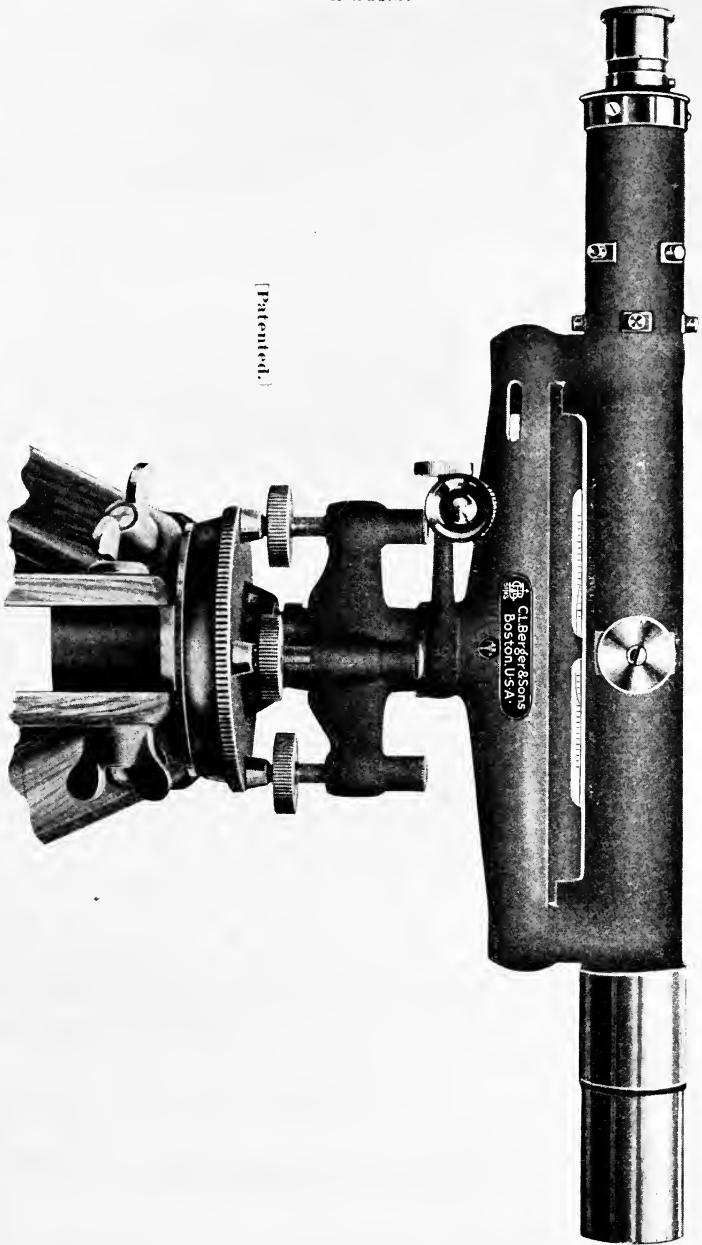
This feature as shown below is furnished with the 14, 15 and 17½ inch Monitor Type Dumpy Levels and protects the telescope's focussing slides almost completely from grit and water within their entire range.



C. L. BERGER & SONS BOSTON MASS U.S.A.

EXTENDED

CONTRACTED



Berger 17 1/2" Monitor Type Dumpy Level.

Erecting Telescope.

(For a full description, prices and particulars see pages 130 and 131a.)

Code Words for Dumpy Levels.

17 1/2-inch erecting telescope	Aenia
17 1/2-inch erecting telescope with fixed stadia wires	Actus

(For Extras and changes from Aenia and Actus see page B of complete code at back.)

18" The Berger MONITOR TYPE WYE LEVEL.

A combination of our Dumpy and Wye Levels, see pages 126-135.

For close bench leveling and construction work whether used on the surface or underground.

Essential features :- Compactness with great strength as exemplified in our Dumpy Level, to resist severe treatment in rough country work. **Protection of spirit-level and collars**, thereby securing **increased accuracy, efficiency and greater permanency of adjustment.**

In this new type of instrument the adjustment of the line of collimation of the telescope and telescope level is made in the same manner as that in the regular Wye Level, but to **prevent the wear on the collars** and to **secure compactness**, it differs from that insofar as the telescope can only be revolved in the wyes about 20 to 30° to permit of the lateral adjustment of the spirit-level, so as to reduce the wear on the collars to a minimum. The **line of collimation** of the telescope needs to be verified only at times by lifting the latter out of its wyes after bi-secting a point and then replacing it with the telescope rotated 180°, to have level now up thereby securing the same condition as where the telescope is revolvable in the wyes.—It is a well-known fact that the wear on the collars where the telescope is revolvable is often so marked that their equality of diameter and true form cannot be depended on, and therefore, while the instrument apparently is in adjustment it may be very much out. The only course left open in such a case is to treat the instrument like a Dumpy level and to adjust the level to the telescope by the two-peg method.

The **Spirit-level** guarded by the telescope and by a double casing formed as it were by the protection at the sides raises it to the standard of a glass-protected level vial shown in the Precise Levels described later on, but without the detriment common to the latter devices when films settling on the inaccessible vial and inner surfaces of such a protecting glass cover impair the reading of the bubble. To fully protect this level vial from sun and rain at times, or in underground work from smoke and gases a thin piece of transparent celluloid over the exposed part of the vial and held in place by the sides of the cross-bar, will accomplish the same end, and it can be cleaned and renewed at will, thus securing to this instrument and its spirit-level all the advantages possessed by our precise levels, at a very low cost.

Size, power and all other particulars are like those of our regular 18" Engineer's Wye Level, page 134, but it is almost entirely finished in our superior and durable leather finish, securing permanency of adjustment and presenting a very **fine external appearance.**

SPECIFICATIONS:—

Telescope. Objects erect, aperture $1\frac{3}{8}$ inch, power 35 dia. Focussing slide, very long and fully protected by dust guard. **Collars hard bell metal.**

Eye-piece with large flat field of view, provided with an improved screw arrangement permitting to focus the wires by simply turning its head slightly to right or left. **Line of collimation correct** for all distances. **Telescope balanced** each way from center when focussed for a mean distance with sunshade attached, to secure highest accuracy attainable. **Stop** provided so that the cross wires will always be horizontal and vertical in instrument.

Spirit-Level $8\frac{5}{8}$ inch (between centers of supporting arms) level vial accurately ground to a true curvature and barrel shape.

Center hard bell metal (very large in dia. and long, strong and unyielding).

Mahogany box provided with strap, lock, and hooks, contains sunshade, wrench, screwdriver and adjusting pin.

Weight of instrument 11 lbs. **Weight of tripod** about 10 lbs.

Gross weight, securely packed for shipment in two boxes, about 55 lbs.

Code word, Acway

Price, as above, **140.00**

Extras to Monitor Type Wye Levels.

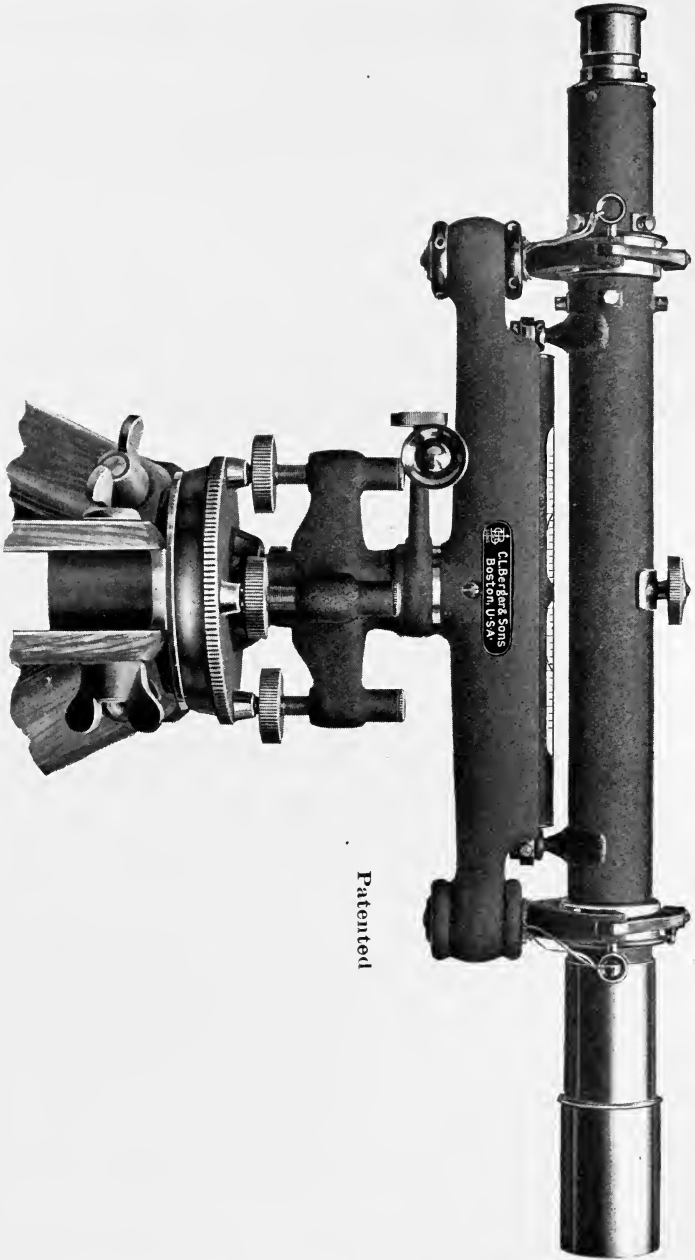
Steel center running in a socket of cast iron, to insure freest motion with perfect fit	\$15.00
Stadia wires, fixed	3.00
Short focus lens (see pages 101, 203), one \$8.50 per pair	16.00
Fine mirror with universal joint readily attachable to either side of the instrument, facilitating the reading of the bubble without stepping aside	10.00
Gossamer water-proof hood, to protect instrument from rain or dust	1.00
Bottle of fine watch-oil to lubricate the level center35

20 $\frac{1}{2}$ " MONITOR TYPE WYE LEVEL.

Aperture $1\frac{1}{2}$ inch, Power 38 dia.

Code word, Aczell

Price, as described above, **\$145.00**



18 inch Monitor Type Wye Level.

(Power 35 diameters)

As made by C. L. Berger & Sons.

Patented

Code Words for Monitor Type Wye Levels

18 inch erecting telescope enumerated page 130	<u>Acway</u>
20½ inch erecting telescope	<u>Aczell</u>

18" MONITOR TYPE WYE LEVEL.

Tubular Bar

The correct alignments and the handy arrangement of all operating parts make this type of level a profitable investment in any Engineering Department. Designed, built and inspected with typical Berger thoroughness, it can be depended upon to produce accurate work through years of constant service.

A close inspection of the illustration will reveal a Wye level of a different design embodying many of the features of our standard types. The telescope is supported most rigidly in the two Wyes, which are mounted unusually low on a Bar which is Tubular in form and practically "flexure resisting." This form of Bar permits an entire Rotation of the telescope in its Wyes as in our Engineers 18" and 14" Wye Levels, Pages 134—135. Owing to its peculiar construction the clamp and a good part of the spindle and its socket are concealed within this Bar which not only protects these parts from serious injury but keeps out grit and other foreign matter. This instrument has been reduced in height noticeably which gives it an appearance of great compactness. The Bar is designed so that air-currents which are constantly changing in temperature may pass freely through the top and around the Bar. All this has been done without changing the original length of the spindle which has identified all Berger instruments since 1871, for their wonderful steadiness and freedom from tremor in a high wind.

The levelling socket is very different in design and a vast improvement over other makes. It consists of a single piece casting of most peculiar form. The center will not bind in the socket from any strain exerted either by the spindle clamp or leveling screws. When instrument is clamped the telescope and its level remain absolutely undisturbed owing to its construction—there being a very deep recess between the center's socket and the bearing for the center's clamp. This feature is now in universal use on our levels.

The telescope level is close to the line of collimation. The eye-piece and object slides are dust protected by guards. The cap of the eye-piece is large in diameter to protect the observer's eye from the sun.

The principal parts are treated with our wear resisting leather finish (see page 9) which secures a lasting covering to a field instrument and for fine appearance has no equal. This finish introduced by us in 1907 is in universal favor. Some small parts are still lacquered which enhance and bring out more forcibly the beauty of its constructional lines.

SPECIFICATIONS:—

Telescope. Objects erect, aperture $1\frac{3}{8}$ inch, power 35 dia. Focussing slide, very long and fully protected by dust guard. Collars hard bell metal.

Eye-piece with large flat field of view, provided with an improved screw arrangement permitting to focus the wires by simply turning its head slightly to right or left. Line of collimation correct for all distances. Telescope balanced each way from center when focussed for a mean distance with sunshade attached, to secure highest accuracy attainable. Stop provided so that the cross wires will always be horizontal and vertical in instrument.

Spirit-Level $8\frac{5}{8}$ inch (between centers of supporting arms) level vial accurately ground to a true curvature and barrel shape.

Center hard bell metal (very large in dia. and long, strong and unyielding).

Clamp and Tangent Screw.

Mahogany box provided with strap, lock, and hooks, contains sunshade, wrench, screwdriver and adjusting pin.

Weight of instrument 11 lbs. **Weight of tripod** about 10 lbs.

Gross weight, securely packed for shipment in two boxes, about 55 lbs.

Code word, Adacta

Price, as above, 140.00

Extras to Monitor Type Wye Levels.

Steel center running in a socket of cast iron, to insure freest motion with perfect fit	\$15.00
Stadia wires, fixed	3.00
Short focus lens (see pages 101, 203), one	\$8.50
pair	16.00
Fine mirror with universal joint readily attachable to either side of the instrument, facilitating the reading of the bubble without stepping aside	10.00
Gossamer water-proof hood, to protect instrument from rain or dust	1.00
Bottle of fine watch-oil to lubricate the level center	.35

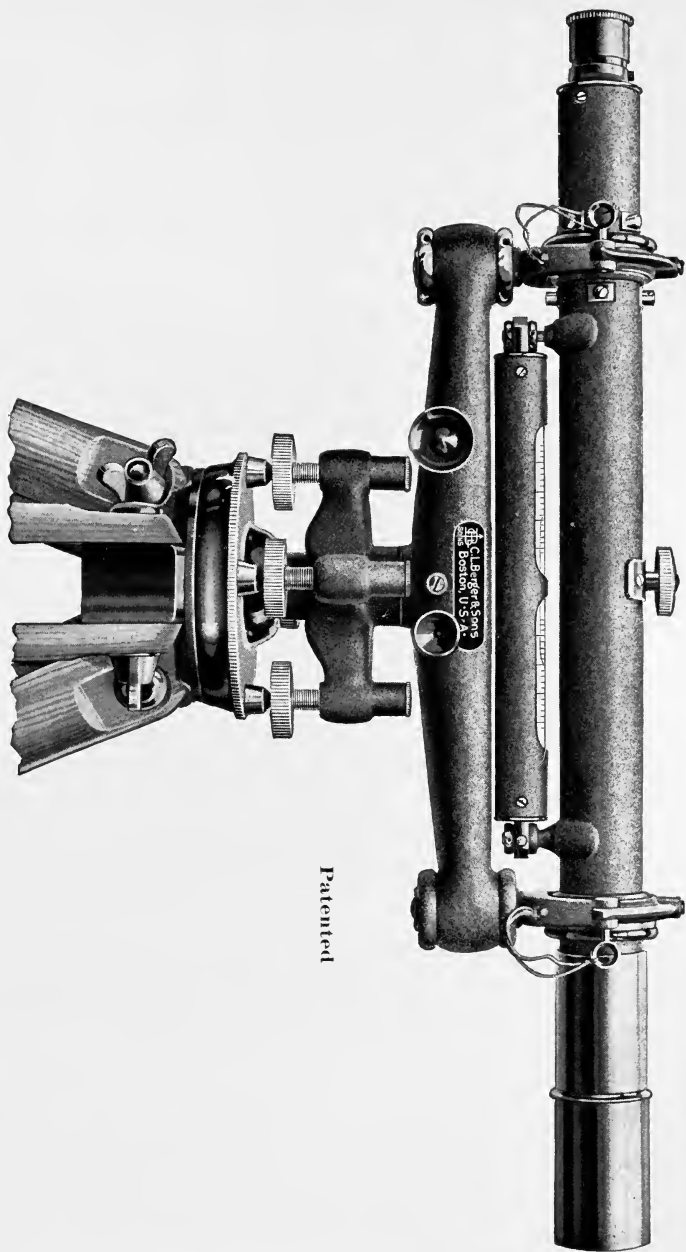
20 $\frac{1}{2}$ "

MONITOR TYPE WYE LEVEL.

Aperture $1\frac{1}{2}$ inch, Power 38 dia.

Code word, Adulom

Price, as described above, \$145.00



Berger 18" Monitor Type Wye Level, (Tubular Bar)

Erecting Telescope

(Power 35 diameters.)

For Price and Description see page 132.

This Level kept in stock. To save time may be ordered by telegraph using our code words.

Code Words for Monitor Type Wye Levels

18 inch erecting telescope enumerated page 132
 20½ inch erecting telescope

Adaeta
Adulom

18" ENGINEERS' WYE LEVEL.

Leveling Instrument of Precision.

For Fine Bench Leveling, Water-works, Railroad Construction, etc.

Instrument has the **strong, hollow** and **long cross-bar**, introduced by us in 1871, mounted upon which are the wyes supported by adjusting nuts of **large diameter**, which, together with the **long center** also of **large diameter**, gives the necessary stability to withstand rough treatment. To secure compactness the **telescope and level tube** are close together (to protect latter from sun and rain), and, as both are close to the cross-bar, the instrument is steady in a strong wind. To ensure permanency of adjustment, the telescope and level mounting tube have our leather finish (see page 11), which treatment enables us to combine many parts into one, that would have to be screwed together, thereby securing not only great rigidity, but reducing to a minimum the effect of sudden changes of temperature, and affording a degree of satisfaction in the field, secured in no other way. This finish presents a fine appearance and is more durable than a metal finish. As much depends upon the **sensitiveness of the spirit level** we select this for the character of the field work, and, therefore, it ranges in value in this style of instrument from 10 to 20 seconds of arc to one tenth of one inch of scale.

SPECIFICATIONS:

Telescope. Objects erect, aperture $1\frac{3}{8}$ inch, power 35 dia. Focussing slide very long and protected by dust guard. Collars hard bell metal and of large diameter.

Eye-piece with large flat field of view, provided with an improved screw arrangement permitting to focus the wires by simply turning its head slightly to right or left. **Line of collimation correct** for all distances. **Telescope balanced** each way from center when focussed for a mean distance with sunshade attached, to secure highest accuracy attainable. **Stop** provided so that the cross wires will always be horizontal and vertical in instrument.

Spirit-Level $8\frac{5}{8}$ inch (between centers of supporting arms) level vial accurately ground to a true curvature and barrel shape.

Center hard bell metal (very large in dia. and long, strong and unyielding).

Mahogany box, provided with strap, lock, and hooks, contains sunshade, wrench, screwdriver and adjusting pin.

Weight of instrument, 11 lbs. **Weight of tripod**, about 10 lbs.

Gross weight, securely packed for shipment in two boxes, about 55 lbs.

Code word Adlumia.

Price, as above, \$140.00

Extras to Engineers' 18" Wye Level.

Steel center running in a socket of cast iron, to insure freest motion with perfect fit. (See cut on opposite page).	\$15.00
Stadia wires , fixed	3.00
Short focus lens (see pages 101, 203), one \$8.50 pair	16.00
Fine mirror with universal joint readily attachable to either side of the instrument, facilitating the reading of the bubble without stepping aside	10.00
Extra sunshade with smaller aperture, for use with the 18-inch wye level when the sun's rays are too bright for accurate work	1.50
Gossamer water-proof hood to protect instrument from rain or dust	1.00
Bottle fine watch oil, to lubricate the level center35

14" ENGINEERS' WYE LEVEL.

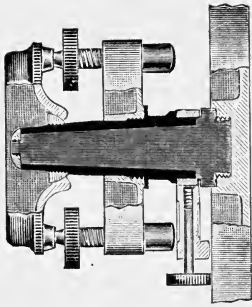
Its **essential features** are like those *enumerated above*, and shown in cut of eighteen-inch Engineers' Wye Level, with the **exception of size and weight**. It is designed for use *where a lighter instrument is desirable*. The **Telescope** has an aperture of $1\frac{1}{4}$ inches and a power of 27 diameter. The $5\frac{3}{4}$ inch spirit level is very sensitive. The center is of bell metal. Full length, split-leg tripod.

Weight of instrument, about $9\frac{1}{2}$ lbs; **weight of tripod**, $5\frac{3}{4}$ lbs.

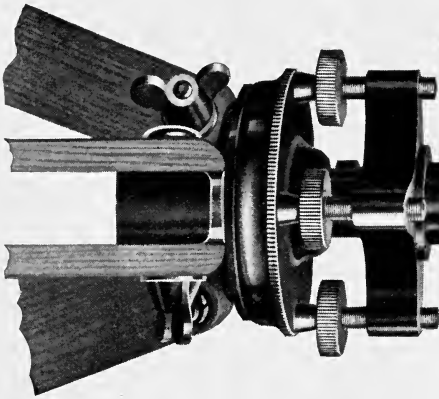
Gross weight of instrument, packed securely for shipment in two boxes, about 40 lbs.

Code word Alyssum.

Price, as above \$130.00



The above cut shows the center of instrument as made of steel running in a cast-iron socket to insure freest motion with perfect fit. See note, page 134.
 For price see extras to Wye Level, page 134.



Patented.

Engineers' 18-inch Wye Level.

(Power 35 diameters.)
 As made by C. L. Berger & Sons.

Code Words for Wye Levels.

18 inch erecting telescope enumerated page 134 (usual style)

Adlumia

14 inch erecting telescope

Alyssum

(For Extras and changes from Adlumia and Alyssum, see page B of complete code at back.)

18" HYDROGRAPHER'S WYE LEVEL

Having a three-screw* leveling base with arms of greater radius** (3-inch) to afford maximum stability when exposed to wind pressure and to better control the spirit level of this instrument.

The instrument shown on opposite page has the upper part, viz: cross-bar, telescope and level exactly similar in size and style to our regular Engineers' 18" Wye Level (page 134) except the telescope which in this instrument is mostly of the inverting kind.—If an erecting telescope is desired we will be pleased to furnish it, in which case the aperture will be the same but the power will be 35 dia. only.—As regards the mode of securing the instrument to the tripod by means of the fastener, see cut and description, page 46, in article, "Shifting Center."

This fastener is very simple and even in the coldest weather easy to manipulate. It adds very little to the weight and secures the necessary stability in taking up all back lash of the leveling screws after wear. It is better than any other device that we know of to achieve this end.

The tripod bolts are the same distance from the center as the leveling screws.

Made to order only

SPECIFICATIONS:—

Telescope; objects inverted, aperture $1\frac{3}{8}$ inch, power 40 dia.; focussing slide very long and protected by dust guard; collars hard bell metal; line of collimation correct for all distances; telescope balanced each way from center when focussed for a mean distance with sunshade attached to secure highest accuracy attainable; stop provided so that the cross wires will always be horizontal and vertical in instrument.

Eye-piece perfectly achromatic with large, flat field of view; provided with an improved screw arrangement permitting to focus the wires by simply turning its head to right or left.

Center of hard bell metal is large in dia., long, strong and unyielding.

Spirit Level $8\frac{5}{8}$ inches between centers of suspending arms. Sensitiveness is 8 to 10 seconds of arc for one tenth inch of the scale. (unless otherwise specified).

Mahogany box provided with strap, lock and hooks, contains sunshade, wrench, screwdriver and set of adjusting pins.

Weight of instrument about 12 lbs. **Weight of split-leg tripod** about 13 lbs.

Gross Weight securely packed for shipment in two boxes about 60 lbs.

Code name **Andromeda**

Price as above **\$158.00**

Extras to Hydrographer's Wye Level.

Stadia wires fixed	\$3.00
Steel Center running in a cast iron socket to insure freest motion with perfect fit.	15.00
Fine mirror mounted in metal frame with universal joint. (This is readily attachable to either side of the instrument and facilitates the reading of the bubble on soft ground without stepping aside).	10.00
Extra sunshade with smaller aperture for use with the telescope when the sun's rays are too bright for accurate work	1.50
Gossamer water-proof bag, to protect the instrument in case of rain or dust	1.00
Bottle of fine oil to lubricate the level center	0.35

Prior to 1888 we have sometimes placed upon this instrument an adjustable wye with a micrometer screw arrangement for the pointing of the telescope and setting of the bubble independently of the leveling screws. The very marked wear on the collars at the point of contact in the wyes when the telescope is moved in altitude has induced us to abandon this feature. A perfect instrument in this line and at the same time entirely free from any change in height when the micrometer screw is extensively used during an extended leveling operation is our Engineers' Precise Level, page 139. This latter instrument is capable of the most precise work and is offered at a price so very low that it should be included in the instrument equipment for precise leveling of any magnitude.

To prevent a change of height, after an appropriate leveling of an instrument with three leveling screws, it is advisable to clamp one of the leveling screws by its clamp screw at the side, and to level up by the other two screws alone. This should be done in like manner, also, to correct for slight changes in the level caused by the settling of the tripod-legs.

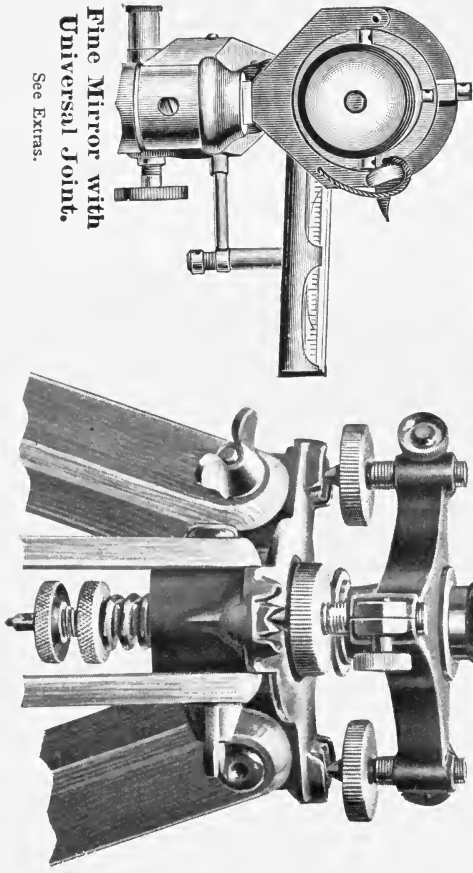
* Four leveling screws commend themselves in the more ordinary class of instruments for the greater rapidity with which an instrument can be leveled up approximately, and that (no matter how much the leveling screws may be worn) when brought to a true bearing on the lower leveling plate, all such looseness is taken up.

** NOTE: In some types of leveling instruments mounted on a three-screw leveling base the latter is often too small for the length, power, height and weight of the instrument, making it top heavy, thereby rendering it unsteady and unsuitable for close work.

C. L. BERGER & SONS.



Patented

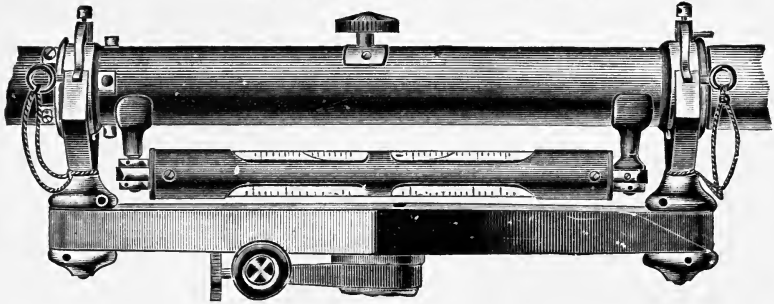


Fine Mirror with
Universal Joint.
See Extras.

Hydrographer's 18-inch Wye Level,
With three Leveling Screws. As made by C. L. Berger & Sons.

Reversion Level.

Applicable to any of our Engineers' Wye Levels.



The spirit level used in this feature differs from the ordinary one in that it is ground to the true shape of a barrel so that the tangents to the level bubble curves, at the zero points of the scales, are parallel and diametrically opposite. By the use of this reversion level, attachable to any of our Engineers' Wye Levels, in place of the single reading level, it is possible to do good leveling, though the adjustments of the spirit level and cross wires are entirely deranged and the collars worn (see remark below), by first making the level bubble central and taking a reading, then by revolving the telescope 180° in its wyes, which point is indicated by an adjustable stop,* making the bubble again central and taking another reading. The arithmetical mean is the correct result.

This device will, in an emergency, be appreciated when it is known that by the use of the method above the work will average as good as that done with an ordinary good wye level, in adjustment. The adjustment of an instrument provided with a reversion level is made in precisely the same manner as if the spirit level was of the single reading kind, since the adjustment of the level when it is reversed will take care of itself.

The reversion level is guarded by a revolvable outer tube (*Patented, not shown in cut*) leaving a space of air, as a non-conductor of heat between it and the ordinary level mounting tube. This exterior tube serves both as a protection against breakage and sudden changes of temperature, and, as its inner surface is painted white, it also acts as a reflector which facilitates the reading of the bubble.

Remark: The inequality of worn collars cannot be eliminated in a strict sense by using the reversion level, yet for ordinary good work it may be said to be. Nor can the test for the equality of the collars be directly tested in this way but should be done as in the case of the ordinary wye level; viz., by the two-peg method described under the adjustment of the Dumpy Level (pages 63 and 64 of our handbook). The following modification is to be noted: After the line of collimation has been adjusted for distant objects by rotating the telescope in its wyes and the spirit level has been adjusted by reversing end for end and adjusted laterally, (the telescope having the sunshade attached, as it serves to balance the telescope when the object slide is drawn in), the instrument is set up close to the near target, and a reading is taken with the level tube in the direct position. In order to eliminate the error of collimation for nearer objects, should any exist, another reading is taken with the telescope rotated 180° in the wyes, and the mean taken as the true reading. If, now, the horizontal wire also bisects the distant target and the bubble remains central in each position of the telescope, the collars are of equal diameter. Should the latter not be the case, the error may be corrected thus: Bisect the distant target with the telescope in its direct position, and adjust the level till the bubble is central. Rotate the telescope 180° in its wyes, indicated by the stop, and note the number of divisions through which the bubble moves in order that the distant target remains bisected, so that a correction can be made when most precise work is required.

It is assumed that in making this test the temperature of the two collars has been alike and that the telescope has been in proper balance by being focussed for a distance of about 300 feet with sunshade attached. A scratch on the telescope or object slide indicates the focus which the maker used in equalizing the collars. An apparent error found as above may be due to a change in the shape of the level tube which may occur in time (for which the maker, of course, cannot be held responsible), as well as to a worn condition of collars, or these causes combined.

In order to trace the error to its source the only sure test is made with a striding level. (See Engineer's Precise Level.)

Price, as above, if ordered with our Wye Level in place of the single reading kind **\$20.00.**

It is an extremely difficult matter to grind a level of this kind so that the bubble will remain central at all positions during this rotation through 180° . The stop just mentioned is so adjusted, however, by the maker, that when the level has been turned exactly 180° it gives a correct reading.

C. L. BERGER & SONS' ENGINEERS' PRECISE LEVEL.

Patented. (For cut see page 141.)

With micrometer screw for close setting the spirit level.

For use in cities in establishing benches, etc., also for all work requiring speed and the highest degree of accuracy in spirit levelling.

It is a well-known fact that, satisfactory as it may be on account of its great simplicity and compactness, the ordinary wye level (pp. 134, 135) will fail in degree of accuracy or in rapidity of manipulation when the closest results are required. It often happens when precise work is required, the time spent in leveling up and keeping the level bubble of an ordinary good wye level in the center of its graduation by means of the four leveling screws is often very considerable and, when the course is over swampy or frozen ground, the vexation attending the work is apt to be great, and the results vitiated by the numerous readjustments required to keep the bubble in its place. This manipulating of the leveling screws is very apt to lead to a change in the height of the telescope, varying in magnitude according to the style of the instrument. (It is here to be noted that this change in the height of the telescope is less in our levels, or transits with leveling attachments, than is the case with the instruments of other makes).

To aid the Engineer in the prosecution of exact work, avoiding the errors caused by the readjustments above referred to, we have designed and are prepared to furnish the instrument shown on page 141.

By referring to the cuts it will be seen that this instrument is mounted on three leveling screws, and that the center about which the instrument revolves is unusually long and unyielding. Two small spirit levels attached to arms extending from what we may call the cross-bar (since the center of the instrument is permanently secured to it as in the ordinary style of levels) serve to put the center in a vertical position, thus securing at once a nearly horizontal position to the cross-bar. These small levels are adjusted the same as the ordinary plate levels of a transit.

At the eye end this cross-bar carries a micrometer screw by which the telescope and its level can be raised or lowered at will independently of the leveling screws. A strong spiral spring on the same side holds the wye-bar down upon the micrometer screw. This arrangement provides a most delicate motion up and down, and enables one to set the bubble accurately at every sight and in a very much better manner than can be done by the leveling screws alone. The head of the micrometer screws is divided into one hundred parts, and as a rule its pitch will be such that 250 to 252 parts of revolution of the screw will make a change of one foot in the reading of the rod held at a point 100 feet away from the center of the instrument. It may be seen that the instrument can be very advantageously used for making grade measurements. The graduated disc, when reading zero on the index-bar, brings the instrument at once within one or two divisions of its normal position. The disc can also be readily turned on its hub by taking hold of the milled head (the disc is held on its arbor simply by friction), so that, for convenience, a reading may always start from zero, though the cross-bar be not leveled up. This instrument, as above stated, is provided with three leveling screws, which give a firm support on the tripod, and allow a closer setting of the bubble when the instrument is run as an ordinary wye level, without making use of the micrometer. (See p. 44.)

The Chief Feature of the Instrument, however, consists in the fact that the pivots * on which the wye bar can be raised or lowered, are in the middle of the instrument and within a fraction of an inch of the plane of the line of collimation, thus securing to the telescope a motion in altitude free from any change in height of the line of collimation, though the telescope were to move throughout the entire range of the micrometer screw during an extended leveling operation. As a rule, the working range of the micrometer will be limited to a few revolutions each way from its normal position in order to keep the instrument as compact as possible. The instrument is also arranged so that, whenever desirable, it may be used as an ordinary wye level. For this purpose, it is provided, at the object end of the cross-bar, opposite the micrometer screw, with a milled-head screw and check nut, by means of which, and by the micrometer screw, when set at zero (see cut), the wye bar may be set exactly at right angles to the vertical center. However, for the fine settings of the bubble in bench leveling or pointing of the telescope, etc., the micrometer screw should be used exclusively.

A clamp and tangent screw motion is also provided and so arranged, that it can be readily reached from the eye end of the telescope. The cross and wye-bars are cast hollow and the former fits inside the latter.

*NOTE.—It will be noticed that in instruments of a similar character, having pivot screws acting in and below the wye opposite the micrometer screw, as for instance, in the U. S. Coast Survey geocentric levels, designed after Stampfer (see Report 1879), any motion of the telescope in altitude will also change its height. By an injudicious use of the micrometer screw our own hydrographic wye level (see page 104, catalogues 1888-1891), partook of this same error, and this together with the marked wear on the collars due to this same motion led us to the abandonment of it. We note, however, that other firms who are in the habit of copying our styles and patterns have since brought it out as a detail of a precise level.

The Telescope will be invariably *inverting* in order to admit of as large an aperture and as high a power as is possible. Thus: its aperture will be $1\frac{1}{2}$ inches, the total length is about 17 inches, and it will have a magnifying power of 40 diameters. It will be provided with fixed stadia wires, in the proportion of 1 to 100, the distance to be measured from a point in front of the objective equal to its focal length.

The Spirit Level is of the single reading kind, and is generally made so that one division (of $\frac{1}{16}$ of an inch) equals from 8 to 10 seconds of arc. The sensitiveness of the level will, however, be adapted to the particular requirements. It is not necessary, however, to have it any more sensitive than is required for a fine field instrument, as an over-sensitive level is apt to give more trouble than benefit in its use.

A Reversion Level of same sensitiveness might be applied instead of the single reading level, if desired, as a convenience (see Reversion Level p. 136), when the highest precision is not needed. Of course in fine work the reversion level must be used in the direct position as with a single reading level. However, one will understand that a reversion level is very apt to change its true barrel form in time thus becoming wholly unreliable, and therefore we do not advise it at all, and particularly not for an instrument of such a fine character as this is.

A Metal Mirror will be furnished with the instrument, attachable to either side of the level, enabling the operator to read the bubble without stepping aside; a convenience which will be appreciated when working on shaky ground.

Adjustment. The adjustment of the telescope and the level must be made precisely as in an ordinary wye level. (See adjustment of the wye level, pages 59 and 63 of this hand-book.) The spirit level will be in thorough adjustment when the telescope with its *sunshade attached is focussed for a distance of about 400 feet*, when the telescope is in perfect balance and the equality of the collars is assured thereby; for shorter distances, however, there is a small error due to the unbalancing of the telescope caused by the object slide being thrown out. Small as this error may be it can be entirely eliminated by simply bringing the bubble to the center by the use of the micrometer screw.

Explanation. The foregoing has been written at some length to give a clear understanding of the principal features of this instrument. Naturally, the question may now present itself, why not use a striding level alone, in place of the fixed or reversion level, as is done in some of the best types of instruments, particularly as the pivot arms, extending from the middle of the cross-bars, must necessarily be spread quite a distance apart, to readily permit the revolution of the telescope with the fixed level in the wyes. To this we may say, that a fixed level placed below the telescope, where it is guarded against breakage and, in a measure, from the action of the sun, is better adapted to the wants of the *Civil Engineer* in running quick and accurate levels in cities, towns, etc., than a striding level with its more cumbersome features and manipulations would be, particularly if the work was to be of the most precise character.

It is only when the collars of a telescope are badly worn or imperfectly made that the striding level has any advantage over a fixed one. As a rule a fixed level keeps in better adjustment, is simpler to manipulate than the striding level, and is free from the errors due to the uncertainty of contact of the collars and the wyes. Moreover, the construction of the new instrument is such that it has a greater stability than those of previous make. We therefore believe that the fixed level has as legitimate a standing as the striding one.

For the above and similar reasons the American Engineers have and will give preference to the instrument which has the level fixed to the telescope; and this has led us to the adoption of this feature in our new instruments. This idea is also prevalent among the best instrument makers and engineers in Europe, as may be seen by examining Prof. Nagel's published description of a similar instrument.

Instrument, Finish, Packing, Weight, etc. The telescope is leather-finish, while some of the more bulky parts of the instrument are simply treated either with cloth finish or japan, in order to lessen the cost. No attempt will be made to give an elaborate finish at the expense of accuracy and utility; altogether, as all the other parts will be bronzed and lacquered in a manner customary with us, it will present a handsome appearance. This instrument is packed erect in one box in the same manner as we pack the regular engineer's wye level. It is secured to the tripod in the same manner as are all of our instruments with three leveling screws. (See page 136 for description.)

The mahogany box contains a sunshade, wrench, screw-driver and adjusting pin.

Weight of instrument, $11\frac{1}{2}$ pounds; weight of tripod, $10\frac{1}{2}$ pounds; weight of mahogany box, $10\frac{1}{2}$ pounds; gross weight of instrument complete, securely packed in two boxes for shipment, 60 lbs.

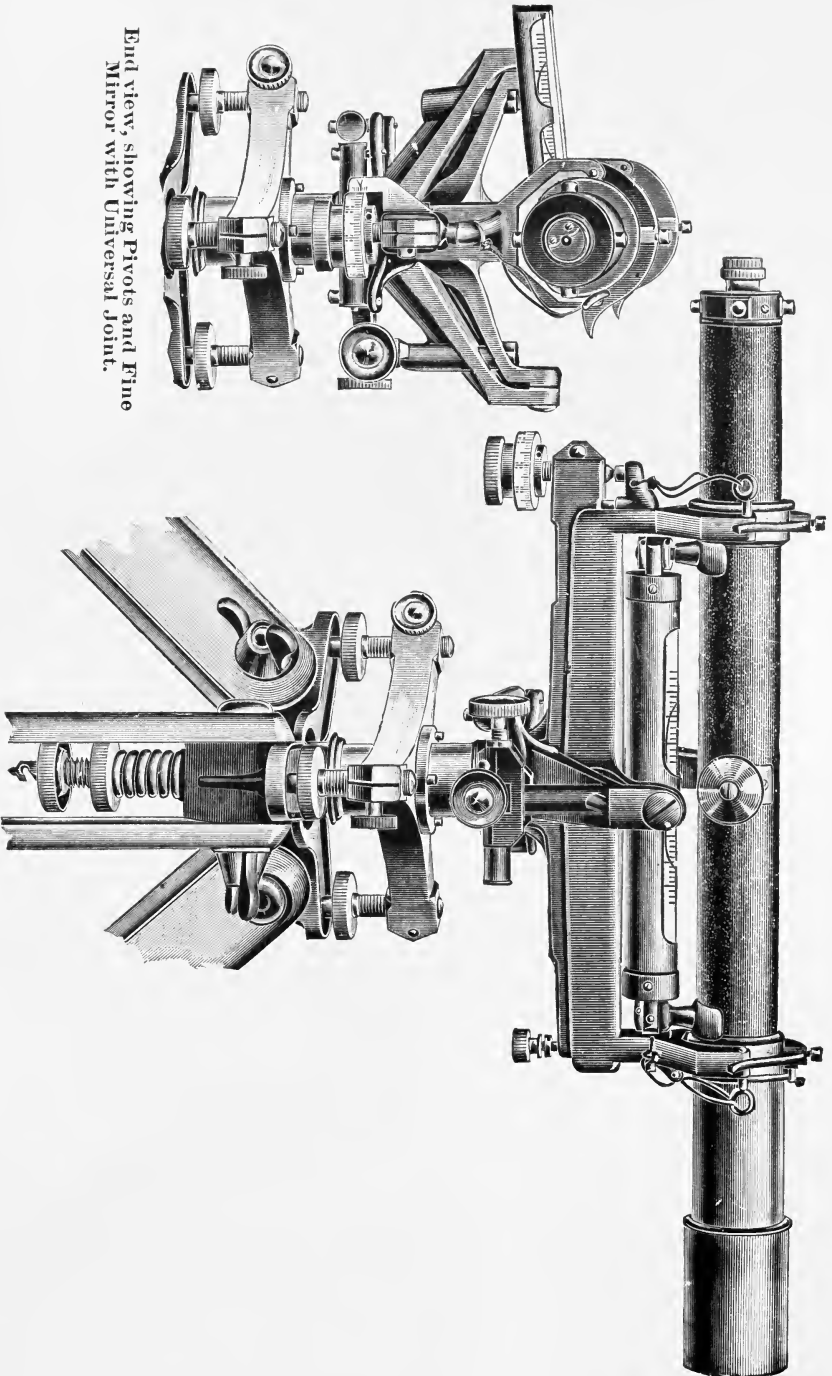
Price of this instrument, inverting telescope, leather-finish, fine mirror mounted in case, fixed stadia wires, and a *single reading fixed spirit-level*, **\$215.00**

Extras to Engineers' Precise Level

Center of instrument made of steel, and hardened and running in a socket of cast iron, improved style (see cut, page 135),	15.00
Sunshade with smaller aperture, for use with the telescope when the sun rays are too bright for accurate work,	1.00
Gossamer bag, to protect instrument,	1.00
Bottle of fine watch oil for lubricating the centers, etc.,	0.35

+ If geodesic work is to be done, a higher sensibility might be permissible, but our customary fluid would be sluggish in such a level, and the bubble tube would have to be filled with pure ether, in order to make it quick acting (see pages 7, 18, 38). An air chamber would be necessary to allow for adjustment of the bubble, which in this case changes its length rapidly for slight changes in temperature. By adding a chamber, a feature is introduced which is liable to affect the reliability of the spirit level and entail extra expense.

Code Word. Engineers' Precise Level but with steel centre **Arethusa**



End view, showing Pivots and Fine Mirror with Universal Joint.

C. L. Berger & Sons' Engineers' Precise Level.

[Patented.]

THE GEODETIC LEVEL.

In response to a request of President T. C. Mendenhall to construct for the Worcester Polytechnic Institute a Precise Wye Level, the senior member of this firm in 1896 designed and made the type shown on next page.

The leading features are great compactness, rigidity, simplicity of design, ease of manipulation, and thorough adaptation of every part to its purpose. In order to lessen the height above the tripod, the weight of the instrument and the surfaces exposed to wind pressure, this particular form of cradle bar has been adopted; and, while this reduction might have been carried to a greater extent by placing the vertical revolving center inside the tripod head, it was thought not advisable, as sometimes it is desirable to set the instrument on the leveling screws when detached from the tripod.

As will be seen, the improved tripod is of a very stiff form, which is necessary where telescopes of great power and highly sensitive spirit levels are used. To eliminate the effect of unequal expansion, the telescope collars are of smallest possible diameter compatible with the diameter of the object glass, and at first were of hardened steel resting on agates at point of contact in wyes. The striding level adopted in place of the fixed level is of tubular form and has very short legs. To still further reduce the effect of unequal expansion, the substructure, such as cradle bar, fixed bar and other parts, below the agates at point of contact in wyes in this instrument, consisted of steel and iron. Subsequently, however, as the danger of rusting in the field became very apparent, the use of steel and iron was not thought to be as important in portable field instruments when used on tripods as in the stationary astronomical instruments: therefore we are making the substructure of our customary hard gun-metal, and shall so furnish them, unless ordered to be of steel, in which case the instrument will have to be specially made. (See below.) The same may be said of the hardened steel collars. Unless ordered otherwise the collars will be made of hardest bell-metal.

All the parts that must be handled during a field operation are protected by a shield of a non-heat-conducting material. By means of a micrometer screw the telescope can be moved in the vertical plane around the center in the middle of the instrument in order not to disturb the height of the instrument.

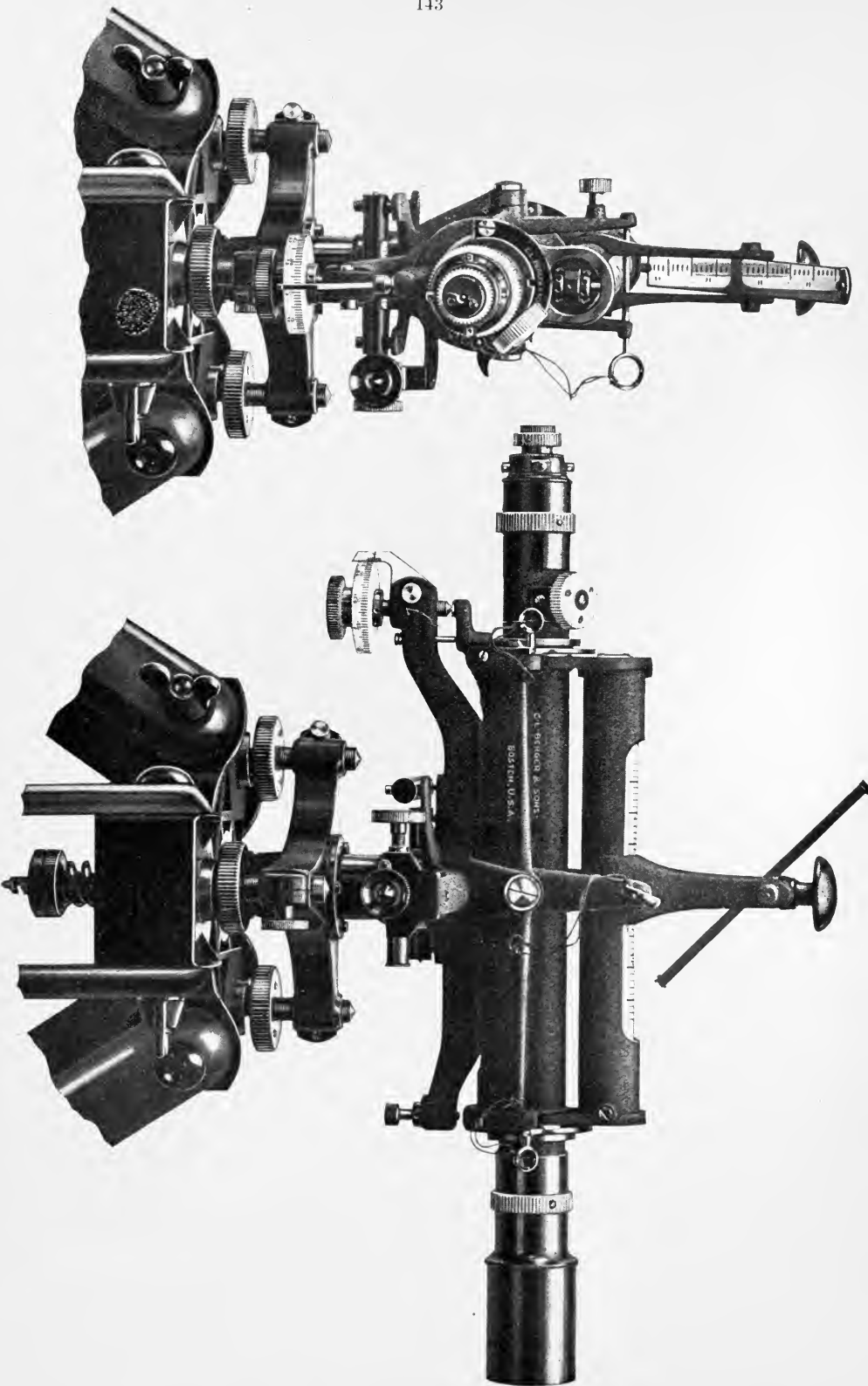
The striding level has a bubble tube reading to 3" of arc and is provided with an air chamber. Mounted above it is a mirror to enable the observer to read the bubble without stepping aside. Provision is made to readily lock the striding level to the cradle bar, to enable one to use the instrument like an ordinary Wye Level (with level fixed to the telescope); and to carry the instrument on its tripod from station to station. An arrangement is also provided by which the striding level upon reversing will always find its proper plane on the collars, so as to require but very little attention on the part of the operator. By means of a clamp screw opposite the micrometer screw the cradle bar can be secured so that the instruments can be used for ordinary wye level work.

Two auxiliary levels placed at right angles serve to level up approximately; after which the final setting of the striding level is done by the micrometer screw attached to the fixed bar. The vertical center is of hardened steel and runs in a socket of cast iron. All the main parts are either cloth finished or japanned. The beautiful appearance of the instrument does not depend upon the external finishing and polishing of parts, but entirely upon the harmony, simplicity and excellence with which the essential features of the instrument are designed.

For a detailed description of the instrument we refer to a paper read by Mr. David Molitor before the Am. Soc. of C. E. (See Proceedings 1899-1900.)

The telescope is inverting, with an object glass of $1\frac{1}{2}$ " focal length of 17", and a power of 40 diameters. It is provided with the usual cross and stadia wires. Instrument packs in pine wood box, which contains a sunshade, screw driver, adjusting pin and gossamer bag.

Weight of instrument	14 lbs.
Weight of tripod	15 lbs.
Gross weight of instrument packed securely for shipment in two boxes	75 lbs.
Price as above, of brass and bell metal collars,	\$280.00
Price of instrument, substructure of steel, as above, extra,	25.00
Price of instrument, collars of telescope of hardened steel, extra,	25.00



The Berger Geodetic Level.

COAST SURVEY PRECISE LEVEL

The demand for a level whereby the utmost precision possible in leveling may be obtained comes from many sources in work where the absolutely correct determination of the relative height of a line of benches is sought.

The Coast Survey Precise Level, illustrated by accompanying cuts, is designed to meet this demand; and it is probably the most perfect instrument made of the **dummy level type**.

The essential feature which gives value to this instrument is the fixed adjustment between the line of collimation and the level by the use of nickel iron, with coefficient of expansion of 0.000004 per degree Centigrade, in combination with nickel steel, with coefficient of expansion of 0.000001 per degree Centigrade; and the location of the level partially within the telescope and as near as possible to the line of collimation.

The instrument is so made that the line of collimation is adjusted by the maker once and for all as in our Dummy Level, by revolving the telescope in auxiliary wyes on rings turned concentric with the bore of the telescope tube. If it becomes necessary to replace broken wires in the field, the reticule must be removed, wires and reticule then replaced in the telescope, and adjusted for collimation by its capstan-headed screws and the two-peg method. This latter operation assumes that the position of the spirit level in relation to the telescope has not been disturbed, and that its adjustment is still perfect or nearly so.

An important feature of the instrument is the prismatic reading attachment for the level bubble, whereby the observer reads with one eye the rod and with the other eye the level simultaneously without change of position.

With short sights the instrument permits great accuracy and quick action in skilled hands.

Standing erect, the observer takes the back sight by reading the three horizontal wires on the "self-reading" rod, and then again the middle wire as a check, each of the readings being made with the bubble set to the normal by means of the vertical fine motion screw. Swinging the telescope round to the forward rod, he repeats this process for the foresight. The records of the Coast and Geodetic Survey show that the time of occupying one station is somewhat less than 5 minutes. In the season of 1911 one of the engineers of the Survey ran 14.35 miles single or 11.547 kilometers completed (back and forth) line in one day of 7 hours 30 minutes actual work. None of this leveling required re-running, all of it closing within the error of tolerance, i. e., $4 \text{ mm } \sqrt{K}$, in which K stands for the distance expressed in kilometers.

In constructing this instrument we follow absolutely the Coast Survey specifications, using nickel-iron and nickel-steel as called for, thus insuring a rigid maintenance of the adjustment of instrument under marked changes of temperature.

This level is guaranteed to pass the Coast Survey's inspection.

For details of construction and use, see Transactions of the American Society of Civil Engineers, June, 1901, pp. 127-175; U. S. Coast and Geodetic Survey Report for 1902, Appendix No. 4, and Report for 1900, Appendix No. 6.

SPECIFICATIONS:—

Telescope, inverting, length 17 inches, aperture $1\frac{3}{4}$ ", power about 40 diameters.

Level to telescope, length $5\frac{3}{4}$ inches, chambered, graduated in 2 mm divisions—each sensitive to $2''$ of arc.

Stadia wires, ratio 30 cm to 100 meters.

Micrometer screw, 100 revolutions to 1 inch; head divided into 100 parts.
A cam is provided for lifting telescope from micrometer screw when not in use.

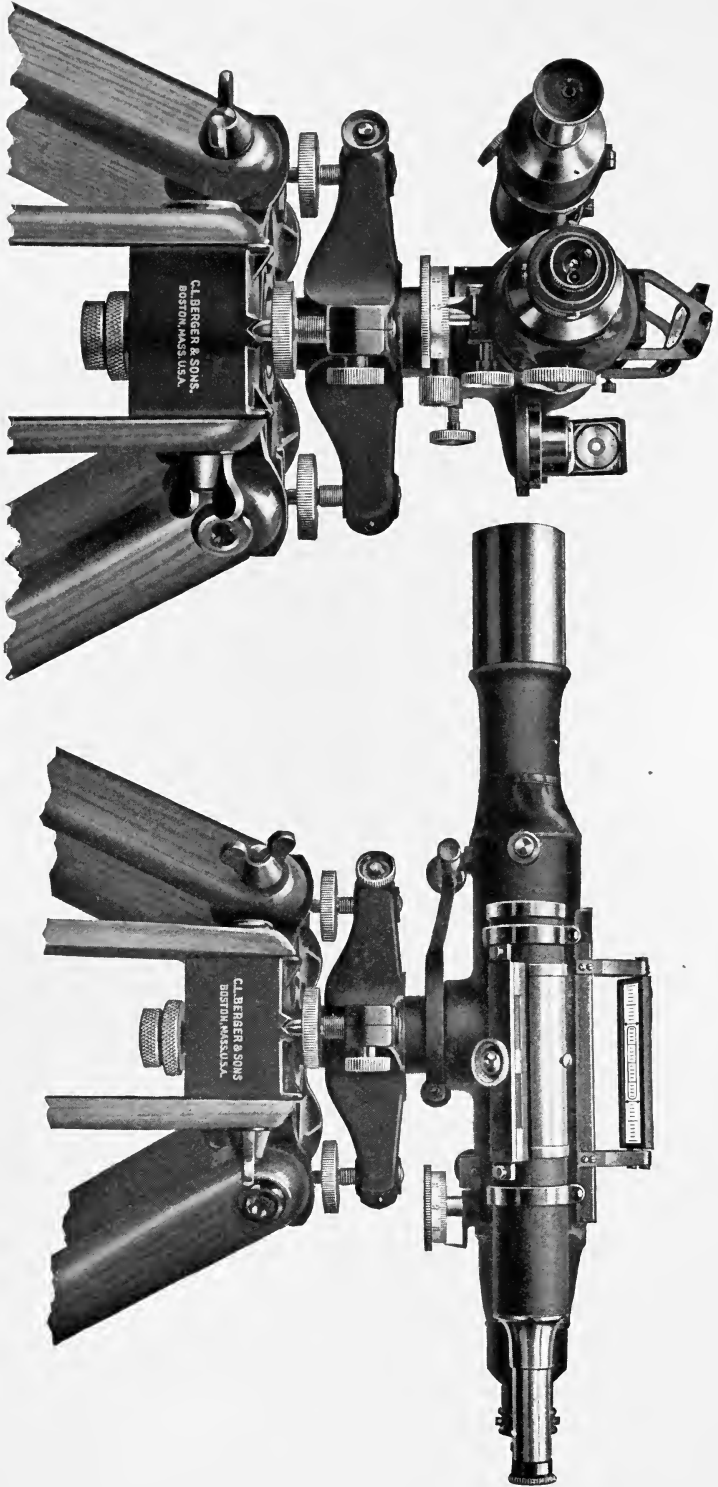
Weight of tripod, about 19 lbs.; in packing box about 50 lbs.

Weight of instrument, about 14 lbs.; in instrument box about 30 lbs.

Gross weight of level packed securely in two boxes for shipment, about 120 lbs.

Code word, **Aster.**

Price \$375.00



U. S. Coast and Geodetic Survey Precise Level.

PLANE TABLE

This instrument, as shown in cut on opposite page, has been designed to fill a want where a high class of work in topography is required. It is made in two sizes. The alidade is built strong and light. The ruler is of brass. Other parts are of aluminum, or brass, as best serving the purpose. The telescope is well lighted, powerful, and of greater length than usual, the latter enabling the observer to readily sight at an object when the alidade is some distance from the edge of the board. The ruler is provided with two fixed levels and is so arranged that lines can be ruled in the vertical plane of the telescope, if desired.

To obtain great rigidity and strength, the diameter of the bearing surface of the lower motion in both sizes is larger than usual and the board rests on radial arms extending considerably beyond this bearing surface. The tripod head is of corresponding size. To be portable, all the essential parts are built on the skeleton plan. To avoid a loosening of the leveling screw fastenings so often experienced where the latter are fitted into tripod heads made of wood, we make this head of composition brass, or of aluminum, and to prevent all wobbling of the leveling screws when worn, these latter are also provided with check nuts. Materials and workmanship are of the best.

SPECIFICATIONS:—

Alidade. Length of ruler 22 inches.

Telescope. Inverting. Aperture $1\frac{3}{8}$ inches. Length 16 inches. Power 35 dia.

(For adjusting the line of collimation, the telescope can be revolved 180° on its longitudinal axis.)

Stadia wires. Ratio 1:100.

Vertical arc. $4\frac{1}{2}$ inches, graduated on solid silver, double verniers reading to minutes. — The vernier arm is provided with a level on top for a ready control of zero of verniers.

Striding level. 6 inches over all.

Compass needle. $4\frac{1}{4}$ inches.

Lower motion, (usual size) with tangent screw (for boards 24×30 in. or 22×24 in.) Spread of arms from center $4\frac{1}{2}$ inches.

Weight of Alidade with brass ruler,	about	7 lbs.
“ “ Lower motion, usual size, with arms $4\frac{1}{2}$ inches,	“	.9 “
“ “ Tripod,	“	15 $\frac{1}{2}$ “
“ “ Board,	“	9 “
“ “ Alidade and accessories in mahogany box,	“	18 “
“ “ Lower motion in special box, with legs detached,	“	15 “
“ “ Board in canvas case,	“	11 “

Gross weight of instrument packed in four boxes ready for shipment, 100 “

Price of Plane Table as above, and as in cut, including one board 24×30 inches, detached compass, screw-driver, clamps, reading glass, plumb-bob, (board and tripod packed in pine wood shipping cases, alidade with attachments in mahogany box, lower motion in pine wood box) **\$300.00**

Price of Alidade alone, as above, with striding level, detachable compass, etc., in mahogany box, but without board and lower motion and tripod, **\$200.00**

Price of Interchangeable Micrometer
Code Word—Atlas. Made to order only. **\$50.00**

Price of Canvas Case for board **\$2.00**

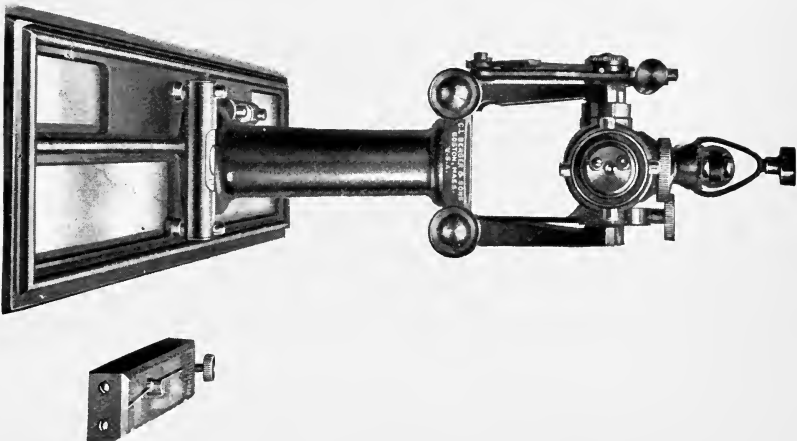
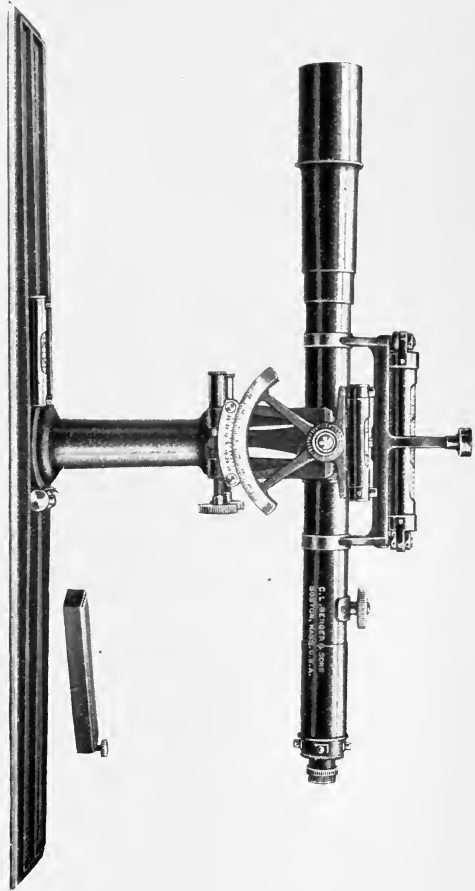
Note: Lower motion as above, but with a bearing surface 8 inches in diameter, having arms extending to 6 in. from the center, can be supplied for regular or larger boards, in place of the one specified above. Weight about 11 lbs.

Price extra, \$10.00

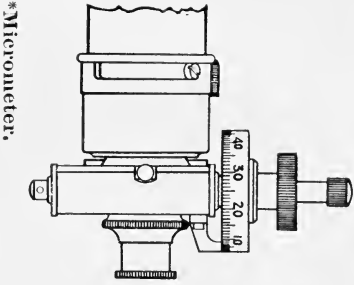
To meet a want where greater portability and lightness are thought to be more advantageous than greater rigidity and consequent accuracy, we are prepared to furnish in place of the above described lower motion of the Plane Table (shown in the accompanying cut) one of the Johnson type and character. A description of this may be omitted here, since it is described in any of the modern text-books on Plane Table Work. Suffice it to say that this motion is operated in a manner similar to that described under our Quick Leveling Attachment (see pages 45 and 118) of which it is an inverted adaptation, but is of greater size, range and steadiness.

This movement, with legs all complete, weighs only from 9 to 10 lbs.

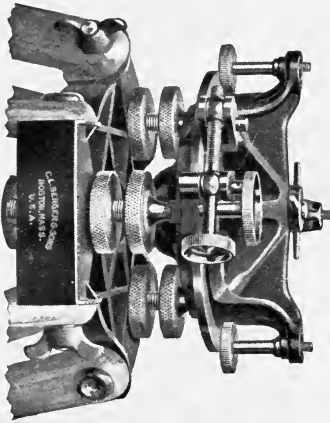
Price of Johnson's Improved Plane Table Movement,
mounted on large tripod **\$45.00**



Plane Table Alidade. Lower Motion and Compass.



*Micrometer.



The vernier arm of the $4\frac{1}{2}$ -inch arc has a level attached at top for the ready control of zero of the vernier.

*The micrometer is interchangeable with the regular eyepiece. It has means for collimating the cross wires in both directions and can be turned from a vertical to a horizontal position. The ordinary cross and stadia wires used with the regular eyepiece remain in the telescope without disturbing their adjustment for collimation while the micrometer is attached. Made to order only. For price see opposite page.

6 $\frac{1}{4}$ " ENGINEERS' AND SURVEYORS' TRANSIT.

This instrument is designed for engineering work of a high class, such as is required in bridge building, water-works, and for city and land surveying. The size of the circle is such that it may be graduated to read to 30" or 20" without fatigue to the eye. The telescope is of the best definition, and has a large aperture with perfectly flat field. The eye-piece is achromatic, and gives a large field with plenty of light. We advise our customers to order *solid silver* graduations for this instrument. Silvered graduations are made to order only, being of rare inquiry.

Transits size No. 1—No. 1c.

Specifications:—Horizontal Circle

6 $\frac{1}{4}$ in. (edge of graduation), double opposite verniers read to minutes, two rows of figures in opposite directions from 0° to 360°, figures on limb and verniers inclined in the direction they should be read, verniers protected with fine plate glass, and provided with glass shades, **graduations silvered**; long compound centers with heavy flanges; **edge-bar* magnetic needle 4 $\frac{1}{4}$ in.**; spring tangent screws; fine **telescope 11 $\frac{1}{2}$ inches** long, objects erect, aperture 1 $\frac{1}{4}$ inches, power of telescope 24 diam. (well adapted for stadia work), eye piece provided with an improved screw arrangement for accurately focussing the cross-wires, telescope perfectly balanced reverses at both ends, line of collimation correct for all distances, protection to object-slide, adjustment for vertical plane of telescope; **spirit levels** of standard length, ground and extra sensitive; shifting center to set the instrument exactly over or under a given point; top of telescope provided with a **very fine punch mark** to also enable to center the transit from a point above; standards **leatherized** (see p. 11), **full length split-leg tripod**, etc.

The Mahogany Case has a leather strap, hooks, etc., and contains a sun-shade, a wrench, a screw-driver, an adjustable plumb-bob, a magnifying glass, adjusting pin, and weighs from 9 $\frac{1}{2}$ to 10 lbs.

Weight of Plain Transit No. 1	13 $\frac{1}{2}$ lbs.	} Weight of tripod about 9 lbs.
" " Transit with Level Attachment (No. 1a)	14 "	
" " Complete Transit (No. 1b and No. 1c)	14 $\frac{1}{2}$ "	

Gross Weight of Instrument complete, packed securely for shipment in two boxes, about 60 lbs.

Plain Transit, size No. 1, as described above, see cut on opposite page.

Code Word, **Babelle**.

Price (graduations silvered), **\$180.00**

Transit No. 1a, size, etc., as under **No. 1** above, with long, sensitive level, clamp and tangent screw to telescope, see cut page 152.

Code Word, **Balmode**.

Price (graduations silvered), **\$210.00**

Transit No. 1b, size, etc., as under **No. 1** above, but with a level, clamp and 5-inch vertical arc to telescope. Arc has double verniers reading to minutes, see cut page 153.

Code Word, **Besica**.

Price (graduations silvered), **\$225.00**

Transit No. 1c, size, etc., as under **No. 1** above, but with a level, clamp and 5-inch full vertical circle to telescope. Vertical circle has double verniers reading to minutes, and is protected by an aluminum guard, as in cut page 154.

Code Word, **Boscardo**.

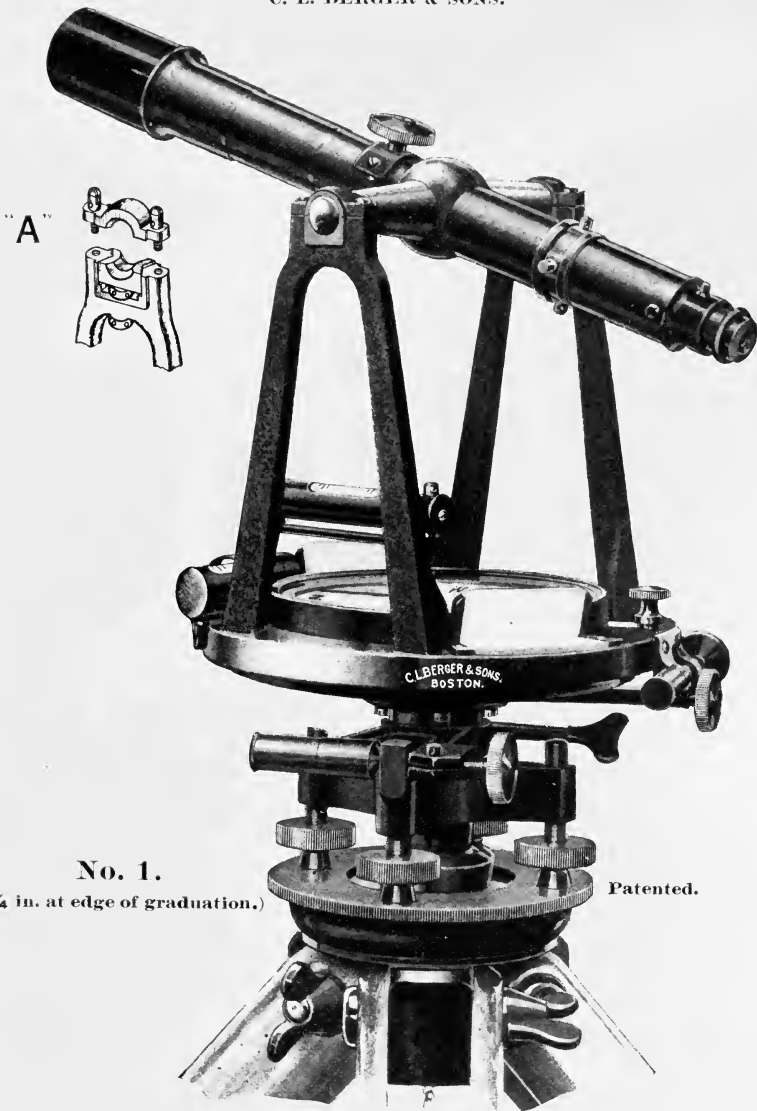
Price (graduations silvered), **\$237.00**

Extras to Plain Transit No. 1—Transit No. 1c inclusive.

Standards polished and lacquered (no leather finish), made to order only	\$5.00
Graduation of horizontal circle, on heavy inlaid ring of <i>solid silver</i>	10.00
" " " " reading to 30"	10.00
" " " " " 20"	20.00
" " vertical arc or vertical circle on heavy inlaid ring of <i>solid silver</i>	5.00
Gradiometer attachment (see pp. 6 and 45)	5.00
Stadia Wires, fixed	3.00
Short Focus Lens (pp. 101, 203). One pair	16.00
Arrangement for <i>offsetting at right angles</i>	5.00
Variation plate, adapted for all declinations E. or W.	10.00
Cravenette hood (heavy, gives good protection); silk (light, not waterproof) each	1.00
Bottle of fine watch-oil to lubricate the centers, etc., of transit	0.35

An **Inverting Telescope** of 1 $\frac{1}{2}$ " aperture, 11 $\frac{1}{2}$ " focal length and power of 28 dia. can be supplied with the above transits in place of the regular erecting one at no additional cost. This telescope is particularly well adapted for stadia work. The weight is 9 oz. more. This instrument is **made to order only**.

* Correct form having no index error. See pages 98, 99.



No. 1.

(6¼ in. at edge of graduation.)

Patented.

Plain Transit.

For size and description of this instrument, as well as for Extras, see opposite page.

Plain Transit No. 1, as shown above, and as described under Plain Transit No. 1 (Babelle), on opposite page, verniers reading to minutes, but with graduations on solid silver, as usually supplied.

Code word, **Babiana.**

Price, \$190.00

(For code words for Extras and changes from Babiana, see page C of complete code at back.)

The verniers of this instrument can be placed at an angle of 90° to line of sight, if so ordered to be made specially.

Sketch "A" shows the bearings in the standards for the V-shaped form of the telescope's axis, the improved manner of fitting the adjustable Wye block in the standard by means of dovetails instead of pins, also the adjustment of the block by opposing capstan-headed nuts, securing thereby:—

1. Greater rigidity of the bearing block in the standard, resulting in a truer motion of the telescope.

2. Greater ease of making the vertical plane adjustment, as compared with other makes of the same class.

3. Greater permanency of this adjustment when made.

**No. 1 a.**

6¼ in. at edge of graduation.)

Transit with Level Attachment* to Telescope.

For size and particulars of this instrument, as well as for Extras, see page 150.

Transit No. 1 a, same as shown above, and as described under Transit No. 1 a. (Balnode), page 150, verniers reading to minutes, but with graduations on solid silver and with fixed stadia wires as usually supplied.

Code Word, Balsam.

Price, \$223.00

(For code words for Extras and changes from Balsam, see page C of complete code at back.)

The verniers of this instrument can be placed at an angle of 90° to line of sight, if so ordered to be made specially.

* With a level attachment of the above kind, good leveling can be done, as the power of the telescope and the sensitiveness of the spirit-level are equal to that of most Wye-levels.

**No. 1 b.**

(6¼ in. at edge of graduation.)

Complete Engineers' and Surveyors' Transit.

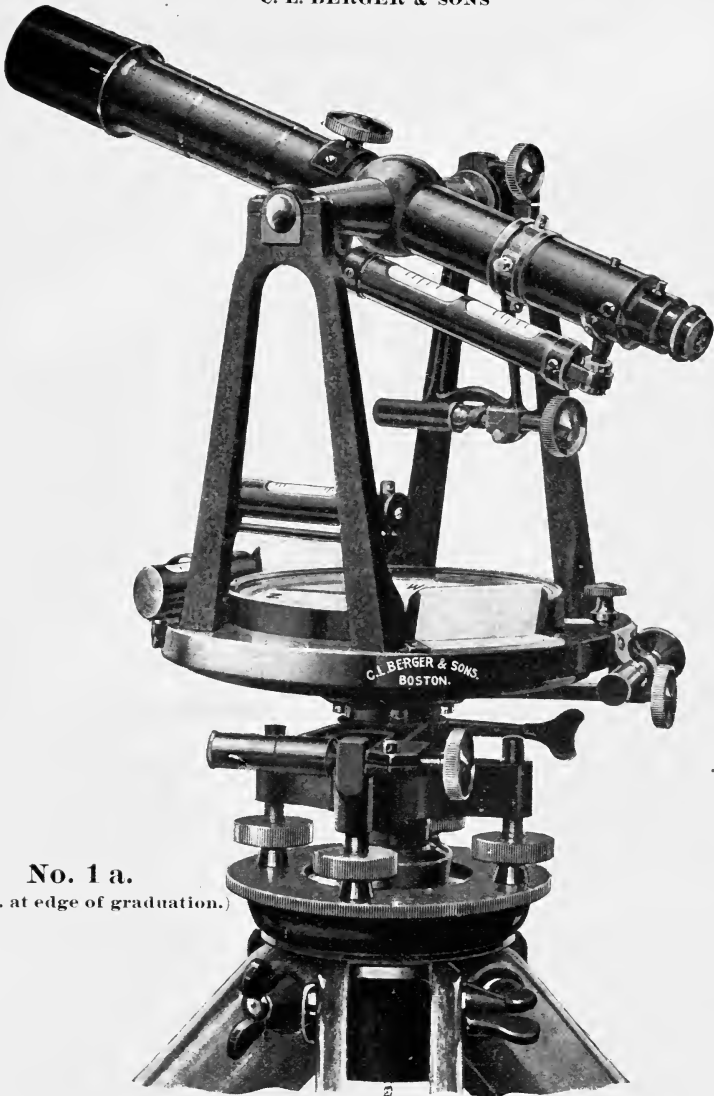
For size and description of this instrument, as well as for Extras, see page 150.

Transit No. 1 b, as shown above, and as described under Transit No. 1 b (Besica), on page 150, verniers reading to minutes, but with graduations on solid silver and with fixed stadia wires as usually supplied.

Code word, **Betonica**.**Price, \$243.00**

(For code words for Extras and changes from Betonica, see pages C, D and F of complete code at back.)

The verniers of this instrument can be placed at an angle of 90° to line of sight, if so ordered to be made specially.

**No. 1 a.**

6¼ in. at edge of graduation.)

Transit with Level Attachment* to Telescope.

For size and particulars of this instrument, as well as for Extras, see page 150.

Transit No. 1 a., same as shown above, and as described under Transit No. 1 a. (Balnode), page 150, verniers reading to minutes, but with graduations on solid silver and with fixed stadia wires as usually supplied.

Code Word, Balsam.

Price, \$223.00

(For code words for Extras and changes from Balsam, see page C of complete code at back.)

The verniers of this instrument can be placed at an angle of 90° to line of sight, if so ordered to be made specially.

* With a level attachment of the above kind, good leveling can be done, as the power of the telescope and the sensitiveness of the spirit-level are equal to that of most Wye-levels.

**No. 1 b.**

(6¼ in. at edge of graduation.)

Complete Engineers' and Surveyors' Transit.

For size and description of this instrument, as well as for Extras, see page 150.

Transit No. 1 b, as shown above, and as described under Transit No. 1 b (*Besica*), on page 150, verniers reading to minutes, but with graduations on solid silver and with fixed stadia wires as usually supplied.

Code word, **Betonica**.**Price, \$243.00**

(For code words for **Extras** and changes from *Betonica*, see pages **C**, **D** and **F** of complete code at back.)

The verniers of this instrument can be placed at an angle of 90° to line of sight, if so ordered to be made specially.

**No. 1 c.**

(6¼ in. at edge of graduation.)

Patented.

Complete Engineers' and Surveyors' Transit.

For size and particulars of this instrument, as well as for Extras, see page 150.

Transit No. 1 c, same as shown above, and as described under Transit No. 1 c. (Boscardo), page 150, verniers reading to minutes, but with graduations on solid silver and with fixed stadia wires, as usually supplied.

Code word, **Bouvardia**.**Price, \$255.00**

(For code words for Extras and changes from Bouvardia, see pages C, D and E of complete code at back.)

The verniers of this instrument can be placed at an angle of 90° to line of sight, if so ordered to be made specially.

Special Vertical Circle.

A $5\frac{1}{2}$ -Inch Vertical Arc or Full Circle with flat graduations of style shown for No. 1 b and No. 1 c but reading to $30'$ can be furnished in place of the regular 5-inch. Made to order only.

Code Word—**Bowana**

Price, extra \$5.00

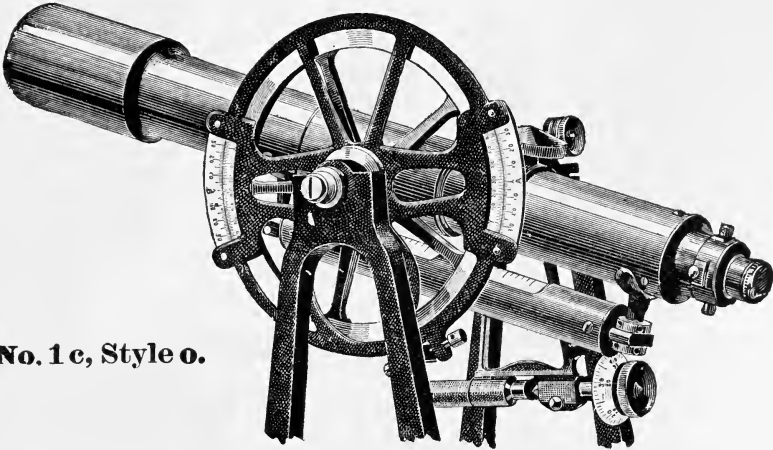
Beaman Stadia Arc.

An attachment for reducing inclined stadia readings to horizontal distances, and at the same time, giving differences of elevation between instrument and base of rod. It can be attached to Transits with flat vertical circles $5\frac{1}{2}$, 5 and 4 inches diameter and having the verniers between the legs of standards, as in No. 1 c.

It may also be used for arcs with an open edge graduation, as for Plane Table Alidades, etc. Attached to our instruments to order only. See page 197.

Code Word—**Beaman**

Price, extra \$30.00



No. 1 c, Style o.

The Berger Double Opposite Vernier Attachment for transits provided with a 5-inch full vertical circle, verniers reading to minutes. For more information and adjustments of this feature see page 49.

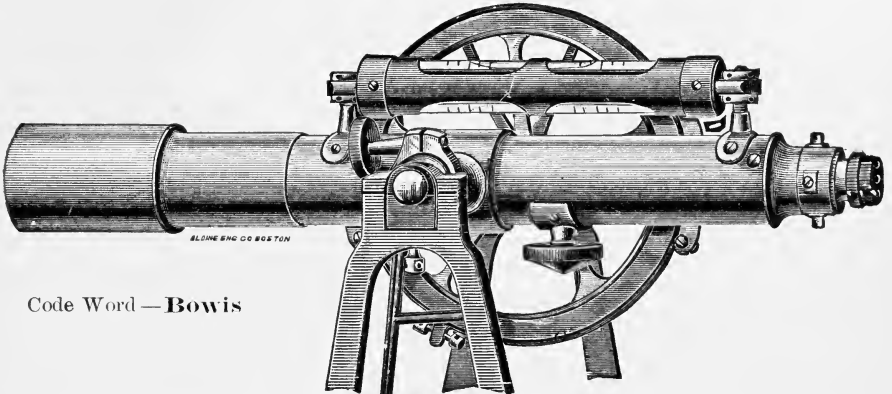
Made to order only.

Code Word—**Bowek**

Price, extra \$20.00

For price of Double Opposite Vernier Attachment with Open Frame protected vertical circle, graduation glass-covered, see page 199.

Reversion Level.



Code Word—**Bowis**

Applicable to any of our Transits of sizes No. 1, 2 3, 4, 5 and 6.

Price, extra (over price of transit with level attachment to telescope), \$12.00

NOTE.—This level has a revoluble cover guard to protect the exposed side of the level and to act as a reflector while in use.

The adjustment of this level and the horizontal cross-wire has to be made in the manner described for the fixed level attached to the transit telescope, see pages 54 and 63.



No. 1 c, Style p.

($\frac{3}{8}$ in. at edge of graduation).

Tachymeter.*

For size and particulars, as well as for extras, see pp. 150-153.

No. 1 c, Style p. Graduations of horizontal and vertical circles on solid silver, reading to minutes; 5-inch full vertical circle with two double opposite verniers reading to minutes; glass shades over verniers; $3\frac{1}{4}$ -inch striding level; gradient attachment; fixed stadia wires; etc. Standards leather finished.

Code Word, **Buckwheat.**

Price as above, **\$296.00**

This instrument without a striding level,	less,	\$20.00
“ “ “ double opposite verniers for vertical circle, but with a double vernier between the legs of the standard as in No. 1c, page 154.	less,	\$16.00

*The name *Tachymeter*, or rapid measurer, has been applied for many years, in Europe to instruments of this description. The characteristic of *tachymetry* is, that all the data required for the location of points are rapidly determined by the instrument, by means of horizontal and vertical angles, and stadia measurements of distance.



No. 1 d.

As made by C. I. Berger & Sons.

Tachymeter.

For size and particulars of this instrument see pages 150-153.

No. 1 d, as in cut, graduation of horizontal circle on solid silver, opposite verniers reading to 20'; graduation of vertical arc on solid silver, verniers reading to minutes; glass shades over verniers; detachable reading glasses for both circles, 11¼-inch telescope showing objects inverted, power 27 diameters; 3½-inch striding level; gradienter attachment; fixed stadia wires; etc. Standards leather finished.

Code Word, **Bumelia**.

Price, as above, **\$312.00**

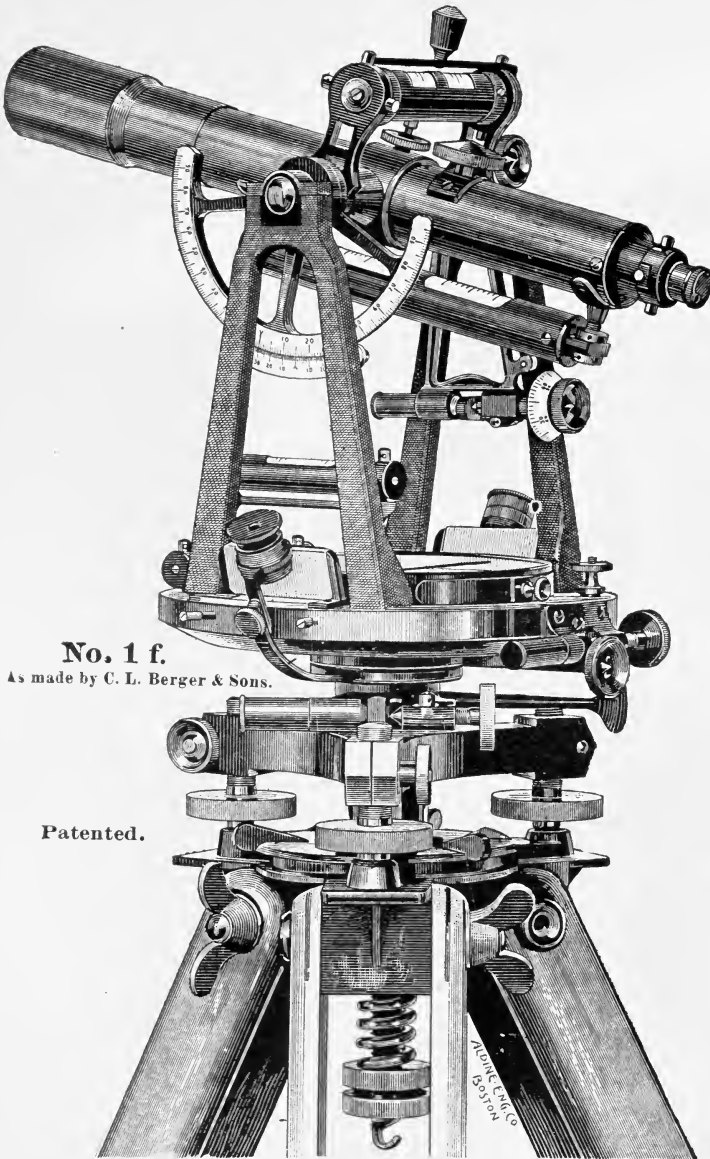
No. 1 d, as in cut above, and as described under No. 1 d "Bumelia" but with full vertical circle protected by an aluminum guard as shown in No. 1 c, page 154.

Code Word, **Burton**.

Price, **\$321.00**

This instrument without a detachable reading glass to the vertical arc, less \$5.00

NOTE.—For a description of the striding level, its use and adjustment, see page 56. This striding level and the detachable reading glasses, as shown above, can be attached only to our transits of the above description; we cannot attach them to instruments already made.



No. 1 f.

As made by C. L. Berger & Sons.

Patented.

Tachymeter.

With three Leveling Screws and Shifting Center.

No. 1 f, as in cut. Graduation of horizontal circle on solid silver, opposite verniers reading to 20'; graduation of 5 inch vertical arc on solid silver, verniers reading to minutes; glass shades over verniers; detachable reading glasses for horizontal circle; 11½-inch telescope showing objects inverted, power 27 diameters; 6-inch spirit level parallel to telescope; 3½ inch striding level; gradienter attachment; fixed stadia wires, etc. Standards leather-finished.

Price, as above, \$322.00

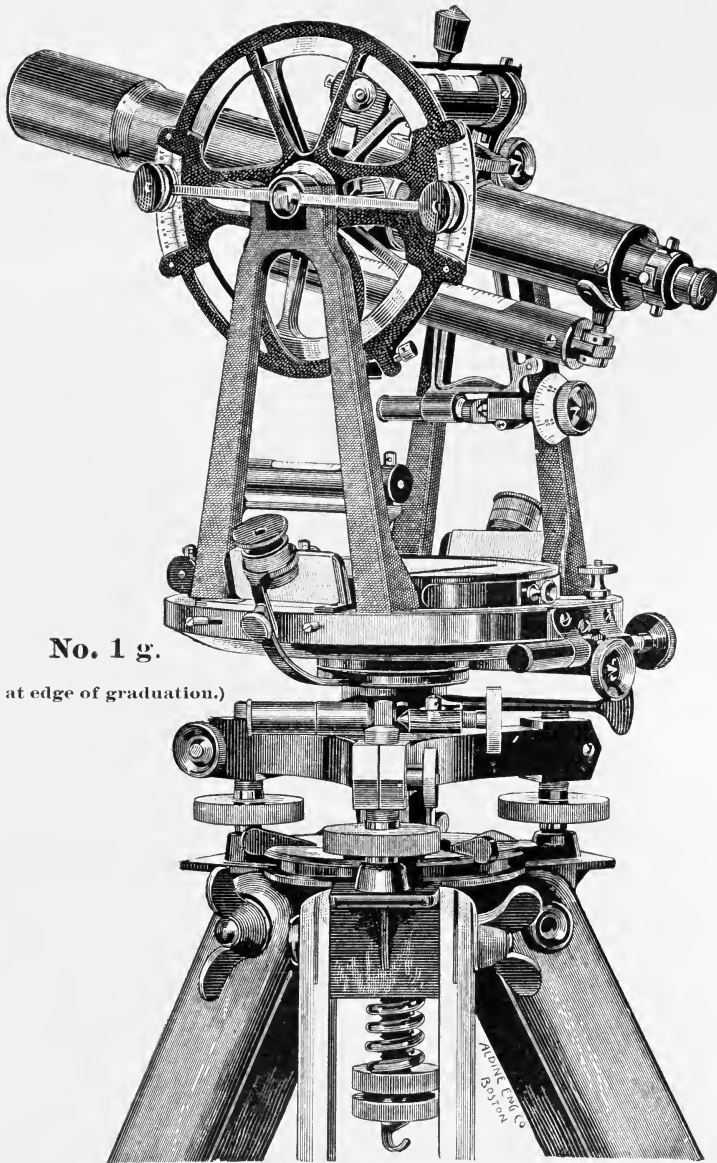
For size and particulars of this instrument, as well as for Extras see pages 150-153.

For adjustment of Transverse striding-level resting on special collars see page 56.

NOTE.—An instrument of this size with three leveling screws requires a larger leveling base than is usual with those of the same size provided with four leveling screws. The tripod head must also be larger in an instrument of this class, in order to make the steadiness of the tripod correspond with the increased accuracy expected from such an instrument. This increase of size not only adds about 3 lbs. to the weight of the tripod, but renders it at the same time less portable on the shoulder on account of the greater circumference of the legs at the tripod-head. The packing of an instrument with three leveling screws in its box is also more complicated. These disadvantages should be fully considered before ordering an instrument of this kind, reading as it does only to 20' direct. We do not graduate instruments of this size and style to read to 10'; the 6¼ inch circle being too small for accurate and easy reading when divided so finely. For finer instruments see types enumerated under transit No. 11, etc.

* For more information on this point see page 44.

Code word Burdock.



No. 1 g.

(6¼ in. at edge of graduation.)

Tachymeter.

For size and particulars of the above instruments, as well as for extras, see pp. 150-153.

No. 1 g, as in cut. Same as No. 1 f, but having a 5-inch full vertical circle with two double opposite verniers reading to minutes, and two reading-glasses to the vertical circle.

Code Word. **Buttercup.**

Price as above, **\$352.00**

6 $\frac{1}{4}$ " MONITOR TYPE

Engineers' Transit No. 1 m.

With Yoke Standards and Wye-Bearings. Without Compass.

For Triangulation, General Construction, Tunnel and all classes of Underground Work.

In the Transit illustrated on opposite page the yoke-shaped standard frame carrying the wye-bearings for the telescope's axis of revolution, is cast in one piece, and its form, being of superior design, is such as to give great upright and lateral stiffness, with comparative lightness in weight. This fact, coupled with the desire to have an instrument free from the defects so often noticed in the Transits enumerated under Nos. 1 and 2, etc., with compasses where the necessary lateral rigidity of the standards must be obtained by the peculiar conically-shaped pivot ends of the telescope's axis of revolution, at the expense of accuracy, led us to adopt the cylindrical form of pivots resting in wye bearings, to ensure a true motion of the telescope in the vertical plane, (one that is free from any deflection of the line of sight caused by wobbling in bearings loose from wear and lateral strain). In this Transit the telescope reverses only through the standard, as usual, the aim being to furnish a Transit most eminently fitted for the highest class of engineering work of all kinds, but at a cost lower than those enumerated later on under Triangulation Transits. In this instrument the wye-bearings are well protected from dust and water. The main plate level is placed in the center of the upper plate, where it is entirely protected by the base of the standard frame and by the aid of a special guard, and where it can easily be read from both sides. The upper surface of the vernier plate is slanting downwards, and the vernier openings are raised above the surface, and special channels are provided, so that water will run off immediately. The Yoke standard frame will be leather-finished. In this, as in all other instruments, the fine appearance and general character depends principally on simplicity of design, coupled with fine workmanship, and a high state of efficiency of every part. Other parts that cannot easily be finished and lacquered in the usual—but mostly antiquated—manner, are therefore also leather-finished. This is in line with good taste and modern thought and improvements, to enable us to unite as many pieces as possible to secure great stability and steadiness under all conditions in order to arrive at quick and thoroughly reliable results.

Transit No. 1 m, as in cut (for size, weight and particulars, see Transit No. 1, page 142); graduation of horizontal circle on solid silver, double opposite verniers reading to 30'; graduation of 5-inch vertical circle on solid silver, double vernier reading to minutes; aluminum guard to vertical circle; glass shades over verniers; 11 $\frac{1}{4}$ -inch erecting telescope with 1 $\frac{1}{4}$ -inch aperture; power 24 diameters; long spirit-level to telescope; fixed stadia wires; etc. Made to order only.

Price, as above **\$265.00**

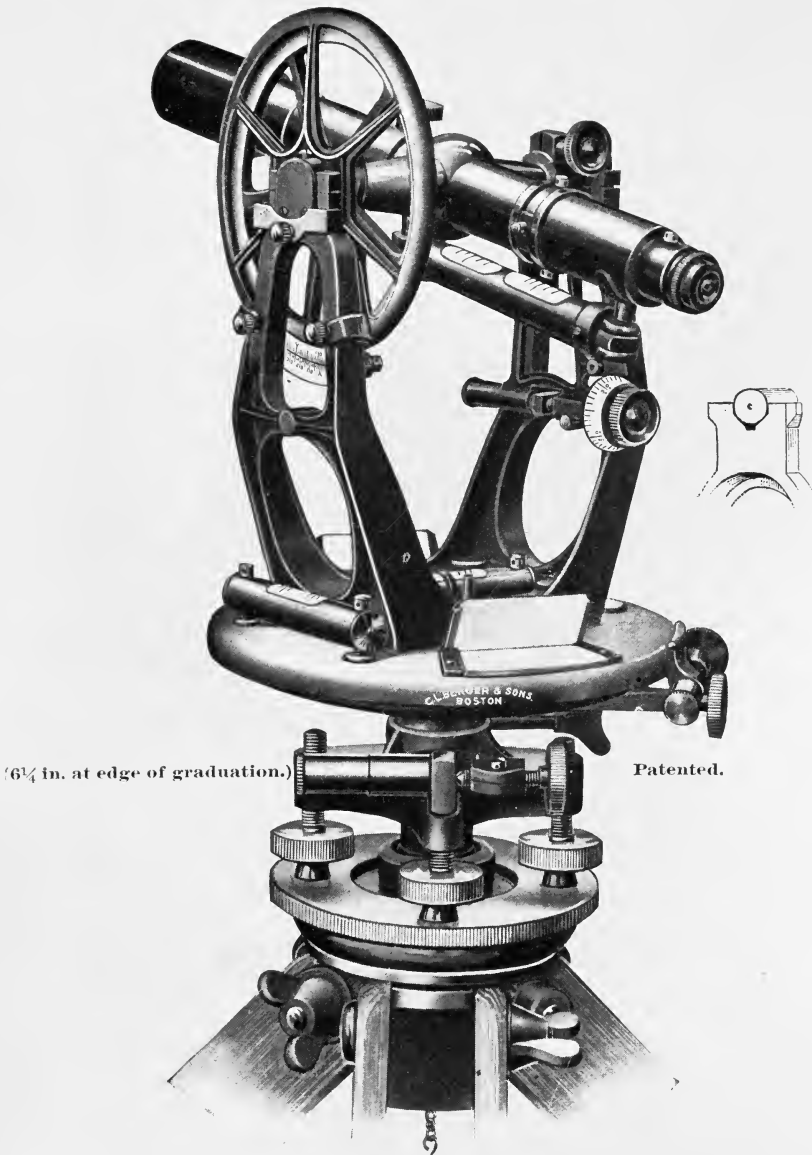
Code Word **Buxana**

This transit can be made with inverting telescope when so ordered; length 12 inches, clear aperture 1 $\frac{3}{8}$ inches, power 28 diameters. No extra charge.

If desired with inverting telescope add to the **Code word "Invert."**

Oblong Compass permanently fastened to and within the confines of vernier plate at side of standard. The 3-inch needle can be read 5° each side of the zero of the graduation.

Code Word—Oblong **Price extra, \$15.00**



Engineers' Transit No. 1 m.

With Yoke Standards and Wye-Bearings. Without Compass.

For Triangulation, General Construction, Tunnel and all classes of Underground Work.

6 $\frac{1}{4}$ " SURVEYORS' TRANSIT No. 1 s.

With Compass, Yoke Standards and Wye-Bearings.

It is well known that in Transits with compass (styles Nos. 1, 2, 3, 4, 5 and 6) the strength required for the standards to support the telescope, and to prevent the latter from shifting laterally in the bearings, is derived mainly from the vernier plate and its compass ring as a base, from the rigidity of the standards themselves and their width apart, and last — but most important — from the peculiar shape of the pivot-ends of the horizontal axis of revolution, which latter prevents both of the standards from swaying to and fro. Ingenious and time-honored as this construction is — being exemplified in many thousands of instruments — it cannot compare in degree of accuracy with that afforded when the ends of the telescope's axis are of cylindrical form running in wye-bearings, provided the necessary upright and lateral stiffness can be obtained in the standard frame. The Yoke standard frame, shown in the cut on opposite page, is of great strength combined with lightness, and enables to successfully mount the telescope's axis by means of cylindrical pivots in wye-shaped bearings. The motion of the telescope in the vertical plane is therefore entirely free from such defects, as deflection of the line of sight, etc., noticed in the older styles, when caused by wear and strain. To obviate this, has been the object of introducing the yoke frame — common in all our triangulation Transits — but having a compass mounted in the central portion of its base. With this arrangement the surveyor is now placed in possession of an instrument whose chief features have no superior in point of accuracy, fine workmanship and thorough adaptation to his needs. The telescope reverses through the standards only. The Yoke frame will be leather-finished; all other parts will be polished and lacquered. The whole instrument has a fine appearance.

Transit No. 1 s, as in cut (for size, weight and particulars, see Transit No. 1, page 150); graduation of horizontal circle on solid silver, double opposite verniers reading to minutes; 5-inch vertical circle with one double vernier reading to minutes, at eye-end; graduation on solid silver; aluminum guard; glass shades over verniers; 11 $\frac{3}{4}$ -inch erect telescope with 1 $\frac{1}{2}$ -inch aperture, power 24 diameters, long spirit-level to telescope; fixed stadia wires; 3 $\frac{9}{15}$ -inch magnetic needle with variation plate; etc.

Made to order only.

Price **\$300.00**
Code Word **Buxota.**

Extras to Transit No. 1 s.

Horizontal circle graduated to read to 30", extra 10.00
 " " " " " " " 20" " 20.00

This transit can be made with inverting telescope when so ordered; length 12 inches, clear aperture 1 $\frac{3}{8}$ inches, power 28 diameters. No extra charge.

If desired with inverting telescope add to the **code word** "Invert."

5 $\frac{1}{8}$ " SURVEYORS' TRANSIT No. 2 s.

Horizontal circle 5 $\frac{1}{8}$ in. at edge of graduation.

Transit No. 2 s (size, weight and particulars as in **No. 2**, page 168), but with magnetic needle 2 $\frac{1}{2}$ " long, variation plate; otherwise with same features as for **No. 1 s** above.

Made to order only

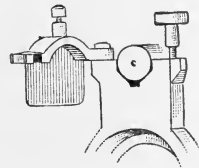
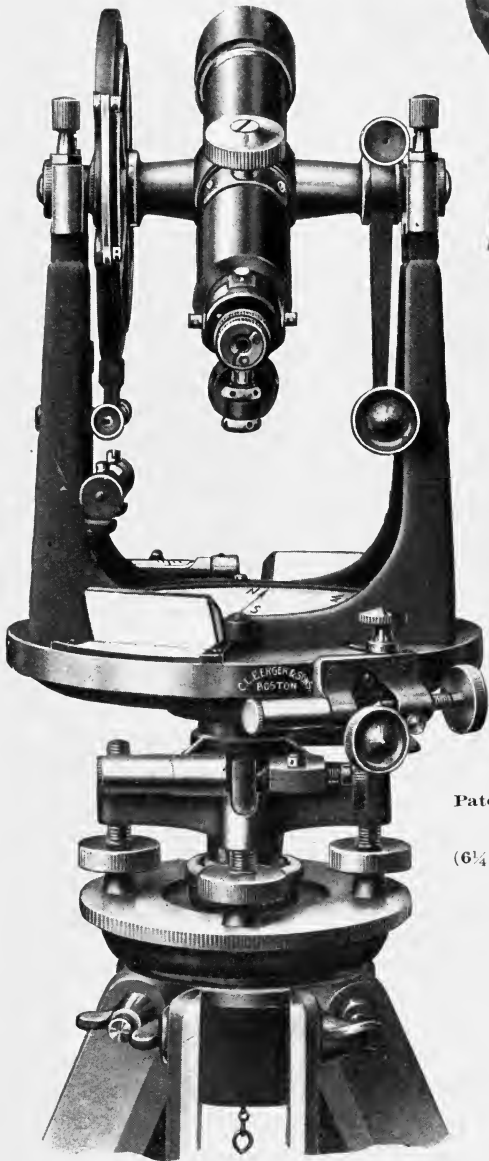
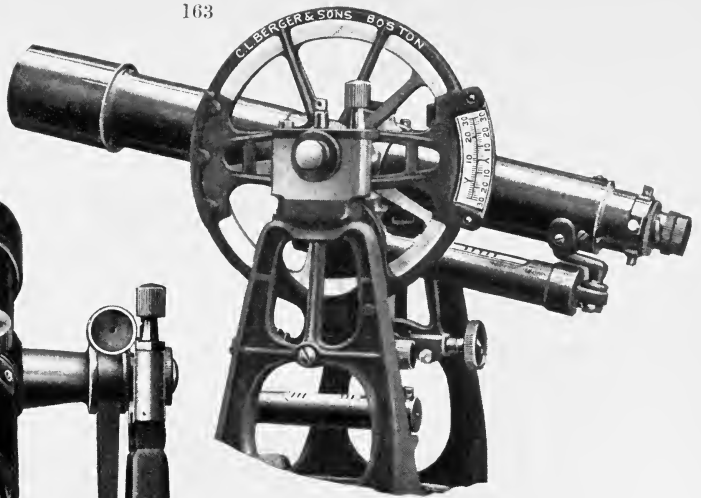
Price **\$300.00**
Code Word **Buylis.**

This instrument with inverting telescope, add to the **Code Word** "Invert."

Transits No. 1 s and **No. 2 s**, enumerated above, may have a 5" vertical arc, with the verniers between the Yoke standard frame instead of the full vertical circle with the verniers at eye end.

Price **\$280.00**
Code Word, Transit No. 1 s **Buzada.**
 " " **Transit No. 2 s** **Buzemo.**

For prices of solar attachments, etc., see pages 172 to 175.



Patented.

($6\frac{1}{4}$ in. at edge of graduation.)

Surveyors' Transit No. 1 s.

With Compass, Yoke Standards and Wye-Bearings.

(Above instrument is shown with inverting telescope.)

5¹/₂" ENGINEERS' AND SURVEYORS' TRANSIT*

A **Standard Size** of less weight than transit **No. 1**, but larger than size **No. 2**.

The telescope has nearly the same power as **No. 1 Erecting** and when made **Inverting** is more powerful.

The outer or **contra clockwise row of figures** on the horizontal circle and those of the verniers of the right side of verniers **A** and **B** can be furnished in **Red** but will be **made to order only**, see cat. page 41. Instrument stands upright in carrying case.

Transit, Size No. 5¹/₂

SPECIFICATIONS:—

Horizontal circle 5¹/₂-inch (at edge of graduation), graduated on **heavy ring of solid silver**, double opposite verniers, read to minutes, two rows of figures 0 to 360 in opposite directions; figures inclined in the direction verniers should be read, verniers at 30° to line of sight.

Vertical circle 5-inch, graduated on **solid silver**, double verniers read to minutes, between legs of standard, and **Aluminum Guard**.

Telescope 10¹/₂-inch, objects erect, † aperture 1¹/₄ inch, power 20 dia.

Stadia wires, fixed, in ratio 1:100.

Spirit-level 5¹/₂-inch, with clamp and tangent screw to telescope.

Plate-levels of standard length and very sensitive.

Magnetic needle 3¹/₂-inch, edge-bar form. (See pages 98–99.)

Shifting center, to set instrument exactly over a given point.

Punch mark on top of telescope, to enable to center the transit from a point above.

Transit leatherized (see page 9). All important parts treated in our durable and handsome leather finish.

Full length split-leg tripod.

The Mahogany case has a leather strap, hooks, etc. It contains a sun-shade, a wrench, a screw-driver, an adjustable plumb-bob, a magnifying glass, an adjusting pin, and weighs about 7 lbs.

Weight of transit about 13 lbs.; **weight of tripod** from 9 to 9¹/₂ lbs.

Gross weight of transit packed securely for shipment in two boxes, about 55 lbs.

Code Word, **Cakula**.

Made to order only. Price \$252.00

Transit as above, with a 5-inch Arc in place of a full Vertical Circle.

Code Word, **Cagana**.

Made to order only. Price, \$243.00

Transit as under **Cagana**, but without arc.

Code Word, **Cadagon**.

Price, \$223.00

Extras to Transit No. 5¹/₂.

Graduation of Horizontal Circle, reading to 30"	\$10.00
Gradienter attachment	5.00
Offsetting arrangement	5.00
Variation Plate, adapted for all declinations E. or W.	10.00
Extension Tripod, in addition to the split-leg tripod furnished with the transit	19.50
Plain Prism, with colored glass, for observing the sun's altitude (fig. 7), page 175	8.00
Improved Prism, with colored glasses, for observing the sun's altitude (fig. 5), page 175	12.00
Davis' Solar Attachments, screen with improved prism mounting (page 175)	18.00
Berger's Solar Attachment (small) (pages 172 and 173)	52.00
Latitude Level Attachment	15.00
Short Focus Lens Attachment (see pages 101 and 203) One \$8.50, pair	16.00
Leather Cover over case arranged to be strapped to a saddle of a horse	13.00
Leather Cover over case as above with shoulder straps	15.00
Cravette hood (heavy, gives good protection) silk (light, not waterproof), each	1.00
Bottle of fine watch oil, for the centers, etc., of transit	0.35

*Unusual size; see our **No. 5¹/₂ Monitor Transit**, pages 166 and 167.

†An **Inverting Telescope of 1¹/₄" aperture, 10¹/₂" long, power 23 dia.** can be supplied with the above transit in place of the regular erecting one at no additional cost. This telescope is particularly well adapted for stadia work. **Made to order only.**

C. L. BERGER & SONS, BOSTON.

**No. 5½.**

5½ in. at edge of graduation.

Patented.

No. 5½ Engineers' and Surveyors' Transit.

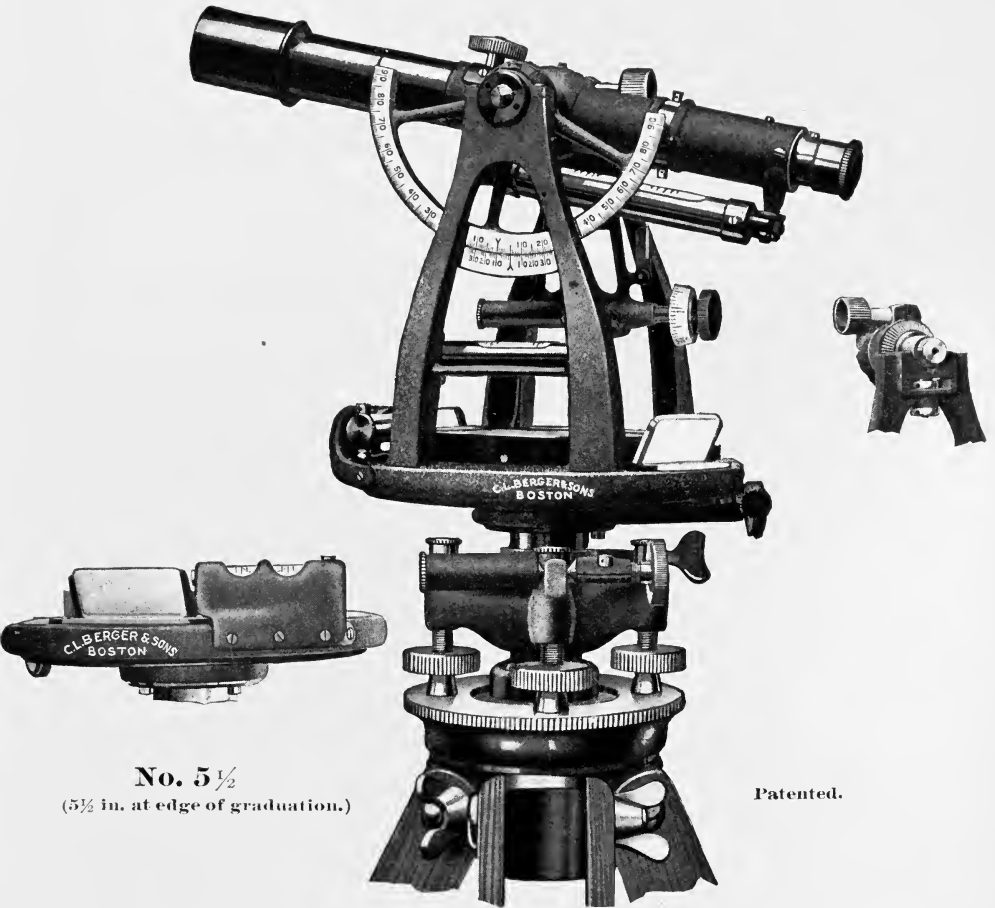
Unusual size, **made to order only.** (See No. 5½ complete Monitor Transit, pages 166 and 167.)

For size, weight, particulars and extras of this instrument see opposite page.

Code word **Cakula****Price, \$252.00**

The **Front Plate Level** is fully protected its entire length by an aluminum guard which is independent of the level and its adjustments.

To avoid mistakes and to save time telegraph Code name.

**No. 5 1/2**

(5 1/2 in. at edge of graduation.)

Patented.

No. 5 1/2 Complete Monitor Type Transit

For size, weight, particulars and extras of this instrument see opposite page.

Code word Caboa

Price, \$243.00

Cylindrical Pivots to telescope's axis running in the improved Wye bearing. The center point is located on a round hub on the telescope's axis to better distinguish it in dark places when centering under a point above the transit.

The Eye Piece Cap is large in diameter. It affords a protection to the eye of the observer in a glaring sun. It has been combined with a dust guard which fully protects the Eye Piece focussing slide.

The Front Plate Level is fully protected its entire length by an aluminum guard which is independent of the level and its adjustments.

Improved Levelling Head with dust caps to levelling screws.

To avoid mistakes and to save time telegraph Code name.

5 $\frac{1}{8}$ " ENGINEERS' AND SURVEYORS' TRANSIT.

The essential features of this transit are like those enumerated under No. 1, page 150, with the exception of size and weight. We strongly recommend it for use where a lighter instrument is desirable for land surveying, railroad, mining and underground work, etc., of all kinds and where a graduation reading direct to single minutes and to 30'' and 20'' by estimation is preferred. Every part is made with great care and the aperture, focal length and power of telescope are properly related to each other and to the size of plate to make this a very compact, portable and accurate transit.*

Complete Transit Size No. 2. As in cut (see opposite page), but with verniers at 30° to line of sight (unless ordered to be at 90°). **SPECIFICATIONS:—**

Horizontal circle 5 $\frac{1}{8}$ -inch (at edge of graduation), graduated on heavy inlaid ring of solid silver, double opposite verniers reading to minutes, two rows of figures 0 to 360 in opposite directions; figures inclined in the direction verniers should be read; verniers at 30° to line of sight.

Vertical arc 5-inch, graduated on solid silver, double verniers read to minutes.

Telescope 10 $\frac{1}{4}$ -inch, objects erect, † aperture 1 $\frac{1}{4}$ inch, power 18 dia.

Stadia wires, fixed, in ratio 1:100.

Spirit level 5 $\frac{1}{2}$ -inch, with clamp and tangent screw to telescope.

Plate levels of standard length and very sensitive.

Magnetic needle 3 $\frac{3}{4}$ " edge-bar form having no index error.

Shifting center, to set instrument exactly over a given point.

Punch mark on top of telescope, to enable to center the transit from a point above.

Standards leatherized (see page 9).

Full length split-leg tripod.

The Mahogany case has a leather strap, hooks, etc. It contains a sun-shade, a wrench, a screw-driver, an adjustable plumb-bob, a magnifying glass, an adjusting pin, and weighs about 7 lbs.

Weight of transit about 10 lbs.; **weight of tripod** from 9 to 9 $\frac{1}{2}$ lbs.

Gross weight of transit packed securely for shipment in two boxes, about 55 lbs.

Code Word **Calypso**.

Price, \$243.00

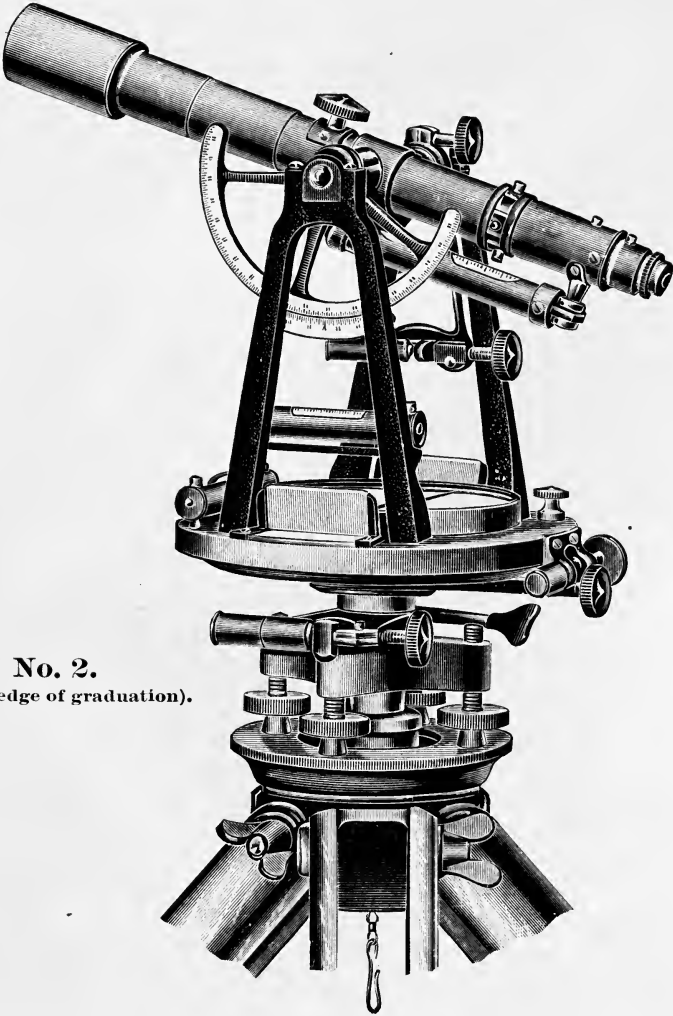
{	Transit No. 2 as in Calypso but without solid silver, graduations silvered.	
	Code Word Calixa .	Price, \$228.00
	Transit No. 2 as in Calypso but without vertical arc (see No. 1 a, page 152).	
	Code Word Calamus .	Price \$223.00
	Transit No. 2 as in Calypso but without level, clamp, tangent screw, arc or stadia wires to telescope (see cut Plain Transit No. 1, page 151).	
	Code Word Caladium .	Price \$190.00

Extras to Complete Transit No. 2.

Standards polished and lacquered (no leather finish). Extra	\$5.00
5-inch full vertical circle (in place of arc), graduation on solid silver, double vernier between legs of standard reading to minutes, with aluminum guard (as in cut, page 177).	9.00
Gradiometer attachment	5.00
Offsetting arrangement	5.00
Short Focus Lens (see pp. 101, 203). One pair	16.00
Variation Plate , to set off all declinations E. or W.	10.00
Cravenette hood (heavy, gives good protection); Silk (light, not waterproof), each	1.00
Bottle of fine watch-oil , to lubricate the center, etc., of transit	0.35

* For close stadia work, Transit telescope **size No. 1**, with its longer focal length and higher power, will be best suited for that purpose. But in all cases where greater lightness and portability and where only general good results in stadia work, as obtained with a less powerful telescope, will be deemed satisfactory, **size No. 2** should be chosen. We cannot put a telescope of the size described under No. 1 upon a Transit size No. 2.

† An **Inverting Telescope** of 1 $\frac{1}{4}$ " aperture, 10 $\frac{1}{4}$ inches long and with a power of 22 dia. can be supplied with the above transits in place of the regular erecting one at **no additional cost**, but the instrument must be made to order. This telescope is particularly well adapted for stadia work.

**No. 2.**

($5\frac{1}{8}$ in. at edge of graduation).

5-inch Complete Engineers' and Surveyors' Transit.

For size, weight, particulars and extras of this instrument see opposite page.

Transit No. 2, as already described on opposite page — **Calypso** — and as shown above, but with verniers at 30° to line of sight (unless ordered to be at 90°), graduations on solid silver, fixed stadia wires.

Code word, **Calypso**.

Price \$243.00

(For code words for **Extras** and changes from **Calypso**, see pages **C**, **E** and **F** of complete code at back.)

NOTE — If verniers are desired at 90° to line of sight, as in cut above, the instrument must be made specially, — no extra charge.

The Surveyors' Solar Attachment.

Placed on the side of the transit it permits the main telescope to be reversed through the standards at all times.

Our Surveyor's Solar Attachment, or meridian finder, is in principle like Pearson's (made by us heretofore), not requiring computation, but instead of the lens-bar it has a **small telescope** with $\frac{1}{2}$ -inch aperture and 6 inches focal length. This telescope is provided with a detachable prism and colored glass for the eye-piece, and also a plain colored glass for use with the main, or solar telescope, and our customary solar square as in figure RR, page 122.

This **solar** attaches by means of a screw to the end of the cross-axis of the transit telescope on the side of the clamp and tangent-screw, as shown in the cut, and when not in use can be again readily detached from the instrument proper. It has no declination arc. The declination of the sun, and the latitude of the place of observation are both set by the vertical circle of the transit. All settings for position, viz., that of the polar axis for latitude, that is, for coincidence with the zero marks of the vertical circle and verniers, and the setting of the declination, are secured by two spirit levels placed upon the polar axis and upon the solar telescope, as will be seen in the cut. The degree of precision attainable and the ease of manipulation in the use of this attachment is commensurate with that of our engineers' and surveyors' transit.

To determine true meridian at any hour of a day, it is only necessary that the declination and refraction of the sun on that particular day and hour be known to the observer, and that the polar axis be raised precisely to the co-latitude of the place of observation.

By the use of our **Latitude Level** (also attaching to the cross-axis at the side of the vertical circle, as shown in the second cut), not requiring a reading of the vertical circle for every setting of the polar axis for latitude except once in a day, observations can be made repeatedly with speed and accuracy. With the declination and refraction of the sun previously worked out for the various hours of a day, observations can be made nearly as fast as a needle can be read of the surveyor's compass.

A concise description of both attachments will be found in our manual. The accompanying illustrations of the solar attachment represent them as applied to transits No. 1 and No. 2. Of all the different kinds in use, we believe it to be the **most efficient**. **Owing to its position at the side of the transit, it can be easily manipulated. The adjustments are few and simple, and need to be verified only from time to time; besides, they can be readily proved and perfected, being similar to those in the transit.**

Weight of this Solar attachment is 1 lb., that of the **latitude level** about $\frac{1}{4}$ lb. Both are packed in a **separate box of mahogany** provided **with a shoulder strap**, and can also be packed in the box with the instrument.

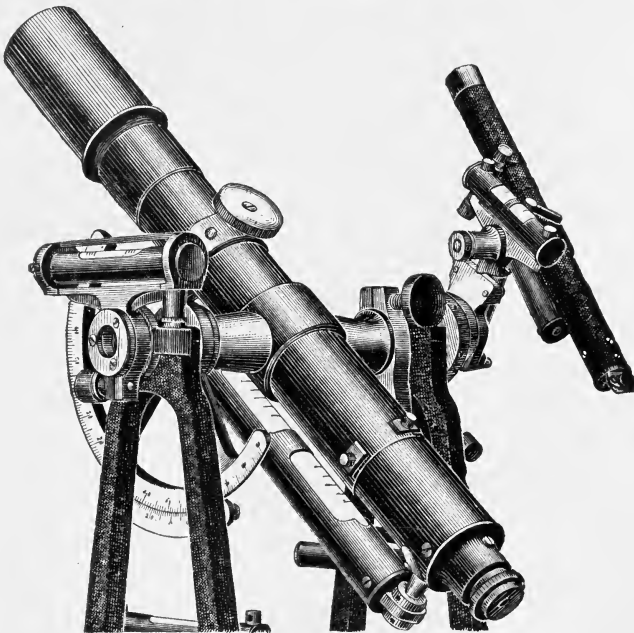
Price of Solar attachment, as above, with counterpoise, prism with colored glasses and additional colored glass to apply to the telescope of the transit to observe the sun's altitude, in order to apply the correction for refraction in solar transit work, **\$85.00**

Price of latitude level, as above, **15.00**

Surveyors' Solar Attachment (Smith Solar), as used by "General Land Office of U. S. A.," attached to transits No. 1-s and No. 2-s on pages 162 and 163 as well as the $4\frac{1}{2}$ " transit of the same style.
Complete Transits No. 1-s, No. 2-s and No. 4½-s with Smith Solar, **Price, \$363.00**



Surveyors' Solar Attachment.



Latitude Level Attachment.

Shown as applied to a Transit with Solar Attachment.

NOTE.--The surveyors' solar attachment and our latitude level can be placed only upon Transits No. 1, No. 2, and No. 3, and then only when ordered with the instrument.

The Berger Solar Attachment

Attachable to Transits, Sizes 1, 5½, 2, 4½ and 4, having a Full Vertical Circle.
For U. S. Deputy Surveyors, Surveyors and Mining Engineers.

This Solar Attachment may be used as a first-class solar in surface surveying for determining meridian. The solar telescope being longer and more powerful than heretofore, and as its horizontal axis is provided with our patented lateral adjustment * (see cuts *a*, *a* on right-hand side of illustration), we are enabled to place its line of collimation so truly above that of the main telescope as to be exactly in the same vertical plane.

As a solar attachment, or meridian finder, it is in principle like Pearsons' and that formerly made by us (see cut page 65), not requiring computation; but instead of the lens bar, or small telescope, † it is now constructed with a telescope of one-inch aperture and six-inch focal length, provided with a diagonal eye-piece, colored glass and wires arranged in a square, as shown on next page and described on page 71.

This solar attachment fastens by means of a screw to the cross axis of the transit telescope. It has no declination arc. The declination of the sun and the co-latitude of the place of observation are both set off by the vertical circle of the transit. All settings for position, viz. that of the polar axis, to be truly at right angles to line of sight of main telescope and the setting of the declination, are secured by the spirit level attached to the solar telescope. The degree of precision and simplicity of manipulation attained thereby is commensurate with that of our Engineers' Transit.

To determine true meridian at any hour of the day it is only necessary that the declination and refraction of the sun on that particular day and hour be known to the observer, and that the polar axis be raised precisely to the co-latitude of the place of observation. The adjustments are few and simple, and need to be verified only from time to time; besides, they can be readily verified, being similar to those in the transit proper.

Latitude and transit observations can also be made with this telescope when the sun's altitude is too high for observations with the main telescope, in the same manner as described on page 97 for our Interchangeable Auxiliary Telescope style I.

This solar attachment can be readily attached or detached from the transit without altering its adjustments. When detached the transit is then simply an ordinary complete Engineers' and Surveyors' Transit.

By the use of our **Latitude Level** ‡ (fastening to the cross axis at the side of the vertical circle, see cut) not requiring a reading of the vertical circle for every setting of the polar axis for latitude except once in a day, observations can be made repeatedly with speed and accuracy. Indeed, with the declination and refraction of the sun previously worked out for the various hours of the day, observations can be made nearly as fast as a needle of the surveyor's compass can be read. A concise description and use of both attachments will be found in the Manual.

The weight of the solar attachment and top telescope combined is 1 lb., with counterpoise, 2 lbs.; that of the latitude level about ⅓ lb. Both are screwed into the instrument box.

Code Words

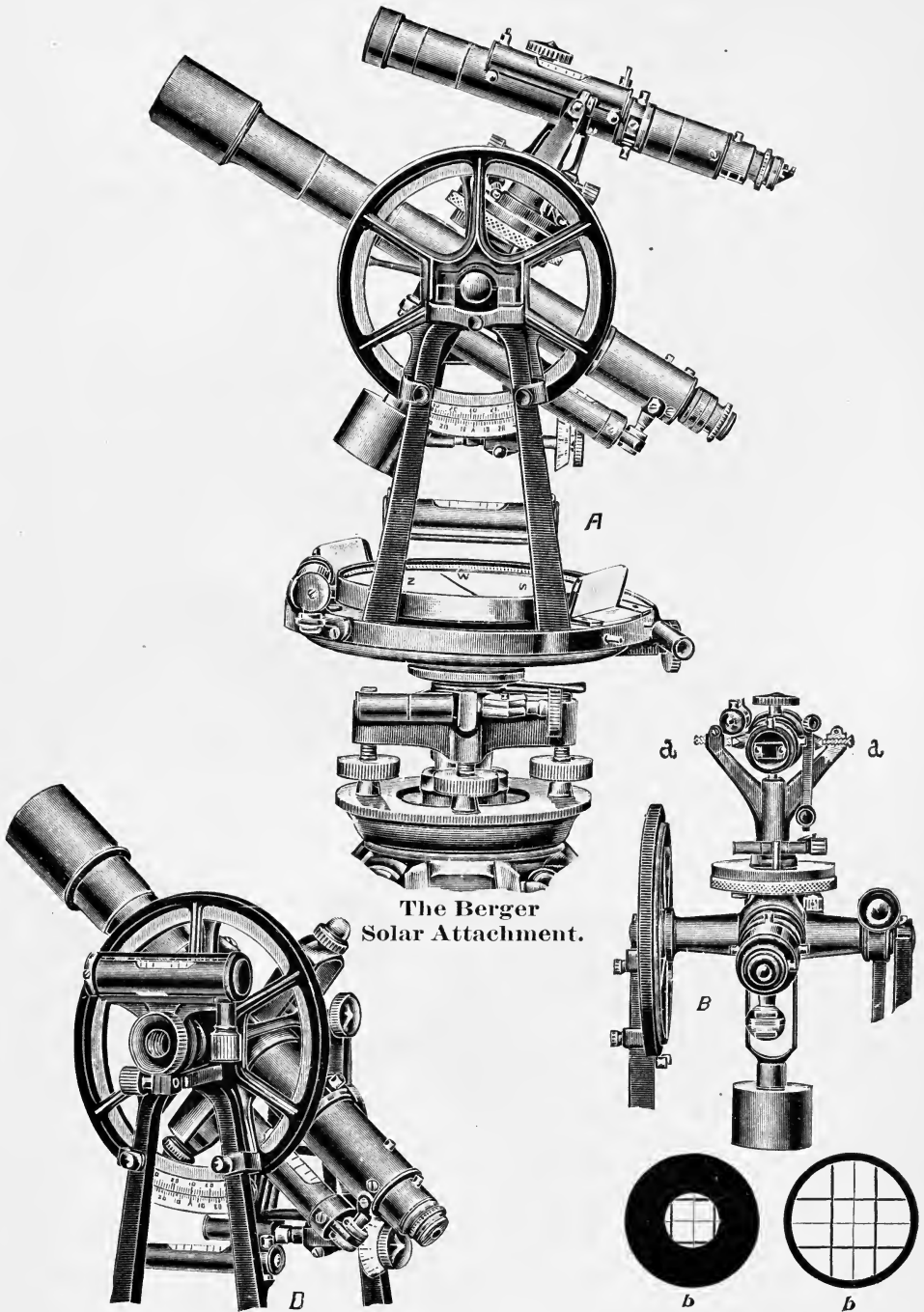
Dianthus	Price of Solar Attachment with Small Telescope , as generally supplied for solar work, without counterpoise, § but with prism and colored glass,	\$52.00
Dicentra	Price of Latitude Level , as in cut,	\$15.00

* Other telescopic solars of similar design as heretofore made may be out from ⅓ to ¼" from the center of the main telescope, and then of course there must be a divergence of the lines of sight of both telescopes involving errors to that amount.

† The honor of first conceiving the idea of applying a small telescope in place of the lens bar and of using a spirit level for the accurate setting of the polar axis, belongs to Mr. C. L. Berger, of this firm. See Catalogue of 1878.

‡ This latitude level can also be used for grades and distance measurements, etc. It will be found to form a very useful adjunct to the Engineers' Transit, even without the solar attachment.

§ It is not strictly necessary to counterpoise the smaller solar attachment in order to obtain good work.



The Berger
Solar Attachment.

- A. Instrument with Solar Attachment ready for an observation.
 B. Eye end view of Solar Attachment showing patent lateral adjustment to enable us to place the Solar Telescope exactly in the same vertical plane with the main one.
 D. Latitude Level, if ordered, for use with Solar Attachment.
 b, b. Wire Diaphragm in Solar Telescope.

Davis' Patent Solar Attachment.

This invention is destined to supersede all other solar attachments, being by far *the most accurate, the most simple, and the cheapest* in use. The sun observations are made with the instrument's telescope direct, whereby greater range and power are secured, and limiting the adjustments to those common to the instrument proper itself. It can be attached to any engineers' and surveyors' transit which has a good vertical arc or full vertical circle. A great many have been placed on our transits (sizes Nos. **1, 2, 3** and occasionally on No. **4**), for the use of U. S. Deputy Surveyors, and others having occasion to do solar work.

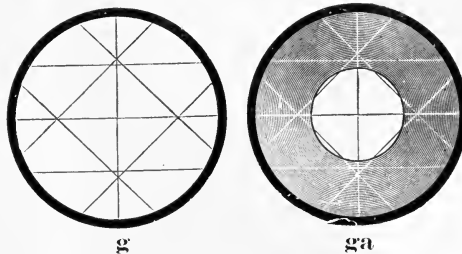
However, as its manipulation involves a few mathematical calculations, differing somewhat from ordinary solar attachments, we advise our patrons to carefully read pages 81 and 82, etc., of manual, where a full description will be found.

The screen, shown in Fig. **2**, can be applied with erecting and inverting telescopes. In making an observation with an erecting telescope the full aperture of the object glass is utilized, but with an inverting telescope it must be limited to about $\frac{1}{4}$ or $\frac{3}{8}$ inch diameter to get the wires sharply defined on the screen. To this end the telescope cap is provided with a central opening, permitting of such an adjustment, which may be closed entirely when not in use.

Attachments shown in Figs. **3** and **4** are for direct observation when the sun's altitude does not require the screen. These latter attachments are now made by us in a manner superior to those shown in these cuts on opposite page. They are mounted as in Fig. **5**, upon a frame, readily attachable to the eye-piece by means of a clamp, which can be clamped in any position most convenient for the observer. To bring the colored glasses or the prism before the peep-hole of the eye-piece, it is only necessary to revolve them, hence they can be used in rapid succession. It will be seen that these solar attachments are easy to manipulate, and therefore must insure better results than heretofore obtainable with mechanical devices of any other kind.

Price of Solar Screen, Figs. 1, 2 and 3	\$ 6.00
“ “ Plain colored glass, Fig. 4	2.00
“ “ “ “ mounted in Shutter, Fig. 6, when ordered with Transit	2.50
“ “ “ “ Fig. 6 with Eye Piece Cap, when subsequently ordered	3.00
“ “ Prism and colored glass, Fig. 7	8.00
“ “ Prism and colored glass, improved mounting, Fig. 5	12.00
“ “ Solar Screen with improved prism and colored glasses combined.	18.00

Code-Daphne



C. L. Berger & Sons' Patent Inclined Square.

For Sun Observations with Davis' Patent Solar Attachment.

This device consists of four additional wires forming an inclined square of equal sides placed at an angle of 45° with the usual cross wires, and equi-distant from the latter's point of intersection in the Surveyor's Transit Telescope. The space contained within this square, as will be seen in the greatly enlarged Figures **g** and **ga**, is slightly smaller than the sun's disc; thus an observation of the sun for position can be made by simply setting the telescope by means of the tangent screws until the four segments, formed by the black lines against the bright disc of the sun, are of equal size. In this manner the sun's disc can be better bisected, as when it must be quartered by the cross lines alone — but, if desired, both methods can be applied as a check upon each other.

The arrangement of the wires in the inclined square is in no way confusing, as it keeps the cross and stadia wires distinctly apart for the regular work of the transit, and, in rapid work, is a help to distinguish the horizontal from the stadia wires, as shown above, which cannot be said of the erect square H — also patented, — shown on the page illustrating the various sighting wire diaphragms. Part I.

Price of Patent Inclined Square, but only, when ordered with the instrument, extra	\$4.00
“ “ “ “ also provided with Stadia Wires, as in cut,	7.00
“ “ “ “ with cross and stadia wires for instruments of other make	10.00

Fig. 2.

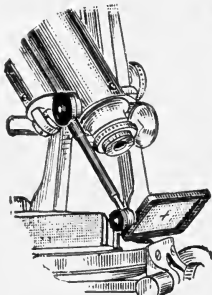
Solar Screen
Daisy

Fig. 1.

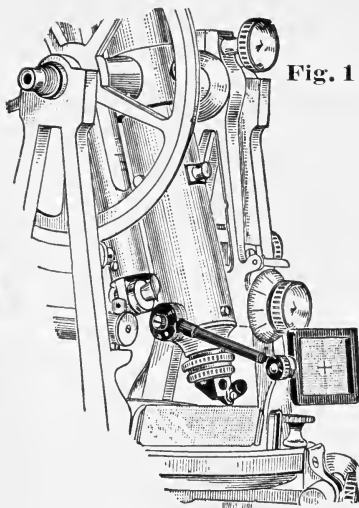
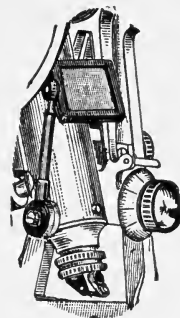


Fig. 3.



Davis' Solar Attachments.

Fig. 4.

Glass
mounted in
Cap.
Dandelion.



Colored Glasses for
Sun Observations
Attachable to any of our
Transit Eyepiece Caps

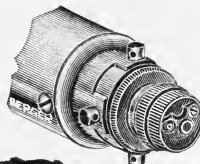
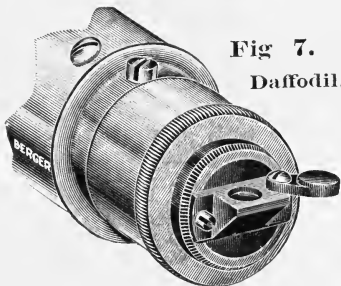


Fig. 6.
Glass
mounted in
Shutter.
Daorma.

Fig. 7.

Daffodil.



Plain Prism
with colored glass
Attached to Eyepiece Cap.

Fig. 5.

Dahlia.



Berger Improved Prism and colored glass attachment
"A" — Prism, "B" — Peephole, "C" — Colored Glasses.

Fig. 8.

Diagonal Eyepiece with Swivel Adapter

for Zenith Stellar Observations
applicable only to
Inverting telescopes of
Transit-Theodolites
No. 11, 12, 15



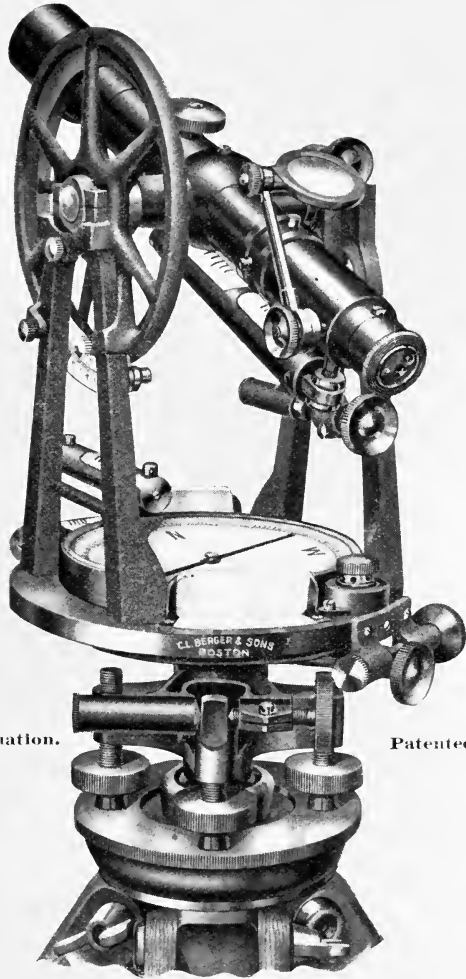
Zenith

Price, \$20.00

NOTE. —

A diagonal Eyepiece cannot be advantageously attached to a mine transit, since it must interchange with the regular eyepiece of the inverting kind, and therefore frequent breaking of the cross wires from dirt and water would be a constant source of annoyance, especially in dark places. Besides, in such instruments the telescope must be pushed considerably farther through the axis and a heavy counterpoise permanently attached to the eye-end of barrel to balance the telescope, and the latter will then only reverse at eye-end through the standards. For sights inaccessible to the main telescope in mine work, nothing better has been introduced than our interchangeable auxiliary telescope, described later on.

C. L. BERGER & SONS.



5 1/8 in. at edge of graduation.

Patented.

Mountain Transit No. 2.

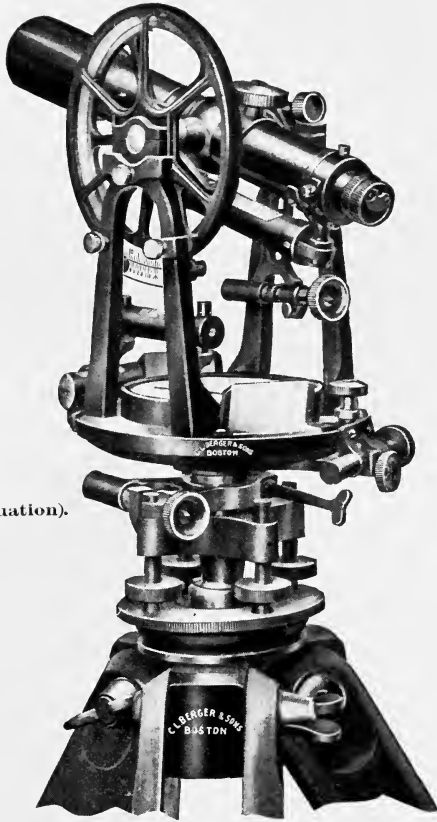
(Shown with Solar Screen Attachment.*)

For size, weight, particulars and extras of this instrument see opposite page.
Code Word (without screen), Forsythia.

Price \$252.00

(For code words for **Extras** and changes from **Forsythia**, see pages **C**, **F** and **G** of complete code at back.)

* For description of this Solar Attachment see page 81 of the Manual, and for illustration and prices see pages 174 and 175.



No. 4½

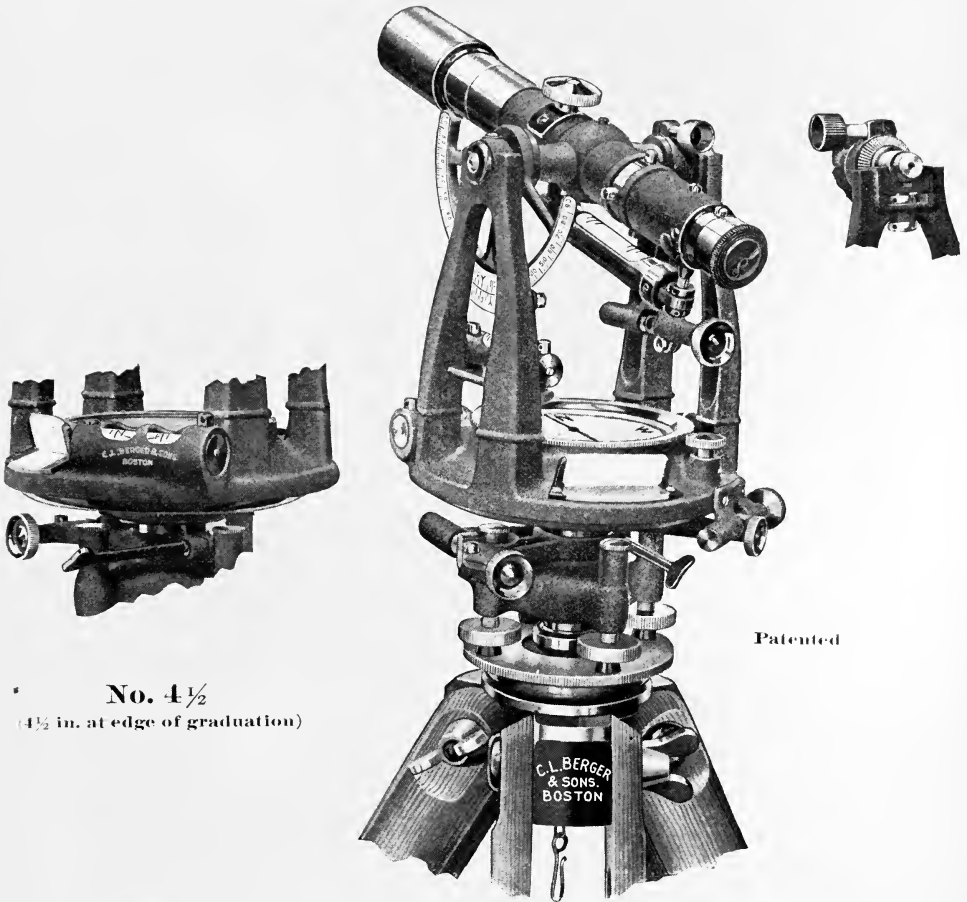
(4½ in. at edge of graduation).

**Complete
Mountain and Mining Transit.**

For size and particulars of this instrument, as well as for Extras, see opposite page.

Code word, Genila.

Price, \$247.00



Patented

No. 4 1/2

(4 1/2 in. at edge of graduation)

No. 4 1/2 Complete Monitor Type Transit

For size and particulars of this instrument, as well as for Extras, see page 180.

Code word, GeminolPrice, ~~\$288.00~~ \$248.00

Cylindrical Pivots to telescope's axis running in the improved adjustable Wye-Block Bearing. The center point is located on a round hub on the telescope's axis to better distinguish it in dark places when centering under a point above the transit.

The Eye-Piece Cap is large in diameter. It affords a protection to the eye of the observer in a glaring sun. It has been combined with a dust guard which fully protects the Eye-Piece focussing slide.

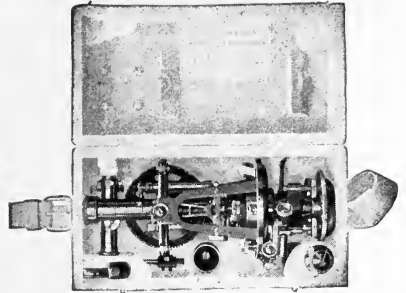
The Front Plate Level is fully protected. Improved Leveling Head with dust caps to leveling screws.

To avoid mistakes and to save time telegraph Code name.



No. 4

(4 in. at edge of graduation.)



**Instrument
Packed Lying Down**

**Complete
Mountain, Mining and Reconnoissance Transit.**

For size and particulars of this instrument, as well as for Extras, see opposite page.

Code word, Genista.

Price, as above, \$247.00

(For code words for Extras and changes from Genista, see pages **C**, **F** and **G** of complete code at back.)

The 4"

Complete Transit-Theodolite No. 4b.

With Yoke Standards and Wye-Bearings. Without Compass.

Size as in No. 4, page 182.

For triangulation, filling in details, etc., in secondary triangulation, also for explorers, engineers and surveyors where the large instruments described under No. 11, etc., become undesirable on account of their size and weight.

The Yoke Standard frame is of our advanced pattern, cast in a single piece of aluminum* (unless ordered to be of brass composition), to gain great lateral stiffness, and is leatherized. The inverting telescope can be reversed over the bearings by turning the upper covers aside, and also in the usual way through the standards. The graduation of the horizontal circle and its verniers are protected by glass.

If double opposite verniers are desired for the vertical circle the figures will then run from 0-90-0 and back (as in the regular field instruments), instead of clockwise with single opposite verniers enumerated below. A level is attached to the vernier arm (instead of to the telescope as in No. 4). This instrument will be made with three leveling screws only and packed lying down in its carrying case.

Made to order only.

Complete Transit-Theodolite No. 4 b, as in cut on opposite page.

SPECIFICATIONS:—

Horizontal circle 4-inch (at edge of graduation), graduated on heavy inlaid ring of solid silver, single opposite verniers read to minutes, one row of figures 0 to 360; verniers at 90° to line of sight.

Vertical circle 4-inch, graduated on solid silver, single opposite verniers read to minutes, one row of figures 0-360 clockwise (unless ordered otherwise).

Compound centers of bell metal.

Telescope 7½-inch, objects inverting, aperture 1¼ inch, power 18 dia. Stadia wires, fixed, in ratio 1:100

Spirit level 2¾-inch, with reversible clamp and tangent screw to vernier arm.

Striding level rests at points of contact in wyes.

Reading glasses to horizontal and vertical circles.

Plate levels both of standard length and very sensitive.

Shifting center, to set instrument exactly over a given point.

Punch mark on top of telescope, to enable to center the transit from a point above.

Standards leatherized (see page 9).

Extension tripod.

The Mahogany case has a leather strap, hooks, etc. It contains a sun-shade, a wrench a screw-driver, an adjustable plumb-bob, a magnifying glass, an adjusting pin, and weighs about 7 lbs.

Weight of transit about 5 lbs; **weight of extension tripod** 9 lbs.

Gross weight of transit packed securely for shipment in two boxes, about 50 lbs.

Price of Small Complete Transit-Theodolite No. 4b, as described above and shown in cut (with extra vertical wires if desired for stellar observation)

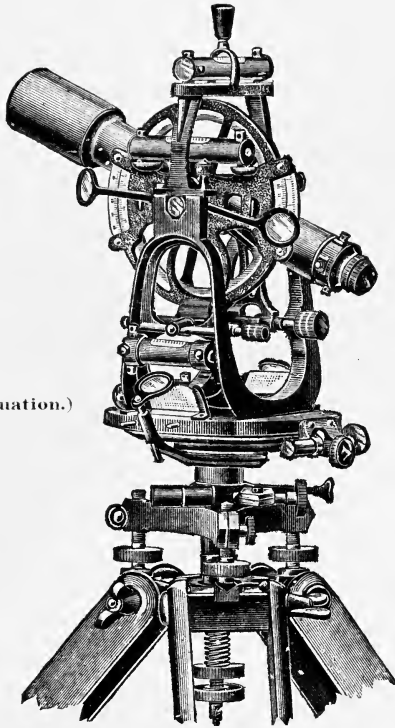
Code word, **Gorastis.**

\$315.00

Extras to Transit No. 4b.

Compound centers made of steel running in sockets of cast iron to insure freest motion with perfect fit	\$20.00
Spirit level 4-inch with reversible clamp and tangent screw to telescope (see cut No. 4.) in addition to level to vernier arm shown in the opposite cut	12.00
Plain prism and colored glass (Fig. 7, page 175)	8.00
Split-leg tripod in addition to extension tripod (latter furnished with transit)	16.50
Leather cover with shoulder straps	12.50
“ “ without “	10.50
Hood to protect transit from rain and dust	1.00
Bottle of watch oil	.35

* If desired, the U-shaped standard frame can be made of brass, weighing about 1 lb. more, no extra charge. If instrument is to be used near salt water, brass will prove more durable for this standard frame, as aluminum and its alloys are apt to be affected by salt water, saline and alkaline vapors and liquids.



No. 4b.
(4 in. at edge of graduation.)

**Small
Complete Transit-Theodolite No. 4b.**

For size and particulars of this instrument, as well as for extras, see opposite page.

Code word **Gorastis**.

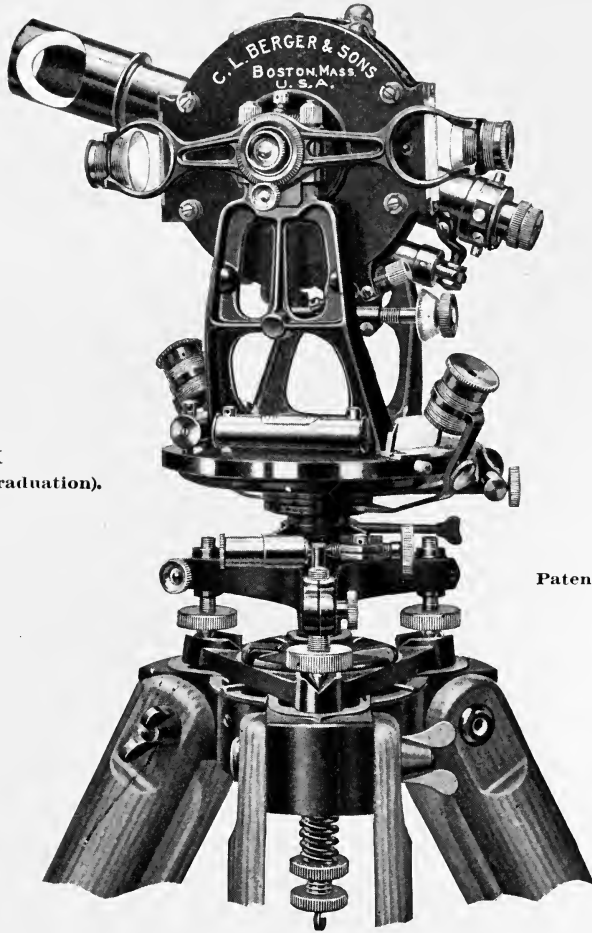
Price, as above, \$315.00

Made to order only.

For code words for **Extras** and changes from **Gorastis** see pages **F**, **G** and **H** of complete code at back.)

For a transit of a similar description but with a **4½-inch horizontal circle**, see next page. Made to order only.

C. L. BERGER & SONS.



No. 4k
 (4½ in. at edge of graduation).

Patented.

Complete Mine Transit, No. 4k
 With edge graduation and fully enclosed vertical circle.

For use in Mines and Tunnels.

Also for Bridge and Topographic work, etc., when provided with our open form vertical circle.

(For a front view of this instrument see colored illustration.)

For size, weight, particulars and extras of this instrument, see opposite page.

Code word, **Grallus**.

Price, \$336.00

(For code words for Extras to Grallus,
 see pages **F** and **H** of complete code at back.)

Mining Transits.

All of the foregoing instruments, *particularly Nos. 2, 4½ and 4*, we recommend for general underground work. (The latter instruments chiefly on account of their greater portability and lightness.) The telescope may be either inverting or erect, and may have a prism attachable to the ordinary erecting or inverting eye-piece to facilitate sighting in inclined shafts. We frequently attach to the cross-axis a side telescope, swinging free of the plates, of nearly the same length and power, which permits of vertical sighting up or down a shaft (see pp. 93 to 95). We also furnish attached above and parallel with the line of sight of the main telescope of Nos. 4, 4½, 5 and 6, another one of shorter length and lesser power mounted on a central pillar cast on to the cross-axis of the main telescope, as in Style I. (See interchangeable auxiliary telescope, pp. 189, 192, 193, 95 and 96.)

This latter telescope, which of necessity is of lesser power as compared with our regular side telescope, will in most cases be deemed sufficient, as sights in mines are short. Its power varies from 8 to 15 diameters, according as the telescope is erecting or inverting. We are, however, prepared to mount one of same length as our regular side telescope in cases where a complete revolution of cross-axis is not required. It will be seen that vertical sighting up or down a shaft can be done with ease and accuracy, and this latest device has nearly all the advantages of a telescope mounted on inclined standards with none of its faults. When not in use the auxiliary telescope may be removed at will and stored in the box. As will be seen by reference to the description and cuts of this device, pp. 95, 96, and 189, the auxiliary telescope can also be readily attached to the end of the cross-axis of our Mining Transits Nos. 4, 4½, 5 and 6 when it becomes a side telescope.

The ready interchangeability from top to side makes the auxiliary telescope one of the most desirable additions to a Mining Transit.

To avoid errors in reading cardinal points, the compass ring is figured from 0° to 360°, the same as the horizontal circle. Mining instruments should have large vernier openings to admit of as much light as possible, and all graduations should be on solid silver. For the illumination of the cross-wires, a small reflector is sometimes placed in the center of the cross-axis of the telescope of our larger instruments; but as in the smaller telescopes much light is being cut out by its use, we prefer to attach a reflector shade in front of the object glass.

No. 5. Mining Transit.—Dimensions as in No. 1 (unusually large size); graduations on solid silver; verniers reading to minutes are provided with ground glass shades; 5-inch full vertical circle with aluminum guard; spirit level, fixed stadia wires, clamp and tangent screws to telescope; extension tripod, etc. **Price, \$260.00**

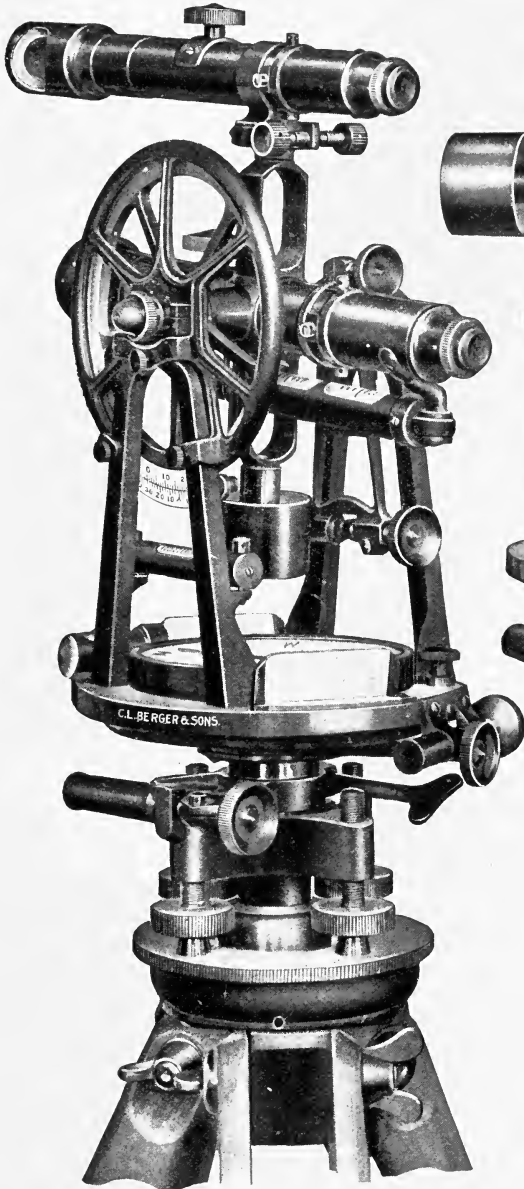
No. 6. Mining Transit.—Dimensions as in No. 2 (customary size); graduations on solid silver; verniers reading to minutes are provided with ground glass shades; 5-inch full vertical circle with aluminum guard; spirit level, fixed stadia wires, clamp and tangent screw to telescope; extension tripod, etc. **Price, \$266.00**

Extras to Mining Transits Nos. 4, 4½, 5, 6 and 7

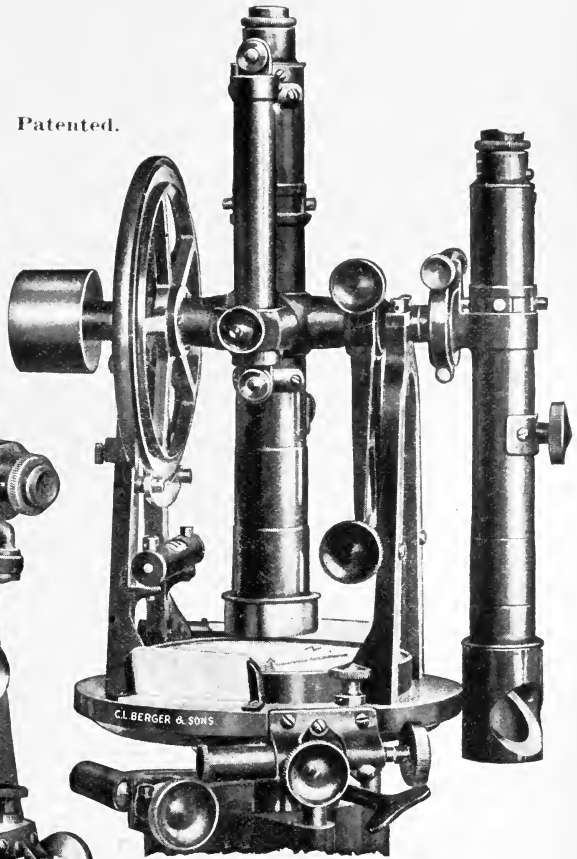
Striding level (for description and illustration, see pp. 156 and 211)	\$20.00
Stadia wires, fixed	3.00
Disappearing cross and stadia wires for erecting telescopes (p. 190). Patented	6.00
Gradienter attachment for Nos. 5 and 6	5.00
Five-inch vertical circle provided with double opposite verniers (see p. 155)	20.00
Edge graduation for vertical circle with a double vernier at eye-end, which is glass-covered, as in cut (p. 198)	35.00
Edge graduation for vertical circle with double opposite verniers (p. 198)	45.00
Patent short focus lens (pp. 103, 191). No. 1, \$8.50; No. 2, \$8.50; Nos. 1 and 2	16.00
Reflector for illuminating the cross-wires	4.00
Aluminum guard to vertical circle	4.00
Prism, attachable to eye-piece	8.00
Detachable side telescope with counterpoise (pp. 189, 193)	35.00
Patent interchangeable auxiliary telescope. Style I, described on p. 96 and shown on p. 193	37.00
Berger Solar attachment with small telescope (pp. 172-173)	52.00
Arrangement for offsetting at right angles to telescope	5.00
Quick leveling attachment for size No. 4, \$20.00; for all other sizes	15.00
Half-length tripod	13.50
Extra extension tripod	23.50
" split-leg tripod (see note to No. 3)	16.50
Plummet lamp (large size)	10.00
" (small size)	8.00
Bracket in box, with strap, auger, and lever (Fig. I, on p. 203)	15.00
Trivet (see p. 204)	6.00
Plumbing device for carrying a line down a shaft (p. 191), \$3.00 each; per pair	25.00
Patent Lateral Adjuster (p. 191)	7.50
Large plumb bob, weight 4 lbs., for use in shafts	.35
Bottle of fine watch oil	1.00
Silk bag, to cover transit	10.50 to 12.50
Leather case for No. 4, with or without shoulder straps	13.00 to 15.00
" " No. 6,	



Diaphragm showing arrangement of wires as used with our mine transits, to distinguish center horizontal wire from stadia wires, to avoid mistakes.



Patented.



Complete Mining Transit, With Style I, Interchangeable Auxiliary Telescope.

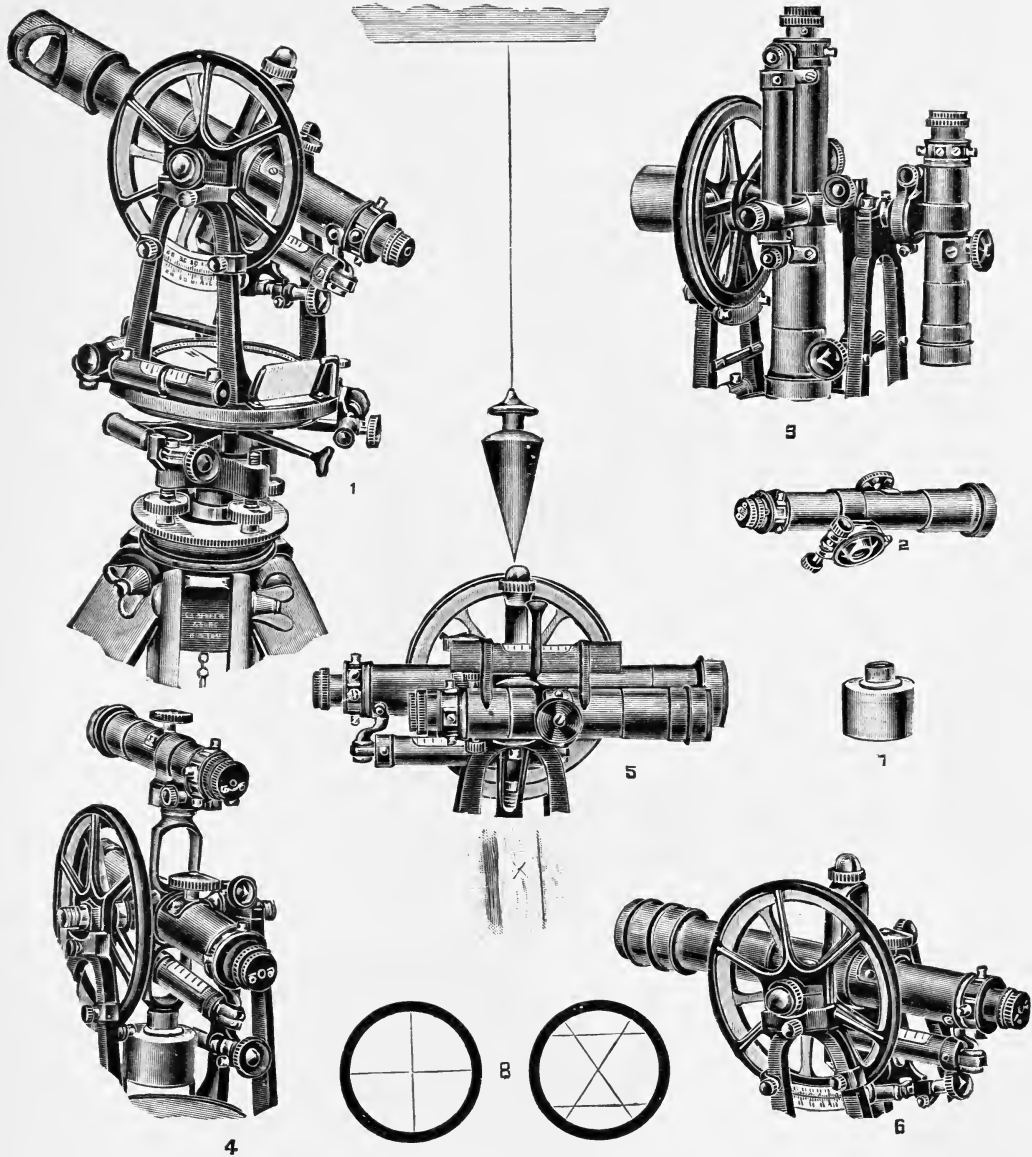
Size as in Nos. 5, 6, and 7. For a general description for Style I, etc., see pages 96-97. For price and attachments, page 188.

NOTE. — With the addition of the interchangeable auxiliary telescope as an aid to the customary mine transits, with main telescope in the center of the instrument, the most difficult engineering problems in underground surveying become at once very simple and the results obtained are as accurate as those in surface work — with its aid all sights in the vertical plane are possible where the main telescope will fail, and the vertical and horizontal angles can be measured without an offset or corrections for excentricity caused by the distance of the auxiliary telescope from the main telescope. *It is sufficient to remember, when sights become inaccessible through the main telescope when measuring horizontal angles, to place the auxiliary telescope on top, and when the same conditions prevail in measuring vertical angles, to place it on the side.*

When the auxiliary telescope is detached, the transit is just as serviceable for surface work as any other.

For use of the auxiliary telescope for astronomical observations, see page 97. For finding meridian with its aid and the use of the solar, see page 71.

All our transits are provided with a fine punch mark on top of telescope to enable to center instrument from a point above as well as from below.

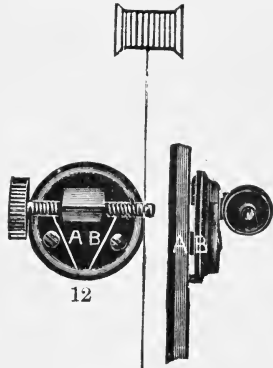


The Berger Patent Mine Tachymeter Nos. 4, 4½ and 6.

With Style 1 Patent Interchangeable Auxiliary Telescope (pages 97 and 193).

See *Mining Transits*, sizes 4 and 6, pages 97 and 193. For price of instrument and extras, see pages 182 and 183.

- Fig. 1. General arrangement of instrument showing upright post for auxiliary telescope, and a reflector attached to object-glass.
- Fig. 2. Interchangeable auxiliary telescope; Fig. 7 its counterpoise.
- Fig. 3. Auxiliary telescope at side when measuring vertical angles, also for making latitude observations (see page 97), when sun is too high for observations with the main telescope.
- Fig. 4. Auxiliary telescope attached to vertical post for use as top telescope when measuring steep horizontal angles and when surface or meridian lines must be carried down a shaft when objects cannot be seen by main telescope, as well as for time observations when sun is too high for observation with the main telescope.
- Fig. 5. Side telescope placed parallel with the main telescope in emergencies by means of the striding level; also showing manner of centering from point above.
- Fig. 6. Patent short focus lens attached to main telescope, p. 100.
- Fig. 8. Patent Disappearing cross and stadia wires; inclined wires indicating center for stadia wires, for erecting telescope, p. 122. *Continuation on page 191.*



12

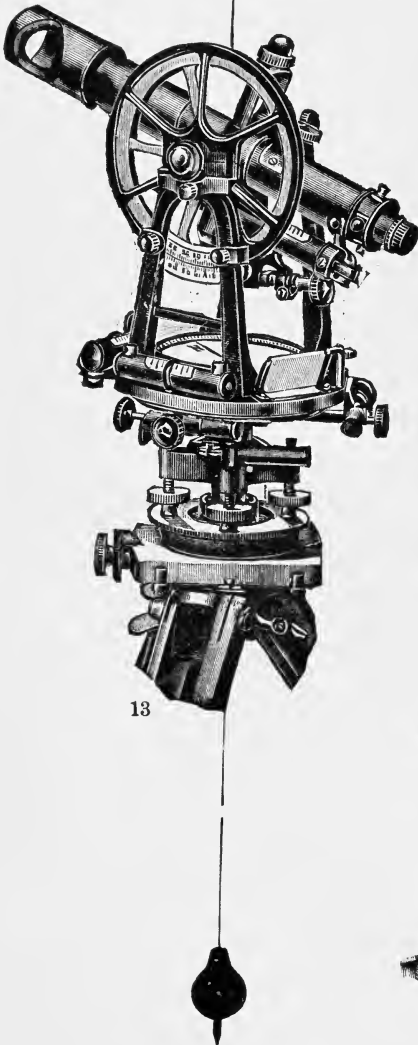
Fig. 9. Leather case with shoulder straps. For prices see page 188.

Fig. 12. Plumbing Device A and B for carrying a meridian or surface line down a shaft by the plumb-line method.* Fig. 14.

Fig. 13. Lateral adjuster attached to tripod with transit mounted upon it for ranging transit on to given line. For description and method of application see page 205.

Fig. 14. Shows in graphical manner the method of carrying a line down into the shaft by means of the plumbing devices and lateral adjuster.

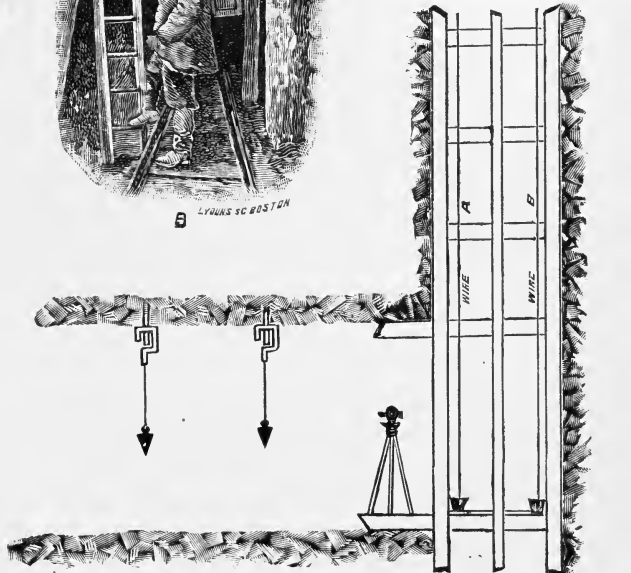
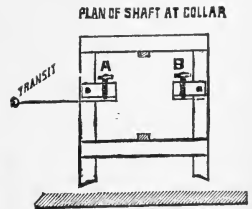
*For valuable suggestions in carrying out the perfection of this device we are indebted to Mr. G. H. Potter, M. E., of Butte, Mont.



13



L. FRANKS & CO. BOSTON



VERTICAL SECTION THROUGH SHAFT

14

The Berger Patent Mine Tachymeter.

Complete Mining Transit No. 6D, without Compass.

Shown with our Patent Interchangeable Auxiliary Telescope, Style I.

(See pages 95 and 96.)

Responding to many solicitations to make for mines containing magnetic ore, or an electric plant, a transit similar in style and accuracy to our No. 11 (see page 180), we have designed the instrument illustrated on opposite page. It is *light, portable, and of the same size as our Nos. 4, 4½, 2 and 6 transits*; but, owing to the omission of the compass, the standards are cast in a single piece, affording greater lateral stiffness, with increased capability to withstand rough treatment. It is adapted to all the complex conditions prevailing in underground work, and is very simple in style and manipulation. It possesses all the advantages, as regards accuracy of division, highest permissible telescopic power, and sensitive spirit-levels of larger instruments. With the interchangeable auxiliary telescope added for use in steep sighting, either on top or on the side of the main telescope, as required, it becomes a most capable instrument for correctly solving what would otherwise require special instruments and methods. When the auxiliary telescope is detached, it is just as applicable to the common work in the mine or on the surface as our regular engineers' and mining transits **Nos. 4, 4½, 2 and 6**.

The U-shaped standard frame of the telescope is made of aluminum, covered with a fine dark Japan not affected by moisture; all other parts are finished in the same manner as in our other instruments. The plate-levels are of our standard character and length, mounted directly upon the upper plate, where they are easily accessible for the purpose of adjustment and ready observation, and are fully protected from falling bodies. The principal plate-level is directly under the eye-end of the telescope. The two opposite verniers of the horizontal circle are in line of sight with the telescope, and are protected from dripping water by cemented glass covers. The circle itself is provided with two rows of figures from 0° to 360°, in opposite directions, with double verniers to correspond to them (unless otherwise ordered). The vertical circle, with figures from 0° to 180°, both ways from zero, has a double vernier, to enable the observer to read angles of elevation or depression with equal facility, and is provided with an aluminum protection guard, which carries the vernier and also serves to readily adjust the latter to zero. Double opposite verniers can also be placed on the vertical circle, when the figures will run from 0° to 90° each way and back to zero. The transit has inverting telescopes (*unless otherwise ordered*). A new and important feature of the instrument, which greatly increases its value, is this: the line of collimation of the main telescope is adjusted for distant, very near, and intermediate distances, by means of our recently patented device, to a nicety never before attained; and no readjustment for near distances is necessary except after a severe accident.

The Style I interchangeable auxiliary telescope described on pages 95 and 96, and illustrated on opposite page, is non-adjustable, but it has been so much improved that the line of collimation of its principal wire, which is the vertical one when used as top telescope, and becomes the horizontal wire when used as a side telescope, lies so nearly parallel to that of the main telescope as to be practically correct in most cases.

<i>Weight of Mining Transit No. 6D</i>	11 lbs.
" auxiliary telescope and counterpoise, each 12 oz.	1½ "
" extension tripod	about 9 "
" instrument in mahogany box, with plumb-bob, sun-shade, reading-glass, etc., etc.	about 22 "

Gross weight of instrument complete, packed securely for shipment in 2 boxes 50 "

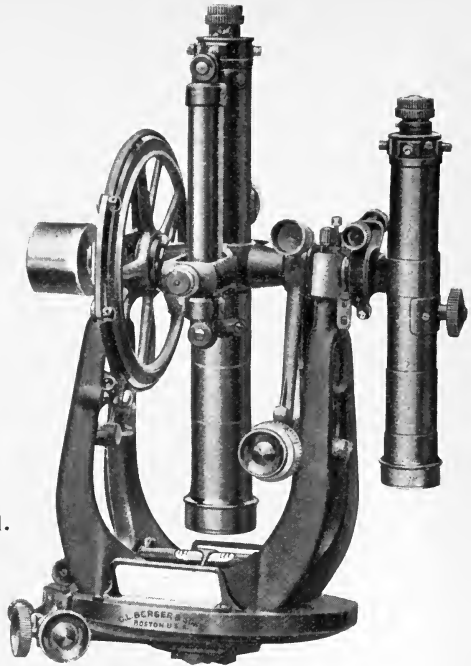
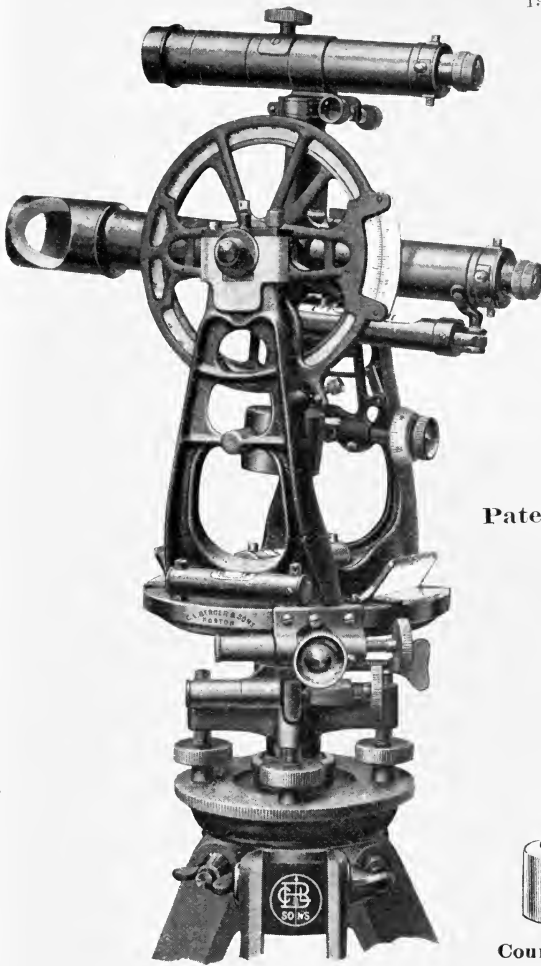
No. 6D. Mining Transit without Compass, as in cut, with Style I Interchangeable Auxiliary Telescope. Horizontal and vertical circles, 5 inches; solid silver graduations reading to minutes; ground-glass shades; 5-inch level to telescope; 2 plate-levels; **inverting** telescope, 10 inches long by 1¼-inch aperture; (**if erecting**, 9¾ by 1¼ inches); powers, 24 diameters; **inverting** auxiliary telescope 6½ by 1 inch aperture; (**if erecting**, 7 by 1 inch); fixed stadia wires; gradienter; 2 illuminator shades; extension tripod, etc. **Price, complete as above, \$327.00**

Price , with double opposite verniers to vertical circle,	extra, \$ 5.00
" " prism attachment to eye-piece	" 8.00
" " quick leveling attachment	" 10.00
" <i>without</i> Style I auxiliary telescope	less, 37.00
" with one illuminator shade only for main telescope	" 4.00

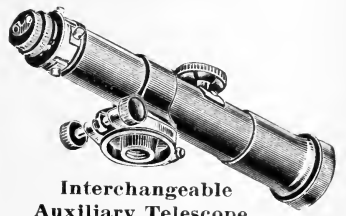
Our Interchangeable auxiliary telescope, being of the most substantial construction and character, may also be used for finding meridian and latitude when direct observations cannot be made with the main telescope. See page 97.

Magnolia
Marigold

Code Words.
Mining Transit No. 6D, as enumerated with inverting main and auxiliary telescopes
Above instrument same as Magnolia, but with erecting main and auxiliary telescopes
(Telescopes will be either both inverting or both erecting.)
(For Extras see pages F and H of complete code at back.)



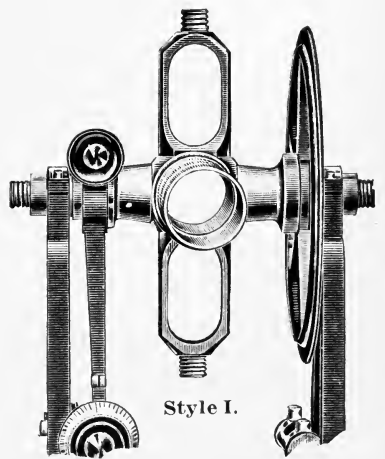
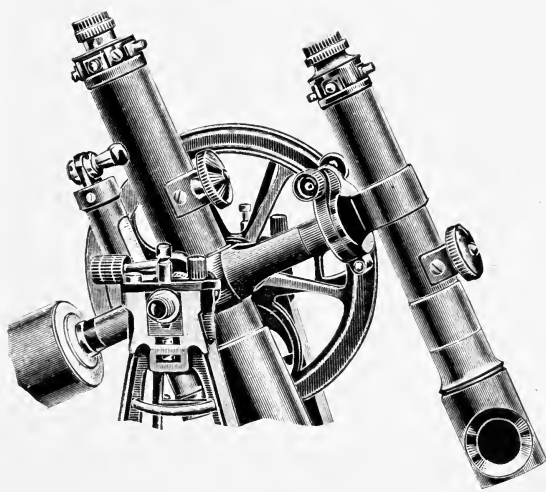
Patented.



Interchangeable Auxiliary Telescope.



Counterpoise.



Style I.

Complete Mining Transit, No. 6 D,
With Patent Interchangeable Auxiliary Telescope (Style I.)

Complete Wet-Mine Transit No. 6H, without Compass.

For sole use underground.

Shown with our Patent Interchangeable Auxiliary Telescope, Style 1.

This Transit is of same size and has the same characteristic features described under No. 6D, pages 192-3, with this difference, however, that it is specially designed to meet the more exacting requirements existing in wet mines, with the object of fully protecting the horizontal and vertical circles from dripping water, and also to a certain extent from the action of fumes and gases, if used in coal-mines. To this end the upper surface of the vernier plate of the horizontal circle is slanting downward, the vernier openings are raised above the surface, and special channels are provided so that the water will run off immediately. The same can be said of the vertical circle, as will be seen in the illustration on opposite page. In order to more fully protect the main plate level from accidents, and to facilitate its reading from either side of the instrument in the dark, it has been placed just below the telescope in the center of the upper plate, and is fully protected by a guard. The yoke standard frame has therefore been remodeled, and like its prototype No. 6D, page 193, is of our most advanced design in this line, combining lightness with strength, beauty and general adaptation to poor artificial light. The verniers are so placed that no shadow can fall on and interfere with the reading of them in a faint light. The yoke standard frame, as well as the casing surrounding the vertical circle and the upper horizontal plate, is leather finished—mine waters and acids do not affect it (see page 9).

Owing to the limited distance between the standards and the larger space occupied by the wholly encased vertical circle, no stride or revolving cross-level can be applied to this instrument. The plate level in the center, however, is one of sufficient length and sensitiveness to insure a full control of the motion of the line of collimation in the vertical plane. The yoke standard frame enables to read steeper vertical angles direct with the main telescope alone, thus often obviating the use of the auxiliary telescope. The whole instrument is of sturdy build, and therefore will withstand rough treatment. No water can come in contact with the vertical circle or verniers as they are completely enclosed in a casing resembling a disc in form, thereby allowing all water to trickle off while in use, but when the instrument is carried on the tripod or in hand it should be so held that the front surface of the vertical circle is tilted slightly upward.

Owing to this **disc-casing** this instrument is not so well adapted to surface work where a strong wind pressure against the disc would produce vibrations of the instrument and great liability to be blown over. However to meet a growing demand for a transit of type No. 6 H for surface as well as for mine work—where conditions in latter are more favorable—we can attach in place of the fully enclosed vertical circle any one of the other open frame protected vertical circles, see pages 193 to 200.

Made to order only.

No. 6H Complete Wet-Mine Transit without Compass, as in cut, but having only one double vernier to vertical circle at eye end, with **Style I. Interchangeable Auxiliary Telescope**. Horizontal and vertical circles, 5 inches; solid silver graduations reading to minutes; ground glass shades; **edge graduation for vertical circle fully encased**; 5-inch level to telescope; 2 plate-levels; inverting telescope, 10 inches long by 1½-inch aperture; (if erecting, 9¾ by 1½ inches); powers, 24 diameters; inverting auxiliary telescope, 6¾ by 1 inch aperture; (if erecting, 7 by 1 inch); fixed stadia wires; gradienter; 2 illuminator shades; extension tripod, etc.

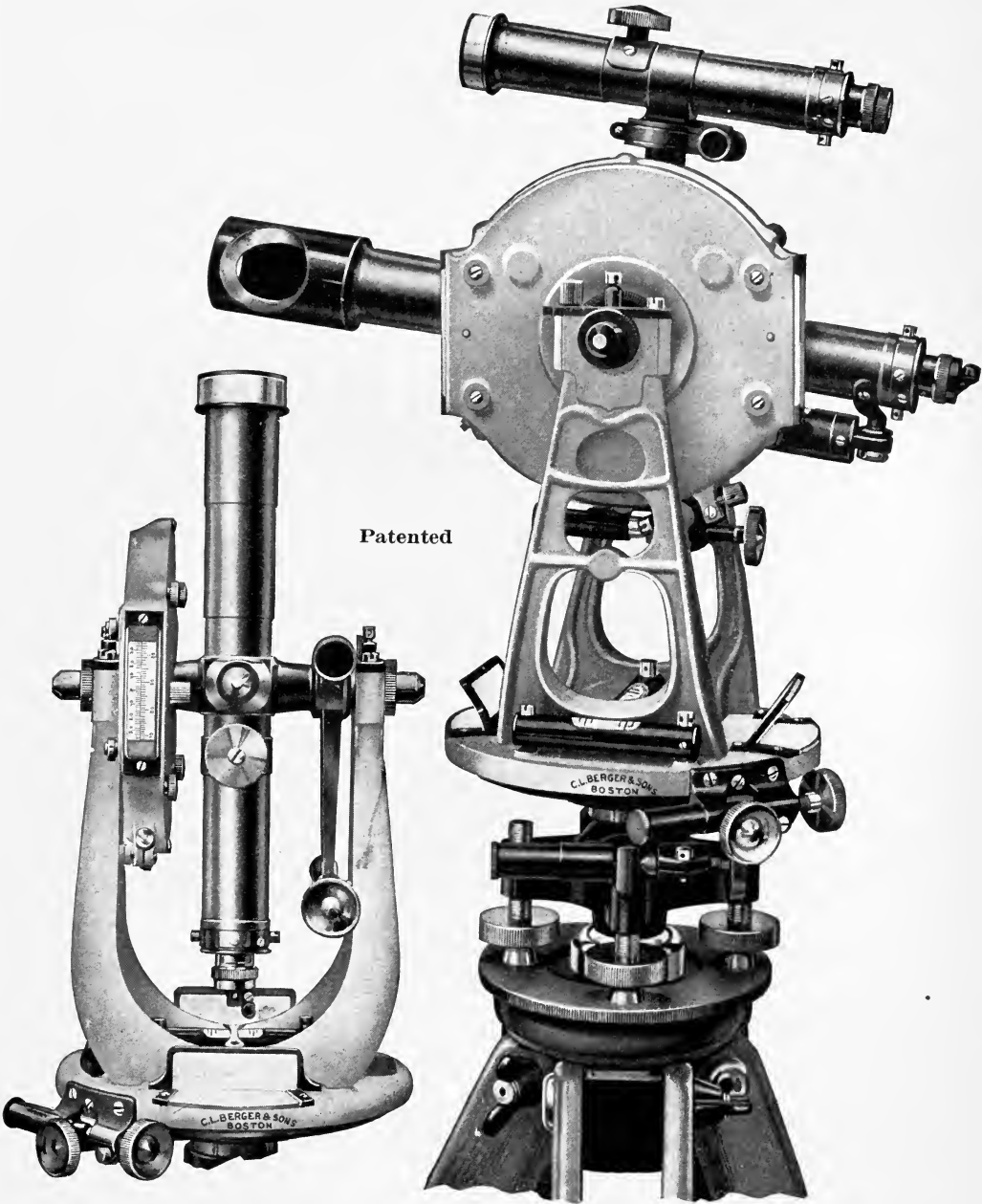
Price, complete as above, \$352.00

Price , with double opposite verniers to the edge graduations of the vertical circle,	extra, \$ 10.00
“ “ flat glass covered graduation to vertical circle (in place of edge graduation) with double vernier at eye end as shown on p. 199	350.00
“ “ flat glass covered graduation to vertical circle (in place of edge graduation) but with two double opposite verniers, see page 199	360.00
“ <i>without</i> style I. auxiliary telescope	less, 37.00
“ “ style I. auxiliary telescope but with provision for same, “	27.00
“ with one illuminator shade only for main telescope “	4.00

For other Extras see page 188.

NOTE.—Our Interchangeable auxiliary telescope, being of the most substantial construction and character, may also be used for finding meridian and latitude when direct observations cannot be made with the main telescope. See page 97.

Code Words. with inverting main and auxiliary telescopes
Mining Transit No. 6H, as enumerated, with erecting main and auxiliary telescopes
Memolls, but with erecting main and auxiliary telescopes
Mipotum
 (For Extras see pages F and H of complete code at back.)



Complete Wet-Mine Transit. No. 6H.

For Price and Description see page 194.

Different Types of Vertical Arcs and Circles for Mine Transits, etc.

The regular arcs and vertical circles shown in the Engineer's and Surveyor's Transits No. 1b, page 153, No. 1c, etc., commend themselves for their simplicity of style, accuracy of graduation and ease of reading. The latter feature is particularly well attained in the above instruments where the double verniers are situated between the legs of the standard, where they are well protected from injury and can be read simultaneously with the level attached below.

In mines and underground work, where often the Transit must be set up in cramped places and on stages erected in shafts, the difficulty of reading the vertical verniers without stepping aside, or without shifting the horizontal plate, becomes apparent. To improve these conditions and in order to obtain compactness the vertical arc in the older types of instruments, used extensively in the coal mines of Pennsylvania, is permanently screwed to the side of the standard. It is of larger diameter, and has a movable vernier arm. In other types the verniers are placed at the sides, as exemplified in No. 6d, page 193, etc., or the graduations are placed on the edge of the vertical circle, which latter type embodies, however, a great deal of mechanical refinement.

All of these types have advantages and disadvantages, and therefore should be chosen simply with a view to attain highest efficiency of an instrument intended for special work. It will hardly be commendable to put the most refined style of vertical circle (requiring a more careful treatment — not to speak of its attendant greater cost to make and keep in repair) upon an instrument intended for the more ordinary purposes, while in changed conditions all these refinements may become necessary to obtain maximum efficiency under trying circumstances.

To enable to make the proper selection for the various instruments the different styles are given below.

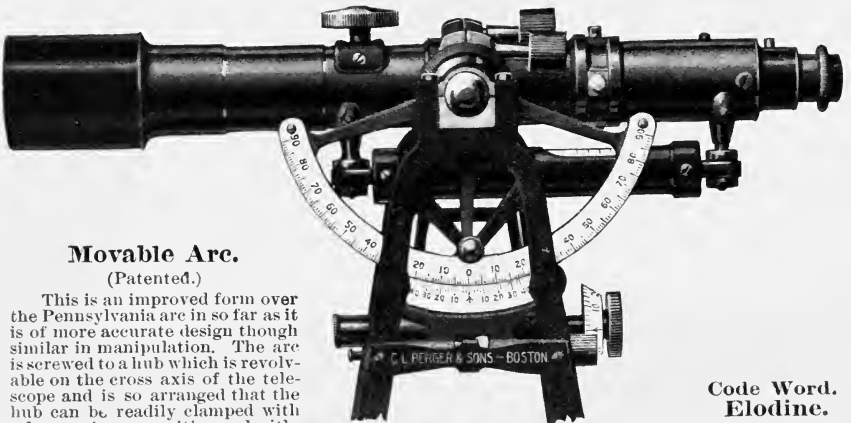
The Pennsylvania Arc.

This arc is of larger diameter than usual but is not strictly of high accuracy. It differs from the regular arc in that it is permanently screwed to the standard, and that its movable vernier arm can be readily set at zero and clamped to the cross axis with the telescope in any position, enabling to read vertical angles, plus or minus from the horizontal plane to about 50 to 60° as well as to read also vertical angles between any two points, when by clamping the vernier arm at 0 for first point and then pointing the telescope at second point the angle can be read from 0 of graduation.



**Code Word.
Eleusine.**

This arc can be attached, without extra cost, to any Transit of size and style No. 1 and No. 2, in place of a regular arc enumerated with instrument. **Made to order only.**



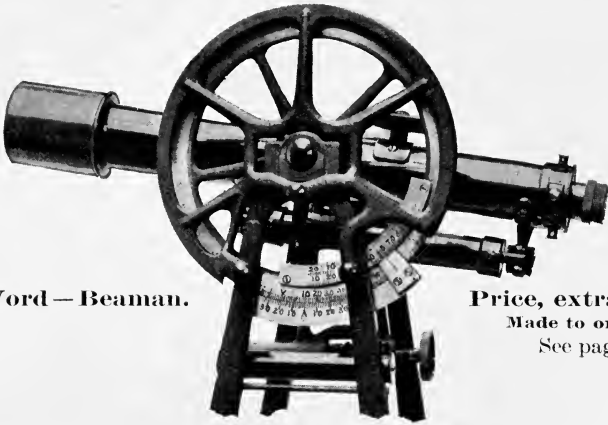
Movable Arc. (Patented.)

This is an improved form over the Pennsylvania arc in so far as it is of more accurate design though similar in manipulation. The arc is screwed to a hub which is revolvable on the cross axis of the telescope and is so arranged that the hub can be readily clamped with telescope in any position and without straining the arc. During non-use the arc can be clamped to the vernier frame and therefore, unlike the regular arc, never projects above the standards when the telescope is in reversed position. The vernier can be set to read zero by means of a tangent screw.

The mechanical arrangement of the various parts of this device is, however, more complicated, as will be seen from the cut, and on this account it is not only more expensive to make but is more liable to derangement as compared with the Pennsylvania arc or the regular arc (page 153) fixed to the cross axis of telescope. **Made to Order only.**

**Code Word.
Elodine.**

Price extra (above price enumerated for regular arc) \$18.00



Code Word — Beaman.

Price, extra, \$30.00.

Made to order only.

See page 155.

The Beaman Stadia Arc.

By means of this stadia arc there is determined rapidly and exactly the difference in elevation between instrument and rod, and also the reduced horizontal distance to the rod, without the measurement of an angle as such; without the use of either a vernier or a table, slide rule or diagram, and with but trifling computation.

Stadia Arc. The Stadia arc carries two scales:

V. A multiple scale, used only for elevation determinations.

H. A reduction scale, used only to reduce inclined stadia readings to horizontal.

Index. Either scale is read by reference to an index adjusted to read the zero or initial point of the scales when the telescope is level. This adjustment is carefully made by us and should remain fixed.

Signs Proved. The initial graduation of multiple scale is marked 50 instead of 0, so that its direct reading will indicate, and the notes afterward prove, the sign of the angular value thereby represented.

To obtain desired multiple, therefore, subtract 50 from multiple scale reading and use algebraic remainder; e.g., if scale reads 56, multiple is $56 - 50 = +6$. If the scale reads 47, multiple is $47 - 50 = -3$. The numeral 50 has been selected arbitrarily as a convenient one to use.

Whole Numbers. A unique feature of the use of the multiple scale is that only such inclinations of the telescope are used as will give a whole number scale reading, the fractional part of the elevation being more quickly and accurately determined by a final rod reading.

There are upwards of 80 such graduations on the multiple scale (indicating multiples running from +40 to -40). The process involves setting the telescope so far as to catch one of these even divisions, thereby obtaining a whole number as a multiple and an easy multiplication.

Difference in Elevation Between Instrument and Rod.

Find such a whole number multiple arc setting (e.g., 55 or 42 set opposite index) as will throw middle stadia wire somewhere on rod, it does not matter where. The arc reading, minus 50, when multiplied by the observed stadia distance (in feet subtended) will give the exact difference in elevation to that height on rod which the middle stadia wire now happens to cut. This height on rod is noted and allowed for as a final correction.

Reduction of Observed Distance to Horizontal.

The direct reading of the reduction scale, taken at the same pointing, gives the percentage of correction (always subtractive) necessary to reduce observed stadia distance to true horizontal distance. This scale may be read to nearest division (per cent) or by estimation to any subdivision desired.

Illustration—Suppose the observed stadia distance to be 6.40 (640 feet), and that the telescope is afterward inclined so that multiple scale reads 33, at which arc setting the middle stadia wire reads 7.4 feet on rod. The multiple then is $33 - 50 = -17$, and the computation for a foresight would be $6.40 \times -17 = -108.8$; and $-108.8 - 7.4 = -116.2$ feet = difference in elevation between instrument and base of rod.

At above setting reduction scale would read 3 or 3%. Then 3% of 640 = 19.2 feet, and $840 - 19 = 821$ feet = reduced horizontal distance.

Difference in Elevation When Half Wire Interval is Used.

If, however, the half wire intercept must be doubled to read a long distance, it may happen that no exact arc graduation setting can be found which will throw middle wire anywhere on rod. Then, instead, make such even arc setting as will throw lower wire anywhere on rod. (Can always be done if middle wire misses rod.) To height on rod thus cut by lower wire, add half wire intercept above, which obviously gives height of middle wire on an imaginary extended rod. Then compute as usual.

Illustration—If half wire interval is 4.2, the full distance would be 8.4 (840 feet). If multiple scale reads 46 while lower wire cuts rod at 9.2 feet above its base, the computed middle wire reading would be $9.2 + 4.2 = 13.4$ feet. Then, with multiple of -4, compute as previously explained.

Edge Graduation for Vertical Circle with One Double Vernier at Eye-End.

In the Transits for underground work provided with a full vertical circle it is often desirable to read the angles from the eye-end of the telescope, to enable the manipulator to secure all his observations without stepping aside. The Edge Graduation shown here is in principle like that illustrated on Transit No. 6d, page 193. The graduation is on the edge, protected by an aluminum frame, and the double vernier at eye-end is glass covered. The graduation is on solid silver and reads to minutes. It is made in a most substantial manner. In case of an accident the cost of repairing is considerably greater than that of the regular vertical circle. **Made to Order only.**

Price of Edge-Graduation, as shown in cut, with double vernier at eye-end, glass covered, (extra over price of Transits Nos. 4, 5 and 6, enumerated with regular full vertical circle) **\$35.00**

Price extra over price of instrument No. 6d **25.00**

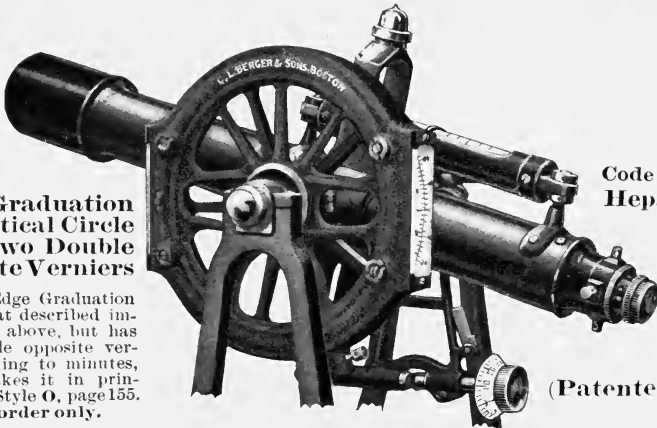


Code Word, **Heliotrope.**

(Patented.)

Edge Graduation for Vertical Circle with Two Double Opposite Verniers

This Edge Graduation is like that described immediately above, but has two double opposite verniers reading to minutes, which makes it in principle like Style O, page 155. **Made to order only.**



Code Word, **Hepatica.**

(Patented.)

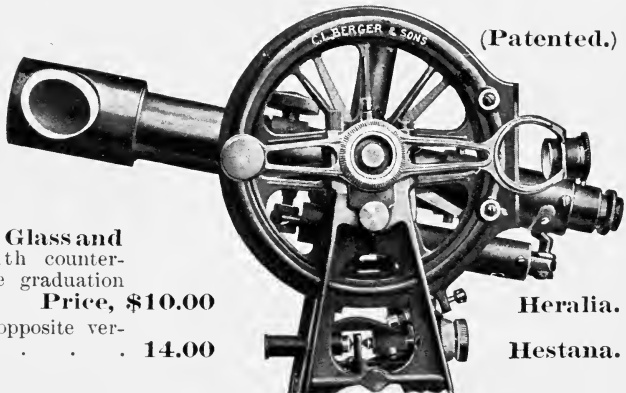
Price of Edge Graduation, with two double opposite verniers, glass covered, (extra over price of Transits Nos. 4, 5 and 6, enumerated with regular full vertical circle) **\$45.00**

Price extra for No. 6d **35.00**

Berger Reading Glass and Reflector with counterpoise, for edge graduation

Price, \$10.00

Same for double opposite verniers **14.00**



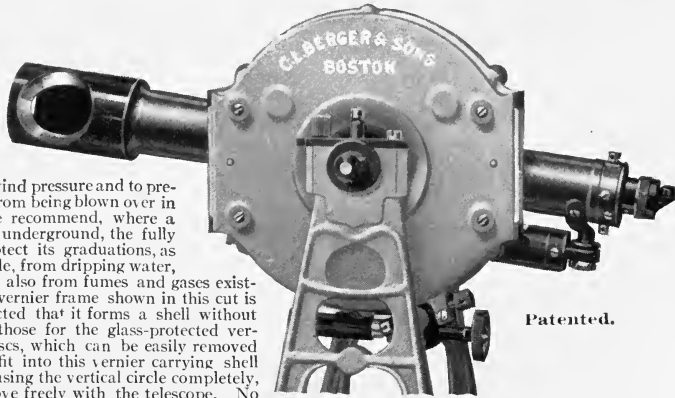
(Patented.)

Heralia.

Hestana.

The Fully Enclosed Vertical Circle with Edge Graduation.

For Transits used only in Mines, Tunnels, etc.
Applicable to Transits No. 4, 5, 6D, 6H, and 7.



Patented.

In distinction to the open frame form of the protected vertical circle shown in the foregoing illustrations, designed to offer the minimum resistance of the exposed

area of a Transit to wind pressure and to prevent the instrument from being blown over in surface surveying, we recommend, where a transit is used only underground, the fully enclosed type to protect its graduations, as in the horizontal circle, from dripping water, and to a great extent also from fumes and gases existing in mines. The vernier frame shown in this cut is therefore so constructed that it forms a shell without any openings except those for the glass-protected verniers. Two semi-discs, which can be easily removed whenever desirable, fit into this vernier carrying shell at the back, thus encasing the vertical circle completely, but allowing it to move freely with the telescope. No water can penetrate inside this shell at any time while in use, nor when carried on its tripod or in hand, if caution is taken to carry the instrument so that its front outside surface is slightly inclined in an upward direction.

in use, nor when carried on its tripod or in hand, if caution is taken to carry the instrument so that its front outside surface is slightly inclined in an upward direction.

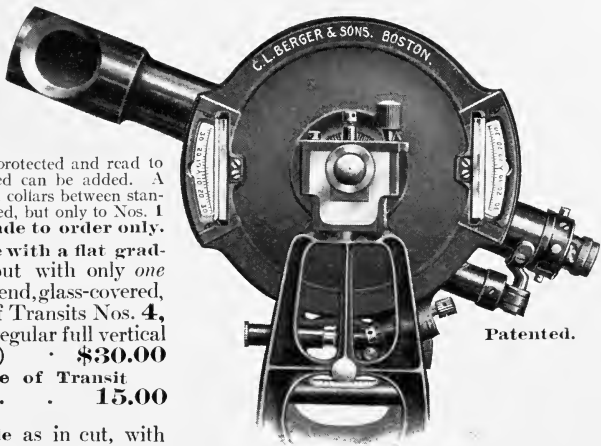
Made to order only.

Code Words

Price of vertical circle with edge graduation, as in cut, reading to minutes, but with only one double vernier at eye-end, glass-covered — extra over price of Transits No. 4, 5 and 6, enumerated with regular full vertical circle	\$35.00	Hestard
Price, extra over price of Transit No. 6D	25.00	Hestene
Price of vertical circle with edge graduations as in cut, with two double opposite verniers, reading to minutes, glass-covered — extra over price of Transit No. 4, 5 and 6, enumerated with regular full vertical circle.	45.00	Hestite
Price, extra, for Transit No. 6D	35.00	Hestium

The Fully Enclosed Vertical Circle with the Customary Face Graduation.

For Transits used only in Mines, Tunnels, etc.
Attachable to Transits Nos. 4, 5, 6, 6D, 6H and 7



Patented.

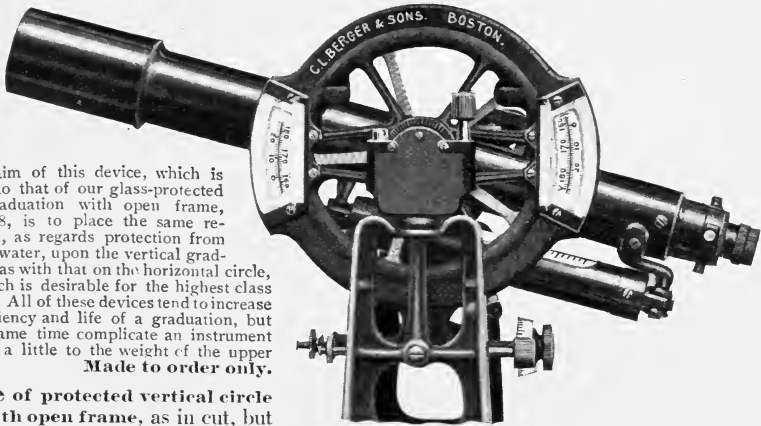
In this type the regular vertical circle and verniers with a flat graduation (pages 155 and 193) are encased in a shell, closed at the back by semi-discs, to protect their graduation, from dripping water, etc. In all other respects the design is similar to that described above for the edge graduation; verniers are glass-protected and read to minutes; glass shades if desired can be added. A striding level to rest on special collars between standards, can be attached if desired, but only to Nos. 1 and 5 Transits.

Made to order only.

Price of vertical circle with a flat graduation as in cut, but with only one double vernier at eye-end, glass-covered, extra over price of Transits Nos. 4, 5, 6 and 7, having regular full vertical circle (see page 196)	\$30.00	Hestmos
Price extra over price of Transit No. 6D	15.00	Hestnia
Price of vertical circle as in cut, with two double opposite verniers, glass covered, extra over price of Transits Nos. 4, 5, 6 and 7, having regular full vertical circle,	\$40.00	Hestota
Price extra for Transit No. 6D.	25.00	Hestra

The Open-Frame Protected Vertical Circle with the Customary Face Graduation.

For Transits used in Surface and Mine Surveying.
 Attachable to Transits sizes No. 1, 2, 3, 4, 5, 6 and 7.



The aim of this device, which is similar to that of our glass-protected edge graduation with open frame, page 198, is to place the same refinement, as regards protection from dust or water, upon the vertical graduations, as with that on the horizontal circle, when such is desirable for the highest class of work. All of these devices tend to increase the efficiency and life of a graduation, but at the same time complicate an instrument and add a little to the weight of the upper part.

Made to order only.

Price of protected vertical circle with open frame, as in cut, but with only one double vernier reading to minutes at eye-end, glass-covered, see Heliotrope page 198, — extra over price of Transits enumerated with full vertical circle, size Nos. 1, 2, 4, 5 and 6

Price extra over Mining Transit No. 6D

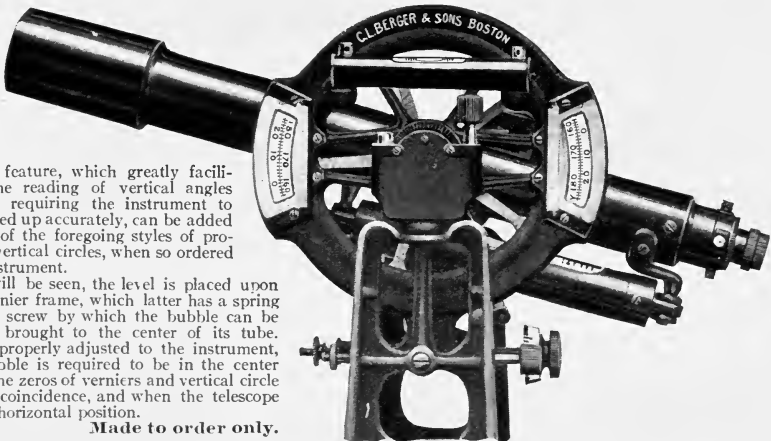
Price of protected vertical circle as in cut, with two double opposite verniers, glass-covered, — extra over price of transits Nos. 1, 2, 4, 5, 6 and 7, when enumerated with a regular full vertical circle.

Price of protected vertical circle with open frame as above, extra for Transit No. 6D

Price of reading-glasses if desired for double opposite verniers, extra

Code word
 Hestula
 Hesudil
 Hesudra
 Hesudo
 Hetarda

The Level to the Vernier Frame of Protected Vertical Circle.



This feature, which greatly facilitates the reading of vertical angles without requiring the instrument to be leveled up accurately, can be added to any of the foregoing styles of protected vertical circles, when so ordered with instrument.

As will be seen, the level is placed upon the vernier frame, which latter has a spring tangent screw by which the bubble can be readily brought to the center of its tube. When properly adjusted to the instrument, the bubble is required to be in the center when the zeros of verniers and vertical circle are in coincidence, and when the telescope is in a horizontal position.

Made to order only.

Price of level with tangent screw attached to any of the foregoing protected vertical circles, extra

Code word
 Hetesy

Stride Levels

Resting on Special Collars between the Standards (pages 148 and 149).

If desired, a stride level resting on special collars between the standards, so as to revolve with the telescope, can be attached to Mine Transits Nos. **5** and **6** only, if latter are not to be provided with a central post for style 1 or 2 interchangeable auxiliary telescope. This stride level cannot be attached to any instrument already made—such Transits must be specially made.

Price, extra, \$20.00

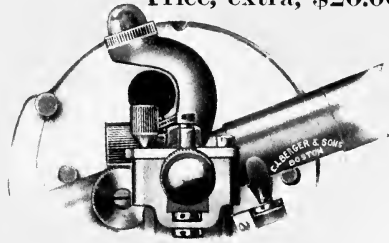
If a stride level of the above kind is to be attached to Mine Transits Nos. **5**, **6** or **7**, having style 1 or 2 interchangeable auxiliary telescope, then the arrangement of the central post and stride level will be as shown in the annexed cut, shown also on page 209.

Made to order only.

Price, extra, \$30.00

NOTE.—A stride level resting on special collars cannot be attached to Transits size Nos. **4**, **6D** nor **6H**.

For adjustment of this stride level of improved form, see page 56.



Patented.

The Revolving Cross-Level for Mine Transits.

This is a very ingenious device to control the line of collimation of the telescope at any altitude, in place of the stride-level, but owing to the limited distance between the standards, and the short distance between them and the vertical circle, it can be applied only to our Mine Transits Nos. **5** and **6**; or to No. **6D** if latter is provided with an open vertical circle of style shown on page 193.

Unlike the regular detachable stride-level, this cross-level is permanently mounted upon the telescope's axis of revolution by means of two adjustable uprights. Its advantages is that it is revolvable between its uprights, and therefore enables to watch the bubble in very steep sighting. We recommend it only in cases where a regular stride-level cannot be applied owing to size and style of instrument, and where it is considered that some form of stride-level is a necessary adjunct to a Mine Transit. The adjustment of this device is somewhat more complicated than that of the ordinary stride-level (in comparison with which it is also of a somewhat minor degree of accuracy), but by the aid of the instructions given below it can be made at any time, if required.



Patented.

Made to order only.

Price, \$35.00

Code, Hetica

Adjustment of the Revolving Cross Level.

To make the adjustment of the revolving cross level, level up the instrument approximately, place its supporting arms vertical and bring the bubble of the revolving level to the center of its tube by the instrument leveling screws, and clamp horizontal plate. Now first verify the lateral adjustment of the revolving level by turning it on its axis some 20 to 30° each side of the vertical. If this adjustment is made properly the bubble will stay in the middle of its tube. If not, make it so (as in a Wye Level) by the two capstan-headed screws at the side of the revolving level.

Revolve the telescope 180° on its cross axis, turn the revolving level face up again, and see if also correct. If not, remove half the error by the vertical capstan-headed screws of the revolving level tube and half by the vertical capstan-headed screws of the supporting arm (this latter must be done in order to also adjust the revolving level simultaneously to the telescope's horizontal axis of revolution) and then repeat, if necessary.

This being done, place the supporting arms horizontal and also make the adjustment of the supporting arm at 90 degrees to the former adjustment by the other pair of capstan-headed screws of the supporting arm and then revolve the telescope 180° to see if correct, and repeat this adjustment if necessary.

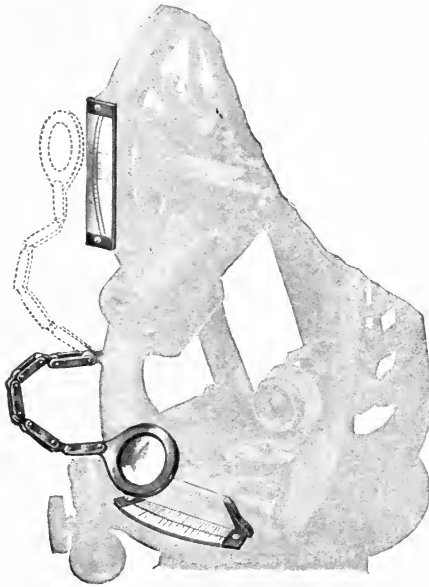
These adjustments being made, it is well to repeat all of them in the above succession until perfected. When this is accomplished, it will be necessary to make the adjustment of the standards, so that the telescope's axis shall be truly at right angles to the vertical axis of the instrument; in other words, that the line of collimation travel in a truly vertical plane. This can be done and verified by simply turning the instrument 180° on its vertical center and removing half the error, if any, by the leveling screws and the other half by the raising or lowering, as the case may be, of the vertical adjusting screws provided on one of the standards.

On the whole, it is a somewhat delicate adjustment to make, requiring some patience, and is best performed on a window-sill. When properly performed it is just as likely as permanent as that of the plate or a stride-level.

C. L. BERGER & SONS.

Flexible Jointed Arm with Magnifier

Attachable to Any of Our Transits for Reading the Vertical and Horizontal Verniers



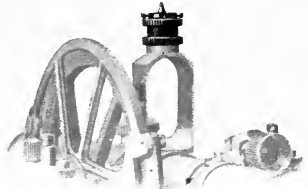
Price, \$7.50

Code Word Hetide

The Adjustable Center

On Top of Transit Telescopes used Underground.

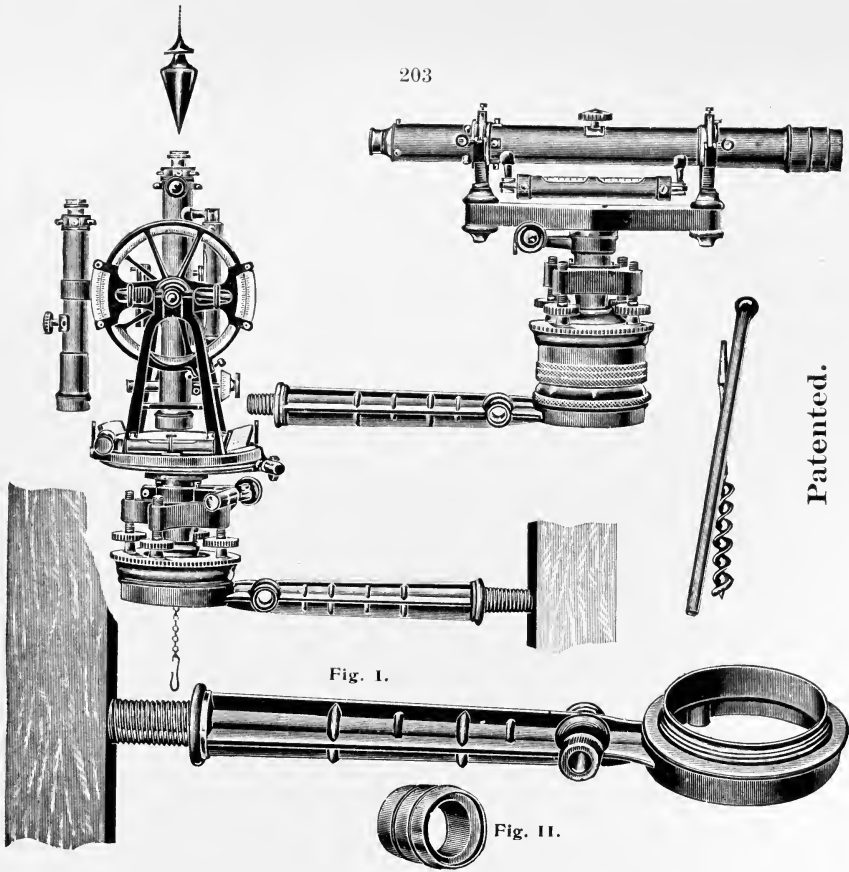
Our transits are made mechanically so perfect that the fine punch-mark provided on top of the telescope, to enable to center the instrument from a point above, is seldom more than one to two hundredths of an inch from the true center, without any other device, and is generally considered sufficient. But for cases where even this small eccentricity is objected to, in mine and tunnel engineering of a very precise character, we have devised an adjustable center, as shown in cut, to be attached to the post (or if there is no post, to the top of the telescope's axis, if same has been originally provided with a stud to receive it when being made) by means of which the center can be adjusted to be correct, enabling to set up the instrument under a given point so that the prolongation of the vertical axis of revolution of the transit be truly in line with the plumb-bob hung from a point above, thus leaving nothing to be desired.—This operation can be very much simplified by the use of our lateral adjuster, see page 205.—When not needed, the adjustable center can be unscrewed and screwed in the box. If a top telescope is to be used, the transit proper should first be set up correctly under the given point. This done, the adjustable center can be removed and the top telescope screwed in its place. This device once properly adjusted to its transit by us, does not require any more attention in the future, unless the instrument should meet with an accident, such as bending of the standards, or of the telescope's axis, etc., when naturally, after it has been repaired, this adjustment of the centering device must again be made.



Patented.

Price of adjustable center \$3.50

Code word Hetillo



Patented.

The Berger Bracket for Transit or Level.

This bracket is designed for supporting the instrument under conditions when the use of even our extension tripod is inadmissible, and will be found a valuable auxiliary for mining work. The instrument can be screwed upon the bracket, as on a tripod, and the transit can be centred above or below a given point. The bracket is made of brass, so fashioned as to offer the greatest rigidity, and is furnished with an auger and a lever.

Price, One bracket made for Transit No. 4, with four leveling screws in box, with auger and lever \$14.00
 One bracket made for Transit No. 6, as above 15.00
 Every additional bracket extra, for either size 9.00

Price of Bracket as above (but for instruments with **three** leveling screws size **No. 5** and **6**) with instrument fastener and lateral motion packed complete in box with auger, etc. 25.00

Price of Bracket for transits with three leveling screws size **No. 4** and **4 1/2** inch 24.00

Short Focus Lens Attachment. (For extended description see page 100.)

The above cut of our wye level and Fig. II illustrate our patented Focus Lens Attachment, attachable to the object end of the main telescope, which permits the focusing of objects nearer than the range of the main telescope will permit. As a rule the main telescope can be made only to focus objects five to six feet distant from instrument. These lenses are generally furnished in pairs. Lens **No. 1** will permit focusing of objects about 4 feet from instrument. Lens **No. 2** will permit focusing of objects about 2 1/2 feet from instrument; used together they permit focusing of objects about two feet from instrument.

The lenses are adjustable to the line of collimation of the main telescope and permit of a high degree of accuracy. They will often prove of great convenience as an auxiliary to view objects that are too near for observing without them. Attachable to transits Nos. **1, 2, 3, 4, 5, 6**, and to our wye and dumpy level.

Price, Lens No. 1 \$8.50
 " " " 2 8.50
 " Lenses " 1 and No. 2 16.00

Code Words
Hibiscus.
Hildine.

Hilgrim
Hilitos



Patented

Style of trivets used with transits and levels having four leveling screws. (Also for use with lateral adjusters, see page 205.)

The Berger Trivets

For mounting Levels and Transits with **FOUR** leveling screws, on wall brackets, planks etc., in underground work.

Brass trivets should be ordered for instruments with compass. These trivets may be of iron for instruments without compass, or when latter is considered of no importance, at a price reduced in proportion to the difference in price of the metals; but when made of iron the thread receiving the instrument and the working parts should be kept well oiled to prevent rusting. A metal cap* is furnished with each trivet. In ordering trivets for old instruments the *serial* number of the instrument **MUST** always be given.

	Material	Weight	Height	Radius	Price	Code Name
Trivet (light and very portable) for transit No. 4	Brass	9 oz.	1 7/8 inch.	2 1/2 inch.	\$ 5.00	Topadil
" (very heavy) for transit No. 4	Brass	3 lbs.	2 1/4 "	4 1/2 "	6.50	Topalate
" (light and very portable) for transits No. 1, 2, 3, 5, 6 and 11, also for Wye and Dumpty Levels	Brass	2 lbs.	3 1/2 "	3 1/4 "	6.50	Topana
" same as Topana, but of larger radius	Brass	2 lbs.	3 1/2 "	4 5/8 "	6.50	Topalis
" (regular size) for transits No. 1, 2, 3, 5, 6 and 11, also for Wye and Dumpty Levels	Brass	3 lbs. 9 oz.	2 7/8 "	4 1/4 "	8.00	Topaxset
" — see large cut — (extremely high and heavy for use in extended tunnel operations) for transits No. 1, 2, 3, 5, 6 and 11, also for Wye and Dumpty Levels	Brass	6 lbs.	4 1/4 "	4 1/4 "	8.75	Topazula

Trivets for Levels and Transits with **THREE** leveling screws.

Trivet — see small left-hand cut above — (high and very heavy) without shifting center, but with instrument fastener, only for Wye and Dumpty Levels	Iron	6 lbs.	4 3/4 inch.	4 3/4 inch.	13.50	Topecota
" same as Topecota, but low and heavy — see small right hand cut — without shifting center, but with instrument fastener, only for Wye and Dumpty Levels	Iron	4 lbs. 10 oz.	3 "	4 1/2 "	12.80	Topella
" with shifting center and instrument fastener, for centering the transit above or below a given point as in small right hand cut, but with high legs and very heavy — for transits No. 1 f, No. 1 g and No. 11 (when latter is provided with three leveling screws) also for Wye and Dumpty Levels	Brass	6 lbs. 12 oz.	4 1/4 "	4 3/4 "	19.50	Topemmus
" same as Topemmus, but of iron (shifting center and instrument fastener of brass)	Iron	6 lbs. 12 oz.	4 1/4 "	4 3/4 "	17.75	Topeneda
" same as Topemmus, but low and very heavy	Iron	5 lbs. 6 oz.	3 "	4 1/2 "	19.25	Topesum
" same as Topesum, but of iron	Iron	5 lbs. 6 oz.	3 "	4 3/8 "	17.50	Topetony

* Price of any of the above Trivets without metal cap, less \$1.50.



Patented.

The Berger Lateral Adjuster

For Transits with **FOUR** leveling screws.*

For use on tripods and trivets.

The Lateral Adjuster shown above is an attachment, made of brass, separate from the Engineers' Transit and its tripod. It screws to the tripod and then the instrument is screwed on top of it. It is designed to range the line of sight of a Transit after it has been leveled up, quickly and accurately onto a given line which may be indicated by the plumbing wires **A** and **B** in a shaft, as shown in a graphical manner on page 191, or onto a line given by any two station points in a tunnel or in surface work, without disturbing the position of the level bubbles.

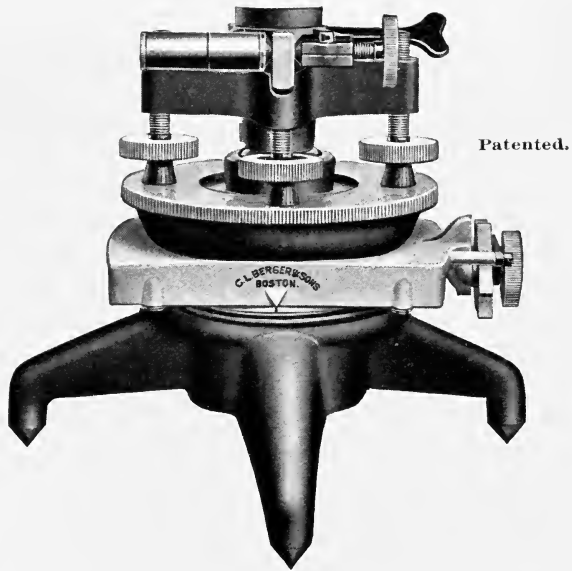
Being primarily intended for underground work the indicator wheel of the feed screw may serve as an aid in moving the instrument a required distance in the dark in ratio of hundredths and thousandths of a foot.

TO OPERATE THE LATERAL ADJUSTER.—Screw it firmly to the tripod and also attach Transit to it. Place both index marks of the Lateral Adjuster in coincidence, and also place Transit about in the center of its shifting motion. Then place tripod firmly on the ground in such a manner that the longitudinal axis of the Lateral Adjuster is approximately at right angles to the line given by the plumbing wires **A** and **B**, and at the same time that the line of sight shall be as nearly in line with these wires as possible. Now level up carefully and move the line of sight of telescope on to wires **A** and **B** by the feed screw of the Lateral Adjuster until the intersection of the cross-wires of the telescope and both plumbing wires are contained in the same vertical plane. When Trivets and Lateral Adjusters are ordered for old instruments the **serial number must** be given.

	Weight	Price	Code Name
Lateral Adjuster for transit No. 4 with four leveling screws, see large cut above	1½ lbs.	\$25.00	Topexura
This lateral adjuster provided with detachable trivet Topadil , see page 204.	2 lbs.	30.00	Topibus
This lateral adjuster provided with detachable trivet Topalate	4½ lbs.	31.50	Topicomus
Lateral Adjuster for transits No. 1, 2, 3, 5, 6 and 11 , see large cut above	2 lbs. 7 oz.	25.00	Topilera
This lateral adjuster provided with detachable trivet Topana , see page 204.	4 lbs. 7 oz.	31.50	Topimot
This lateral adjuster provided with detachable trivet Topalis	4 lbs. 7 oz.	31.50	Topiris
This lateral adjuster provided with detachable trivet Topaxset	6 lbs.	33.00	Topisine
This lateral adjuster provided with detachable trivet Topazula	8 lbs. 7 oz.	33.75	Topitel
Lateral Adjuster and Trivet Combined † see small cut above — for transits Nos. 1, 2, 3, 5, 6 and 11 (when latter is provided with four leveling screws)..	4 lbs. 5 oz.	30.00	Topixdil
Lateral Adjuster and Trivet Combined , same as Topixdil but with an adapter for use with transit No. 4	4 lbs. 5 oz.	33.80	Topodillo
Lateral Adjuster and Trivet Combined , † same as Topixdil but with instrument fastener for transits Nos. 1, 2, 3, 4, 5, 6 and 11 with three* leveling screws	5 lbs.	36.00	Topogony

* For transits with **three** leveling screws, see Tunnel Tripod with centering and aligning device, page 210.

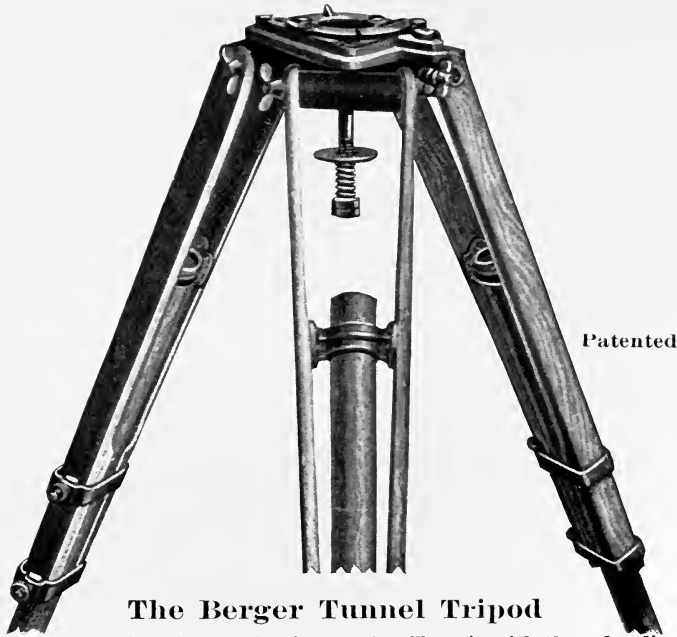
† This device is to be placed upon the regular tripod head of our transits **Nos. 1, 2, 3, 5, 6** and **11**, when these are ordered to be provided with **THREE** leveling screws, or it may be used independently on a bracket. As will be seen above there is also provided on top the instrument thread for attaching transits **Nos. 1, 2, 3, 5, 6** and **11** having **four** leveling screws, so that all the above styles and sizes of instruments having either three or four leveling screws may be used interchangeably on **this three-screw tripod**. It is of great advantage when a variety of instruments are to be used on the same work.



**The Lateral Adjuster screwed to a Trivet
For Transits with FOUR leveling screws.**

**For use in Tunnels and Underground Work of all
kinds; also useful in the erection of long
Bridges, Factories and their
machinery equipment, etc.**

**For Prices and Particulars of these auxiliaries,
see pages 204 and 205.**



The Berger Tunnel Tripod

with Centering and Aligning Device for moving Transit with three leveling screws under or above a given point or onto a given line—see cut of No. 10 b.

The above tripod has been designed to facilitate the placing of our Transits with three leveling screws in the axis of a tunnel or onto a given line of sight. For this reason, in addition to our centering device, a lateral motion has been provided, which allows the Transit to be moved with ease and precision and without disturbing the position of the level bubbles mentioned in describing the Lateral Adjuster for transits with **FOUR** leveling screws, page 205.

This centering and aligning device is very simple to manipulate, but increases the weight of the tripod-head, particularly when the latter is wholly made of brass. Thus the tripod-head for size No. 1 and No. 11 Transits is heavier by about $2\frac{1}{2}$ to 3 lbs., that for No. 2 about 2 to $2\frac{1}{4}$ lbs., and for No. 4 about $1\frac{1}{2}$ to 2 lbs., and in the case of No. 10 and 12 about 5 lbs.

TO USE.—First place the uppermost triangular shifting piece, upon which the instrument rests, in the center of its motion, which is indicated by equal spaces all around it, and also place the lateral adjuster, which is the lower slide, in the center of its range, indicated by two small projections on the tripod head and slow motion piece of the lateral adjuster.

Then place the tripod head in such a position that the motion of the Lateral Adjuster is about at right angles to the line of sight; after which level up, and center over or below the given point; then clamp the large winged central nut in the usual manner and apply a slight pressure by turning milled headed nut which acts against the spring of the instrument fastener. The instrument is now ready for angle work.

TO USE THE LATERAL ADJUSTER FOR ALIGNMENT.—Clamp the milled headed screw on top, bearing in mind that, in order to enable the feed screw to move the instrument during this lateral motion, *with the large winged central clamping nut on top of tripod and fastener spring below must first be released.*

Inasmuch as the pitch of the feed screw corresponds to tenths of a foot, each motion of a tooth of the star indicating wheel corresponds to a thousandth of a foot. Thus it will be seen that if the pointing of the telescope on a distant scale requires the instrument to be moved $1/1000$ th or $5/1000$ ths of a foot, as the case may be, that the manipulator turns 1 or 5 teeth around the index mark and the object will be attained. When the line of sight of the telescope is in the given line in the tunnel then slightly clamp the large winged central clamping nut on top of tripod and again slightly apply the spring of the instrument fastener.

If in the course of operations the line of sight must be moved laterally, then the central clamping nut and spring nut must again be first slightly released from the shifting piece before any lateral motion should be attempted.

To use the tripod head as a trivet, unscrew the extension legs and screw the three 4-inch iron legs in the places assigned them. It can then be used on brackets or any other special device rigged up to receive it in the axis of the tunnel.

To obviate the removing of the legs so that attachment can be used as a trivet, a special tripod head, having centering and lateral adjuster devices, but without wooden legs, may be ordered. This extra head complete would have the three 4-inch iron legs heretofore mentioned.

After the Lateral Adjuster has been used, before putting it away, it will be well to clean it, placing the triangular shifting piece, as well as the lower slow motion slide of the Lateral Adjuster, again in a normal position, and then clamp both by the central clamping nut and small knurled nut.

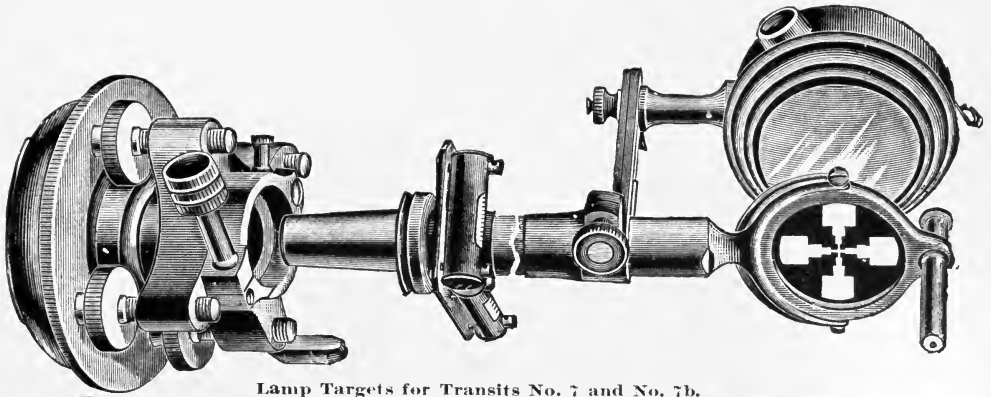
The tripod is made with fine mechanical nicety and should be well taken care of in order to preserve it in good condition.

This device (for instruments with **THREE** leveling screws only) is made in four sizes as follows:—

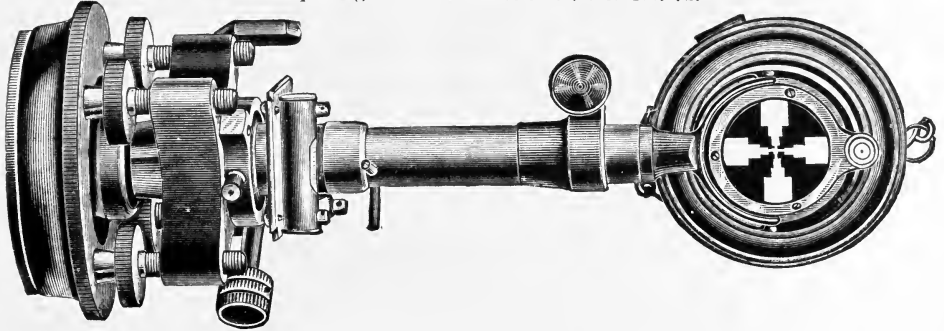
For Transits No. 1, 5 and 11,	Code Name	Topolium
“ Transits No. 2, 3 and 6,	“	Topomara
“ Transit No. 4	“	Toponia
“ Transits No. 10 and 12	“	Toposmus

The price of this lateral adjuster over the regular centering device furnished with our transit tripods will be given upon application.

**Mining Transit interchangeable with Lamp Targets
above Leveling Screws.**



Lamp Targets for Transits No. 7 and No. 7b.

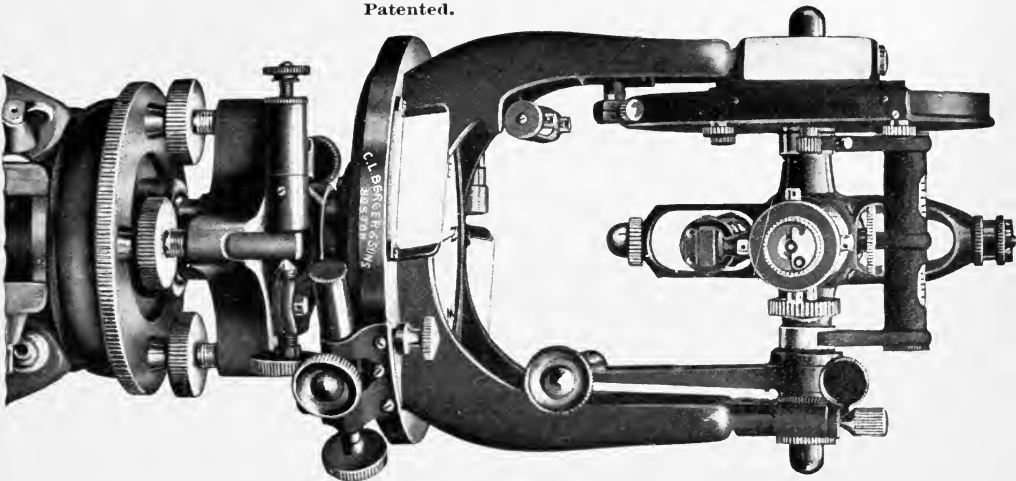


Mining Transit No. 7b.

With Yoke Standards.

As made by C. L. Berger & Sons.

Patented.



Tunnel Transits.

No. 10a Tunnel Transit with **four** leveling screws and **without** lateral adjuster, otherwise as enumerated below and shown on opposite page.

SPECIFICATION : —

Horizontal circle 6¼-inch, graduated on solid silver, double opposite verniers reading to **20''**, two rows of figures from 0°-360°.
Telescope 12-inch inverting, aperture 1¾-inch, power 28 dia., telescope reversible over the bearings as well as through the standard frame, reversible clamp and tangent screw.
Spirit level to telescope, 6-inch.
Striding level resting on special collars, 3½-inch,
Stadia wires fixed.
Reflector.
Shifting center.
Standard frame of aluminium or brass, latter preferred on account of its greater resistance to gases and fumes.
Extension tripod **Made to order only.**

Code word, Mobaco.

Price, \$292

No. 10b. Tunnel Transit as in cut, with **three** leveling screws; tunnel tripod with centering and aligning device.

SPECIFICATION : —

Horizontal circle 6¼-inch, graduated on solid silver, double opposite verniers reading to **20''**, two rows of figures from 0°-360°.
Telescope 12-inch inverting, aperture 1¾-inch, power 28 dia., telescope reversible over the bearings as well as through the standard frame, reversible clamp and tangent screw.
Spirit level to telescope, 6-inch.
Striding level resting on special collars, 4½-inch.
Stadia wires fixed.
Reflector.
Shifting center.
Standard frame of aluminum.
Extension tripod. **Made to order only.**

Code word Mobalis.

Price, \$342

No. 10c Tunnel Transit as in cut on opposite page and as described in **No. 10b**, but having an extension tripod **with shifting center only** as shown in **No. 11 f**.

Made to order only.

Code word, Mobatony.

Price, \$307

Extras to Tunnel Transit No. 10a and No. 10b.

Lateral adjuster for transit No. 10a with four leveling screws	\$25.00
7-inch horizontal circle, double opposite verniers reading to 10 sec.* extra	30.00
5-inch full vertical circle, solid silver graduation, double opposite verniers reading to minutes, as in cut, page 214	50.00
Reading glasses to horizontal circle	15.00
Striding level resting at points of contact in Y's (instead of resting on special collars as in cut) extra	10.00
Aperture, 1½-inch instead of 1¾-inch, length of telescope 12 or 13½ inch long, powers respectively 28 or 34 dia.	10.00
Gradiometer attachment	5.00
Steel center running in cast-iron socket	20.00
Extra extension tripod, with shifting center only, for transit having 3 leveling screws	32.50

*Detachable reading glasses should always be ordered for a 10 sec. graduation.

For additional Extras to Tunnel Transits, see Extras to Mining Transits.



Transit Theodolite

**No. 10 b
Tunnel Transit**

With three leveling screws mounted on tunnel tripod with Shifting Center and Aligning Device. See page 207.

For **Price** and description of the above instrument, as well as list of extras, see preceding page.

Codeword — Mobalis.

Triangulation Transit-Theodolites.

For use in Cities and in Bridge and Tunnel Construction, etc.

Since the introduction by us in 1875 of this style Transit with Yoke standard frame cast in one piece and mounted directly on the top flange of the inner center, the demand for them in all lines of engineering requiring high accuracy has attained so great a magnitude, on account of their excellence, as could not be foreseen at that time. Many of these instruments are in use in the survey and triangulation of our largest cities, and are giving great satisfaction. Many also have been supplied to Colleges and are in use in State and Boundary Line surveys.

The great lateral stiffness attained by this form of standard frame enables to make the **trunnions** of the telescope's axis cylindrical and to mount them in wye-bearings, thereby securing to the telescope the most accurate movement in the vertical plane known. The telescope reverses through the standards as usual and over the bearings. The trunnions are protected by dust-caps, and wherever possible capstan-headed screws will take up any looseness between these dust-caps and the trunnions.

These Transit-Theodolites are made with three or four leveling screws.

No. 11. Plain Transit-Theodolite, with **four** leveling screws, as in cut, on opposite page, but *without* level, clamp and tangent screw, vertical arc, or striding level to telescope; in all other respects as in cut of **No. 11c**. Specifications: horizontal circle $6\frac{1}{4}$ inches, **single opposite verniers**, as in fig. 5 page 38, reading to **20"**, glass protected graduation and verniers, one row of figures 0 to 360 clockwise; 12-inch **inverting** telescope, aperture $1\frac{3}{4}$ inch, power 28 diameters, achromatic eyepiece; telescope is reversible over the bearings, as well as through the standards; long compound centers of hard bell-metal; shifting center; **split-leg tripod**; aluminum standard frame—leather-finished; mahogany box with screw-driver, reading glass, adjusting pins, etc.

Made to order only.

Code word, Mobax

If instrument is desired with an erecting telescope of 24 diameters, add to code word "**erect.**"

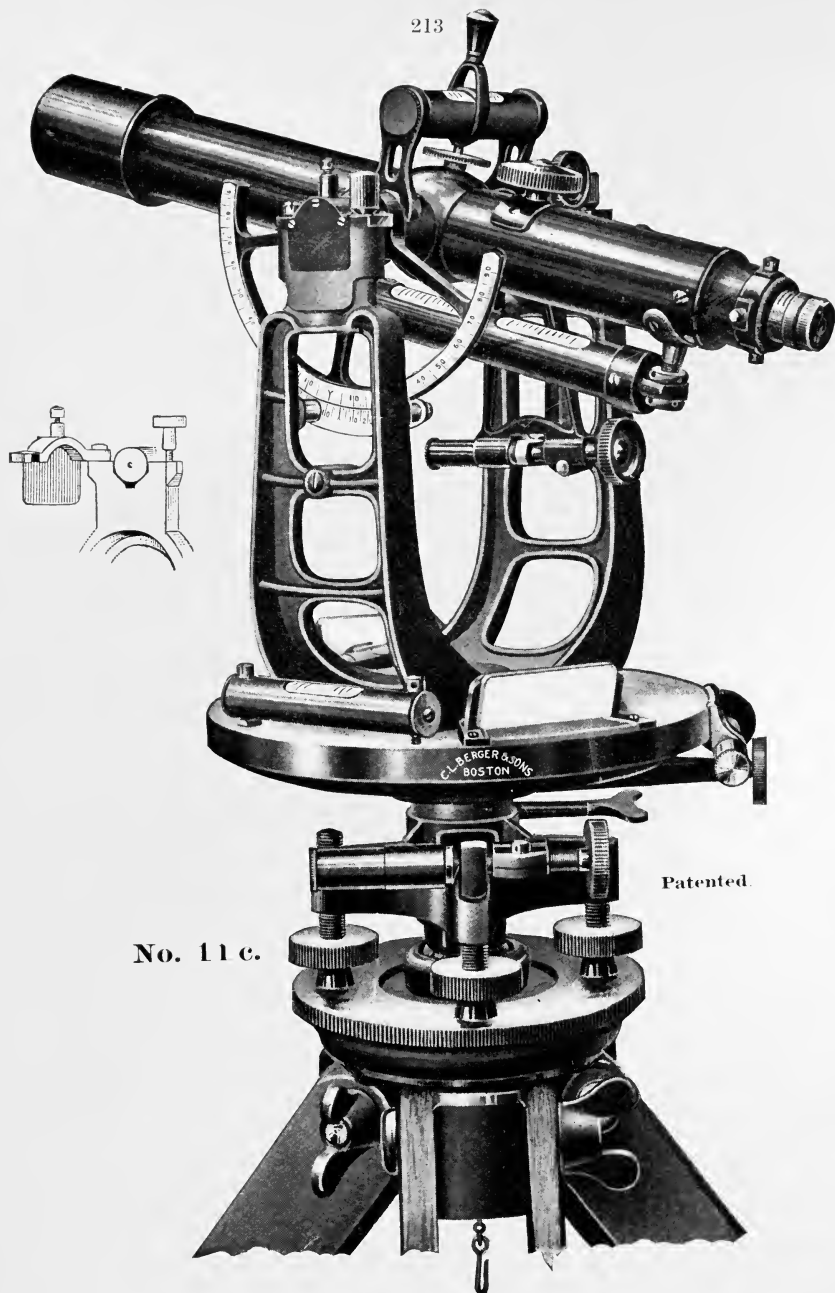
Weight of instrument, about 14 lbs. Weight of tripod, about 10 lbs.

Gross weight packed in two boxes, ready for shipment, about 60 lbs.

Price of Plain Transit-Theodolite No. 11, as above, with **four** leveling screws **\$225.00**

Extras to Plain Transit-Theodolite No. 11.

Three leveling screws with shifting center (see page 52)	15.00
7-inch horizontal circle reading to 10" by single opposite verniers, single row of figures 0° to 360° clockwise	30.00
Reading glasses to horizontal circle (should always be ordered with instrument reading to 10")	15.00
Reversible clamp and tangent screw to telescope, but without level to latter	15.00
6-inch spirit level with reversible clamp and tangent screw to telescope	30.00
3-inch striding level , as in cut, to rest on special collars to revolve through the standards	20.00
5-inch striding level resting at points of contact in wyes, see page 214	30.00
5-inch vertical arc , as in cut on opposite page	20.00
5-inch full vertical circle , (as in cut page 214) but with only one double vernier reading to minutes at eye-end; reversible tangent screw	45.00
5-inch vertical circle , see cut page 214, double opposite verniers reading to minutes, reversible tangent screw	50.00
3-inch level to vernier frame of vertical circle, see cut page 214	8.00
Two reading glasses to vertical circle, see cut page 214	10.00
Stadia wires , fixed, ratio 1:100	3.00
Gradiometer screw	5.00
Center of instrument of steel running in a socket of cast iron, for instrument with three leveling screws, having no compass	20.00
Oblong compass mounted on vernier plate at side of standard, with motion for setting off the variation (three-inch needle reads only a few degrees each way from zero) [For instruments with bell-metal centers only]	15.00



No. 11 c.

Patented.

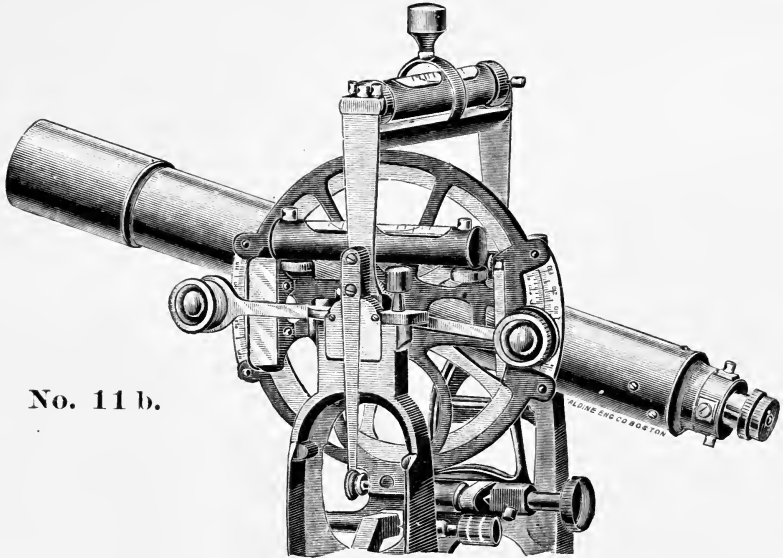
No. 11 c, Complete Transit-Theodolite with four leveling screws, (size and particulars as described in Plain Transit-Theodolite No. 11) but **with level, clamp, and tangent screw, 5-inch vertical arc, striding level, and fixed stadia wires** to telescope. as shown above.

Made to order only.

Code word, Mobaya.

Price, \$300

For Extras see list of Extras to Transit-Theodolite No. 11.



No. 11 b.

Complete Double Opposite Vernier Attachment to 5-inch Vertical Circle, with Level, Reading Glasses and reversible Tangent Screw to vernier frame.

Attachable to **Plain Transit-Theodolites No. 11**, page 212 and **11d**.

NOTE.—The telescope in the above cut has no level attached to it, as is frequently the case in these instruments, and in consequence the vernier frame of vertical circle carries a 3-inch level by which a complete control of the position of its verniers is assured when vertical angles are measured.

For **price** and **particulars** see **Extras** to Plain Transit-Theodolite No. 11, page 212.

Triangulation Transit-Theodolite.

For use in Cities, by Colleges, and in Bridge and Tunnel Construction.

No. 11d. Plain Transit-Theodolite with **three** leveling screws, as in cut on opposite page, but **without** reading glasses to horizontal circle, also **without** level, clamp, tangent screw, vertical arc and striding level to telescope. Yoke standard frame is of aluminum and of pattern shown in No. 11g.

Specifications: —

Horizontal circle $6\frac{1}{4}$ -inch, single opposite verniers (as in fig. 5, page 38) reading to **20'**, glass protected graduation and verniers, one row of figures 0° to 360° clockwise; 12-inch **inverting** telescope, aperture $1\frac{3}{8}$ -inch, power 28 diameters, achromatic eye-piece; telescope is reversible over the bearings and through the standards; long compound centers of hard bell and phosphor bronze metal; shifting center (see page 52). Mahogany box contains reading glass, screwdriver, wrench, adjusting pins, etc.

Made to order only.

Code word, Mobeda.

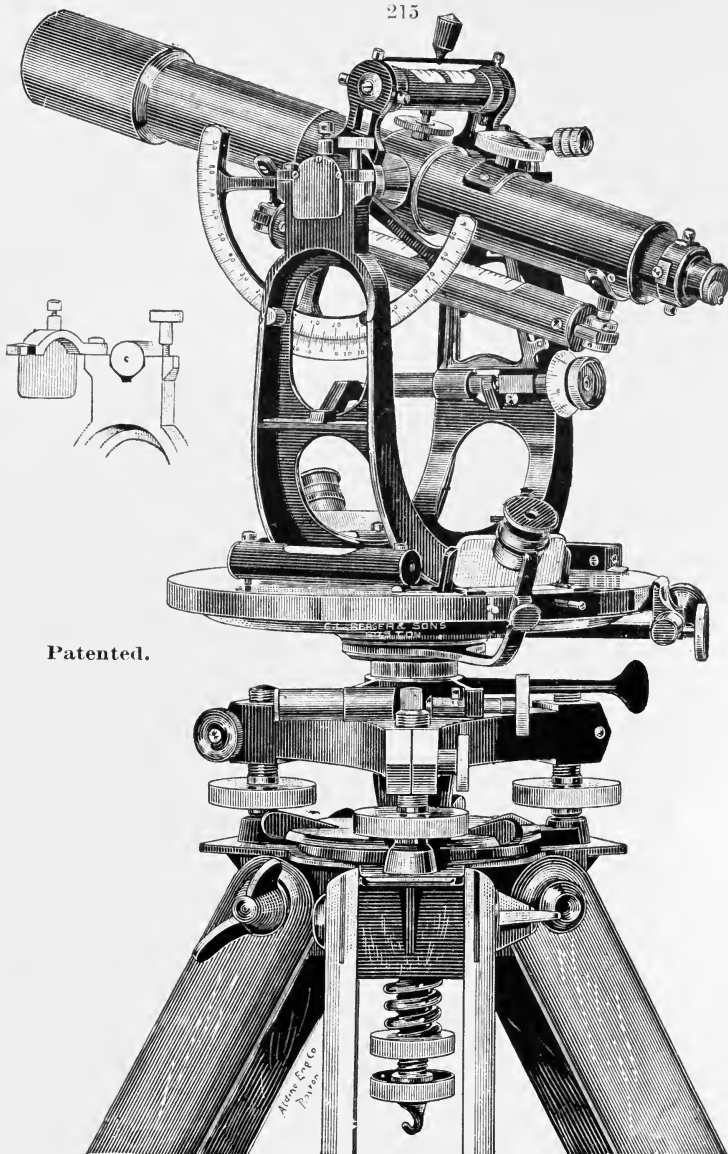
Weight of instrument about 14 lbs.

“ “ tripod about $13\frac{1}{2}$ lbs.

Gross weight, securely packed in two boxes for shipment, about 60 lbs.

Price of **Plain Transit-Theodolite No. 11d**, with **three** leveling screws, as described above **\$245.00**

For **Extras** to **Plain Transit-Theodolite No. 11d** see **Extras** to Plain Transit-Theodolite **No. 11**, page 212.



Patented.

No. 11 f.

Complete Transit-Theodolite.

For use in Cities, in Tunnels, and for Triangulation.

As made by C. L. Berger & Sons.

No. 11 f. Size and particulars are in all respects like those described under No. 11, page 212, and No. 11d, page 214, but having **three** leveling screws, reading glasses to horizontal circle, level, clamp, and tangent screw, five-inch vertical arc, gradienter, fixed stadia wires, and striding level to telescope as shown above.

Made to order only.

Codeword, Mobekia

Price, \$343.00

For Extras see Extras to Plain Transit-Theodolite, page 212.

(For Code Words for Transit-Theodolite and Extras and changes see page J, Complete Code at back.)

No. 11 m.**7-inch Complete Transit-Theodolite.****SPECIFICATIONS:—**

No. 11 m Transit-Theodolite as in cut on opposite page.

Horizontal circle 7-inch, single opposite verniers reading to **10'**, one row of figures 0°–360° clock-wise, reading glasses to horizontal circle.

Vertical circle 5-inch, with one double vernier at eye end reading to single minutes, one row of figures from 0°–90°–0°.

Level to vernier frame with reversible tangent screw.

Telescope 12-inch inverting, aperture 1¾-inch, achromatic eye-piece, power 28 dia., telescope reversible over the bearings as well as through the standard frame and provided with reversible clamp and tangent screw.

Striding level at points of contact in wyes.

Stadia wires fixed.

Long compound centers of hard bell-metal.

Shifting center.

Standard frame of aluminum, leather-finish.

Split-leg tripod.

Instrument packs in one box of mahogany.

Made to order only

Weight of instrument about 14 lbs.

“ “ tripod about 13½ lbs.

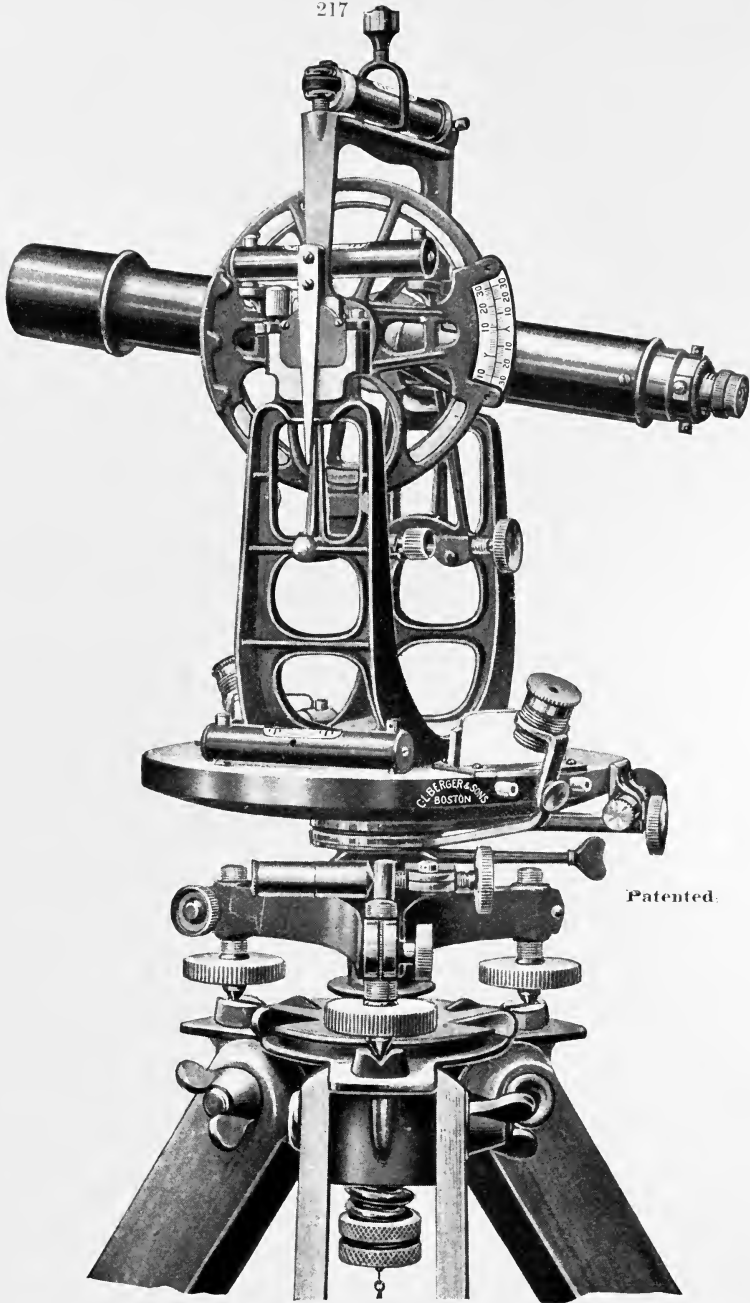
Gross weight packed in 2 boxes ready for shipment, about 60 lbs.

Code word, Mobekey

Price, \$385.00

Extras to Transit-Theodolite No. 11 m.

Steel centers running in sockets of cast iron to insure freest motion with perfect fit	\$20.00
Two double opposite verniers to vertical circle (as in cut page 214, in place of one double vernier only at eye end)	10.00
Two reading glasses to vertical circle	10.00
6-inch spirit level to telescope	15.00



No. 11m.

7-inch Complete Transit-Theodolite.

For use in Cities, Colleges, State and Boundary-Line Surveys.

For Size, Price and Particulars, see preceding page.

No. 11 g.**7-inch Complete Triangulation Transit-Theodolite.****SPECIFICATIONS:—**

No. 11g Transit-Theodolite, as in cut.

Horizontal circle 7-inch, one row of figures 0° to 360° clockwise, single opposite verniers reading to **10''**.

Vertical circle 5-inch, open-form face graduation, glass protected verniers, one row of figures 0° to 360° clockwise, single opposite verniers reading to **30''**.

Level to vernier arm with reversible tangent screw.

Reading glasses to horizontal and vertical circles.

Telescope 12-inch inverting, aperture $1\frac{3}{8}$ inch, power 29 diameters, telescope reversible over the bearings as well as through the standards and provided with reversible clamp and tangent screw.

Spirit level to telescope, 6-inch.

Striding level at points of contact in wyes.

Stadia wires fixed.

Gradiometer.

Shifting center.

Standard frame of aluminum, leather-finish.

Made to order only.

Codeword, Mobello.

Price as above, \$466.00

This instrument with **steel centers** running in sockets of cast iron to insure freest motion with perfect fit **extra 20.00**

Weight of instrument about 16 lbs.

“ “ tripod about 14 lbs.

Gross weight of instrument, complete, packed securely for shipment in 2 boxes, about 60 lbs. .



No. 11 g.

As made by
C. L. Berger & Sons

Patented.

7-inch Complete Transit-Theodolite.

For use in Cities, Triangulation, Tunnels, Colleges and Boundary-Line Surveys.

For size, weight, particulars and extras of this instrument,
see opposite page.

No. 12. 8-inch Transit for Triangulation.

As made by C. L. Berger & Sons.

No. 12. The form of frame chosen for mounting the telescope is similar to that in the cut, which permits the reversal of the telescope through the standards as well as over the bearings. It is of improved design and somewhat resembles that shown on page 219. It is very stiff and very steady in strong winds, and being of aluminum, very light.

The inverting telescope has a clear aperture of $1\frac{1}{2}$ inches, focal length of $13\frac{1}{2}$ inches, power 28 to 32 diameters, reversible clamp and tangent; six-inch vertical arc graduated to read to $30''$ by a double vernier between the legs of the standard frame, figures run from 0° to about 45° each way. The horizontal axis of the telescope is provided with a $4\frac{1}{2}$ -inch striding level resting at points of contact in wyes. The horizontal circle is 8 inches in diameter, single opposite glass-covered verniers reading to $10''$, one row of figures 0° to 360° clockwise, with reading glasses. The radius of the three leveling screw-base is larger than usual, and as the head of the tripod is proportionately larger, the instrument has great stability. It is provided with a shifting center. The Yoke standard frame will be japanned or cloth finished, as we deem it best. In this, as in all our instruments, the fine appearance and general character depends principally on simplicity of design, coupled with fine workmanship, and a high state of efficiency of every part. Other parts that cannot easily be finished and lacquered in the usual — but mostly antiquated — manner, are therefore also treated in japan.

This is in line with good taste and modern thought and improvements, to enable us to unite as many pieces as possible in one to secure great stability and steadiness under all conditions in order to arrive at quick and thoroughly reliable results. Made to order only.

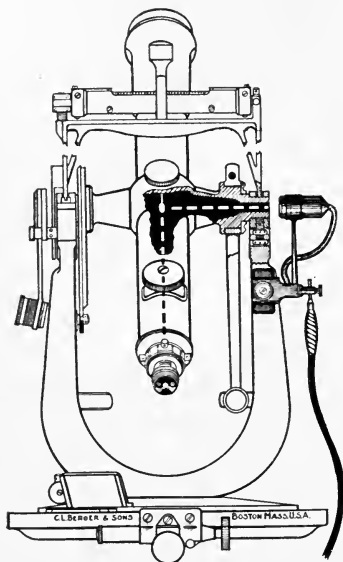
Weight of instrument, $18\frac{1}{2}$ lbs.; weight of tripod, 19 lbs.

Price as above, **\$405.00**

This instrument without arc and clamp to telescope, less **\$35.00**

No. 12a Transit with a six-inch full vertical circle (instead of with arc as shown in cut) vernier frame all open as in style **No. 11b** page 214, single opposite verniers reading to $30''$, one row of figures 0° to 360° clockwise, reading glasses, level to vernier arm
\$443.00

No. 12b Transit with a six-inch vertical circle with protected open-form vernier frame, face-graduation, single opposite verniers glass-covered, as shown in cut page 219, reading to $20''$, one row of figures 0° to 360° clockwise, reading glasses, level to vernier arm,
\$473.00

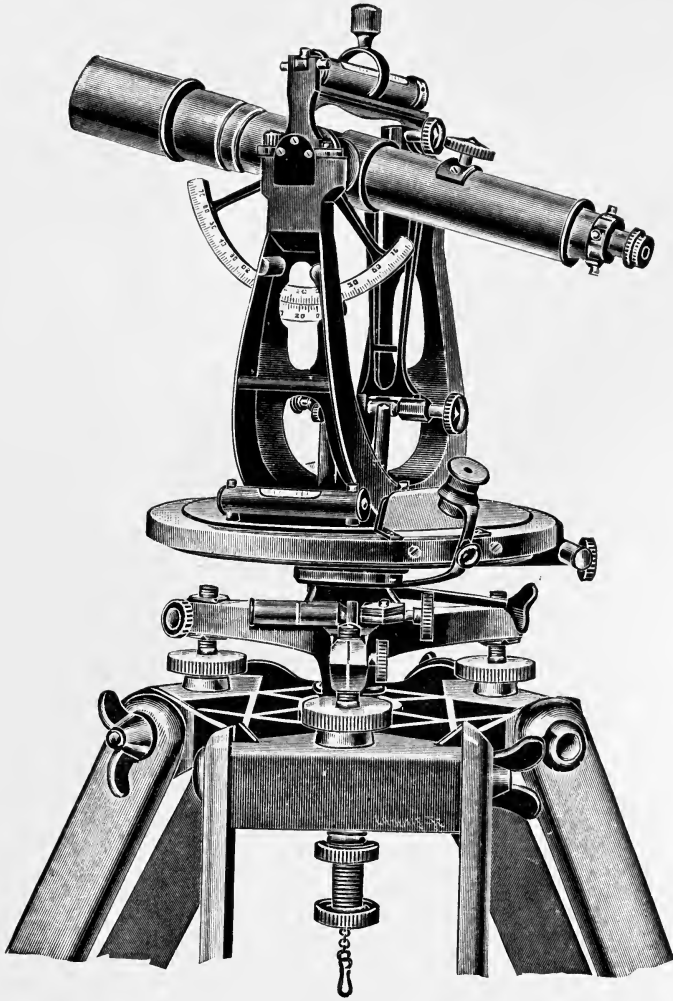


Illumination of Cross Wires by Mirror, Electric Bulb and Dry Battery.

This feature with the battery attached to a tripod leg is very convenient, but is open to the objection that the small mirror* placed as it is in the center of the telescope cuts out the best rays of the object glass and at a point where they already considerably converge toward the eye piece. For this reason the simpler form of attaching a reflector in front of the object glass is generally preferred for the smaller transits.

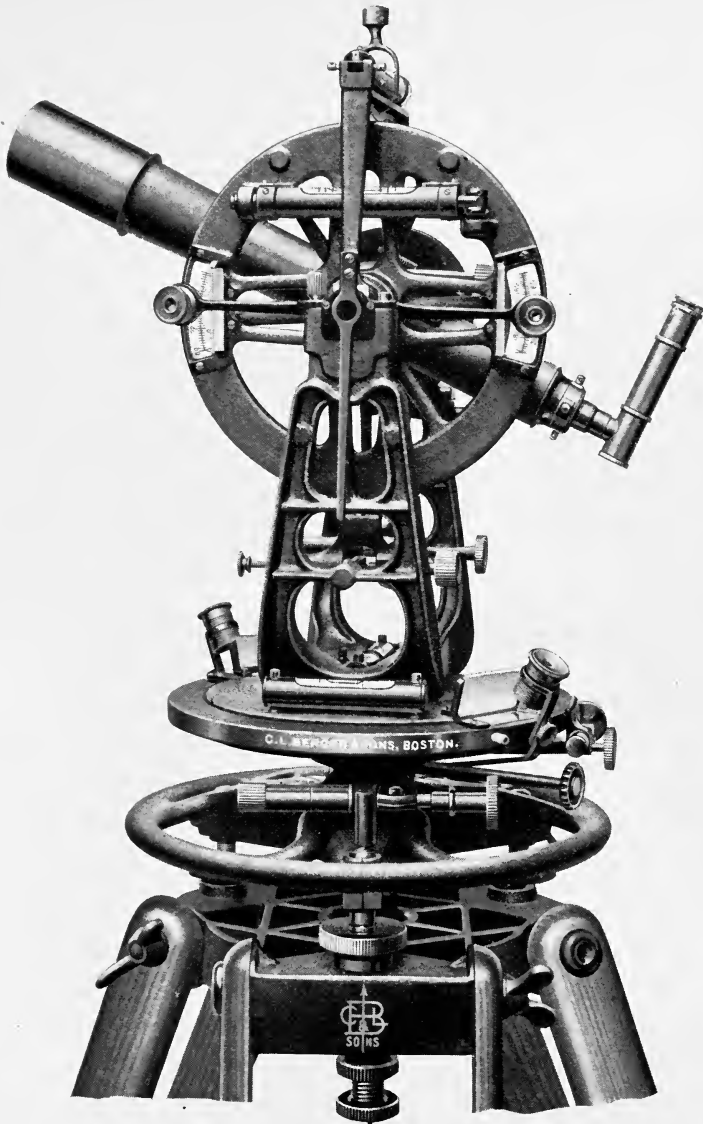
Price, when ordered with Transit Theodolites
No. 12 to No. 15 **\$22.00**

* The mirror can be removed when not needed for illuminating purposes.



No. 12.

8-inch Transit for Triangulation.



No. 15.
8" Alt-Azimuth.

SPECIFICATIONS :

No. 15 Alt-Azimuth, as in cut.

Horizontal circle 8", one row of figures 0 to 360 clockwise, single opposite verniers reading to 5".

Vertical circle 7", open-form face graduation, glass-protected verniers, one row of figures 0 to 90 to 0, double opposite verniers reading to 10", red and black figures.

Level to vernier arm with reversible tangent screw.

Reading glasses to horizontal and vertical circles.

Telescope 12" inverting, aperture 1½", power 30 diameters; telescope reversible over the bearings, as well as through the standards, and provided with reversible clamp and tangent screw.

Striding level at points of contact in wyres, 5" long, 2 seconds of arc for 1 division of 2 millimeters.

Electric axial illumination, with reflector in telescope.

Trunnions, Invar steel.

Diagonal eye-piece, power 39 diameters.

Centers of steel or bell metal.

Wires, 5 vertical time wires, with interval of 10 equatorial seconds; 2 horizontal wires closely spaced.

Ring on leveling piece, to lift instrument.

Tripod, full length, split-leg, **without** shifting center.

Standard frame of brass or aluminum, leather finish.

Made to order only.

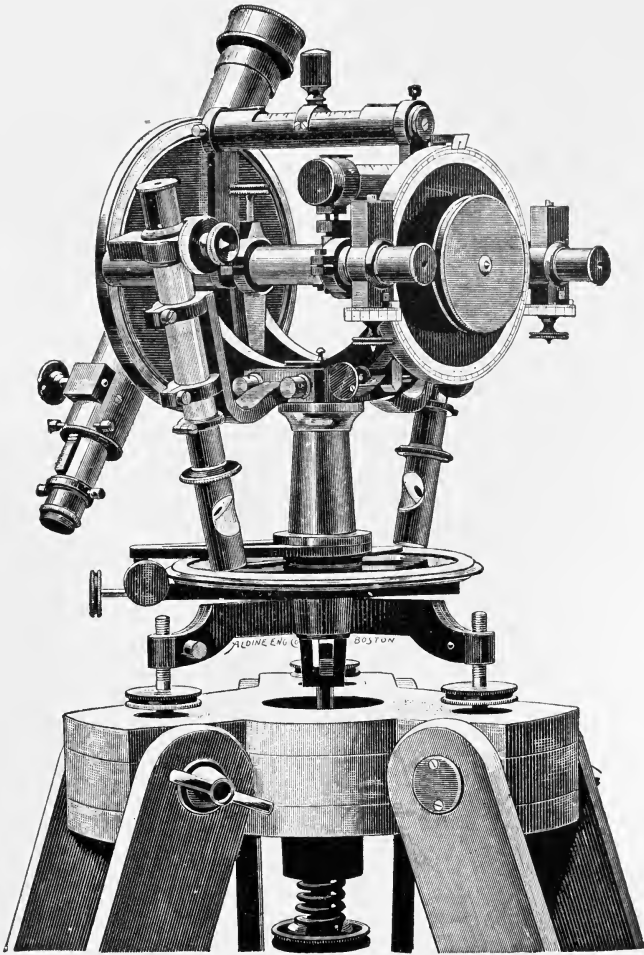
Code word

Price upon application.

Weight of instrument about 27 lbs.

" of tripod about 17½ lbs.

Gross weight of instrument complete, packed securely for shipment in 2 boxes, about 100 lbs.

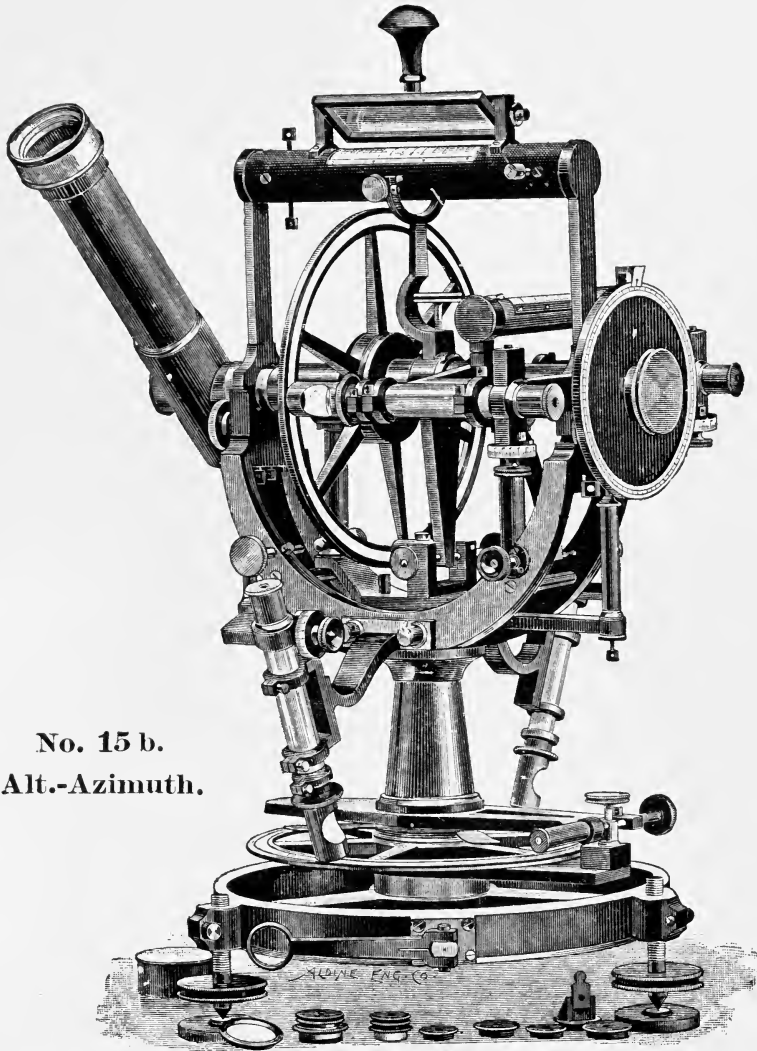


No. 15 a.

Alt.-Azimuth.

Alt.-Azimuth, as in cut. Graduations of $5\frac{1}{2}$ inch circles on solid silver, two opposite micrometer-microscopes for each circle reading to $10''$, and by estimation to $2''$. Both circles can be shifted, so as to bring different parts of the graduation under the micrometer-microscopes. The telescope is 10 inches long, has an aperture of $1\frac{1}{4}$ inch and a power of 24 diameters. Telescope is provided with a level on top and with 3 horizontal wires for leveling and for stadia measurements, and if desired with 5 vertical wires for star observation. The telescope must be reversed in its bearings by hand. Telescope axis is of hardened steel. The striding and microscope levels read to $5''$ of arc. Two ordinary small levels attached to the instrument serve to place it in an approximate horizontal position. Complete in box.

Price, as above, \$580.00



No. 15 b.
Alt.-Azimuth.

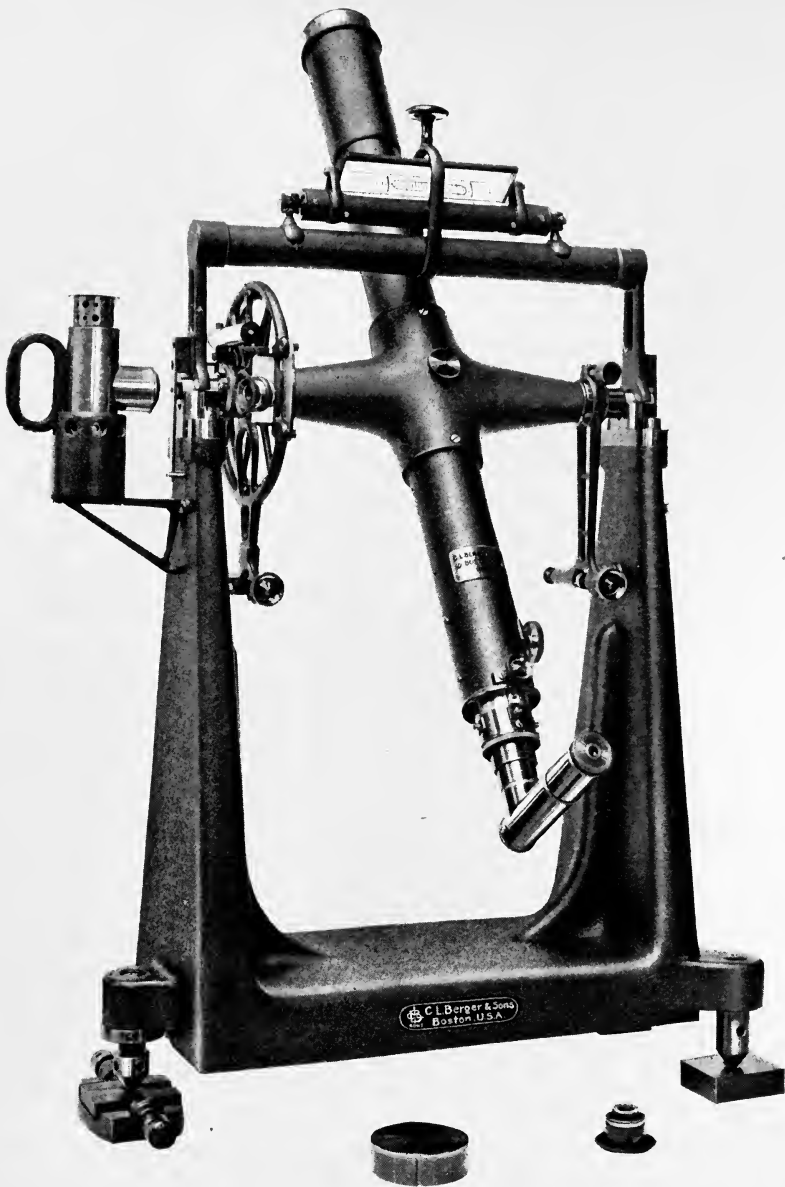
Alt.-Azimuth, as in cut. Circles $8\frac{1}{2}$ inches diameter, micrometer-microscopes reading to 5 seconds direct, and by estimation to single seconds. Telescope, 1.6 in. aperture; focal length, $16\frac{1}{2}$ inches; power, 32 and 48. Telescope axis is of hardened steel and balanced by friction rollers. Reversing apparatus. Complete in one box.

Price, as above, \$920.00

This instrument without reversing apparatus, less, \$100.00

No. 15 c, Alt.-Azimuth, as in cut above. Circles $10\frac{1}{4}$ inches diameter, micrometer-microscopes reading to single seconds direct. Every single degree figured. Telescope, $1\frac{3}{4}$ -inch aperture; focal length, $20\frac{1}{4}$ inches; power, 40 and 60. Telescope axis is of hardened steel and balanced by friction rollers. Complete in two boxes.

Price, as above, \$1300.00



Portable 2" Time Transit Instrument.

As made by C. L. Berger & Sons.

Transit Instrument, as shown, has 2 $\frac{1}{8}$ " clear aperture, by 24.45" focal length, with one Kellner eye-piece power of 33 diameters and one large elbow eye-piece of 30 diameters; there are 5 time wires, spaced 20 seconds of time apart, and 2 closely spaced horizontal wires; a reflector in the center of telescope for illuminating the cross wires, and lard-oil lamp is attachable to either side of standard frame.

The 6" **aluminum vertical circle** is graduated on Sterling silver, has double opposite verniers reading to minutes, with one row of figures from 0 to 180 to 0 for zenith distances; circle reading 0 when telescope points to the zenith; reading glasses are attached, and a control level; it has a reversible clamp and tangent.

The **stride level** has a value of 6 seconds of arc for $\frac{1}{10}$ " run, provided with an adjustable mirror for reading the bubble.

The **standard frame** is provided with two leveling screws and one fixed point, with base plates. In-

strument adjustable in azimuth by opposing capstan screws on one base plate; finished in our handsome leather finish.

The instrument is packed securely in two stout wooden boxes, to withstand long transportation.

Weight of instrument complete, 130 pounds.

Gross weight packed for shipment, 260 pounds.

If instrument is to be used at several stations, and it is desired to pack same to permit of ready transportation from place to place, an extra charge for this special packing will be made.

With rack motion for observing transit or stars.

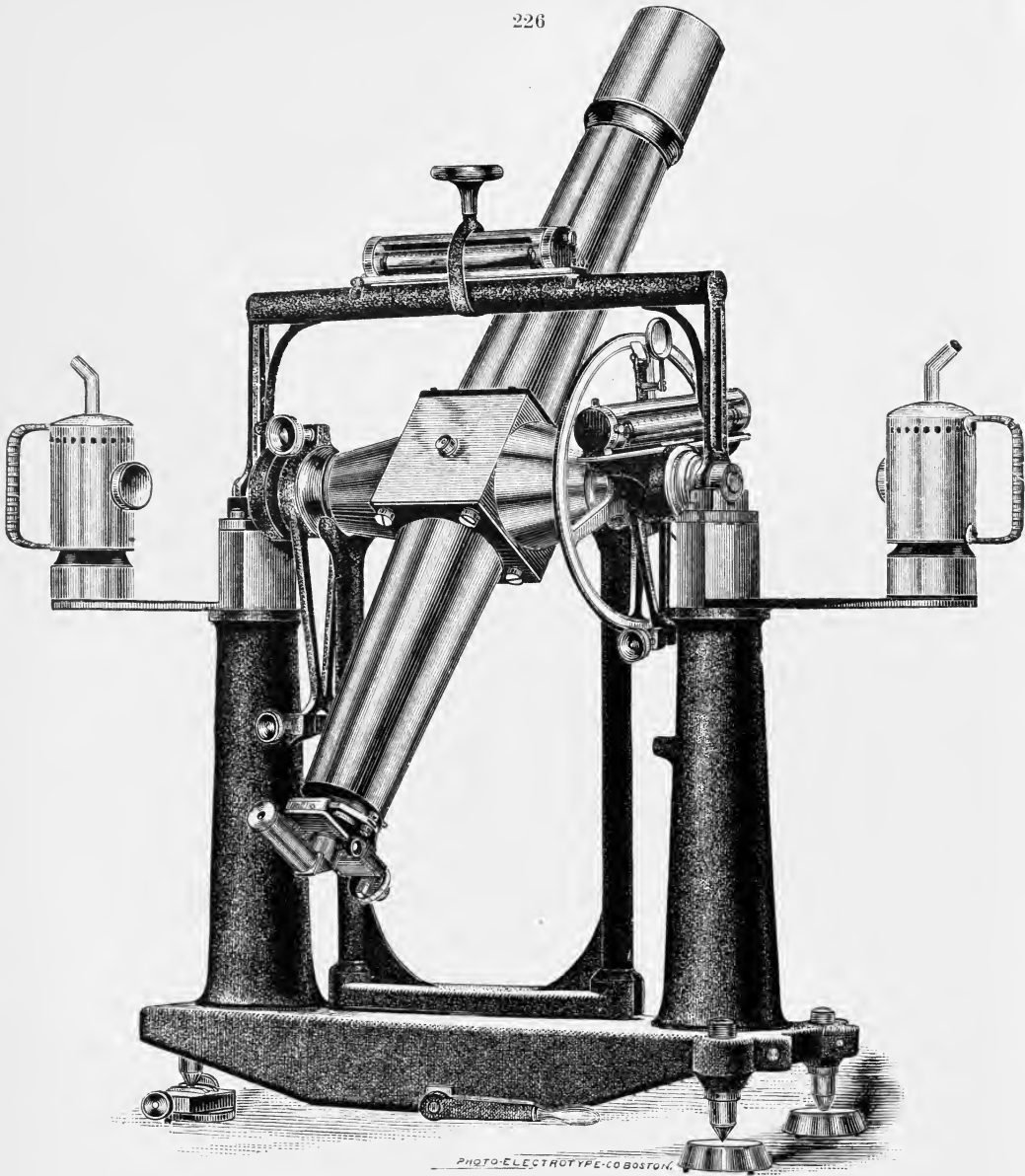
Extra

For **striding level** reading to single seconds of arc

Filar micrometer, reading to single second of arc

Impersonal micrometer **Extra**

Prices upon application.

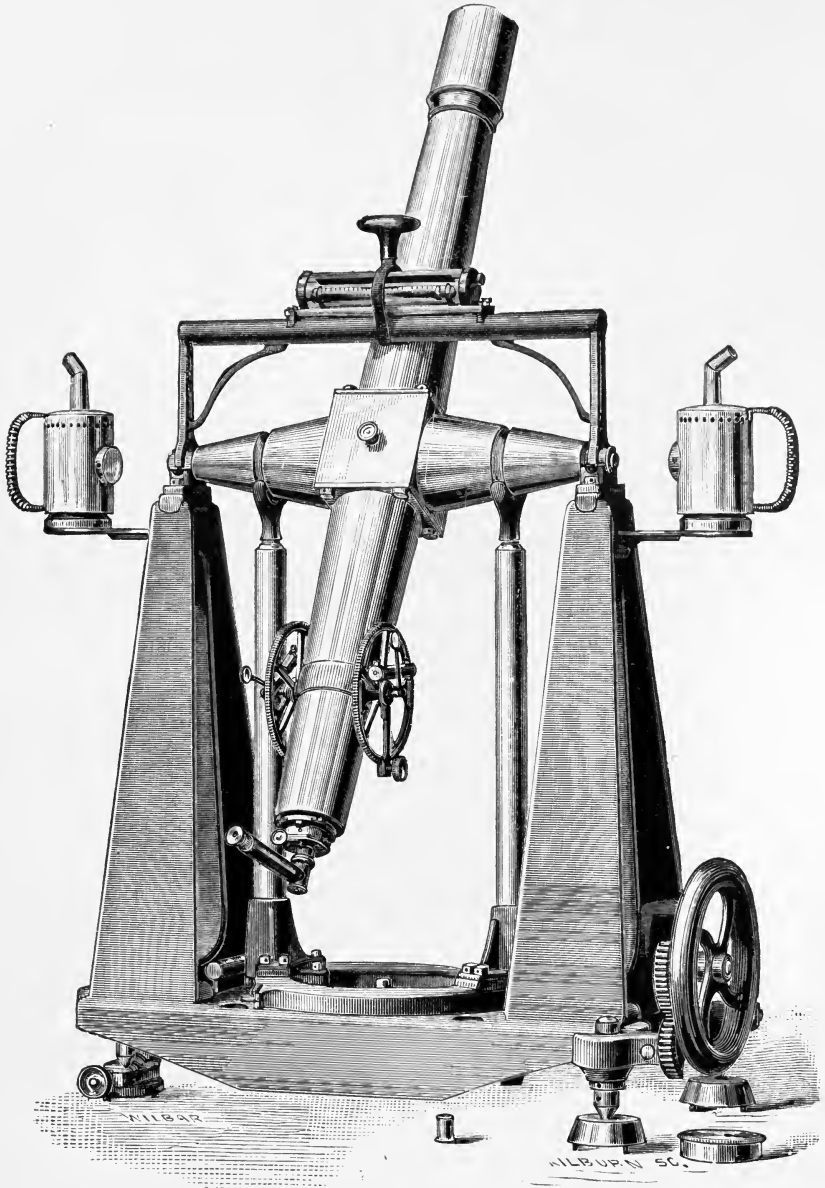


Portable Transit Instrument for Latitude Observations.

As made by C. L. Berger & Sons.

No. 16. Aperture of object-glass 3 in.; focus 28 in.; spider-line or glass micrometer; micrometer screw reads to seconds of arc; spirit-levels read to seconds of arc; diagonal eye-piece 80 dia.; Ramsden eye-piece 40 dia.; vertical circle 8 in. in dia.; bell-metal pivots, two lamps and arms, adjustable reflector; reversing apparatus; two cases, etc.

Price \$980.



Portable Astronomical Transit Instrument.

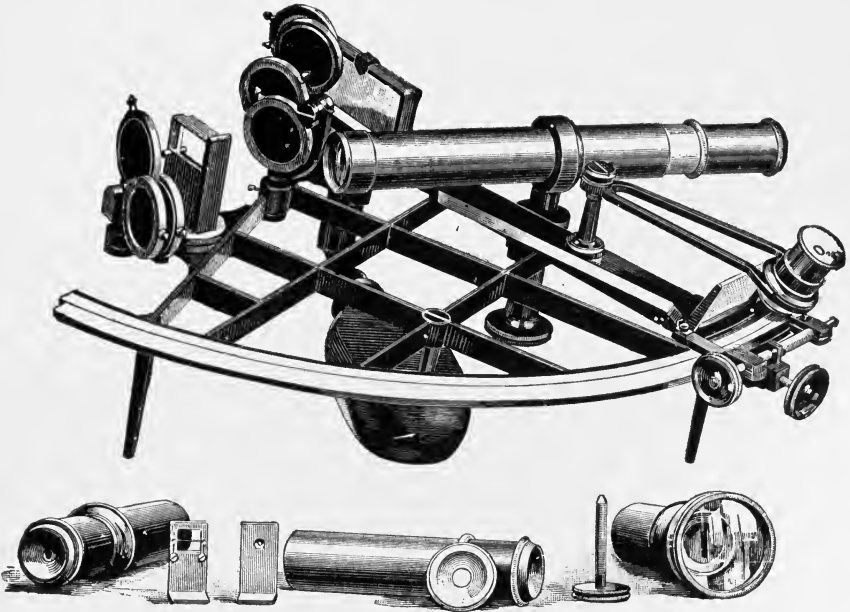
As made for U. S. Lake Survey.

No. 17. Aperture of object-glass 3 in.; focus 39 in.; spider-line or glass micrometer; diagonal eye-piece magnifies from 90 to 120 dia.; Ramsden eye-piece magnifies 75 dia.; striding level reads to seconds of arc; adjustable mirror to read the level from below; reserve level; pivots of hardened steel; small adjustable plane reflector; two lamps and arms; reversing apparatus; two finding circles each provided with double verniers; cast-iron frame rests on three leveling screws of steel, which are provided with foot-plates — one of them is adjustable to set instrument in the meridian; two cases, etc.

Price \$1300.00

(Notice of this Instrument, with full description, in Johnson's New Universal Cyclopaedia, under article "Transit.")

The above instrument provided with an **Impersonal Micrometer, U. S. C. & G. S. Pattern.**
Price on application.



Sextant.

Sextant. Radius, 7 inches, 145°; four sun-glasses between the large and the small reflecting mirror, and three sun-glasses behind the small reflecting mirror, all of which can be turned on their axis 180°; graduation on solid silver, reading to 10". telescope $\frac{3}{4}$ inch aperture; two astronomical eye-pieces with powers of 6 and 10 dia. One Galilean telescope with extra large objective, power 3 dia.; one fixed reading glass; two sights for examination and correction of the large reflecting mirror. All complete in box. Best quality, imported. . . . **Price, as above, \$130.00**
Sextant, as above. Radius 10 inches, all complete in box. . . . **Price, 150.00**
Pocket Sextant, best quality **" 43.00**

Magnetometer, according to design Carnegie Institute, Dept. Terrestrial Magnetism, **Price on application.**

Pendulum Apparatus for determining gravity. U. S. C. & G. S. Pattern. **Price on application.**

Current Meters.

The types of current meters, as shown in Figs. I, II, and III, in our former Catalogues, have been omitted, owing to the many improvements made and embodied in the Meter, as shown in Figs. IV, V, and VI, this Catalogue. We are, however, prepared to make to order Current Meter No. III, as designed by Mr. Clemens Herschel, if so desired.

Current Meter No. IV.

The electric form of meter shown in Fig IV is especially adapted for observations upon large rivers, arms of the sea, etc. It has its registering apparatus above the surface of the water, or on the bank of a river, and current measurements may be made with it at any depth, and may be continued for a week, or longer, without stopping, if desired. Half a dozen or more of these meters may be strung on one and the same vertical rod or wire, and *simultaneous* observations then taken of the velocities at different depths below the surface.

This form was used upon the gauging of the Connecticut River* by General Ellis, and was designed particularly to avoid the catching of floating substances, such as leaves and grass, upon either the vanes or the axis, and to render the record of the instrument independent of the position of its axis with respect to the line of the current, also, to get less friction upon the axis so as to measure low velocities accurately.

This current meter is constructed upon the principle of Robinson's Anemometer, turning by the difference of pressure upon opposite vanes of the wheel. The vanes of this meter, however, instead of being hemispherical cups with a straight stem, are made conical at the ends, and are hollow and taper to the central hub, so as to offer no obstruction to the slipping off of straws, leaves, or grass, as the wheel revolves. The central hub is made tapering, so that any object can slide off easily, and it extends over the joints at the ends of the axis, so as to enclose and protect them from floating substances. The axis runs in iridium bearings. The forward end of the frame which carries the wheel can be turned and secured in any position, so that the wheel can be horizontal, vertical, or at any desired angle.

The electrical connection is made by carrying an insulated wire from near the center of the instrument, where the insulated wire from the battery is attached to it by a binding screw when in use, out to the end of one arm of the wheel frame, where it ends in a fine platinum wire resting upon a ring in the hub of the wheel. This ring is made of alternate interchangeable sections of silver and hard rubber, secured in place by screws, so that their position can be changed to register whole or part revolutions as desired. There is also a socket and set-screw in the body of the frame near the center, for the return current, which can be carried through a plain wire slightly twisted around the insulated wire so as to form one cord. If the instrument is run upon a wire, or has a metallic connection with the surface, the return current can be made through that. A better method now in vogue is to use a "twin" insulated wire.

The universal motion at the center of the frame and the tail are of the usual construction. This meter can be used in connection with any apparatus for registering the revolutions of the wheel by the breaks in the electric circuit.

Price complete, as in Fig IV, with electric register and one battery
etc., packed in three cases, **\$195.00**
Price of this instrument without electric register and battery \$135.00

* For further information on this point, see Gen'l G. K. Warren's Report of Surveys and Examinations of Connecticut River.

We can have this meter, as well as Nos. V and VI, carefully rated at an additional expense of from \$15.00 to \$25.00. Unless ordered otherwise, the instruments will be sent unrated.

Current Meters No. V and No. VI.

This form of Current Meter, invented by Fteley & Stearns,† and illustrated on page 198, is specially adapted for observations upon smaller rivers, streams, conduits, flumes, etc. The 3½ inch wheel has vanes of true standard screw pitch welded to the rim and axle and is perfectly balanced. All edges are sharp to cut the water to avoid eddies. Its axle is provided with points of iridium, so as not to be affected by grit in the water and to run in the bearings with minimum friction. These points, combined with accurate workmanship and good design, insure a permanent and unvarying rating curve.

The instrument is provided with a registering apparatus, the dial wheels of which are completely protected by a glass cover readily removable at will. This counting mechanism is operated by a string, by means of which the dial wheels are thrown in and out of gear. One short pull throws them in and the next pull throws them out; next in, and so on.

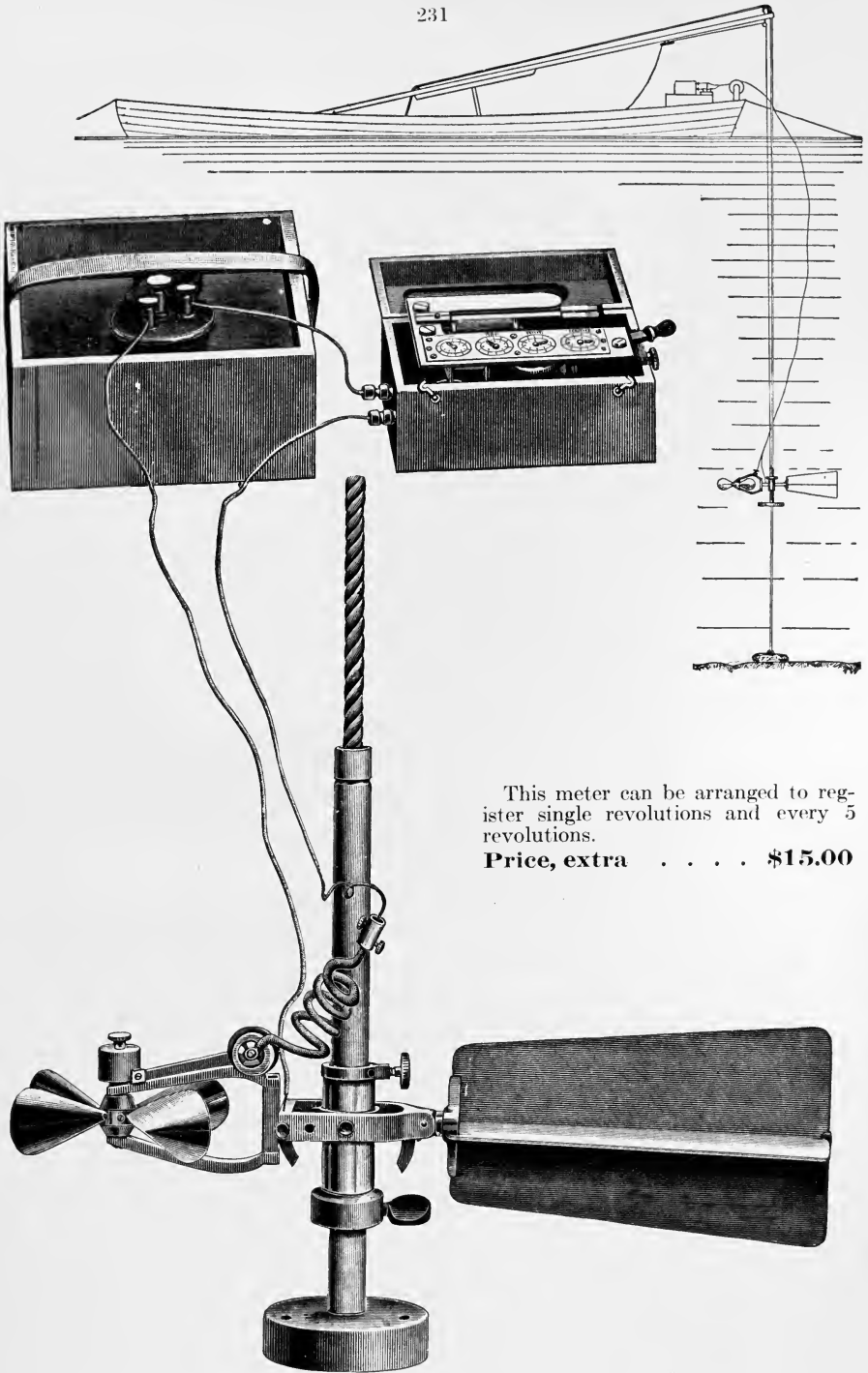
Guards placed over this mechanism and the wheel protect them from injury and floating substances. Those of the wheel are far removed from it to avoid checking the flow of water.

For more extended observations upon rivers, etc., a separate electric register and battery, shown on page 232, can be supplied with this instrument.

Price of Current Meter No. V, supplied only with the ordinary registering apparatus, as shown in the main cut on page 232, and with 12 feet of brass tubing, made in sections of four feet, and graduated in feet and tenths. Complete in two cases, \$135.00

Price of Current Meter No. VI, in all respects similar to that above, but in addition to the ordinary registering apparatus this instrument is provided with an electric register, one battery and copper wire, as shown in the smaller cuts on page 232. Complete in four cases, . . . \$195.00

† For further information on this Current Meter, read "Description of some experiments on the Flow of Water, made during the Construction of Works for Conveying the Water of Sudbury River to Boston," by A. Fteley and F. P. Stearns (Transactions of the Society of Civil Engineers, Jan.-March, 1883). Also, "On the Current Meter, together with a Reason why the Maximum Velocity of Water Flowing in Open Channels is Below the Surface," by F. P. Stearns; a paper read at the Annual Convention of the American Society of Civil Engineers, St. Paul, Minn., June 21, 1883. (Transactions, etc., Vol. XII, August, 1883).

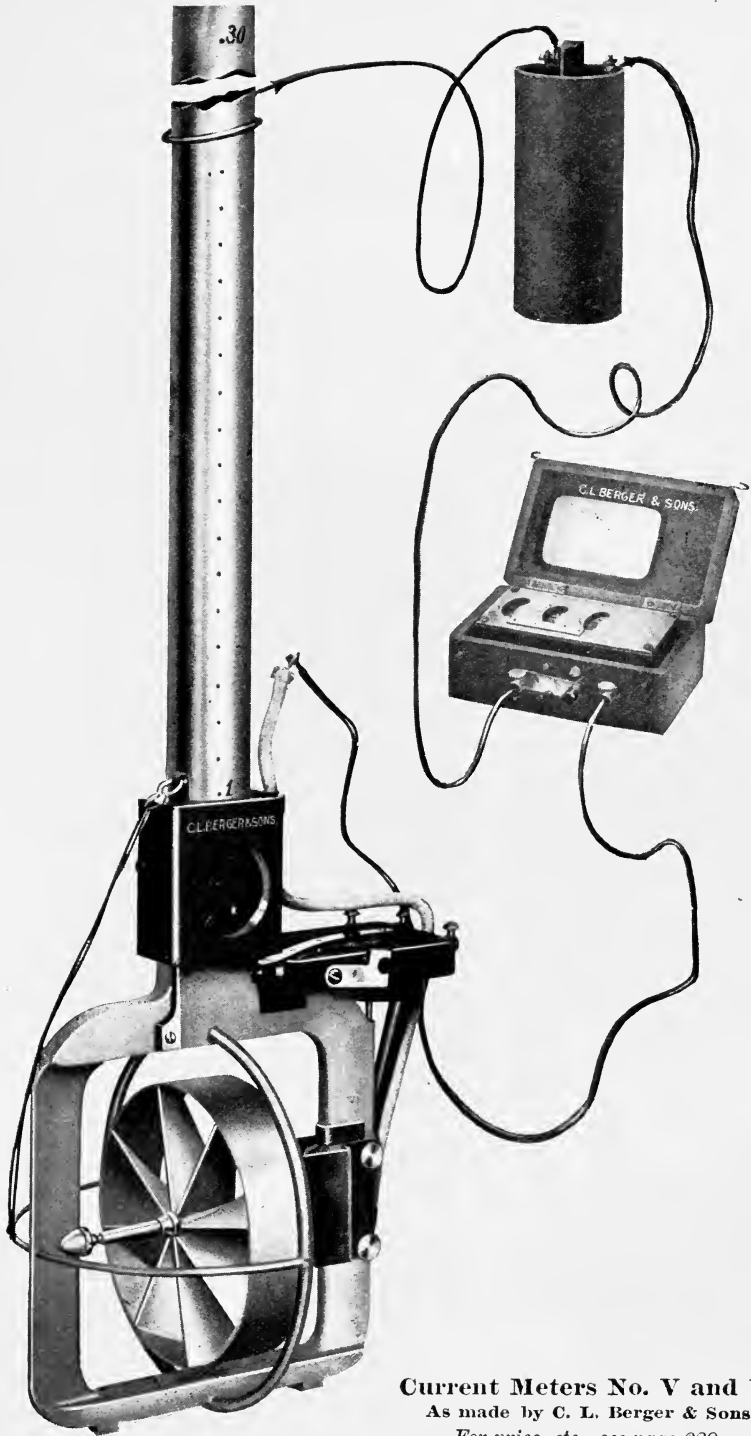


This meter can be arranged to register single revolutions and every 5 revolutions.

Price, extra \$15.00

Current Meter No. IV.

As made by C. L. Berger & Sons.



Current Meters No. V and VI,

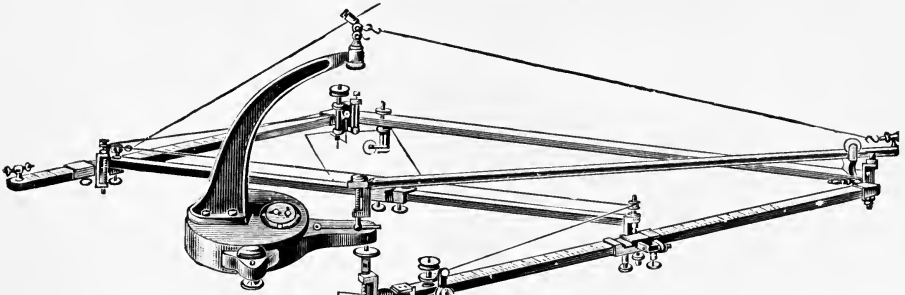
As made by C. L. Berger & Sons.

For price, etc., see page 230.

This No. VI. meter can be arranged to register single revolutions and every 5 revolutions. **Price, extra \$15.00**

For the convenience of our customers we append a list of miscellaneous articles kept in stock, but most of them are not of our manufacture. Those not made by us are of the best quality obtainable, and the prices quoted are identical with those in the market.

Precision Pantographs.



The arms of these Pantographs, to avoid friction on the paper, are suspended from a solid iron support (as will be seen in cut), the latter being supplied with levels and leveling screws. The instrument is very useful for copying.

The brass arms are hollow and square in cross-section, and are divided to millimeters with verniers reading to $\frac{1}{10}$ mm. For the accurate setting of the verniers slow motion screws are provided. All swivel joints turn upon center points. The disengaging mechanism is a special convenience. The ratios from $\frac{3}{4}$ to $\frac{1}{2}$ are set with pole at end, those from $\frac{3}{2}$ to $\frac{1}{3}$ are set in the middle. The pole and pencil-holder are therefore interchangeable.

No. 99. **Suspended Pantograph**, arms about 24 inches long, in wooden case.

Price, as above, **\$150.00.**

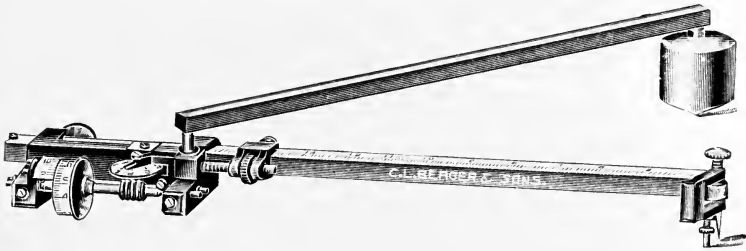
No. 100. **Suspended Pantograph**, arms about 38 inches long, in wooden case.

Price, as above **\$180.00.**

NOTE. — The Pantograph with 24-inch arms when set at $\frac{1}{2}$ can circumscribe a 19-inch square, or an oblong $15\frac{1}{2} \times 24$ inches, approximately.

The Pantograph with 38-inch arms can circumscribe a 31-inch square, or an oblong $27\frac{1}{2} \times 39$ inches, approximately.

Compensation Planimeter.



The compensation Planimeter illustrated above consists of two parts, which pack separately in the case, the tracing frame and the pole arm. The tracing frame rests on 3 points, the measuring wheel, the tracer point and the roller. A finely polished steel ball, fixed at one end of the pole arm, rests in an opening of the tracer arm, forming a ball and socket joint. This joint forms the axis of rotation of the tracer arm, which by means of the pole arm moves on a circle as guide line; at the same time it enables the tracing frame always to rest with its three points on the plan. The length of tracer arm is about 9 1-2 inches and pole arm 7 1-2 inches.

The pole consists of a brass cylinder attached at one end of the pole arm. Its lower surface forms an edge at right angles to the pole arm, which by the rocking motion provided by this edge can be lowered until its other end, which carries the ball, is firmly secured in the socket. In the center of this brass cylinder a small steel pin is inserted and kept in place by a set screw. This pin terminates at both ends in a finely hardened point, one of which projects slightly under the lower edge of the cylinder. The tracer arm is provided with a vernier and micrometer screw by which it can be placed at any division mark on the tracer arm, which is graduated throughout in 1-2 mm. The axle of the measuring wheel, ending in finely made pivots, is of the best hardened steel working in cylindrical steel point bearings. With the Planimeter is supplied a proving bar, which enables by its graduations to describe several circles of known radii.

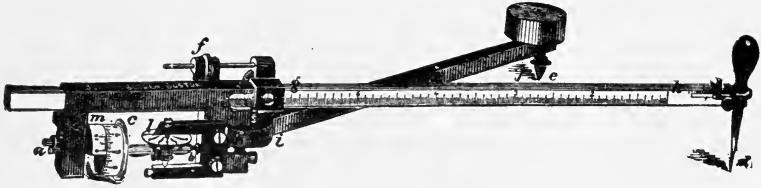
In using, place the Planimeter approximately in the center of the area to be measured, so that the plane of the measuring wheel, if extended, passes through the pole. After obtaining the measurement by using the Planimeter with the pole arm on one side of the tracer arm, the pole arm may be placed on the other side and another measurement made. The mean of these two readings will eliminate any error of the measuring wheel, thus this form of instrument is a compensation Planimeter.

If the area to be measured is too large for the scope of the instrument it should be subdivided into smaller areas. According to the importance of results to be obtained, one measurement may be sufficient around the plan, but when very accurate results are desired it will be good practice to make 2 or 3 consecutive measurements with the pole arm on one side of the tracer arm and afterward the same number of consecutive readings with the pole arm on the other side of tracer arm, and by taking the mean of the averages of readings obtained, very close results will be obtained.

The **Compensation Planimeter** is made of German silver and bronzed brass. The tracer arm is adjustable and graduated to the end, pole weight of improved pattern. Instrument complete in velvet-lined case, with table of constants for U. S. standard measure, adapting it to any scale.

No. 107. Price complete as above **30.00**
 No. 108. " " " " when specially rated **34.00**

Plain Polar Planimeter.



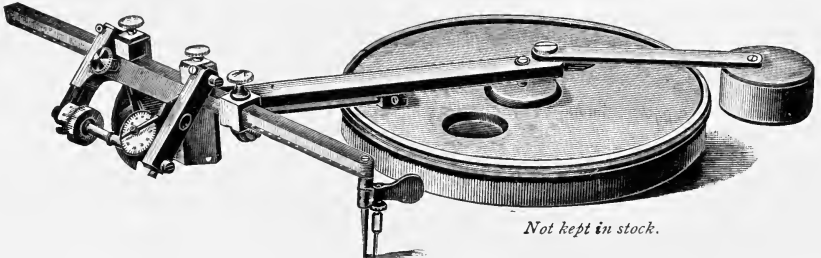
This **Planimeter** is of German silver, with adjustable tracer arm fully graduated, about 9 inches long, in polished mahogany box with proving bar.

Price of instrument when rated	\$31.00
" " " not rated but with all the improvements	27.00

Precision Planimeters.

These Planimeters are very much more accurate than the ordinary Polar Planimeters. The graduated rollers do not touch the paper at all, but roll, instead, on a hard, highly polished surface of steel, thus eliminating all errors due to the irregularities of the paper surface.

No. 109. Large Suspended Ball Planimeter.



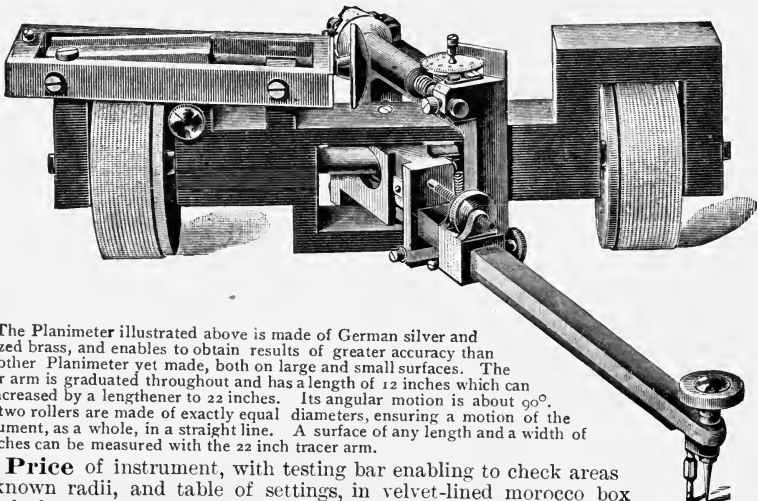
Not kept in stock.

This instrument is capable of doing very accurate work. The tracer arm is 11½ inches long, the pole arm is 6¼ inches long, and the diameter of the toothed circle on the pole is 6¼ inches. The angular motion of the tracer arm is about 90°.

Surfaces from 2½ x 4 inches to 7 x 10 inches can be measured without moving the pole.

Price of instrument complete packed in morocco box	\$75.00
---	----------------

No. 110. Large Rolling Ball Planimeter.

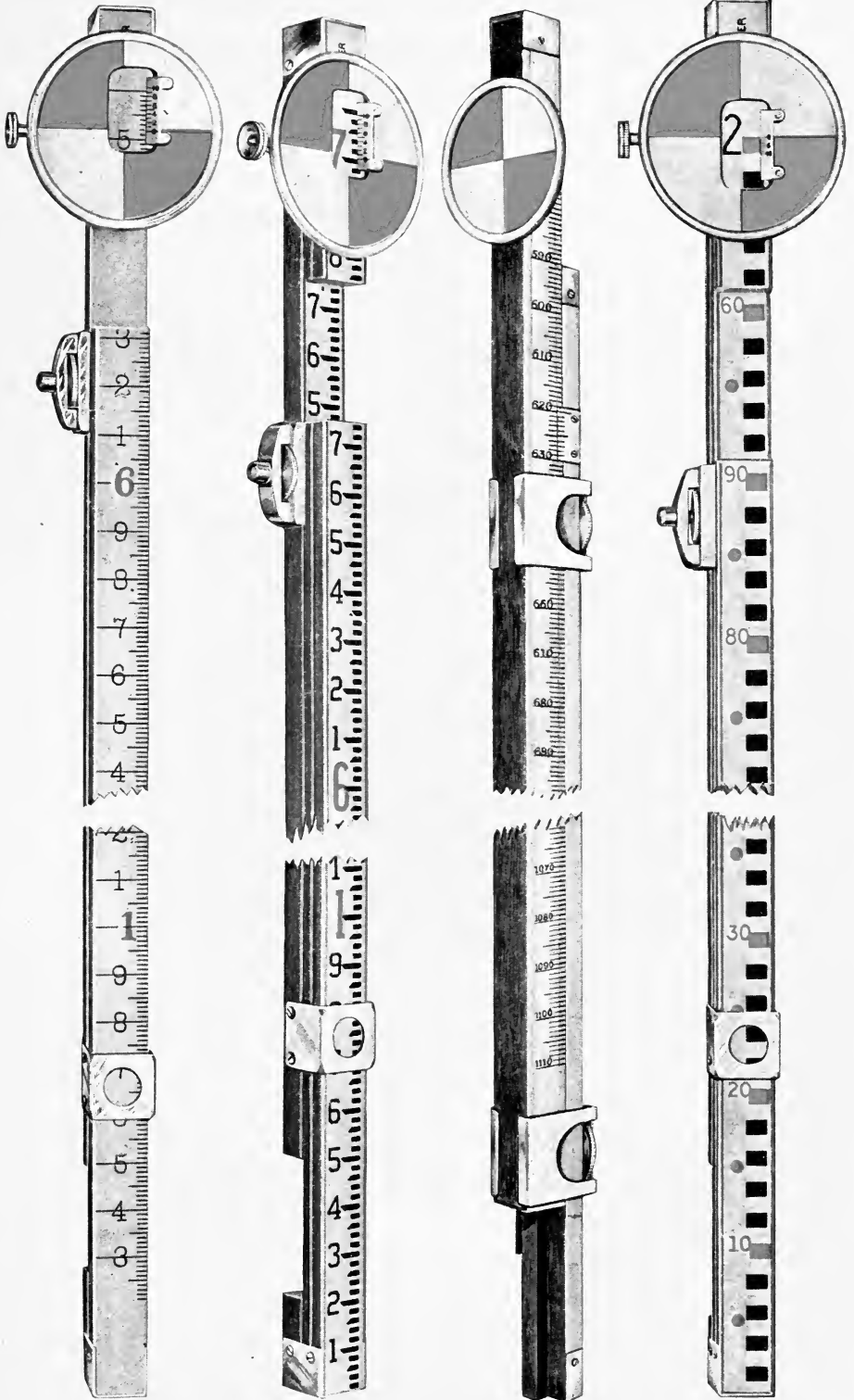


The **Planimeter** illustrated above is made of German silver and bronzed brass, and enables to obtain results of greater accuracy than any other **Planimeter** yet made, both on large and small surfaces. The tracer arm is graduated throughout and has a length of 12 inches which can be increased by a lengthener to 22 inches. Its angular motion is about 90°. The two rollers are made of exactly equal diameters, ensuring a motion of the instrument, as a whole, in a straight line. A surface of any length and a width of 20 inches can be measured with the 22 inch tracer arm.

Price of instrument, with testing bar enabling to check areas of known radii, and table of settings, in velvet-lined morocco box with lock

\$90.00

Leveling Rods



No. 145

No. 146

No. 147

No. 150

Leveling Rods

The leveling rods illustrated are of best make and are always carried in stock.

No. 145. New York Rod. $6\frac{8}{10}$ ft. extending to 12 ft., reading by vernier to 1000ths of a foot, with improved mountings . . . **\$14.00**

No. 145a. Extra Target for N. Y. Rod for use with gradienter or stadia measurements . . . **5.00**

No. 146. Philadelphia Rod, self reading, $7\frac{3}{10}$ ft. extending to 13 ft., reading by vernier to 1000ths of a foot. **14.00**

No. 146a. Extra Target for Philadelphia Rod . . . **5.00**

No. 147. Boston Rod. 6 ft. extending to 11 ft., reading by vernier to 1000ths of a foot . . . **14.00**

No. 148. Mining Rod. Philadelphia pattern like No. 146, 5 ft. **12.00**

No. 148a. Mining Rod. Philadelphia pattern like No. 146, $3\frac{1}{2}$ ft. **12.00**

No. 148b. Mining Rod. N. Y. pattern like No. 145, 5 ft. **12.00**

No. 148c. Mining Rod. N. Y. Pattern like No. 146, $3\frac{1}{2}$ ft. **12.00**

No. 149. Flexible Self-reading Level Rod. 10 ft. long, 3 inches wide. This rod is graduated on canvas and can be rolled up. When used it is fastened upon a board with thumb-tacks . . . **3.25**

No. 150. Metric Level Rod. Philadelphia pattern, 2 meters to 3.7 meters . . . **14.00**

No. 151. Metric Level Rod. N. Y. pattern, 2 meters to 3.7 meters **14.00**

No. 151a. Rod Level for plumbing rod **3.00**

Ranging Poles

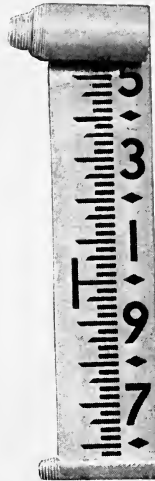
Painted red and white alternately each foot.

No. 152. Range Pole. Solid steel octagon, 6 ft., $\frac{1}{2}$ inch dia. **3.00**

No. 153. Range Pole, iron tube round, 6 ft., $\frac{7}{8}$ inch dia **2.75**

No. 154. Range Pole of wood, 8 ft., steel shoe **2.25**

No. 155. Range Pole, like No. 154 but 10 ft. **2.50**



No. 149

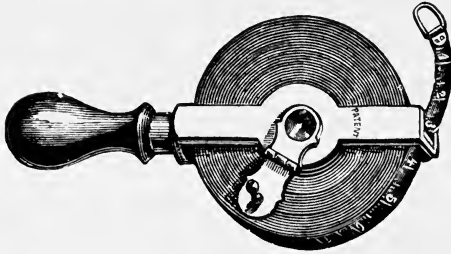
Ranging Poles



Rods

Steel Tape Measures.

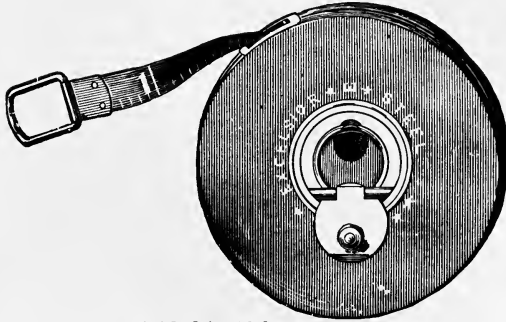
½ inch wide. Patent Brass Frame with Handle.



No. 170.	100 feet Steel Tape, divided in 10ths,	\$11.50
" 171.	50 " " " " " " " " " " " "	6.60

Steel Tape Measures.

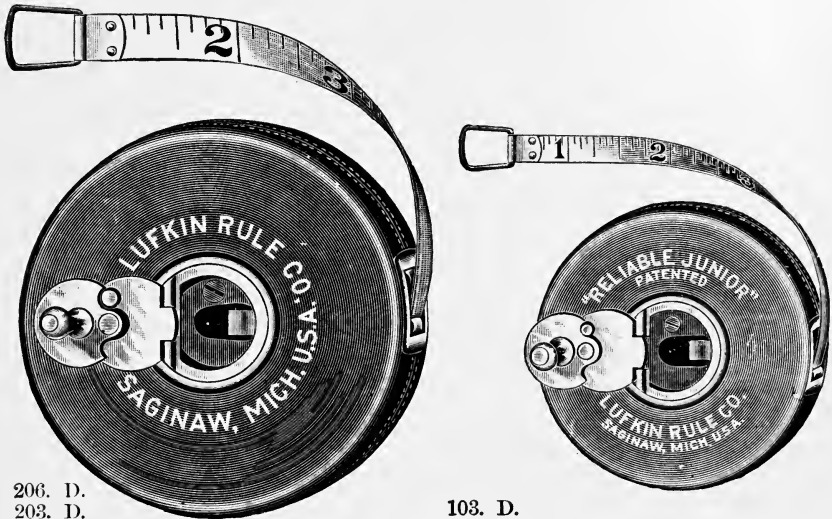
½ inch wide. In Leather Boxes.



No. 172.	100 feet Steel Tape, divided in 10ths,	\$11.50
" 173.	66 " " " " " " " " " " " "	8.00
" 174.	50 " " " " " " " " " " " "	6.50

Lufkin Steel Tape Measures.

¾ inch wide. In leather case.



206. D.							
203. D.							
No. 206. D.	100 feet Lufkin Steel Tape, divided in 10ths,	\$11.00					
No. 203. D.	50 " " " " " " " " " " " "	6.00					
No. 103. D.	50 " " " " " " " " " " " "		¼ inch wide; 2¼				
	inch dia.; 5 oz. in weight; can be carried in vest pocket .						4.00

Tapes

Chains.



- No. 195. Surveyors' Chain, 2 poles, 50 links, No. 12 best steel wire, brazed links and rings, \$5.50
- " 196. Surveyors' Chain, 4 poles, 100 links, No. 12 best steel wire, brazed links and rings, 9.00
- " 197. Engineers' Chain, 50 feet, 50 links, No. 12 best steel wire, brazed links and rings, 6.00
- " 198. Engineers' Chain, 100 feet, 100 links, No. 12 best steel wire, brazed links and rings, 10.00

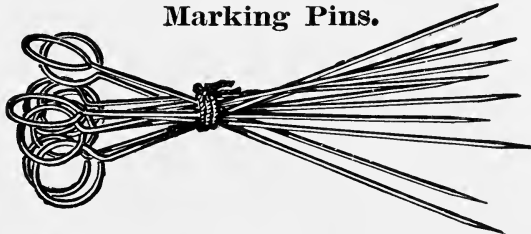
Metric Chains.

- No. 199. 20 Meter Chain, 100 links, No. 12 best steel wire, brazed links and rings, 10.00
- " 200. 10 " " 50 " " " " " " " " " " 5.50

Extras to Tapes and Chains.

- No. 201. Pocket Thermometer, \$1.50
- " 202. Spring Balance and Level, 5.00

Marking Pins.



- No. 203. Set of Marking Pins, eleven in a set, steel wire, No. 6, . . . \$1.50

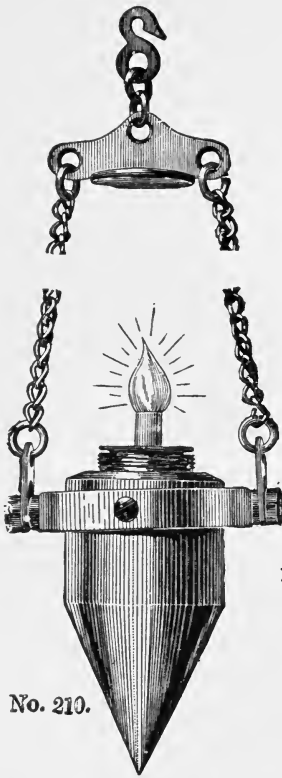
Odometer.

- No. 204. An instrument for measuring distances traveled by carriage, . . . \$15.00

Pedometer.

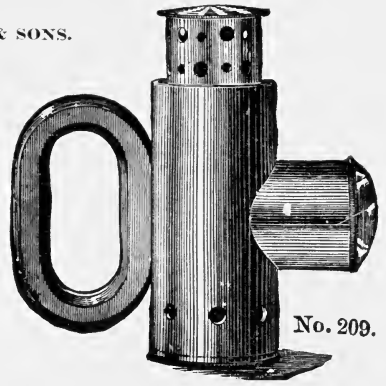
- No. 205. An instrument for measuring distances walked, in german silver case, of the size of a watch, . . . \$5.00

C. L. BERGER & SONS.



No. 210.

Plummet Lamp.



No. 209.

Lamp for Illuminating Cross Wires.

- No. 209. Lamp for illuminating cross wires through the axis of the telescope when mounted at the side, for use in underground work, of brass and nickel-plated, with ground lens, . \$7.00
- “ 210. Small Plummet Lamp, of brass, steel point, 16 oz., . 8.00
- “ 211. Large Plummet Lamp, of brass, steel point, 24 oz., . 10.00
- Box with shoulder straps, for pair of Plummet Lamps, . 3.00



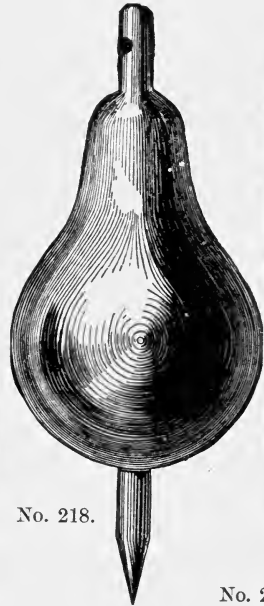
No. 212.



No. 214.



No. 216.



No. 218.

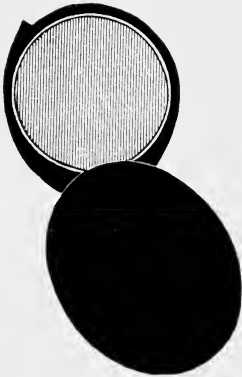


No. 220.

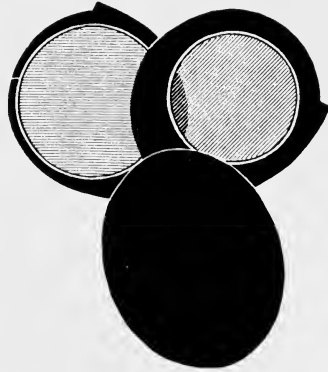
Plumb Bobs of Precision.

No. 212.	Plumb Bob of Brass, steel point, shape as in cut, 8 oz.,	\$1.75
“ 213.	“ “ “ “ “ No. 212, 11 oz.,	2.00
“ 214.	“ “ “ “ “ in cut, 6 oz.,	1.75
“ 215.	“ “ “ “ “ No. 214, 9 oz.,	2.00
“ 216.	“ “ “ “ patent reel adjustment, 8 oz.,	1.75
“ 217.	“ “ “ “ “ 12 oz.,	2.25
“ 218.	“ “ “ “ with steel shank passing through the body for shaft work, 3 lb.,	6.00
“ 219.	“ “ “ “ “ “ “ “ “ 4 lb.,	7.50
“ 220.	Mercury Plumb Bob (body of steel) 12 oz., 5 3/8 inches long 7/8 inch diameter	2.25
	“ “ “ “ “ 16 oz., 6 “ “ “ 1 “ “ “	2.75

Pocket Magnifiers.



No. 221.



No. 224.

No. 221.	Zylonite Case, as in cut,	size of lens 1 inch diameter,	\$0.60
" 222.	" " " " 221,	" " " 1¼ " " " " " " " " " " " "90
" 223.	" " " " 221,	" " " 1½ " " " " " " " " " " " "	1.15
" 224.	" " " " cut	" of lenses, 1½ and 1¼ in diameter,	1.30

Gossamer, Cravenette and Silk Bags.

No. 225.	Gossamer or Waterproof Bag, to cover Level in case of rain or dust,	\$1.00
" 226.	Silk Bag, to cover Transit with solid silver graduations	1.00
" 226a.	Cravenette Bag to cover Transit,	1.00

Lubricants.

No. 227.	Bottle of Fine Watch Oil, for lubricating Transit Centers, etc.	\$0.35
----------	---	--------

Utensils for Cleaning Instruments.

No. 228.	Camel's Hair Brush	\$0.40
" 229.	Stiff Brush for cleaning screw-threads40
" 230.	Chamois-skin for cleaning lenses, centers, etc.50
" 231.	Stick for cleaning centers30

Spirit Levels.

No. 232.	Engineers' Spirit Levels of all sizes and grades of sensitiveness, accurately ground and tested by us.	
Per inch,	according to length and diameter	from \$0.80 to \$1.00



Surveyor's Umbrella

Large, well-made umbrella designed as a protection from sun's rays and wind, during field work. Staff provided with a side socket and shoe. Umbrella has rings to which guy lines may be attached.

Code word, **Tycum**

Price \$6.00

Portable Anemometers.

These instruments are extensively used in studying and controlling the ventilation of dwellings, public buildings, factories, mines, etc.

The velocity of the air current is measured by means of a very light fan wheel, whose revolutions are recorded on a dial.

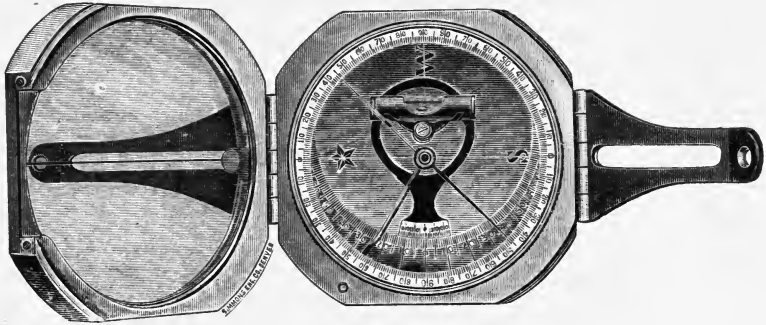
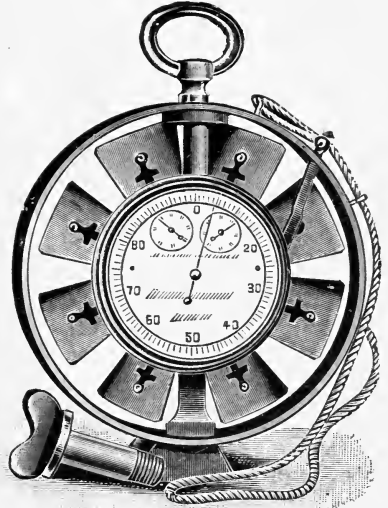
This fan wheel is very delicate, the vanes being made of aluminum, and the axis of hard steel runs in jewel bearings.

The counting mechanism is enclosed in a dust-proof case, and can readily be thrown into or out of action by a disconnecting lever.

The instrument is provided with a thumb-screw for attaching it to a rod for use in measuring the velocity of air currents at any point on the surface of the earth, mine shafts, in pipes, conduits or narrow channels. In this case the counting mechanism is thrown in or out of gear by pulling on cords of different colors.

This Anemometer is carefully rated and supplied with a CORRECTION NUMBER.

Anemometer, Counting up to 10,000,000 ft. ; diameter of fan, 6 in. ; complete, packed in polished wooden box, **\$30.00.**



The Brunton Patent Pocket Mine Transit.

A pocket instrument which takes the place of a sighting compass, clinometer, prismatic compass, and an Abney level or Locke's level. Weight 8 ounces. Price, **\$20.00**

Brunton Mine Transit with leather sling case,

22.25

ode Words,
winleaf.

vilum.

PRICES SUBJECT TO CHANGE
WITHOUT NOTICE

Leveling Head:

*Leveling screw with ball and socket cup attached (See Note A)	@ 1.80	.04	Capal
Cup only for leveling screw	.25	.01	Caddy
Foot plate on which instrument is mounted	4.50	.30	Calm
Spiral Spring for tangent motion	.20	.01	Callid
Spring bolt or plunger	.25	.01	Canal
Screw cap at end of spring box case	.25	.01	Capar
Hook and chain for plumb bob suspension	.10	.01	Calmy

Horizontal Circle and Vernier Plate:

Clamp screw	1.20	.02	Dace
*Tangent screw (see Note A)	1.00	.02	Dais
*Vernier glass , of plano-parallel crystal glass. (See Note E)	1.00	.03	Dater
Ground glass shade for vernier	.60	.03	Delve
Shade frame for ground glass shade (See Note E)	1.20	.02	Dlvan
Spiral spring	.20	.01	Depth
Spring bolt or plunger	.25	.01	Digit
Screw cap to hold spring in case	.25	.01	Ditch

Compass:

Needle , (See Note F) and pivot (must be fitted to the instrument)	5.00		Domal
Pivot	.50		Donzel
Glass cover , (plano-parallel crystal glass)	1.00	.14	Eldam

Telescope's Cross Axis:

Clamp screw (See Note G)	1.00	.03	Fadge
Spiral spring	.20	.01	Fagot
Spring bolt	.25	.01	Fancy
Screw cap for spring case	.25	.01	Faint
Acorns (protecting ends of cross axis)	@ .50	.02	Felon

Vertical Circle:

Screws for guard	@ .25	.01	Gnarl
-------------------------	-------	-----	--------------

Telescope:

(We cannot supply new object glasses and eye-pieces without having the instrument, or at least the telescope. See Note H.)

Cross and stadia wires (see Note I.)			
Cap for object glass for sizes No. 1 and 2 Transit, (1 $\frac{1}{8}$ " to 1 $\frac{1}{2}$ " dia.)	1.00	.02	Haify
" " " " No. 4 Transit (1 $\frac{1}{8}$ " and less dia.)	.80	.02	Halse
" " eye-piece erecting	1.20	.02	Harsh
" " " " inverting	1.00	.02	Helix
Sunshade , for transits of our regular size and kinds give diameter where it is to fit	.75 and 1.00	.04	Hoist

Spirit Levels:

Plate level , finely ground and graduated	\$1.50	.05	Ibex
Mounted in its tube when latter is sent us including registration	1.95		Ichor
Standard level finely ground and graduated	1.50	.05	Ideal
Mounted in its tube when latter is sent us including registration	1.95		Ides
Telescope level finely ground and graduated	3.50	.05	Image
Mounted in its tube when latter is sent us including registration	4.00		Imban
Adjusting nut	.20	.01	Incog

NEW PARTS FOR WYE AND DUMPY LEVELS.

For illustration see page 60.

For prices of other parts not given here see above list of **New Parts for Transits.**

Hood of gossamer rubber, give length of telescope over all	1.00	.05	Jadea
Stirrup locking pin	.70	.01	Jamb
Center nut at bottom of spindle	.35	.01	Javel
Spirit level , finely ground and graduated, \$4.50		.25†	Jetty
Mounted in its tube when latter is sent us. 5.00			

NOTES TO THE PRECEDING LIST OF ARTICLES SUPPLIED BY MAIL.

NOTE A. Concerning Tangent and Leveling Screws.

Tangent and leveling screws can only be made to fit as nearly as possible without having the instrument in our shop. Both kinds are micrometer screws, made with great care and fitted to the particular instrument, and, therefore, are not interchangeable. When possible the tangent piece or bracket, or in the case of a leveling screw the whole leveling head should be sent us, so that we can fit it properly.

If for instance the tangent screw sent you in the absence of the tangent piece or bracket should fit too tightly and you have nobody to fit it, then if you can wait, unscrew the tangent piece and send it to us by registered mail. Make sure to replace each small screw into its screw hole in the plate. If the screws are transposed they may project through, touching the circle and injuring it.

If you have an instrument repairer in your vicinity, he can fit the screw by working it in and out in its nut with a little tallow until it works freely, then in the temperate or frigid zone the tallow must be removed from the screw and female thread by using a little benzine on a rag wrapped around a stick. When free from tallow a little watch oil or vaseline should be applied as a lubricant. A jeweler or optician should be able to do this.

Under no circumstances should any emery be used on one of these screws, as this would spoil it for ever. If not successful the entire tangent piece and the screw should be sent us by registered mail, as already mentioned.

NOTE B. Tripod head.

When a new tripod head is required for an instrument having four leveling screws on account of its being bent, or the screw threads worn too loose, then generally a new lower foot-plate to leveling head (see list above) and a new packing piece to screw instrument to the slide board in box will be needed also.

NOTE C. Tripod bolts, nuts, washers, clamps and shoes.

Send us an outline sketch on paper obtained by running a sharp pointed pencil closely around the article desired.

NOTE D. Tripod legs.

As the extension tripod legs and clamps vary in size and have been changed in style from those formerly supplied, it will be necessary to denote the size by sending the outline obtained as in Note C.

NOTE E. Glass shades, vernier glasses and shade frame.

Send the broken pieces or an outline sketch as described in Note C. If the vernier glasses, etc., sent are too large a local optician may grind them to size. If too loose the frame should be narrowed at the top.

NOTE F. Magnetic needle.

When a new needle seems to be required on account of loss of magnetism, the trouble is usually that the **point of the pivot is dull and then needs to be carefully sharpened to a fine point or that the jewel cap may have become rough or rusty and needs to be polished.**—A very little magnetism is required to make the needle work satisfactorily when the pivot point is sharp and the cap well polished. —To preserve the sharpness of the pivot it is necessary to use great care in lowering the needle onto the center point, since it may be dulled the first time it is used if the needle is dropped carelessly upon its pivot.

NOTE G. Clamp screws to the telescope's axis.

Only an ordinary regular telescope clamp screw can be supplied. All transits provided with a striding level or a solar attachment require a clamp screw especially made with head of smaller diameter to enable the passage of these features around the head of the clamp screw when the telescope is revolved on its horizontal axis. A sketch with the size and length of head is to accompany the order.

NOTE H. Object glass and Eye-piece.

Sometimes it happens that an object glass is slightly warped by the excessive heat of summer, shown by a distortion of the image, making it impossible to obtain a sharp, well defined image, or that the extreme cold of winter may crack the balsam (see description of the telescope page 31) with which the lenses are cemented together, shown by numerous streaks or stars. (A few such streaks or stars are not hurtful, since they cut out only a very small amount of light.) Such an object glass should be sent to us for recementing. Then, in most cases, a new cell is also needed in which to mount it again which adds to the cost of repairing.

In every permissible case the entire telescope should be sent us. After the object glass or telescope is returned to the sender **it is necessary to readjust the cross wires for collimation as explained under "Adjustments"** on page 54 of catalog.

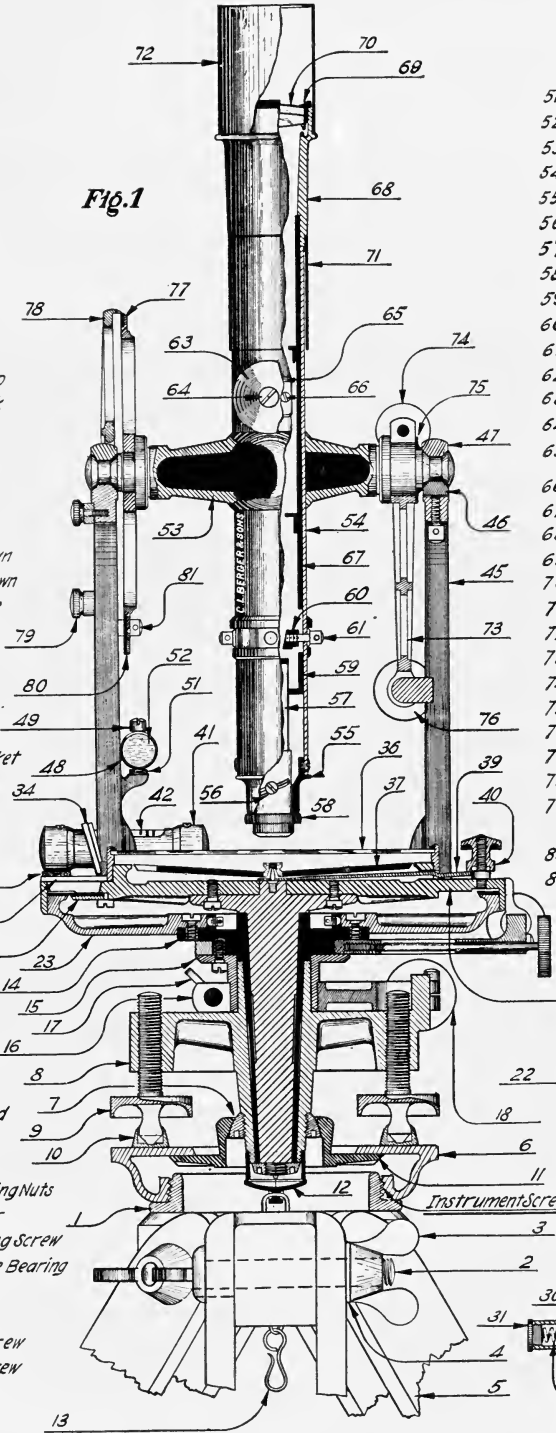
NOTE I. Stadia wires.

Stadia wires must be fitted specially to the focal length of each object glass, and therefore, we should receive the **entire telescope if possible, or at least the object glass, and it will also be well to state whether the telescope is erect or inverting, as otherwise we can only furnish the wires approximately correct.**

When a new object glass is required, new stadia wires as a rule must be supplied also.

Fig. 1

- 1 Tripod Head
- 2 " Bolt
- 3 " " Nut
- 4 " " Washer
- 5 " " Leg
- 6 Foot Plate
- 7 Ball and Socket Joint
- 8 Leveling Head
- 9 " Screws
- 10 " Screw Cups
- 11 Shifting Plate
- 12 Plumb Bob Suspending Cup
- 13 " " Chain and Hook
- 14 Repeating Center
- 15 Clamp Collar
- 16 Lower Clamp
- 17 " " Thumb Screw
- 18 " " Tangent Screw
- 19 " " Spring, Not Shown
- 20 " " Piston, Not Shown
- 21 " " Cap, Not Shown
- 22 Inner Center
- 23 Horizontal Circle
- 24 Vernier Plate Clamp
- 25 " " " Screw
- 26 Vernier Plate
- 27 " " Tangent Bracket
- 28 " " " Screw
- 29 " " " Spring
- 30 Tangent Spring Piston
- 31 " " Cap
- 32 Horizontal Vernier
- 33 Vernier Cover Glass
- 34 " Shade Frame
- 35 " " Glass
- 36 Compass Cover Glass
- 37 Needle
- 38 " Pivot
- 39 " Lifter
- 40 " " " Screw Head
- 41 Front Plate Level
- 42 " " " Vial
- 43 " " " Adjusting Nuts
- 44 " " " Rocker
- 45 Standard with Adjusting Screw
- 46 " Adjustable Wye Bearing
- 47 " Cap and Screws
- 48 Side Level
- 49 " " Adjusting Screw
- 50 " " Fastening Screw



- 51 Side Level Rocker
- 52 " " Vial
- 53 Telescope Axis
- 54 " Barrel
- 55 Eye Piece Mounting
- 56 Spiral Groove Screw
- 57 Terrestrial Eye Piece
- 58 Eye Piece Cap
- 59 " " Ring
- 60 Wire Reticule
- 61 " " Adjusting Screws
- 62 Pinion and Washer, Not Shown
- 63 " Head
- 64 " " Screw
- 65 " " Saddle
- 66 " " " Screws
- 67 Object Slide
- 68 " Head
- 69 " Glass Cell
- 70 " Glass
- 71 " Slide Dust Guard
- 72 Sun Shade
- 73 Telescope Clamp
- 74 " " " Screw
- 75 " " " Washer
- 76 " Tangent Screw
- 77 Vertical Circle
- 78 " " " Guard
- 79 " " " Screws
- 80 Vertical Vernier
- 81 " " " Screws

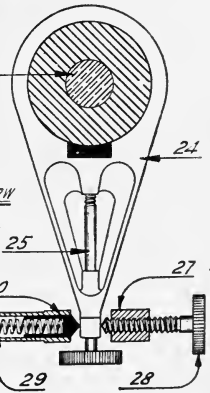
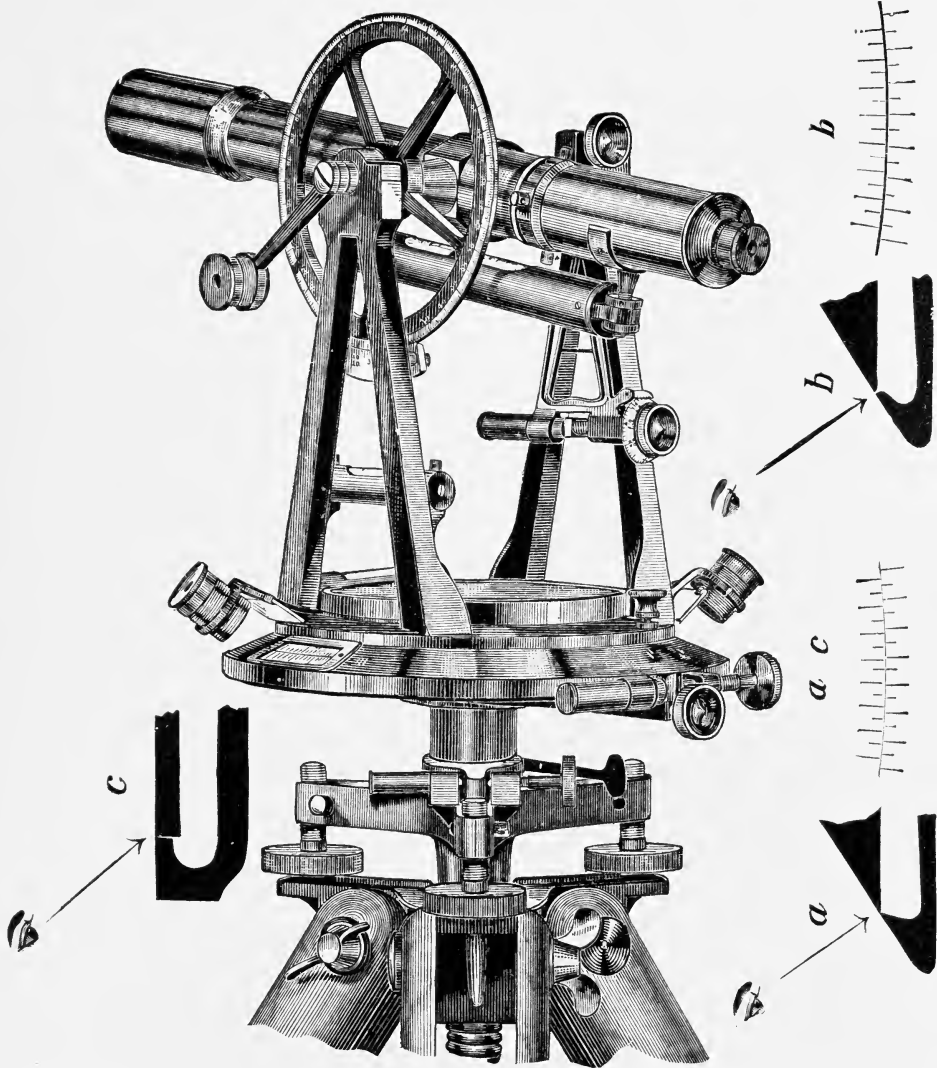


Fig. 2

Cross section of the Berger Transit.



C. L. Berger & Sons' Bevel-Limb Transit.

The above cut represents our Bevel Transit as made by us to order since 1871.

NOTE. While a bevel-limb graduation of a horizontal circle can be somewhat more readily seen than one on a horizontal surface, it is well to remember, before ordering instruments to be made so, that there are very serious objections to their general adoption for engineers' field-instruments. As will be seen in the annexed cuts, the sharper and therefore more delicate edges of the soft solid silver, necessitated by the bevel at the junction of limb and verniers, are much more liable to injury and wear in field use than the common horizontal graduation, where the same edges are carried down nearly rectangularly below the graduated surface. Thus, while a bevel possesses some advantages when *new and well constructed*, it soon becomes impaired by slight dents and the edges rounded by brush or finger when dust and oxyd must be removed at certain times. It then can be read only with difficulty and becomes a source of great annoyance, particularly as the eye looks squarely at it, thus defeating the very object sought and rendering the instrument almost unfit for good work, although otherwise in good condition. We say this with an experience of twenty-five years to back up. To make it plain we must have recourse to the diagrams. Fig. *c* is the cross-section of a horizontal limb and vernier as commonly made. It is obvious that the fine silver edged at the junction of limb and verniers are in this form better protected from wear, and also that, when slightly rounded by wear, or when the graduated surfaces are not in the same plane, the eye, being stationed at an angle of about 45° to the limb, requiring an observer to glance along the graduated lines, will more readily see and estimate differences in the reading of limb and verniers, thereby enabling him to obtain closer results, as verified by the superior results in triangulation obtained with horizontal graduations over bevel ones formerly in vogue. Fig. *a* is a cross-section of a bevel limb, showing the sharper edges of the graduated surfaces. When new and properly made the edges of limb and verniers appear the same as those in Fig. *c* and *a c*, but when worn off they will leave a big circular space between them, making the reading of an angle all the more difficult and uncertain. There are other reasons, against their general adoption, such as that the standards for the telescope have in bevel instruments not the stability so important in angle-measuring instruments unless they are mounted on a special horizontal base provided for them, (instead of on the bevel surface of the upper plate) which means a great increase in weight, or that the distance between them be quite short, resulting in a shortening of transverse axis of the telescope, as in the cut above, thereby increasing the instability of the same, particularly if the telescope is of modern power and length, besides reducing the size of compass, length of plate levels, and with this the degree of sensitiveness of the latter. In both these instances the standards are apt to change their distance apart affecting the adjustment of the line of collimation for near distances. — The greater expence of repairing, in case of accident, is also an item that should be considered. It is often double or triple that of a horizontal graduation. To our mind bevel graduation should be confined to exceptional cases and to the larger instruments read by micrometer microscopes.

CABLE ADDRESS:
BERGER, BOSTON, MASS.

MAIL ADDRESS:
37 WILLIAMS ST., BOSTON, MASS., U. S. A.

C. L. BERGER & SONS' CODE FOR THEIR ENGINEERING AND SURVEYING INSTRUMENTS.

Explanation.

In order to shorten the time between ordering and receiving an instrument and also to lessen the expense of telegraphing we have prepared this code, knowing that it is very difficult to provide for all combinations of instruments and accessories manufactured by us. While some manufacturers give a certain instrument a code word like "Rose" for Transit, it does not meet requirements, as it is still necessary to enumerate the essential features and extras besides, and the expense is as great. In such a case it would be as well to use the word "Transit" or "Level," as the code word.

In using the code, first consult our catalogue and decide upon size, style and extra features desired, make a note of them and turn to our code to find the same enumeration. Supposing the code word is **Boneset** telegraph us this way: — "BERGER, BOSTON, MASS., SEND ONE (or any number of instruments desired) **Boneset** (then your full address) JOHN BROWN, MELBOURNE." We will then understand we are to ship you the following instrument: — One Engineer's Transit No. 1b, as in cut page 145, with vertical arc, level, clamp, tangent screw and fixed stadia wires to telescope, all graduations on solid silver horizontal circle reading to 30", erect telescope, variation plate, gradienter, glass shades to verniers, latter placed at 35° to line of sight, standards leather-finish, and full length tripod.

Now if you wish some special feature for this instrument different from those enumerated under **Boneset** say in place of the erect telescope one that is inverting you would then telegraph us: — "BERGER, BOSTON, MASS., SEND ONE (or any number of instruments desired) **Boneset** INVERTING, JOHN BROWN, MELBOURNE," and we would understand that you wish the Transit No. 1b as enumerated in code but to have an inverting telescope.

If you cannot readily find the code word for a combination covering your needs and do not mind a little extra expense, then it will be well to telegraph us this way: — "BERGER, BOSTON, MASS., SEND TRANSIT No. 1b, INVERTING, SILVER, THIRTY SECONDS, STADIA, GRADIENTER, ETC., ETC.," thus wiring all the essential features. This will tell us to make and send you one Transit No. 1b, with inverting telescope, all graduations on solid silver, horizontal circle reading to thirty seconds, fixed stadia wires, leather-finish standards, gradienter, etc.

In all cases where you do not find a code word for a combination with an extra feature desired add to the code word the name of the feature or extra.

In every case a letter should follow by mail giving full enumeration and explicit shipping directions, so that there may be no mistakes.

Telegrams should always be addressed thus:

C. L. Berger & Sons, 37 Williams St., Boston, Mass.

Code

C. L. BERGER & SONS' CODE.—CONTINUED.

TRANSITS NO. 2.

For List of Extras, and Solar Attachments, prisms, colored glasses, etc., to Transits No. 2 see pages F and H. For particular changes from the customary enumeration of the various styles, such as inverting telescope, position of verniers, leather-finish, extension tripod, etc., see NOTE to Transits No. 1, page C.

Transit No. 2 Plain, page 168, without level to telescope or vertical arc (see cut of Plain Transit No. 1, page 151) with solid silver graduation reading to minutes, glass shades to verniers, latter placed at 35° to line of sight, erecting telescope, standards leather-finish, full length tripod
Above instrument same as Caladium, but with variation plate

PRICE
\$190.00
200.00

Caladium
Calamint

Transit No. 2, page 168, with level attachment to telescope, (see cut of Transit No. 1a, page 152) clamp, tangent screw also fixed stadia wires to telescope, solid silver graduation reading to minutes, glass shades to verniers, latter placed at 35° to line of sight, erecting telescope, standards leather-finish, full length tripod
Above instrument same as Calamus, but with variation plate
 " " " " and gradienter
 " " " " gradienter

Calamus 223.00
Calendula 233.00
Calopogon 238.00
Caltha 228.00

Transit No. 2, as in cut page 169, with vertical arc, level, clamp, tangent screw and fixed stadia wires to telescope, solid silver graduation reading to minutes, glass shades to verniers, latter placed at 35° to line of sight, erecting telescope, standards leather-finish, full length tripod

Calypso 243.00
Camella 253.00
Campanula 258.00
Capsella 248.00

Calypso
Camella
Campanula
Capsella

Transit No. 2, page 168, with full vertical circle protected by aluminum guard, (see cut of Transit No. 1c, page 154) with level, clamp, tangent screw and fixed stadia wires to telescope, solid silver graduation for both circles reading to minutes, glass shades to verniers, latter placed at 35° to line of sight, erecting telescope, standards leather-finish, full length tripod

Capsicum 252.00
Caraway 262.00
Carpinus 267.00
Cassandra 257.00

Capsicum
Caraway
Carpinus
Cassandra

NOTE: If occasionally a 30" graduation is wanted for No. 2 size Transit add to the code word "thirty seconds".

These prices do not include bag (\$1.00), oil (.35)

C. L. BERGER & SONS' CODE.—CONTINUED.

6

MOUNTAIN TRANSIT NO. 2.

For particular changes from the customary enumeration of the various styles, such as inverting telescope, no leather-finish, to standards, position of verniers, etc., see NOTE to Transits No. 1, page C.

For List of Extras and Solar Attachments, such as prisms, colored glasses, etc., to Transit No. 3 see pages F and H.

Mountain Transit No. 2, as per page 176, with full vertical circle protected by aluminum guard, with level, clamp, tangent screw, fixed stadia wires to telescope, solid silver graduation for both circles reading to minutes, glass shades to verniers, latter placed at 35° to line of sight, erecting telescope, standards leather-finish, extension tripod

Above instrument same as Forsythia, but with variation plate

“ “ “ “ vertical arc (in place of full vertical circle see cut No. 1b, page 153)

“ “ “ “ variation plate

(For metal finish see Note to Transit page C)

PRICE
\$252.00

Forsythia
Foxglove 270.00
Fuchsia 251.00
Fumaria 261.00
Finish 5.00

MOUNTAIN, MINING AND RECONNOISSANCE TRANSIT NO. 4.

For List of Extras and Solar Attachments, prisms, colored glasses, etc., to transits No. 4, see pages F and H.

Mountain, Mining and Reconnaissance Transit No. 4, page 183, with vertical arc, level, clamp, tangent screw and fixed stadia wires to telescope, solid silver graduations reading to minutes, glass shades to verniers, latter placed at 35° to line of sight, inverting telescope, standards metal finished, extension tripod

If a full length stiff leg tripod is desired in place of the extension tripod add

Above instrument same as Galanthus, but with variation plate

“ “ “ “ full vertical circle, as in upper cut, page 183, protected by aluminum guard

“ “ “ “ variation plate

“ “ “ “ , style I interchang. aux. teles., page 189

“ “ “ “ “ ; solar equatorial adapter, p. 191

“ “ “ “ style I interchang. auxiliary telescope

Galanthus 238.00
Longtripod

Galeopsis 248.00
Genista 247.00
Genian 257.00
Geranium 294.00
Gerardia 344.00
Gladiolus 284.00

NOTE: If occasionally an erecting telescope is desired for the No. 4 size, add to the code word “erect”.

If a heavier extension tripod is desired (which we strongly recommend on account of increased steadiness) add to the code word “extenheavy”.

These prices do not include bag (\$1.00), oil (.35)

C. L. BERGER & SONS' CODE.—CONTINUED.

MINING TRANSIT NO. 6.

For particular changes from the customary enumeration of the various styles such as offsetting arrangement, figuring of horizontal circle, etc., see **Note** to Transits **No. 1**, page **C**.

For **List of Extras**, such as **Edge graduation**, **Solar Attachments**, prisms, colored glasses, etc., to Transit **No. 6**, see pages **F** and **H**.

Mining Transit No. 6, (customary size), page 188, with full vertical circle protected by aluminum guard, with level, clamp, tangent screw and fixed stadia wires to telescope, solid silver graduation reading to minutes for both circles, glass shades to verniers, latter placed at 35° to line of sight, erecting telescope, standards metal finished, extension tripod

Above instrument same as Laburnum , but with variation plate	Laburnum	\$260.00
" " " " " and gradienter	Lantana	270.00
" " " " " gradienter	Larkspur	275.00
" " " " " style 1 interchange, aux. teles.	Laurel	265.00
" " " " " " " and variation plate	Lavender	297.00
" " " " " " " " and gradienter	Leontil	307.00
" " " " " " " " " and gradienter	Lespedeza	312.00
" " " " " " " " " gradienter	Ligustrum	302.00

NOTE: Sometimes we are asked to place a 30" instead of the minute graduation upon Mining Transits **No. 4** and **6**, and while we can do so, we wish to state that such a graduation in underground work is more difficult to read than when graduated to minutes only. The minute graduation, as made by us, is so sharp and clear cut that even the 4 inch circle can be easily read to 1/2 and 1/4 minutes by estimation. While we can graduate these Mining Transits **No. 4** and **6** to 30", and will be glad to do so if desired, in the interests of our customers we advise the minute graduation.

MINING TRANSIT NO. 6D. AND 6H.

For **List of Extras**, such as **Edge graduation**, **Solar Attachments**, prisms, colored glasses, etc., to Transit **No. 6D**, and **6H**, see pages **F** and **H**.

Mining Transit No. 6D, as in cut page 193, without compass, with **style 1**, interchangeable auxiliary telescope, full vertical circle protected by aluminum guard, with level, clamp, tangent screw and fixed stadia wires to telescope, gradienter, 2 illuminator shades, solid silver graduation reading to minutes for both circles, glass shades to verniers, latter placed in line of sight, inverting main and auxiliary telescopes, U shaped standards, extension tripod

Magnolia	327.00
Marigold	327.00

Above instrument same as **Magnolia**, but with erecting main and auxiliary telescopes
Mining Transit No. 6H, as described and enumerated on page 196, with one double vernier to the vertical circle at eye-end (shown in cut on page 167aa with two double opposite verniers to the vertical circle) and having inverting main and auxiliary telescopes
Above instrument same as **Memolis** but with erecting main and auxiliary telescopes

Memolis	352.00
Mipotum	352.00

If double opposite verniers are desired in place of the double vernier at eye end, price extra \$10.00.

These prices do not include bag (\$1.00), oil (.35)

SUPPLIES.

	PRICE		PRICE
Locke's Hand Level , page 119	\$8.00	LEVEL RODS.	
Abney Level and Clinometer , page 119	14.00	No. 145. New York Rod	\$14.00
Road Builder's Dumpy Level , page 123	75.00	“ “ “ with extra target	19.00
Sextant, 7" , page 229	150.00	No. 146. Philadelphia Rod	14.00
“ 10", page 229	150.00	“ “ “ with extra target	19.00
CURRENT METERS.		No. 147. Boston Rod	14.00
Current Meter, No. IV , complete with electric register and battery, page 230	195.00	No. 148. Mining Rod, Phil. pattern, 5 ft.	12.00
As above but without electric register and battery, page 230		“ “ “ “ 3 “	12.00
Current Meter, No. V , pages 230 and 232	135.00	“ “ “ “ N. Y. “ 5 “	12.00
“ “ No. VI, with electric register and battery, pages 230 and 232	135.00	No. 149. Flexible Level Rod	12.00
(See Note to Transit page C)	220.00	No. 150. Metric Rod, Philadelphia pattern	3.25
		No. 151. “ “ New York pattern	14.00
PANTOGRAPH AND PLANIMETERS.		RANCE POLES.	
No. 99. Suspended Pantograph, arms 24" , page 233	150.00	No. 152. Steel, solid, 6 ft.	3.00
No. 100. Suspended Pantograph, arms 38" , page 233	180.00	No. 153. Iron Tube, 6 ft.	2.75
No. 107. Compensation Planimeter, page 233	30.00	No. 152. Wood, 8 ft.	2.25
No. 108. “ “ “ specially rated, page 233	34.00	See Note to page Transit C	
Plain Polar Planimeter , specially rated, page 234	31.00	STEEL TAPES.	
Plain Polar Planimeter , not rated,	27.00	No. 206D. 100 ft. Lufkin steel tape, divided in 10ths	11.00
Large Rolling Ball Planimeter , page 234	90.00	“ 203D. 50 “ As above	6.00
		“ 103D. 50 “ As above, vest pocket size 1/2"	4.00
		No. 160. 100 “ Paine's steel tape, divided in 10ths, page 238, in leather case	11.00
		“ 161. 50 “ As above	6.00
		“ 162. 100 “ “ divided in 10ths on one side and centimeters on the other	15.00
		No. 163. 100 “ Chesterman's steel tape, divided in 10ths, in leather case	11.00
		“ 164. 60 “ As above	8.00
		“ 165. 50 “ “	6.00
		“ 166. 33 “ “	5.00

(See Note to Transit page C)

SUPPLIES.—CONCLUDED.

STEEL TAPES.—CONCLUDED.

No. 170.	100 ft. Excelsior steel tape, patent brass frame with handle, divided in 10ths	
" 171.	50 " As above page 239	
" 178D.	100 " Lucas steel tape, divided in feet, each 5 feet by soldered bands marked with figures, end feet to 10ths page 241	
" 178K.	66 " Lucas steel tape, graduated to links, with figured bands every five links	
" 179 1A.	100 ft. Roe steel tape, graduated every foot by brass rivet, end foot in 10ths, marked every 5 feet by brass plate and every 10 feet with copper plate with the Nos. on reel with pair of handles	
" 179 7A.	50 " Roe steel tape, as above	
" 180.	100 " Standard steel tape, graduated every 10 feet, last 10 feet foot in 10ths page 242	
" 200	" Standard steel tape, graduated as above	
" 300	" As above	
" 400	" " " " " "	
" 500	" " " " " "	
Extras to Standard steel tape No. 180.		
	Reel, Handle and Stop to wind up tape	
	2 Large Brass Handles to unship	
	Clamping Handles	
	Small Brass Clamp to fasten on tape	
" 191.	20 Meter Steel tape, divided in meters and centimeters	
" 192.	10 As above	
" 193.	20 Meter Metallic tape, divided in meters and centimeters	
" 194.	10 As above	

No.	Description	PRICE	Chains, Marking Pins, Etc.	PRICE
No. 195.	Surveyors' chain, 2 poles, 50 links, No. 12 best steel wire, brazed links and rings	\$11.50	Tamarisk	5.50
" 196.	As above, 4 poles 100 links, etc.	6.60	Tangerine	10.00
" 197.	Engineers' chain, 50 ft., 50 links, No. 12 best steel wire, brazed links and rings	4.00	Taxodium	6.00
" 198.	As above, 100 feet, 100 links, etc.		Teasel	10.00
" 199.	20 Meter chain, 100 links, No. 12 best steel wire, brazed links and chains	3.50	Tecoma	10.00
" 200.	10 Meter chain, 50 links, as above		Tetragonia	5.50
" 201.	Pocket Thermometer		Theobroma	1.50
" 202.	Spring balance and Level		Thermopsis	5.00
" 203.	Set of marking pins		Thistle	1.50
Plummet Lamps. Plumb Bobs.				
" 210.	Small plummet lamp of brass, steel point, 16 oz.	5.00	Thumbergia	8.00
" 211.	Large plummet lamp of brass, steel point, 24 oz.	4.00	Toadflax	10.00
	Box with shoulder straps for pair of plummet lamps	6.30	Toothwort	3.00
" 212.	Plumb bob of brass, steel point, 8 oz.	9.45	Trefoil	1.75
" 213.	" " " " " " 11 oz.	12.60	Tricentalis	2.25
" 214.	" " " " " " 6 oz.	15.75	Trifolium	1.75
" 215.	" " " " " " 9 oz.	18.90	Trillium	2.25
" 216.	" " " " " " patent reel attachment, 8 oz.		Tritonia	1.75
" 217.	Same as No. 216, 12 oz.	3.50	Tuberose	2.25
" 218.	Plumb bob of brass, steel point, for shaft use 3 lb.	2.50	Tupelo	5.00
" 219.	Same as No. 218, but 4 lb.	1.50	Turnip	7.50
" 220.	Mercury Plumb bob, 12 oz.	.75	Tussilago	2.25
	" " " " " " 16 oz.		Typha	2.75
	Braunton Pocket Mine Transit	11.00	Twinleaf	25.00
	" " " " " " with leather sling case	6.00	Twilum	27.00
	Spearmint	\$3.50		
	Spikenard	2.75		

CODE FOR INQUIRIES AND REPLIES — Continued.

SHIPMENT.

Have you shipped? Volcanoceria
 When did you ship? Walnut
 By what express or steamship line have you shipped? Waxwork
 Send tracer for Weigela
 When can you fill our order of Whahoo
 How shall we ship? Wheat

ANSWERS to above:

We will ship Whitlavia
 We hope to ship about Wigandia
 We cannot ship until funds are received Willow
 Shipped as per your instructions Wistaria
 We shipped Wolfsbane
 We are doing all we can to hurry your order, hope to send it Woodbine

MISCELLANEOUS.

Send latest catalogue Woodsia
 Enter order for the following instruments and hold subject to instructions Woodwardia
 Order received and instruments are taken in hand today. See letter Xanthium
 Add to order the following Xiphion
 Acknowledge receipt of letter, telegram or cable Xyris
 Acknowledge receipt of letter, telegram or cable by telegram or cable Yarrow
 Reply by letter Yastris
 Answer by cable or telegraph Yaupon
 Your letter has been received and contents are satisfactory Yellowroot
 Please refer to your letter of Yucca
 Please refer to our letter of Yulan
 We have written you on the subject Zamia
 You will receive letter of instructions Zebrina
 Please reply to our letter of Zinnia
 We do not know what you refer to Zizania
 The following word _____ is not understood, please repeat it Zizicet

YC 33012

800290

UNIVERSITY OF CALIFORNIA LIBRARY

