

TELEPHONY.

PART V.

THE SUBSTATION

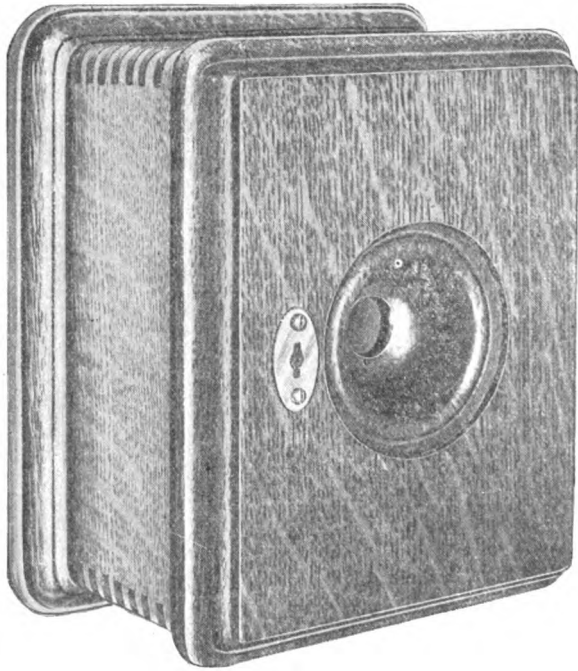

THE BLAKE TRANSMITTER.

TELEPHONY

*A MANUAL OF THE
DESIGN, CONSTRUCTION, AND OPERATION
OF TELEPHONE EXCHANGES.*

IN SIX PARTS.

PART V.
THE SUBSTATION
WITH 310 ILLUSTRATIONS.

BY
ARTHUR VAUGHAN ABBOTT, C. E.

NEW YORK
McGRAW PUBLISHING COMPANY.

1904

COPYRIGHTED, 1904,
BY THE
MCGRAW PUBLISHING COMPANY,
NEW YORK.

TR
AB2

5

PREFACE.

The sub-station appeals to the public. It is the machinery that the subscriber sees, feels, uses and is to him a reality. That a central office exists he is dimly aware but chiefly as an object of anathematization, and as for the wire plant, few even know that there is such a thing. Therefore, aside from all technical consideration it is the most important portion of the telephone exchange. Sub-stations are distributed over an immense field, both geographically and psychologically. They extend from the pole and equator, from the desk of the magnate and the palace on Fifth avenue to a shelf in the Chinese laundry and the walls of an East-side tenement. To meet conditions so utterly diverse requires a display of the most profound ingenuity; a skill that is technical to enable the apparatus to successfully cope with the most heterogeneous physical conditions; and a skill that is psychologic to enable it to satisfy conditions that are equally diverse mentally. There is little danger that the telephone engineer will forget the central office or wire plant, for these are ever present to his eyes, but owing to its distribution the sub-station is less conspicuous. Naturally the sub-station has been a favorite topic of many writers, so little that is novel can be claimed for the present presentation. Historical references are of the briefest, so possibly the work

may appear superficial as thousands of devices are not even mentioned because however ingenious or otherwise meritorious, they have, for one reason or another, failed to meet the test of time and experience or to pass that criterion of commercial adaptability necessary to make telephonic apparatus interesting either to the engineer or the operator. The attempt has been made to present the subject in its practical aspect only, but withal to embrace the point of view of the subscriber as well as that of the telephone manager and to treat this section as one factor of a number that compose the telephone exchange.

ARTHUR VAUGHAN ABBOTT.

NEW YORK, September, 1904.

CONTENTS.

PART V.

CHAPTER.	PAGE.
I. INTRODUCTION	1
II. THE RECEIVER	4
III. TELEPHONE TRANSMITTERS	144
IV. INDUCTION COILS AND SUB-STATION CIRCUITS	221
V. TRANSMISSION AND CURRENT SUPPLY	294
VI. SIGNALLING APPARATUS	332
VII. PROTECTION	364
VIII. PARTY LINES	393
IX. SUB-STATION ASSEMBLAGE	434
X. COSTS OF INSTALLATION AND OPERATION	457

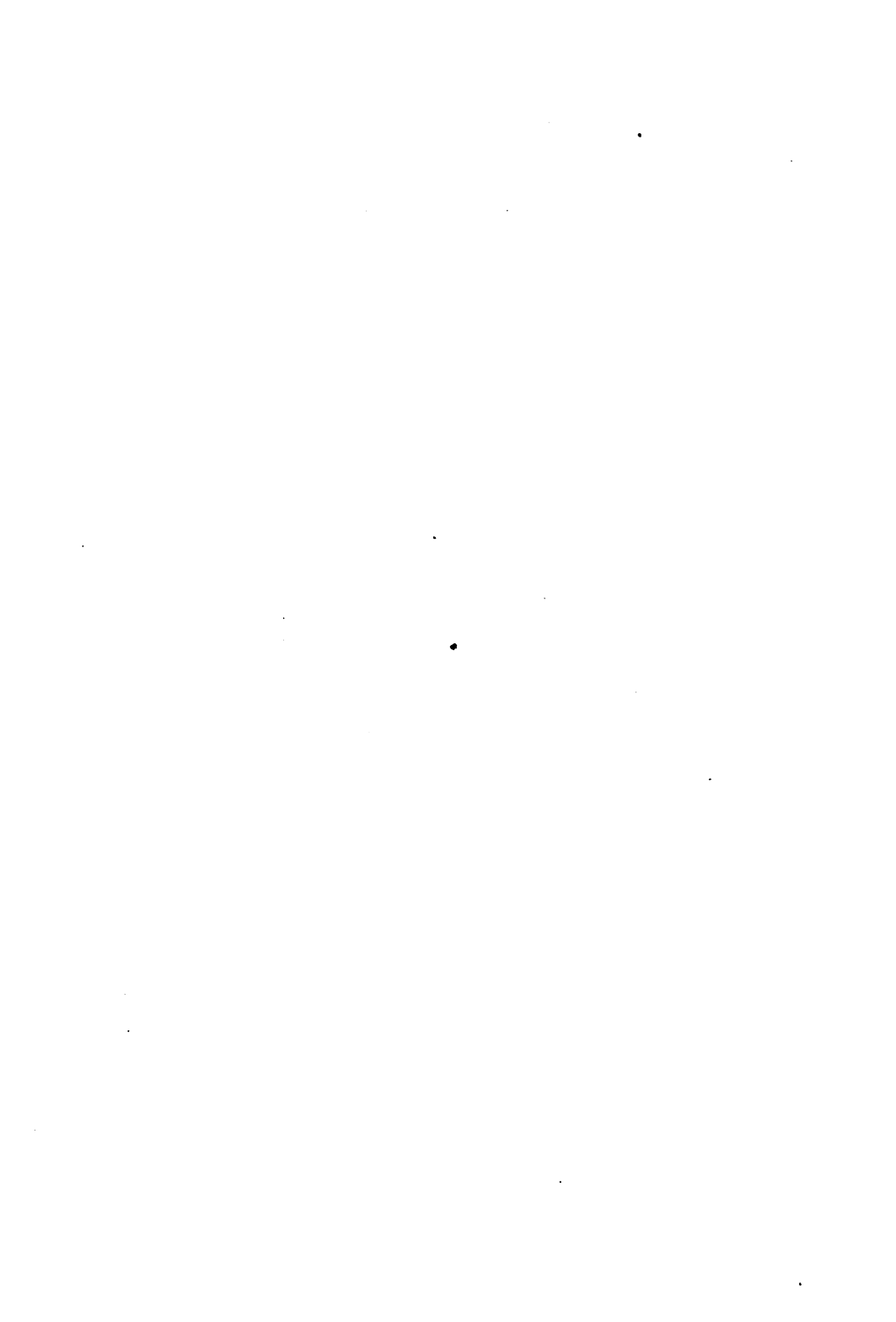

LIST OF TABLES.

PART V.

TABLE.	PAGE.
I. REMANENCE AND COERCIVE FORCE OF VARIOUS SAMPLES OF STEEL	56
II. MAGNETIC PROPERTIES OF IRON ALLOYS	60
III. COMPOSITION OF STEEL	61
IV. RELATIVE MAGNETIC PROPERTIES OF STEELS CONTAINING MANGANESE, NICKEL AND TUNGSTEN	63
V. MAGNETIC QUALITIES OF SILICON AND ALUMINUM IRONS	67
VI. RECEIVER DATA. MAGNETIC SYSTEM	140
VII. POLE PIECES	141
VIII. LINE COILS	142
IX. THE DIAPHRAGM	143
X. LINE CURRENTS FROM VARIOUS TRANSMITTERS	225
XI. RELATION OF LINE CURRENT TO PITCH OF SOUND	226
XII. INDUCTION COIL TESTS. SWISS TELEPHONE DEPARTMENT	228
XIII. INDUCTION COIL TESTS. SWISS TELEPHONE DEPARTMENT	230
XIV. INDUCTION COIL DATA FROM PRACTICE	232, 233
XV. DATA FOR WINDING COILS	246, 247
XVI. DIMINUTION IN TRANSMISSION DUE TO BATTERY AGE.	299
XVII. DATA OF COPPER OXYDE BATTERY	320
XVIII. HEAT COIL ALLOYS	370
XIX. PARTY LINE COSTS	399
XX. SCHEDULE OF APPARATUS COSTS	458



LIST OF ILLUSTRATIONS.

PART V.

FIGURE.		PAGE.
FRONTISPIECE, BLAKE TRANSMITTER.		
1.	BELL'S EARLY MODEL	2
2.	MODEL SHOWN IN PATENT ON MARCH 7, 1876	4
3.	ARTICULATING MODEL	6
4.	CENTENNIAL MODELS	8
5.	DIAGRAM OF OPERATION	9
6.	DIAGRAM OF PULSATING AND UNDULATING CURRENTS	11
7.	SINGLE-POLE BELL RECEIVER	12
8.	SECTION OF BELL RECEIVER	14
9.	BIPOLAR RECEIVER	16
10.	DIAGRAM OF CONNECTIONS OF TWO JOINED LINES	18
11.	DIAGRAM SHOWING CIRCUIT OF SUB-STATION, COMMON BATTERY SYSTEM	23
12.	DIAGRAM OF HYPOTHETICAL MAGNETIC CIRCUIT	29
13.	MAGNETIC CONSTANTS	36
14.	DIAGRAM OF RECEIVER MAGNETIC SYSTEM	40
15.	MAGNETIC CYCLE FOR STEEL	47
16.	MAGNETIC CYCLE FOR SOFT IRON	49
17.	PERMEABILITY BRIDGE	53
18.	HYSTERESIS METER	54
19.	CURVES FOR TUNGSTEN STEEL	57
20.	CURVES FOR MANGANESE STEEL	58
21.	CURVES FOR NICKEL STEEL	59
22.	CURVES FOR SPECIAL IRONS	66
23.	RECEIVER PHANTOM, POLE PIECES DETACHED	68
24.	RECEIVER PHANTOM, POLE PIECES IN PLACE	69
25.	RECEIVER PHANTOM, DIAPHRAGM IN PLACE	71
26.	RELATION BETWEEN STRENGTH OF FIELD, THICKNESS OF DIAPHRAGM AND INDUCED CURRENT; FERROTYPE DIAPHRAGM	74
27.	RELATION BETWEEN STRENGTH OF FIELD AND INDUCED CURRENT; DIAPHRAGMS OF SOFT AND HARD STEEL	75
28.	RELATION BETWEEN STRENGTH OF FIELD AND DIAPHRAGMS OF VARIOUS THICKNESSES OF SHEET IRON	77
29.	RELATION BETWEEN STRENGTH OF FIELD, INDUCED CURRENT AND THICKNESS OF DIAPHRAGM IN A RECEIVER	78
30.	RELATION BETWEEN STRENGTH OF FIELD AND MOTION OF DIAPHRAGM WITH VARYING LINE CURRENTS	81

FIGURE.	PAGE.
31. DETAILS OF CONNECTING CORD	87
32. ASSEMBLED BELL RECEIVER, C. B. TYPE	92
33. DISSECTED BELL RECEIVER	93
34. PHANTOM WITHOUT DIAPHRAGM	95
35. PHANTOM WITH DIAPHRAGM, BELL RECEIVER	96
36. BELL HEAD RECEIVER ASSEMBLED	97
37. BELL RECEIVER, CAP AND DIAPHRAGM REMOVED	97
38. BELL HEAD RECEIVER DISSECTED	98
39. MAGNET OF BELL HEAD RECEIVER	99
40. PHANTOM OF BELL HEAD RECEIVER WITHOUT DIAPHRAGM.	99
41. PHANTOM OF BELL HEAD RECEIVER WITH DIAPHRAGM	100
42. STROMBERG-CARLSON RECEIVER ASSEMBLED	101
43. STROMBERG-CARLSON RECEIVER SECTION	101
44. STROMBERG-CARLSON RECEIVER PARTLY DISSECTED	102
45. STROMBERG-CARLSON RECEIVER COMPLETELY DISSECTED	103
46. STROMBERG-CARLSON RECEIVER PHANTOM, DIAPHRAGM RE- MOVED	104
47. STROMBERG-CARLSON RECEIVER PHANTOM, NORMAL POSI- TION OF DIAPHRAGM	105
48. STROMBERG-CARLSON PHANTOM, DIAPHRAGM ONE-EIGHTH INCH FROM POLE PIECE	106
49. STROMBERG-CARLSON WATCH CASE RECEIVER	107
50. STROMBERG-CARLSON WATCH CASE RECEIVER WITH HEAD BAND	107
51. AMERICAN RECEIVER DISSECTED	108
52. AMERICAN RECEIVER PHANTOM, DIAPHRAGM REMOVED	109
53. DIFFERENT TYPES OF RECEIVERS	110
54. KELLOGG RECEIVER DISSECTED	111
55. KELLOGG RECEIVER IN SECTION	112
56. KELLOGG RECEIVER IN SECTION	113
57. PHANTOM OF KELLOGG RECEIVER	114
58. PHANTOM OF KELLOGG RECEIVER	115
59. MANHATTAN HAND TELEPHONE DISSECTED	116
60. MANHATTAN HAND TELEPHONE PHANTOM	117
61. WATCH CASE TELEPHONE DISSECTED	119
62. MANHATTAN WATCH CASE RECEIVER PHANTOM	120
63. PHANTOM OF WATCH CASE RECEIVER	121
64. ERICSSON RECEIVER DISSECTED	122
65. ERICSSON RECEIVER PHANTOM	123
66. ERICSSON RECEIVER PHANTOM	124
67. WESTERN TELEPHONE COMPANY RECEIVER PHANTOM	125
68. WESTERN TELEPHONE COMPANY RECEIVER PHANTOM	126
69. SWEDISH-AMERICAN RECEIVER ASSEMBLED	127
70. SWEDISH-AMERICAN RECEIVER DISSECTED	128
71. SWEDISH-AMERICAN RECEIVER DETAILS	129
72. SWEDISH-AMERICAN RECEIVER DETAILS	129
73. SWEDISH-AMERICAN RECEIVER DETAILS	129

LIST OF ILLUSTRATIONS.

xiii

FIGURE.	PAGE.
74. SWEDISH-AMERICAN RECEIVER DETAILS	129
75. SWEDISH-AMERICAN RECEIVER PHANTOM	130
76. SWEDISH-AMERICAN RECEIVER PHANTOM	131
77. HOLTZER-CABOT RECEIVER ASSEMBLED	132
78. HOLTZER-CABOT RECEIVER DISSECTED	133
79. HOLTZER-CABOT RECEIVER, DIAPHRAGM REMOVED	134
80. HOLTZER-CABOT RECEIVER PHANTOM	135
81. SOLID RECEIVER	136
82. COLUMBIA RECEIVER	136
83. SUN RECEIVER	138
84. CONDENSER TRANSMITTER	147
85. EDISON CARBON TRANSMITTER	149
86. HUGHES MICROPHONE	151
87. HUGHES MICROPHONE	153
88. BLAKE TRANSMITTER	156
89. BLAKE TRANSMITTER OPENED	157
90. BLAKE TRANSMITTER SECTION	158
91. SERIES CONTACT TRANSMITTER	160
92. MULTIPLE CONTACT TRANSMITTER	161
93. HUNNING TRANSMITTER	163
94. SOLID BACK TRANSMITTER	164
95. SOLID BACK TRANSMITTER HEAD	165
96. SOLID BACK CASE REMOVED	165
97. SOLID BACK CASE REMOVED	166
98. SOLID BACK DISSECTED	166
99. SOLID BACK DISSECTED	167
100. SOLID BACK SECTION	168
101. SECTION OF KELLOGG TRANSMITTER	171
102. SECTION OF KELLOGG TRANSMITTER	172
103. SECTION OF KELLOGG TRANSMITTER	173
104. DIAPHRAGM OF KELLOGG TRANSMITTER	174
105. WHITE & KELLOGG TRANSMITTER COMPARED	175
106. GROUP OF TRANSMITTERS	177
107. AMERICAN TRANSMITTER	178
108. AMERICAN TRANSMITTER	179
109. INTENSIFYING TRANSMITTER	180
110. INTENSIFYING TRANSMITTER	181
111. PARTS OF TRANSMITTER CAPSULE	183
112. WESTERN ELECTRIC SUPPLY TRANSMITTER	184
113. WESTERN ELECTRIC SUPPLY COMPANY TRANSMITTER	185
114. CENTURY TRANSMITTER	186
115. CENTURY TRANSMITTER	187
116. STROMBERG-CARLSON TRANSMITTER	188
117. STROMBERG-CARLSON TRANSMITTER	188
118. SWEDISH-AMERICAN TRANSMITTER	190
119. SWEDISH-AMERICAN TRANSMITTER	191
120. ERICSSON COMBINED RECEIVER AND TRANSMITTER	192
121. ERICSSON INSTRUMENT DISSECTED	193

FIGURE.	FIGURE.
122. ERICSSON TRANSMITTER PARTS	195
123. ERICSSON TRANSMITTER DISSECTED	196
124. MANHATTAN TRANSMITTER	197
125. MANHATTAN TRANSMITTER	193
126. WILLIAMS TRANSMITTER	199
127. WILLIAMS TRANSMITTER	201
128. WILLIAMS TRANSMITTER	202
129. WILLIAMS TRANSMITTER	203
130. DOUBLE DIAPHRAGM TRANSMITTER	204
131. DOUBLE DIAPHRAGM TRANSMITTER	206
132. FAHNESTOCK TRANSMITTER	208
133. FAHNESTOCK TRANSMITTER	209
134. FAHNESTOCK TRANSMITTER	210
135. FAHNESTOCK TRANSMITTER BUTTON	211
136. FAHNESTOCK TRANSMITTER DETAILS	212
137. CARBON ELECTRODES	214
138. GRANULAR CARBON MAGNIFIED	215
139. CURVES OF TRANSMISSION TESTS	219
140. SIMPLEST TELEPHONE LINE	221
141. LINE WITH BATTERY TRANSMITTER	222
142. LINE WITH INDUCTION COIL	223
143. CURRENT FROM BATTERY TRANSMITTER	225
144. CURRENT WITH INDUCTION COIL	226
145. LOW RESISTANCE COIL	235
146. DOUBLE WOUND IRON CLAD COIL	235
147. COIL USED WITH BLAKE TRANSMITTER	236
148. LOCAL BATTERY COIL	237
149. COMMON BATTERY COIL A	238
150. COMMON BATTERY COIL B	239
151. DOUBLE WOUND COIL	240
152. INDUCTION COILS IN TRANSMITTER ARM BASE	243
153. A COLLECTION OF COILS	244
154. SERIES CIRCUIT	252
155. BRIDGING CIRCUIT, GENERATOR AND BELL IN SERIES	254
156. BRIDGING CIRCUIT, GENERATOR AND BELL PARALLEL	256
157. BRIDGING CIRCUIT, GENERATOR AND BELL DISCONNECTED.	257
158. RING GROUND, TALK METALLIC	258
159. COIL TO HOOK SWITCH TERMINAL	259
160. HOLTZER-CABOT CIRCUIT	260
161. LOCAL STORAGE CIRCUIT	262
162. STONE LOCAL STORAGE CIRCUIT	264
163. COMMON BATTERY CIRCUITS	265
164. STONE COMMON BATTERY CIRCUIT	266
165. HAYES COMMON BATTERY CIRCUIT	267
166. SCRIBNER COMMON BATTERY CIRCUIT	268
167. KELLOGG COMMON BATTERY CIRCUIT	269
168. KELLOGG COMMON BATTERY CIRCUIT	269
169. CONDENSER COMMON BATTERY CIRCUIT	270

LIST OF ILLUSTRATIONS.

xv

FIGURE.	PAGE.
170. CONDENSER CIRCUIT No. 1	271
171. CONDENSER CIRCUIT No. 2	272
172. CONDENSER CIRCUIT No. 3	272
173. CONDENSER CIRCUIT No. 4	273
174. CONDENSER CIRCUIT No. 5	273
175. CIRCUIT WITH RETARDATION COIL	274
176. RECEIVER IN LOCAL CIRCUIT	275
177. OPERATION OF INDUCTION COIL	276
178. DEAN CIRCUIT No. 1	278
179. DEAN CIRCUIT No. 2	279
180. RUSSIAN COMMON BATTERY CIRCUIT	280
181. SCRIBNER COMMON BATTERY CIRCUIT	281
182. LOCAL TALKING COMMON BATTERY SIGNAL	282
183. ANTI-SIDE TONE	283
184. SERIES STATION	285
185. BRIDGING STATION	286
186. DESK SET. MAGNETO	287
187. DESK SET. C. B.	287
188. HOOK SWITCH	288
189. KELLOGG HOOK SWITCHES	289
190. STROMBERG-CARLSON HOOK SWITCH A	290
191. SWEDISH-AMERICAN SWITCH	290
192. A FREQUENT TYPE OF HOOK SWITCH	291
193. STROMBERG-CARLSON SWITCH B	291
194. HOOK SWITCHES WITH VERTICAL SPRINGS	292
195. DESK SET HOOK SWITCH	293
196. BATTERY DEPRECIATION No. 1	295
197. BATTERY DEPRECIATION No. 2	296
198. CURRENT TRANSMISSION RELATION	297
199. AGE OF BATTERY AND TRANSMISSION	298
200. TRANSMITTER CURRENT CURVES	301
201. COMMON BATTERY TRANSMISSION	302
202. DIAGRAM OF BATTERY	305
203. GRAVITY BATTERY	308
204. FULLER CELL	310
205. FULLER CELL IMPROVED	311
206. TESTS ON FULLER CELLS	312
207. EDISON-LALANDE CELL	317
208. EDISON-LALANDE PLATES	317
209. EDISON-LALANDE ELEMENT	318
210. GORDON CELL	318
211. NUNGESSER CELL	319
212. HARRISON BATTERY	321
213. LACLANCHE BATTERY	322
214. PRISM BATTERY	323
215. BAG BATTERY	324
216. CARBON BATTERY	324
217. TESTS ON LECLANCHE CELL	325

FIGURE.	PAGE.
218. DRY CELL, ROUND	327
219. DRY CELL, SQUARE	327
220. DRY CELL, TESTS A	328
221. DRY CELL, TESTS B	329
222. DRY CELL, TESTS C	330
223. DRY CELL, TESTS D	331
224. RINGER, ASSEMBLED	333
225. RINGER, ONE GONG REMOVED	334
226. RINGER DISSECTED	335
227. RINGER DIAGRAM	336
228. RINGER, COMPARATIVE SIZES	337
229. RINGER ADJUSTMENT	339
230. RINGER, WILLIAMS	340
231. RINGER, WILLIAMS, PHANTOM	341
232. RINGER, WILLIAMS-ABBOTT	342
233. RINGER, BIASED	343
234. DYNAMO DIAGRAM	345
235. MAGNETO DIAGRAM	346
236. RINGING GENERATOR	347
237. RINGING GENERATOR, SKELETON VIEW	347
238. RINGING GENERATOR, DISSECTED	348
239. RINGING GENERATOR, MAGNETS REMOVED	348
240. VARIOUS MAGNETS	349
241. ARMATURE LAMINATIONS	351
242. ARMATURE LAMINATIONS, READY TO WIND	351
243. ARMATURE COMPLETE	352
244. SHUNT—WESTERN ELECTRIC	353
245. SHUNT—POST	354
246. SHUNT—COOKE	355
247. SHUNT—HOLTZER-CABOT	356
248. DIAGRAM OF FIELD	357
249. SINE CURVE	359
250. MAGNETO WAVES	360
251. DIRECT CURRENT GENERATOR	362
252. HEAT COIL CURVES	371
253. SCHEME OF PROTECTION	375
254. SINGLE POLE SPARK GAP	377
255. DOUBLE POLE SPARK GAP	378
256. CARBON SPARK GAP	379
257. COMBINED FUSE AND SPARK GAP	381
258. DETAIL OF FUSE	382
259. ROLF PROTECTOR	383
260. ROLF PROTECTOR CIRCUITS	383
261. ROLF PROTECTOR HEAT COIL	384
262. COMMON BATTERY PROTECTOR	385
263. COMMON BATTERY PROTECTOR, SPARK GAP AND FUSE SEPARATE	386
264. D. & W. PROTECTOR	387

LIST OF ILLUSTRATIONS.

xvii

FIGURE.		PAGE.
265.	COOKE PROTECTOR	388
266.	FUSES	389
267.	CABLE PROTECTOR	390
268.	PROTECTED CIRCUIT	391
269.	NEW MODEL FUSE	392
270.	PARTY LINE, SERIES CIRCUIT	404
271.	PARTY LINE, BRIDGING CIRCUIT	406
272.	PARTY LINE, HIBBARD CIRCUIT	408
273.	PARTY LINE, CORD CIRCUIT	410
274.	PARTY LINE, SCRIBNER CORD CIRCUIT	411
275.	PARTY LINE, MAGNETO CIRCUIT, FOUR PARTIES	414
276.	PARTY LINE, MAGNETO CIRCUIT, TWO PARTIES	415
277.	PARTY LINE, TELEPHONES, WIRING OF	416
278.	LEICH SYSTEM	418
279.	THOMPSON'S SYSTEM	419
280.	DEAN SYSTEM	420
281.	SCRIBNER LOCK-OUT	422
282.	IMPROVED LOCK-OUT	423
283.	BUSY SIGNAL	424
284.	INTERCOMMUNICATION CIRCUIT No. 1	426
285.	INTERCOMMUNICATION CIRCUIT No. 2	427
286.	INTERCOMMUNICATION CIRCUIT No. 3	428
287.	NESS WALL SET	429
288.	NESS HOOK SWITCH	430
289.	NESS DESK SET	431
290.	BLAKE SET	435
291.	SOLID BACK SET	436
292.	DESK SET	437
293.	CABINET WALL SET	439
294.	COMMON BATTERY SET	440
295.	RESIDENCE SET	441
296.	RESIDENCE SET, OPEN	442
297.	STROMBERG-CARLSON SET No. 1	443
298.	STROMBERG-CARLSON SET No. 2	443
299.	STROMBERG-CARLSON SET No. 3	444
300.	DESK SET	445
301.	SWINGING ARM SET	446
302.	TABLE SET	447
303.	COMMON BATTERY SET	448
304.	RESIDENCE SET	449
305.	DRY BATTERY SET	450
306.	WET BATTERY SET No. 2	452
307.	WATERPROOF SET, CLOSED	453
308.	WATERPROOF SET, OPEN	453
309.	WATERPROOF SET, INNER DOOR OPEN	454
310.	SUB-STATION WIRING	455

TELEPHONY.

CHAPTER I.

INTRODUCTION.

THE sub-station is the *raison d'etre* of the telephone exchange, for it is the machinery that enables the subscriber to talk. The switchboard holds the apparatus for connecting subscribers' lines together; the wire plant is the path that guides the electric waves along their predetermined course; but the sub-station is (in a sense) the thing that does the *talking*; it is the vital organ of the whole plant, without which neither pole lines, cables, conduits nor central offices could have any existence. The sub-station contains the *telephone*; and this single expressive phrase exhibits the vital relation of the sub-station to the exchange as a whole. To injure the sub-station is to de-vitalize the wire plant, and paralyze the busiest switch-board.

As telephone exchanges are now constructed every sub-station must be designed to perform two functions that are inherently completely distinct and separate from each other. These are:

A. The Signaling Function.

B. The Conversational Function.

On further analysis each is again divisible into two parts. Thus the signaling function must be arranged so

that the subscriber can call the exchange, and so that the exchange can notify the subscriber. Similarly the conversational function must be so organized that the sub-

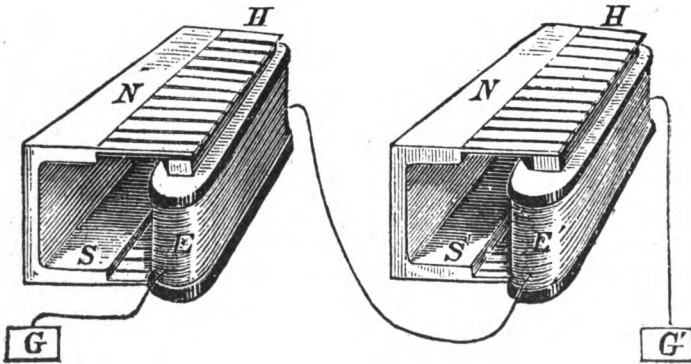

FIG. 1.—BELL'S EARLY MODEL.

scriber can talk to other parties, and so that he may receive conversation from others. Therefore, there are four divisions of sub-station apparatus:

1. The Apparatus for Receiving Signals.
2. The Apparatus for Sending Signals.
3. The Apparatus for Receiving Conversation.
4. The Apparatus for Transmitting Conversation.

Subordinate to this general classification come the subdivisions comprising the various methods used for the assemblage of sub-station apparatus, the wiring of the subscribers' premises, and such auxiliary apparatus as protective appliances, message meters, coin boxes and the like, the types of batteries to be used in local battery sub-stations, induction coils, etc., and finally the various general modifications necessitated by party line service.

It is now proposed to examine what appears to be the best current practice in the construction of sub-stations, and the lines along which development seems likely to take place. The history of the telephone, and the theory of the interconvertibility of sound and electricity will only be touched upon collaterally in so far as it may be wise to the development of the subject.

CHAPTER II.

THE RECEIVER.

. THE history of the human race is a record of a step-by-step progress. To this rule of progress even the most wonderful inventions are no exception. They never burst in full glory upon the startled horizon of humanity, but from small beginnings develop gradually to marvelous proportions, and it is only a retrospective consideration that reveals them in their true bearing, while the perspective of the past causes astonishment at the seeming rapidity of development. Under this great law of progress the telephone has evolved.

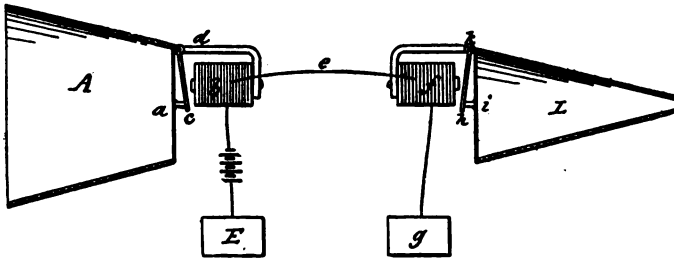

FIG. 2.— MODEL SHOWN IN PATENT OF MARCH 7, 1876.

Working in conjunction with his father, Prof. Alexander Graham Bell had, many years prior to 1875, been carrying on experiments to perfect some kind of apparatus to teach the deaf to speak, by imparting to them a notion of sound, or rather an idea of the use of the vocal organs, through other nervous channels than those of the ear. Through these studies he was led to consider the possibility

of the electrical transmission of sound. Many experiments were tried with all kinds of vibrating circuit-breakers, which were attended with as little success as the similar efforts of earlier workers in this field. Finally, following an idea suggested by an apparatus built by Helmholtz for the artificial production of vowel sounds, Prof. Bell devised an apparatus illustrated in Fig. 1. A series of reeds, *H*, are secured to a frame, *N*, and are placed in close proximity to the poles of a magnet, *E*, surrounded by a coil of wire, the end of which extends to a precisely similar apparatus located at a distance. When any one of the reeds at the sending station was vibrated mechanically, the corresponding reed at the receiving station was set in motion, and emitted a sound of the same pitch as the original one. If several of the reeds at the sending station were simultaneously vibrated a composite sound issued from the receiver. While the device shown in Fig. 1 bears little resemblance to the modern receiver, it is very evident that steel reeds, the magnet, coil of wire and line embraced all the elements of the modern receiver, and the instrument could certainly sing if not talk.

This harp-like affair was far too complicated. Perceiving this, the inventor strove to simplify, and on February 14, 1876, filed a patent application for an apparatus shown diagrammatically in Fig. 2, which is a reproduction of Fig. 7 of the famous Bell patent of March 7, 1876. At the sending station there is a funnel, *A*, to receive the sound waves, the small end of which was closed by a diaphragm, *a*, of gold beater's skin. The center of this was connected to a swinging iron armature, *c*, set in front of an electromagnet, *b*, while a battery, line and similar receiving station completed the outfit. For the first time

this patent clearly and broadly describes the office of the moving armature, *c*, to vary the magnetic field in which it hangs, and thus originate an *undulatory current* in the

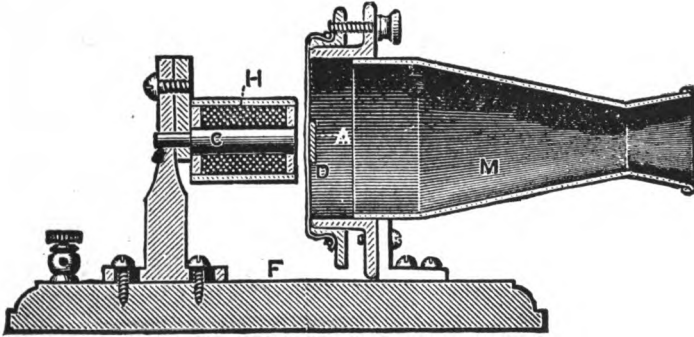

FIG. 3.— ARTICULATING MODEL.

line in distinction from the pulsating impulses of a circuit-breaking apparatus, though the model shown in Fig. 2 was still defective and failed to give good articulation by reason of the contact at *c*. The final solution of the problem was achieved in the instrument shown in section in Fig. 3. An electromagnet, *H*, was mounted on a baseboard, *F*, the circuit being extended to the binding posts. In front of the magnet a funnel was placed over the end of which, set directly in front of the magnet a piece of gold beater's skin was stretched. In the center of the diaphragm thus formed a small piece of soft iron, *A*, was cemented, concentrically with the pole of the magnet. In this device one recognizes all the elements of the most modern telephonic receiver, and between the hand telephone of 1903 and the model of 1876, there is no functional change.

To review the long, bitter and much-to-be-deplored legal controversies as to priority of invention that at once arose between Bell and a host of would-be inventors, who, seeing that the problem of the electrical transmission of speech was solved, immediately desired either a share in the glory or to enviously destroy the deserved tribute paid to another, is entirely foreign to these paragraphs. Unfailingly have the highest legal tribunals accorded to Prof. Bell the full credit of the undulatory transmission of sound, and from such a verdict only the malicious desire an appeal.

At the Philadelphia Centennial of '76 Bell exhibited other models, shown in Fig. 4, one with a double-pole magnet, and one in which the diaphragm is placed horizontally, on a magnet supported on a base. To substitute a permanent magnet carrying a small wire coil for the electromagnet of the early types, and a thin iron diaphragm for the fragile gold beater's skin, is a bit of good mechanics, scarcely more, for the fundamental operation of the instrument remains unchanged. Such is the history of the birth of the telephone.

Consider the theory of operation. Fig. 5 is a diagrammatic representation of a pair of magnetic telephones connected for conversation. Each instrument consists of a bar magnet, NS , on one end of which is a coil of wire, H . In front of the magnet is a thin iron diaphragm. These, then, the magnet, the wire coil and diaphragm, are the vital, and the only vital organs of the telephone receiver, though obviously there must be some kind of mechanical support to retain them in the relative positions shown, and this support plays no unimportant roll.

If any sound, articulate or otherwise, be produced in the vicinity of the diaphragm, the sound waves will im-

pinge on the plate, and as this is thin and elastic, the impact of the waves will cause it to vibrate, each excursion of the moving plate very closely, though not exactly resem-

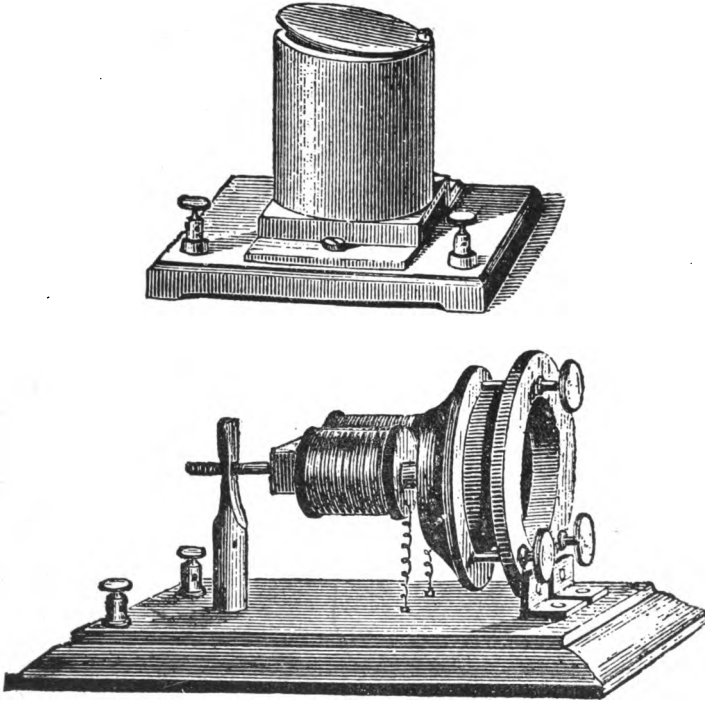

FIG. 4.—CENTENNIAL MODELS.

bling the sound wave that produced it. As the diaphragm is placed close to the magnet, *N S*, it is in a strong magnetic field, and thereby is magnetized. Experiment shows that any relative motion of magnets in close proximity to each other changes the magnetic field existing between

them, and experiment also teaches that a coil of wire placed in a varying magnetic field becomes the seat of an e.m.f. that is proportional to the rate at which the magnetic field is changing. The magnetized diaphragm is moving synchronously with the sound waves that excite its motion, hence the magnetic field in which the coil of wire, H , is placed is similarly disturbed, and an e.m.f. correspondingly changing, and proportional to the rate of change in the magnetic field is set up in the coil. Suppose from the ends of coil H a circuit either by two wires, or by one insulated conductor and ground be completed to another precisely similar apparatus. The varying e.m.fs excited in the coil, H , will cause undulatory currents of electricity to traverse the circuit in which the coil of the second telephone is included. Experiment teaches that the magnetism of a bar magnet surrounded by a coil of wire carrying a current is changed approximately in proportion to the current passing; therefore, the magnetism of the second magnet will ebb and flow with the undulations of the current in the line wire. The diaphragm of the

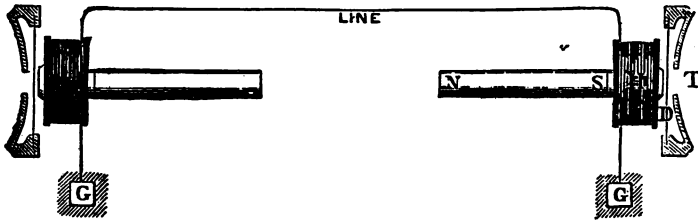

FIG. 5.—DIAGRAM OF OPERATION.

second telephone being in a similar magnetic field to that of the first one, is under a tension produced by the pull of the magnet. As this field is alternately weakened and

strengthened by the reactions of the current in the coil, the stress on the diaphragm rises and falls, and with this flux and reflux, obeying the laws of its own elasticity, the diaphragm swings to and fro, repeating with wonderful, though not with absolute fidelity in shape, but displaced a whole period in time, the motions of the diaphragm, *T*. As the second diaphragm swings to and fro it carves the air into sound waves, and thus the second telephone faithfully reproduces what is spoken into the first one. This most remarkable and interesting cycle is one of the most convincing demonstrations of the law of conservation of energy and may be recapitulated as follows:

1. Sound waves impinge on the first diaphragm and set it vibrating.
2. The moving iron causes changes in the magnetic field.
3. The field changes excite undulatory e.m.fs in the wire coil of the first telephone.
4. These e.m.fs produce currents between the two instruments.
5. These currents cause corresponding changes in the magnetic field of the second telephone.
6. These field changes set the second diaphragm vibrating.
7. The vibrations of this diaphragm initiate air sound waves similar to the original ones.

Prior to Bell's researches much time and many experiments had been spent on an endeavor to transmit speech electrically. But all of the various pieces of apparatus devised were based on the plan of completely opening and closing a transmitting circuit with each sound wave; *vide*, the famous apparatus of Reiss, invented in 1861, which differed from Bell's only in this one very important par-

ticular. The Reiss telephone had a vibrating diaphragm armed with a platinum point that opened and closed a battery circuit with every pulsation. The line current from such an instrument would be represented by a diagram like *A*, Fig. 6, for with a make-and-break instrument, the current will be zero when the contact is open, and its full value immediately it is closed; there are no other conceivable values. Such an apparatus can repeat a

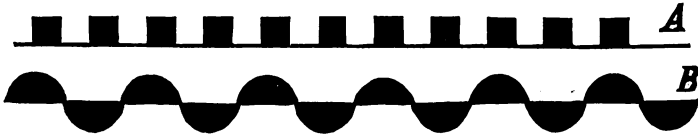

FIG. 6.— DIAGRAM OF PULSATING AND UNDULATING CURRENTS.

simple sound that consists of only one set of waves, like the note of an organ pipe. As there is only one contact it is obviously impossible for it to do more. But in the voice there are coincidentally many vibrations varying both in number or pitch, and in amplitude or loudness. Such complexity a simple make-and-break cannot repeat. In a diaphragm free to vibrate in a magnetic field the limitations of the make-and-break are removed, and such an apparatus causes a current that may be represented by *B*, Fig. 6. Here there is a delicacy obtained capable of reproducing all of the infinite gradations of vocal utterances. In 1875-6 little was known of magnetic fields and the intimate reaction of current and field. So all the more credit is due to Prof. Bell for the contrivance of an apparatus which depended on *undulatory* currents without which complex speech cannot be reproduced, and the courts have always held Bell's invention to consist in the *undu-*

latory current, or rather its electro-mechanical production and utilization in the transmission of speech.

An examination of the sound waves emitted by the voice in speaking shows them to consist of a basic or fundamental tone, relatively low in pitch, but of great amplitude or loudness, on which are superimposed a large number of harmonics or over-tones, that consist of vibrations two, three, four or more times as rapid; all correspondingly higher in pitch, and of small amplitude.

It is the presence of these over-tones, and the relative

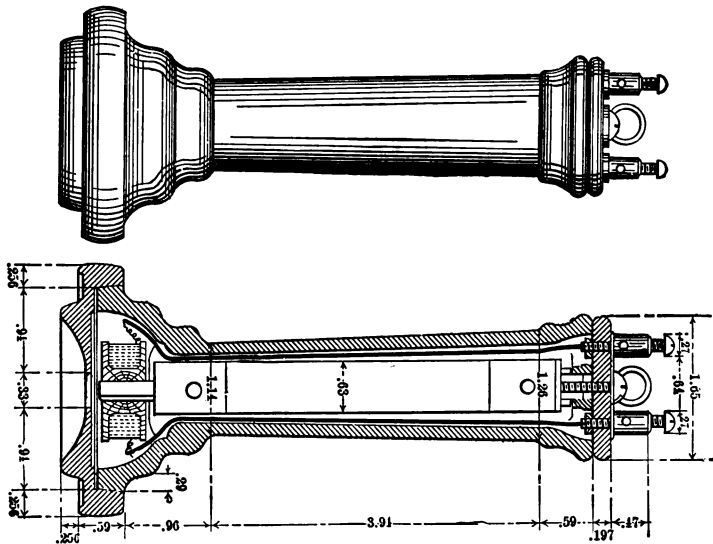

FIG. 7.— SINGLE-POLE BELL RECEIVER.

proportion and intensity of each one that endows different voices with their distinguishing properties, and enables one to infallibly recognize the tone of a friend. As the quality of the voice depends in each case on the relation

between the fundamental and each of the many over-tones, it is essential, in any speech transmission, that this ratio should be most exactly preserved. If the short harmonic waves were transmitted faster than the fundamental, speech would presently become unintelligible, for a portion of one word would thrust itself into the middle of the preceding one. There is, however, little to be feared from this contingency, for while there is a perfectly measurable and accurately known amount of time consumed in the transmission of every telephone wave, each portion of every word, of every syllable, of every letter, is equally tardied, and though all are delayed, the ratio of delay for each is constant.

The mental impression produced by any sound depends on the number of vibrations per second (the pitch) and the square of the amplitude, or distance through which the wave rises and falls. It is for this reason that a high, shrill voice attracts more attention than a deep tone. A change in the amplitude (which varies the loudness) does not alter the pitch, but it does produce a very great change in the mental impression produced by the sound. If the amplitude of all the waves of a composite sound like the voice be uniformly changed, the ear at once knows that the sound is more or less loud, but is equally sure that its distinctive quality is unchanged. If on the contrary the waves of some of the harmonics are reduced more than others the sound entirely loses its characteristics, and the ear fails to recognize its source. Therefore, in telephonic transmission the *relative amplitude* of all waves must be exactly reproduced or speech will be unintelligible. It is perfectly legitimate to reduce within certain limits the amplitude of all waves and thus equally decrease loudness.

But to change some waves more than others is to destroy characteristic quality. Unfortunately this is exactly what does occur, and moreover this distortion takes place not only in the receiver, but also in the line and the transmitter, and in an endeavor to eliminate this distortion, much investigation has been spent, with as yet but very partial success.

As the receiver is now used in telephony, its function consists in taking from line the undulatory waves of electricity impressed thereon by the transmitter, causing them to vary the field of a permanent magnet in which a diaphragm is suspended capable of vibrating with the field changes. *Ceteris paribus*, that receiver is the best whose

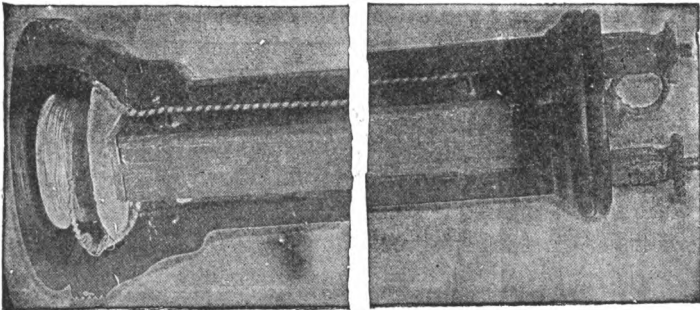

FIG. 8.—SECTION OF BELL RECEIVER.

electric, magnetic and acoustic properties are such that the sound waves emitted by the diaphragm correspond most closely in amplitude, shape and energy to the electric pulsation of the line, and the three organs of the receiver, the coil, magnet and diaphragm must be so planned in relation to each other as to secure this result.

Unfortunately, systematic investigations of the principles of the receiver designed from such a point of view are very meagre. In America, the most extensive studies are those undertaken at the Massachusetts Institute of Technology by Messrs. Cross, Williams, Hayes, Mansfield and Phillips and reported in the proceedings of the American Academy of Sciences.¹ A somewhat similar study was undertaken by Mercadier² in 1889. Other limited investigations have been made by Blake, Salet,³ Fröhlich⁴ and Franke.⁵

Aside from these investigations there seems to have been little attempt to formulate a scientific receiver design. For a long time the American Bell adhered to the single-pole type, a dimension drawing of which appears in Fig. 7 and a photograph of a section in Fig. 8. Several years ago this company commenced to use the bi-polar design, shown in Fig. 9, which has proved itself so decidedly superior to the single-pole that the latter has nearly disappeared. The American Bell has always been exceedingly averse to the diffusion of telephonic investigations of any description, so it is not surprising that there is little information extant as to the construction of this receiver.

The Bell receiver was, and is by no means perfect, and owing to excessive conservatism, it has changed little since the bi-polar type was adopted. The younger companies have been more flexible and quicker to profit by experience,

¹ See proceedings of American Academy of Sciences, Vol. for 1888, Page 113; Vol. for 1890, Page 233; Vol. for 1892, Page 93; Vol. for 1893, Page 234.

² See Comptes Rendus, Vol. cviii, Pages 735, 797. 1889; Vol. cxii, Page 96. 1891; Vol. xcv, Page 178. 1882.

³ See La Lumiere Electrique, Vol. xxv, Page 180. 1887.

⁴ See Elektrotechnische Zeitschrift, Vol. xl, Page 228. 1890.

⁵ See Journal Society of Tel. Eng., Vol. vii, Page 247. 1878.

and there are many Independent receivers that are superior to the Bell in mechanical design, and several in which both the mechanical design and shop execution are better, but in electric, magnetic and acoustic properties, the Independent instruments are less successful, for there are few receivers that talk as well as those of the American Bell, and only two or three that can be said to be perceptibly superior. The Independent Companies have been so occupied in catching up to telephone business that they have had but little time for systematic study along scientific lines, but the time is now ripe for an investigation

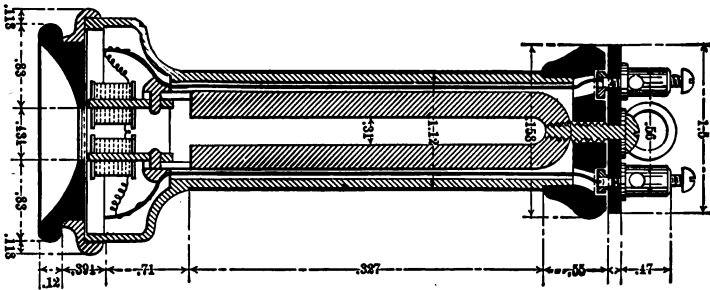

FIG. 9.— BIPOLAR RECEIVER.

of the principles of receiver design. Competition is slowly but surely awarding business to those who do it best, and he who is sufficiently altruistic to do some missionary work in this field will surely reap a reward.

The illustrations in Figs. 10 and 11 are diagrams of a pair of telephone lines as they would appear when connected for conversation. In Fig. 10 the sub-stations are shown as equipped with a local battery transmitter and receiver. The lines then extend to the office into a branch terminal switchboard, and are connected by the usual cord

and plug. In Fig. 11 common battery sub-stations and switchboard are represented. The approximate resistances of the various parts of the circuit in both illustrations are given, for the object of these illustrations is simply to convey a faint mental picture of the chief conditions which prevail during a telephonic conversation.

When one speaks into one of the transmitters the result is to produce (as will be subsequently explained) an undulating e.m.f. in the induction coil. As the circuit between the two lines is closed by the switchboard cords, this e.m.f. excites electric waves which oscillate backward and forward around the circuit. To secure the best results it is evident that the winding of the receiver coil must be such as to appropriate and transfer to the magnet on which it is placed as large an amount as possible of the energy impressed on the line by the transmitter.

In dealing with alternating currents, particularly with those of as high frequency as telephonic waves, the operation of inductance and capacity becomes of far more importance than that of mere ohmic resistance, and must be treated with corresponding consideration. The ohmic resistance of the line is divided between the coil of the receiver, the windings of the induction coil, the line wire, the various connections and other miscellaneous apparatus distributed over the circuit. Similarly each part of the circuit is endowed with its portion of the inductance and capacity of the whole. It is easy to measure with a suitable dynamometer the e.m.f. at the terminals of the transmitter or even to calculate it. If the maximum value of this e.m.f. be represented by E , the total resistance, inductance and capacity of the circuit respectively by the symbols R , L and C , and the number of waves per second of

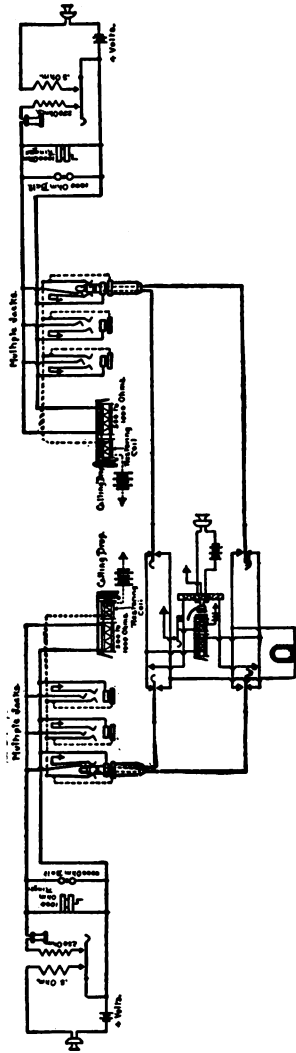

FIG. 10.—DIAGRAM OF CONNECTIONS OF TWO JOINED LINES.

time by n , it is easy to show* that the resulting maximum current, I , is expressed by the formula:

$$I = \frac{E}{\sqrt{R^2 + \left(2\pi n L - \frac{1}{2\pi n C}\right)^2}}$$

It can also be shown that the current wave may either lag behind or be in advance of the e.m.f. wave depending on whether $2\pi n L >$ or $< \frac{1}{2\pi n C}$ for the algebraic sum of these quantities is the tangent of the angular relation of the current and the e.m.f. The quantity $2\pi n L - \frac{1}{2\pi n C}$ is known as the *reactance* of the circuit, and manifests itself as an opposition, and a very serious one, to the establishment of a current under the action of a varying e.m.f. As telephonic apparatus deals largely with coils of wire and magnets, whose capacity is very small, the portion of this formula, $\frac{1}{2\pi n C}$, may oftentimes, with sensible accuracy, be neglected, and the expression simplified by writing,

$$I = \frac{E}{\sqrt{R^2 + (2\pi n L)^2}}$$

In this formula, $\sqrt{R^2 + (2\pi n L)^2}$ is called the *impedance* of the circuit. It opposes the passage of the current in a manner that closely resembles the barrier offered by the more familiar "ohmic resistance" and is often expressed as equivalent to so many ohms. Ohmic resistance, however, operates to destroy, or degrade a portion of the electrical energy, and change the same irrecoverably into heat, which is radiated away from the circuit. But inductance and capacity, while they absorb energy, retain

* *Alternating Currents*, Bedell & Crehore, p. 150.

and store it, the one in the magnetic field which is created about every conductor through which a current passes, and the other in the form of a charge or portion of electricity that seems to adhere, so to speak, to the surfaces of the conductors, and at the proper time the energy thus retained both magnetically and by capacity may be recovered. It is this property of giving up absorbed energy that causes the current to either lag behind, or advance before the propelling e.m.f.

There are two other exceedingly important deductions to be derived from the formula. In the quantity termed reactance, $2\pi nL - \frac{1}{2\pi nC}$ the factor, "n" enters. This is the number of waves per second. Now speech consists of a great many different waves, varying very greatly in speed. If n increases, the reactance will increase; that is, there will be a much greater opposition to the transmission of quick waves than to slow ones. This is the explanation of the fact that *ceteris paribus*, a bass voice can be heard better over telephone lines than a high, shrill one. Furthermore, it is evident that in any voice the high, shrill tones will, from this cause, suffer greater obliteration than the lower fundamental; hence the distortion that is noticeable in all telephonic transmission, and the reason why the letters, *s* and *c* particularly, and *b*, *p*, *t*, etc., are with difficulty distinguished. If we examine the quantity, $2\pi nL - \frac{1}{2\pi nC}$ still further it is seen that $\frac{1}{2\pi nC}$ is negative, and the thought at once occurs to so design apparatus as to make $\frac{1}{2\pi nC}$ equal to $2\pi nL$, and thus neutralize inductance with capacity. In other branches of electrical engineering this method is practiced with great success, and this principle is the basis of Dr. Pupin's in-

vention for improving transmission over cables and aerial lines. In the line that portion of the reactance due to capacity, namely $\frac{1}{2\pi n C}$ is much greater than that owing to inductance, $2\pi n L$. So in the Pupin loaded conductor additional impedance in the shape of coils of wire are inserted at frequent intervals for the purpose of balancing the capacity, and the test of practice shows that conversation is equally transmitted over a loaded conductor that is five times as long as an unloaded one. But in telephony one deals simultaneously with vibrations differing very widely in number, and the quantities themselves are exceedingly minute, both as regards e.m.f. and current. Thus Dr. Kennelly cites some experiments showing that .000000044 amp. can produce an audible sound in a receiver. This is about equivalent to saying that the energy developed by a weight of one grain falling one inch could keep a receiver sounding for two and a half years. Other investigations show results that are practically concordant. It is exceedingly difficult to deal with quantities so minute, for the possibilities of the unknown, and (at the present) unknowable are vastly greater. For example, any mechanic can, on any lathe, turn up a bridge pin six inches in diameter to fit an eye bar, within a few thousandths of an inch. The pin is tossed on a freight car, rolled down a sandy embankment at the bridge site, and driven home in its place in the chords with never a thought of its gritty condition. But take a watch pinion possibly but one or two-thousandths of an inch in diameter. The error of a millionth of an inch is fatal. The kick of a fly's foot may bend it, and a grain of dust that even a sensitive eye could tolerate can arrest its motion.

To deal with a transmission plant reckoning voltage by tens of thousands, and amperage by hundreds is doubtless difficult, and taxes engineering science to the uttermost. But at the other extreme when the pressure and current become so small that the most analytic mind cannot grasp their minuteness, calculation fails, and only the cut-and-try method of experiment remains. Nevertheless, even if telephonic magnitudes are so small as to elude the clutch of mathematics, electrical principles apply as a guide with as much force to telephone circuits as to any others, and it is certain that apparatus designed along well-known electrical lines is much more likely to succeed than any haphazard heterogeneous concatenation of parts thrown together by the accident of ignorance. For example, the line has for a quarter of a century remained unimproved. Now, owing to the suggestion of Dr. Pupin, transcontinental telephony is assured, and transoceanic telephony within grasp. Yet Dr. Pupin is a mathematician, pure and simple, and the problem was solved at the desk and in the laboratory and not in the field. We may, therefore, be quite certain that all improvements in telephone apparatus will follow definite electrical laws, and that those who are quick to perceive them will be the first to design the better types so ardently desired.

From the preceding formula it is seen that with a given varying e.m.f. the current from instant to instant varies with the reactance. By the laws of the electro-magnet we know that the rate of change in the magnetic field produced by a coil of wire carrying a current will be proportional to the number of ampere-turns. Ampere-turns may be increased by either augmenting the amperes, or the turns, or both. But to increase the turns in any coil to

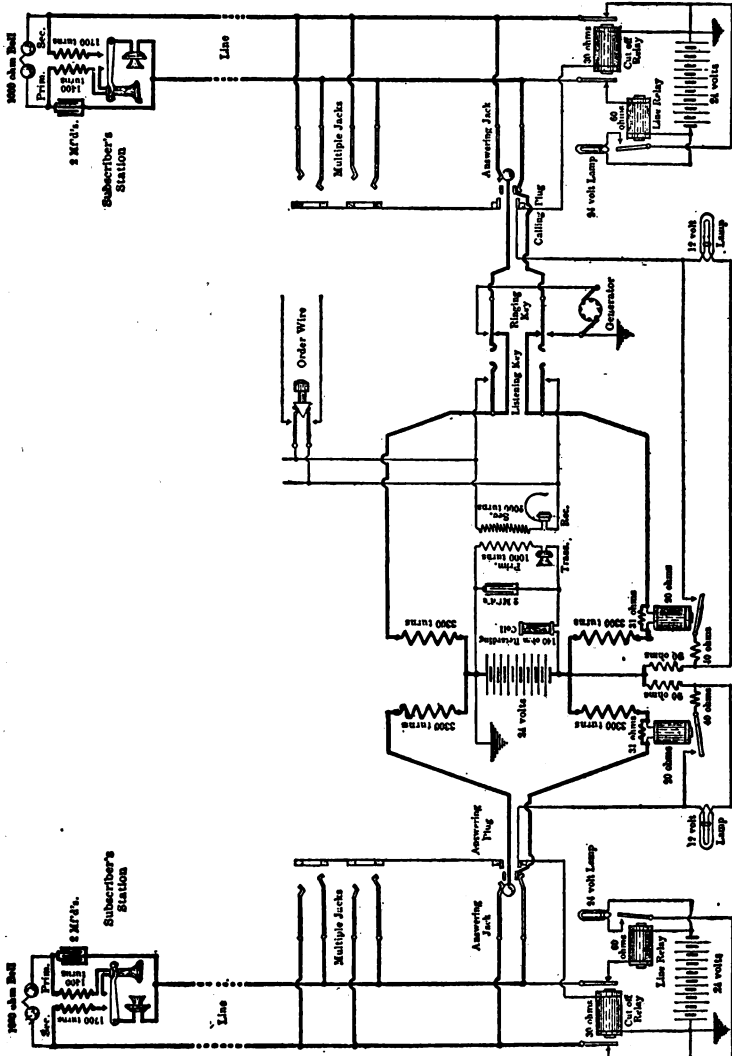

FIG. 11.—DIAGRAM SHOWING CIRCUIT OF SUB-STATION, COMMON BATTERY SYSTEM.

which a given e.m.f. is applied is to decrease the amperes, by augmenting the impedance of the circuit, and the problem is to determine the dimensions of the coil which will give the best result. That portion of the impedance due to ohmic resistance may be decreased by using a large wire of low resistance. This means a bulky coil of large radius, to hold heavy wire. Now the inductance of any coil is proportional to the square of its radius and the square of the number of turns, while the ohmic resistance is proportional to the radius and the number of turns. From the formula it is evident that the current will be a maximum when the denominator is a minimum, and as L varies as the square of the same quantities (the radius and number of turns of the coil) with which R varies directly, it is evident that the denominator will be a minimum when $R = \sqrt{2\pi n L}$, but space considerations will usually preclude putting this theory into practice.

Not only does impedance reduce the total current that traverses a circuit on which an undulating e.m.f. is impressed, but it operates to prolong the time occupied by the current in reaching its possible maximum value. We are so accustomed to think of all electric action as being instantaneous, that it is hard to realize that every tick of a telegraph sounder, and every vibration of a telephone diaphragm requires a certain very measurable though minute period of time for its accomplishment, and whenever impedance is added to a circuit, the "time constant" or interval required by the current to reach its (approximately) full value is increased. It is easy by a formula given by Helmholtz to calculate the current in such a circuit at any interval of time after the e.m.f. has been

applied. Suppose i be the current, t seconds after the application of the e.m.f., then

$$i_t = \frac{E \left(1 - 2.7183 - \frac{Rt}{L} \right)}{R}$$

in which E , R and L have the same meaning as before. It is evident by inspection that $\frac{E}{R}$ will always be reduced by the value of the quantity inside the parenthesis, and hence the current will theoretically never cease rising. Practically, however, it attains a value sensibly equal to the theoretical amount in a very small interval of time, although with the large field magnet of dynamo machines, two or three minutes may sometimes elapse. As L enters into the parenthetic coefficient, it is evident that the time constant will vary with L , and will also be proportional to the square of the number of turns and the radius of the coil.

To calculate the impedance of a circular coil in air is not difficult, but when the complications of an irregular shaped space, occupied by wire with an indefinite thickness of insulation, the insertion of an iron core of unknown permeability, and the addition of a permanent magnet of uncertain strength, an accurate calculation becomes impractical. By winding the coils in several sections connected in parallel, some advantage is gained. The ampere-turns are decreased directly as the number of coils, while impedance is reduced as the square of the number of turns is decreased. For example, if the two coils with which receivers are usually supplied be joined in parallel the ampere-turns are reduced one-half, for half the current will flow through each coil, but the impedance will be diminished to one-fourth, for there are only one-half as many

turns on the line. There is, therefore, a decided decrease in reactance by winding the coils in sections joined in parallel. Several wires on one spool serve somewhat the same end, but with very small wire the proportion of the total coil bulk occupied by insulation is so great compared to the volume of copper, that this plan soon ceases to be of advantage.

The capacity of receiver coils is even under the most adverse circumstances very small, so small as to be almost negligible compared with the relatively enormous inductance. What little capacity there is is probably of advantage in balancing to some extent the inductance. In this respect improvement in receiver design is likely to take the shape of the addition of more capacity to neutralize more perfectly the inductance, than any attempt to reduce that which already exists.

Some attempts have been made in the direction, but were never carried to any decisive conclusion. This certainly seems a promising direction for the ambitious inventor, and deserves to be explored.

Considering all these diverse elements, it is exceedingly difficult to arrive theoretically at the best size, shape, wire gauge, resistance and number of turns for receiver coils. Practical experience seems to have settled down to making the spools about .90 in. long, .45 in. wide, and .50 in. deep for the ordinary hand receiver, and .70 in. long, .30 in. wide, .40 in. deep for a head receiver. The very best single silk-covered wire is used and great care taken with the winding to pack the wire as closely and tightly as possible on the spool. The end of the winding of each spool is reinforced by a few inches of relatively heavy wire, say No. 28 to 30, to guard against rupturing the

coil during the operation of assembling. Local battery or high-resistance receivers are usually wound with from No. 34 to No. 40 wire to a resistance of 100 to 125 ohms. Some few makes carry the resistance to 175 or 200 ohms, but such instruments are rare. Low-resistance receivers, or common battery instruments, are usually wound with from No. 32 to No. 36 wire, and have a resistance of 40 to 60 ohms. Some are made as low as 25 ohms and some as high as 80, but these again are the exceptions. The spools should be made of some non-metallic substance like fibre or rubber, but if of metal it should be laminated to prevent eddy currents. When complete the coil should be thoroughly impregnated with a non-hygroscopic insulator like shellac or paraffin, and covered with moisture-proof varnish or tape.

The earliest models of the receiver employed an electromagnet to create the field in which the diaphragm should swing, but this complication was almost immediately perceived to be unnecessary, and the simpler permanent magnet, amply sufficient. It was at first considered desirable to secure the strongest possible magnetic field with which to surround the diaphragm, and receiver magnets were bent and contorted into all conceivable shapes, so that one leg of the magnet could be connected to and polarize the diaphragm, but with very disappointing results. With present familiarity with the theory of magnetism this failure is easily understood, but twenty years ago less knowledge existed.

To view the magnetic system of a telephone receiver from the standpoint of the present conception of magnetism is to clear up many obscure points in receiver design, for we now believe that electricity and magnetism are so closely related that similar methods of reasoning apply

to both, but as the units now employed in calculating magnetic mechanisms, and their use, is less familiar than the similar formulæ applied to electrical estimations, a brief *resumé* may be valuable to refresh the mind of the reader.

If the poles of a battery, dynamo or other electric generator be joined by a wire, something which we call "electricity" seems to traverse the conductor, apparently going away from the generator and returning thereto over the circuit. The amount of this something is found by experiment to be directly proportional to the power (e.m.f.) of the generator to push it along, and inversely proportional to the resistance of the circuit. This relation is stated by the famous Ohm's law to be $C = \frac{E}{R}$, in which C is the current in amperes, and E the e.m.f. in volts, which propels the current against the resistance, R , in ohms. Similarly when magnetism is under consideration there appears to be a something which traverses the bodies magnetized in a manner somewhat analogous to the electricity on the wire. To produce magnetism in any body a certain amount of force must be applied which may be termed *magnetomotive force*, as analogous to *electromotive force*, and the amount of magnetism produced will be directly proportional to the amount of magnetomotive force, and inversely proportional to the resistance of the body to be magnetized.

As a magnet seems to exercise more or less attraction or repulsion upon bodies in its neighborhood, it was natural to picture magnetism as something emitted, or projected from the poles of the magnet into space. Faraday gave the name of "*lines of force*" to this something, and conceived that these lines of force issued from the north pole of the magnet in the form of closed curves which swept

through the surrounding material back to the south pole, in much the same fashion that electricity proceeds from the generator through the circuit and returns to its source.

We really know absolutely nothing as to the true nature of magnetism, but a very satisfactory working hypothesis is to imagine that this phenomenon is due to a stream, or flow in the ether. Suppose $A B$ (Fig. 12) to be a tube or pipe, with a centrifugal pump located in the middle at C , and conceive the entire apparatus to be submerged in a tank of water. If the pump, C , be operated, it will force the

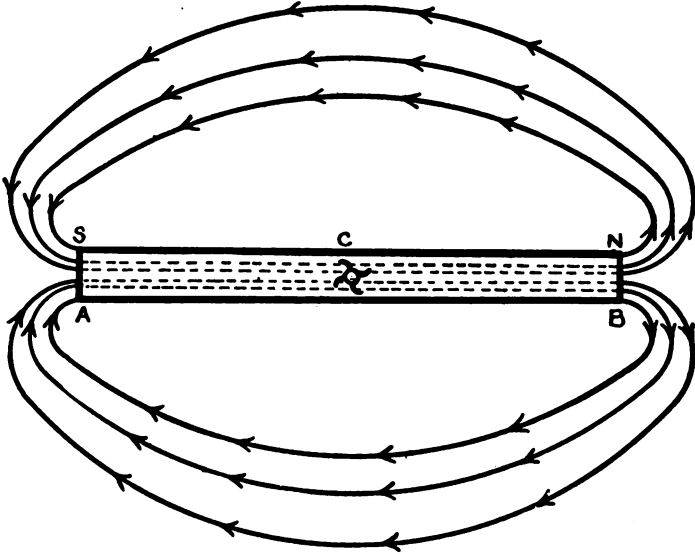

FIG. 12.—DIAGRAM OF HYPOTHETICAL MAGNETIC CIRCUIT.

water along the tube toward B . As soon as the end of the confining walls of the tube is reached at B , the water current will fan out in all directions through the tank. Mean-

while to supply the place of the water forced out at *B* new supply must enter the tube at *A*. So presently a current is set up running through the tube in the direction *A B*, then spreading throughout the tank in all directions and returning by the end, *A*. Evidently the amount, or velocity, of the current will depend on the power of the pump, the resistance offered to the water flow by the friction of the walls of the tube, and the viscosity of the surrounding fluid. We may imagine that this is a rough analogy of the phenomenon of magnetism. The tube is the analogue of the ordinary bar magnet, the pump the magnetomotive force that sets up streams of ether that flow through the bar, issuing from the north pole, streaming through space to return by the south pole, and it is these streams of ether which we term a magnetic field. Now the amount of magnetism, or quantity of ether streams, will be proportional to the power of the pump (the magnetomotive force) and the resistance of the tube (the magnet) and that of the surrounding medium in which it is placed. In the case of the water pump the friction of the tube and fluid in the tank requires a constant expenditure of energy to maintain the current, but the ether is supposed to be *frictionless*, hence while an ether stream will always require the expenditure of energy to start it, or stop it, but after it is once set in motion, it will continue to flow until forcibly arrested; herein lies the explanation of the constant exhibition of magnetism by a magnet after it has once been magnetized.

But all this, while a beautiful though somewhat fanciful theory, is too intangible for the engineer who wishes to express in definite units the entities with which he deals and calculates therewith.

In the c.g.s. system the unit of force is that amount of force which, acting for one second, will produce a velocity of 1 cm. per second, in a mass of 1 gram; this is called the *dyne*; measured in gravitation units, this force is approximately equivalent to the weight of a milligram. As a magnet exercises a force upon a body placed in its vicinity it was natural to assume as the unit magnet, such a magnet as would exercise a force of one *dyne* upon another exactly similar magnet 1 cm. away from it. To project its force over this centimeter of space the magnet must display a certain amount of magnetomotive force, in order to overcome the resistance or *reluctance* of the air space, as this opposition is usually called (in contradistinction to electrical resistance), so the *reluctance* of a cubic centimeter of air is assumed as the unit of magnetic resistance. Theoretically the unit of reluctance is that of a cubic centimeter of an air pump vacuum, but to all intents and purposes, for practical work at least, the magnetic reluctance of a cubic centimeter of all non-magnetic materials (everything but iron, nickel and cobalt) is the same as that of an air pump vacuum. This unit of reluctance is called the "*oersted*" and is symbolized by the script letter, \mathcal{R} . From what precedes the unit magnet will exercise a pull or a push of one unit of force at a distance of one unit of space; in other words, it delivers a unit of magnetism through a unit of reluctance. This unit of magnetic *flow*, or *flux*, or *stream*, as it is variously called, is termed the *maxwell*, and it is usually indicated by the Greek letter, ϕ . Lastly, the unit of magnetomotive force is the *gilbert*, and from the foregoing is that amount of magnetomotive force needed to drive one maxwell through one oersted. The symbol for the gilbert is usually a script letter, \mathcal{F} . The

law of the magnetic circuit can now be stated in terms which are as similar and as simple as those which apply to the electric circuit.

$$\phi = \frac{\mathcal{F}}{\mathcal{R}} \text{ or}$$

$$\textit{The Flux} = \frac{\textit{The Magnetomotive force.}}{\textit{The Reluctance}}$$

For example, if a magnetomotive force of $\mathcal{F} = 500$ gilberts be applied when the total reluctance, $\mathcal{R} = 5$ oersteds, the total magnetic flux in maxwells, or number of lines of force, will be

$$\phi = \frac{500}{5} = 100$$

We now know of but two sources from which a magnetomotive force can be derived. The first, oldest, and in many respects the least valuable source is that peculiar property which seems to be inherent in the molecules of certain kinds of matter, such as the loadstone, iron, nickel and cobalt, by reason of which they not only become magnets themselves, but are capable of creating the same condition in other similar bodies, and of filling the space that surrounds them with magnetic flux. The second is by the use of an electric current, for it is found, by experiment, that the space surrounding every conductor traversed by a current is vested with the properties of the magnetic field, and that the intensity of this field is proportional to the current. Now, if the conductor be bent in the form of a ring there will, with any given current, be a certain flux, or definite number of maxwells inside this ring, and if the current be doubled the flux will be doubled.

Evidently the same result can be attained by keeping the current constant and causing the wire to make two turns; hence the magnetomotive force of any coil of wire carrying a current will be proportional to the current, and the number of turns; or that is the same thing proportional to the product of the amperes and the turns as *ampere-turns*. It is found that one gilbert is equal to .796 ampere-turns, or one ampere-turn equals 1.257 gilberts, hence the magnetomotive force of any coil can at once be expressed in gilberts by multiplying the ampere-turns by 1.257.

For example, assume a ring of wood having a cross-section of 5cm^2 and a circumference of 100 cm, and suppose the ring to be covered with 500 turns of wire through which 2 amp. flow. The magnetomotive force, $\mathcal{F} = 500 \times 2 \times 1.257 = (\text{number of turns} \times \text{number of amperes} \times 1.257) = 1,257$ gilberts. As the reluctance of wood is unity per cm^3 , the total reluctance of the ring is evidently directly proportional to its length, 100 cm, and inversely proportional to its area, 5 sq. cm, or $\beta = \frac{100}{5} = 20$ oersteds.

The total magnetic flux in maxwells is $\phi = \frac{1257}{20} = 62.85$.

According to present ideas, this stream of magnetism circulates round and round inside of the coil, and as the area is 5 sq. cm the intensity or number of maxwells per sq. cm, or number of lines per sq. cm, is $\frac{62.82}{5} = 12.57$.

In electrical measurements this corresponds to *amperes per square unit of area of the conductor*, a unit of measurement frequently used, but for which there is no individual name. In magnetism, however, there is a special unit for intensity of flux called the *gauss*. Its value is one maxwell per sq. cm, hence in the preceding example

the intensity is 12.57 gausscs. The total magnetomotive force, \mathcal{F} , was found to be 1,257 gilberts, and as the ring is 100 cm around it the magnetomotive force per centimetre of length is $\frac{1,257}{100} = 12.57$ gilberts. The magnetomotive force per *unit of length* of a coil is usually symbolized by a script letter, \mathcal{H} , and when the coil contains only non-magnetic material it is numerically equal, as shown above, to the flux density, and so $\mathcal{H} =$ gilberts per linear centimetre in gausscs.

The analogy so far traced between the electrical circuit and the magnetic circuit has been exceedingly close, but in two respects there are very grave differences. To the passage of both electricity and magnetism it is found by experiment that different substances offer very different amounts of opposition per unit of volume. Thus all of the metals are relatively very perfect electrical conductors when compared to the non-metals, although the poorest metallic conductors offer upwards of a hundred times the resistance of the best ones. In the case of electricity, the resistance per unit of volume is *constant*, no matter what amount of electricity may be driven through the conductor; thus any given wire will have exactly the same resistance whether it carries one-hundredth of an ampere or a hundred amperes. With magnetism, however, there are two striking peculiarities. In the first place there are only three substances, iron, nickel and cobalt, whose magnetic conductivity differs greatly from unity, and secondly the opposition which these three exceptions offer to magnetic flux is *not constant* as in the case of electricity, but varies with the *amount of magnetic flux* that happens to be passing. The result of this is to greatly add to the difficulty of making magnetic calculations, particularly as it is im-

practical to express this change in reluctance, in a simple form, and the only satisfactory way yet devised is to test experimentally samples of various substances and plot as a curve the relation between the magnetomotive force and the resulting flux. Fortunately only the various forms of iron are used to any extent in electromagnetic mechanisms, otherwise the labor of investigating, plotting and using a multitude of curves would have been overwhelming.

So far as telephone receivers are concerned, soft iron and hard steel are the only magnetic materials of which cognizance need be taken. Fig. 13 gives a set of magnetic constants chosen as particularly applicable to receiver design. On the left-hand side of the sheet curve *A* relates to soft iron and is applicable to pole pieces and diaphragms, while curve *G* is for glass-hard steel, useful in connection with permanent magnets. The lower horizontal scale, beginning at the left-hand corner and reading to the right, gives the value of \mathcal{H} in gilberts *per centimetre of length* of coil; that is, if we suppose the magnetomotive force to be created by coil of wire supplied by a current, each centimetre of the coil must produce \mathcal{H} gausses. This is the intensity of the field, or number of lines of force, or number of maxwells per sq. cm, inside the coil, so long as it is occupied by air or other non-magnetic material. Now, suppose a piece of soft iron to be inserted in the coil, and the current traversing it to be slowly augmented so that \mathcal{H} may increase from zero to any desired amount. Instead of the flux ϕ being numerically equal to and growing in direct proportion with \mathcal{H} , as would be the case if the coil were occupied by non-magnetic material, it is found to be enormously increased, and by measuring the values of the flux with

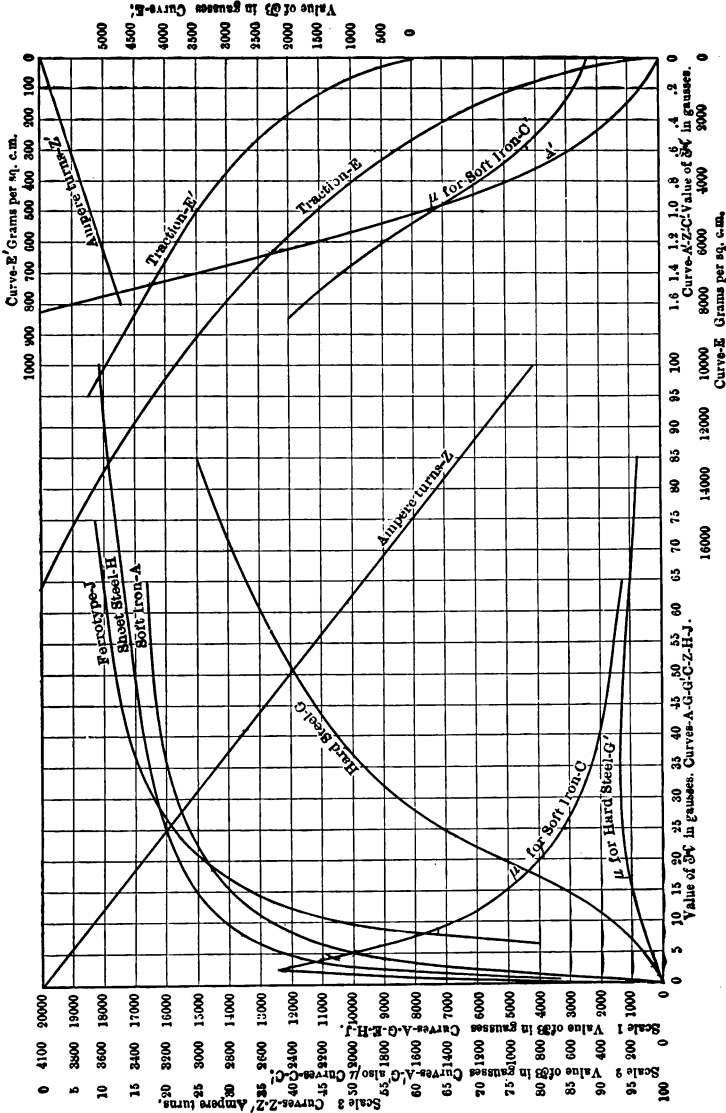

FIG. 13.— MAGNETIC CONSTANTS.

different values of \mathcal{H} , a curve can be plotted showing the relation between them. Curve A is such a line. Scale No. 1 on the left-hand side of the sheet gives the number of gausses or maxwells per sq. cm in the iron, which is usually represented by a script letter, β . In order to exhibit the entire curve rather small scales had to be chosen, but as for receiver design the lower portions of the curve are important, and the beginning of curve A is shown considerably magnified on the right hand of the sheet marked A' . The lower horizontal scale designated A' gives the value of \mathcal{H} in gausses for this curve and reads from *right to left*. Scale No. 2 on the left hand of the cut gives the corresponding values of β . When \mathcal{H} equals 1 (curve A') β is found to be 1,550; with $\mathcal{H} = 2.5$, β is 6,250 (curve A) and this enormous increase in flux continues in nearly the same ratio till $\mathcal{H} = 5$. It seems, then, as if the ability of the iron to carry the flux gradually became exhausted, and as \mathcal{H} is increased the ratio between \mathcal{H} and β decreases until it finally falls nearly to unity. This curious property of iron to increase the flux has been usually explained by saying that the *reluctance* of the iron is much less than that of air, or in other words that its *permeability* is much greater. The symbol of permeability is the Greek letter μ and the points on the curves, A and A' , may be expressed by the relation $\beta = \mu \mathcal{H}$. In electrical parlance one would say that the iron was a much better conductor, or had much less resistance. It is improbable that this explanation is a correct one, but it forms the easiest working hypothesis that one can employ. But calculating the various values of μ in terms of \mathcal{H} from the formula $\mu = \frac{\beta}{\mathcal{H}}$ a very useful curve may be plotted showing the reluctance of iron as compared with air for all values of \mathcal{H} . Such a curve is shown

at C (Fig. 13). The values of \mathcal{H} are shown on the same lower scale as for curve A , while the values of μ are given by scale No. 2 on the left hand. This curve rises suddenly from 0 to about 2,500, then abruptly turns and drops toward the horizontal axis, at first very rapidly and then slowly, till it nearly reaches unity. By means of the data exhibited in these curves, it is easy to determine for soft iron either the reluctance per cubic centimetre, the magnetomotive force needed to produce any desired flux, or the flux which will be obtained with any given value of \mathcal{H} . For example, with a magnetomotive force of $\mathcal{H} = 15$ gilberts per linear centimetre, the value of β is 14,000 gausses, μ is 1,000, and the reluctance per cubic centimetre is $\frac{1}{1,000} = .001$ oersteds.

Curves G and G' contain similar data for hard steel such as might be employed for receiver magnets. There is a striking difference between the curve for steel and that for iron. At all points the value of β for steel is much less than for iron with the same value of \mathcal{H} , and consequently μ is correspondingly smaller. Again, the curve β is less concave toward the horizontal axis, which means that steel, unlike iron, does not show so marked a saturation point beyond which it is difficult to push magnetization. Curve G' gives the value of μ curve in G in a manner similar to the data shown by curve C for curve A .

The second noteworthy point of difference between electricity and magnetism is the fact that there is no such thing as a magnetic *insulator*. Strictly speaking, this statement is true of electricity, for there is no substance that will not allow some electricity to leak, but as the difference between the ordinary conductor and ordinary insulator is many million fold, electrical leakage is

too small in most cases to be of serious consideration. With magnetic circuits on the other hand, the curves of Fig. 13 show that even under the most favorable conditions the resistance of one of the best insulators (air) is less than 3,000 times as great as that of the best conductor (iron), and as magnetic mechanisms are usually designed, the difference is only a very few hundred fold. With any magnetic circuit, therefore, there is comparatively an enormous amount of leakage, which interferes materially with both the operation and the efficiency of the apparatus.

The tractive effort which a magnet is able to exert is an important consideration in the design of a receiver system. According to Maxwell, the law of magnetic traction may be stated as follows:

$$P = \frac{33^2 A}{24,642}$$

in which P is the pull in grams, β the flux in gausses, and A the area of one pole piece in square centimetres. In Fig. 13 this relation is plotted in curves E and E' . For curve E the value of β is to be found by scale 1 on the left-hand side of the sheet, while the corresponding tractive effort in grams per square centimetre is shown by the horizontal scale marked E , commencing at the left hand on the bottom of the sheet and reading from left to right. For example: A flux of 10,000 gausses gives a tractive effort of 4 kilos per sq. cm. As it is difficult to read the lower portion of this curve with accuracy, curve E' is plotted at the top right-hand corner and gives the values of the beginning of curve E somewhat magnified. For this curve the β scale is given on the right-hand side of the sheet and designated E' , while the corresponding tractive efforts are shown upon the top of the sheet and similarly labeled.

Consider now this theory of the magnetic circuit as applied to the design of the magnetic system of a receiver. For ease in analysis it is convenient to imagine the receiver magnet as an electromagnet, as was actually the case in the

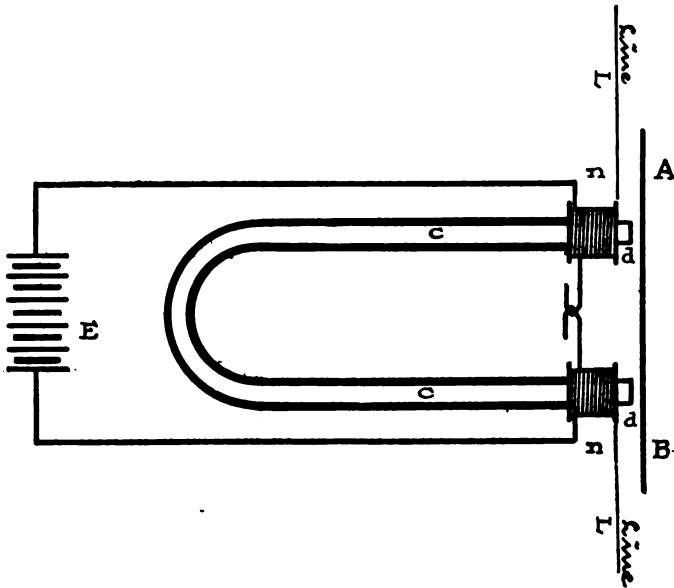

FIG. 14.— DIAGRAM OF RECEIVER MAGNETIC SYSTEM.

older forms; and after the calculations are made, the electromagnet may be replaced by an equivalent permanent magnet without changing the results. Fig. 14 is a diagrammatic representation of such a receiver system, in which *A B* is the diaphragm of soft iron, *d d* the air-gap, or space between the diaphragm and the soft iron bar, *c c*, that forms the magnet; *n n* the wire coils on the end

of the U-shaped bar, each coil having two windings, one connected to the line, $L L$, and the other to the battery, E , which may be supposed to be variable, so that any desired degree of magnetic excitation may be produced in $c c$. From the curves E and E' (Fig. 13) it is seen that the tractive force which is exercised on the diaphragm $A B$ will vary as the square of the intensity of magnetism in $c c$, and at first sight *strength of field* would seem to be the prime requirement. But a little consideration will show that mere pull avails nothing. The office of the diaphragm is to *vibrate* with *changes* in the magnetic field in which it is placed. These changes are caused by the line current which traverses the coils $n n$, therefore, the condition of the magnet $c c$ must be such that the smallest impulse from the line will produce the greatest change in the magnetism of $c c$, and thus the greatest effect on the diaphragm. Further the condition of the diaphragm must be such that the smallest change produced by $c c$ in the field or air space, $d d$, will be followed by the greatest possible change in the magnetism induced in the diaphragm, in order to secure the greatest sensitiveness. Now referring to the curves A and A' (Fig. 13), it is seen that soft iron is most sensitive to changes in magnetism when it is placed in a field having an intensity of from three to five gausses. This is the keynote to the design of the magnetic system, for we know that we must create a field of an intensity of three to five gausses in which to place the diaphragm, and that the bar, $c c$ (assuming it to be of soft iron), must be so proportioned that *when* it creates such a field it will itself be magnetized to such a pitch as to be the most sensitive to the line current changes, or in other words, both magnet and diaphragm must be in unstable magnetic equilibrium.

From the curve this intensity, it is seen, must not exceed 10,000 gaussses. Let us now take some dimensions, say such as resemble those found in practice, and calculate what the magnetic system should be. Assume the diaphragm to be $2\frac{1}{4}$ in. (5.72 cm) in diameter, and .014 in. (.03 cm) thick. Suppose the air space to be $\frac{3}{64}$ in. (.12 cm) wide and the magnet to be .25 in. thick \times by .625 in. wide, with a length of 9 in., measured around the bar from d to d . The cross-section of the magnet will then be .156 sq. in. (1.01 sq. cm, say 1 sq. cm) and the length 23 cm. If the distance between the centers of the pole pieces be taken at $\frac{1}{2}$ in. (1.27 cm), the portion of the diaphragm in front of the magnet that acts as an armature and is included in the magnetic circuit will be $1.59 \times .03 = .048$ sq. cm. This is on the assumption that there is no spread of the magnetic induction between the ends of the pole pieces and the diaphragm, but the magnetic flux *will* fan outwards, in all directions, particularly across so wide an air-gap, so that it is conservative to assume that practically the theoretical cross-section will be much increased, say 50 per cent. The diaphragm, then, must be credited with a section of say .075 sq. cm and a length of 1.27 cm between centers of the pole pieces. To secure maximum sensitiveness the magnetization must not exceed 10,000 gaussses. Hence the flux in the diaphragm will be $10,000 \times .075 = 750$ maxwells. As the magnet is a long U-shaped bar, whose adjacent sides are close together, leakage will be very great. A rough estimate of probable leakage may be made by considering the relative resistances of the path through the air-gap and diaphragm, and that offered by the air space between the parallel sides of the magnet. These sides are 1.56 cm wide, 11.5 cm long (the mean distance around the

magnet through its center) and .95 cm apart; then the area of the flat sides of the magnet between which leakage will take place is $1.56 \times 11.5 = 18$ sq. cm. The reluctance of this path will be $\frac{.95}{18} = .053$ oersteds. Between the poles and the diaphragm there are two air-gaps, each of which may be regarded as having the same area (1 sq. cm) as the pole opposite to it, and a length of .12 cm. The reluctance of the air-gap will then be $\frac{2 \times .12}{1} = .24$ oersteds. Therefore, the reluctance of the path through the air-gaps is to the reluctance of the leakage path as .24 is to .053; or, in other words, but 20 per cent. of the flux through the magnet will reach and traverse the diaphragm. Consequently, the total flux through the magnet will be $\frac{750 \times 100}{20} = 3,750$ maxwells. From the curve A' (Fig. 13) it is seen that when $\mathcal{H}\beta$ equals 3,750 \mathcal{H} is 1.6 gaussses per centimetre of length. As the magnet is 23 cm long, and 1 gilbert is equivalent to .796 ampere-turns, or 1 ampere-turn = 1.256 gilberts, the total required ampere-turns to produce this flux is $1.6 \times 23 \times .796 = 29.3$. As the air-gap is relatively large considerable leakage will take place across the gap, and it will not be far out of the way to assume that the mean flux through the air-gap to produce 750 maxwells in the diaphragm must be a thousand maxwells. To force 1,000 maxwells through 1 cm air requires a magnetomotive force of 1,000 gaussses. The resistance of the air-gap has already been shown to be .24 oersteds, and hence the ampere-turns necessary to drive the desired flux through air-gap will be $1,000 \times .24 \times .796 = 191.3$. In the diaphragm the flux is 750 maxwells, the area is .075 sq. cm and the length 1.27, so the flux density is 10,000 gaussses, to produce which curve A (Fig. 13) shows

that 5 gaussess per linear centimetre must be provided, hence the amp-turns to produce the flux in the diaphragm will be $5 \times 1.27 \times .796 = 5.03$. The magnetomotive force then required for such a magnetic system will stand as follows:

	Gausses.	Ampere-turns.
Magnet.....	36.80	29.3
Air-Gap.....	240.02	191.3
Diaphragm.....	6.46	5.08
	<hr/>	<hr/>
	283.28	225.68

From curve E' (Fig. 13) it is seen that a flux of 3,750 maxwells per sq. cm will produce a tractive effort of 580 grammes per sq. cm. As the total area of the poles is 2 sq. cm, the tractive effort will be $2 \times 580 = 1,160$ grammes (about 2.3 pounds), and it is a common specification to require telephone receiver magnets to lift a 2-pound weight.

In order to facilitate the interconversion of gilberts and ampere-turns, two lines are drawn on Fig. 13 to the top corners of the sheet. These lines are designated "ampere-turn curves," Z and Z' . The curve Z is to be used with the \mathcal{H} scale on the bottom of the sheet at the left hand, and Scale 3 as a vertical scale. For line Z this Scale 3 reads directly, but for Z' it must be divided by 10. For example, to find the ampere-turns equal to 30 gilberts follow a vertical from 30 as the lower left-hand scale to the curve Z , thence a horizontal to Scale 3, finding 24. Also to find ampere-turns equivalent to .8 gilberts, follow a vertical from .8 on the right-hand lower scale to curve Z' , thence a horizontal to Scale 3, finding 6.5; divide by 10, obtaining .65.

In the hypothetical magnetic system of this example a battery has been imagined as furnishing the exciting magnetomotive force, because the calculation of the necessary

quantity of magnetomotive force was, by this artifice rendered more simple. The only other source of magnetomotive force now at our disposal is that of a permanent magnet. As we are utterly in the dark as to the mechanism whereby a magnet is able to act in this fashion, the estimation of a magnet to emit a definite quantity of magnetomotive force is correspondingly obscure. By measurement it is possible to determine the amount of flux any magnet emits, and it is perhaps justifiable to assume that if the magnet produces this flux it can in some mysterious way develop the magnetomotive force necessary to create and maintain the ether stream represented thereby. Experiment can show how much flux can be developed in steel magnets per unit of area. Hence the proper size magnet is determined by dividing the desired flux by the unit flux thus ascertained. The chief practical material so far discovered from which it is desirable to make permanent magnets is steel, and experiment shows that average specimens can rarely be depended upon to develop a flux of more than 3,000 to 5,000 gausses. The preceding calculation has shown that it is necessary to obtain a flux of 3,750 maxwells for this system, and that 224 ampere-turns were required for the purpose. If, therefore, for the soft iron bar, coil and battery of Fig. 14 a permanent magnet be substituted that contains 3,750 maxwells, the same effect should be produced, and the rest of the system will remain as previously calculated. On the basis of 3,000 gausses a magnet of 1.25 sq. cm would be needed.

There is another property which iron exhibits under magnetic influence, which plays an important rôle when this metal is subjected to rapidly alternating electric currents such as constitute the bulk of the line currents in telephone circuits. If a piece of iron entirely in a neutral

condition be subjected to a slowly increasing magnetic field, the curve, A , in Fig. 13, shows that the flux through the iron gradually increases until it becomes practically saturated and thereafter the flux changes with relative slowness. If after such magnetization the magnetizing force is decreased to zero, it is found that the iron does not at once return to its original condition, but on the contrary retains more or less of the magnetism which it has acquired, and that in order to destroy this magnetism, and to enable the piece to assume its original condition of neutrality, a very sensible amount of *demagnetizing* force must be applied. Fig. 15 is an illustration of the way in which a piece of steel behaves under changing magnetic conditions. In this illustration the horizontal scale shows the magnetomotive force, \mathcal{H} , while the vertical scale indicates the resulting flux, β . These scales are plotted from zero in the center of the diagram to show both positive and negative values. If we imagine a piece of neutral metal placed in space containing no magnetic field, its condition will be represented by the zero point of the diagram, and if now a magnetic force, \mathcal{H} (by a coil and battery) be gradually applied and increased as represented along the axis of X , the induction will follow the line $O G A$, which is similar to the A curve shown in Fig. 13. Suppose, when the magnetizing force reaches 100 that it be gradually decreased in the same manner that it was applied, it is then found that the induction in the metal does not return along the line $A G O$, but on the contrary decreases much less rapidly than it rose. With the first application of magnetic field, when \mathcal{H} reached 10, the induction was 800; at 30 it was 3,750; at 70 it was 10,100, and rose to 12,700 at $\mathcal{H} = 100$. Let us suppose at this point that the magnetizing force be arrested and decreased at exactly the same rate that it was

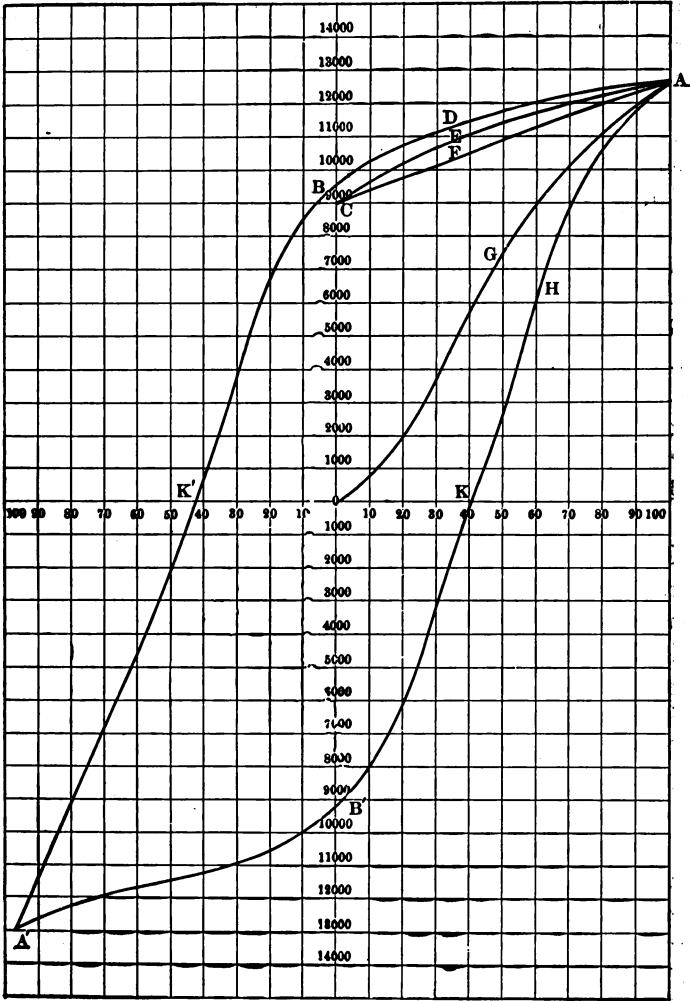

FIG. 15.— MAGNETIC CYCLE FOR STEEL.

originally applied, under these circumstances the induction instead of returning the same way, along the line $A G O$, follows quite a different path, $A D B$, and even when the magnetizing force has been reduced to 0, remains at 9,500. Now, in order to return the piece to its original neutral condition, it is necessary to apply a negative magnetizing force, represented by $O K'$, and as this force increases the induction falls along the line $B K'$, so that the bar does not finally reach its original state until a negative force of 40 has been applied. If now the negative magnetizing force be still further increased a negative induction is created and the piece passes through similar magnetic cycle on the negative side of the axis of X . If we imagine the magnetizing force to continually vary from positive to negative in the manner indicated, the magnetic condition of the iron will follow in a series of cycles that are graphically represented by $A K' A' K A$. Evidently to cause the metal to pass through this cyclical change requires an expenditure of energy, which is derived from the electric current that excites and maintains the changing magnetic field, and the area of the diagram shows the amount of energy which is thus expended in doing internal work upon the molecules. The result of this work is to set up some obscure form of molecular friction that manifests itself as heat, and under long-continued and rapidly alternating magnetomotive forces, pieces of iron become intensely hot. This energy is dissipated by radiation and cannot be usefully employed in any electromagnetic mechanisms. The reader will at once argue that a bit of soft iron will thus waste much less energy than hardened steel. Such is precisely the verdict of experiment, and in Fig. 16 a portion of a similar curve is shown for a piece of soft iron. To save space Fig. 16 only includes the portion of the curve

on the positive side of the X axis. The vertical scale is exactly the same as in Fig. 15, but the horizontal scale is magnified ten times. If this were not done the loop formed by the rising and falling lines of magnetization

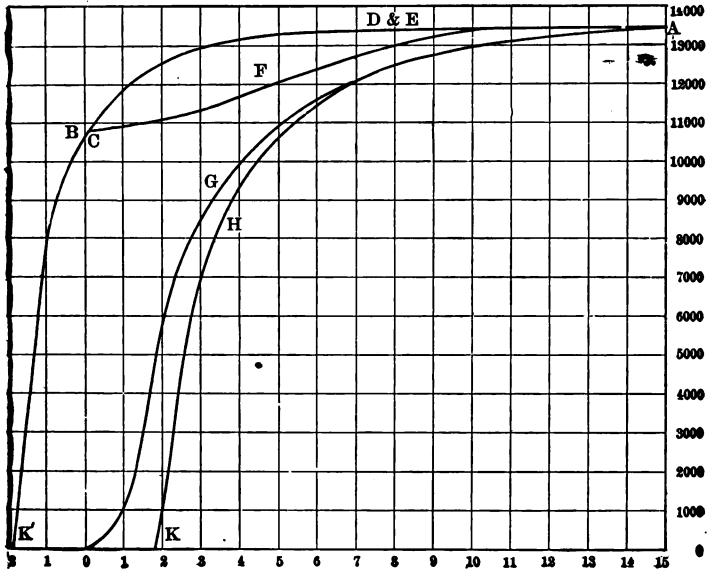

FIG. 16.— MAGNETIC CYCLE FOR SOFT IRON.

would be so close together for the iron as to be almost imperceptible because to produce an induction of 12,500 in steel required 100 gaussses, but in the iron only 8, and it is easy to see by inspection that the steel loop averages nearly twenty times as wide as the iron one. Evidently the area of such a diagram is a measure of the expenditure of energy employed to perform the magnetic cycle. To this phenomenon Prof. Ewing has given the name of *hysteresis*.

In a telephone receiver it is the function of the line current to create alternating magnetomotive forces by the coil which surrounds the magnetic system, and it is obvious that a certain amount of this energy must, therefore, be dissipated in the hysteretic losses in the material that forms the magnets. As the magnetomotive forces developed by the line currents are very small in comparison with the magnetomotive force of the entire magnetic system of the receiver, it is impossible for them to carry the magnet through a complete hysteretic cycle, such as is shown in Figs. 15 and 16. But the iron is carried through a small portion of such a cycle, which is represented in both illustrations by the loop $A E C F A$. Thus suppose, in Fig. 15, that after the magnetomotive force has reached an intensity of 100, it be reduced to 0, and then be increased to 100, the flux will follow the path $A E C F A$. Similarly in Fig. 16, if the magnetomotive force be carried to 15, then decreased to zero and then increased again to 15, the induction follows the line $A E C F A$ on that diagram, and an amount of energy which is represented by the areas of these loops will be dissipated. While such losses are small they are significant when it is remembered that the energy developed in the line current is exceedingly minute, and it is only by the exercise of the greatest possible economy in losses in every direction that improvement in telephone receivers can be made. So it is desirable to secure for the magnetic system such a metal as will show the highest degree of sensitiveness to the feeble line currents, and will simultaneously waste the smallest fraction of this energy in hysteresis.

The curves of Figs. 13, 15 and 16 show that soft iron is much more sensitive to slight changes in magnetism: exhibits a much smaller opposition to magnetic flux; and

dissipates far less energy in hysteresis than steel. Some of the earlier forms of receivers were arranged to have one pole of the magnets carry the line coil, while the other was attached to the diaphragm. This design comprised a magnetic system having great reluctance and large hysteretic losses. As one pole was magnetically attached to the diaphragm, the latter, unless very thick, became supersaturated with the flux from the magnet, and was correspondingly insensitive to the field variations produced by the line current. We are now in a position to understand the logic of the later models in which the magnet carries *two soft iron pole* pieces on which the field coils are wound. The office of the magnet is to create such a field as will maintain all of the magnetic system in its most sensitive condition or state of unstable magnetic equilibrium. Hence the permanent magnet as a generator of the necessary magnetomotive force must have such dimension in relation to the air-gap and diaphragm as will maintain the latter in its most susceptible condition. The proportions of the magnet will, therefore, depend in the thickness and permeability of the pole pieces and diaphragm and the length of the air-gap. The pole pieces form that portion of the magnetic system directly affected by changes in the line current. They must, in addition, transmit to the air-gap the flux created by the permanent magnet that shall, so to speak, sensitize the diaphragm. Hence the pole pieces must have such a section in proportion to permeability as normally to be in the most susceptible condition to respond to the line currents; they must be of such a material as will give the greatest value to μ ; and dissipate the least quantity of energy by hysteresis. To make the whole apparatus as sensitive as possible the air-gap must be as short as is consistent to allow

the diaphragm to make its greatest range of vibration without actually touching the pole pieces to avoid any blurring of its vibrations and prevent the possibility of magnetic adherence to the pole pieces; lastly, the diaphragm must be designed to contain as large a volume of the most permeable material as is consistent with the acoustic principles to be presently developed. We are now prepared to consider materials and methods of constructing permanent magnets, pole pieces and diaphragms.

There are three properties desirable in material for permanent magnets. First, to minimize bulk, the material should have a high permeability in order that it may accept a large amount of magnetism. Second, after magnetization the material should retain as large a proportion of the flux created as possible. The quality of magnetic *retentiveness*, or the ability of a substance to retain and keep the flux impressed upon it, is termed *remanence*. Third, the remanence should be *permanent*; that is, the magnetic state should not gradually change and decay, but should always remain, otherwise the usefulness of the mechanism will sooner or later fail. The ability of any substance to retain permanently magnetism impressed upon it, may be measured by the amount of *demagnetizing force*, which has to be applied, in order to return it to the neutral condition. Thus the specimen from which the curve of Fig. 15 was plotted required a negative magnetomotive force of 40 to cause its magnetism to disappear, while for the one shown in Fig. 16 only 1.9 gaussses were expended. The first sample would be said to be about twenty times as permanent as the second. The amount of negative magnetomotive force that must be expended to cause a body to return to neutrality after having been magnetized is termed "*coercive force*," and such diagrams

as are exemplified in Figs. 15 and 16 are valuable means of estimating magnetic characteristics.

For any specimen of magnetic material the *remanence* is shown by the induction or value of B on the vertical scale, when the value of H is reduced to zero on the return path from a much greater magnetization. The coercive force is measured by the amount of negative magnetomotive force that must be applied to destroy the remanence. Thus in Fig. 19 for the specimens marked 1,294L the rema-

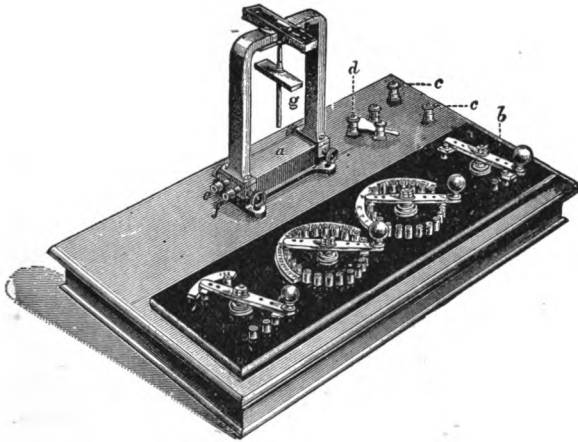

FIG. 17.—PERMEABILITY BRIDGE.

nence is 9,100 and the coercive force 14. There is no means of predicting *a priori* the magnetic characters of any sample of iron or steel, and so much depends on chemical and physical qualities that are at present very obscure that different lots made by the same manufacturer by identical processes will vary widely from a magnetic standpoint. The only sure way is to test a sample of each lot

purchased and plot for each test piece a characteristic curve.

Fortunately apparatus can now be found on the market with which the $B-H$ curve of any sample can be plotted as easily as the resistance of a relay spool can be measured with a Wheatstone bridge. In fact, Ewing's permeability bridge, shown in Fig. 17, performs exactly the office for reluctance that Wheatstone's does for resistance. The operation is as follows: The vertical U bar, g , on the

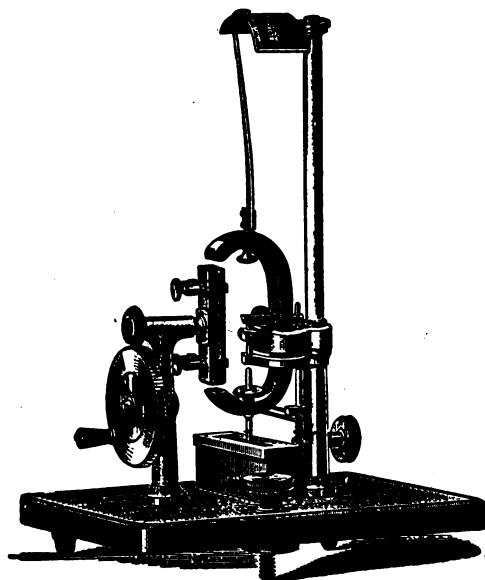

FIG. 18.—HYSTERESIS METER.

rear of the baseboard carries a compass needle. At the base of this U are two holes, e and f , into one of which a standard piece of iron or steel is placed, whose $B-H$

curve is carefully determined. This corresponds to a standard resistance coil. Alongside of this standard is placed the bar to be tested. Magnetizing coils are provided in the base of the apparatus controllable by the sliding contacts of the switch handle seen in front. Now, if the magnetic condition of the standard bar and the test bar are exactly the same no effect is produced on the needle on the top of the yoke, but if they are not the same, the needle deflects and the magnetizing effect of the coils is altered till the needle comes to zero exactly as in a Wheatstone bridge the pegs are moved till the galvanometer reads zero. To measure hysteresis the same inventor has produced the apparatus shown in Fig. 18. The sample to be measured is clamped on the spindle that can be rapidly rotated by the gear and crank. It is then set in motion and whirled between the poles of a suspended magnet. This magnet is supplied with a long pointer moving over a graduated arc on the top of a column to which the magnet hangs, and the hysteresis is measured by the deflection of the needle. With such facilities at command there is little excuse for any manufacturer who fails either to provide the best magnetic materials or maintain a uniform standard.

From time to time many investigations of the magnetic qualities of various irons and steels have been made. The chief early workers in this field were Ewing and Hopkinson, from whose researches, as well as from various other sources, the general data of Table I is compiled. But it must be remembered that while such information is of value as a general guide it can by no means supplant the necessity for each maker to watch and test the particular brands he employs; as well expect an engineer to build a

bridge on general principles, without exacting tests of the particular channels, eye beams and eye bars that he uses.

TABLE I.

Remanence and Coercive Force of Various Samples of Steel.

Kind of steel and observer.	Max. H applied.	Max. R attained.	Residual B	Coercive force,
Ewing.				
Steel wire, hard drawn	57	14,300	8,200	16
Steel wire, annealed	53	14,600	11,700	17.5
Steel wire, glass-hard	55	9,400	6,800	39
Piano forte steel wire, normal temper.	92	14,600	11,800	27
Piano forte steel wire annealed	94	14,300	10,500	24
Piano forte steel wire glass-hard	98	12,700	9,600	41
Cast iron	16	3,700	2,600	8
Very soft iron wire	17	13,500	11,000	1.9
Annealed wrought iron	90	16,200	12,700	3
Whitworth mild steel, annealed	250	16,120	10,740	8.3
Hopkinson.				
Whitworth mild steel, oil-hardened.....	250	16,120	8,736	19.4
Chrome steel, as forged	250	14,680	7,568	18.4
Chrome steel, annealed	250	13,233	6,489	15.4
Chrome steel, oil-hardened	250	12,868	7,891	40.8
Tungsten steel, as forged	250	15,718	10,144	15.7
Tungsten steel, annealed	250	16,498	11,008	15.3
Tungsten steel, hardened tepid water..	250	15,610	9,482	30.1
Tungsten steel, (French) oil-hardened..	250	14,480	8,663	47.1
Tungsten steel, very hard	250	12,133	6,818	51.2
Weber, common steel magnet			3,947	
Von Waltenhofen tungsten steel, glass-hard			4,638	
Perry, Jowitt's steel			12,600	
Preece, Wall's steel			1,519	
Preece, Ashford's steel			1,704	
Preece, Saunderson's steel			1,435	
Preece, Jowitt's steel			1,435	
Preece, Vicker's steel			1,174	
Preece, Crewe "rivet steel"			186.6	
Preece, Crewe "spring steel"			1,391	
Preece, Clemandot steel (compressed and tempered)			2,264	
Preece, Clemandot steel (compressed but untempered)			1,333	
Preece, Marchal steel			2,540	
Preece, Allevard steel (mercury-hardened)			1,315	
Preece, Allevard steel (water-hardened). ..			1,660	
Gray, magnet steel, glass-hard			6,536	
Evershed, Wall's and Jowitt's steels (mean)			4,000	
			to	
			5,000	
			6,000	
Brown, magnet steel, glass-hard.....			to	
			7,000	

Recently Messrs. Barrett, Brown and Hatfield have made a very extended investigation upon the magnetic properties of the more modern steels and irons, the results of which

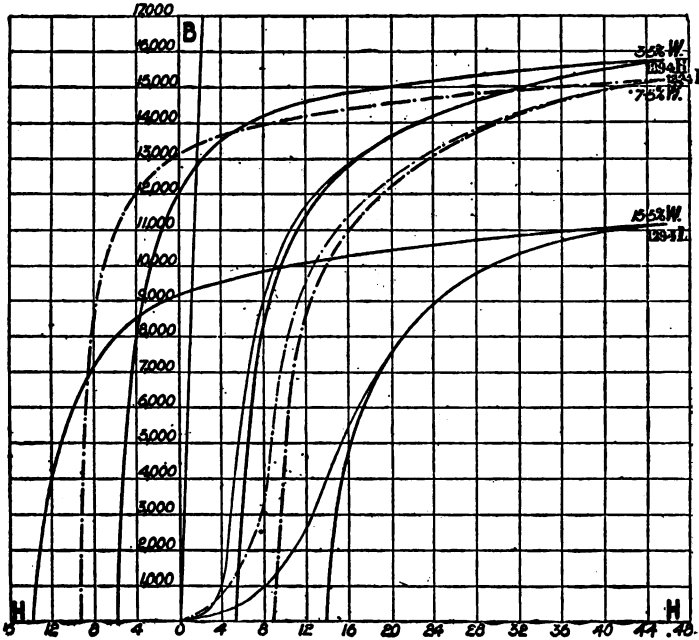

FIG. 19.— CURVES FOR TUNGSTEN STEEL.

have appeared in a paper before the Institution of Electrical Engineers.* A portion of the results obtained by these investigators that are of particular value to telephonists

* See *Journal of the Institution of Electrical Engineers*, Vol. xxi, No. 156.

as showing that some peculiar alloys of iron would seem to be specially adapted to the magnetic system of receivers.

The data exhibited in these tables show there is a wide variation in the properties of the various steels obtainable for permanent magnets. In Table II the steels that appear the most valuable to the telephonists are those con-

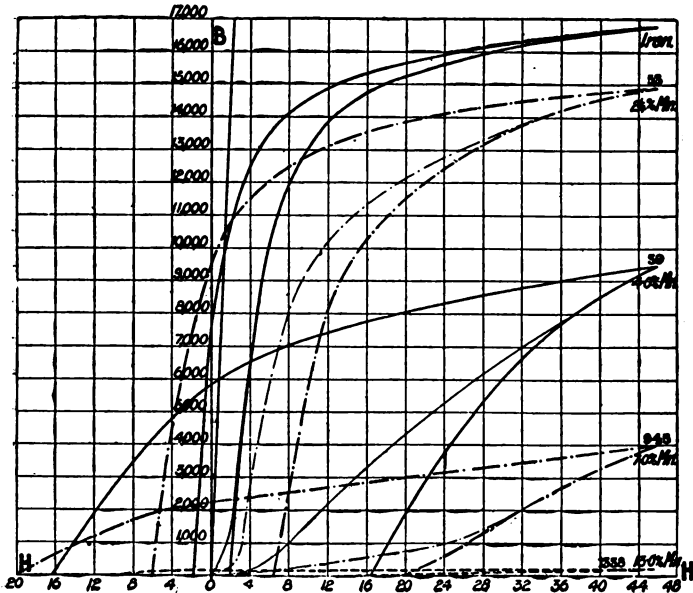

FIG. 20.— CURVES FOR MANGANESE STEEL.

taining manganese, nickel and tungsten, and to exhibit the properties of these steels more completely Figs. 19, 20 and 21 give the hysteretic curves for the various samples referred to in Table II. From these curves it is easy to

pick out by inspection four samples that are seemingly the best suited to the manufacture of permanent magnets. The relative qualities of these specimens are shown in Table III.

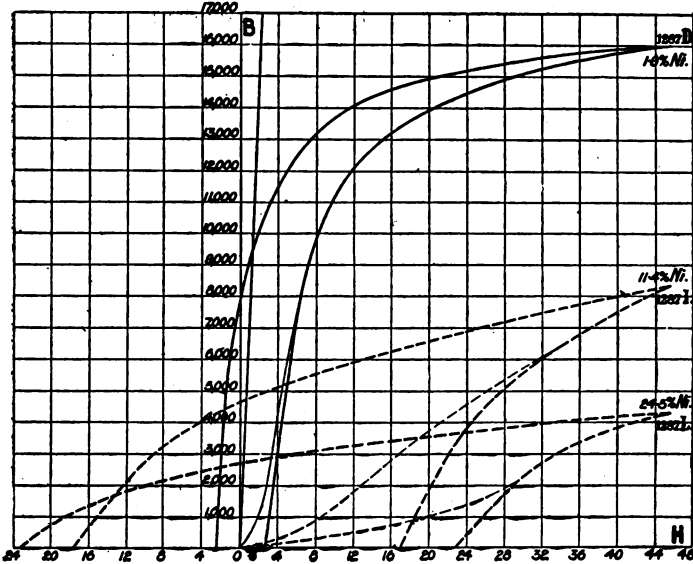

FIG. 21.— CURVES FOR NICKEL STEEL.

In selecting a steel for a permanent magnet two somewhat opposing qualities must be balanced. A high permeability and, in general, relatively great remanence is usually coupled with a low coercive force. Hence while such steels exhibit the ability to develop (temporarily at least) a large magnetomotive force per unit of volume they are apt to soon decay, and lose the magnetism impressed on them. Magnets made of such material may be of light

TABLE II.
Magnetic Properties of Iron Alloys.

GROUP.	Mark.	Percentage of main element alloyed with iron.	Maximum induction for H = 46.	Permeability μ for H = 8.	Remanence in terms of B.	Coercive force in terms of H.	Energy dissipated per complete cycle. Ergs. per c. c.
Carbon steels.....	B	0.08C.	16,800	1,025	9,770	1.66	10,760
	LSS	0.05C.	15,720	1,500	9,090	1.66	11,800
	611	0.58C.	15,610	1,035	10,370	2.66	22,200
	613	1.00C.	14,000	654	9,000	6.48	32,750
	614	1.25C.	14,000	375	9,040	6.48	33,980
	48	0.50Mn.	16,000	1,165	10,000	3.20	19,650
Manganese steels.....	4147	1.00 Wn.	15,540	1,100	11,320	3.4	22,150
	53	2.25Mn.	14,720	1,060	10,460	6.0	31,580
	89	4.00Mn.	9,370	125	5,950	16.2	39,500
	84	4.75 Wn.	6,320	73	5,40	19.6	39,400
	945A	7.00Mn.	3,820	23	230	20.0	19,650
	1267D	1.92Ni.	16,000	1,360	9,140	2.67	15,800
	1267E	3.82Ni.	16,190	1,375	9,320	2.76	15,80
	1267B	4.75Ni.	10,500	125	6,910	14.25	39,800
	1267I	11.39Ni.	8,190	118	4,690	17.35	32,050
	1447B	12.10Ni.	4,170	4,500	22.40	21,850
Nickel steels.....	1447A	12.70Ni.	4,480	3,900	22.10	24,280
	1267K	19.64Ni.	7,770	90	4,770	20.00	36,850
	1267L	24.50Ni.	4,240	32	2,790	22.50	22,200
	1449	31.40Ni.	4,460	257	1,720	0.50	603
	1294F	1.0 W.	16,000	1,400	10,000	3.23	14,150
	1294H	3.5 W.	15,720	1,220	12,720	5.73	25,050
	1294I	7.5 W.	15,230	500	13,280	9.02	47,500
	1294L	15.5 W.	11,090	125	9,320	13.92	44,000
	1167D	0.75Al.	16,000	1,500	10,500	1.80	11,000
	1167H	2.25Al.	16,900	1,700	10,500	1.00	8,000
Aluminum steels.....	1167I	5.50Al.	13,000	1,200	4,150	1.00	6,500
	898E	2.5	16,420	1,630	4,080	0.90	7,900
	898H	5.5	15,980	1,630	3,439	0.85	6,500
Silicon steels.....	1264A	1.59	14,600	10,520	5.0
	1264B	2.5	14,300	10,410	5.4
	1178B	1.74Cr.	14,490	1,040	10,350	6.0	25,760
Chromium-aluminum steels.	1178D	0.75Al.
	1178D	1.5 Cr.	13,890	1,180	9,080	3.52	17,550
	1178E	2.25Al.
	1178E	1.5 Cr.	13,150	1,060	8,560	1.77	13,420
	1179B	4.5 Al.
	1179B	3.5 Cr.	13,540	466	9,550	8.0	34,700
	1286A	1.0 Al.
	1286A	0.75Cr.	16,480	1,210	7,730	3.0
Chromium-nickel steel.....	1286C	2.75Ni.
	1286C	1.75Cr.	15,120	475	11,110	7.9
	1210J	2.5 Ni.
Manganese-nickel steel.....	1254C	4.5 Cr.	18,650	9,800	13.1
	1108A	2.5 Ni.
	1108A	3.75Mn.	6,410	121	3,770	19.6
Silicon-nickel steels.....	1108C	4.0 Ni.
	1108C	2.0 Si.	15,750	1,085	6,780	2.0
	1108C	3.25Si.	15,480	1,240	7,050	1.9
Tungsten-cr. steel.....	1189B	3.5 Ni.
	1189B	2.0 W.	15,950	1,125	12,150	5.3
	1189B	0.75Cr.
Tungsten-mn. steel.....	687	3.25W.	15,250	815	12,080	6.5
	687	2.35Mn.

weight and of small volume. On the other hand, steels which show a high coercive force indicative of great permanence have relatively low remanence because their permeability is small, and it is impossible to make them retain even with the most intense fields more than 5,000 to 8,000 gauss. Magnets made of such steels, while exhibiting great durability, can only emit a relatively feeble magnetomotive force per unit of volume, so such magnets must be large in volume and correspondingly heavy. On the whole for telephone receivers great coercive force is to be preferred, but the quality of remanence must not be entirely ignored or the magnet will become too bulky. Of the specimens in Table III, sample No. 3 showed the

TABLE III.
Composition of Steels.

Kind of steel.	Remanence.	Coercive force.
1 Manganese, 4% Mn	66%	86%
2 Nickel, 11.4% Ni	56%	75%
3 Nickel, 24.5% Ni	28%	100%
4 Tungsten, 15.5% W	100%	58%

highest coercive force, but the remanence is very low. While such a steel would be "permanent" its power of producing magnetomotive force would be small, necessitating a large and heavy magnet to secure the requisite flux. Sample No. 4 shows very great remanence, and excellent coercive force. Such a steel would be better suited to receiver magnet manufacture than any of the others.

Not only does the permanent magnet depend for its success upon the kind of material from which it is manufactured, but as much is involved in the treatment which the metal receives at the hands of the smith in forging and tempering. A general impression exists that the harder the temper, the better the magnet will be; but like

many other current ideas this is fallacious. It is more a question of careful working and *judicious* tempering, than the attainment of great hardness; furthermore, the temper to be given depends somewhat upon the shape of the magnet, for experiment has shown that short magnets should receive a harder temper than long ones. It is eminently desirable that all heating and forging should be done in a muffle with the greatest care; hammering should be avoided as much as possible and forming done in a die with a press, for a careless smith may irretrievably injure the very best steel.

There are two methods of hardening steel; one involves heating and suddenly cooling by plunging in water, oil or mercury, and the other by subjecting to the metal great pressure while in a molten or semi-molten condition. There is no doubt but that the latter gives by far the most satisfactory results, but this process requires an elaborate and expensive plant. The aim in tempering should be to secure as fine, uniform and homogeneous a grain in the finished bar as possible. Each manufacturer has some pet method to attain this result, but all of these dodges, and the various nostrums which are advocated as tempering baths, probably possess but little actual influence upon the final physical condition of the steel, but have considerable influence psychologically upon the man who is making the magnets, and inspires him with confidence and care in their manufacture.

It has been observed that the desirable degree of hardness for permanent magnets depends somewhat upon the size of the magnet, or rather upon the relation of its length to its diameter. No absolutely conclusive experiments have been made to determine the precise connection that exists between hardness and the ratio to length of diameter.

but in a general way it is understood that short magnets should be harder than long ones.

Some experiments of Stonhal and Barus, while not final evidence of the dependence of permanent magnets upon hardness, and of hardness to shape of magnet are indicative of the relations which exist between these quantities.

The results alluded to are summarized in Table IV.

TABLE IV.

Relative Magnetic Properties of Steels Containing Manganese, Nickel and Tungsten.

Designation.	Relative hardness in per cent. glass-hard = 100.	Relative length to diameter.				
		10	20	30	40	50
		Magnetization.	Magnetization.	Magnetization.	Magnetization.	Magnetization.
Glass-hard	100.0	100.0	87.5	65.0	54.5	50.5
Annealed 1 hr. in steam	88.0	94.0	84.0	62.0	52.0	48.5
Annealed 3 hrs. in steam	83.5	94.0	82.0	61.0	51.0	47.5
Annealed 6 hrs. in steam	80.0	94.0	82.0	61.0	51.0	47.5
Annealed 10 hrs. in steam	78.0	94.0	82.0	61.0	51.0	47.5
20 min. at 185 centigrade	66.0	85.0	82.0	63.5	54.0	51.0
1 hr. at 185 centigrade	63.0	86.0	90.0	66.5	56.5	54.0
3 hrs. at 185 centigrade	58.0	87.0	92.0	71.5	61.5	58.0
7 hrs. at 185 centigrade	55.0	88.0	97.0	78.0	67.5	64.0
13 hrs. at 185 centigrade	52.5	84.0	98.5	80.0	69.0	69.0
10 min. at 240 centigrade	50.5	82.0	100.0	83.0	76.5	72.0
1 hr. at 330 centigrade	43.5	76.5	100.0	93.5	88.5	87.0
1 hr. at 420 centigrade	37.0	58.0	88.0	100.0	100.0	100.0
Annealed	34.0	16.0	21.0	25.0	31.0	40.0

According to our present notions each molecule of a magnetic substance is surrounded by the same sort of a stream of ether as that which we imagine issuing from and returning to the poles of an ordinary bar magnet. In soft iron the molecules are heterogeneously arranged, conse-

quently the ether stream from one particle is neutralized and annulled by those from its neighbors, consequently the entire piece is in a non-magnetic condition. When magnetized all of the particles are turned so that their respective ether currents flow in the same direction and thus the stream from one particle uniting with those of its neighbors gradually increase the flux until it becomes of sufficient volume to impress itself upon our senses. Annealed iron is so soft that it is easy for a slight magnetizing force to pull the molecules in line, and as soon as this force is removed there is so little tenacity that the particles readily drop back in their neutral condition. With hard steel the material possesses so much more resistance that it is difficult to impress magnetism upon it, and a much stronger magnetic force is required to produce a corresponding result. Owing to the greater tenacity of the piece, after it has once been magnetized the molecules are unable to return to their original positions and consequently it retains its magnetism. If this theory be correct anything which tends to disturb the molecular condition will correspondingly operate to injure and destroy permanent magnetism. This is abundantly verified by experiment, for if a piece of soft iron be magnetized it will, if undisturbed, retain a noticeable amount of the impressed magnetism after the magnetomotive force is removed, but if it be jarred in the slightest degree so as to set its particles vibrating, it will immediately lose nearly if not all traces of the magnetic charge. Similarly in the case of a piece of tempered steel, while it exhibits much greater permanency it is nevertheless sensitive to all kinds of shocks, and after magnetization care should be exercised not to pound or jar it.

The tables and curves show that it is possible with some varieties of relatively hard steel to confer a flux of from

10,000 to 14,000 gaussers. But such material shows so little coercive force that magnets made therefrom can hardly be called permanent, for even with the utmost pains to avoid vibration, pieces so highly magnetized will by mere lapses of time lose a notable fraction of the charge. Contrariwise other steels which cannot be magnetized more than 4,000 or 6,000 gaussers, exhibit sufficient retentiveness to retain all the magnetism imparted for many years in spite of much ill treatment in the way of shocks and blows. To secure permanence, therefore, it is advantageous to artificially age magnets before they are used. After being carefully forged and properly hardened the magnet should be as powerfully magnetized as possible. Almost every maker has a pet method of charging, but all that any can accomplish is to subject the bar to as powerful a magnetic field as possible, and while under the magnetic flux it is well to jar it or pound it in order to bring as many molecules as possible into proper magnetic alignment. After the magnet has been charged it should be allowed to rest quietly for a few days, to allow the molecules to become accustomed to their new positions. Aging should then be performed by *cooking* the magnet; namely, it should be put in a steam bath or boiled at a constant temperature of 212° for some hours or even days. Under this treatment a portion of the magnetism is lost, but that which is retained may be considered highly permanent, for magnets made of the best steel, carefully forged, thoroughly magnetized and subsequently well aged, show almost no magnetic change even after the lapse of several years.

Material for pole pieces and the diaphragm should possess diametrically opposite magnetic qualities to those described for permanent magnetic. Formerly the softest

and best annealed charcoal iron has been found the best material for the purpose, as it possesses the great permeability and small coercive force.

In Fig. 13 a $B-H$ curve is given for sheet steel and for ferrotype metal. The latter has in the past been al-

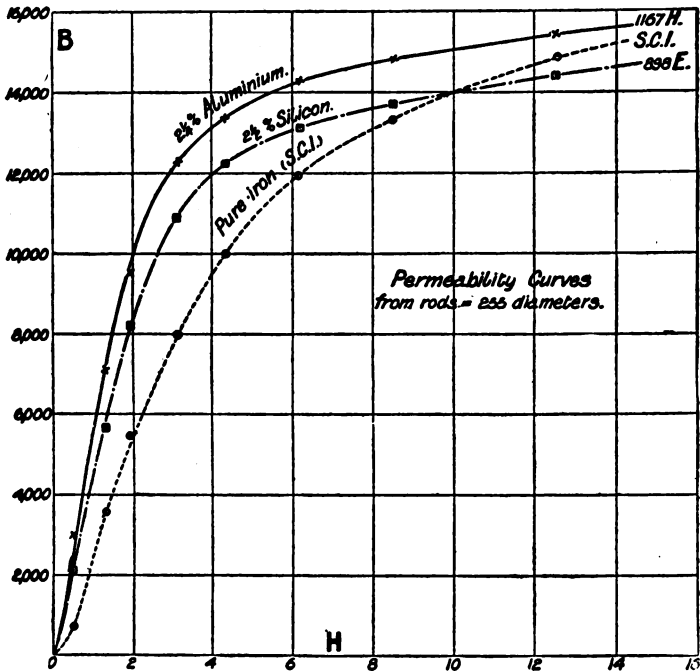

FIG. 22.— CURVES FOR SPECIAL IRONS.

most exclusively used for diaphragms, and while it shows a very high ultimate permeability with intense fields ($H = 30$), it is less sensitive than soft iron or sheet steel. Further, its hysteric losses are considerable, and its co-

erceive force high. In these respects sheet steel shows itself the peer of any metal save some of the more unusual iron alloys. But with improved metallurgical processes other alloys of iron show themselves to be superior to the older charcoal brands. Thus the researches of Barrett, Brown and Hatfield show irons containing $2\frac{1}{2}$ per cent. of silicon, and $2\frac{1}{4}$ per cent. of aluminum, that are respectively 33 per cent. and 45 per cent. more permeable than the best of charcoal irons. The magnetic characteristics of these alloys compared to charcoal iron are shown in Fig. 22, while Table V exhibits additional tests of some such alloys as compared with the best annealed Swedish iron. The sample 898E by analysis gave iron, 97.3 per cent.; silicon, 2.50 per cent. No. 1178H had a composition of iron, 97.33 per cent.; carbon, .24 per cent.; aluminum, 2.25 per cent.; silicon, .18 per cent.

TABLE V.

Magnetic Qualities of Silicon and Aluminum Irons.

H	Charcoal iron.		898 E. Silicon iron.		1167 H Aluminum iron.	
	B	w	B	w	B	w
2	7,400	3,700	10,200	5,100	12,000	6,000
4	11,150	2,790	12,300	3,075	13,800	3,450
6	12,600	2,100	13,400	2,233	14,500	2,416
8	13,600	1,700	13,800	1,725	14,900	1,862
10	14,300	14,300	14,200	1,420	15,200	1,520

It appears well worth the while for receiver manufacturers to secure samples of such alloys and see whether some improvement in receiver construction could not be accomplished by their employment for diaphragm and pole pieces. Finally to avoid the eddy currents which are inevitably set up whenever a change in magnetic field occurs, it is from a theoretical standpoint advisable to laminate thoroughly the permanent magnets, the pole pieces and the

coil spools (if constructed of metal). That this refinement would undoubtedly add considerably to the cost of the receivers is unquestioned, and whether the "game would be worth the candle" can only be determined by experiment. But it is certainly a move in the right direction, and the time is rapidly approaching when in all departments of telephony it will not be the *cheapest apparatus*, but the *best apparatus* which will alone be tolerated, and

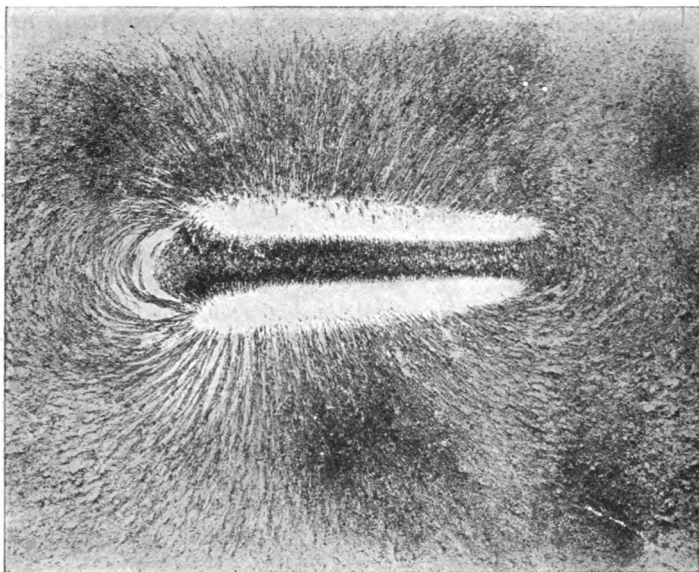

FIG. 23.—RECEIVER PHANTOM; POLE PIECES DETACHED.

it is only those who are foresighted enough to see that the best is always in the end the cheapest, who will be able to survive in the competition which daily grows more and more fierce.

One of the best methods for investigating the magnetic properties of a telephone receiver system is to examine the field by means of iron filings, making a so-called *phantom*. Such a picture of the magnetic field only indicates the distribution of the flux in one plane, and by no means can be considered an accurate quantitative measure of the magnetic system, but if some precautions are observed the

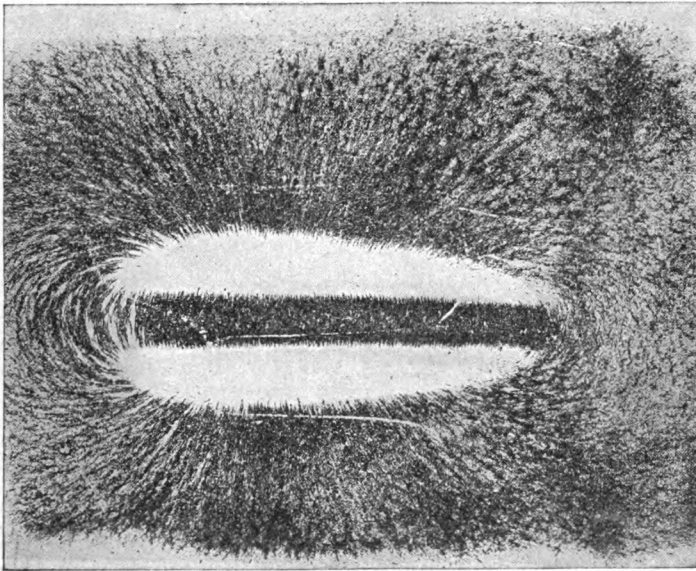

FIG 24.—RECEIVER PHANTOM; POLE PIECES IN PLACE.

relative fields of two instruments may be compared with considerable accuracy. It is best to prepare the iron filings by sifting them through two sieves of nearly the same sized mesh; for example, one sieve of No. 40 and one of No. 50, namely 1,600 meshes and 2,500 meshes per square inch,

accepting for the purpose only those filings which are retained by No. 40 sieve and passed by No. 50 sieve. A definite amount of filings, measured preferably by weighing, should be selected, and the same quantity used for each test. This quantity of filings should be carefully and evenly distributed over a photographic plate by sifting them through a slightly coarser sieve, say No. 35. In this way each plate used is uniformly covered with almost the same number of filings and consequently the density of the filings per unit area is about the same. The best plate for the purpose is a celluloid film, because it is much thinner than the ordinary glass plate. After the filings are properly deposited on the celluloid it should be gently laid in proximity to the magnet under investigation and tapped. In each case the same number of blows of the same intensity should be given in order that equal liberty shall be given to the filings to arrange themselves in the field. For this purpose an electric bell, provided with a heavily weighed clapper, to retard its motion, is an excellent device. Some results by this method of study of the magnetic system of a receiver is shown in Figs. 23, 24 and 25. The receiver selected for the purpose was a Stromberg-Carlson.

In Fig. 23 the field of the permanent magnet is shown with the pole pieces detached. Here the fanning out of the lines of force across a gap usually occupied by pole pieces is conspicuously shown. In Fig. 24 the pole pieces occupy their normal position. A noticeable change in the field is shown as it is denser, with fewer leakage lines between the limbs of the magnet and the leakage across the gap pole pieces is less marked. In Fig. 25 the diaphragm has been put in place and here the change in the field is exceedingly conspicuous. The leakage across the poles is

much reduced. The field around the magnet bar is less dense and the lines of force in the surrounding field markedly reduced. In this way a valuable analyses of the behavior of the magnetic systems of receivers may be obtained

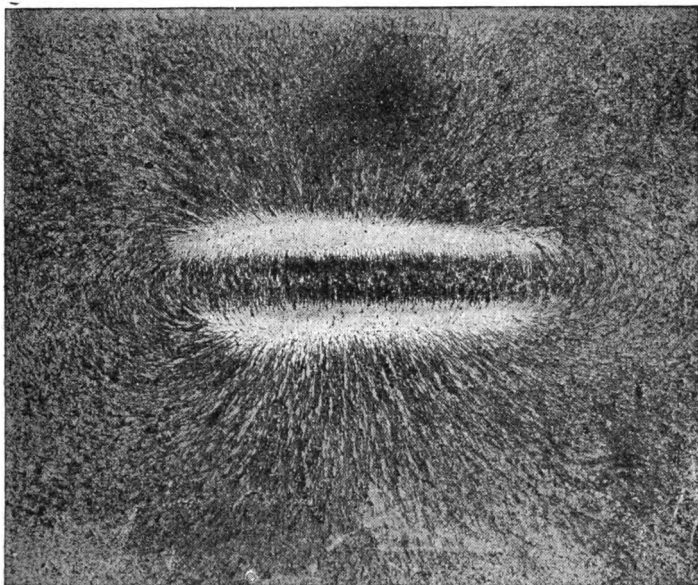

FIG. 25.—RECEIVER PHANTOM; DIAPHRAGM IN PLACE.

and estimates formed as to the relative proportions of the magnet, the pole pieces and the diaphragm, and by making a series of such diagrams of a number of such instruments valuable deductions may be drawn as to the relative desirability of the various designs employed.

The office of the diaphragm is to vibrate under the impulsion of the changing magnetic field produced by the line current, and by its motion to create the sound waves

that shall convey to the listener the words spoken at the transmitter. The diaphragm must, therefore, be considered from two points of view: its ability to respond to field changes, or its magnetic properties; and its ability to produce sound waves or acoustic properties. Its magnetic qualities, at least from the standpoint of the prevailing notions of the magnetic circuit, have been considered, but it remains to examine such experimental evidence as exists that may tell for or against this theory. Unfortunately, such experimental evidence, at least so far as it exists outside the private archives of various receiver makers, is exceedingly meagre.

In 1878 Dr. C. J. Blake described before the Society of Telegraph Engineers (British) a series of experiments on the vibration of the diaphragm, and exhibited curves drawn on smoked glass, showing an excursion of the diaphragm of .02 mm., which seems a large value. In 1882 Salet describes in *Compt Rendus* a similar study, but only shows a vibration amplitude between .0002 mm and .0003 mm. The next investigation was by Fröhlich, published in *La Luminière Electrique* in 1887, who found a maximum amplitude of .035 mm. In the *Elektrotechnische Zeitschrift*, of 1890, Franke describes an investigation and concludes that an audible sound could be produced by a diaphragm vibrating .00000012 mm. Probably the most carefully conducted study is that made by Messrs. Cross, Williams, Hayes, Mansfield and Phillips during 1888-1893 at the Rogers Laboratory of Physics, the results of which appeared in the *Proceedings* of the American Academy of Science. Some of the conclusions of these investigators are here summarized.

The apparatus used consisted in a magnetic system composed of a round bar of soft iron carrying a coil of wire

connected to a battery, rheostat and ammeter, whereby any desired magnetomotive force could be produced, and a magnetometer with which the actual magnetism developed in the bar could be measured. On the end of the magnet thus formed a coil of fine wire was placed that represented the line coils of the ordinary receiver. To produce the line current an alternating-current transformer, having a frequency within the common range of vocal sound, was employed in some cases, and a powerful transmitter in others, but in all tests the line current was measured with a dynamometer or milliammeter. An exploring coil was also provided so that the results of the motion of the diaphragm in producing electrical waves could be measured by another dynamometer. Finally in front of the magnet a means for holding diaphragms was contrived so arranged that the different sample diaphragms to be tested could be held rigidly at any desired distance from the pole. The apparatus was so designed that the diaphragm could be suddenly mechanically vibrated a definite amount by a falling weight, and thus its action in producing an induced current in the exploring coil measured, also by a microscopic micrometer, the movement of the diaphragm under the action of any desired line current could be measured. By this means the apparatus could be operated either as a *transmitter* (an electromagnetic one) or as a *receiver*.

The first set of tests was made by using the apparatus as a transmitter. The diaphragm was of ferrotype metal .01 in. thick and $2 \frac{5}{16}$ in. in diameter, set .03 in. from the pole. By means of the falling weight it could be given a vibration of about .01 in. The exciting current of the magnetic system was varied, and the electrical impulses produced in the exploring coil measured. The results are shown by curve 1 (Fig. 26). As the field strength

increased from 0 to 14, the induced current rose rapidly to 28, then declined to about 11 and thereafter remained nearly constant. Unfortunately the scales of these results are arbitrary ones and no data is given by which to correlate them with the units now used in connection with

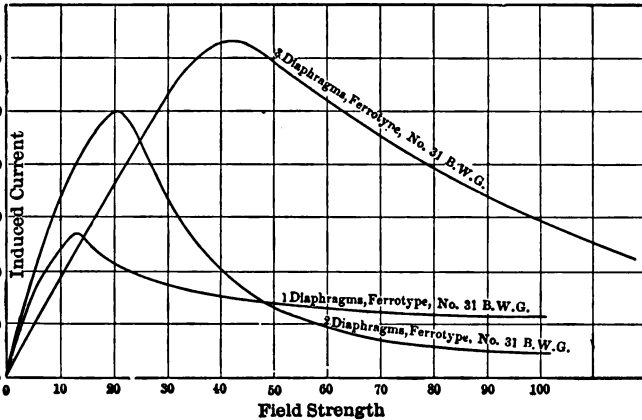

FIG. 26.—RELATION BETWEEN STRENGTH OF FIELD, THICKNESS OF DIAPHRAGM AND INDUCED CURRENT; FERROTYPIC DIAPHRAGM.

the magnetic circuit except that the induced ordinate 100 corresponds to a discharge of about .00000097 coulombs. But nevertheless curve No. 1 shows very plainly that the maximum reaction of the diaphragm takes place in a field that is quite weak, and that as the greatest range of action is a very narrow peak, much care is needed to proportion the field to the diaphragm to secure the best results. Curves 2 and 3 are plotted from similar tests made by using respectively two thicknesses, and three thicknesses of No. 31 B. W. G. gauge ferrotypic metal in place of one. In each test the shape of the curve is the same; a sudden rise to a high peak and a slower decline. The relative

ordinates measuring the current induced, and the relative field strengths at which the maximum ordinate occurs, are very nearly proportional to the diaphragm thickness; so nearly as to be well within the range of probable experimental error. These curves teach that it is the relative magnetic saturation of the diaphragm that controls the line impulse given by its vibration. The thicker the diaphragm, the stronger the field may be, and the greater the impulse, both of the quantities being almost directly proportional to the thickness of diaphragm, finally the necessity of an accurate proportioning of field to thickness is

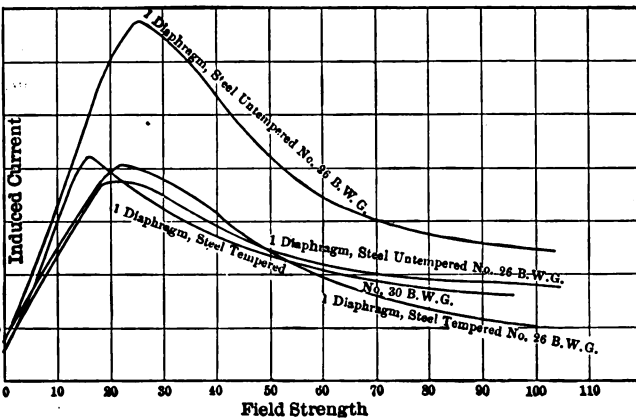

FIG. 27.—RELATION BETWEEN STRENGTH OF FIELD AND INDUCED CURRENT; DIAPHRAGMS OF SOFT AND HARD STEEL.

most clearly shown, with the inference that there is a much greater margin in which to work with thick diaphragms than with thin ones.

To further demonstrate the effect of variation in permeability trials were made with diaphragms made of steel, both soft and hard. In Fig. 27 curve 1 shows

the relation between strength of field and induced current with a diaphragm of untempered steel No. 26 B. W. G. in thickness. No. 26 is 180 per cent. as thick as the No. 31 gauge diaphragm of Fig. 26, hence the maximum ordinate of induced current is higher, reaching 68, but the field strength is 25, against 13 of Fig. 26, showing, as would be expected, that a larger magnetizing force is needed with a less permeable material. The curve, though, is the same shape, but broader, because for steel there is no such sharp bend in the β - \mathcal{H} curve as in iron. Curve 2 gives the results on a hardened diaphragm of the same thickness. The peak of the induced current ordinate has fallen to 42, and the field strength to 17. With the decrease in permeability that accompanies tempering, the induced current ordinate would be lower, but it would also be expected that the subsequent portion of the curve would fall off less rapidly than in the case of soft metal, as the β - \mathcal{H} curve for hard steel shows no marked saturation point. Such, however, is not the case, for the curve closely resembles in shape those from iron of No. 31 B. W. G.

The curves of Fig. 26 show the results obtained by superimposing two and three thicknesses of iron, one upon the other in making up the diaphragm, but evidently such a mass of separate laminae would be quite non-uniform, and one might well be distrustful of results. In Fig. 28 further tests on diaphragms of sheet iron of a number of different thicknesses are given, but here each test is for a solid sheet, and the material is somewhat more permeable than ferrotype metal. In all respects the results are confirmatory of the deductions of the previous tests, and taken in connection therewith form a valuable mass of data well worthy of careful study by those who design and operate receivers.

In the preceding investigation the apparatus was used as if it were a transmitter, for a vibratory impulse was given to the diaphragm, and the resulting electric pulse

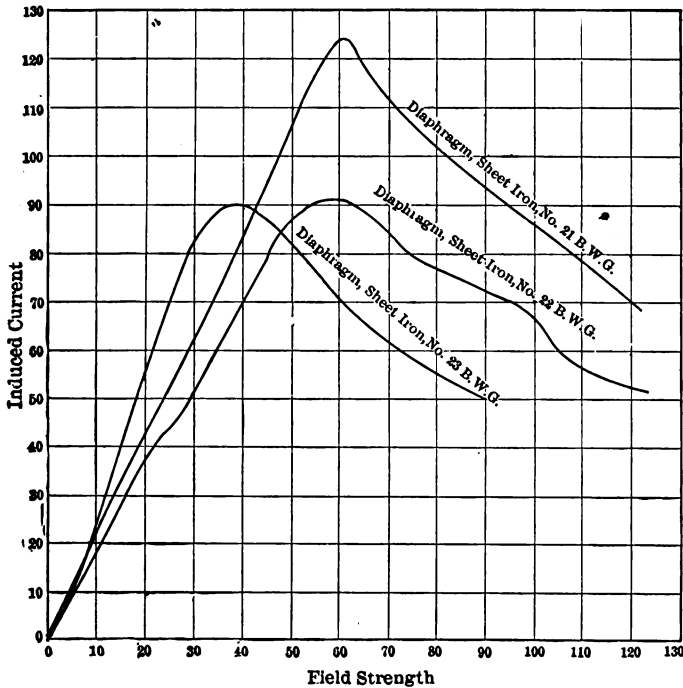

FIG. 28.—RELATION BETWEEN STRENGTH OF FIELD AND DIAPHRAGMS OF VARIOUS THICKNESSES OF SHEET IRON.

(as a momentary line current) measured. The conditions were then reversed, a small current, representing a wave from a transmitter, was sent through the line coil, and the effect, as an induced current measured by the ex-

ploring coil. In the first trial no diaphragm was used. The results are shown by curve B, Fig. 29. The field

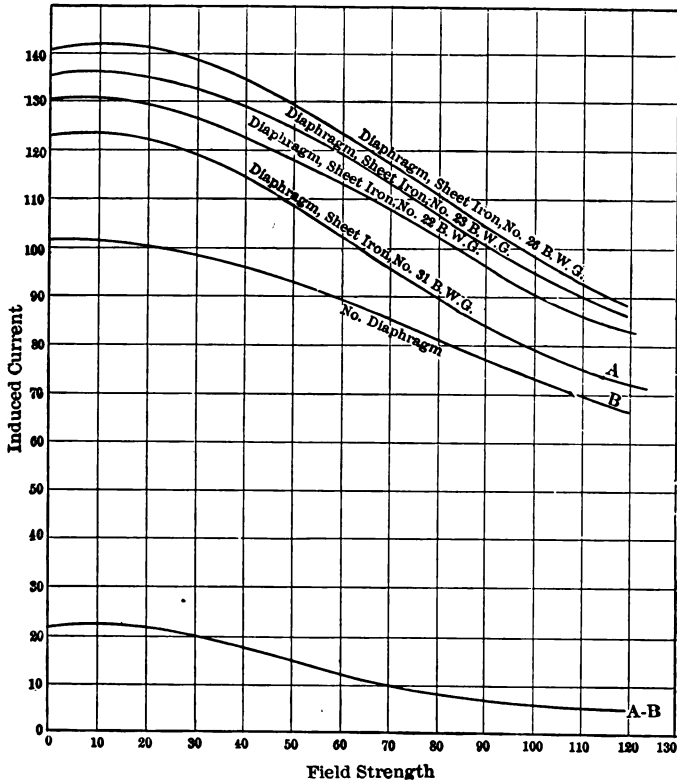

FIG. 29.—RELATION BETWEEN STRENGTH OF FIELD, INDUCED CURRENT AND THICKNESS OF DIAPHRAGM IN A RECEIVER.

strength was varied from 0 to 120, electric impulses of constant amount sent into the line coil and the effect on the exploring coil measured. With no diaphragm

the induced current commenced nearly at a maximum of 102, remained nearly constant till a field of 20 was reached and then steadily declined. Such a result would be anticipated from the general appearance of a β - \mathcal{H} curve for very weak fields, for the relative magnetizing effect of a small increment of current is much greater with a weak field than with a strong one. A diaphragm of No. 31 B. W. G. sheet iron was then added and the effect is shown by curve *A*. Here the induced current increased markedly from a field of 0 to one of 10, and then drops with a decidedly greater slope. The lowest curve in Fig. 29, marked *AB*, is the difference between curves *A* and *B*, and shows the effect on the induced current of the presence of the diaphragm, by introducing into the field a substance of greater permeability. The test apparatus, as is readily seen from the description, was similar to a *single* pole receiver, having an air-gap equal to the length of the magnet. It is to be regretted that similar trials were not made with a double-pole type when the presence of the diaphragm would be expected to produce a much more marked effect. Many experiments on diaphragms of different thicknesses were made, those for Nos. 22, 23 and 26 being reproduced in Fig. 29. An examination of these curves show that the induced current rose in value as the diaphragm was reduced in thickness, also that the strength of field similarly increased. A careful examination of the results shows the following values:

Thickness in B. W. G.	Induced current.	Field.
21	131	6
22	132	10
23	137	13
26	142	18

With thin diaphragms the slope of the curve is more rapid than with thick ones, showing a narrower margin

with thin diaphragms. Probably the explanation of the greater value of the induced current with thin diaphragms lies in the fact that they are less rigid and move a greater distance in the field with a given change in the line current, thus causing more lines of force to cut the exploring coil.

The foregoing tests determined the relation between strength of field and induced current produced by a pre-determined mechanical movement of the diaphragm, also strength of field and induced current produced by a pre-determined line current impulse. It now remains to ascertain the relation between strength of field, and resulting mechanical motion of the diaphragm, with line impulses of varying intensity. The apparatus was similar to that already described; the same diaphragm being used in all tests, set 1-32 in. from the magnet. The line currents were produced by a powerful microphone transmitter, excited by an organ pipe blown by a carefully regulated air blast giving a pitch C_3 . In Fig. 30 the inside scale of the vertical axis gives the movement of the diaphragm in thousands of a millimeter, and the horizontal scale the strength of field. In these tests the ampere-turns of the magnetizing coil are given, so it is possible to plot the field in gaussses, which has been done. Four curves are shown, C , D , E and F , in which the line current was respectively 3.37, 2.80, 2.20 and 1.5 milliamperes. These curves teach four things: First, as the field increases the excursion of the diaphragm increases to a maximum and then decreases to a nearly constant quantity. Second, The maximum excursion ordinate occurs at about the same point for all line currents. These two results would be anticipated from the previous tests, and the fact that the same diaphragm was used, placed at the same distance from the magnet. Third, the excursion of the diaphragm varied with the

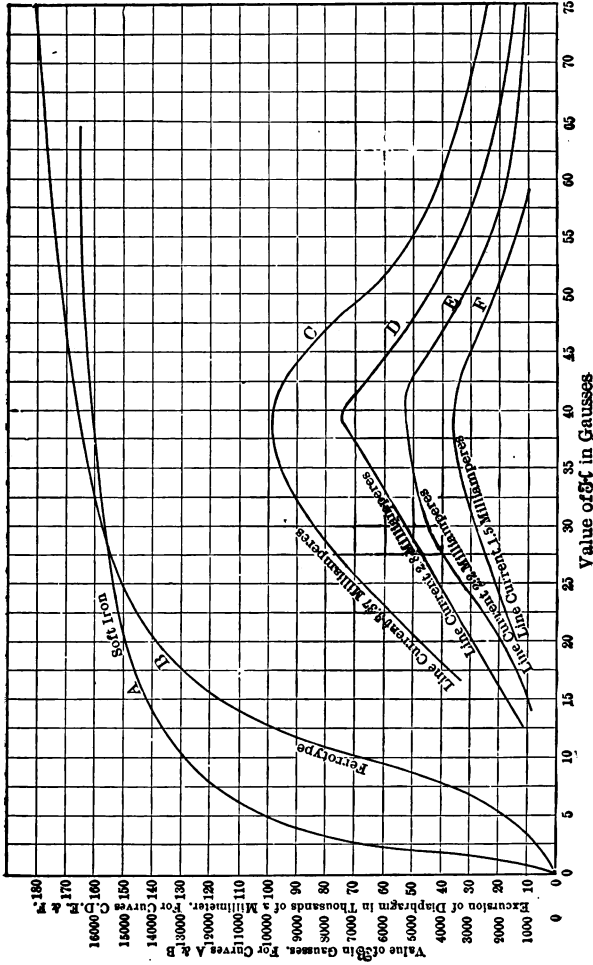

FIG. 30.—RELATION BETWEEN STRENGTH OF FIELD AND MOTION OF DIAPHRAGM WITH VARYING LINE CURRENTS.

line current and was nearly proportional thereto, for if the line currents be represented by 1, 1.46, 1.87 and 2.24 the excursion will be represented by 1, 1.47, 2.08 and 2.72. Fourth, the maximum excursion was found in a field of about 40 gaussess. For comparison, a β - \mathcal{H} curve for soft iron, from Ewing, and one for ferrotype metal, from Steinmetz, are plotted on the same sheet. The soft iron is more permeable and earlier saturated, but with a field of 40 the ferrotype shows an induction of 16,600 lines. These results confirm those which precede, and supply the additional numerical data that a ferrotype diaphragm to give the loudest sound should be set in a field of about 40, provided its thickness is such as to give an induction of 16,000 gaussess.

Half the secret of building a good receiver lies in a first-class mechanical design, for receivers are placed in situations particularly exposed to injury, and under all circumstances maintenance expenses are large. They are used by persons not only ignorant of the way in which such apparatus should be normally treated, but who are also often not only careless but malicious. From a mechanical standpoint, therefore, receiver design should be such as to produce an instrument, which, while it shall be simple and economical to construct, shall over all be reliable and unlikely to get out of order.

Extended experience has not as yet shown any material equal to hard rubber from which the case may be constructed. Many substitutes have been proposed, but all of the various compositions so far advanced have been brittle, suffer severely from changes in temperature, are more or less hygroscopic and fail adequately to protect the receiver from moisture. It is a grave mistake to make the case too light, for receivers are constantly liable to be dropped, are frequently banged about and dangle sus-

pended from the cord which connects them to the substation set. Cases, therefore, should be amply strong and able to resist usage of this kind. The various models which use a case of spun metal, coated with rubber, have advantage, both in cheapness and durability, but they are open to the objection of using poor insulation and the possibility of exposing the user to a disagreeable or even painful shock, due to leakage of ringing current, or what is even more dangerous a cross with an electric light or power wire, or a lightning discharge during a thunder shower. While the percentage of injury from such cases is insignificant, it is an objection always advanced by the timorous and may be a deterrent to a prospective subscriber. From many standpoints it is desirable to make the case in but two pieces — the body and the cap — although when there are good reasons on account of other constructive details, a tail piece is not a serious obstacle.

The magnetic system and the diaphragm should be so designed as to be connected to the case at only one point, for the coefficients of expansion of rubber and metal are so different that when the magnetic system and the diaphragm are separately secured to the case, at two or more places, and their relative adjustment depends on such support, it is impossible to keep them in their proper relative positions. So it is decidedly preferable to so design the receiver that the case is merely a cover which protects the organs of the apparatus from the inspection of the too curious. In this respect the Stromberg-Carlson, the Swedish-American and the Sun receivers present models of design worthy of careful consideration. Of other models, those which use the case as the framework to support the mechanism, and which secure the magnetic system by means of a screw thread upon the exterior of the case

which engages with a similar thread located usually on the magnet, appear to be most desirable, while those which secure the magnetic system by a screw through the rear of the tail piece, and hold the diaphragm upon the surface of the other end of the case, present the greatest liability to get out of adjustment.

Mechanically there is little to be said about the diaphragm, but the method of supporting it in relation to the magnetic system is worthy of the most careful attention. Diaphragms, which are buckled slightly, talk better than plain ones and a good mechanical device which shall secure the slight buckling necessary to this improvement in speech repetition is to be desired. Otherwise to secure the material which is best from the magnetic standpoint for the diaphragm, the cutting of the disc truly and accurately to size, so that it shall be flat without dishing, seems to present the best features for this portion of the receiver.

To protect the diaphragm from rusting the japan of ferrotype sheets, or the tin of common tin plate, are favorite methods, between which there is not a great deal to choose. From a magnetic standpoint, ferrotype leaves something to be desired, and from a magneto-acoustic one the writer has often wondered why a spun diaphragm that was thick in the center, so that a stronger field could be used, and thin around the circumference to present as little resistance to vibration has never been advocated.

To build up the permanent magnet from a series of thin flat bars undoubtedly presents the most expensive, but at the same time yields a better, more permanent, more perfect magnetic system. Otherwise the design and shape of the magnets is not a matter of great moment and is chiefly interesting from the manufacturing standpoint, for other things being equal, that design which can be manufactured

at the least cost is undoubtedly superior. But the shape of the magnet must be considered when deciding on the proper temper.

For the pole pieces the most permeable iron should be secured, and the attachment of the pole piece to the magnet should be such as to present an extremely large surface, in order that the reluctance of even the smallest air-gap which the best mechanics can achieve shall be reduced to a minimum. This joint should be machined and the method of securing the pole pieces to the magnet such that when taken apart they may be returned to exactly their original position, or otherwise a complete readjustment of the receiver is necessary. One excellent method of obtaining this result is to machine the recesses into which the pole pieces fit, and to secure them by means of a non-magnetic bolt that is slightly tapered and will draw the pole pieces and magnet to an accurate bearing.

From an electrical standpoint, the coil spools should be made of some non-metal. Some receivers employ a spool made of fibre or similar material, while others use spools which are pressed from brass or similar sheet metal, but if made of metal the spools should be laminated. It is usual to press the spools on to the ends of the pole pieces and depend on friction or a slight heading of the pole piece after the receiver is assembled to retain them in place.

The method of attaching the receiver cord to the pole piece coils is a point of great structural weakness. Preferably the last few turns of the receiver coils should be made of quite heavy wire, which is lashed firmly into place on the coil with strong silk. Then leading-in wires of about No. 18 or 20 gauge are soldered to the end of the coil and extended to the rear of the receiver. Now there is a choice of two methods. Some models carry the leading-in wires to binding posts on the tail piece and then solder them,

and attach the cord to the posts outside of the receiver. Others secure the leading-in wires firmly to a block bolted to the magnet and bring the entire cord through a hole in the tail piece and make the electrical connection at the magnet block. This latter design presents many points of excellency, for then the leading-in wires become an intrinsic part of the receiver mechanism, and when the instrument is dissected, are never broken.

The receiver cord consists of two flexible conductors, which must be overlain with the strongest possible braid. This cord should be carried inside the tail of the receiver and substantially secured to either the case, or the magnetic system, by an extension of the braid, so that under no circumstances will any strain be brought upon the conductors themselves. It must possess the greatest flexibility and strength and secure good electrical continuity. A common construction uses two insulated conductors composed of braided or twisted fine wire; another uses one conductor of stranded wire surrounded by a spring wrapping of bronze wire, but this presents the objections of considerable resistance and inductance. The stranded conductors are universally made of very fine copper or copper bronze wire, or what is technically called tinsel, and the finer and more numerous the threads the better. The conductor insulation is usually made of silk, to stand the severe usage imposed on the cord, but it is desirable to apply some waterproofing in order that moisture from damp hands may not affect the cord insulation.

It is the universal practice to use cord tips in connecting the cords with the sub-station instruments. The cord tip is usually made by inserting a sharpened wire into the end of the cord. This wire is turned over into a hook and the tinsel of the receiver cord soldered thereto. The

tip is then wrapped with wire over which a protecting funnel is soldered. The general details of this are shown

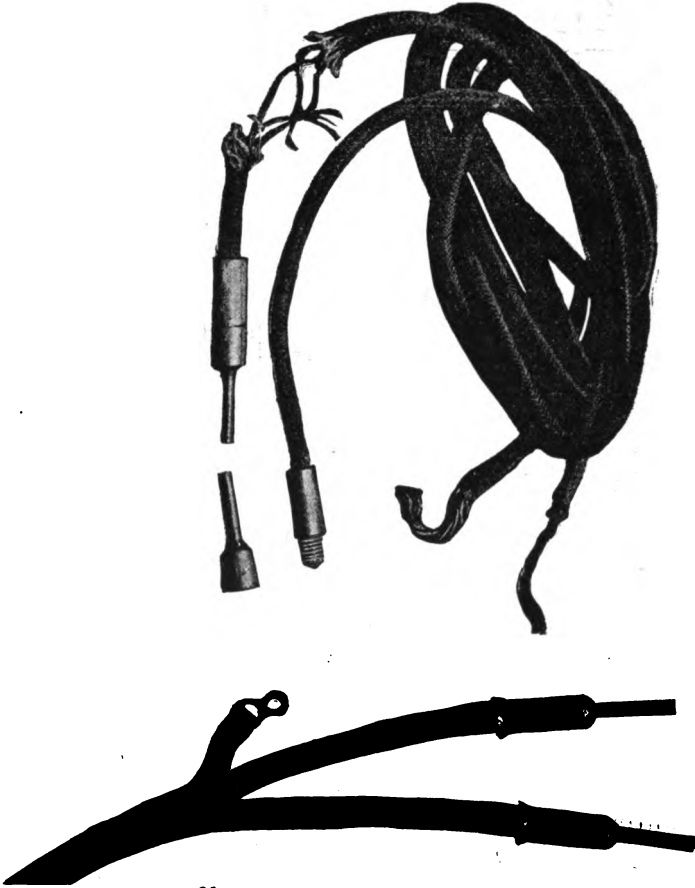

FIG. 31.—DETAILS OF CONNECTING CORD.

in Fig. 31. Finally the receiver is an instrument of precision and its construction should receive the very best

machine work in every respect and a high degree of finish. A poorly-built receiver is sure to mean large maintenance expense and constant complaint from subscribers.

The adjustment of the diaphragm and pole pieces is the most important detail. The requisites are: First, the diaphragm must be exactly perpendicular to the pole piece in all directions. Second, it must be as near the pole piece as possible without any possibility of coming in contact with them. Third, it must always retain this adjustment under all changing conditions of temperature, etc. Some receivers, like the Stromberg-Carlson, arrange the diaphragm to be adjustable. Scientifically this is admirable, but is more expensive to build and is a temptation to the curious. Other models grind the face of the case and pole pieces flat after the instrument is assembled, and then with a die, dish the diaphragm, two or three sixty-fourths of an inch in the center. This is exemplified in the American and others. Models using a threaded case, machine a bearing on the top of the thread, and fasten a plate or stop on the magnetic system, which is brought to a bearing on this shoulder, and is supposed to bring the pole pieces into a correct relation to a flat diaphragm. Each plan has some excellences and some defects, but if carefully made each can secure the desired result.

Probably the acoustic properties of the diaphragm have received less attention than any other portion of the receiver, for as the general properties of vibrating plates emitting sound have been studied from time to time, investigators have probably concluded that there was nothing left worthy of investigation; this is far from the truth. When any body like a receiver diaphragm is acted on by a force it is set in motion, and the tendency is for it to vibrate as a whole, emitting a more or less

deep note called its fundamental, and also to split up into parts, each one of which vibrates on its own account and so produces a series of higher notes called overtones. It is these overtones which confer that peculiar character whereby we are able to distinguish one musical instrument from another, even if all play the same air. In the case of the diaphragm the varying magnetic field furnishes the impelling force, and the first tendency is for the diaphragm to vibrate as a whole and give forth such a note as is called for by its mass and elasticity. There is also a tendency for it to split up into many small parts, each one emitting the note peculiar to itself. In addition, the problem is still further complicated by the fact that the diaphragm is clamped at its margin and by no means free to move as it may wish. Such clamping damps out the vibrations which it would make if free, and artificially introduces others totally foreign to the plate itself. Thus it is seen that there are several causes which operate to distort the fidelity with which a receiver can reproduce the sound initiated by the changing magnetic field; so the accuracy attained is indeed marvelous. These considerations have led to the idea that the ability of the receiver to talk was really due not to a *molar* motion of the plate as a whole, but to a *molecular* motion of its component atoms, and there is much to support such an hypothesis. However this may be, it is generally believed that while a thick diaphragm can be made to give a very loud sound the distinctive overtones are wanting, there is little crispness and sharpness, and it is difficult to understand single words. With a thin diaphragm clearness is greatly improved, but at the expense of volume. A similar result can be obtained by clamping the diaphragm between sharp

metal rings set around its circumference, or by dishing it. Too thin a diaphragm makes communication appear to be unnaturally shrill and high-pitched, so one has to steer between a Scylla of shrillness on the one hand and a Charybdis of "boomy" volume on the other; and in this connection it should not be forgotten that all the cavities of the receiver act as resonant chambers which should be made as small as possible, and in every design attuned to reinforce the fundamental note of the diaphragm.

An analysis of the telephone receiver indicates that it may be viewed from three different standpoints. It may be considered magnetically, electrically or mechanically. There is no receiver now manufactured which is best from all of these various standpoints, but each one contains certain admirable features which make it superior for a particular purpose, and so the manager of a telephone plant must weigh the various advantages offered by each model and choose that which seems best suited for his particular service. Receivers for local battery exchanges must be utterly different electrically from those designed for common battery installations. Where many toll lines exist, and a large proportion of the business is long-distance work, a type of receiver entirely different in design, both electrically and magnetically, is desirable from that which is sufficient for the country village whose conversations are relatively of less importance and never traverse more than a mile or two of wire. Mechanically, the highest types of receiver are more expensive to construct, produce better results and last longer than the cheaper varieties. Naturally a small country exchange, can use a type of receiver which would not be tolerated by the city plant having tens of hundreds of subscribers.

Viewed from the standpoint of the magnetic circuit, receivers may be subdivided into four classes:

- 1st. Single-pole receivers.
- 2d. Double-pole.
- 3d. Single-bar magnets.
- 4th. Laminated magnets.

Electrically, according to the design of switchboard into which receivers are to work, there are two divisions:

- 1st. Local battery receivers.
- 2d. Common battery receivers.

Mechanically, it is possible to class receivers into two divisions, depending upon the method of assembling.

1st. Receivers in which the magnetic system and diaphragm are rigidly connected together, independently of the case, and

2nd. Those in which the case forms the supporting foundation for the entire mechanism. Under the two classes of this division there are two sub-classes, namely (*a*) receivers with external cord connections, and (*b*) those with internal cord connections.

It is proposed to examine and describe a few of the more familiar types. As comparisons under all circumstances are invidious, none will be drawn, though subsequently methods of testing, applicable to both transmitters and receivers, will be developed, whereby performance of either the receiver or transmitter may be tested and conclusions formed as to the type of service to which any particular instrument is best fitted. Manufacturers are constantly improving in receiver building, and the receiver itself is so complex a machine that even with the most perfect system of interchangeable manufacturing it is difficult to produce two instruments that are exactly alike; nor has interchangeability been carried to anything

like perfection that is witnessed in watch works, the sewing machine factory or a gun shop; and so, while the models described may be taken to be fairly representative, it is quite certain that other examples from the same shop may differ considerably in many of their properties.

The first models of the receiver manufactured by the American Bell were of the single-pole variety, shown in Fig. 7. This design has been so universally supplanted by the bipolar type that the earliest form is merely of historic interest. The bipolar receiver is shown by dimension drawing and sectional photograph in Figs. 8 and 9. The complete receiver is given in Fig. 32, while in Fig. 33 the instrument is dissected. The case is made of hard rubber and consists of three parts: the body, *A*, Fig. 33, the tail piece, *B*, and the diaphragm cap, *C*. The magnetic system shown at *D* consists of two rectangular bars $3\frac{1}{4}$ in. long, the outer corners of which are chamfered. The bars are .63 in. wide and .26 in. thick. At the rear end the bars are bolted together with a soft iron filling piece and



FIG. 32.— ASSEMBLED BELL RECEIVER (COMMON BATTERY TYPE).

iron bolt, while in the front the filling piece and bolt are of non-magnetic material. Between the bars a lead weight is cast, so that the receiver may be sure to hold the hook switch in proper position. At the front end the

filling piece carries a screw thread whereby the entire magnetic system may be secured in the body of the case in which a similar thread is cut. The pole pieces are recessed between the front filling piece and the magnets and all clamped by a substantial bolt. The magnet bars are placed $\frac{1}{2}$ in. apart and exercise a tractive effort of 1.13 pounds (588 grams). The sectional area is about .164 sq. in. (1.06 sq. cm). This corresponds to a tractive effort of 550 grams per sq. cm, which would indicate a reme-

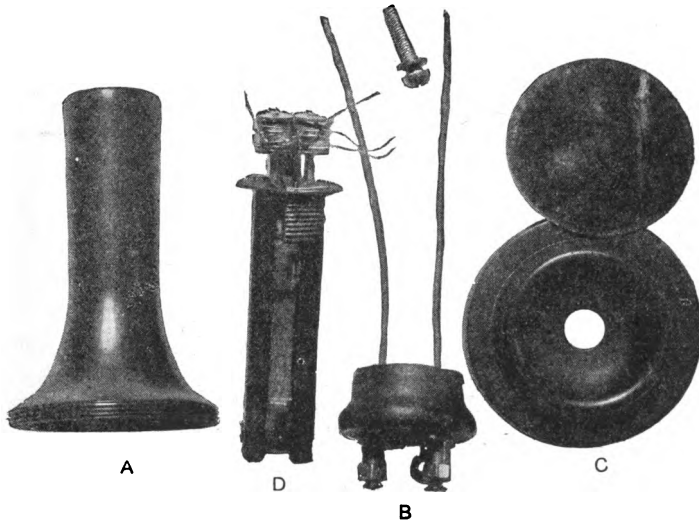

FIG. 33.—DISSECTED BELL RECEIVER.

nance of 4,200 gaussess. The pole pieces are set $\frac{1}{2}$ in. apart centers. They are .54 in. wide, .086 in. thick and 1.36 in. long, giving an area of .046 in. (.3 sq. cm) so the pole flux

would be 9,800 gausses. The coil spools are .09 in. deep, .40 in. wide and .43 in. long, made of brass, giving a winding volume of .06 sq. in. (.385 sq. cm). The winding is No. 34 or 36 B. & S. silk-covered copper wire, for the common battery receivers, both coils being connected in series. The usual resistance is about 60 ohms, but receivers are wound as low as 20 ohms and as high as 100. For local battery stations the winding is one or two gauges finer and the resistance carried to about 75 ohms. The diaphragm is of ferrotype metal No. 31 B. W. G. .01 in. thick, 2.25 in. in diameter over all, with a free diameter of approximately 2 in. As a protection from moisture, the diaphragm is thoroughly varnished. The body of the case is faced presumably at right angles to the thread cut to hold the magnetic system, and the magnets screwed into the case till the pole pieces are from $1/64$ to $3/64$ of an in. away from the diaphragm. Upon the outside of the tail piece, *B*, a pair of binding posts are placed, to which leading-in wires of cotton-covered copper are soldered and extend alongside of the magnetic system through a fibre disc which is placed just beneath the pole pieces and are soldered to the ends of the line coils. Thus, it is impossible to take the receiver apart without unsoldering some of the electrical connections. The tail piece is secured in place by being slipped over the end of the case body and held by a screw that is tapped into the rear of the magnet. The mouth noticeably flares much more than most of the other models and the resonant cavity enclosing the diaphragm is considerably larger. Fig. 34 is a phantom with the diaphragm removed. The field is quite uniform and symmetrical, but not sufficiently intense to affect the iron filings over the entire area of the plate. Fig. 35 is

a phantom with the diaphragm in place, from which it appears that the field is fully sufficient to saturate the diaphragm at least in the immediate neighborhood of the pole pieces. The diaphragm is secured between the cap

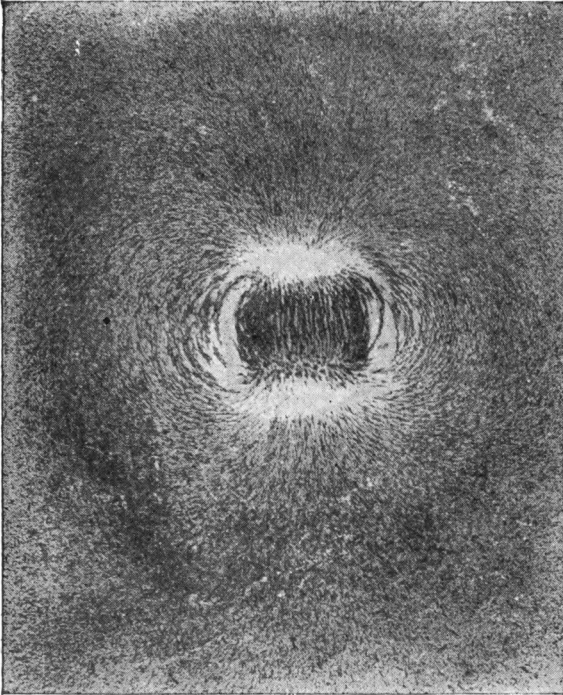

FIG. 34.—PHANTOM WITHOUT DIAPHRAGM. BELL RECEIVER.

and the case, consequently adjustability is attained only by loosening the tail piece screw, and moving the magnetic system in and out of the case.

When a receiver is in constant use it becomes burdensome to constantly hold it to the ear, and it is customary to build a very small and light instrument, which may be supported on the head by means of a band or cap, and

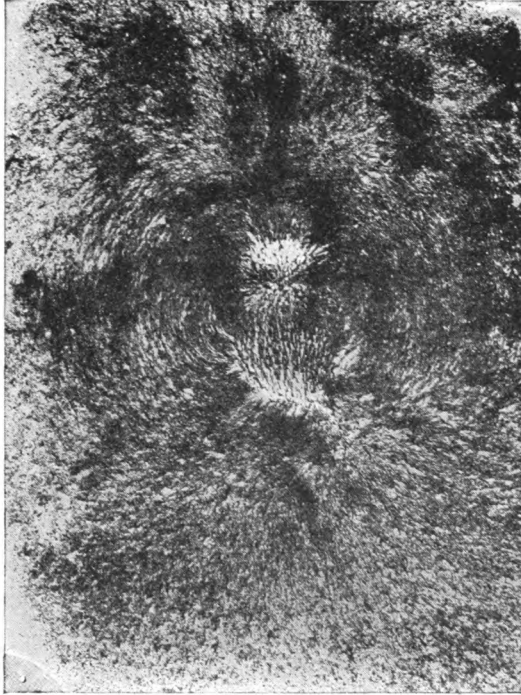

FIG. 35.—PHANTOM WITH DIAPHRAGM. BELL RECEIVER.

thus adjusted to the proper place at the ear, leaving the hands free to follow other avocations. Such telephones are a necessity to switchboard operators. One of the

models of this form manufactured by the American Bell is illustrated in Figs. 36 to 41, inclusive. The assembled receiver is shown in Fig. 36. In Fig. 37 the cap and diaphragm are removed, while in Fig. 38 the instrument is dissected. The receiver case consists of a light shell of pressed brass, about the size of a watch case, and so these instruments are frequently denominated "watch receivers." The case is about 2 in. in diameter and 11/16 in. deep. The edge is chamfered to form a bearing for the dia-



FIG. 36.—BELL HEAD RECEIVER ASSEMBLED.

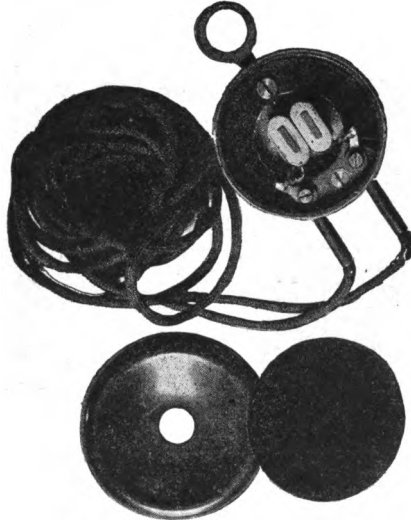

FIG. 37.—BELL RECEIVER CAP AND DIAPHRAGM REMOVED.

phragm, and on the exterior is a screw thread engaging with the rubber diaphragm cap. The magnetic system consists of two bars of steel $\frac{1}{8}$ in. thick, $\frac{7}{16}$ in. wide,

forged into circular segments as shown in Fig. 39. The laminated magnet thus formed is placed on the bottom of the brass case and secured thereto with one screw. To each end of the magnet a soft iron pole piece is attached which, as is seen in Fig. 38, extends inwardly towards the center of the magnet, and is there turned upwards at right angles. The pole pieces are .357 in. wide, .085 in. thick and $\frac{1}{2}$ in. deep. Upon the pole pieces the line spools are placed, made of brass .37 in. wide, .68 in.

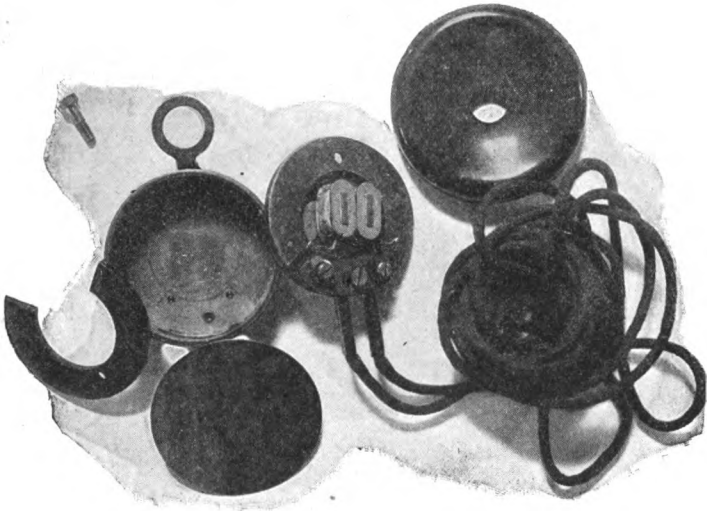

FIG. 38.— BELL HEAD RECEIVER DISSECTED.

long, and .31 in. deep. The spools are usually wound with No. 38 wire to a resistance of about 60 ohms. Between the ends of the magnet a fibre block is screwed to the case, to which the terminals of the line coils are attached. The receiver cord is often made of two strands, each of which carrying its appropriate tip passes through a hole on the

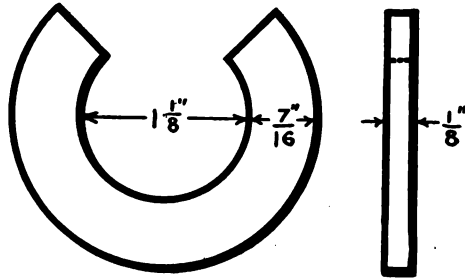

FIG. 39.—MAGNET OF BELL HEAD RECEIVER.

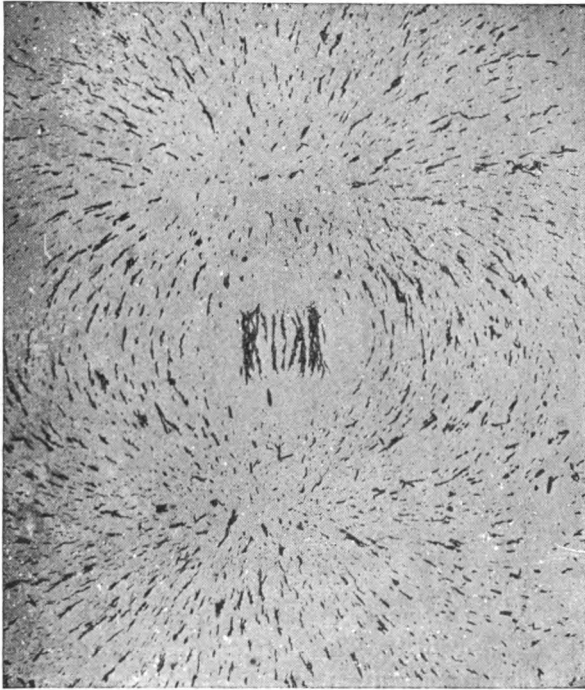

FIG. 40.—PHANTOM OF BELL HEAD RECEIVER WITHOUT DIAPHRAGM.

side of the case, and is clamped in the fibre block by means of two screws (Fig. 38) that connect the tips with the terminals of the line coils. The diaphragm is of ferro-type metal .01 in. thick, 2 in. in diameter over all, with a free diameter of 1.93 in.; it is perfectly flat. The

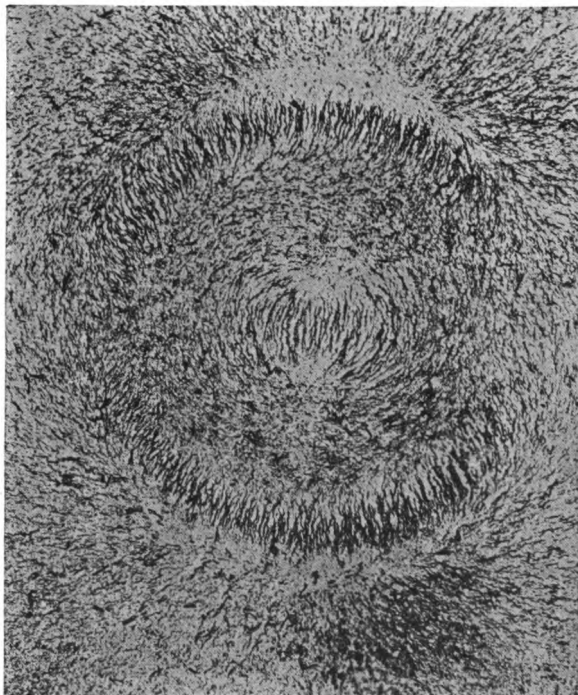
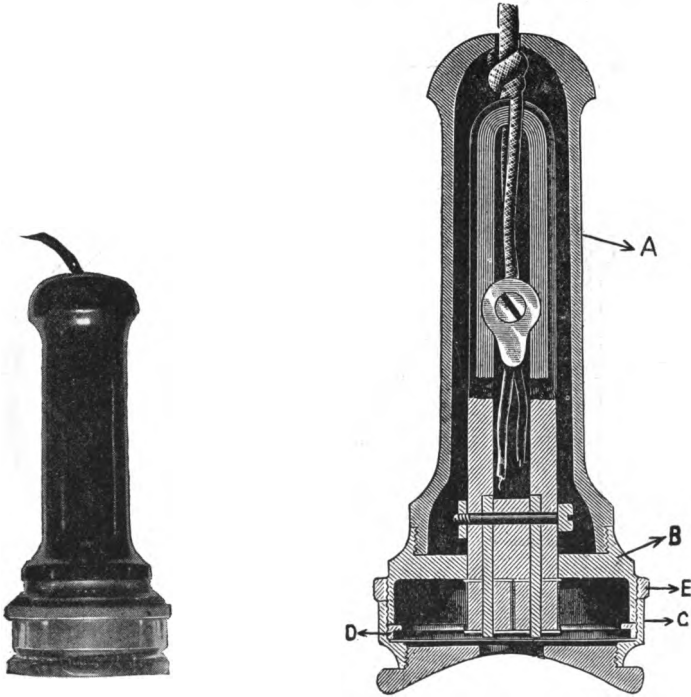

FIG. 41.— PHANTOM OF BELL HEAD RECEIVER WITH DIAPHRAGM.

magnets of this receiver exercise a tractive effort of 1.313 pounds (477 grams). This corresponds to a tractive effort of 690 grams per sq. cm, and indicates a remanence of 3,500 gaussses. The weight of the entire receiver is $5\frac{1}{2}$

ounces; this is not an uncomfortable burden even if constantly worn against the ear. Fig. 40 is a phantom of the magnetic system with the diaphragm removed, showing an evenly distributed though not very intense field. Fig. 41 is a phantom with the diaphragm in place. At first



STROMBERG-CARLSON.

FIG. 42.— RECEIVER ASSEMBLED. FIG. 43.— SECTIONAL VIEW OF RECEIVER.

sight this appears strange, as there is distinct evidence of a field around the circumference of the case. A little consideration, however, shows that this is caused by leakage

from the circumference of the circular magnets to the diaphragm, and thence through the diaphragm to the pole pieces in the center.

The Stromberg-Carlson is a highly developed instrument and of great interest. The assembled receiver is shown in Fig. 42 and a sectional view in Fig. 43. In Fig. 44 the magnetic system is removed from its case, while in Fig. 45 the receiver is completely dissected. The case shown at *A* in Figs. 43, 44 and 45 is composed of a single

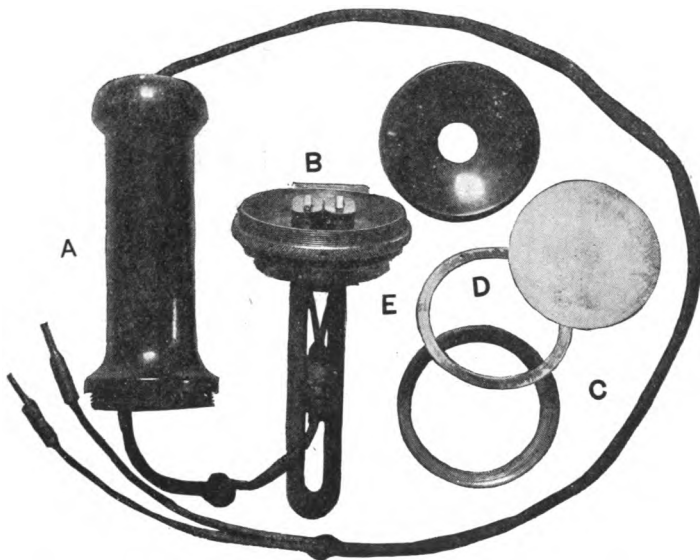

FIG. 44.— STROMBERG-CARLSON RECEIVER PARTLY DISSECTED.

piece of hard rubber, on one end of which a screw thread is cut, while at the rear the case is reinforced and the cord passes through a hole in the center to reach the terminals

of the line coils. On the front end a brass cap, *B*, is secured. This cap is very substantial and carries in its center a projection, *X* (Fig. 45), to which the pole pieces

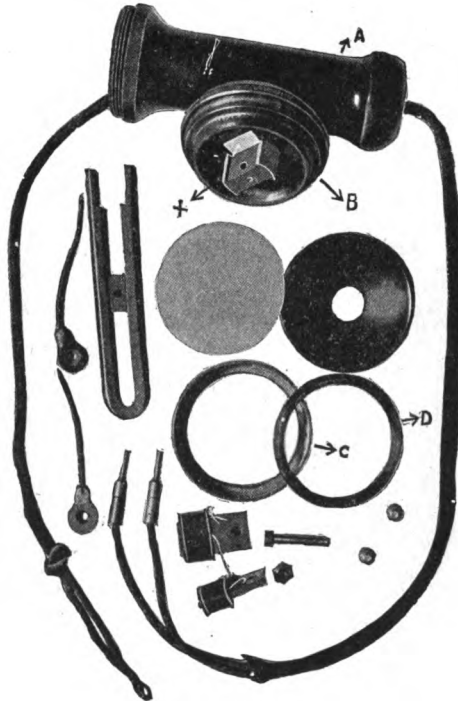

FIG. 45.—STROMBERG-CARLSON RECEIVER COMPLETELY DISSECTED.

and magnetic system are secured as in Fig. 43, by a bolt which passes directly through both of the poles and the projection, so that this cap forms a solid foundation for the whole instrument. On the outside the cap is threaded and a circular brass ring, *C*, is cut to engage with this thread.

The diaphragm is placed on the inside of this ring and secured against a shoulder by means of a follower ring, *D*, threaded into the inside of the cap, *C*. Thus the diaphragm is clamped firmly between two sharp circular brass rims, and the adjustment of the diaphragm with reference to the pole pieces can be made with the utmost nicety. To

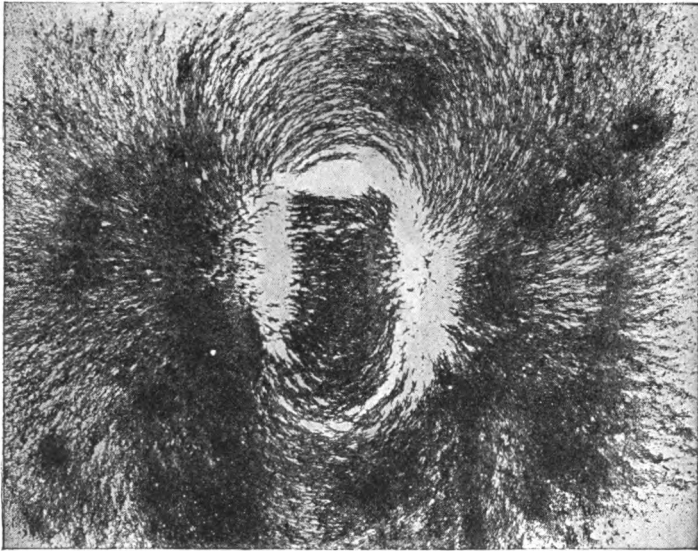

FIG. 46.—STROMBERG-CARLSON RECEIVER PHANTOM WITH DIAPHRAGM REMOVED.

secure the cap, *C*, in its place, a follower ring, *E*, which acts as a lock nut, is screwed up against the cap when it is in its final position. The diaphragm is of sheet iron tinned .01 in. thick, 2.19 in. in diameter over all with a free diameter of 2.12 in. The magnetic system consists of one U-shaped bar of steel .625 in. wide and .24 in. thick, with

its outside edges slightly chamfered. There is a distance of .35 in. between the sides of the U, while the magnet is 4.60 in. in length. The pole pieces are of soft iron

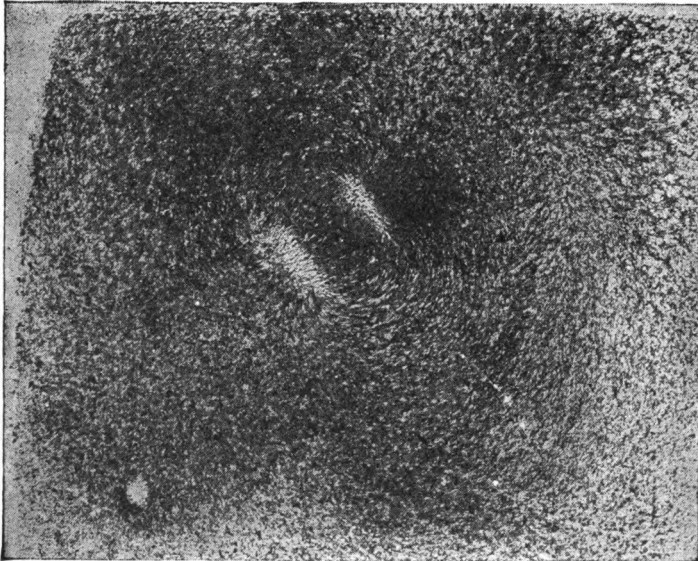

FIG. 47.— STROMBERG-CARLSON RECEIVER PHANTOM WITH DIAPHRAGM IN NORMAL POSITION.

.590 in. wide, .10 in. thick and 1.18 in. long. The coil spools are of fibre .44 in. wide, .860 in. long and .50 in. deep. The winding of the local battery instruments is of No. 38 wire, having a resistance of from 90 to 100 ohms, with about 1,200 turns, the line coils being connected in series. The tractive effort is 2.940 pounds (1,332 grams). This corresponds with tractive effort per sq. cm of 1,755 grams, giving an induction in the pole pieces of 13,100

gausses, corresponding to a remanence in the permanent magnet of 5,800 gaussses. The receiver cord passes through a hole in the rear of the case. On the inside a large and

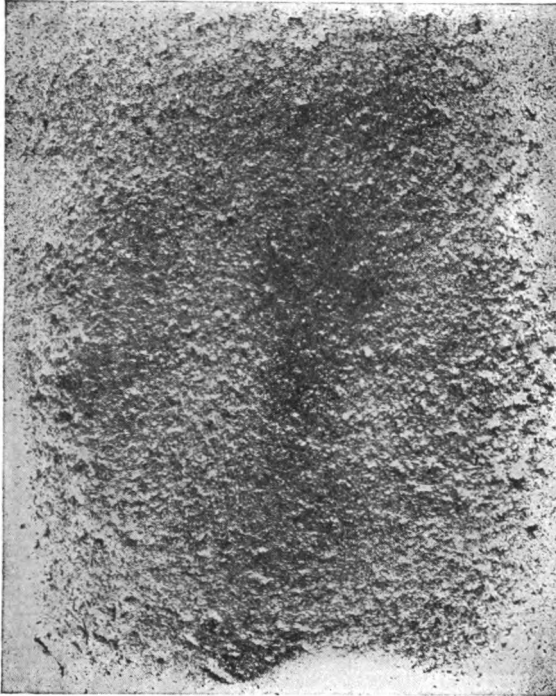
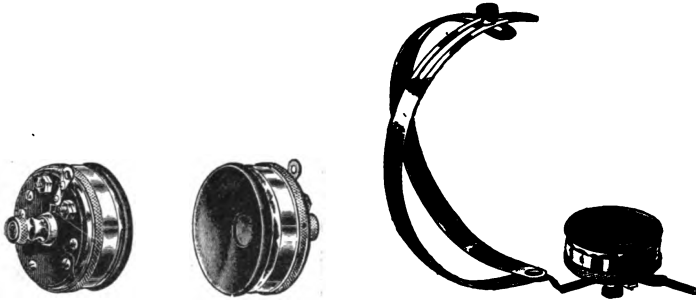

FIG. 48.—STROMBERG-CARLSON RECEIVER WITH DIAPHRAGM $\frac{1}{8}$ IN. FROM POLE PIECE.

heavy knot is tied in the cord, which forms a flexible stop, and prevents the weight of the receiver from producing any strain upon the terminals. Between the faces of the magnet a fibre block is placed to which the line wire ter-

minals are carried by means of two pieces of okonite wire that pass through the cap, *B*. These terminal wires carry two brass terminal pieces that are secured to the fibre block



STROMBERG-CARLSON.

FIG. 49.—WATCH CASE RECEIVER.

FIG. 50.—WATCH CASE RECEIVER WITH HEAD BAND.

by means of screws, to which the cord tinsel is connected. Figs. 46, 47 and 48 are phantoms from this model. Fig. 46 is the phantom with the diaphragm removed, exhibiting a most powerful field. Fig. 47 is the phantom with the diaphragm in place, showing the diaphragm fully saturated, while Fig. 48 is a phantom taken with the diaphragm removed $\frac{1}{8}$ in. away from the pole pieces, and illustrates the effect of changing the adjustment with reference to the pole pieces.

Figs. 49 and 50 illustrate the Stromberg-Carlson watch case receiver. In general design this receiver adopts as far as practical the model and the principles in the hand telephone, departing therefrom only in so far as necessary to secure the requisite lightness. In Fig. 50 the assembled receiver including a band, whereby it may be supported from the head, is shown.

The American receiver exhibits another method of securing adjustment between the pole pieces and the dia-



FIG. 51.—AMERICAN RECEIVER DISSECTED.

phragm. Fig. 51 shows this receiver dissected. The case consists of two pieces of composition. Upon the front the diaphragm cap is threaded, while the receiver cord passes through a hole in the rear. The magnetic system consists of a U bar .655 in. wide, .25 in. thick and 4.25 in. long, the U being formed so that there is .32 in. between the parallel sides. The pole pieces are .61 in. wide, .10 in. thick and 1.5 in. long, and are recessed in the top of the

U bar. Before the pole pieces are put in place a wash-dish shaped cup of brass is set under the pole pieces and on top of the U. This wash-dish piece is pressed on by a die and after it is in position the face of the dish and the face of the pole pieces are grounded exactly in line. The diaphragm is of sheet iron tinned and as is shown in Fig. 51 is dished, the dishing being sufficient to carry the center of the diaphragm about .03 in. away from the pole pieces. The edge of the diaphragm rests upon the face of the brass dish that is secured between the pole

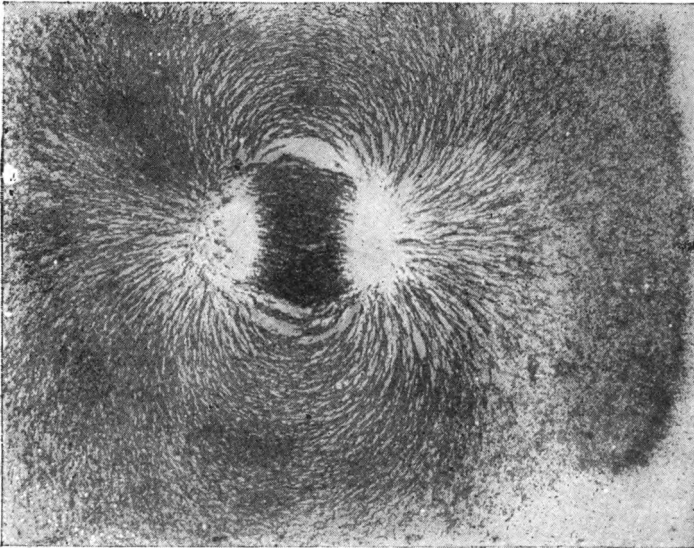

FIG. 52.— PHANTOM OF AMERICAN RECEIVER WITH DIAPHRAGM REMOVED.

pieces and the magnet. The receiver is assembled by slipping the magnet into the case, placing the diaphragm on

the face of the dish, and clamping the whole with the diaphragm cap. It is evident from this mode of construction that there is no means of making any adjustment of the

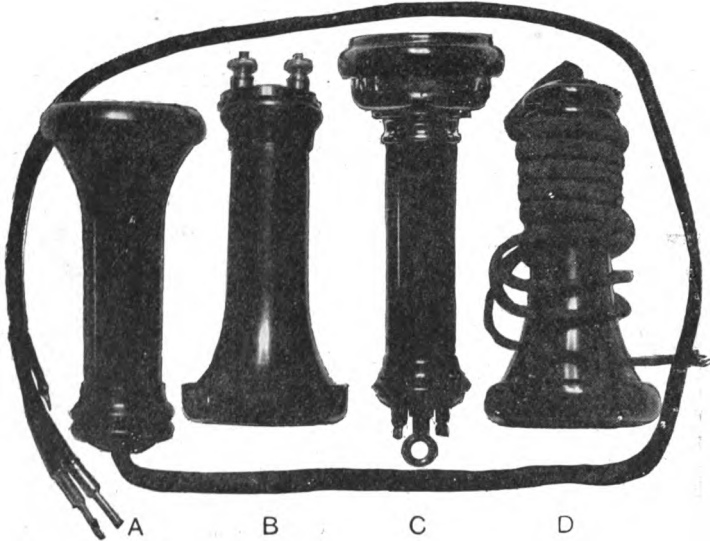

FIG. 53.—DIFFERENT TYPES OF RECEIVERS.

A — KELLOGG RECEIVER. B — MANHATTAN RECEIVER. C — ERICSSON RECEIVER. D — WESTERN TELEPHONE COMPANY RECEIVER.

distance between the diaphragm and the pole pieces after the process of manufacture is once completed. The receiver cord enters the instrument through a hole in the rear of the case and is then knotted after the fashion of the Stromberg-Carlson model. The terminals pass to a block placed between the parallel faces of the magnet and are there connected to the leading-in wires. From this block the leading-in wires of heavy copper pass through

holes drilled in the brass dish to the line spools. The line spools are made of brass .40 in. wide, .90 in. long and .62 in. deep. The winding is of No. 36 wire and the resist-

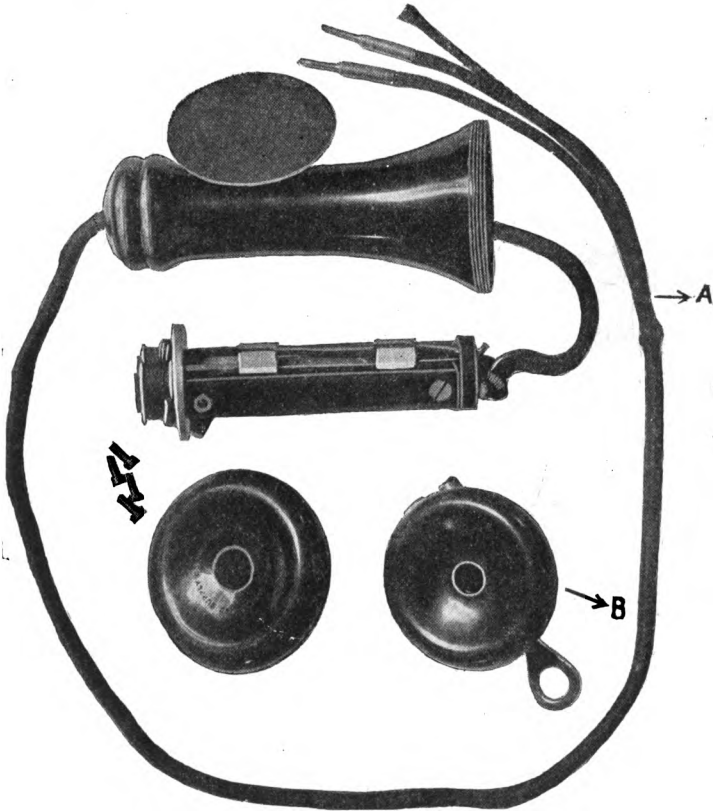

FIG. 54.— A — KELLOGG RECEIVER DISSECTED. B — MANHATTAN WATCH CASE RECEIVER ASSEMBLED.

ance about 125 ohms. The tractive effort is 2.170 pounds (964 grams). This corresponds to a tractive effort of

1,240 grams per sq. cm., indicating an inductance of 10,900 gausses in the pole piece. The remanence is 4,750 gausses. Fig. 52 is a phantom with the diaphragm removed.

The characteristics of the receiver of the Kellogg Switchboard and Supply Company are illustrated in Figs. 53 to 58, inclusive. At *A*, Fig. 53, the assembled receiver is shown. In Fig. 54 it is dissected into its component parts. Figs 55 and 56

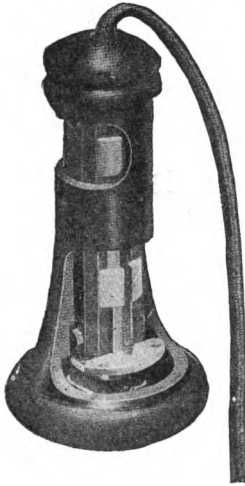

FIG. 55.—SECTION OF
KELLOGG RECEIVER.

show sectional drawings. In one model the case consists of three pieces: the diaphragm cap, the case body and the tail piece, as shown in the sectional drawing (Fig. 56). In the model of Fig. 54 there are only two parts: a body and diaphragm cap. The magnetic system (Fig. 54) consists of two bars .630 in. wide, .24 in. thick and $3\frac{1}{2}$ in. long. These bars are secured by means of a non-magnetic bolt and block at the pole-piece end and iron screw and magnetic filling piece at the rear. The diaphragm is of ferrotype .011 in. thick, 2.18

in. over all in diameter, with a free diameter 1.93 in., and is perfectly flat. The line coils are wound upon brass spools .41 in. wide, .90 in. long and .62 in. deep; the wire is No. 30 and the resistance from 65 to 70 ohms. The pole pieces are .54 in. wide, .10 in. thick and 1.25 in. long; they are secured to the magnet by recessing the ends of magnet bars and by bolting the pole pieces with the same bolt that

secures the ends of the magnet. In order that the receiver may be heavy enough to hold the switch hook in its proper place a lead weight is cast between the magnet bars. The tractive effort is 2.437 pounds (1,170 grams). This corresponds to a tractive effort 1,620 grams per sq. cm., indicating an induction in the pole pieces of 12,300 gausses, and a remanence in the magnets of 5,400 gausses. The case is faced off perpendicular to the axis of the magnet

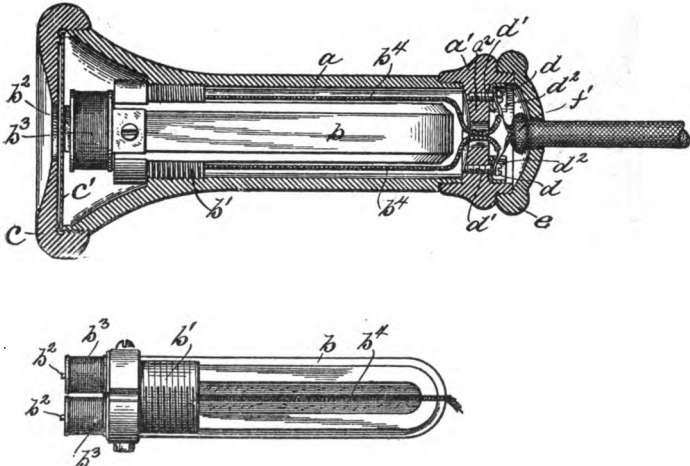

FIG. 56.— ANOTHER MODEL OF THE KELLOGG RECEIVER.

and the diaphragm secured by clamping it between the face of the case and the underside of the cap. In Figs. 54 and 55 it will be noticed that between the pole pieces and the magnet bars a round disc of non-magnetic metal is placed, which is parallel with the face of the pole pieces. The inside of the case carries a shoulder which is machined to be parallel with the face of the case. When

the magnetic system is dropped into place the disc bears against this shoulder and the whole magnetic system is secured in place by four screws, which pass through the disc and into the case.

In Fig. 56, a somewhat different model of the Kellogg receiver is shown. Here a threaded block, b^1 , is placed on

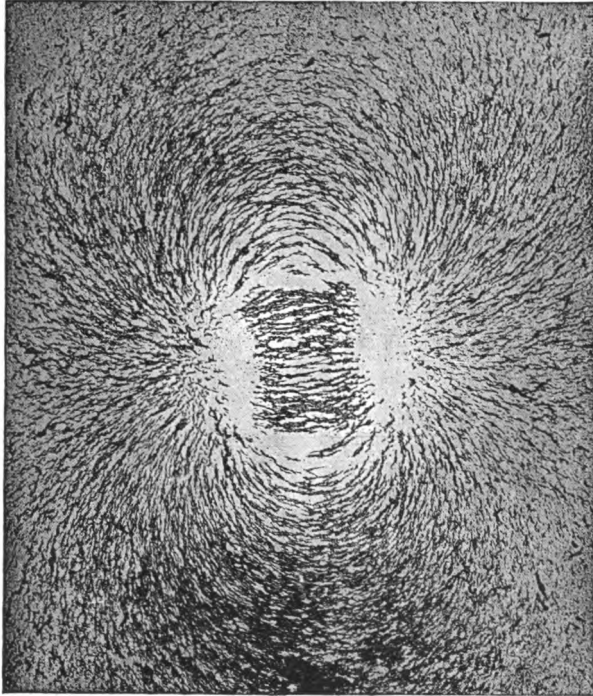

FIG. 57.— PHANTOM OF KELLOGG RECEIVER WITH DIAPHRAGM REMOVED.

the top of the magnet bars, which engages in a screw thread on the inside of the case. By this means adjustability is secured between the pole pieces and the dia-

phragm. Fig. 56 also illustrates the method of attaching the receiver cord. On the rear of the case is a cap, *e*, which is secured by means of a screw thread. Underneath this cap a partition is formed in the receiver case having a hole in its center. The leading-in wires from the line coils pass along through the case beside the magnet and

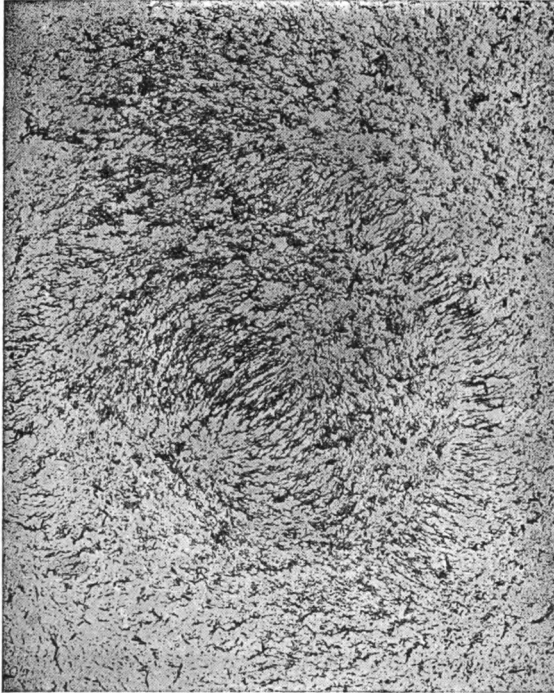

FIG. 58.— PHANTOM OF KELLOGG RECEIVER WITH DIAPHRAGM IN PLACE.

through a hole in the center of the partition, *a*². On the top of this partition are two screws, *d*, to which the leading-in wires are attached. The receiver cord passes through

a hole in the tail cap, *e*, and is then knotted at *f*¹. From the receiver cord the conductors pass to the screws, *d*¹, thus securing electrical connection with the leading-in wires. Figs. 57 and 58 are the phantoms of the Kellogg receiver, Fig. 57 is taken with the diaphragm removed,



FIG. 59.—MANHATTAN HAND TELEPHONE DISSECTED.

while Fig. 58 shows the field with the diaphragm in place. The phantom of Fig. 57 is noticeable for the uniformity of the field which is produced, while Fig. 58 indicates

that the magnetic relations between the diaphragm and the field are well preserved.

The Manhattan hand telephone is illustrated in Figs. 53, 59 and 60. Fig. 53B shows the instrument assembled, while in Fig. 59 it is dissected. The case consists of three pieces: the body, the diaphragm cap and a tail piece, which is simply a composition disc, carrying two binding posts, through the center of which a screw runs into the interior of the instrument and is tapped into the magnetic system.

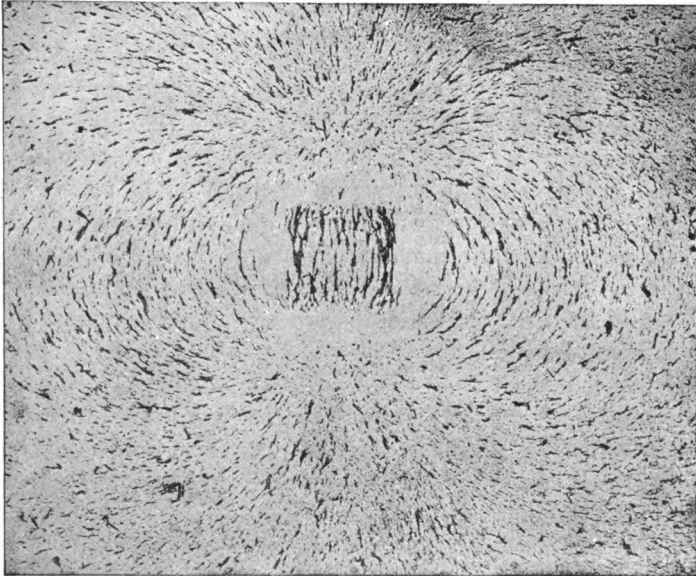

FIG. 60.— PHANTOM OF MANHATTAN HAND TELEPHONE.

The magnetic system consists of two bars of steel .628 in. wide, .120 in. thick and 3.75 in. long. In the rear the bars are clamped together by means of a screw bolt and

a filling piece of soft iron, while in front there is a filling piece cast of non-magnetic metal that carries a screw thread which engages with a similar thread on the inside of the case. This block is provided with a shoulder and presumably the magnetic system is to be screwed into the case until the shoulder reaches a bearing. This receiver is noticeable in having no pole pieces. The magnet bars extend directly through the composition block and on to their ends the line spools are forced. The spools are .44 in. wide, 1.0 in. long and .54 in. deep. The winding is of No. 34 or No. 36 wire and the resistance from 68 to 70 ohms, both of the line coils being joined in series. The diaphragm is flat, of ferrotype metal .01 in. thick, 2.25 in. in diameter over all, and 1.75 in. free diameter. The tractive effort is .851 pounds, corresponding to 369 grams. This is equivalent to a tractive effort of 1,216 grams per square cm., showing an induction of 5,500 gaussses in the pole pieces, and the same remanence in the magnets. The leading-in wires pass from the line spools through two slots in the composition filling piece and thence extend to the rear of the receiver and are soldered into the binding posts. The leading-in wires are carefully insulated with rubber tube. Fig. 60 is the phantom from the Manhattan model with the diaphragm removed. The field is exceptionally symmetric and uniform and is less intense than that of other models.

The Manhattan head telephone is a curious model. It is illustrated in Figs. 54, 61, 62 and 63. In Fig. 54B the instrument is shown assembled, while in Fig. 61 at B it is dissected. The instrument consists of a wash-bowl shaped casting of hard iron or steel. In the center of this a small round hard steel stud is secured, which extends upwards and is faced off even with the rim of the casting.

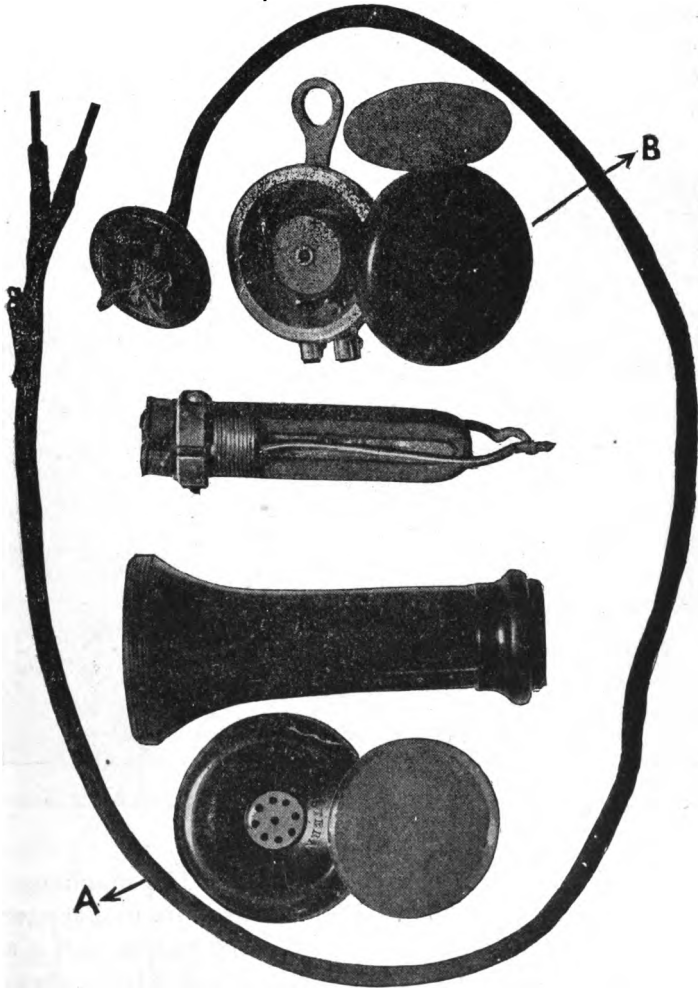

FIG. 61.— A — WESTERN TELEPHONE RECEIVER DISSECTED.
B — MANHATTAN WATCH-CASE RECEIVER DISSECTED.

Around this central stud is a wooden spool, which carries the line coil. Through the side of the case two holes are drilled and are furnished with small binding posts to which the cord tips may be attached and from which

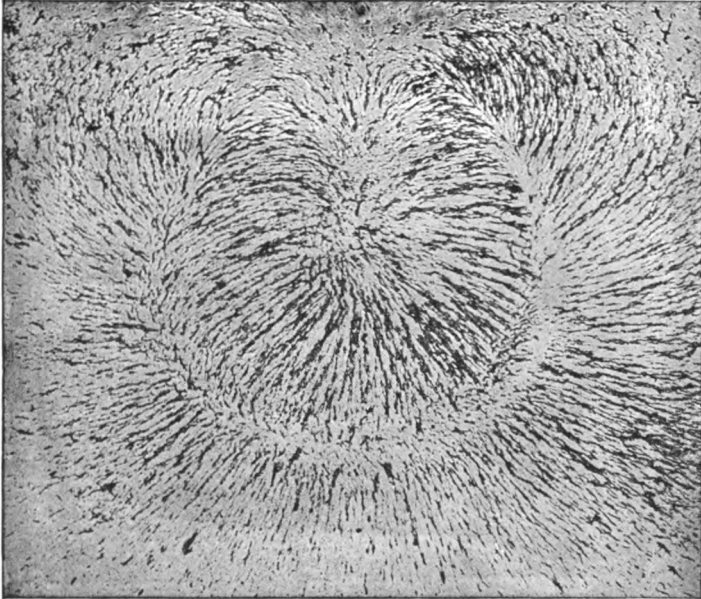

FIG. 62.—PHANTOM OF MANHATTAN WATCH-CASE RECEIVER WITH DIAPHRAGM REMOVED.

the leading-in wires pass to the spool. The diaphragm is flat, of ferrotype, .005 in. in thickness, 2 in. in diameter over all and 1.75 in. free diameter. The exciting coil is a single spool of wood 1 in. in diameter and .312 in. deep. The receiver is wound with No. 38 wire to 70 to 80 ohms. The pole piece, if it may be so termed, is a steel stud .280

in. outside. The tractive effort is .344 pounds corresponding to 156 grams. This is equivalent to 276 grams per sq. cm., showing an induction of 5,300 gausses in the pole piece. The phantoms of this model are shown in Figs. 62 and 63, Fig. 62 being the phantom with the diaphragm removed, while Fig. 63 is that taken with the diaphragm

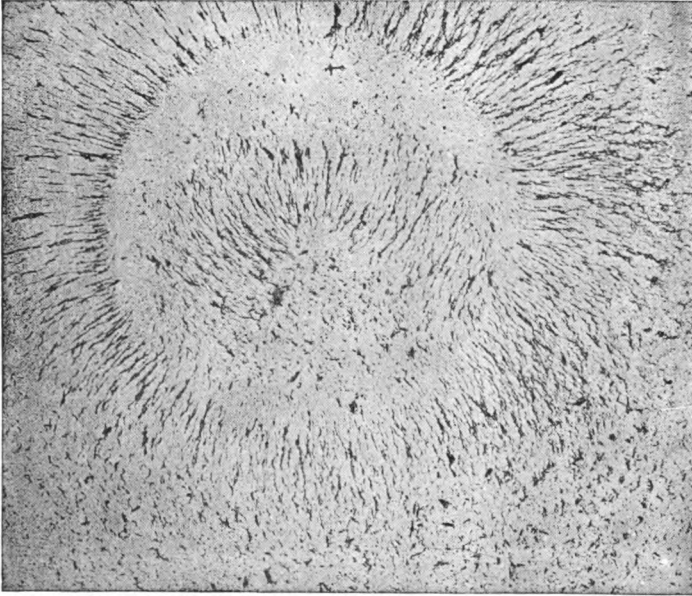

FIG. 63.— PHANTOM OF MANHATTAN WATCH-CASE RECEIVER WITH DIAPHRAGM IN PLACE.

in place. The field shown in Fig. 62 is a curious one, but is what would be expected. The effect of the central magnet is clearly shown. In Fig. 63 the phantom taken with diaphragm in place it is curious to notice that the reluctance of the diaphragm is sufficient to cause a notice-

able magnetic leakage from the circumference of the casting which forms the case of the instrument.

The model adopted by the Erickson Telephone Company is shown in Fig. 53c and in Figs. 64, 65 and 66.



FIG. 64.—ERICSSON RECEIVER DISSECTED.

Fig. 53c illustrates the receiver assembled, while in Fig. 64 it is dissected, Figs. 65 and 66 are the phantoms. In this receiver a pressed brass case forms the foundation of the instrument over the handle portion of which a tube of rubber

or other insulating material is slipped, which is furnished with a tail piece that carries the binding posts to which the receiver cord is attached and in the center of which is a screw eye to which a supplementary cord is knotted to support the receiver and relieve binding posts and cord conductors of any strain. In this respect this model is a departure from those that have been previously considered, for the foundation in the case is entirely metallic

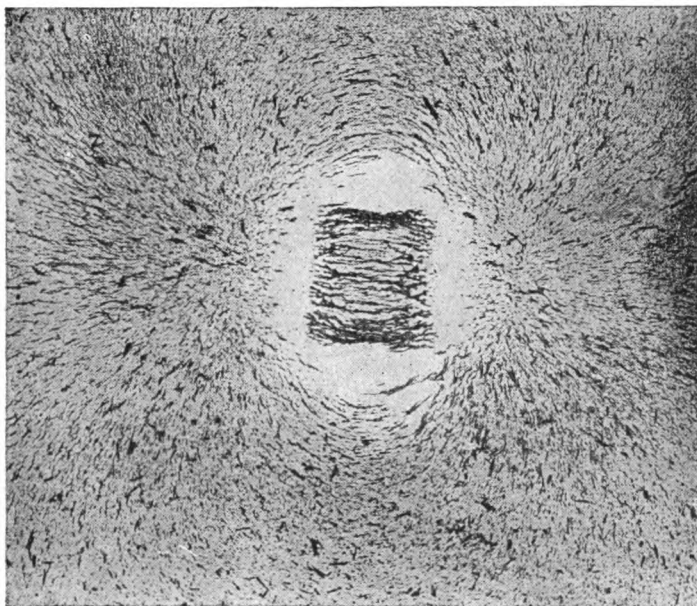

FIG. 65.— PHANTOM OF ERICSSON RECEIVER WITH DIAPHRAGM REMOVED.

and merely enough insulation provided to protect the user. The magnetic system consists of a U bar .622 in. wide and .20 in. thick; the magnet is 4 in. long. Each

pole piece is bolted to its appropriate side of the U by means of a bolt and nut. The pole pieces are .573 in. wide, .115 in. thick and .970 in. long. The tractive effort is 2.595 pounds (corresponding to 1,177 grams). This corresponds with tractive effort 1,315 grams per sq. cm., the induction in the pole pieces is 11,600 gausses, and a remanence of 6,000 gausses. The line coils are of brass .41 in. wide, .88 in. long and .31 in. deep. The receiver

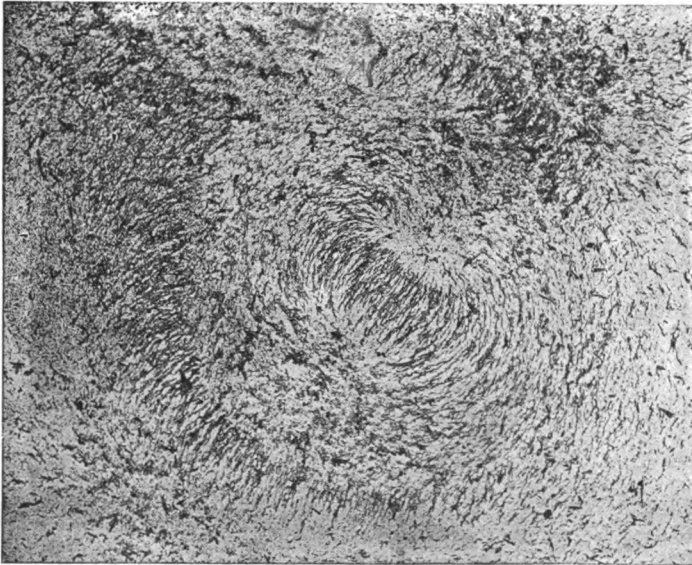

FIG. 66.— PHANTOM OF ERICSSON RECEIVER WITH DIAPHRAGM IN PLACE.

is wound with No. 36 wire with about 2,000 turns and has a resistance of 120 to 125 ohms. After the magnetic system is slipped in the case two holes are bored through the sides and the magnet bars, and two screws inserted

from the exterior. By this means the case and magnets are bolted firmly together. The screw holes in the case are slightly elongated and thus it is possible to adjust the pole pieces with reference to the diaphragm. The surface of the case is faced off and the diaphragm by means of the cap clamped firmly upon the exterior of the shell. The leading-in wires are insulated

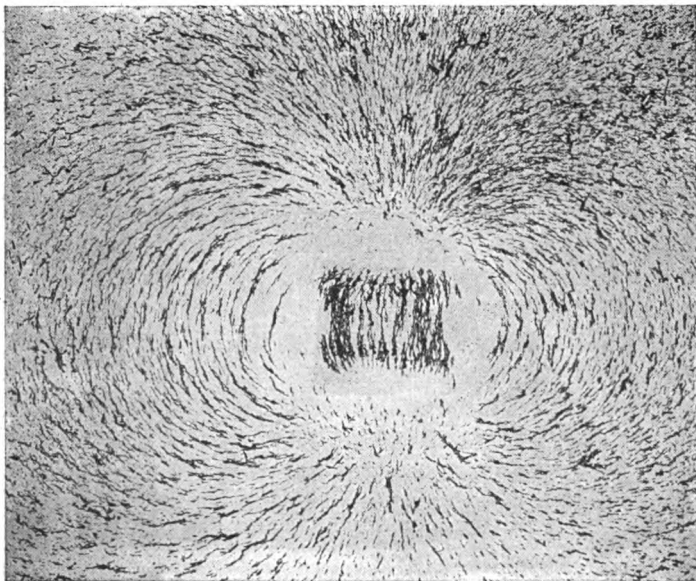

FIG. 67.—PHANTOM OF WESTERN TELEPHONE COMPANY RECEIVER, DIAPHRAGM REMOVED.

with a double covered paraffined cotton. They are attached directly to the line coil wire and thence carried backward to the case and soldered to the binding posts. The diaphragm is flat, of tin .01 in. thick, 2.31 in. in diameter

over all, giving 2 in. in free diameter. The phantoms of this model are shown in Figs. 65 and 66. Fig. 65 shows a field that is uniform and intense. The phantom of Fig. 66 is taken with the diaphragm in place and shows a uniform distribution of field and that the diaphragm is slightly above saturation.

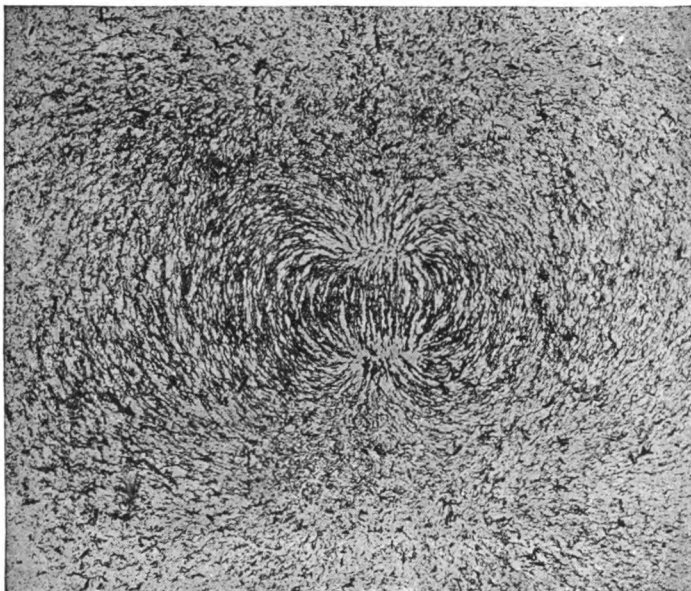

FIG. 68.—PHANTOM OF WESTERN TELEPHONE COMPANY RECEIVER, DIAPHRAGM IN PLACE.

The receiver of the Western Telephone Construction Company is shown in Figs. 53, 61, 67 and 68. Fig. 53D is the receiver assembled, while in Fig. 61 it is dissected. The case is of three parts, consisting of a body, a diaphragm cap and the tail piece. The magnetic system con-

sists of a U bar .627 in. wide, .24 in. thick and $3\frac{1}{2}$ in. long, with a lead filling as shown in Fig. 61. The pole pieces are .459 in. wide, .09 in. thick and .97 in. long and are bolted to the magnet by means of a bolt that extends through a non-magnetic composition filling piece, which is cast between the adjacent surface of the magnetic system. This pole piece carries a screw thread, which engages with a similar thread on the inside of the case. Lead is



FIG. 60.— SWEDISH-AMERICAN RECEIVER ASSEMBLED.

cast between the faces of the magnet in order to give sufficient weight. The coil spools are of brass .42 in. wide,

.53 in. long and .37 in. deep. The winding is No. 36 and the resistance from 95 to 100 ohms. The tractive effort is 1.188 pounds (553 grams). This corresponds to a tractive effort of 964 grams per sq. cm., and an induction in the pole pieces of 9,680 gausses; the remanence is 4,000



FIG. 70.— SWEDISH-AMERICAN RECEIVER DISSECTED.

gausses. The diaphragm is flat, of tinned sheet iron .011 in. thick, 2.13 in. in diameter over all, and 1.93 in. diameter free. The leading-in wires are rubber-covered okonite

and extend upward to the line spools from the rear of the case and are there attached to two screws in a partition between the end of the body and the tail cap. The receiver cord passes through the tail cap and is there knotted

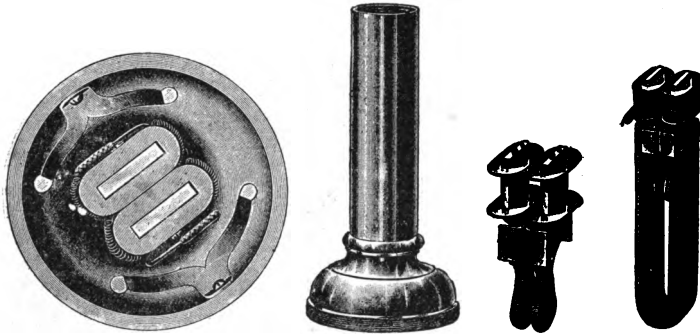

FIGS. 71, 72, 73 AND 74.—DETAILS OF SWEDISH-AMERICAN RECEIVER.

and attached to the same screws. The phantoms of this receiver are shown in Figs. 67 and 68. Fig. 67 is the phantom with the diaphragm removed, showing an exceedingly uniform and well-distributed field. In Fig. 68 the diaphragm is in place and it is quite evident that it is fully saturated.

The receiver of the Swedish-American Telephone Company is shown in Figs. 69 to 76, inclusive. In Fig. 69 the receiver is assembled. In Fig. 70 it is dissected, while Figs. 71, 72, 73 and 74 are details. It consists of a substantial pressed metal case over which a tube of insulating material is slipped to form the necessary handle. The magnetic system consists of a U bar and is shown in Figs. 70 and 74. This bar is .623 in. wide, 3 in. thick, of D-shaped steel. The distance between the face of the

bar is .25 in. The magnet is 3.25 in. long. The pole pieces are .625 in. wide, .120 in. thick, 1.31 in. long, and are secured by two brass bolts which pass through the magnet bars, the pole pieces and the filling piece, which is in-

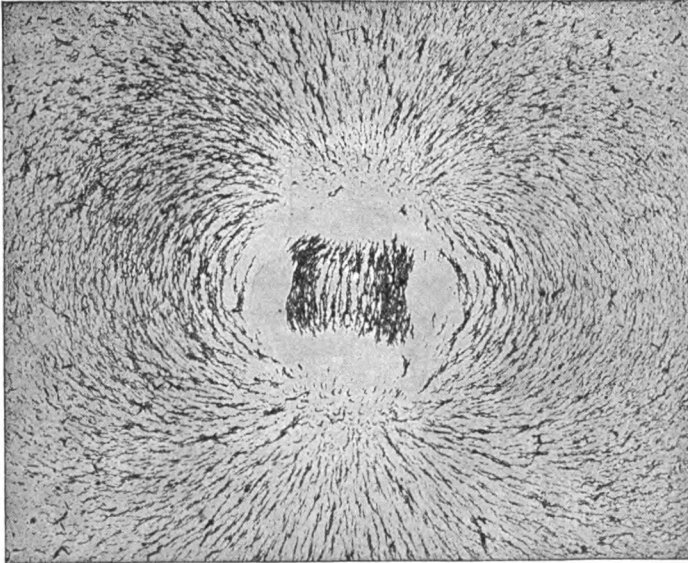

FIG. 75.— PHANTOM OF SWEDISH-AMERICAN RECEIVER, DIAPHRAGM REMOVED.

terposed between the faces of the magnet bars. The coil spools are .43 in. wide, .92 in. long, .43 in. deep and are made of brass. The winding is Nos. 34 to 36 wire to a resistance of about 70 to 80 ohms. Underneath the line coils is a wash-bowl shaped brass casting. The face of this casting is machined to be .02 to .03 in. in advance of the pole pieces, and the diaphragm is laid flat upon the face

of this casting. Then the entire system is slipped inside of the case and the diaphragm cap screwed down to a bearing. When the cap is home, the diaphragm and brass casting are pinched firmly to the metal of the case. There is, therefore, in this receiver, no adjustment between diaphragm and the pole pieces, subsequent to a final assemblage. The diaphragm is flat, of sheet iron, tinned, .014 in.

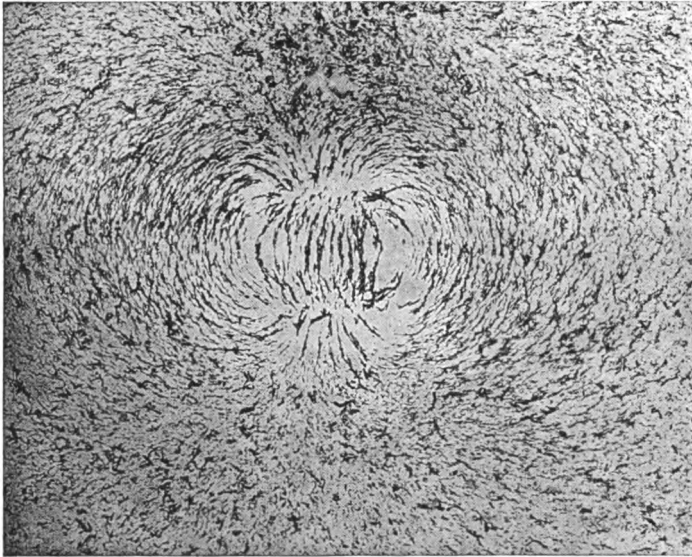

FIG. 76.— PHANTOM OF SWEDISH-AMERICAN RECEIVER, DIAPHRAGM IN PLACE.

thick, 2.19 in. in diameter over all and 2 in. free diameter. The tractive effort is 1.685 pounds (761 grams). This is equivalent to 795 grams per sq. cm., giving an induction of 8,800 gausses and a remanence of 4,500 gausses. Fig. 72 shows the interior metal shell of the receiver before

the insulating tube is slipped in place. Fig. 73 shows one method adopted for building the pole pieces and line coils, while in Fig. 74 the assembled magnet, pole

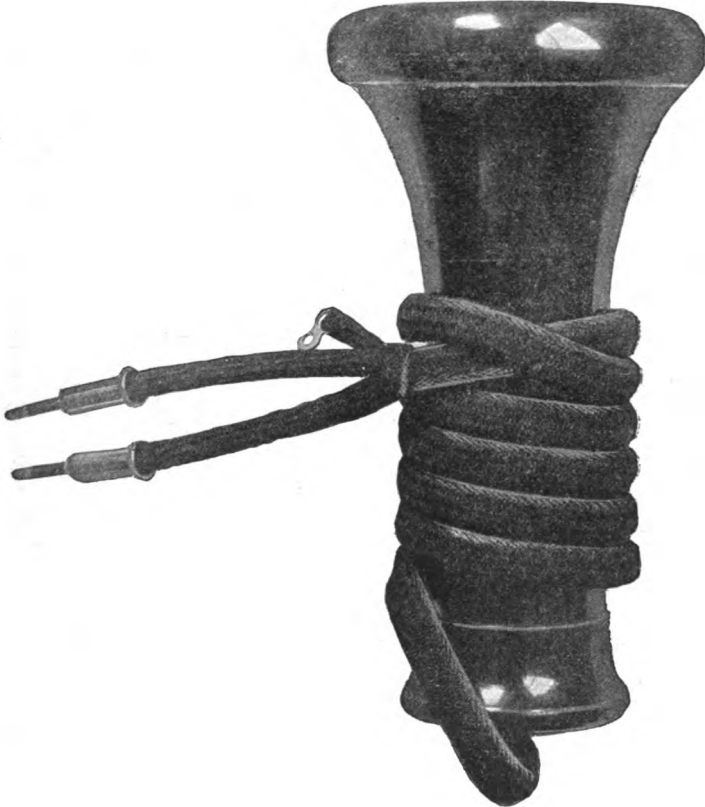

FIG. 77.— HOLTZER-CABOT RECEIVER ASSEMBLED.

pieces and spools are indicated. Fig. 71 is a front elevation of the receiver assembled and shows a model in

which two damper springs are used for the purpose of checking the vibrations of the diaphragm. Figs. 75 and 76 are the phantoms. Fig. 75 shows the phantom with



FIG. 78.— HOLTZER-CABOT RECEIVER DISSECTED.

the diaphragm removed, while Fig. 76 is taken with the diaphragm in place.

The Holtzer-Cabot receiver is illustrated in Figs. 77 to 80, inclusive. Fig. 77 shows it assembled in readiness for use. In Fig. 78 it is dissected. The case consists of two parts, a body and a receiver cap. The magnetic system is

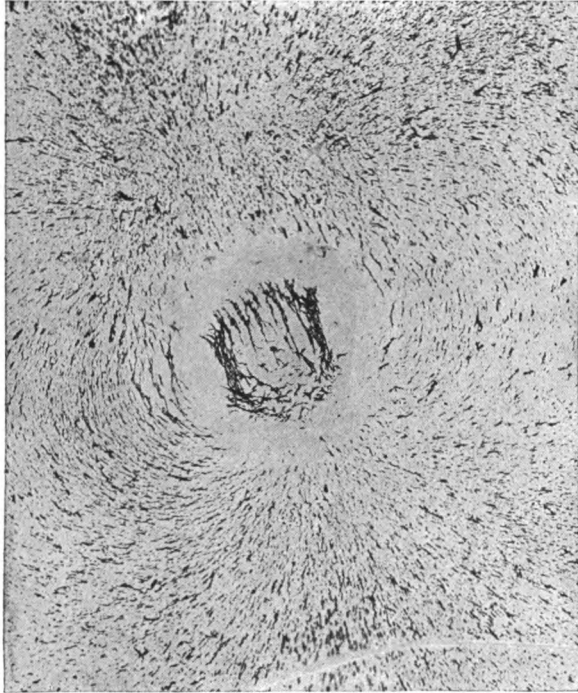

FIG. 79.—PHANTOM OF HOLTZER-CABOT RECEIVER WITH DIAPHRAGM REMOVED.

built of U-shaped bars of steel which are slightly semi-circular in section. The bar is .624 in. wide and .26 in. thick and 3.5 in. long. The pole pieces are nearly semi-cir-

cular in section, .47 in. wide, .15 in. thick, and 1.25 in. long, and are secured to the magnet by a pin, which is driven through the magnet bars, the pole pieces and a filling piece. The coil spools fit the pole pieces and are

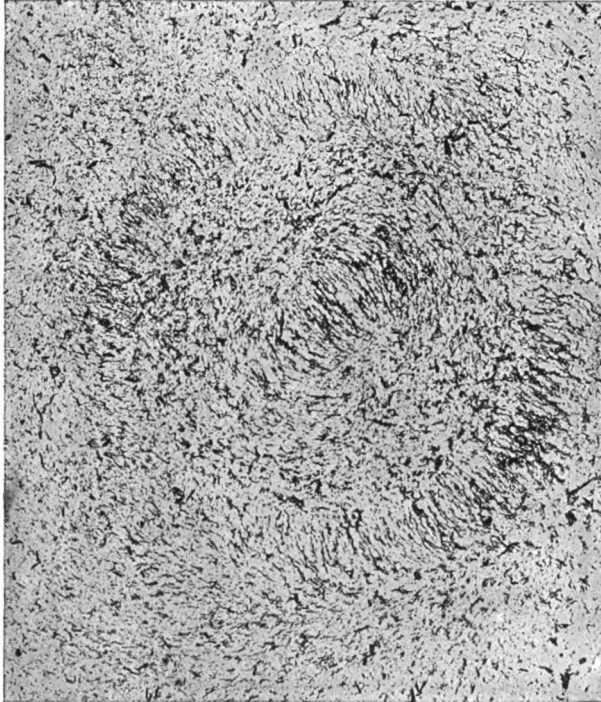

FIG. 80.—PHANTOM OF HOLTZER-CABOT RECEIVER WITH DIAPHRAGM IN PLACE.

.43 in. wide, .81 in. long and .36 in. deep. The winding is No. 36 wire and the resistance 70 to 80 ohms; the coils are connected in series. On the inside of the shell a bearing is faced. Between the magnet bars and the line

spools a non-metallic disc is set which is brought to a bearing upon the ledge on the inside of the shell, and the magnetic system held in place by four screws, which pass through this disc into the receiver case. The diaphragm

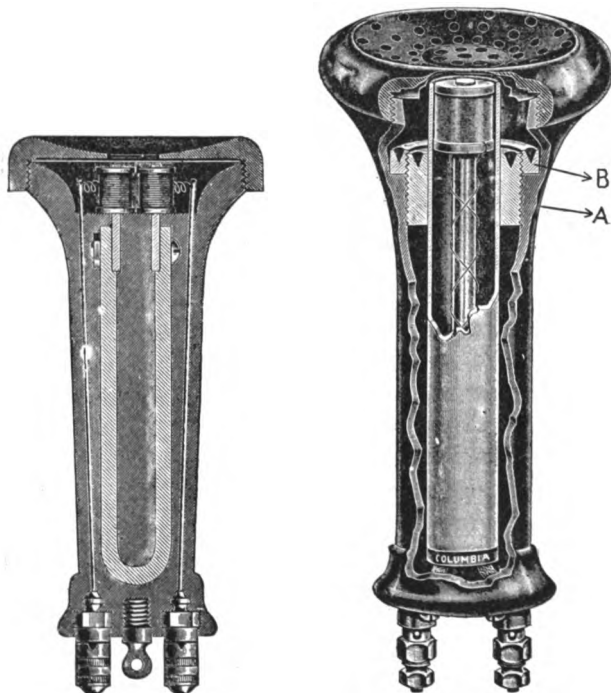

FIG. 81.—THE SOLID RECEIVER.

FIG. 82.—COLUMBIA RECEIVER.

is of sheet iron, tinned, flat; .013 in. thick, 2.1 in. in diameter and 1.87 in. free diameter. The face of the case is machined and the diaphragm clamped between the cap and the body. The receiver cord passes through a hole

in the rear, the braid of the cord is then looped around the U of the magnet, and there tied so that the entire receiver hangs by the braid attached to the magnetic system. Between the faces of the magnet a fibre block is placed to which the cord terminals are carried and attached by means of two screws. Upon this fibre block two clips are placed. The cord terminals are attached to one end of the clip, the leading-in wires to the other, and then they extend to the coil spools. Figs. 79 and 80 are the phantoms, Fig. 79 with the diaphragm removed. The field is almost circular in cross-section, which would apparently correspond in distribution closely to the shape of the diaphragm. Fig. 80 is the phantom with the diaphragm in place, and indicates an exceedingly uniform distribution with a diaphragm not oversaturated.

Fig. 81 is rather a unique model of receiver and is only shown as being an attempt to produce a design which could be subjected to any amount of abuse. The magnetic system consists of a U bar upon the end of which the customary pole pieces are placed. Besides this U bar two leading-in wires are placed that are attached to two binding posts set near the end of the magnet. Then the whole arrangement is placed in a mold and composition pressed around it so that the leading-in wires, magnetic system and pole pieces are cast into a solid block of composition. The case is then faced off, the coil spools pressed on and terminal wires soldered to the leading-in wires. The diaphragm is then placed on the case and the cap secured home. Obviously there is no possibility of adjustment, and in case of any injury to any part the easiest method of repair is to throw the receiver away and buy a new one.

The Columbia receiver, shown in Fig. 82, is a design using a tubular magnet instead of a bar magnet, as is shown

in the illustration. The magnetic system consists of a central pole piece, upon the end of which the line wire coil is placed. This bar is enclosed in an iron tube, which forms the other half of the magnet system. Around this tube a composition bushing is placed which is threaded to fit a corresponding screw thread in the interior of the case. The magnetic system is then screwed home and adjusted at the proper distance from the diaphragm. Then a lock nut is screwed on the outside of the bushing, which locks it against a ledge machined in the receiver case. The diaphragm is secured in the usual manner by clamping it to the face of the case by means of a diaphragm cap. The

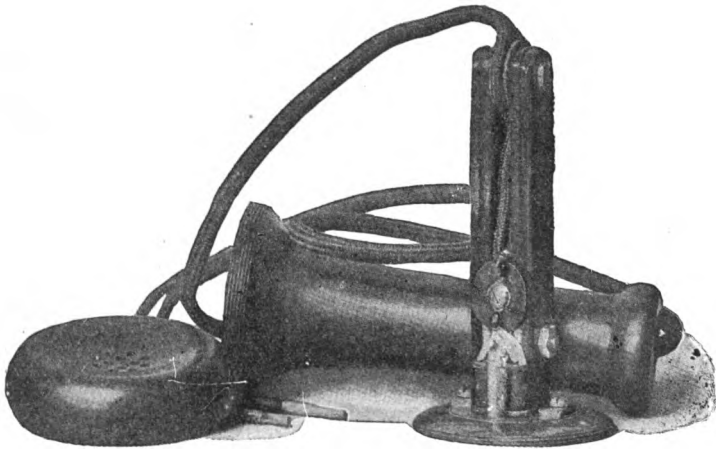

FIG. 83.—THE SUN RECEIVER. \

Columbia receiver adopts the method of perforating the diaphragm cap with a number of small holes instead of a large central aperture. This is considered an advantage,

as it prevents the curious or malicious from poking the diaphragm with a pencil or other object, and thus bending it out of shape. Doubtless this is an advantage from a maintenance standpoint, and while it is asserted that this method of making the diaphragm cap does not perceptibly impede the delivery of sound waves to the air, it seems almost certain that the larger number of small holes must exercise some perceptible retarding action upon the air impulses.

The model known as the Sun receiver, exhibits a peculiarity in the adjustment of the pole pieces to the diaphragm. As is shown in Fig. 83, the model consists of a case, body and a diaphragm cap. The magnetic system is composed of two parallel bars that are united by two bolts and filling pieces, those at the rear being of magnetic and those in the front of non-magnetic material. The pole pieces are secured to the front bolt and carry the coil spools to which is bolted a heavy brass plate, on top of which the diaphragm is placed. The pole pieces extend through the brass plate, which is faced off and forms a bearing for the diaphragm. This brass plate bears against the body of the case, and the diaphragm cap clamps the diaphragm case and magnetic system together at a single operation.

For the sake of easy comparison the data of the models illustrated is collected into the following four tables: No. VI, the magnetic system; No. VII, the pole pieces; No. VIII, the line coils; No. IX, the diaphragm.

TABLE VI.

Receiver Data. The Magnetic System.











Serial No.	Name.	Width of bar, in.	Thickness of bar, in.	Shape.	Dist. between bars in.	Area, sq. in.	Length, in.	Traction effort, grams.	Remanence (Gausses.	No. of bars.
1	A. B. T. Co. hand receiver.....	.630	.25		.50	.157	3.25	588	4250	2
2	A. B. T. Co. hand receiver	.425	.127	038	477	3500	2
3	Stromberg Carlson hand receiver625	.24		.32	.150	4.60	1332	5500	1
4	American Electric Telephone Co. receiver655	.25		.32	.164	4.25	964	4750	1
5	Kellogg Switchboard & Supply Co. receiver630	.24		.38	.151	3.50	1170	5400	2
6	Manhattan hand receiver.....	.623	.120		.31	.075	3.75	364	4300	2
7	Manhattan watch-case receiver	Steel	Cast'g		156
8	Ericsson Telephone Co. receiver622	.20		.50	.127	4.00	1177	6000	1
9	Western Telephone Construction Co. receiver627	.24		.38	.151	3.50	553	4000	1
10	Swedish-American receiver.....	.623	.23		.25	.142	3.75	761	4500	1
11	Holtzer-Cabot receiver624	.26		.38	.158	3.50	1262	5500	1

TABLE VII.
Receiver Data. The Pole Pieces.

No.	Name.	Width, in.	Thickness, in.	Length, in.	Area, sq. cm.	Distance centers, in.	Magnetization.
1	A. B. T. Company hand receiver.....	.540	.085	1.36	30	311	9800
2	A. B. T. Company head receiver.....	.375	.084	.50	2.07	500	9700
3	Stromberg-Carlson hand receiver.....	.590	.100	1.18	38	456	13100
4	American Electric Telephone Company receiver.....	.610	.100	1.50	30	490	10900
5	Kellogg Switchboard & Supply Company receiver.....	.540	.102	1.25	38	420	12500
6	Manhattan hand receiver.....	.630	.120	1.52	52	480	6000
7	Manhattan watch-case receiver.....	Steel pin	.290" diam.	.26	36	5800
8	Ericsson Telephone Company receiver.....	.573	.115	.370	43	415	11600
9	Western Telephone Construction Company receiver.....	.485	.090	.370	33	412	9800
10	Swedish-American receiver.....	.625	.120	1.31	45	500	8800
11	Holtzer-Cabot receiver.....	.470	1.50	1.120	46	475	10500

Prolongation
of magnets
.145" hole

TABLE VIII.
Receiver Data. The Line Coils.

No.	Name.	Width, in.	Length, in.	Depth, in.	Material.	Wire, No. B. & G.	Resistance, ohms.
1	A. B. T. Company hand receiver.....	.40	.90	.43	Brass	36	20 to 100
2	A. B. T. Company hand receiver.....	.37	.68	.31	Brass	36	60
3	Stromberg-Carlson hand receiver.....	.44	.86	.50	Fibre	36	94
4	American Electric Telephone Company receiver.....	.40	.90	.63	Brass	36	125
5	Kellogg Switchboard & Supply Company receiver.....	.41	.90	.43	Brass	30	69
6	Manhattan hand receiver.....	.44	1.00	.43	Brass	36	68
7	Manhattan watch-case receiver.....	1 spool	Circ. 1" diam.	.312	Wood	36	73
8	Ericsson Telephone Company receiver.....	.41	.88	.31	Brass	36	121
9	Western Telephone Construction Company receiver.....	.42	.83	.37	Brass	36	98
10	Swedish-American receiver.....	.43	.92	.43	Brass	36	84
11	Holtzer-Cabot receiver.....	.43	.81	.36	Brass	36	75

TELEPHONY

1200

1200

TABLE IX.
Receiver Data. The Diaphragm.

No.	Name.	Thickness, in.	Diameter over all, in.	Free diameter, in.	Material.	Coating.	Shape.
1	A. B. T. Company hand receiver.....	.01	2.25	1.98	Ferrotypc	Varnish	Flat
2	A. B. T. Company hand receiver.....	.01	2.00	2.00	Ferrotypc	Varnish	Flat
3	Stromberg-Carlson hand receiver.....	.01	2.19	2.12	Sheet iron	Tin	Flat
4	American Electric Telephone Company receiver.....	.01	2.12	1.87	Sheet iron	Tin	Dished
5	Kellogg Switchboard & Supply Company receiver.....	.01	2.18	1.98	Ferrotypc	Varnish	Flat
6	Manhattan hand receiver.....	.01	2.25	1.75	Ferrotypc	Varnish	Flat
7	Manhattan watch-case receiver.....	.005	2.00	2.00	Ferrotypc	Varnish	Flat
8	Ericsson Telephone Company receiver.....	.01	2.31	2.00	Sheet iron	Tin	Flat
9	Western Telephone Construction Company receiver.....	.01	2.13	1.98	Sheet iron	Tin	Flat
10	Swedish-American receiver.....	.014	2.19	2.00	Sheet iron	Tin	Flat
11	Holtzer-Cabot receiver.....	.018	2.18	1.87	Sheet iron	Tin	Flat

CHAPTER III.

TELEPHONE TRANSMITTERS.

THE magneto telephone is a reversible device and can act either as a transmitter or as a receiver; so Prof. Bell's invention solved the problem of the electrical transmission of speech by providing an instrument that could be used interchangeably at each end of the line. In earliest telephone installations only a magneto was provided, which was alternately a transmitter and a receiver, but it needed but a brief experience to demonstrate that while the Bell instrument was so efficient a receiver that the models of to-day show but little change, it was eminently unsatisfactory as a transmitter, for when the magneto telephone is used for transmission it is only possible to converse over very short lines, and even under the most favorable conditions one must so shout as to make the use of the telephone a burden to the speaker, and an annoyance to the listener. But the electrical transmission of speech, even in the somewhat uncertain fashion of the earliest instruments, was so stupendous an achievement that every inventor was aroused to an effort to improve, each seeking to use some different electrical principle, either to produce a better instrument or to evade earlier invention.

Every transmitter so far invented operates upon one of the following three principles: *First, electromagnetic induction; second, electrostatic induction; third, microphonic contact.*

Electromagnetic Transmitters.—Naturally first endeavors were efforts at the improvement of the magneto

telephone, and it presently appeared under a thousand different guises: Magnets were bent and contorted into numerous curious and grotesque forms, instruments equipped with several diaphragms appeared, and all the possible combinations of the various parts of the receiver were unearthed and tried, until inventors, weary of further quest, decided that it was necessary to seek in some other direction for an improved transmitter, and the magneto instrument was relegated to the office of the receiver. Nevertheless, for a full survey of the subject, a consideration of the principles of the magneto as a transmitter must not be overlooked, for the operation of that instrument is not quite so simple as at first sight appears, and experts are not unanimous in the explanations offered. Some are disposed to credit the ability to excite electrical waves to a molecular motion of the particles of the iron core under the magnetic changes produced by the movement of the diaphragm. Doubtless this action exists, but it appears insufficient to account for the results produced.

It has been believed that there is some sort of reaction between the spirals composing the field coils — perhaps partly due to an electrostatic action, and partly to an electromagnetic one. But this assumption seems also inadequate. It is certain that the motion of the diaphragm does cause marked changes in the magnetic circuit, which seem to be sufficient to explain upon the basis of electromagnetic induction the operation of the instrument as a transmitter, and on the whole the balance of opinion favors this explanation, though it is probable that all three actions are operative.

If it be true that the ability of the magneto instrument, when acting as a receiver, to initiate sound waves depends upon a varying magnetic field produced by elec-

tric currents over the line, the greater the changes in line current the louder the receiver will talk. Hence, the object of the transmitter should be to produce the greatest possible variation in such currents. When the magneto instrument is used as a transmitter, its ability to create pulsations in the line depends upon the amount of motion which its diaphragm can make under the impulse of the sound waves which it receives, and its limitations under such circumstances are very obvious.

When one speaks into any transmitter, only a small percentage of the energy of the sound waves reaches the diaphragm. Owing to rigidity, molecular friction, losses in the magnetic field and the conducting system, the little energy that affects the diaphragm is still further reduced, so that it has been estimated that at the receiving end only two or three-tenths of one per cent. of the energy expended at the transmitting end reappears as sound. Naturally the first attempts at improvement were concentrated upon the diaphragm in an endeavor to obtain a greater excursion; but in this direction the limitations were soon reached, for while it is easy to secure a greater volume of sound, distinctness of articulation is almost at once sacrificed by the confusion which arises from the splitting up of the diaphragm into parts which vibrate independently of each other. So to secure crispness and distinctness the diaphragm must be thin, and vibrate through a small space, considerations which obviously preclude a magneto instrument from developing powerful impulses in the line.

Electrostatic Transmitters.—One of the earliest attempts to improve the transmitter was an effort to utilize electrostatic induction instead of electromagnetic. A telephone operating upon this principle was brought out by

Mr. Edison in 1877. Fig. 84 shows the general method adopted. In the model, *A*, a resonant chamber, *V*, having a mouthpiece, was provided, around the circumference of which a number of plates, *P*, were placed, which were connected through a battery to the line. Just inside of this row of plates a second set was placed, which were free to

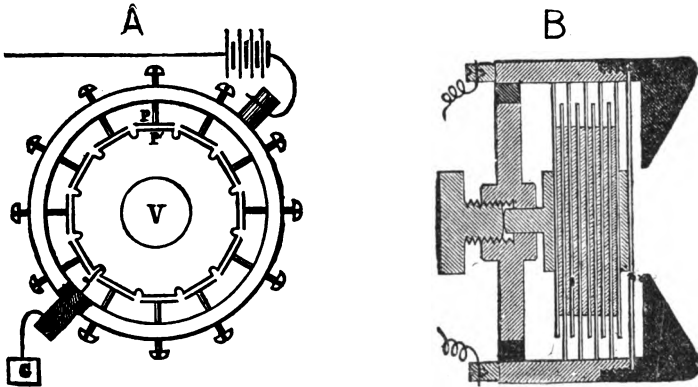

FIG. 84.—CONDENSER TRANSMITTER.

vibrate under the sound waves. As the plates moved to and fro they increased and diminished the space intervening and thus varied electrostatic capacity. A more practical model is shown at *B*, in which there are a number of metal plates free to move, separated by insulating material. One set of plates is connected to one side of the line and the other set to the other side. Speaking against the front plate of the system sets up a vibratory motion between all the plates, thus varying electrostatic capacity. Instruments of this kind are found to give exceedingly excellent articulation, and will act both as transmitter and receiver; but like the magneto instrument, they are

very deficient in power and can only be used on the shortest lines and under the most favorable circumstances.

Microphonic Contact Transmitters.— The next step was to provide some exterior source of electricity which should be entirely independent of the motion of the diaphragm, capable of delivering to the line any desired volume of current, and then to arrange the vibrating system to be merely a regulator or valve to control the amount of current, so that it shall be proportional to the acoustic waves. A somewhat similar example is that of a gun. The energy that propels the ball resides in the charge of explosive, and a very feeble pressure upon a properly-arranged trigger is sufficient to release an enormous amount of energy. It was hoped that by providing a battery to supply the electrical energy, a vibrating mechanism could be invented that should control this current in accordance with the sound waves. In other words, the transmitter ought to be a valve operated by the sound impulses which should allow more or less current to flow. In a rough way an ordinary Morse key operates upon this plan, for under the touch of the fingers it injects into the line squirts of electricity from the battery, whose relative duration and frequency form the telegraphic alphabet.

It was upon this plan that the old Reis telephone was built, which consisted of a battery and a diaphragm that carried a platinum contact which opened and closed the circuit with every sound wave, but for the successful transmission of speech something infinitely finer and more delicate was necessary. In the Reis telephone the surface of the bearings were made of polished platinum and all possible pains taken to obviate the resistance, which even at that time was well known to exist in a circuit containing an imperfect contact. Therefore, when the contact

pieces touched each other there was essentially no resistance in the circuit, save that of the metallic conductors, and if the contact pieces were separated by ever so small an amount the resistance of the circuit was almost infinite. It was a dead open-and-shut affair, with no possibility of any intermediate condition that could render the gradations necessary to articulate speech, so this apparatus was only a slightly refined reproduction of the Morse key, capable of sending little else than dots and dashes.

For several years prior to the appearance of the Bell telephone it had been known that an imperfect contact introduced great resistance into an electrical circuit, and that this resistance would vary widely with the pressure applied to the surfaces. But all inventors had ignored the

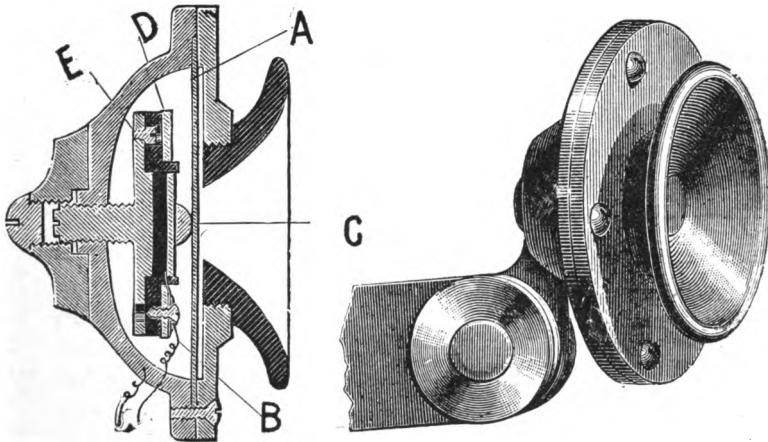

FIG. 85.—EDISON CARBON TRANSMITTER.

possibility of utilizing this fact in the construction of an electro-acoustic valve that would produce a more powerful

transmitter. In 1877 Mr. Edison produced a transmitter whose operation he explained upon the theory of varying pressure applied to a bit of carbon. This transmitter is shown in Fig. 85. *A B* is the diaphragm against which the sound waves impinge, in the center of which is a button, *C*, which presses against an electrode, *D*, which is in contact with a thin circular cake, *E*, made of compressed lampblack. This rests against a metal button that forms the other electrode. Over transmitters utilizing either electromagnetic or electrostatic induction this instrument was a vast improvement, and it probably operated on the principles now included in all carbon transmitters.

Mr. Edison is reported as explaining the operation of this transmitter by assuming that the specific resistance of the carbon button varied very greatly under pressure, and that the slight changes in pressure, due to the motion of the diaphragm, were sufficient to account for the improvement in the volume of transmission. Experiments have since shown that with any pressure up to the actual crushing point of carbon there is too little change in its resistance to make this theory a satisfactory one. About the same time, Mr. Berliner, while practising with the Morse key, discovered that the resistance of an imperfect contact could be greatly varied by a slight change in the pressure applied thereto, and, on April 4, 1877, filed a caveat in the American Patent Office covering this principle. About a year subsequently Prof. Hughes published a description of an instrument which he termed the microphone, on account of its apparent ability to greatly increase the loudness of faint sounds.

There seems little reason to doubt at all that both Berliner and Edison were the earliest *constructors* of microphonic transmitters; but, either owing to the reticence

imposed by patent law, or by a failure to fully comprehend the extent of the discoveries embraced in their models, these inventors failed to describe their inventions in so clear a manner as to reserve to themselves the full credit thereof. Prof. Hughes sought no patents and certainly was the first one to fully and clearly *describe* the *action* of the microphonic contact.

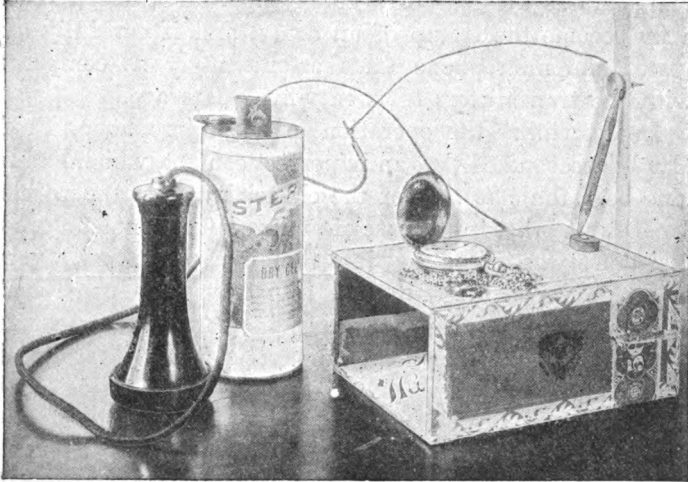

FIG. 86.— ILLUSTRATION OF HUGHES MICROPHONE.

A microphone built upon the Hughes plan is illustrated in Fig. 86, from which it is seen that the foundation of the instrument consists of a box which acts as a resonant chamber. In the illustration a cigar box is used to show how easily such an instrument can be made. Upon the box a small piece of carbon is placed upon which a lead pencil or any piece of carbon rod stands, the upper portion of which leans lightly against another carbon block.

A dry cell and a receiver are placed in circuit with the carbon pencil; if, under these circumstances a faint sound wave impinges upon the box, the receiver will emit a greatly intensified reproduction, and by adjusting the carbon rod so that a very poor contact is made with the carbon blocks, the instrument can be made almost incredibly sensitive. The ticking of a watch placed upon the sound board reappears as the roar of a boiler shop. The footsteps of a fly become the tramp of an army, and if carefully adjusted the microphone talks astonishingly as compared with the transmitters of twenty-five years ago.

In describing the operation of the microphone, Prof. Hughes recognized that an imperfect contact, which had so long been the *bête noir* of the electrician was responsible. He assumed that in the case of an imperfect contact a great resistance was introduced into the circuit, but that a very slight change in pressure was able to vastly change such resistance, with a corresponding increase or decrease in the current. For telephonic purposes the very thing which electricians had striven to avoid was the one solution of the problem. Prof. Hughes showed that the material of which the microphone was constructed mattered little, and that almost any substance would be operative provided the contract between its surfaces was poor. As shown in Fig. 87, it is feasible to construct an excellent microphone out of three screws, one of which is laid across the other two, and it matters little whether they are iron or brass, only the older, dirtier and more rusty, the better. The operation of the microphone is explained as follows: Under normal conditions the carbon rod stands loosely upon the lower block, and leans very lightly against the upper one. There are, therefore, two places of contact between which the pressure is exceedingly small. Consequently,

the resistance of the circuit at these points is large and but little current will pass. Suppose a sound wave impinges upon the apparatus, throwing all of its parts into vibration. Owing to inertia, the carbon rod and the blocks do not

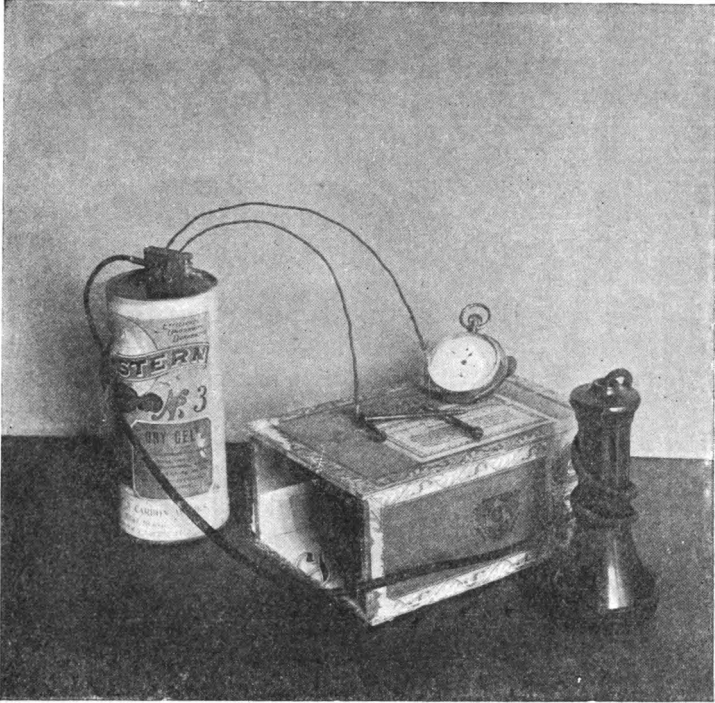

FIG. 87.— ANOTHER FORM OF HUGHES MICROPHONE.

move mathematically together. Consequently, the pressure between the contact surface varies with every sonorous intonation, increasing and decreasing as the wave ebbs and flows and exactly in proportion thereto. Now, while the

actual change in pressure between the surfaces is exceedingly small, even when measured in a fraction of a grain; yet the fact remains that an almost inconceivably minute change in pressure can produce a relatively very great change in the electrical resistance of a bad contact. Therefore, a small sound wave may produce a great variation in the current traversing the receiver, and so excite in its diaphragm vibrations of great amplitude, with a production of correspondingly loud sounds. The microphone does *not magnify* sound in the same sense in which the microscope enlarges the object at which one gazes, for the receiver only repeats the *energy changes* in the current in the circuit, and these energy changes may, or may not, faithfully repeat the sound waves that originated them. The fact that under the very best conditions speech reproduction is markedly imperfect is conclusive evidence that microphonic reproduction is by no means infallible. While it is certain that the success attending the employment of the microphone as a speech transmitter is due to the changes in contact resistance, we are quite in the dark as to how a slight change in pressure is able to effect such a marked change in resistance. There are four theories, none of which is entirely satisfactory, and it is probable that all play a part.

First, there is the theory originally advanced by Mr. Edison that a change in pressure effects an actual change in the specific resistance of the material employed. This theory has probably the least support.

Second, it is believed that upon the surface of bodies resembling carbon, air and other gases exist in a peculiar state of condensation about which very little is known, and that very slight variations in pressure affect both the thickness and the state of condensation of the gas envelope that

encloses every particle. It is supposed that this variation may be sufficient to account for the changes in resistance. Mr. Berliner has recently advocated this explanation.*

Third, according to the atomic theory, it is supposed that even in the densest solid the ultimate molecules are not in contact, but are separated by spaces which, in proportion to molecular sizes, are very great, and that the cohesive attraction to which the strength of all bodies is attributed is not due to actual contact between the particles, but merely to the fact that many of them have come within each other's sphere of attraction. In the case of a bad contact it is imagined that only a few molecules of one body are close enough to those of the other to be within this sphere. So it is quite conceivable that a very slight increase in pressure might result in squeezing an enormously greater number of molecules within each other's orbit. On the whole, this theory seems to be the most probable, and has the greatest number of adherents.

Fourth, it is imagined that between the carbon particles slight arcs may form, and that as the resistance of carbon varies very rapidly with changes in its temperature a slight current may warm the carbon sufficiently to lower its resistance markedly. This would cause a still greater current to flow, with further heating, so that the carbon would react upon itself and continually allow more and more current to pass. That arcs do form in carbon transmitters, experience amply proves, but so soon as they occur the quality of transmission almost immediately changes and the listener is at once made aware that something unusual is happening. Usually the character of transmission is unfavorably affected, so that this explanation seems inadequate.

* See American Electrician, March 7, 1897.

Whether any or none of these hypotheses shall prove to be the true explanation of microphonic contact, the future only can decide, but whatever that verdict shall be, it is certain that to-day every successful commercial transmitter is a microphone in some form or other, and so a study of commercial instruments leads to a classification according to the way in which microphonic contacts are employed.

- 1st. The single-contact transmitter.
- 2d. The series-contact transmitter.
- 3d. Multiple-contact transmitter.
- 4th. Multiple-series transmitter, or granular instruments.

First, Single-contact Instruments.—The first microphone was a carbon pencil leaning against a pair of carbon blocks. To make a microphonic transmitter it was essen-

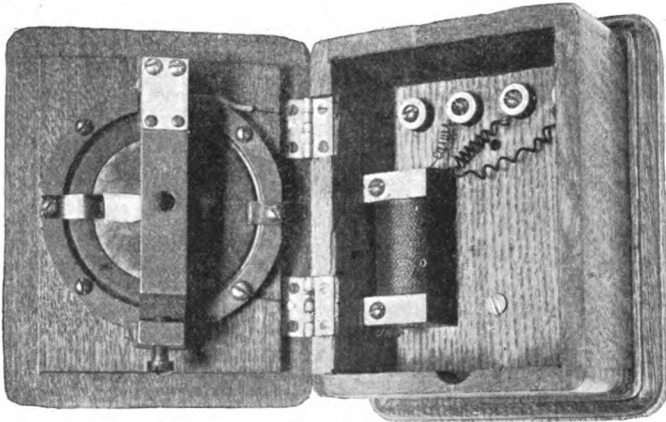

FIG. 88.—BLAKE TRANSMITTER, SHOWING MECHANISM.

tial to put this apparatus in commercial shape. This resulted in the famous Blake transmitter, invented by Fran-

cis F. Blake, of Boston, which for many years was almost solely employed by the American Bell Telephone Co., and which to-day may be seen in some localities, although the

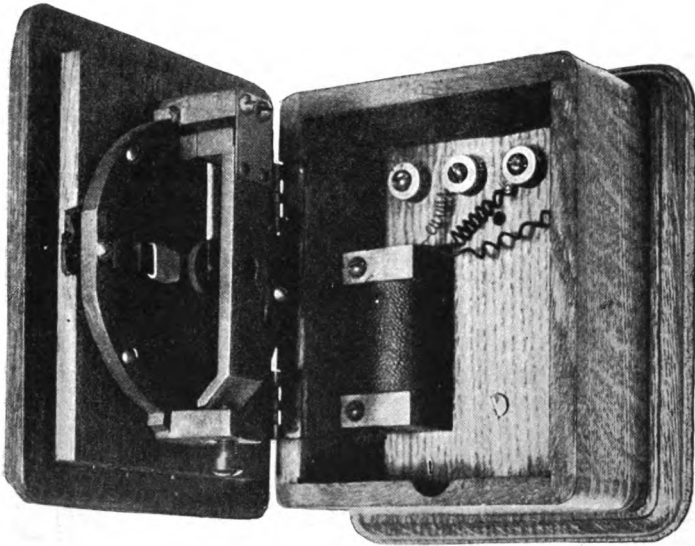

FIG. 89.—BLAKE TRANSMITTER, SHOWING BUTTON.

more modern solid back has almost displaced it. The general appearance of the Blake transmitter is shown in the Frontispiece, while Figs. 88 and 89 are from two photographs of the instrument opened. A section and an elevation of the transmitter mechanism is shown in Fig. 90. The Blake transmitter consisted of a small black walnut box $5 \frac{9}{16}$ in. wide \times $6 \frac{11}{16}$ in. high and $2 \frac{13}{16}$ in. deep, the dimensions being over all. The object of the box was to provide a receptacle for the induction coil and to protect the working parts of the trans-

mitter from injury. The mechanism was placed inside the door of the box, the center of which was, on the outside, hollowed to a trumpet-shaped cavity, containing a hole in the center through which the sound waves could impinge upon the diaphragm. Fig. 90 gives a section through the mechanism and the elevation of the inside of the door. A heavy brass ring, *e*, was screwed to the door, which formed

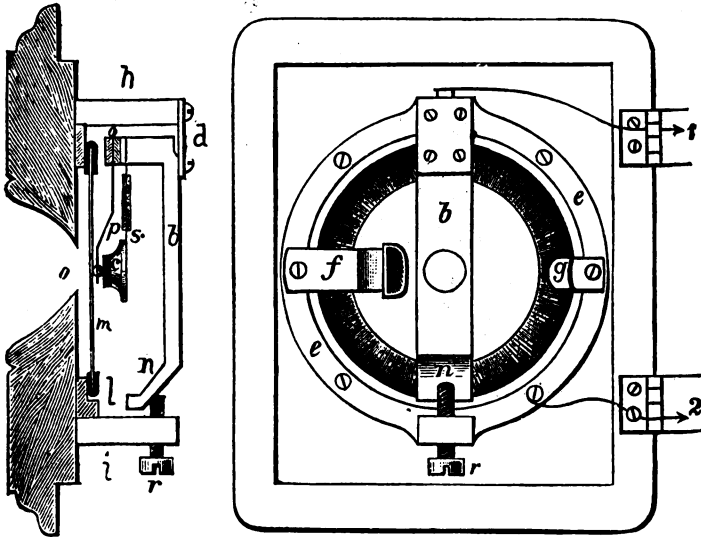

FIG. 90.— BLAKE TRANSMITTER, SECTION AND ELEVATION.

the foundation of the transmitter. A diaphragm of sheet iron $2\frac{1}{2}$ in. in diameter and .013 in. thick, whose edges were covered with a rubber strap, was placed in the center of this ring, and retained in place by means of a clamp, *g*, and a rubber-tipped damping spring, *f*. Upon the foundation ring two lugs, *h* and *i*, were cast. From the upper

lug, *h*, a U-shaped piece of brass was suspended by means of a german silver spring, *d*. In the lug *i* the adjusting screw, *r*, is inserted, which bears upon the U brass at *n*. The carbon button was $\frac{3}{8}$ in. in diameter and $\frac{1}{8}$ in. in thickness. It was made of the purest and most homogeneous carbon, free from grit and with a surface as highly polished as possible. The button was spun into a case, *c*, which may be of any convenient size sufficient to adequately hold the button, and the whole affair suspended from the upper end of the U brass by means of a small steel spring .01 of an inch thick and $\frac{9}{64}$ in. wide, over which is slipped a rubber band to prevent vibrations. A german silver spring, *p*, about .005 in. thick and $\frac{1}{8}$ of an inch wide armed at its lower extremity with a minute globule of platinum was likewise attached to the upper end of the piece, *b*, and so adjusted that the platinum bead stands in the center of the carbon button, and between the button and the diaphragm. When in proper adjustment the german silver spring should press gently against the carbon so as to follow the latter when it is pulled away for a distance of about $\frac{1}{8}$ in. and then leave it. The steel spring is adjusted while speaking into the transmitter by varying the tension with the screw, *r*, until the listener reports the most favorable result. With the Blake transmitter commercial telephony became a possibility, and so far as clearness and fineness of articulation is concerned few, even of the most modern instruments, equal the Blake, and it is doubtful if any sensibly excel it. But the Blake, even under the most favorable circumstances, is so deficient in volume that even upon short lines, those whose hearing is in the slightest below normal, find the use of the telephone an impossibility, and upon long lines it is impractical for any.

Second, The Series-contact Transmitter.— This type of instrument is represented in Fig. 91, one form of the many instruments proposed, which should embrace several microphonic contacts in series with each other. A diaphragm,

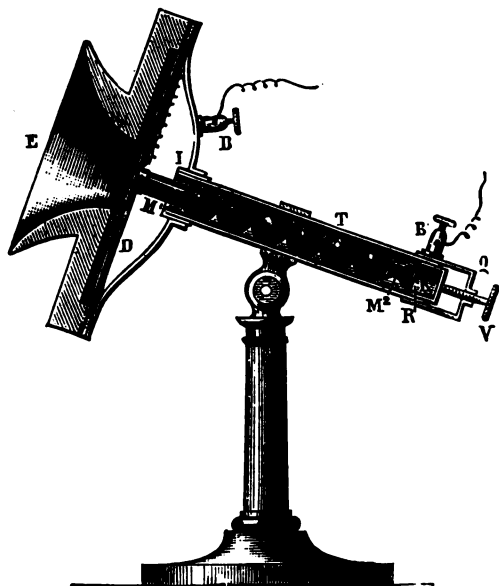

FIG. 91.— SERIES-CONTACT TRANSMITTER.

D, was furnished with a plunger, *M*, behind which a tube, *T*, was placed that contained a number of carbon bullets. The rest of the construction of this model is self-evident from the illustration. Transmitters of this description have not been markedly successful, and from our present conceptions of the operation of the microphone contact, one is likely to wonder at the expenditure of so much time and energy upon series contacts, for it is very obvious that if

the operation of the transmitter is to be that of a valve it is either necessary to make one valve large enough to accommodate the maximum desired current or to put a number of valves in *multiple*, as it is manifestly impossible that one valve in series with another of the same capacity can transmit a greater volume than a single one is able to pass.

Third, The Multiple-contact Transmitter.— It was soon perceived that it was hopeless to expect great improvements from the series-contact instrument, and designers then turned attention to arranging contacts in multiple in order to obtain a greater volume of current without interfering with the delicacy of control. A typical instrument on the

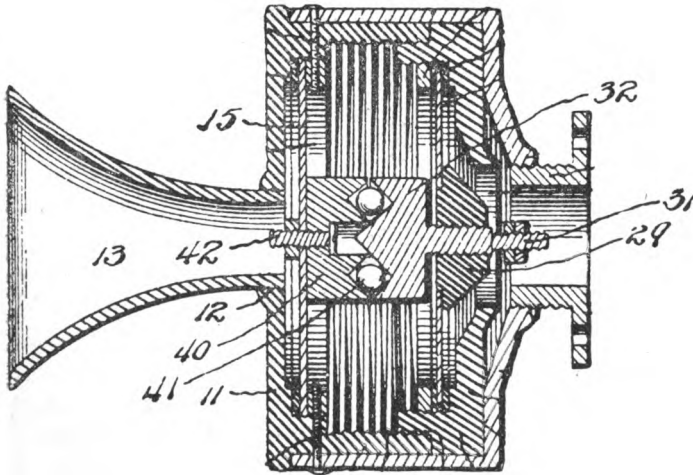

FIG. 92.— MULTIPLE-CONTACT TRANSMITTER.

multiple-contact plan is shown in Fig. 92, and all instruments of this class are similar in general construction. There is a case, 11, provided with a mouthpiece, 13, behind

which a diaphragm, 15, is situated. In the center of this diaphragm a carbon button, 40, is secured by means of a screw, 42, through the center of the diaphragm. This carbon button has a V-shaped groove cut in the face opposite the diaphragm. Upon the rear of the case, enclosing the apparatus, a second carbon button, 32, is attached which carries a similar V-shaped groove, the two buttons being adjusted with reference to each other, so that these two grooves are concentric. When the instrument is assembled a series of carbon balls, 41, about as big as No. 8 shot, are placed in the rectangular cavity formed by the V-shaped grooves. By this means quite a number of microphonic contacts in parallel may be obtained. The angles of the groove are such that the carbon balls by gravity always tend to assume the lowest position and normally lie in contact with the two buttons; thus any vibration of the diaphragm will cause a variation in pressure between many and probably all of the contacts thus provided. Multiple-contact instruments have been much more successful than the series-contact type, and at present several models are manufactured and are fairly successful.

Fourth, Multiple-series Transmitters or Granular Instruments.—To carry the multiple-contact idea to the extreme is to provide a transmitter with a multitude of such contacts. The first, and most famous, instrument of this type is the Hunning transmitter, illustrated in Fig. 93. It was an exceedingly simple device, consisting of a case, *B*, containing a hollow receptacle, in front of which a diaphragm, *D*, was placed. This diaphragm was in the first model made of platinum, while the rear of the case was lined with a similar material, and the intervening space filled with powdered carbon, or in other words the carbon bullets of Fig. 92 were made as small as possible

and as numerous as possible. This so-called granular instrument has formed the foundation of all of the modern types, and has, to all intents and purposes, practically displaced every other design.

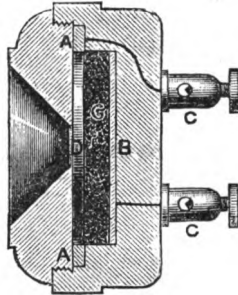

FIG. 93.— HUNNING TRANSMITTER.

The Hunning transmitter was at once recognized as much more powerful than any of its predecessors. Unfortunately, it was afflicted with a disease, toward the remedy of which all subsequent inventors have directed their efforts with as yet but partial success. This difficulty is known as “packing” and seems to be due to the gradual settlement of the carbon granules under the inevitable jarring and vibration to which the instrument is subjected, into a compact mass at the bottom of the receptacle which holds them, and under these circumstances the contact between the granules is no longer affected by the slight change of pressure produced by the diaphragm and the instrument ceases to talk.

In some systematic investigations upon the relation between pressure and transmission, conducted at the Massachusetts Institute of Technology it was shown that the

operation of a Blake transmitter depended partly upon the pressure which the springs holding the carbon button and platinum globule exerted, and partly upon the inertia of the button itself. In order to eliminate one of these factors Mr. Anthony C. White carried on an extended investigation, which resulted in the production of the "*White transmitter*," usually known as the "*Solid Back*," from

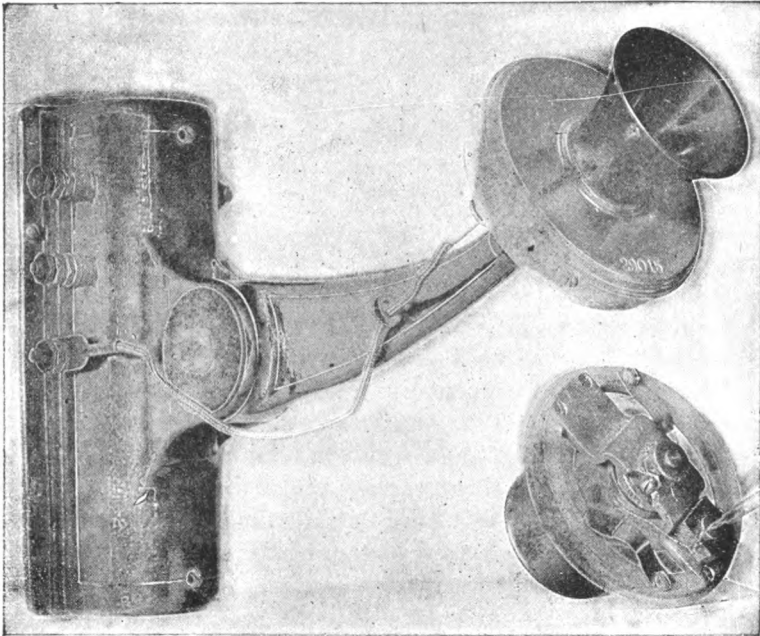

FIG. 94.— SOLID-BACK TRANSMITTER.

the fact that the rear electrode, instead of being mounted upon a spring, as in the case of the Blake instrument, was made as rigid and substantial as possible. The complete

White Solid Back is shown assembled in Fig. 94. Fig. 95 shows the transmitter head. In Figs. 96 and 97 the rear of the case is removed. In Figs. 98 and 99 the instrument is entirely dissected, while in Fig. 100 is a full-sized sectional drawing.

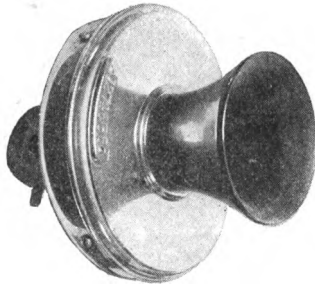

FIG. 95.— WHITE SOLID-BACK TRANSMITTER HEAD.

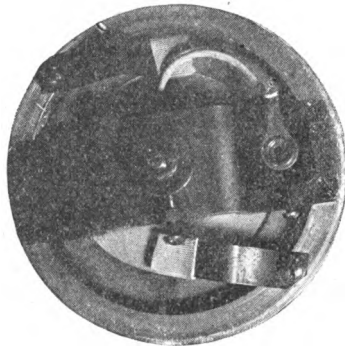

FIG. 96.— SOLID-BACK WITH CASE REMOVED.

There are four essential parts: A base plate, *E*, Fig. 100: This is a solid, substantial brass plate, $3\frac{1}{4}$ in. over all, in the center of which a $\frac{7}{8}$ -in. hole is cast and threaded for the reception of a funnel-shaped rubber mouthpiece. The



FIG. 97.— SOLID-BACK WITH CASE REMOVED (SIDE VIEW).

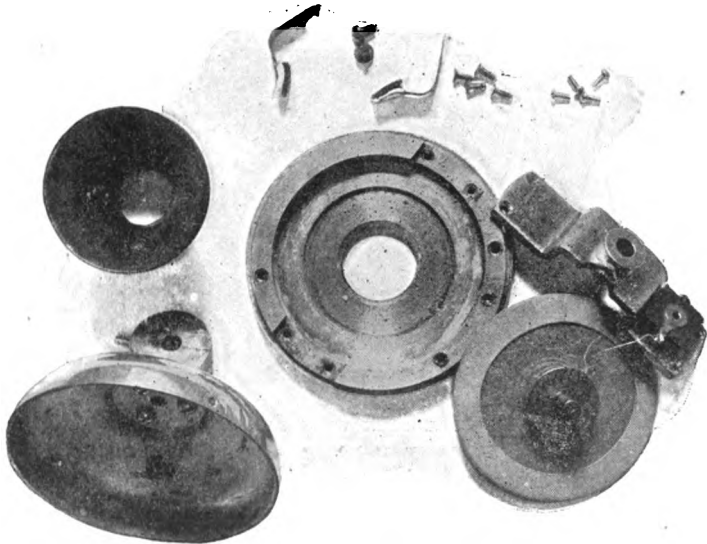

FIG. 98.— SOLID-BACK PARTLY DISSECTED.

inside of this brass plate is faced off for the reception of the diaphragm, *D*. This is now usually made of aluminum $2\frac{1}{2}$ in. in diameter and .022 in. in thickness. Experience has shown that the aluminum is likely to corrode under the moisture deposited from the breath, and it is now customary to thoroughly varnish the diaphragm as a protection. The diaphragm is surrounded with a soft

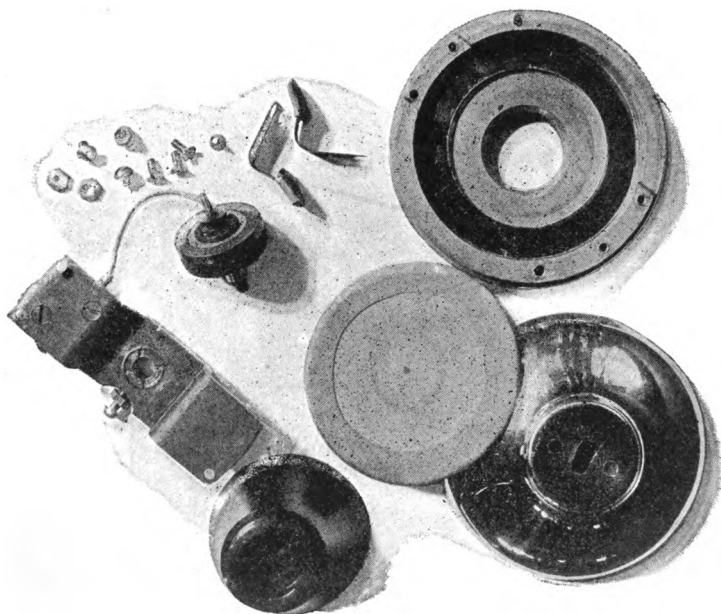

FIG. 99.— SOLID-BACK COMPLETELY DISSECTED.

rubber band of sufficient width, so that it laps around the edge of the diaphragm $\frac{1}{4}$ in. This forms a cushion and affords an even bearing between the diaphragm and the face plate. A piece of brass 1 in. wide and $\frac{1}{8}$ to $\frac{3}{16}$ in.

in thickness, termed the "bridge," *M*, is substantially bolted across the front of the face plate. This metal piece is bent in the form of a U in order to afford room for the capsule which contains the granular carbon. As is shown in Figs. 98 and 99, this capsule consists of a brass cup $\frac{3}{4}$ in.

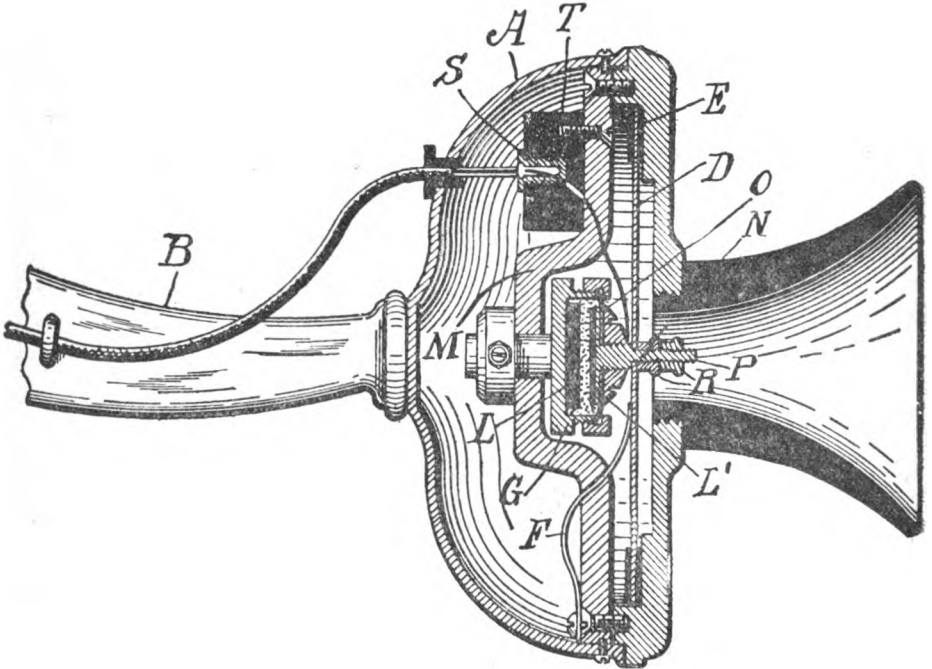

FIG. 100.— SECTION OF SOLID-BACK (FULL SIZE).

in diameter and $\frac{5}{16}$ in deep. Upon the rear of this cup a stud projects which passes through the bridge and is secured therein by a nut, a set-screw and lock-nut. Upon the bottom of this brass cup the rear electrode is placed.

This consists of a carbon disc as hard as possible, and carefully and highly polished, $21/32$ in. in diameter and $1/16$ in. in thickness. Over the front of this brass cup a mica diaphragm, *O*, is placed and secured by a circular ring of brass, which is screwed down on top of the diaphragm, clamping it to the front edge of the cup. This diaphragm is $27/32$ in. in diameter and as thin as the mica can be readily split. The front electrode consists of a piece of carbon similar in all respects to the rear electrode. Both carbons are electroplated and soldered to their respective holders. The support for the front carbon consists in a disc-shaped piece of brass having a threaded stem, *P*. This passes through the mica diaphragm and by means of a nut, *O'*, the electrode and the mica diaphragm are clamped firmly together. Then the stem is inserted in a hole in the diaphragm and secured by means of a second nut, *R*. Two damping springs, *F*, made spring steel $11/32$ in. wide, $1/100$ in. thick, $1\ 7/16$ in. long, bent to be at right angles when not in place, and tipped with rubber, are employed to check vibrations of the diaphragm, and secured by two screws to the face plate, as indicated in Figs. 96 and 97. One pole of the battery is connected to the framework, *B*, of the transmitter and current reaches the rear electrode; passing through the granular carbon it reaches the front electrode, thence to the nut, *O'*, and thence by a fine wire soldered thereto, to an insulated terminal, *S*, to which the other battery pole is attached (Fig. 96). The essential features of the White Solid Back are thus seen to be: A substantial support for the rear electrode; a capsule to contain the granular carbon between carbon electrodes, closed in such a manner as to be air-tight and moisture-proof, and to permit the freest

possible motion of the front electrode; a vibrating diaphragm rigidly attached to the front electrode, so as to convey to it its motion in the freest manner; finally, the whole apparatus covered by a thin cap of spun brass, which is turned to fit against a shoulder in the face plate and secured thereto by means of four screws.

The perfection of the solid back marked an important era in the development of the transmitter. It was so successful that since its completion the American Bell Telephone Company have discontinued the use of other forms and have gradually replaced those of earlier construction with the solid back, until now it is rare to find any other in use. Since the original design of Mr. White there has been little change in the solid back, excepting in minor matters of detail, and when the patent situation became such as to invite the more courageous of independent telephonists to undertake the manufacture of transmitters, the first effort was to copy the solid back in an attempt to produce a model which should equal it; so the majority of transmitters upon the market are more or less close imitations thereof. In most respects the attempt has been made to keep each transmitter as near as possible to the original type without patent infringement, but some builders have shown considerable ingenuity in changing the details of construction and some have even gone so far as to entirely depart from the fundamental principles. Transmitters, therefore, can be divided into three classes:

1st. The solid backs, or those which are, to all intents and purposes, copies of the White.

2nd. The elastic cell transmitter, in which there is no secondary flexible diaphragm, but the receptacle containing the carbon is made of elastic material (such as a ring of felt) and the diaphragm is pressed directly against this

ring. Such instruments are described more forcibly than elegantly by the term of "*Cornplaster*" transmitters.

3rd. Double diaphragm transmitters.

Considering the first class, the transmitter manufactured by the Kellogg Switchboard & Supply Company is a prominent example. A full-size section through the Kellogg

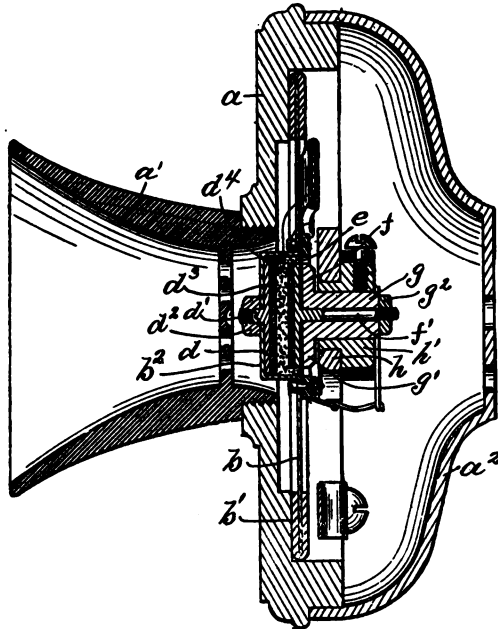

FIG. 101.— SECTION OF KELLOGG TRANSMITTER, FULL SIZE.

transmitter is shown in Fig. 101. In Fig. 102 the rear cap is removed. In Fig. 103 the instrument is entirely dissected and in Fig. 104 a front view of the diaphragm is shown. The section of Fig. 101 shows the instrument to

consist of a solid face plate, *a*, which is almost exactly similar to that of the White instrument. A hard rubber mouth-piece, *a*¹ is threaded into a hole into this plate. There is a perforated partition just in front of the diaphragm, the object of which is to prevent injury to the transmitter from the too curious, who often like to investigate a telephone by poking it with a lead pencil. Across the base plate and bolted thereto a substantial brass bridge, *h*, is placed. As shown in Figs. 102 and 103 this bridge differs from that

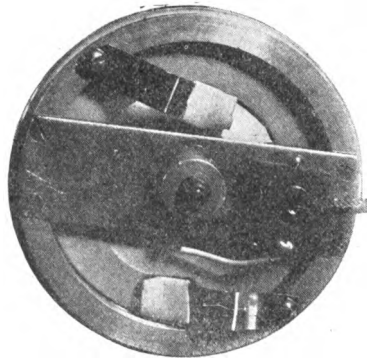

FIG. 102.—KELLOGG TRANSMITTER,
CASE OPENED.

used in the White instrument in being perfectly straight. The diaphragm, *b*, Fig. 101, is made of aluminum essentially the same size and thickness as that used in the White transmitter, but possesses a distinct feature in that the receptacle to hold the front electrode and the granular carbon is formed in the diaphragm by pressing a cup-shaped depression in the center.

This construction is shown clearly in Figs. 103 and 104. The front electrode, *d*³, Fig. 101, is a thin, flat piece of

carbon highly polished and brazed to a brass disc, d , furnished with a short, small stem, d^1 . This is inserted in a hole drilled in the center of the bottom of the cup pressed in the diaphragm and by means of the nut, d^2 , the electrode is clamped in its place. The rear electrode, d^4 , in Fig. 101, is formed of a similarly shaped disc of carbon about

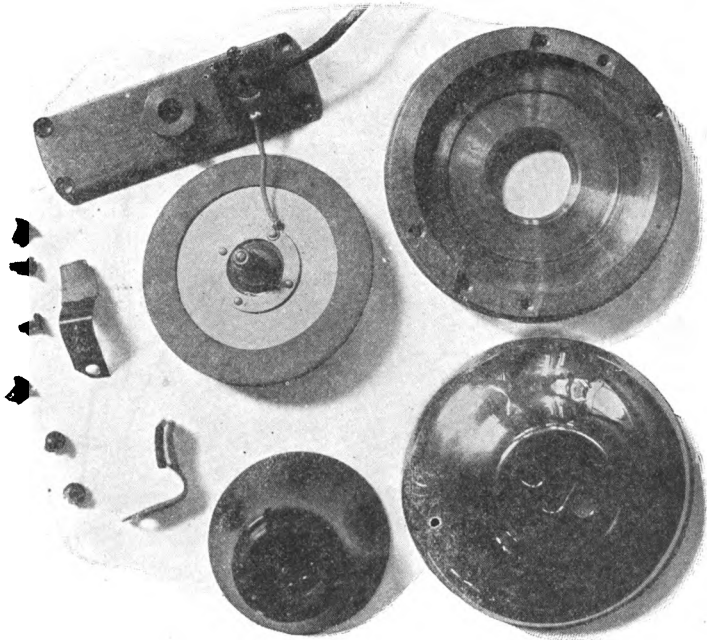

FIG. 103.—KELLOGG TRANSMITTER DISSECTED.

$\frac{1}{8}$ in. less in diameter than the front electrode. It is also brazed to a brass disc provided with a shank, f^1 , placed in the center of a circular mica disc, e . On the outside of the mica disc a brass nut, g , is slipped over the shank, f^1 , and

clamped by means of the nut, g^2 . The necessary amount of granular carbon is placed in the cup, the rear electrode inserted; the mica washer then covers the entire opening of the cup. A thin aluminum ring is then placed over the mica washer and riveted. This hermetically seals the electrodes and enclosed carbon. The shank of the brass disc, g , is then inserted in the bridge and clamped in its proper place by a set-screw. By this design the rear electrode is clamped firmly against the bridge, but the entire cup containing the front electrode and carbon vibrates with every motion of the diaphragm. So the first essential difference between the White transmitter and that of the Kellogg Company is that in the White instrument the carbon receptacle is fixed and in the Kellogg instrument it is movable. It is claimed that this motion of the carbon receptacle is efficacious in preventing packing, because the carbon is

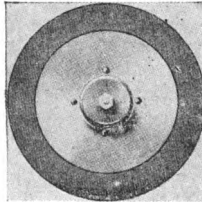

FIG. 104.—KELLOGG TRANSMITTER DIAPHRAGM.

constantly in motion. This has not conclusively been proven, and it is doubtful if the motion of the diaphragm is sufficient to be of material aid in stirring up the carbon granules. There is much evidence to show that prevention of packing is more a matter of mechanical design in obtaining the relative, proper sizes of electrodes, diameter of

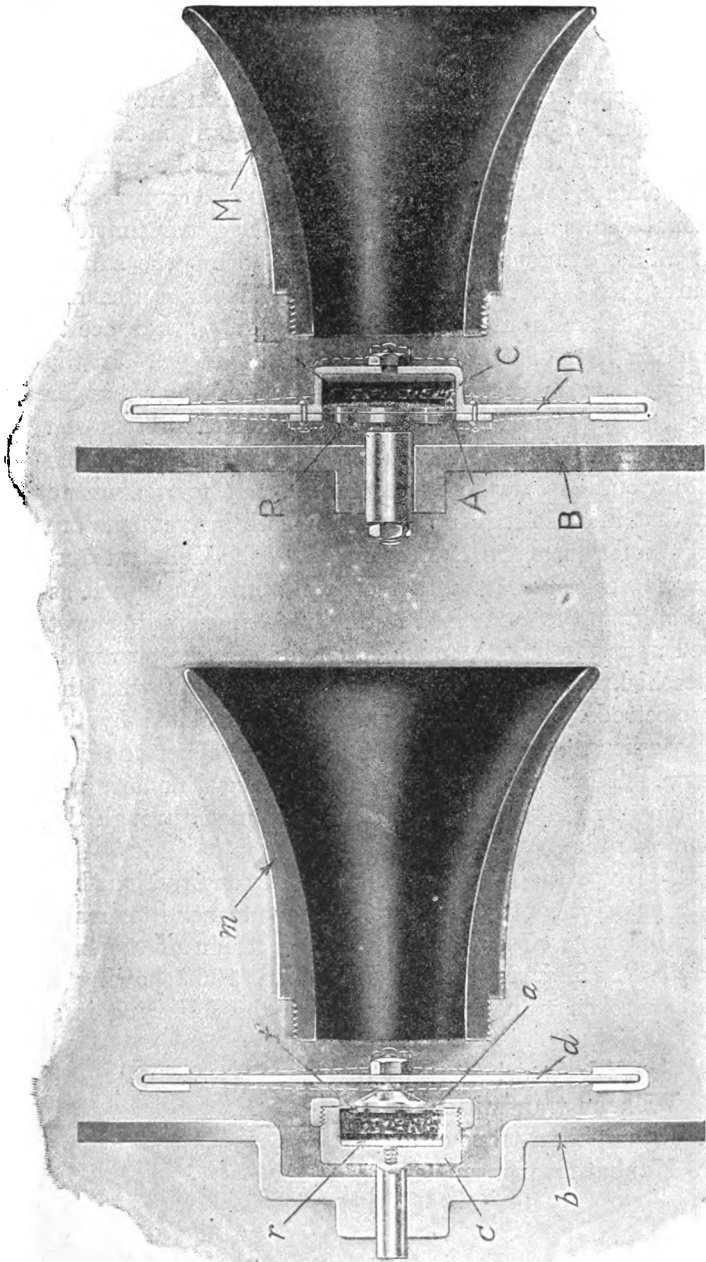

FIG. 105.—COMPARATIVE SECTION VIEWS OF THE WHITE AND KELLOGG TRANSMITTER.

carbon receptacle, thickness of layer of carbon and proper sizing of the individual granules, than to any method of stirring up the transmitter in order to release the granules from a clamped position. Fig. 105 shows two comparative sectional views of the White and Kellogg transmitters, with all superfluous parts removed, to bring the salient features into relief. In the White the diaphragm carries nothing but the front electrode, and the only hindrance to its motion is the stiffness of the mica diaphragm. In the Kellogg there is the additional burden of the granular carbon. To form the cup in the center of the diaphragm would seem to injure its acoustic qualities. *A priori* the White would seem the better model, but tests seem to show that the transmitting powers of both instruments are nearly if not quite equal. The circuit of the Kellogg transmitter is very similar to that of the White, inasmuch as the diaphragm is connected to an insulating binding post placed upon the bridge, to which one of the line terminals is attached. This affords electrical connection with the rear electrode. The front electrode is insulated by the mica washer and the rubber ring which encloses the diaphragm. Therefore, by connecting the other line terminal with the transmitter case, circuit is obtained through the carbon granules.

Not only in the general principles of construction, but also in exterior conformation the various transmitter manufacturers have closely adhered to the design of the first solid back. This is evidenced by Fig. 106, showing a group of seven transmitters, of which the following is a list:

- A. Swedish-American transmitter.
- B. Wilhelm transmitter.
- C. Intensifying transmitter.
- D. Manhattan transmitter.

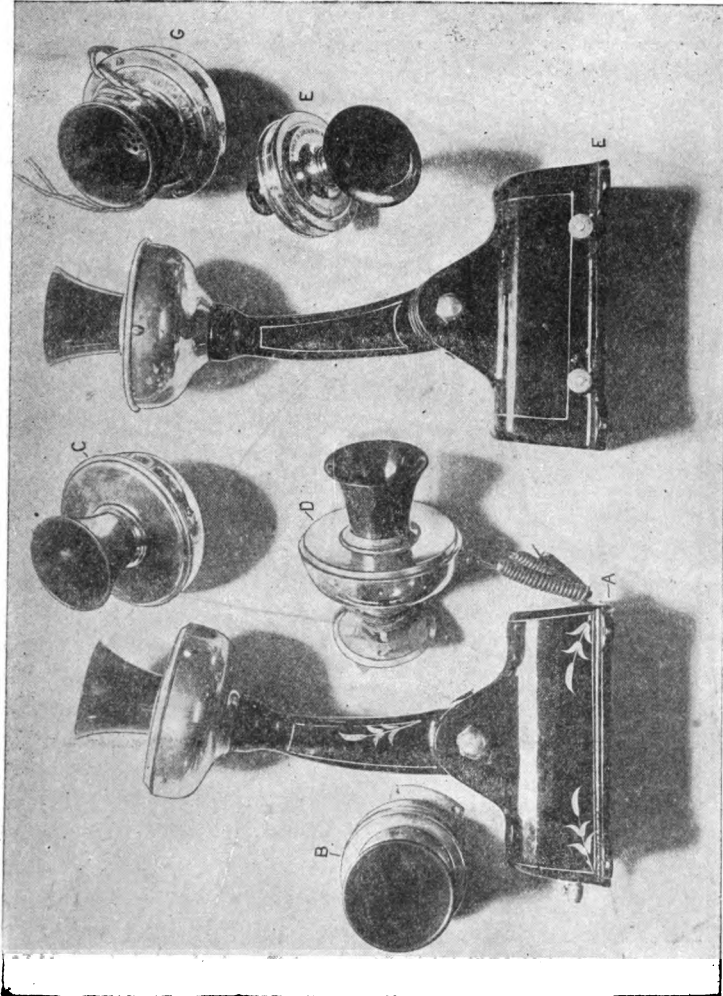

FIG. 106.—GROUP OF TRANSMITTERS.

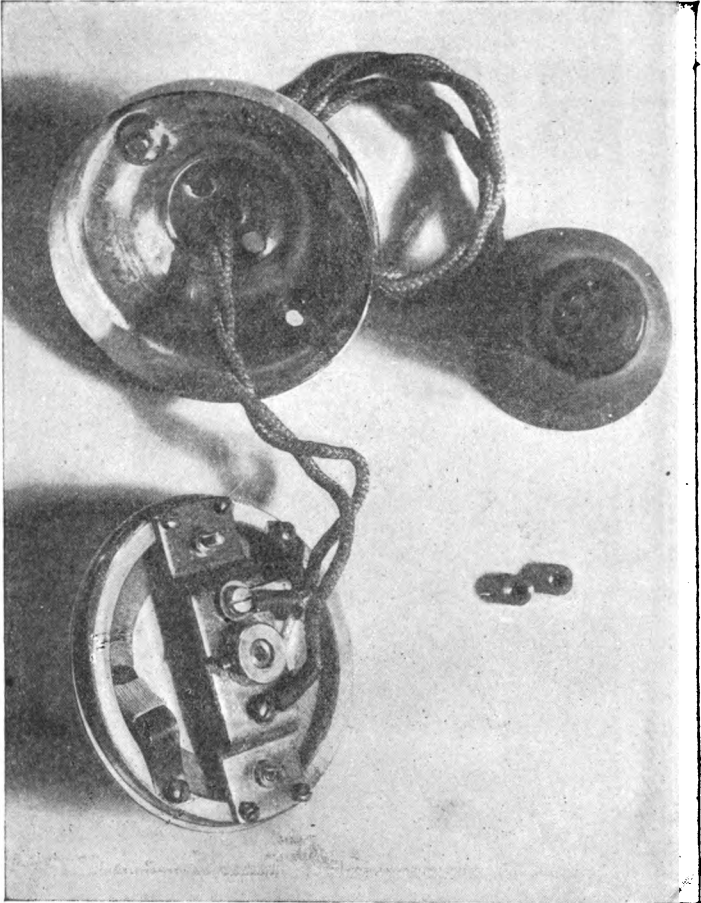

FIG. 107.— AMERICAN TRANSMITTER WITH COVER REMOVED.

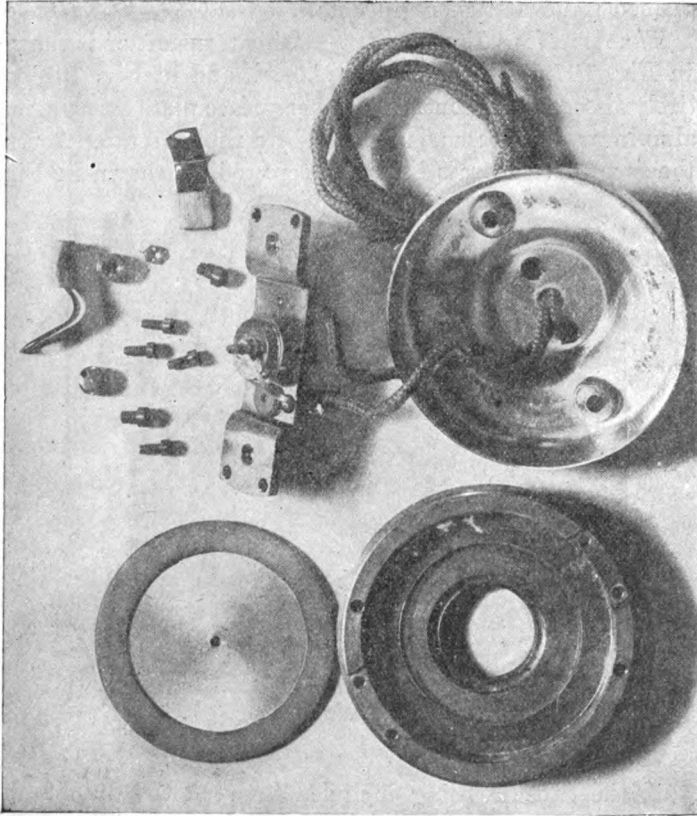

FIG. 108.— AMERICAN TRANSMITTER DISSECTED.

- E. Century transmitter.
- F. Ericsson transmitter.
- G. Williams transmitter.

These instruments and a few other models will be described somewhat more in detail.

The American Transmitter.— This transmitter is shown in Fig. 107, with the cover removed, and in Fig. 108 entirely dissected. It consists of a heavy face plate carrying an aluminum diaphragm, cushioned by a rubber strap. Across the face plate a brass bridge is screwed, as shown in Fig.

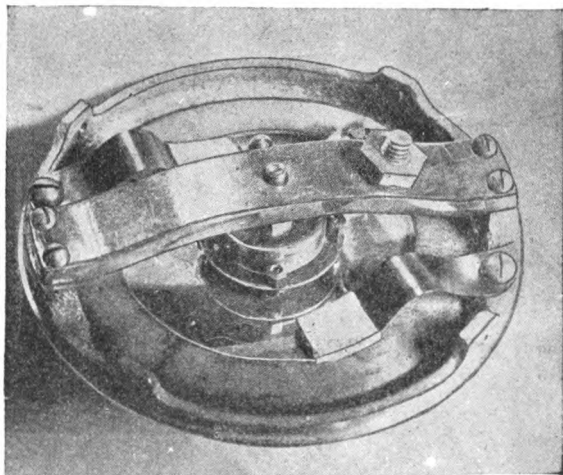

FIG. 109.— INTENSIFYING TRANSMITTER.

107, the capsule being included between the diaphragm and the under side of the bridge. The cover of the transmitter is a hemispheric case of spun brass fastened by two specially-formed nuts, which prevent its removal excepting with the aid of a particular tool which will fit the nuts in

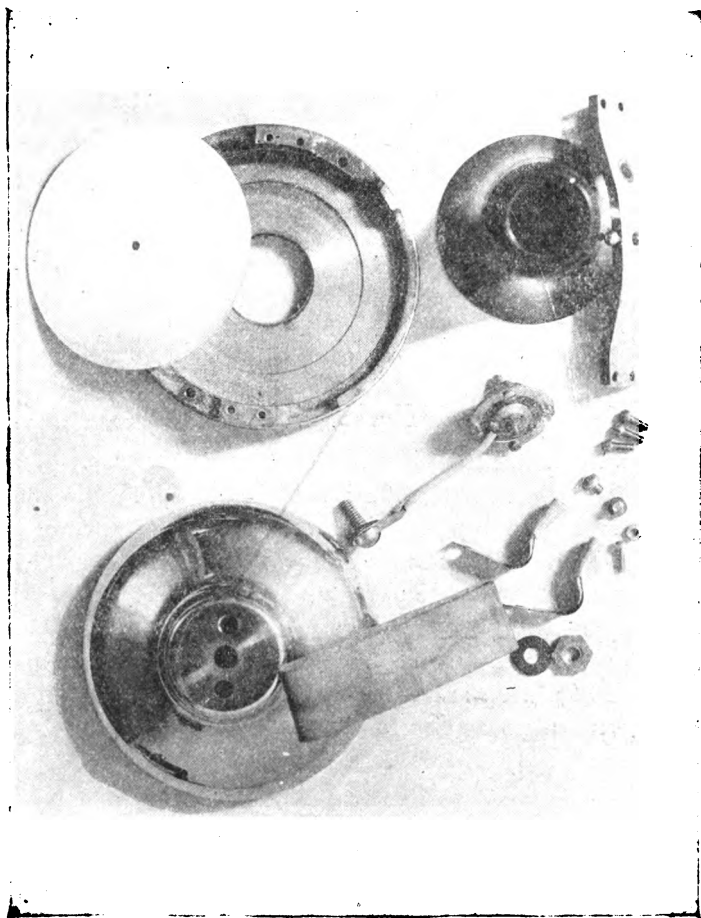

FIG. 110.— INTENSIFYING TRANSMITTER DISSECTED.

question. In Fig. 108 the bridge is removed and turned upside down. The capsule containing the granular carbon consists of a thin spun brass cup, over the face of which a mica diaphragm is placed, and the entire capsule closed by spinning a brass washer over the mica and the edge of the cup.

The Intensifying Transmitter.—This model is shown assembled, with the cover removed, in Fig. 109; in Fig. 110 the instrument is entirely dissected, excepting the capsule, while in Fig. 111 the parts of the capsule are shown. The foundation of the instrument is a heavy cast brass plate $3\frac{1}{4}$ in. over all. The diaphragm is of polished aluminum $2\frac{1}{2}$ in. in diameter and .021 in. thick. The rubber strap which forms a cushion for the diaphragm is $2\frac{1}{2}$ in. long \times $\frac{3}{4}$ in. wide. The bridge is a piece of wrought brass $\frac{1}{2} \times \frac{1}{8}$ in. thick and secured to the case by four screws. The springs are clock springs .01 in. thick, $\frac{5}{16}$ in. wide and $2\frac{1}{2}$ in. long, and bent at right angles. Each spring is tipped with rubber. One spring bears upon the rubber strap surrounding the diaphragm, while the other is placed half way between the diaphragm and the capsule. The capsule consists of a spun brass cup $\frac{3}{8}$ in. in diameter inside, $\frac{3}{16}$ in. deep and .015 in. thick. In the bottom of this capsule the rear electrode is placed, which is $\frac{5}{8}$ in. in diameter and is soldered to a brass support that extends to the bridge. The front electrode is also of carbon $\frac{3}{8}$ in. in diameter. Each electrode, including the brass supports, is .067 in. thick, giving a space of .07 of an in. between the faces of the electrodes. The front electrode is placed in the center of a mica disc $\frac{7}{8}$ in. in diameter, .003 of an in. thick. This disc, as is shown in Fig. 111, is secured to the face of the cup by means of four screws and

a brass ring. The cup is filled with 8 grains of granular carbon. One electrode is connected to the case of the instrument, while the other runs to an insulating binding post upon the bridge and thence by means of a rubber-covered wire to the brass washer that clamps the mica diaphragm.

The Transmitter of the Western Electric Supply Company.—The rear cap of this model is shown removed in Fig. 112, while the instrument is dissected in Fig. 113:

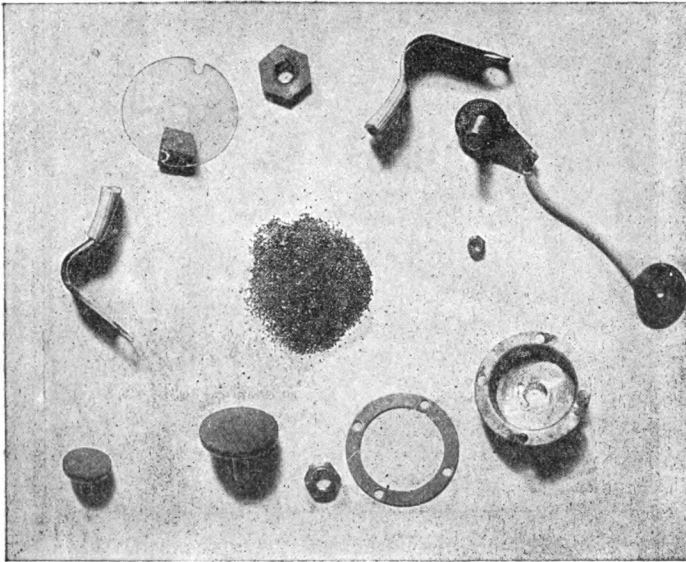

FIG. 111.—PARTS OF TRANSMITTER CAPSULE.

There is the usual cast face plate $3\frac{1}{4}$ in. in diameter over all. The diaphragm is rough aluminum $2\frac{1}{2}$ in. in diameter by .023 in. in thickness. The bridge is $15/16$ in.

wide and $\frac{1}{8}$ of an in. in thickness. It is surmounted in the center by a substantial block of hard rubber $\frac{5}{16}$ in. thick, $\frac{3}{4}$ in. wide and $1\frac{3}{8}$ in. long. In the center of this block is a brass bushing which supports the capsule. The leading-

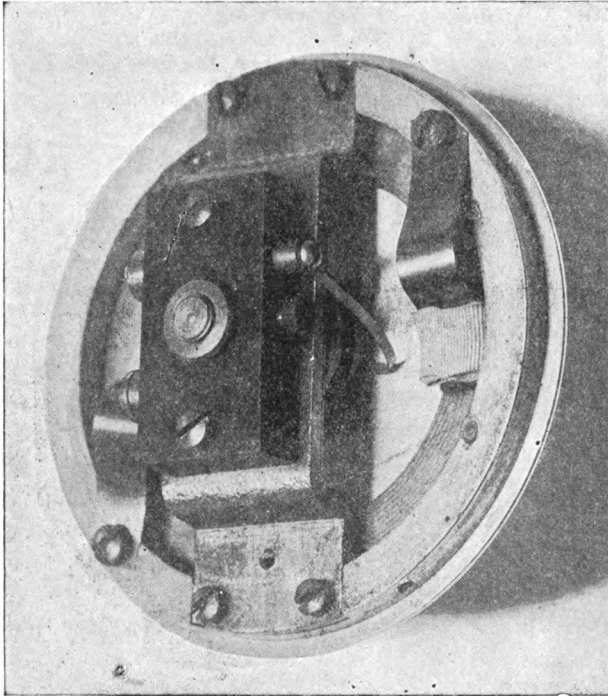

FIG. 112.— WESTERN ELECTRIC SUPPLY TRANSMITTER.

in wires run to the rubber block and are thus connected respectively to the front and rear electrodes. The capsule consists of a brass ring $\frac{11}{16}$ in. in diameter and $\frac{3}{8}$ in. deep. Upon each side of this ring two mica washers are

placed $\frac{1}{8}$ in. in diameter and .005 of an in. thick. The electrodes of carbon are each $\frac{1}{2}$ in. in diameter and clamped to its respective mica disc. The discs are then placed upon the ring and over each mica disc another brass ring

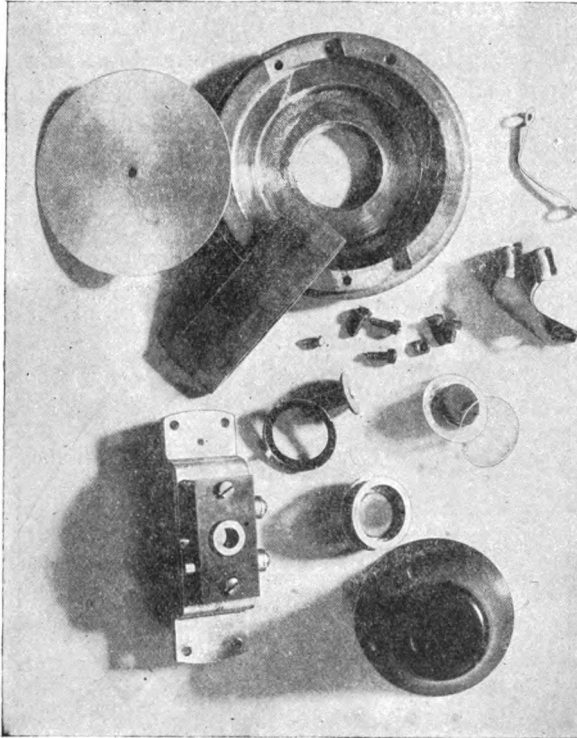

FIG. 113.— WESTERN ELECTRIC SUPPLY CO. TRANSMITTER DISSECTED.

is fitted and secured by means of four small ears, which are pinched underneath a ledge upon the center ring. Thus, in this model the front electrode can move to and fro with

the diaphragm and also the entire capsule is movable through the elasticity of the mica washer that is supported on the rear electrode.

The Century Transmitter.—This transmitter resembles in some respects that made by the Western Electric Supply Company. The Century transmitter, however, differs in having its diaphragm made of iron $2\frac{1}{2}$ in. in diameter and .018 in. thick covered with varnish to prevent rusting. There are two carbon electrodes each $\frac{1}{2}$ in. in diameter, the rear one screwed to a bridge made of cast

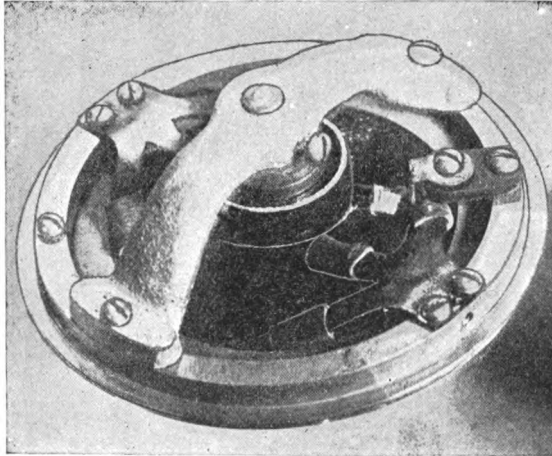

FIG. 114.— CENTURY TRANSMITTER.

brass. In Fig. 114 the Century transmitter with the rear cover removed is shown, while in Fig. 115 it is dissected entirely. The capsule is made of a piece of very thin rubber tube, about $\frac{3}{4}$ of an in. in diameter and $\frac{5}{32}$ in. long. It contains a piece of felt to which two mica discs

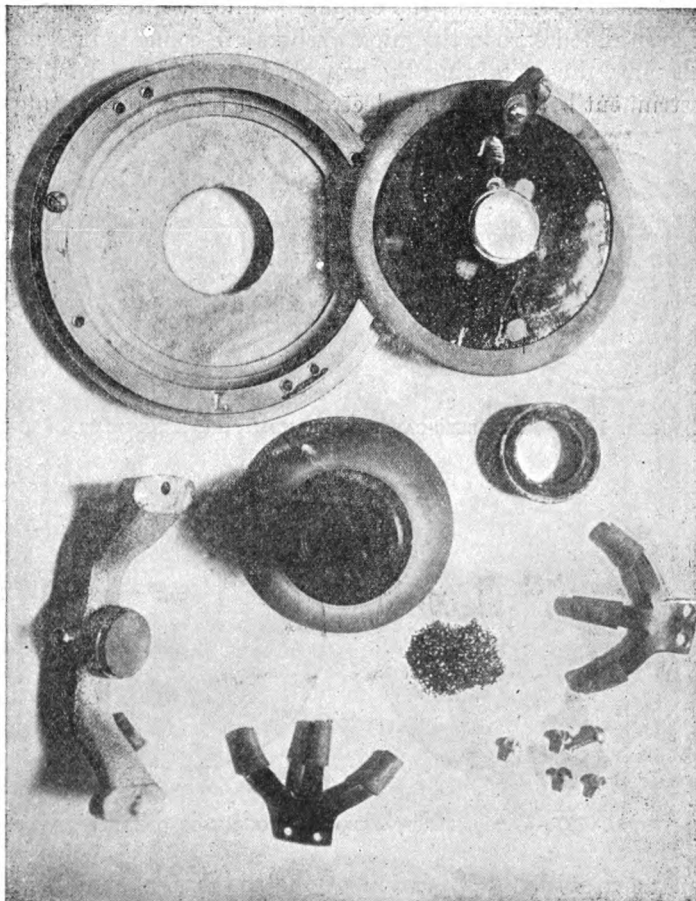

FIG. 115.— CENTURY TRANSMITTER DISSECTED.

are cemented. Each carbon electrode is supported by a disc of brass about $\frac{1}{8}$ of an in. greater in diameter than the electrode, and after the capsule is filled with 10 grains of granulated carbon the mica washers are cemented to the felt ring, thus retaining the capsule in position. In this instrument both the front electrode and the entire capsule

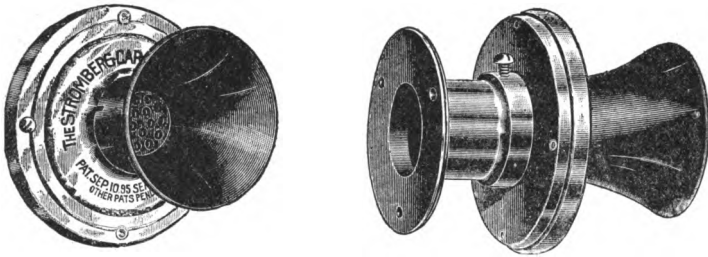

FIG. 116.— STROMBERG-CARLSON TRANSMITTER ASSEMBLED.

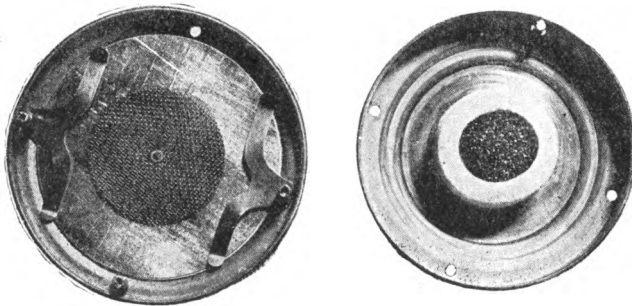

FIG. 117.— STROMBERG-CARLSON TRANSMITTER OPENED.

can move with the vibration of the diaphragm, but here all comparison of the previously-mentioned transmitter ceases. To check undesirable vibrations of the diaphragm the Century transmitter provides two thin-pronged iron

springs, as shown in Fig. 115. Each of these is secured to the edge of the face plate by means of two screws, as is shown in Fig. 114.

The Stromberg-Carlson Transmitter.—The first of the so-called “Cornplaster” type transmitters, and one of the widest known models is that manufactured by the Stromberg-Carlson Company, as shown in elevation in Fig. 116, and opened in Fig. 117. This transmitter differs materially from the designs, so far illustrated. It is much smaller and lighter, for the case consists merely of two pieces of pressed brass. The diaphragm is of tin and is secured in the front half of the case by two springs, as shown in Fig. 117. In the center of the diaphragm a piece of wire gauze, which has been gold-plated, is placed, and serves as the front electrode. Upon the rear half of the case there is another piece of gold-plated gauze, forming the rear electrode. Between these two there is a round felt ring which is about two-thirds filled with granular carbon. When the ring is in place the two halves of the transmitter are put together and riveted, so that it is impossible to open the instrument without mutilating it.

The Swedish-American Transmitter.—The transmitter manufactured by the Swedish-American Telephone Company is shown assembled at A in Fig. 106. In the bottom of the casting, supporting the transmitter arm, the induction coil for local battery instruments is placed, the terminals of which may be seen in the illustration. Fig. 118 shows this transmitter with the rear cap removed, and in Fig. 119 it is dissected. The face plate is of cast brass, $3\frac{3}{8}$ in. in diameter. The bridge is peculiar in that it is a substantial piece of sheet brass, formed in a die, as shown in Fig. 119, thus obtaining one of the stiffest and at the same time one of the lightest designs. There are two springs that

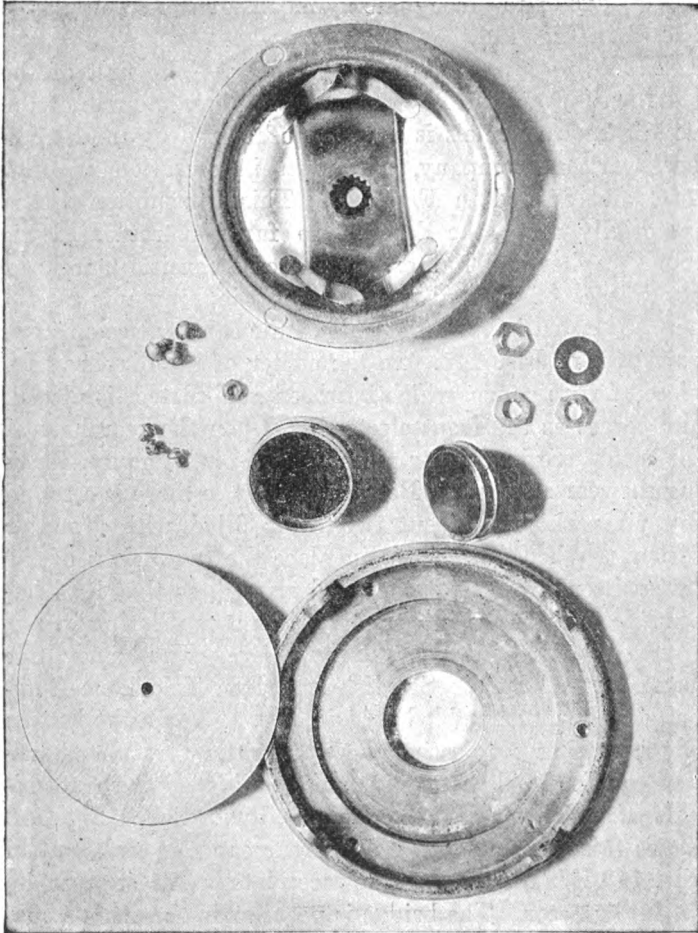

FIG. 118.— SWEDISH-AMERICAN TRANSMITTER DISSECTED.

are screwed to the bridge piece directly, each of which has two points; thus there are four points of spring contact on the diaphragm to check undesirable vibrations. The capsule is made of two pieces, one being a pressed brass cup, into which a grooved ring, carrying the front electrode, is placed and secured by four screws. The rear electrodes

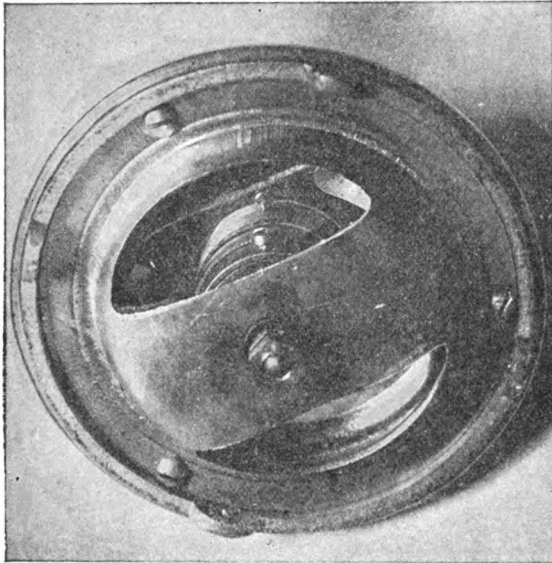

FIG. 119.—SWEDISH-AMERICAN TRANSMITTER, CAP REMOVED.

are $\frac{3}{4}$ of an in. in diameter and the front $\frac{3}{8}$ of an in. and the cup is filled with 10 grains coarse granular carbon.

Ericsson Transmitter.—The Ericsson Telephone Co. presents a transmitter which is somewhat unique in design and differs decidedly from most of those of American manufacture. In Fig. 120 a combined transmitter

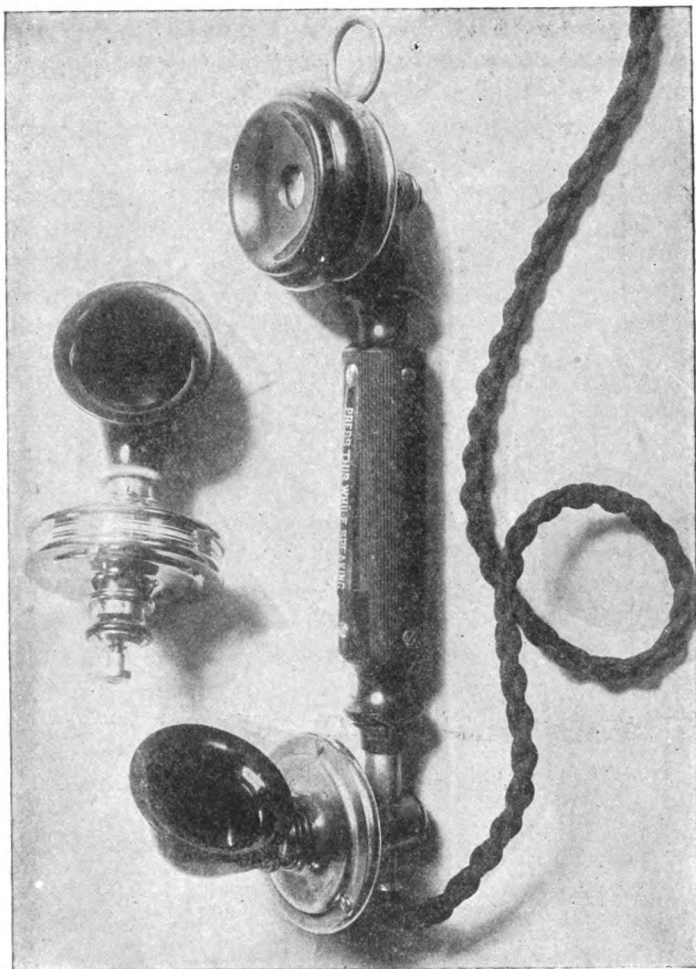

FIG. 120.—ERICSSON COMBINED TRANSMITTER AND RECEIVER.

and receiver is shown, and also a model of the transmitter by itself. In Fig. 121 the transmitter of the combined model is shown dissected. In Fig. 122 the individual transmitter is opened, while in Fig. 123 it is completely

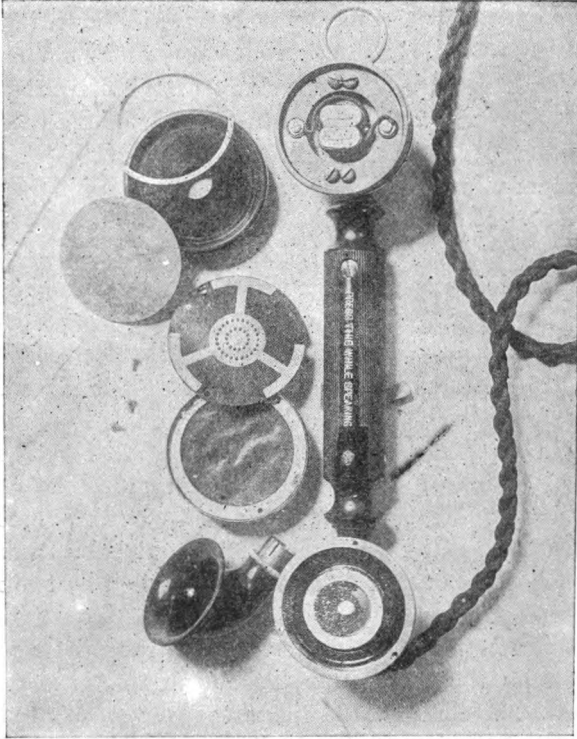

FIG. 121.—ERICSSON INSTRUMENT DISSECTED.

dissected. In many respects the Ericsson transmitter resembles that manufactured by the Stromberg-Carlson Co.

The transmitter consists of a case of two parts $\frac{1}{2}$ in. thick and $2\frac{1}{4}$ in. in diameter, made of pressed brass. The front half carries the diaphragm, as is shown in Fig. 122. This is of iron $2\frac{1}{8}$ in. in diameter and .012 in. thick. The front electrode consists of a piece of brass in which a number of corrugations are punched, as is shown in Figs. 121 and 122. This front electrode may or may not be gold-plated, and is secured to the front of the diaphragm by means of a screw and carried to one side of the case and then attached underneath one of the springs, which check diaphragm vibrations. The capsule containing the carbon is curious. It consists in the first place of a pressed brass cup, as shown in Figs. 121, 122 and 123. This is lined with a celluloid washer, upon which a spider-shaped copper spring is placed. On top of the copper spring a carbon electrode is secured and then around this electrode a felt ring $\frac{5}{16}$ in. thick and $1\frac{1}{4}$ in. in diameter is placed. In the center of the electrode a little bit of felt is placed, as shown in Fig. 121. The interior of the felt ring is filled with 12 grains of coarse granular carbon. The carbon electrode is $\frac{7}{16}$ in. in diameter, and contains three circular grooves. The diaphragm is protected by means of two heavy layers of oil silk and is cushioned by two rings of blotting paper.

The Manhattan Transmitter.—The transmitter manufactured by the Manhattan Telephone Co. is shown at *D*, Fig. 106. In Fig. 124 the rear cover is removed and in Fig. 125 the instrument is dissected. There is a light brass face plate fashioned in the usual manner, which contains a rough aluminum diaphragm $2\frac{3}{8}$ in. in diameter and .021 in. thick. On this diaphragm a heavy piece of flannel is cemented, and in the center of the flannel is



FIG. 122.—ERICSSON TRANSMITTER PARTS.

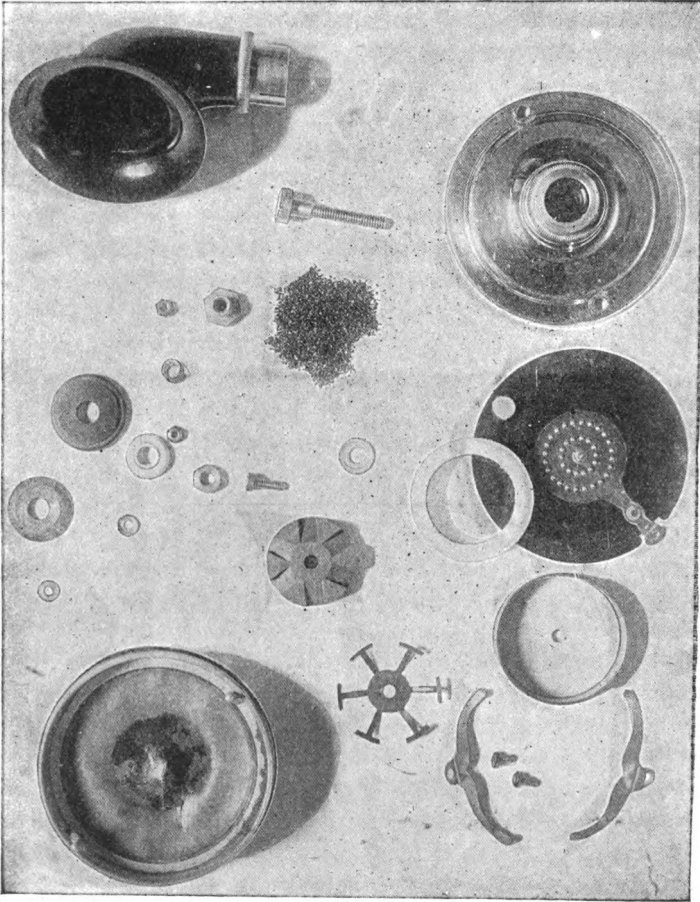

FIG. 123.—ERICSSON TRANSMITTER DISSECTED.

placed a carbon electrode $\frac{1}{2}$ in. in diameter. The rear electrode is designed to combine both the functions of an electrode and of a capsule for retaining the granular carbon. It consists of a round carbon block, having a deep cavity and a sharp edge, as shown in Fig. 125. This carbon block is $\frac{1}{8}$ in. more in diameter than the front electrode

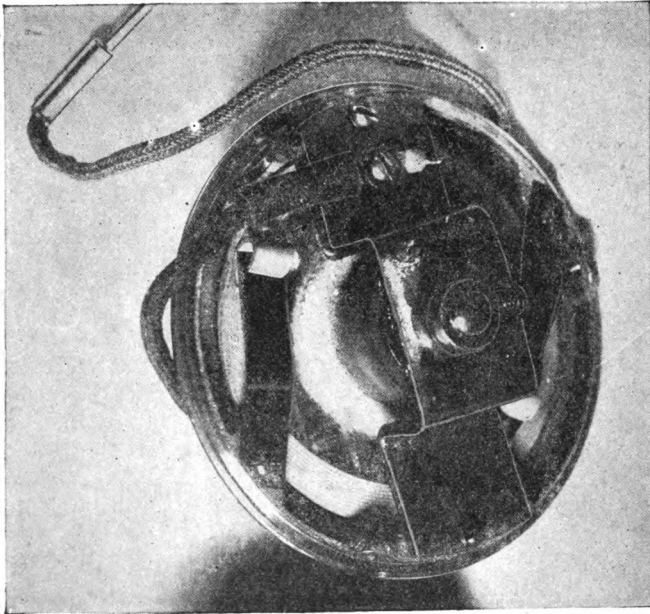

FIG. 124.—MANHATTAN TRANSMITTER WITH REAR COVER REMOVED.

and is filled with 8 grains of granular carbon; then the diaphragm is placed over it so that the flannel covers the sharp edge of the cup. The bridge, $\frac{1}{8}$ in. wide and $\frac{1}{16}$ in. thick, is then placed over a stud to which the carbon

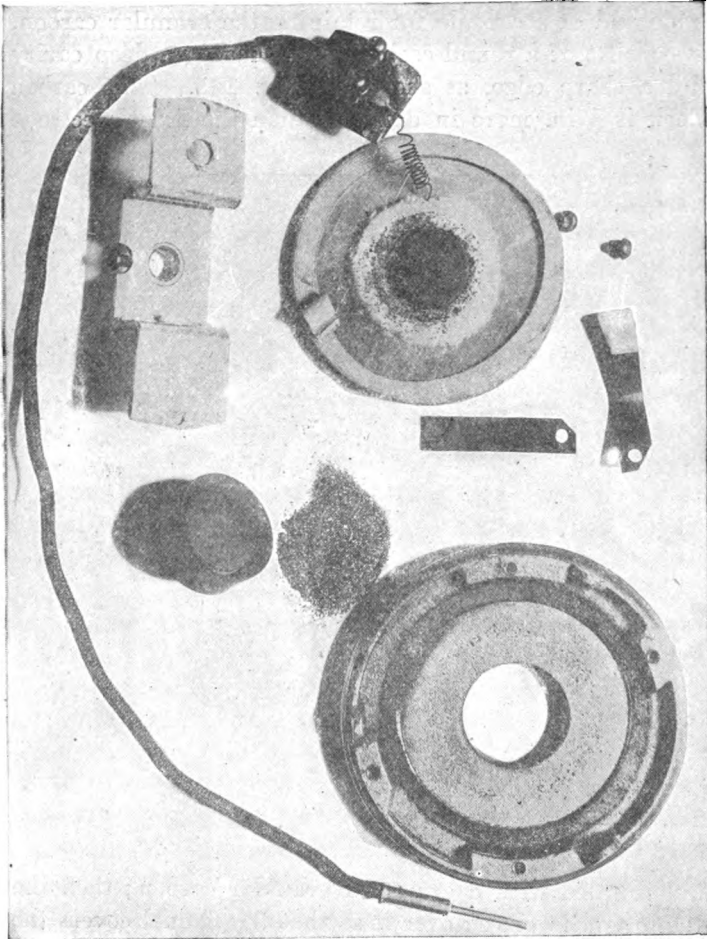

FIG. 125.—MANHATTAN TRANSMITTER DISSECTED.

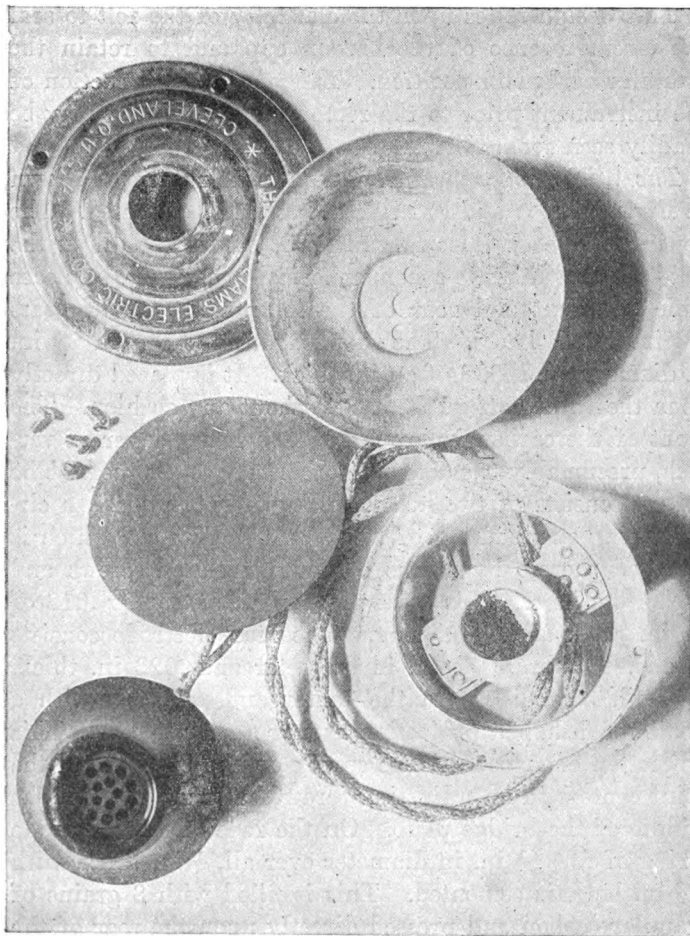

FIG. 126.— WILLIAMS TRANSMITTER DISSECTED.

cup is attached and the whole placed upon the face plate, the bridge being secured by two screws.

This design relies upon the elasticity of the felt to seal the circumference of the carbon cup and to retain the granular carbon in position. The general construction of the instrument prior to the removal of the bridge may be readily seen from Fig. 124.

The Williams Transmitter.— This instrument is shown in Fig. 104 at *G* and in Figs. 126 and 127 dissected. The general shape of this transmitter is similar to all of the solid backs which use a hemispherical cap, but in this case both the front and rear of the instrument are of brass .03 in. in thickness. The diaphragm is of carbon $2\frac{1}{2}$ in. in diameter and .038 of an in. thick. It is placed directly upon the front half of the case without any cushion. The front of the carbon is covered with a heavy layer of varnish, presumably to make the carbon moisture-proof. The bridge consists of two parts, as shown in Fig. 127, a circular ring stamped out of brass, and a cross bar which is attached thereto by means of four insulated screws and rubber washers. This cross piece carries a spring .018 of an in. thick and 2 in. long. The rear electrode consists of a disc of brass $1\frac{1}{8}$ in. in diameter and .022 in. thick. This plate is dished in the center and provided with a small spool-shaped projection having a sharp point. This projection engages with the spring on the bridge, and the point centers in an adjusting screw that runs through the middle of the bridge plate. On the face of this electrode a ring of felt $1\frac{1}{8}$ in. in diameter over all, $\frac{1}{8}$ in. thick, with a $\frac{3}{4}$ -in. hole, is cemented. This is filled with 8 grains of granular carbon and pressed directly upon the rear of the carbon diaphragm. It is evidently the office of the spring upon the bridge to keep the rear electrode and its ring of



FIG. 127.—WILLIAMS TRANSMITTER DISSECTED.

felt pressed tightly against the carbon diaphragm, while the adjusting screw is supposed to secure the necessary solidity by impinging upon the sharp tip which projects from the rear of the brass plate.

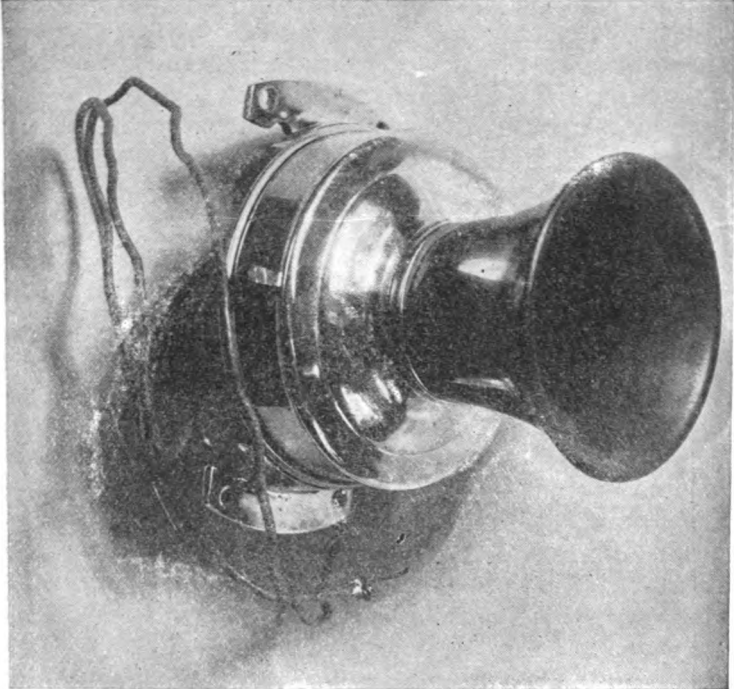

FIG. 128.— WILHELM TRANSMITTER ASSEMBLED.

The Wilhelm Transmitter.— The Wilhelm transmitter assembled is shown in Fig. 128. It resembles the Ericsson and Stromberg-Carlson by consisting of a brass case $2\frac{3}{8}$ in. in diameter \times $7/16$ in. thick, made of pressed sheet metal.

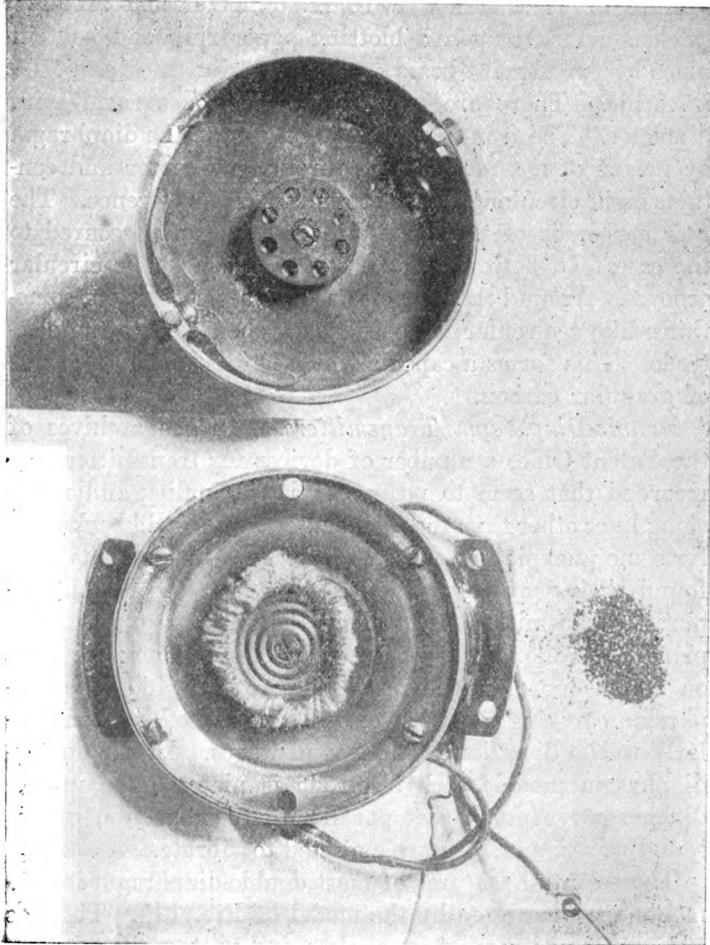

FIG. 129.— WILHELM TRANSMITTER OPENED.

In Fig. 129 the instrument is opened. The diaphragm consists of sheet iron $2 \frac{3}{16}$ in. diameter and .018 in. thick, supported upon a blotting paper ring and held in place by two 2-point brass springs .023 in. thick and .105 in. wide. There are two carbon electrodes each $\frac{3}{4}$ in. diameter. The front electrode is secured to the diaphragm by means of a screw passing through its center and contains eight circular pockets around its circumference. The rear carbon is of the same size and similarly secured to the case. It, however, has a series of concentric circular grooves. Around the rear electrode is a piece of felt, something like a circular lamp wick, which is tied to the electrode. This forms a capsule which is filled with 15 grains of granular carbon.

Double-Diaphragm Transmitters.— In the archives of the Patent Office a number of devices for transmitters are recorded that seem to possess both originality and merit along lines other than those embodied in the solid backs, but for some unexplained reason few of such instruments have found their way into practice. In fact, the double-diaphragm transmitter forms about the only exception. The principle of the solid back is to provide an immovable anvil on which one electrode rests, in front of which the diaphragm carrying the other electrode is placed, perpendicularly to the direction of the sound waves. In the double-diaphragm models each electrode is placed on a mobile diaphragm, which is set parallel to the direction of the sound waves, and both are expected to vibrate.

The essential features of most double-diaphragm instruments are illustrated by the model of Fig. 130. There is a drum-shaped case, *A*, to enclose and protect the mechanism, provided with a sound-receiving funnel, *A'*. In the

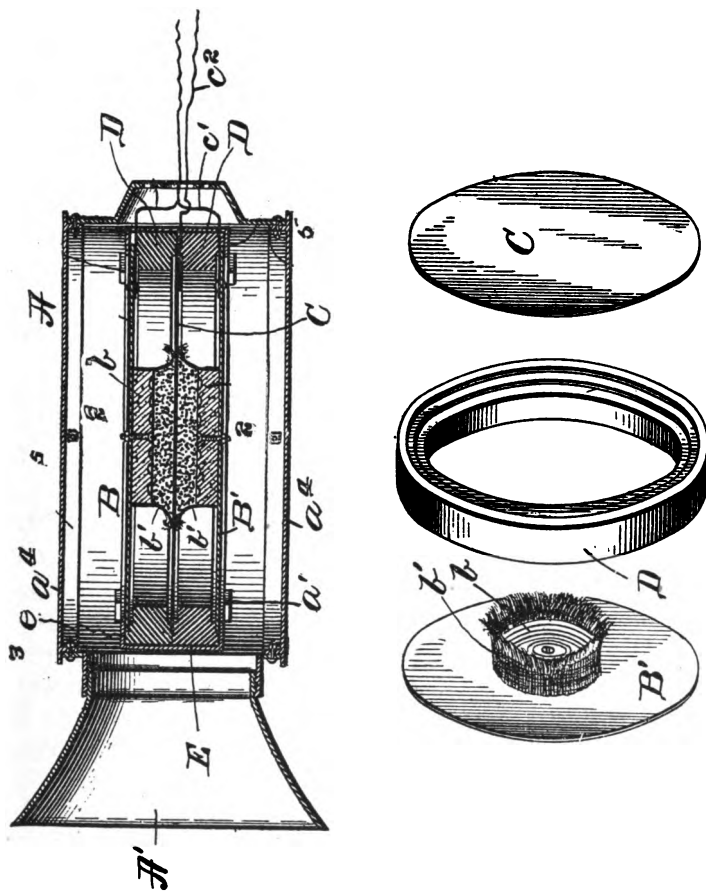

FIG. 130.— DOUBLE DIAPHRAGM TRANSMITTER, MODEL 1. (FULL SIZE.)

center of the case a ring, *D*, is fixed. On each face this ring is recessed to receive diaphragms *B* and *B'*, which may be of either carbon or metal. To the center of each diaphragm is secured an electrode, *b*, usually of carbon, around which is placed an elastic ring of felt, *b'*, and the space

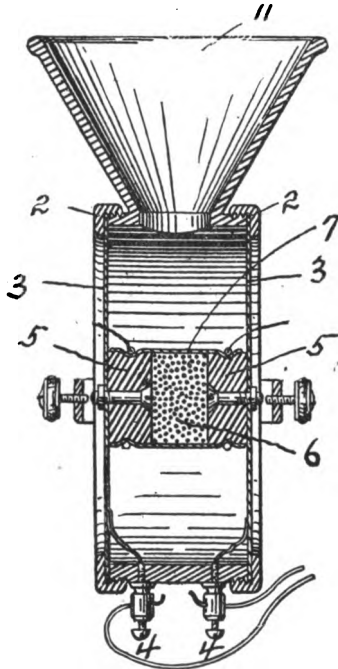

FIG. 131.—DOUBLE DIAPHRAGM TRANSMITTER,
MODEL 2. (FULL SIZE.)

between the electrodes filled with granular carbon. In the model of Fig. 128 there is a septum, or partition, *C*, in the center, and the ring, *D*, is made in two parts, thus

this instrument is really two transmitters placed back to back. One battery wire, C^2 , runs to the center partition and the other to C' , to both diaphragms. There are no damping springs and by making the diaphragms very light and properly proportioning them to the resonant cavity an instrument of great power and delicacy of articulation should be produced.

In Fig. 131 a different design is shown. The two diaphragms, 3-3, supported by the rings 2-2, form the sides of a resonant chamber, into which the sound funnel, 11, opens. The carbon electrodes, 5-5, are bolted to the center of the diaphragms, and surrounded by a flexible fibrous wrapping, 7, while the cavity thus formed is filled with granular carbon. The simplicity and cheapness of such designs is certainly remarkable.

The Fahnestock Transmitter.—The transmitter manufactured by Fahnestock Transmitter Co., represents in many respects the highest development in transmitter building. The assembled instrument is shown in Fig. 132. There is a base 4 in. long, 2 in. wide, to which a swinging arm $6\frac{1}{2}$ in. long is pivoted, that provides reasonable range of motion to the mouthpiece. The base carries the induction coil in local battery instruments. On the end of the arm there is a rectangular chamber $1\frac{5}{8}$ in. \times $1\frac{5}{8}$ in. \times $\frac{3}{4}$ in., which is surmounted by the usual rubber voice funnel. The rectangular chamber contains the talking mechanism. Fig. 133 shows the instrument dissected. There are seven principal parts. The arm, *A*, mouthpiece, *B*, button, *C*, cover, *E*, mouthpiece ring, *D*, and screws, *F*. The end of the arm carries the rectangular cavity into which the button *C*, is placed. The cover, *E*, is then set over the button and secured with the screws, *F*. Finally the mouthpiece, *B*, is screwed into the cover, *E*, the ring,

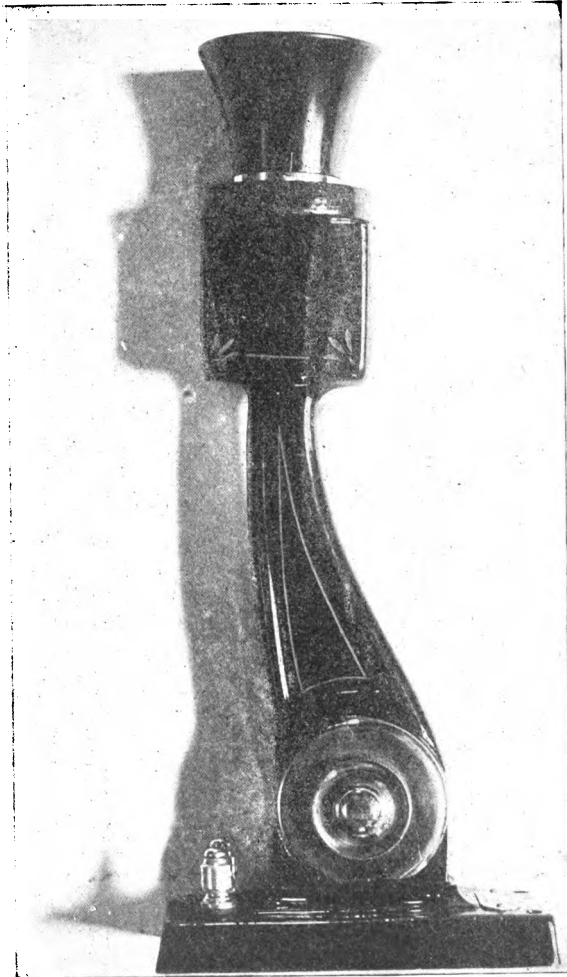

FIG. 132.—FAHNSTOCK TRANSMITTER ASSEMBLED.

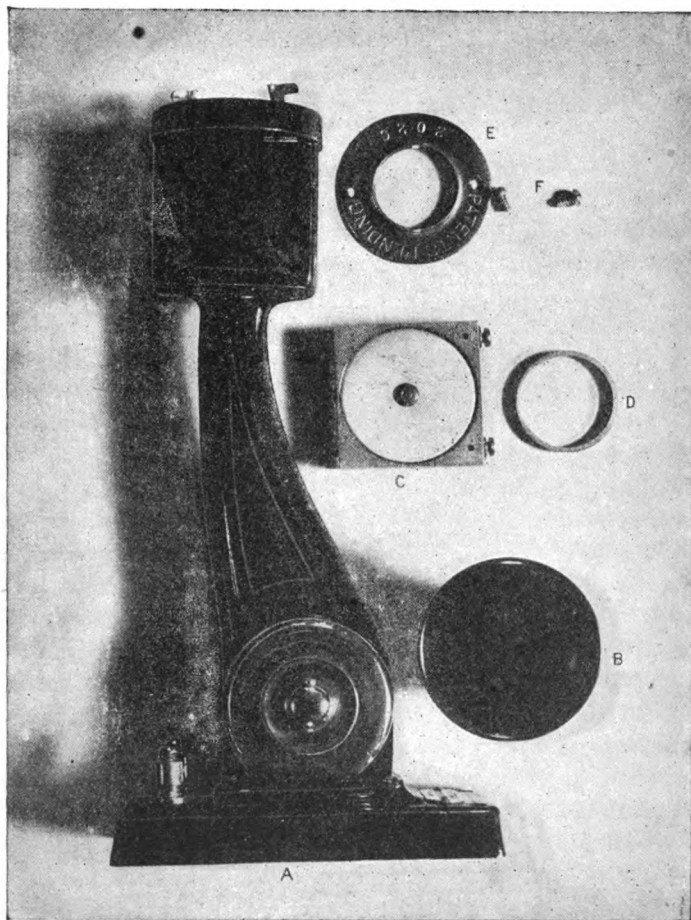

FIG. 133.— FAIRSTOCK TRANSMITTER DISSECTED.

D, serving to take up any slack. Fig. 134 is a phantom drawing showing the button in place and the circuit connections. The speaking mechanism is shown in detail in Figs. 135 and 136. There is a metallic block, *A*, *A'*, $1\frac{1}{2}$ in. \times $1\frac{1}{2}$ in. \times $\frac{7}{16}$ in. recessed as at *A* on both sides. In each of the inner recesses a disc of mica is placed to

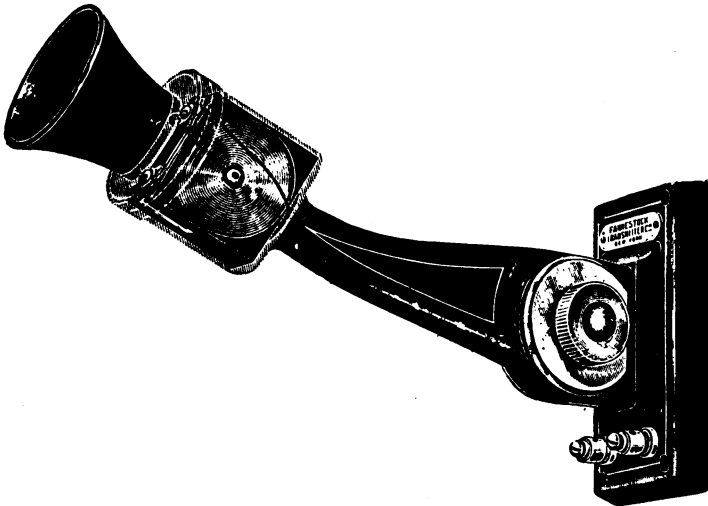

FIG. 134.— FAHNESTOCK TRANSMITTER.

which a gold-plated electrode is secured, and which is fastened in place by the ring, *C*. Each electrode carries a brass stud to which an aluminum diaphragm is attached. The outside of the diaphragm is shown at *B* and the inside, with an electrode in place, at *B'*. Around the edge the diaphragm is dished to fit into the recess cut in the block, *A*. The space between the electrodes is filled with granular carbon and the rings, *C*, squeezed into place, mak-

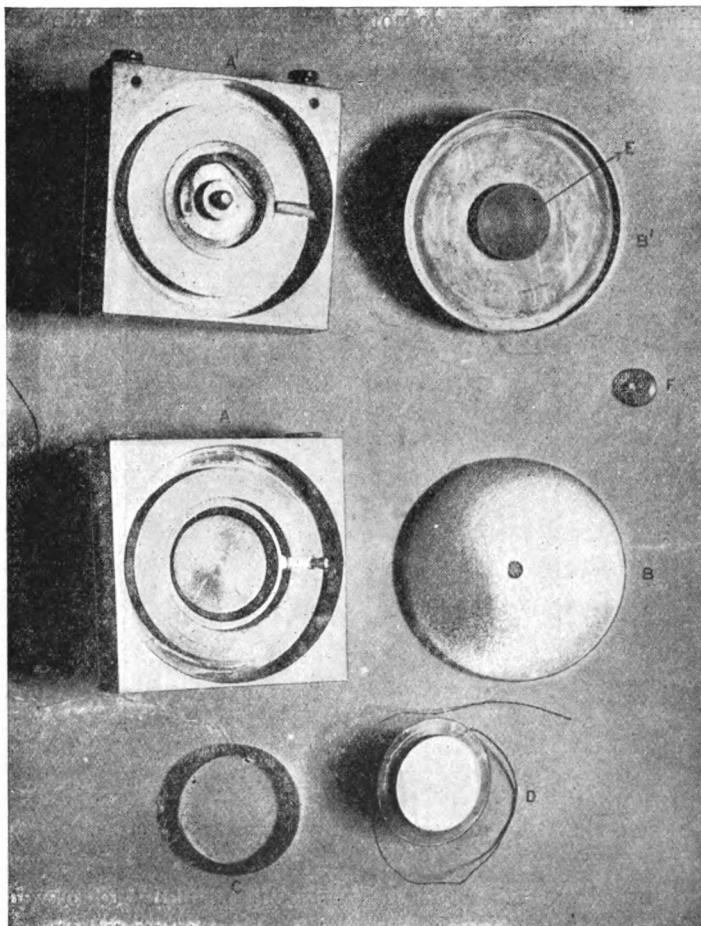

FIG. 135.—THE BUTTON OF FAHNESTOCK TRANSMITTER DISSECTED.

ing an air-tight joint. Then each diaphragm is secured to its studs by the nut, *F*. The recess in the block is cut so large that the diaphragms do not *touch anything* except the stud that holds them to the electrode, hence there is nothing

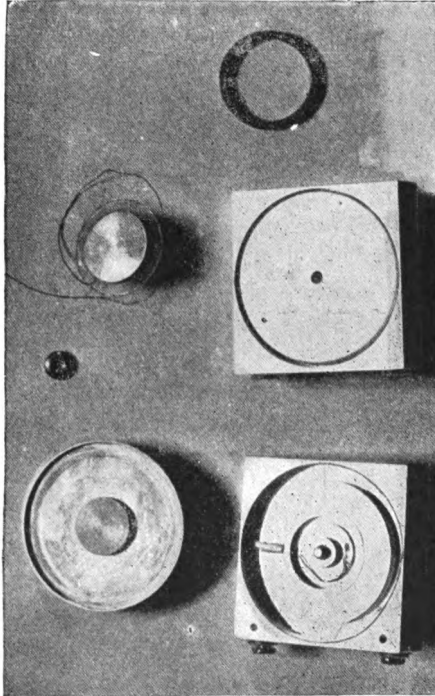

FIG. 136.—DETAILS OF FAHNESTOCK TRANSMITTER.

to impede or distort their vibration. Finally to prevent the sound waves from affecting both sides of either diaphragm, the joint between the diaphragm and block is sealed with a thick solution of india rubber. From each

electrode an insulated wire runs to a screw on the top of the block as at A' . These screws connect to leading-in wires. From an acoustic standpoint, instruments of the double-diaphragm type would seem to present many possibilities of which inventors have not as yet fully availed themselves.

The Design of the Microphone.—The essential part of the transmitter is the contact. Some transmitters use metal electrodes, and give excellent results, but on the whole experience is inclined to favor all contacts of carbon, and so far no other substance is approximately as good.

The most common form of electrode is a flat carbon plate, ranging from $\frac{1}{4}$ in. to 1 in. in diameter, and from $1/16$ in. to $1/8$ in. in thickness. Electrodes should be made of the hardest densest carbon; those which are soft may be greatly improved by repeated boilings in a very dense solution of sugar, after each of which the carbon disc should be placed in a crucible covered with charcoal or carbon dust and heated to a bright red. Many other forms of electrodes have been tried with varying degrees of success. Some such forms are illustrated in Fig. 137. About the granular carbon itself a cloud of mystery has always hung. But it is after all a simple matter, though to produce the best variety requires some practice. The National Carbon Co., and Pinnar, of New York, furnish excellent products. Fig. 138 shows four samples of granular carbon magnified about eight diameters. Samples A and B are so-called No. 24; that is to say, are sized through a sieve with twenty-four meshes per linear inch. Samples C and D are No. 50 carbon. Most transmitter builders prefer to have both the electrodes and the granular highly polished. Electrodes can be surfaced by any of the well-known methods of polishing. An excellent way is to use

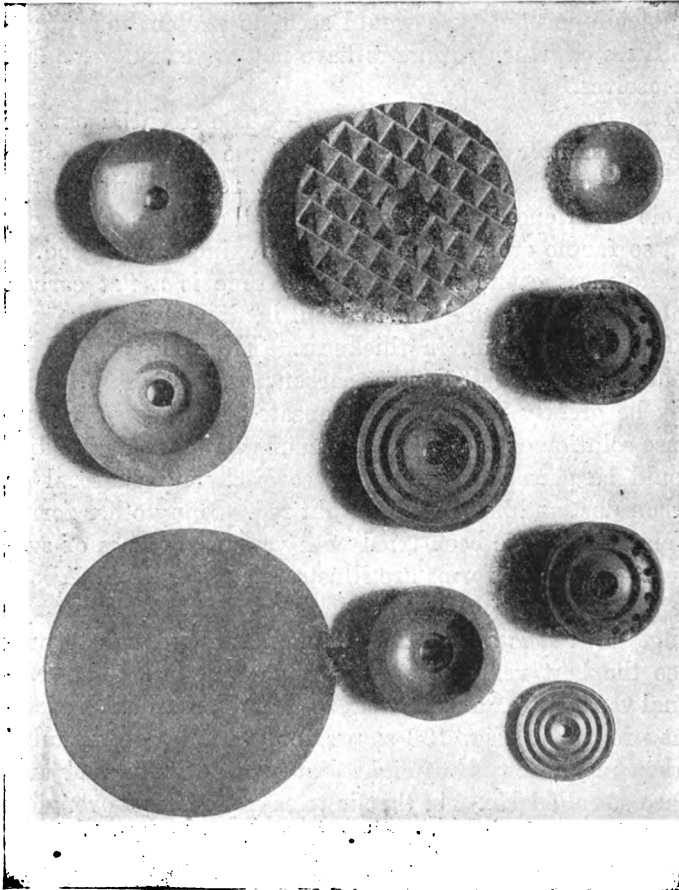

FIG. 137.— CARBON ELECTRODES.

carbon dust on a flat lap, with a final finish of crocus or putty powder. But to receive a remotely satisfactory surface the hardest and densest carbon must be used. With the granular polishing is much more difficult, because the sharp edges of the granules should be as far as possible preserved. In Fig. 138 *A* and *C* are specimens with dull finish and *B* and *D* are polished. One of the most important points is careful sizing as a prevention against

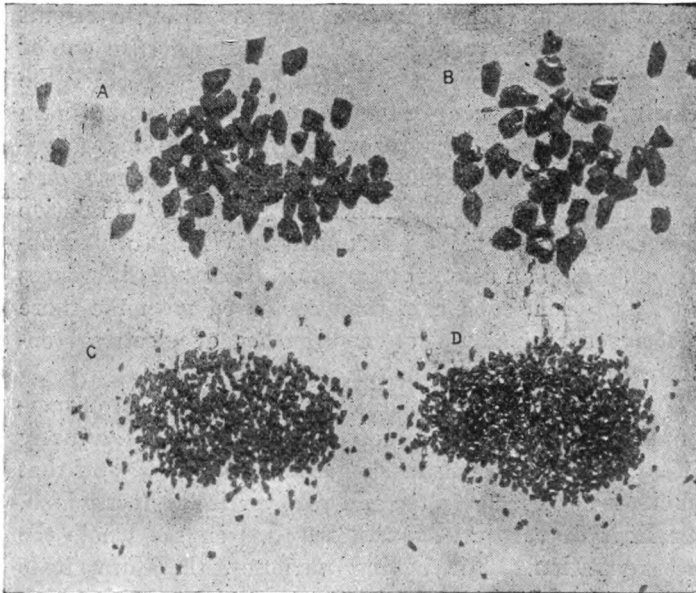

FIG. 138.— GRANULAR CARBON MAGNIFIED.

packing, for this difficulty is best obviated by providing ample room around the electrodes, and the use of a thin layer of granular, which has by repeated sifting been sorted till all the particles are as nearly as possible of the same size.

Testing Transmitters and Receivers.—To determine the merit of transmitters or receivers is one of the most difficult of tests. This is chiefly because there is no recognized standard or unit of measure. People vary enormously both in their ability to talk and to understand, over a telephone line entirely apart from the ability of the apparatus to transmit and reproduce sound. Hence, what to one person seems sufficient will be perhaps more than adequate to another, and unsatisfactory to a third. It is common to test transmitters and receivers by arranging a circuit between two rooms out of earshot of each other, in one of which the transmitters are placed and in the other the receivers. An inspector at the transmitter end counts from one to ten in a rather loud, sustained tone into one instrument after the other, while another inspector at the receiving end forms the best conclusion he may as to the relative efficiency of the various instruments. While trained observers develop an astonishing skill in detecting differences in transmission, such a method compared with the more exact measurements of other branches of electrical engineering appears crude in the extreme.

To the practical man quality of transmission is proportional to the ability to understand each word individually without requiring his correspondent to repeat it, and that combination of transmitter and receiver is the best which, over lines of varying lengths, requires on the whole the least repetition. For testing purposes, therefore, it is necessary to provide a transmitter and receiver with which all other instruments may be compared, and a variable line over which tests can be made. As there is no established standard instrument, it matters little what ones are selected for this purpose, for all results will be relative only. In a general way two of the best instruments obtain-

able should be taken, set aside for the purpose and used for nothing else. For the line nothing can excel an actual working line, but as tests should include trials over at least a thousand miles of wire, there are few who can avail themselves of such a plant, and it is equally difficult to carry on experiments on a commercial circuit. It is, therefore, better to build an artificial line exclusively for test purposes. For this purpose a number of coils of wire can be made, each of which shall represent, by having the same resistance, inductance and capacity, a certain section, say 10 or 100 miles of line.

The artificial line is best made by preparing 220 spools of wood. Each spool should have a 1-in. hole through its center and be about $3\frac{1}{2}$ in. over all in diameter and $3\frac{1}{2}$ in. high. The flanges and core should be about $\frac{1}{4}$ in. thick, leaving a winding space about 3 in. \times 3 in. The spools should be made of soft wood thoroughly baked and boiled in paraffine. To represent aerial lines No. 20 wire is a convenient size to use, while for cable lines No. 28 or No. 30. Each spool should be wound with sufficient wire to represent 10 miles of open wire or 1 mile of cable. To secure the proper inductance more or less of the wire can be wound noninductively, so that each spool when finished shall have accurately the resistance and inductance of either 10 miles of open wire or 1 mile of cable. The necessary capacity is best secured by making a small condenser of tinfoil and paraffined paper, exactly like a substation condenser. For each pair of open wire spools the condenser should have a capacity of .1 mf. and for each cable wire spool .08 mf. When completed a frame is to be prepared having two long rubber or glass rods. On each rod 110 coils, 10 representing 10 miles of cable wire, and 100 each representing 10 miles of open wire, are

placed. Between the two rods a substantial wooden strip is arranged underneath which the condensers are secured, and on top of which there are a number of brass plugs similar to those used in Wheatstone bridges. A condenser is joined between each pair of coils, and all coils connected in series through the plugs, so that each plug when in its place short-circuits a pair of coils. Thus any combination of cable and open wire up to 1,010 miles can be obtained. Such an apparatus can be built for about \$500, and while seemingly elaborate and expensive is essential for the proper testing of telephone apparatus.

For actual trials there should be three inspectors — a speaker, a listener and a manipulator — for in order to avoid the unconscious error due to personal equation, neither the speaker nor the listener should know anything about the apparatus they are testing, which should be arranged in all cases entirely independently of their knowledge. Three rooms are necessary, entirely distinct from each other, both visibly and audibly. The transmitters should be placed in room No. 1, the artificial line in No. 2 (the middle one), and the receivers in No. 3. In the following method of testing the listener must be an expert stenographer, and the method consists in finding the percentage of errors between sentences uttered in the transmitter and those received with varying line length. The first thing is to determine the *error coefficient* of the speaker and listener. The speaker reads to the listener in the usual conversational tone, and at a fair rate of speed, 10 sections of 1,000 words each, of 10 different subjects. The listener transcribes the 10 selections, and the manipulator compares the transcription with the original and counts the number of errors made. This is the *error coefficient* and is usually from 3 per cent. to 5 per cent.

The manipulator then, unknown to both speaker and listener, adjusts either a transmitter or a receiver to be tested, for only one instrument can be tried at once. The speaker then reads to the listener over the telephone line 10 different selections of 1,000 words each. After each set of 1,000 words the manipulator changes the length of the line. The listener transcribes the shorthand notes, the manipulator compares with the original and counts errors. The results may then be plotted as a function of line length, and by making a number of such tests with

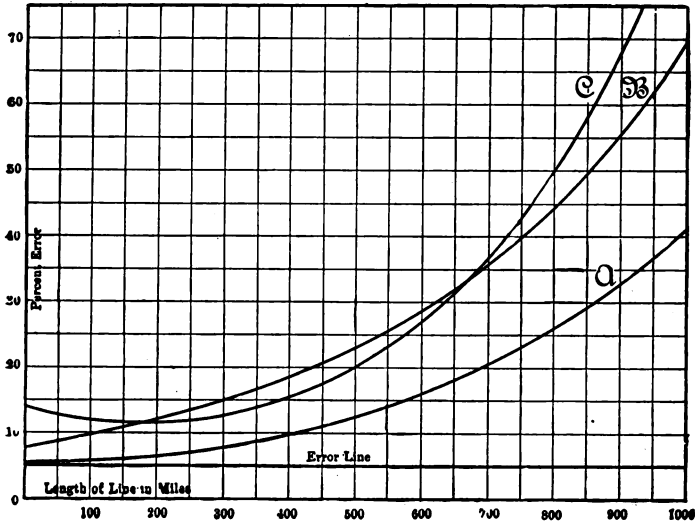

FIG. 139.— CURVES OF TRANSMISSION TESTS.

different transmitters and receivers quite accurate relative results can be secured.

The curves of Fig. 139 are illustrative of the method. The horizontal scale is the length of the artificial line in

miles, while the left-hand scale is percentage of error. The line marked "error line" is the percentage of normal errors, when the speaker read directly to the stenographer. Curves *A*, *B* and *C* show the results of tests on three rather well-known types of transmitters working with the same receiver. Transmitter *A* showed the least percentage of error. Instrument *B* showed about 2 per cent. more error on short lines and 30 per cent. more on long lines, indicating a deficiency in volume. Instrument *C* was poorer than *B* on lines up to 200 miles, and subsequently gave marked falling off in volume.

Tests as thus described show what may be termed the *general efficiency* of transmission. It is also well to compare volume by actuating the transmitter by an organ pipe, blown by a blast of constant pressure, and measuring the distance from the ear of an observer at which the sound first becomes audible. The listener should be blindfolded and the manipulator should noiselessly move the receiver to and from the ear of the listener along a graduated scale, noting both the distance at which the sound is first perceived, when the instrument *approaches* the ear, and the point at which sound *fails* to be heard when it recedes. The mean of a number of such tests give relative volume. To test for articulation the speaker should read to the listener a list of a thousand words of great similarity, such as fine, rhyme, dine, sign, mine, etc.; mowing, rowing, throwing, going, etc. Also the letters of the alphabet in heterogeneous order. These tests should be conducted on different lengths of line and the percentages of errors calculated and plotted as previously described. Finally, a comparison of the general test, and tests for loudness and articulation, showing the net result of all three will give quite accurate ideas of relative excellence.

CHAPTER IV.

INDUCTION COILS AND SUB-STATION CIRCUITS.

Induction Coils.—The earliest telephone line was simplicity itself. As illustrated in Fig. 140 it consisted of two magneto-telephones, each of which

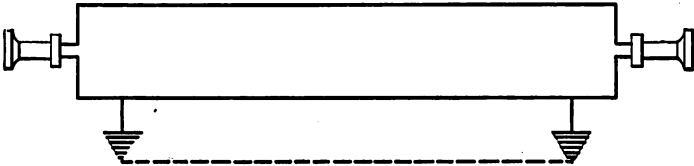

FIG. 140.— SIMPLEST TELEPHONE LINE.

acted as transmitter and receiver alternately, united by a pair of wires, or even one wire could be dispensed with, and the “ground” employed as a return, as shown by dotted line. But such a circuit could be employed only over short distances, because the impulses of the magneto-telephone are too feeble to be intelligible over long lines. The invention of the battery telephone, which acted as an electric valve to allow power from a source independent of the transmitter to be available, rendered it practical to talk over much longer lines; but with this improvement simplicity had to be sacrificed. It was necessary to provide a separate receiver and transmitter at each station, and introduce a battery as a source of electricity, something as shown in Fig. 141. Consider such a circuit in the light of the transmitter operating as

an electric valve. The effect on the receivers will be approximately proportional to the *changes* in the currents that traverse the circuit, and not to the actual volume of electricity. These pulsations are produced solely by such variations in the total opposition offered to the flow of electricity from the battery, as are due to the increase and decrease in the resistance of the microphonic contact in the transmitter set up by the changes in pressure on its diaphragm caused by the sound waves that impinge thereon. A circuit of this kind may be divided into four

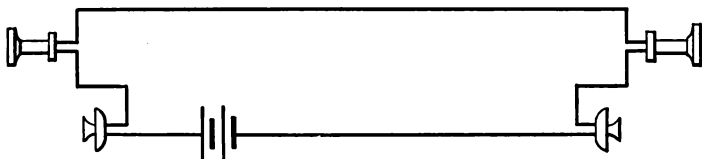

FIG. 141.— LINE WITH BATTERY TRANSMITTER.

parts, each of which presents its own individual barrier to the passage of electricity: First, there is the opposition due to the receivers. The ohmic resistance of the receiver may vary from 20 to 100 ohms; but as its coils are wound upon an iron core, its reactance is large, and, at the high frequency of telephonic currents, its impedance is considerable. Second, there is the opposition offered by the line wire, which will vary with its length, material and size. Assuming the line to be essentially straight, and of average length, say, about a mile, its opposition will be chiefly due to ohmic resistance, because its inductance is inappreciable, and the entire impedance of this portion of the circuit will not exceed, say, 100 ohms. Third, there is the opposition of the battery that is entirely non-induc-

tive, and, even in the case of high resistance cells, will not exceed a dozen ohms. Finally, there is the variable, though non-inductive, resistance of two transmitters, either of which may, from time to time, change from a fraction of an ohm to several hundred ohms, though it is rare to find transmitter resistance of more than 60 or 80 ohms.

So a telephone line connected, as shown in Fig. 141, will offer an impedance of a thousand ohms or more, though its ohmic resistance would rarely rise above 200 to 300. Now, to make a favorable assumption, suppose the transmitter to be endowed with an ability to produce a maximum variation of 50 ohms; it would then be able to change the total impedance of the circuit about 5 per cent., and, therefore, its power of producing pulsations in the line current will be correspondingly small. To enable a transmitter to produce a greater effect, the circuit must be so planned that the change in the transmitter resistance will

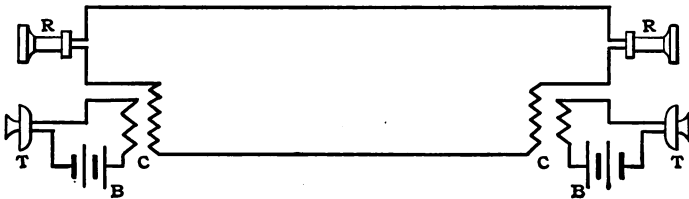

FIG. 142.—LINE WITH INDUCTION COIL.

be much a greater proportion of the total circuit impedance. This Mr. Edison accomplished in 1878 by the aid of a *transformer*, or, in telephonic language, an induction coil. Mr. Edison's arrangement, and one which still survives unchanged in local battery installations, is shown in Fig. 142. Two receivers (*RR*) are united by a line, at each

end of which a sub-station transformer (*C*) is introduced. This transformer consists of an iron core upon which there are two windings, one of coarse wire, having relatively few turns, and of low resistance, while the other is of fine wire, much higher resistance and many more turns. The fine wire is placed in series with the line and receivers, while the coarse wire forms a local circuit, having a transmitter and battery in series with it. Fifteen years ago the theory and use of the transformer was but little known and practised, the spark coils of Rhumkoff and others being about the only application of the principles of induction. While Prof. Gray had previously employed an induction coil in telegraphic work, Edison's application to the battery transmitter must be regarded as one of the great inventions of telephony.

The induction coil performs four entirely separate and distinct functions: First, it provides a local circuit for each transmitter, that by proper design can be made of so low an impedance that the variations in the resistance of the microphonic contact shall form a very large percentage of the total electrical opposition of the circuit. Second, it removes both transmitters from the line circuit, thus decreasing its resistance. Moreover, as the transmitter is of variable resistance, its direct presence in the talking circuit is exceedingly objectionable. Third, the analogy of the transmitter to the electric valve leads to the belief that all the impulses it produces are positive quantities, or, so to speak, the transmitter injects jets of electricity into the line. Its action may be illustrated by Fig. 143, in which *AB* is the line of no current, *CD* the current line when the transmitter is at rest, and *EF* a representation of positive impulses superimposed upon

the line *AB*. Even under the most favorable conditions, the impulses produced by the transmitter are small in comparison with electrical quantities that are met with under other circumstances. A few measurements upon transmitter currents have been made, the most recent of which are the experiments by Prof. Cross at the Massachusetts Institute of Technology. The various vowel sounds were pronounced in as uniform a tone as possible in front of various transmitters and the result on line cur-

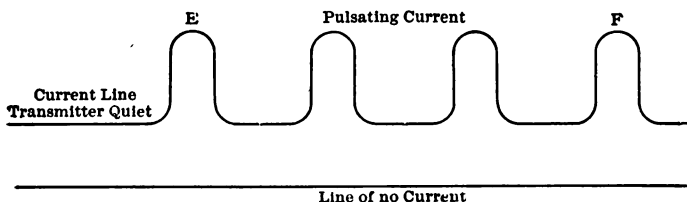

FIG. 143.— DIAGRAM OF CURRENT FROM A BATTERY TRANSMITTER.

rent measured by a dynamometer. These tests are summarized in Table No. X.

TABLE X.

Line Currents From Various Transmitters with Different Vowel Sounds.

Kind of Transmitter.	Vowel Sounds and Currents in Milliamperes.			
	a	o	u	i
Hunnings737	.787	.503	.213
Fitch450	.548	.442	.264
Blake123	.144	.114
Edison088	.123	.144	.072
Magneto123	.260	.238	.103

Subsequently, other tests were made with a solid back, to test the effect upon the line current of varying pitch of the voice an octave. These results are shown in Table No. XI.

TABLE XI.

Relation of Line Current to Pitch of Sound.

Vibrations per second.	Vowel Sounds and Current in Milliampères.				
	a	e	i	o	u
128	.300	.270	.250	.350	.200
236	.670	.620	.420	.680	.540

Fourth, the addition of the transformer changes radically the form of the impulses, because a pulsating current impressed upon the primary gives rise to a wave in the secondary which is an alternating one, and is more efficient in exciting the diaphragm of the receiver. This is illus-

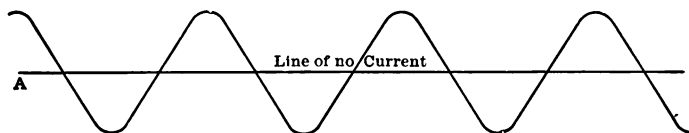

FIG. 144.— DIAGRAM OF CURRENT WITH INDUCTION COIL.

trated in Fig. 144, in which *AB* is the line of no current, corresponding to *AB* of Fig. 143, while *CD* represents the current wave in the secondary, corresponding to *EF* in the primary. Fifth, it is well known that one of the most valuable properties of the transformer is its ability to vary the current and pressure relations of its primary and secondary circuits. This variation is nearly in proportion to the ratio of the number of turns in the primary to the number of turns in the secondary. Thus, if

there are P turns in the primary and P' turns in the secondary, the ratio is $\frac{P'}{P}$. If V volts be applied to the primary producing in the secondary a current of C amperes, the volts at the terminals of the secondary will be $\frac{V P'}{P}$ and the current will be $\frac{C P}{P'}$. Now, line losses in any

transmission system are proportional to the square of the current which is employed, while the energy transmitted is proportional to the product of the pressure and the current. Consequently, by reducing the current and increasing the pressure, the same amount of energy may be transmitted, accompanied by much less loss. Owing to arcing at the microphonic contacts it is impossible to operate a transmitter excepting at low voltages; but the induction coil affords the ability to transform the low pressure and relatively large current of the local circuit into correspondingly small current and high pressure in the secondary circuit.

Enough has been said to indicate the importance of the induction coil, and, therefore, the desirability of obtaining such a design as will secure a maximum of the advantages thus outlined. Unfortunately, records of experiments made to determine the best proportions for induction coils are few and difficult to secure. A valuable set of experiments upon a number of coils made by the Swiss Telephone Department is reported by Sir William Preece. The results of these experiments are summarized in Table No. XII.

The tests referred to were made by taking the induction coil of a Blake transmitter as a standard and comparing therewith, over various lengths of lines, the coils designated in the first column of the table. Unfortunately, the electrical properties of the standard coil were not recorded.

A number of experiments upon induction coils have recently been made in the Electrical Engineering Laboratory of the Iowa State College. A set of 23 coils was obtained, four of which were those commonly made by well-known telephone manufacturers, while the remaining nineteen were experimental coils constructed for the purpose of trial. These coils were tested by selecting No. 21 of Table No. XIII, as a standard and comparing all of the other coils therewith, first over a line of six miles in length, and then over a line 106 miles. The results of these tests are shown in Table No. XIII. The left-hand half of the table gives the electrical properties of each coil. The right-hand half is divided into two parts, one of which gives the results of the tests with the 6-mile line, and the other those obtained from the 106-mile circuit. The opinions of the investigators making these experiments is expressed in the columns headed volume and clearness. The figures therein contained show the idea which was formed as to relative intensity and clearness of articulation of each coil as compared with No. 21.

Unfortunately the results shown in Tables XII and XIII do not lead to the formulation of any rules as to the best proportions to be observed in the design of induction coils. On the contrary, these experiments seem to teach that coils of quite widely varying properties yield fairly satisfactory results. Theory indicates that to secure the very highest efficiency the coil should be proportioned to the particular

TABLE XIII.
Tests on Induction Coils, Iowa State University.

Designation of coil.	Properties of Coils Tested.										Tests on 6 Mile Line.					Tests on 106 Mile Line.					
	Primary.					Secondary.					Volts at terminals.	Current, amperes.	Per cent. volume.	Per cent. clearness.	Relative efficiency, per cent.	Volts at terminals.	Current, amperes.	Per cent. volume.	Per cent. clearness.	Relative efficiency, per cent.	
	Number of turns.	Size of wire, B. & S.	Resistance, ohms.	Inductance, henrys.	Number of turns.	Size of wire, B. & S.	Resistance, ohms.	Inductance, henrys.	Ratio of turns.	Diameter of core.											Length of core.
1.	111	22	.932	.0061	5139	32	157	1.264	46.3	1 1/2	4	18	2.83	155	62.5	72	3.00	140	163	96	106.7
2.	44	22	.14	.0012	2246	32	70.7	.218	51.5	1 1/2	3	18	2.80	.172	47.5	67	3.00	135	177	93	70.35
3.	108	22	.62	.0021	2164	32	87.9	.315	10.9	1 1/2	3	18	2.83	159	100	81	2.80	135	110	98	101.5
4.	80	22	.274	.0034	2413	32	76.3	.239	30.16	1 1/2	3	18	2.80	157	27.5	67	2.35	130	95	18	76
5.	44	22	.699	.0012	2088	32	79	.268	61	1 1/2	3	18	2.85	158	40	72	3.00	115	30	32	46.35
6.	132	22	.364	.00869	2534	32	82.25	.208	17.8	1 1/2	3	18	2.80	165	30	77	2.90	120	105	80	99
7.	324	22	.24	.0074	1240	32	43	.079	10	1 1/2	3	20	2.90	163	30	81	2.95	118	92.5	40	133.37
8.	2340	32	.73.5	.365	4000	30	134.3	.854	1.5	1 1/2	4	18	3.00	1040	35	64	1.05	040	50	40	98
9.	208	22	.54	.0225	1400	36x32	30	34.5	7.39	1 1/2	4	18	2.86	105	100	65	2.95	120	102.5	84	103.6
10.	400	20	2.08	.0674	1506	28	13.4	.0812	3.70	1 1/2	4	18	3.00	105	80	75	2.85	122	72.5	73	82.35
11.	228	22	.32	.0174	800	36	36.4	.045	4	1 1/2	4	20	3.00	105	80	68	3.00	120	105	70	67.5
12.	228	22	.32	.0174	800	36	36.4	.045	4	1 1/2	4	20	3.00	105	80	68	3.00	120	105	70	67.5
13.	200	20	2.07	.0487	1241	36	46.3	.0473	3.1	1 1/2	4	20	2.97	120	87.5	68	3.00	120	105	63	62.5
14.	200	22	.451	.0225	1500	36	420	1.124	25	1 1/2	4	20	2.97	120	87.5	68	3.00	120	105	63	62.5
15.	202	16	.23	.0029	420	32	1.91	.0073	1.65	1 1/2	4	20	2.85	105	110	70	2.50	070	48	47	49.0
16.	1400	22	.23	.0029	1700	32	21.36	.0835	1.27	1 1/2	4	20	2.85	105	110	70	2.50	070	48	47	49.0
17.	1400	22	.23	.0029	1700	32	21.36	.0835	1.27	1 1/2	4	20	2.85	105	110	70	2.50	070	48	47	49.0
18.	370	22	.398	.0046	2534	32	1.71	.394	6.7	1 1/2	3	18	3.70	109	45	62	3.95	105	105	83	102.7
19.	370	22	.398	.0046	2534	32	1.71	.394	6.7	1 1/2	3	18	3.70	109	45	62	3.95	105	105	83	102.7
20.	370	22	.398	.0046	2534	32	1.71	.394	6.7	1 1/2	3	18	3.70	109	45	62	3.95	105	105	83	102.7
21.	270	22	.50	.0634	2500	32	94	.300	16.0	1 1/2	3	18	3.70	108	102.5	63	3.05	065	100	69	100
22.	270	22	.50	.0634	2500	32	94	.300	16.0	1 1/2	3	18	3.70	108	102.5	63	3.05	065	100	69	100
23.	270	14	.88	.0015	1200	32	82	.0078	7.8	1 1/2	3	22	3.10	110	100	77	3.05	110	107	69	100
24.	270	14	.88	.0015	1200	32	82	.0078	7.8	1 1/2	3	22	3.10	110	100	77	3.05	110	107	69	100
25.	275	18	.88	.0022	3910	30	217	.463	14.2	1 1/2	3 1/2	23	3.00	112	102	67	3.05	110	115	77	101.8

transmitter, receiver and line with which it is to be connected. In commercial operation this is impossible, so it is perhaps fortunate that practice shows it to be feasible to work over widely differing lines, with coils of many designs and obtain sensibly the same results. Probably, therefore, the best guide to the plan of an induction coil is to be found by dissecting a number of coils, that have survived the test of time and experience, and building along the lines thus indicated. As an aid to the designer the proportions used by half a dozen or more of the principal manufacturers will be found in Table XIV, and the succeeding sketches.

TABLE XIV — (Continued).
Induction Coil Data from Practice.

Maker.		General Specification, Secondary Coil.														
		Wire.							Tube.				Core.			
		Gauge, B. & S.	Insulation.	Weight, oz.	Length, ft.	Resistance, ohms.	Turns per layer.	Number of layers.	Total turns.	Insulation between layers.	Diameter, in.	Material.	Size of wire, B. & S.	Length, in.	Number of pieces.	Weight, oz.
Ericsson.....	Bare wire.	1.25	516	60	200	17 3300	Paper.....	5-16	Fibre.....	20	34	73	.63			
Kellogg.....	23 Varley coil.....	1.50	300	20	240	9 2200	Paper.....	4	Paper.....	24	8	96	.50			
Manhattan.....	34 White silk.....	1.37	1045	250	230	19 5350	Paper.....	7-16	Paper.....	25	8	206	.75			
Western Tel. Con. Co.....	23 Cotton.....	1.75	350	30	230	7 1650	None.....	7-16	Paper.....	20	4	148	2.125			
American Electric.....	28 Green silk.....	1.125	152	30	215	8 700	None.....	4	Paper.....	20	3 1/2	176	2.125			
Stromberg-Carlson.....	30 Green silk.....	2.37	525	50	240	9 2400	Paper.....	7-16	Paper.....	20	4 1/2	128	1.75			
Century Tel. Co.....	34 Green silk.....	1.37	900	230	460	10 5000	None.....	5-16	Paper.....	23	4 1/2	120	.88			
Swedish-American.....	34 Green silk.....	.875	450	115	336	6 2200	Paper.....	5-16	Fibre.....	20	3 1/2	120	.70			

SPECIFICATIONS FOR FIG. 145.

Frame.—Two heads, maple painted black $\frac{3}{8}$ in. thick $1\frac{1}{4}$ in. by $1\frac{1}{4}$ in. Core tube, paper, made of a sheet $6\frac{3}{4}$ in. wide, 9 in. long, .004 in. thick rolled around a mandrel $\frac{1}{2}$ in. diameter and glued. Tube glued into heads.

Base.—Hard wood, varnished, $8\frac{1}{2}$ in. long, 3 in. wide, $\frac{5}{8}$ in. thick.

Core.—Best annealed iron wire, varnished, cut $6\frac{3}{4}$ in. long. Diameter of wire, .016 in.

Primary.—Single white silk covered copper wire. No. 28 B. & S. To be wound in two parts, each having 1,550 turns. Resistance, 16 ohms. Terminals to be reinforced with stranded wire and soldered to clips. Winding to be in two layers.

Secondary.—Single white silk-covered copper wire No. 28 B. & S., to be wound in two parts, each having 1,550 turns. Resistance, 23 ohms. Terminals to be reinforced with stranded wire and brought out and soldered to clips. Winding to be in two layers. Coil to be wrapped with black "seal cloth."

SPECIFICATIONS FOR FIG. 146.

Frame.—Two heads to be made of maple, varnished, shaped as at *A*, *B*, Fig. 146. Heads to be 11-116 in. thick, 1 5-116 in. in diameter.

Core Tube.—To be made of a sheet of paper $6\frac{3}{4}$ in. wide, 9 in. long, .004 in. thick, rolled on a mandrel $\frac{1}{2}$ in. in diameter and glued. Tube to be glued into heads.

Base.—Hard wood, varnished, 11 in. long, $1\frac{3}{4}$ in. wide, $\frac{5}{8}$ in. thick.

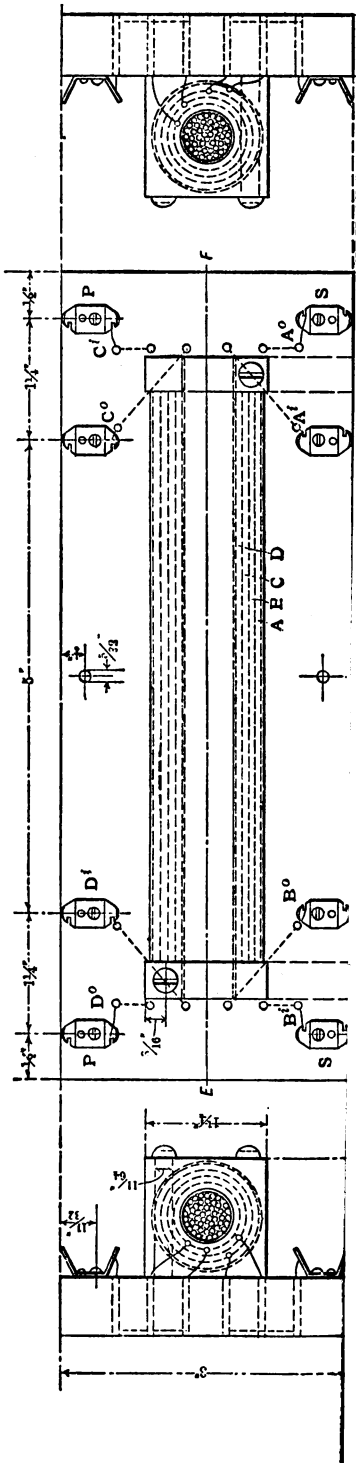

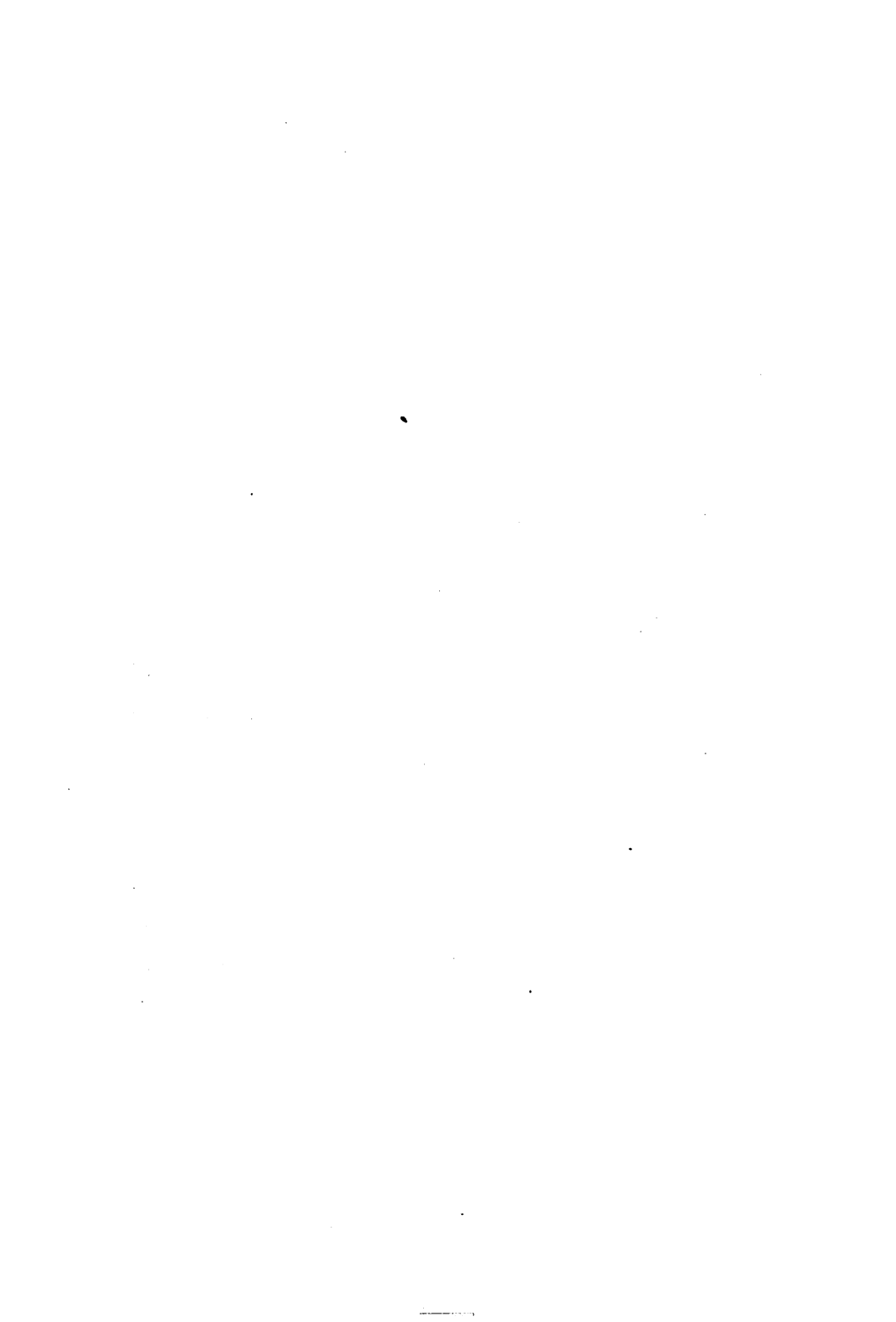

Iron Shield.—Annealed wrought iron pipe, $6\frac{7}{8}$ in. long, $1\frac{1}{4}$ in. diameter inside, recessed as shown. Two caps $\frac{1}{8}$ in. thick cut to fit pipe. Heads to be secured by upsetting pipe after coil is in place. All to have two coats of black paint.

Core.—Best annealed wrought iron wire cut, $6\frac{1}{4}$ in. long, varnished. Diameter of wire, .016 in.

Primary.—To be of best white single silk covered copper wire, No. 27 B. & S. To be wound in two parts, each having 1,565 turns, and a resistance, 14 ohms. Each part to have two layers.

Secondary.—To be of best white single silk covered copper wire, No. 27 B. & S. To be wound in two parts, each having 1,565 turns, resistance to be 21 ohms. Each part to have two layers. Coil to be wrapped with black "seal cloth."

Terminals.—The terminals shall consist of two pieces of stranded wire of the same description as that specified for the winding of the coil. That part of the terminal which extends beyond the iron sheath shall be covered with a braided cotton covering.

Finish.—The coil and its accessories shall be assembled and finished in a workmanlike manner.

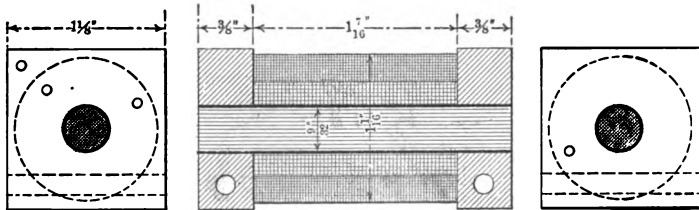

FIG. 147.—COIL USED WITH BLAKE TRANSMITTER.

SPECIFICATIONS FOR FIG. 147.

- Core: Bundle of No. 24 soft iron wire.
 Diameter of core, $\frac{9}{32}$ in.
 Length of core, $2\frac{1}{4}$ in.
 Winding space, $1\frac{7}{16}$ in.
 Paper insulation around core, $\frac{1}{32}$ in. thick.
 End blocks, $\frac{3}{8}$ in. thick, $1\frac{1}{2}$ in. square.
- Winding: Inside winding.
 Resistance, .6 ohms.
 290 turns No. 22 single silk covered wire.
 Two layers of common paper insulation around it.
- Outside winding.
 Resistance, 250 ohms.
 3,000 turns No. 36 single silk covered wire.

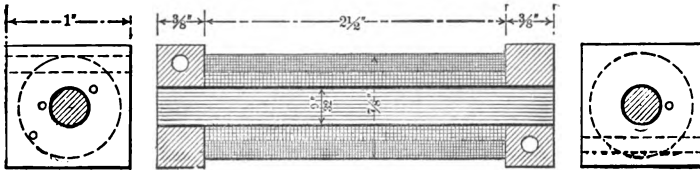

FIG. 148.— LOCAL BATTERY COIL.

SPECIFICATIONS FOR FIG. 148.

- Core: Bundle of No. 24 soft iron wire.
 Diameter of core, $\frac{9}{32}$ in.
 Length of core, $3\frac{1}{4}$ in.
 Winding space, $2\frac{1}{2}$ in.
 Paper insulation around core, $\frac{1}{32}$ in. thick.
 End blocks, $\frac{3}{8}$ in. thick, 1 in. square.

Winding: Inside winding.

Resistance, 1.76 ohms.

400 turns No. 26 single silk covered wire.

Two layers common paper insulation.

Outside winding.

Resistance, 21 ohms.

1,600 turns No. 28 single cotton covered wire.

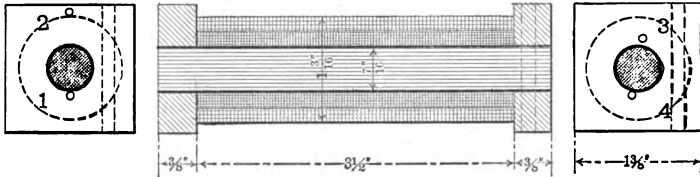

FIG. 149.—COMMON BATTERY COIL A.

SPECIFICATIONS FOR FIG. 149.

Core: Bundle of No. 24 soft iron wire.

Diameter of core, $\frac{7}{16}$ in.

Length of core, $4\frac{1}{4}$ in.

Winding space, $3\frac{1}{2}$ in.

Paper insulation around core, $\frac{1}{32}$ in. thick.

End blocks, $\frac{3}{8}$ in. thick, $1\frac{3}{8}$ in. square.

Winding: Inside winding.

Resistance, 28 ohms.

1,000 turns No. 33 single silk covered wire,
wound in three layers.

Two layers of common paper insulation.

Outside winding.

Resistance, 51 ohms.

2,500 turns of No. 28 single cotton covered
wire.

Terminals: 1 and 2 outside winding.
 3 and 4 inside winding.
 1 to receiver.
 2 to hook.
 3 to condenser.
 4 to hook.

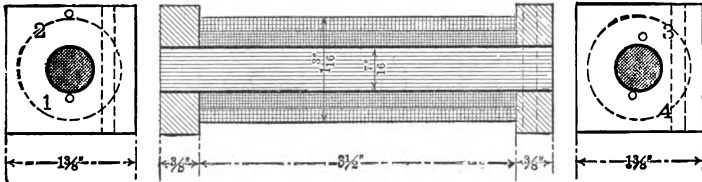

FIG. 150.—COMMON BATTERY COIL B.

SPECIFICATIONS FOR FIG. 150.

Core: Bundle of No. 24 soft iron wire.

Diameter of core, $\frac{7}{16}$ in.

Length of core, $4\frac{1}{4}$ in.

Winding space, $3\frac{1}{2}$ in.

Paper insulation around core, $\frac{1}{32}$ in. thick.

End blocks, $\frac{3}{8}$ in. thick, $1\frac{3}{8}$ in. square.

Winding: Inside winding.

Resistance, 28 ohms.

1,404 turns No. 31 single cotton covered wire.

Two layers common paper insulation around it.

Outside winding.

Resistance, 17 ohms.

1,705 turns No. 26 single cotton covered wire.

Terminals: 1 and 2 to outside wiring.

3 and 4 to inside wiring.

1 to line.

2 to hook.

3 to condenser.

4 to hook including receiver.

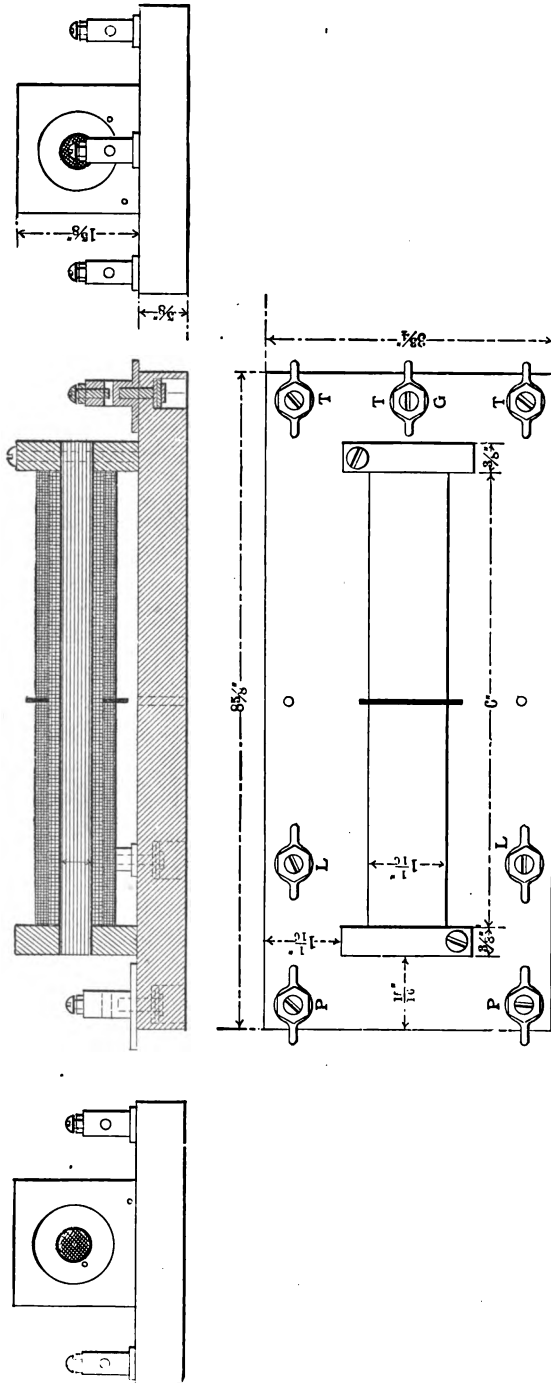

FIG. 15].—DOUBLE WOUND COIL.

SPECIFICATIONS FOR FIG. 151.

- Core:** Bundle of No. 24 soft iron wire.
 Diameter of core, $\frac{1}{2}$ in.
 Length of core, $6\frac{3}{4}$ in.
 Winding space, 6 in.
 Paper insulation around core, $\frac{1}{32}$ in. thick.
 End blocks, $\frac{3}{8}$ in. thick, $1\frac{5}{8}$ in. square.
- Winding:** Inside winding.
 Resistance, .5 ohms.
 380 turns No. 18 single covered wire wound in three layers.
 Two layers of common paper insulation around it.
 Outside winding.
 Resistance, 84 ohms on each side = 168 ohms total.
 2,500 turns on each side = 5,000 turns total.
 Wound from end to center and from center to end.
 Secondary. Two coils separated by hard rubber ring $\frac{1}{16}$ in. thick.
- Terminals:** Primaries to operator's telephone.
 L. L. to keyboard.
 T. T. to telephone.
 G. to center of telephone or ground.

Considering the importance of the induction coil, too much pains cannot be taken in its design, or too great liberality allowed in its proportions. In its construction and assemblage the very best material and the highest standard of workmanship should be used. Under increasing competition there is a great and mistaken tendency to skimp both in quality and quantity. The general aim of

design should be to produce a coil of the least possible impedance and the greatest mutual inductance. To this end the primary should be of large wire, the core ample in size and long enough to accommodate the necessary turns of the primary, which should not be less than 300 turns in two layers. The ratio of transformation between the primary and secondary should be from 8 to 10, and the size wire employed in the secondary such as to enable the requisite number of turns to be obtained in not to exceed five layers. For both primary and secondary white single silk covered copper wire should be used, and it is desirable that each coil should be wound with a single piece without splices. In the winding care should be taken to wind evenly and uniformly without piling or crossing any of the turns. Between the primary and the secondary an insulation of at least four thicknesses of paraffined paper should be provided, and it is well to interpose two thicknesses of paper insulation in the middle of the secondary. The terminals of both primary and secondary should be reinforced by means of stranded wire extended from the inside of the winding through holes drilled in the heads and soldered to clips secured either upon the head or upon the base. The stranded terminal wire should be heavily insulated with a silk or cotton wick. The core should be composed of the very best and softest Swedish iron wire, thoroughly annealed. The wire should not be over a No. 20 B. & S. gauge and preferably No. 26 or 28. It should be thoroughly varnished, cut to proper length and packed into the core tube, and each piece of wire composing the core should be the full length of the tube. Short pieces or spliced pieces should not be allowed.

For the coil frame fibre heads about $\frac{1}{4}$ in. in thickness and from 1 in. to $1\frac{1}{4}$ in. square, mounted upon a fibre

tube $\frac{1}{2}$ in. in diameter and from 4 to 6 ins. in length is preferable. While many makers use paper tubes and wooden heads fibre is much more desirable.

The mounting of an induction coil usually depends on the place where it is to be used. Coils which accompany a

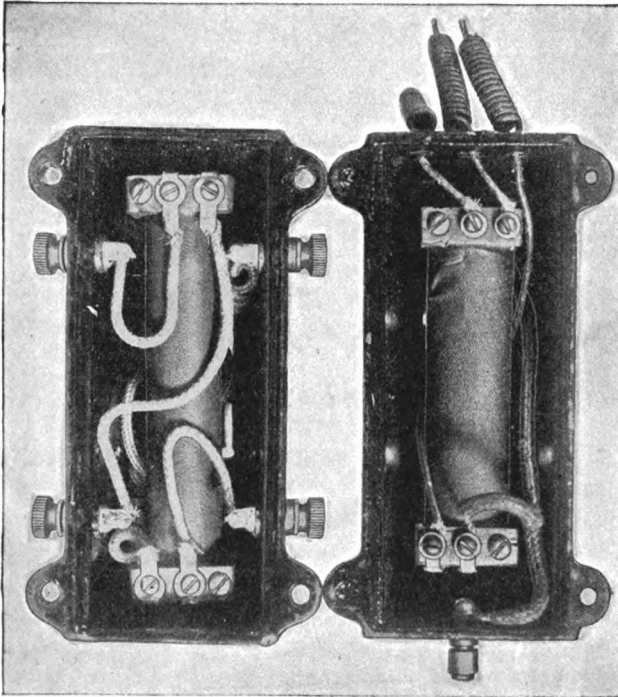

FIG. 152.—INDUCTION COILS IN TRANSMITTER ARM BASE.

wall or cabinet set are merely wound on a spool and placed in a chamber made by expanding the base of the transmitter arm, as illustrated in Fig. 152. For switch-

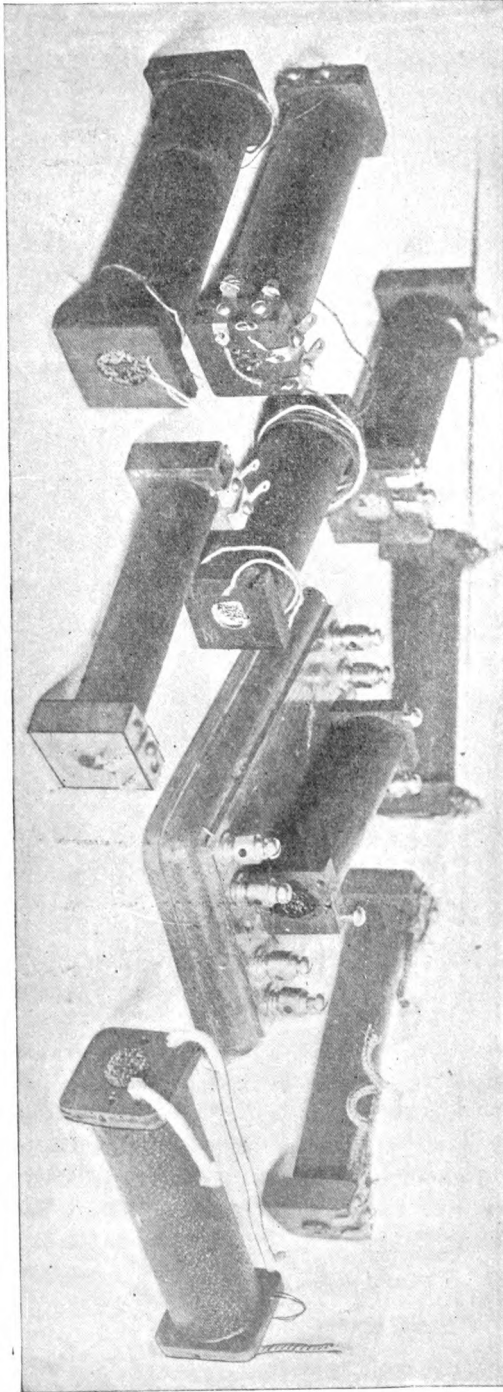

FIG. 153.—A COLLECTION OF COILS.

boards and desk sets when the coil is to be attached to neighboring woodwork it is usually mounted on a wooden base. Fig. 153 is from a photograph of the group of coil dissected to form Table XIV.

As an aid in designing the winding of induction and other coils Table XV is appended, collected from experimental data gained in the winding of many coils with various kinds of insulation.

TABLE XV.
Data for Winding Coils.

Size of wire, B. & S.	Diameter in Mils. Over Insulation.			Turns per Linear Inch.			Turns per Square Inch.		
	Bare wire.	Single cotton.	Double cotton.	Single silk.	Double silk.	Single cotton.	Double cotton.	Single silk.	Double silk.
0000	460.000	610.000	627.000	1.558	1.388	1.8714
000	469.640	590.000	627.000	1.802	1.498	1.9768
00	484.800	525.000	628.000	1.816	1.590	2.0106
0	494.800	475.000	573.000	2.140	1.980	2.5070
1	498.800	460.000	573.000	2.170	2.090	2.5490
2	499.680	390.000	517.800	3.540	3.400	10.0460
3	499.680	367.680	477.600	4.970	4.850	12.5400
4	499.680	339.480	440.600	6.500	6.300	14.8125
5	499.680	314.810	399.800	8.000	7.750	18.4000
6	499.680	294.000	366.000	9.500	9.200	22.9121
7	499.680	276.000	336.000	11.000	10.600	28.4849
8	499.680	260.000	309.000	12.500	12.000	35.0286
9	499.680	245.000	284.000	14.000	13.400	42.5425
10	499.680	231.000	261.000	15.500	14.800	51.0241
11	499.680	218.000	239.000	17.000	16.200	60.4725
12	499.680	206.000	219.000	18.500	17.600	70.8925
13	499.680	194.000	199.000	20.000	19.000	82.2900
14	499.680	183.000	180.000	21.500	20.400	94.6675
15	499.680	172.000	162.000	23.000	22.300	108.0225
16	499.680	161.000	145.000	24.500	23.700	122.3625
17	499.680	150.000	129.000	26.000	25.100	137.6875
18	499.680	140.000	114.000	27.500	26.500	154.0000
19	499.680	130.000	99.000	29.000	28.000	171.2925
20	499.680	120.000	85.000	30.500	29.500	190.5675
21	499.680	110.000	72.000	32.000	31.000	211.8225
22	499.680	100.000	60.000	33.500	32.500	235.0675
23	499.680	90.000	49.000	35.000	34.000	260.3000
24	499.680	80.000	39.000	36.500	35.500	287.5225
25	499.680	70.000	30.000	38.000	37.000	316.7375
26	499.680	60.000	22.000	39.500	38.500	348.0425
27	499.680	50.000	15.000	41.000	40.000	381.4375
28	499.680	40.000	9.000	42.500	41.500	417.9225
29	499.680	30.000	5.000	44.000	43.000	467.5000
30	499.680	20.000	2.000	45.500	44.500	530.1675
31	499.680	10.000	1.000	47.000	46.000	607.0225
32	499.680	48.500	47.500	698.1675
33	499.680	50.000	49.000	803.5925
34	499.680	51.500	50.500	924.3000
35	499.680	53.000	52.000	1060.2925
36	499.680	54.500	53.500	1212.5675
37	499.680	56.000	55.000	1381.1225
38	499.680	57.500	56.500	1567.0675
39	499.680	59.000	58.000	1770.5000
40	499.680	60.500	59.500	1992.5225
41	499.680	62.000	61.000	2234.1375
42	499.680	63.500	62.500	2496.4425
43	499.680	65.000	64.000	2780.5400
44	499.680	66.500	65.500	3087.4325
45	499.680	68.000	67.000	3418.1200
46	499.680	69.500	68.500	3773.6025
47	499.680	71.000	70.000	4154.9800
48	499.680	72.500	71.500	4563.2525
49	499.680	74.000	73.000	5000.4200
50	499.680	75.500	74.500	5468.4925
51	499.680	77.000	76.000	6000.4600
52	499.680	78.500	77.500	6599.3225
53	499.680	80.000	79.000	7268.0800
54	499.680	81.500	80.500	7919.8325
55	499.680	83.000	82.000	8656.5800
56	499.680	84.500	83.500	9481.3225
57	499.680	86.000	85.000	10408.0600
58	499.680	87.500	86.500	11440.7925
59	499.680	89.000	88.000	12583.5200
60	499.680	90.500	89.500	13841.2425
61	499.680	92.000	91.000	15219.9600
62	499.680	93.500	92.500	16725.6725
63	499.680	95.000	94.000	18365.3800
64	499.680	96.500	95.500	20146.0825
65	499.680	98.000	97.000	22075.7800
66	499.680	99.500	98.500	24161.4725
67	499.680	101.000	100.000	26412.1600
68	499.680	102.500	101.500	28837.8425
69	499.680	104.000	103.000	31448.5200
70	499.680	105.500	104.500	34254.1925
71	499.680	107.000	106.000	37265.8600
72	499.680	108.500	107.500	40493.5225
73	499.680	110.000	109.000	43947.1800
74	499.680	111.500	110.500	47636.8325
75	499.680	113.000	112.000	51572.4800
76	499.680	114.500	113.500	55865.1225
77	499.680	116.000	115.000	60524.7600
78	499.680	117.500	116.500	65561.4925
79	499.680	119.000	118.000	71095.2200
80	499.680	120.500	119.500	77146.9425
81	499.680	122.000	121.000	83836.6600
82	499.680	123.500	122.500	91184.3725
83	499.680	125.000	124.000	99310.0800
84	499.680	126.500	125.500	108344.7825
85	499.680	128.000	127.000	118408.4800
86	499.680	129.500	128.500	129621.1725
87	499.680	131.000	130.000	142102.8600
88	499.680	132.500	131.500	155973.5425
89	499.680	134.000	133.000	171363.2200
90	499.680	135.500	134.500	188401.8925
91	499.680	137.000	136.000	207228.5600
92	499.680	138.500	137.500	228003.2225
93	499.680	140.000	139.000	250886.8800
94	499.680	141.500	140.500	276059.5325
95	499.680	143.000	142.000	303601.1800
96	499.680	144.500	143.500	333701.9225
97	499.680	146.000	145.000	366461.6600
98	499.680	147.500	146.500	402081.3925
99	499.680	149.000	148.000	440761.1200
100	499.680	150.500	149.500	482700.8425
101	499.680	152.000	151.000	528100.5600
102	499.680	153.500	152.500	577160.2725
103	499.680	155.000	154.000	629980.0800
104	499.680	156.500	155.500	686760.8825
105	499.680	158.000	157.000	747700.6800
106	499.680	159.500	158.500	813000.4725
107	499.680	161.000	160.000	882860.2600
108	499.680	162.500	161.500	957480.0425
109	499.680	164.000	163.000	1037060.8200
110	499.680	165.500	164.500	1122900.5925
111	499.680	167.000	166.000	1215300.3600
112	499.680	168.500	167.500	1314560.1225
113	499.680	170.000	169.000	1421980.8800
114	499.680	171.500	170.500	1537860.6325
115	499.680	173.000	172.000	1662500.3800
116	499.680	174.500	173.500	1796200.1225
117	499.680	176.000	175.000	1939260.8600
118	499.680	177.500	176.500	2092980.5925
119	499.680	179.000	178.000	2257660.3200
120	499.680	180.500	179.500	2433600.0425
121	499.680	182.000	181.000	2621100.7600
122	499.680	183.500	182.500	2821460.4725
123	499.680	185.000	184.000	3035080.1800
124	499.680	186.500	185.		

INDUCTION COILS.

TABLE XV — (Continued).
Data for Winding Coils.

Size of wire, B. & S.	Diameter in Mils. Over Insulation.			Turns per Linear Inch.			Turns per Square Inch.			
	Bare wire.	Single cotton.	Double silk.	Single cotton.	Single silk.	Double silk.	Single cotton.	Double cotton.	Single silk.	Double silk.
22	22.571	28.471	26.771	84.400	28.970	88.19	1188.8900	889.2003	1468.4761	1202.8909
24	20.100	26.000	24.300	86.900	81.850	42.37	1861.6100	962.8225	1796.2169	1532.9386
25	17.900	23.800	22.100	88.000	88.920	47.02	1454.0000	1150.5664	2210.8004	1848.5486
26	15.940	21.840	20.140	42.000	86.290	52.06	1763.0000	1316.9641	2710.2486	2191.1761
27	14.195	20.095	18.395	48.000	86.850	57.67	2201.0000	1517.0925	3826.8289	2661.5281
28	12.641	18.541	16.841	53.000	41.610	63.86	2808.0000	1731.8920	4014.4696	3184.3449
29	11.257	17.157	15.457	56.500	44.370	70.11	3062.2600	1959.8829	4915.4121	3789.6586
30	10.025	15.925	14.225	59.660	46.990	77.14	3859.3156	2202.4249	5841.4706	4490.9041
31	8.928	14.828	13.128	64.125	49.780	84.64	4112.01562	2478.0454	7163.9296	5940.3121
32	7.950	13.850	12.150	68.600	52.940	92.72	4705.8600	2789.4756	8586.9984	6113.6761
33	7.080	12.980	11.280	73.060	55.100	101.65	5388.3025	3086.0100	10658.7225	7084.3686
34	6.314	12.204	10.504	77.900	57.870	112.11	6068.4100	3314.3048	12568.6521	8179.3686
35	5.614	11.514	9.814	82.600	60.040	119.70	6822.7600	3604.8016	14628.0900	9389.6100
36	5.000	10.900	9.200	87.100	62.510	130.15	7686.4100	39.2.5001	16898.0225	10722.6025
37	4.453	10.353	8.653	91.870	64.700	140.60	8440.0669	4186.0600	19768.3600	11144.0400
38	3.905	9.805	8.105	95.000	66.800	151.05	9025.0000	4482.2404	22816.1025	12653.9225
39	3.381	9.431	7.781	100.700	68.800	163.40	10140.4900	4788.4400	26669.5600	15018.5025
40	3.144	9.044	7.344	108.000	71.800	177.65	11286.0000	5089.4400	31578.5225	16692.5600

Owing to the scarcity of data upon induction coil construction, the design of a new coil is more or less a matter of experiment, and for this purpose it is well after roughly designing the windings to construct experimental coils which shall enable the design to be tested. For this purpose it is advantageous to arrange the primary and secondary to be separable so that the combination of various primaries with other secondaries may be tested. For example: Assume that a coil having 300 turns in the primary and 2,500 turns in the secondary be considered desirable. Assume the core to be from $\frac{1}{2}$ in. in diameter and provide a winding space of 5 ins., construct five such cores; wind one with two layers of No. 24 wire. This will give approximately 300 turns. Wind one other core with No. 13 wire, obtaining 100 turns and one with No. 19 wire, giving 200 turns; also one with No. 27 wire, obtaining 400 turns and one with No. 32 wire, giving 500 turns. Construct in a similar manner five secondaries, each wound upon a paper tube so that they may be slipped over any one of the primaries. One secondary should be wound of No. 33 wire, giving 2,500 turns in five layers; one with No. 24 giving 1,000 turns; one with No. 28, giving 1,500; one with No. 36, giving 3,000, and one with No. 35, giving 4,000 turns. As each secondary may be tested with any one of the previous primaries, the construction of five coils will give twenty-five combinations. A trial with each of these will show which combination gives, on the whole, the best results under the particular circumstances the coil is to be used, and from a preliminary test of this kind the probable final proportions of the most desirable coil can be readily determined.

Subscribers' Circuits.— Every substation has four functions: (1) To receive signals, (2) to send signals, (3) to receive conversation and (4) to transmit conversation. It is necessary that apparatus should be in a condition successively to perform all of these functions, for when a subscriber is talking he neither wishes to signal others nor be called. When he is not talking, the transmitter is out of service and it would be wasteful to allow its battery to discharge. Apparatus must therefore be arranged so that each part shall perform its function at the proper time. This must be accomplished with the least possible machinery, constructed in the simplest and most substantial manner, for substations are counted by millions, are placed often in the hands of the ignorant, sometimes in those of the idly vicious, so nothing that is not as near "fool-proof" as possible is even remotely suitable; and as experience shows that the annual maintenance of the substation is from a fourth to a third of the entire expense of service, the necessity for a design to reduce this cost to a minimum is evident.

Substation apparatus is usually classified into two divisions depending on the method of supplying current to the transmitter. When each station has a battery of its own it is termed "local battery." When all connected to one central office are supplied from one battery located in that office they are termed "common battery." The phrase "central energy" is frequently employed to mean the same thing, but seems less preferable than the older and more accurate "common battery." Substations are also classified according to the method of signalling. Those which are supplied with a small hand dynamo or a "magneto" are called "magneto stations," while those which use a battery at the central office are called "automatic signal

stations," because the apparatus is so arranged that the removal of the receiver from its hook automatically signals the operator. Magneto stations may or may not be operated by common battery, and a local battery station may or may not be arranged for automatic signalling. As a matter of practice it is reasonably accurate to say that all magneto stations are "local battery," and that all "common battery" stations have automatic signalling. But it is not true to say that all automatic signal stations are common battery, for because of the patent situation, many small exchanges have been built having local batteries for talking and with a signal battery at the central office.

The arrangement of conductors and apparatus at the substation whereby the subscriber may successively place the different portions into proper relations for use is called the *substation circuit*. To recite every combination which has been tried for this purpose, or to attempt to depict all the circuits that the larger manufacturers commonly use, would be impracticable. But there are certain fundamental principles of circuit design which are common to each class of circuits,—these it is proposed to discuss.

The magneto local battery circuit.—In this class there are seven elements. Three of them — the transmitter, its battery and induction coil — constitute the talking apparatus; two, the magneto bell and generator, form the signal receiving and sending apparatus. A magneto telephone is the conversation receiver; and finally a switch is employed to place the various pieces of apparatus in proper relation to the line.

An early telephonic difficulty was an adequate subscribers' signal. It would seem that the inevitable transmitter battery, with the addition of a push button and

vibrating bell costing a couple of dollars, would have supplied an ideal calling device. But, excepting in intercommunicating systems of a small number of stations, the battery bell has never been popular. It is believed to be unreliable, but why more unreliable in telephony than in other cases is hard to see. A vibrating bell costs much less than a magneto bell to say nothing of the expensive generator, and it would seem as if a considerable saving in installation investment could cover some extra maintenance. Be this at it may, the hand generator and magneto bell are universal factors in substation equipment and must be dealt with accordingly.

To perform the various necessary circuit changes the early telephone station was provided with a switch which the subscriber manipulated by hand, and which immediately developed into an unbearable nuisance. For the subscriber always forgot to turn it on when he wished to talk, and was equally oblivious to change it when conversation was completed. Though the Patent Office records several inventors, history leaves us somewhat in doubt as to who was the first to suggest the simple expedient of combining a switch with a hook on which the receiver should be supported when not in use, thereby securing an automatic circuit changer that was reasonably independent of the subscriber's memory, though even now, one of the greatest substation troubles is forgetfulness to hang up the receiver.

Consider now how these seven units may be arranged to best suit service. There are four essential conditions: (1) When the line is not in use for conversation, the bell must be ready to receive a signal. (2) When the subscriber wishes to signal, the generator must be connected to the line. (3) During conversation the receiver must

be connected to the line, and the transmitter, battery and coil placed in a local closed circuit. (4) On the completion of connection the battery circuit must be opened.

The series circuit.— In the earliest circuits most of the apparatus was placed in series in the line. This is illustrated in Fig. 154 in which L and L' are the two sides of

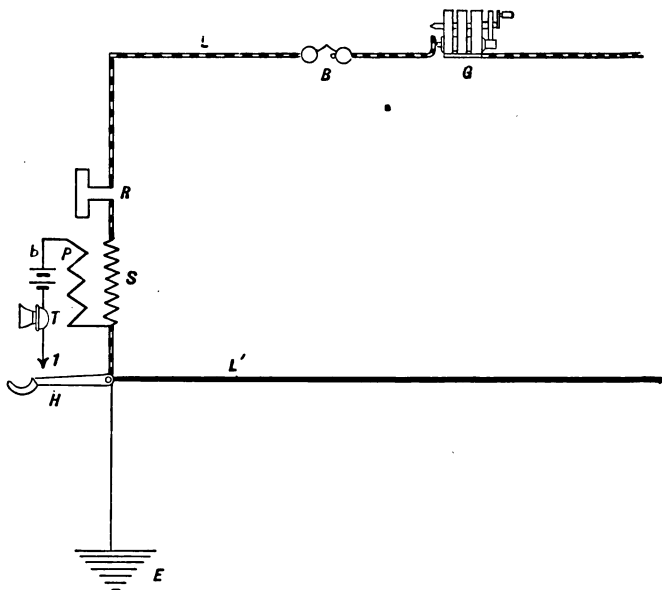

FIG. 154.— THE SERIES CIRCUIT.

the line, R the receiver, T the transmitter, H the hook switch, B the magneto bell and G the generator. The generator, bell, receiver and secondary S of the induction coil are all placed directly in series with each other and the line connected to the hinge of the hook switch. The

primary of the induction coil P , the battery b and the transmitter T are in series in a local circuit one end of which is attached to the hinge of the hook switch, while the other terminal passes to contact 1. When the receiver is on the hook H , the contact 1 is open, and the battery circuit severed. In this position a signalling current traversing the line passes through the generator, bell and secondary. When the hook switch is raised the transmitter circuit is closed; speaking into the transmitter varies the resistance of the local circuit causing pulsations to circulate. Between the primary and secondary of the induction coil these impulses are raised in voltage, and pass through the line traversing the receiver, bell and generator. To keep the resistance as low as is practical the bell is never wound with more than 80 ohms resistance and sometimes less. The ringing generator is constructed so that when out of service a shunt is placed around the armature, thus cutting it out of the circuit. The shunt is opened when one pushes upon the crank and thus the act of ringing automatically introduces the armature into circuit. This arrangement can be worked either grounded or metallic, for if the conductor L' be removed and a ground connection E substituted, as shown by dotted line, the old-fashioned grounded circuit is obtained.

The bridging circuit.—But a short experience was necessary to demonstrate the inexpediency of placing the ringing apparatus in series with the line, and to Mr. J. J. Carty belongs the credit of successfully arranging signalling devices so that they could be placed as shunts, having large impedance across the line. Such circuits are termed “*bridging circuits*” and are shown in Figs. 155 and 156. In Fig. 155, L and L' are the two sides of

the line. At the points *a* and *c* a bridge or shunt is placed between *L* and *L'*, and in this the bell *B* and the generator *G* are in series. From a point near the hinge of the hook switch *H* the battery *b*, primary of the induction coil *P* transmitter *T* and contact 2 are in series. In a continuation of *L* the secondary of the induction coil *S*, the receiver *R* and the contact 1 are placed. When the re-

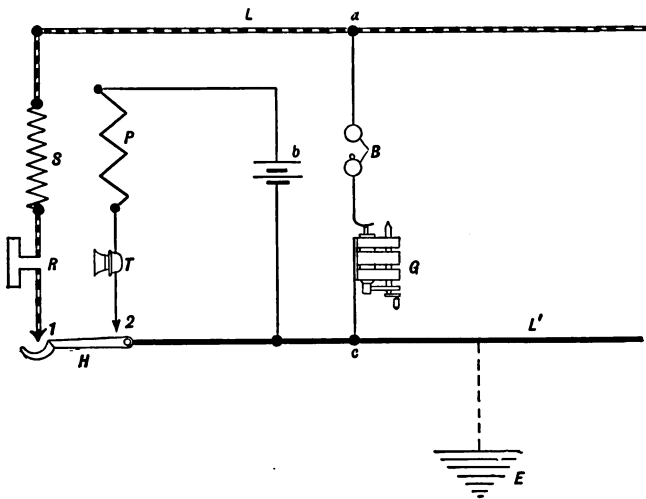

FIG. 155.— BRIDGING CIRCUIT, GENERATOR AND BELL IN SERIES.

ceiver is on the hook the switch is depressed, contacts 1 and 2 are opened and nothing but the bell and the generator remain in circuit. The generator is of the shunt type, and therefore when out of service offers no resistance to the reception of the ringing current. Upon the removal of the receiver from the hook switch contacts 1 and 2 are closed,

and the local circuit of the transmitter is the same as in Fig. 154; while by means of contact 1 the receiving circuit is completed. There is, therefore, a permanent bridge across the line which might appear injurious as tending to shunt both incoming and outgoing talking currents. But the bell is wound to 1,000 or even 2,000 ohms, and in addition presents a great impedance to the high frequency of

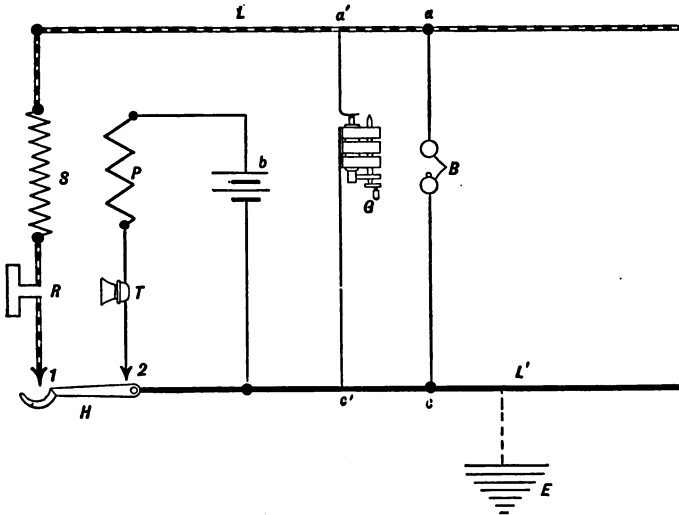

FIG. 156.—BRIDGING CIRCUIT, GENERATOR AND BELL IN PARALLEL.

telephonic currents. So great is this opposition that practically no difference can be detected whether the circuit ac is or is not closed.

In Fig. 156 a modification of Fig. 155 is shown. Here there are two paths between L and L' for signalling. The path ac contains the bell B , while the generator has been re-

moved and placed in a line by itself. When this form of circuit is used a different style of generator is employed, one in which the armature is no longer shunted, but the bell is provided with an automatic switch, which is operated from the crank in a manner similar to the automatic shunt, but with the difference that when the hand releases the crank the generator circuit automatically springs open and is no longer a bridge across the line. Such a generator is usually termed an "open generator." In all other respects Fig. 156 is similar to Fig. 155, nor is there much to choose between these two circuits. Either of them may at pleasure

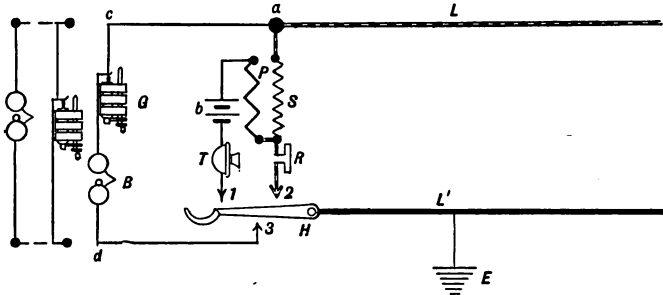

FIG. 157.—BRIDGING CIRCUIT, BELL AND GENERATOR DISCONNECTED DURING CONVERSATION.

be worked as a metallic or as a grounded line. For by the omission of the wire L' and the substitution therefor of a ground E , as shown by dotted line, the metallic circuit is converted into a grounded one.

In circuit Fig. 157 a different arrangement or apparatus is shown. Here the hook switch is provided with three contact 1, 2 and 3, Nos. 1 and 2 being similar to the correspondingly numbered contacts in the preceding circuits.

Contact 3 is underneath the hook switch and is closed when the hook is depressed. No. 3 is connected to the L side of the line by means of the path acd , the bell and generator being in this conductor. When the hook switch is depressed the receiver and transmitter are cut out of circuit and the bell and ringing generator are connected. Conversely the removal of the receiver disconnects the bell and generator and connects transmitter and receiver. In

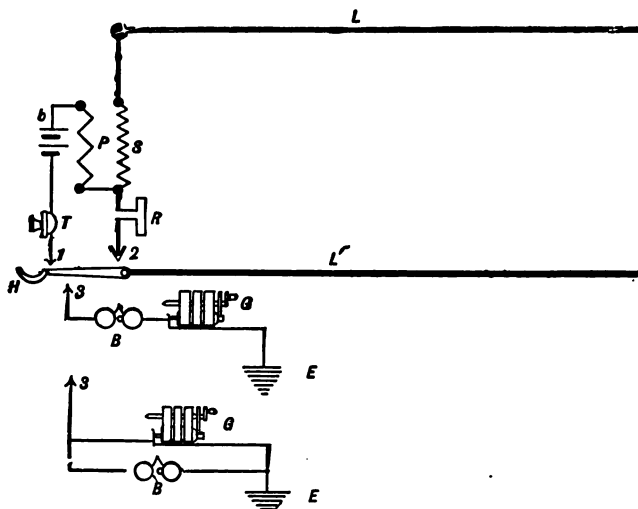

FIG. 158.—“RING GROUND, TALK METTALIC.”

this circuit there is no bridge, for all apparatus which is not in service is disconnected. The bell B and the generator G may be arranged in series as shown at cd , or in two separate lines as indicated by the dotted portion of the diagram. This circuit can easily be operated either grounded

or metallic by substituting for the line L' the ground E . While this circuit has the advantage of entirely disconnecting the signal apparatus at all periods when it is out of service, it has the disadvantage of requiring an extra contact on the hook switch. But with the perfection that has now been obtained in apparatus of this description this appears slight.

In Fig. 158 another modification is shown which is commonly called the circuit to "*ring ground and talk metallic.*" The talking portion is arranged as in Fig. 157, the contacts 1 and 2 on the top of the hook switch closing respectively the transmitter local and the receiver line as soon as the receiver is removed. Contact No. 3 is underneath the hook switch and is closed upon the replacement of the receiver when Nos. 1 and 2 are opened. This contact goes to ground E , the bell B and generator G being in series therewith. When the operator desires to signal she rings over the L' side of the line with a grounded generator. As shown by the supplementary diagram the generator and bell may be either a shunt generator in series with the bell or an open generator in parallel. In this circuit as soon as the receiver is removed from the hook the signaling apparatus is entirely disconnected. Circuit of Fig. 158 has been widely received in practice. The principal objection to it is the presence of the ground through the ringing apparatus. It is argued that such an arrangement is likely to introduce foreign currents into a telephone system that may either injure the substation or the switchboard, or may make any or all lines noisy. These are valid objections, and, where trolley roads exist, the possibility of danger is not to be lightly regarded. Injury, when it occurs, however, is chiefly confined to the ringer and the

generator and if the ringers be reasonably high wound, their impedance is so great that noisy lines are not as imminent as many suppose.

Circuit of Fig. 159 is a modification of those of Figs. 155 and 156. Here the transmitter *T*, battery *b* and terminal of the induction coil are attached to the hinge of the hook switch. The secondary of the coil runs to the same point and is in series with the receiver *R* to the *L'* side of the line, and to terminal 2 on the upperside of the hook switch. The *L'* side of the line runs to terminal 3. The ringer *B* and

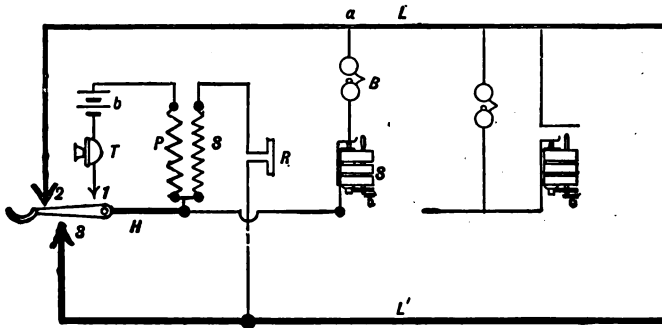

FIG. 159.— COIL TO HOOK SWITCH TERMINAL.

generator *G* are connected from the point *a* at the *L* side of the line to the hinge of the hook switch. A bridging bell and shunt generator or a bridging bell and an open generator as shown by dotted lines are used. In this circuit the ringing apparatus is constantly closed to the hinge of the hook switch. When the receiver is in place the transmitter circuit and *L* side are open, while the *L'* side is closed to the receiver, secondary and contact 3.

Circuit of Fig. 160 is an ingenious arrangement, pro-

posed by the Holtzer-Cabot Mfg. Co., devised, it is reported, to evade the Carty bridging bell patent. The generator and bell have no physical connection with the line, but there is a transformer, the primary P' being in a local circuit while the secondary S' is bridged across the line at $a' c'$. The generator is of the open type, and the bell B is bridged across the local circuit $a c d e$. When the generator is operated, current is transmitted through the primary P which induces smaller current and higher potential waves in the secondary S . These traverses the line and operate any

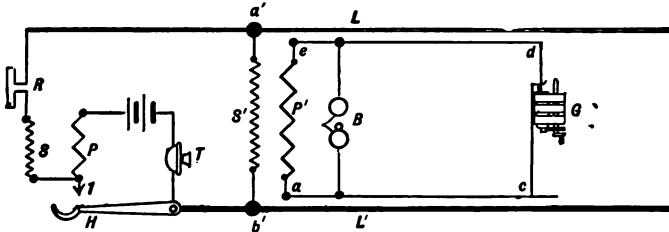

FIG. 160.—HOLTZER-CABOT CIRCUIT.

form of signal at the exchange. Conversely, when a subscriber's station is signalled, the ringing current traverses the secondary S' , inducing a lower potential and greater current in the primary P' than that which circulates through the line. Such a circuit presents many points that are curious and interesting. For example: The ringers and bells may be made of lower resistance and consequently more cheaply, while the secondary S' can be made of as great impedance as is thought desirable.

Substitution of local storage for local primary batteries. — Where the invention of the battery transmitter wonder-

fully improved the transmission of articulate speech, it was not long before operating companies found themselves confronted with an exceedingly serious problem in the maintenance of the substation. Experience indicated that the Fuller battery was an excellent form to use in this connection but in order to give satisfactory service the cells should be renewed two or three times per year. In New York, there are upward of 100,000 subscribers. If these were operated with local battery there would be 300,000 cells to be replaced every year, or about 1,000 cells per day. It needs but the slightest reflection to perceive that such a task is of the gravest kind and not only entails a very serious expense, but requires an enormous plant and executive administration of no mean order. More than a decade ago the formidable dimensions of this problem became apparent and many attempts were made to devise some other method of supplying electricity to the subscriber's transmitter. It has been shown that the advantage of the local battery lies in the possibility of placing the transmitter in a circuit whose resistance should be very small in comparison with its own. In order to retain this feature, it was proposed to substitute a small storage battery for the primary battery and to charge this battery over the subscriber's line by means of electricity supplied from the central office. Several circuits for this purpose have been suggested, Fig. 161 showing one which received an extensive and successful development in practice. The drawing indicates the entire subscriber's circuit including the central office apparatus, because with the local storage system it became possible to remove the generator and to provide subscribers with devices for automatic signalling. The

hook switch is connected to the side of the line L' with two cells of storage battery located close to the hinge. The local circuit was formed through the conductor $a c b 1''$ including the transmitter T , the storage battery b'' and the primary P of the induction coil. Contact 1 is on the upper side of the hook switch so that when the receiver is removed the transmitter circuit is completed, including the storage bat-

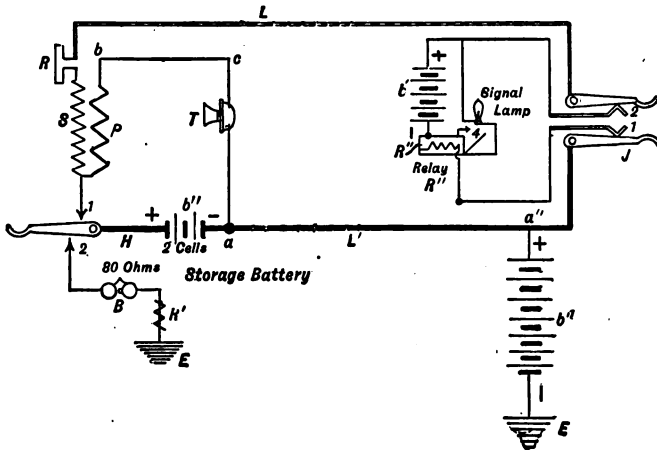

FIG. 161.—LOCAL STORAGE CIRCUIT.

tery. Contact 1 also completes the receiver circuit through the hook switch, secondary of the induction coil S and receiver R . With the receiver in place contact 1 is open and contact 2 is closed. This contact passes to an 80 ohm ringer B , thence to resistance coil R' and to ground E . On the same side L' of the line, a battery b'' or other generator of electricity is placed at the central office, one pole thereof being connected to L' at the point a'' , while the other pole

is grounded. Evidently when the receiver is in place electricity from b'' will pass over the line through the local storage battery and to ground, and by properly proportionating the voltage b'' and the combined resistance of the line L' , ringer B and resistance coil R' to the counter electromotive force of the storage battery b'' , the requisite current can be maintained to keep the cells b'' constantly charged. At the central office, the line terminates in a two point jack J , having the contacts 1 and 2. These contacts are in series with the battery b' and the relay R'' . So long as contact 1 is open no current flows from b' , but if the subscriber removes the receiver the circuit b' is completed, the relay R'' energized, contact 4 is closed, and the signal lamp is illuminated. This circuit makes calling automatic by the mere removal of the receiver. As a storage battery has the smallest resistance of any electric generator it is particularly adapted to the transmitter, and as the battery is kept fully charged up to within a very few seconds of the commencement of conversation, it is always in the best possible condition and its voltage considerably above that obtained with primary local battery.

Against the circuit of Fig. 161 it has been urged that the ground might become either a source of danger or of noise, and that charging local cells over one side of the line required a generator of objectionably high voltage at the office. Mr. Stone's circuit, Fig. 162, meets this objection. A battery b' is placed at the central office with one pole grounded, the other pole passes to the center of a retardation coil ac which is bridged across the line. At the sub-station, the secondary of the induction coil is placed across the line as shown at $a' c'$. From the center of this coil there is a tap to the contact 2, thence to contact 1 and the center

of the primary P which is placed in a local circuit including the transmitter T , the storage battery b and the ground E . When the receiver is removed the current will flow from b' over both sides of the line meeting in the center of the secondary passing thence through the center of the primary and around the local circuit in both directions. A portion of the current will pass directly through the transmitter; another portion will traverse the battery B and charge it. The signal circuit is completed by placing the bell B and generator G in series with contact 3 on the

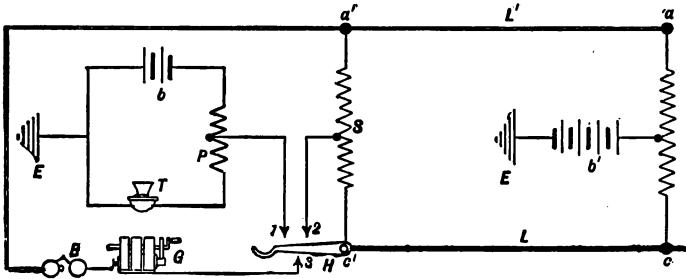

FIG. 162.—STONE LOCAL STORAGE CIRCUIT.

underside of the hook switch. This circuit allows the battery b to charge only during such time as the receiver is removed from the hook, and at first sight it would appear that it would be insufficiently replenished to give good service. But this is far from being the case, for a circuit of this kind is really a kind of common battery circuit and the battery b may be entirely removed and good transmission still be obtained; or it may be replaced by a condenser or an electrolytic cell, whose current storage capacity is almost infinitesimal and yet give transmission of an

eminently satisfactory character. Probably the chief objection is the ground upon the circuit during conversation and which in spite of the fact that both sides of the line are in parallel may become a prolific source of noise.

Common battery circuits.— Though local storage circuits were a marked improvement upon the primary battery, both in quality of transmission and in the economy of service, they still remained a notable source of maintenance expense, and the next step was the entire elimination of the subscriber's battery and operation of the transmitter by a supply of electricity direct from

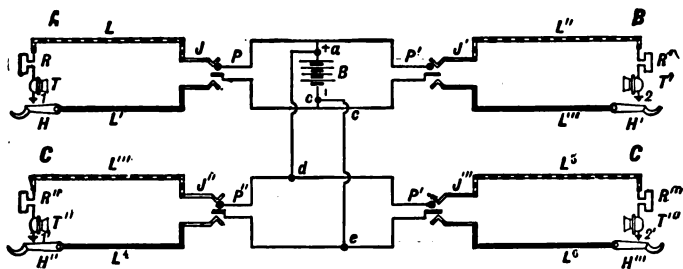

FIG. 163.— DIAGRAM COMMON BATTERY CIRCUIT.

the central office. Such circuits are known under the name of "*Common Battery Circuits.*" To clearly perceive the requisites of a common battery circuit its evolution must be traced, and in Fig. 163 four substations A B C and D are shown connected to a central office. In the figure all accessories of the circuits are stripped away so that the talking factors only are indicated. At each substation the transmitter *T* and receiver *R* are in circuit with contact 1 and hook switch *H* which puts them into connection with the line *L L'* which terminates in a jack *J*.

A common battery *B* is placed at the office, its positive pole *a* being connected to say the tip side of every cord at the points *a* and *d*, while the negative side is connected to the sleeve side at points *c* and *e*. When a pair of subscribers *A B* are connected by such a cord, current will evidently flow to the points *a c* and then will divide passing over each line and through each subscriber's receiver and transmitter. Such a circuit is subject to all the defects previously pointed out for batteries at a distance from the transmitter and, in addition, there are three other difficulties. If the line to *A* is of much lower resistance than that to *B* the *A* station will rob the *B* station and prevent it from obtain-

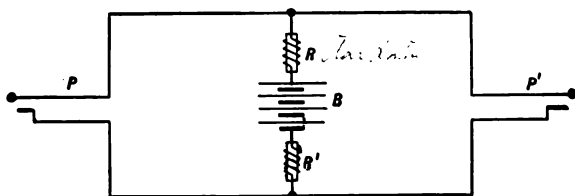

FIG. 164.—STONE COMMON BATTERY SYSTEM.

ing its fair supply of current. As the battery *B* is of low resistance and no impedance, the talking currents from either *A* or *B* will be shunted through the battery and prevented from reaching their proper destination. When another pair of subscribers is placed in connection as shown at *C* and *D* violent cross talk appears because the voice currents from each station are directed to all of the others. A multitude of remedies have been proposed, three of which have come into general use. One of these is the Stone system; Fig. 164 shows a diagram of each central office cord. Between the battery *B* which is common to

all independent retardation coils R and R' are placed one for each side of each cord. These coils are wound upon iron cores with large wire to have low ohmic resistance and high impedance. The coils do not prevent the battery from supplying current to both subscribers as fast as the transmitters may demand it, but the high impedance offers so great a barrier to the voice currents that they are not short circuited by the battery, but traverse the line from station to station. This is successful to prevent cross talk it does not, however, entirely obviate an equal distribution of current between two subscribers whose lines are of widely different resistance.

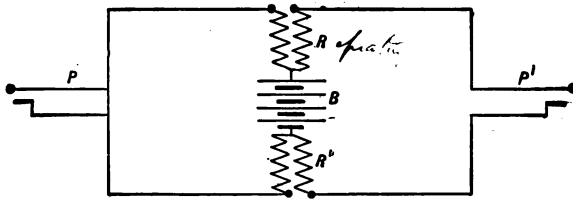

FIG. 165.—HAYES COMMON BATTERY SYSTEM.

The Hayes circuit in Fig. 165 is an effort to remedy this objection. Here the retardation coil R' of Fig. 165 is replaced by a repeating coil, one winding of which is common to each side of each cord. By this device each subscriber's circuit is individualized and its battery supply taken directly from the buss bars. The voice currents from each station circulate through the repeating coil and one-half of each cord repeats to the other half. When properly designed the repeating coil injures transmission but a few percent. To make a still further improvement Mr. Scribner has bridged the repeating coil by means

of a condenser C as shown in Fig. 166. Some observers report that this circuit is a slight improvement, but others are of the opinion that the introduction of the condenser is of insufficient value to be worth the additional expense.

A third arrangement invented by engineers of the Kellogg Switchboard & Supply Co. is shown in Figs. 167 and 168. In Fig. 167 the central office is supplied with two distinct batteries. The answering half of each cord being connected with one battery while the connecting half is attached to the other battery. All cords are supplied with a repeating coil R and R' . This device evades the patents

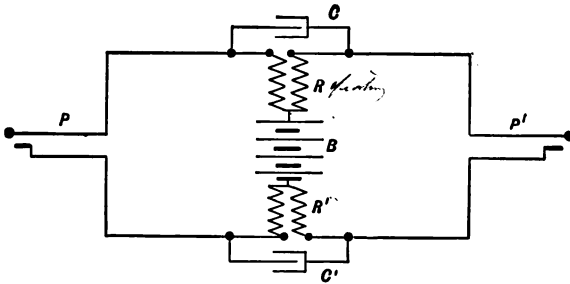

FIG. 166.— SCRIBNER COMMON BATTERY SYSTEM.

of Stone, Hayes and Scribner, and while somewhat more complicated, gives equal or even better service. In Fig. 168 the *double battery common battery* cord circuit is slightly modified. The batteries B and B' are connected to the respective halves of each cord through the retardation coils R R' R'' and R''' . These retardation coils are usually portions of the supervisory signals and consequently serve a double purpose. Between the two batteries the repeating coil R C is placed which repeats from one side of the cord to the other, and, in the center, each half is open by means

of the condenser $C C'$, so that the battery is never short circuited. For the condenser a plug switch may be easily substituted if desired.

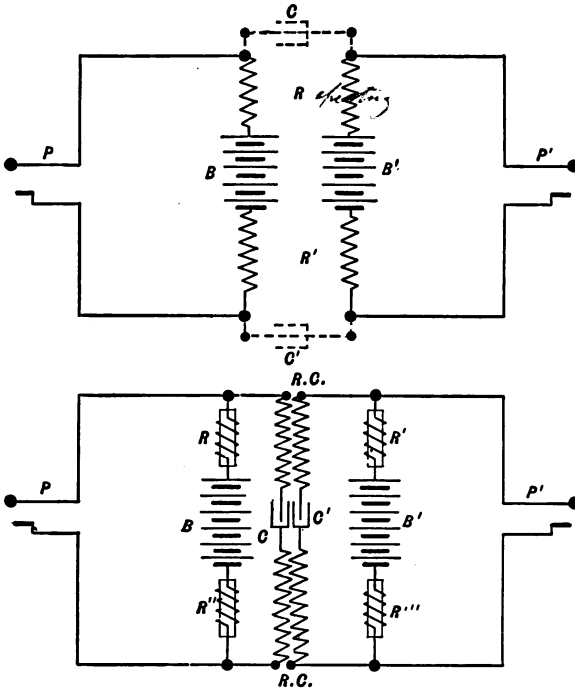

FIG. 167.—KELLOGG COMMON BATTERY SYSTEM WITH REPEATING COIL.

FIG. 168.—KELLOGG COMMON BATTERY SYSTEM WITH REPEATING AND RETARDATION COILS.

Returning now from a consideration of the office arrangement of the common battery to the substation, Fig. 169 shows the complete subscriber circuit. At the office there is a 24-volt battery B . Each line is connected to this bat-

tery by means of the contacts C and C' in the cut-off relay R'' . From the contacts C and C' the two sides of the line L and L' extend to the subscriber's station. The transmitter is placed in the side L' , near the hinge of the hook switch H . Just before the transmitter is reached, a bridge AB is placed across the line which contains the condenser c and the bell B . The condenser prevents any flow of current through the bell. The L side of the line passes through the secondary of the induction coil to the contact 1 and thence, when the receiver is off the hook, to the hook

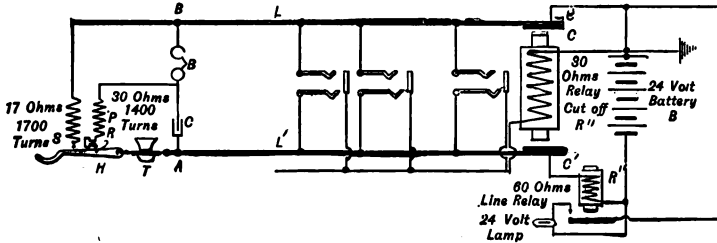

FIG. 169.—COMMON BATTERY CONDENSER CIRCUIT.

switch. The local circuit comprises the contact 2, transmitter T , receiver R , primary P of the induction coil and condenser c . As soon as the receiver is removed from the hook, battery current passes over the L' side of the line through the transmitter and thence finds two paths, one through the contact 2, receiver R , primary P , bell B to the point B ; and the other through contact 1, secondary S to the line L . The battery also charges the condenser c . When the transmitter is spoken to its resistance varies, and pulsations of battery current traverse the line, but, as has been previously pointed out, the transmission of such a circuit would be inferior to that of a local battery, because

the variation in the transmitter resistance is but a small fraction of the total resistance of the line, and consequently current variations are small. It has been shown in circuit of Fig. 162 that the condenser acts as a local reservoir of electricity. It is kept constantly charged by the battery, but with each instantaneous variation in transmitter resistance the charge of the condenser varies, and acts like a spring to store up and release energy that is supplied from a foreign source. Thus the presence of the condenser is twofold; it not only prevents waste of battery through the bell, but redeems the common battery circuit from the disastrous effect of the removal of the battery to a distant point.

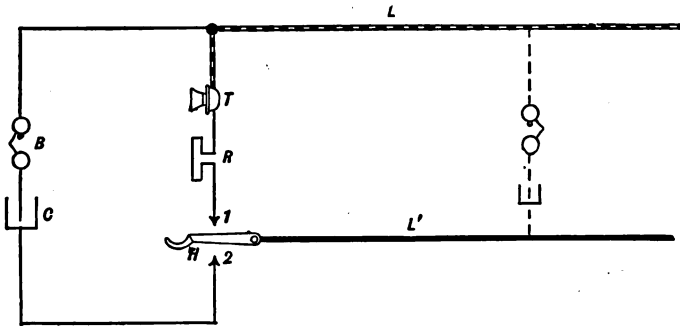

FIG. 170.—CONDENSER CIRCUIT NO. 1.

In an effort to secure the best results in transmission with a common battery a great variety of combinations have been tried. Experience has sifted out three types of circuit upon some one of which nearly all existing common battery systems now operate. In the simplest circuit, illustrated in Fig. 170, the transmitter T and receiver R and contact 1 are in series across the line, and bell B and con-

denser C are either bridged permanently between the sides of the line L and L' or are placed around the line in combination with the contact 2. In this latter arrangement the ringing apparatus is entirely removed when the hook switch is raised and contact with transmitter and receiver made. For reasons already pointed out this circuit does not give entire satisfaction.

The circuit usually employed by the Bell Companies is shown in Fig. 169 and has been fully described. This

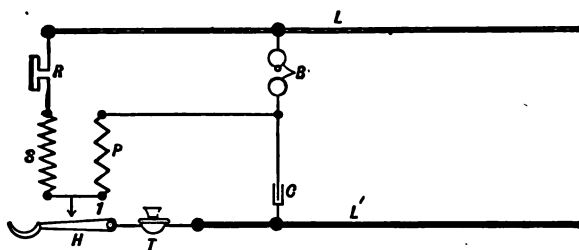

FIG. 171.—CONDENSER CIRCUIT NO. 2.

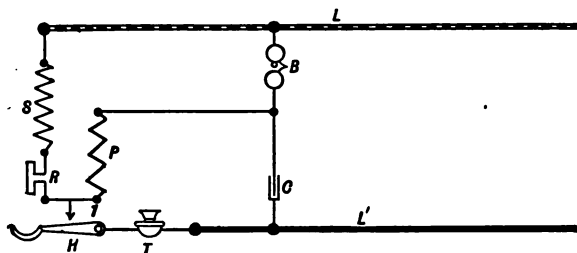

FIG. 172.—CONDENSER CIRCUIT NO. 3.

arrangement often goes by the name of the condenser circuit and on the whole has been found one of the most satisfactory. Modifications of this circuit are shown in Figs. 171, 172, 173 and 174. In 171 the receiver and the second-

ary are placed across the line, while the primary, transmitter and condenser are in the local circuit. In 172 the positions of the secondary and receiver are reversed. In 173 the receiver and primary are in series and are also in parallel with the secondary. None of these have proved

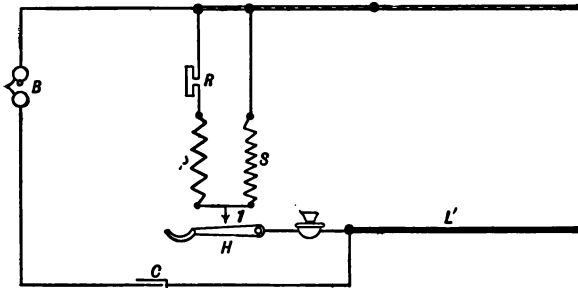

FIG. 173.— CONDENSER CIRCUIT NO. 4.

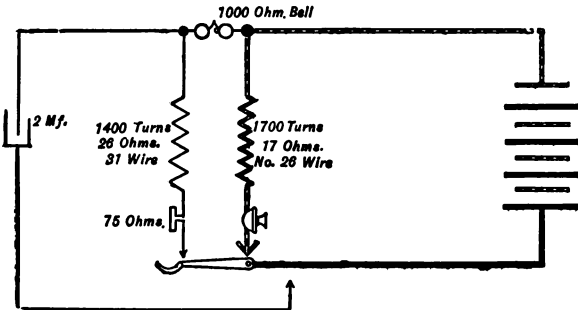

FIG. 174.— CONDENSER CIRCUIT NO. 5.

superior to that of Fig. 169 and usually have been found less advantageous. The modification shown at 174 is somewhat peculiar. In Fig. 169 the receiver, transmitter, condenser and one winding of the induction coil, are in

series in a local circuit. Hence the transmitter if sensitive and powerful picks up all local noise, and the "side tone" of this circuit is apt to be annoying. In 174 the transmitter is placed in the main circuit with one winding of the induction coil, while the receiver, condenser and other winding are in a local circuit. In this circuit a high wound receiver can be used, and "side tone" is much reduced.

To evade patent complications circuit Fig. 175 has been used by a number of independent manufacturers, notably the Kellogg Switchboard & Supply Co. There is no induction coil in the true sense of the word. Between L and

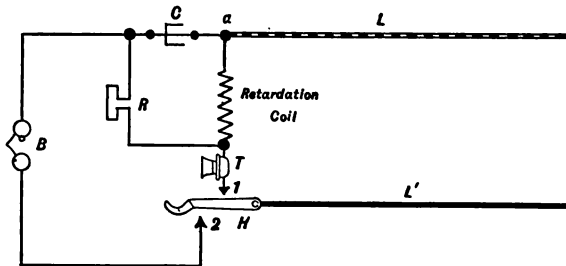

FIG. 175.—COMMON BATTERY CIRCUIT WITH RETARDATION COIL.

L' the transmitter is placed in series with a retardation coil and the contact 1. Beyond the point a the condenser is inserted and then the receiver is placed between the bell and condenser, and the retardation coil and the transmitter. The chief object of the retardation coil seems to be to prevent the receiver from being short circuited by the transmitter and at the same time perhaps remove from the transmitter the necessarily large impedance of the receiver. This circuit has given satisfactory results and has obtained a wide currency. Fig. 176 is another modification, often

employed by the Stromberg-Carlson and American Electric Co. The bell and condenser are placed across the line between points *a* and *b*. Beyond this bridge the secondary of an induction coil *S*, the transmitter *T* and contact 1 are in series. The receiver is placed in a local circuit by itself, in which is the primary of the coil. By this means the receiver is entirely removed from the line and the operation of the induction coil is to reduce the voltage and increase

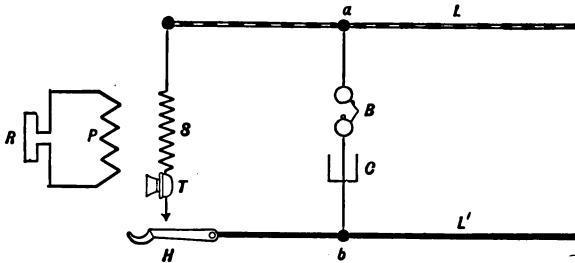

FIG. 176.— RECEIVER IN LOCAL CIRCUIT.

the current in the receiver circuit and thus produce a more powerful effect upon its magnet.

The operation of an induction coil in a common battery circuit is somewhat perplexing and is likely to be confused by the meaning ordinarily attached to the terms "primary" and "secondary." These phrases have their origin in electric lighting, when transformers were used originally to raise the voltage of a generator circuit in order to reduce line losses. The coil which is connected with the source of electricity is usually termed the primary, because it is of coarse wire and few turns, while the line coil is of fine wire and many turns. When transformers are used in common battery circuits no such marked distinction exists, and it would be much better to use the

terminology “*line coil and local coil*,” rather than primary and secondary. The operation of the transformer in a common battery circuit may be best explained by reference to Fig. 177, which shows circuit No. 169 as it is usually connected. The sides of the line are represented by L and L' , the office battery by B' . Between the points x and g the bell B and condenser C are permanently bridged. At the point E a tap runs to one side of the receiver R and

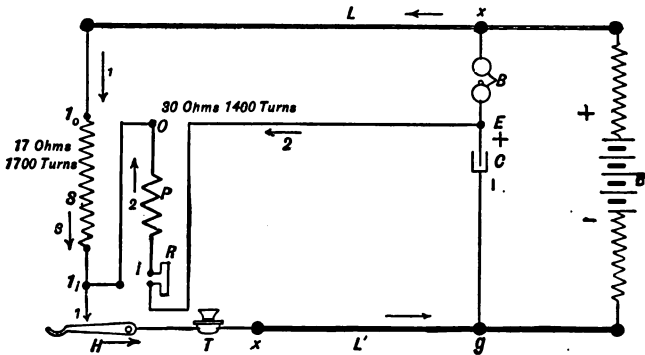

FIG. 177.— OPERATION OF INDUCTION COIL.

thence to point i , which is called the “inside terminal” of the primary of the induction coil or preferably the “local coil.” This coil has a resistance of 30 ohms and contains 1,400 turns. From the point o , the outside terminal of the local coil, a conductor passes to the contact 1. From this contact there is a conductor to i' which is the inside terminal of the secondary or, preferably, the “line” winding of the induction coil. This winding has a resistance of 17 ohms and contains 1,700 turns. From the point o' , the outer terminal of this coil, a conductor runs to the L side of the line. The transmitter T is inserted between the

hook switch and the point g . Assume the transmitter T to be at rest; it has a certain resistance, and under the pressure of the battery B' , a current will flow from the positive side in the direction of the arrow, along the L side of the line, through the line winding of the induction coil in the direction of arrow 1 to the hook switch, thence through the transmitter and back to the negative side of the battery. Between the points x and there will be a certain difference of potential and the condenser C will be charged to the same pressure. Suppose the transmitter be spoken to and its resistance suddenly decreased, not only will a greater current flow through the path just described, but, in addition, a portion of the charge in the condenser will pass from the positive side in the direction of arrow 2, through the local winding P of the induction coil, and along the L' side of the line to g and thence to the negative side of the condenser, the same direction as before. This current traversing the P winding, in the direction of the arrow 2, will induce in the S winding a current in the direction of arrow 3 the same as arrow 1. As this is in the same direction as the previous current it will be added to it. Therefore the discharge of the condenser combined with the action of the coil increases the effect of the transmitter. If this arrangement is beneficial it is pertinent to inquire why a still greater ratio between the two sides of the coil would not improve matters. Telephonic apparatus is so sensitive to the minutest variations in current that it is difficult to give mathematical proportions for the induction coil and it can only be said that these windings have, on the whole, been sanctioned in practice.

Only a single cycle has been described, but it is easy to see that the same sequence will be repeated for every sound wave which impinges upon the diaphragm, and

those who wish to test this explanation experimentally can readily prove the value of the induction coil by interchanging the connections at o and i or at o' and i' , when it will at once be found that transmission is seriously impaired.

Mr. Dean has proposed a common battery system which is shown in Fig. 178 and is recognized as a modification

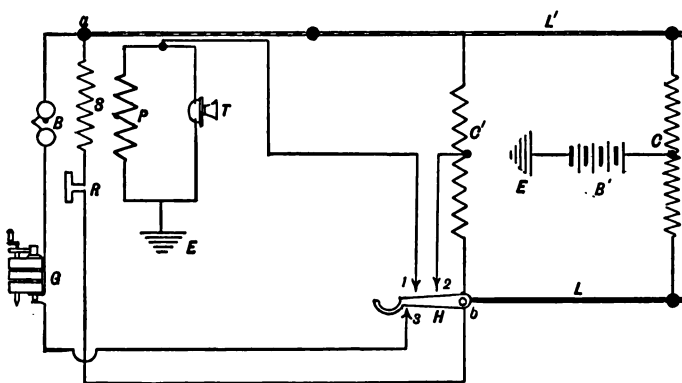

FIG 178.—DEAN COMMON BATTERY CIRCUIT NO. 1.

of his local storage circuit. At the central office the common battery B' has one pole earthed at E , while the other runs to the center of a retardation coil C bridged across the circuit. At the substation there is a second and similar coil C' , from the center of which there is a conductor to contact 2. When the hook switch is raised 2 is connected to 1 and thence current passes to a local circuit which contains the transmitter T and the local winding of the induction coil P . This circuit is earthed at E . Between the points $a b$ the receiver R and line winding S of the induction coil are placed in series. While between a and

3 the bell *B* and the generator *G* are placed. The operation of this circuit is similar to that of the Dean local storage circuit, excepting that no storage battery is introduced, and transmission depends entirely upon the current flowing over both sides of the line and through the local circuit to ground.

Another of Mr. Dean's circuits is shown in Fig. 179 which has many points of merit and has been satisfactorily used by the Kellogg Switchboard & Supply Co. Between the points *a* and *c* on the two sides of the line the bell *B*

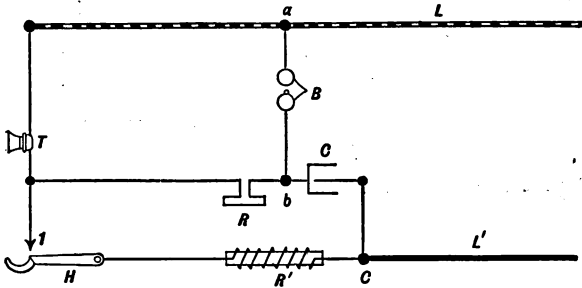

FIG. 179.—DEAN COMMON BATTERY CIRCUIT NO. 2.

and condenser *C* are bridged. At the point *b* a tap is taken off including the receiver *R* and transmitter *T* extending to the *L* side of the line. Between the point *c* and the hinge of the hook switch *H* a retardation coil *R'* is introduced. The condenser *C* prevents current from entering the receiver. In many respects this is a distinct advantage, for if current flows through the receiver its magnetism will be increased, if it be properly connected, but in making common battery installations installers too frequently misplace the receiver and reception is impaired. It is possible to use a high wound receiver because it is

removed from the transmitting circuit and its impedance does not oppose the transmitter.

Among many proposed common battery circuits those of Figs. 180 and 181 appear worthy of notice. Fig. 180 is a Russian device, and though complicated and expensive, would appear likely to produce exceedingly good transmis-

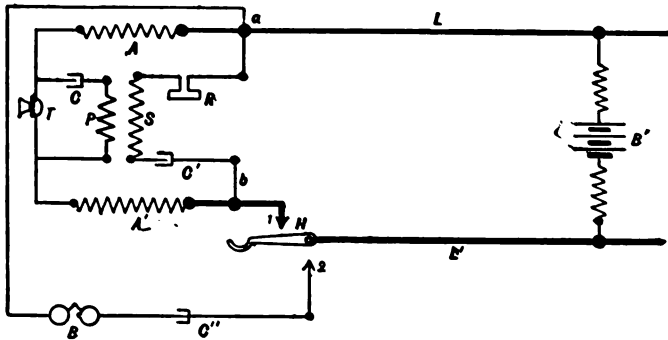

FIG. 180.—RUSSIAN COMMON BATTERY CIRCUIT.

sion. At the points a and b on the L and L' sides of the line the conductors split; one runs from a through the bell B , condenser C'' to the contact 2 . Another passes from a to b through the retardation coils $A A'$ and the transmitter T , while a third passes through the receiver R , the secondary S of the induction coil and the condenser C' . The transmitter has a local circuit including the condenser C and the primary P of the induction coil. A little consideration will show that through retardation coils $A A'$ the transmitter is supplied with current, but these operate to choke back the voice impulses which are thereby confined to the local circuit $T C P$, which operates exactly like a local battery circuit, and by the secondary of the induction

coil S produces in the line a similar effect. The condenser C opens the receiver circuit to the battery current.

Fig. 181 is a circuit proposed by Mr. Scribner. Across the two sides of the line the signalling apparatus is placed between the point a and contact 2. From a there is a path to the contact 1 upon the upper side of the hook switch.

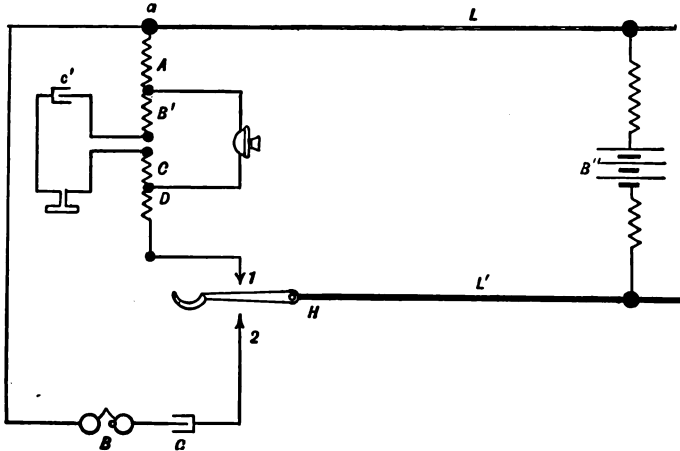

FIG. 181.— SCRIBNER COMMON BATTERY CIRCUIT.

This includes a peculiar coil wound in two parts $A B'$ and $C D$. From the center of this coil a circuit is carried through the receiver that is opened by means of a condenser C' . The transmitter is connected between the coils A and B' and C and D . This ingenious arrangement provides a coil which operates both as an induction coil and as an impedance coil, and though this circuit does not appear to have been widely employed it seems to have much promise.

As a partial evasion of common battery patents, many exchanges have been installed in which the substations are

provided with local battery for the transmitters, while at the central office a common battery is installed to furnish automatic signalling. The local battery automatic signal circuit is shown in Fig. 182. Between *a* and *c* is the usual bell and condenser, and the local circuit from the hinge of the hook switch through the transmitter *T*, battery *b*, primary and secondary of the induction coil and receiver *R* will be readily recognized.

Receivers and transmitters designed to operate upon common battery circuits have such a degree of sensitive-

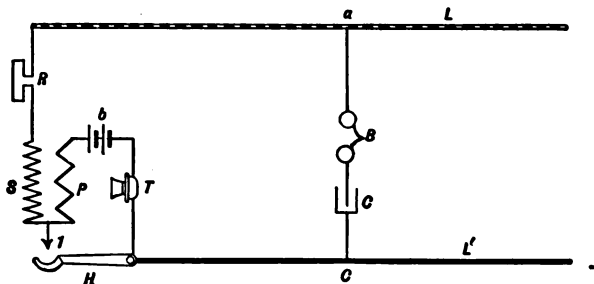

FIG. 182.—CIRCUIT FOR LOCAL BATTERY TALKING AND COMMON BATTERY SIGNALING.

ness that they readily reproduce all sounds which occur in the neighborhood, and with undesirable intensity the voice of the speaker often becomes audible in the receiver of the set to which he is talking. This peculiarity is termed "side tone" and there have been many attempts to obviate it. These have frequently taken the form of an endeavor to reduce the sensitiveness of the transmitter either by interposing a resistance in the battery circuit or by so constructing the microphone as to decrease its power. While such efforts have decreased side tone, they have correspondingly impaired general efficiency of transmis-

sion, and the problem has now been attacked from the standpoint of the induction coil, as is illustrated in Fig. 183. Here the induction coil consists of three windings, a primary P and two secondaries S & S' . The primary P is wound with No. 26 wire to a resistance of 30 ohms, while each secondary is composed of No. 31 wire wound to a resistance of 26 ohms. Each secondary covers one-half the length of the primary. In the secondary S is a 75 ohm receiver, making a complete local circuit, while a second-

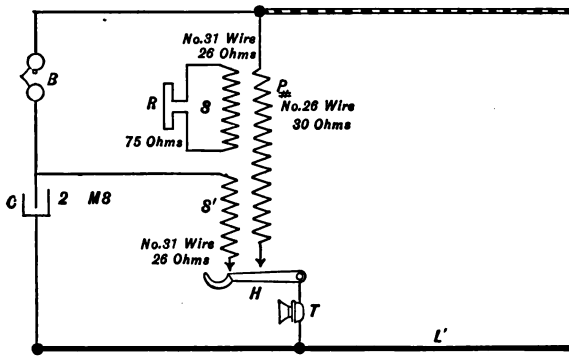

FIG. 183.—CIRCUIT TO REDUCE "SIDE TONE."

ary S' is in series with the transmitter T , the hook switch H and the condenser C . Under these circumstances it is possible to employ a high wound receiver and to decrease its sensitiveness to side tone by the use of a fraction of the primary winding. With a receiver of greater resistance a less step down effect is needed for the proper reception of the line impulses, and by the introduction of the other secondary S' , all of the features of the ordinary common battery circuit are retained. While this device has not as

yet received the sanction of extended introduction, limited experience therewith has been exceedingly satisfactory.

The diagrams embody the salient features of the circuits most commonly met with in practice. To attempt to depict all the circuits that are employed by the various manufacturers in the numerous substation equipments which are offered would be a hopeless task, both in quantity and because each day sees new designs in which slight details are altered. So it only remains to show two or three typical examples of substation wiring and to suggest that the telephonist thoroughly familiarize himself with the relations which the various component parts of substation apparatus bear to each other so thoroughly that they become alphabetic and that both brain and hand shall be nimble in sketching the fundamental characteristics of circuits. If this be done it will require but a few moments inspection of any substation outfit to determine exactly to what type of circuit it belongs and to trace unerringly its connections.

Fig. 184 shows the usual method of wiring a local battery series substation. In the lower right hand corner a skeleton diagram is given, in which the various binding posts of the instrument are numbered, and similar numerals are attached to the complete picture. The line enters at binding posts 1 and 3, 2 is the lightning arrester to ground. The receiver is connected between 4 and 5, the battery between 6 and 7, while the hook switch and induction coil are between posts 8 and 9.

Fig. 185 is a similar illustration of a complete wiring diagram for a bridged substation. This is sufficiently plain to need no further description. Fig. 186 is the circuit of a magneto desk set, while Fig. 187 gives a wiring diagram for a common battery desk set.

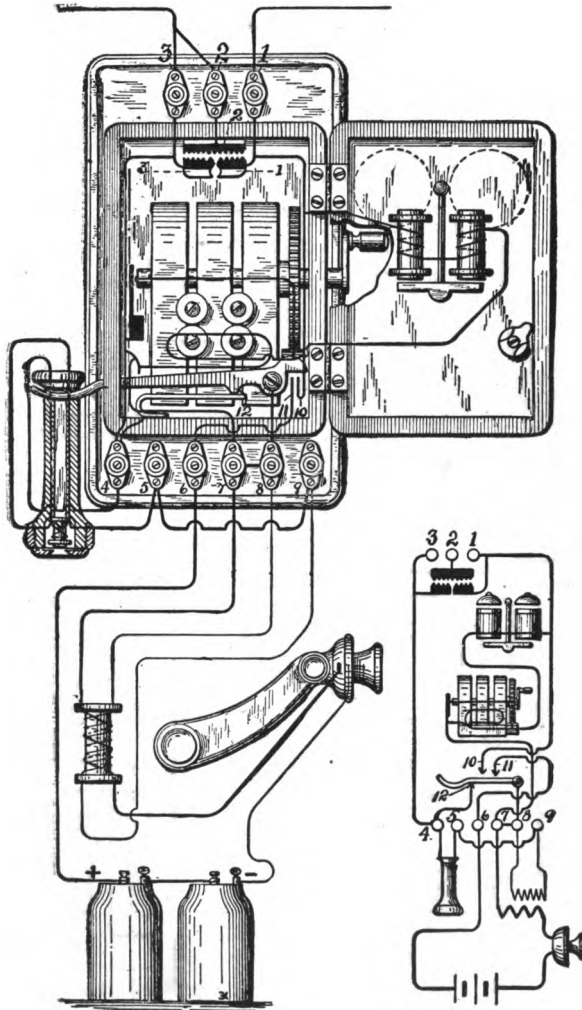

FIG. 184.—DETAIL WIRING SERIES STATION.

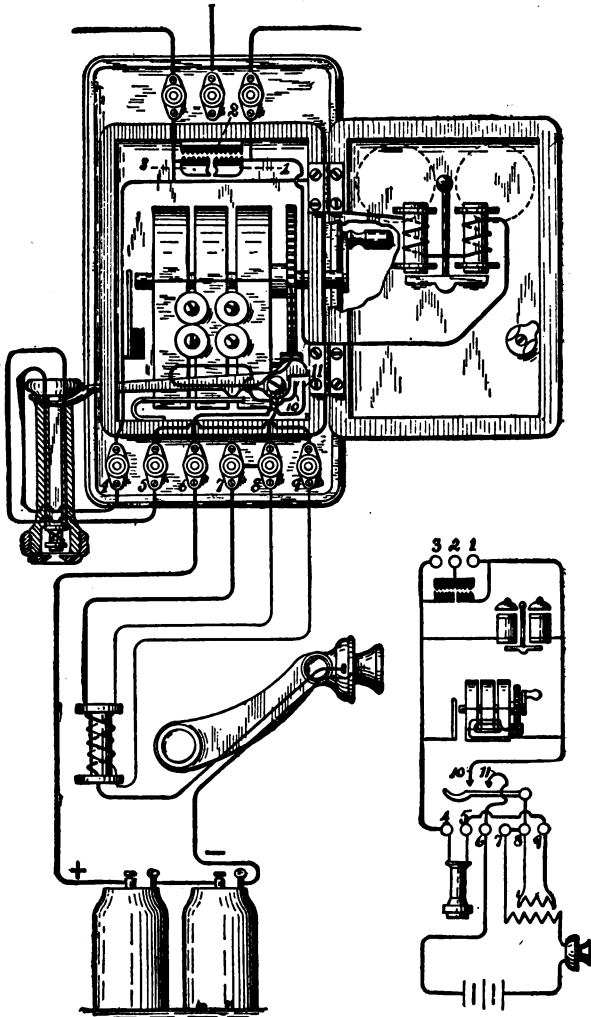

FIG. 185.—DETAIL WIRING OF BRIDGING STATION.

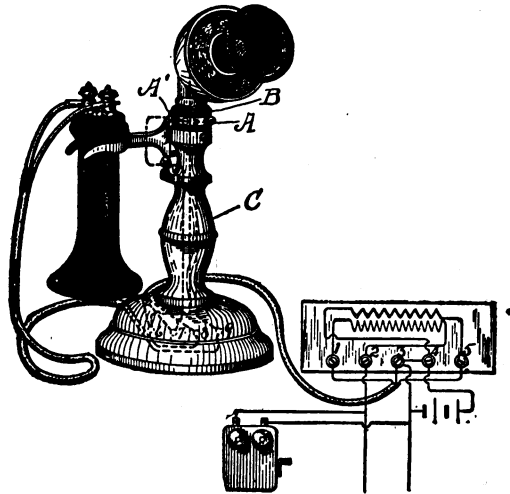

FIG. 186.— MAGNETO DESK SET.

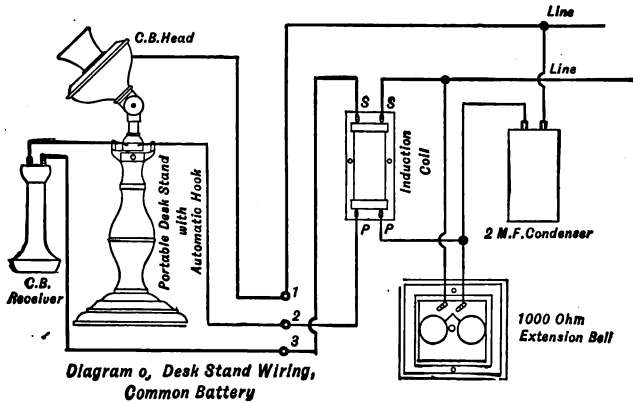

FIG. 187.— COMMON BATTERY DESK SET.

The circuit survey is incomplete without reference to the hook switch, which it is evident from what has preceded is one of the most important pieces of substation apparatus. Upon this device almost endless time and ingenuity have been expended to produce a contrivance which should be thoroughly reliable. No other piece of apparatus has in the past given so much trouble and no other has appeared so simple. Some of the earlier forms of hook switch are shown in Fig. 188. At *A* the contacts are merely pieces of spring which press against the side of the casting which

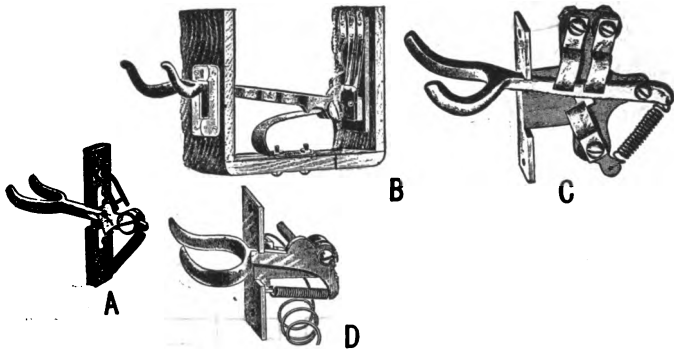

FIG. 188.— EARLY TYPE OF HOOK SWITCH.

forms the hook lever. Switches made in this manner are unreliable. The constant friction on the springs soon cuts away the metal both on the lever and the spring itself. Accumulations of dust and grit, notwithstanding the springs form a rubbing contact, open the circuit and produce no end of vexation. The models at *B*, *C* and *D* are open to similar objections, for the contacts become inoperative and the coil springs usually give out.

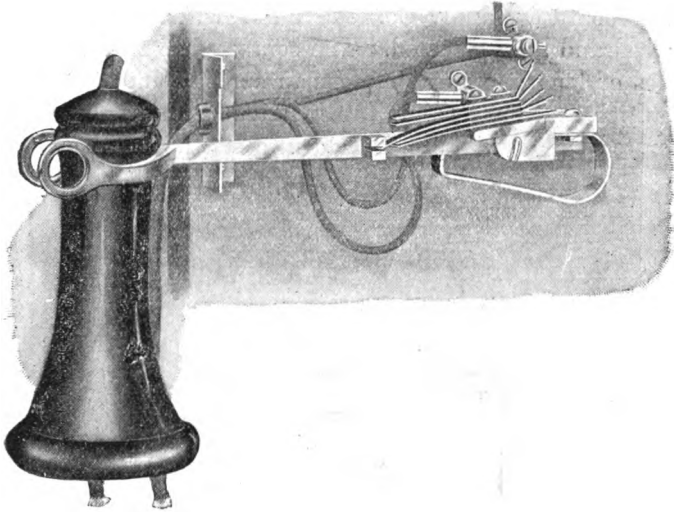

FIG. 189A.— SWITCH DOWN.

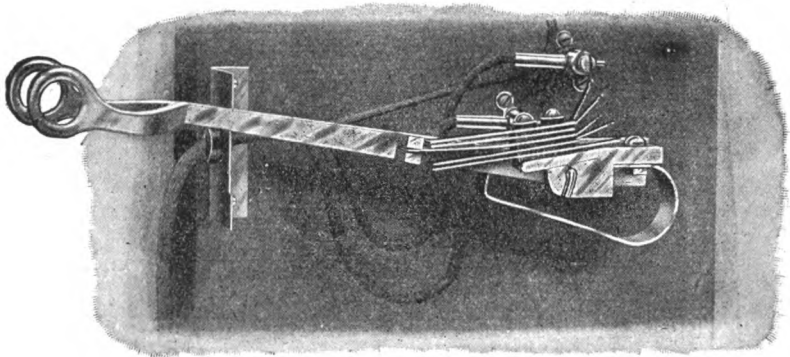

FIG. 189B.—KELLOGG HOOK SWITCH — SWITCH UP.

Fig. 189 *A* and *B* shows a recent model of the Kellogg Switchboard & Supply Co. At *A* the switch is shown depressed and at *B* elevated. The contacts are formed by a series of long and flexible German springs, into the ends of which platinum points are inserted. The springs are operated by a flexible lever held in a slot upon the switch

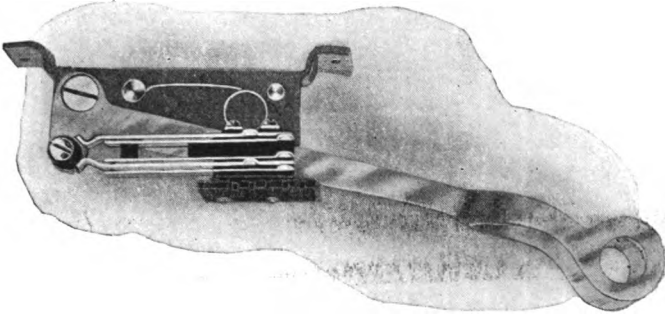

FIG. 190.— STROMBERG-CARLSON SWITCH A.

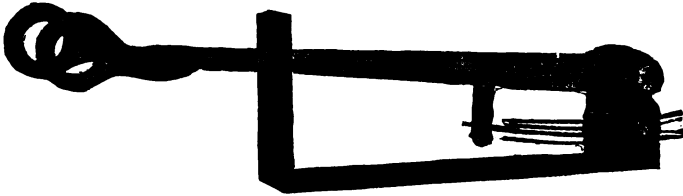

FIG. 191.— SWEDISH-AMERICAN SWITCH.

arm. Experience has shown that this general type is on the whole the most reliable.

Figs. 190 to 194, inclusive, are types of hook switches of various designs, all of which, however, embody the principles described. The desk set presents the hardest prob-

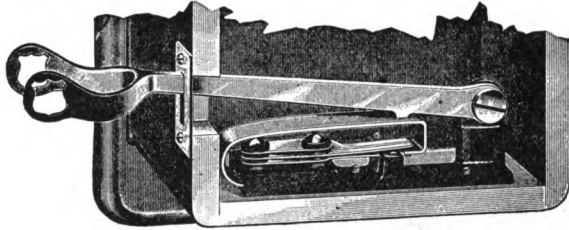

FIG 192.— A FREQUENT TYPE OF HOOK SWITCH.

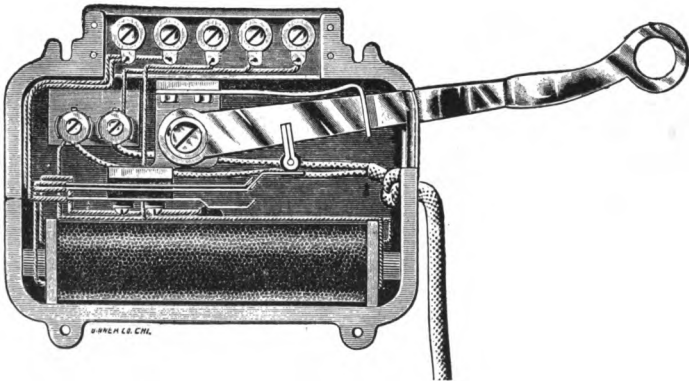

FIG. 193.— STROMBERG-CARLSON SWITCH B.

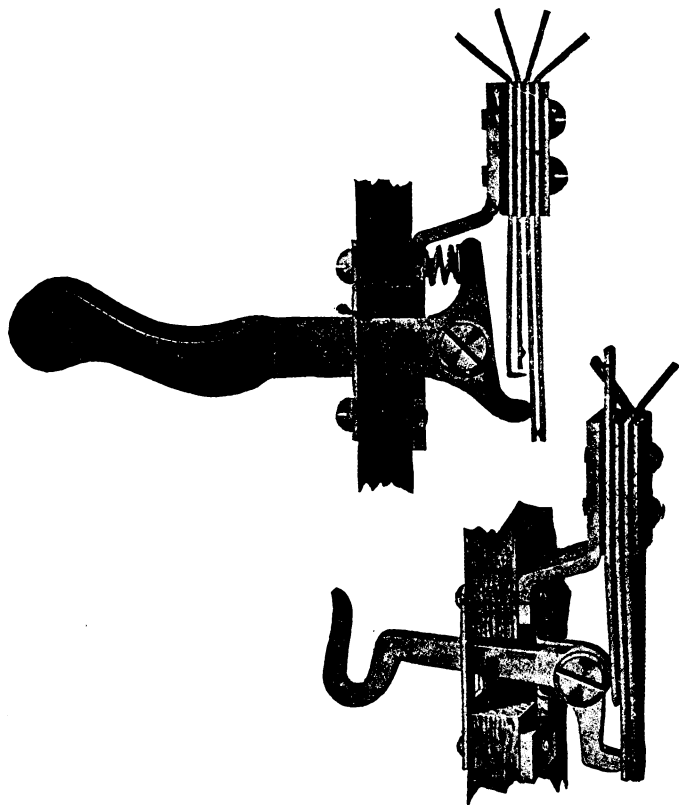

FIG. 194.—HOOK SWITCHES WITH VERTICAL SPRINGS.

lem to the designer of hook switches, for it is necessarily so compact that it is exceedingly difficult to obtain room for the apparatus. Fig. 195 illustrates one form of desk



FIG. 195.—DESK SET HOOK SWITCH.

set hook switch which is self-explanatory. Numerous other types might be cited but the examples given appear to illustrate sufficiently the desirable features of construction.

CHAPTER V.

TRANSMISSION AND CURRENT SUPPLY.

BUT little experience was needed to demonstrate the superiority of the battery transmitter over the magneto. Then the question of current supply therefor became of vital importance. A quarter of a century ago there were no dynamos or storage batteries, so early telephonists had to content themselves with such primary batteries as commerce afforded. The volume of transmission depends on the energy which is given to the transmitter, but it is also necessary to design the transmitter for the current to be supplied to it. A transmitter built for heavy currents will, when operated on a small current, give results which are much inferior to one particularly designed for low amperage, and conversely. So the selection of a standard of transmission implies the adoption of an arbitrary current strength as the energy supply, and the design of a transmitter which shall with this current produce a maximum volume. When the White solid back was invented the Fuller battery was selected as the most reliable and cheapest source of current, because at that time nothing better was known. It was believed that three cells of this battery would not entail an excessive maintenance expense, hence arose a standard of current supply, that has long been accepted, and such a transmitter was designed as would yield the greatest volume of transmission when attached to such cells. As telephone exchanges grew in number and magnitude other portions, such as cables, switchboard apparatus, etc., followed the lead of the transmitter. Subsequently other transmitter designs have been made which can pro-

duce a much greater volume than those in common use, but these require a correspondingly larger current. With an increase in current strength the existing margin between silence and audible cross-talk, now perilously small, disappears; and as experience has shown the present transmitter to be adequate for average service, there are few reasons for an increase in volume, and many against it. Therefore the practical transmission standard has come to be one equivalent to that produced by a transmitter designed to give the highest efficiency with three Fuller cells in first class condition.

The Fuller cell rapidly deteriorates, so that standard transmission is only obtained when the battery has been freshly set up. This loss in efficiency depends upon the amount of use to which the cells are put, so that, if the battery is constantly in service, the length of its useful life is greatly reduced. Furthermore, the battery is always more efficient after a prolonged period of rest, so in practice there is a diurnal variation in efficiency, which tends

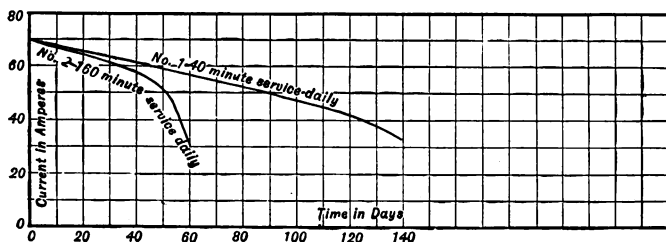

FIG. 196.—RATE OF BATTERY DEPRECIATION NO. 1.

to perceptibly lower the volume of transmission toward the end of each day. This variation in the battery may produce a change of from five to ten per cent. in volume of

transmission depending upon the time which has elapsed since the battery was set up, and upon the use of the transmitter.

The rapidity with which a Fuller battery depreciates depends upon the daily use of the transmitter. Fig. 196 shows the results of experiments made to determine the relation between the decrease in current strength delivered by three cells of Fuller battery and the age of the battery.

Curve No. 1 shows the rate at which the battery output would decrease were it used with a transmitter 40 minutes per day; while curve No. 2 shows the same current-time relation if the battery is used 160 minutes per day. For the majority of substations the use of the telephone would probably be such as to give a time-current

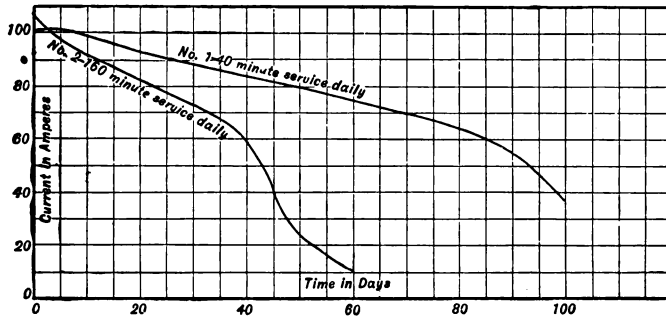

FIG. 197.—RATE OF BATTERY DEPRECIATION NO. 2.

curve between those shown, but nearer the upper than the lower one.

As many telephone companies are inclining to the practice of using two cells of Fuller battery, rather than three, Fig. 197 is introduced to show the time-current relation under this condition, and shows the curves similar to those shown in Fig. 196.

Figs. 196 and 197 show the current strengths to be expected, and the question at once arises, how is standard transmission affected by changes in current strength. Off-hand, the problem seems simple — measure the current and transmission and plot a transmission-current curve. But this operation is beset with difficulties. There is no actual standard of transmission, like a foot rule, and it is only possible to take the opinion of many skilled observers as to how far a particular case seems to depart from the results obtained with three Fuller cells. Then as the resistance of every transmitter is constantly varying it is impractical to measure current. An indirect solution has

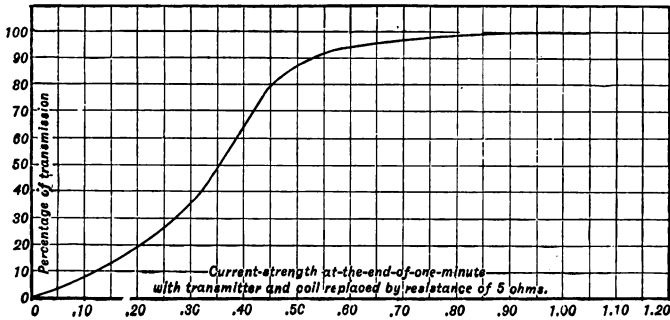

FIG. 198.—CURRENT-TRANSMISSION RELATION.

been obtained by the following method. A resistance of 5 ohms is selected as representing a transmitter and its induction coil. A battery is arranged to give varying current strengths from .1 amperes upwards through this coil. The apparatus is adjusted to give a particular current strength, say .3 amperes; then the 5 ohm coil is removed and a standard transmitter and induction coil substituted, and the results obtained carefully checked by

several observations with the three cell standard. In this way an approximate current-transmission curve is obtained which is shown in Fig. 198. Hence it appears that an e.m.f. sufficient to give about 1.00 ampere through 5 ohms is needed to yield acceptable transmission; that ninety per cent. transmission can be secured with an e.m.f. sufficient to give .52 amperes through 5 ohms, and that thereafter transmission is very closely proportional to e.m.f. until voltage is so decreased as to produce but .2 amperes through 5 ohms.

Combining the curve shown in Fig. 198 with those shown in Figs. 196 and 197, the results of Fig. 199 are obtained, indicating the volume of transmission which may be expected from a solid back when used with two or with three

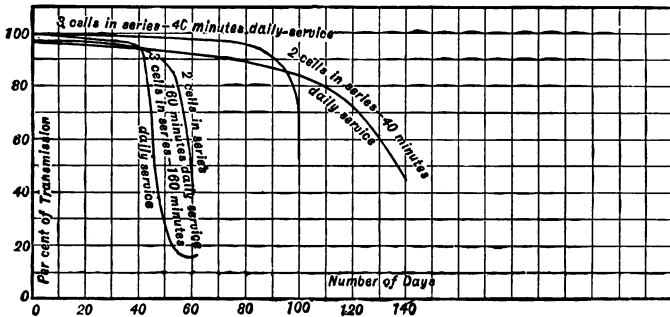

FIG. 199.—RELATION BETWEEN AGE OF BATTERY AND TRANSMISSION.

cell of Fuller battery on both moderate and severe service during such periods of time as the batteries can be considered serviceable. If a battery is subjected to severe service it should be renewed at the end of six weeks and, if used moderately, at least as often as once in three months, provided the best service is desired. But it must be borne

in mind that the average service probably lies somewhere between the two curves for each number of cells and that, with four renewals a year, which is common, the average volume of transmission during the three months the batteries are in use will be over eighty per cent.

However interesting the data thus developed, the practical telephonist always looks askance at the deductions of the electrician. From time to time investigations have been made on transmission from substations in service. These tests go to show that there are three causes that detract from a realization of the highest efficiency. There are variations in battery condition, changes in transmitters and resistance of the subscriber line. Table XVI shows the probable changes in transmission due to battery age:

TABLE XVI. RESULTS IN PRACTICE.

Diminution in Transmission Due to Battery Age.

2 Cells of Fuller Battery.

Age in days.	Vol. of Transmission.
20	92%
30	88%
40	84%
50	80%
60	76%
70	70%
80	62%
90	54%

Taking a number of tests in several places an average battery condition of eighty-five per cent. is found.

The transmitter itself does not always retain its original

efficiency. Like everything else it is afflicted with the irremediable disease of old age and gradually loses at least a portion of its power to talk. Taking practical observation again, average transmitter efficiency may be placed at about eighty-seven per cent.

The transmission data so far entirely omits from consideration the effect of the resistance of the circuit which is external to the transmitter and coil (battery leads, etc.), nor as far as the writer is aware has there been any extensive investigation on this not unimportant question. Turning to Fig. 198 one might argue that because 1 ampere through 5 ohms gives one hundred per cent. transmission it is only necessary to apply an effective e. m. f. of 5 volts to a transmitter to get the best effect. This is by no means the case. To put a transmitter on a 500 volt circuit in series with 495 ohms will not yield the same result as to put the same instrument in circuit of little or no resistance with a 5 volt storage battery. Yet the effective e. m. f. at the terminals of the transmitter is the same in both cases. Transmission depends in a large measure upon the energy changes in the circuit due to the varying transmitter resistance, and if this is but a small percentage of the total resistance the transmission is relatively poor. So in designing the transmitter circuit, the resistance of the source of current supply is as important a consideration as its e. m. f. It would also follow from Fig. 198 that in calculating the amount of energy required, one ampere minute, or five watt minutes per conversation minute should be allowed. As transmitter resistance is constantly varying, this estimate is well on the safe side and it is expedient to use it, especially as local action of an unknown amount always tends to reduce the expected output of a battery.

It is difficult to make observations upon the demands of transmitters for current in actual service; but so far as experiments in this direction have gone, they reasonably substantiate the preceding estimates.

Fig. 200 shows in the form of curve some observations made upon busy transmitters. The horizontal axis gives

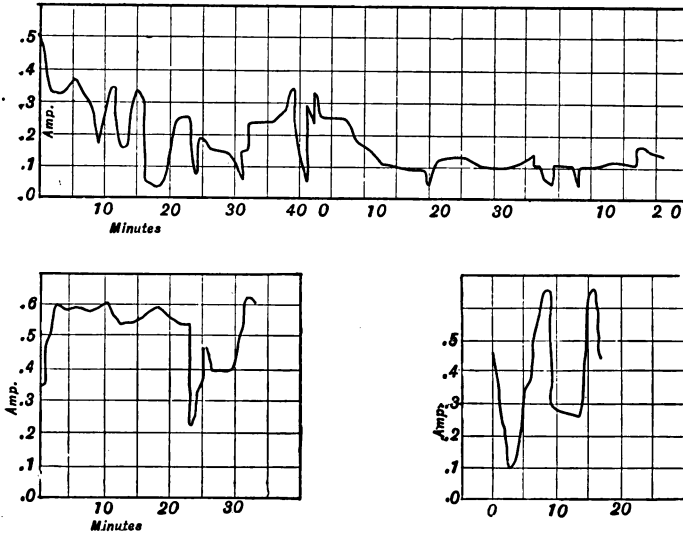

FIG. 200.—CURRENT CURVES FROM TRANSMITTERS.

the number of minutes occupied in conversation, while the vertical axis upon the left shows the variations in current.

Even under the most favorable circumstances and despite the fact that the local battery when in best condition gives unexcelled transmission, it is expensive to install and more costly and difficult to maintain. Its presence makes the substation set bulky and cumbersome, its chemicals are

likely to injure the subscribers' premises and from every standpoint it is objectionable. As exchanges increase in number, local battery installations become more and more difficult, because the areas over which the maintenance must be carried on increase very nearly as the square of the number of subscribers. To eliminate this most objectionable feature the various common battery or central energy methods of supplying the substation with electrical energy have been devised, whereby all battery is located at the central office. The various circuits proposed have already been discussed, nor does it need any further argument to demonstrate the incomparable superiority of the common battery system over any conceivable arrangement of local batteries. The various circuits for this purpose

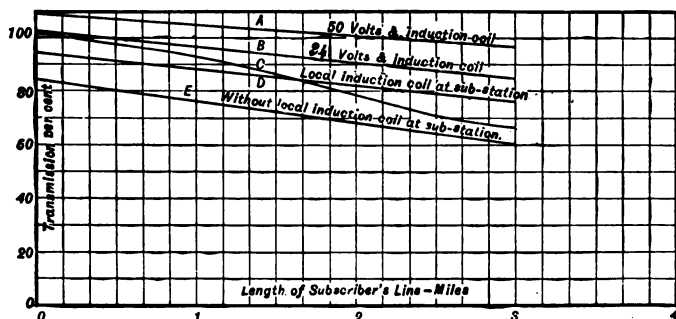

FIG. 201.— COMPARISON OF COMMON BATTERY TRANSMISSION.

have already been described, hence it remains now only to consider the relative excellence of transmission.

As subscribers' stations become more and more remote from the central office, lines increase correspondingly in length and resistance, and with any given battery the supply of energy to the transmitter will be inversely propor-

tional to the resistance of the subscribers' lines, and the transmission quality will vary, both as the resistance of the line, and as the proportion which this resistance bears to the variation which the transmitter is able to set up.

Chapter IV, Figs. 169, 170 and 178 show three forms of common battery circuits. In Fig. 170 there is no induction coil at the substation. The circuit of Fig. 169 contains an induction coil, while that of Fig. 178 is an arrangement whereby both sides of the line are used to transmit the current to the substation, and the ground employed as a return. Fig. 201 shows five curves, plotted from experiments made to compare the operation of these various circuits, equipped with batteries of different voltages, with local battery transmission. The results plotted in curve *A* are obtained by the use of a 50 volt battery and circuit shown in Fig. 169. Curve *B* is the same circuit but operated by a 24 volt battery. Curve *C* shows tests of circuit of Fig. 178 operated by a 24 volt battery, while curves *D* and *E* are comparative of the results obtained with a 16 volt battery and the circuit of Figs. 169 and 170. The general deductions from these curves are as follows: First, a common battery system equipped with circuit of Fig. 169 and 50 volts will give better transmission than local battery, provided the length of the subscriber line does not exceed two miles, which would rarely be the case. From curve *B* it appears that the common battery system of Fig. 169 will give results equal to or superior to that of the local battery, provided the subscriber line does not exceed half a mile in length. This about represents the average condition in large cities. From curve *C* it appears that the circuit of Fig. 178 is in no way superior from a transmission standpoint to those

of Fig. 169. Curves *D* and *E* demonstrate that the local induction coil produces a decided improvement in transmission. It should be further remembered that these comparisons are instituted between local battery in first class condition and common battery. Experience has shown that it is only a small fraction of time that the local battery continues in the best condition, while the common battery, always under the eye of the wire chief and re-charged every night, is continuously in its best working condition. It is fair to conclude that common battery transmission with 24 volts will be better than local battery transmission, unless the subscriber's line exceeds half a mile in length, and by the employment of a 50 volt battery, against which little or no objection can be advanced, transmission over subscribers' lines over two miles in length can be made equal to the best results from the local battery and superior to it on any lines that are shorter.

Primary Batteries.—A primary battery is a contrivance whereby a portion of the energy of chemical action may be converted into electricity. If a piece of zinc be placed in dilute sulphuric acid it is slowly dissolved, and as it is eaten away bubbles of hydrogen gas make their appearance. In this process the zinc unites with the oxygen of the water, and is as truly burned as a lump of coal when placed on a fire. While the solution of the zinc is progressing, the vessel holding the acid becomes sensibly warm. This is due to the heat produced by the combustion of the zinc. If the zinc be touched with a piece of copper also immersed in the acid three things happen: first, the zinc is dissolved more rapidly; second, less heat makes its appearance, and third, a current of electricity passes between the metals. It has been supposed that in a liquid there is a constant interchange of atoms between the fluid molecules. In the

simple cell just assumed we may suppose the arrangement of the molecules to be symbolically as follows :

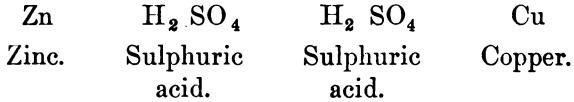

When the metals are electrically connected, the zinc pushes out the hydrogen from the molecule next to it and takes its place ; the " Sulphion," or SO₄ part of the acid,

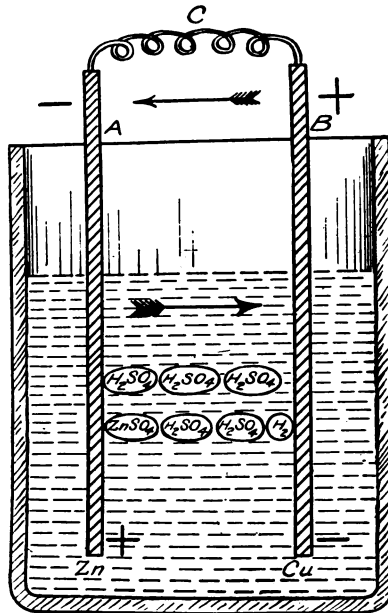

FIG. 202.—DIAGRAM OF BATTERY ACTION.

repeats the process with the next one, and so on till the copper plate is reached. This is illustrated in Fig. 202

which is an ideal section of such a cell, in which *A* represents the zinc plate and *B* the copper one connected by the wire *C*. Experiment shows that in the air through the wire *C* a current passes from *B* to *A*, hence the copper is called the *positive pole* or *anode* and the zinc the *negative pole* or *cathode*. But under the liquid the conditions are reversed, for the current travels from the zinc to the copper, and hence the zinc is called the *positive plate* and the copper the *negative plate*. The queries at once arise as to what the function of the copper is, why does it not dissolve equally in the acid, what makes the current flow? In answer, about all that can be said is that when equal weights of oxygen are used to burn zinc and copper, the zinc produces 2.35 times as much heat as the copper, hence it is argued that the affinity of the zinc for oxygen is so much greater than of the copper that it is impossible for the oxygen to attack the copper so long as zinc is present. In other words, the oxygen is by chemical attraction pulled toward the zinc more than twice as hard as toward the copper, and this chemical energy produces in some unknown fashion the electromotive force which causes the current. Accepting this as a working hypothesis a primary battery must possess the following characteristic constituents: Some substance which can combine with two others, one of which has a greater chemical affinity for combination than the other. Thousands of such combinations can be formed, but so far as the telephonist is practically concerned, zinc is always used as the *positive plate*; carbon or copper as the *negative*; chromic acid, sodium hydrate, salammoniac, or sulphate of copper as the electrolyte, or combining solution.

Before considering the various market forms, one other phenomenon must be noticed. Fig. 202 shows that the

hydrogen is pushed toward the negative plate. In the simple zinc-copper cell the gas soon accumulates on the surface of the metal in such quantities as to almost completely coat it and stop action. This is termed "*polarization*" and must be prevented if the cell is to be used continuously. Two methods are employed, one, mechanical, such as roughening the plate in such a manner as to prevent the gas bubbles from clinging to its surface; the other, chemical, which consists in introducing into the cell some compound which will absorb and combine with the hydrogen as fast as it is formed. The latter is the preferred plan. When a cell is in service only for a few minutes at a time succeeded by relatively long periods of rest, polarization is not troublesome, for the hydrogen does not have sufficient time to accumulate while the cell is in service and during rest it has a chance to escape. Hence batteries are divided into *open circuit* and *closed circuit* cells depending on their ability to maintain for longer or shorter periods a steady current. From the telephonic standpoint the following list comprises the chief closed circuit cells, or those best adapted for service when transmitters are in constant use and a high grade of transmission demanded.

The Bichromate or Fuller.

The Sulphate of Copper or Gravity.

The Oxyde of Copper, Edison-Lalande or Gordon.

The earliest form of closed circuit battery was invented by Prof. Daniell, and bears his name. This cell consisted of a positive zinc plate immersed in a solution of sulphate of zinc and a negative one of copper in a solution of sulphate of copper. Usually the plate was rolled into a cylinder, inside of which was a porous cup, containing a roll of copper placed in a saturated solution of sulphate of copper. This cell was expensive to construct and equally expensive

to maintain. As sulphate of copper is considerably heavier than sulphate of zinc, it is possible to omit the porous cup and thus cheapen construction. This has resulted in the so called Gravity battery which is illustrated in Fig. 203.

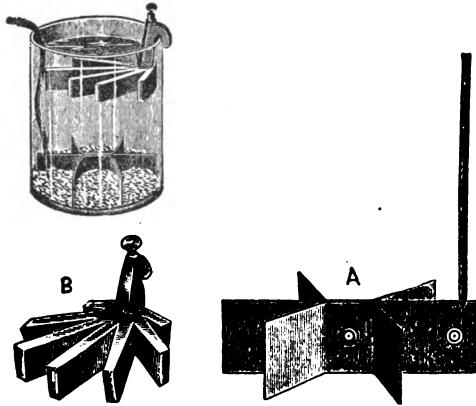

FIG. 203.— GRAVITY BATTERY.

There is a glass jar upon the bottom of which is placed some sheet copper bent into a spider form as at *A*. From this plate an insulated wire extends upward out of the jar forming the positive pole. Zinc is cast into a form shown at *B* and from its general resemblance to a crow's foot this battery has received the name of the Crowfoot battery. The copper is buried in crystals of copper sulphate, the jar is then cautiously filled with water. Presently the sulphate of copper dissolves and owing to its superior specific gravity remains at the bottom, while the zinc is suspended in the solution above, which is gradually converted into a sulphate of zinc.

To set up the cell unfold the copper strip so as to form a cross and place it in the bottom of the jar. Suspend the

zinc about four inches above the copper. Pour clean water into the jar so as to cover the zinc. Then drop in blue vitriol in small lumps, not over six or eight ounces per cup. The resistance may be reduced and the cell be made immediately available by using instead of water about half a pint of solution of sulphate of zinc from a battery already in use or by pouring into the water four or five ounces of pulverized sulphate of zinc.

Blue vitriol should be dropped into the jar as it is consumed, care being taken that it goes to the bottom. The need of the blue vitriol is shown by the fading of the blue color, which should be kept as high as the top of the copper, but should never reach the zinc.

The chemical reaction of the sulphate of copper cell is as follows:

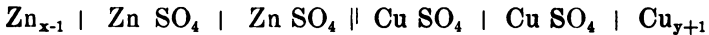
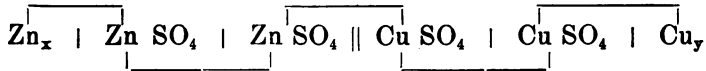

The e. m. f. of the gravity cell is usually about 1.08 volts and it is often taken as a fair standard of e. m. f. It has, however, a high internal resistance, from .8 to 1.5 ohms and for this reason is rarely used in telephony excepting for transmitters at the switchboard and sometimes for small common battery exchanges. For these purposes it is an admirable cell to employ.

Experience has shown that the purity of zinc which is employed in primary batteries has a great effect upon the life of the cell. If impure zinc is used, what is called

local action is set up, that is to say the zinc is rapidly dissolved by the electrolyte, even when the battery circuit is open and consequently is quickly wasted. To secure immunity from this action it is necessary to procure the very purest zinc. It has also been found that coating the zinc with mercury largely reduces the tendency to local action. This is termed amalgamation and is best performed by dipping the zinc either into dilute sulphuric or hydrochloric acid and then immersing in, or brushing over

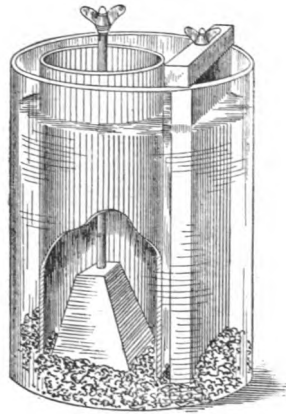

FIG. 204.—EARLY TYPE OF FULLER CELL.

with mercury. The action of the mercury seems to be its ability to bring to the surface pure zinc, while foreign substances are left behind, and therefore amalgamated zinc acts as if it were chemically pure.

Instead of amalgamating zinc as above described it is possible to use an alloy of zinc and mercury from which battery plates may be manufactured, and this gives results which are decidedly superior. Some experiments have

shown that unamalgamated zinc wastes from 50 to 10,000 times as fast as that which is amalgamated.

The *Bichromate Cell* has, on the whole, proved itself the most popular cell for telephonic circuits. It consists of zinc for the positive plate, and carbon for the negative, immersed in a solution containing chromic acid, the object of which is to act as a depolarizer and absorb hydrogen. The usual model of this cell is called the Fuller, and pos-

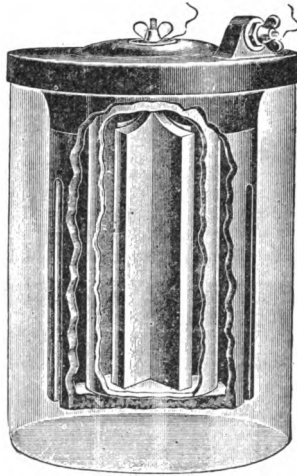

FIG. 205.—IMPROVED FULLER CELL.

sesses a high electromotive force, about 2 volts, little or no local action when upon open circuit and a reasonably low resistance, about $\frac{1}{4}$ of an ohm, so that it is particularly advantageous for transmitter work.

Fig. 204 shows the common type of Fuller cell. There is a glass jar into which a porous cup is placed which contains a pyramidal block of zinc. The porous cup is filled

with diluted sulphuric acid or a common salt solution. The glass jar is filled with a solution of chromic acid and into this a carbon plate is placed. An improved form of

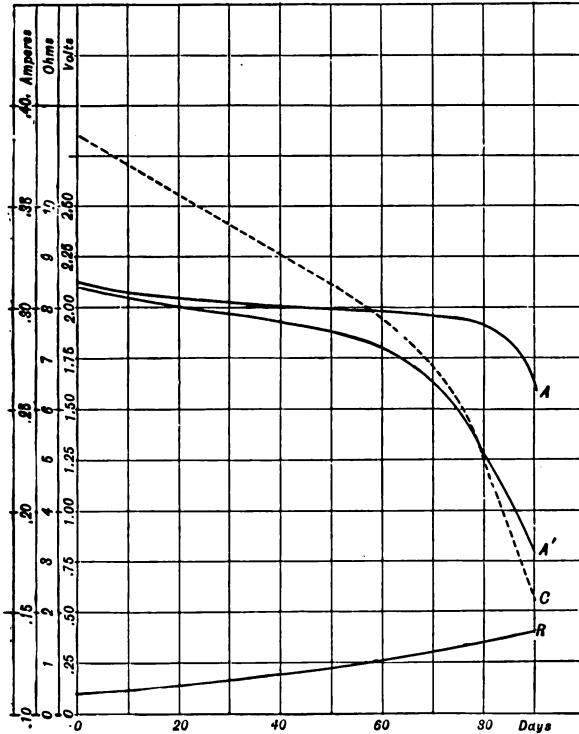

FIG. 206.— TESTS ON FULLER CELLS.

Fuller cell is shown in Fig. 205. Here the elements are suspended from a rubber or wooden cap which closes the jar, the zinc is in the form of a cruciform casting, while

the carbon is a complete cylinder that surrounds the porous cup. Fig. 206 gives the results of some tests made in the following manner upon the ordinary Fuller cell:

A chronograph was arranged to close the battery circuit through a given resistance of from 5 to 10 ohms, for two minutes out of every six, or for twenty minutes per hour, and the cells kept on trial from eight to nine hours per day. Measurements of electromotive force, current, and cell resistance were made and are plotted as shown in the curves, which are designated as follows:

A — electromotive force, morning.

A' — The same in the evening.

R — resistance.

C — average current.

The solution to be used in the Fuller battery is prepared as follows:

Sulphuric Acid.—The sulphuric acid should have a specific gravity not less than 1.831, and contain not less than ninety-two per cent. of sulphuric acid. The acid should be colorless, or nearly so, and free from arsenic.

Sodium Bichromate.—The bichromate of sodium should be completely soluble in water and contain at least sixty-eight per cent. of chromium trioxide.

Water.—The water should be distilled or pure soft water should be used.

Solution.—The solution shall be prepared by mixing the materials above mentioned in the following proportions by weight:

Sodium bichromate	9 per cent.
Sulphuric acid	25 per cent.
Water	66 per cent.

The bichromate solution should have a specific gravity of 1.20 or greater and on analysis shall yield not less than eight per cent. of sodium bichromate ($\text{Na}_2\text{Cr}_2\text{O}_7$) and not less than twenty-three per cent. of sulphuric acid (H_2SO_4).

The solution should be prepared in stone-ware or porcelain lined vessels and glass or porcelain rods should be used for stirring. The sodium bichromate should first be dissolved in the water and then the sulphuric acid should be *slowly and cautiously* added. As considerable heat is generated by the action of the sulphuric acid, it is necessary to allow the solution to cool before using.

It is sometimes convenient to ascertain whether battery solution is correctly prepared, and for this purpose the following tests may be found of value:

First: Specific gravity should not be less than 1.20.

Second: Dissolve ten grams, of fine iron wire in hydrochloric acid. To the hot solution, add, drop by drop, a solution of stannous chloride until the yellow color disappears, *but avoid excess*. Dilute with four or five times its volume of water and cool. Then add about twenty c.c. of a saturated solution of mercuric chloride. A white precipitate will form, rendering the solution turbid. To the solution thus obtained add one hundred c.c. of battery solution and stir, and then add a few drops of potassium ferricyanide solution. If a *deep blue* precipitate forms, insufficient bichromate of soda has been used.

Third: Take ten c.c. of battery solution, dilute it with several times its volume of water, add two c.c. of alcohol and heat nearly to the boiling point, until the color of the solution becomes a deep, pure green. Then add *one and five-tenths grams* of freshly fused sodium

carbonate previously dissolved in water, and stir. Continue to heat for a few minutes. If a dense, flocculent, greenish precipitate forms after this treatment, insufficient sulphuric acid has been used.

The reagents are made as follows:

Stannous Chloride Solution.—Dissolve one part of the crystallized salt in six parts of water acidulated with hydrochloric acid, and keep in the solution a few pieces of metallic tin.

Mercuric Chloride. (Corrosive sublimate).—A saturated solution.

Alcohol.—About ninety-five per cent., strength a good quality.

Sodium Carbonate.—Pure sodium bicarbonate heated to dull redness for ten minutes, to expel one-half of the carbonic acid. Should be used as a ten per cent. solution.

Briefly stated the chemistry of the Fuller cell is as follows: When a solution of sodium carbonate is treated with sulphuric acid chromic acid is formed.

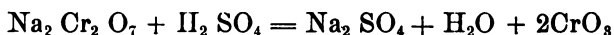

The value of the chromic acid CrO_3 lies in its ability to act as a depolarizer by oxydizing the hydrogen as follows:



So, finally, sulphate of zinc is produced at the positive plate and sulphate of chromium, sodium and water in the cell.

The Bichromate battery has appeared in a great number of different forms and under a variety of different names, none of which, however, show any particular advantage

over the Fuller cell, which has on the whole obtained the widest practical application.

The oxyde of copper cell is a valuable one to the telephonist. In the cells so far described the depolarizer has been in the form of a solution, for in this state it is usually most efficient, but the oxyde of copper cell is based upon the ability of oxyde of copper to give up its oxygen in the presence of hydrogen, becoming reduced to metallic copper. So the oxyde of copper cell consists of a positive plate of zinc immersed in a solution of sodium hydrate, and of a negative plate consisting of oxyde of copper, either pressed into the form of a slab or carried in a basket or cup. The chemical reaction of the oxyde of copper cell is as follows:

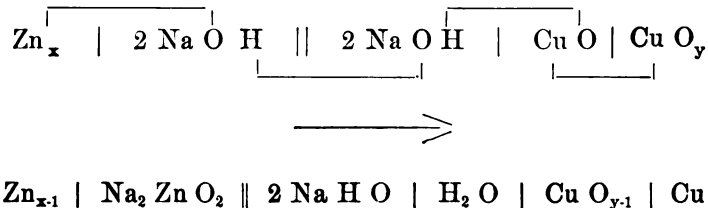

From this it appears that when the cell is exhausted there is found a considerable amount of chemically pure copper which may be sold at a fair price, and thus the by-products are of some value which is not the case in any other make of cell. The Oxyde of copper cell is best known under the names of the Edison-Lalande and Gordon, cell. The cell is shown in Fig. 207, *A* giving a side elevation and *B* an end elevation. There are two similar zinc plates, one of which is shown in Fig. 208, between which a slab of pressed oxyde of copper is placed. This is held in a frame

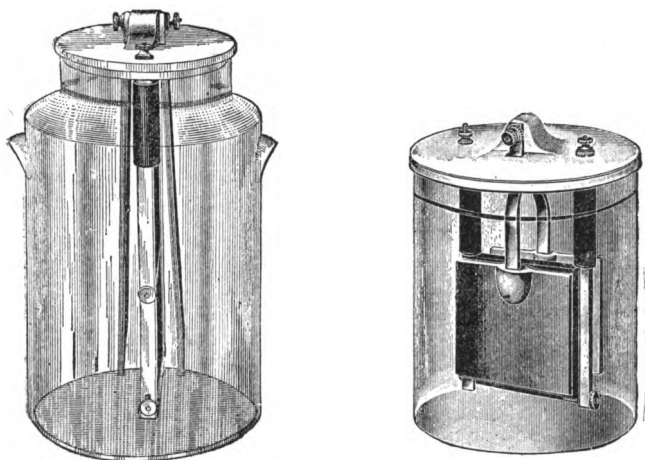

FIG. 207.— EDISON-LALANDE CELL.

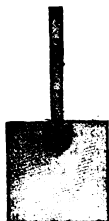

FIG. 208.— EDISON-LALANDE PLATES.

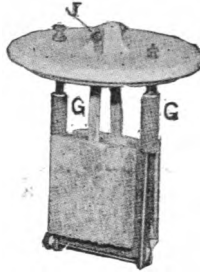

FIG. 209.— EDISON-LALANDE ELEMENT.

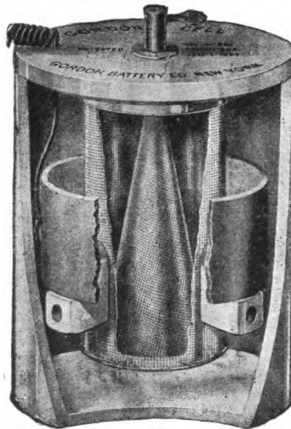

FIG. 210.— GORDON CELL.

work suspended from the cover, as in Fig. 209 the zincs being hung in a similar manner. The jar is filled with a solution of sodium hydrate and the elements suspended from the cover. The arrangement adopted by the Gordon Battery Co. is shown in Fig. 210. A porous vase is arranged into which the oxide of copper is placed. This is suspended from the jar cover, while surrounding it is a circular zinc plate resting upon insulators, secured to the porous vase.

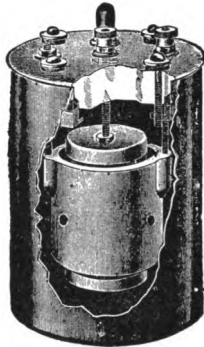

FIG. 211.—THE NUNGESSER OXYDE OF COPPER CELL.

The Nungesser type of this cell is shown in Fig. 211, and differs little from others excepting in unimportant mechanical details. The most reliable tests upon the copper oxide battery are those made by Dr. A. E. Kennelly and are abstracted in Table XVII.

TABLE XVII. DATA OF COPPER OXYDE BATTERY.

Type of Cell.	Mean Working E. M. F. Volts.	Average Inter- nal Resistance Ohms.	Maximum Deliv- ery Current Amperes.	Capacity in Am- pere Hours.	Continuous Cur- rent Amperes.
Fuller Bichromate...	1.8	0.40	4.50	68	
Western Union Car- bon, Bichromate Type.....	1.8	0.40	4.50	5	
Partz Motor Cell...	1.83	0.51	3.58	65	
Hussey Eclipse	1.4	0.8	1.75	45	
Leclanché.....	1.5 to 0.5	0.5	3.0		
Gravity, Daniell, Western Union Type.....	1.0	0.5	2.0		
Edison Primary:					
Type BB	0.667	0.089	7.495	100	1.5
Type Q	0.667	0.070	9.528	150	2.5
Type Z	0.667	0.089	7.494	100	1.5
Type V	0.667	0.070	9.528	150	2.5
Type AA	0.667	0.043	15.511	300	4.0
Type RR	0.667	0.043	15.511	300	4.0
Type S	0.667	0.025	26.680	300	6.0
Type SS	0.667	0.025	26.680	300	6.0
Type W	0.667	0.020	33.350	600	7.0

A form of cell known as the Harrison has lately appeared, which would seem to possess many advantages for the telephonist. It consists of a positive zinc plate with a negative of peroxyde of lead, in a dilute solution of sulphuric acid. It resembles a storage battery, having a low internal resistance and high electromotive force, from

2 to $2\frac{1}{2}$ volts. After the battery has been exhausted by service, it is possible to recharge it in the same fashion as the storage battery. Fig. 212 is an illustration of this type of cell. It has a capacity of 40 ampere hours.

The only open circuit battery which has obtained extended application in telephony is the salammoniac cell in



FIG. 212.— HARRISON BATTERY.

its various modifications which include most of the dry batteries. In this cell zinc is the positive plate, carbon the negative, and a solution (or paste in a dry cell) of ammonium chloride or salammoniac. In some makes depolarization is affected by making the carbon surface very large and rough, in others by surrounding the carbon with manganese dioxide, which gives up its oxygen to the hydrogen in the formation of water.

The chemical reactions are as follows:

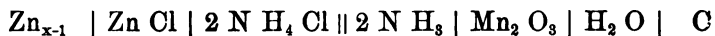
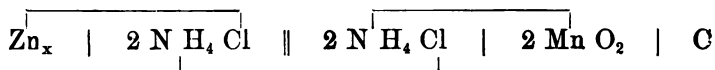

The salammoniac battery first appeared under the name

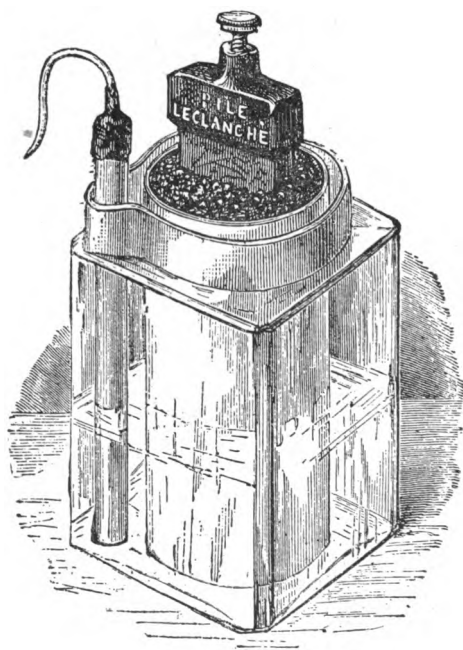

FIG. 213.—LECLANCHÉ CELL.

of the Leclanché cell, and is illustrated in Fig. 213. Since its first appearance the cell has undergone many modifica-

tions, chiefly directed to the removal of the porous cup which contained the dioxide of manganese. The prism battery shown in Fig. 214 is an effort in this direction. From the illustration it appears that the negative element

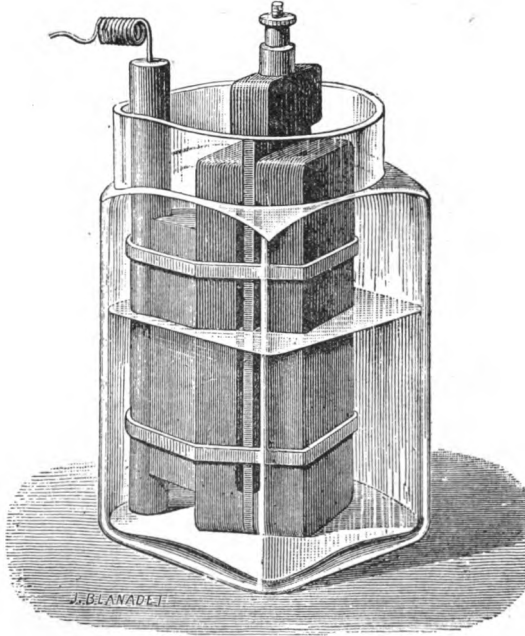

FIG. 214.— PRISM BATTERY.

is a carbon plate which is clamped between two blocks by means of rubber straps. These blocks contain the dioxide of manganese which is employed as depolarizer.

In Fig. 215 the Bag battery is shown. Here the depolarizer is contained in a bag, which is a cheaper substitute for the porous cup.

Fig. 216 is a type known as the carbon cell, since the negative plate is a fluted cylinder of pressed carbon which forms a receptacle into which the dioxyde of manganese



FIG 215.— BAG BATTERY.

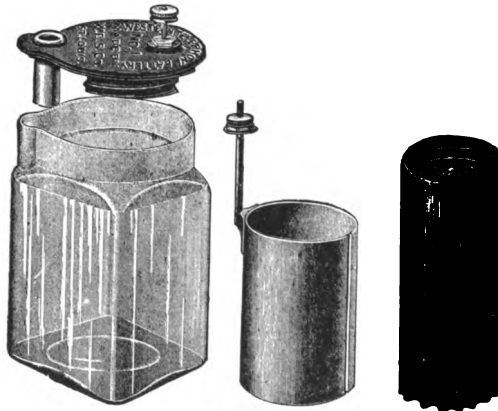

FIG. 216.— CARBON CELL.

can be placed. It is essential in the Leclanché cell to use zinc of the greatest possible purity, containing at least ninety-nine per cent. zinc. Little difference has been

found between cast and rolled zinc, although the latter is usually considered preferable. The salammoniac should be pure and should yield on analysis at least thirty-one and five-tenths per cent. of ammonia, sixty-five and five-tenths of chloride, and leave not more than three per cent. of residue when ignited. The best strength of solution for

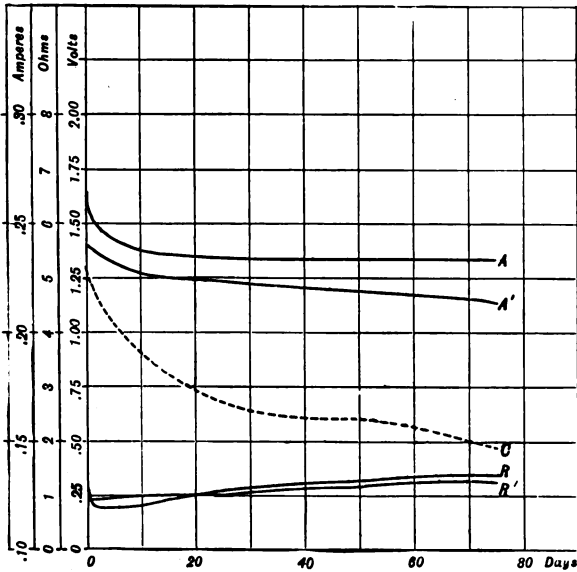

FIG 217.—TESTS ON LECLANCHE CELL.

the salammoniac cell is practically a saturated solution made by dissolving three parts of salammoniac in ten of water, and for this purpose only clean soft water should be used.

Fig. 217 gives the results of tests made upon salam-

moniac cells in a manner similar to those already described for the Fuller cell.

Dry Batteries.— To avoid the maintenance expense and other difficulties attending the use of the cells described, together with the possibility of injury to the subscribers' premises due to the employment of corrosive chemicals, the use of the so called *dry cell* has recently been much extended. In a sense the term "dry cell" is a misnomer, for no cell that was desiccated, in the true meaning of the word, would deliver any current. The term is usually understood to mean a cell so manufactured as to be *non-spillable*. Most dry cells are composed of a pasteboard case called a carton into which a negative zinc element is placed. This is either surrounded by a porous substance, such as cellulose, saw dust, gelatine or a similar spongy material which is capable of absorbing and retaining the electrolyte, or else some kind of a pasty composition is employed. In the center of the mass is placed the positive element, which is usually some form of carbon and peroxide of manganese, so that the dry battery is really but a convenient modification of the salammoniac cell. This description applies to those which are chiefly used for telephonic purposes for there are many other forms commercially obtainable, and it is easy to conceive that many additional combinations might be easily contrived. The dry cell differs chiefly from the wet in having a greater internal resistance and smaller output in watt hours, in being exceedingly portable and considerably cheaper in initial expense. The greater internal resistance is objectionable from the transmission standpoint, but, to offset this, transmitters particularly designed to work in connection with dry cells, possessing a resistance of from 30 to 80 ohms, are now commonly manufactured, and while, so far as the writer is

aware, there are no tests which demonstrate that the high resistance transmitter and dry cell produce transmission which is equal to that of the wet cell, the results which are obtained are sufficiently good for local service; consequently such installations are well adapted to service in which there are few or no toll line connections, such as

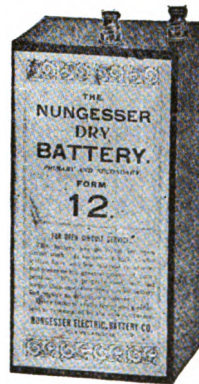

FIG. 218.—DRY CELL, ROUND TYPE.

FIG. 219.—DRY CELL, SQUARE PATTERN.

are found in the smaller towns and villages and in rural communities. Here the decreased maintenance cost has made this type of installation a favorite. The typical dry cell is represented in Fig. 218, which shows it to be

cylindrical, about three inches in diameter and about six inches in height. Various makers produce cells of various sizes and capacities; some adopt a square form, as in Fig. 219, instead of the cylindrical one. But in general there is little choice, for as the cells vary in size their output and price correspondingly changes. The electromotive force ranges from 1.5 volts to .5, depending on the

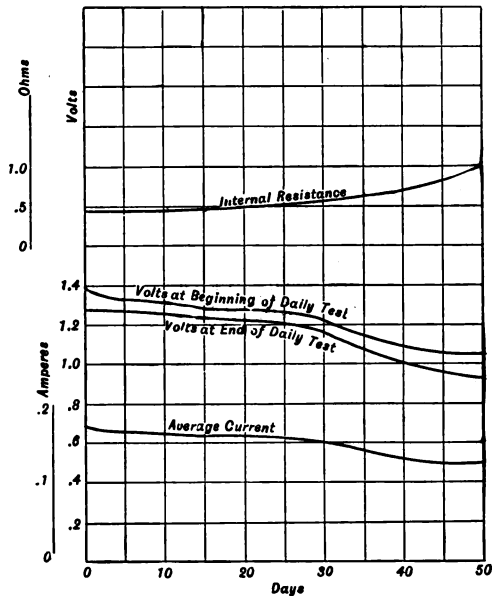

FIG. 220.— TESTS ON DRY CELL A.

make and age, and the internal resistance from .5 ohm to 2 or more.

Figs. 220, 221 and 222 give the results of some tests made upon three different styles of dry cells which have received a considerable employment in telephony. In order

to meet a rapidly increasing desire to employ the dry cell, some of the independent manufacturers, notably the Kellogg Switchboard & Supply Co., have perfected transmitters particularly designed to operate in connection with dry cells, and having an internal resistance, from 30 to 80 ohms.

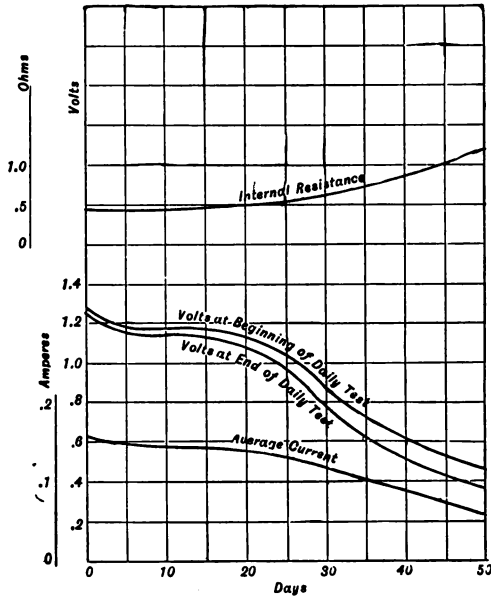

FIG. 221.—TESTS ON DRY CELL B.

Mr. R. H. Manson of the Kellogg Switchboard & Supply Co. reports results obtained with dry cells and high resistance transmitters which are interesting, particularly in connection with telephonic installations in rural districts, where service conditions are easy. Mr. Mamson assumes that the terminal e.m.f. of a transmitter must not fall be-

low $1\frac{1}{2}$ volts, and based upon this assumption he shows the curves of Fig. 223, and calculates the telephonic life of dry cells, based upon eight calls per day of $2\frac{1}{2}$ minutes each, as follows: Battery *A* 3.55 years; battery *B* 2.58 years; battery *C* 1.94 years, and assuming dry cells to cost 25

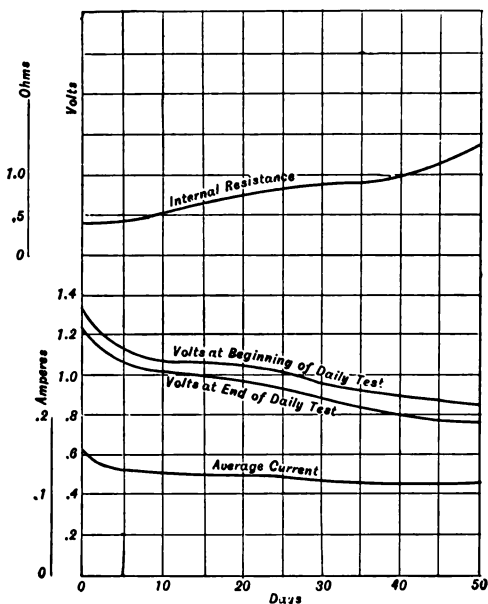

FIG. 222.—TESTS ON DRY CELL C.

cents apiece, and allowing 50 cents for expense of renewal, the cost per substation by Mr. Manson's results would vary from about 28 cents to \$1.00 per year per station. It is not known how the transmission under these circumstances compares with that given by older practice; but from considerable practical experience in substations operated

by dry batteries, the writer fears while the transmission might be considered adequate for a small exchange, it

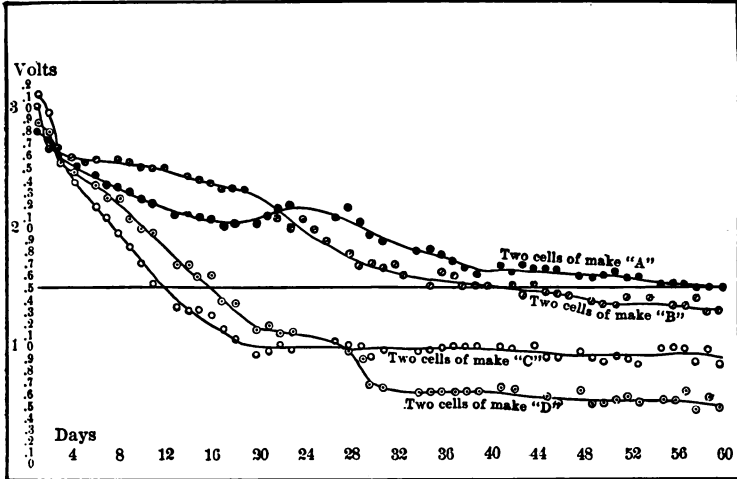

FIG. 223.— COMPARATIVE TESTS IN FOUR DRY CELLS.

would be insufficient for the important districts of larger cities and would be utterly inadequate for toll service over long distances.

CHAPTER VI.

SIGNALLING APPARATUS.

WHILE the invention of the magneto telephone rendered the electrical transmission of speech possible there were many problems to be solved ere a telephone system could become practical. One of the most vexatious was that of providing some form of signal that should attract attention to the telephone when a call was to be answered. For this purpose the voice of the magneto receiver itself was so feeble as to be utterly useless. Many experiments were tried in the hope of producing some sort of mechanism, such as a tuning fork, which, vibrated in front of the transmitter, would cause the receiver to emit a sound of sufficient intensity to attract attention, but without success. With the advent of the battery transmitter attempts were made to employ a bell, actuated by an electro-magnet, and to use the transmitter battery to operate it. Grave difficulty was experienced with the burning and oxydizing of the bell contacts, and it was found that the two or three celled battery employed for the transmitter was too feeble a source of electro motive force to work the bells over lines of more than a few hundred feet unless excessively large wire was used. Various forms of visual signals to be operated electro-magnetically by the transmitter battery were tried, for substation calling, but all proved inadequate either for the preceding reasons, or because a visual signal is useless unless some one is watching it, and this, for the substation, is impracticable. The final solution was found in the invention of the so called "magneto-bell" or ringer, which has proved itself so

superior to all other forms of telephonic signals that it has replaced every other device and is now universally used at the subscribers' station. Fig. 224 is a view of a typical magneto bell, removed from its case; Fig. 225 shows the magneto mechanism with gong removed, while Fig. 226 shows the bell dissected. The ringer consists of a cross piece or yoke *A A*, to which the gongs *G G* are attached.

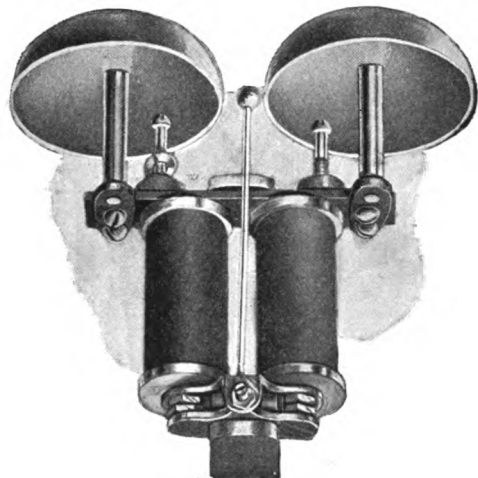

FIG. 224.—RINGER ASSEMBLED.

The cross piece also supports two electro-magnets *B B* and a permanent magnet *N S* bent into a kind of U. A clapper *C* attached to a wire arm is operated by an armature *D* that is pivoted in front of the poles of the electro-magnets. A magneto ringer is always actuated by an alternating current and so a small alternating current generator is always used to operate telephone bells, for they cannot be used with a battery or direct current. The philosophy of the ringer can be better understood by refer-

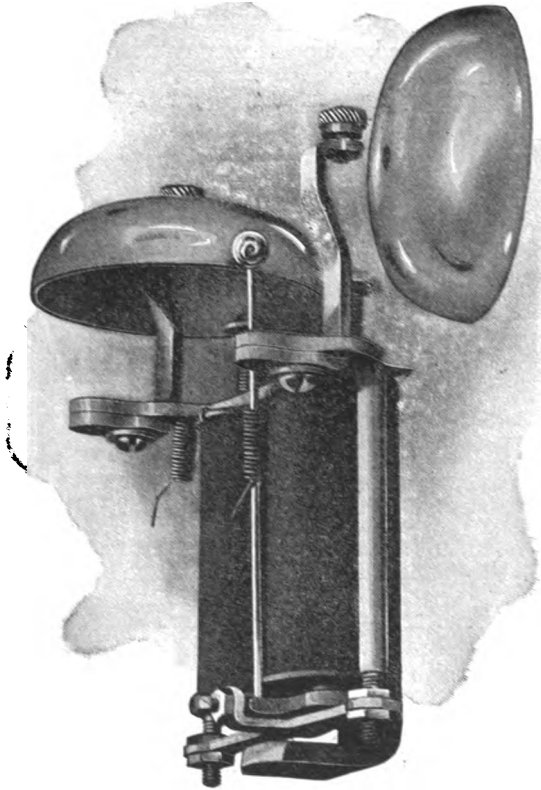

FIG. 225.—RINGER WITH ONE GONG REMOVED.

ence to Fig. 227. In this illustration G is an alternating current generator connected to the ringer by the conductors $L L'$. In the ringer $N'' S$ is the permanent magnet. This magnetizes by induction the pivoted armature a , producing a south pole at S and two north poles at each end of the armature N''' . This magnet also energizes the cross piece A producing a north pole N'' in the middle, and two south poles S'' one at the end of each of the core. Now, as there is a north pole N''' opposite each south pole

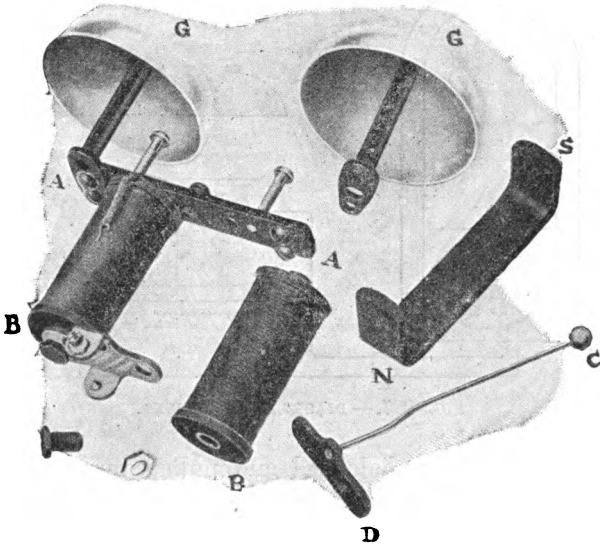

FIG. 226.—RINGER DISSECTED.

S'' at each end of the armature, and as these are of approximately equal strength, the pull at each end of the armature is equal, so that it is balanced and remains quiet. If the alternating current generator be rotated an

electric wave or pulsation will traverse the line $L L'$ and the coils wound on the cores $B B'$. With every revolution of the generator there will be two waves, one positive and the other negative. It will also be noticed that the winding on coil B is opposite in direction to that on B' . Suppose, when the generator is started, the first wave is in such a direction as to increase the strength of the south pole S'' in the end of the core fy . This wave will then weaken or reverse the pole at the end of ex . Hence the

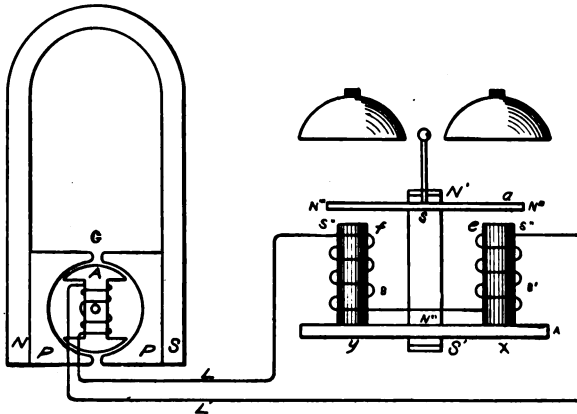

FIG. 227.— DIAGRAM OF RINGER.

armature will be unbalanced and pulled toward f causing the clapper to strike the gong on the left. A fraction of an instant later the generator produces a wave in the opposite direction. This weakens or reverses the S'' pole at f and strengthens the S'' pole at e , hence the armature is drawn in the opposite direction, and the clapper strikes the right hand gong. Consequently so long as the generator is actuated the armature vibrates to and fro, and by means of the pair of gongs a clear continuous ring is given.

Owing to the operation of the permanent magnet to induce magnetism in the armature and yoke, bells of this kind are sometimes called *polarized bells*.

There are many advantages in a bell of this description. As there are no contacts whatsoever there is no burning or oxydization, and no difficulty from open circuits save that due to an occasional actual rupture of a conductor. The little generator *g* can be easily made to deliver a much higher voltage than can be obtained from a primary battery, and as there are no acids to corrode, or liquids to

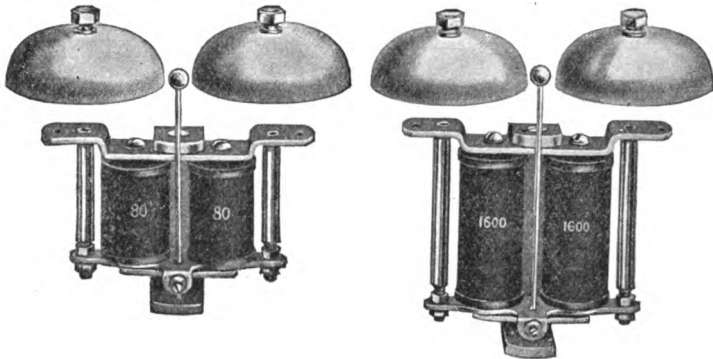

FIG. 228.—COMPARATIVE SIZES OF RINGERS.

evaporate, the maintenance of the magneto generator is much simpler and less expensive than any form of cell.

When magneto bells were first employed it was customary to wind the magnet spools to as low a resistance as possible, say 80 ohms, in order that a number of stations might be placed in series upon a line, and yet not interpose a resistance so great as to render the bell inoperative. Subsequently, Mr. Carty devised the "Bridging Bell." In this ringer the spools of the bell are bridged, or placed

directly in shunt, across the line, and are often permanently connected thereto. Therefore they must have sufficient impedance so that the branch circuit which they offer will not seriously divert the voice currents from the transmitter from reaching their proper destination. To accomplish this result bridging ringer spools are usually wound to at least 1,000 or 1,600 ohms and sometimes to 2,000 or 2,500. Fig. 228 shows the relative appearance of a series and a bridging bell. Sometimes ringer spools are made of high resistance by using fine German silver wire for a part of the winding. This is a fallacy, because the amperage of voice currents is so small that they are not seriously affected by resistances, even of many thousands or even millions of ohms, but their frequency is so high that a coil of any kind, particularly one containing iron, offers a very great impedance. So what is needed in a bridging magneto bell is not great ohmic resistance, but great impedance, and this is best secured by winding the bell with relatively large wire and with a great many turns. Experience also shows that it is expedient to make the ringer cores long and slim, giving a correspondingly long shallow winding, for this makes a much more sensitive bell, one which can be used with a generator of higher frequency and one which acts more promptly and quickly than if the magnets are short and fat. In order to prevent the armature from sticking to the core tops from residual magnetism, a thin film of some non-magnetic material should be interposed between the armature and the ends of the core. This is readily done by driving a copper rivet into the core, or armature, or by plating either with copper, or some similar metal, which prevents actual contact between the core and the armature. To secure satisfactory operation the armature should be made ad-

justable with reference to the poles and the magnet in order to attain to proper sensitiveness. Sometimes this is accomplished by threading the ends of the rods (Fig. 228) and securing the cross piece carrying the armature between two nuts which permit it to be placed in any desired location with reference to the cores.

Another method is shown in Fig. 229. This ringer is manufactured by the Stromberg-Carlson Co. Here the armature *C* is supported by a spring plate *D* that has two holes to receive the ends of the cores. There is a cross bar *F* which is placed over the poles and into this a screw *B* is threaded which passes through a hole in the magnet *A*. This screw has a shoulder which bears on the plate *D*. By turning this screw to and fro the plate *D* is caused to

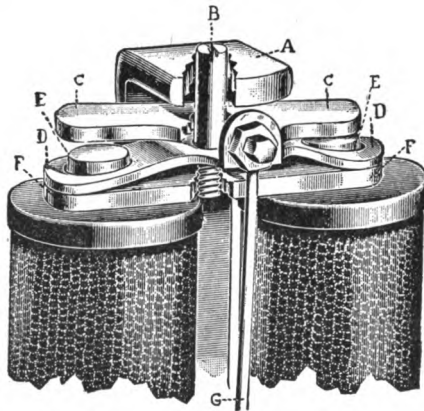

FIG. 229.—ADJUSTMENT OF STROMBERG-CARLSON RINGER.

advance or retreat from the cores and thus secures adjustability for the armature.

An ingenious ringer, shown in Fig. 230 is manufactured by the Williams Electric Co. There is a U shaped

magnet O which is so charged as to have a consequent pole N in its center, and two south poles $S S'$ at the ends. These south poles are prolonged by the bars $B C$ and connected to the ends of the core of the coil A . Directly under N the armature Q is pivoted. Evidently the pole of the permanent magnet N produces a consequent south pole

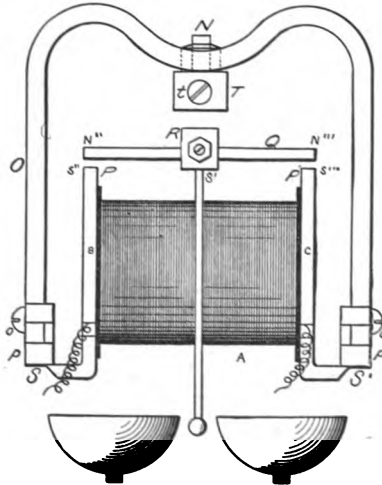

FIG. 230.— WILLIAMS RINGER.

directly beneath it at R in the armature and two north poles N'' and N''' at the ends thereof. Also the two south poles S and S' of the magnet are continued by the bar B and C and form south poles directly under the north poles N'' and N''' of the armature. When an impulse from the generator traverses the coil A in one direction the south pole S'' , for example, is weakened and S''' is strengthened, then the end N''' of the armature Q is attracted and the gong on the left hand side sounded. When

the next wave traverses the coil the operation is reversed. Fig. 231 is a reproduction of the phantom in iron filings of the magnetic circuit of the ringer. Note the strong field produced by the consequent pole in the center of the permanent magnet, tending to polarize the armature. Adjustability is secured by making the pole piece *N* movable so that by shifting it to and fro the polarization of the armature can be varied.

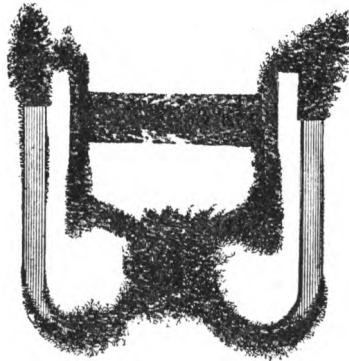

FIG. 231.—PHANTOM OF WILLIAMS RINGER.

Another ringer of somewhat similar design is shown in Fig. 232 manufactured by the Williams-Abbott Co. A U shaped magnet is provided so charged as to have say a consequent north pole at *N* and two south poles at *S S*. Across the poles *S S* is secured an iron yoke and upon this yoke two electro magnets are mounted, consequently the upper end of the cores of these magnets are also south poles. The armature *O* is pivoted below *N* and is magnetized by induction. Obviously this ringer operates in a manner very similar to the Williams ringer previously described. Both of these designs are exceedingly com-

part. The upper parts of the ringer are protected by the magnet and the whole apparatus can be easily made strong and substantial.

In the polarized bells so far described the armatures and magnets are so designed as to mutually balance each other, therefore the clapper is responsive to any electric wave whether positive or negative that may traverse the coils of the bell.

For some kinds of service, that of polystation lines, for example, a selective signal is desired, or one which will

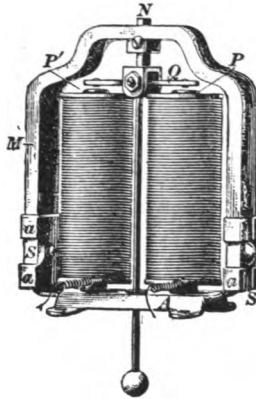

FIG. 232.— WILLIAMS-ABBOTT RINGER.

respond to only one kind of impulse in order that the central office operator may ring one party without disturbing others joined to the same circuit. For this purpose a "Biased Bell" is used. This type of ringer is illustrated in Fig. 233 and differs from the common polarized bell only in the addition of a light spiral spring which is attached at pleasure to either one side or the other of the

armature. The effect of this spring is to destroy the balance that exists in its absence, and the armature is tipped out of center with reference to the magnets. It will thus only respond to one kind of wave, for example a positive one, such as will cause the pole of that spool which is not nearly in contact with the armature to attract it. Obviously the spring can be placed on either one side or the

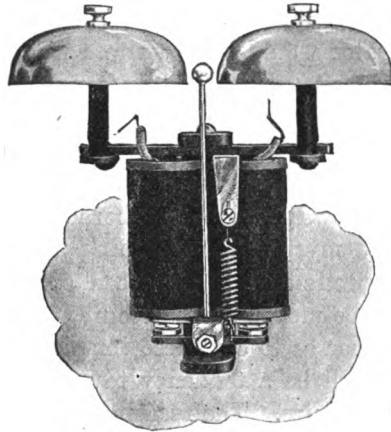

FIG. 233.—BIASED RINGER, 2,500 OHMS.

other of the armature pivot and by changing the location of the spring the responsiveness of the bell is reversed and can be easily made responsive to a negative or positive current. Experiment is necessary to determine upon which side of a given bell the spring should be placed in order to make it sensitive to a predetermined current. For ringers of this kind very careful adjustment of both armature and spring is necessary in order to secure even remotely satisfactory operation, yet in spite of the narrow

margin upon which this apparatus operates the biased bell is an important form of substation signal. A host of different designs in polarized bells can be found, for each manufacturer has some pet design which he follows. Nevertheless the bulk of those on the market correspond at least in general design to the examples given.

Ringling Generators.— The ringing generator is a small dynamo machine. To describe all of the principles that the designer must take into consideration in planning the ringing generator would be to write a treatise on dynamo electric machinery. This far transcends the scope of the present work, but a very brief account of fundamental laws involved, in so far as they apply particularly to the ringing generators used in telephony, may be *apropos*.

Experiment shows that the neighborhood of every magnet is filled with a mysterious something to which the name "lines of magnetic force" has been given, and further, that if a wire be moved in the vicinity of such a magnet in such a manner as to cut these imaginary lines of magnetism, there will be a tendency to produce a current of electricity in the wire. The reason for this lies buried far deeper in the secrets of nature than any investigator has yet been able to penetrate, so a bare statement of facts must suffice. This tendency to produce an electric current, or to create an electro-motive force, depends upon the speed at which the wire moves and the density of the magnetic field through which it travels, hence by arranging the wire in the form of a coil so that successive turns may intersect the lines of force the e.m.f. may be greatly augmented. Essentially therefore a dynamo machine consists of a magnet, to create the necessary magnetic field, and a wire so arranged that it may be moved therein. A diagram-

matic representation is shown in Fig. 234. Here NS represents a section of a horseshoe magnet, while a coil of wire is placed between its poles so that it may be rotated. The ends of the wire terminate in two rings placed on a shaft which supports the coil, and upon these rings a pair of conductors bear. When the shaft carrying the wire is turned, its rotation through the magnetic field produced by the poles N and S causes currents to flow as shown by the arrows,

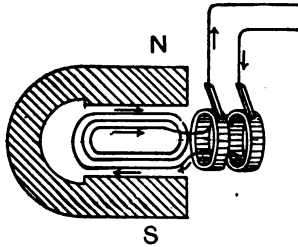

FIG. 234.— DIAGRAM OF A DYNAMO.

and these by means of the conductors may be carried to and utilized at any desired location.

Experience shows that air opposes a high resistance to magnetism, while iron does not; consequently, by winding the wire upon an iron spool, a greater quantity of magnetism between the poles can be secured, and this enhances the output. By supplying the magnet with cheeks or pole pieces the air space may be still further reduced, and then the cross section of the machine appears as shown in Fig. 235. Here NS is a horseshoe magnet, P and P' a pair of cheeks placed upon its extremities which surround a shuttle shaped iron spool A upon which the coil is wound. The fundamental organs therefore of a ringing generator con-

sist in one or more permanent magnets to create the magnetic field, a coil of wire wound upon an iron core (called an armature) a crank or other means for turning the armature and a pair of rings (or similar device) upon which two sliding conductors are placed for the purpose of collecting the electricity generated. When these parts are assembled the ringing generator takes the general appearance of Fig. 236. Fig. 237 is an imaginary skeleton view, in

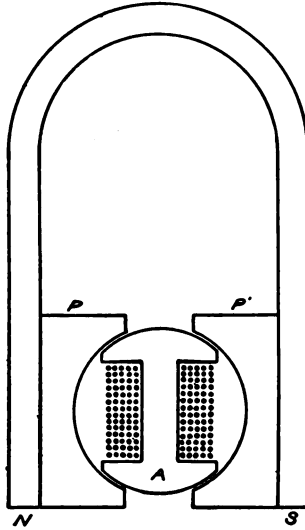

FIG. 235.— DIAGRAM OF MAGNETO.

which the magnets are drawn as if they were transparent, thus permitting a view of the interior. In Fig. 238 the machine is completely dissected. From these illustrations a ringing generator is seen to consist of a frame, Fig. 238, which is usually made to form the pole pieces; a set of mag-

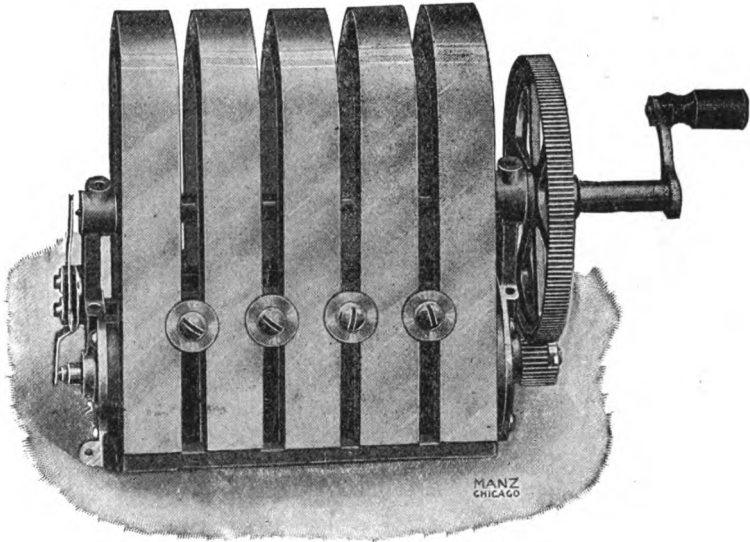

FIG. 236.—RINGING GENERATOR.

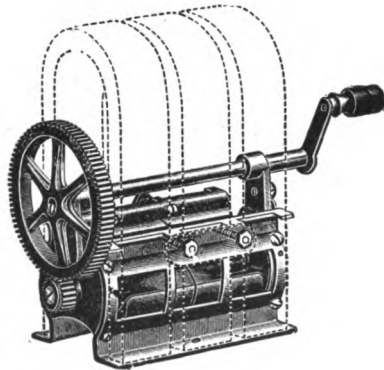

FIG. 237.—SKELETON VIEW OF MAGNETO.

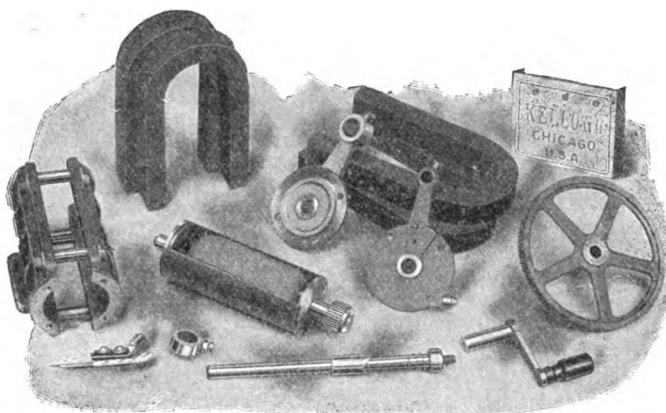

FIG. 238.— MAGNETO DISSECTED.

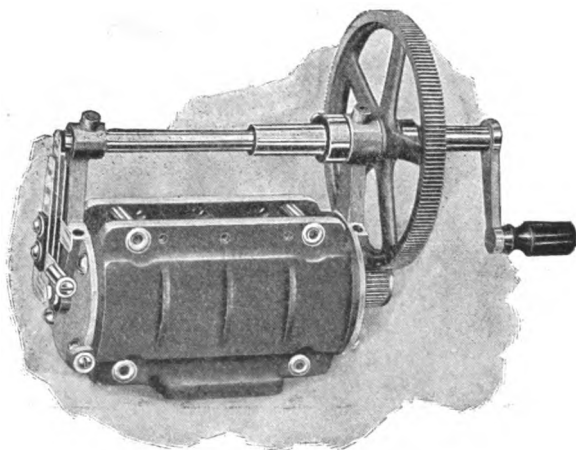

FIG. 239.— MAGNETO WITH MAGNETS REMOVED.

nets are bolted to the frame; two bearing plates that are bolted to ends of the frame each of which contains two bearings one for the armature shaft and one for the crank shaft; an armature with its pinion; the crank shaft with its crank; the gear with collar and the shunt springs. In Fig. 239 all the parts of the generator are shown assembled excepting the magnets. The bearing plates are bolted to the frame with the armature and crank shaft in place, together with the shunt springs secured to plate opposite the crank.

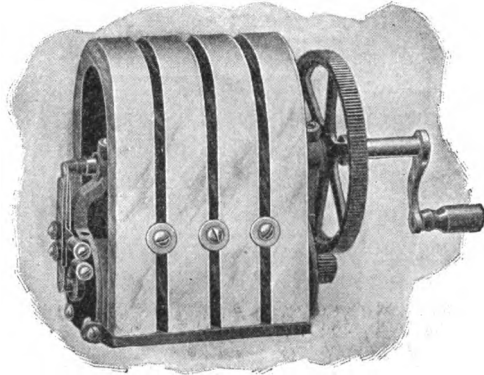

FIG. 240.— A COMMON SIZE OF MAGNETO.

The e.m.f. produced by a generator depends upon the strength of the magnetic field. It is only possible to endow permanent magnets with a certain, not very large, quantity of magnetism. In order to obtain greater power the number of magnets must be increased. This has given rise to the classification of ringing generators depending upon the number employed. The smallest sizes usually have two or three magnets, while others have four, five or even eight. A common size is shown in Fig. 240. So

generators in the trade are often termed as 3, 4 and 5 bar machines depending upon the number of magnets. There is another method of rating which is that of stating the *number of ohms resistance* through which a generator can ring its own bell. Thus a 10,000 ohm machine will ring through 10,000 ohms. Generators of 10,000, 25,000, 50,000 and 100,000 ohms are common and those of 150,000 or even 200,000 can be procured.

The precautions necessary to the successful manufacture of permanent magnets have been discussed in the sections on receivers, in which will be found an outline of such chemical composition as experience has indicated desirable, together with an idea of the best method of manufacturing and charging magnets.

The armature is another vital organ of the ringing generator. It was formerly customary to construct the armature of a cylinder of cast iron along the sides of which a pair of slots were cut to receive the wire. A solid bar is a poor design, for the magnets in addition to setting up desirable electric currents in the coil of wire surrounding the bar initiate wasteful currents in the material of the core itself. This may be prevented by building the armature of a number of thin sections of sheet iron which are slightly insulated from each other by varnish, thin paper or even rust. Fig. 241 shows the general method adopted by the makers of all desirable machines. A series of iron punchings cut from sheet iron, from Nos. 24 or 28 *B. W. G.* are made; each is shaped like a dumb-bell with a hole through the shank whereby it may be threaded upon a shaft. After the proper number has been assembled to secure the required length for the armature, pairs of bolts are inserted in holes punched in the heads of the disk thus clamping together the entire pile. The material should be

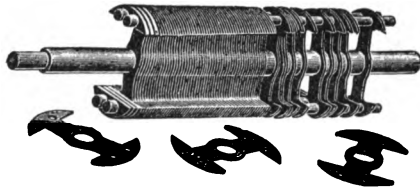
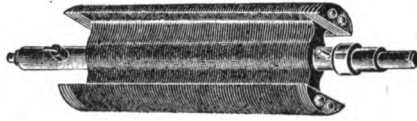

FIG. 241.— ARMATURE LAMINATIONS.

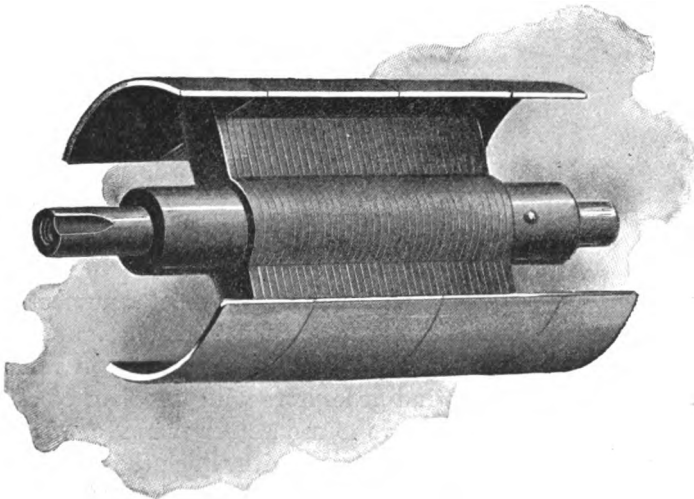

FIG. 242.— ARMATURE READY TO WIND.

the softest and best of Swedish sheet iron, or what is nearly as good, the mildest of so called structural steel. Each disk should be so varnished or oxydized as slightly to insulate it from its neighbors, and shaped to form two longitudinal channels, whose office is to receive and protect the wire of the coil. Fig. 242 is an illustration of a completely finished armature ready to receive the winding.

The winding should be done with the very best silk covered copper wire. The size of the wire, the number of turns, and consequently the resistance of the armature, will depend upon the service which is demanded of the

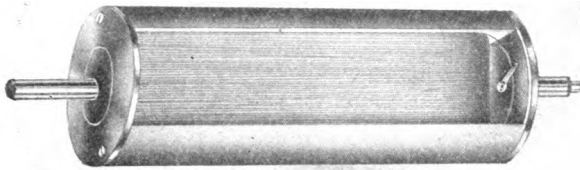

FIG. 243.— COMPLETED ARMATURE.

machine. By winding with fine wire a greater number of turns can be secured and consequently a greater e.m.f., but this is accompanied by a corresponding increase in resistance. It is rare to wind generators with less than No. 30 wire, and it is equally rare to use a finer than No. 38; 34 and 36 are the most common sizes with which the resistance will vary from 300 to 1,000 ohms. A completed armature is shown in Fig. 243.

When the generator is in service its armature must be connected in series with the line, but to allow the impedance of the coil to remain in the circuit excepting when the generator is actually turning is objectionable, so, whenever the generator is not in use, the armature should be removed from the circuit. This is done by providing a very low resistance shunt around the armature so that when the generator is at rest its resistance is cut out. Obviously this

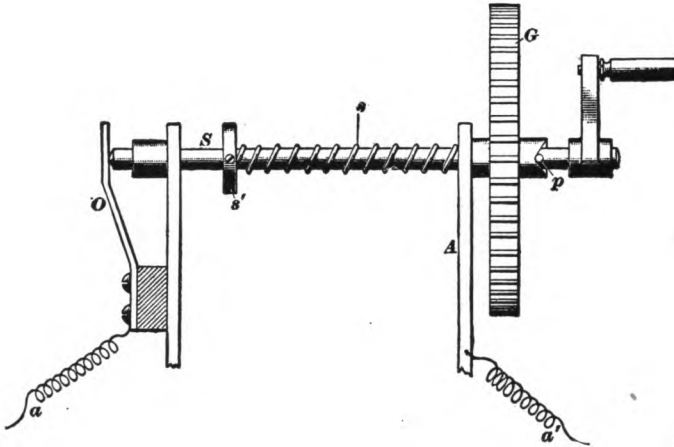

FIG. 244.—WESTERN ELECTRIC SHUNT.

device must be arranged so that the armature will be cut into circuit as soon as the crank begins to revolve, and be short circuited when it stops. It is impossible to depend upon the memory of the subscriber to press a button or turn a switch for this purpose, so that it is necessary to make the shunt automatic. A familiar method is that of the Western Electric Co., shown in Fig. 244. The large gear wheel *G* is loosely mounted upon the shaft *S* and is free to turn

through a portion of a revolution. The crank shaft S is pressed to the left by a spiral spring s wound upon it, bearing against the upright end A and the collar S' that is rigidly secured to the shaft. The hub of the gear G is provided with a V shaped notch in which rests a pin p , secured to the crank shaft. There is a spring O to which one terminal a of the armature winding is connected. This bears against the end of the shaft when the machine is at rest and therefore completes a short circuit. When the crank revolves, the pin p rides out of the notch and pulls the shaft against the pressure of the spring s out of contact with the spring O , thus cutting the armature winding into circuit.

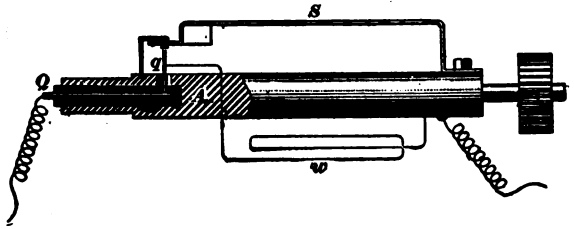

FIG. 245.— POST SHUNT.

Fig. 245 is known either as the centrifugal or Post shunt. A coil of the armature winding is represented diagrammatically by W . One side is attached to the armature shaft and the other to the pin q that is secured to an insulated bushing driven in a hole bored in the end of the shaft A (shown in section). The spring S is attached to one end of the armature shaft and when at rest bears upon the pin q short circuiting the winding. When rotation commences the spring S , which is equipped with a weight, is by centrifugal force driven away from q , opening the shunt.

Another form is that manufactured by the Sterling Elec-

tric Co., known as the Cooke Shunt, indicated in Fig. 246. BB are the bearings supporting the crank shaft. The gear wheel G is mounted on a hub g'' , rigidly secured to a sleeve g' . This sleeve turns within the bearings BB and is free to turn on the shaft S' , but cannot slide endwise. There is a coiled spring S , tightly wrapped around the sleeve which connects it to the shaft. One end is fastened to a collar g' rigidly secured on the sleeve, while the other is attached to a screw pin p that passes through a diagonal slot in the sleeve and into the shaft. The spring holds this

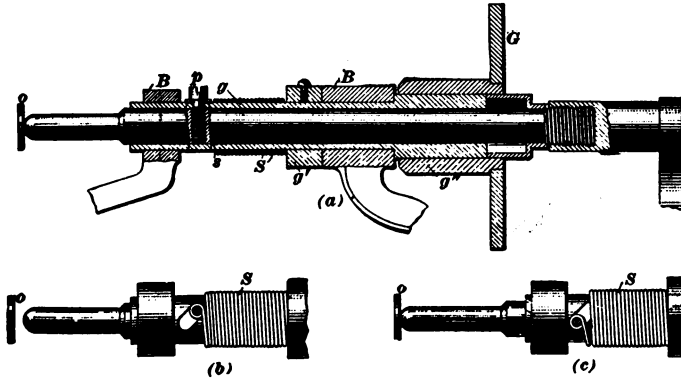

FIG. 246.—COOKE SHUNT.

pin normally at one end of the slot and the shaft is held in contact with spring o , as shown at c , and the armature is short circuited. When the crank is turned, the pin is forced along the slot, and the shunt opened as at b .

An ingenious form of shunt is that devised by the Holtzer-Cabot Co., illustrated in Fig. 247 at a and b . The shaft of the generator is at P and is surrounded by a box or case having insulating sides. This case is filled with metallic

filings sufficiently to submerge the armature shaft and connect it metallically with the circumference which is of metal. When the machine is at rest the filings occupy the position as shown at *a* making electrical connection between the shaft and the case, shunting the coil. As soon as rotation commences, centrifugal force drives the filings to the circumference and they take up the position shown at *b*, thus opening the shunt and cutting the armature into circuit.

The driving gear is a most important feature. Usually a small pinion is placed on the armature shaft and a large

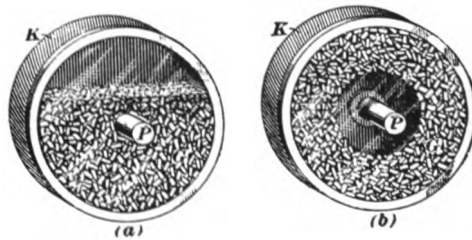

FIG. 247.—HOLTZER-CABOT SHUNT.

gear (from 5 to 10 times the diameter of the pinion) upon the crank shaft. Unless this gear is well designed much trouble will arise from rapid wear of the pinion and tendency of the gear to cut a rut thereon. The number of teeth in the pinion and gear should be odd multiples of each other so that a tooth on the gear shall strike the same tooth on the pinion very infrequently.

A great fault is that gears and pinions have been made too narrow. As the pinion revolves from 5 to 10 times as often as the gear, it is subjected to severe wear. Teeth should therefore be liberally proportioned, carefully cut

and built of anti-friction metal. The plan of making the gear with a narrow face and fluting has been tried, then as the gear revolves it travels a sinuous path on the face of the pinion. The Williams ringer embodies this novel and successful feature. Even with the best design gearing is a source of annoyance and the Holtzer-Cabot magneto adopts the plan of chain driving by providing the crank shaft and armature with sprocket wheels connected by a link belt.

The form of the wave given by the generator is important.

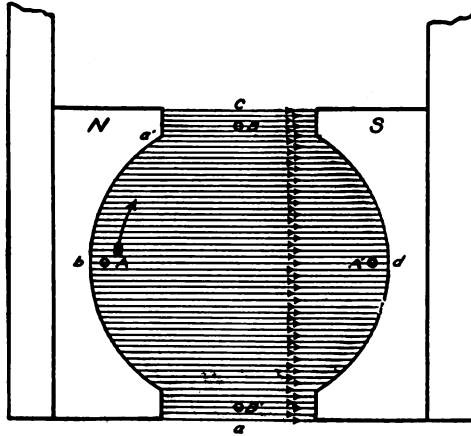

FIG. 248.— DIAGRAM OF FIELD.

Consider the diagram of Fig. 248. *NS* represents the poles of a magnet that produces a field of force indicated by light horizontal lines between the pole pieces. This is assumed to be a uniform field. Let *A* be the section of a wire that revolves uniformly in the direction of the arrow. While the wire is traversing the portion of the field represented by *A* it is nearly at right angles to the lines of

force and consequently cuts them with the greatest rapidity. When the wire reaches the point *B* and is moving in a direction nearly parallel to the lines of force, the rate of cutting is the slowest. Further, when the wire is moving at *A* it is traversing the field produced by a north pole. When it is moving near *A'* it is immersed in a field produced by a south pole. As the e.m.f. is proportional to the rate at which the wire cuts the lines of force it is evident that in each revolution there will be four different conditions. Starting at the point *a* the wire as it moves toward *b* cuts the lines in the field of the north pole at a constantly increasing rate which is a maximum when the wire reaches the point *b*. Throughout this portion of its path the e.m.f. is correspondingly increasing and may be termed "positive." From *b* to *c* the rate of cutting is reversed and is decreasing and hence the e.m.f. which was a positive maximum at *b* declines to zero at *c*. From *c* to *d* the rate of cutting is again on the increase, but the wire is now traveling in a south polar field and hence the e.m.f. is reversed or is negative. When the wire reaches *d* the rate of cutting is a maximum and the e.m.f. reaches its highest value, declining from this point as the wire travels toward its starting point *a*. This analysis shows that during every revolution of the armature of a ringing generator there will be two waves produced, a positive and a negative, each of which will reach their greatest values when the coil is traveling opposite the center of the pole pieces. With appropriate apparatus it is easy to measure the changes in e.m.f. from instant to instant as the armature revolves and if this is done an e.m.f. curve can be plotted which usually closely resembles the line shown in Fig. 249, which is termed a "sine curve." These diagrams have been based upon the assumptions that both

the action of the wire and the magnetic field were uniform; such, however, is never the case, for with the hand driven generator all sorts of speeds will obtain, and owing to the shape of the pole pieces and cross section of the armature the distribution of magnetism is anything but uniform and, if the density of the magnetic field changes, a corresponding variation will be found in the e.m.f. curve. The form of electric wave shown in Fig. 249 has been found by experience most suitable for the operation

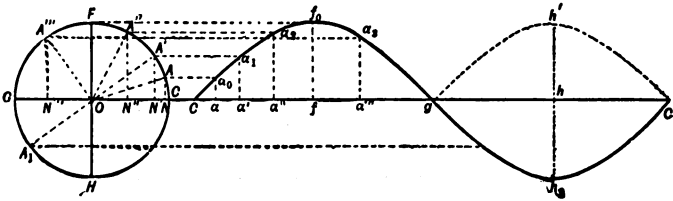

FIG. 249.—SINE CURVE.

of polarized bells, but, unfortunately, to secure the sine curve, requires a machine that is difficult and expensive to construct. Nevertheless by modifying the relative shape of the pole pieces and the armature, a close approximation thereto can be secured. If the cheeks of the armature core are too narrow to span the gap between the pole pieces when the plane of the armature coil is horizontal, the wave produced will assume a form approximating to that of Fig. 250A, or will consist of two very distinct peaks both in the positive and negative pulsations, which are separated by a depression more or less deep. The origin of these peaks is readily explained. When the cheek of the armature core is in the centre between the pole pieces, a con-

siderable air gap exists and the density of the field is suddenly decreased; this causes a depression in the top of the wave. If the armature cheeks are so wide that they considerably overlap the intervals between the pole pieces, the curve, representing the wave, will be flattened on top, as shown at Fig. 250B, but will not contain any marked depression. The overlapping of the armature supplies

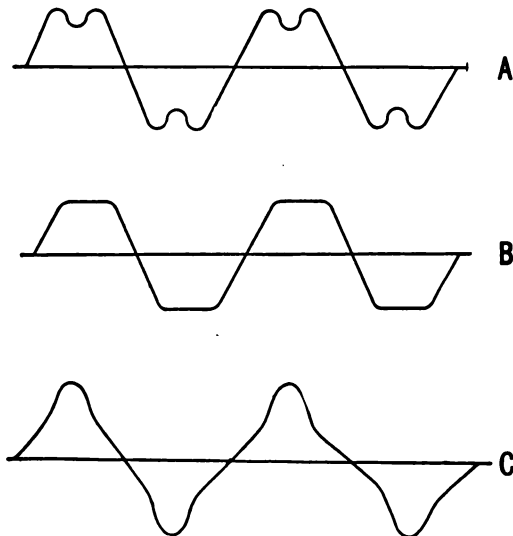

FIG. 250.—ARMATURE CHEEKS TOO NARROW.
 CHEEKS TOO WIDE.
 CHEEKS PROPERLY PROPORTIONED.

the field between the poles with a good conductor of magnetism, and consequently tends to extend the time occupied by the conductors in cutting the lines of force at their maximum speed, and this produces the flattening. An air

gap which is too great or an armature whose cheeks cover too great a proportion of its circumference, produces a form of wave which is objectionable. Experience has shown that on the whole the best results are obtained by proportioning the pole pieces and the armature cheeks so that each occupies 90 degrees of the circumference through which the armature rotates. Or in other words the armature cheek should just about fill the gap between the two pole pieces when the plane of the armature coil is horizontal. Machines built with this design produce waves which correspond closely to Fig. 250C. While this is not a true sine curve it is as close an approximation as can be obtained thereto without excessive difficulty or expense in construction.

For some purposes of selective signalling, particularly those adopted in some of the modern toll boards and in certain forms of polystation service, it is desirable to have direct current. For this purpose ringing generators are sometimes built supplied with a commutator, the office of which is to rectify the alternating current waves that have been described, and cause the machine to deliver current which is nearly of uniform polarity and intensity. One form of direct current generator is shown in Fig. 253. It differs in few particulars from the machine previously illustrated, excepting that the plate carrying the automatic shunt is supplied in addition with a commutator, which consists of a pair of insulated semi-cylinders clamped upon the end of the armature shaft. Two springs are arranged to bear upon these cylinders which thus serve to rectify the current delivered by the generator.

Another improvement recently made in ringing generators provides one which is designed to give either alter-

nating or direct current at pleasure. In this device the armature shaft, provided with a shunt so arranged that if the crank is rotated right handedly the shunt is opened, the armature cut in the circuit in the usual manner and the generator delivers alternating current, while, if the crank be rotated left handedly the shunt is also opened but in its

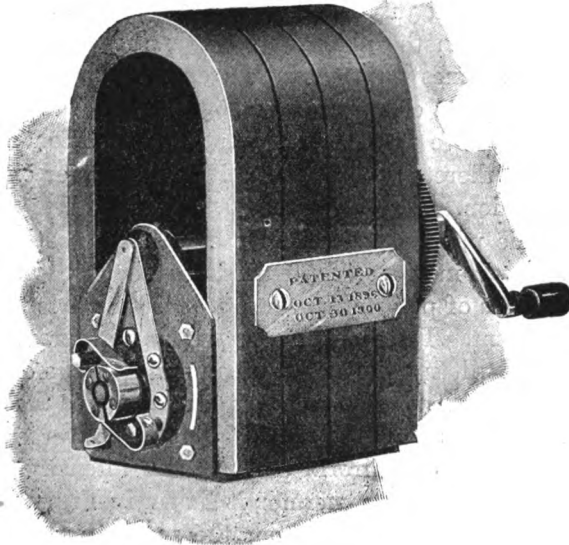

FIG. 251.—DIRECT CURRENT GENERATOR.

place a commutator is cut into circuit and the machine can deliver direct current.

In some substation circuits the generator is bridged across the line, or else is legged on one side of the line to earth. In such cases it is desirable that when the generator is out of service it should be open circuited in order

that it may not operate as a shunt to either voice or signalling currents. To achieve this end the operation of the automatic shunt already described is reversed in such a way that when the generator armature is standing still the armature circuit is completely opened, while, when the crank is turned, the circuit is closed through the armature in the normal manner. Such generators are termed "Open Circuit Generators" in distinction from those whose armatures are shunted out of circuit leaving the line closed.

CHAPTER VII.

PROTECTION.

THE currents used in telephony are of slight amperage, consequently only the smallest sizes of wire are employed in the construction of substation and central office apparatus. Telephone lines may be exposed to heavy currents and then the apparatus connected to them is almost certain to be injured or destroyed by the heating of the conductors. The buildings containing them may be set on fire, and in case conversation is passing the users might be exposed to a disagreeable or even an injurious shock. To avoid such catastrophes it is customary to equip central offices and substations with certain electro-mechanical, or electro-thermal devices having for their object the rupture of the line, and isolation of the apparatus in case abnormal conditions present themselves, before damage can be done. Such devices are termed "*Protectors.*"

Exposure to abnormal currents may arise from accidental contact with other conductors, such as electric light and power wires, or from the operation of atmospheric causes such as lightning, and the successful protector must be adequate against both high and low voltages, and be equally efficient with direct or alternating currents under all frequencies. Telephone lines which are completely underground may be said to be entirely immune from all danger from atmospheric electricity, for it is to the last degree improbable that a lightning flash will penetrate a sheathed cable enclosed in a conduit. Contact with other circuits is equally rare except during times of construction, repair or rearrangement. Underground lines which

enter and traverse buildings illuminated by electricity may, inside of the building, come in contact with lighting circuits, but this risk is now considered so remote that present practice has abandoned placing protection upon underground telephone circuits and considers it sufficient to protect only those which are wholly or partly aerial.

The requisites of a successful protector are best ascertained by a consideration of what happens when a line is exposed to an abnormal current. Take the exceedingly rare though conceivable event of a thunder bolt striking the wire or poles. Probably both would be destroyed and it is doubtful if any of the commercial protectors would suffice against even a very moderate lightning flash.

A much more common occurrence is that of a heavily charged cloud which by gradual approach induces a static charge in the earth, and telephone line beneath. Suppose the cloud to be suddenly discharged by a flash, then the charge upon the line and the earth is no longer bound, but seeks equilibrium by all possible paths. At the substation and central office the rushing charge encounters the impedance of the receivers, relays and other apparatus, and will probably manifest itself by a sparking which punctures the insulation and ruins the coils. Such a discharge is relatively of high voltage and frequency and finds no difficulty in jumping an air gap that is a perfect barrier to all telephonic currents. To protect against atmospheric discharges of such character is relatively a simple matter. A carefully grounded conductor is provided that is as short and straight as possible in order to have the least impedance. This is carried to a point near the apparatus to be protected and terminated in a plate either of metal or carbon. The telephone line is supplied with a corresponding plate set close to the first one, and yet at such dis-

tance as will prevent any telephonic currents from crossing the intervening air gap. In order to divert the flash from the telephone line to the ground it is sometimes customary to introduce just beyond the air space an impedance coil usually termed a "choke coil." Such a coil constructed of relatively large wire is rarely injured, but affords so much opposition to the high frequency of the lightning flash as to aid in diverting it across the air gap to earth. In other cases the impedance of the apparatus is relied upon to produce the same effect. Such an apparatus is termed a "lightning arrester," "spark gap" or "open space cut-out." The best form consists of two carbon plates separated by a thin piece of mica from 1/50th to 1/200th of an inch in thickness. The mica is perforated with holes or cut in the form of a U thus allowing an uninterrupted air space across which the discharge may occur. Such a mica separator affords at once a cheap and accurate means of maintaining the plates at a constant distance from each other. Experience has shown that carbon is the best material for spark gaps for the molecular condition of its surface is such as to facilitate a discharge, and even if indefinite number of flashes do take place, there is but little tendency to burn the plates nor is any trouble experienced by the fusing of them together which sometimes takes place when metal is used. As the air gap presents considerable resistance it is desirable, if a discharge takes place, to automatically ground the line and thus remove this resistance from the safety path, should the flow continue, and to provide additional protection in case of a second discharge. This is accomplished by setting the carbon plates horizontally and excavating in the upper one a small cavity which is filled with a drop of easily fusible metal, so if a discharge continues for any

length of time the drop fuses and short circuits the air gap.

Another method consists in placing a lead shot in the cavity imbedded in wax which is melted in the same manner by the heat of the discharge. As soon as the wax fuses the shot rolls across the air gap and dead-grounds the line.

If a telephone line becomes crossed with a wire carrying a high potential current, much the same sequence of events occurs, for the spark gap breaks down and the apparatus protects by permanently grounding the carbon plates. In this case another hazard is imminent, for the foreign circuit may carry so large a quantity of current, as to heat the carbon plates or the telephone wire until these become dangerous as a possible source of fire. It is therefore customary to interpose in the line, outside of the spark gap, a fuse from 3 to 7 ins. in length, capable of carrying from 5 to 7 amperes. Usually this fuse is of the enclosed type, both as to matter of mechanical protection, and because, by enclosure, the inevitable arc formed when the fuse blows is more readily extinguished, either by immersing it in some compound that suppresses the arc, or by relying upon the expansive force of the metallic vapor formed inside the enclosure to blow out the flame. As soon as the spark gap breaks down and the metallic button or shot, dead-grounds the line, a rush of current follows sufficient to blow the fuse, which, if placed outside of the wall of the building completely, severs all connection with the charged wire.

There still remains a more insidious danger against which neither fuse nor spark gap are effective. This is the *sneak current*, or current of so low voltage as to be unable to leap the air gap, and of so low amperage as

successfully to traverse the fuse, and yet of sufficient quantity to burn out receivers or drops if long continued. The spark gap must have sufficient resistance to be inoperative with the highest voltage used in telephony, or else it will paralyze regular service. Usually the ringing generator supplies 80 to 120 volts. Most of the Edison three wire systems carry 110 volts and hence will not break down the spark gap, if it be sufficient to withstand the potential of the ringing generator. There are alternating circuits which distribute at 50 volts, hence the spark gap would not protect against a cross with such lighting circuits, and in this event both substation and central station apparatus would probably be injured and the user of the telephone subjected to a dangerous exposure, for there are cases on record where 50 volt alternating circuits have been known to kill.

There is little telephone apparatus which is designed to carry over $\frac{1}{2}$ ampere continuously, hence the protector must operate under small amperage and on the other hand it must without failure transmit the normal currents used in common battery installations.

The first thought is to employ another fuse for this purpose, but experience has shown that the small current fuse is an exceedingly unreliable device. It is very difficult to prepare a light fuse which shall have a constant melting point. If alloys are used the slightest variation in chemical composition changes the fusing point greatly. If a simple metal is taken, the fusing temperature becomes so high that in order to ensure failure with a slight current the wire must be so small as to be mechanically insecure, and liable to rupture with the slightest accident. Changes in environing temperature operate to increase unreliability. A fuse located in a warm protected situa-

tion will carry much less current than a similar one exposed to cold and draught. For these reasons the fuse is discarded as untrustworthy and while many devices have been proposed, the so called "Heat Coil" has best survived the test of time and experience. This is a small coil of resistance wire which surrounds a pin or other device to which it is secured by an easily fusible solder and the whole enclosed in a case of non-conducting material. A spring is arranged to bear upon the pin in such a way that it is released by the fusing of the solder and allowed to move to contact with a ground, at the same time opening the line which passes through the coil. Hence when a telephone wire is exposed to a current of too low voltage to cross the air gap, and too slight amperage to melt the line fuse, the heat coil is expected to protect by opening the line on the apparatus side, and grounding it upon the line side. As soon as this grounding occurs a rush of current takes place exactly as when the carbon plates are short circuited. This increase of current is expected to blow the main fuse, thus affording complete isolation.

✓ The carrying power of any heat coil will depend on the resistance of the wire with which it is wound, the radiating power of the case enclosing the coil and the temperature at which the solder holding the pin will melt. The coil is usually wound with German silver wire from 5 ohms to 50 ohms, depending on the sensitiveness desired, and on whether the coil is to be used on magneto or common battery circuits. In order to present as little impedance as possible to voice currents it may be wound non-inductively for the heating effect is solely proportional to ohmic resistance, and is unchanged by the method of winding. What is called 160° metal is often used as a solder. This is a compound of lead and various other metals, the precise

composition changes with every maker. Table XVIII shows some compositions used for this purpose.

TABLE XVIII. HEAT COIL ALLOYS.

Bismuth.	Lead.	Tin.	Cadmium.	Melting Point.
8 parts	5 parts	3 parts	0 parts	212° F
2	1	1	0	200° F
5	3	2	0	190° F
8	4	2	2	160° F

It is obviously essential that the heat coil shall carry without failing the maximum current which is to operate the telephone line upon which it is placed, and it is equally plain that the best protection is afforded by such a coil as will fail with as small a current as possible in excess of the normal current for which it is designed. Magneto exchanges operate with very much smaller currents than common battery installations, and for such work heat coils are usually designed to carry safely about 1/10 of an ampere. Common battery lines usually carry about $\frac{1}{4}$ of an ampere, sometimes from $\frac{4}{10}$ to $\frac{5}{10}$ of an ampere, and for such systems the heat coil must be correspondingly less sensitive. Fig. 252 is a curve showing the relation between the current and time required to cause an ordinary common battery heat coil to operate. This curve indicates that the coils will carry indefinitely $\frac{4}{10}$ th of an ampere and will carry $\frac{5}{10}$ th of an ampere for a period of fifty seconds. Any current above $\frac{8}{10}$ th of an ampere will cause the coil to fail within one second. By changing the resistance of the wire with which the coil is wound, or the melting point of the solder, or the radiating surface of the coil case, any relation between current and time of failure can be readily obtained. This curve shows

that a heat coil may be rated in one of three ways. 1st. Its permanent current carrying capacity may be specified. This corresponds to the points on the curve at and below $4/10$ th of an ampere. 2d. The current which will cause the coil to fail in a second or less may be indicated. This corresponds to the part of the curve above $8/10$ th of an ampere. 3d. Finally the portion of the curve between $5/10$ th of an ampere and $8/10$ th of an

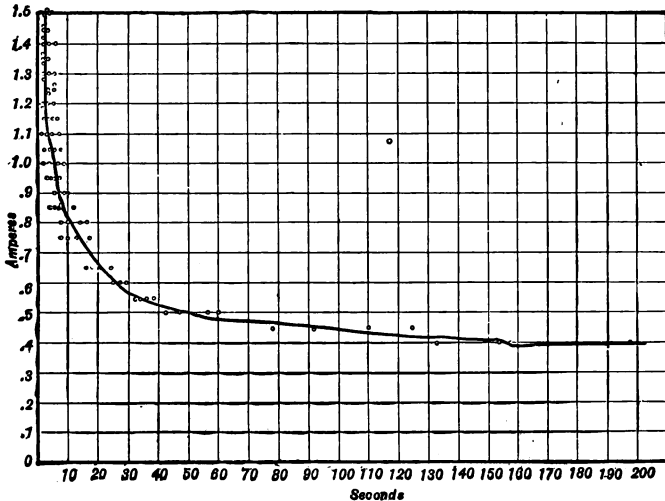

FIG. 252.— TIME-CURRENTS RELATION FOR HEAT COILS.

ampere may be expressed as ampere-seconds; that is to say, the product of the current and the time that it acts in order to make the coil fail. As the relation between current and time is a curve, the ampere seconds will vary with different amounts of current, but it is often customary to take the average of the ampere seconds and rate

the coil accordingly. Thus the type of coil illustrated in Fig. 253A would be called a safe coil for $4/10$ th of an ampere; a sneak current rating of two ampere-seconds; and instantly sensitive to current rushes of $8/10$ th of an ampere.

The location of protective apparatus is a matter for careful consideration. Consider a line of entirely open wire. If such a circuit be exposed to an abnormal current, both the substation and the switchboard ends must be protected, and to ensure protection the devices must be located as close as possible to the telephone set, and to the switchboard, otherwise exposure may take place between the protector and the apparatus. Therefore at each end of the line protection must be installed. At the central office it is usual to place the protection either upon the main distributing board, or upon the cable heads in case the latter are used inside the building. If cable heads are employed, the protectors are usually placed upon the sides of the iron box, and each entering line is furnished with its individual device. If protection is placed upon the main distributing board it must be located either on the cable side, or on the switchboard side,—the latter is usually the location chosen, because there is always some excess wire plant over working lines, and as it is only the switchboard plant which needs guarding, fewer protectors and a cheaper installation will suffice if placed upon the switchboard side. But this location leaves all the jumper wiring of the distributing board unprotected. Often such wiring is of okonite and quite inflammable. Further, a slight fire may injure a large number of jumpers, so that the surest though most expensive method is to protect the cable side. It has become common practice to use wool covered wire for jumpers. This insulation is fairly non-combustible and goes far

to obviate fire risks in the distributing board. Therefore, the tendency of present practice is to equip the switch-board lines only, and to take the chances.

The design of central office protective apparatus varies considerably. There can be no question but that the combination of heat coil and carbon plate is universally considered to be the best, whether mounted upon the cable head or the distributing board. Still many exchanges content themselves with simply a short fuse or a pair of carbon plates, and run the risks.

At substations a complete outfit, consisting of a line fuse, carbon plate, or spark gap and heat coil should be installed. But there is considerable difference of opinion as to the location of the line fuse. It is held by some that all protective devices, fuse, plates and coil should be combined in one fireproof enclosure, so placed as to be readily accessible for inspection and repairs, and set as near as possible to the telephone set. Obviously this leaves all the wiring inside the building exposed to the full pressure of any circuit with which the telephone wire may be accidentally crossed, and consequently such telephone wiring must be so installed as to be safe in the event of such a contingency. In other cases the protector is located on the housewall, outside of the building. That this practice secures greater safety is unquestioned, and makes a cheaper class of interior wiring tolerable, but the protector is now exposed to the elements and must be properly housed. It is more likely to get out of order, and it is more difficult of access when repairs become necessary. Hence both installation and maintenance costs are increased.

In other cases the heat coil and carbon plates are set close to the telephone set, while the line fuse is placed

outside the building. This plan has many obvious advantages. The housewiring is guarded by the line fuse and may be of the most economical character. The heat coil and carbon plates, which form the most delicate parts of the protector, are located close to the instrument and are of easy access, but in case of trouble the inspector may have to visit two places in order to discover the cause of the difficulty.

There is considerable diversity of opinion as to the protective equipment desirable for substations. That the combination of fuse, spark gap and heat coil is the best, no one questions, but many substations omit the fuse, while others are supplied merely with the spark gap.

So far, only the case of a completely open wire line has been considered, but the use of aerial cable is rapidly extending and presents somewhat different conditions. Cable conductors are much smaller than open line wire. The paper with which they are insulated is a frail barrier against abnormal currents and hence, if a cable is connected to an open wire line, a lightning discharge, or a cross which would be easily resisted by the open wire, may enter the cable and destroy it, even though the central office and substation are so carefully guarded as to be immune. To guard aerial cable it is usual to introduce a protective device between open wire line and the cable head at which the open wire line terminates. Protection at this point may consist either of a fuse or of a spark gap, or both. The latter is certainly the surest and most preferable, so for this purpose cable heads are now designed having fuses and carbon plates for each line which they carry.

The complete protective scheme for aerial wire lines is exhibited in Fig. 253. Here the switchboard side of

the main distributing frame is shown at *A*, equipped with a heat coil and carbon plates for each side of the line. From the line side of the distributing frame the diagram indicates an aerial cable passing to a cable head secured upon the line pole. At *B* this head is installed inside of an appropriate stormhouse and furnished with carbon plates and line fuses. From the terminals of the line fuse a bridle wire passes to the insulators upon the cross arms, and thence, by means of open wire, to the subscriber's premises *C*. Here the protecting device consists of fuse, carbon plate and heat coil for each side of the line.

Aside from the engineering questions connected with protection there are two aspects of the subject which must

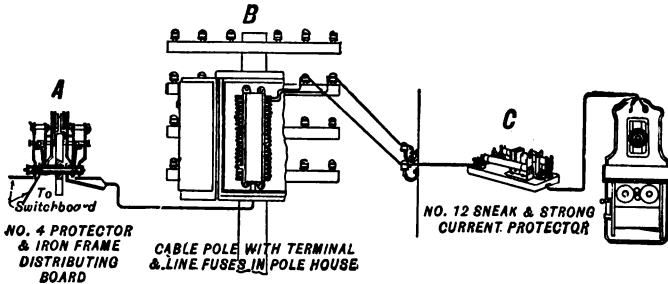

FIG. 253.—GENERAL SCHEME OF PROTECTION.

receive consideration. The first is one for the general manager of the telephone company. He must weigh the probable advantages of protection and determine whether or not it is for the economic interest of the company to employ it. Protectors are somewhat expensive and add from \$1.00 to \$1.50 per line for every subscriber that is fully equipped. In addition to the installation cost, annual maintenance expense is decidedly enhanced by their use, the number

of cases of trouble augmented, and the certainty of a somewhat less satisfactory service, for the subscriber rarely analyzes sufficiently, or discriminates well enough, to differentiate an open line caused by the normal operation of the protector, from that due to any other form of trouble.

That protectors do not always protect cannot be gainsaid, although general experience confirms the belief that they usually do. So the general manager must determine whether the cost of installation and maintenance of the protectors will be more than sufficient to recoup the company for damages which may be inflicted by strong currents.

The other aspect is that from which the subscriber and the various insurance companies may consider the question. In the past insurance companies have formulated rules exceedingly burdensome for telephone companies to put into execution. But it is gratifying to note that underwriters are becoming more reasonable, more keenly alive to advantages of telephonic connections, and more sensible of the small hazard which telephonic wires introduce. Yet it is certainly reasonable that both the subscriber and the underwriter should require the telephone company to so install wiring that buildings entered may be subjected to the least reasonable hazard. Experience has shown that the full protection of line fuse, carbon plates and heat coil have in a great many instances averted dangerous fires. Therefore, it does not appear unreasonable for the subscriber and underwriter to require the installation at each substation, connected to an aerial line, of the most complete and effective protection known to the art, and in some of the larger cities insurance companies condition underwriting upon the installation and maintenance of complete protection. In the smaller cities and towns

such concerted action has not yet taken place, but in case of damage by fire, where it could be shown that the telephone company had failed to use adequate protection for the substation, insurance policies might be held vitiated and possibly the telephone company liable for damages. Thus, so far as the substation is concerned, the manager who omits complete protection is assuming a risk that appears entirely incommensurate with any possible saving.

The question at the central office is different. Here the apparatus is always, and the building often, the property of the telephone company. If protection is omitted, any injury following falls chiefly upon the telephone com-

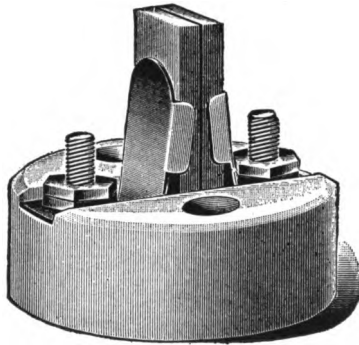

FIG. 254.—SINGLE POLE SPARK GAP.

pany which may either underwrite itself, or coax insurance companies into accepting the risk either with or without protectors, as they may see fit.

Consider now how the various commercial forms of protectors commonly to be met with in the market fulfill requirements. The simplest form is the open space cut-out which occurs in an innumerable number of forms of which

Figs. 254, 255 and 256 are representative. In Figs. 254 and 255 a porcelain block is provided upon which suitable springs for holding carbon plates are mounted. In Fig. 254 there are two plates, one of which is grounded, while the other is attached to the line. Such a contrivance is only

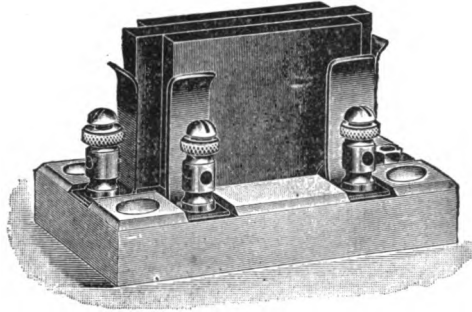

FIG. 255.—DOUBLE POLE SPARK GAP.

suitable for a single wire and is insufficient for a metallic circuit. In Fig. 255 there are two plates, the center one being grounded, while a companion plate on each side of the center plate is attached to one of the line wires. In all arresters of this type the carbon plates are separated by a thin sheet of mica which serves to maintain accurately a constant air space. As the sensitiveness of the open space cut-out depends on the thickness of the mica, it is a great mistake to change this unadvisedly, or to insert two pieces of mica as is sometimes done if the gap often operates. The fact that a gap discharges frequently is a danger signal, an indication that the line *needs protection*, and not that the gap should be decreased in efficiency; as well as put out the red lights on a railway to avoid delay to trains.

Fig. 256 shows an attempt to combine a carbon and

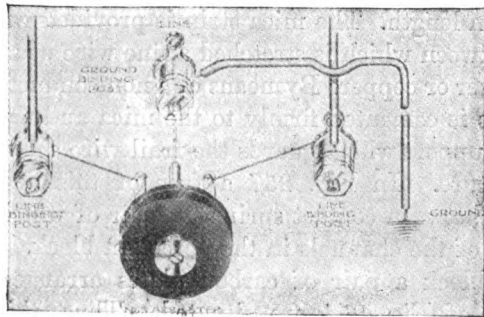
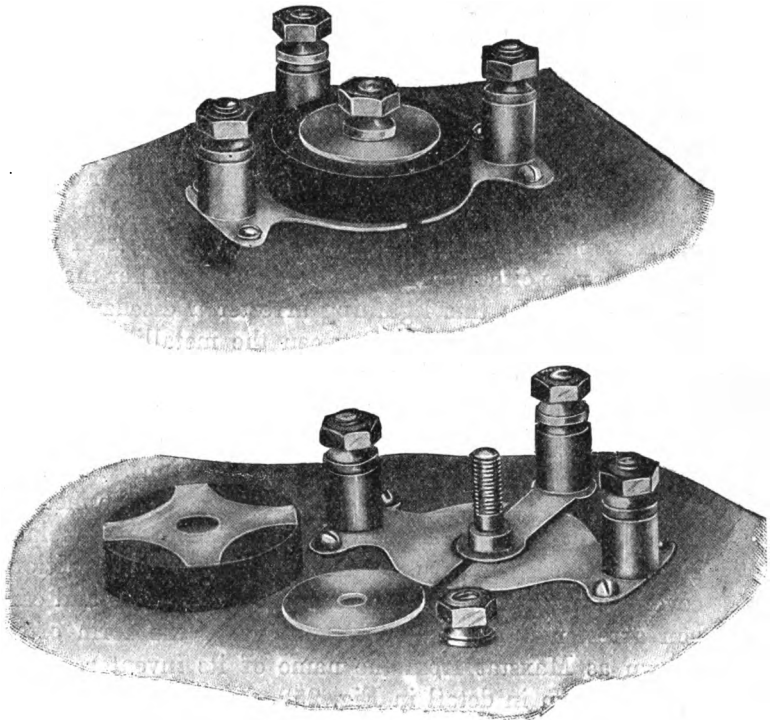

FIG. 256.—CARBON AND METALLIC SPARK GAP.

metallic plate lightning arrester, together with the method of wiring. The line wires are attached to the binding posts standing on two plates with sharpened or serrated edges. Between these plates, separated therefrom a short air space, is a third plate carrying a post to which the ground wire is attached. In the center of this plate is a stud upon which a circular disc of carbon is placed separated from the line plates by a sheet of mica which may be either perforated or slightly smaller than the carbon disc. In this lightning arrester a discharge may take place either directly between the metallic plates or from the metallic plate to the carbon block and thence to ground. Such an arrester is usually mounted directly upon the woodwork of the substation set. On the whole either Figs. 254 or 255 form preferable designs. Fig. 257 represents a somewhat more evolved type, and the method of attaching it to the telephone set. Here a porcelain block is divided into two channels by a central partition, covered by a mica plate. In each channel a fuse and carbon arrester is located. The fuse is of the form often known as Maxstat from the name of its inventor. The fuse is shown in detail in Fig. 258, from which it is seen to consist of a strip of mica $\frac{1}{2}$ in. wide and from $1\frac{1}{2}$ to 2 inches in length. The mica strip is provided with metallic ends between which is stretched a fine wire usually of German silver or copper. By means of a non-conducting varnish the wire is cemented firmly to the mica and thus supplied with a support which guards the frail wire against accidental rupture. In Fig. 257 a fuse of this description is slipped between contact springs, a pair of which is located in each of the channels in the porcelain block. At the end of the block a pair of carbon plates arranged after the fashion of Fig. 254 are situated. Thus, this protector

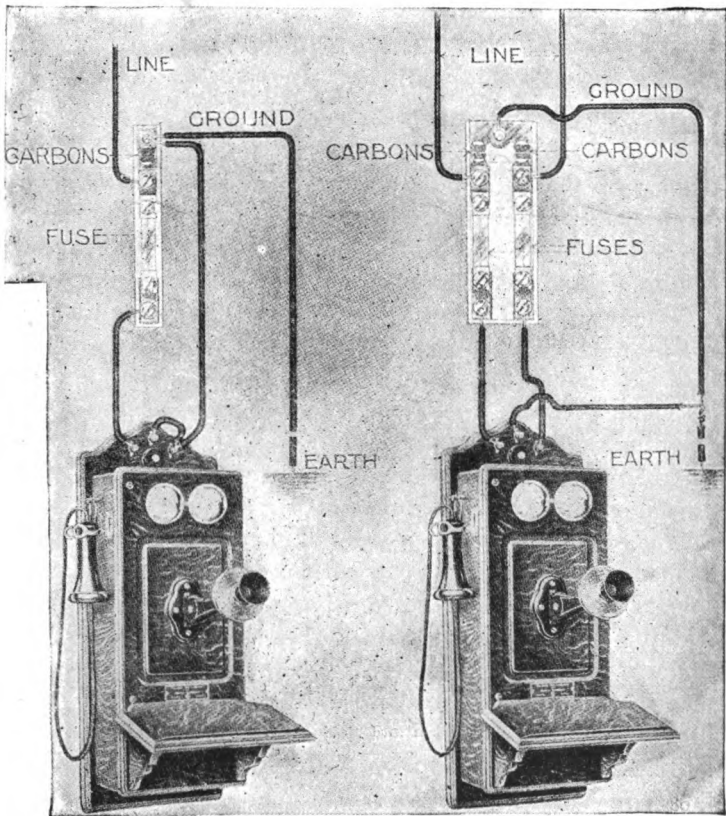
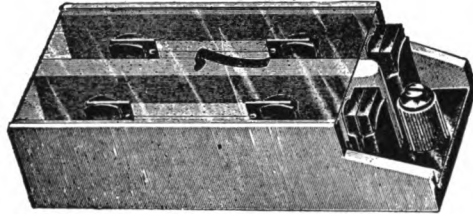

FIG. 257.—COMBINED SPARK GAP AND FUSE.

provides an open space cut-out, and a fuse of reasonably low carrying capacity and fair reliability.

A more highly developed protector is shown in Fig. 259 while Fig. 260 is a diagram of the circuit. There is a porcelain base upon which two pairs of springs are mounted, one for each side of the line. Directly back of the springs a "shunt" lever is situated that is pivoted to a ground



FIG. 258.—DETAIL OF FUSE.

plate. At the top of each pair of springs an exceedingly ingenious heat coil is placed in such a manner as to draw the springs together and away from the lever. In case an abnormal current traverses either side of the line the heat coil operates, the springs are released and contact is made with the lever *A*. In case the abnormal current traverses both sides of the line at once, both heat coils operate and both sides of the line are grounded, simultaneously on touching the lever but as an additional protection, in case only one of the heat coils fuses the spring pushes the lever in contact with the spring of the other side of the line, and thus one coil grounds both sides of the line. Just behind the heat coils there are two carbon plates, one for each side of the line. These are separated from a grounded metallic plate by mica strips. The whole apparatus is enclosed by a glass cap. This form of lightning arrester provides no fuse, as it is built with the intention of having the line fuse mounted on the outside of the wall of the building. The heat coil is exceedingly ingenious, and it is shown in detail in Fig. 261. There are two metallic caps

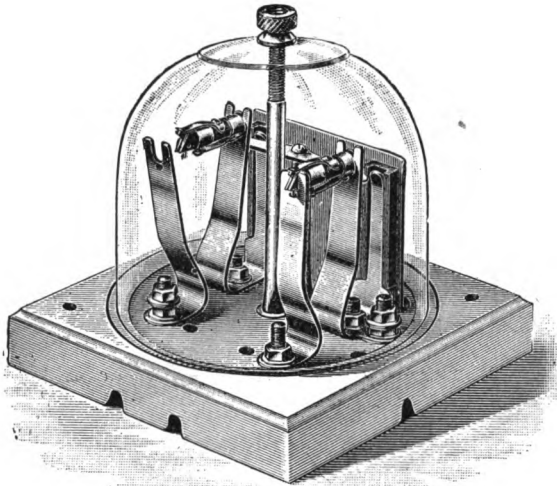

FIG. 259.—ROLF SUBSTATION PROTECTOR.

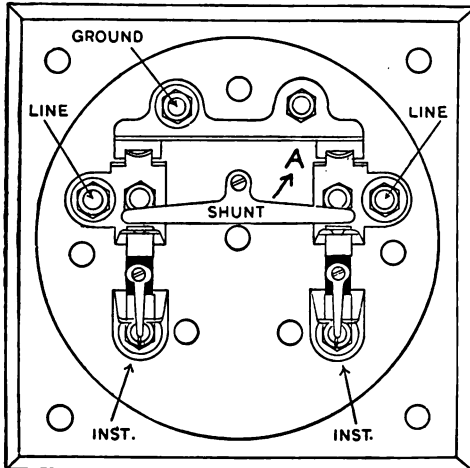

FIG. 280.—CIRCUITS OF ROLF PROTECTOR.

A and *B*, one of which, *A*, is supplied with a slot that engages with one of the line springs, the other cap, *B*, carries two cheeks which embrace a star wheel as at *C*, or a lever as indicated at *D*. Either wheel or lever is secured by a pivot passing through the cheeks, and normally holds the line springs in position as shown at *C*. The lever or wheel is soldered between the cheeks by fusible metal. A carbon rod or other high resistance conductor

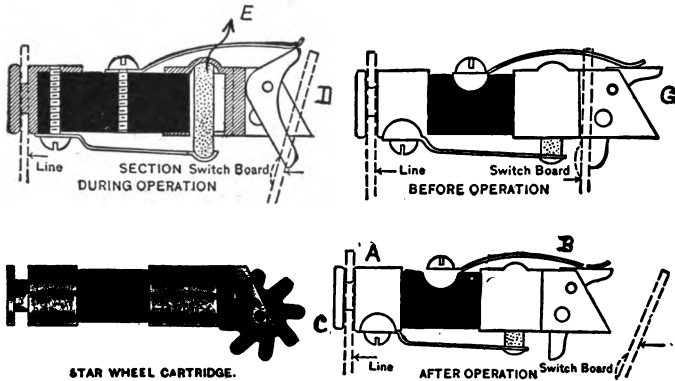

FIG. 261.—HEAT COIL OF ROLF PROTECTOR.

is inserted in the circuit through the cap *B*, as at *E*. In case of an abnormal current the carbon rod becomes heated, the metal cap containing it warmed and the solder holding the lever or wheel melted. This allows it to turn upon its pivot under the tension of the line spring, which is thereby released. As soon as this happens a spring placed on the top of the heat coil returns the lever to its normal position and as the line current has been interrupted the cap cools, and self solders itself in operative condition, so all that is necessary to restore the appa-

ratus to working order is to lift out the heat coil and to return the line spring under it to its place. The successive steps in the action are shown in Fig. 261.

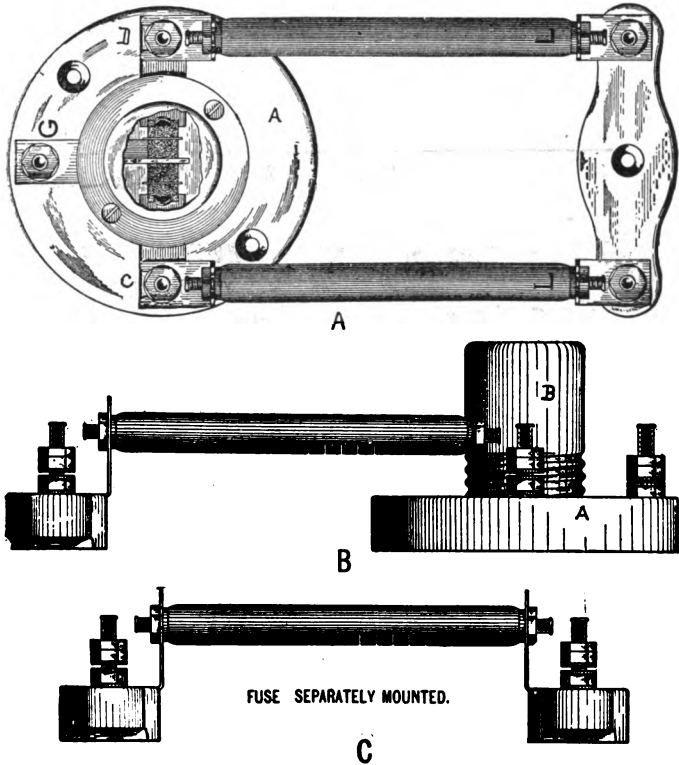

FIG. 262.—COMMON BATTERY PROTECTOR.

A protector advocated by the American Telephone & Telegraph Co., for common battery substations, is that shown in Fig. 262, in which *A* is plan and *B* an eleva-
 25

tion. Upon a circular base of porcelain, *A*, a pair of carbon plates are mounted between appropriate springs, the

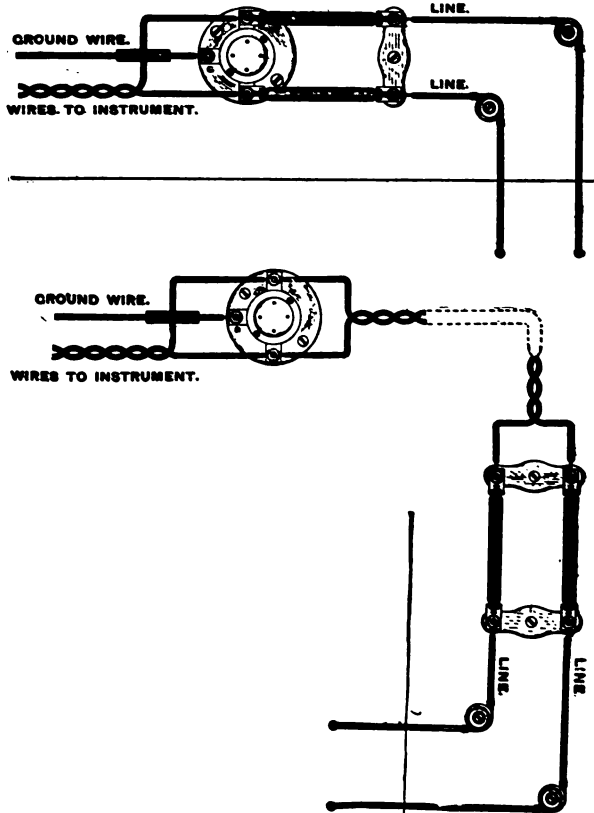

FIG. 263.—COMMON BATTERY PROTECTOR FUSES SEPARATED FROM SPARK GAP.

whole being protected by a brass cap *B* which screws over the plates. One plate of each pair is connected to the

terminal *G* which is grounded. From the terminals *C* and *D* a pair of fuses are extended to a second porcelain block, thus this form of protector contains an air space cut-out and a line fuse. It is easily mounted by attaching it to convenient wood work. In order to suit all conditions this arrester is so designed that if desired the carbon plates may be separated from the fuses and the latter mounted outside the house wall, while the plates are set in close proximity to the telephone set, as is shown in the elevation and plan in Fig. 263.

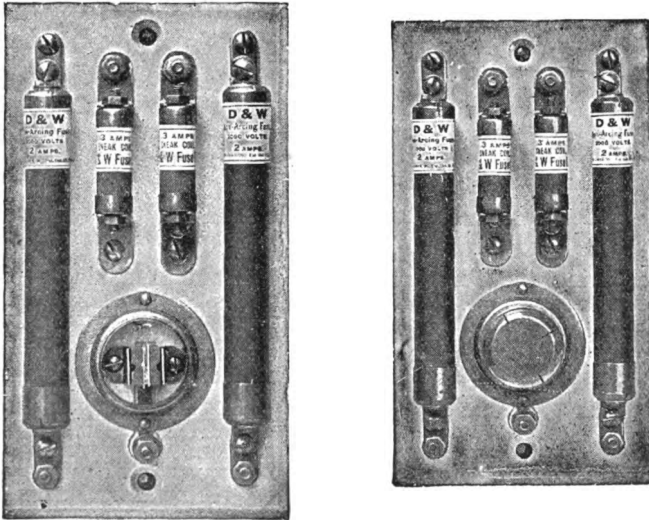

FIG. 264.—D. & W. PROTECTOR.

Protectors known as American Bell No. 8, the D. & W. telephone protector, and the Frank Cooke house protector, are the most complete devices. The No. 8 and the D. & W. telephone protector so closely resemble each other that

one illustration and description is sufficient for both. This is shown in Fig. 264. There is a porcelain block about 7 inches long by 4 inches wide; upon this is mounted a pair of line fuses, a pair of heat coils, and a pair of carbon blocks, so that this protector provides a sneak current arrester, an open space cut-out and a line fuse, all combined in a single piece of apparatus. The Cooke protector, shown in Fig. 265, somewhat resembles the other two, in

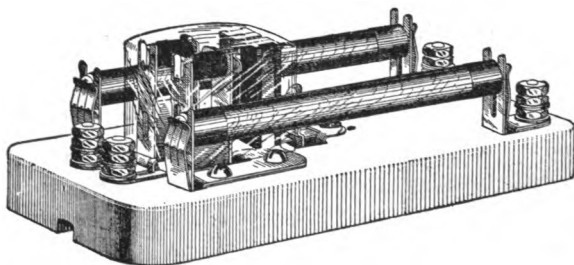

FIG. 265.— COOKE PROTECTOR.

combining the three protective elements in a single piece of apparatus. It, however, differs widely in the construction of the heat coils, and in the arrangement of the coils and carbon plates under a single shield formed of a rectangular glass bell.

The American Telephone & Telegraph protectors and the Cooke protector use fuses of somewhat similar construction in general resembling those represented in Fig. 266. This same style of fuse is also used as a line fuse either on the outside wall of the building or at the cable box. As is shown in Fig. 266 the fuse consists of an insulating tube either of wood or fibre, usually about $4\frac{1}{2}$ inches in length provided with metallic caps which afford a means both of attachment to the line, and of sustain-

ing the fuse wire, which is usually of a lead alloy, stretched through the interior of the tube. When such a fuse is used in a house protector, caps are arranged to be secured to the line springs. When used in aerial construction the terminals are furnished with a clip or clamp whereby they may be conveniently attached to the line wire.

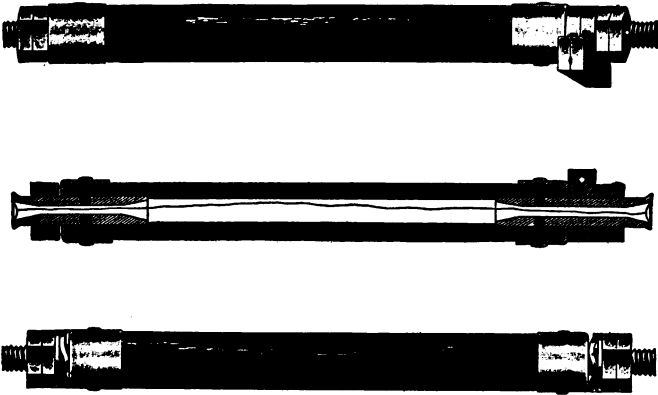

FIG. 266.— FUSES.

In Fig. 266 the fuse wire is shown simply stretched through the interior of the tube and the expansive force of the heated air is assumed to blow out the arc. In the D. & W. and other makes, the fuse is immersed in some compound that is supposed to aid in extinguishing the arc.

Numberless combinations of fuses and carbon plates have been devised for the protection of the junction between the open wire and the cable. Generally the method adopted is to provide a cable head something as is shown in Fig. 267, to the sides of which the carbon plates and

fuses are attached. This cable head is secured upon the line pole, the cable wires extending to the inside thereof, and soldered to terminals carrying the fuses and carbon plates, while from the exterior of the fuse terminals bridle wires run to the open wire. Finally the whole device may

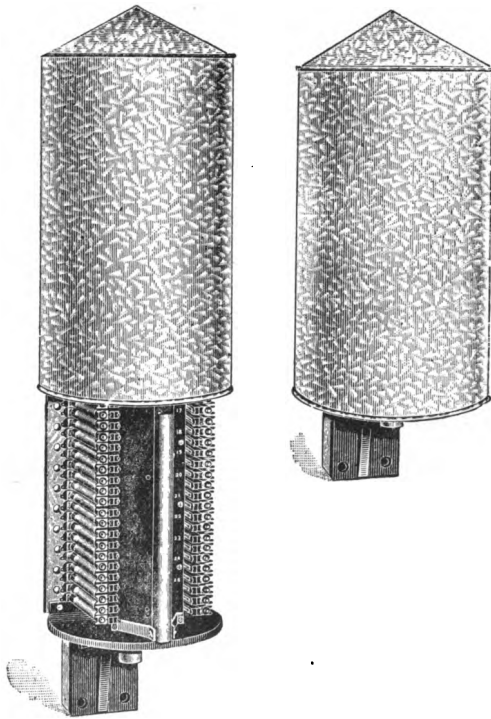

FIG. 267.—CABLE PROTECTOR.

be placed either in a balcony box or covered by a storm cap.

Considering the question of protection broadly, the

tendency seems on the whole to be toward more and more thorough methods. This is evidenced by a scheme recently proposed and put into service by the American Telephone & Telegraph Co. which is diagrammatically shown in Fig. 268. At the exchange the usual heat coils H and H'

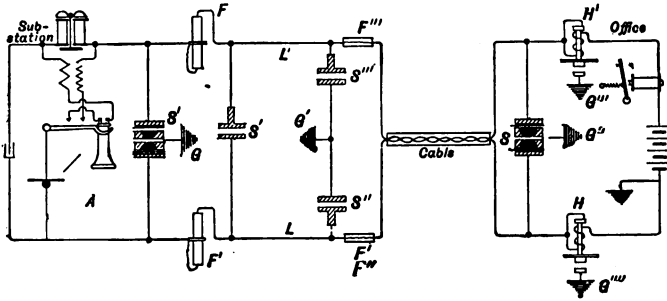

FIG. 268.— COMPLETE PROTECTIVE CIRCUIT.

on each side of the line together with the open space cut-outs S are used. Between the aerial cable and the open wire two line fuses of the usual type F''' and F'''' together with a pair of open space cut-outs S'' and S''' are introduced, one fuse and cut-out on each side of the line. At the substation an open space cut-out S' is bridged across the line, then comes a pair of fuses F and F' , which are a special design. The open space cut-out and the pair of fuses are placed outside of the house wall. At the instrument, a pair of heat coils and two more open space cut-outs, one for each side of the line, are installed. The fuses F and F' differ in some particulars from the ordinary line fuse and are shown in Fig. 269. The device consists of an insulating base of porcelain or other material B , upon which there are two standards G and D . These carry a fibre tube made long and heavy consisting of two

parts, an outer tube *A* and an inner tube *C* whereby the necessary strength is obtained. One of the line terminals *L'* is secured to the standard *G* that is in metallic contact with a plug *H* which fits and is firmly secured to one end of the fibre tube. The other end of the tube is open. The fuse is secured by means of a screw to the plug *H* and extending throughout the tube is turned back from the open end and soldered to the terminal *E* which carries the other line wire *L*. This fuse is constructed in a particular manner as it is smaller in section throughout the portion *F*

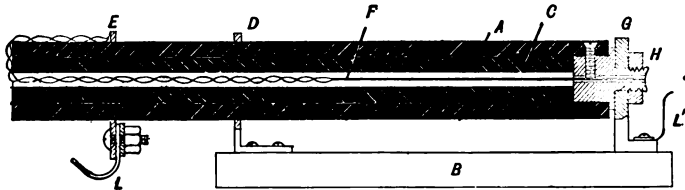

FIG. 269.—NEW MODEL FUSE.

and larger toward the open end of the tube. This causes the fuse to melt first near the rear of the fibre tube and the sudden expansion of the enclosed air caused by the arc formed, blows the fuse out of the open and extinguishes the arc. It is reported that the object of the method outlined is to provide greater safety owing to the rapid extension of alternating current plants which are operating at higher and higher potential.

CHAPTER VIII.

PARTY LINES.

THE load factor of any manufacturing undertaking is usually defined to be the ratio between the actual output and the possible output if the plant is operated continuously at normal full load. Thus an electric light plant having a capacity of 100 K.W. has an annual normal rating of 87,700 K.W. hours ($100 \times 24 \times 365$). Suppose such a plant to actually deliver 45,000 K.W.H., then the load factor would be $\frac{45,000}{87,700} = 51.3\%$. The load factor is an important consideration in determining the necessary charge per unit of output, for when the cost of supplying any commodity is reckoned there are many items of expense, such as interest on investment, allowance for depreciation, taxes, salaries of general officers, etc., which for a given installation either do not change at all, or so slightly, with variation in output, as to be inappreciable.

A plant with a small output, which means a low load factor, must make a higher unit charge in order to pay expenses than would be required provided the load factor were larger.

It is common in telephony to take the call as the unit of output of the plant, though it will be subsequently shown that the assumption of this as a unit contains a certain element of error. Experience shows that the time required for the average urban message is a little less than 2 minutes, dating from the time the subscriber removes the receiver, to the instant when the operator has replaced the cords after receiving the disconnect signal. Suburban

and rural messages are slower and subscribers talk longer, so from $2\frac{1}{2}$ to $3\frac{1}{2}$ minutes are expended, hence possible annual capacity, between stations taken in pairs, of a telephone exchange would be from approximately 150,000 to 262,000 messages. Some lines have been known, under exceptional circumstances, to originate from 125 to 150 calls per day. The average number of originating calls per station in the busiest offices of the largest cities rarely reaches 30. Small towns and cities usually average from 10 to 12 calls, while residence and rural districts may be placed from 3 to 4. The average for the United States is about $6\frac{1}{4}$ calls per day. Doubling these figures to allow for incoming messages and reckoning Sundays and holidays at about one-tenth the traffic of week days, the load factors for a telephone exchange calculated upon the preceding assumptions will be respectively 35%, $6\frac{1}{4}$ %, 2% and 0.67%. Excluding the 35% as an abnormal instance it is seen that the load factor is exceedingly low, which means that the plant is only in active service but a very small fraction of the time, yet in order that the business shall be self-sustaining, fixed charges must be paid, and either the cost per unit of output must be large, or means must be devised so that the plant can be kept in operation a greater proportion of the time. So, as the average substation uses its apparatus but a few minutes daily, the first thought that occurs is to connect several stations to one line and one set of switchboard terminals;—hence the so called “*party lines*,” which are now more properly termed “*polystation*” or “*multistation*” lines. Thus the origin of the “*polystation*” line is an attempt to reduce cost of installation and consequently cost of service by dividing the annual fixed charges over a greater number of substations, thereby reducing the amount to be assessed to each. This

is its only *raison d'être*, nor is there any other conceivable one, for it surely can never be asserted that polystation service is any *better* than can be given by a single line under similar conditions, though, with a slight stretch of the imagination, the multistation line could be considered equally good. Therefore in a discussion of this topic, economy is the paramount, and only consideration, and unless the polystation line can show beyond a peradventure a distinct and decided gain in this direction it has no business to exist.

The equipment of every telephone plant can be divided into three parts, namely such apparatus as belongs exclusively — 1st, to the substation; 2d, to the line connecting the substation with the exchange, and 3d, apparatus used only in handling traffic. The cost of equipment used for each of these divisions is almost completely independent of that which is necessary for either of the others. For example the number and cost of substation instruments will be directly proportional to the number of subscribers, while if many polystation lines are in use the number and cost of the line and terminals will be less than if each subscriber is placed upon a single circuit. The size of the operator's cord shelf (number of cords, plugs, signals, etc.), the number of trunk lines and the number of operators together with their equipment has little to do with either the number of lines or the number of stations, but only with the traffic, for it is easy to see that if one station originates 100 calls per day, it will require exactly the same attention, occupy as many cords and plugs, and require the same quantity of trunk line apparatus (operators' equipment and trunks) as a hundred stations, each making one call, assuming the traffic in both cases to be distributed over the same space of time. Hence to deter-

mine whether polystation lines are, or are not, desirable the functions of the different classes of apparatus must be kept strictly in mind, for to economize in one, and add a greater or equal expense to another, is certainly no gain.

Commencing, therefore, at the substation it is evident that the polystation line effects no economy, for there must be just as many substation sets as there are subscribers, whether there be one or many circuits extending to the central office, nor does it appear that any cheaper kind of set can be employed on the polystation line than on the single line, for each must perform the same functions, and do them equally well. Possibly in some cases a subscriber may tolerate a less ornamental outfit on a polystation at his residence than he would require on a single line at his office, but the tastes of customers seem to have little bearing upon the question of single versus polystation lines. On the contrary, in the various attempts to give to polystation lines a service that is both secret and selective, subscribers' sets are tending to become more and more complicated; this raises the cost of manufacture, and owing to greater intricacy such apparatus is more frequently out of order, and requires a higher grade of expert attendance to repair, thus that portion of the apparatus which strictly belongs to the substation is not cheapened by the use of polystation service, but if anything expense is increased.

Consider next the line. This consists of the necessary wire plant extending from the substation to the central office, together with a proper portion of the cable run, main and intermediate distributing boards, switchboard cable, answering jack and signal. Now there will not be the slightest change in any part of this equipment, whether

one or many stations be attached thereto, and hence, if many subscribers are placed upon one line, its investment, and all annual charges, can be divided directly in proportion to the number of stations.

Lastly, consider the question of traffic. To answer a definite number of calls originated in a specified time requires the use of a certain number of cords, plugs, trunks, etc., together with the operators to manipulate the apparatus, and it is evidently entirely immaterial whether all the calls come in on one jack, or whether they arise on separate ones. So assuming the traffic to remain constant (for it is inconceivable that the mere arrangement of stations upon lines shall have any materially modifying influence on the number of calls), no economy can be shown in either investment or annual expense. On the contrary the endeavor to provide selective signals has increased both the cost and annual expense of the operator's cord shelf by requiring a greater amount of more complicated apparatus, and has also tended to drag the operator, and cause her to do more work per call, and consequently answer fewer calls per day. So in this direction the poly-station line may become a source of increased expense. From these considerations it appears evident that where subscribers' lines are long, and the grouping is such as to enable a number of stations to be connected to a single circuit without materially increasing the expense of drop wires, and where apparatus is wisely chosen to avoid increased complexity, a distinct economy, both in installation cost and annual expense results. On the other hand when lines are so short that the installation cost and annual expense charged to the line is but a small fraction of the total investment and annual cost, little or no economy results from the grouping of stations upon circuits, and

that little may often be more than sacrificed by the probable increase in the expense of the substation and traffic apparatus.

To illustrate the preceding argument assume three cases of polystation lines respectively $\frac{1}{2}$ mile, 1 mile and 2 miles in length and consider what the probable change in investment and annual expense becomes by the addition of more than one station. This is shown in Table XIX in which costs of installation and annual expense are given, for exchanges having central offices of say, about 2,500 subscribers, using modern common battery switchboards, allowing each line to have relative proportions of underground wire, aerial cable and open wire that are generally found in practice, together with the prices for apparatus now current.

Installation costs have been grouped under the items of Substations;— including subscriber's instrument, cost of installing the same and drop wire to the nearest circuit;— Lines,— including the entire circuit, open wire, aerial cable, underground and proportion of cable run in offices together with terminals on the main distributing board— Switchboards including answering jack, line and cut-off relay, proportion of intermediate and main distributing board and such part of the multiple jacks and A operators' apparatus as is attributable to lines. The item for Traffic is based upon the necessary plant required to answer 700 calls per station per annum, and includes A and B operators' outfit, proportion of all multiple jacks chargeable to traffic and trunk line plant.

TABLE XIX.
Party Line Costs.

A. Line $\frac{1}{2}$ mile long.	Investment.			Annual Expense.		
	No. Parties.			No. Parties.		
	1	2	4	1	2	4
Substation	\$15.50	\$31.00	\$62.00	\$5.60	\$11.20	\$22.40
Line.....	22.50	22.50	22.50	2.50	2.50	2.50
Switchboard.....	8.65	8.65	8.65	3.25	3.25	3.25
Traffic 700 calls.....	3.50	7.00	14.00	2.45	4.90	9.80
Totals	\$50.15	\$99.15	\$107.15	\$19.80	\$21.85	\$37.95
Cost per Station....	50.15	34.37	26.78	19.80	10.92	9.48

B. Line 1 mile long.	Investment.			Annual Expense.		
	No. Parties.			No. Parties.		
	1	2	4	1	2	4
Substation	\$15.50	\$31.00	\$62.00	\$5.60	\$11.20	\$22.40
Line.....	45.00	45.00	45.00	5.00	5.00	5.00
Switchboard.....	8.65	8.65	8.65	3.25	3.25	3.75
Traffic 700 calls.....	3.50	7.00	14.00	2.45	4.90	9.80
Totals	\$72.65	\$91.65	\$129.65	\$16.80	\$24.35	40.95
Cost per Station....	72.65	45.82	32.41	16.80	12.17	10.23

C. Line 2 miles long.	Investment.			Annual Expense.		
	No. Parties.			No. Parties.		
	1	2	4	1	2	4
Substation.....	\$15.50	\$31.00	\$62.00	\$5.60	\$11.20	\$22.40
Line.....	90.00	90.00	90.00	10.00	10.00	10.00
Switchboard.....	8.65	8.65	8.65	3.25	3.25	3.25
Traffic 700 calls.....	3.50	7.00	14.00	2.45	4.90	9.80
Totals	\$117.65	\$186.65	\$174.65	\$21.30	\$29.35	\$45.45
Cost per Station....	117.65	68.32	48.66	21.30	14.67	11.36

The preceding table clearly demonstrates the increasing advantage presented by polystation lines, where subscribers are located in a group at a considerable distance from the central office. But in considering these figures it must be remembered that the full efficiency of polystation lines can never, or rarely, be completely realized, for it is only possible under the most exceptional circumstances to find groups of subscribers that can be reached without the expenditure of some additional wire plant. Further, in the nature of the business when polystation service is offered there will be many cases when a subscriber pays for four party line service, and it is only practical to place two or three parties upon his line. From an analysis of many plants offering this form of service it has been found that the actual wire plant efficiency rarely rises over 85%, and that the station efficiency, meaning by this term the proportion of lines which are completely filled with the type of service offered, to the number of lines in existence, is rarely over 80%, and therefore the calculations in the preceding table convey an impression which is somewhat too favorable. Also in the foregoing analysis no account has been taken of the increased installation expense due to more complicated apparatus at the substation, or on the cord shelf; or to increased annual expense necessitated by the more expensive maintenance, of apparatus of greater cost and complexity; or of enhanced cost of operating. Hence on this score the deductions of Table XIX are, if anything, too favorable to polystation service.

There is yet another lesson: The rates at which polystation service is offered, usually show a marked reduction between single stations and two and four party lines. This fallacy the preceding table exposes, for it is seen that

the difference in annual expense between single party service and four party line service does not exceed \$10 even for lines which are two miles in length. It is common to find a greater difference than this in the rates offered. The subscriber is plausibly told that by putting several parties upon a line the company can afford to do business at a marked reduction. The real explanation is that the party line service offers the general manager an excuse to cut rates. So far as it is possible he endeavors to secure single line subscribers who will pay the highest price and from which he can make proportionally the greatest net income. But there are classes of subscribers who cannot thus be reached and the party line affords an opportunity to make a sweeping reduction without prejudicing the more valuable form, so the general manager not only gives the subscriber the benefit of a cheaper form of service, but also cuts the company's profits to him.

There is yet another aspect, that is the traffic question and a very vital one it is. The telephone is pre-eminently a time and labor saver, and to fulfill its mission in this respect it must always be ready for instant use. To pick up the receiver and be told that the line of a desired correspondent is busy is annoying—to find that some other fellow is using one's own line is exasperating, while to believe that a desired correspondent could be obtained, were not his line in use by some objectionable third party seems, to the mind of the average subscriber, the addition of insult to injury. Hence complaints, which even if they are unreasonable must be dealt with, and the placation of the polystation subscriber is the general manager's hardest task. Again, what shall be said to the single line subscriber, who, paying the highest price for service often fails to get a desired correspondent placed upon a

party line because others are using it. Seemingly this is an unmerited hardship inflicted upon a customer who should receive the best treatment.

From the operating standpoint the polystation line has its objections and for the same reasons, for as such lines are often found busy, subscribers must call again. The operator thus finds a much larger number of "*busies*" and the percentage of uncompleted connections rises — making operating more expensive since more testing has to be done, and subscribers are requested to call again, originating more calls which must be handled. Under measured service systems this is particularly objectionable because only completed connections are paid for. So in addition to the purely economic questions the traffic manager must make a wise selection of those, who, from this standpoint, can be offered polystation service. Fixed rules to govern the arrangement of polystation subscribers are impractical, and service which is tolerable in one place, would be rejected in another. In a general way it appears unwise to offer such service to business houses in the busier portions of the larger cities, say those above 50,000 or where the traffic is likely to be above 10 or 12 calls per day. In smaller places, or where the traffic drops to 8 or 10 calls a two party line service is permissible, but excepting for the smallest of business concerns the placing of more than two parties per line does not seem to be desirable. For residences, or when the call rate does not exceed three or four, the four party line has proved itself a success. In rural districts and villages multistation lines of 10 or 12 parties are not uncommon and have proved fairly successful, but the conditions of such service are so totally different from those obtaining in even the larger villages that the two cases are incom-

parable. While there are some advocates for the plan of placing a large number of stations upon city lines the whole trend of experience is so against this practice that it seems advisable to attempt it only in isolated and peculiar conditions.

In the earliest forms of polystation line the various instruments were arranged in series upon the line the circuit of which is shown in Fig. 270. To this plan there were four serious objections. 1st, As all bells were in series, any subscriber when talking had to speak through the combined impedance of the line and the magnet coils of the bells of all other stations. So with even two or three stations, conversation was greatly impaired, and with many, became impracticable, particularly over long lines. 2nd, The system was non-selective, and to call any subscriber all bells had to be rung. To prevent every station from answering a code of a different number of rings, or a combination of long and short ones was used. This entailed three objections. (a) Every station was always advised when any other one was in use, thus exposing subscribers to a temptation which was, alas, all too often irresistible, for many good people who would scorn to use a keyhole, will unhesitatingly unhook the receiver when they know a companion party is using the line. (b) With the most ingenious codes, subscribers often mistook one signal for another, even if correctly given, so that two parties would answer, to the consequent confusion of both, and the utter demoralization of both the calling party and the operator. (c) In case a subscriber did not answer immediately the operator had to ring again. She had either to remember what party was called, or ask the originating subscriber to repeat the order. In the rush of the busy hour, the best memory fails, hence

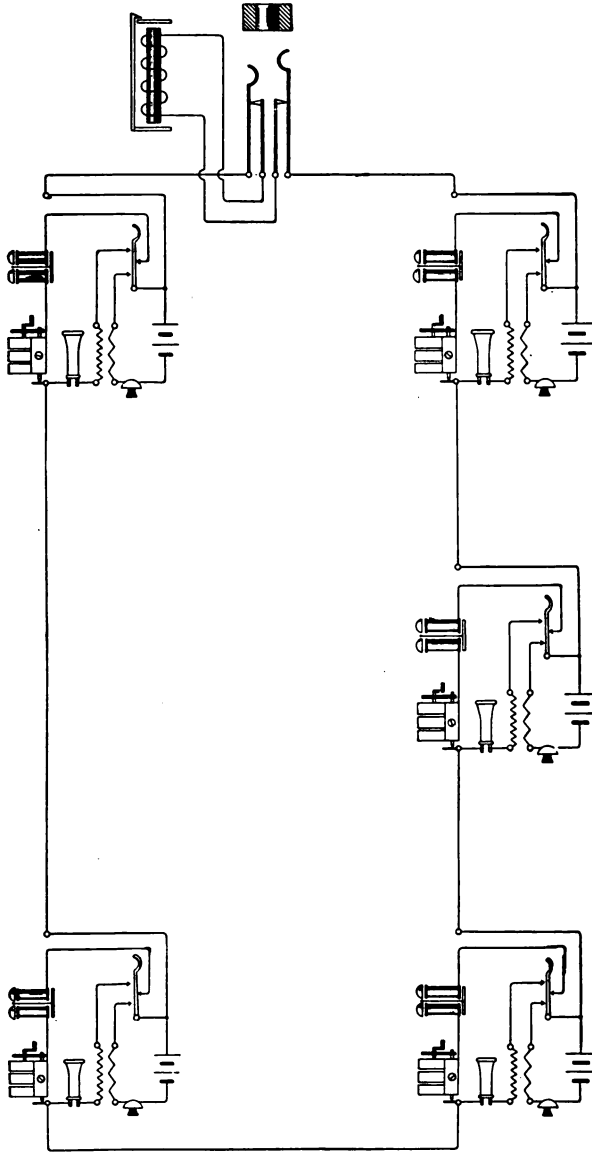

FIG. 270.—THE SERIES PARTY CIRCUIT.

mistakes, or if the operator requests the order repeated, the subscriber is annoyed, and in any event there is confusion and delay. 3rd. This system is non-secret. Any subscriber might unwittingly, though in good faith, trying to signal the office, give two parties already in connection a "ring in the ear." 4th. The use of any form of code to call different stations is unfortunate from an operating standpoint. Work at the switchboard is exceedingly trying at best, and subjects the operator to the severest nervous strain, and her work should be simplified as much as possible and rendered as easy as its character will permit. To expect an operator to give long and short rings, or to ring different parties a varying number of times, is to court error, and confusion, and to enormously decrease the operator's possible load. Both add greatly to operating expense. It would, of course, be possible to devise (as has been tried) some form of mechanical code ring, for example a revolving commutator which should give any desired number of rings, or a combination of long and short ones, and provide each cord with corresponding keys. While attempts of this kind have been mechanically successful, the complication and expense of the necessary apparatus has so far prevented any wide application of the system.

The first step in improvement was the invention of the Carty bridging bell. By this device all the ringers were removed from a series position in the line and placed as shunts across the circuit, as is shown in Fig. 271. The path of the talking currents was thus cleared from all the impedance of the magnets, and it became possible to place a much larger number of parties on a line, to work over far greater distances, and give much better service. But the other three objections still existed in full force. The

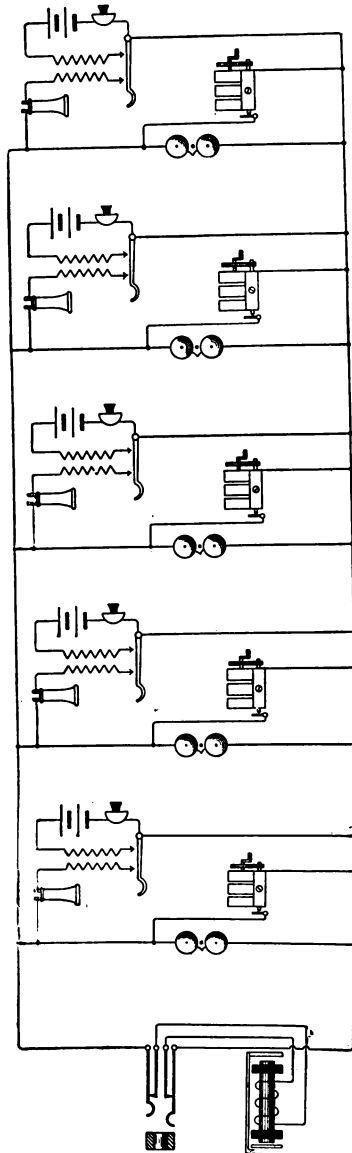

FIG. 271.— THE BRIDGING PARTY LINE CIRCUIT.

bridging party line has received a wide application particularly in the smaller communities. This is fully merited, for it fulfills all the economic requirements excepting that of removing the drag inflicted on the operator, who is required to give code signals. It is true that the bridging bell is more expensive than the series ringer by from 25% to 50%. But this increase in expense is more than compensated by the greater number of parties that can be bridged across one line, to say nothing of improvement in service over the series system.

The second radical advance in party line improvement and the basis of many of the practical methods now in use was the Hibbard system. The essential features are shown in Fig. 272 from which it is seen that the number of parties is limited to four. The two sides of the line are indicated by *S T* and the stations by *A B C* and *D*. At the central office the line ends in a jack, which may be of the cut-off type with a ground on one point and a battery and lamp signal on the other or a cut-off relay may be used. The hook switches of two of the parties are attached to the tip side *S* of the line, and those of the other two to the sleeve side *T*. Each party is supplied with a biased bell, legged to ground, and connected normally to the hook switch by an under contact when the receiver is in place. Thus there are two bells connected to one side of the line and two to the other. By properly arranging the biasing springs, one bell and only one on each side of the line can be made responsive to a positive pulsating current, and the other to a negative pulsating current. Now if at the central office the operator be supplied with four ringing keys the first of which shall supply positive current to the tip side of the line only, the second, negative current, while the third and fourth deliver corresponding positive and

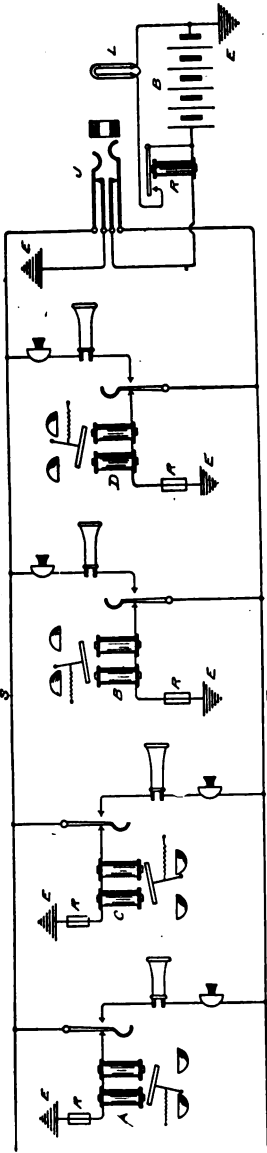

FIG. 272.—THE HIBBARD CIRCUIT.

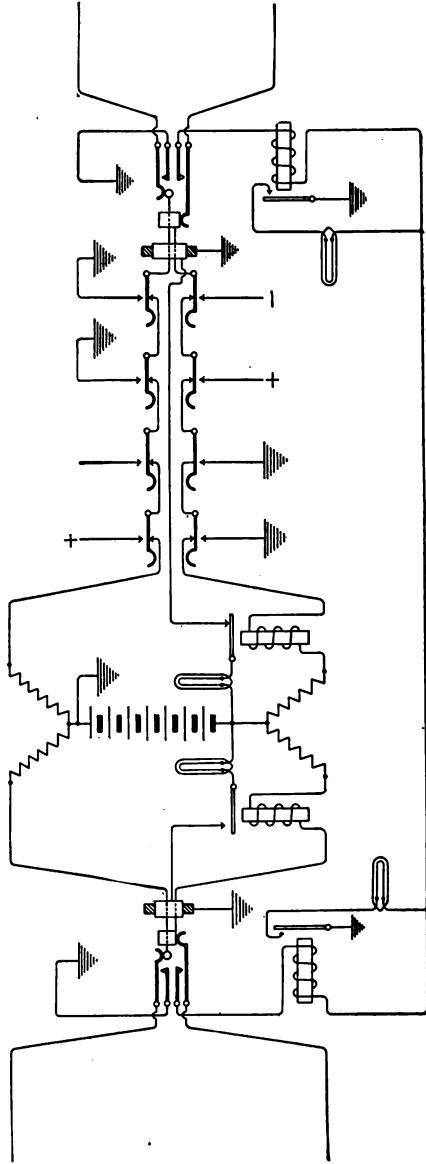

FIG. 273.—CORD CIRCUIT.

negative current to the sleeve side, it is evident that by merely inserting the connecting plug into the jack and pressing the proper key the operator will ring the desired bell, and only that one. The following disadvantages appear: The system is limited to four parties provided signalling is to be strictly selective, though a much larger number can be served by a simple code. Thus eight parties may be called by the use of a code of one and two rings. The limitation to four parties is not so serious as it at first appears, for experience is rapidly proving the inexpediency of offering polystation service containing more than four parties per line, excepting to the smallest of rural communities. As the bells are normally grounded there will, when the line is out of service, be four grounds, two of which are on the live side, which causes a continual drain. Exhaustion of the battery may be obviated by the use of magneto circuits or reduced to a minimum by the installation of a high ohmic resistance, from 5,000 to 20,000 ohms, between the bell and ground. The presence of at least two grounds during conversation interferes with the proper operation of supervisory signals as usually placed in common battery cord circuits, is likely to make lines noisy, and is entirely against the tendency of modern telephonic practice which is to remove all grounds of every description. The objection of possible noise is not so serious as it at first appears for the bell magnets in series with the additional ohmic resistance present so great impedance that it is only in the exceptional case that inductive troubles are perceptible. To provide for the operation of the supervisory signals is a more difficult matter. In Fig. 273 one common form of relay board cord circuit is shown. If the plug be inserted in the jack of a single party metallic line, current will flow

through the winding of the supervisory signal so long as by the removal of the subscriber's receiver from the hook a path for the current is provided between the two sides of the line, and the operation of the signal is normal. If the sleeve side of the line is permanently grounded, as is the case in the circuit of Fig. 272, replacement of the receiver will not interrupt all current through the relay, and the supervisory lamp cannot light. It is not practical to open the bell to ground to battery current with a condenser because this condenser by alternately charging and discharging converts the pulsating current into an alternating one, and the system becomes non-selective. To put the signal relays on the tip side of the cord would seem a remedy, but then the cord circuit would be inoperative with the grounded lines which are still in existence, also the grounds on the sleeve side would shunt the current through the supervisory. By making the resistance R as large as is permissible and the supervisory relays as insensitive as practical the circuit of Fig. 272 can be worked, but it becomes in telephonic parlance very "*marginal*" and this is detestable. Mr. Scribner has proposed a modification of the relay board cord circuit, whereby it is adapted to work with party lines of this description. This is shown in Fig. 274. The change consists in the addition of another pair of supervisory relays S'' and S''' shown by dotted lines to the sleeve side of the cord. When the plug is inserted in the jack of a completely metallic line both relays are magnetized. In the case of a line with grounds on the sleeve side both relays are excited so long as the receiver is off the hook, because there is circuit through the tip side of the cord as well as through the ground.

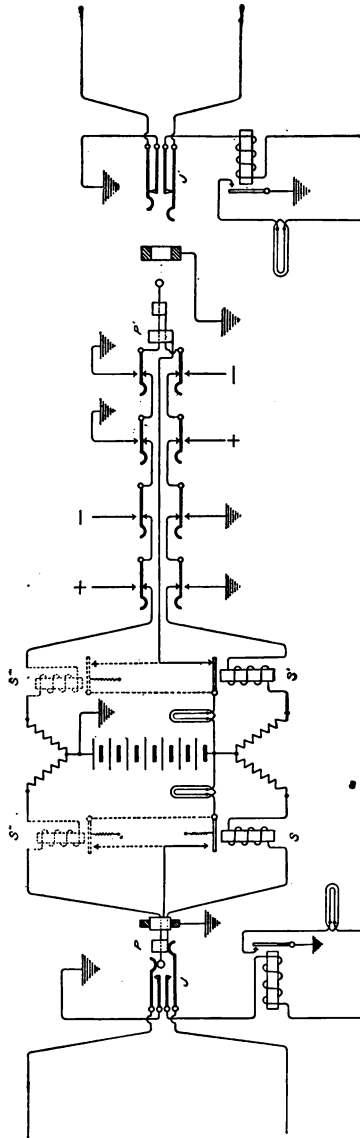

FIG. 274.— SCRIBNER'S MODIFIED CORD CIRCUIT.

But when the receiver is replaced, the tip side of the cord is opened, hence relay S'' is demagnetized and the lamp lighted even though the armature of relay S remains pulled up by current through its coils to ground. This circuit only becomes inoperative when there is a dead ground on the tip side near the jack which shunts all current from the relay S'' . In both Figs. 273 and 274 a four part ringing key is shown. Two of the springs on the tip side are grounded and two are on the sleeve. One spring of the remaining pair on each side is connected to a source of positive pulsating current and the other to a negative one. To this key there are four buttons, hence by a single movement the operator can send positive or negative current to either side of the line at pleasure. Each button is supplied with an indicator so the operator always knows what party was last called, thus avoiding confusion. Usually a fifth pair of springs is added supplied with regular alternating current for single line subscribers.

This system was the first to afford a four party line selective circuit free from expensive intricate apparatus. At the substation, only the addition of the ohmic resistance coil is necessary, costing about 50 cents. At the central office either each cord must be supplied with a special ringing key—or else each position must be equipped with a four part master key, whereby the proper current can be switched to the regular ringing key. The individual cord key costs from \$6.00 to \$8.00 per cord, or about \$100.00 per position. A master key may be installed for about \$6.00, but this requires the operator to use two hands in ringing and produces a marked drag. Also it is impossible for the master key to keep tab upon parties rung. Usually all the cords at B positions are individu-

ally equipped, particularly where there is machine ringing. Then all party lines are grouped upon one or more special A positions having a full set of keys to each cord; this, on the whole, makes the best and most economical arrangement. The expense of apparatus to supply the necessary pulsating current is small, from \$75.00 to \$100.00 being sufficient to either remodel an old ringing generator or to pay for the extra attachment of a new one.

On the whole this system seems to have most successfully met the party line demand, and as its use has extended many modifications have developed, an important one being the adaptation to magneto exchanges. For this service the circuit is shown in Fig. 275. If at each substation a *direct current generator* is used the station can signal the office without ringing the bells of any other, and the system continues to be completely selective. A further modification is to supply a *Two Party Line*, which is excellently adapted to the needs of small business houses. The circuit for this arrangement is given in Fig. 276.

To avoid carrying a large stock, each substation set is so wired that it can be employed for either one, two or four parties by a simple change in connection. The substation circuits used for this purpose by the Kellogg Co., are as in Fig. 277.

The American Electric Telephone Company offer a four party signal system devised by Mr. Leich, that resembles the Hibbard system and is in some respects superior. The circuit is shown in Fig. 278, from which it appears that, like the Hibbard, two party selective service can be given, both ringing and talking being completely metallic, as shown on the left; or a four party circuit is feasible as shown on the right which rings ground and talks metallic. By the latter plan the bells are connected

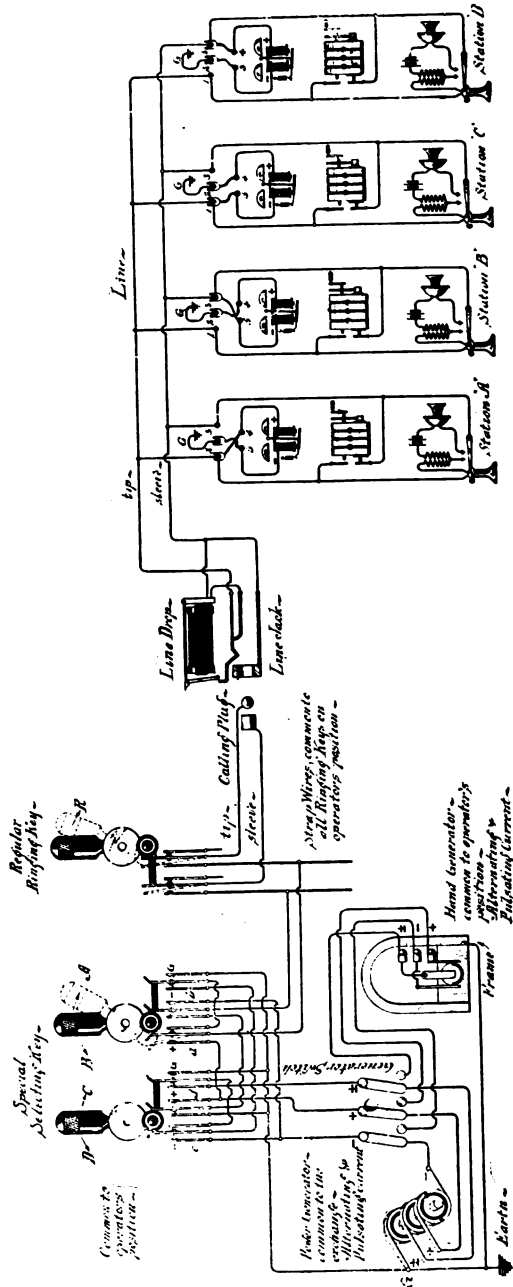

FIG. 275.—FOUR PARTY LINE MAGNETO CIRCUIT.

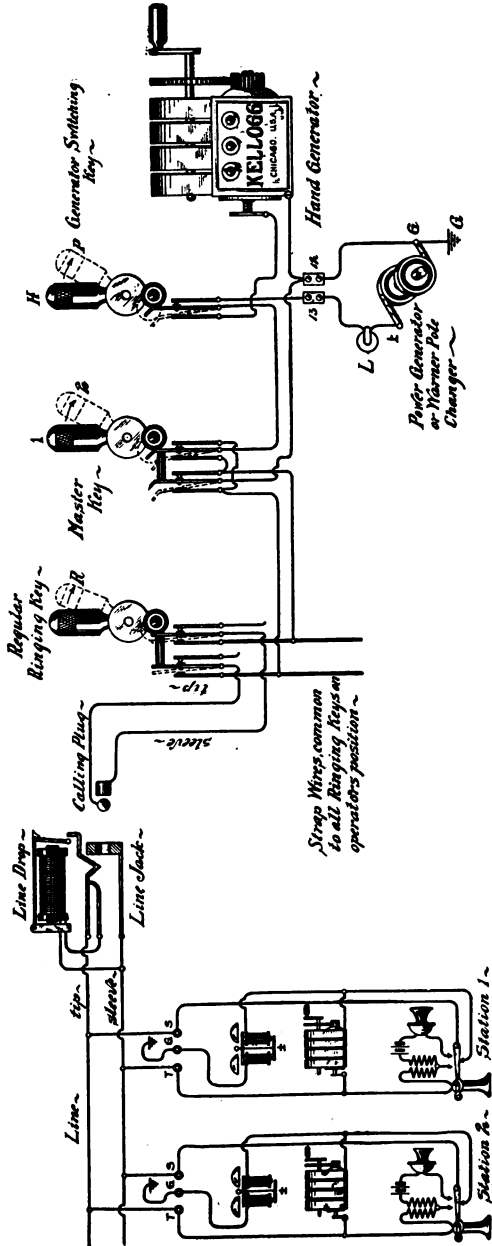
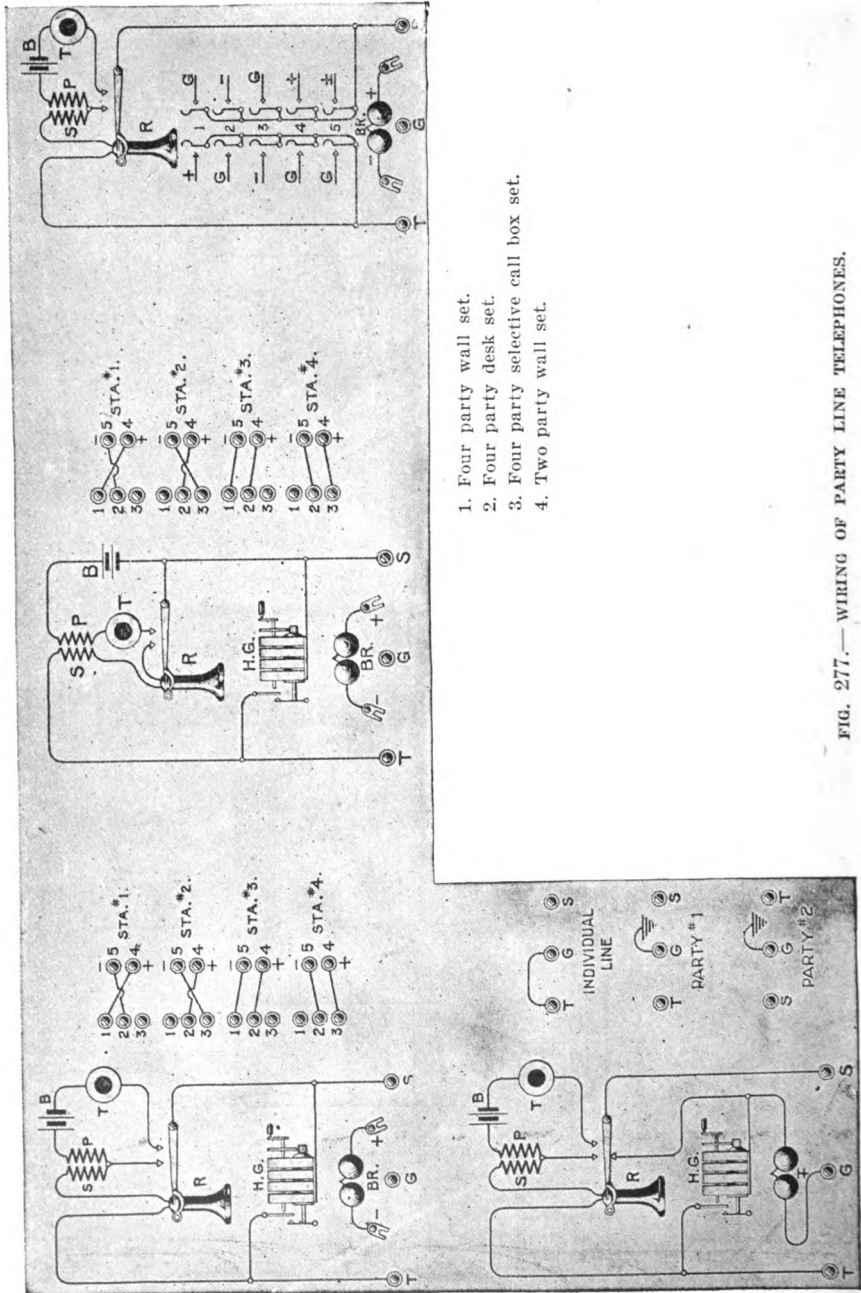

FIG. 276.—TWO PARTY LINE MAGNETO CIRCUIT.



1. Four party wall set.
2. Four party desk set.
3. Four party selective call box set.
4. Two party wall set.

FIG. 277.—WIRING OF PARTY LINE TELEPHONES.

to ground, two on each side of the line, but instead of containing a high resistance each bell circuit is supplied with a condenser and an impedance as at *A B C* and *D*. For the four party system, each bell with its condenser and impedance is grounded while for the two party metallic the bell circuit is across the line.

The ringing generator instead of supplying positive and negative pulsating current gives alternating current of two frequencies, 2,400 and 7,200 per minute. By placing the condenser impedance and bell in series as at *A C*, and *A* and *B*, the impedance of the ringing circuit is greater than when the bell and impedance are in parallel and in series with the condenser as at *B M* and *C* and *D*. Hence the low frequency generator can actuate the bells at *A C*, and *A* and *B*, but not those at *B M*, and *C* and *D*, while the high frequency can ring the bells at *B M*, and *C* and *D* but not those at *A C*, and *A* and *B*. The cord is equipped with a seven button key, one for each of the stations as marked, and a release button to restore any of the keys if a subscriber fails to answer.

The Leich system is superior to the Hibbard as, owing to the condenser, the circuit is always open to continuous currents. There is therefore no leakage of battery nor is it necessary to use a special supervisory signal; otherwise the double frequency generator is no cheaper than the pulsating current one and the impedance and condenser are more expensive than the resistance coil. As the bells are grounded there is about as much likelihood of noisy lines in one circuit as in the other.

Ceteris paribus, groundless polystation systems are preferable; two solutions have been offered, one by Thompson and Roche and the other by Dean. Thompson's sub-

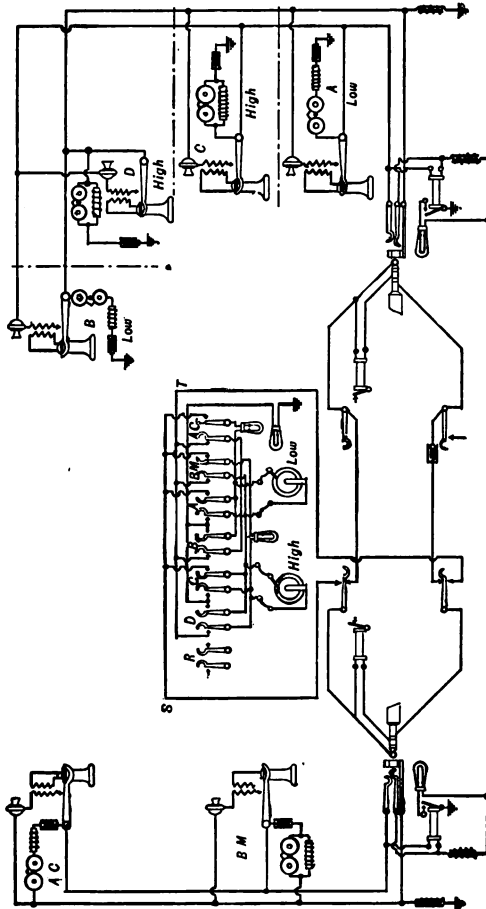

FIG. 278.—THE LEICH SELECTIVE SYSTEM.

station circuit is shown in Fig. 279, cord circuit being shown in Fig. 273. Across the line the subscribers' stations are bridged, each one being supplied with a special relay *R* and condenser *C*. Otherwise the regular condenser substation circuit is employed. In the relay lies the essence, for it is so designed as to be responsive to pulsating currents. When, therefore, an operator rings, the armatures of all the relays are attracted and, as they close, each relay connects a grounded bell to the proper side of the line. All bells are biased to be properly responsive to either a positive or negative

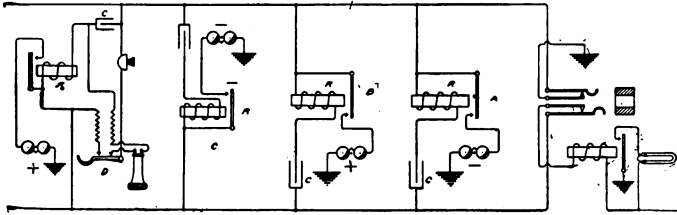
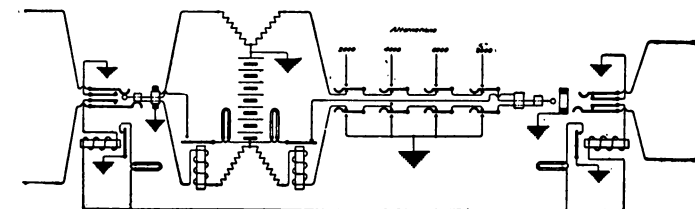

FIG. 279.—THOMPSON'S CIRCUIT.

pulsating current and as by the action of the relays two are connected to one side of the line and two to the other, a selective system, grounded only during the ringing is obtained. By the Thompson circuit it would be practical to carry selective signalling to a higher number of subscribers, for after the relays are closed it would be possible to use currents of different frequencies as well as pulsating currents, and thus eight or more parties could be selected. This circuit has recently been modified by Mr. Stryker, who provides a sluggish relay which, in series with a condenser, is legged to ground, two stations being placed at each side of the circuit. This relay is

sensitive to pulsating currents, and when closed bridges a selective ringer across the sides of the line. It will be seen that this invention differs from that of Thompson and Robes by placing the relay to ground and the bell in a bridge instead of the bell to ground and the relay in the bridge.

The circuit adopted by Mr. Dean is shown in Fig. 280. Each substation is bridged across the line through a con-



DEAN CORD CIRCUIT.

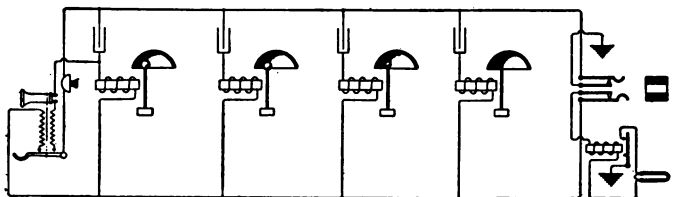

FIG. 280.—DEAN PARTY LINE SYSTEM.

denser as in Thompson's, but in lieu of substation relays the armature of each bell is arranged to be responsive to only one particular rate of alternating current. This is accomplished by employing a bell having but one gong, and by making the moving system of each ringer (armature, bell clapper and rod) of a different weight from that of every other station. Thus each bell tongue is given a predetermined natural period of vibration so it will

move only in response to an alternating current of the same frequency. By supplying the exchange with as many different frequencies as there are bells the operator can select any one at pleasure. The chief peculiarity of the Dean cord circuit is in the ringing key. This has four pair of springs each one of which leads to a ringing generator of a different frequency from all others. The frequencies selected are 2,000, 4,000, 6,000 and 8,000 per minute. Both ringing and talking are entirely metallic, and obviously the system could be extended to select from a larger number of substations by providing more frequencies and keys.

All systems so far described are completely non-secret, and even if selective, other parties may unintentionally break in. The simplest lock-out system is that shown in Fig. 281 devised by Mr. Scribner. In this system, each substation is provided with two magnets, one, *a*, called the "circuit controlling magnet" and the other, *b*, the "stop controlling magnet." There is also a lever pivoted at *b'* which carries the armature of the magnet *b*. Suppose Subscriber 1 calls. The removal of the receiver causes the hook switch to first make the contact *c*, and immediately after, the one at *c'*. As there is no battery upon the *l'* side of the line the closure of the contact *c* produces no effect upon the magnet *b*, and therefore the stop lever *b'* is not operated. Closing contact *c'* establishes circuit from the battery *B* over the *l* side of the line through magnet *a* and contact *c'*, hook switch and ground. This excites magnet *a*, draws up lever *f* and closes contact *g*, connecting the transmitter and receiver across the line. If any other subscriber now removes his receiver, the magnet *b* at his station will be energized because the instant the hook switch touches contact *c* there

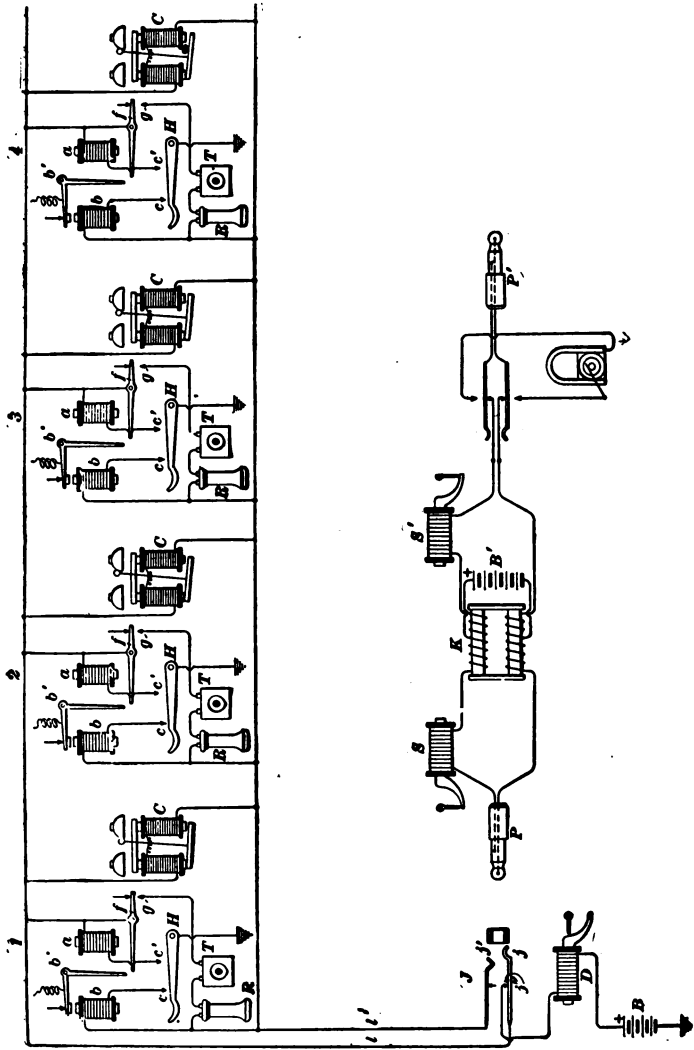

FIG. 281.— SCRIBNER LOCK-OUT SYSTEM.

is circuit with the battery *B*, through the line wire *l'*, hook switch and ground. This magnet *b*, which is excited slightly before magnet *a* can become energized, attracts the stop controlling magnet *b* and pulls its lower end over the lever *f*, preventing this lever from closing contact *g*, and therefore the subscriber's circuit cannot be completed. A simplified method to secure the same result is shown in Fig. 282. A magnet, *b*, is provided with a rocking arma-

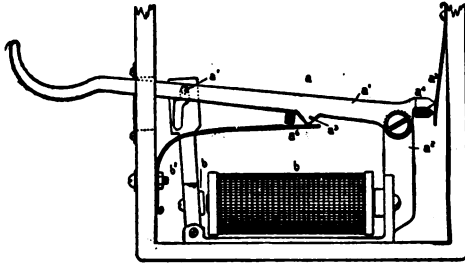

FIG. 282.—IMPROVED LOCK-OUT.

ture having a shouldered slot in its upper end. The switch hook, has a pin a^7 that plays in the slot. The magnet is connected between the spring a^6 and ground. The hook a^1 is connected to one side of line, and the talking set connected from spring a^3 to the other side of line. The office battery is normally connected to the line wire last mentioned; but when a plug is in the jack, battery is connected on the other side, thus ready, if switch hook rises, to flow through the spring a^6 which makes contact, and receives current, before a^3 , so that the magnet being instantly energized, the armature is pulled up, and the pin a^7 striking against the shoulder of the slot prevents further movement.

Little imagination is needed to conceive that the movement of a stop lever can be made to display a signal to notify the subscriber that the line is occupied. Such an arrangement is shown in Fig. 283. The lock-out magnet *f* is supplied with a bell crank lever *f'* which carries on its upper end a catch *d'*, that can control the long end of a weightel lever *b*. This lever is supplied with a target bearing the word, "Busy." Normally this lever is held by the catch *d'* in such a position that the target is out of sight. When the subscriber tries to use a line that is busy the magnet *f* unlocks the lever *b*, and the weight *b²*

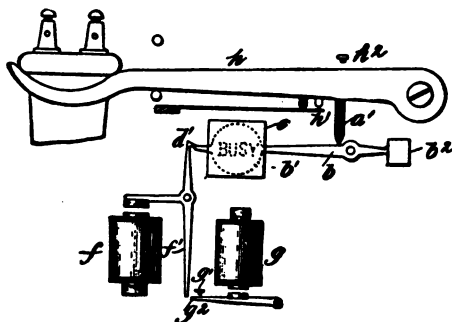

FIG. 283.—BUSY SIGNAL DEVICE.

causes the "busy" signal to be displayed through a hole in the encasement of the instrument. When the subscriber hangs up the receiver the switch hook forces the "busy" signal back to its normal position.

The polystation systems outlined comprises, in principle at least, the bulk of those which have seen any extended application. Thousands of other devices have been proposed, for no other department of telephony seems to

possess such a fascination for the would-be inventor. The files of the Patent Office teem with patents (and each week augments their number) more ingenious than wise, monuments of misdirected energy, which never have, and never will, venture beyond the archives of the Patent Office or the files of their respective inventors. Volumes would be needed merely to outline the devices which while possibly practical from an electric or mechanical standpoint, are impossible commercially, and it is the failure to duly appreciate this factor that so often misleads both the inventor and the telephone manager.

Depending upon the method of signalling, all party line devices fall into one of two great classes, the selective and non-selective; the latter may be split into six divisions. First, those which select by some form of step by step mechanism. Second, those which select by a variation in the strength of the current used in signalling. Third, those which select by a variation in the polarity of the signalling current. Fourth, those which select by a combination of the second and third methods. Fifth, those which select by variation in frequency of contact. Sixth, those which select by some harmonic method.

From time to time apparatus based on each of these methods has been put into service and thoroughly tested. Table XIX shows that the difference in installation and operating cost of the party line over the single one is small. With the exception of the systems discussed, practice has shown that other designs have been so complicated as to extinguish this margin, and none have lived to enjoy a widespread introduction.

Intercommunicating systems.—By a stretch of imagination the term polystation line may be extended to include two other forms of installation. The Intercom-

municating System has sometimes received the name of the "Speaking Tube Outfit," because it is a telephonic installation usually arranged to handle a number of stations either in the same or closely adjacent buildings, much after the plan of the old-fashioned speaking tube, and its earlier cognomen arises from the fact that it has displaced the older and more clumsy method. A great variety of methods for wiring "intercommunicating systems" have been devised, but all of them are based

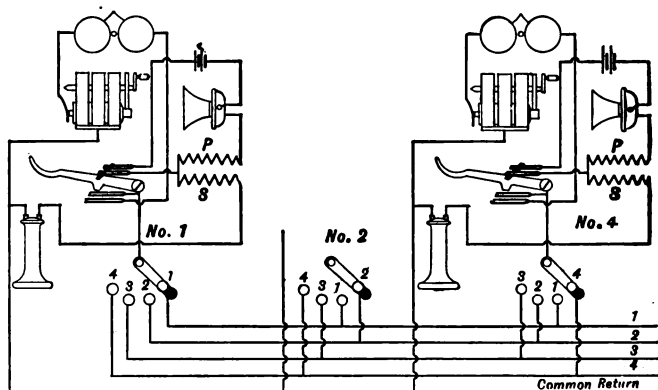

FIG. 284.— INTERCOMMUNICATION CIRCUIT NO. 1.

upon certain general fundamental principles generally illustrated in the following examples. In the system shown in Fig. 284 one wire is needed for each station, plus one for a common return, hence if there are n stations there will be $n + 1$ wires. By the circuit shown, a local battery is installed to supply current for talking at each station, also each one is fitted with a magneto bell and hand generator. It is possible to use a vibrating bell and either local

or common battery for signalling. At each substation there is a switching device, having as many points as there are stations. This apparatus may be either a switch as shown, or a set of jacks and plugs, or any other device whereby different lines can be connected at pleasure with the substation set. To call any station, the switch lever is set to the proper point, or the plug placed in the right jack. Then the magneto is operated or a push button pressed and the bell of the desired station rung. In all systems using a common return there exists the probability of cross talk,

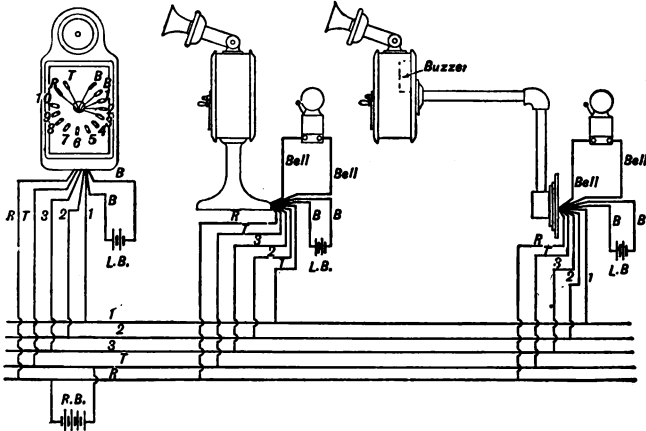

FIG. 285.—INTERCOMMUNICATING CIRCUIT NO. 2.

hence all wiring should be done in the most careful manner using nothing but cable containing the full number of twisted pairs extended to every station. In Fig. 285 there are $n + 2$ wires, one pair of leads being reserved for signalling. In the circuit shown there is a centralized battery for this purpose. While this plan is slightly more expen-

sive to install, it is much more likely to be free from disturbance. A ringing generator and magneto bells could be substituted. In Fig. 286 the method of providing a com-

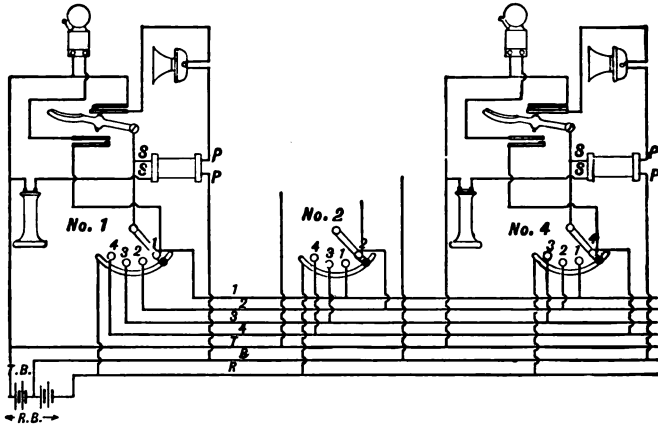

FIG. 286.—INTERCOMMUNICATING CIRCUIT NO. 3.

mon talking return is shown, hence if there are n stations there are $n + 3$ wires, and all supply of electricity, both that for signalling and that for talking, can be centralized. This is the best and most complete plan.

The great objection to all intercommunicating systems is that the subscriber forgets to return the switch to the calling contact when conversation is completed, hence he cannot be signalled. Many schemes have been devised to make the switch return automatically. A representative one is that offered by the Holtzer-Cabot Co., called the Ness system. The general appearance of the substation set is shown in Figs. 287 and 289, each telephone being equipped with a switch which the subscriber moves to the

contact point leading to the station with which he desires to talk. The hook switch is supplied with an automatic mechanism for restoring the switch shown in Fig. 288 which is operated by hanging up the receiver. Upon the



FIG. 287.— NESS WALL SET.

short arm of the hook lever is pivoted a dog, *D*, adapted, when the receiver is replaced, to engage a notch in the pawl, *P*, and lift it out of engagement with the ratchet wheel. This allows a spiral spring to return the switch

lever, *S*, to contact with the home button. After raising the pawl the dog slips out of the notch on the pawl, thus allowing the latter to return into contact with the ratchet

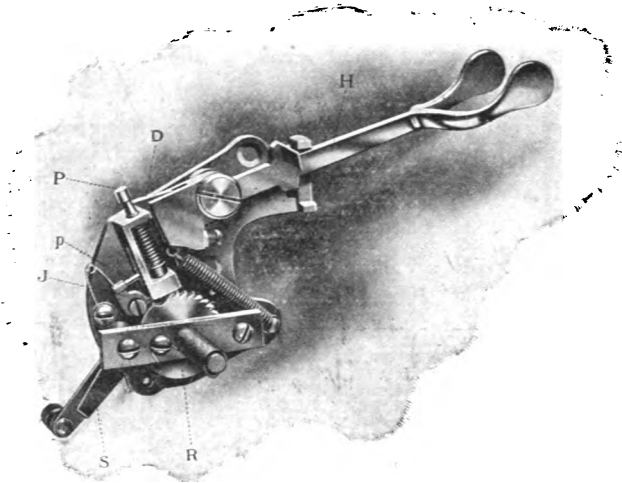

FIG. 288.—NESS HOOK SWITCH.

wheel ready for the next use of the telephone. That the pawl may not engage the ratchet before the lever, *S*, has fully returned to its normal position, a second dog, *J*, is provided, which is pressed by a spring to occupy a position under the pin, *P*, carried on the pawl, holding it out of engagement until the rotation of the lever is completed. At this point a cam, on the under side of the ratchet wheel, pushes the dog, *J*, out of engagement with the pin, *P*, and thus allows the pawl to drop into position.

In the private branch exchange the highest development of the polystation system is reached. In reality the private

branch exchange is a small central office located in the middle of a group of subscribers who desire frequent connection with each other, and occasional service to other

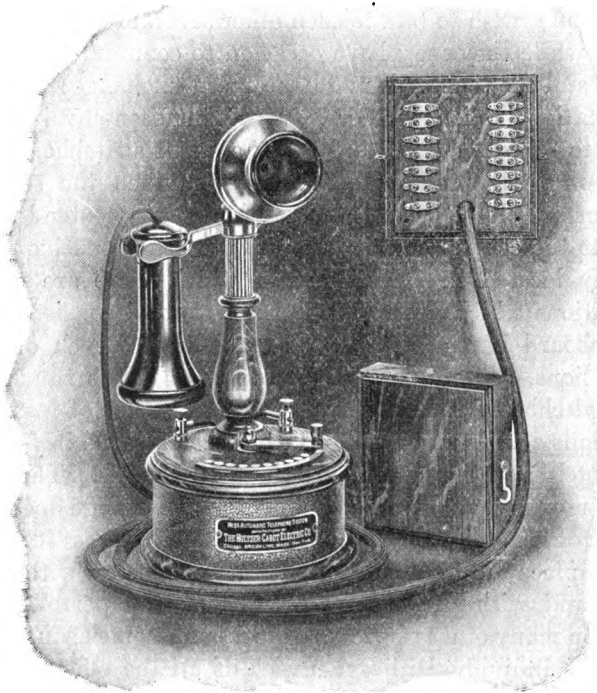

FIG. 289.— NESS DESK SET.

subscribers outside of their particular coterie. So, on a final analysis, the private branch exchange does not differ in any way excepting in size from one of the central offices

which compose a large telephone exchange. It is equipped with a switchboard that is in all respects similar, and its operators are as highly educated and as carefully drilled. Its function is only to relieve the central office from a portion of the labor which the particular group of subscribers originates, and to economize wire plant. Thus, *A, B, C* and *D* may wish to talk to each other several score of times daily, while they may have occasion to communicate with *F, G* and *H* (subscribers to the main exchange) but infrequently. It is, therefore, an evident economy in wire plant to serve *A, B, C* and *D* by a small switchboard located in their immediate vicinity, provided the several stations are close to each other, rather than to extend their lines to the central office. The private branch exchange is usually located in a building in which there are many substations which desire mutual service and consists of a switchboard having short lines extending to each of the substations, while a few trunks are arranged to run from this switchboard to the central office. This type of installation finds a wide and constantly increasing scope in factories, hotels and the offices of large corporations. The tendency now is to make the private branch exchange operator a kind of general confidential clerk, whose business it is not only to place different substations into connection with each other and with the central office, but who performs in addition many other services. She must become acquainted with the individual idiosyncrasies of all the officials connected to her board. She must know whether or no Mr. Smith wants to see Mr. Jones, or whether it is inexpedient to disturb him even for a telephone call. She orders railway tickets, theatre accommodations, and performs a thousand and one services that would be entirely outside the function of the ordinary exchange operator, and is rapidly

becoming a necessary and highly valued adjunct of the modern business office. In some cases the private branch exchange is so arranged that a portion of the subscribers can be afforded connection only between themselves, while the apparatus of another set is so designed that they may not only talk to every subscriber tributary to their particular branch, but may be also given service to the main exchange. Technically two such groups of subscribers are respectively called "private exchange subscribers" and "private branch exchange subscribers." The term "private subscriber" signifying only those who can talk among themselves, while the private branch exchange subscribers are those to which the additional facilities of the whole exchange is given. As the private branch exchange has a switchboard which differs only in size from that of any central office, a description and discussion of its features is foreign to this division and will therefore be more fully treated under the heading of switchboards.

CHAPTER IX.

SUBSTATION ASSEMBLAGE.

THE following schedule shows the apparatus required at each substation.

SYSTEM.

<i>Magneto.</i>		<i>Common Battery.</i>
Transmitter		Transmitter
Receiver		Receiver
		No Coil
Induction Coil	}	Impedance Coil
		Induction Coil
Switch Hook		Switch Hook
Battery		Condenser
Call Bell		Call Bell
Magneto Generator		None
Protective Device		None for underground lines.

In order to associate these various pieces of apparatus in proper relative position, and to protect and adequately maintain them, it is customary to assemble the various parts in a wooden encasement.

In the days of the Blake instrument, the substation assemblage consisted of a back board, usually made of black walnut upon which the ringing generator and ringer were enclosed in a black walnut box. Directly beneath the ringer the Blake transmitter box was set and underneath the transmitter a third box was provided into which the

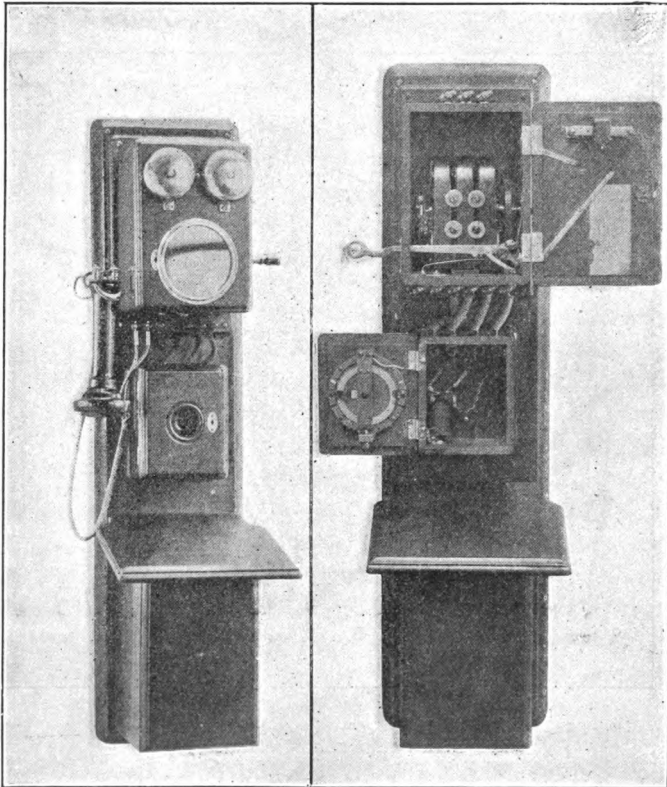

FIG. 290A.

FIG. 290B.

BLAKE SET.

necessary battery cups were placed. This arrangement, closed, is shown in Fig. 290A, while the transmitter and generator box are opened in Fig. 290B, showing the disposition of the various parts. The top of the battery box was provided with a sloping shelf to afford a place upon

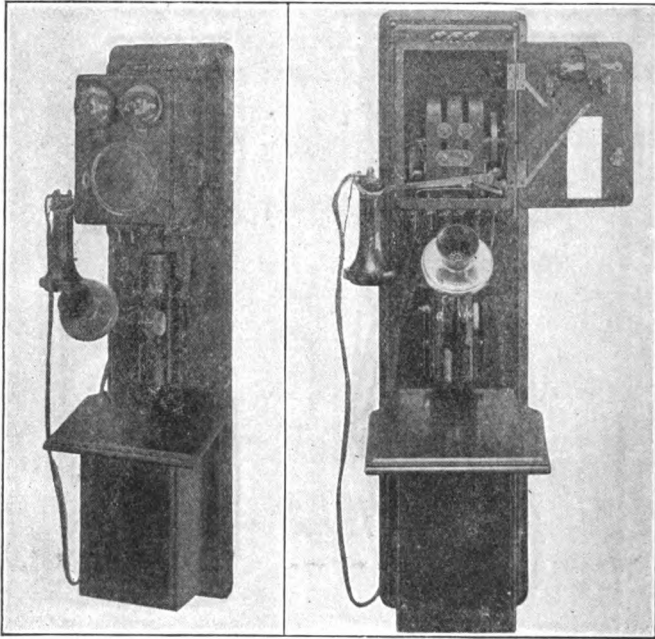

FIG. 291A.

FIG. 291B.

SOLID BLACK SET.

which memoranda could be written. It was customary to mount the protective device directly on top of the generator box, while the hook switch was enclosed therein, bringing the receiver in close proximity to the transmitter. With the advent of the solid back transmitter the simplest transition

was to remove the Blake transmitter and substitute therefor a White transmitter mounted upon a hinged arm sup-

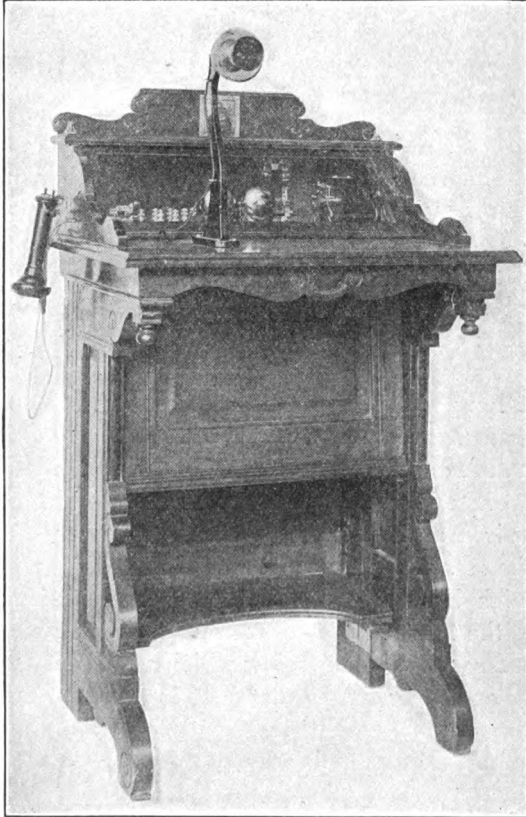

FIG. 292.—DESK SET.

ported by a semi-cylindrical iron case which served as an enclosure for the induction coil. The solid back wall set is

shown closed in Fig. 291A and open in Fig. 291B. Simultaneously there arose a desire for a more elaborate and ornate instrument, and the so called cabinet desk sets were designed to fill this want. The customary form is shown in Fig. 292 and consists of a mahogany desk of convenient height at which to sit. Upon the table of the desk the transmitter was mounted on a swan's neck-shaped iron arm, the head of the transmitter being hinged to be adjustable. In the rear, a glass covered compartment enclosed the magneto generator, the ringer and the protective device. To the left of this compartment the hook switch projected through the wall of the side of the desk and supported the receiver. Beneath the shelf of the desk a commodious compartment afforded room for enclosing the necessary batteries.

For a long time the so called cabinet wall set was a favorite, particularly for office installations. This is shown in Fig. 293A closed, and in Fig. 293B open. It consisted of a tall coffin like affair carrying the transmitter upon a swinging iron arm mounted in the center of a panel at the top of the set. About half way up, a shelf was provided upon which books and paper could be kept, and which served as the top of an inclosure into which the ringer and call bell were placed, and below which a cupboard was provided for enclosing the battery. It is difficult to imagine a more ungraceful and inelegant piece of apparatus, and it is almost inconceivable why early telephonists took so little pains to provide artistic lines and attractive exteriors for substitution sets.

The advent of a common battery decreased the substitution apparatus by omitting the ringing generator and the battery, and it became possible to economize the space required by the substitution set. In consequence thereof the

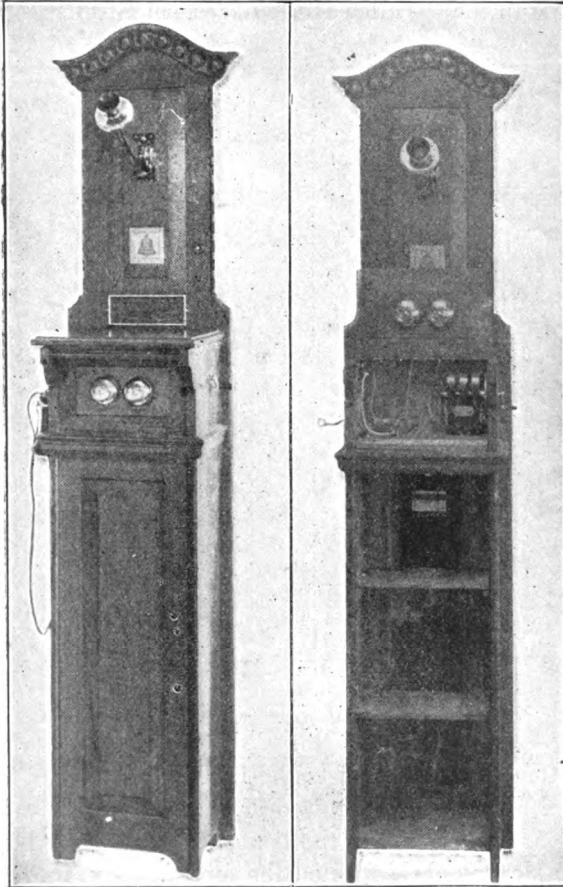

FIG. 293A.

FIG. 293B.

CABINET WALL SET.

backboard and the woodwork was markedly curtailed and more pains taken with the appearance of the outfit as is indicated in the so called No. 69 Western Electric, or com-

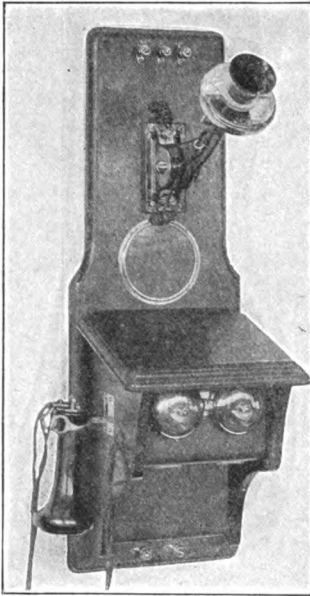

FIG. 294B.

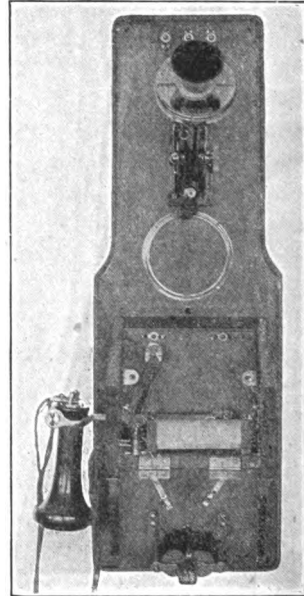

FIG. 294A.

COMMON BATTERY SET.

mon battery wall set, illustrated in Figs. 294A and 294B. The back board was narrowed and shortened but still remained as a support for the transmitter, directly beneath which a sloping shelf formed the top of a box, into which the call bell, induction coil, hook switch and condenser were placed. The shelf was hinged and the front of the box similarly arranged so that a single movement could throw the apparatus open for inspection.

About this time the selective signal polystation set appeared, which going to the other extreme, was made as small and inconspicuous as possible. Figs. 295 and 296 show this design opened and closed. It consisted of a small ebonized box about 6 inches by 8 inches and 4

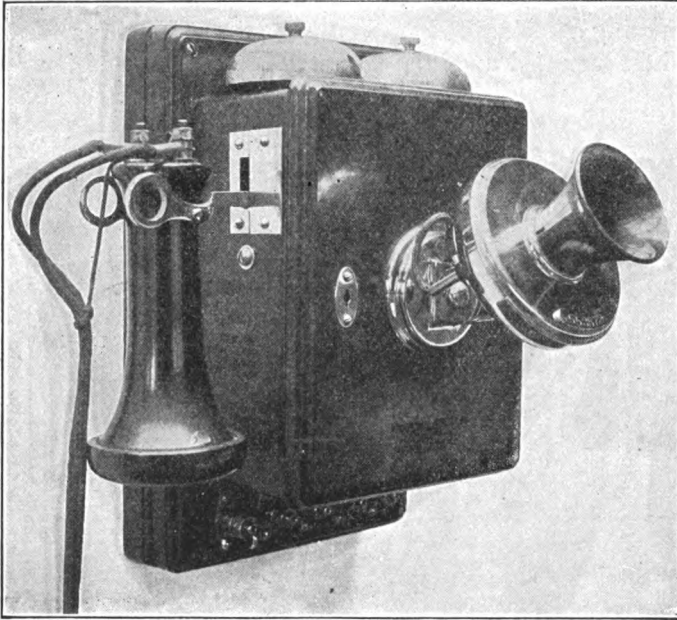

FIG. 295.— RESIDENCE SET.

inches deep, mounted upon a back board which contained the condenser. The box had sufficient capacity to accommodate the magnets of the ringer, the gongs of which were mounted outside on the top, the induction coil, protective device and hook switch. The transmitter was fixed upon

the door, the whole affair being but slightly larger than the ancient Blake transmitter box.

The advent of independent telephony infused new blood into manufacturing concerns and gave a great impetus to the artistic design of substation assemblage. Fig. 297 shows a unique set devised by the Stromberg-Carlson Telephone Mfg. Co. It consists of a small iron box, carrying a hook switch and an induction coil with a transmitter mounted upon the front. There is no provision for

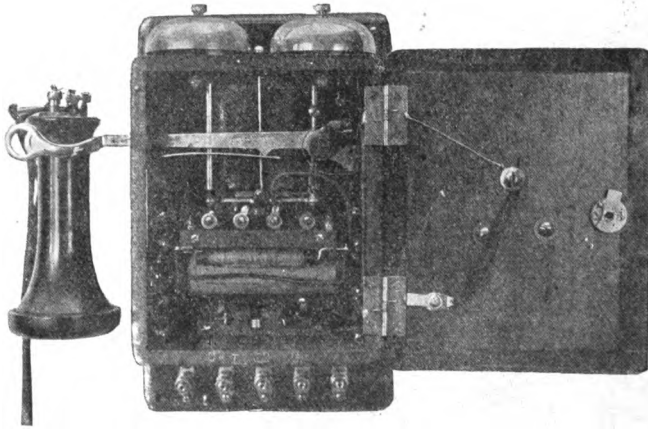

FIG. 296.—RESIDENCE SET OPEN.

a magneto generator as the set is intended for common battery, nor is there any ringer, as the set is used for outward calls only or is provided with a separate extension bell which is located elsewhere.

Telephonists in Europe have departed so widely from the ideas followed in America regarding substation apparatus that foreign apparatus seems almost bizarre to our eyes. Usually the transmitter and receiver are con-

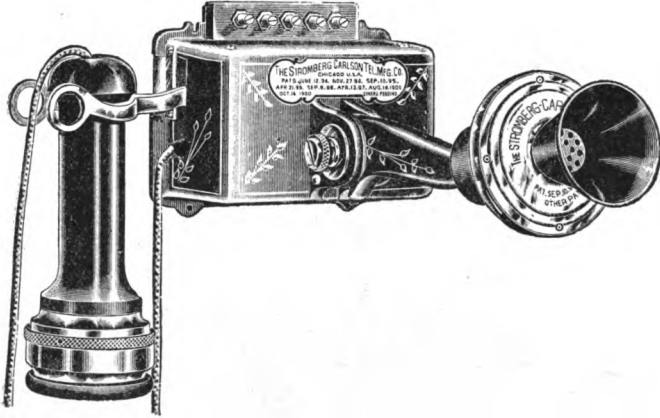

FIG. 297.— STROMBERG-CARLSON SET.

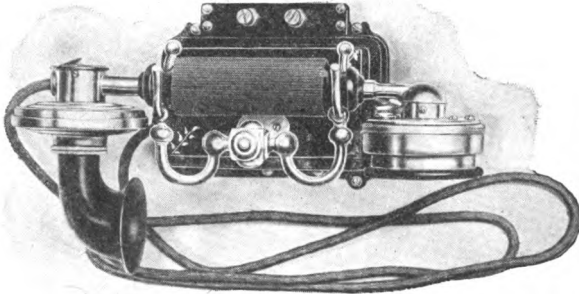

FIG. 298.— EUROPEAN MODEL NO. 1.

nected by a handle that serve to simultaneously support both instruments. The cases for holding the other parts are often excessively ornate and sometimes superfanciful

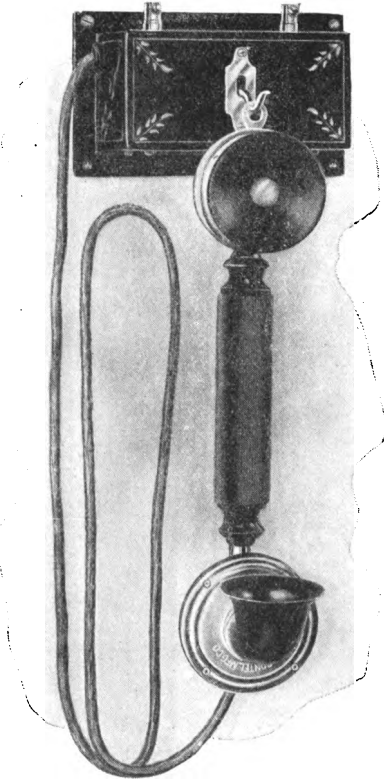

FIG. 299.—EUROPEAN MODEL NO. 2.

in design, but, despite all, the American makers could learn many profitable lessons from European models. Figs.

298 and 299 show a pair of substation sets made by the Stromberg-Carlson Mfg. Co. copied after German designs, that give one of the most compact and at the same time

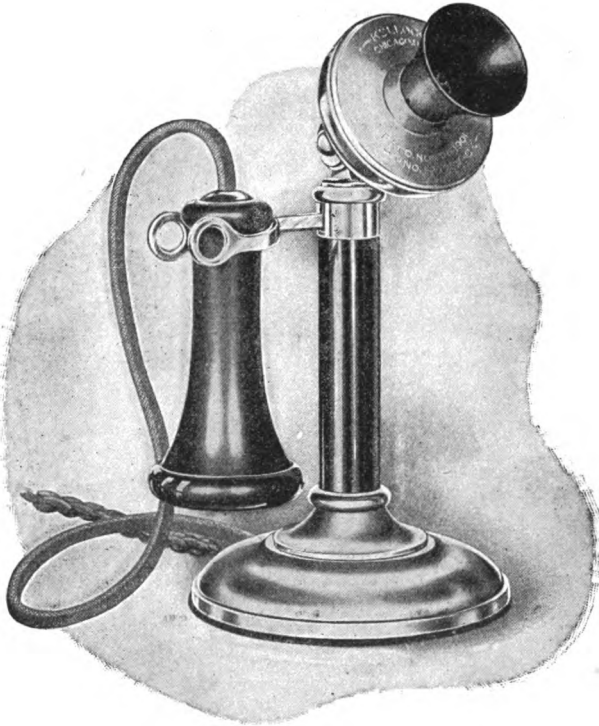

FIG. 300.—DESK SET.

tasteful substation sets that the market now affords. The receiver and transmitter are mounted together upon an arm and hang from the hook switch as a single piece, as

shown in Fig. 299, or they may be mounted upon a rack as indicated in Fig. 298.

The so called desk is almost universally found in offices. Each company has its pet design, but all so closely resembles each other that the example of Figs. 300 and 301 answer for every make. A pedestal is provided, usually of



FIG. 301.— SWINGING ARM DESK SET.

metal, which, upon the top, supports the transmitter, hinged to have sufficient adjustability as to make it easily accessible to the lips of the speaker. Below the transmitter, the receiver hangs upon the hook switch. Some manufacturers mount the induction coil separately and connect the set thereto by means of a flexible cord. Others place the induction coil either in the base of the pedestal or in the column that supports the transmitter. While such

an arrangement makes a more compact set, the apparatus is heavier, and is more inaccessible in case repairs become necessary.



FIG. 302.— STROMBERG-CARLSON TABLE SET.

The modern Table Set is shown in Fig. 302. Its small size, compact design and graceful lines are a striking commentary on the clumsy ponderousness of the old-fashioned cabinet set of Fig. 292.

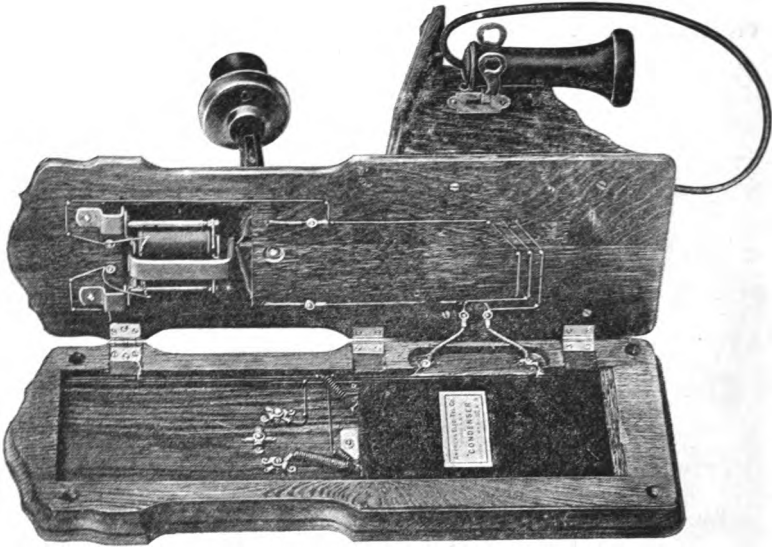

FIG. 303B.

COMMON BATTERY SET.

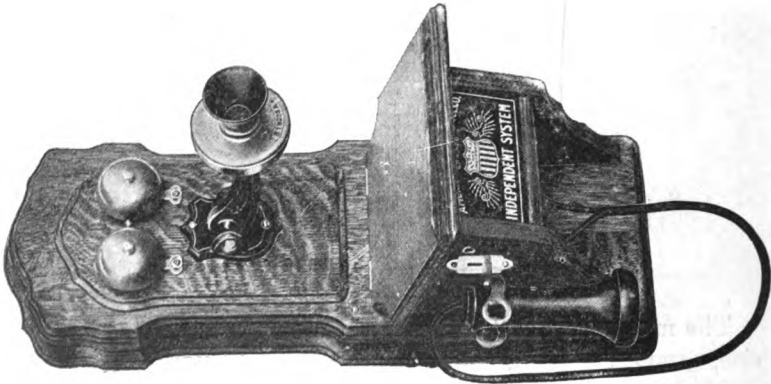

FIG. 303A.

Figs. 303A and B are illustrations of a common and advantageous design for common battery sets. The back board is made of much greater thickness than in the older instruments and is hollowed out so that it may receive the

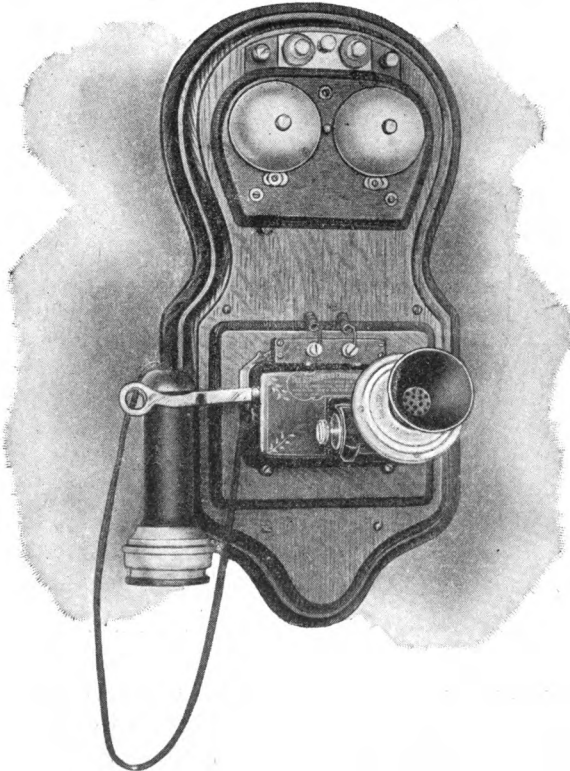

FIG. 304.—RESIDENCE SET.

condenser and ringer, the spools of which hang vertically. The condenser is placed at the bottom of the cavity thus formed and is secured to the rear half of the backboard.

The other half of the backboard forms a door and is hinged to the part secured to the wall. This door carries the ringer, transmitter and hook switch. The transmitter is screwed upon the face of the door directly beneath the ringer, and underneath it the customary memorandum

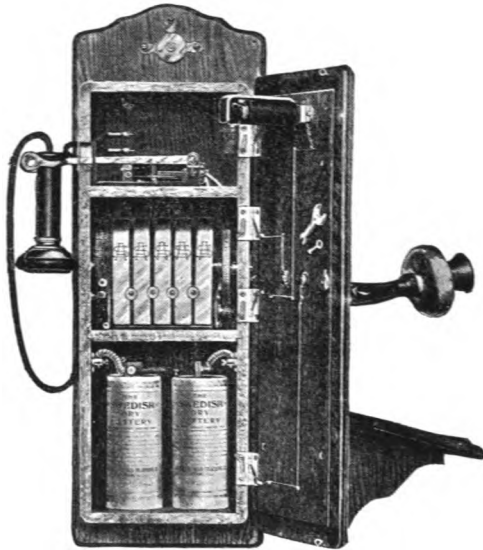

FIG. 305.—LOCAL BATTERY SET NO. 1.

shelf is placed. The hook switch is situated below the shelf enclosed in a box of which the shelf is the top. In this design it is possible to inspect all parts of the substitution set in their normal working condition, for by opening the door each piece is exposed to view. This design renders the detection and clearing of trouble simple and inexpensive.

Fig. 304 is a design for a residence or hotel set operated upon the common battery plan. The backboard is hollowed out for the reception of the condenser, the ringer is made as small as possible and screwed to the top of the back board which is heart shaped. The transmitter and receiver are placed directly beneath. For this service no memorandum shelf is provided as it is unnecessary.

Turning to local battery instruments, Figs. 305 and 306 are representatives types. The backboard is made as small and compact as possible and forms the rear of a kind of closet divided into three compartments, as shown in Fig. 305. The upper one contains the hook switch and affords space for the ringing magnets which are horizontal and screwed to a door which forms the front. In the center compartment the ringing generator is placed, while below there is sufficient room for a pair of cells. The transmitter is secured upon the face of the door and underneath it the memorandum shelf is located. The protective device appears on the back board on the top of the box. This arrangement embodies the features of Fig. 303 by permitting all apparatus to be in normal working condition when under inspection. Fig. 306 is a somewhat less pretentious set advocated for rural districts. The lower part of the closet is dispensed with, the batteries being placed upon an iron shelf supported upon the bottom of the base board, and are constantly open to examination. On the top, a small box encloses the ringer and the magneto generator.

In certain exposed locations as in mines, electric railway installations and for police service, the substation must be arranged to be waterproof. An approved design for this purpose is shown in Figs. 307, 308 and 309. Fig. 307 indicates the exterior and shows the entire apparatus

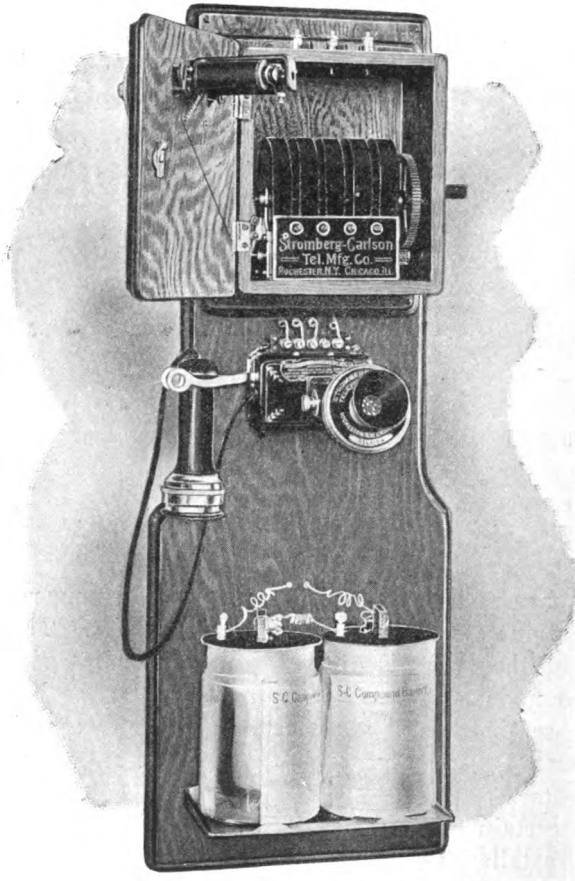

FIG. 306.—LOCAL BATTERY SET NO. 2.

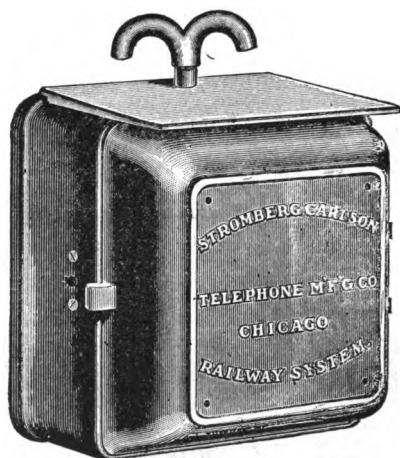

FIG. 307.— WATER PROOF SET.

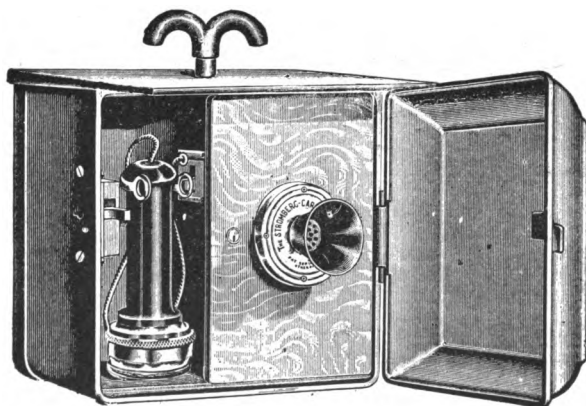

FIG. 308.— OUTER DOOR OPEN.

enclosed in a waterproof iron box provided with a waterproof entrance for the circuits. Figs. 308 and 309 show the set open. Unlocking the cover reveals the transmitter screwed to an iron plate which forms the door of a waterproof compartment, while a receiver is suspended from a compact hook switch to the left. For inspection and repairs the inner door which is normally kept locked is opened, disclosing the remainder of the mechanism,—the induction coil, hook switch and condenser with wiring

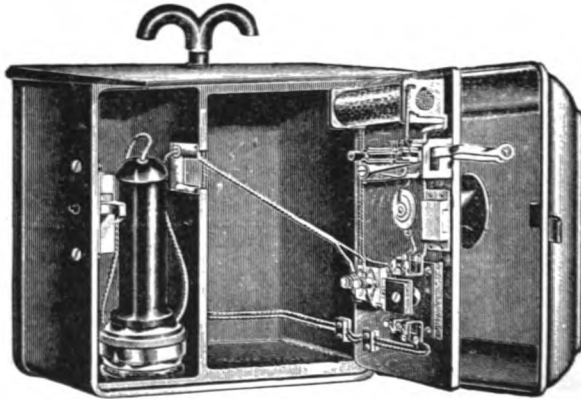

FIG. 309.—INNER DOOR OPEN.

located upon the rear of the door, all arranged so that inspection may be made under working conditions.

The actual wiring of substation sets may be done in a infinite variety of ways, and each maker has his own pet plan. Fig. 310 as representation of good practice shows the methods adopted by the Kellogg Company.

In addition to the appearance of substation installations the mechanical and electrical features should receive the most careful consideration. For ordinary conditions

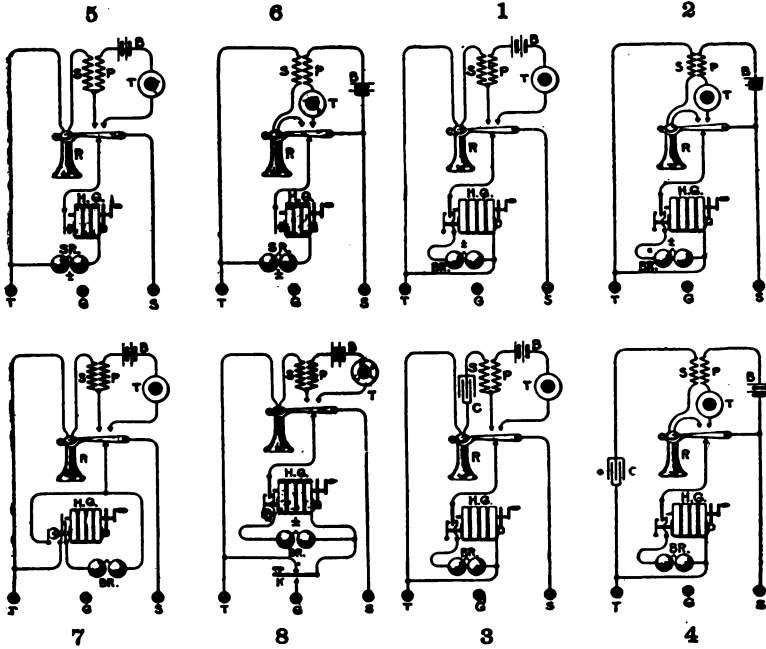

FIG. 310.—SUBSTATION WIRING.

1. Bridging circuit wall set.
2. Bridging circuit desk set.
3. Condenser in secondary of induction coil wall set.
4. Condenser in secondary of induction coil desk set.
5. Series wall set.
6. Series desk set.
7. Bridging circuit D. C. generator.
8. Bridging circuit with grounding key.

wood has been found to be most suitable, but care should be taken to select only that which is carefully and thoroughly seasoned. The kind of wood is largely a matter of taste, black walnut was formerly, and is now used in a great proportion of designs; this may be finished either in natural color or ebonized. Quarter sawed oak seems to have next preference and by many is considered superior. Mahogany, strange to say, is rarely used, while birds eye maple is sometimes demanded by the fanciful. Whatever kind of wood is selected it should receive the most careful seasoning and should be selected from the best and soundest of timber. After being completely machined, all the necessary cutting and fitting for wiring the apparatus should be done, and then the wood should be finished with a sufficient number of coats of oil and varnish to secure a perfect and durable surface. All wiring should be made with high grade rubber insulation, as it is a serious mistake to use the poorer qualities of cotton covering. All connections, should be soldered, but no soldering acid should ever be employed, only resin being used as a flux. Connections should not be carried through hinges of doors or boxes, as imperfect contacts are sure to result. The screws and hinges employed should always be brass, for even with the best of care iron hinges are likely to rust and iron screws become so firmly imbedded by corrosion that repairs are difficult or impossible.

Finally the best quality of material, the highest grade of workmanship, and the most artistic and pleasing designs should be chosen, for such add relatively little to cost of manufacture, while the satisfaction of the subscriber, the increased durability of the installation, and the reduced annual maintenance expense are the surest and most rapid methods of increasing both quantity and profit of business.

CHAPTER X.

COSTS OF INSTALLATION AND OPERATION.

It is difficult to accurately schedule the expense of substation apparatus, because owing to improved methods of manufacture and increasing competition there is a constant tendency toward reduction in costs. Prices for labor and material vary; and finally, different manufacturers make different grades of apparatus, although each maker claims reasonable excellence.

In Table XX the apparatus chiefly used at the substation has been scheduled; there are two price columns, one giving the probable minimum price to be expected and the other the maximum, thus the reader may be informed as to expected range of price as well as average cost. Amounts under the heading of "Minimum" are those quoted by manufacturers of the lowest priced forms of the various items enumerated, while those in the column headed "Maximum" are quotations of the highest grades of standard apparatus. Between the two extremes may be found makers who incline more or less either to one or the other. Quotations apply to fair average market values and do not recognize such special discounts as manufacturers will often give under the pressure of intense competition; for orders of unusual magnitude, or under the operation of other special causes. Such modifying conditions it is impossible to recognize and the quotations presented are only intended to furnish a basis upon which the designer may make a careful and fairly intelligent estimate, or to be used as the basis of calculating annual expense and fixed charge.

TABLE XX.

Schedule of Apparatus Costs.

Item.	Minimum Price.	Maximum Price.
Transmitters:		
Head only	\$0.85	\$2.00
With single joint arm	1.25	2.50
With double joint arm	1.50	2.75
With iron base, holding induction coil, and coil	2.00	3.25
Induction coil only50	1.25
Transmitter cords15	.50
Receivers:		
Receiver Cords two conductors, worsted 3 ft. to 6 ft.....	.25	.75
Silk cord, 2 ft.....	.60	1.00
Silk cord, 6 ft.....	1.00	1.50
Ringers (Magneto Bells):		
80 Ohms	2.00	3.00
1,000 Ohms	3.00	4.00
1,600 Ohms	4.00	5.00
2,000 Ohms	5.00	6.00
Generators:		
10,000 Ohms	3.00	5.00
20,000 Ohms	3.50	6.00
30,000 Ohms	4.00	7.00
40,000 Ohms	4.50	8.00
50,000 Ohms	5.00	9.00
Hook Switch50	1.75

Item.	Minimum Price.	Maximum Price.
Complete Substation Sets:		
A. Magneto Sets:		
Wet Battery, 1,000 ohms ringer.	\$12.00	\$16.00
Dry Battery, 1,000 ohms ringer.	11.00	14.00
Cabinet Wall sets, 1,000 ohms ringer	15.00	20.00
Cabinet Desk sets, 1,000 ohms ringer	16.00	23.00
Portable desk sets, 1,000 ohms ringer	12.00	16.00
Party Line sets, 1,000 ohms ringer	10.00	14.00
B. Common Battery Sets, 1,000 ohms ringer		
Party Line sets, 1,000 ohms ringer	8.00	12.00
Cabinet Wall sets, 1,000 ohms ringer	9.00	12.00
Cabinet Wall sets, 1,000 ohms ringer	12.00	15.00
Cabinet Desk sets, 1,000 ohms ringer	14.00	18.00
Portable desk sets, 1,000 ohms ringer	11.00	15.00

When higher wound ringers are used add to above the difference in price for the ringer.

Protection:		
Mica Fuses	\$0.75	\$1.50 per 100
Heat Coils	2.00	4.00 per 100
Complete Substation Protectors	1.00	1.50 each
Enclosed fuses	6.00	10.00 per 100

Item.	Minimum Price.	Maximum Price.
Protection — (<i>Continued</i>):		
Paystation for 5¢ & 10¢ coins....	\$5.00	\$20.00
Paystation for 5, 10 & 25¢ coins ..	10.00	25.00
Message Counters40	.75
Batteries:		
Gravity, Complete Cell30	.60
Renewal parts: Zinc15	.25
Copper06	.10
Jars15	.25
Sulphate of copper.	.08	.16
Cost of Renewal including labor ..	.30 to	.40
Fuller, Complete Cell55 to	1.50
Renewal parts: Jar13 to	.18
Covers03 to	.05
Zincs08 to	.12
Carbons10 to	.15
Porous Cups08 to	.12
Solution05 to	.08
Mercury03 to	.05
Cost of renewal including labor, per cell average life17 to	.25
Cost per station per year, two cells..	2.25 to	2.75
Cost per station per year, three cells.	3.50 to	4.00

OXYDE OF COPPER BATTERY.

Edison Lalande.

Type.	BB	O	X	R	Z	V	AA	S	W	Y
Complete batteries.	\$1.50	\$2.20	\$2.60	\$2.90	\$2.00	\$2.50	\$3.50	\$3.00	\$4.85	\$2.50
Copper oxide plate.	.24	.31	.28	.55	.24	.31	.55	.62	1.10	.55
Zinc plate28	.28	.20	.50	.28	.35	.58	.50	.82	.35
Caustic potash, one charge15	.17	.20	.28	.15	.17	.28	.28	.52	.28
Paraffine oil, one charge05	.06	.06	.07	.05	.06	.07	.06	.06	.07

Discount on above prices 10 per cent. to 25 per cent. depending on quantity ordered.

Gordon Battery:

Gordon No. 1 6 x 8 inch glass cell, complete with charge	\$3.00
Gordon No. 1 cell without jar with charge...	2.75
Recharge complete, including zinc, copper electro-sodium and oil for No. 1 Gordon Battery	1.75
Gordon No. 1, Zinc only45
Gordon No. 1, Copper only50
Gordon No. 1, Sodium and Oil only.....	.30
Gordon No. 2 Glass Cell, complete with charge ..	2.00
Gordon No. 2 Steel Enamel Cell (fibre cover) complete with charge	2.25
Gordon No. 2 Steel Enameled Cell (steel cover) complete with charge.....	2.50
Recharge complete, including zinc, copper, electro-sodium and oil for No. 2 Gordon Battery ..	1.00
Gordon No. 2 Recharge complete, less oil..	.95
Gordon No. 2 Zinc only25
Gordon No. 2 Copper only50
Gordon No. 2 Electro-Sodium and Oil only..	.25
Gordon No. 2 Electric-Sodium only20

Discount 10% to 20% depending on quantity ordered.

	Minimum Price.	Maximum Price.
Nungesser No. 1:		
Complete cell	\$1.50	\$2.00
Renewal complete90	1.40
Parts: Copper cup filled		
Zinc25	.40
Chemicals and oil25	.40
Jar10	.18
Harrison Battery:		
Complete cell60	1.08
Renewal parts: Lead electrode		
Zinc20	.35
Acid05	.08
Jar10	.15
Cover05	.07
Binding posts03	.06
Salammoniac Battery:		
Leclanché cell40	.60
Renewal parts: Porous cup		
Jar10	.15
Zinc04	.08
Salammoniac08	.12
Bag Battery:		
Same as Leclanché.		
Carbon Cylinder Batteries complete20	.30
Sampson Battery:		
Sampson No. 1, Complete cell		1.00
Carbon65
Zinc16

	Minimum Price.
Sampson Battery — (<i>Continued</i>):	
Sampson No. 2, Complete cell	\$1.25
Complete cell with R. R. zinc.	1.50
Carbon80
Zinc18
Railroad Zinc (1 lb.)35
Sampson No. 3, Complete cell	1.75
Carbon	1.20
Zinc40
Semi-Dry, Complete cell	2.00
Carbon	1.20
Zinc40
Complete recharge	1.65

Discount 10% to 40% depending on quantity ordered.

Dry Batteries \$0.10 to \$0.30

INSTALLATION EXPENSE.

Installation expense is usually understood to mean the necessary labor and material required to set up the substation inside the house wall. Where the subscriber's line runs to an aerial circuit the latter is usually brought to the window nearest the location of the telephone set and interior wiring connects the aerial line with the telephone, so that the installation cost comprises running this circuit. In the case of underground distribution a pair of leads, or where many telephones are included in one building, a cable is extended from the conduit through the building wall and terminated in a distributing box or cable head. From this point interior wiring is carried to the various substation sets, and installation cost includes such interior

work. From averages over a large number of stations, the wire and miscellaneous material varies from 75 cents to \$2.00, while the labor varies from \$2.50 to \$5.00 per station.

ANNUAL EXPENSE.

A. Maintenance.

The expense of maintaining the substation will vary with the size of the territory tributary to a single office, the average daily use of the telephone and the character of the community in which it is placed. Busy telephones on common battery systems require at least four inspections annually, while for residence stations, one may suffice. There is more or less breakage of cords, receivers and transmitters than there is cost of current supply. In the United States, all expense of moving telephones is borne by the telephone companies. From general averages maintenance expense per station is found to be within the following limits for common battery stations:

	Minimum Price.	Maximum Price.
Labor	\$0.50	\$1.50
Material25	1.25
Current supply common battery10	.30
General expense chargeable to nitie..	1.00	2.00
Proportion of moving expense50	1.00
	<hr/>	<hr/>
	\$2.35	\$6.05
	<hr/>	<hr/>

Where magneto stations are installed the maintenance of the magneto adds from 25 to 50 cents per year, and

the cost of local battery current supply varies with kind of battery and use of telephone, as follows:

Fuller battery 3 cell 4 renewals	\$3.50
Fuller battery 2 cell 5 renewals	2.50
Local storage battery current at 10¢ per K. W.	
H.	1.60
Local storage battery current at 5¢ per K. W.	
H.80
Salammoniac cells	\$4.00 to 6.00
Dry battery local service only	1.00 to 1.75

B. Depreciation.

Substation depreciation is severe, owing to carelessness in the use of the apparatus, improvements and changes in design, sacrifice necessary to removal, etc. It would be hard to find to-day a substation in the country that had not to be replaced within five years. In the future it is confidentially expected that depreciation expense can be reduced, but until this is proven a conservative estimate is 12½% of installation cost.



INDEX.

NUMBERS REFER TO PAGES.

- Alloys of Iron and Their Magnetic Properties, 60, 67.
Alloys, Heat Coil, 370.
American Transmitter, 178, 179, 180.
Ampere Turns, 33.
Annual Expense, 464.
Apparatus, 2.
Apparatus of Sub-Station, 250.
Apparatus Schedule, 458, 459, 462.
Armatures, 350, 351, 352, 360.
Armature Checks, 360.
Arrester, 366.
Assemblage, 434.
Assembled Bell Receiver, 92, 97, 101.
- Bag Battery, 324.
Bar Magnets, 93.
Battery, 308, 309.
Battery, 315, 322, 323, 326.
Battery Action Diagram, 305, 306.
Battery, Age, and Transmission Relation, 298, 299.
Battery, Closed Circuit, 307.
Battery, Desk Sets, 287.
Battery Depreciation, Rate of, 295, 296.
Batteries, Local Storage Substituted for Local Primary, 261.
Batteries, Primary, 303, 304.
Battery Set, 440, 450.
Battery Systems, 266, 269, 270.
Bell-bridging, 405.
Bell's Invention, 4, 5, 6, 7, 8, 11, 12.
Bell Receiver, 14, 15, 16.
Bichromate Battery, 315.
Bichromate or Fuller Cell, 307, 310, 311.
Biased Ringer, 343.
Bipolar Receiver, 16.
Blake Set, 435.
Blake Transmitter, 156, 157, 158.
Branch Line, 431, 432.
Bridging Bell, 405, 407.
Bridging Circuit, 254, 255, 256, 257.
Bridging Station Wiring Detail, 286.
- Cable Conductors, 374.
Cable Protector, 390.
Carbon Cell, 324.
Carbon Electrodes, 214, 215.
Carbon Transmitter, 149.
Capsule Parts, 183.
Carty Bridging Bell, 405.
Cases, 82, 83.
C. B. Circuit with Retardation Coil, 274.
Cell, 307, 316, 317, 318, 319, 324, 327, 330.
Cell, Fuller, 295, 299.
Central Energy, 250.
Century Transmitter, 186, 187.
Charging Magnets, 64, 65.
Circuit, 29, 307, 404, 406, 410, 413, 414, 419, 426.
Circuit Bridging, 254.
Circuit C. B., Scribner, 281.
Circuit, Common Battery Diagram, 265.
Circuit Condenser, C. B., 270, 271, 272, 273, 274.
Circuits, C. B., 303.
Circuit Complete, 391.
Circuit Controlling Magnet, 421.

- Circuit Closed Battery, 307.
 Circuit for Local Battery, Talking and C. B. Signalling, 282.
 Circuit, Holtzer-Cabot, 260.
 Circuit of Subscriber, 249.
 Circuit Receiver, 275.
 Circuit with Retardation Coils, 274.
 Circuit to Reduce "Side Tone," 283.
 Circuit, Sub-Station, 23, 251.
 Circuit Storage, 262, 263, 264.
 Circuit Series, 252, 253, 255.
 Closed Circuit, 307.
 Closed Circuit Battery, 307.
 Coercive Force, 52, 53, 56.
 Coil, 369.
 Coils, 26, 142, 221, 234, 235, 236, 240, 244.
 Coil Data, 232, 233.
 Coil Operation, Induction, 276.
 Coils, Retardation, 269, 274.
 Coil Tests, 228.
 Coil to Hook Switch Terminal, 259.
 Columbia Receiver, 137.
 Common Battery Circuits, 303.
 Common Battery, Circuit Diagram, 265.
 Common Battery Circuit, Russian, 280.
 Common Battery Circuit, Scribner, 281.
 Common Battery Condenser Circuit, 270, 273, 274.
 Common Battery Protector, 385, 386.
 Common Battery Circuit, Dean, 278, 279.
 Common Battery, Desk Sets, 287.
 Common Battery Set, 440, 448.
 Common Battery System, 268, 303.
 Common Battery Transmission Comparison, 302.
 Common Battery System, Hayes, 267.
 Common Battery System, Kellogg, 269.
 Common Battery System, Stone, 266.
 Condenser Circuit, C. B., 270, 271, 272, 273, 274.
 Condenser Transmitters, 147.
 Connecting Cord, 87.
 Connections of Joined Lines, 18.
 Conductors, 374.
 Conversational Function, 1, 17.
 Core, 236, 237, 238, 239, 241.
 Cord, 86, 87.
 Cook Shunt, 355.
 Cord Circuit, 410, 411.
 Cord-tips, 86.
 Cornplaster Transmitters, 171.
 Costs of Installation, 398, 457, 463.
 Currents, 10, 11, 17, 19, 22, 32, 33, 67, 80, 226, 367.
 Current Curves from Transmitters, 301.
 Current Generator, 362.
 Current from a Battery Transmitter, 225.
 Current with Induction Coil, 226.
 Current and Sound Pitch, 226.
 Current Transmission Relation, 297.
 Current Supply and Transmission, 294.
 Curves for Special Irons, 66.
 Curve for Steel and Iron, 38, 57, 58, 59.
 Curves of Current from Transmitters, 301.
 Curves of Transmission Tests, 219.
 Data for Winding Coils, 246, 247, 248.
 Data of Transmission, 300.
 Dean Common Battery Circuit No. 1, No. 2, 278, 279.
 Dean Party Line System, 420, 421.

- Demagnetizing Force, 52.
 Depreciation, 465.
 Depreciation of Battery, 295, 296.
 Desk Sets, 287, 293.
 Desk Set (Ness), 430, 431, 437, 445, 446.
 Diagram of Operation, 9.
 Diaphragm, 41, 72, 73, 74, 75, 76, 77, 78, 79, 80, 81, 84, 88, 89, 90, 94, 104, 143.
 Dissected Bell Receiver, 93.
 Double Diaphragm Transmitters, 204, 205, 206.
 Double Pole, 91.
 Double Wound Coil, 240.
 Dry Batteries, 326, 329.
 Dynamo, 345.
 Dyne, 31.

 Edison-Lalande Cell, 307, 317.
 Edison Transmitter, 149, 150.
 Electrodes of Carbon, 214.
 Electro-Magnetic Transmitters, 144.
 Electro-Motive Force, 28.
 Electrostatic Transmitters, 146.
 E. M. F., 17, 28.
 Energy, Central, 250.
 Equipment, 395.
 Ericsson Receiver Dissected, 122.
 Ericsson Transmitter, 180, 191, 193, 195, 196.
 European Models, 443, 444.
 Expense, 398, 457, 463, 464.

 Fahnestock Transmitter, 207, 208, 209, 210, 211, 212.
 Ferrotpe Diaphragm, 82.
 Field of Diagram, 357.
 Force (Lines of), 28, 52, 53, 56.
 Formula for Current and Time, 25.
 Fuller Cell Tests, 312.
 Fuller Cell, 295, 299, 316.
 Fuller Cell, Early and Improved Types, 310, 311.
 Function, 1, 17.

 Fuses, 389, 392.
 Fuse and Spark Gap Combined, 381, 382.

 Gauss, 33, 37.
 Generator, 344, 347, 350, 362, 363, 417.
 Gilbert, 31, 33.
 Gordon Cell, 307.
 Granular Carbon, 215.
 Gravity Battery, 308, 309.
 Group of Transmitters, 177.

 Harrison Cell, 320.
 Hayes Common Battery System, 267.
 Head Receiver Dissected, 98.
 Heat Coil, 369.
 Heat Coil Alloys, 370, 371.
 Hibbard System, 407, 408.
 Hook Switch, 430.
 Hook Switch, Early Type, 288.
 Hook Switch Terminal, 259.
 Holtzer-Cabot Circuit, 260.
 Holtzer-Cabot Receiver, Assembled and Dissected, 132, 133.
 Holtzer-Cabot Shunt, 356.
 Hook Switches, 291, 292, 293.
 Hunning Transmitter, 163.
 Hughes Microphone, 151, 152, 153.
 Hysteresis, 49, 50, 54.

 Impedance, 19, 24, 25.
 Induction Coils, 221, 224, 243.
 Induction Coil Data, 232, 233, 248.
 Induction Coil Operation, 276.
 Intensifying Transmitter, 180, 181, 182.
 Intercommunicating Systems, 425, 426, 427, 428.
 Inspectors, 218.
 Insulator, 38.
 Installation Costs, 398, 457, 463.
 Instrument, Stromberg-Carlson, 102.

- Introduction, 1.
 Iron Alloys, 60.
 Iron Magnets, 45.
 Iron Shield, 236.
 Iron and Steel Curves, 38.
 Kellogg, C. B., System with Repeating and Retardation Coils, 269.
 Kellogg Hook Switch, 289.
 Kellogg Receiver Dissected, 111, 112, 113.
 Kellogg Switchboard and Supply Co., 329.
 Kellogg Transmitter Diaphragm, 174.
 Kellogg Transmitter Dissected, 171, 173, 176.
 Laminated Magnets, 91.
 Law of Magnetic Circuit, 32, 43.
 Leading-in Wires, 86.
 Leclanche Cell, 322, 325.
 Leich System, 417, 418.
 Lightning Arrester, 366.
 Lines, 393, 394, 407, 409, 412.
 Line Coils, 142.
 Line Currents from Various Transmitters, 225.
 Lines of Force, 28, 344.
 Line with Induction Coil, 223.
 Line with Battery Transmitter, 222.
 Local Battery Sets, 450, 452.
 Local Circuit Receiver, 275.
 Lock-Out Improved, 423.
 Low Resistance Coil, 234.
 Local Storage Circuit, 262, 263, 264.
 Magnets, 45, 51, 52, 61, 64, 65, 84, 91.
 Magnet Bars, 93.
 Magnetic Circuit, 29, 30, 42, 43.
 Magneto Control, 421.
 Magnetic Constants, 36.
 Magnetic Cycle for Soft Iron, 49.
 Magnetic Cycle for Steel, 47.
 Magneto Diagram, 346, 347, 348, 349.
 Magneto Desk Set, 287.
 Magnetic Field, 30, 69, 70, 71, 77, 78, 79, 81, 121.
 Magnetic Flux, 33, 34, 45.
 Magneto Instrument, 145.
 Magnetic Insulator, 38.
 Magnetism, 29, 34, 64.
 Magneto Local Battery Circuit, 251.
 Magneto-Motive Force, 28, 32, 33, 34, 44, 45.
 Magnet of Head Receiver, 99.
 Magnetic Qualities of Silicon and Aluminum Irons, 67.
 Magneto Station, 250.
 Magnetic System, 137, 140.
 Magnétic Receiver System, 40, 42.
 Manganese Steel Curves, 58.
 Manhattan Telephone Dissected, 116, 117.
 Manhattan Transmitter, 194, 197, 198.
 Materials, 456.
 Material for Pole Pieces and Diaphragm, 65.
 Maxwell, 31.
 Meter, 54.
 Microphone, 213.
 Microphonic Contact Transmitters, 148, 150, 151, 152, 153.
 Molecular Motion in Plate, 89.
 Multiple Contact Transmitter, 161.
 Multistation Lines, 394.
 Multiple Series Transmitters or Granular Instruments, 162.
 Negative Magnetic Force, 48.
 Ness Hook Switch, 430.
 Ness Wall Set, 429.
 Nickel Steel Curves, 59.
 "Oersted." 31.
 Ohmic Resistance, 17, 19, 24.
 Open Circuit, 307.
 Open Space Cut-Out, 366.
 Open Set, 454.
 Overtones, 12, 80.

- Oxyde of Copper Cell, 316, 319, 320.
 Oxyde of Copper, Edison-Lalande or Gordon Cell, 307.
 Party Lines, 393, 395, 412, 414, 416, 420.
 Permanent Magnet, 65, 84.
 Phantom, 68, 69, 117, 125, 129, 130, 134.
 Phantom of Ericsson Receiver with Diaphragm Removed and in Place, 123, 124.
 Phantom of Kellogg Receiver, Diaphragm Removed and in Place, 114, 115.
 Phantom of Holtzer-Cabot Receiver with Diaphragm Removed, 134.
 Phantom of Manhattan Watch Case Receiver with Diaphragm Removed and in Place, 120, 121.
 Phantom with Diaphragm, 96, 100, 106, 125.
 Phantom without Diaphragm, 95, 99, 125, 130, 134.
 Phantom with Diaphragm in Normal Position, 105, 130, 134.
 Phantom with Diaphragm Removed, 103, 109.
 Polarization, 307.
 Pole Pieces, 141.
 Polystation Lines, 394, 400, 402, 403, 409.
 Post Shunt, 354.
 Primary Batteries, 304.
 Protective Circuit Complete, 391.
 Prism Battery, 323.
 Protection, 364, 372, 373, 374, 375, 376, 383, 384, 387.
 Reactance, 20, 21, 22.
 Receivers, 4, 12, 14, 15, 16, 26, 27, 35, 40, 68, 82, 88, 90, 91, 92, 93, 97, 101, 102, 110, 118, 127, 132, 136, 138.
 Receiver Assembled, 101, 111, 132.
 Receiver Coils, 26.
 Receiving Conversation, 2.
 Receiver, Columbia, 137.
 Receiver Completely Dissected, 104, 108, 111, 119, 122, 133.
 Receiver Cord, 86, 98.
 Receiver in Local Circuit, 275.
 Receiver Phantom, 68, 69, 71.
 Receiving Signals, 2, 4, 12.
 Reiss Telephone, 10, 11, 148.
 Relation Between Age of Battery and Transmission, 298, 299.
 Relation Between Strength of Field Thickness of Diaphragm and Induced Current; Ferrotype Diagram, etc., 74, 75, 82.
 Relative Magnetic Properties of Steels, 63.
 Reluctance, 31.
 Remanence, 52, 56, 61.
 Residence Set, 441, 442, 449.
 Resistance, 17, 19, 24.
 Ringer Assembled and Dissected, 333, 335, 337.
 Ringing Generators, 344, 347.
 Ringing Generator, 417.
 "Ring Ground, Talk Metallic," 258.
 Retardation Coils, 269, 274.
 Russian, C. B. Circuit, 280.
 Salammoniac Battery, 322.
 Scribner, C. B. Circuit, 281.
 Scribner Common Battery System, 268.
 Scribner Lockout System, 422.
 Secondary Wire, 236.
 Sectional View of Receiver, 101.
 Sending Signals, 2.
 Series-Contact Transmitters, 160.
 Series Circuit, 252, 253.
 Series Party Circuit, 404.
 Series Station Wiring Detail, 285.
 Setting, 430, 437, 440, 445, 450, 453, 454.
 Shield, 236.
 Shunt, 353, 354, 355.
 "Side Tone" Circuit, 283.

- Signalling Apparatus, 331.
 Signalling Function, 1, 2.
 Signal Systems, 417, 424, 425.
 Signalling and Talking Circuits, 282.
 Single-Bar Magnets, 91.
 Single-Contact Transmitters, 156.
 Sine Curve, 359.
 Single Pole Bell Receiver, 12.
 Single-Pole Receivers, 91, 92.
 Sneak Current, 367.
 Solid Back Set, 436.
 Solid Receiver, 136.
 Solid Back Transmitter, 164, 165, 166, 167, 168, 169, 170, 294.
 Sound Pitch Relation to Current, 226, 227.
 Spark Gap, 366, 368, 377, 378, 379, 381.
 Spool Winding, 98.
 Station, Magneto, 250.
 Station Wiring, Detail, 285.
 Station Wiring, Bridging Detail, 286.
 Steel Magnets, 45, 62.
 Steel and Iron Curves, 38, 57.
 Stone Common Battery System, 266.
 Stone Storage Circuit, 264.
 Storage Batteries, Substituted for Local Primary Batteries, 261.
 Storage Circuit, 262, 263, 264.
 Stromberg-Carlson Instrument, 83, 88, 102, 103, 188, 189.
 Stromberg-Carlson Ringer, 339.
 Stromberg-Carlson Set, 443, 447.
 Stromberg-Carlson Switch, A. & B., 290, 291.
 Swedish-American Receiver Assembled and Dissected, 127, 128, 129.
 Swedish-American Transmitter, 189, 190, 191.
 Swedish-American Switch, 290.
 Switches, 289, 290, 291, 292, 430.
 Switch, Early Type Hook, 288.
 Subscribers' Circuits, 249.
 Sub-Station, 1.
 Sub-Station Apparatus, 250.
 Sub-Station Assemblage, 437.
 Sub-Station Circuit, 251.
 Sub-Station Wiring, 455.
 Sulphate of Copper or Gravity Cell, 307.
 Supply Current and Transmission, 294.
 System, Magnetic, 140.
 Talking and Signalling Circuits, 282.
 Telephone and Telegraph Protectors, 388.
 Terminal Coil to Hook Switch, 259.
 Tests, Coil Induction, 228, 230.
 Tests for Relation Between Strength of Field and Induced Current, 80.
 Tests in Fuller Cell, 312.
 Tests of Transmission, 219, 220.
 Theory of Operation, 5, 7, 8, 9, 10.
 Thompson's Circuit, 419.
 Transmission, Common Battery, Comparison, 302.
 Transmission and Current Supply, 294.
 Transmission Data, 300.
 Transmission Relation, 297.
 Transmission Relation Between Age of Battery and, 298, 299.
 Transmitters, 144, 145, 146, 147, 148, 149, 156, 161, 162, 164, 171, 177, 180, 184, 190, 195, 204.
 Transmitters, 294.
 Transmitter Current-Curves, 301.
 Transmitting Conversation, 2.
 Transmitter Capsule, 183.
 Transmitter Diaphragm, 174.
 Types of Receivers, 110.
 Vibrations, 11, 12, 21.
 Wall Set, 429, 438, 439.
 Watch-Case Receiver, 107.

- Water Proof Set, 453.
Wave Amplitude, 13.
Western Electric Shunt, 353.
Western Electric Supply Transmitter, 184, 185.
Western Telephone Receiver Dissected, 119, 126.
White Solid Back Transmitter, 294.
White Transmitter, 164, 165, 170, 174, 175, 176.
Wilhelm Transmitter, 202, 203.
Williams Ringer, 340, 341.
Williams-Abbott Ringer, 342.
Williams Transmitter, 180, 199, 200, 201.
Winding, 94, 105, 118, 237, 238, 239, 240, 241, 246, 247.
Wiring Bridging Station Detail, 286.
Wires Leading in, 86.
Wiring Local Battery, Series Sub-Station, 284.
Wiring Series Station Detail, 285.
Wiring Sub-Station, 455.

